



M E T R I C

THE VALUE LEADER IN
ELECTRONIC TEST EQUIPMENT

1-800-432-3424

3486 Investment Blvd., Hayward CA 94545
Phone: (510) 264-0887 • Fax: (510) 264-0886

Please Return All Accessories

HP 3325B Operating Manual

Synthesizer/Function Generator

COPYRIGHT AND DISCLAIMER NOTICE

Copyright – Agilent Technologies, Inc. Reproduced with the permission of Agilent Technologies Inc. Agilent Technologies, Inc. makes no warranty of any kind with regard to this material including, but not limited to, the implied warranties of merchantability and fitness for a particular purpose. Agilent Technologies, Inc. is not liable for errors contained herein or for incidental or consequential damages in connection with the furnishing, performance, or use of this material or data.

Operating Manual
MODEL HP 3325B
Synthesizer/Function Generator

Serial Numbers
All



HP Part Number 03325-90014
Microfiche Part No. 03325-90214
Printed in U.S.A.

Print Date: March 1990

©Hewlett-Packard Company, 1978, 1981, 1984, 1988, 1990. All rights reserved.
8600 Soper Hill Road, Everett, WA 98205-1298

Warning



To prevent potential fire or shock hazard, do not expose equipment to rain or moisture.

SAFETY SUMMARY

The following general safety precautions must be observed during all phases of operation, service, and repair of this instrument. Failure to comply with these precautions or with specific warnings elsewhere in this manual violates safety standards of design, manufacture, and intended use of the instrument. Hewlett-Packard Company assumes no liability for the customer's failure to comply with these requirements. This is a Safety Class 1 instrument.

GROUND THE INSTRUMENT

To minimize shock hazard, the instrument chassis and cabinet must be connected to an electrical ground. The instrument is equipped with a three-conductor ac power cable. The power cable must either be plugged into an approved three-contact electrical outlet or used with a three-contact to two-contact adapter with the grounding wire (green) firmly connected to an electrical ground (safety ground) at the power outlet. The power jack and mating plug of the power cable meet International Electrotechnical Commission (IEC) safety standards.

DO NOT OPERATE IN AN EXPLOSIVE ATMOSPHERE

Do not operate the instrument in the presence of flammable gases or fumes. Operation of any electrical instrument in such an environment constitutes a definite safety hazard.

KEEP AWAY FROM LIVE CIRCUITS

Operating personnel must not remove instrument covers. Component replacement and internal adjustments must be made by qualified maintenance personnel. Do not replace components with power cable connected. Under certain conditions, dangerous voltages may exist even with the power cable removed. To avoid injuries, always disconnect power and discharge circuits before touching them.

DO NOT SERVICE OR ADJUST ALONE

Do not attempt internal service or adjustment unless another person, capable of rendering first aid and resuscitation, is present.

DO NOT SUBSTITUTE PARTS OR MODIFY INSTRUMENT

Because of the danger of introducing additional hazards, do not install substitute parts or perform any unauthorized modification to the instrument. Return the instrument to a Hewlett-Packard Sales and Service Office for service and repair to ensure the safety features are maintained.

DANGEROUS PROCEDURE WARNINGS

Warnings, such as the example below, precede potentially dangerous procedures throughout this manual. Instructions contained in the warnings must be followed.

WARNING

Dangerous voltages, capable of causing death, are present in this instrument. Use extreme caution when handling, testing, and adjusting.

SAFETY SYMBOLS

General Definitions of Safety Symbols Used On Equipment or In Manuals.



Instruction manual symbol: the product will be marked with this symbol when it is necessary for the user to refer to the instruction manual in order to protect against damage to the instrument.



Indicates dangerous voltage (terminals fed from the interior by voltage exceeding 1000 volts must be so marked.)

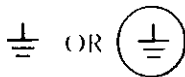

Protective conductor terminal. For protection against electrical shock in case of a fault. Used with field wiring terminals to indicate the terminal which must be connected to ground before operating equipment.



Low-noise or noiseless, clean ground (earth) terminal. Used for a signal common, as well as providing protection against electrical shock in case of a fault. A terminal marked with this symbol must be connected to ground in the manner described in the installation (operating) manual, and before operating the equipment.

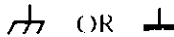

Frame or chassis terminal. A connection to the frame (chassis) of the equipment which normally includes all exposed metal structures.



Alternating current (power line.)



Direct (power line.)



Alternating or direct current (power line.)

WARNING *The WARNING sign denotes a hazard. It calls attention to a procedure, practice, condition or the like, which if not correctly performed or adhered to, could result in injury or death to personnel.*

CAUTION *The CAUTION sign denotes a hazard. It calls attention to an operating procedure, practice, condition or the like, which, if not correctly performed or adhered to, could result in damage to or destruction of part or all of the product.*

NOTE *The NOTE sign denotes important information. It calls attention to procedure, practice, condition or the like, which is essential to highlight.*

Herstellerbescheinigung

Hiermit wird bescheinigt, daß das Gerät/System

HP 3325B SYNTHESIZER/FUNCTION GENERATOR

in Übereinstimmung mit den Bestimmungen von Postverfügung 1046/84 funkentstört ist.

Der Deutschen Bundespost wurde das Inverkehrbringen dieses Gerätes/Systems angezeigt und die Berechtigung zur Überprüfung der Serie auf Einhaltung der Bestimmungen eingeräumt.

Zusatzinformation für Meß- und Testgeräte

Werden Meß- und Testgeräte mit ungeschirmten Kabeln und/oder in offenen Meßaufbauten verwendet, so ist vom Betreiber sicherzustellen, daß die Funk-Entstörbestimmungen unter Betriebsbedingungen an seiner Grundstücksgrenze eingehalten werden.

Manufacturer's declaration

This is to certify that the equipment

HP 3325B SYNTHESIZER/FUNCTION GENERATOR

is in accordance with the Radio Interference Requirements of Directive FTZ 1046/1984. The German Bundespost was notified that this equipment was put into circulation, the right to check the series for compliance with the requirements was granted.

Additional Information for Test- and Measurement Equipment

If Test- and Measurement is operated with unshielded cables and/or used for measurements on open set-ups, the user has to assure that under operating conditions the Radio Interference Limits are still at the border of his premises.

Table of Contents

Table of Contents

| | | | |
|--|------|---|------|
| OPERATION AND REFERENCE | 1-1 | Modulation | 1-28 |
| HP 3325B Turn-On and Warm-Up | 1-1 | Introduction | 1-28 |
| Turn-On and Power-Up Self Tests | 1-1 | Amplitude Modulation | 1-28 |
| Turn-On State | 1-4 | Phase Modulation | 1-29 |
| Power-Down State/Turn-On Preset | 1-4 | Modulation Source | 1-29 |
| Warm-Up | 1-4 | Arbitrary Waveforms | 1-30 |
| The Preset State and the Instrument | | Disabling Modulation | 1-30 |
| Preset Key | 1-5 | Storing/Recalling Instrument States | 1-31 |
| Shift Key | 1-7 | Storing Instrument States | 1-31 |
| Main Signal Output | 1-8 | Recalling Instrument States | 1-31 |
| Main Signal Output Connectors | 1-8 | Memory Clear | 1-31 |
| The High Voltage Option | 1-9 | Calibration and Self Test | 1-32 |
| Selecting the Output Function | 1-11 | Amplitude Calibration | 1-32 |
| The Main Function Keys and | | Self Test | 1-32 |
| Indicators | 1-11 | The HP-IB Status | |
| Data Entry And Modification | 1-12 | Keys/Indicators/Connector | 1-33 |
| The Data Keys | 1-12 | Local | 1-33 |
| Clear Display | 1-13 | Bus Address | 1-34 |
| Error Messages | 1-13 | The RS-232 | |
| Viewing Setup Parameters | 1-14 | Switches/Indicators/Connector | 1-35 |
| Modifying Parameter Values | 1-15 | RS-232 Local/Remote | 1-36 |
| Frequency Step | 1-15 | Marker / Z-Blank (Pen Lift) / X-Drive | |
| The Entry Keys | 1-16 | Outputs | 1-37 |
| Frequency | 1-16 | Marker | 1-37 |
| Amplitude | 1-17 | Z-Blank | 1-38 |
| DC Offset | 1-17 | X-Drive | 1-38 |
| Phase | 1-20 | Synchronization Outputs | 1-40 |
| Asgn Zero Φ | 1-20 | AUX 0 dBm 21–60 MHz Output | |
| Frequency Sweeps | 1-21 | (Extended Frequency) | 1-41 |
| Introduction to Sweeps | 1-21 | External Reference or Oven-Stabilized | |
| Start Frequency | 1-22 | Frequency Option | 1-42 |
| Stop Frequency | 1-22 | 10 MHz Oven Output (High-Stability | |
| Time | 1-22 | Frequency Reference) | 1-42 |
| Marker Frequency | 1-23 | External Frequency Reference | 1-42 |
| Mkr \rightarrow CF | 1-23 | | |
| Reset/Start Sweep | 1-24 | | |
| $\Delta f \times 2$, $\Delta f \div 2$ (Modify Bandwidth) | 1-24 | | |
| Single Sweep | 1-24 | | |
| Continuous Sweep | 1-24 | | |
| Linear Frequency Sweeps | 1-25 | | |
| Log Frequency Sweep | 1-25 | | |
| Discrete Frequency Sweep | 1-26 | | |

Table of Contents (con't)

| | | | |
|---|------------|---|------------|
| REMOTE OPERATION | 2-1 | GENERAL INFORMATION | 3-1 |
| Remote Operation via HP-IB | 2-2 | Introduction | 3-1 |
| Description of the HP-IB | 2-2 | Specifications | 3-1 |
| Capabilities of the HP-IB | 2-2 | Safety Considerations | 3-1 |
| Bus Structure | 2-3 | Instrument Description | 3-1 |
| HP 3325B HP-IB Capability | 2-5 | New or Enhanced Features | |
| Talk/Listen Addresses | 2-5 | of the HP 3325B | 3-5 |
| Viewing the HP 3325B HP-IB Address | 2-6 | Compatibility with the HP 3325A | 3-5 |
| Changing the HP-IB Address | 2-7 | Options | 3-6 |
| Bus Commands | 2-7 | Accessories Supplied | 3-7 |
| Masking The Status Byte | 2-9 | Accessories Available | 3-7 |
| The Status Byte | 2-10 | | |
| Remote Operation via RS-232 Interface | 2-11 | | |
| Description of the RS-232 Interface | 2-11 | | |
| The Cable | 2-12 | | |
| Setting the Switches | 2-13 | | |
| Remote and Local Functions | 2-15 | | |
| HP 3325B Remote Operation | | | |
| Command Set | 2-16 | | |
| Command Syntax | 2-17 | | |
| Interrogating The HP 3325B For | | | |
| Setup Parameters | 2-18 | | |
| Remote Operation via RS-232 | | | |
| Interface | 2-18 | | |
| Command Reference | 2-19 | | |
| HP 3325A Compatibility | 2-67 | | |
| Writing Compatible Programs | 2-69 | | |
| Example Programs | 2-70 | | |
| Quick Reference Programing Guide | 2-72 | | |

Introduction

This operating manual contains information necessary to operate the Hewlett-Packard Model 3325B Synthesizer/Function Generator. This covers direct operation via the front panel as well as remote operation via the HP-IB or RS-232 interface. Also included with the HP 3325B is an installation manual that provides information and procedures to install and check the performance of the HP 3325B as well as a service manual to adjust, and service the HP 3325B.

- Operation Manual (Chapters 1, 2, 3)
- Installation Manual (Chapter 4, includes performance tests)
- Service Manual (Sections 5, 6, 7, 8)

This operating manual is divided into three chapters:

1. Operation and Reference
2. Remote Operation
3. General Information

The HP part number of this operating manual is listed on the title page along with the microfiche part number. The Microfiche part number can be used to order 4 × 6 microfilm transparencies of the operating manual. Each microfiche package also includes the latest manual change supplements for the operating manual.

OPERATION AND REFERENCE

This chapter contains a description of the manual operation of the HP 3325B Synthesizer/Function Generator. The subdivisions in this chapter describe each major function of the HP 3325B. Chapter 2, "HP 3325B Remote Operation" contains a complete list of commands used for remote operation of the HP 3325B with a computer. Figure 1-1 identifies and describes the front and rear-panel controls, connectors, and indicators.

Caution *Prior to operating the HP 3325B, check that the fuse rating and line voltage setting are correct for the local ac power source. The Power Requirements section in "HP 3325B Installation" contains information for setting the line voltage and selecting the fuse.*

HP 3325B Turn-On and Warm-Up

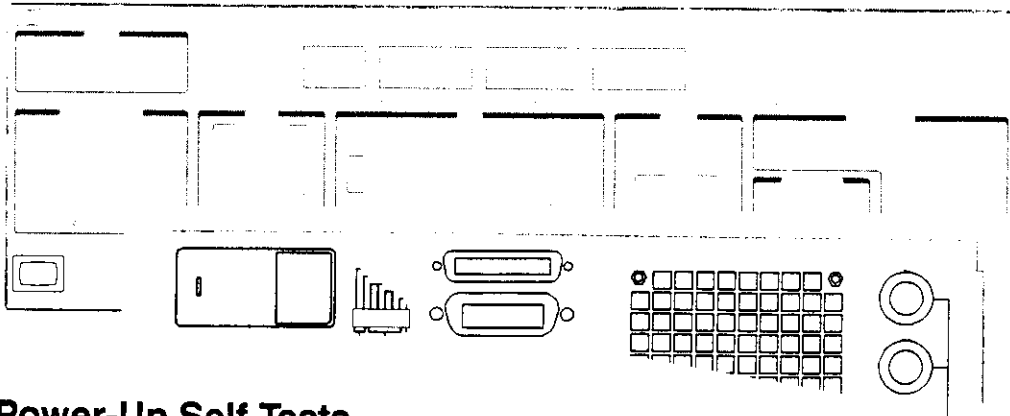

Turn-On and Power-Up Self Tests

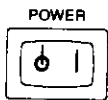

Turn on the HP 3325B by pressing the l-side of the power switch. When turned on, power is applied to all of the HP 3325B circuits and the display shows "3325" followed by a list of the installed options. Then the HP 3325B initiates a series of self tests and calibrates internal circuits. When the o-side of the Power key is pressed, the HP 3325B is placed in standby.

Note If Fail appears in the display, the HP 3325B has sensed a circuit failure or an amplitude calibration failure. If the Fail message appears in the display, send the instrument to qualified service personnel for repair.

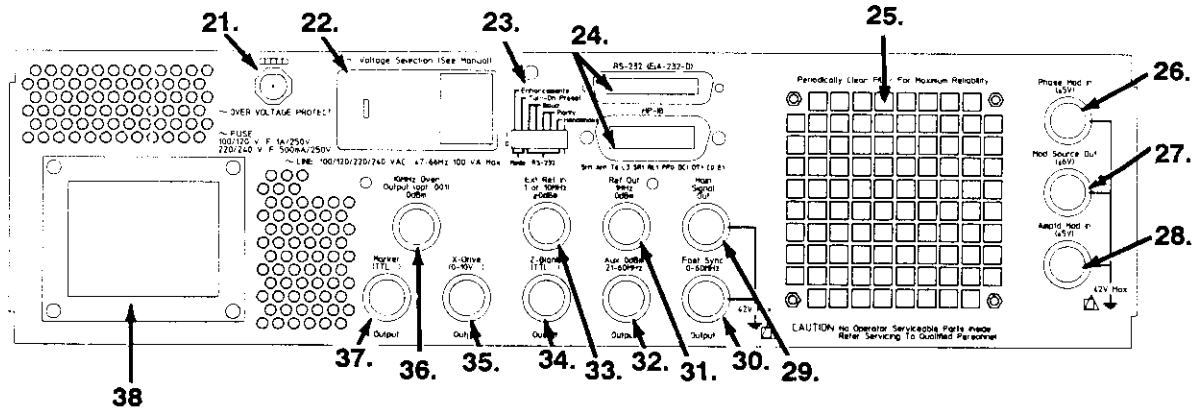
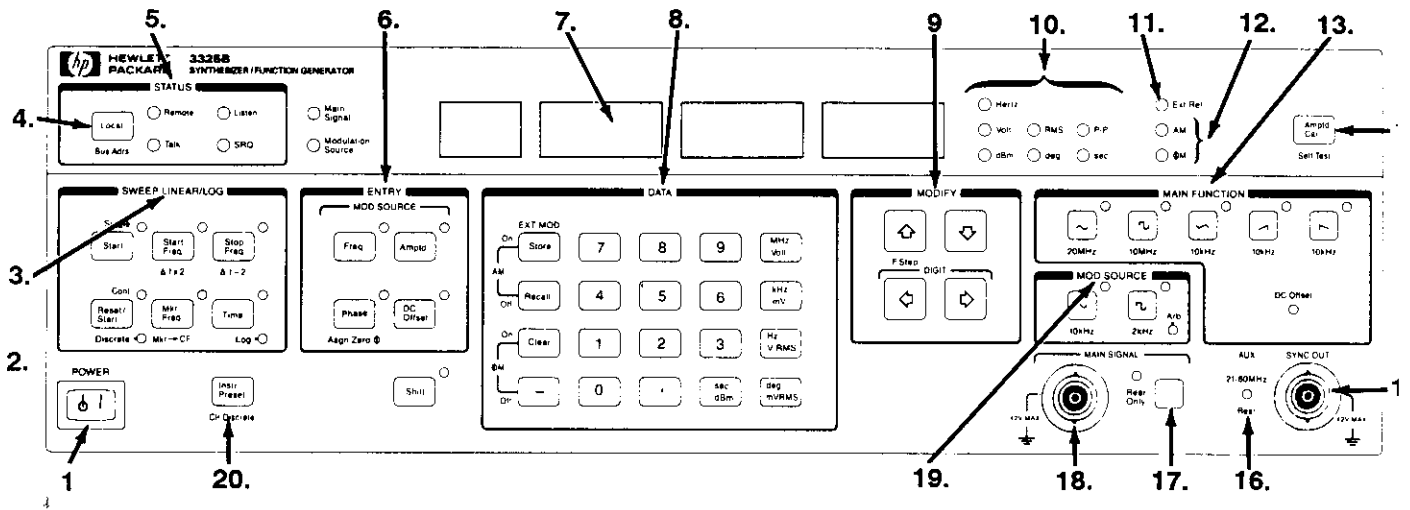

1. **Power switch:** In the standby (⓪) position, power is applied to the oven (option 001), the HP-IB interface circuits external to the isolation barrier, and the high voltage output circuits (option 002), in addition to the power supply circuits.
2. **Blue [Shift] key:** Press the [Shift] key to access the key function labeled in blue.
3. **Sweep Linear/Log key group:** These are entry prefix keys for the sweep parameters, and the sweep start keys. When preceded by the [Shift] key, the sweep parameter keys control sweep modification functions and linear/log/discrete selection.
4. **[Local] key:** Returns HP 3325B from remote control to front-panel control unless local lockout has been programmed. When preceded by the [Shift] key, the HP 3325B HP-IB address is displayed.
5. **Status indicator group:** The indicators show the HP 3325B HP-IB status: Remote, Addressed to Listen, Addressed to Talk, and Request Service (SRQ).
6. **Entry key group:** These are the entry prefix keys for the main and modulation source signal parameters.
7. **Display:** Displays the value of the entry parameter selected, error codes, and self test results.
8. **Data key group:** This group includes the numeric data keys, the data suffix keys, the [Store] and [Recall] keys, and the entry [Clear] key. When preceded by the [Shift] key, the keys in the left column control the modulation functions.
9. **Modify Group:** The horizontal arrow keys select the digit to modify (indicated by the flashing digit), and the vertical arrow keys increment or decrement the digit. Preceding the up-arrow with the [Shift] key selects the frequency step parameter for display and modification.
10. **Units Indicators:** The indicators display the units of the value represented by the numeric display.

- 11. **Ext Ref Indicator:** The Ext Ref Indicator illuminates if an external reference or option 001 (internal 10 MHz oven reference) is connected to the rear-panel Ref In connector. The indicator flashes if the internal oscillator is not phase-locked to the external reference.
- 12. **Modulation Indicators:** The modulation indicators illuminate if amplitude or phase modulation is enabled.
- 13. **Main Function key group:** These keys select the main signal output function or dc-only.
- 14. **[Amptd Cal] key:** This key calibrates the amplitude and offset of the output signal. When preceded by the [Shift] key, it initiates an instrument self test.
- 15. **Sync Out:** A square wave synchronized output signal is available at this connector and rear-panel Fast Sync connector. This signal is synchronized with the output signal crossover point (zero volts or dc offset voltage). The front-panel sync output functions for frequencies below 21 MHz.

Caution *The maximum peak voltage that can be safely applied between chassis and outer conductor of any of the HP 3325B input or output signal connectors is $\pm 42V$.*

- 16. **Aux 21-60 MHz Rear Indicator:** This indicator illuminates when the rear-panel Aux output is active.
- 17. **[Rear Only] key:** In standard instruments, this key switches the signal output from front-panel to rear-panel. The rear-panel output is active when the adjacent indicator illuminates. In instruments with the high voltage option (002), this key switches from normal to high voltage output. The adjacent indicator illuminates when the high voltage output is enabled. The key is labeled "40 V_{pp}, 40 mA, 0-1 MHz" for option 002. In option 002 instruments, no rear-panel signal output is provided.
- 18. **Main Signal output:** Standard output impedance is 50 Ω . High voltage output option 002 output impedance is nominally < 1 Ω at dc and < 10 Ω at 1 MHz. Load impedance must be at least 500 Ω . Standard and high-voltage outputs are fuse-protected.

Note *If the standard instrument signal output is not terminated by an external 50 Ω load, undesirable distortion may result, particularly at higher frequencies. Similar conditions may result if the high voltage output (option 002) is terminated by less than 500 Ω .*

- 19. **Modulation Source key group:** These keys select the modulation signal function.
- 20. **[Instr Preset] key:** This key restores the HP 3325B to a predefined state (see table 1-1). When preceded by the [Shift] key, Instr Preset clears the discrete frequency sweep segments from memory.

- 21. **Circuit Breaker Reset Button:** Disconnects power supply from power line when the line voltage exceeds upper limit. See the Installation Manual for information on resetting the breaker and voltage limits.
- 22. **Voltage selection vs fuse used:** This module contains the line fuse and configures the HP 3325B for local line voltages. Refer to the HP 3325B Installation Manual for line fuse selection and line voltage configuration.
- 23. **Mode/RS-232 switch:** These switches enable the HP 3325B enhancements, turn-on configuration, and RS-232 characteristics.
- 24. **HP-IB/RS-232 connectors:** Remote control of the HP 3325B by an external controller is accomplished through these connectors.
- 25. **Fan Filter:** See "Instrument Cooling" in the Installation Manual for information concerning the fan and its filter.
- 26. **Phase Mod In:** Input connector for a phase modulating signal of $\pm 5V$ maximum peak voltage.
- 27. **Mod Source Out:** Output connector for the internal modulation source.
- 28. **Amptd Mod In:** Input connector for an amplitude modulating signal of $\pm 5V$ maximum peak voltage.
- 29. **Main Signal Out:** The output signal is switched to this connector by the front-panel [Rear Only] key. Instruments with the high voltage option 002 cannot switch the main signal to the rear-panel connector.
- 30. **Fast Sync:** A square wave synchronizing output signal is available at this connector. This signal is synchronized to (changes state at) the output signal crossover point (zero volts or dc offset voltage) and operates from 0 to 60 MHz..
- 31. **Ref Out:** A 1 MHz signal from the HP 3325B reference circuits is available at this connector.
- 32. **Aux 0 dBm:** A signal is available at this output for frequencies between 19 MHz and 59 999 999.999 Hz.
- 33. **Ext Ref In:** This external frequency reference may be used to phase-lock the internal 30 MHz oscillator.
- 34. **Z-Blank:** A TTL-compatible output is present during a sweep operation.
- 35. **X-Drive:** This output ramps from 0V to 10V during a sweep-up.
- 36. **10 MHz Oven Output:** This signal is present only in instruments with option 001. Normally it is connected to the Ext Ref In connector (item 33) with a special connector (HP Part No. 1250-1499) supplied with option 001.
- 37. **Marker:** This TTL-compatible output goes low at the selected marker frequency during a sweep up, and high at completion of the sweep.
- 38. **Power Transformer**

Turn-On State



The initial state of the HP 3325B at power up is dependent upon the setting of the rear-panel Turn-On Preset switch. With the Turn-On Preset switch in the up (1) position, the turn-on state is the preset state described in “The Preset State and the Instr Preset Key.” With the Turn-On Preset switch in the down (0) position (and the Enhancements switch in the up (1) position), the setup state in effect when power is removed is used as the turn-on state.

Enhancement Mode

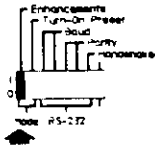

Enhanced mode refers to the HP 3325A features that were improved to create the HP 3325B. In this mode all stored information is retained in nonvolatile memory. Stored information may be erased by overwriting the information in memory or by applying power with the green [Instr Preset] key depressed (memory clear).

HP 3325A (Compatibility) Mode

In this mode, stored information cannot be recalled after the power switch is set to the standby position.

Note See table 3-2 for a comparison of compatible and enhanced features.

Power-Down State/Turn-On Preset

The last operating state prior to removing power is also retained in nonvolatile memory. This operating state is restored by pressing the [Recall] key followed by the [-] (minus) key.

The setup state stored in the power-down memory can be selected as the turn-on state through the use of the Enhancements and Turn-On Preset switches. To allow the HP 3325B to restore the power-down state, set the Enhancements switch to the up (1) position, and the Turn-On Preset switch to the down position (0). Restoring the power-down state at turn-on is disabled by setting the Turn-On Preset switch in the up (1) position.

Warm-Up

Warm-up time is the amount of time the HP 3325B is connected to power. The HP 3325B without the high stability frequency reference (option 001) requires 30 minutes of warm-up time to meet all specifications. The HP 3325B with option 001 requires 15 minutes of warm-up time to meet frequency specifications if power is disconnected for less than 24 hours. If power is disconnected from the HP 3325B with option 001 for more than 24 hours, up to 72 hours of warm-up time may be required to meet frequency specifications. The HP 3325B with option 001 requires 30 minutes of warm-up to meet other specifications.

Note Moving the power switch from the I position to the 0 position places the HP 3325B in standby. In standby, power is removed from all circuits except those that should be kept warm to minimize warm-up time.

The Preset State and the Instrument Preset Key

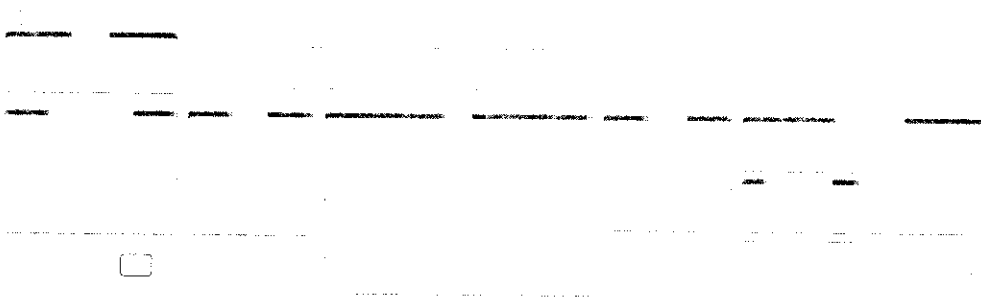

Instr Preset

Table 1-1 lists the *preset state* of the HP 3325B. This is a predefined state selected by pressing the green [Instr Preset] key. It is also the active state at power-up if the rear-panel Turn-On Preset switch is in the up (1) position. Instrument preset provides a convenient starting state for establishing an instrument setup. Instrument preset does not erase instrument states, modulation source ARB waveforms, or the discrete sweep table in internal memory.

Table 1-1. HP 3325B Preset State

| Key Group | Parameter | Preset State/Value |
|------------------|--------------------------|-----------------------|
| Status | Local | No effect |
| | Bus Adrs | No effect |
| Function | Sine wave | Enabled |
| Entry | Freq | 1 kHz |
| | Amptd | 0.001 V _{pp} |
| | Phase | 0° |
| | DC Offset | 0V |
| | Assign Zero Φ | - |
| | Mod Source Freq | 1 Hz |
| | Mod Source Amptd | 0.1 V _{pp} |
| Sweep Linear/Log | Sweep | Off |
| | Start Freq | 1 MHz |
| | Stop Freq | 10 MHz |
| | Mkr Freq | 5 MHz |
| | Time | 1 second |
| | Discrete Sweep/Log Sweep | Off |

Table 1-1. HP 3325B Preset State (Cont'd)

| Key Group | Parameter | Preset State/Value |
|------------------|------------------|-------------------------------|
| Modulation | Ext Mod AM | Off |
| | Ext Mod Φ M | Off |
| Modify | F Step | 0.0 Hz |
| Mod Source | Mod Source | Off |
| Other Keys | [Shift] | Off |
| Signal | High Voltage | Off |
| | Rear-Only | Disabled (Front-panel output) |

Shift Key

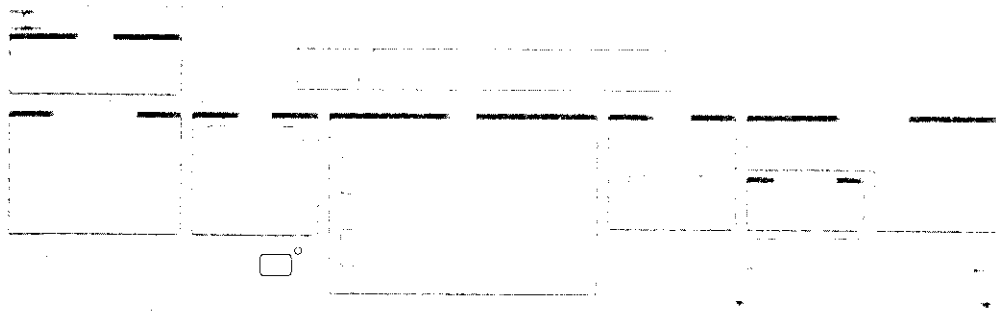

Some keys control two functions. The first function name appears on the key itself and is activated by pressing the key. If a key has another function, its name appears in blue below the key and it is activated by first pressing the blue [Shift] key. This manual may refer to shifted key names with or without reminding you to press the [Shift] key first. Always look for both names of a key when searching the front panel for a key name.

The indicator adjacent to the [Shift] key illuminates when the [Shift] key is pressed to indicate that the shifted key names may be selected.

Main Signal Output

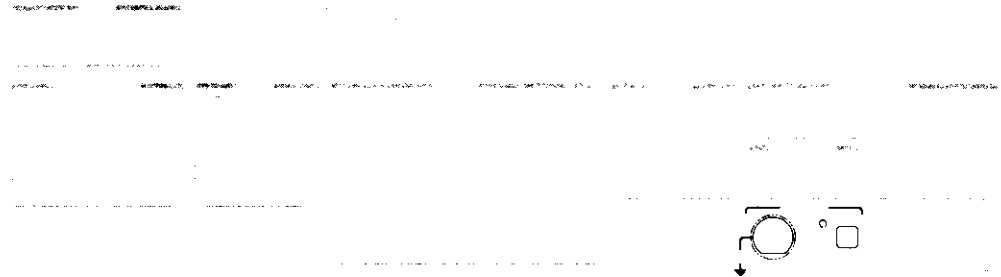

Main Signal Output Connectors

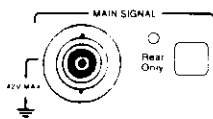

The Main Signal is available at one of two BNC connectors located on the front and rear panels. The front-panel [Rear Only] key selects which of these two connectors has the main signal output. The active connector is indicated by the rear-only indicator; an illuminated rear-only indicator denotes that the rear-panel output is active.

Both outputs share the same ground and may be floated up to ± 42 volts peak relative to earth ground.

Caution *The maximum peak voltage (ac + dc) that can be safely applied between chassis and the outer conductor of the HP 3325B input and output connectors is ± 42 volts peak.*

Note When the high voltage option (option 002) is installed, the key by the Main Signal output connector (labeled "40 V_{pp}, 40 mA, 0-1 MHz") controls the high voltage amplifier. On these instruments, the rear-panel Main Signal output connector is inactive.

The specifications for the Main Signal output impedance and return loss are:

- Impedance: $50\Omega \pm 1\Omega$ from 0 to 10 kHz

- Return Loss: 20 dB 10 kHz to 20 MHz except
 > 10 dB for > 3V, 5 MHz to 20 MHz

- High Voltage < 2Ω at dc
(option 002): < 10Ω at 1 MHz

The High Voltage Option (option 002)

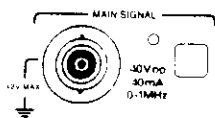
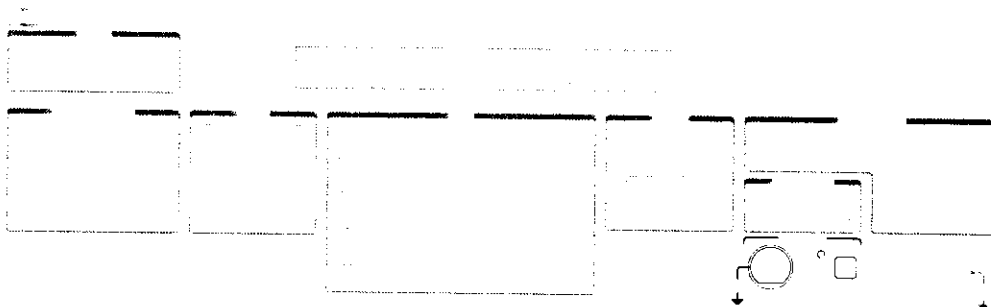

On instruments with the High Voltage Option (option 002) installed, the [40 V_{pp}] key enables or disables the high voltage output. The 40 V_{pp} indicator illuminates when the high voltage output is enabled. The high voltage option increases the available output voltage range to a maximum value of 40 V_{pp} (into a high impedance). Enabling the high voltage option reduces the maximum output frequency for the sine and square waves to 1 MHz, and decreases the output impedance (see Main Signal output). The output signal momentarily drops to zero volts when internal attenuator settings change.

Note

The rear-panel signal output is inactive (no internal signal connection) if the HP 3325B has the high voltage output (option 002) installed. Instructions in the Service Manual describe activation of the rear-panel signal output in one of two ways:

1. Disconnecting the front-panel signal output and placing the standard/high voltage output on the rear panel only, or
2. Disabling the high voltage output and enabling the standard front/rear output.

If one of these modifications is required, arrange for the work to be done by qualified service personnel.

The HP 3325B specifications apply when the external load resistance is $> 500\Omega$ and the total capacitance is < 500 pF. The same entry procedures and display features apply as for the standard configuration. Maximum and minimum amplitudes are listed in table 1-2.

Table 1-2. High Voltage Amplitudes (option 002)

| Function | V_{pp} | | V_{rms} | |
|------------|----------|------|-----------|---------|
| | Max. | Min. | Max. | Min. |
| Sine | 40V | 4 mV | 14.14V | 1.42 mV |
| Square | 40V | 4 mV | 20.0V | 2.0 mV |
| Triangle | 40V | 4 mV | 11.55V | 1.16 mV |
| \pm Ramp | 40V | 4 mV | 11.55V | 1.16 mV |

Selecting the Output Function

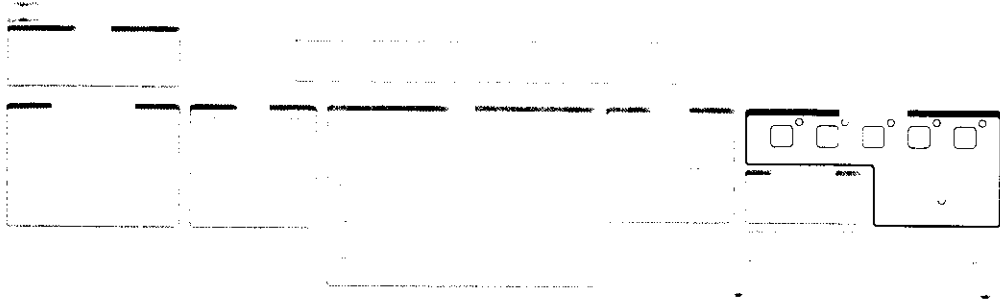

The Main Function Keys and Indicators

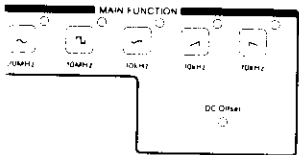

Pressing one of the five Main Function keys selects the function output of the HP 3325B. The indicator adjacent to a function key illuminates when that function is selected. Pressing the function key for the selected function a second time removes the ac component of the signal leaving only the selected dc offset (if any is entered). Removing the ac signal in this way, automatically displays dc offset and illuminates the dc offset entry indicator. Pressing the disabled function key again restores the ac signal. Unless a dc offset is entered, the output signal for each function is centered about zero volts.

The DC Offset indicator illuminates when a non-zero dc offset exists.

Note

The standard instrument signal output must be terminated by an external 50 Ω load or sine wave distortion and square wave over-shoot may result, particularly at the higher frequencies (> 1 MHz). All specifications apply with a 50 Ω load connected to the HP 3325B main signal output except where indicated (table 3-1, Specifications).

Data Entry And Modification

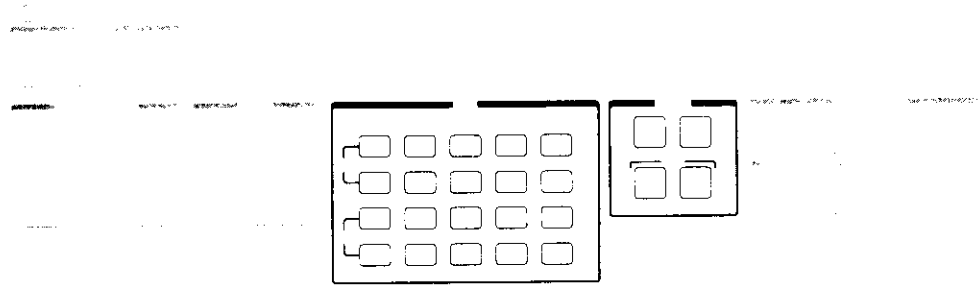

The Data Keys

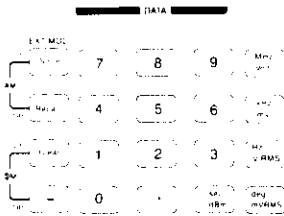

Entering setup values with the numeric keypad is a simple three step process:

1. Select a parameter to change.
2. Enter the desired value (most significant digit first).
3. End the entry with a units key.

For example, to change the output amplitude to 1 V_{RMS} , press the [Amptd] (amplitude) key to display the current amplitude value. Press the [1] key in the numeric keypad, and press the [Hz / V RMS] units key to end the entry. For the example, the V_{RMS} units from the [Hz / V RMS] units key is assigned to the data value. The HP 3325B assigns the units to the data value that corresponds to the parameter being changed. If an entered value exceeds the HP 3325B range limits, the HP 3325B ignores the entered value and displays an error message (refer to table 1-4). To cancel an incomplete data entry, press any key that requires the display for data entry (see table 1-3).

Table 1-3. Parameters Accepting Data Entry

| | |
|------------------|-----------------|
| Amptd | Mod Source Freq |
| Bus Adrs | Phase |
| DC Offset | Start Freq |
| F Step | Stop Freq |
| Freq | Store |
| Mkr Freq | Recall |
| Mod Source Amptd | Time |

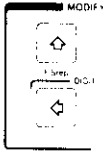

The value entered with the Data keys may be edited during data entry with the left-arrow key in the Modify key group. Each time the left-arrow key is pressed, the least-significant digit or decimal point is removed from the display. After the incorrect digits are removed from the display value, data entry can continue.

Clear Display



Pressing the [Clear] key (in the left column of the Data key group) clears the display to zero. This key is useful when an error is made while entering data.

Error Messages

If an attempt is made to enter or modify operating parameters beyond the HP 3325B capabilities, the new input is ignored and an error message and code is displayed. Table 1-4 lists the error messages and explanations of the errors.

Table 1-4. Error Messages

| Error Code | Description |
|------------|--|
| 100 | The value entered for the selected parameter exceeds the valid limits |
| 200 | The units key selected is improper for the selected parameter |
| 201 | The units key selected is improper for the selected parameter with high voltage option |
| 300 | The frequency entered is too high for the waveform function selected |
| 400 | The sweep time entered is too large for the frequency span (sweep span is too small) |
| 401 | The sweep time is too small for the frequency span. |
| 500 | Amplitude and dc offset values are incompatible |
| 501 | The dc offset is too large for amplitude |
| 502 | The amplitude is too large for the dc offset |
| 503 | Amplitude is too small |
| 600 | Sweep frequency improper |
| 601 | Sweep frequency too large for function |
| 602 | Sweep bandwidth too small |
| 603 | Log sweep start frequency too small |
| 604 | Log sweep stop frequency less than start frequency |
| 605 | Discrete sweep segment is empty |
| 700 | Unknown command |
| 701 | Illegal query |
| 751 | Key ignored front-panel key pressed while the HP 3325B is in remote (press LOCAL key) |

Table 1-4. Error Messages (Cont'd)

| Error Code | Description |
|------------|--|
| 752 | Key ignored front-panel key pressed while the HP 3325B is in local lockout |
| 753 | Feature disabled in compatibility mode |
| 754 | Attempt to recall a memory register that has not been stored since power up |
| 755 | Amplitude modulation not allowed on selected function |
| 756 | Modulation source arbitrary waveform memory register is empty |
| 757 | Too many modulation source arbitrary waveform points |
| 758 | Firmware (program) failure |
| 800 | A remote HP-IB or RS-232 command has a syntax error |
| 801 | Illegal digit for selection item |
| 802 | Illegal binary data block header |
| 803 | Illegal string, string overflow |
| 810 | RS-232 overrun – characters lost |
| 811 | RS-232 parity error |
| 812 | RS-232 frame error |
| 900 | Option not installed |
| -CAL- | Calibration in progress |
| PASS | A self test is successful |
| FAIL | A self test is unsuccessful – refer the HP 3325B to qualified service personnel for repair |

Viewing Setup Parameters

Pressing a front-panel key which accepts data entry (such as the [Freq] or [Amptd] key) displays the current value of a setup parameter. Table 1-3 lists the front-panel keys which accept data entries. Pressing one of these keys does not alter the current setup values.

The units of the displayed parameter are indicated by an illuminated indicator at the right of the display. The indicators at the left of the display indicate whether the display value is associated with the Main Signal or the Modulation Source.

Modifying Parameter Values

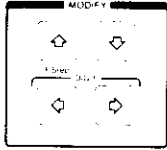

The arrow keys in the Modify key group are used to modify the display value. The right and left-arrow keys select the digit for modification as indicated by the flashing digit. Pressing the right-arrow key selects the next least significant digit for modification; pressing the left-arrow key selects the next most significant digit for modification. To extinguish the flashing digit, press a right or left-arrow key until the flashing digit moves off the display.

The flashing digit is the least significant digit that is modified with the up- and down-arrow keys. The up-arrow key increments the value of the display, while the down-arrow decrements the value of the display. The up- and down-arrows modify the display value until the boundary limit is reached.

Frequency Step



The frequency step is how much change in the frequency parameter occurs when the up or down-arrow keys are pressed. The [F Step] (Frequency Step) key enables display, entry, or modification of the frequency step parameter. The [F Step] key is selected by pressing the blue [Shift] key prior to the up-arrow key. The displayed frequency value is changed with the numeric keypad and units keys, or modified with the modify controls. The MHz, kHz, and Hz units allow convenient entry of frequency values. During frequency step entry, the Hz units indicator is illuminated but the Frequency Entry indicator is extinguished.

The up-arrow and down-arrow keys increment and decrement the display by the F Step value when all the following are true:

1. The frequency step is non-zero (in the case of the main signal) or less than frequency resolution (for the modulation source)
2. A main signal or modulation source frequency value is displayed, and
3. No flashing digits appear in the display

The Entry Keys

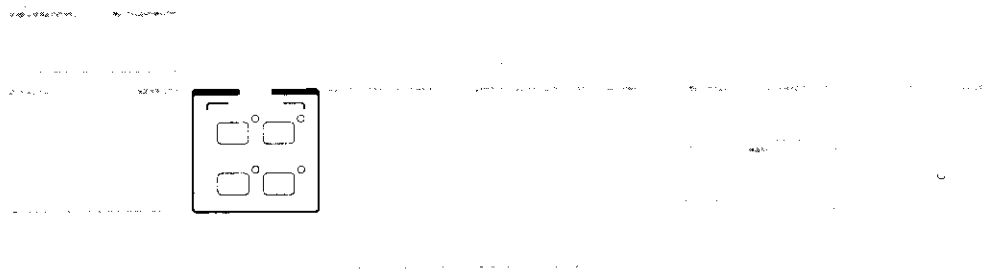

Note An illuminated indicator adjacent to an entry key denotes it as the active entry parameter. For example, if the [Freq] entry key indicator is illuminated, it is not necessary to press that key before entering data.

Frequency



The [Freq] (Frequency) key enables display, entry, or modification of the frequency of the signal output. The indicator adjacent to the [Freq] key illuminates when the output frequency value is displayed. Frequency values are displayed in Hertz and changed with the numeric keypad and units keys or modified with the modify controls. The MHz, kHz, and Hz units allow convenient entry of frequency values.

Resolution of the frequency entry is 1 μ Hz for frequencies below 100 kHz, and 1 mHz for 100 kHz and above. At 100 kHz and above, 1 μ Hz resolution is possible through the use of the F Step parameter. Also, as a modify key is used to cross above the 100 kHz boundary, any μ Hz resolution value is maintained but not displayed. Frequency ranges are dependent upon the function selected and high voltage option (see table 1-5). During a frequency change, the main output signal is phase-continuous; that is, there are no phase discontinuities in the output waveform.

Table 1-5. Frequency Limits

| Function | Main Signal |
|-----------------|-----------------------------------|
| Sine | 0 \rightarrow 20 999 999.999 Hz |
| Square | 0 \rightarrow 10 999 999.999 Hz |
| Triangle, Ramps | 0 \rightarrow 10 999.999 999 Hz |

Amplitude



The [Amptd] (amplitude) key enables display, entry, or modification of the amplitude of the signal output. The indicator adjacent to the [Amptd] key illuminates when an amplitude value is displayed. The displayed amplitude value is changed with the numeric keypad and units keys, or modified with the Modify keys. The Volt, mV, V RMS, mV RMS, and dBm units allow convenient entry of amplitude values. Amplitude values are displayed in Volts rms, Volts peak-to-peak (V_{pp}), or dBm as denoted by the indicators at the right of the display. The amplitude range is dependent upon selection of dc offset and the high voltage option (see table 1-6). The output signal is momentarily set at zero volts when internal attenuator settings change.

The HP 3325B units keys convert amplitude values to V_{pp} , V_{rms} , or dBm for any function. For example, if a sine wave amplitude of 10 V_{pp} is displayed, pressing the [V_{rms}] or [mV_{rms}] key displays the same amplitude as 3.536 V_{rms} , while pressing the [dBm] key displays the value as 23.98 dBm. When changing from one function to another, the last amplitude displayed is held constant.

Table 1-6. Amplitude Limits of AC Functions

| Function | V_{pp} | | V_{rms} | | dBm (50 Ω) | |
|------------|----------|------|-----------|----------|--------------------|--------|
| | Max. | Min. | Max. | Min. | Max. | Min. |
| Sine | 10V | 1 mV | 3.536V | 0.354 mV | +23.98 | -56.02 |
| Square | 10V | 1 mV | 5.000V | 0.5 mV | +26.99 | -53.01 |
| Triangle | 10V | 1 mV | 2.888V | 0.289 mV | +22.22 | -57.78 |
| \pm Ramp | 10V | 1 mV | 2.888V | 0.289 mV | +22.22 | -57.78 |

DC Offset



The [DC Offset] key enables display, entry, or modification of the dc offset of the signal output. The indicator adjacent to the [DC Offset] key illuminates when a dc offset value is displayed. The displayed dc offset value is changed with the numeric keypad and [Volt] or [mV] units key, or modified with the modify controls. The dc offset range is dependent upon amplitude and the high voltage option. Figure 1-2, and table 1-7 and 1-8 list the maximum output of the HP 3325B. The output signal momentarily drops to zero volts when internal attenuator settings change.

The DC Offset indicator in Main Function key block illuminates when a non-zero dc offset value exists.

AC with DC Offset

When dc offset is added to any ac function, there are minimum and maximum offset limits which must be observed. These limits are affected by the ac voltage and internal attenuator settings, listed in table 1-7. Figure 1-2 contains a set of graphs which show the approximate maximum dc offset permissible for a given ac peak-to-peak voltage. Resolution of a dc offset entry (with ac function) is determined by the resolution of the ac amplitude. The following equation may be used to determine maximum offset voltage:

$$\text{Maximum dc offset} = (5 \div A) - (\text{Amptd} \div 2)$$

Where A = Attenuation factor (from table 1-7)

Amptd = Amplitude in V_{pp} of the ac function.

If a dc offset too large for the amplitude already programmed is entered or if the ac amplitude is increased beyond the level where the amplitude and offset are compatible, an error code between 500 and 503 appears in the display momentarily and the entry value is not accepted. The display then indicates the nearest acceptable value.

Table 1-7. Maximum DC Offset with any AC Functions

| AC Amplitude Entry (peak-to-peak) | | Maximum DC Offset (+ or -) | Minimum DC Offset Entry | Range | Attenuation Factor |
|-----------------------------------|------|----------------------------|-------------------------|-------|--------------------|
| 1.000 mV to 3.333 mV | with | 4.500 mV | 0.001 mV | 7 | A = 1000 |
| 3.334 mV to 9.999 mV | with | 14.99 mV | 0.001 mV | 6 | A = 300 |
| 10.00 mV to 33.33 mV | with | 45.00 mV | 0.010 mV | 5 | A = 100 |
| 33.34 mV to 99.99 mV | with | 149.9 mV | 0.010 mV | 4 | A = 30 |
| 100.0 mV to 333.3 mV | with | 450.0 mV | 0.100 V | 3 | A = 10 |
| 333.4 mV to 999.9 mV | with | 1.499V | 0.100 V | 2 | A = 3 |
| 1.000 V to 9.998 mV | with | 4.500 V | 1.000 mV | 1 | A = 1 |
| | with | 0.001 mV | | | |

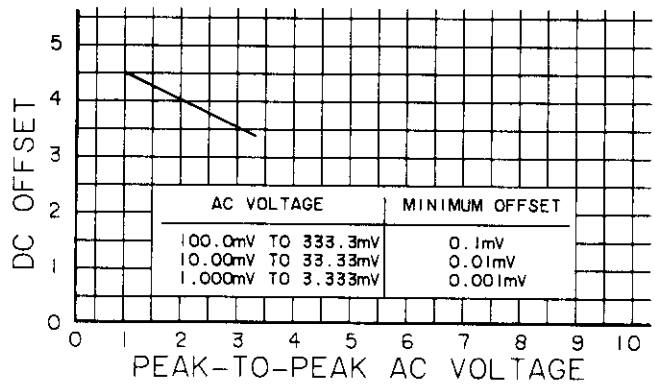
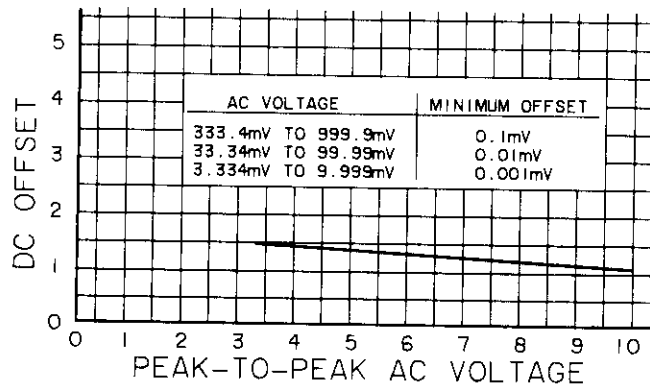
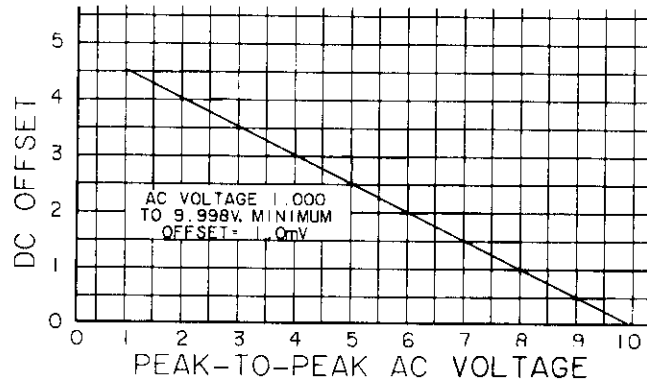

Figure 1-2. Maximum DC Offset with any AC Functions

DC Only

When the Main Function selections are disabled (all indicators extinguished), the HP 3325B automatically displays the DC Offset value and selects the [DC Offset] key for entry of DC Offset values. Without an ac function selected, the dc voltage output ranges from 0 mV to $\pm 5V$, with four-digit resolution.

High Voltage Option

With the high voltage option enabled, the dc offset range is ± 20 volts (ac + dc peak value or dc only). DC offset with the high voltage option is dependent on the ac amplitude. With the high voltage output (option 002) selected, the minimum and maximum permissible dc offset voltages may be determined by multiplying the amplitude and offset values in table 1-7 (and figure 1-2) by 4. The equation for determining maximum dc offset is:

$$\begin{aligned} \text{Maximum dc Offset} &= (20 \div A) - (\text{Amptd} \div 2) \\ \text{Where } A &= \text{Attenuator factor (from table 1-7)} \\ \text{Amptd} &= \text{Amplitude in } V_{pp} \text{ of the ac function.} \end{aligned}$$

| | |
|-------------|---|
| <i>Note</i> | When the high voltage output is selected, minimum amplitude for dc only (no ac function) is 0.01 mV and maximum is 20.0V. |
|-------------|---|

Phase



The [Phase] key enables display, entry, or modification for the phase of the Main Signal. The indicator adjacent to [Phase] key illuminates when a phase value is displayed. The displayed phase value is changed with the entry keys and [Deg] (degrees) units key, or modified with the modify controls. The phase display range is $\pm 719.9^\circ$ with a resolution of 0.1° . Phase values of $\pm 1440^\circ$ entered with the entry keys are accepted and the value is displayed modulo 720. For square wave frequencies below 25 kHz, phase changes greater than 25° may result in a phase shift $\pm 180^\circ$ from the desired amount.

After entering a phase shift, the new phase may be assigned the zero-phase position; subsequent changes in phase are with reference to that value. To assign zero phase, press the blue [Shift] key followed by [Asgn Zero Φ] key.

Asgn Zero Φ

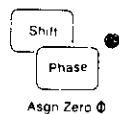

The [Asgn Zero Φ] (Assign Zero phase) key assigns a reference of zero degrees to the existing phase parameter of the Main Signal without changing the phase of the output waveforms. Subsequent changes in phase are with respect to that value. The [Asgn Zero Φ] key is selected by pressing the blue [Shift] key prior to the [Phase] key.

Frequency Sweeps

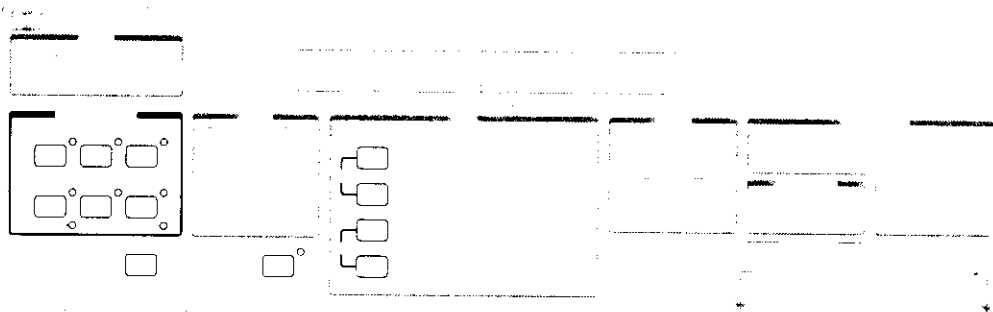

Introduction to Sweeps

The HP 3325B performs three kinds of sweeps: linear, log, and discrete. Linear sweeps of any function have sweep-time limits of 10 ms to 1000s and may be single or continuous. Single linear sweeps may be either up or down in frequency. Continuous sweeps move back and forth between the start and stop frequency in an up/down/up/down. . . fashion. The marker functions only during up-sweeps.

Log sweep times range from 1s to 1000s for single sweeps and from 0.1s to 1000s for continuous sweeps. Single log sweeps are up-only; they always start at the start frequency and sweep up to the stop frequency. The marker does not function during log sweeps.

Discrete sweeps allow the creation of custom sweep patterns. A discrete sweep consists of up to 100 linear sweeps or frequency steps (called segments). Each segment has four parameters: start frequency, stop frequency, sweep time, and marker frequency, which may be entered from the front panel or down-loaded from a computer. The marker functions as specified for each segment whether the sweep is up or down.

Single or continuous frequency sweeps are selectable with the [Start] and [Reset/Start] keys. Sweep parameters are entered with the [Start Freq] (start frequency), [Stop Freq] (stop frequency), and [Time] keys. The [Mkr → CF] (marker into center frequency), [$\Delta f \times 2$], and [$\Delta f \div 2$] keys allow convenient modification of the sweep parameters. The [Mkr Freq] (marker frequency) key allows the rear-panel TTL level marker output signal to be specified.

Linear sweeps are phase-continuous over the full frequency range of the main output signal; that is, there are no phase discontinuities in the swept output waveform. When the HP 3325B is turned on, the sweep is off, the sweep mode is set to linear, and the parameters are set as follows:

| | |
|------------------|-----------------|
| Start Frequency | 1 000 000.0 Hz |
| Stop Frequency | 10 000 000.0 Hz |
| Marker Frequency | 5 000 000.0 Hz |
| Time | 1s |

Note The marker frequency should be lower than the stop frequency by a sufficient amount to permit the marker pulse width to be approximately 400 μ s.

To change any of the sweep parameters, press the appropriate Sweep Linear/Log entry key, then enter the desired data. To select log sweep, press the blue [Shift] key followed by the [Log] (Time) key to illuminate the log indicator. The sweep mode is linear unless the log or discrete indicators are illuminated. To select discrete sweep, press the [Shift] key and then the [Discrete] key. When a discrete sweep is selected, the discrete indicator is illuminated.

Start Frequency



The [Start Freq] (start frequency) key enables display, entry, or modification of the sweep start frequency for the main signal. The indicator adjacent to the [Start Freq] key illuminates when a start frequency value is displayed. The displayed frequency value may be changed with the entry and units keys, or with the modify keys. The MHz, kHz, and Hz units allow convenient entry of frequency values. Frequency resolution is 1 μ Hz for frequencies below 100 kHz and 1 mHz for frequencies above 100 kHz. The upper frequency limit is established by the function selected.

Stop Frequency



The [Stop Freq] (stop frequency) key enables display, entry, or modification of the sweep stop frequency of the main signal. The indicator adjacent to the [Stop Freq] key illuminates when a stop frequency value is displayed. The displayed frequency value is changed with the entry and units keys, or with the modify keys. The MHz, kHz, and Hz units allow convenient entry of frequency values. Frequency resolution is 1 μ Hz for frequencies below 100 kHz and 1 mHz for frequencies above 100 kHz. The upper frequency limit is established by the Main Function selected.

Time



The [Time] key enables display, entry, or modification of the sweep time for the Main Signal. The indicator adjacent to the [Time] key illuminates when a time value is displayed. The displayed time value is changed with the entry and units keys, or modified with the modify keys. The [SEC] units key ends entry of numeric values.

The maximum time per sweep (up or down) for all sweep modes is 1000 seconds, with a resolution of 0.01s for times \geq 1s, and 0.001s for times $<$ 1s.

Note The X-Drive output functions only when sweep time is $<$ 100s. See the discussion, later in this chapter, on the marker, Z-blank, and X-drive rear-panel connectors.

Minimum times are:

| | |
|-------------------------|--------|
| Single Linear Sweep | 0.010s |
| Continuous Linear Sweep | 0.010s |
| Single Log Sweep | 1.000s |
| Continuous Log Sweep | 0.100s |

Note When the enhancements are turned off, single log-sweep sweep time is increased by the processing time required between segments. The time increase (in seconds) is approximately equal to:

$$\text{Time Increase} = 0.045[10 \log(\text{stop freq.} \div \text{start freq.})]$$

Marker Frequency



The marker is a TTL-compatible signal on a rear-panel connector that goes low at the specified marker frequency during linear up-sweeps. It may also be used with discrete sweeps where it operates while sweeping up or down.

The [Mkr Freq] (marker frequency) key enables display, entry, or modification of the sweep marker frequency. The indicator adjacent to the [Mkr Freq] key illuminates when the marker frequency value is displayed. The displayed frequency value is changed with the entry and units keys, or with the modify keys. The MHz, kHz, and Hz units allow convenient entry of frequency values. Frequency resolution is 1 μ Hz for frequencies below 100 kHz and 1 mHz for frequencies above 100 kHz.

For a marker signal to be generated, the marker frequency may be set to any point within the sweep band to within approximately 400 μ s of the stop frequency. If the marker frequency is set beyond this point, the stop frequency is automatically increased so that the marker pulse is approximately 400 μ s wide. The following equation may be used to determine the approximate maximum marker frequency:

$$\text{Max marker freq.} = \text{stop freq.} - (0.0004 \times \text{bandwidth} \div \text{sweep time})$$

Note The marker signal is not generated on the down-sweep of a continuous sweep. See the discussion, later in this chapter, on the marker, Z-blank, and X-drive rear-panel outputs.

Mkr → CF

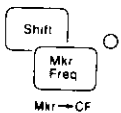

The [Mkr→CF] (marker into center frequency) key centers the sweep band on the frequency value of the marker parameter. The [Mkr→CF] key is selected by pressing the blue [Shift] key followed by the [Mkr Freq] key.

Reset/Start Sweep



The [Reset/Start] key performs three functions for the sweep operations:

1. If a continuous or single sweep is in progress, Reset/Start cancels the sweep. When a sweep is stopped, the current frequency appears in the display.
2. For single sweeps, the first press of the [Reset/Start] key resets the sweep to the start of the sweep.
3. After a single sweep is reset, pressing the [Reset/Start] key again starts the frequency sweep.

$\Delta f \times 2$, $\Delta f \div 2$ (Modify Bandwidth)

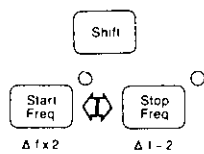

In linear sweep mode, the [$\Delta f \times 2$] and [$\Delta f \div 2$] keys may be used to double or halve the sweep bandwidth. If either the new sweep start or stop frequency exceeds the frequency limits, an error message is displayed. These two keys have no effect on discrete sweeps.

Single Sweep



The [Reset/Start] key resets the sweep the first time it is pressed. A single sweep starts the second time the [Reset/Start] key is pressed. An illuminated *Single* indicator denotes that a single linear sweep is in progress. A single sweep sweeps from the start frequency to the stop frequency over the specified sweep time.

Continuous Sweep



The [Start] key initiates a continuous (repetitive) sweep. The Cont indicator adjacent to [Start] key illuminates when a continuous sweep is in progress. Continuous sweeps move back and forth between the start and stop frequencies in an up/down/up/down. . . fashion. If the marker is active, it functions only during the up-sweep. Sweep parameters should be entered before starting a continuous sweep. See previous discussion on start and stop frequencies and sweep time.

Linear Frequency Sweeps

In linear mode, either continuous or single sweeps are available. Single sweep is from the start to stop frequency, where either the start or stop frequency may be the higher value.

To begin a single sweep:

1. Press [Reset/Start] to set output and display to the start frequency selected and reset the X-Drive ramp.
2. Press [Reset/Start] again to start the sweep.

The output signal frequency sweeps to the selected stop frequency and remains there. This frequency appears in the display.

Continuous linear sweeps alternate between up and down-sweeps. A continuous sweep begins when the [Start] key is pressed. The Cont indicator illuminates while the continuous sweep is active. Continuous sweeps may be stopped by pressing the [Start] key or by pressing [Reset/Start], [Freq], or [Phase] keys. With enhancements turned off, the sweep may stop when other parameters are changed. With enhancements turned on, the sweep does not stop for parameter changes that do not affect the sweep (i.e., amplitude or offset changes do not cause the sweep to stop). Pressing [Amptd Cal], [Self Test], [Asgn Zero Φ], or changing the function stops a continuous sweep. When a sweep stops, the display indicates the frequency at which the sweep stopped.

Linear Sweep Bandwidth

The maximum bandwidth is the full frequency range for the function selected. The minimum bandwidth for each function is as follows:

| | |
|----------|--|
| Sine | $(10 \text{ MHz/s}) \times (\text{sweep time})$ |
| Square | $(5 \text{ MHz/s}) \times (\text{sweep time})$ |
| Triangle | $(0.5 \text{ MHz/s}) \times (\text{sweep time})$ |
| Ramps | $(1 \text{ MHz/s}) \times (\text{sweep time})$ |

For sweep bandwidths of less than 100 times the minimum bandwidth, bandwidth selected should be an integral multiple of the minimum bandwidth or sweep-time errors and stop-frequency errors will occur.

Log Frequency Sweep

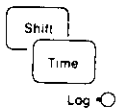

In either single or continuous log sweep mode, the stop frequency must be higher than the start frequency and the sweep is up-only (continuous log sweep is a repetitive start-to-stop sweep, only). The minimum bandwidth for log sweep is one decade. Single log sweep is a line-segmented log approximation in one-tenth decade segments, and continuous log sweep is a two-segment-per-decade log approximation.

Note

For narrow-band log sweeps, the actual stop frequency may be higher than the selected stop frequency. The error decreases as sweep time is increased. This error is minimized by activating enhancements.

Discrete Frequency Sweep



Discrete sweeps consist of up to 100 linear sweeps (called segments) combined to form a custom sweep pattern. Parameters for each sweep segment consist of start frequency, stop frequency, sweep time, and marker frequency. These parameters are entered by programming a standard linear sweep and storing it into a discrete sweep segment as described in *Storing Discrete Sweep Segments*.

To perform a discrete frequency sweep, the HP 3325B sequences through the segment entries, performing the designated sweeps and skipping blank entries. The sequence is always from segment 00 to 99. For single sweep operation, the HP 3325B sequences through the elements each time the sweep is reset and started with the [Reset/Start] key. For continuous sweeps, the HP 3325B sequences through the segments repeatedly.

Clearing All Discrete Sweep Elements

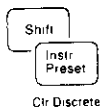

The [Clr Discrete] (clear discrete) key empties all discrete sweep segments in nonvolatile memory. This should be done before entering new parameters. The [Clr Discrete] key is activated by pressing the blue [Shift] key and then the green [Instr Preset] key.

Storing Discrete Sweep Segments

Discrete sweep entries may be made whether the discrete sweep is active or not. Each sweep segment is a linear sweep; it may be considered a frequency step if the start frequency is the same as the stop frequency. The entries are saved in nonvolatile memory.

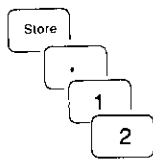

To store a discrete sweep segment:

1. Enter the start and stop frequencies, sweep time, and (optionally) the marker frequency as you would for any linear sweep.
2. Press the [Store] key.
3. Press the [.] key in the data group.
4. Enter a two-digit number by pressing numeric keys in the data group. Numbers between 1 and 9 should be preceded with a 0 (zero). No units or other terminating keystrokes are required. This number is the entry number in the discrete sweep segment list, the order of which determines the pattern of the discrete sweep. Segments may be saved in any order but are always executed sequentially from 00 to 99.

Discrete sweep segment entries may also be made by down-loading the parameters from a computer through one of the rear-panel interface connectors. In some cases, this is the preferred method of setting up discrete sweeps; especially if more than one pattern is used on a regular basis. See Chapter 2, Remote Operation, for more information.

Recalling Discrete Sweep Segments

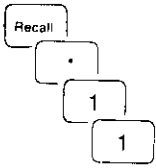

Discrete sweep parameters for any segment (start, stop, and marker frequency and sweep time) may be examined by recalling the discrete sweep segment entry and then pressing the key corresponding to the parameter of interest. To recall a discrete sweep segment:

1. Press the [Recall] key.
2. Press the [.] key.
3. Enter a two-digit number by pressing numeric keys in the data group. Numbers between 1 and 9 should be preceded by a 0 (zero). No units or other terminating keystrokes are required. This number is the entry number in the discrete sweep segment list, the order of which determines the pattern of the discrete sweep. If an empty segment is recalled the message "Error 605" is displayed.

The key sequence [Recall], [.] , [1], [1] recalls the linear sweep segment previously stored in segment 11.

Enabling Discrete Sweeps

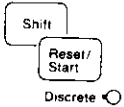

The [Discrete] key enables and disables discrete frequency sweeps. The [Discrete] key is activated by pressing the blue [Shift] key and then pressing the [Reset/Start] key. The Discrete indicator illuminates when a discrete frequency sweep is enabled.

Single Discrete Sweeps



The [Reset/Start] key initiates a single discrete frequency sweep. The indicator adjacent to [Reset/Start] key illuminates when a single sweep is in progress. The [Reset/Start] key initiates a sweep from discrete frequency sweep segment 00 to 99, skipping empty segments. Pressing the [Reset/Start] key during a sweep stops the sweep and displays the present frequency. Pressing [Reset/Start] again resets the frequency to the start frequency of the first sweep segment.

Continuous Discrete Sweeps



When discrete sweep is selected, pressing the [Start] key initiates a continuous discrete frequency sweep. The indicator adjacent to [Start] key illuminates when a continuous sweep is in progress. Continuous discrete sweeps sequence through the segment table from 00 to 99, starting again at 00, repetitively. Pressing [Start] while a sweep is in progress stops the sweep.

Modulation

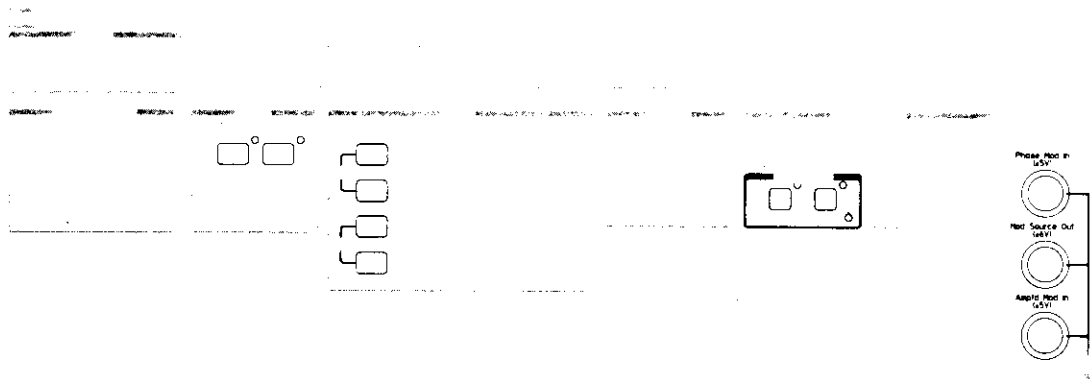

Introduction

The Main Signal may be amplitude or phase-modulated by a signal connected to either of the two corresponding rear-panel connectors (Amptd Mod In or Phase Mod In). The signal may originate from another signal generator or the internal modulation source may provide the signal. After the connections are made to the rear-panel connectors, modulation of the Main Signal is controlled by the operator.

The Mod Source keys provide an independent sine wave, square wave, or arbitrary waveform signal through the rear-panel Mod Source Out connector. This signal may be used to modulate the Main Signal by connecting it to the rear-panel modulation input connector(s) and pressing the appropriate front-panel keys to activate modulation and control the Mod Source signal.

Amplitude Modulation

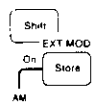

Amplitude modulation of the Main Signal is enabled by pressing the [AM On] ([Shift] [Store]) key which illuminates the AM indicator. Amplitude modulation is disabled by pressing the [AM Off] ([Shift] [Recall]) key which extinguishes the AM indicator, or by presetting the HP 3325B. The modulating signal is applied to the HP 3325B through the rear-panel Amptd Mod In connectors.

When amplitude modulation is enabled, the value entered for the amplitude of the Main Signal is the maximum value possible, or 100% modulation value. When no modulating signal is present or that signal is 0V, the amplitude of the Main Signal is half the entered value. (0V is considered to be 50% modulation.) A modulation input of approximately 5 V_{pk} results in 100% modulation. Modulation frequency may range from 0 to 400 kHz. If amplitude modulation is on when functions other than sine wave are selected, the output may be gated, depending on the level of the modulation input. Amplitude modulation should only be used with the sine wave function, and the modulation input should not exceed ± 10 V_{pk}.

A dc voltage may be applied to the Amptd Mod input to control the HP 3325B output level, or a pulse may be used to gate the output. Approximately +5V cuts off the output signal, while approximately -5V doubles the output (maximum input is 10 V_{pp}). DC or pulse inputs should not exceed ±5 V_{pk}. The impedance of the Amptd Mod input is 10 kΩ (5 kΩ when AM is off).

Phase Modulation

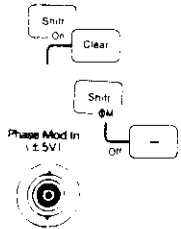

The [ΦM] (phase modulation) keys in the data group enable and disable phase modulation of the Main Signal. Phase modulation is enabled by pressing the [ΦM On] ([Shift] [Clear]) key, which illuminates the ΦM modulation indicator. Phase modulation is disabled by pressing the [ΦM Off] ([Shift] [-]) key, which extinguishes the ΦM modulation indicator, or by presetting the HP 3325B. The modulating signal is applied to the HP 3325B through the rear-panel Phase Mod In connector.

The phase modulation signal at the rear-panel Phase Mod Input connector should not exceed ±10 V_{pk}. The input impedance is 40 kΩ. The modulation signal frequency may be dc to 5 kHz. An input of ±5V results in the following approximate phase deviation (±170° per volt for the sine function):

| HP 3325B Function | Phase Deviation |
|-------------------|-----------------|
| Sine | ±850° |
| Square | ±425° |
| Triangle | ±42.5° |
| ±Ramp | ±85° |

Modulation Source



The modulation source provides a second independent signal source, available at the rear-panel Mod Source Out connector. This signal may be used to modulate the main signal by connecting the mod source out connector to the (amplitude or phase) input modulation connector(s) and then controlling main signal modulation and the mod source signal.

Note

The Mod Source output signal should be connected to the Phase or Amplitude Modulation input connector with a BNC coaxial connector at the rear panel. There is no internal connection.

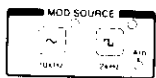

The modulation source is enabled by pressing the Mod Source sine wave or square wave key. The modulation source is disabled by pressing the Mod Source sine wave or square wave key adjacent to the illuminated Mod Source indicator to extinguish that indicator.



The Mod Source amplitude is entered by pressing the [Shift] key followed by the [Amptd] key. The Modulation Source indicator to the left of the display illuminates to indicate the display contains a modulation source value. Valid modulation source amplitudes range from 0.1 to 12 V_{pp} with 0.1V resolution. Amplitudes may be entered in either V_{pp} or V_{rms}.



The Mod Source Frequency is entered by pressing the [Shift] key followed by the [Freq] key. The Modulation Source indicator illuminates to indicate the display contains a modulation source value. The sine wave frequency values range from 0.1 Hz to 10 kHz with 2-digit resolution. The square wave frequency values range from 0.1 Hz to 2 kHz with 2-digit resolution. The modulation signal is momentarily disabled during modulation frequency changes.

The Modulation Source is a free-running signal which is not phase-locked to the Main Signal output or External Reference input. It has no DC offset or phase parameters. The Modulation Source output is intended to drive high impedance inputs and should not be terminated in 50Ω. It may be connected to both modulation inputs at the same time but the extra loading may draw the output signal voltage down.

Arbitrary Waveforms

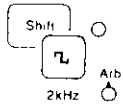

The modulation source may be programmed as an arbitrary waveform source by a computer via HP-IB or RS-232. Once programmed, the waveform is retained in nonvolatile memory and may be initiated from the front panel. Select the arbitrary waveform with the [Shift] Mod Source square wave key which illuminates the Arb indicator. The repetition rate of the arbitrary waveform is set with the [Shift] [Freq] key. Repetition rates range from 0.1 Hz to 10 kHz (the HP 3325B adjusts the value to compatible internal frequencies). The default waveform is dc (after memory is cleared).

Disabling Modulation

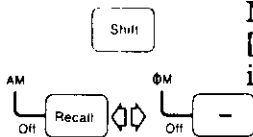

Modulation is disabled by pressing the [AM Off] ([Shift] [Recall]) key or [ΦM Off] ([Shift] [-]) key. The extinguished AM or ΦM modulation indicators provide a visual indication that modulation inputs are disabled.

Storing/Recalling Instrument States

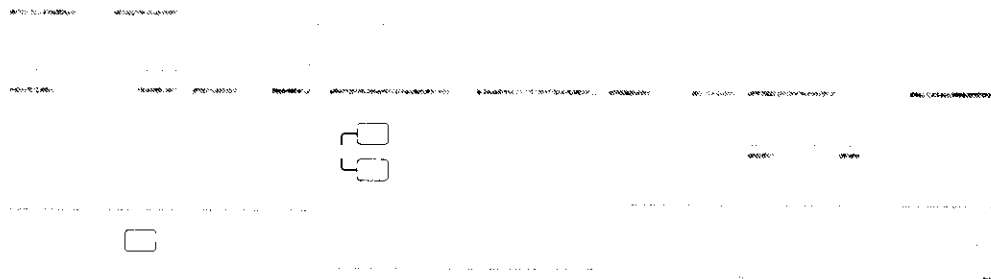

Storing Instrument States

Store

The [Store] key, followed by a digit from 0 to 9, saves the current operating state in internal memory. The digit following the [Store] key specifies the memory location for storing the operating state. If two operating states are saved in the same memory location, the operating state saved first is overwritten. These states are not cleared by instrument preset; they are cleared by a memory clear (power up while pressing the preset key).

Note

Any phase information stored is invalid when recalled because the instrument performs an amplitude calibration on Recall. The phase relationship between the output signal and the reference is not maintained when an amplitude calibration occurs.

Recalling Instrument States

Recall

The [Recall] key, followed by a digit from 0 to 9, recalls an operating state saved in internal memory. The digits 0 to 9 select the memory location for the recall operation. Pressing [Recall] [-] recalls the state of the instrument just before it was last powered down.

Memory Clear

Inst
Preset

Applying power to the HP 3325B with the green [Inst Preset] key depressed replaces the contents of all nonvolatile memory registers with the instrument preset state. All saved operating states (including power-down) are replaced with the instrument preset state, discrete frequency sweep elements are cleared, the arbitrary waveform registers are set to dc, the HP-IB address is set to 17, and the message "Fail 36" is displayed.

Calibration and Self Test

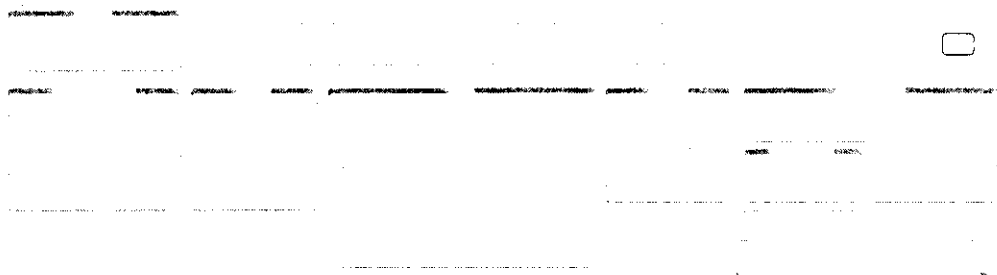

Amplitude Calibration



The [Amptd Cal] key initiates a calibration of the output signal each time the key is pressed. The Main Signal output amplitude changes to less than 4 mV_{pp} while the calibration is in progress. An amplitude and offset calibration is performed automatically whenever the function is changed and at instrument turn-on.

Self Test

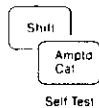

A self test is initiated by pressing the blue [Shift] key prior to the [Amptd Cal] ([Self Test]) key. During a self test, all indicators and display segments briefly illuminate, -CAL- is displayed, and a series of internal tests is initiated. After each internal test, Pass or Fail and a number is displayed to indicate the test results. During a self test, the outputs are disabled.

Note

If the message "Fail 21" through "Fail 29" is displayed momentarily after a self test, the HP 3325B should be sent to qualified service personnel for repair.

The HP-IB Status Keys/Indicators/Connector

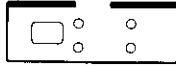

The HP-IB (Hewlett-Packard Interface Bus) key and status indicators are used during remote operation. An overview of the HP-IB and a description of the HP 3325B HP-IB characteristics and commands is contained in Chapter 2.

Local



The [Local] key removes the HP 3325B from remote (HP-IB or RS-232) operation if local lockout is not in effect. Remote operation is indicated by the illuminated Remote indicator.



The Remote indicator illuminates when the HP 3325B is operating under remote control. While in remote (and local lockout is not in effect), only the [Local] key is recognized.



The Listen indicator illuminates when the HP 3325B is addressed to listen over the HP-IB.



The Talk indicator illuminates when the HP 3325B is addressed to talk over the HP-IB.



The SRQ (service request) indicator illuminates when the HP 3325B has requested service (HP-IB only).

Bus Address

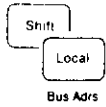

The [Bus Adrs] (bus address) key enables display or entry of the HP-IB address. The [Bus Adrs] key is selected by pressing the blue [Shift] key prior to the [Local] key. After selection of the [Bus Adrs] key, the HP-IB address is entered with the data entry keys or changed with the modify keys. For address values entered with the data entry keys, pressing any units key sets the address. The HP-IB address is an integer in the range of 0 to 31 and is retained in nonvolatile memory. Entering an address value of 31 places the HP 3325B in the listen-only mode and the HP 3325B displays LO rather than the address value.

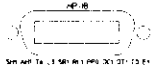

The HP 3325B is connected to other HP-IB devices through the rear-panel HP-IB connector.

The RS-232 Switches/Indicators/Connector

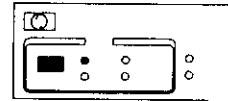
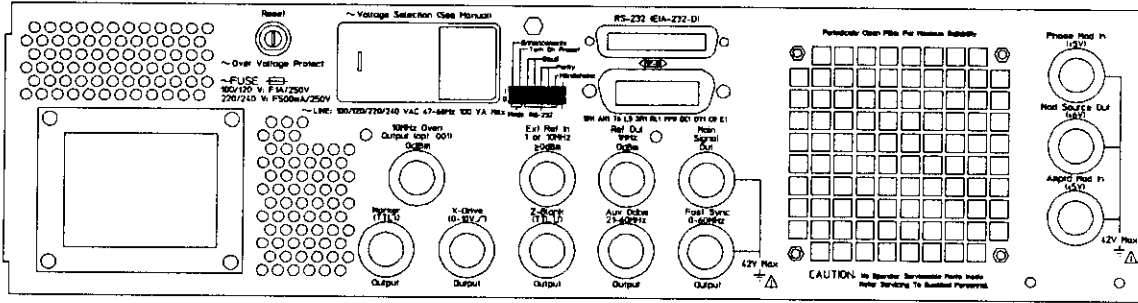

The RS-232 serial interface provides an alternate method (to the HP-IB) of remotely controlling the HP 3325B. Chapter 2 provides an overview of remote operation and contains a complete list of the remote operation commands.

The 25-pin female connector is configured as Data Terminal Equipment (DTE). Chapter 2 contains a description of the characteristics of the connectors. Five of the small switches on the rear panel configure the HP 3325B for operation with the serial RS-232 communications link.

Baud Rate

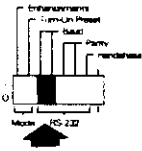
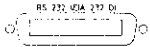

The Baud switches (switches 3 and 4) control the transmission speed (baud rate) of the RS-232 serial interface. Table 1-8 lists the available baud rates and switch settings for them. Whenever the baud switches are changed, the new rate value is displayed. For example, when switch 3 and 4 are placed in the down position, the HP 3325B displays “bAUd = 4800”.

Table 1-8. RS-232 Baud Rate

| Rate | Switch 3 | Switch 4 | Display Message |
|------|----------|----------|-----------------|
| 300* | up | up | bAUd = 300 |
| 1200 | up | down | bAUd = 1200 |
| 2400 | down | up | bAUd = 2400 |
| 4800 | down | down | bAUd = 4800 |

* Factory setting

Word Length/Parity

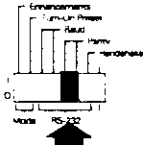

The Parity switches (switches 5 and 6) control the parity and word length of the serial data exchanged with the host computer. Table 1-9 lists the available word lengths and parity and corresponding switch settings. Whenever the parity switches are changed, the new parity value is displayed.

Table 1-9. RS-232 Word Length and Parity

| Word Length | Parity | Switch 5 | Switch 6 |
|---------------|--------|----------|----------|
| 7 data bits * | Even | up | up |
| 7 data bits | Odd | up | down |
| 8 data bits | None | down | up |
| 7 data bits | Zero | down | down |

* Factory setting

Handshaking

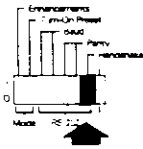

The Handshake switch (switch 7) sets the handshaking characteristics used to communicate with host computer. Table 1-10 lists the handshaking available and corresponding switch settings. Whenever the Handshake switch is changed, the new handshaking characteristics are displayed.

Table 1-10. RS-232 Handshaking

| Handshaking | Switch 7 | Display Message |
|-----------------------|----------|-----------------|
| Software (Xon/Xoff) * | up | HAnd = Soft |
| Hardware (DTR/RTS) | down | HAnd = dtr |

* Factory setting

RS-232 Local/Remote



The [Local] key removes the HP 3325B from remote (HP-IB or RS-232) operation if local lockout is not in effect. Remote operation is indicated by the illuminated Remote indicator.

The Remote indicator illuminates when the HP 3325B is operating under HP-IB or RS-232 control. While in remote (and local lockout is not in effect), only the [Local] key is recognized.

Marker / Z-Blank (Pen Lift) / X-Drive Outputs

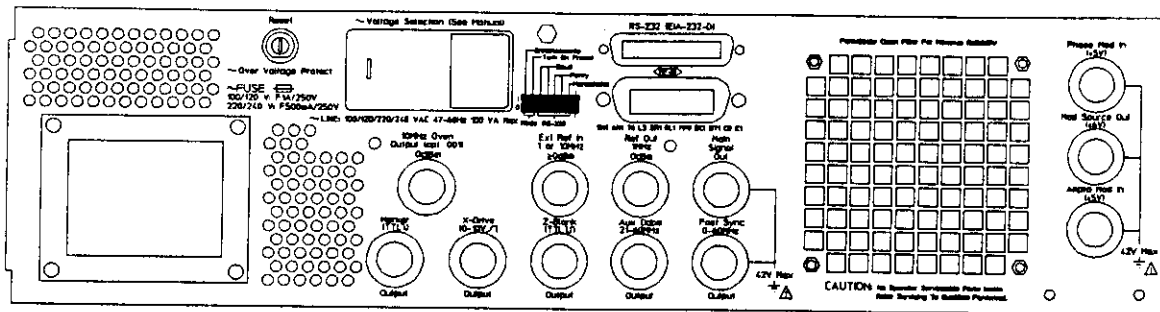

The Marker, Z-Blank, and X-Drive connectors provide outputs to drive an analog plotter or oscilloscope display during sweep operation.

Marker



The rear-panel Marker connector provides a TTL-level signal indicating when the sweep frequency reaches the value entered for the marker frequency.

Single/Continuous Linear Sweep

During a sweep up, the marker signal starts at a high level at the start frequency, drops to a low level at the selected marker frequency, and returns to the high level at the stop frequency. The marker output is disabled during a sweep down. If the marker value entered is out of the sweep span, no marker transition occurs.

Log Sweep

The marker is disabled during log sweeps.

Discrete Sweep

For discrete frequency sweeps, the marker goes to a high value at the start of each frequency segment, drops to a low level at the selected marker frequency and remains low until the start of the next sweep segment. Each of the sweep segments may have a different marker frequency. (See the discussion on discrete sweeps, earlier in this chapter, under Frequency Sweeps.) If the marker value entered is out of the sweep span of the segment, the marker output stays high during the duration of the sweep segment. The marker functions for up or down-sweeps when executing discrete sweeps. If the start, stop, and marker frequency parameters of a segment are equal, the marker output is low during the segment sweep time.

Z-Blank



The Z-Blank output drops low at the start of sweep and remains low until the end of a sweep. At the end of a sweep, the Z-Blank output signal goes to a high level and remains high until another sweep segment is initiated. The Z-Blank connector is located on the rear panel and the output is TTL-compatible. The Z-Blank low level is capable of sinking current from a positive voltage source through a pen-lift circuit or other device. When this output is low the maximum Z-Blank ratings are:

Maximum current sink: 200 mA
Allowable voltage range: 0 to +42V dc
Maximum power (voltage at output × current): 1 W

Single Linear Sweep

Z-Blank drops to a low level at the start of sweep and remains low until the end of a sweep. At the end, the Z-Blank output goes to a high level and remains high until the sweep is restarted.

Continuous Linear Sweep

Z-Blank drops to a low level during the sweep up, and goes to a high level for the sweep down.

Single Log Sweep

Z-Blank drops to a low level at the start frequency, and goes to a high level at the stop frequency and remains high until the sweep is restarted.

Continuous Log Sweep

Z-Blank drops to a low level at the start frequency, and momentarily goes to a high level at the stop frequency.

Discrete Frequency Sweep

Z-Blank drops low at the start of the first segment and stays low until the end of the last segment, when it returns to a high level. During continuous sweeps, Z-Blank remains high for approximately 400 μ s.

X-Drive



During sweep operation, the rear-panel X-Drive connector provides a 0 to > 10 volt linear ramp proportional to the sweep time (ramps up). For sweep times of 100 seconds or more the X-drive output stays at 0 volts.

Note

The X-Drive output has a nominal voltage of just over 10 volts at the end of a sweep to ensure compatibility with oscilloscopes with a horizontal sensitivity of 10 volts for full-screen deflection.

Single Linear Sweep

During a sweep, X-Drive Out increases linearly from 0 to > 10 volts from the start frequency to the stop frequency. At the end of a sweep, the output remains at approximately 10 volts until reset for the start of the next sweep. (Voltage drifts downward less than 10 mV/s.)

Continuous Linear Sweep

During the up sweep, X-Drive output signal increases linearly from 0 to > 10 volts. The output drops to 0 volts at the start of the down sweep and remains there during the down sweep.

Log Sweep

X-Drive increases linearly from 0 to > 10 volts with the sweep segments.

Discrete Frequency Sweep

The X-Drive output is disabled during discrete sweeps.

Synchronization Outputs

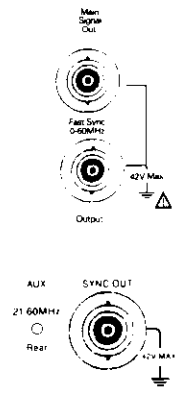

A square wave with the frequency and phase of the main signal output is available at the front-panel Sync (synchronous) Out and rear-panel Fast Sync connectors. The Sync transition occurs at the signal zero-crossing or when the signal crosses the dc offset voltage.

The output impedance of Sync Out is approximately 50Ω with a frequency range matching the main signal output. When the Sync Out output is terminated in a 50Ω resistive load, the output levels are:

Front Sync
Low level < +0.2V
High level > +1.2V

Rear Fast Sync
Low level < +0.5V
High level > +1.5V

Note

When the Sync output is connected to a high impedance load ($\geq 1\text{ M}\Omega$), the voltage levels are approximately twice the values listed. Improper termination of a 50Ω system may cause ringing at the signal positive and negative transitions. It may be terminated into larger impedances, if necessary to drive TTL circuits to 60 MHz.

The rear-panel Fast Sync output impedance is approximately 50Ω with a frequency range extended to 60 MHz. The output levels for the Fast Sync connector may fall below the TTL minimums when terminated into 50Ω .

AUX 0 dBm 21–60 MHz Output (Extended Frequency)

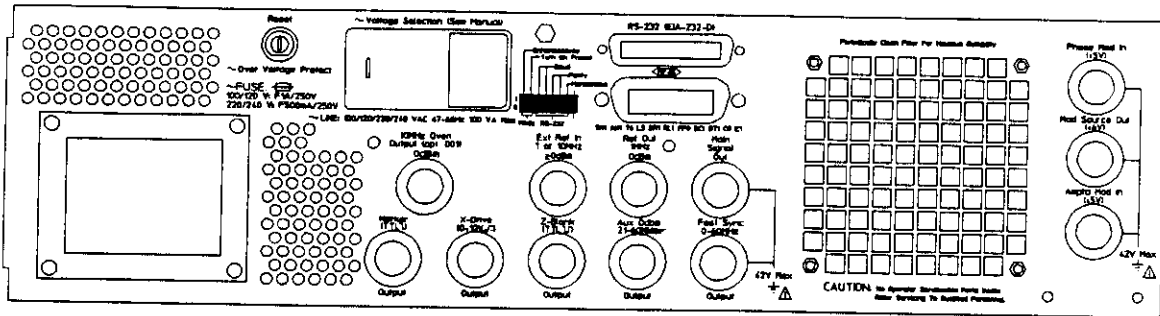

The rear-panel Aux 0 dBm 21–60 MHz connector supplies a signal when the HP 3325B frequency is set above 21 MHz. Once active, the frequency of this output ranges from 19 MHz to a maximum of 60 999 999.999 Hz. Frequencies below 19 MHz reactivate the main signal output connector. The auxiliary output is ac-coupled with a level approximately 0 dBm into 50Ω.

External Reference or Oven-Stabilized Frequency Option

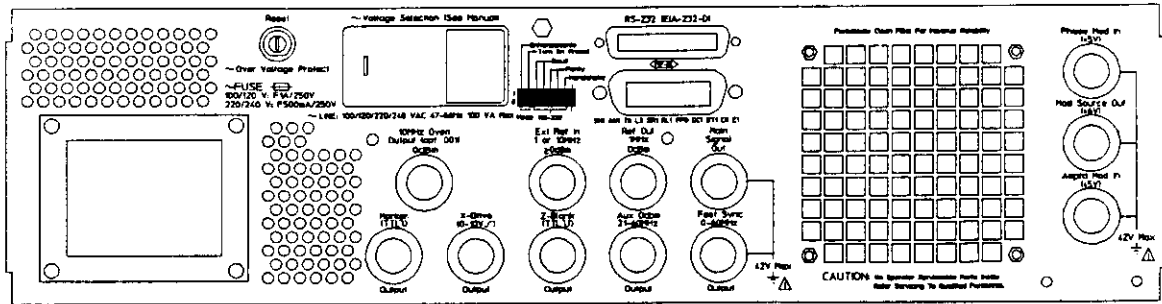

10 MHz Oven Output (High-Stability Frequency Reference)

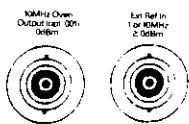

The 10 MHz oven output signal is available at a connector on the rear panel if the high-stability frequency reference (option 001) is installed. It is a 10 MHz temperature-stabilized crystal oscillator which connects to the HP 3325B frequency reference input by connecting the 10 MHz oven output connector to the External Ref In connector with a BNC-to-BNC adapter (HP part number 1250-1499). The 10 MHz oven signal has a level greater than 0 dBm (50Ω). The output signal is present whenever the HP 3325B is connected to a power source.

To reduce the warmup time and obtain maximum performance from an HP 3325B equipped with option 001, leave the HP 3325B connected to a power source. Power is supplied to option 001 whenever the HP 3325B is connected to a power source. An HP 3325B with option 001 requires 15 minutes of warmup time to meet frequency specifications if power is disconnected for less than 24 hours. If power is disconnected for more than 24 hours, the HP 3325B may require up to 72 hours of warmup time to meet frequency specifications.

External Frequency Reference

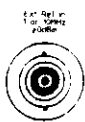

The External Ref In connector phase-locks the HP 3325B to external frequency references. Phase-locking to an external frequency reference transfers the external reference's frequency accuracy and aging rate to the HP 3325B. The level of the frequency reference must be from 0 dBm to +20 dBm (50Ω). The frequency must be 10 MHz (± 10 ppm) or a subharmonic down to 1 MHz (e.g., 1, 2, 3.33, 5, or 10 MHz). The front-panel Ext Ref indicator illuminates when the HP 3325B is connected to an external frequency reference. The Ext Ref indicator blinks if the HP 3325B is unable to synchronize to the reference. The 10 MHz oven output normally connects to the External Ref In connector if the high stability frequency reference (option 001) is installed.

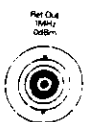

The Ref Out 1 MHz connector supplies a 1 MHz square wave derived from the frequency reference of the HP 3325B. The square wave has a level greater than 0 dBm (50Ω) and can be used to phase-lock an analyzer or other instrumentation to the frequency reference of the HP 3325B.

Chapter 2

REMOTE OPERATION

This chapter contains two sections:

1. General information concerning the operation of the selected interface (either HP-IB or RS-232)
2. Interface commands specific to the HP 3325B.

The first is an overview of the Hewlett-Packard Interface Bus (HP-IB) and its relationship to the HP 3325B as well as a general description of the RS-232 interface. Both contain information that is general interface information, only; i.e., commands that might be used with any instrument.

The second section contains descriptions of commands used specifically for the HP 3325B.

Remote Operation via HP-IB

Description of the HP-IB

The HP-IB is a bus structure that links the HP 3325B to desktop computers, minicomputers, and other HP-IB controlled instruments to form automated measurement systems. The HP-IB is Hewlett-Packard's implementation of the IEEE Standard 488-1978 and ANSI Standard MC 1.1.

All of the active HP-IB interface circuits are contained within the various HP-IB controlled devices. The interconnecting cable is entirely passive and its role is limited to connecting the devices in parallel so that data can be transferred from one device to another.

Every participating device must be able to perform at least one of the following roles: talker, listener, or controller. A talker transmits data to other devices called listeners. Most devices can be both a talker and listener, but not at the same time. A controller manages the operation of the bus system by designating which device is to talk and which devices are to listen at any given time. The HP 3325B can be either a talker or a listener.

The full flexibility and power of the HP-IB is realized when a controller is added to the system. An HP-IB controller participates in the measurement by being programmed to automate, monitor, and coordinate instrument operation as well as process the measurement results. There may be more than one controller on the bus but only one can be active at a time. (Changing the active controller is accomplished with the *pass control* bus message.) One (and only one) of the controllers should be hard-wired as the *system controller*.

Capabilities of the HP-IB

Number of Interconnected Devices

Up to 15 devices, maximum, may be on one contiguous bus.

Interconnection Path/Maximum Cable Length

Star or linear bus network. Total transmission path length = 2 meters times number of devices, or 20 meters, whichever is less, with a maximum of 3 meters separating any two devices.

Message Transfer Method

Byte-serial, 8 bit-parallel, asynchronous data transfer using a 3-wire handshake.

Data Transfer Rate

One megabyte per second (maximum) over limited distances; actual data rate depends upon the capability of the slowest device involved in the transmission.

Address Capability

Primary addresses: 31 talk, 31 listen; secondary (2-byte) addresses: 961 talk, 961 listen. 1 talker and 14 listeners, maximum, at one time. The HP 3325B has only primary address capability. Table 2-2 lists the talk and listen HP-IB addresses.

Multiple Controller Capability

In systems with more than one controller, only one controller can be active at a time. The active controller can pass control to another controller but only the system controller can assume unconditional control. Only one system controller is allowed per system.

Interface Circuits

Driver and receiver circuits are TTL compatible.

Bus Structure

The HP-IB signal lines consist of eight data lines (DIO1–DIO8), five bus management lines, (explained in following text), and three handshake lines. This is shown in figure 2-1.

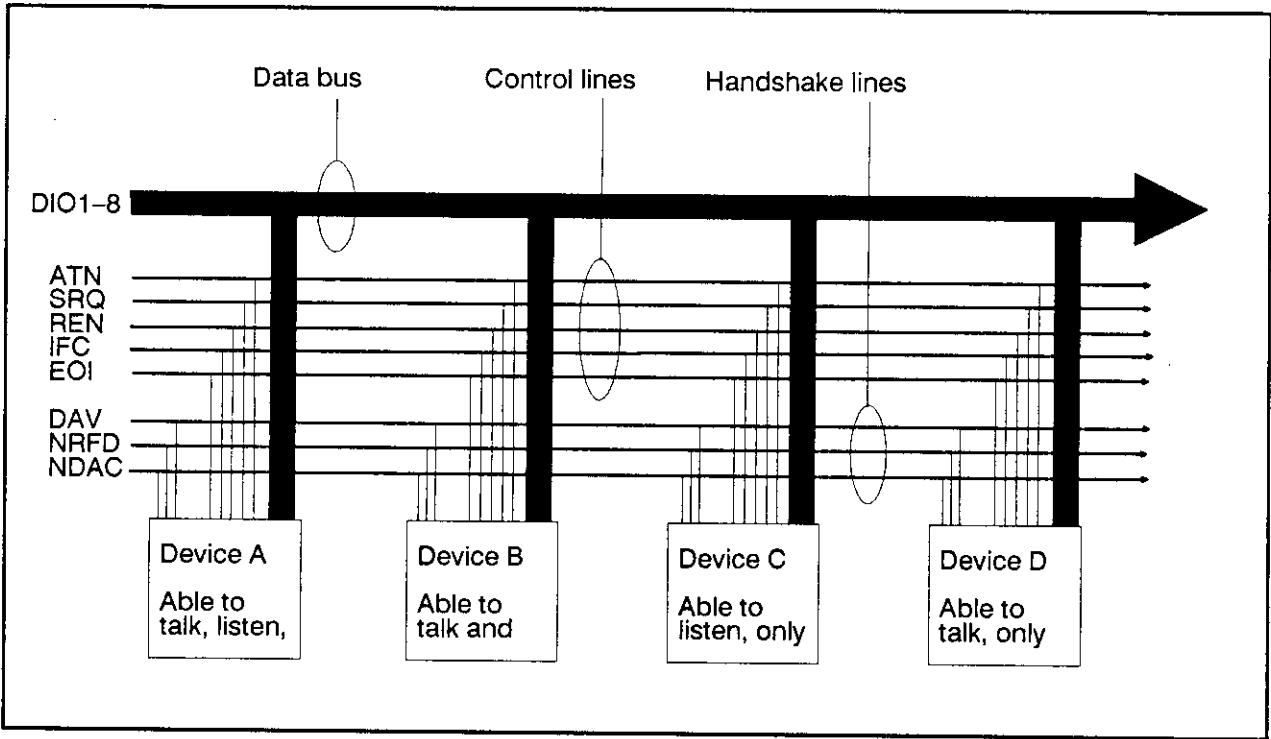

Figure 2-1. HP-IB Structure

HP-IB Management (Control) Lines

ATN – Attention. This line is used by the active controller to define how information on the data lines should be interpreted by other devices on the bus.

When ATN is low (true) the HP-IB is in the *command mode* and the data lines should be interpreted as *bus commands* (see “Bus Commands” later in this chapter). In the command mode the controller is active and all other devices are waiting for instructions. Also, devices on the HP-IB are addressed or unaddressed as listeners or talkers while the bus is in command mode.

When ATN is false the HP-IB is in *data mode* and the data lines should be interpreted as device-dependent commands. In the *data mode*, data and instructions are transferred between devices on the HP-IB. Instructions transferred to the instrument are called *device-dependent commands*. All the commands specifically for the HP 3325B fall into this category. The HP 3325B device-dependent commands configure the HP 3325B, initiate measurements, initiate data transfers, or define error-reporting conditions. These device-dependent commands are meaningless for other instruments. The HP 3325B device-dependent commands are listed later in this chapter under the heading “HP 3325B Remote Operation Command Set.”

SRQ – Service Request. This line is set low (true) by any instrument requiring service. The controller should be programmed to respond to most service requests by polling the devices on the bus to determine which one initiated the request. The HP 3325B responds to a serial poll by putting its status byte on the data lines.

REN – Remote Enable. The system controller must set REN low and then address specific device(s) to listen before they can operate under remote control.

IFC – Interface Clear. Only the *system controller* can activate the IFC line. When IFC is set true (low), all devices on the bus become inactive.

EOI – End Or Identify. This line is used to indicate the end of a multiple-byte transfer sequence (in the *data mode*) or by the controller, in conjunction with ATN, to execute a parallel poll.

HP 3325B HP-IB Capability

The HP 3325B interfaces to the HP-IB as defined by IEEE Standard 488-1978. The interface functional subset which the HP 3325B implements is specified in table 2-1.

Table 2-1. HP 3325B HP-IB Capability

| Code | Function |
|------|---|
| SH1 | Complete source handshake capability |
| AH1 | Complete acceptor handshake capability |
| T6 | Basic talker; serial poll; unaddressed to talk if addressed to listen; no talk-only |
| L3 | Basic listener; unaddressed to listen if addressed to talk; listen-only |
| SR1 | Complete service request capability |
| RL1 | Complete remote/local capability |
| PP0 | No parallel poll capability |
| DC1 | Device clear capability |
| DT1 | Device trigger capability |
| C0 | No controller capability |
| E1 | Driver electronics – open collector |

Talk/Listen Addresses

Each HP-IB device has at least one talk and one listen address unless the device is either totally transparent or is a talk-only or listen-only device. Device addresses are used by the active controller in the *command mode* (ATN true) to specify the talker (via a talk address) and the listener(s) (via listen addresses). Only one device may be addressed to talk at a time.

The address of a device is usually preset at the factory but may be set to another value during system configuration. In the binary representation of the address, the device address is the decimal equivalent of the five least-significant bits of the address. (On HP-IB devices with selector switches, these are the five address switches.) The address can be from 0 to 31, inclusive. The sixth and seventh bits determine if the address is a talk or listen address, respectively. High-level HP-IB controllers typically configure these two bits automatically. Table 2-2 lists the HP-IB addresses if a controller requires the talk and listen addresses.

Table 2-2. HP-IB Addresses

| Device Address | Binary Address | Address Characters | |
|----------------|----------------|--------------------|------------------------------|
| | | Talk | Listen |
| 0 | 0000 0000 | @ | Space |
| 1 | 0000 0001 | A | ! |
| 2 | 0000 0010 | B | " |
| 3 | 0000 0011 | C | # |
| 4 | 0000 0100 | D | \$ |
| 5 | 0000 0101 | E | % |
| 6 | 0000 0110 | F | & |
| 7 | 0000 0111 | G | ' |
| 8 | 0000 1000 | H | (|
| 9 | 0000 1001 | I |) |
| 10 | 0000 1010 | J | * |
| 11 | 0000 1011 | K | + |
| 12 | 0000 1100 | L | , |
| 13 | 0000 1101 | M | - |
| 14 | 0000 1110 | N | . |
| 15 | 0000 1111 | O | / |
| 16 | 0001 0000 | P | 0 |
| 17 | 0001 0001 | O | 1 (HP 3325B default address) |
| 18 | 0001 0010 | R | 2 |
| 19 | 0001 0011 | S | 3 |
| 20 | 0001 0100 | T | 4 |
| 21 | 0001 0101 | U | 5 (typically the controller) |
| 22 | 0001 0110 | V | 6 |
| 23 | 0001 0111 | W | 7 |
| 24 | 0001 1000 | X | 8 |
| 25 | 0001 1001 | Y | 9 |
| 26 | 0001 1010 | Z | :: |
| 27 | 0001 1011 | [| ::: |
| 28 | 0001 1100 | \ | < |
| 29 | 0001 1101 |] | = |
| 30 | 0001 1110 | ^ | > |

The talk and listen addresses fall within the printable ASCII character set. When a device receives one of these characters while ATN is true, it becomes addressed. The ASCII character "?" (ASCII 31) unaddresses all devices while ATN is true. The device address (set from the HP 3325B front panel) is used by HP-IB controllers, most of which automatically send the talk and listen address characters.

Viewing the HP 3325B HP-IB Address

The HP-IB address is stored in a nonvolatile memory location (there are no address switches). The address appears in the display when you press [Bus Adrs] key ([Shift] [Local]). The address message is removed from the display by pressing another key that requires the display.

Changing the HP-IB Address

Every device on the HP-IB must have a unique address. The HP 3325B address can be set at any address between 0 and 31, inclusive, and is stored in internal nonvolatile memory. When selecting an address, remember that the controller also has an address (usually 21).

To change the HP-IB address:

1. Press the blue [Shift] key followed by the [Local] key in the HP-IB Status block to display the HP-IB address.
2. Enter the address with the data entry keys or change it with the arrow keys.
3. Press any units key to enter the new address.

| | |
|--------------|--|
| <i>Notes</i> | <p>An address entry of 31 sets the HP 3325B to <i>listen only</i> and the message "Addr. = LO" appears in the display.</p> <p>If you enter an address greater than 31, the message "Error 100" appears in the display (entry parameter out of range).</p> <p>The HP-IB address is reset to 17 after a memory clear operation (hold down the Preset key and cycle power).</p> |
|--------------|--|

Bus Commands

The HP-IB interface system operates in one of two modes, controlled by the ATN bus management line: *command mode* (ATN true) or *data mode* (ATN false). (If an HP controller is used, the bus management lines are configured automatically and all necessary command strings are issued.)

Bus commands are issued while the HP-IB is in the command mode. These commands may instruct the instrument's HP-IB interface to control the instrument (like Clear or Trigger) but are more often used for bus management (Remote, Local, Polls, Service Request, Abort interface activity, or Pass Control). Bus commands are issued through the use of one of the five bus management lines or through the eight-bit data bus. The bus commands and the HP 3325B responses to them are described in the following:

Abort

The *abort* command (interface clear – IFC true) halts all HP-IB activity. The system controller assumes unconditional control of the bus. The HP 3325B responds by becoming unaddressed.

Clear

The clear command causes all devices addressed to listen to reconfigure themselves to a predefined device-dependent condition. The HP 3325B responds to the clear command (both the device clear, DCL, and selective device clear, SDC) by clearing the interface command buffer of any pending commands, clearing the error register, and resetting the instrument to the Preset state.

Clear Lockout/Set Local

The clear lockout/set local command removes all devices from the local lockout mode and returns the HP 3325B to local (front panel) control. The HP-IB is in the local mode because the REN bus management line is set false.

Local

The *local* command clears the remote command from the listening device and returns the listening device to local (front panel) control. If local lockout is not in effect, the HP 3325B responds by returning to front panel control. The Remote indicator on the front panel extinguishes if the HP 3325B is in Remote prior to the Local command.

Local Lockout

The *local lockout* command disables the Local front panel key to avoid operator interference. The HP 3325B front panel is locked out.

Parallel Poll

The *parallel poll* command is a controller operation used to obtain information from the devices under its control. The HP 3325B does not respond to this bus command.

Pass Control

The *pass control* command shifts system control from one controller to another. The HP 3325B does not respond to this command.

Remote

The *remote* command directs an instrument to take instructions from the HP-IB instead of the instrument's front panel. To implement the remote command, the controller must set the REN bus management line true. When the HP 3325B accepts the remote command, the Remote front panel indicator illuminates and the front panel is disabled except for the Local key which can return control of the instrument to the front panel if pressed. If the *local lockout* message is also issued, the mode cannot be changed from remote to local via the front panel [Local] key.

Serial Poll

The *serial poll* is issued by the active controller along with a specific address. If the address matches the address setting of the HP 3325B, it responds by putting its status byte on the data lines for the controller to read. The HP 3325B status byte consists of eight bits indicating the states of several operating parameters (refer to "The Status Byte").

Service Request

The *service request* (SRQ) bus management line is used by a device to indicate a need for attention from the controller. When the HP 3325B requires service (as is determined by the setting of the status byte mask) it issues an SRQ (pulls the SRQ line low), sets bit 6 of the status byte (see the "Status Byte"), and illuminates the front panel SRQ indicator. The SRQ is cleared by executing a serial poll of the HP 3325B. Bit 6, the require-service bit, is sometimes referred to as the status bit in connection with a poll. Bits 0, 1, 2, and 3 in the status byte may initiate an SRQ, depending on the setting of the status byte mask. The status byte may be masked to select which of the four bits cause the HP 3325B to issue the SRQ.

Trigger

The *group execute trigger* (GET) or *selective device trigger* (SDT) command causes all addressed instruments with HP-IB trigger capability to execute a predefined function simultaneously. The HP 3325B responds to the HP-IB trigger command by starting a single sweep, providing the HP 3325B is in the enhancements mode and the sweep was reset using the RSW command.

Masking The Status Byte

The HP 3325B MS and ESTB commands specify which bits in the status byte are enabled (to generate an SRQ). These commands are described under the HP 3325B Remote Control Command Set. Table 2-3 describes the HP 3325B status byte and lists the decimal value of each bit position.

The Status Byte

The status byte is an eight-bit word transmitted by the HP 3325B in response to a serial poll. The state of each bit indicates the status of an internal HP 3325B function. Table 2-3 describes the HP 3325B status byte bit positions and the events and conditions that set and reset each bit. A status bit is enabled (set) when the condition it represents changes from false to true. When a bit is enabled, bit 6 is also set and an SRQ is generated if the Boolean AND of the status byte and the status byte mask is not equal to zero. See the MS command and table 2-3 for more information on masking the status byte.

Table 2-3. HP 3325B Status Byte

| Bit | Value | Description |
|-----|-------|--|
| B0 | 1 | ERR. Program or front panel entry error. Use IER or ERR? to query for error number. Set when an error occurs. Cleared by a serial poll, QSTB?, or power on. Not cleared by HP-IB clear, *RST, ERR?, or IER commands. |
| B1 | 2 | STOP. Sweep stopped; set by completion of a single sweep or by and command that stops a single sweep. Cleared by a serial poll, QSTB?, or starting a sweep. Not cleared by the HP-IB clear command, *RST command, or a single sweep reset. |
| B2 | 4 | START. Sweep started. Set when a dingle or continuous sweep starts. Cleared by serial poll, QSTB?, completion of a single sweep, or any command that stops a sweep. |
| B3 | 8 | FAIL. Hardware failure. Set by Self Test failure, Calibration failure, External Reference Unlock, Oscillator Unlocked, or Memory Lost conditions. Cleared by power-on, serial poll, and QSTB?. Not cleared by HP-IB clear or *RST. |
| B4 | 16 | Bit 4. Always zero. |
| B5 | 32 | SWEEP. Set when a sweep is in progress, clear when a sweep is not in progress. Cannot be configured to cause SRQ. |
| B6 | 64 | Require Service. Set when the HP 3325B requires service (sent an SRQ). Its main function is to identify the instrument as having requested service when it is polled by the controller. It is set by the occurrence of an event which sets the ERR, STOP, START, or FAIL bits (if they are not masked; see the MS command and table 2-34). Cleared by a serial poll or QSTB? command, an HP-IB clear command, a *RST (reset) command, when the HP 3325B is preset (front panel), or when power is cycled. NOTE: this status bit is not set if one of the bits which sets it is set but masked, and is then unmasked. Recommend you poll after changing the mask. |
| B7 | 128 | BUSY. Set while a command is being executed, clear when instrument is not busy. Cannot be configured to enable SRQ. |

Remote Operation via RS-232 Interface

Description of the RS-232 Interface

The RS-232 interface provides a serial data communications link between the HP 3325B and controllers such as desktop computers.

Note The RS-232C interface can be used when it is not possible or feasible to use the HP-IB. Never try to use both the RS-232 interface and HP-IB at the same time.

Serial data communication differs from the HP-IB in that serial data is transmitted one bit at a time while the HP-IB moves a byte (eight bits) at a time. The serial data format is shown in figure 2-2.

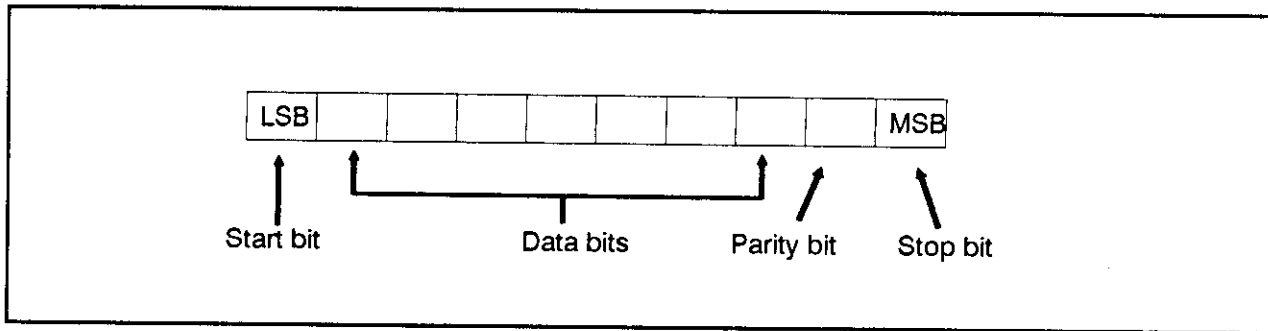

Figure 2-2. Serial Word Configuration

The HP 3325B RS-232 interface implements a subset of the signals defined in ANSI/EIA-232-D-1986 and CCITT V.24. The connector is a standard 25-pin female connector configured as Data Terminal Equipment (DTE). The HP 3325B sends and receives ASCII characters using an asynchronous format.

Table 2-4. RS-232 Connector Pin Assignments

| Pin No. | Signal Name and Description |
|---------|---|
| 1 | Shield: Connected to the HP 3325B chassis. |
| 2 | BA or TXD (transmit data): Bit-serial data transmitted from the HP 3325B. |
| 3 | BB or RXD (receive data): Bit-serial data received by the HP 3325B. |
| 4 | CA or RTS (request to send): An output from the HP 3325B that is usually +10V. If hardware handshaking is enabled, this signal changes to -10V when the HP 3325B buffer has room for less than 128 characters. |
| 7 | AB or Signal Ground: The reference potential for other signals. Note: <i>to prevent ground loops, the HP 3325B RS-232 interface circuits are isolated from earth ground and from signal ground.</i> |
| 20 | CD or DTR (data terminal ready): An output from the HP 3325B that is usually +10V. If hardware handshaking is enabled, this signal changes to -10V when the HP 3325B buffer has room for less than 128 characters. No other pins are connected. |

The Cable

A standard printer cable should be used to connect the HP 3325B to another DTE device such as a computer or terminal. The printer cable switches the receive and send connections, as is necessary when a DTE device is connected to another DTE device. Use an HP 13242G to connect the HP 3325B to a controller with a 25-pin connector. Use an HP 24542G to connect to a 9-pin male connector as may be found on a serial interface in a desktop computer. Use an HP 92221P to connect to a 9-pin female connector as may be found on HP Series 9000/300 computers.

A standard modem cable should be used to connect the HP 3325B to a modem (HP 13242N).

Setting The Switches

Seven switches on the RS-232C rear panel determine the interface's baud rate, active handshake, and parity. All switches are set to the up position at the factory. New settings are recognized immediately displayed on the front panel when a switch setting is changed. The switch settings are defined in the following pages.

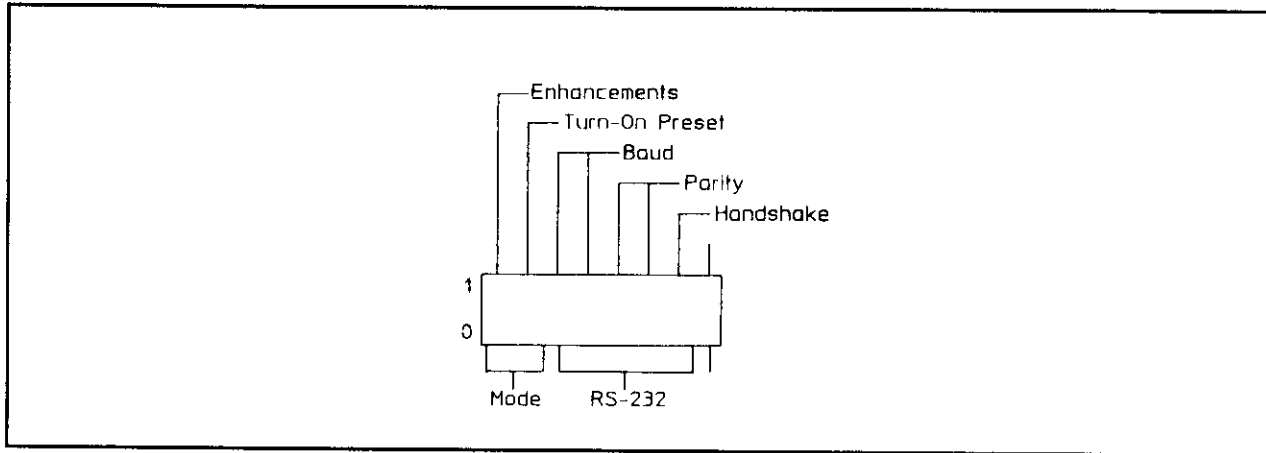

Figure 2-3. Rear-panel RS-232 switches

Mode Settings

Switches 1 and 2 select the enhancements/compatibility setting and the power-on state of the HP 3325B. These two switches are not directly tied to remote operation of the HP 3325B. They are explained here, in the remote control chapter, for the sake of completeness. They are explained again in Chapter 3, General Information.

Enhancements – Switch 1 determines the enhancement setting. *Enhancements* refers to capabilities that are improved on or added to those of the HP 3325A. When the enhancement mode is off, the HP 3325B is in the *compatible* mode. The enhancements mode may also be controlled with the ENH command as described later in this chapter.

Turn-On Preset – Switch 2 determines the turn-on settings. The choice is between the instrument preset state or the state of the instrument when it was last turned off.

Table 2-5. Mode Settings: switches 1 and 2

| | Up | Down |
|---|--------------|------------------------|
| Switch 1 – Enhancements Switch 2 – Turn-on state | on Preset | off Turn-off state* |

* Requires that enhancements be on

Baud Rate

Four different baud rates are available. These are selected by changing rear panel switches numbers three and four as shown in table 2-6. When a switch is changed the new baud rate is displayed on the front panel.

Table 2-6. Baud Rate Selection: switches 3 and 4

| Baud Rate | Switch 3 | Switch 4 |
|-----------|----------|----------|
| 300 | up | up |
| 1200 | up | down |
| 2400 | down | up |
| 4800 | down | down |

Word Length and Parity

Word length and parity are selected by setting switches five and six as shown in table 2-7.

Table 2-7. Switch settings for word length and parity: switches 5 and 6

| Description | Switch 5 | Switch 6 |
|---|----------|----------|
| 7 data bits, 1 parity bit, even parity | up | up |
| 7 data bits, 1 parity bit, odd parity | up | down |
| 8 data bits, no parity | down | up |
| 7 data bits, 1 parity bit, parity bit always 0 (zero) | down | down |

Handshake Selection

Handshaking, or *receive pacing*, is performed by the HP 3325B to prevent its character buffer from overflowing. Data is lost if it is sent to the HP 3325B when its data buffer is full. The data buffer can hold 256 characters. The handshaking may be accomplished with one of two different methods, selected with switch 7: *software handshake* or the *hardware handshake*.

When *software handshaking* is selected, the HP 3325B sends the Xoff character (decimal 19 or DC3) when there is room for less than 128 characters in its buffer. After sending Xoff the HP 3325B processes characters until there is room for 256 characters, when it sends the Xon character (decimal 17 or DC1) to indicate that it is ready for more characters.

The *hardware handshake* performs the same function using hardware connections to signal its readiness for data. Both the RTS (request to send) and DTR (data terminal ready) lines become false (-10V) when there is room for less than 128 characters in the character buffer. This handshake is not recommended when the HP 3325B is connected to a modem since dropping the DTR line may cause the modem to disconnect.

The HP 3325B uses receive handshaking, only. It does not respond when it receives the Xoff character and no hardware connection is made which would signal it to stop sending data. All data sequences sent by the HP 3325B are short enough that transmit pacing should not be necessary.

Table 2-8. Setting the Handshake: switch 7

| Handshake description | Switch 7 |
|---|------------|
| Software (Xon/Xoff) Hardware (DTR/RTS) | up down |

Remote and Local Functions

The first character of a remote command puts the HP 3325B in *Remote Mode* which causes the Remote LED to illuminate. The Talk and Listen LEDs are not used when using the RS-232 interface for remote control. When the HP 3325B receives the "LCL" command or the [Local] front-panel key is pressed, the HP 3325B returns to front-panel control.

Other remote-control commands that are useful for RS-232 operation are ECHO, RMT, *RST, and QSTB. These are described in more detail later in the chapter.

| | |
|-------------|---|
| <i>Note</i> | The RS-232 interface does not alert the controlling computer when the instrument issues a service request (SRQ), as the HP-IB does. We recommend checking the status byte periodically with the QSTB? command when the RS-232 interface is used for remote control. |
|-------------|---|

HP 3325B Remote Operation Command Set

The commands for operating the HP 3325B with a computer controller are listed here. Some of these commands correspond to front-panel keystrokes; the rest are remote-only commands. Remote commands corresponding to front panel keys are described in Chapter 1.

The HP-IB Remote status light, located in the HP-IB Status block on the left side of the front panel, indicates whether the instrument is currently operating under *local* (front panel control) or *remote* control. Remote operation is accomplished only via commands transmitted through one of the two interface connectors located on the rear panel.

| | |
|-------------|---|
| <i>Note</i> | The Remote indicator on the HP 3325B can be used for a quick operational check of the remote interface. If you are using the HP-IB interface, refer to the controller operating manual for a description of the HP-IB Remote message. If you are using the RS-232 interface, send the RMT command. When this message is sent to the HP 3325B, the Remote indicator should illuminate. If this does not occur, check the cabling, the HP 3325B HP-IB address and the syntax of the controller statement (for HP-IB), or the baud rate, word length and parity settings (for RS-232). |
|-------------|---|

Changing from local control to remote control does not alter the current operating state. Changing from local to remote control may be accomplished by issuing a remote command such as REMOTE (HP-IB) or RMT (RS-232).

Changing the HP 3325B from remote control to local control causes the HP 3325B to return to front panel control without changing the operating state. This may be accomplished by either pressing the [Local] key (if local lockout is not in effect), or by issuing a command remote command such as LOCAL (an HP-IB bus message) or LCL (an RS-232 command).

Command Syntax

The following conventions apply to the HP 3325B HP-IB commands:

- The HP 3325B accepts data in 7-bit ASCII code and ignores the 8th (parity) bit.
- All spaces and lower case alphabetic characters are ignored by the HP 3325B; they may be used to improve program readability.
- Under HP-IB control, two data transfer modes are available. Refer to the MD command for more detail. An asterisk or line feed is required to terminate a command string in data transfer mode 2.
- A semicolon can be used to separate commands (recommended but not required).
- Range values may be in integer, real, or exponential form. For positive values, only the first eleven digits of the mantissa are used. For negative values, only the first ten digits of the mantissa are used. Leading zeros before the decimal point are ignored.

The HP 3325B uses the following forms for remote commands:

| Command Form | Example | Example Description |
|---------------------------------|---------|----------------------------------|
| <mnemonic> | AC | Amplitude Calibrate |
| <mnemonic> <data> | FU2 | Square wave function select |
| <mnemonic> <rangedata> <suffix> | AM1.2VO | Amplitude of 1.2 V _{pp} |
| <mnemonic>? | FR? | Interrogate frequency |
| <mnemonic> | IFR | Interrogate frequency |

where:

- **<mnemonic>** is the HP-IB mnemonic
- **<suffix>** is an alphabetic code for units, function, or mode
- **<data>** is a numeric code for a function or mode
- **<range data>** is the value for an entry parameter
- **?** is used to interrogate the HP 3325B.

A program string for the HP 3325B may contain multiple HP-IB commands such as

“FU2 FR 1 MH AM 2 VO FR?”

Interrogating The HP 3325B For Setup Parameters

The value of a setup parameter is read over the HP-IB by sending the parameter HP-IB mnemonic followed by a question mark (?). For example, sending the mnemonic FR? sets up the HP 3325B to respond with the frequency value. HP-IB data is transmitted when the HP 3325B is addressed to talk. RS-232 data is transmitted 100 ms after the interrogation. Each interrogation response ends with the carriage return (ASCII 13) and line feed (ASCII 10) characters. Each interrogation may include command mnemonic and suffix, depending on the setting of the HEAD command.

Remote Operation via RS-232 Interface

Setup parameters include frequency, amplitude, offset, phase, sweep start frequency, sweep stop frequency, sweep marker frequency, sweep time, modulation source frequency, and modulation source amplitude. The current value for a setup parameter is displayed on the HP 3325B front panel if the corresponding HP-IB mnemonic is sent without data and a suffix. For example, sending the mnemonic AM displays the amplitude value but does not change the amplitude value.

The units for the displayed value of a setup parameter change to new units if the corresponding command mnemonic and new suffix are sent without data. For example, sending the mnemonic AM DB displays the current amplitude value in dBm. Sending the AM DB command does not change the amplitude value.

| | |
|-------------|---|
| <i>Note</i> | If the display is disabled with the DSP0 command, the requested value is not displayed. |
|-------------|---|

Command Reference

Syntax Drawing Rules

All characters in circles or ovals are *terminal* symbols and must be sent exactly as shown. Items in boxes are *non-terminal* symbols; descriptions of these items are given following the syntax drawings. Spaces and lower case letters are ignored; they can be inserted to improve readability.

The *Response Format* tables specify what is returned by the instrument in response to a query. All responses are terminated with \langle carriage return \rangle and \langle line feed \rangle with the HP-IB EOI (bus management line) active. The “#” symbol represents one digit.

Definitions

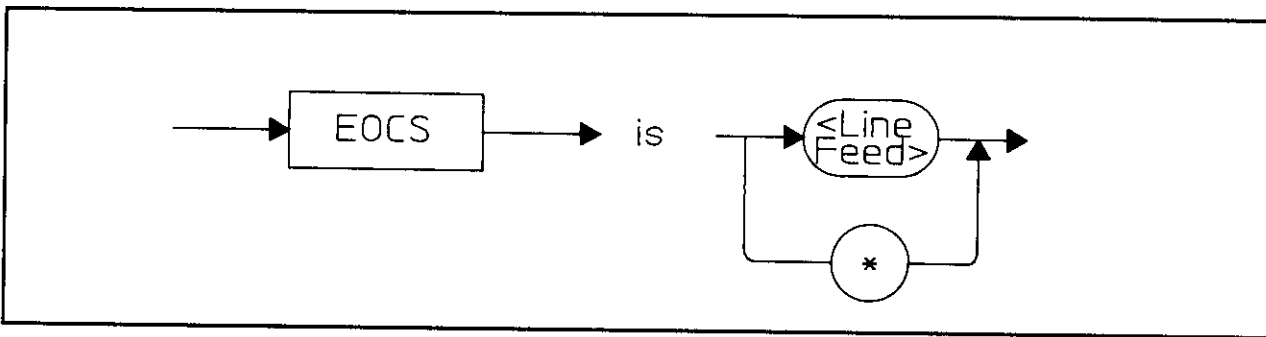

Figure 2-4. Definition of EOCS

The End-Of-Command-String character is used in Data Transfer Mode 2 (see the MD command). In data transfer mode 2, device-dependent commands are accepted and stored in an internal buffer and are not processed until the End-Of-Command-String (EOCS) character is received or the buffer is filled (48 bytes).

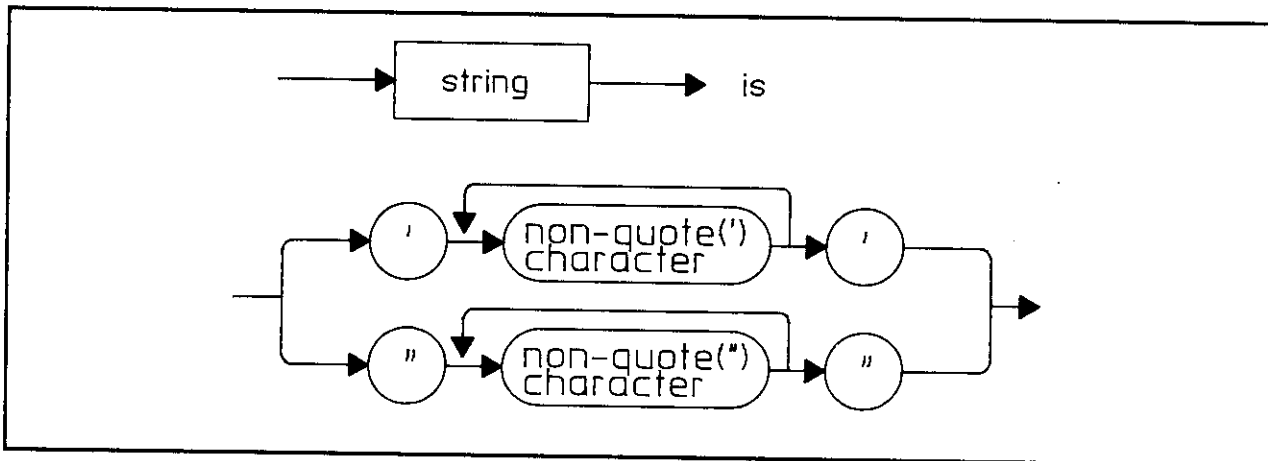

Figure 2-5. Definition of "String"

Strings can not include the End-Of-Command-String characters (* or \langle line feed \rangle).

AC; Amplitude Calibration Command

The AC command performs an amplitude calibration. If calibration is not successful, the FAIL bit of the status register is set.

Command Availability

| | AC |
|----------|-----|
| HP 3325B | Yes |
| HP 3325A | Yes |

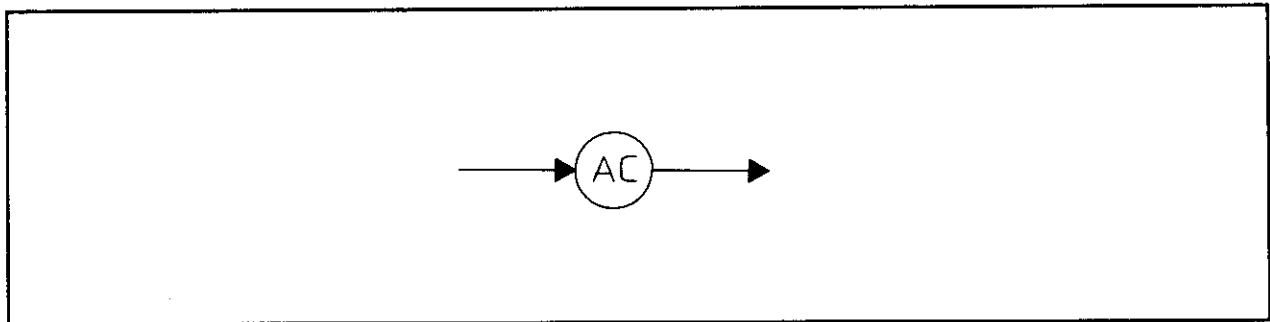

Figure 2-6. AC Syntax Diagram

AM; Amplitude Command

The AM command sets the amplitude of the main signal. Sending AM with no value or units displays the current amplitude. Sending AM and units without any value causes the current amplitude to be displayed in the new units. Issuing IAM or AM? causes the instrument to output its current amplitude. See MOAM to set the amplitude of the modulation source.

Instrument Preset value: 1.0 mV_{pp}

Command Availability

| | AM | IAM | AM? | DV |
|----------|-----|-----|-----|-----|
| HP 3325B | Yes | Yes | Yes | Yes |
| HP 3325A | Yes | Yes | No | No |

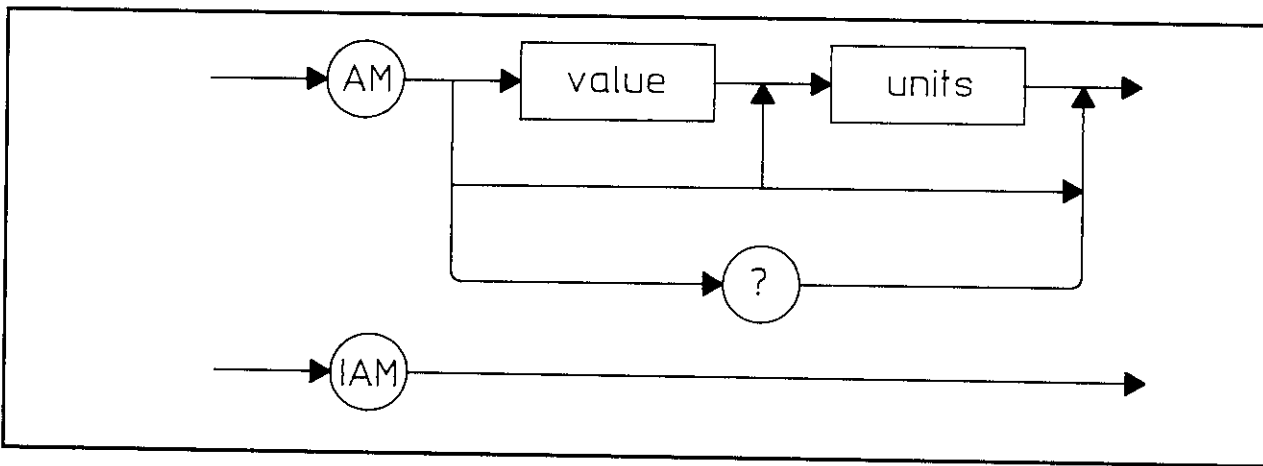

Figure 2-7. AM Syntax Diagram

Table 2-9. AM “value” Restrictions Given “units”

| Value range | Units | Description | High Voltage” |
|-----------------|-------|--------------------|---------------|
| 0.001 → 10.0 | VO | V _{pp} | Off |
| 0.004 → 40.0 | | On | |
| 1.0 → 10000.0 | MV | mV _{pp} | Off |
| 4.0 → 40000.0 | | On | |
| 0.000354 → 3.53 | VR | V _{rms} | Off |
| 0.00142 → 14.1 | | On | |
| 0.354 → 3530.0 | MR | mV _{rms} | Off |
| 1.42 → 14100.0 | | On | |
| -56.02 → 23.98 | DB | dBm | Off |
| Illegal | | | |
| -69.01 → 10.97 | DV | dBV _{rms} | Off |
| -56.97 → 23.01 | | On | |

Table 2-10. AM? and IAM Response Format

| Current Units | HEAD-on response | HEAD-off response |
|--------------------|------------------|-------------------|
| VO or MV | AM#####.#####VO | #####.##### |
| VR or MR | AM#####.#####VR | #####.##### |
| DB or DV | AM-#####.###DB | -#####.### |
| DB or DV (special) | AM-#####.###DV | -#####.### |

AP; Assign Zero Phase Command

The AP command assigns the current phase value to zero; subsequent changes in phase are referenced to that point.

Command Availability

| | AP |
|----------|-----|
| HP 3325B | Yes |
| HP 3325A | Yes |

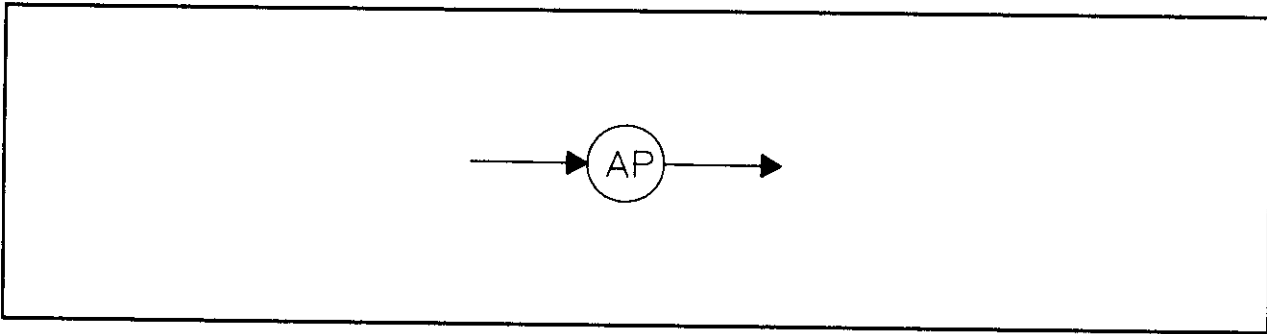

Figure 2-8. AP Syntax Diagram

CALM; Calibration Mode Command

The CALM command allows all functions to be calibrated once. In this mode, function changes are faster.

Instrument Power-on value: 0

Instrument Preset, HP-IB clear value: not changed.

Command Availability

| | CALM |
|----------|-------------|
| HP 3325B | Yes |
| HP 3325A | No |

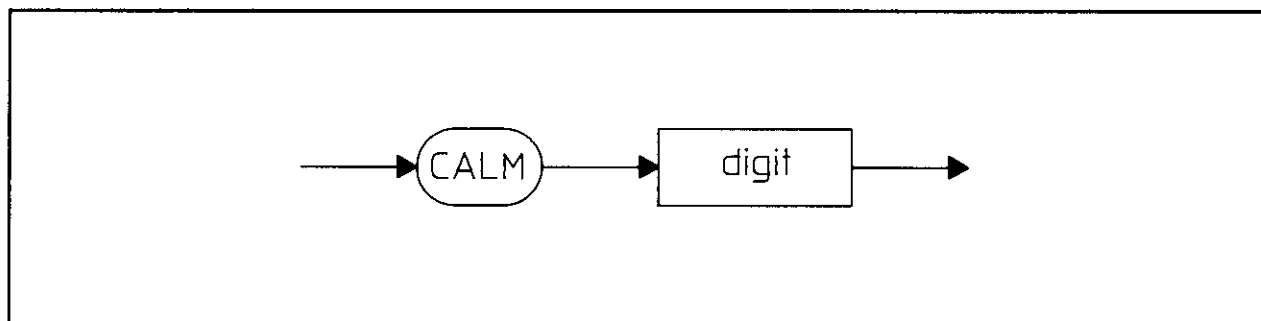

Figure 2-9. CALM Syntax Diagram

| Digit | Meaning |
|--------------|---|
| 0 | Perform an Amplitude Calibration whenever the waveform function is changed. |
| 1 | Perform an Amplitude Calibration on all functions immediately, do not re-calibrate when waveform function is changed. |

DCLR; Discrete Sweep Table Clear Command

The DCLR command clears all previously stored discrete sweep vectors.

Command Availability

| | DCLR |
|----------|-------------|
| HP 3325B | Yes |
| HP 3325A | No |

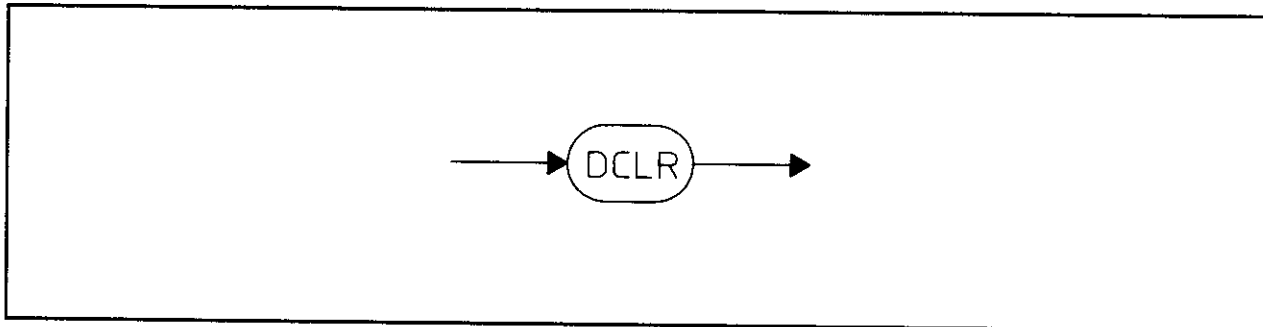

Figure 2-10. DCLR Syntax Diagram

DISP; Display On/Off Command

The DISP command allows the display to be turned off. "DISP OFF" is displayed until the display is turned back on.

Instrument Power-on value: On

Instrument Preset, HP-IB clear value: not changed.

Command Availability

| | DISP |
|----------|-------------|
| HP 3325B | Yes |
| HP 3325A | No |

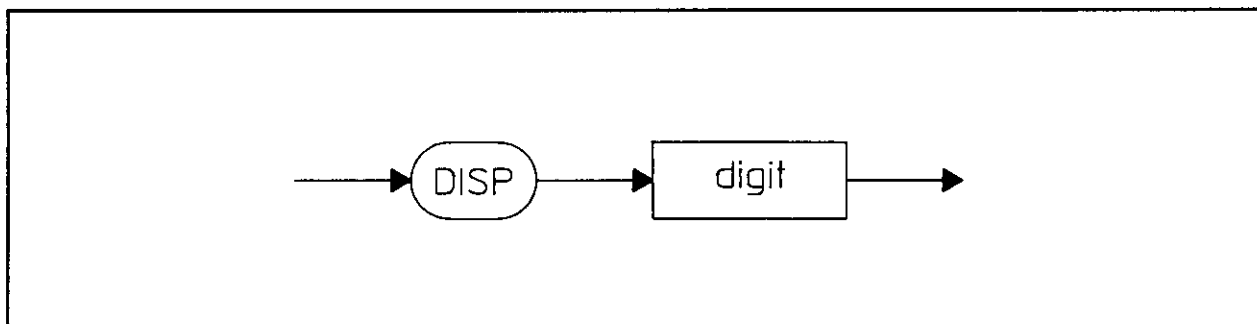

Figure 2-11. DISP Syntax Diagram

| digit | Meaning |
|--------------|----------------|
| 0 | Display off. |
| 1 | Display on. |

DRCL and DSTO; Discrete Sweep Store and Recall Commands

DRCL recalls the discrete sweep vector number specified by the two digits. Start frequency, stop frequency, marker frequency, and sweep time values are overwritten with the recalled values.

DSTO saves the current start frequency, stop frequency, marker frequency, and sweep time values in the discrete sweep vector number specified by the two digits.

Command Availability

| | DRCL | DSTO |
|----------|------|------|
| HP 3325B | Yes | Yes |
| HP 3325A | No | No |

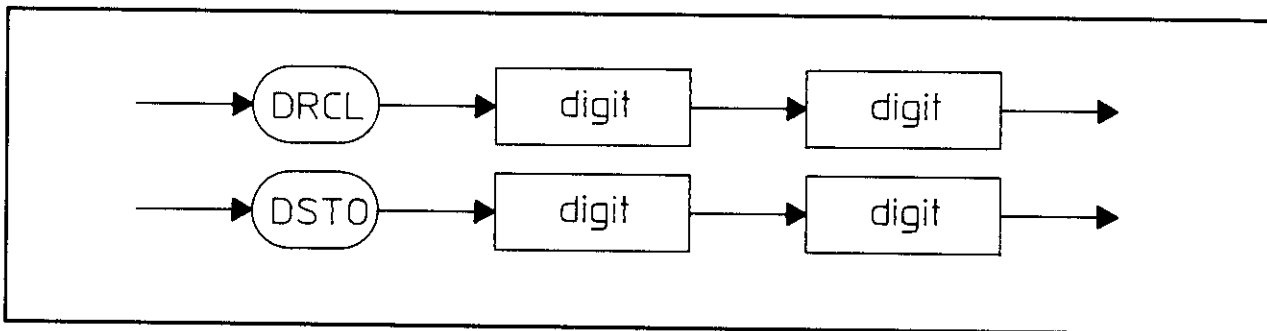

Figure 2-12. DRCL and DSTO Syntax Diagrams

DSP; Display String Command

The DSP command allows a message to be put in the instrument's display. Some alphabetic characters may be hard to distinguish when displayed in the 7-segment numeric displays.

Command Availability

| | DSP |
|----------|-----|
| HP 3325B | Yes |
| HP 3325A | No |

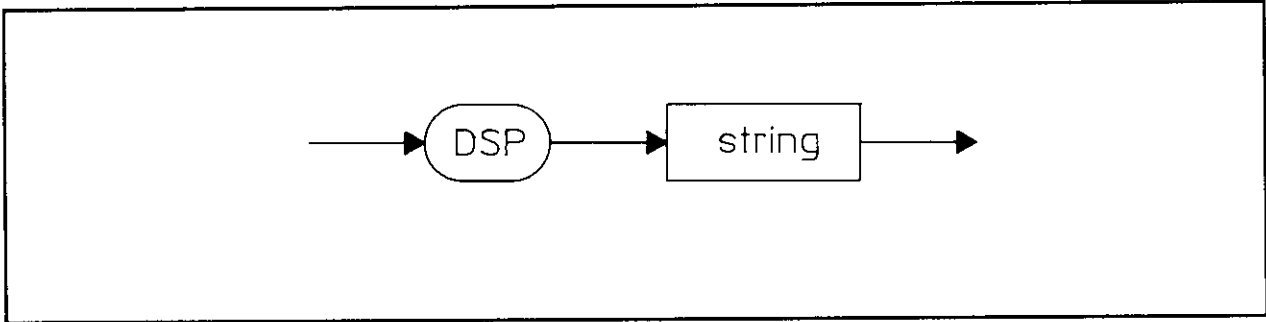

Figure 2-13. DSP Syntax Diagram

ECHO; RS-232 Echo-Control Command

The ECHO command enables echoing of in-bound RS-232 characters. This is useful when using a full-duplex terminal to program the HP 3325B. The carriage return character is echoed as <carriage return> and <line feed>.

Instrument Preset, HP-IB clear value: not changed

Instrument Power-on value: 0

Command Availability

| ECHO | |
|----------|-----|
| HP 3325B | Yes |
| HP 3325A | No |

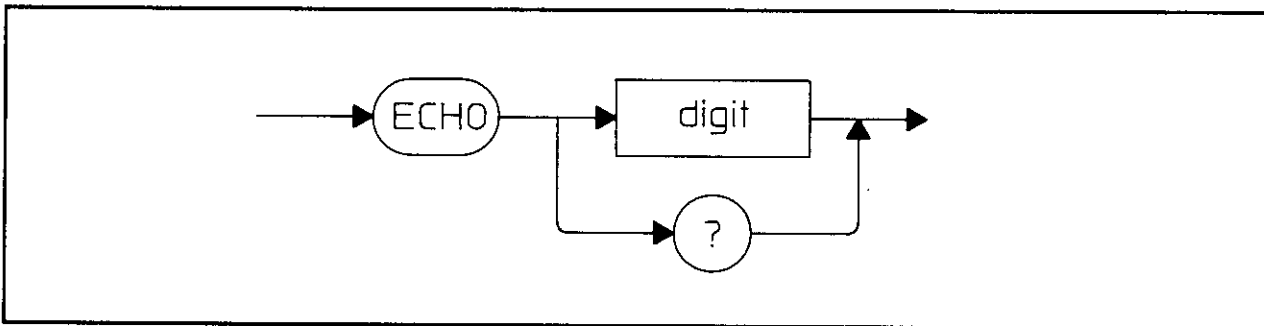

Figure 2-14. ECHO Syntax Diagram

| digit | Meaning |
|-------|-------------------------|
| 0 | Do not echo characters. |
| 1 | Echo characters. |

Table 2-11. ECHO? Response Format

| HEAD-on response | HEAD-off response |
|------------------|-------------------|
| ECHO# | # |

ENH; Enhancements Control Command

The ENH command selects between the *enhancements* mode and the *compatibility* mode. In the *enhancements* mode, new features of the HP 3325B are enabled. In the *compatibility* mode, some new features are disabled, but only those which may cause compatibility problems. Refer to Chapter 3, General Information, for a description of the differences in the two settings.

Instrument Preset, HP-IB clear value: not changed

Instrument Power-on value: rear-panel switch setting

Command Availability

| | ENH |
|----------|-----|
| HP 3325B | Yes |
| HP 3325A | No |

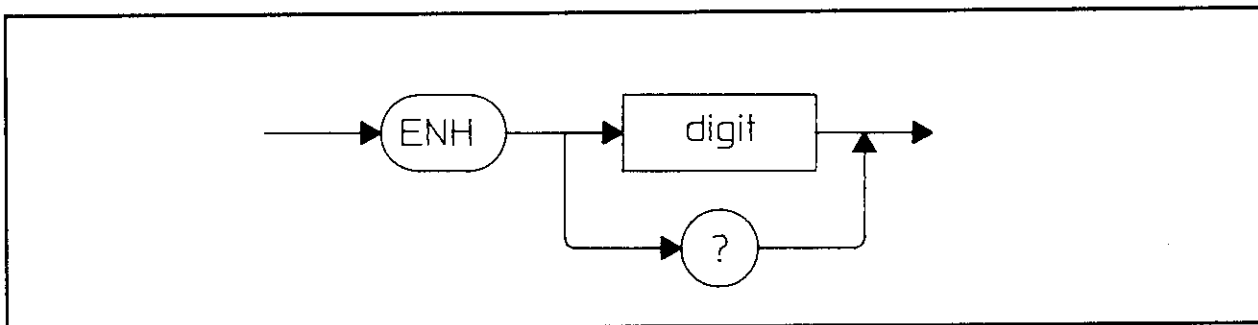

Figure 2-15. ENH Syntax Diagram

| digit | Meaning |
|-------|--------------------------------|
| 0 | Select the compatibility mode. |
| 1 | Select the Enhancements mode. |

Table 2-12. ENH? Response Format

| HEAD-on response | HEAD-off response |
|------------------|-------------------|
| ENH# | # |

ERR? and IER; Error Query

These commands query the instrument for the most recent error code. The IER query returns a one-digit code. The ERR? query returns a three-digit code, the first digit of which is the same as the IER query; the other two digits provide more detail as described in table 2-51 later in this chapter. If no error occurred, 0 is returned. Issuing either command clears both error codes to 0.

Instrument Power-on: Clears any errors.

Instrument Preset, HP-IB Clear: Clears any errors.

Command Availability

| | ERR? | IER |
|----------|------|-----|
| HP 3325B | Yes | Yes |
| HP 3325A | No | Yes |

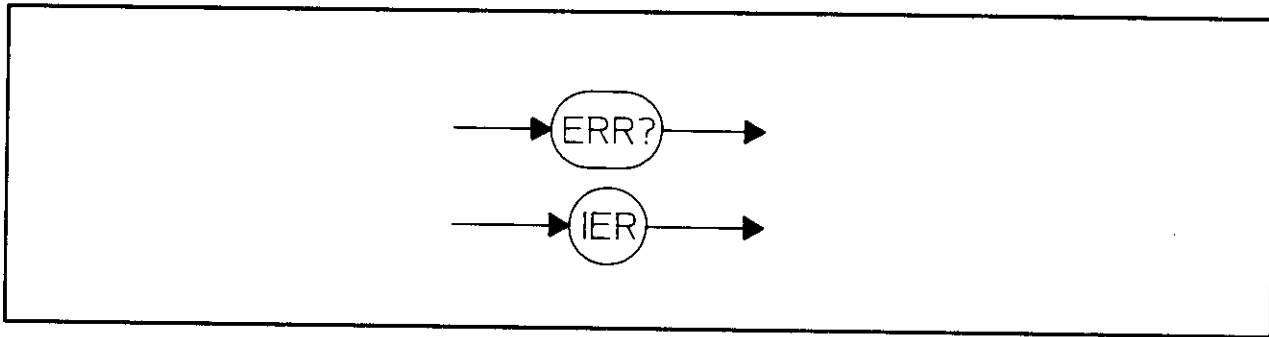

Figure 2-16. ERR Syntax Diagram

Table 2-13. ERR? and IER Response Formats

| Command | HEAD-on response | HEAD-off response |
|---------|------------------|-------------------|
| ERR? | ERR### | ### |
| IER | ER# | # |

ESTB; Service Request Enable Command

The ESTB command is used to set the status byte mask. Four lists in the status byte are capable of causing a service request (SRQ). When they are enabled (unmasked). They may be enabled or masked in any combination as defined in the table 2-34. The MS Command accomplishes the same thing using alpha characters instead of decimal characters.

In the syntax diagram of Figure 2-17, **value** is a decimal number whose binary (base 2) equivalent represents the bits of the Status Register. The range of **value** is 0 thru 15.

Instrument Power-on value: 0 (all masked)

Instrument Preset, HP-IB-clear value: not changed

Command Availability

| | ESTB | ESTB? |
|----------|------|-------|
| HP 3325B | Yes | Yes |
| HP 3325A | No | No |

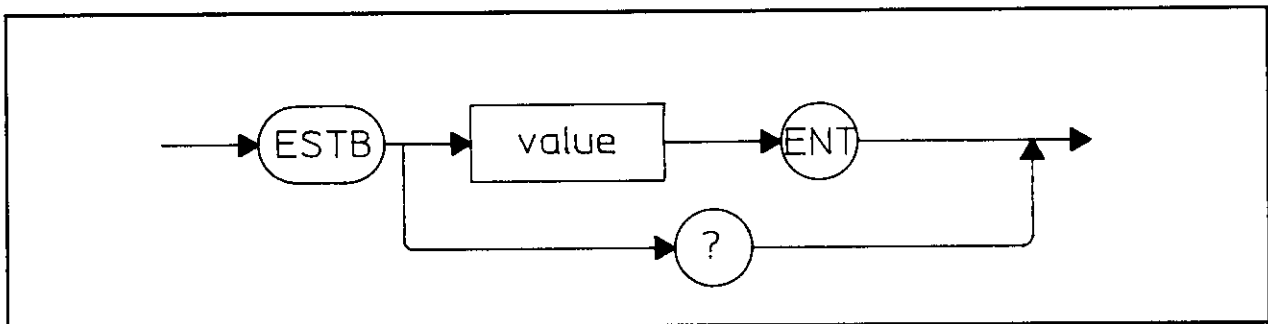

Figure 2-17. ESTB Syntax Diagram

Table 2-14. Status-Register Bits that can be enabled to cause SRQ

| Bit | Value | Name | Description |
|-----|-------|-------|----------------------------------|
| 0 | 1 | ERR | Program or keyboard entry error. |
| 1 | 2 | STOP | Sweep stopped. |
| 2 | 4 | START | Sweep started. |
| 3 | 8 | FAIL | Hardware failure. |

Table 2-15. ESTB? Response Format

| HEAD-on response | HEAD-off response |
|------------------|-------------------|
| ESTB###ENT | ### |

EXTR?; External Reference Locked Query

The EXTR? query returns 1 if the reference oscillator is locked to an external input, 0 if not.

Command Availability

| | EXTR |
|----------|------|
| HP 3325B | Yes |
| HP 3325A | No |

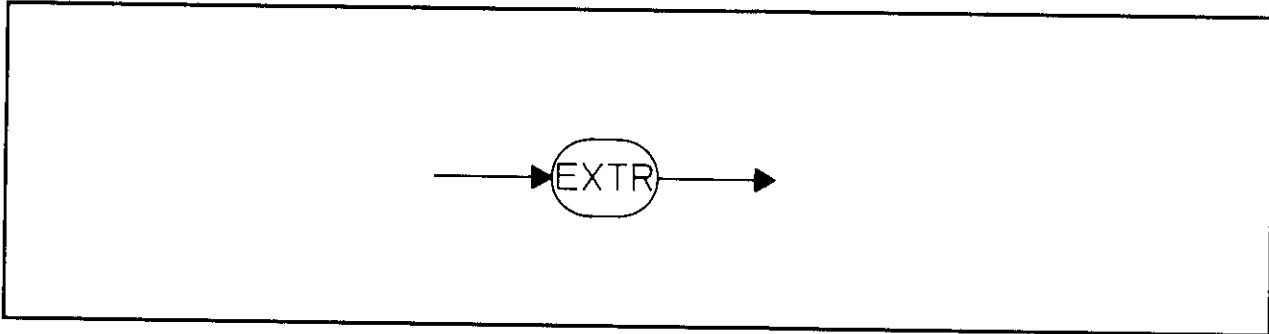

Figure 2-18. EXTR? Syntax Diagram

Table 2-16. EXTR? Response Format

| HEAD-on response | HEAD-off response |
|------------------|-------------------|
| EXTR# | # |

FR; Frequency Command

The FR command sets the frequency. Sending FR with no value or units displays the current frequency. IFR and FR? cause the instrument to output its current frequency. See MOFR to set the frequency of the modulation source.

Instrument Preset value: 1000.0 Hz

Command Availability:

| | FR | IFR | FR? |
|----------|-----|-----|-----|
| HP 3325B | Yes | Yes | Yes |
| HP 3325A | Yes | Yes | No |

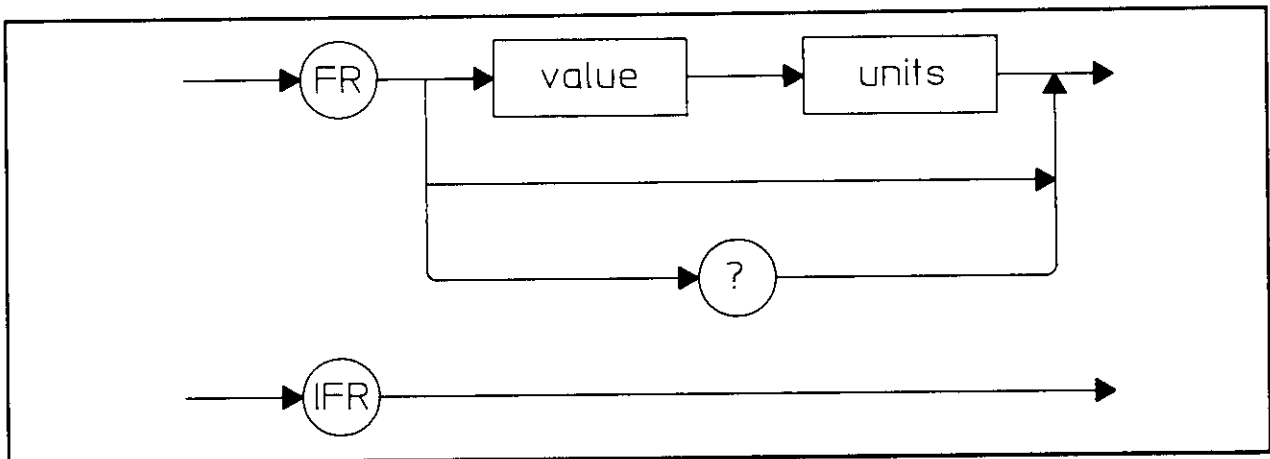

Figure 2-19. FR Syntax Diagram

Table 2-17. FR “value” Restrictions Given “units”

| Units | Description | Range Restrictions for “value” (sine) |
|-------|-------------|---------------------------------------|
| HZ | Hertz | 0.0 → 60999999.999 |
| KH | kHz | 0.0 → 60999.999999 |
| MH | MHz | 0.0 → 60.999999 |

Table 2-18. FR? and IFR Response Format

| μ Hz programmed | HEAD-on response | HEAD-off response |
|---------------------|------------------|-------------------|
| No | FR#####.###HZ | #####.### |
| Yes | FR#####.#####HZ | #####.##### |

FU; Waveform Function Command

The FU command selects the waveform function for the main signal output.

Instrument Preset value: 1

Command Availability

| | FU | IFU | FU? |
|----------|-----|-----|-----|
| HP 3325B | Yes | Yes | Yes |
| HP 3325A | Yes | Yes | No |

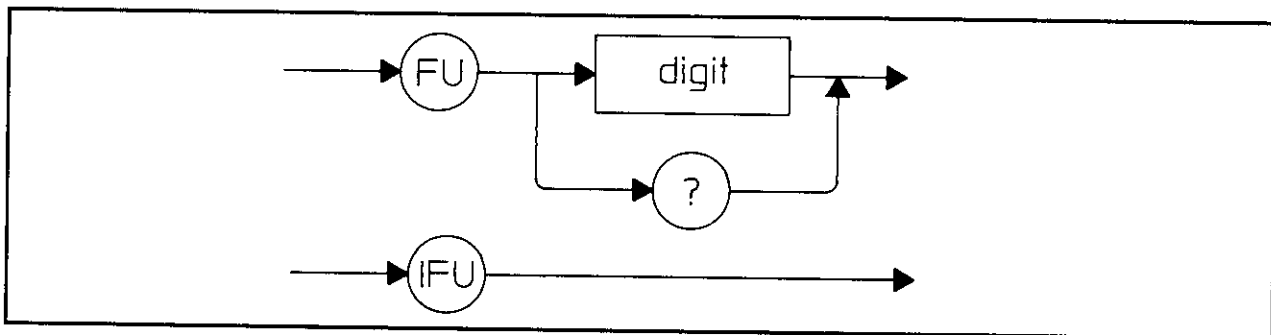

Figure 2-20. FU Syntax Diagram

Table 2-19. Waveform Selections for "digit"

| digit | Waveform |
|-------|------------------------|
| 0 | Selects DC only. |
| 1 | Selects Sine wave |
| 2 | Selects Square wave. |
| 3 | Selects Triangle wave. |
| 4 | Selects Positive ramp. |
| 5 | Selects Negative ramp. |

Table 2-20. FU? and IFU Response Format

| HEAD-on response | HEAD-off response |
|------------------|-------------------|
| FU# | # |

HEAD; Response Header Control Command

The HEAD command enables or disables the alpha header (and units suffix) for query responses. With HEAD on, the response can be used to re-program the item. With HEAD off, only the numerics are sent which can make it easier to read into a numeric variable in a program.

Instrument Power-on value: 1.

Instrument Preset, HP-IB clear value: not changed.

Command Availability:

| HEAD | |
|----------|-----|
| HP 3325B | Yes |
| HP 3325A | No |

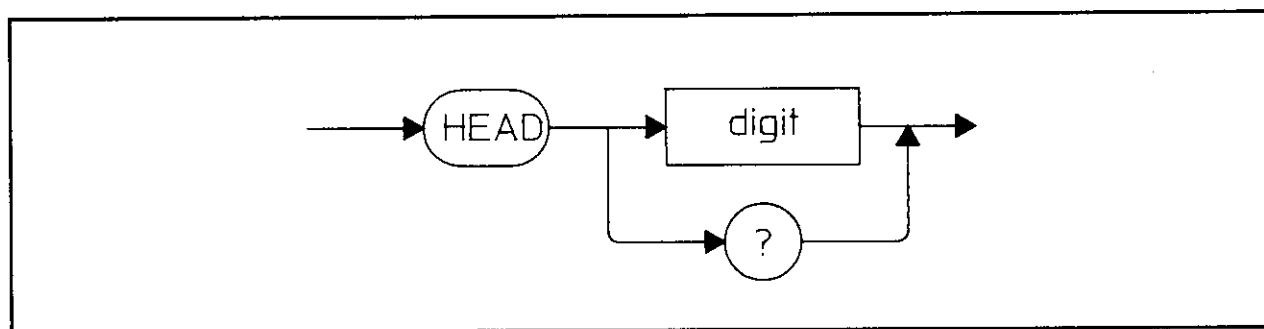

Figure 2-21. HEAD Syntax Diagram

| "Digit" | Mode |
|---------|--------------------------|
| 0 | Selects header OFF mode. |
| 1 | Selects header ON mode. |

Table 2-21. HEAD? Response Format

| HEAD-on response | HEAD-off response |
|------------------|-------------------|
| HEAD# | # |

HV; High Voltage Output Command

The HV command controls the High Voltage amplifier option for the main signal output.

Instrument Preset value: 1.

Command Availability

| | HV | IHV | HV? |
|----------|-----|-----|-----|
| HP 3325B | Yes | Yes | Yes |
| HP 3325A | Yes | Yes | No |

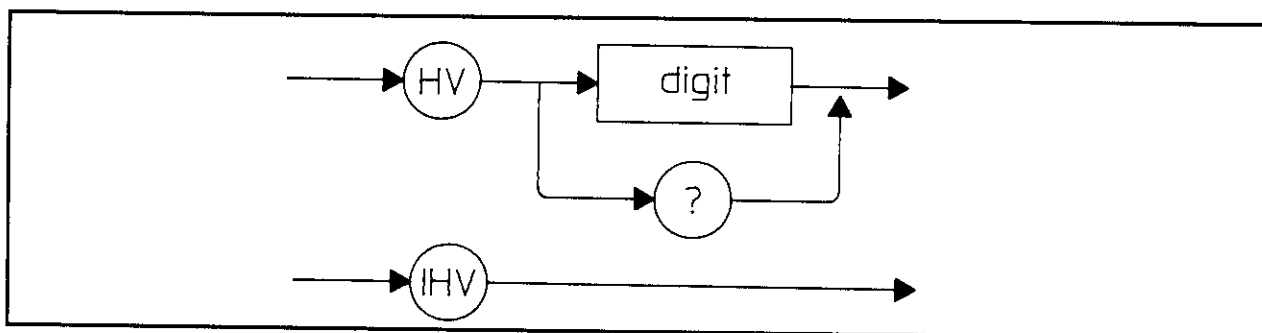

Figure 2-22. HV Syntax Diagram

| digit | Meaning |
|-------|-------------------------------------|
| 0 | Disable the high voltage amplifier. |
| 1 | Enable the high voltage amplifier. |

Table 2-22. HV? and IHV Response Format

| Option Installed | HEAD-on response | HEAD-off response |
|------------------|------------------|-------------------|
| Yes | HV# | # |
| No | RF# | # |

ID?, *IDN?; Identification Query

This query returns the instrument manufacturer, model number, serial number, and firmware revision code.

Note In data transfer mode 2, an asterisk terminates a command string. Therefore use IDN?, without an asterisk, in data transfer mode 2.

Command Availability

| | *IDN? | ID? |
|----------|--------------|------------|
| HP 3325B | Yes | Yes |
| HP 3325A | No | No |

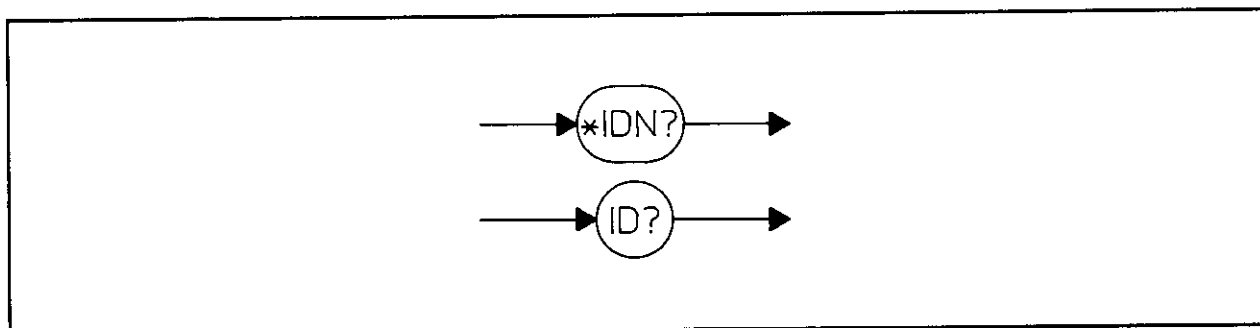

Figure 2-23. ID? and *IDN? Syntax Diagrams

Table 2-23. ID? and *IDN? Response Format

| ID? response | *IDN? response |
|---------------------|---------------------------------------|
| HP3325B | HEWLETT-PACKARD,3325B,2800A00000,2800 |

LCL; Local Command

The LCL command places the instrument in *local mode* and clears any local lockout. This command has the same effect as the HP-IB *local bus* command but can be issued when using the RS-232 interface.

Command Availability

| LCL | |
|------------|-----|
| HP 3325B | Yes |
| HP 3325A | No |

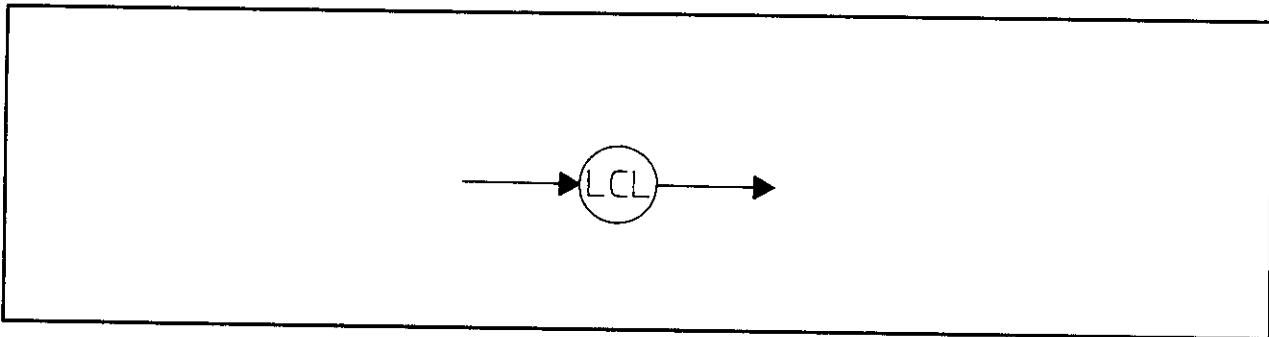

Figure 2-24. LCL Syntax Diagram

MA; Amplitude Modulation Command

The MA command enables and disables amplitude modulation of the main signal output. Amplitude modulation is only valid for sine waves.

Note If MA is enabled and no signal is applied to the AMPTD MOD input, the main signal amplitude is one half of its programmed value since 0 Volts corresponds to 50% modulation.

Instrument Preset value: 0.

Command Availability

| | MA | IMA | MA? |
|----------|-----|-----|-----|
| HP 3325B | Yes | Yes | Yes |
| HP 3325A | Yes | Yes | No |

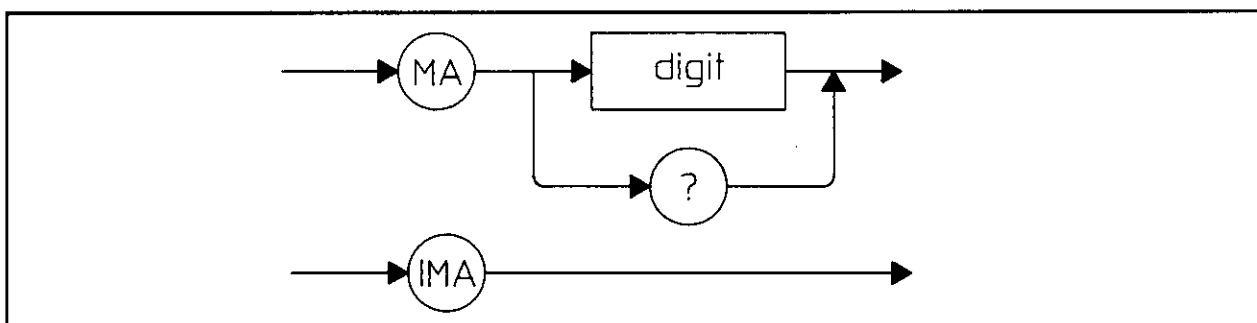

Figure 2-25. MA Syntax Diagram

| "Digit | Meaning |
|--------|-------------------------------|
| 0 | Disable amplitude modulation. |
| 1 | Enable amplitude modulation. |

Table 2-24. MA? and IMA Response Format

| HEAD-on response | HEAD-off response |
|------------------|-------------------|
| MA# | # |

MD; Data Transfer Mode Command

The MD command selects the HP-IB data transfer mode. (This command has no effect when the RS-232 interface is used.) In mode 1, each device-dependent character is processed when received. No other communications are permitted on the bus until the entire HP 3325B program string has been accepted and all but the last character processed. In mode 2, device-dependent characters are accepted and stored in an internal buffer; they are not processed until the End-Of-Command-String (EOCS) character is received or the buffer is filled (48 bytes). Valid EOCS characters are the <line feed> character (ASCII decimal 10) or the asterisk (*) character (ASCII decimal 42).

Instrument Power-on, HP-IB Clear value: 1.

Instrument Preset value: not changed.

Command Availability

| | MD | MD? |
|----------|-----|-----|
| HP 3325B | Yes | Yes |
| HP 3325A | Yes | No |

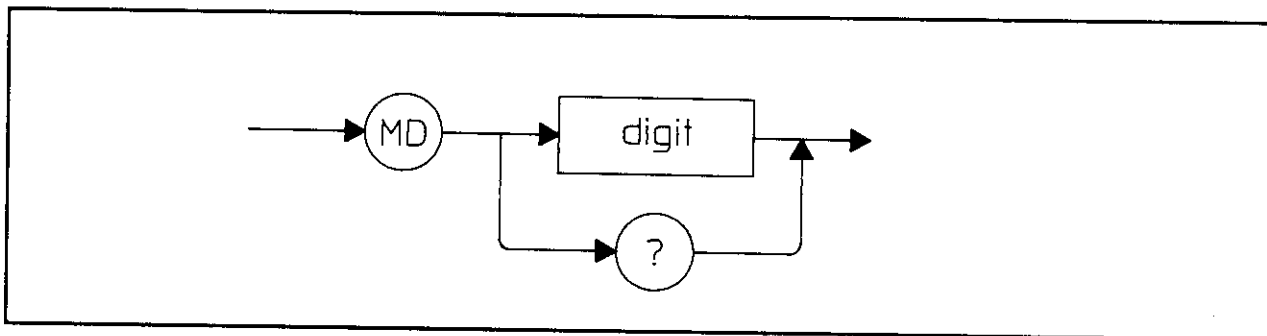

Figure 2-26. MD Syntax Diagram

| Digit" | Meaning |
|--------|--|
| 1 | Each character processed when received. |
| 2 | Characters buffered, EOCS starts processing. |

Table 2-25. MD? and IMD Response Format

| HEAD-on response | HEAD-off response |
|------------------|-------------------|
| MD# | # |

MF; Marker Frequency Command

The MF command sets the marker frequency. Sending MF with no value or units displays the current frequency. IMF and MF? cause the instrument to output its current frequency.

Instrument Preset value: 5.0 MHz

Command Availability

| | MF | IMF | MF? |
|----------|-----|-----|-----|
| HP 3325B | Yes | Yes | Yes |
| HP 3325A | Yes | Yes | No |

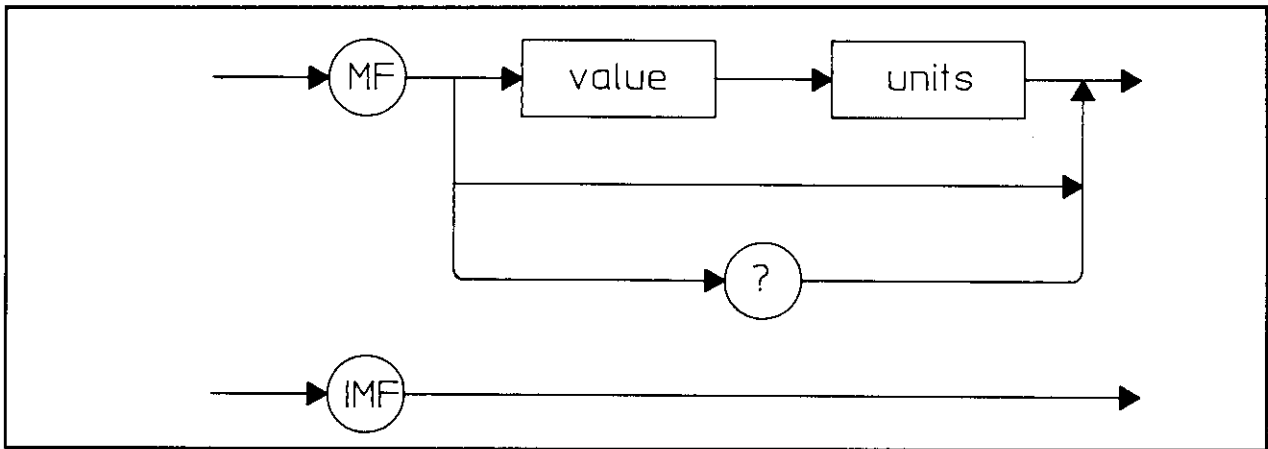

Figure 2-27. MF Syntax Diagram

Table 2-26. MF “value” Restrictions Given “units”

| “Units” | Description | Range Restrictions for “value” |
|---------|-------------|--------------------------------|
| HZ | Hertz | 0.0 → 20999999.999 |
| KH | kilo-Hz | 0.0 → 20999.999999 |
| MH | mega-Hz | 0.0 → 20.999999999 |

Table 2-27. MF? and IMF Response Format

| μ Hz programmed | HEAD-on response | HEAD-off response |
|---------------------|------------------|-------------------|
| No | MF#####.###HZ | #####.### |
| Yes | MF#####.#####HZ | #####.##### |

MOAM; Modulation Source Amplitude Command

The MOAM command sets the amplitude of the modulation signal. Sending MOAM with no value or units displays the current amplitude. Sending MOAM and units without any value displays the current amplitude in the new units. MOAM? causes the instrument to output the current amplitude.

Instrument Preset value: 0.1 Vpp

Command Availability

| | MOAM | MOAM? |
|----------|------|-------|
| HP 3325B | Yes | Yes |
| HP 3325A | No | No |

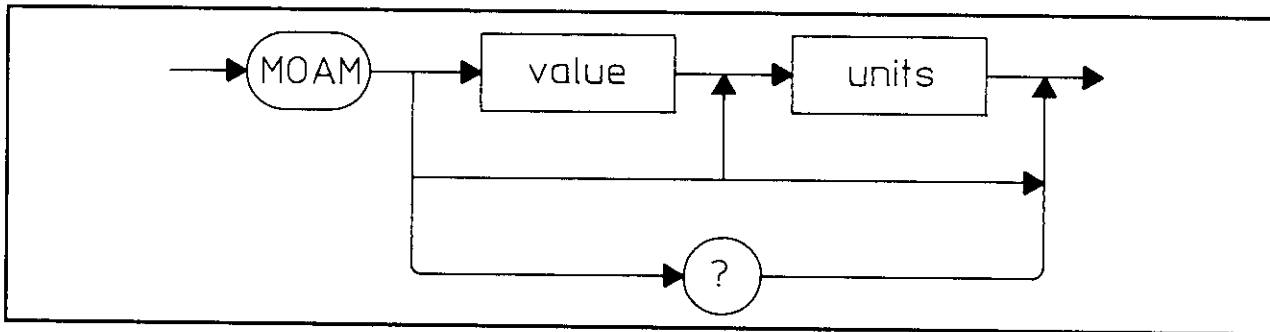

Figure 2-28. MOAM Syntax Diagram

Table 2-28. MOAM “value” Restrictions Given “units”

| value range | units | Description |
|-------------|-------------------|---------------|
| VO | V _{pp} | 0.0 → 12.0 |
| MV | mV _{pp} | 0.0 → 12000.0 |
| VR | V _{rms} | 0.0 → 4.2 |
| MR | mV _{rms} | 0.0 → 4200.0 |

Table 2-29. MOAM? Response Format

| Current Units | HEAD-on response | HEAD-off response |
|---------------|------------------|-------------------|
| VO or MV | MOAM#####VO | ##### |
| VR or MR | MOAM#####VR | ##### |

MOAR; Write Modulation Source Arbitrary Waveform Data

The MOAR command defines an arbitrary waveform for the modulation source. From 1 to 4096 waveform sample points can be programmed. A value of 0 corresponds to 0.0 volts, and +1.0 corresponds to full scale which is half the MOAM voltage (since MOAM is in peak-to-peak). Issuing this command turns the modulation source off, so it should be followed with a MOFU3 command.

When using arbitrary waveforms, the MOFR command sets the frequency at which the entire waveform block is repeated. Only certain discrete frequencies are available and these depend on the number of entries in the waveform. The HP 3325B selects a frequency as near as possible to the value entered with the MOFR command.

Command Availability

| MOAR | |
|----------|-----|
| HP 3325B | Yes |
| HP 3325A | No |

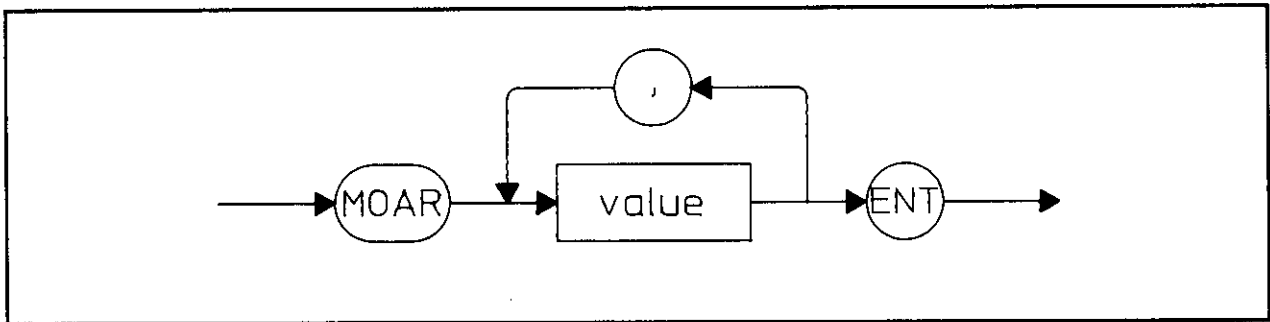
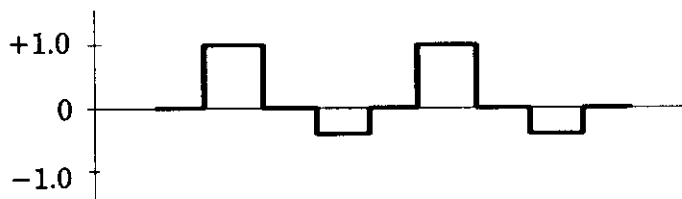

Figure 2-29. MOAR Syntax Diagram

Where *value* is a waveform sample whose value ranges from -1.0 to +1.0.

Example:

MOAR 1,0,- 0.4,0 ENT results in the following waveform:



MOFR; Modulation Source Frequency Command

The MOFR command sets the modulation source frequency. Sending MOFR with no value or units displays the current frequency. Issuing MOFR? causes the instrument to output its current frequency.

- Notes**
- Only two digits of frequency resolution are available.
 - The timebase is not locked to the main signal or an external reference input.
 - Programming the frequency causes the signal to turn off momentarily.

Instrument Preset value: 1000.0 Hz

Command Availability

| | MOFR | MOFR? |
|----------|------|-------|
| HP 3325B | Yes | Yes |
| HP 3325A | No | No |

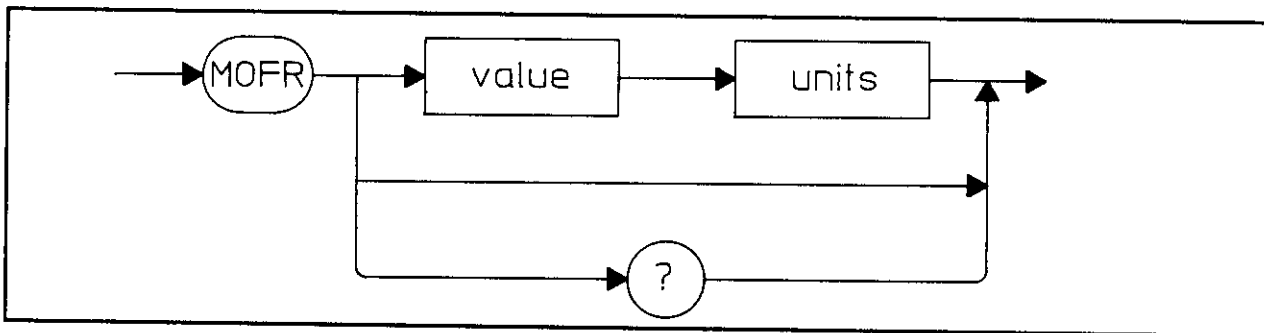

Figure 2-30. MOFR Syntax Diagram

Table 2-30. MOFR "value" Restrictions Given "units"

| Value Range | Units | Description |
|---------------|-------|-------------|
| 0.0 → 10000.0 | HZ | Hertz |
| 0.0 → 10.0 | KH | kilo-Hz |
| 0.0 → 0.01 | MH | mega-Hz |

Table 2-31. MOFR? Response Format

| HEAD-on response | HEAD-off response |
|------------------|-------------------|
| MOFR#####.###HZ | #####.### |

MOFU; Modulation Source Waveform Function Command

The MOFU command selects the waveform function for the modulation source output.

Instrument Preset value: 0.

Command Availability

| | MOFR | MOFR? |
|----------|------|-------|
| HP 3325B | Yes | Yes |
| HP 3325A | No | No |

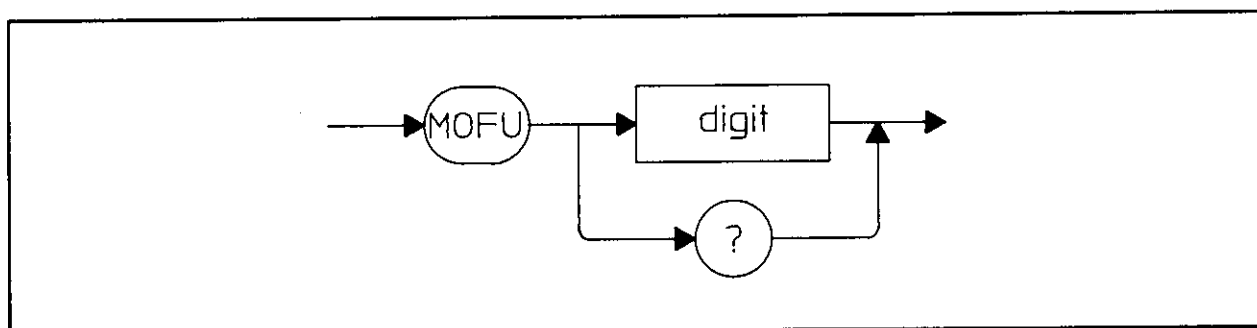

Figure 2-31. MOFU Syntax Diagram

| "Digit" | Waveform |
|---------|-------------------------|
| 0 | All functions off. |
| 1 | Selects Sine wave. |
| 2 | Selects Square wave. |
| 3 | Selects Arbitrary wave. |

Table 2-32. MOFU? Response Format

| HEAD-on response | HEAD-off response |
|------------------|-------------------|
| MOFU# | # |

MP; Phase Modulation Command

The MP command enables and disables phase modulation of the main signal output.

Instrument Preset value: 0.

Command Availability

| | MP | IMP | MP? |
|----------|-----|-----|-----|
| HP 3325B | Yes | Yes | Yes |
| HP 3325A | Yes | Yes | No |

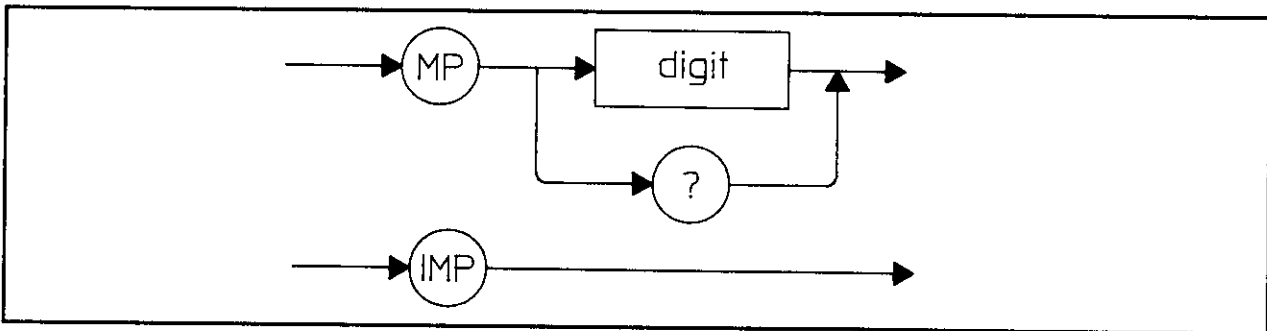

Figure 2-32. MP Syntax Diagram

| "Digit" | Meaning |
|---------|---------------------------|
| 0 | Disable phase modulation. |
| 1 | Enable phase modulation. |

Table 2-33. MP? and IMP Response Format

| HEAD-on response | HEAD-off response |
|------------------|-------------------|
| MP# | # |

MS; Status Byte Mask Command

The MS command is used to set the status byte mask. Four lists in the status byte are capable of causing a service request (SRQ) when they are enabled (unmasked). They may be enabled or masked in any combination as defined in table 2-34. The ESTB command accomplishes the same thing using decimal numbers instead of alphabetic characters.

Instrument Power-on value: @ (no bits enabled).

Instrument Preset, HP-IB Clear value: not changed.

Command Availability

| MS | |
|-----------|-----|
| HP 3325B | Yes |
| HP 3325A | Yes |

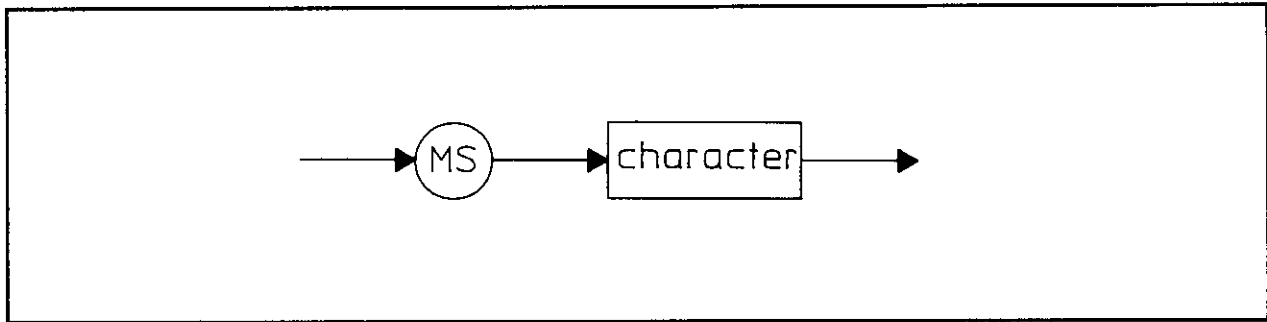

Figure 2-33. MS Syntax Diagram

Table 2-34. Status Byte Mask Characters

| "character" | Status Bits | | | |
|-------------|-------------|--------|--------|--------|
| | FAIL | START | STOP | ERR |
| @ | Mask | Mask | Mask | Mask |
| A | Mask | Mask | Mask | ENABLE |
| B | Mask | Mask | ENABLE | Mask |
| C | Mask | Mask | ENABLE | ENABLE |
| D | Mask | ENABLE | Mask | Mask |
| E | Mask | ENABLE | Mask | ENABLE |
| F | Mask | ENABLE | ENABLE | Mask |
| G | Mask | ENABLE | ENABLE | ENABLE |
| H | ENABLE | Mask | Mask | Mask |
| I | ENABLE | Mask | Mask | ENABLE |
| J | ENABLE | Mask | ENABLE | Mask |
| K | ENABLE | Mask | ENABLE | ENABLE |
| L | ENABLE | ENABLE | Mask | Mask |
| M | ENABLE | ENABLE | Mask | ENABLE |
| N | ENABLE | ENABLE | ENABLE | Mask |
| O | ENABLE | ENABLE | ENABLE | ENABLE |

OF; DC Offset Command

The OF command sets the DC offset of the main signal. Sending OF with no value or units displays the current offset. When programming DC offset with an AC function, the DC offset range is further restricted by the AM setting and the resulting attenuator range. See the discussion in Chapter 1 under the heading "AC with DC Offset."

Instrument Preset value: 0.0 V_{pp}

Command Availability

| | OF | IOF | OF? |
|----------|-----|-----|-----|
| HP 3325B | Yes | Yes | Yes |
| HP 3325A | Yes | Yes | No |

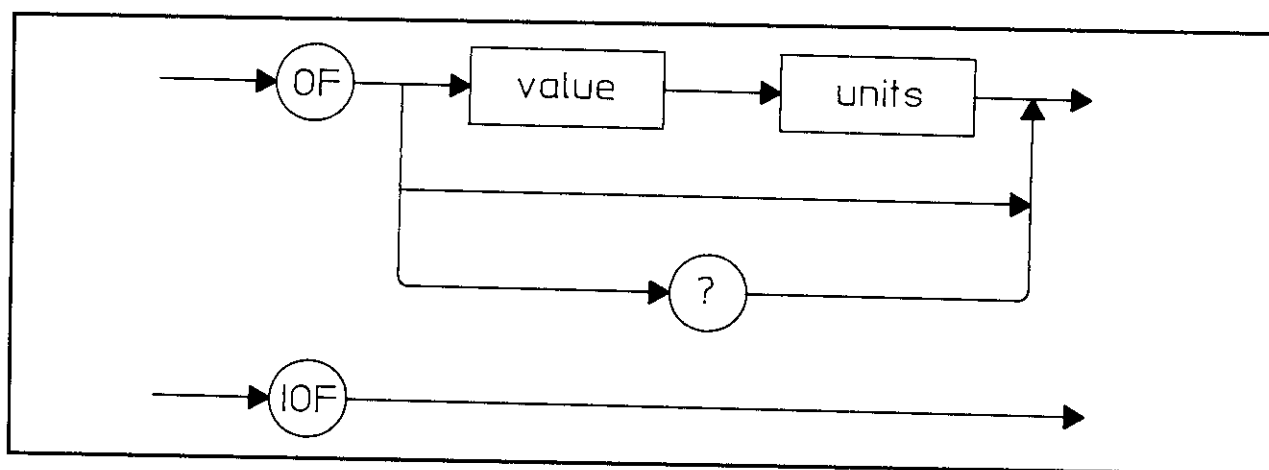

Figure 2-34. OF Syntax Diagram

Table 2-35. OF "value" Restrictions Given "units"

| Units | Description | High Voltage | Value Range(DC only) |
|-------|-------------|--------------|----------------------|
| VO | Volts | Off | -5.0 → 5.0 |
| MV | mVolts | On | -20.0 → 20.0 |
| | | Off | -5000.0 → 5000.0 |
| | | On | -20000.0 → 20000.0 |

Table 2-36. OF? and IOF Response Format

| Current Units | HEAD-on response | HEAD-off response |
|---------------|------------------|-------------------|
| VO or MV | OF#####VO | ##### |

OPT?; Option Query Command

The OPT? query returns a list of the options installed in the instrument.

Command Availability

| OPT? | |
|-------------|-----|
| HP 3325B | Yes |
| HP 3325A | No |

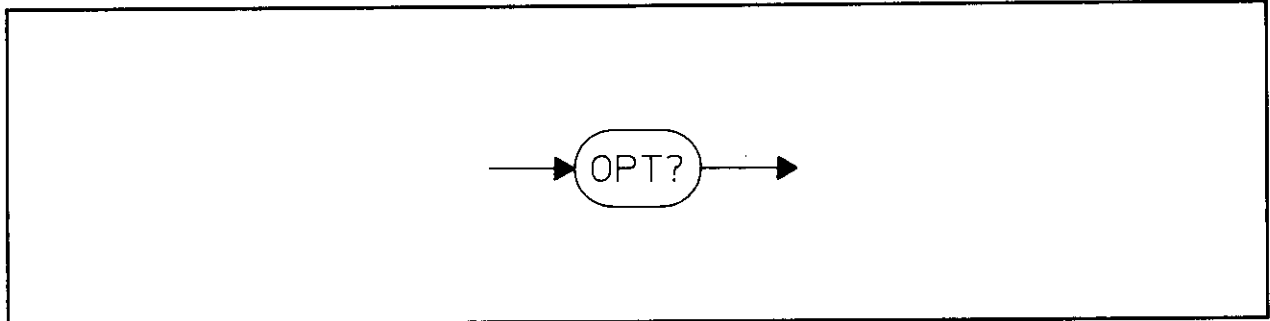

Figure 2-35. OPT? Syntax Diagram

Table 2-37. OPT? Response Format

| Options installed | HEAD-on response | HEAD-off response |
|--------------------------|-------------------------|--------------------------|
| none | OPT0,0 | 0,0 |
| Oven | OPT1,0 | 1,0 |
| High Voltage | OPT0,2 | 0,2 |
| Oven and High V. | OPT1,2 | 1,2 |

PH; Phase Command

The PH command sets the phase of the main signal. Sending PH with no value or units displays the current phase. Values outside the -720 to +720 range are treated as (value modulus 720).

Instrument Preset value: 0.0 Degrees

Command Availability

| | PH | IPH | PH? |
|----------|-----|-----|-----|
| HP 3325B | Yes | Yes | Yes |
| HP 3325A | Yes | Yes | No |

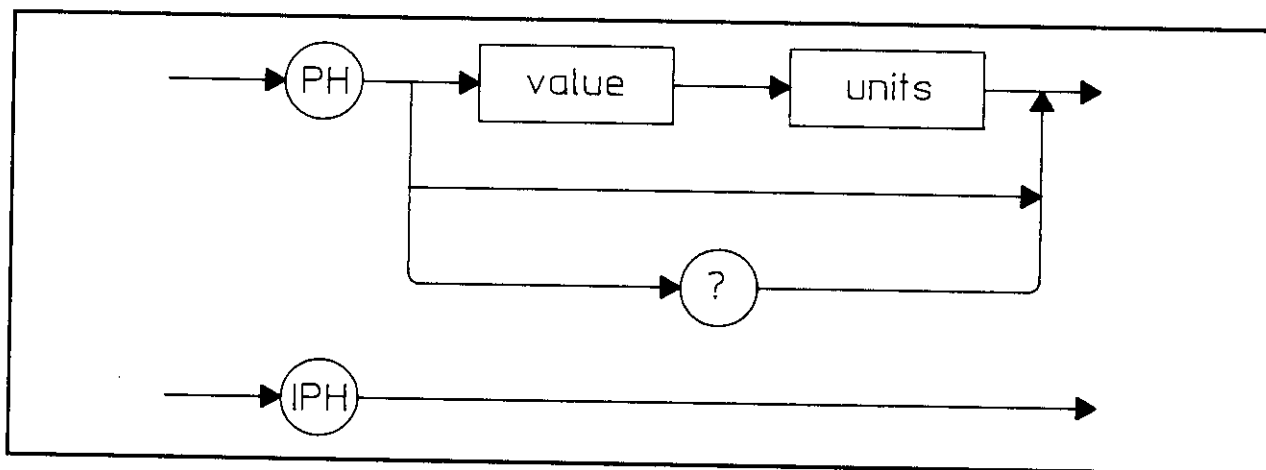

Figure 2-36. PH Syntax Diagram

Table 2-38. PH "value" Restrictions Given "units"

| "Units" | Description | Range Restrictions for "value" |
|---------|-------------|--------------------------------|
| DE | Degrees | -720.0 → 720.0 |

Table 2-39. IPH and PH? Response Format

| HEAD-on response | HEAD-off response |
|------------------|-------------------|
| PH#####.###DE | #####.### |

QSTB; Query Status Byte (RS-232)

The QSTB? query command is used to upload the *status byte* over the RS-232 interface. The HP 3325B responds to this command by returning the contents of the status register in the form of an integer value ranging from 0 to 255. This integer, when converted to binary (base 2), represents the bits of the Status Register. This command reads the same register as the HP-IB *serial poll* and clears the ERR, STOP, START, FAIL and RQS bits of the status byte.

Command Availability

| QSTB? | |
|----------|-----|
| HP 3325B | Yes |
| HP 3325A | No |

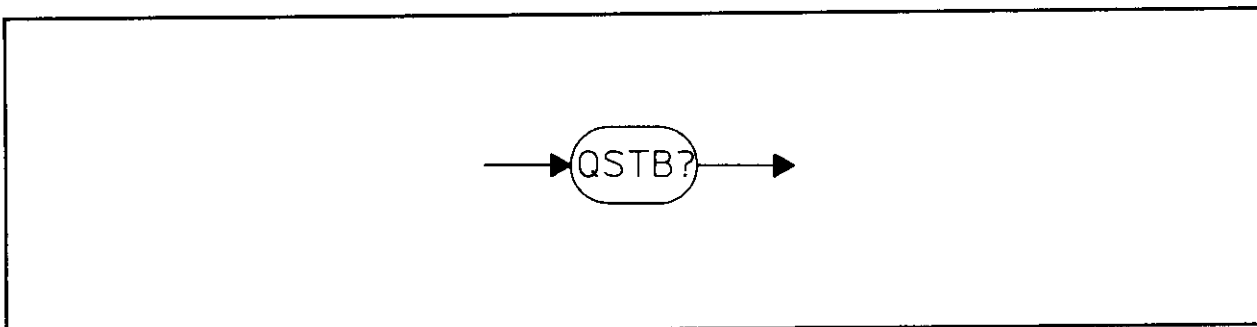

Figure 2-37. QSTB? Syntax Diagram

Table 2-40. Status Register Bit Coding

| Bit | Value | Name | Description |
|-----|-------|-------|---|
| 0 | 1 | ERR | Program or keyboard entry error. |
| 1 | 2 | STOP | Sweep stopped. |
| 2 | 4 | START | Sweep started. |
| 3 | 8 | FAIL | Hardware failure. |
| 4 | 16 | BIT4 | Always zero. |
| 5 | 32 | SWEEP | Sweep in progress. |
| 6 | 64 | RQS | This corresponds to the HP-IB SRQ signal. |
| 7 | 128 | BUSY | Set while a command is being executed. |

Table 2-41. QSTB? Response Format

| HEAD-on response | HEAD-off response |
|------------------|-------------------|
| QSTB### | ### |

RE; Recall State Command

The RE command recalls an instrument setup state from 1 of 11 memory locations. Locations 0 through 9 are programmed with the SR command. Memory location “-” is always the state when power is turned off.

Command Availability

| | RE0 thru RE9 | RE- |
|----------|--------------|-----|
| HP 3325B | Yes | Yes |
| HP 3325A | Yes | No |

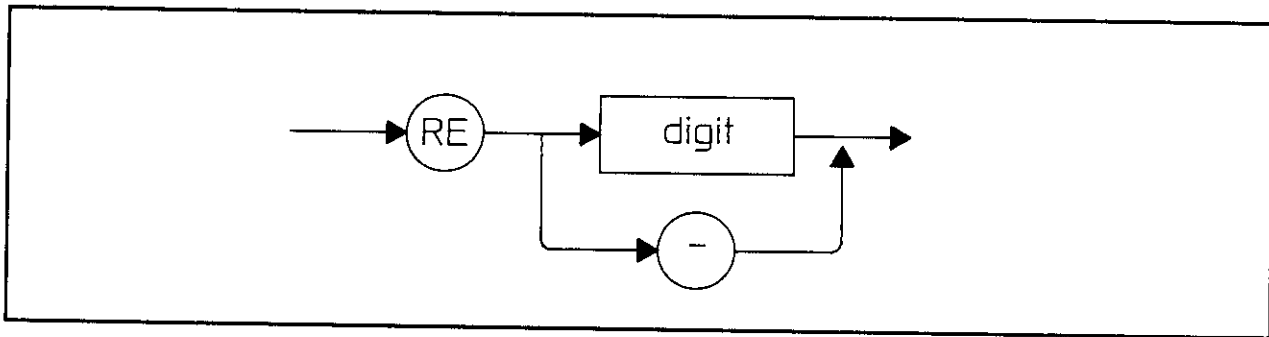

Figure 2-38. RE Syntax Diagram

| “Digit” | Meaning |
|----------------|--|
| 0 → 9 | Recalls state stored in register 0 thru 9. |
| - (minus sign) | Recalls state at power-down. |

RF; Rear or Front Signal Output Command

The RF command determines whether the main signal is present at the rear or front BNC connector.

Instrument Preset value: 1 (front).

Command Availability

| | RF | IRF | RF? |
|----------|-----|-----|-----|
| HP 3325B | Yes | Yes | Yes |
| HP 3325A | Yes | Yes | No |

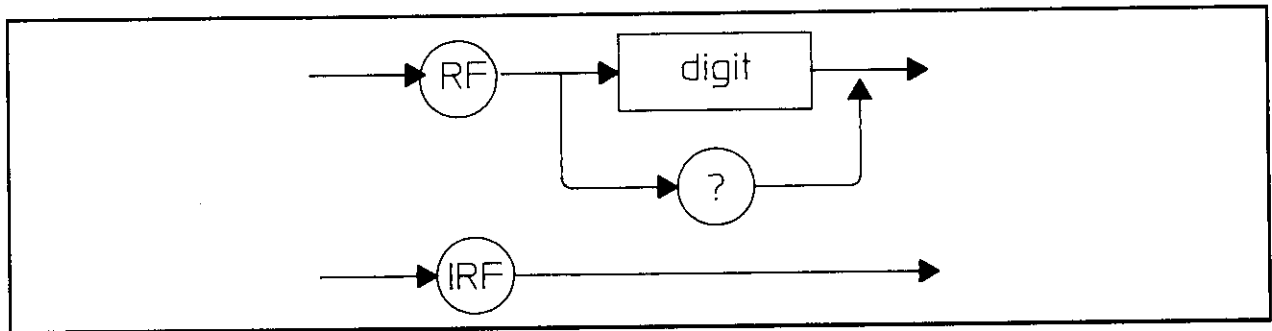

Figure 2-39. RF Syntax Diagram

| "Digit" | Meaning |
|---------|---------------------|
| 1 | Front panel output. |
| 2 | Rear panel output. |

Table 2-42. RF? and IRF Response Format

| HV option | HEAD-on response | HEAD-off response |
|-----------|------------------|-------------------|
| no | RF# | # |
| yes | HV# | # |

RMT; Remote (with Local-Lockout) Command

The RMT command places the instrument in *remote with local lockout* mode. This command has the same effect as the HP-IB Local Lockout bus command but can be programmed using the RS-232 interface.

Command Availability

| | RMT |
|----------|-----|
| HP 3325B | Yes |
| HP 3325A | No |

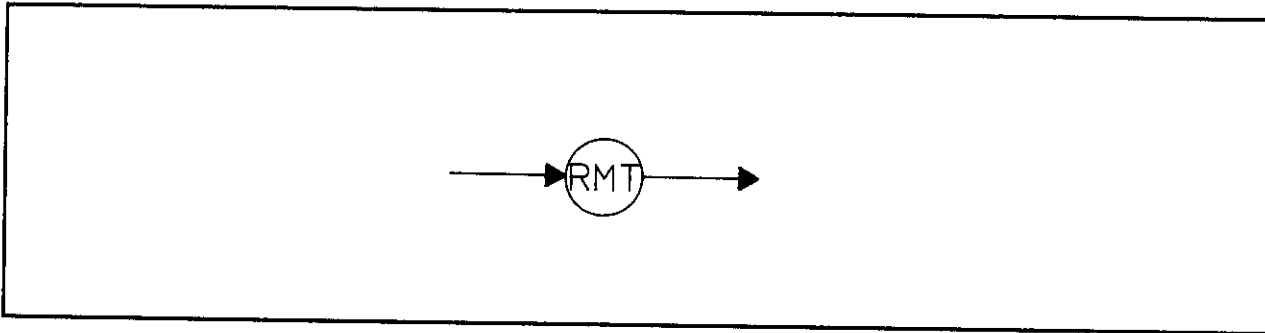

Figure 2-40. RMT Syntax Diagram

***RST; Reset Command**

The *RST command resets the HP 3325B to the state in table 2-43. This command has the same effect as pressing the Instrument Preset key on the front panel and is similar to the HP-IB Device Clear command. *RST does not change the data transfer mode as does the Device Clear command.

Note In data transfer mode 2, an asterisk terminates a command string. Therefore, use RST without an asterisk, in data transfer mode 2.

Command Availability

| | *RST |
|----------|------|
| HP 3325B | Yes |
| HP 3325A | No |

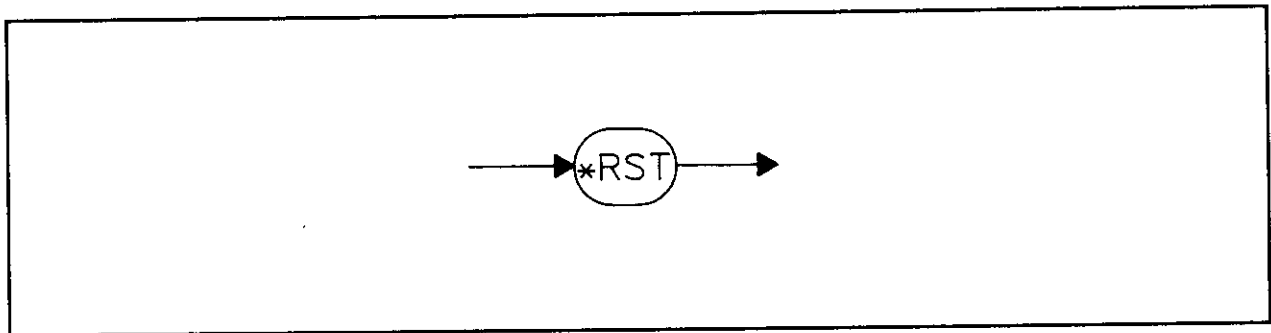

Figure 2-41. *RST Syntax Diagram

Table 2-43. Reset State

| Item | Reset Value |
|----------------------------|----------------------|
| Function | Sine |
| Frequency | 1000.0 Hz |
| Amplitude | 1.0 mV _{pp} |
| Offset | 0.0 V |
| Phase | 0.0° |
| Mod Source Function | Off |
| Mod Source Frequency | 1000.0 Hz |
| Mod Source Amplitude | 0.1 V _{pp} |
| Start Frequency | 1.0 MHz |
| Stop Frequency | 10.0 MHz |
| Marker Frequency | 5 MHz |
| Sweep Time | 1.0 Sec |
| High voltage | Off |
| Front/Rear output | Front |
| Amplitude Modulation | Off |
| Phase Modulation | Off |
| Sweep Mode | Linear |
| Status Byte (bits cleared) | 0, 1, 2, 3, & 6 |

The *RST command does not alter:

- The 10 state storage registers
- HP-IB address
- HP-IB data transfer mode
- Status byte mask
- Enhancement/compatibility mode
- Calibration mode
- Head on/off
- Display on/off
- Echo on/off
- Discrete sweep table
- Modulation source arbitrary waveform data
- Serial number and elapsed time clock

RSW; Reset Single Sweep Command

The RSW command places the instrument in the sweep reset state. The output frequency returns to the Start Frequency and the next SS command starts a single sweep.

Command Availability

| | RSW |
|----------|-----|
| HP 3325B | Yes |
| HP 3325A | No |

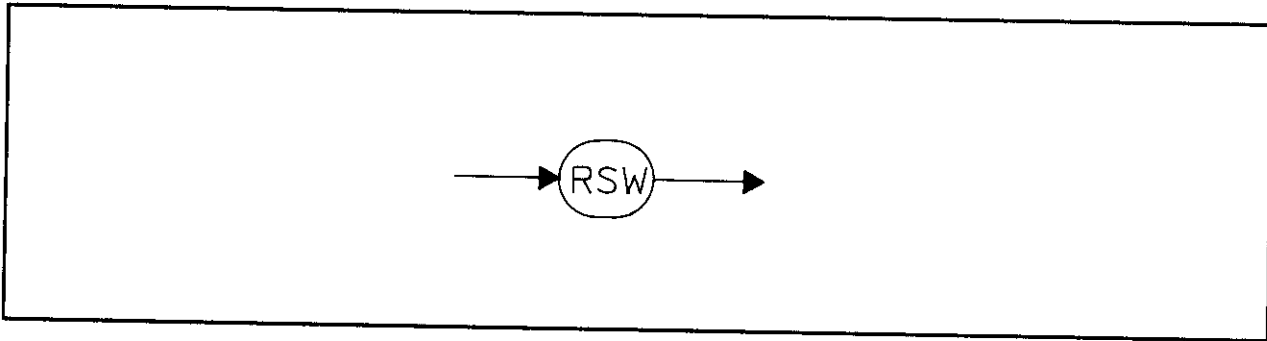

Figure 2-42. RSW Syntax Diagram

SC; Start Continuous Sweep Command

The SC command starts a continuous sweep. If the instrument is already sweeping, this command stops the sweep and does not restart it. FR can be used to stop a sweep.

Command Availability

| | SC |
|----------|-----|
| HP 3325B | Yes |
| HP 3325A | Yes |

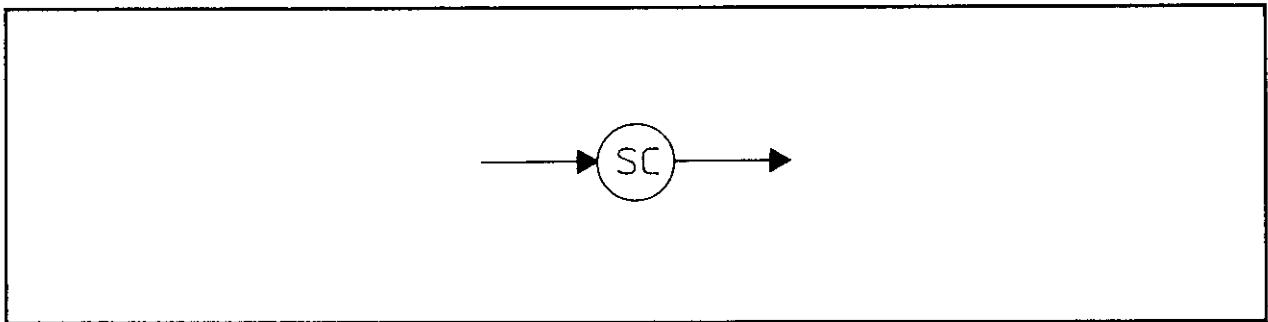

Figure 2-43. SC Syntax Diagram

SM; Sweep Mode Command

The SM command selects the sweep mode.

Instrument Preset value: 1.

Command Availability

| | SM | ISM | SM? | SM3 |
|----------|-----|-----|-----|-----|
| HP 3325B | Yes | Yes | Yes | Yes |
| HP 3325A | Yes | Yes | No | No |

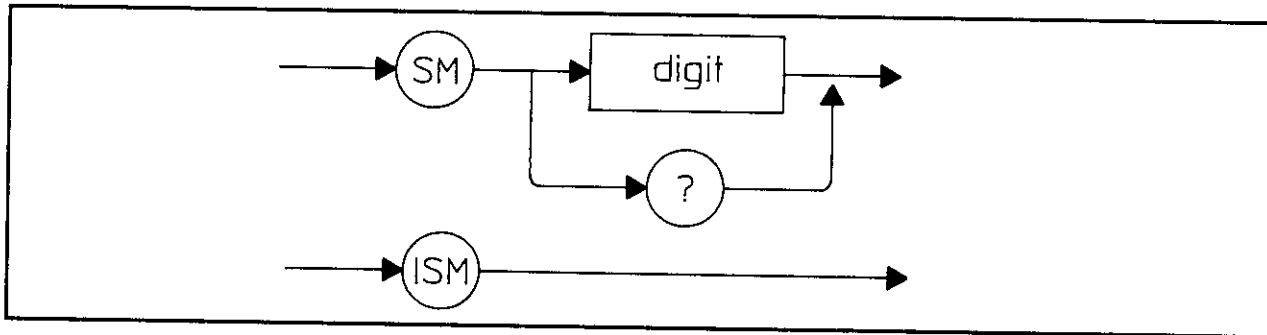

Figure 2-44. SM Syntax Diagram

| "Digit" | Waveform |
|---------|---------------------------------|
| 1 | Selects Linear sweep mode. |
| 2 | Selects Logarithmic sweep mode. |
| 3 | Selects Discrete sweep mode. |

Table 2-44. SM? and ISM Response Format

| HEAD-on response | HEAD-off response |
|------------------|-------------------|
| SM# | # |

SP; Sweep Stop Frequency Command

The SP command sets the sweep stop frequency.

Instrument Preset value: 10.0 MHz

Command Availability

| | SP | ISP | SP? |
|----------|-----|-----|-----|
| HP 3325B | Yes | Yes | Yes |
| HP 3325A | Yes | Yes | No |

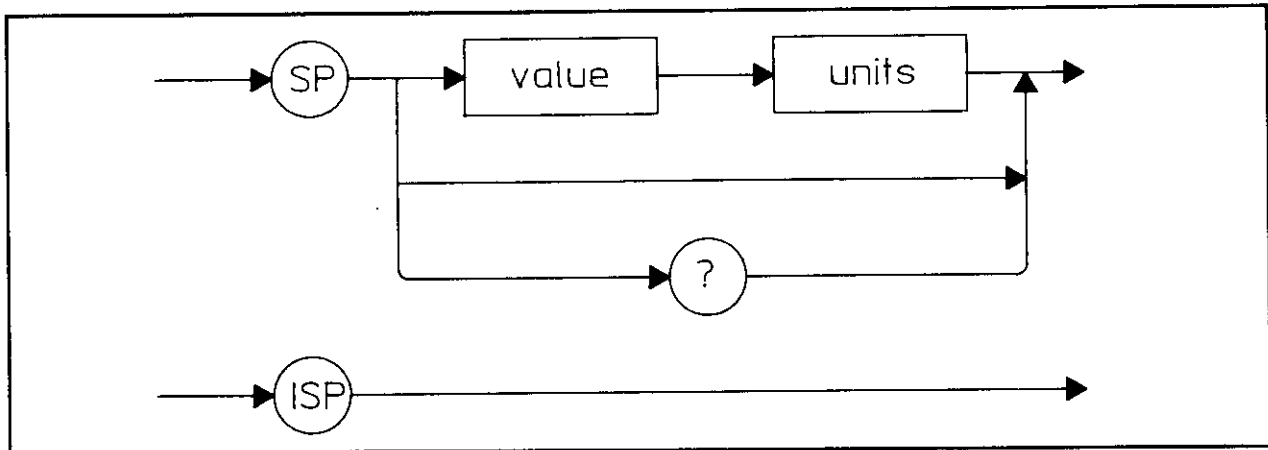

Figure 2-45. SP Syntax Diagram

Table 2-45. SP “value” Restrictions Given “units”

| value range | units | Description |
|---------------------|-------|-------------|
| 0.0 → 20999999.999 | HZ | Hertz |
| 0.0 → 20999.9999990 | KH | kilo-Hz |
| 0.0 → 20.999999999 | MH | mega-Hz |

Table 2-46. SP? and ISP Response Format

| μHz programmed | HEAD-on response | HEAD-off response |
|----------------|------------------|-------------------|
| no | SP#####.###HZ | #####.### |
| yes | SP#####.###HZ | #####.### |

SR; Store State Command

The SR command stores the current instrument setup state in one of 10 memory locations.

Command Availability

| | SR |
|----------|-----------|
| HP 3325B | Yes |
| HP 3325A | Yes |

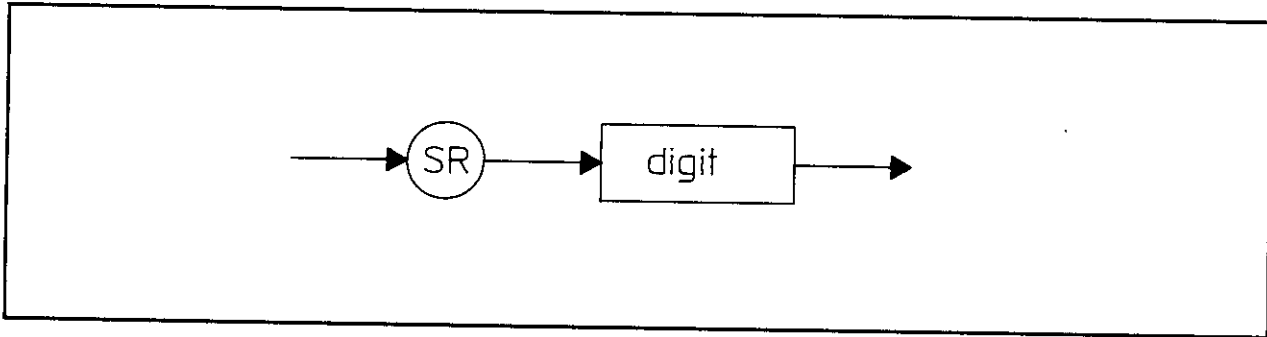

Figure 2-46. SR Syntax Diagram

| "Digit" | Meaning |
|----------------|------------------------------------|
| 0 → 9 | Stores state in location 0 thru 9. |

SS; Start Single Sweep Command

The effect of the SS command depends on the state of the instrument. If the instrument is not sweeping and not in the sweep-reset state, then the SS command puts the instrument in the sweep-reset state at the sweep Start Frequency. If the instrument is already in the sweep-reset state, this command starts a single sweep. If the instrument is sweeping, this command stops the sweep and does not restart it.

Single sweeps can be started using the HP-IB Group Execute Trigger command. Before using the GET command, the HP 3325B must be in the enhancements mode and the sweep must be reset using the RSW command.

Command Availability

| SS | |
|-----------|-----|
| HP 3325B | Yes |
| HP 3325A | Yes |

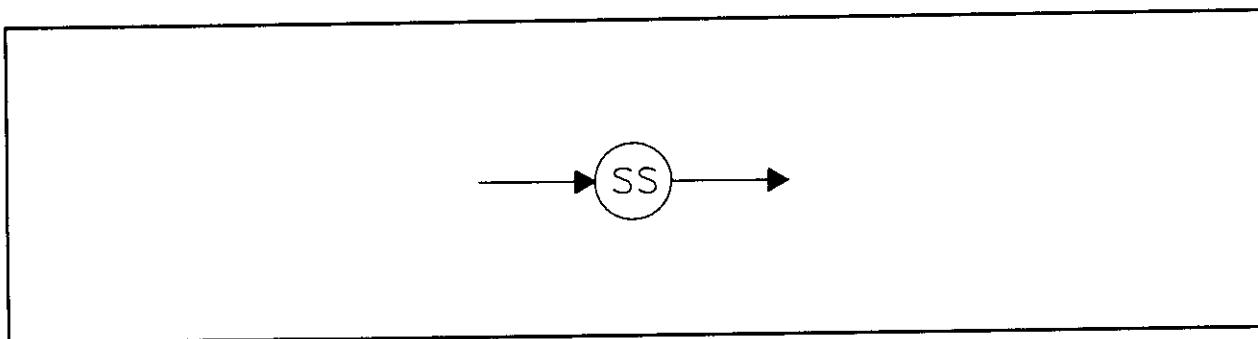

Figure 2-47. SS Syntax Diagram

ST; Sweep Start Frequency Command

The ST command sets the sweep start frequency.

Start Frequency Preset value: 1.0 MHz

Command Availability

| | ST | IST | ST? |
|----------|-----|-----|-----|
| HP 3325B | Yes | Yes | Yes |
| HP 3325A | Yes | Yes | No |

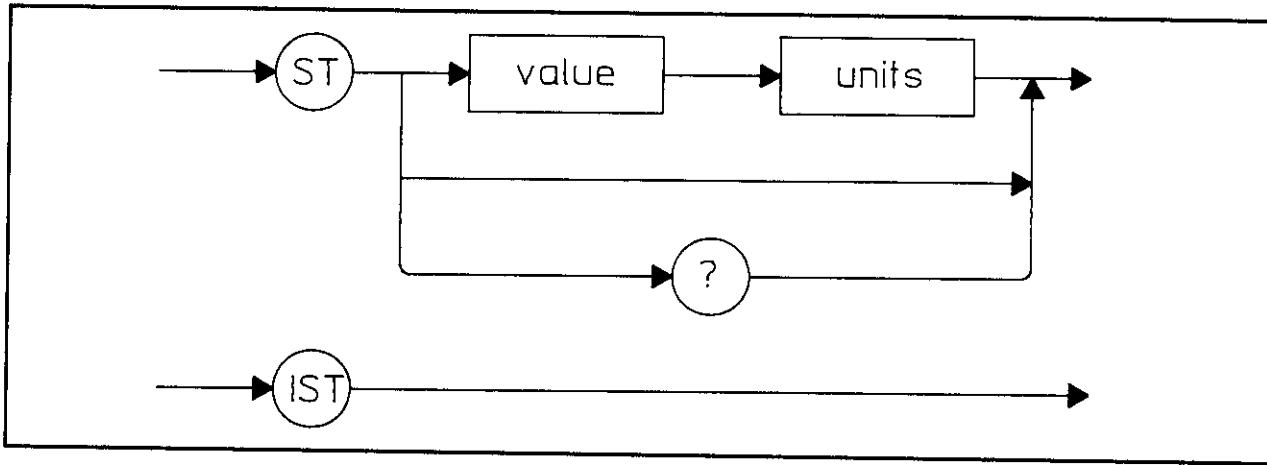

Figure 2-48. ST Syntax Diagram

Table 2-47. ST "value" Restrictions Given "units"

| value range | units | Description |
|---------------------|-------|-------------|
| 0.0 → 209999999.999 | HZ | Hertz |
| 0.0 → 20999.9999999 | KH | kilo-Hz |
| 0.0 → 20.999999999 | MH | mega-Hz |

Table 2-48. ST? and IST Response Format

| µHz programmed | HEAD-on response | HEAD-off response |
|----------------|------------------|-------------------|
| no | ST#####.###HZ | #####.### |
| yes | ST#####.#####HZ | #####.##### |

TI; Sweep Time Command

The TI command sets the sweep time. Sending TI with no value or units displays the current sweep time. ITI and TI? cause the instrument to output its current sweep time.

Instrument Preset value: 1.0 Sec

Command Availability

| | TI | ITI | TI? |
|----------|-----|-----|-----|
| HP 3325B | Yes | Yes | Yes |
| HP 3325A | Yes | Yes | No |

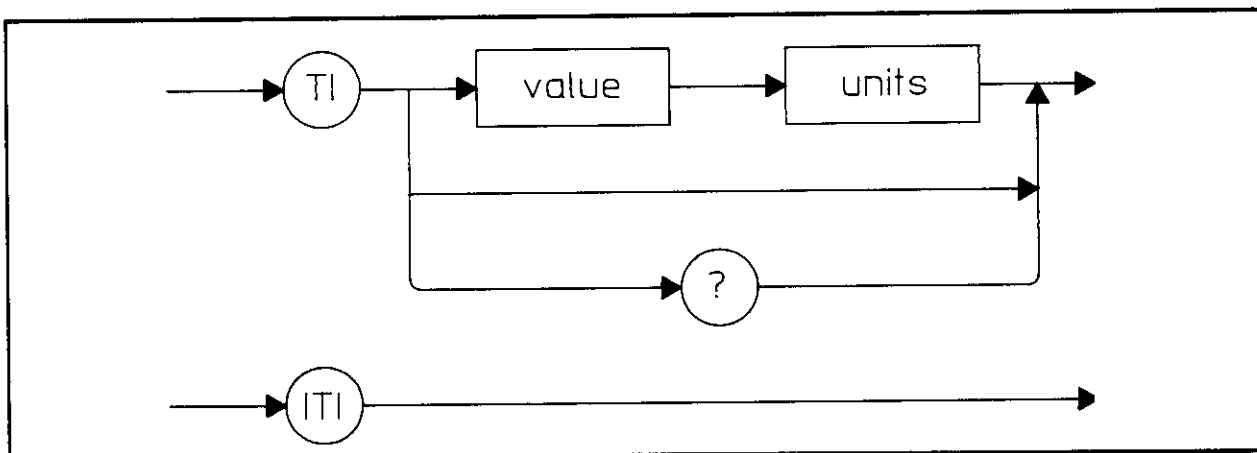

Figure 2-49. TI Syntax Diagram

Table 2-49. TI "value" Restrictions Given "units"

| "Units" | Description | Range Restrictions for "value" |
|---------|-------------|--------------------------------|
| SE | Seconds | 0.0 → 1000 |

Table 2-50. TI? and ITI Response Format

| HEAD-on response | HEAD-off response |
|------------------|-------------------|
| TI#####.###SE | #####.### |

Table 2-51. Error Messages

| Code | Description |
|-------------|---|
| FAIL 010 | Hardware failure, DAC range |
| FAIL 011 | Bad checksum, low byte of ROM |
| FAIL 012 | Bad checksum, high byte of ROM |
| FAIL 013 | Machine data bus line stuck low |
| FAIL 014 | Keyboard shift register test failed |
| FAIL 021 | Signal too big during calibration |
| FAIL 022 | Signal too small during calibration |
| FAIL 023 | DC offset too positive during cal |
| FAIL 024 | DC offset too negative during cal |
| FAIL 025 | Unstable/ noisy calibration |
| FAIL 026 | Calibration factor out of range: AC gain offset |
| FAIL 027 | Calibration factor out of range: AC gain slope |
| FAIL 028 | Calibration factor out of range: DC offset |
| FAIL 029 | Calibration factor out of range: DC slope |
| FAIL 030 | External ref unlocked |
| FAIL 031 | Oscillator unlocked, VCO voltage too low |
| FAIL 032 | Oscillator unlocked, VCO voltage too high |
| FAIL 033 | HP-IB isolation circuits test failed self test |
| FAIL 034 | HP-IB IC failed self test |
| FAIL 035 | RS-232 test failed loop-back test |
| FAIL 036 | Memory lost (battery dead) |
| FAIL 037 | Unexpected interrupt |
| FAIL 038 | Sweep-limit-flag signal failed self test |
| FAIL 039 | Fractional-N IC failed self test |
| FAIL 040 | Modulation Source failed self test |
| FAIL 041 | Function-integrity-flag flip-flop always set |
| Error 100 | Entry parameter out of bounds |
| Error 200 | Invalid units suffix for entry |
| Error 201 | Invalid units suffix with high voltage |
| Error 300 | Frequency too large for function |
| Error 400 | Sweep time too large (same as sweep rate too small) |
| Error 401 | Sweep time too small |
| Error 500 | Amplitude/offset incompatible |
| Error 501 | Offset too big for amplitude |
| Error 502 | Amplitude too big for offset |
| Error 503 | Amplitude too small |

Table 2-51. Error Messages (con't)

| Code | Description |
|-------------|---|
| Error 600 | Sweep frequency improper |
| Error 601 | Sweep frequency too large for function |
| Error 602 | Sweep bandwidth too small |
| Error 603 | Log sweep start freq too small |
| Error 604 | Log sweep stop frequency less than start frequency |
| Error 605 | Discrete sweep element is empty |
| Error 700 | Unknown command |
| Error 701 | Illegal query |
| Error 751 | Key ignored – in remote (press LOCAL)* |
| Error 752 | Key ignored – local lockout* |
| Error 753 | Feature disabled in compatibility mode |
| Error 754 | Attempt to recall a register that has not been stored since power up. (Use enhancements mode)* |
| Error 755 | Amplitude modulation not allowed on selected function (warning only)* |
| Error 756 | Modulation source arbitrary waveform is empty |
| Error 757 | Too many modulation source arbitrary waveform points |
| Error 758 | Firmware failure |
| Error 759 | Error while running XRUN routine |
| Error 800 | Illegal character received |
| Error 801 | Illegal digit for selection item |
| Error 802 | Illegal binary data block header |
| Error 803 | Illegal string, string overflow |
| Error 810 | RS-232 overrun – characters lost |
| Error 811 | RS-232 parity error |
| Error 812 | RS-232 frame error |
| Error 900 | Option not installed |

* *These errors do not set the ERR bit in the status byte.*

HP 3325A Compatibility

For compatibility with existing programs, the HP 3325B supports all of the HP 3325A Synthesizer/Function Generator remote commands. Table 2-52 lists the HP 3325B mnemonics alphabetically and shows compatibility of each with the HP 3325A.

Table 2-52. Remote Command Compatibility

| HP 3325B Command | HP 3325A Compatible? | Description |
|------------------|----------------------|---------------------------------|
| * | yes | End-of-string character |
| AC | yes | Amplitude Calibrate |
| AM | yes | Amplitude |
| AP | yes | Assign zero phase |
| CALM | no | Calibration mode |
| DB | yes | dBm (suffix) |
| DCLR | no | Discrete sweep clear |
| DE | yes | Degrees (suffix) |
| DISP | no | Display on/off |
| DRCL | no | Discrete sweep recall |
| DSP | no | Display string |
| DSTO | no | Discrete sweep store |
| DV | no | dBV _{rms} (suffix) |
| E | no | Exponent character |
| ECHO | no | Echo; for RS-232 |
| ENH | no | Enhancements on |
| ENT | no | Enter, no units (suffix) |
| ER | yes | Error query, 1-digit code |
| ERR | no | Error query, 3-digit code |
| ESTB | no | Stat register mask (same as MS) |
| EXTR | no | Ext Ref query |
| FR | yes | Frequency |
| FU | yes | Function select |
| HEAD | no | Header on/off |
| HV | yes | High voltage |
| HZ | yes | Hertz (suffix) |
| ID | no | Identify, short |
| *IDN | no | Identify, long |
| KH | yes | Kilohertz (suffix) |
| LCL | no | Local, clear lockout (RS-232) |
| MA | yes | Amplitude modulation |
| MD | yes | Data transfer mode |
| MF | yes | Sweep marker frequency |
| MH | yes | Megahertz (suffix) |
| MOAM | no | Mod S amp |
| MOAR | no | Write arbitrary waveform |

Table 2-52. Remote Command Compatibility (con't)

| HP 3325B Command | HP 3325A Compatible? | Description |
|------------------|----------------------|-------------------------------------|
| MOFR | no | Mod S frequency |
| MOFU | no | Mod S function |
| MP | yes | Phase modulation |
| MR | yes | mV _{rms} (suffix) |
| MS | yes | Status register mask (same as ESTB) |
| MV | yes | mV _{pp} (suffix) |
| OF | yes | DC offset entry |
| OPT | no | Option query |
| PH | yes | Phase entry |
| QSTB | no | Status register query |
| RE | yes | Recall state |
| RF | yes | Rear or front output selection |
| RMT | no | Remote with lockout (RS-232) |
| *RST | no | Reset (preset) |
| RSW | no | Reset single sweep |
| SC | yes | Start continuous sweep |
| SE | yes | Seconds (suffix) |
| SM | yes | Sweep mode selection |
| SP | yes | Sweep stop frequency entry |
| SR | yes | Store state selection |
| SS | yes | Start a single sweep |
| ST | yes | Sweep start frequency |
| TI | yes | Sweep time |
| VO | yes | V _{pp} (suffix) |
| VR | yes | V _{rms} (suffix) |

Writing Compatible Programs

Backward Compatible with the HP 3325A

- Use only the two-letter HP 3325B command mnemonics such as FR. The three and four-letter mnemonics such as MOFR are not available on the HP 3325A.
- Do not separate commands with a semicolon.
- Use a leading **I** to interrogate setup parameters instead of a trailing **?**.
- Do not send values in scientific notation.

Programming Practices Compatible with IEEE 488.2

- Separate commands with a semicolon or line feed
- Use a trailing **?** to interrogate setup parameters instead of a leading **I**.
- Do not use data transfer mode 2.

Example Programs

HP-IB Interface Example Program

```

30 !
40 ! HP-BASIC Program to control the HP 3325B synthesizer.
50 !
60 ASSIGN @Hp3325 TO 717      !Select code and bus address
70                          !usually 7 and 17
80 !
90 OUTPUT @Hp3325;"RST"      !reset the 3325B
100 !
110 Stat=SPOLL(@Hp3325)      !read status register
120 IF BIT(Stat,0) OR BIT(Stat,3) THEN PRINT "3325B has an error"
130 !
140 OUTPUT @Hp3325;"FR 123 KH; AM 1 V0" !program freq and amptd
150 OUTPUT @Hp3325;"FR?"      !ask for frequency
160 ENTER @Hp3325;Freq       !read it back
170 PRINT "Frequency in Hz = ";Freq
180 !
190 LOCAL @Hp3325           !return front panel to local control
200 !
210 PRINT "Program done."
220 END

```

RS-232 Interface Example Program for HP-Vectra or IBM/PC

```

10 'HP Vectra BASIC program to control the 3325B Synthesizer.
20 '
30 'First open a communications file to the 3325B
40 'change COM1 to COM2 if needed.
50 OPEN "COM1:" AS #1
60 'OPEN defaults to 300 baud, 7 bits, parity EVEN
70 '
90 PRINT #1,"RST"           'send reset
100 PRINT #1,"HEAD 0"      'turn off heading in 3325B responses
110 '
120 PRINT #1,"QSTB?"       'ask for status register
130 INPUT #1, STAT        'read response from 3325B
150 IF (STAT AND (1+8)<>0) THEN PRINT "3325B has an error"
160 '
170 PRINT "Programming frequency and amplitude"
180 PRINT #1,"FR 123.4 KH; AM 1 V0"
190 PRINT #1,"FR?"         'ask for frequency
200 INPUT #1,FREQ          'read it back
210 PRINT "Frequency in Hz = ";FREQ
220 '
230 PRINT #1,"LCL"         'return front panel to local control
240 '
250 PRINT "Program done"
260 END

```

RS-232 Interface Example Program for HP Series 300

```

30 !
40 ! HP-BASIC Program to control the HP 3325B synthesizer using either
50 ! a HP98644, HP98626, or the build-in serial interface in
60 ! a Series-200 or Series-300 computer.
70 !
80 ! The connecting cable depends on the RS232 interface:
90 !   98644A interface:   use 13242G cable (25 pin M to 25 pin M).
100 !   Built-in interface: use 92221P cable (9 pin M to 25 pin M).
110 !
120 ASSIGN @Hp3325 TO 9           !Select code for the serial interface,
130                               !usually 9 or 10
140 !
160 GOSUB Initialize_card
170 !
190 OUTPUT @Hp3325;"RST"         !reset the 3325B
200 !
210 OUTPUT @Hp3325;"QSTB?"      !ask for status register
220 ENTER @Hp3325;Stat          !read status from 3325B
240 IF BIT(Stat,0) OR BIT(Stat,3) THEN PRINT "3325B has an error"
250 !
260 OUTPUT @Hp3325;"FR 123 KH; AM 1 V0" !program freq and amptd
270 OUTPUT @Hp3325;"FR?"        !ask for frequency
280 ENTER @Hp3325;Freq          !read it back
290 PRINT "Frequency in Hz = ";Freq
300 !
310 OUTPUT @Hp3325;"LCL"        !return front panel to local control
320 !
330 PRINT "Program done."
340 STOP
350 !
360 !-----
370 Initialize_card: !
380 !
390 Isc=SC(@Hp3325)           !Get Interface select code.
400 !
410 Reset_=0                  !constants for CONTROL statements.
420 Baud=3
430 Parity_=4
440 !
450 ! ALL the RS232 switches on the 3325B rear panel should be
460 ! up. This sets baud=300, parity ON, parity EVEN.
470 !
480 CONTROL Isc,Reset_;1      !reset the card
490 CONTROL Isc,Baud;300      !set baud rate
500 CONTROL Isc,Parity_;16+8+0+2 !set parity
510 RETURN
520 END

```

GENERAL INFORMATION

Introduction

This chapter contains general information about the HP 3325B, including its performance specifications, safety considerations, instrument description, available options, supplied accessories, and available accessories.

Specifications

Instrument specifications are listed in table 3-1. The specifications are the performance standards or limits against which the instrument is tested.

Safety Considerations

This product is a safety class 1 instrument (provided with a protective earth terminal). The instrument and manual should be reviewed for safety markings, instructions, cautions, and warnings to ensure safe operation.

This manual may have a yellow *manual change supplement* with it. This supplement contains information to correct errors and incorporate new information to keep the manual current. The supplement for this manual is identified by the manual print date and part number, both of which appear on the manual title page. Complimentary copies of the supplement are available from Hewlett-Packard.

Instrument Description

The HP 3325B Synthesizer/Function Generator produces sine wave, square wave, triangle waveforms, and positive and negative ramp waveforms from 1 μ Hz to a maximum frequency of 20 Mhz for sine wave and 10 Mhz for square wave and 10 kHz for the triangle and ramp functions. (The .999 extensions are assumed.) Frequency resolution is 1 μ Hz or eleven digits. Output amplitude is 1 mV_{pp} to 10 V_{pp}. The output amplitude level may be entered or displayed in V_{RMS} or dBm (50 Ω) as well as V_{pp}. Any function may have a dc offset of up to ± 4.5 V or the output may be dc-only up to ± 5 V. An optional high voltage output produces up to 40 V_{pp} into a load $\geq 500\Omega$, ≤ 500 pF.

The HP 3325B performs linear or log frequency sweeps in any of its waveforms at sweep times of 10 ms to 1000s for linear sweeps. Log sweep times are from 1s to 1000s for single sweeps and from 0.1s to 1000s for continuous sweeps. The direction of a single linear sweep may be up or down. A continuous sweep moves back and forth between the start and stop frequencies in an up/down/up/down/. . . fashion. Log sweeps always start at the start frequency and sweep up to the stop frequency. *Discrete sweep* is a feature which allows creation of custom sweep patterns.

Table 3-1. Specifications

FREQUENCY

Range:

Sine: 1 μ Hz to 20.999 999 999 MHz

Square: 1 μ Hz to 10.999 999 999 MHz

Triangle/Ramps: 1 μ Hz to 10.999 999 999 kHz

Resolution:

1 μ Hz, <100 kHz

1 mHz \geq 100 kHz (1 μ Hz available, not displayed)

Accuracy:

$\pm 5 \times 10^{-6}$ of selected value, 20°C to 30°C, at time of calibration, (Standard Instrument)

Stability:

$\pm 5 \times 10^{-6}$ /year, 20°C to 30°C, standard (See also option 001, high stability frequency reference)

Warm-up Time:

20 minutes to within specified accuracy.

MAIN SIGNAL OUTPUT

(all waveforms)

Impedance:

50 $\Omega \pm 1\Omega$, 0-10 kHz

Return Loss:

> 20 dB, 10 kHz to 20 MHz, except > 10 dB for > 3 V, 5 MHz to 20 MHz

Connector:

BNC; switchable to front or rear panel, non-switchable with option 002 except by internal cable change.

Floating:

Output may be floated up to 42V peak (AC + DC)

AMPLITUDE (all waveforms)

Resolution:

0.03% of full range or 0.01 dB (4 digits).

Range:

1 mV to 10 Vp-p in 8 amplitude ranges, 1-3-10 sequence. Ranges are 1 mV-2.999 mV, 3 mV-9.999 mV, 10 mV-29.99 mV, 30 mV-99.99 mV, .1 V-.2999 V, .3 V-.9999 V, 1V-2.999 V, 3 V-10V, (without DC offset).

| Function | peak to peak | rms | dBm(50 Ω) |
|----------------|--------------|----------|-------------------|
| Sine | min. | 1.000 mV | 0.354 mV |
| | max. | 10.00 V | 3.536 V |
| Square | min. | 1.000 mV | 0.500 mV |
| | max. | 10.00 V | 5.000 V |
| Triangle/Ramps | min. | 1.000 mV | 0.289 mV |
| | max. | 10.00 V | 2.887 V |

Accuracy: (with 0 Vdc offset)

Sine:

| | .001 Hz | 100 kHz | 10 MHz | 20 MHz |
|-------------|-------------|---------|-------------|-------------|
| + 23.98 dBm | $\pm .1$ dB | | $\pm .4$ dB | |
| + 13.52 dBm | $\pm .2$ dB | | $\pm .6$ dB | $\pm .9$ dB |
| - 16.02 dBm | $\pm .2$ dB | | $\pm .6$ dB | $\pm .9$ dB |
| - 56.02 dBm | $\pm .2$ dB | | $\pm .6$ dB | $\pm .9$ dB |

Square Wave:

| | .001 Hz | 100 kHz | 10 MHz |
|---------|-------------|--------------|--------|
| 10 Vp-p | $\pm 1.0\%$ | $\pm 11.1\%$ | |
| 3 Vp-p | $\pm 2.2\%$ | $\pm 13.6\%$ | |
| 1 mVp-p | | | |

Triangle:

| | .001 Hz | 2 kHz | 10 kHz |
|---------|-------------|-------------|--------|
| 10 Vp-p | $\pm 1.5\%$ | $\pm 5.0\%$ | |
| 3 Vp-p | $\pm 2.7\%$ | $\pm 6.2\%$ | |
| 1 mVp-p | | | |

Ramps:

| | .001 Hz | 500 kHz | 10 kHz |
|---------|-------------|--------------|--------|
| 10 Vp-p | $\pm 1.5\%$ | $\pm 10\%$ | |
| 3 Vp-p | $\pm 2.7\%$ | $\pm 11.2\%$ | |
| 1 mVp-p | | | |

With DC offset, increase all sinewave tolerances by .2 dB and all function tolerances by 2%.

SINEWAVE SPECTRAL PURITY

Phase Noise:

- 60 dBc for a 30 kHz band centered on a 20 MHz carrier (excluding ± 1 Hz about the carrier) with option 001 installed.

Spurious:

All non-harmonically related output signals will be more than 70 dB below the carrier (- 60 dBc with DC offset), or less than - 90 dBm, whichever is greater.

WAVEFORM CHARACTERISTICS

Sinewave Harmonic Distortion:

Harmonically related signals will be less than the following levels relative to the fundamental:

| Frequency Range | Harmonic Level |
|-------------------|----------------|
| .1 Hz to 50 kHz | - 65 dBc |
| 50 kHz to 200 kHz | - 60 dBc |
| 200 kHz to 2 MHz | - 40dBc |
| 2 MHz to 15 MHz | - 30 dBc |
| 15 MHz to 20 MHz | - 25 dBc |

Squarewave Characteristics:

Rise/fall time: ≤ 20 ns 10% to 90%, at full output.

Overshoot: $\leq 5\%$ of peak to peak amplitude, at full output.at 1MHz.

Settling time: <1 μ s to settle to within .05% of final value, tested at full output with no load, 10 Hz to 500 kHz.

Symmetry: $\leq .02\%$ of period + 3 ns.

Triangle/Ramp Characteristics:

Triangle/ramp linearity (10% to 90%, 10 kHz): $\pm .05\%$ of full p-p output for each range.

Ramp retrace time: $\leq 3 \mu$ s, 90% to 10%.

Period variation for alternate ramp cycles: $\leq 1\%$ of period.

DC OFFSET

Range:

DC only (no AC signal): 0 to ± 5.0 V/50 Ω

DC + AC: Maximum DC offset ± 4.5 V on highest range; decreasing to ± 4.5 mV or lowest range.

Resolution: 4 digits

Accuracy:

DC only: $\pm .02$ mV to ± 20 mV, depends on offset chosen.

DC + AC, to 1 MHz: $\pm .06$ mV to ± 60 mV, depends on AC output level, $\pm .2$ mV to ± 120 mV for ramps to 10 kHz.

DC + AC, 1 MHz to 20 MHz: ± 15 mV to ± 150 mV, depends on AC output level.

Table 3-1. Specifications (Cont'd)

PHASE OFFSET

Range:
± 719.9° with respect to arbitrary starting phase, or assigned zero phase.
Resolution: 0.1°
Increment Accuracy: ± 0.2°
Stability: ± 1.0 degree of phase/°C

SINEWAVE AMPLITUDE MODULATION

Modulation Depth (at full output for each range):
1-100%
Modulation Frequency Range:
XC to 400 kHz (0-21 MHz carrier frequency)
Envelope Distortion:
- 30 dB to 80% modulation at 1 kHz, VDC offset
Sensitivity:
± 5 V peak for 100% modulation
Input Impedance: 10 kΩ
Connector: Rear panel BNC

PHASE MODULATION

Phase Function Range:
± 850°, ± 5V input
Phase Function-Linearity:
± 0.5%, best fit straight line
Squarewave Range: ± 425°
Triangle Range: ± 42.5°
Positive and Negative Ramps:
85°
Modulation Frequency Range:
C - 5 kHz
Input Impedance: > 40 kΩ
Connector: Rear panel BNC

FREQUENCY SWEEP

Sweep Time:
Linear: 0.01s to 1000s
Logarithmic: 1s to 1000s single, 0.1s to 1000s continuous
Maximum Sweep Width:
Full frequency range of the main signal output for the waveform in use except minimum log start frequency is 1 Hz.
Minimum Sweep Width:

| Function | Minimum sweep width | |
|-----------|---------------------|------------|
| | Sweep time | Sweep time |
| | .01 sec. | 99.9 sec. |
| Sine: | .1 mHz | 999.9 mHz |
| Square: | .05 mHz | 499.5 mHz |
| Triangle: | .005 mHz | 49.95 mHz |
| Ramps: | .01 mHz | 99.99 mHz |

Minimum log sweep width is 1 decade.
Phase Continuity:
Sweep is phase continuous over the full frequency range of the main output.
Discrete Sweep:
Number of segments: 100 maximum (Start and stop frequencies settable for each segment)
Time/segment: 0.01s to 1000s, 0.01s resolution

MODULATION SOURCE:

Frequency Range: Sine 0.1 Hz-10 kHz, Square 0.1 Hz-2 kHz
Frequency Resolution: 2 digits
Frequency Accuracy: Typically 0.1% (Sinewave)
Amplitude Range: 0.1 Vp-p to 12 Vp-p
Amplitude Resolution: 0.1 V
Amplitude Accuracy: Typically ± 200 mV
Impedance: Designed to drive ≥ 10 kΩ loads
Sinewave Purity: Typically better than - 34 dBc
Standard Waveforms: Sine, Square
Arbitrary Waveforms: Vertical resolution 256 points, horizontal resolution 4096 points, 300,000 samples/sec, 10 kHz maximum.
Output Location: Rear Panel BNC

AUXILIARY OUTPUTS

Auxiliary Frequency Output:
Frequency Range: 21 MHz to 60.999 999 999 MHz, underrange coverage to 19.000 000 001 MHz, frequency selection from front panel.
Amplitude: 0 dBm; output impedance: 50Ω
Connector: Rear panel BNC
Sync Output:
Square wave with $V_{high} \geq 1.2 V$, $V_{low} \leq 0.2 V$ into 50Ω. Frequency range is the same as the main signal output for front panel sync and DC-60 MHz for rear panel sync.
Output impedance: 50Ω
Connector: BNC front and rear panels.
X-Axis Drive:
(0-100s sweeps only)
0 to +10 Vdc linear ramp proportional to sweep frequency; linearity, 10-90%, ± .1% of final value (applies for sweep widths which are integer multiples of the minimum sweep width).
Connector: Rear panel BNC.
Sweep Marker Output:
High to low TTL compatible voltage transition at keyboard selected marker frequency. (Linear sweep only.)
Connector: Rear panel BNC.
Z-Axis Blank Output:
TTL compatible voltage levels capable of sinking current from a positive source. Current 200 mA, voltage 45V, power dissipation 1 watt maximum.
1 MHz Reference Output:
0 dBm output for phase-locking additional instruments to the HP 3325B.
Connector: Rear panel BNC.
10 MHz Oven Output:
0 dBm internal high stability frequency reference output for phase-locking HP 3325B or other instruments (option 001 only).
Connector: Rear panel BNC.

Table 3-1. Specifications (Cont'd)

AUXILIARY INPUTS

Reference Input:

For phase-locking HP 3325B to an external frequency reference. Signal from 0 dBm to + 20 dBm into 50Ω. Reference signal must be a subharmonic of 10 MHz from 1 MHz to 10 MHz.

Connector: Rear panel BNC. With option 001 this input may be jumpered to the 10 MHz reference output.

Amplitude Modulation Input:

See modulation specifications.

Phase Modulation Input:

See modulation specifications.

REMOTE CONTROL

Frequency Switching Time (to within 1 Hz exclusive of programming time:

≤10 ms for 100 kHz step; ≤25 msec for 1 MHz step; ≤70 msec for 20 MHz step.

Phase Switching Time (to within 90° of phase lock exclusive of programming time:

≤15 msec.

Amplitude Switching Time (to within amplitude specifications, exclusive of programming time): < 30 ms.

HP-IB Interface Functions:

SH1, AH1, T6, L3, SR1, RL1, PP0, DC1, DT1, C0, E1

RS-232 Interface:

Subset of ANSI/EIA-232D-1986, CCITT V.24

Type: DTE, 25 pin female "D" connector

Baud Rate: 300-4800

OPTION 001 HIGH STABILITY FREQUENCY REFERENCE

Aging Rate:

± 5 × 10⁻⁸/week, after 72 hours continuous operation; ± 1 × 10⁻⁷ mo., after 15 days continuous operation.

Warm-up time:

Reference will be within ± 1 × 10⁻⁷ of final value 15 minutes after turn-on at 25°C for an off time of less than 24 hours.

OPTION 002 HIGH VOLTAGE OUTPUT

Frequency Range: 1 μHz to 1 MHz

Amplitude:

Range: 4.00 mV to 40.00 Vp-p in 8 ranges, 4-12-40 sequence, into 500Ω < 500 pF load. Ranges are four times the standard instrument ranges, without DC offset.

Accuracy: ± 2% of full output for each range at 2 kHz.

Flatness: ± 10% relative to programmed amplitude.

Sinewave Distortion:

Harmonically related signals will be less than the following levels (relative to the fundamental full output into 500Ω, load):

10 Hz-50 kHz: - 65 dB

50 kHz-200 kHz: - 60 dB

200 kHz-1 MHz: - 40 dB

Square Wave Rise/Fall Time:

± 125 ns, 10% to 90% at full output, with 500Ω, 500 pF load.

Square Wave Overshoot:

± 10% of peak to peak amplitude with 500Ω, 500 pF load.

Output Impedance:

< 2Ω at DC, < 10Ω at 1 MHz

DC Offset:

Range: 4 times the specified range of the standard instrument.

Accuracy: ± (1% of full output for each range + 25 mV).

Maximum Output Current:

± 20 mA peak

GENERAL

Operating Environment:

Temperature: 0°C to 55° C

Relative Humidity: 95%, 0°C to 40°C

Altitude: ≤ 15,000 ft.

Power:

100/120/220/240 V, + 5%, - 10%; 48 to 66 Hz; 90 VA, 120 VA with all options

Weight:

9 kg (20 lbs) net; 14.5 kg (32 lbs) shipping

Dimensions:

133.4 mm high × 425.5 mm wide × 498.5 mm deep (5¼" H × 16¾" W × 19½" D)

The HP 3325B is fully programmable through two separate computer interface connectors located on the rear panel. They are the Hewlett-Packard Interface Bus (HP-IB) and an RS-232 serial interface. A desktop computer can be configured and programmed to remotely operate the HP 3325B with either of these two interfaces. Interface information is in Chapter 2, Remote Operation.

New or Enhanced Features of the HP 3325B

The feature set of the HP 3325B is a superset of the HP 3325A features. The additional features and improvements are summarized in the following:

- Non-volatile memory added: battery backup provides power to the memory when the power switch is in the standby position or when the instrument is disconnected from line voltage.
- Modulation source added: a second source of sine wave, square wave, and arbitrary waveforms provides a signal which may be used to modulate the main signal. The output connector for this source is on the rear panel between the two modulation input connectors.
- RS-232 interface added: this serial interface offers an alternative to the HP-IB. Additional remote operation commands have been added to the command set to allow it to be used in the same manner as the HP-IB (i.e.; emulate the HP-IB bus commands).
- Frequency range of the rear-panel sync output extended to 60 MHz.
- Discrete sweep added: a sequence of up to 100 linear sweeps or frequency steps (called segments) offers the ability to create custom sweep patterns. Each segment is composed of a start frequency, stop frequency, sweep time, and marker frequency. Refer to Chapter 1, Operation and Reference, for more information on this feature.
- Additional front-panel conveniences such as a preset key, frequency entry increment and decrement (defined by a new F STEP key), and the use of the left-arrow key as a backspace during parameter entries.
- Over-voltage circuit breaker added: an over-voltage protection circuit provides added reliability and reduces maintenance.
- Extended self-test and diagnostic capabilities to reduce maintenance.

Compatibility with the HP 3325A

The HP 3325B enhancements were designed to improve upon the capabilities of the HP 3325A without sacrificing compatibility. In most cases the new features do not cause compatibility problems. Complete backward compatibility is achieved by turning off the enhancements switch (on the rear panel). This feature is also programmable. Table 3-2 shows a comparison of the HP 3325A features that have been enhanced and are controlled by the enhancements switch.

Table 3-2. Comparison of compatible and enhanced features relative to HP 3325A

| Compatibility Mode | Enhancement Mode |
|--|---|
| <p>Store/recall registers cleared when power is turned off.</p> <p>Programming times compatible with the HP 3325A.</p> <p>Amplitude calibration time compatible with the HP 3325A.</p> <p>Frequency, time, and phase entries are truncated.</p> <p>Amplitude or offset entries stop a sweep.</p> <p>Actual sweep time can vary significantly from value entered for very narrow-band sweeps.</p> <p>Actual sweep stop-frequency can vary from value entered for very narrow-band sweeps.</p> <p>Continuous log sweeps always cover an integer number of decades.</p> <p>Log sweep momentarily pauses between sweeps.</p> | <p>Store/recall registers are non-volatile.</p> <p>Some items program faster.</p> <p>Calibration is faster.</p> <p>All entries are rounded.</p> <p>Amplitude and offset values can be changed while sweeping without stopping the sweep.</p> <p>Actual sweep time value deviates less from value entered.</p> <p>Actual sweep stop-frequency value deviates less from entered value.</p> <p>Partial decades possible.</p> <p>Pause time between log sweep segments minimized.</p> |

Options

Table 3-3 lists the options available for the HP 3325B. These options are available when the instrument is ordered by specifying the option number, or are available for later installation by ordering the option part number.

Table 3-3. Options

| HP 3325B Option | HP Part Number | Description |
|-----------------|----------------|------------------------------------|
| 001 | 03325-88801 | High Stability Frequency Reference |
| 002 | 03325-88802 | High Voltage Output |
| 907 | 5061-0089 | Front Handle Kit |
| 908 | 5061-0077 | Rack Flange Kit |
| 909 | 5061-0083 | Rack Mount Flange Kit with Handles |

Accessories Supplied

Table 3-4 lists the accessories supplied with the HP 3325B. Additional Operating and Service manuals may be ordered through your HP Sales and Service Office.

Table 3-4. Accessories Supplied

| Description | Quantity | HP Part Number |
|---------------------|----------|----------------|
| Operating Manual | 1 ea. | 03325-90014 |
| Installation Manual | 1 ea. | 03325-90006 |
| Service Manual | 1 ea. | 03325-90003 |

Accessories Available

Table 3-5 lists the accessories available for the HP 3325B. These accessories may be obtained through your HP Sales and Service Office.

Table 3-5. Accessories Available

| Accessory | HP Part Number |
|---------------------------|----------------|
| Ground Isolator | 15507A |
| 50Ω Feed-Thru Termination | 11048C |
| Transit Case | 9211-2655 |

HP 3325B HP-IB and RS-232 PROGRAMMING CODES:

COMMANDS:

| CODE | FUNCTION | CODE | FUNCTION |
|-------|-----------------------------------|-------|---------------------------------------|
| AC | Amplitude Cal | MD | Data transfer mode (1-2). |
| AM | Amplitude | MF | Sweep marker frequency |
| AP | Assign zero phase | MOAM | Modulation Source amplitude |
| CALM | Calibration mode (0-1). | MOAR | Write arb waveform |
| DCLR | Discrete sweep clear. | MOFR | Modulation Source frequency |
| DISP | Display (0-1). | MOFU | Modulation Source function (0-3). |
| DRCL | Discrete sweep recall (00-99). | MP | Phase modulation (0-1). |
| DSP | Display a string (' '). | MS | Status reg. mask (also ESTB) (@,A-0). |
| DSTO | Discrete sweep store (00-99). | OF | DC Offset |
| ECHO | Echo for RS-232 (0-1). | OPT? | Option query. |
| ENH | Enhancements mode (0-1). | PH | Phase |
| IER | Error query (1 digit). | QSTB? | Status register query. |
| ERR? | Error query (3 digits). | RE | Recallstate(-,0-9). |
| ESTB | Status reg. mask (also MS) (0-15) | RF | Rear or front output (2-1). |
| EXTR? | Ext Ref query. | RMT | Remote with lockout. |
| FR | Frequency | *RST | Reset (Preset). |
| FU | Function Select (0-5). | RSW | Reset single sweep. |
| HEAD | Query Header Enabled (0-1). | SC | Start continuous sweep. |
| HV | High voltage (0-1). | SM | Sweep mode (1-3). |
| ID? | Model Identify (short). | SP | Sweep stop frequency |
| *IDN? | Model Identify (long). | SR | Store state (0-9). |
| LCL | Local, clear lockout. | SS | Reset or Start single sweep. |
| MA | Amplitude modulation (0-1). | ST | Sweep start frequency |
| | | TE | Self Test |
| | | TI | Sweep time |

Note that most commands may be followed by a question mark (?) to interrogate the related parameter.

DATA:

| | |
|--------|----------------------|
| 0 to 9 | Digits |
| E | Exponent character |
| 'xyz' | Alpha-numeric string |
| - | Minus sign |
| . | Decimal point |

SUFFIX:

| | |
|----|-----------------|
| HZ | Hertz |
| KH | KHz |
| MH | MHz |
| MR | milli-Volts RMS |
| MV | milli-Volts p-p |
| VO | Volts p-p |

| | |
|-----|-----------------|
| VR | Volts RMS |
| DB | dBm |
| DV | dBVrms |
| DE | Degrees |
| SE | Seconds |
| ENT | Enter, no units |
| * | EOS character |

STATUS BYTE:

| BIT | VALUE | NAME | DESCRIPTION |
|-----|-------|--------|----------------------------------|
| 0 | 1 | ERR* | Program or keyboard entry error. |
| 1 | 2 | STOP* | Sweep stopped. |
| 2 | 4 | START* | Sweep started. |
| 3 | 8 | FAIL* | Hardware failure. |
| 5 | 32 | SWEEP | Sweeping. |
| 6 | 64 | RQS | Requested service |
| 7 | 128 | BUSY | 3325 is busy. |

* Only bits 0 to 3 may enable an SRQ.

Quick Reference Programming Information

Bits which can be enabled to generate an SRQ and the arguments for MS and ESTB:

| ARGUMENTS | FAIL | START | STOP | ERR |
|-----------|--------|--------|--------|--------|
| @,0 | Mask | Mask | Mask | Mask |
| A, 1 | Mask | Mask | Mask | ENABLE |
| B, 2 | Mask | Mask | ENABLE | Mask |
| C, 3 | Mask | Mask | ENABLE | ENABLE |
| D, 4 | Mask | ENABLE | Mask | Mask |
| E, 5 | Mask | ENABLE | Mask | ENABLE |
| F, 6 | Mask | ENABLE | ENABLE | Mask |
| G, 7 | Mask | ENABLE | ENABLE | ENABLE |
| H, 8 | ENABLE | Mask | Mask | Mask |
| I, 9 | ENABLE | Mask | Mask | ENABLE |
| J,10 | ENABLE | Mask | ENABLE | Mask |
| K,11 | ENABLE | Mask | ENABLE | ENABLE |
| L,12 | ENABLE | Enable | Mask | Mask |
| M,13 | ENABLE | Enable | Mask | ENABLE |
| N,14 | ENABLE | Enable | ENABLE | Mask |
| O,15 | ENABLE | Enable | ENABLE | ENABLE |

(Example: MSI or ESTBENT cause an SRQ to be generated when an Error or Failure occurs. ESTB? returns the byte value of the mask.)

Hardware Failure Codes:

| | | |
|------|-----|--|
| Fail | 010 | DAC range error |
| Fail | 011 | bad checksum, low byte of ROM |
| Fail | 012 | bad checksum, high byte of ROM |
| Fail | 013 | machine data bus line stuck low |
| Fail | 014 | keyboard shift register test failed |
| Fail | 021 | signal too big during calibration |
| Fail | 022 | signal too small during calibration |
| Fail | 023 | DC offset too positive during cal |
| Fail | 024 | DC offset too negative during cal |
| Fail | 025 | unstable/ noisy calibration |
| Fail | 026 | calibration factor out of range: AC gain offset |
| Fail | 027 | calibration factor out of range: AC gain slope |
| Fail | 028 | calibration factor out of range: DC offset |
| Fail | 029 | calibration factor out of range: DC slope |
| Fail | 030 | external ref unlocked |
| Fail | 031 | oscillator unlocked, VCO voltage too low |
| Fail | 032 | oscillator unlocked, VCO voltage too high |
| Fail | 033 | HP-IB isolation circuits failed self test |
| Fail | 034 | HP-IB IC failed self test |
| Fail | 035 | RS232 test failed loop-back test |
| Fail | 036 | memory lost (battery dead) |
| Fail | 037 | unexpected interrupt |
| Fail | 038 | sweep-limit-flag signal failed self test |
| Fail | 039 | Fractional-N IC failed self test |
| Fail | 040 | Modulation Source failed self test |
| Fail | 041 | function-integrity-flag flip-flop always set |

Programming Error Codes:

| | | |
|-------|-----|---|
| Error | 100 | entry parameter out of bounds |
| Error | 200 | invalid units delimiter for entry |
| Error | 201 | invalid units delimiter with high voltage |
| Error | 300 | frequency too large for function |
| Error | 400 | sweep time too large, sweep rate too small. |
| Error | 401 | sweep time too small. |
| Error | 500 | amplitude/offset incompatible |
| Error | 501 | offset too big for amplitude |
| Error | 502 | amplitude too big for offset |
| Error | 503 | amplitude too small for offset |
| Error | 600 | sweep frequency |
| Error | 601 | sweep frequency too large for function |
| Error | 602 | sweep bandwidth too small |
| Error | 603 | log sweep start freq too small |
| Error | 604 | log sweep stop < start freq |
| Error | 605 | discrete sweep element is empty |
| Error | 700 | unknown command |
| Error | 701 | illegal query |
| Error | 751 | key ignored -- in remote (press LOCAL) |
| Error | 752 | key ignored -- local lockout |
| Error | 753 | feature disabled in compatibility mode |
| Error | 754 | attempt to recall a register that has not been stored since power up (use enhancements mode). |
| Error | 755 | amplitude modulation not allowed on selected function (warning only) |
| Error | 756 | modulation source arbitrary waveform is empty |
| Error | 757 | too many modulation source arbitrary waveform points |
| Error | 758 | firmware failure |
| Error | 800 | Error759 error while running XRUN routine |
| Error | 801 | illegal character received |
| Error | 802 | illegal digit for selection item |
| Error | 803 | illegal binary data block header |
| Error | 810 | illegal string, string overflow |
| Error | 811 | RS232 overrun -- characters lost |
| Error | 812 | RS232 parity error |
| Error | 900 | RS232 frame error |
| Error | 900 | option not installed |

Index

A

- Accessories 3-7
- Amplitude calibration key 1-3, 1-32
- Amplitude key 1-17
- Amplitude limits of ac functions 1-17
- Amplitude modulation 1-28
 - input connector 1-3
 - input impedance 1-29
- Amplitude vs. function 1-10
- Arbitrary waveforms 1-30
- Arrow keys 1-15
- Assign zero phase key 1-20
- Attention (ATN) bus line 2-4
- Auxiliary output connector 1-3

B

- Bandwidth vs. function 1-16
- Bandwidth, linear sweep 1-25
- Baud rate 1-35, 2-14
- Bus commands (HP-IB) 2-7
- Bus management lines (HP-IB) 2-3

C

- Calibration 1-32
- Cancelling sweeps 1-24
- Changing sweep bandwidth 1-24
- Changing the bus address 2-7
- Circuit breaker reset 1-3
- Clear command 2-7
- Clear discrete key 1-26
- Clear display 1-13
- Clear key 1-13
- Clear lockout 2-8
- Clear memory 1-31
 - clear all memory 1-4
- Discrete sweep table 1-3
- Command Mode 2-4, 2-7
- Command syntax 2-17
- Compatibility 2-30, 2-67, 2-69, 3-5 - 3-6
- Compatibility mode 1-4, 2-13
- Connectors
 - Amplitude modulation input 1-3, 1-28
 - Auxiliary output 1-3, 1-41
 - External reference input 1-3
 - Fast sync output 1-3
 - HP-IB 1-34
 - main signal 1-8
 - main signal output 1-41
 - Main signal output (front panel) 1-3
 - Main signal output (rear panel) 1-3
 - marker output 1-37
 - modulation source 1-29
 - Modulation source output 1-3
 - Phase modulation input 1-3, 1-29
 - Reference output 1-3
 - RS-232 1-35
 - Synchronized output 1-3
 - 10 MHz oven 1-42
 - X-drive 1-3, 1-37 - 1-38
 - Z-blank 1-3, 1-38
 - Z-blank output 1-37

Continuous

- discrete sweeps 1-27
- indicator 1-25
- linear sweeps 1-25
- sweeps 1-21, 1-24, 1-37

Converting units 1-17

D

- Data entry 1-12
- Data keys 1-2, 1-12
- Data Mode 2-4, 2-7
- Data transfer rate 2-2
- DC offset 1-11
 - key 1-17
 - limits 1-18
- Default address 2-7
- Description of the HP-IB 2-2
- Disabling modulation 1-30
- Discrete sweep key 1-27
- Discrete sweeps 1-21, 1-26, 1-37
- Display 1-2
 - clear 1-13
 - dc offset 1-11
 - indicators 1-14
 - parameters 1-14
 - units 1-14
- Displaying the bus address 2-6
- Distortion 1-11
 - Causes 1-3

E

- Editing data entries 1-13
- End or Identify (EOI) 2-4
- Enhancements 1-25, 2-13, 2-30
- Entering discrete sweep parameters 1-26
- Entry keys 1-2
- EOCS character 2-19
- Error messages 1-13, 2-65
- Example Programs 2-70
- External frequency reference 1-42
- External reference indicator 1-3
- External reference input connector 1-3

F

- Fan 1-3
- Fan Filter 1-3
- Fast sync output connector 1-3
- Fast sync output signal 1-40
- Frequency
 - bandwidth vs. function 1-16
 - entry indicator 1-15
 - key 1-16
 - reference output 1-42
 - resolution 1-16
 - step key 1-15
 - sweeps 1-21
- Function
 - amplitude ranges 1-10
 - bandwidth 1-16
 - keys 1-11

H

- Handshake lines (HP-IB) 2-3
- Handshake, serial interface 1-36, 2-14
- Hardware handshake 2-14
- High voltage option 1-9
- HP-IB Address
 - default 2-6
 - displaying 2-6
 - talk and listen 2-5
- HP-IB Capabilities 2-2, 2-5
- HP-IB description 2-2
- HP-IB interface 1-3, 1-33

I

- Impedance
 - of amplitude modulation input 1-29
 - of main signal output 1-8
 - of phase modulation input 1-29
- Indicators
 - amplitude 1-17
 - arbitrary waveform 1-30
 - Auxiliary 1-3
 - continuous 1-25
 - dc offset 1-17
 - display 1-14
 - External reference 1-3
 - frequency 1-16
 - frequency entry 1-15
 - function 1-11
 - listen 1-33
 - marker frequency 1-23
 - Modulation 1-3
 - modulation source 1-29
 - phase 1-20
 - rear-only 1-8
 - remote 1-33, 1-36, 2-16
 - shift 1-7

- SRQ 1-33
- start frequency 1-22
- Status 1-2
- stop frequency 1-22
- Units 1-3
- Instrument description 3-1
- Instrument preset key 1-3
- Interface
 - HP-IB 1-3, 1-33
 - RS-232 1-3, 1-35, 2-11
- Interface clear (IFC) 2-4, 2-7

K

- Keys
 - amplitude 1-17
 - Amplitude calibration 1-3, 1-32
 - amplitude modulation 1-28
 - amplitude modulation off 1-30
 - assign zero phase 1-20
 - bus address 1-34
 - clear 1-13
 - clear discrete 1-26
 - Data 1-2
 - data entry 1-12
 - dc offset 1-17
 - discrete sweep 1-27
 - Entry 1-2
 - frequency 1-16
 - frequency step 1-15
 - function 1-11
 - Instrument preset 1-3
 - Local 1-2, 1-33, 1-36, 2-15
 - marker frequency 1-23
 - marker into center frequency 1-23
 - Modify 1-3, 1-15
 - Modulation source 1-3
 - phase 1-20
 - phase modulation 1-29
 - phase modulation off 1-30
 - Rear-only 1-3, 1-8
 - recall 1-31
 - reset/start 1-24
 - Shift 1-2, 1-7
 - start 1-25
 - start frequency 1-22
 - stop frequency 1-22
 - store 1-31
 - Sweep 1-2
 - time 1-22

L

- Limits, offset 1-18
- Linear sweep bandwidth 1-25
- Linear sweeps 1-21, 1-25
- Listen-only address 2-7
- Local command 2-15
- Local HP-IB bus command 2-8
- Local key 1-2, 1-33, 1-36, 2-15
- Local lockout 2-8, 2-55
- Log sweeps 1-21, 1-25, 1-37

M

- Main function keys 1-11
- Main signal
 - bandwidth vs. function 1-16
 - impedance 1-8
 - loading 1-10
 - output connector 1-8
- Output connector (front panel) 1-3
- Output connector (rear panel) 1-3
- return loss 1-8
- Respecification 1-8
 - termination 1-11
- Marker 1-23
- Marker frequency key 1-23
- Marker into center frequency key 1-23
- Masking the status byte 2-8 - 2-9
- Maximum dc offset 1-18
- Memory clear 1-31, 2-7
- Messages, error 1-13, 2-65
- Minimum dc offset 1-18
- Modify bandwidth 1-24
- Modify keys 1-3, 1-15
- Modifying entry values 1-15
- Modulation 1-28
 - Indicators 1-3
 - source 1-28 - 1-29
 - source amplitude 1-29
 - source frequency 1-30
 - Source keys 1-3
 - Source output connector 1-3
 - voltage limits 1-28

N

- New features 3-5

O

- Offset 1-11
- Offset limits 1-18
- Options 3-6
 - handles 3-6
 - high voltage 1-9
 - high-stability frequency reference 1-42
 - rack mount 3-6
- Overshoot 1-11

P

- Parallel poll 2-8
- Parameter units 1-14
- Parameters 2-18
- Parameters, viewing 1-14
- Parity 1-36, 2-14
- Phase modulation 1-28
 - Input connector 1-3
 - input impedance 1-29
- Phase range 1-20
- Power line
 - Voltage limits 1-3
 - Voltage selection 1-3
 - Voltage selection vs fuse used 1-3
- Power switch 1-2
- Power-down state 1-4
- Preset state 1-3 - 1-5, 2-13, 2-56

R

- Rear-only key 1-3, 1-8
- Rear-panel switches 1-3
- Recall discrete sweep segments 1-27
- Recall state 2-53
- Recalling instrument states 1-31
- Receive pacing 2-14
- Reference output 1-42
- Reference output connector 1-3
- Remote (RS-232) 2-55
- Remote command 2-8
- Remote mode 2-15
- Remote operation command list 2-67
- Remote operation commands
 - amplitude calibration 2-20
 - amplitude data entry 2-21
 - amplitude modulation control 2-40
 - assign zero phase 2-23
 - calibration mode 2-24
 - clear discrete sweep table 2-25
 - control location of main signal 2-54
 - data transfer mode control 2-41
 - dc offset data entry 2-49
 - discrete sweep store/recall 2-27
 - discrete sweep table clear 2-25
 - display on/off 2-26
 - display string 2-28

- echo characters (RS-232) 2-29
- enable SRQ 2-32, 2-48
- enhancements control 2-30
- error query 2-31
- external reference locked query 2-33
- frequency data entry 2-34
- function select 2-35
- high voltage output control 2-37
- identification query 2-38
- local command 2-39
- main signal rear/front connector 2-54
- marker frequency data entry 2-42
- mask status byte 2-32, 2-48
- mod source amplitude data entry 2-43
- mod source arb waveform entry 2-44
- mod source frequency data entry 2-45
- mod source function select 2-46
- option query 2-50
- phase data entry 2-51
- phase modulation control 2-47
- query status byte 2-52
- recall state 2-53
- remote command (RS-232) 2-55
- reset 2-56
- reset single sweep 2-57
- response header control 2-36
- set SRQ mask 2-32, 2-48
- start continuous sweep 2-58
- start frequency data entry 2-63
- start single sweep 2-62
- status byte query 2-52
- stop frequency data entry 2-60
- store state 2-61
- sweep mode selection 2-59
- sweep time data entry 2-64
- waveform select 2-35
- Reset/start key 1-24
- Resolution, frequency 1-16
- Resolution, phase 1-20
- Return loss
 - main signal 1-8
- RS-232
 - baud rate 2-14
 - cable pin assignments 2-12
 - interface 2-11
 - remote control 2-18
- RS-232 baud rate 1-35
- RS-232 interface 1-3, 1-35

S

- Safety consideration 3-1
- Selecting a function 1-11
- Self test 1-3
- Serial
 - baud rate 2-14
 - handshake 2-14

- interface 2-11
 - poll (HP-IB) 2-8, 2-52
 - word length 2-14
- Serial handshake 1-36
- Service request (SRQ) 2-4, 2-8
- Set local 2-8
- Setup parameters, viewing 1-14
- Shift key 1-2, 1-7
- Single discrete sweeps 1-27
- Single sweeps 1-21, 1-24, 1-37
- Software handshake 2-14
- Specification 3-1
- Square wave
- Standby 1-4
- Start frequency key 1-22
- Start key 1-25
- State
 - power-down 1-4
 - preset 1-4 - 1-5
 - turn-on 1-4
- Status bit 2-8
- Status byte 2-10, 2-52
 - mask 2-8 - 2-9
- Status indicators 1-2
- Stop frequency key 1-22
- Storing discrete sweep parameters 1-26
- Storing instrument states 1-31
- Sweep
 - Keys 1-2
 - parameter default values 1-21
 - time limit 1-22
- Switches
 - Rear-panel 1-3
- Symbols 2-19
- Synchronized output connector 1-3
- Synchronous output signal 1-40
- Syntax 2-17
- Syntax drawings rules 2-19
- System controller 2-3

T

- Talk/listen addresses 2-5
- Termination, main signal 1-11
- Tests, self-test 1-3, 1-32
- Time key 1-22
- Transfer rate 2-2
- Trigger (HP-IB) 2-9, 2-62
- Turn-on state 1-4, 2-13

U

- Units 1-14
 - conversion 1-17
 - Indicators 1-3

V

Viewing the bus address 2-6
Voltage range vs. function 1-10

W

Warm-up time 1-4

X

X-drive connector 1-3
X-drive signal 1-38

Z

Z-blank connector 1-3
Z-blank signal 1-38