

# Agilent Choosing the Right Power Meter and Sensor

Product Note



Design and manufacturing engineering processes for RF/microwave systems have reached a status undreamed of a decade ago. Wireless communication engineers especially, faced with aggressive project schedules must quickly select and configure power measurement equipment which meets the accuracy and repeatability required by their innovative new modulation formats. New wireless technologies needed to support wideband

data transmissions, now demand power measuring instruments and sensors for average power, as well as time-gated and peak power profiles and peak-to-average ratios, with all those measurements delivered at high measurement-data rates.

The Agilent Technologies' contribution: **unsurpassed accuracy and repeatability—by design.**



**Agilent Technologies**

Innovating the HP Way

In general, power sensors are designed to match user signals and modulation types. Power meters are designed for matching the user's measurement data requirements. That's why you can choose from a versatile line of 33 different power sensors and 6 power meters from Agilent Technologies, as shown in table 1. In addition, Agilent offers many custom configurations for ATE system applications and other calibration, traceability and quality processes.

This product note outlines applications considerations and the newest sensor technologies available from Agilent Technologies. It includes Agilent's new power meters and family of peak and average sensors, designed for pulsed power and the complex-modulation signals of wireless communications markets. It also reviews the families of thermocouple, diode, and two-path, diode-attenuator-diode sensors. It discusses the advantages and disadvantages of each sensor technology as they apply to current and near-future wireless system advances.

Not discussed is the Agilent family of thermistor sensors and the associated Agilent 432A power meter. This venerable technology now is used almost exclusively for the standardization and traceability of power measurements from the U.S. National Institute of Standards and Technology and other international standards agencies. Since the Agilent 432A power meter and thermistor sensor technology is based on the highly-precise DC-substitution method, the sensors are used as transfer standards, traveling between the user's primary lab and the NIST measurement services laboratory. For those users with interest in such metrology power transfer processes, request Agilent's AN 64-1 and 64-4 application notes.

**Table 1. An overview of Agilent power meters and sensors**

	Agilent power meters		
	EPM-P series peak, average and time gating E4416A single Ch E4417A dual Ch	EPM series Averaging E4418B single Ch E4419B dual Ch	System power meters 70100A MMS E1416A VXI
<b>Agilent power sensors</b>			
Thermocouple 8480A/B/H-family R/Q 8486A (11 models)	•	•	•
Diode 8480D-family 8486-W/G-family (7 models)	•	•	•
Diode sensors with extended range E4412A/13A (2 models)	•	•	
Two-path-diode-stack E9300 family (7 models)	•	•	
Peak and average sensors E9320 family (6 models)	•		

# Power measurements on complex modulation wireless signals

Digital vector modulation became the modulation of choice as the digital revolution swept over communication systems some 20 years ago. The need to pack the maximum amount of digital data into the limited spectrum of cellular and data transmission systems made it an obvious choice. RF power measurements for these new complex phase/amplitude formats call for careful applications analysis of the test signals.

The advent of wireless communications technology accelerated the migration from analog to digital modulation formats. Soon came an alphabet soup of digital modulation formats including, BPSK, QPSK, 8-PSK, 16 QAM, etc. Then came important variations such as pi/4-DQPSK and others. Many systems used data streams which depended on TDMA technology (time-division-multiple-access, example; GSM). Other system developers introduced a highly competitive CDMA format (code-division-multiple access, a recent example; IS-95A).

Transmitters at both the base stations and in the individual wireless handsets have demanded the most creative designs to preserve frequency spectrum and reduce power drain. Whether a TDMA system, which feeds multiple carriers through a common output amplifier, or a CDMA system, which encodes multiple data streams onto a single carrier with a pseudo-random code, the resulting transmitted power spectrum features almost white-noise-like characteristics.

Just like white noise, the average power of the transmitted signal is only one of the important parameters. Because of the statistical nature of multiple carrier systems, signal peak-to-average power ratio is crucial, since instantaneous peak powers can approach ratios of 10 to 30 times the average power, depending on formats and filtering.

Those high peak-to-average power ratios imply dangers in saturation of the output power amplifiers. When saturation occurs, the outer symbol locations compress, increasing bit errors and system unreliability. System designers handle this effect by “backing-off” the power amplifiers from their maximum peak ratings to assure that signal peak power operation is always within their linear range.

Therefore, all of these technologies require precise characterization of the pulse performance of their systems’ amplifier power output, including peak-to-average power ratios and time-gated parameters for profiling the pulsed signals, which assures conformity to specified limits.

# Understanding sensor technologies

## Thermocouple sensors

Thermocouples operate because dissimilar metals generate a voltage due to temperature differences at a hot and cold junction of the two metals. Since thermocouple sensors absorb the RF/microwave signal and heat the “hot” junction element, they give the correct average power for all types of signal formats from continuous wave (CW) to pulsed to complex digital modulation, regardless of the harmonic content, waveshape or distortion of the signal. Historically, this made thermocouple power sensors the preferred sensor type for systems with complex modulation formats, as test engineers could be assured that the sensor responded to the total aggregate power across its entire dynamic range. A radar’s peak pulse power was often computed from the average power value and a knowledge of the system duty cycle.

However, thermocouple sensors typically have a dynamic range of only 50 dB, from  $-30$  dBm ( $1 \mu\text{W}$ ) to  $+20$  dBm ( $100 \text{ mW}$ ). A common measurement made on wireless systems is the “mute” test, where the output of the power amplifier is disabled. Thermocouple sensors are required for power amplifier measurements but are not sensitive enough for the mute-test power levels, typically  $> -55$  dBm. This restricted sensor dynamic range makes measuring the lower power levels a slow and cumbersome process, involving swapping thermocouple sensors for diode sensors and then re-calibrating measurement paths. Even measurements at the low-end of the specified range of thermocouple sensors (typically  $-25$  to  $-30$  dBm) require many averages to produce an accurate, stable reading.

## Diode sensors

Diodes convert high frequency energy to DC by means of their rectification properties, which arise from their non-linear current-voltage characteristic. Figure 1 shows a typical diode detection curve starting near the noise level of  $-70$  dBm and extending up to  $+20$  dBm. In the lower “square-law” region the diode’s detected output voltage is linearly proportional to the input power ( $V_{\text{out}}$  proportional to  $V_{\text{in}}^2$ ) and so measures power directly. Above  $-20$  dBm, the diode’s transfer characteristic transitions toward a linear detection function ( $V_{\text{out}}$  proportional to  $V_{\text{in}}$ ), and the square-law relationship is no longer valid.

Traditionally, diode power sensors have been specified to measure power over the  $-70$  to  $-20$  dBm range, making them the preferred sensor type for applications that require high sensitivity measurements, such as verifying input levels in receiver sensitivity tests. In applications that require fast measurement speed, diode sensors are the chosen over thermocouple types because of their quicker response to changes of input power. The Agilent 8480 series D-suffix sensors are examples of this high-sensitivity diode technology.

When testing from  $-70$  dBm up to  $+20$  dBm is necessary, as has become increasingly the case, the traditional approach has been to use a diode sensor to cover the low end, and a thermocouple sensor for the high end. In a high volume manufacturing environment, this dual measurement configuration places a serious demand on test time limitations, especially if optimum accuracy must be maintained.

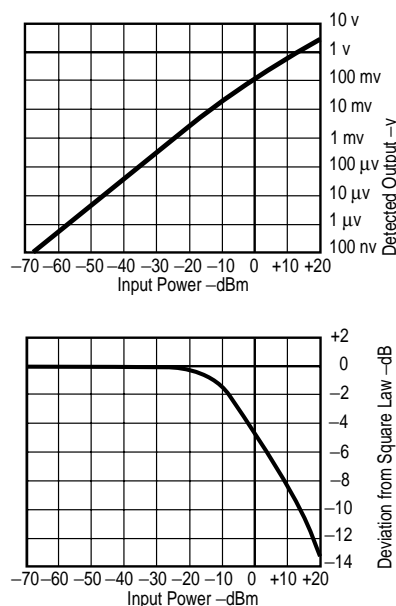

Figure 1. The diode detection characteristic ranges from square law through a transition region to linear detection.

## Extended dynamic range diode sensors

A common approach to extend the dynamic range of diode power sensors above their square law region has been the use of correction factors. Correction factors, derived from a CW source, compensate for the deviation from square law in the transition region (approximately -20 to 0 dBm) and the linear detection region (above 0 dBm) and are stored in the sensor's EEPROM. This results in a single sensor that can accurately measure CW and constant amplitude signals from -70 dBm up to +20 dBm.

However, many commonly used complex digital modulation schemes in today's wireless communications systems do not exhibit constant amplitude, GSM being a notable exception. With signals such as CDMA and TDMA, the correction factors, set by CW performance, lead to additional inaccuracies, on top of the usual mismatch, reference source and instrumentation measurement uncertainties.

With CDMA signals, average power requirements are for accurate measurements in the presence of high peak-to-average power ratios and often exhibit a dynamic range greater than 50 dB. Another issue with the compensated single diode approach, when measuring such high peak-to-average signals, is that reflections of a test signal's low harmonics increase above the square law region - introducing greater mismatch errors and the potential of stray signal distortion in the device under test.

This CW compensation technology is used in the Agilent E4412A/13A sensors, and as described above, caution should be used when choosing this sensor technology for non-CW and constant amplitude signals. A typical application might be for power sensing and stabilization in a metrology laboratory where CW signals are often used as test sources.

## Two-path diode-stack sensors

The ideal sensor would combine the accuracy and linearity of a thermal sensor with the wide dynamic range of the corrected diode approach. Agilent Technologies met this need and design challenge by creating a new family of power sensors in the E-series, based on a dual-path, diode-attenuator-diode topology. This topology has the advantage of always maintaining the sensing diodes within their square law region and therefore responding correctly to complex modulation formats.

The E-series E9300 power sensors are implemented as a Modified Barrier Integrated Diode (MBID). The MBID is comprised of a two diode stack pair for the low power path, a resistive attenuator and a five diode stack pair for the high power path, as shown in figure 2. Only one path is active at a time, and switching between paths is fast, automatic and transparent to the user, effectively producing an 80 dB dynamic range.

This innovative approach has the additional advantage of making the sensor capable of handling higher power levels without damage, than the extended dynamic range diode sensors. This is particularly useful with W-CDMA signals, which exhibit

high peak-to-average ratios. The MBID sensors, that operate over -60 to +20 dBm, have a maximum average power specification of +25 dBm and +33 dBm peak (<10  $\mu$ S duration). This means that the full 80 dB dynamic range can be used to measure signals that simultaneously have both high peak power and high average power.

The new sensor technology facilitates an inherently broadband average power measurement technique, limited by none of the bandwidth or dynamic range trade-off considerations found in sampled techniques. These sensors are an ideal fit for users who need the flexibility to make wideband average power measurements. Together with the E-series E9300 power sensors, the companion Agilent EPM power meters (E4418B/19B) are capable of accurately measuring the power of modulated signals over a wide dynamic range, regardless of signal bandwidth.

The E4418B/19B meters are ideal for all power measuring applications, which do not require time-gated power parameters or peak power measurements.

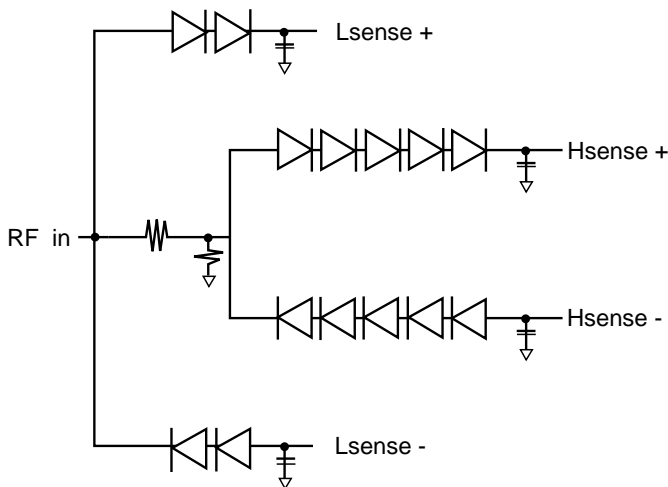

Figure 2. Schematic of the diode-attenuator-diode sensing element

## Peak and average power sensors

The Agilent E9320 family of peak and average power sensors presently cover the 50 MHz to 6/18 GHz frequency ranges and -67 to +20 dBm power range. When teamed with the new Agilent EPM-P series power meters (E4416A/17A), the combination can handle test signals up to 5 MHz modulation bandwidth. The meters' 20 Msamples/second continuous sample rate permits fast measurement speed, via the GPIB, of up to 1,000 corrected readings per second, ideal for use in automatic test system applications.

Agilent peak and average power sensors are designed for characterizing pulsed and complex modulation signals. They feature two-mode operation, **Normal** for most average and peak measurements (with or without time gating), and **Average only** for average power measurements on low level or CW-only signals. Both modes use the same diode-sensor "bulk-head" element. The signal processing is provided by two amplification paths, each optimized to their different data requirements. In the average only mode, amplification and chopping parameters are much the same as in previous Agilent diode sensors.

In the Normal mode, the separate path pulse amplifier provides maximum bandwidths of 300 kHz, 1.5 MHz or 5 MHz, allowing the user to match the test signal's modulation bandwidth to the sophisticated instrument data processing. This permits the meter to measure burst average and peak power, to compute peak-to-average ratios, and display other time-gated pulse power profiles on the power meter's large LCD screen. It can also measure and display other complex wideband modulation formats whose envelopes contain high frequency components up to 5 MHz.

Measurement accuracy is enhanced without compromise, since the sensors store three-dimensional calibration data in an EEPROM, resident in each sensor. The data is unique to each sensor and consists of cal factor versus frequency versus power input versus temperature. Upon power-up, or when the sensor cable is connected, these calibration factors are downloaded into the EPM-P series power meters.

### Bandwidth considerations

The power measurement system, comprising the sensor and meter, has its maximum video<sup>1</sup> bandwidth defined by the E9320 sensor. To further optimize the system's peak power dynamic range, the bandwidth, inside the meter, can be selected to **High, Medium** and **Low**, as detailed in table 2.

**Table 2. E9320 sensor bandwidth versus peak power dynamic range**

Sensor model	Video bandwidth / max. peak dynamic range			
	High	Medium	Low	Off
6 GHz/18 GHz				
E9321A / E9325A	300 kHz / -42 dBm to +20 dBm	100 kHz / -43 dBm to +20 dBm	30 kHz / -45 dBm to +20 dBm	-40 dBm to +20 dBm
E9322A / E9326A	1.5 MHz / -37 dBm to +20 dBm	300 kHz / -38 dBm to +20 dBm	100 kHz / -39 dBm to +20 dBm	-36 dBm to +20 dBm
E9323A / E9327A	5 MHz / -32 dBm to +20 dBm	1.5 MHz / -34 dBm to +20 dBm	300 kHz / -36 dBm to +20 dBm	-32 dBm to +20 dBm

The Off filter mode provides fast settling times and minimal overshoot. When users need to measure the peak power of multiple signal types, within a single sensor, by considering the dynamic range of the bandwidth settings shown in table 2, they can determine if they require only one sensor or need multiple sensors for their application(s).

1. The video bandwidth is the bandwidth detectable by the sensor and meter, over which the power is measured, and is sometimes referred to as the modulation bandwidth.

## Versatile user interface

The E4416A/17A meters feature a user-friendly interface and powerful display controls. Hardkeys control the most-frequently-used functions such as sensor calibration and triggering, while softkey menus simplify configuring the meter for detailed measurement sequences. A save/recall menu stores up to 10 instrument configurations for easy switching of test processes.

For time-gated measurements, the EPM-P series meters excel in versatility. Four independent gate periods with four delay times can each accumulate three different parameters such as average, peak and peak-to-average-power. Each gate can then manipulate the three parameters into two computed parameters (F-feeds) such as F1 minus F2 or F1/F2, to be displayed in one of the four window partitions. This computational power is particularly valuable in TDMA scenarios such as GSM, GPRS, EDGE and IS-136 where various simultaneous combinations of computed parameters are required.

The large LCD can be configured to provide a variety of measurement formats, such as a 4-line display to help interpret and compare measurement results, or a large character readout to permit viewing from a distance or a graphical representation of the pulse.

Figure 3 shows typical time-gated power measurements on a GSM signal. Gate 2 provides the burst average power over the “useful” GSM time period and Gate 1 indicates the peak power over the complete time-slot. Thus, a peak-to-average ratio measurement can be obtained by combining Gate 1–Gate 2 (in dB).

This peak-to-average measurement is made on two different gate times and should not be confused with the peak-to-average ratio measurement in a single gate. A pulse droop measurement can be obtained from the subtraction of the two powers, Gate 3–Gate 4. With the 4-line numeric display, all 3 of these measurements can be simultaneously display on the LCD screen, along with the peak power from Gate 1.

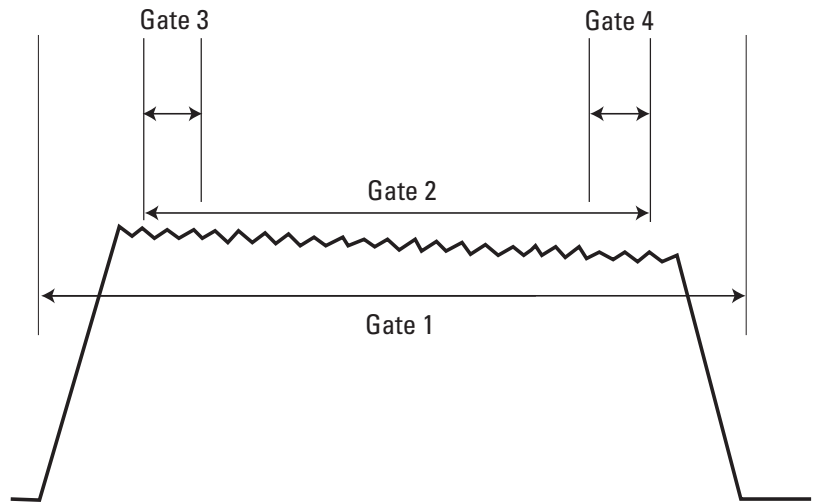

**Figure 3. Powerful data configuration routines permit measurements during 4 gate times, each with 2 data “feeds” for display. Computed parameters such as peak-to-average ratio can also be displayed.**

The E4416/17A power meters measure peak and average powers at user-designated time-gated periods in a test waveform. From that they compute the peak-to-average power ratio. This is a required parameter for assuring that wireless power amplifiers don’t operate into their compression region. The term Crest Factor is a functionally similar ratio, but based on voltage parameters, peak to rms. Since there is a small difference in values, Agilent power meters do not compute or display crest factor.<sup>1</sup>

1. Definition of Crest Factor (pulse carrier): The ratio of the peak pulse amplitude to the root-mean-square amplitude.

## Applications

Table 3 presents an applications profile for the E-series sensors. Each sensor technology fits some applications best, and provides the user data to make an informed choice.

## Pre-defined measurement setups

In addition to all the flexibility designed into the E4416/17A meters for custom measurements, Agilent has also studied the specific measurement and characterizations required for common wireless systems. To this end, the meters feature pre-defined measurement setups for the following systems: GSM, EDGE, NADC, iDEN, Bluetooth, IS-95 CDMA, W-CDMA,

and cdma2000. Such built-in routines simplify and speed up the time needed to configure test stations in production environments.

Table 4 presents the complete applications picture for the Agilent sensor families and how they blanket a wide variety of applications from metrology to the latest wireless signal formats.

**Table 3. Genealogy of Agilent E-series sensors**

E-series power sensor families	Power measurement types	Frequency range <sup>1</sup>	Power range <sup>1</sup>
E441XA family (extended range)	CW and constant amplitude signals	10 MHz to 26.5 GHz	-70 to +20 dBm
E9300 family two-path-diode-stack	CW and average power all modulation formats	9 kHz to 18 GHz	-60 to +44 dBm
E9320 family peak and average	CW, peak and average time-gated	50 MHz to 18 GHz	-67 to +20 dBm

**Table 4. Agilent sensor applications chart**

Recommended sensor application chart	Signal characteristics							
	Typical application examples >	CW	Modulated			Wireless standards		
		CW	Pulse/averaged	Pulse/profiled	AM/FM			
<b>Sensor technology</b>	Metrology lab	Radar/navigation	Radar/navigation	Mobile radio	TDMA GSM EDGE IS-136 IDEN	CDMA IS-95  Bluetooth	W-CDMA 3GPP cdma2000	
Thermocouple sensors	•	•		•	• Avg. only	• Avg. only	• Avg. only	
Diode sensors	•	•		•	• Avg. only	• Avg. only	• Avg. only	
Diode sensors compensated for extended range	•			FM only				
Two-path diode-stack sensors	•	•		•	• Avg. only	• Avg. only	• Avg. only	
Peak and average diode sensors (video BW)	•	• (5 MHz)	• (5 MHz)	•	• (300 kHz) time-gated	• (1.5 MHz) peak, avg., peak/avg.	• (5 MHz) peak, avg., peak/avg.	

1. Sensor dependent



# Agilent power sensor characteristics

Table 5. Agilent power sensor characteristics

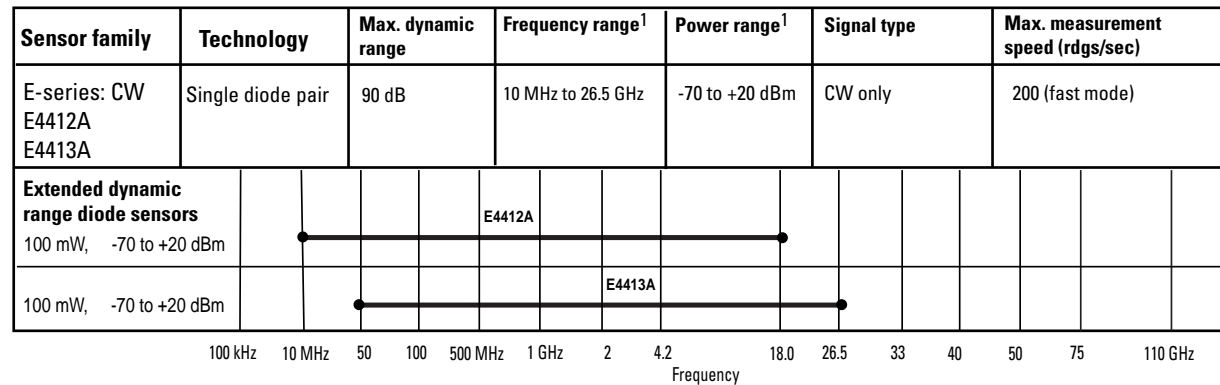
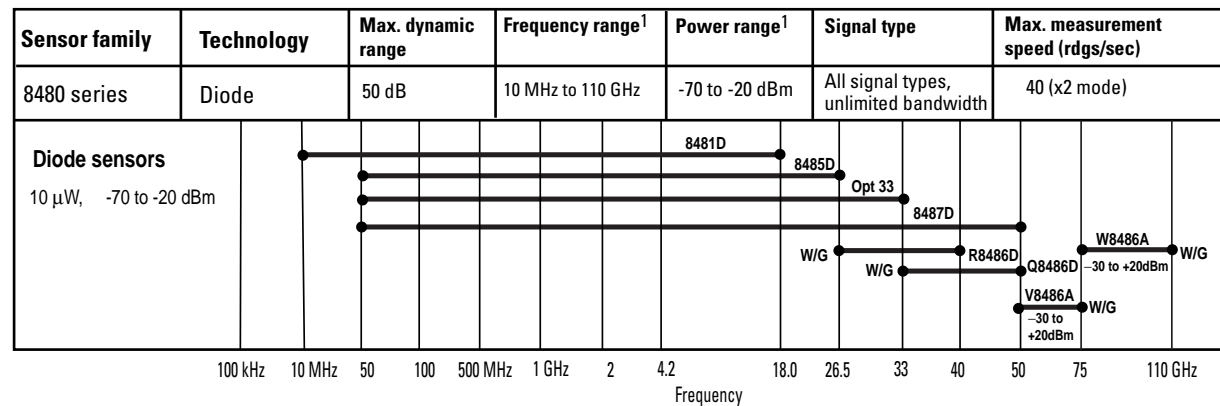
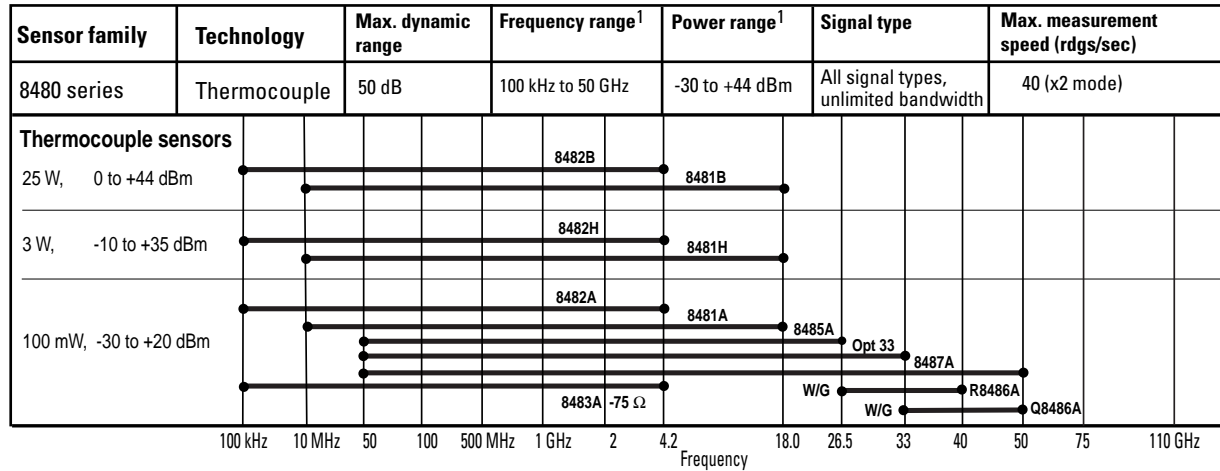

1. Sensor dependent

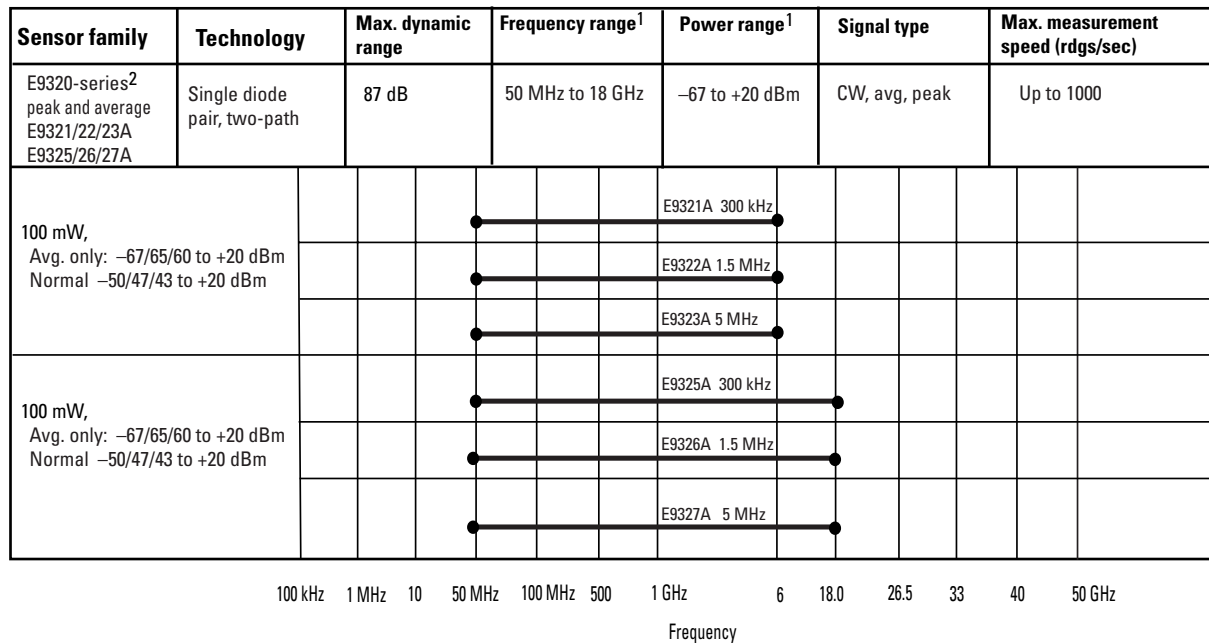
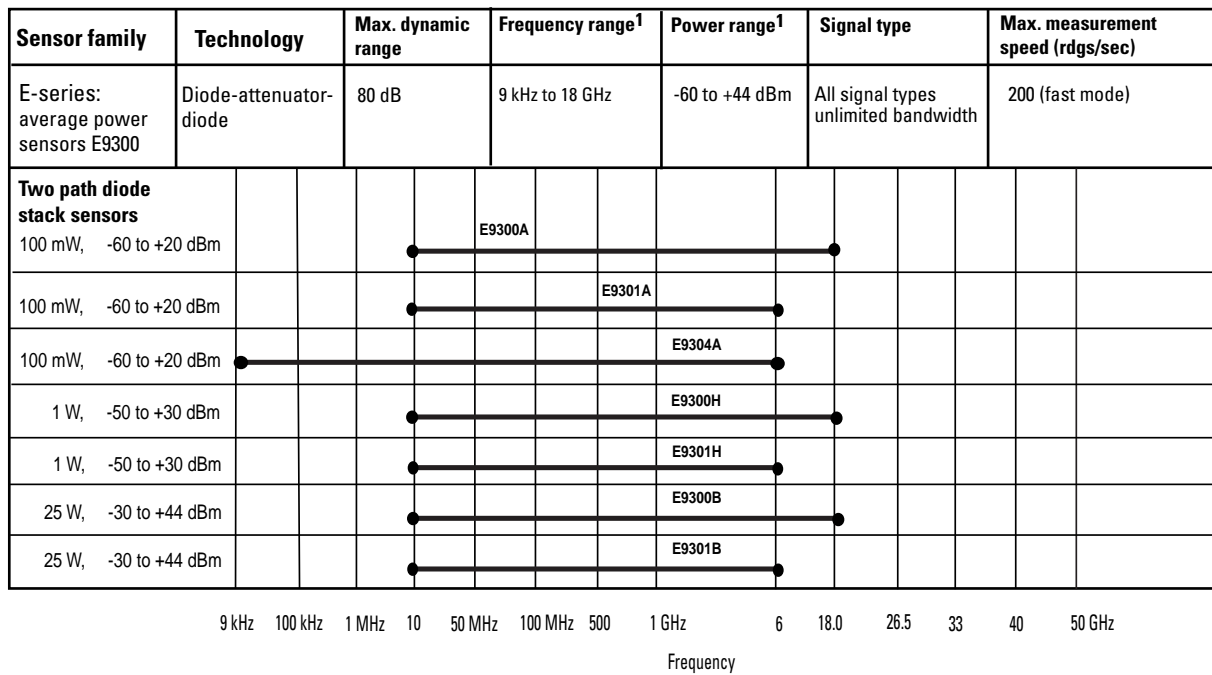

1. Sensor dependent

2. Peak and average sensors must be used with an E9288A, B, or C sensor cable, and only operate with the E4416A/17A power meters

Agilent Technologies is committed to providing measurement solutions for RF/microwave power now and in the future. Agilent power meters and sensors will be enhanced with new capabilities, such as pulse diagnostics with cursor manipulation. Watch our Web site for more information: **[www.agilent.com/find/powermeters](http://www.agilent.com/find/powermeters)**  
Enhancements will be available by disk or downloadable from Agilent.

## Related literature

*EPM-P Series Power Meters and E9320 Power Sensors,*  
Product Overview,  
literature number 5980-1471E

*EPM-P Series Power Meters and E9320 Power Sensors,*  
Technical Specifications,  
literature number 5980-1469E

*EPM Series Power Meters, Brochure,*  
literature number 5965-6380E

*EPM Series Power Meter, E-Series and 8480 Series Power Sensor,*  
Technical Specification,  
literature number 5965-6382E

*EPM Series Power Meters, E-Series Power Sensors,*  
Configuration Guide,  
literature number 5965-6381E

*E-Series E9300 Power Sensors,*  
Product Overview,  
literature number 5968-4960E

*Fundamentals of RF and Microwave Power Measurements,*  
Application Note 64-1,  
literature number 5965-6630E

*4 Steps for Making Better Power Measurements,*  
Application Note 64-4,  
literature number 5965-8167E

## **Agilent Technologies' Test and Measurement**

### **Support, Services, and Assistance**

Agilent Technologies aims to maximize the value you receive, while minimizing your risk and problems. We strive to ensure that you get the test and measurement capabilities you paid for and obtain the support you need. Our extensive support resources and services can help you choose the right Agilent products for your applications and apply them successfully. Every instrument and system we sell has a global warranty. Support is available for at least five years beyond the production life of the product. Two concepts underlie Agilent's overall support policy: "Our Promise" and "Your Advantage."

### **Our Promise**

Our Promise means your Agilent test and measurement equipment will meet its advertised performance and functionality. When you are choosing new equipment, we will help you with product information, including realistic performance specifications and practical recommendations from experienced test engineers. When you use Agilent equipment, we can verify that it works properly, help with product operation, and provide basic measurement assistance for the use of specified capabilities, at no extra cost upon request. Many self-help tools are available.

### **Your Advantage**

Your Advantage means that Agilent offers a wide range of additional expert test and measurement services, which you can purchase according to your unique technical and business needs. Solve problems efficiently and gain a competitive edge by contacting us for calibration, extra-cost upgrades, out-of-warranty repairs, and on-site education and training, as well as design, system integration, project management, and other professional services. Experienced Agilent engineers and technicians worldwide can help you maximize your productivity, optimize the return on investment of your Agilent instruments and systems, and obtain dependable measurement accuracy for the life of those products.

**For more assistance with your test & measurement needs go to**

**[www.agilent.com/find/assist](http://www.agilent.com/find/assist)**

**Or contact the test and measurement experts at Agilent Technologies**  
(During normal business hours)

### **United States:**

(tel) 1 800 452 4844

### **Canada:**

(tel) 1 877 894 4414

(fax) (905) 206 4120

### **Europe:**

(tel) (31 20) 547 2000

### **Japan:**

(tel) (81) 426 56 7832

(fax) (81) 426 56 7840

### **Latin America:**

(tel) (305) 267 4245

(fax) (305) 267 4286

### **Australia:**

(tel) 1 800 629 485

(fax) (61 3) 9272 0749

### **New Zealand:**

(tel) 0 800 738 378

(fax) 64 4 495 8950

### **Asia Pacific:**

(tel) (852) 3197 7777

(fax) (852) 2506 9284

**Product specifications and descriptions in this document subject to change without notice.**

**Copyright © 2000**

**Agilent Technologies**

**Printed in USA 10/2000**

**5968-7150E**



**Agilent Technologies**

Innovating the HP Way