

HP 5314A

O P E R A T I N G A N D S E R V I C E M A N U A L

5314A UNIVERSAL COUNTER



**HEWLETT
PACKARD**

HP 5314A

SAFETY

This product has been designed and tested according to International Safety Requirements. To ensure safe operation and to keep the product safe, the information, cautions, and warnings in this manual must be heeded. Refer to Section I for general safety considerations applicable to this product.

CERTIFICATION

Hewlett-Packard Company certifies that this product met its published specifications at the time of shipment from the factory. Hewlett-Packard further certifies that its calibration measurements are traceable to the United States National Bureau of Standards, to the extent allowed by the Bureau's calibration facility, and to the calibration facilities of other International Standards Organization members.

WARRANTY

This Hewlett-Packard product is warranted against defects in material and workmanship for a period of one year from date of shipment, except that in the case of certain components listed in Section I of this manual, the warranty shall be for the specified period. During the warranty period, Hewlett-Packard Company will, at its option, either repair or replace products which prove to be defective.

For warranty service or repair, this product must be returned to a service facility designated by HP. However, warranty service for products installed by HP and certain other products designated by HP will be performed at Buyer's facility at no charge within the HP service travel area. Outside HP service travel areas, warranty service will be performed at Buyer's facility only upon HP's prior agreement and Buyer shall pay HP's round trip travel expenses.

For products returned to HP for warranty service, Buyer shall prepay shipping charges to HP and HP shall pay shipping charges to return the product to Buyer. However, Buyer shall pay all shipping charges, duties, and taxes for products returned to HP from another country.

LIMITATION OF WARRANTY

The foregoing warranty shall not apply to defects resulting from improper or inadequate maintenance by Buyer, Buyer-supplied software or interfacing, unauthorized modification or misuse, operation outside of the environmental specifications for the product, or improper site preparation or maintenance.

NO OTHER WARRANTY IS EXPRESSED OR IMPLIED. HP SPECIFICALLY DISCLAIMS THE IMPLIED WARRANTIES OF MERCHANTABILITY AND FITNESS FOR A PARTICULAR PURPOSE.

EXCLUSIVE REMEDIES

THE REMEDIES PROVIDED HEREIN ARE BUYER'S SOLE AND EXCLUSIVE REMEDIES. HP SHALL NOT BE LIABLE FOR ANY DIRECT, INDIRECT, SPECIAL, INCIDENTAL, OR CONSEQUENTIAL DAMAGES, WHETHER BASED ON CONTRACT, TORT, OR ANY OTHER LEGAL THEORY.

ASSISTANCE

Product maintenance agreements and other customer assistance agreements are available for Hewlett-Packard products.

For any assistance, contact your nearest Hewlett-Packard Sales and Service Office. Addresses are provided at the back of this manual.

HP 5314A UNIVERSAL COUNTER

OPERATING AND SERVICE MANUAL

SERIAL NUMBER PREFIX: 2714

This manual applies directly to HP Model 5314A having serial number prefix 2714A and below.

NEWER INSTRUMENTS

This manual, with enclosed "Manual Changes" sheet, applies to HP Models 5314A having serial number prefixes as listed on the "Manual Changes" sheets.

©HEWLETT-PACKARD COMPANY 1987, 1993
5301 STEVENS CREEK BLVD, SANTA CLARA, CA 95051-7299

MANUAL PART NUMBER : 05314-90015

Printed: September 1993



TABLE OF CONTENTS

Section	Title	Page
I	GENERAL INFORMATION	1-1
	1-1. Introduction	1-1
	1-4. Specifications.....	1-1
	1-6. Safety Considerations.....	1-1
	1-8. Instruments Covered by Manual	1-1
	1-11. Instrument Identification	1-1
	1-15. Description	1-3
	1-18. Options.....	1-3
	1-20. Equipment Supplied.....	1-4
	1-22. Recommended Test Equipment.....	1-4
II	INSTALLATION	2-1
	2-1. Introduction	3-1
	2-3. Initial Inspection	2-1
	2-5. Preparation for Use	2-1
	2-6. Power Requirements.....	2-1
	2-8. Line Voltage Selection	2-1
	2-10. Power Cable	2-2
	2-12. Bench Operation	2-3
	2-14. Installation of Options 001 and 002	2-3
	2-16. Operating Environment.....	2-3
	2-18. Storage and Shipment	2-3
	2-19. Environment	2-3
	2-21. Packaging	2-3
III	OPERATION	3-1
	3-1. Introduction	3-1
	3-3. Operating Characteristics.....	3-1
	3-5. Frequency Measurements	3-1
	3-7. Period Measurements	3-1
	3-9. Time Interval Measurements.....	3-1
	3-12. Ratio A/B Measurements.....	3-2
	3-14. Totalize A Measurements	3-2
	3-16. Self-Check	3-2
	3-18. Panel Features	3-2
	3-20. Operating Instructions.....	3-3
	3-22. Operator's Maintenance	3-3
	3-24. Power/Warm-Up	3-3
IV	PERFORMANCE TESTS	4-1
	4-1. Introduction	4-1
	4-3. Equipment Required	4-1
	4-5. Operation Verification	4-1
	4-7. Performance Test	4-1
	4-9. Test Record.....	4-1
	4-13. Procedure	4-2

TABLE OF CONTENTS (Continued)

Section	Title	Page
V	ADJUSTMENTS.....	5-1
	5-1. Introduction	5-1
	5-4. Equipment Required	5-1
	5-6. Adjustment Locations.....	5-1
	5-8. Safety Considerations.....	5-1
VI	REPLACEABLE PARTS.....	6-1
	6-1. Introduction	6-1
	6-3. Reference Designations	6-1
	6-5. Replaceable Parts	6-1
	6-8. How to Order a Part	6-1
	6-10. Parts Identification	6-1
	6-14. Contacting Hewlett-Packard.....	6-2
	6-18. Cabinet Parts and Hardware	6-2
VII	MANUAL CHANGES.....	7-1
	7-1. Introduction	7-1
	7-3. Manual Changes	7-1
	7-6. Older Instruments	7-1
VIII	SERVICE	8-1
	8-1. Introduction	8-1
	8-3. Theory of Operation	8-1
	8-5. Troubleshooting.....	8-1
	8-7. Recommended Test Equipment.....	8-1
	8-9. Schematic Diagram Notes	8-1
	8-11. Reference Designations	8-1
	8-13. Identification Markings on Printed Circuit Boards	8-2
	8-16. Safety Considerations.....	8-2
	8-20. Fuse Replacement.....	8-3
	8-22. Line Input Fuse Replacement.....	8-3
	8-24. Option 002 Fuse Replacement	8-3
	8-26. Theory of Operation	8-5
	8-27. Introduction.....	8-5
	8-29. HP 5314A Overall Block Theory of Operation	8-5
	8-31. Detailed A1 Assembly Theory	8-5
	8-45. Power Supply Block Theory.....	8-12
	8-47. Detailed A2 Assembly Theory	8-12
	8-50. Option 002 Battery Charger Block Theory.....	8-12
	8-52. Detailed Option 002 A2 Assembly Theory	8-14
	8-56. Troubleshooting Test Procedures	8-14
	8-59. Procedure #1: Testing of 5314A Power Supply	8-16
	8-61. Procedure #2: Testing of 5314A Reference Oscillator.....	8-16
	8-63. Procedure #3: Testing Input Channels	8-17
	8-65. Procedure #4: Testing of ICM 7226 (Counter-in-a-Chip) and display	8-20
	8-67. Procedure #5: 20 MHz Mode	8-20

SAFETY CONSIDERATIONS

GENERAL

This is a Safety Class I instrument. This instrument has been designed and tested according to IEC Publications 348, "Safety Requirements for Electronic Measuring Apparatus."

Acoustic Noise Emission: LpA <40 dB; no fan installed.

GERAeUSCHEMISSION: LpA <40dB; Kein Ventilator eingebaut.

OPERATION

BEFORE APPLYING POWER verify that the power transformer primary is matched to the available line voltage and the correct fuse is installed (See Section II). Make sure that only fuses with required rated current and of the specified type (normal blow, time delay, etc.) are used for replacement. The use of repaired fuses and the short-circuiting of fuseholders must be avoided.

SERVICE

Although this instrument has been designed in accordance with international safety standards, this manual contains information, cautions, and warnings which must be followed to ensure safe operation and to retain the instrument in safe condition. Service and adjustments should be performed only by qualified service personnel.

Any adjustment, maintenance, and repair of the opened instrument under voltage should be avoided as much as possible and, when inevitable, should be carried out only by a skilled person who is aware of the hazard involved.

Capacitors inside the instrument may still be charged even if the instrument has been disconnected from its source of supply.

Whenever it is likely that the protection has been impaired, the instrument must be made inoperative and be secured against any unintended operation.

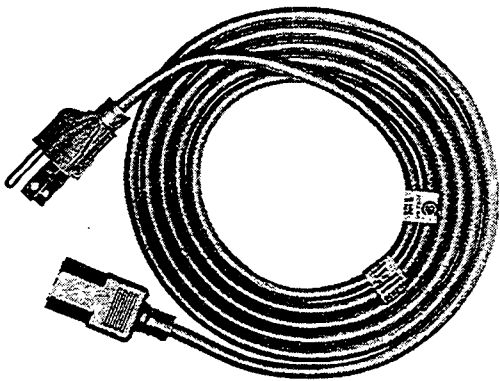
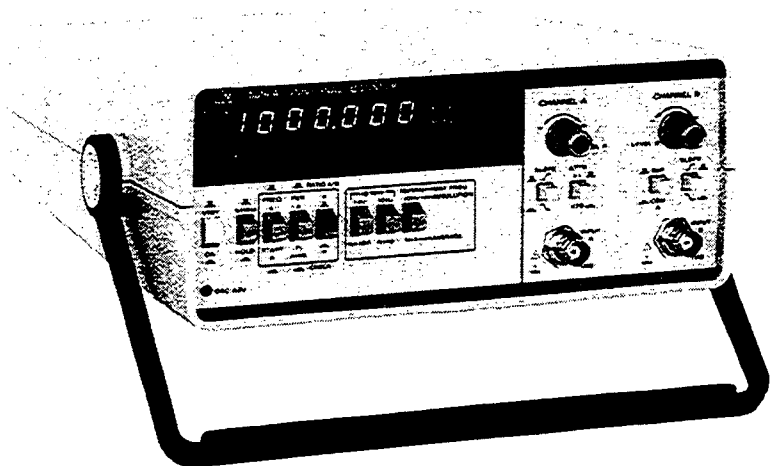

Figure 1-1. Model 5314A and Equipment Supplied

SECTION I GENERAL INFORMATION

1-1. INTRODUCTION

1-2. This manual provides information pertaining to the installation, operation, testing, adjustment, and maintenance of the HP Model 5314A Universal Counter. *Figure 1-1* shows the HP 5314A with the supplied equipment.

1-3. This operating and service manual is divided into eight sections, each covering a particular topic for the operation and service of the HP 5314A. The eight sections are listed here:

Section	Topic
I	General Information
II	Installation
III	Operation
IV	Performance Tests
V	Adjustments
VI	Replaceable Parts
VII	Manual Changes
VIII	Service

1-4. SPECIFICATIONS

1-5. Instrument specifications are listed in *Table 1-1*. These specifications are the performance standards or limits against which the instrument may be tested.

1-6. SAFETY CONSIDERATIONS

1-7. The HP 5314A Universal Counter is a Safety Class I instrument, designed according to international safety standards. This operating and service manual contains information, cautions, and warnings which must be followed by the user to ensure safe operation and keep the HP 5314A in safe operating condition.

1-8. INSTRUMENTS COVERED BY MANUAL

1-9. If the serial number prefix of your HP 5314A is lower than the serial number prefix on the title page of this manual, the manual must be modified for agreement with the HP 5314A. Refer to Section VII, Manual Changes, for the information which will adapt this manual to your HP 5314A. If the serial number prefix is higher, refer to the yellow "manual changes" sheet located inside the front cover.

1-10. The HP 5314A standard instrument, Option 001, and Option 002 are documented in this manual. The differences are noted in the appropriate locations such as Options in Section I, Replaceable Parts in Section VI, and Service in Section VIII.

1-11. INSTRUMENT IDENTIFICATION

1-12. The instrument serial number is located on the rear panel. Hewlett-Packard uses a two-section serial number consisting of a four-digit prefix and a five-digit suffix. A letter between the prefix and suffix identifies the country in which the instrument was manufactured (A=USA, G=West Germany, J=Japan, U=United Kingdom). All correspondence with Hewlett-Packard concerning this instrument should include the complete serial number.

Table 1-1. Specifications

INPUT CHARACTERISTICS

Range:

- Channel A 10 Hz to 100 MHz
- Channel B 10 Hz to 2.5 MHz

Sensitivity:

- Channel A:
 - 25 mV rms to 100 MHz
 - 75 mV peak-to-peak minimum pulse with 5 ns
- Channel B:
 - 25 mV rms to 2.5 MHz
 - 75 mV peak-to-peak minimum pulse width of 50 ns

Coupling: AC

Impedance: 1 MΩ NOMINAL shunted by less than 30 pF

Attenuator: X1 or X20 NOMINAL (A Channel only)

Trigger Level:

Continuously variable ±350 mV times attenuator setting around average value of signal.

Slope: Independent selection of + or - slope

Channel Input: Selectable SEPARATE or COMMON A

Damage Level:

- | | | |
|------|------------------|--|
| X1: | DC to 100 kHz | 350V (DC + peak AC) |
| | 100 kHz to 5 MHz | $2.5 \times 10^7 C \times \text{Hz Product}$ |
| | Above 5 MHz | 5V rms |
| X20: | DC to 1 MHz | 350V (DC + Peak AC) |
| | 1 MHz to 50 MHz | $2.5 \times 10^8 V \times \text{Hz Product}$ |
| | Above 50 MHz | 5V rms |

FREQUENCY (A)

Range:

- 10 Hz to 10 MHz direct count
- 1 MHz to 100 MHz prescaled by 10

LSD Displayed: Direct count 0.1 Hz, 1 Hz, 10 Hz switch selectable. Prescaled 10 Hz, 100 Hz, 1 kHz switch selectable.

Resolution: ± LSD

Accuracy: ± LSD ± (time base error) × FREQ

PERIOD (A)

Range: 10 Hz to 2.5 MHz

LSD Displayed:

$$\frac{100 \text{ ns}}{N} \text{ for } N=1 \text{ to } 1000 \text{ in decade steps of } N$$

Resolution:

$$\pm \text{LSD} \pm 1.4 \times \frac{\text{Trigger Error}}{N}$$

Accuracy

$$\pm \text{LSD} \pm 1.4 \times \frac{\text{Trigger Error}}{N} \pm (\text{time base error}) \times \text{PER}$$

TIME INTERVAL (A TO B)

Range: 250 ns to 1 s

LSD Displayed: 100 ns

Resolution: ± LSD ± START Trigger Error ± STOP Trigger Error

Accuracy: ± LSD ± START Trigger Error ± STOP Trigger Error ± (time base error) × TI

Time interval measurements require an arming signal for both the START and STOP Channels. (See Paragraph 3-11.)

RATIO

Range:

- 10 Hz to 10 MHz Channel A
- 10 Hz to 2.5 MHz Channel B

LSD Displayed:

$$1 \text{ part in } \frac{A}{B} \times N \text{ in decade steps of } N \text{ for } N=1 \text{ to } 1000$$

Resolution:

$$\pm \text{LSD} \pm (B \text{ Trigger Error} \times \text{FREQUENCY A})/N$$

Accuracy:

$$\pm 1 \text{ count of } A \pm (B \text{ Trigger Error} \times \text{FREQUENCY A})/N$$

TOTALIZE (A)

Range: 10 Hz to 10 MHz

Resolution: ± 1 count of input

GENERAL

Check: Counts internal 10 MHz Oscillator

Display: 7-digit amber LED display with gate and overflow indication.

Maximum Sample Rate: 5 readings per second.

Operating Temperature: 0° to 50°C

Power Requirement:

115V, +10%, -25%; 230V, -17%, +9%; 48-66 Hz; 10 VA maximum.

Weight: 2.0 kg (4.4 lbs.)

Dimension: 238 mm wide × 98 mm high × 276 mm long (9 $\frac{3}{8}$ × 3 $\frac{3}{8}$ × 10 $\frac{7}{8}$ in.)

TIME BASE

Frequency: 10 MHz

Aging Rate: <3 parts in 10⁷ per month

Temperature: <±1 part in 10⁵, 0° to 50°C

Line Voltage: <±1 part in 10⁷ for ±10% variation.

OPTIONS

Option 001: High Stability Time Base (TCXO)

Frequency: 10 MHz

Aging Rate: <1 part in 10⁷ per month

Temperature: <±1 part in 10⁶, 0° to 40°C

Line Voltage: <±1 part in 10⁸ for ±10% variation

Option 002: Battery

Type: Rechargeable lead-acid (sealed)

Capacity: TYPICALLY 8 hour of continuous operation at 25°C.

Recharging Time: TYPICALLY 16 hours to 98% of full charge, instrument nonoperating. Charging circuitry included with option. Batteries not charged during instrument operation.

Battery Voltage Sensor: Automatically shuts instrument off when low battery condition exists.

Line Failure Protection: Instrument automatically switches to batteries in case of line failure.

Weight: Option 002 adds 1.5 kg (3.3 lbs.) to weight of instrument.

WARRANTY

ALL COMPONENTS WITHIN OPTION 002, EXCEPT THE BATTERY, ARE WARRANTED FOR ONE FULL YEAR. BATTERY BT1 (HP PART NO. 1420-0253) IS WARRANTED FOR 90 DAYS.

DEFINITIONS

Resolution: Smallest discernible change of measurement result due to a minimum change in the input.

Accuracy: Deviation from the actual value as fixed by universally accepted standard of frequency and time.

Trigger Error:

$$\frac{\sqrt{(80 \mu\text{V})^2 + e_n^2}}{\text{Input Slew Rate at Trigger Point } (\mu\text{V/s})} \text{ (rms)}$$

Where e_n is the rms noise of the input for a 100 MHz bandwidth on Channel A and a 10 MHz bandwidth on Channel B

LSD: Least Significant Digit.

1-13. This instrument has a two-part serial number. The first four digits and the letter comprise the serial number prefix. The last five digits form the sequential suffix that is unique to each instrument. The contents of this manual apply directly to instruments having the same serial number prefix(es) as listed under SERIAL PREFIX on the title page.

1-14. An instrument manufactured after the printing of this manual may have a serial prefix that is not listed on the title page. This unlisted serial prefix indicates that the instrument is different from those documented in this manual. The manual for this instrument is supplied with a yellow Manual Changes supplement which contains change information that documents the differences.

1-15. DESCRIPTION

1-16. The HP 5314A is a 100 MHz/100 ns Universal Counter. It features a seven-digit, seven-segment LED display with overflow indication, seven function performance, and full input signal conditioning. There are two options available for the 5314A. They are a temperature Compensated Crystal Oscillator (TCXO, Option 001) and a battery pack for portable operation (Option 002).

1-17. The seven functions are: Frequency, Single-Shot Period, Period Average, Time Interval, Totalize, Ratio, and Self Check. This is accomplished by a single LSI integrated circuit. The input signal is AC coupled and can be conditioned as follows: slope selection, trigger level, and attenuation.

1-18. OPTIONS

1-19. The following is a list of options available for the 5314A Universal Counter:

NOTE

A full description of the options is given in *Table 1-1, Specifications*. For more information concerning the options for the HP 5314A, contact your local HP Sales and Service Office. A list of HP Sales and Service offices is provided at the end of this manual.

Hardware Options

- | | |
|-----|---------------------------------|
| 001 | High Stability Time Base (TCXO) |
| 002 | Battery with built-in charger |

NOTE

One of the following hardware options **must** be included with each order

- | | |
|-----|--|
| 115 | Line operating voltage factory set at 115V nominal (86V to 127V) ac |
| 230 | Line operating voltage factory set at 230V nominal (190V to 250V) ac |

Support Options

- | | |
|-----|---|
| W30 | Three-year customer return repair coverage |
| W32 | Three-year customer return calibration coverage |
| W34 | Three-year customer return Standard Compliant Calibration Service |
| W50 | Five-year customer return repair coverage |
| W52 | Five-year customer return calibration coverage |
| W54 | Five-year customer return Standard Compliant Calibration service |

Support options are available only at time of purchase. Service contracts are available from Hewlett-Packard for instruments which did not include support options at time of purchase. For information, contact your nearest Hewlett-Packard Sales office (offices are listed at the back of this manual)

For field installation of Options 001 and 002, refer to paragraph 2-14, Installation of Options 001 and 002.

1-20. EQUIPMENT SUPPLIED

1-21. Table 1-2 lists the only equipment supplied with the HP 5314A.

Table 1-2. Equipment Supplied

DESCRIPTION	HP PART NO.
Detachable Power Cord 229 cm (7½ feet long)	8120-1378

1-22. RECOMMENDED TEST EQUIPMENT

1-23. The test equipment listed in Table 1-3 is recommended for use during performance tests, adjustments, and troubleshooting. Substitute test equipment may be used if it meets the required characteristics listed in the table.

Table 1-3. Recommended Test Equipment

Instrument Type	Required Characteristics	HP Model No. Recommended
Test Oscillator	10 MHz, 25 mV rms	3314A
Signal Generator	100 MHz, 25 mV rms	8656B
50-ohm Termination	100 MHz bandwidth	10100C
Digital Voltmeter	10 volts	3466A
Oscilloscope (100 MHz)	V: 5 mV H: 50 ns	1741A
Function Generator	2.5 MHz, 25 mV rms	3312A

SECTION II INSTALLATION

2-1. INTRODUCTION

2-2. This section provides all information necessary to install the HP 5314A. Covered in this section are initial inspection, preparation for use, field installation of options, operating environment, and repackaging for shipment.

2-3. INITIAL INSPECTION

2-4. Inspect the shipping container for damage. If the shipping container or cushioning material is damaged, it should be kept until the contents of the shipment have been checked for completeness and the shipment has been checked mechanically and electrically. The contents of the shipment should be as shown in *Figure 1-1*. Procedures for checking electrical performance are given in Section IV. If the contents are incomplete, if there is mechanical damage or defect, or if the instrument does not pass the electrical performance test, notify the nearest Hewlett-Packard office. If the shipping container is damaged, or the cushioning material shows signs of stress, notify the carrier as well as the Hewlett-Packard office. Keep the shipping material for the carrier's inspection.

2-5. PREPARATION FOR USE

2-6. Power Requirements

2-7. The HP 5314A requires a power source of 115V, +10%, -25%; 230V, -17%, +9%; 48-66 Hz; 10 VA maximum. Power consumption is 10 watts maximum.

2-8. Line Voltage Selection

CAUTION

BEFORE SWITCHING ON THIS INSTRUMENT, make sure the instrument is set to the voltage of the power source. The voltage at which the unit has been factory set, is indicated on the rear panel label.

2-9. Line voltage selection is determined by the position of the line voltage selector switch located inside the instrument on the A2 (05314-60002) power supply assembly. Line voltage is preset at the factor for 115V (86V to 126V) or 230V (172V to 252V) as ordered by the customer. If changing of the line voltage becomes necessary, follow the procedure in *Table 2-1*.

Table 2-1. Line Voltage Changing Procedure

WARNING
THE POWER CORD SHOULD BE REMOVED FROM THE REAR OF THE HP 5314A BEFORE STARTING THIS PROCEDURE.

1. Turn the HP 5314A upside down and remove the four screws near the corners of the cabinet bottom.
2. Holding the top and bottom covers together, turn the HP 5314A right side up and carefully lift the top cover. This exposes the line voltage selector switch located on the A2 (05314-60006) power supply assembly (large pc assembly located in the rear of the cabinet).
3. The two-position switch may now be properly set to match the input voltage (115 for 86V to 126V input or 230 for 172V to 252V input).
4. Replace the top cover and carefully turn the unit upside down. Replace and tighten the four screws, one in each corner, of the cabinet bottom.

NOTE

The line voltage selector switch automatically selects the correct line input fuse configuration (the two fuses are located on the A2 assembly and are in series for 230V selection, and in parallel for 115V selection).

2-10. Power Cable

2-11. The HP 5314A is shipped with a three-wire power cable. The type of power cable plug shipped with each instrument depends on the country of destination. Refer to *Figure 2-1* for the part numbers of the power cable and plug configurations available.

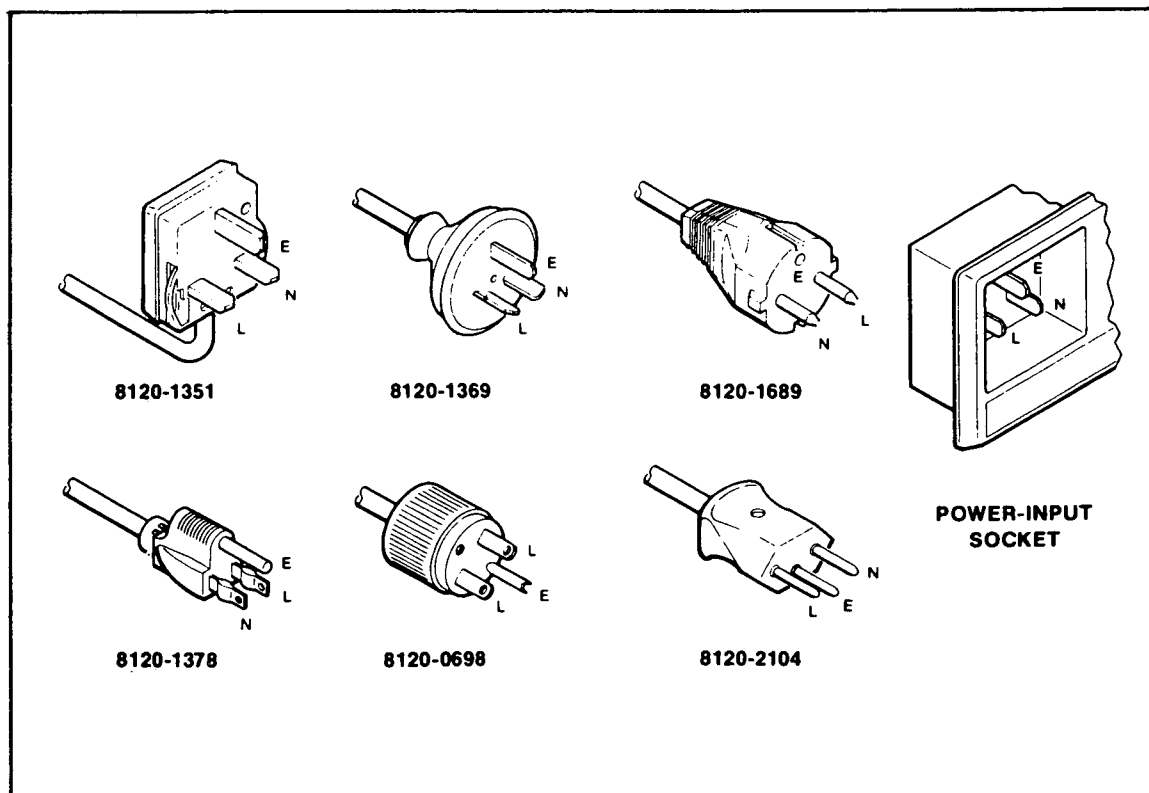

Figure 2-1. Power Cable HP Part Numbers versus Mains Plugs Available

2-12. Bench Operation

2-13. The HP 5314A has an adjustable handle, and two rubber strips located at the rear of the cabinet bottom, for convenience in bench operation. By pulling out the ends of the handle and adjusting it, the front of the HP 5314A may be raised for easier viewing of the front panel. The two rubber strips on the cabinet bottom keep the HP 5314A from sliding on smooth-surface benches.

2-14. INSTALLATION OF OPTIONS 001 AND 002

2-15. For installation of Options 001 and 002, refer to *Tables 2-2* and *2-3*, respectively. Field installation of either option should be performed by qualified service personnel only.

2-16. OPERATING ENVIRONMENT

2-17. In order for the HP 5314A to meet the specifications listed in *Table 1-1*, the operating environment must be within the following limits:

Temperature	0° to +55°C
Humidity	<80% relative
Altitude	<15,000 feet

2-18. STORAGE AND SHIPMENT

2-19. Environment

2-20. The instrument should be stored in a clean, dry environment. The following environmental limitations apply to both storage and shipment:

Temperature	-40°C to +75°C
Humidity	<95% relative
Altitude	<50,000 feet

2-21. Packaging

2-22. ORIGINAL PACKAGING. Containers and materials equivalent to those used in factory packaging are available through Hewlett-Packard offices. If the instrument is being returned to Hewlett-Packard for servicing, attach a tag indicating the type of service required, return address, model number, and full serial number. Also, mark the container FRAGILE to assure careful handling. In any correspondence, refer to the instrument by model number and full serial number.

2-23. OTHER PACKAGING. The following general instructions should be used for repackaging with commercially available materials.

- a. Wrap the instrument in heavy paper or plastic. (If shipping to a Hewlett-Packard office or service center, attach a tag indicating the type of service required, return address, model number, and full serial number.)
- b. Use a strong shipping container. A doublewall carton made of 250 pound test material is adequate.
- c. Use enough shock-absorbing material (3- to 4-inch layer) around all sides of the instrument to provide firm cushion and prevent movement inside the container. Protect the control panel with cardboard.
- d. Seal the shipping container securely.
- e. Mark the shipping container FRAGILE to assure careful handling.

Table 2-2. Option 001 Installation Instructions

NOTE

Installation of Option 001 (TCXO) should be performed by qualified service personnel only.

Option 001 consists of the following parts:

HP Part Number	Qty.	Description
05314-60004	1	TCXO Assembly
0380-0013	1	Spacer (1 in.)
2360-0115	1	6-32 × 3/8" Machine Screw
2360-0219	1	6-32 × 1 3/8" Machine Screw
2420-0001	2	6-32 Nut

PRELIMINARY

1. Turn off the HP 5314A and remove the AC power cord.
2. Turn the HP 5314A upside down and remove the four screws near the corners of the cabinet bottom.
3. Holding the top and bottom covers together, turn the HP 5314A rightside up and carefully lift the top cover.
4. Remove the handle.

There are two sets of instructions for installing Option 001. The first set (Procedure 1) is used to install Option 001 into a standard HP 5314A. The second set (Procedure 2) is used to install Option 001 into an HP 5314A with Option 002.

Procedure 1:

Installation of Option 001 into standard HP 5314A.

1. Remove the rear two black plastic spacers which hold the A2 assembly (05314-60006) in place.
2. Carefully lift the A2 assembly out of the cabinet bottom.
3. Locate the two holes in the pc board between the large electrolytic capacitor (A2C1) and the power transformer (A2T1). These holes are the mounting holes for the Option 001 A4 (05314-60004) assembly. They are also the +5V and ground (⏚) for the A4 assembly.
4. Mount the A1 assembly to the A2 assembly with the componet side of A4 toward the large electrolytic. Use the supplied hardware (short 6-32 screw on the (+) mounting lug and long 6-32 screw and 1 inch spacer on the (⏚) mounting lug). See *Figure 8-1, Top Internal View*, for correct positioning.
5. Remount the combination A2/A4 assembly into the HP 5314A cabinet bottom being careful to properly align the two spacer studs and the line cord input block. Reinstall the two black plastic spacers.
6. Grasp the combination front panel and A1 assembly and carefully lift it away from the cabinet bottom.
7. Use an Allen wrench to remove the two front panel LEVEL knobs.
8. Use a 9/16" nut driver to remove the two front panel securing nuts on the two BNC input jacks.
9. Remove the combination front panel/window from the A1 assembly.
10. Locate jumper wire W1 on the A1 assembly (between A1U2 and A1U4). Using a soldering iron and needle-nose pliers, remove W1.

NOTE

Instruments with TCXO Option 001 require addition of diode A1CR4 on circuit board A1. See *Figure 8-8* for A1CR4 location between A1U2 and A1C2 in lower left corner of illustration. If Option 001 is being installed, add A1CR4 diode (HP Part No. 1901-0050).

Table 2-2. Option 001 Installation Instructions (Continued)

11. Referring to the sketch below, solder the coax cable from the Option 001 A4 assembly to the component side of the A1 assembly as follows. Solder the shield to the solder pad labeled 2 in the sketch and the center conductor to the solder pad labeled 1 in the sketch. The solder pad labeled 1 is left open. Use the diagonal cutters to clip any protruding wire on the circuit side of A1.

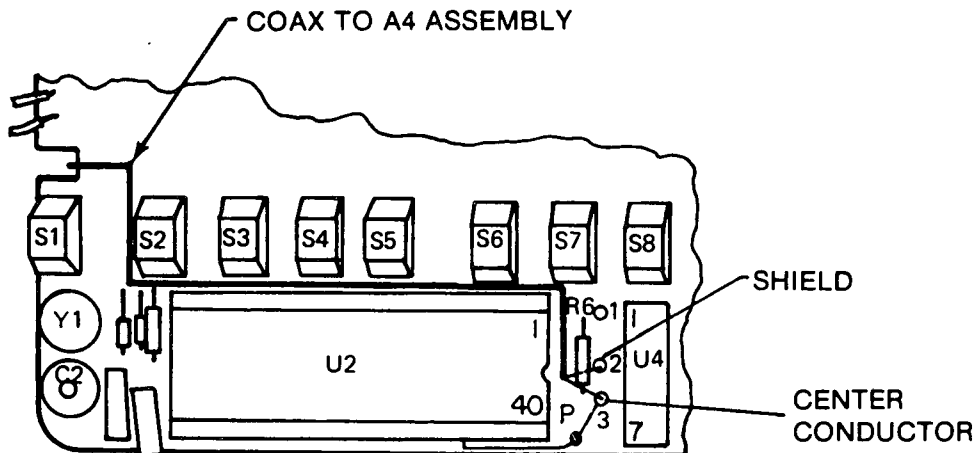

12. Dress the coaxial cable between U2 and the switch pack as shown in the sketch. Lead the coax through the cutout (on the side of the A1 assembly) with the rest of the cables.
13. Assemble the front panel to A1 and secure with a 9/16" BNC nut.
14. Replace the LEVEL knobs, being careful to center them between the + and - positions. Tighten both Allen slugs. Turn the HP 5314A ON.
15. Installation of Option 001 into a standard HP 5314A is now complete. *IMMEDIATELY* proceed to step 4 (PRELIMINARY) of Table 5-3, Option 001 Adjustment.

Procedure 2:

Installation of Option 001 into HP 5314A with Option 002.

1. Remove the red and black cables (of the A3 assembly) from the battery posts by pulling on the terminal lugs.
2. Remove the screw which holds the battery and A3 assembly to the cabinet bottom.
3. Carefully remove the A3 assembly by first pulling the assembly toward the battery and second, lifting the assembly.
4. Remove the two front black plastic spacers which hold the battery in place. Lift the battery out of the cabinet bottom.
5. Perform steps 1 through 14 of Procedure 1 in this table. Then return and continue with step 6.
6. Install the battery pack into the cabinet bottom. Mount the two front black plastic spacers.
7. Install the A3 assembly into J1 of the A2 assembly but **DO NOT** connect the red or black cable to the battery.
8. Insert and tighten the hold-down screw for the A3 assembly.
9. Connect the red and black cables to the battery's positive and negative posts, respectively. Turn the HP 5314A ON.
10. Installation of Option 001 into an HP 5314A with Option 002 is now complete. *IMMEDIATELY* proceed to step 4 (PRELIMINARY) of Table 5-3, Option 001 Adjustment.

Table 2-3. Option 002 Installation Instructions

NOTE

Installation of Option 002 (battery pack) should be performed by qualified service personnel only.

Option 002 consists of the following parts:

HP Part Number	Qty.	Description
05314-60003	1	Battery Charger Assembly
1420-0253	1	6V Lead-Acid Battery
05314-00002	1	Battery Bracket
2420-0001	1	6-32 × 1/2" Machine Screw

1. Turn off the HP 5314A and remove the AC power cord.
2. Turn the HP 5314A upside down and remove the four screws near the corners of the cabinet bottom.
3. Holding the top and bottom covers together, turn the HP 5314A rightside up and carefully lift the top cover.
4. Remove the front two black plastic spacers and washers (located 1 1/2" behind the combination front panel and A1 assembly). Discard the washers only.
5. Assemble the battery and battery hold-down bracket, matching the polarity of the battery with that shown on the hold-down bracket.
6. Dress all A1-A2 interconnect cables to lay across the lower left corner of the cabinet bottom.
7. Install the battery pack and A3 assembly as follows:
 - a. Locate the two spacer studs in the front of the cabinet bottom (approximately 1 1/2" behind the combination front panel A1 assembly).
 - b. Mount the battery pack and bracket so the two spacer studs go through the two large holes on the bracket, and the battery posts (+ and -) are pointing toward the A2 assembly (rear of the cabinet).
 - c. Locate the Option 002 A3 assembly (05314-60003). Lay the assembly on a flat surface (component side up) and dress the two cables (red and black) so they point straight up (perpendicular from the assembly).
 - d. Install the A3 assembly (05314-60003), component-side up, into A2J1 (the 6-pin plastic board connector on the A2 power supply assembly).
 - e. Install a 1/2" 6-32 screw through the board assembly/battery mounting bracket and secure them to the cabinet bottom.

NOTE

Make sure the HP 5314A power switch is in the STBY position!

- f. Connect the red cable to the (+) post of the battery pack.
- g. Connect the black cable to the (-) post of the battery pack.
- h. Install the two black plastic spacers (without washers) onto the front spacer studs.
- i. Installation of Option 002 is now complete. *IMMEDIATELY* proceed to step 4 of Table 5-4, Battery Cutoff Voltage Adjustment.

SECTION III OPERATION

3-1. INTRODUCTION

3-2. This section provides complete operating information needed for the HP 5314A Universal Counter. This section includes a description of all front panel controls, connectors and indicators, operating instructions, operator's checks, and operator's maintenance.

3-3. OPERATING CHARACTERISTICS

3-4. The following paragraphs describe the operating ranges and resolution for frequency, period, time interval, ratio A/B, totalize A, and self-check functions.

3-5. Frequency Measurements

3-6. All frequency measurements are made through the A channel input. The frequency range is 10 Hz to 10 MHz direct count and 10 Hz to 100 MHz prescaled by 10, with a minimum input level of 25 mV rms or 75 mV p-p (with a minimum pulse width of 5 ns) times the attenuator setting. The resolution is 0.1 Hz for frequencies up to 10 MHz. With frequencies above 10 MHz (prescale mode), the resolution is 10 Hz. See *Figure 3-3* for a typical frequency measurement setup.

3-7. Period Measurements

3-8. All period measurements are made through the A channel input. The signal can be a sine wave, square wave, or a wave form with components faster than 10 Hz. The period range is 100 ns to 400 ns (10 Hz to 2.5 MHz). The sensitivity is 25 mV rms or 75 mV p-p. The resolution is 100 ns. See *Figure 3-4* for a typical period measurement setup.

3-9. Time Interval Measurements

3-10. The counter measures time intervals from Channel A to Channel B; that is, Channel A starts the measurement and Channel B stops the measurement. Time between points on a single waveform can be measured by connecting the input signal to CHANNEL A jack and placing the Input Amplifier Control switch to COM A. Under these conditions, the slope and level controls of Channel A and Channel B allow variable triggering on either the + or - slope. With the Input Amplifier Control switch set to SEP, measurements can be made between points on separate waveforms. The time interval range is 250 ns to 1 s. The sensitivity is 25 mV rms (75 mV p-p). The resolution is 100 ns. See *Figures 3-5* and *3-6* for typical time interval measurement setups.

3-11. INITIATING A MEASUREMENT. The HP 5314A does not internally arm itself in time interval. Both Channels A and B **must** be externally armed before a time interval measurement can be initiated, see *Figure 3-1*. Each channel is armed by the first positive or negative edge (corresponding to the slope selection setting) of the input signal. Channel A is armed first. Channel B ignores all input edges until Channel A is armed. Once Channel A is armed, the first positive or negative edge (corresponding to the slope selection setting) arms Channel B. Until Channel B is armed, Channel A ignores any further input edges. Once Channel B is armed, the next slope selected edge in Channel A starts the time interval measurement, and the next slope selected edge in Channel B stops the time interval measurement.

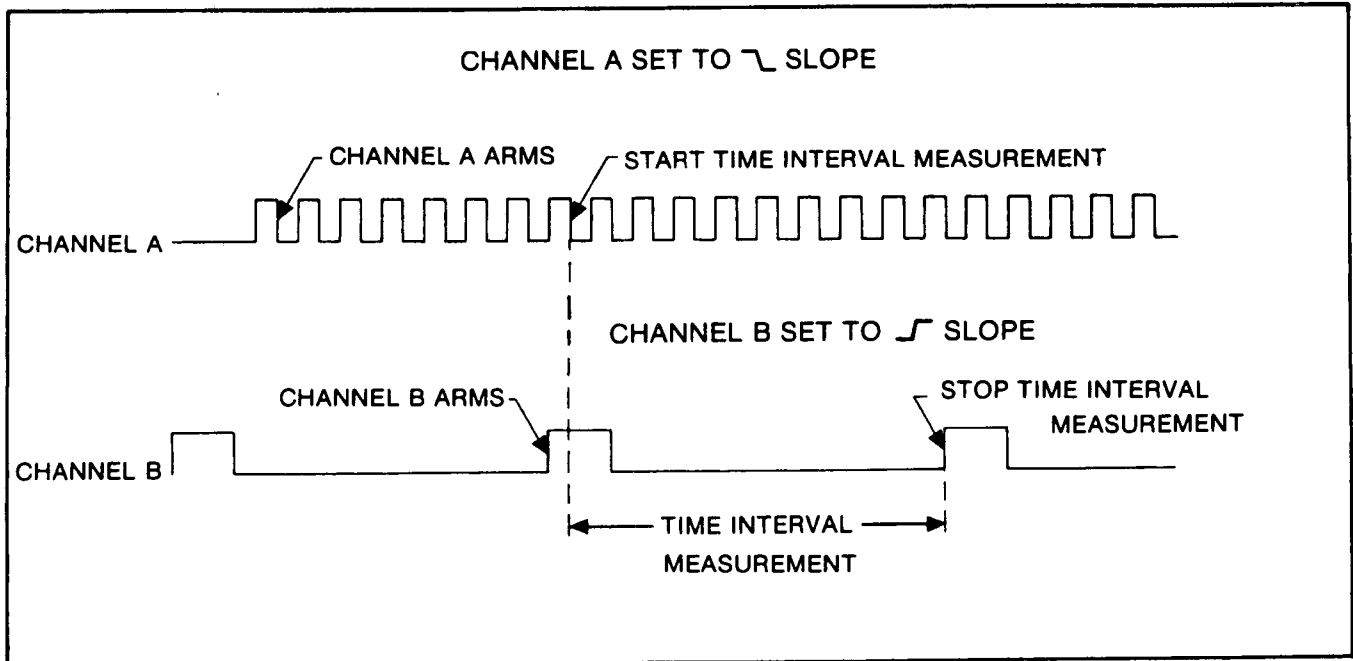

Figure 3-1. Time Interval Measurement Routine

3-12. Ratio A to B Measurements

3-13. The ratio between two frequencies (F_A/F_B) is measured by connecting one signal to Channel A and the other to Channel B. Channel A operates in the range of 10 Hz to 10 MHz. Channel B operates in the range of 10 Hz to 2.5 MHz. If the higher frequency is connected to Channel A, the ratio will be greater than one. The answer for a ratio measurement is a unitless figure. See Figure 3-7 for a typical ratio measurement setup.

3-14. Totalize A Measurements

3-15. The HP 5314A can totalize directly from 10 Hz to 10 MHz with a resolution of 1 count. Input frequencies between 10 Hz and 100 MHz may be totalized in the prescale mode (see Figure 3-8) with a resolution of 10 Hz. The HOLD switch may be used to latch the display. However, the counter continues to increment and when the HOLD is released, the updated count is displayed. See Figure 3-8 for a typical totalize measurement setup.

3-16. Self-Check

3-17. The HP 5314A contains a built in self-check function. The self-check mode programs the unit to make a frequency measurement on its internal 10 MHz time base. For details concerning self-check, see Figure 3-9, Operator's Checks.

3-18. PANEL FEATURES

3-19. Front panel features of the HP Model 5314A are described in Figure 3-2, Front Panel Controls and Connectors. Contained in Figure 3-2 is a description of each of the controls and connectors. Description numbers match the numbers on the illustration.

3-20. OPERATING INSTRUCTIONS

3-21. General operating procedures with the HP Model 5314A Universal Counter connected in typical measurement setups are shown in *Figures 3-3, 3-4, 3-5, 3-6, 3-7, and 3-8*. Many other applications are possible but not shown because the general operating procedure is the same. Description numbers match the numbers on the illustration.

3-22. OPERATOR'S MAINTENANCE

3-23. There is no operator's maintenance for the HP 5314A. All maintenance should be performed by qualified service personnel only.

3-24. Power/Warm-Up

3-25. The HP 5314A has a two position power switch, STBY and ON. For HP 5314A models with Option 002, it is important that the instrument be connected to the power source in the STBY mode when not in use. This supplies power to the battery charging circuitry.

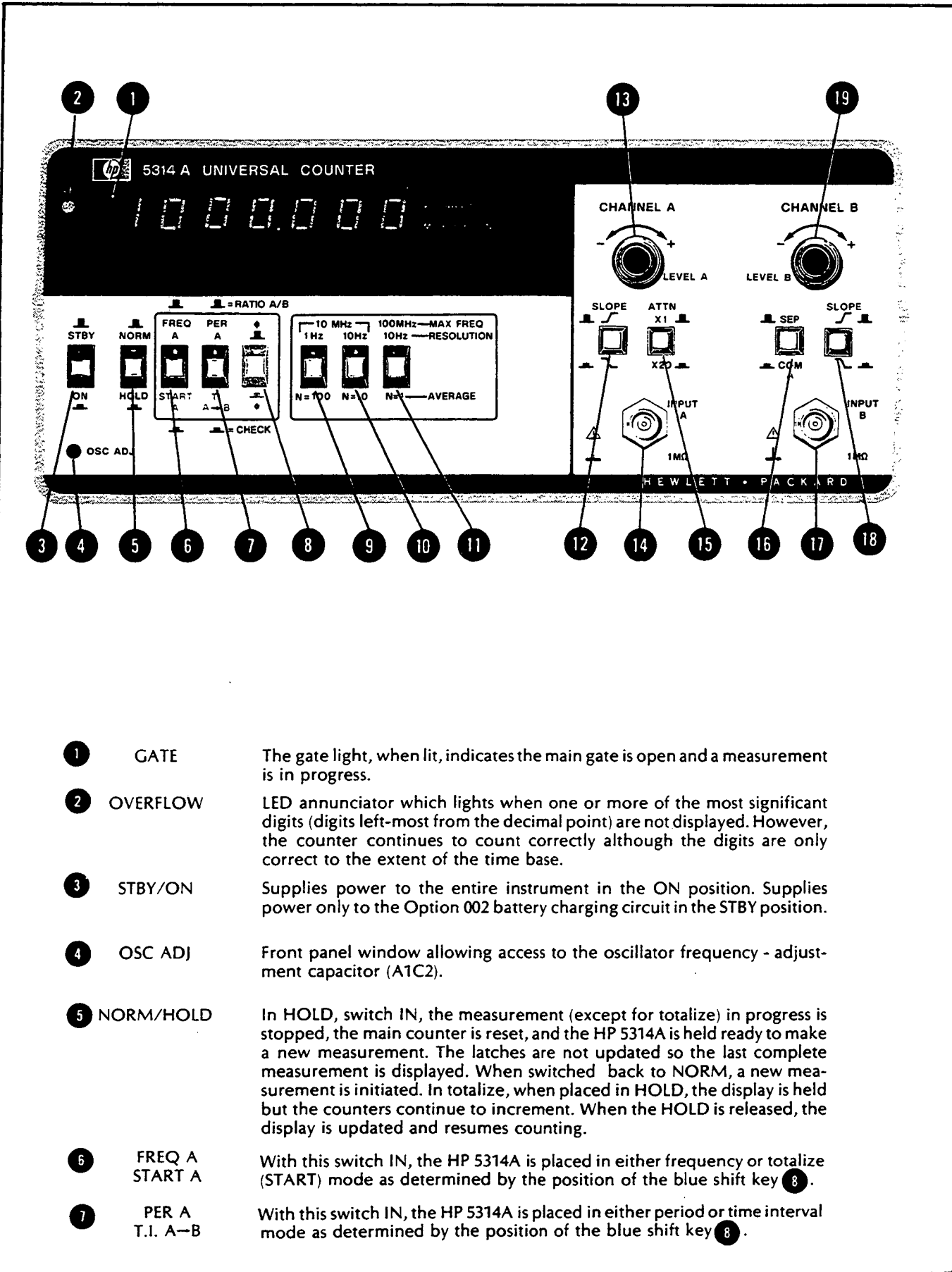

- 1 GATE The gate light, when lit, indicates the main gate is open and a measurement is in progress.
- 2 OVERFLOW LED annunciator which lights when one or more of the most significant digits (digits left-most from the decimal point) are not displayed. However, the counter continues to count correctly although the digits are only correct to the extent of the time base.
- 3 STBY/ON Supplies power to the entire instrument in the ON position. Supplies power only to the Option 002 battery charging circuit in the STBY position.
- 4 OSC ADJ Front panel window allowing access to the oscillator frequency - adjustment capacitor (A1C2).
- 5 NORM/HOLD In HOLD, switch IN, the measurement (except for totalize) in progress is stopped, the main counter is reset, and the HP 5314A is held ready to make a new measurement. The latches are not updated so the last complete measurement is displayed. When switched back to NORM, a new measurement is initiated. In totalize, when placed in HOLD, the display is held but the counters continue to increment. When the HOLD is released, the display is updated and resumes counting.
- 6 FREQ A START With this switch IN, the HP 5314A is placed in either frequency or totalize (START) mode as determined by the position of the blue shift key 8.
- 7 PER A T.I. A-B With this switch IN, the HP 5314A is placed in either period or time interval mode as determined by the position of the blue shift key 8.

Figure 3-2. Front Panel Controls and Connectors

NOTE

There are two additional functions which are selected using combinations of switches 6 and 7. These two functions are Self-Check and Ratio A to B. For self-check mode, place both function switches 6 and 7 in the IN position. The instrument is now making a frequency measurement on the internal 10 MHz time base. Activating switches 9 and 10 causes 10 MHz to be displayed. Activating switch 11 causes 100 MHz to be displayed. Resolution selection switches can now be checked for proper operation. For Ratio A to B, place both function switches 6 and 7 in the OUT position. For more details on Ratio A to B, refer to paragraph 3-12 and Figure 3-7.

8 SHIFT KEY

IN/OUT position determines the function selected by keys 6 and 7. IN position selects the bottom row functions. OUT position selects the upper row functions.

NOTE

The following three switches 9 10 11 are dual purpose. Depending on the function selected (Frequency, Period, Ratio, etc.) the switches either represent the resolution and bandwidth (gate time) or the sample size (N samples).

9 1 Hz/N=100

In frequency (10 Hz to 10 MHz), this switch, when IN, gives a display with a 1 Hz resolution (1 second gate time). For frequencies between 10 MHz and 100 MHz, see the explanation for switch 11. In period, this switch, when IN, causes the HP 5314A to measure 100 periods and display the average value in microseconds. In ratio, this switch when IN, causes the HP 5314A to make 100 measurements and display the average ratio. This switch does **not** improve accuracy beyond 100 nanoseconds for time interval measurements!

10 10 Hz/N=10

In frequency (10 Hz to 10 MHz), this switch, when IN, gives a display with a 10 Hz resolution (100 millisecond gate time). For frequencies between 10 MHz and 100 MHz, see the explanation for switch 11. In period, this switch, when IN, causes the HP 5314A to measure 10 periods and display the average value in microseconds.

In ratio, this switch, when IN, causes the HP 5314A to make 10 measurements and display the average ratio. This switch does **not** improve accuracy beyond 100 nanoseconds for time interval measurements!

NOTE

There is another resolution available using switches 9 and 10 in addition to the two resolutions called out on the front panel. It is 0.1 Hz/N=1000. This is generated when switches 9 10 and 11 are in the OUT position. In frequency (10 Hz to 10 MHz), with these three switches out, the HP 5314A gives a display with 0.1 Hz resolution (10 second gate time). For frequencies between 10 MHz and 100 MHz, see the explanation for switch 11. In period, with these three switches out, the HP 5314A measures 1000 periods and displays the average value in microseconds. In ratio, with these three switches out, the HP 5314A makes 1000 measurements and displays the average ratio. This switch combination does **not** improve accuracy beyond 100 nanoseconds for time interval measurements.

Figure 3-2. Front Panel Controls and Connectors (Continued)

- 11 10 Hz/N=1 This switch, when IN, reroutes the Channel A input signal through a divide-by-10 prescaler circuit (when **6** is in). This switch MUST be used for frequencies between 10 MHz and 100 MHz. In frequency, this switch, when IN, prescales the input signal by 10 and gives a display with a 10 Hz resolution (prescale by 10 with a 1-second gate time). This switch and switch **9** (1 Hz/N=100) IN prescales the input and gives a display with a 100 Hz resolution (prescale by 10 with a 100-millisecond gate time). This switch and switch **10** (10 Hz/N=10) IN prescales the input and gives a display with a 1 kHz resolution (prescale by 10 with a 10-millisecond gate time).
- In Period, this switch IN causes the HP 5314A to measure 1 period and display the value in microseconds (this switch is used for single-shot period measurements).
- In Ratio, this switch IN causes the HP 5314A to make 1 measurement and display the ratio (this switch is used for single-shot ratio measurements).
- In Time Interval, this switch should be pressed. This programs the HP 5314A to make single-shot time interval measurements.
- In Start, the HP 5314A counts the input directly (10 Hz to 10 MHz) and displays in units. With this switch IN, the input is prescaled by 10 and the display is in kilo units. This switch MUST be used in START A for signals above 10 MHz.
- 12 SLOPE This switch setting determines which slope of the Channel A input signal will be used as the triggering slope.
- 13 LEVEL A LEVEL control used in conjunction with the attenuator switch **15**, to select the relative voltage at which triggering occurs. Approximately ± 350 millivolts is the amount varied. The input amplifiers are ac coupled. The actual dc level of the trigger point is unknown.
- 14 INPUT A BNC connector for the A channel signal input. The input impedance is 1 Meg. For more information on the input signal, refer to *Table 1-1, Specifications*.
- 15 ATTN Channel A input signal attenuator switch. Used in conjunction with the LEVEL control to set the trigger point. The input signal is not affected in X1 position. Input signal amplitude is reduced by a factor of 20 in the X20 position.
- 16 SEP/COM A Input amplifier control switch.
- SEP - Allows independent operation of A and B channels.
 - COM A - Operationally connects Channels A and B in parallel. Used for single source time interval measurements. Channel B input jack is not active. The input impedance remains the same as in SEP.
- 17 INPUT B BNC connector for the B channel signal input. The input impedance is 1 Meg. For more information on the input signal, refer to *Table 1-1, Specifications*.
- 18 SLOPE This switch setting determines which slope of the Channel B input signal will be used as the triggering slope.
- 19 LEVEL B LEVEL control used to select the relative voltage at which triggering occurs. When switch **16** is in SEP, the trigger voltage varies approximately ± 350 mV. When switch **16** is in COM A, the trigger voltage varies approximately ± 350 mV times the attenuator (switch **15**) setting. The input amplifiers are ac coupled. The actual dc level of the triggering point is unknown.

Figure 3-2. Front Panel Controls and Connectors (Continued)

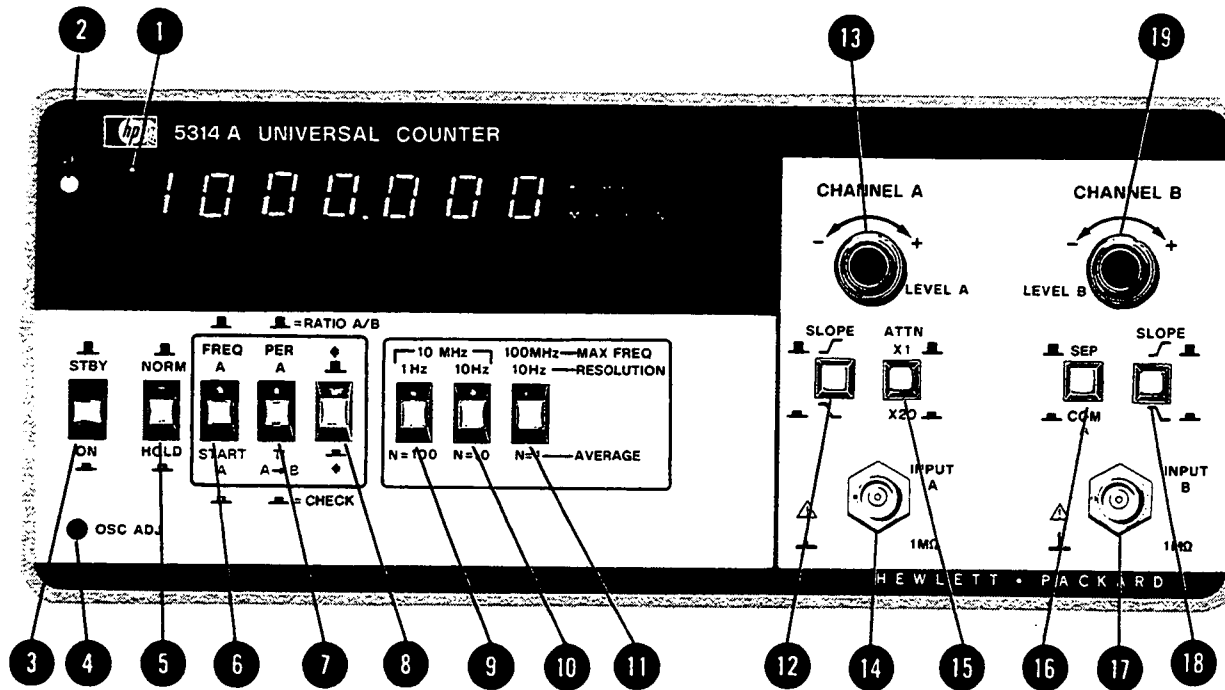

NOTE

See Table 1-1 for the specifications on all input signals concerning bandwidth, accuracy, and amplitude.

1. Set line switch 3 to the ON position.
2. Set COM A/SEP switch 16 to SEP position.
3. Connect the input signal to INPUT A jack 14.
4. Press FREQ A/START A switch 6 IN. Be sure the blue shift key 8 is in the OUT position. This selects the top function of switch 6.
5. Set SLOPE 12, ATTN 15, and LEVEL A 13 to desired positions; see Table 1-1, Specifications, for details.
6. Select either 1 Hz 9 or 10 Hz 10 resolution for frequencies between 10 Hz and 10 MHz. NOTE: 10 Hz 11 may also be used. For frequencies higher than 10 MHz, the 100 MHz/10 Hz switch 11 must be pressed IN.

NOTE

The following three resolutions are available with the HP 5314A but are not printed on the front panel.

- A. For 0.1 Hz resolution (10 second gate time) on frequencies from 10 Hz to 10 MHz, place all three resolution switches 9 10 11 in the OUT position.
- B. For 100 Hz resolution (0.1 second gate time) on frequencies to 100 MHz, place switches 9 and 11 in the IN position.
- C. For 1 kHz resolution (0.01 second gate time) on frequencies to 100 MHz, place switches 10 and 11 in the IN position.

Figure 3-3. Frequency Measurement Setup

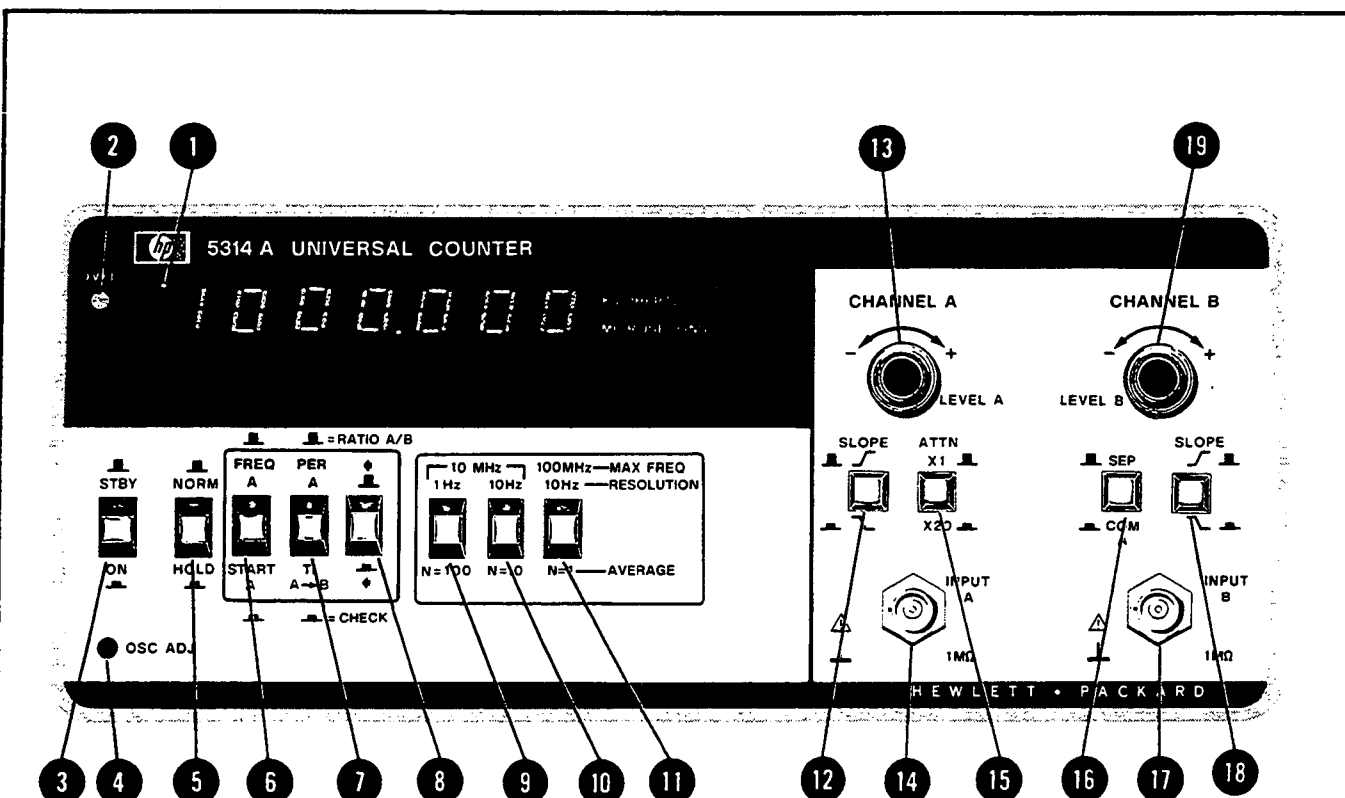

NOTE

See Table 1-1 for the specifications on all input signals concerning bandwidth, accuracy, and amplitude.

1. Set line switch 3 to the ON position.
2. Set COM A/SEP switch 16 to SEP position.
3. Connect the input signal to INPUT A jack 14.
4. Press PER A/T.I. A→B switch 7 IN. Make sure the blue shift key 8 is in the OUT position. This selects the top function of switch 7.
5. Set SLOPE 12, ATTN 15 and LEVEL A 13 to desired positions; see Table 1-1, Specifications, for details.
6. Press desired sample size switch (9, 10, 11). For an explanation of the sample size switches 9, 10 and 11, see Figure 3-2.

Figure 3-4. Period Measurement Setup

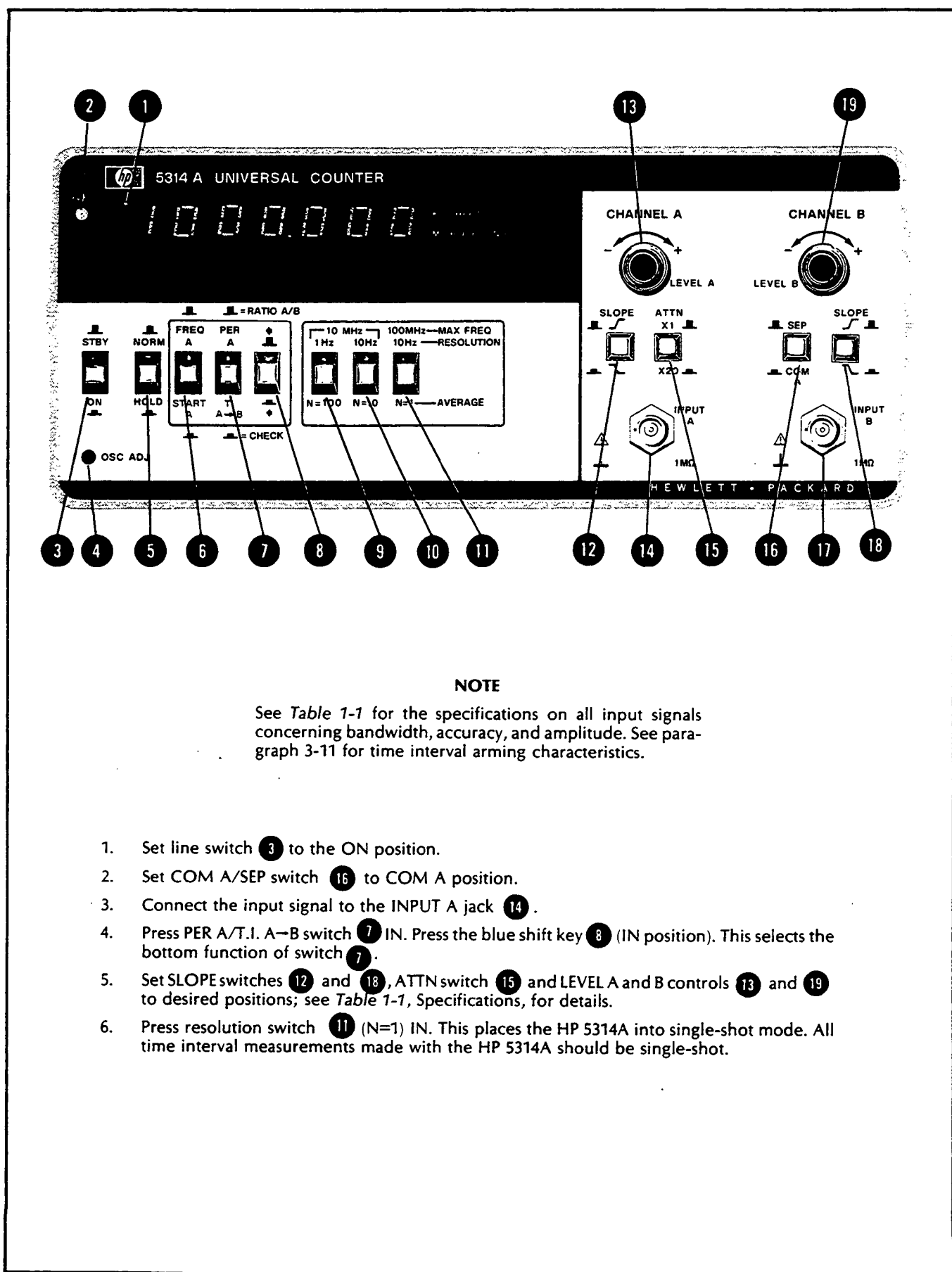

NOTE

See Table 1-1 for the specifications on all input signals concerning bandwidth, accuracy, and amplitude. See paragraph 3-11 for time interval arming characteristics.

1. Set line switch **3** to the ON position.
2. Set COM A/SEP switch **16** to COM A position.
3. Connect the input signal to the INPUT A jack **14**.
4. Press PER A/T.I. A-B switch **7** IN. Press the blue shift key **8** (IN position). This selects the bottom function of switch **7**.
5. Set SLOPE switches **12** and **18**, ATTN switch **15** and LEVEL A and B controls **13** and **19** to desired positions; see Table 1-1, Specifications, for details.
6. Press resolution switch **11** (N=1) IN. This places the HP 5314A into single-shot mode. All time interval measurements made with the HP 5314A should be single-shot.

Figure 3-5. One-Source Time Interval Measurement Setup

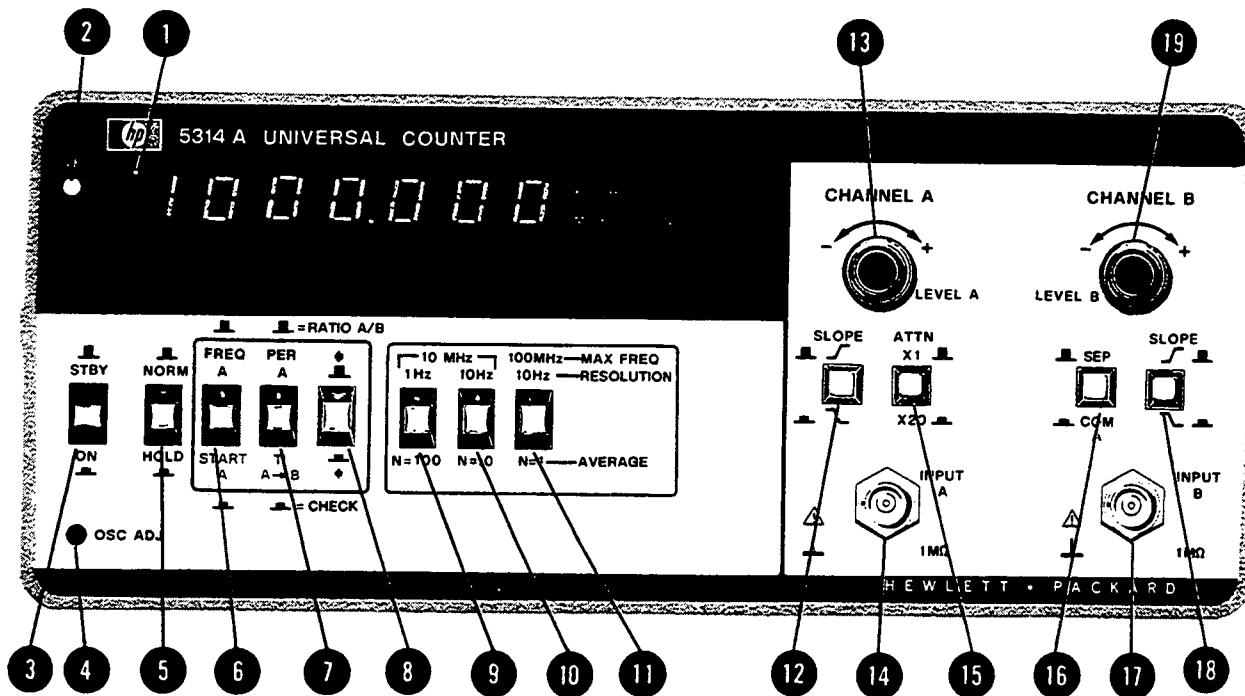

NOTE

See Table 1-1 for specifications on all input signals concerning bandwidth, accuracy, and amplitude. See paragraph 3-11 for time interval arming characteristics.

1. Set line switch **3** to the ON position.
2. Set COM A/SEP switch **16** to SEP position.
3. Press PER A/T.I. A-B switch **7** IN. Press the blue shift key **8** (IN position). This selects the bottom function of switch **7**.
4. Connect the start time-interval signal to the INPUT A jack. **14**. Connect the stop time-interval signal to the INPUT B jack **17**.
5. Set SLOPE switches **12** and **18**, ATTN switch **15**, and LEVEL A and B controls **13** and **19** to desired positions; see Table 1-1, Specifications, for details.
6. Press resolution switch **11** (N=1) IN. This places the HP 5314A into single-shot mode. All time interval measurements made with the HP 5314A should be single-shot.

Figure 3-6. Two-Source Time Interval Measurement Setup

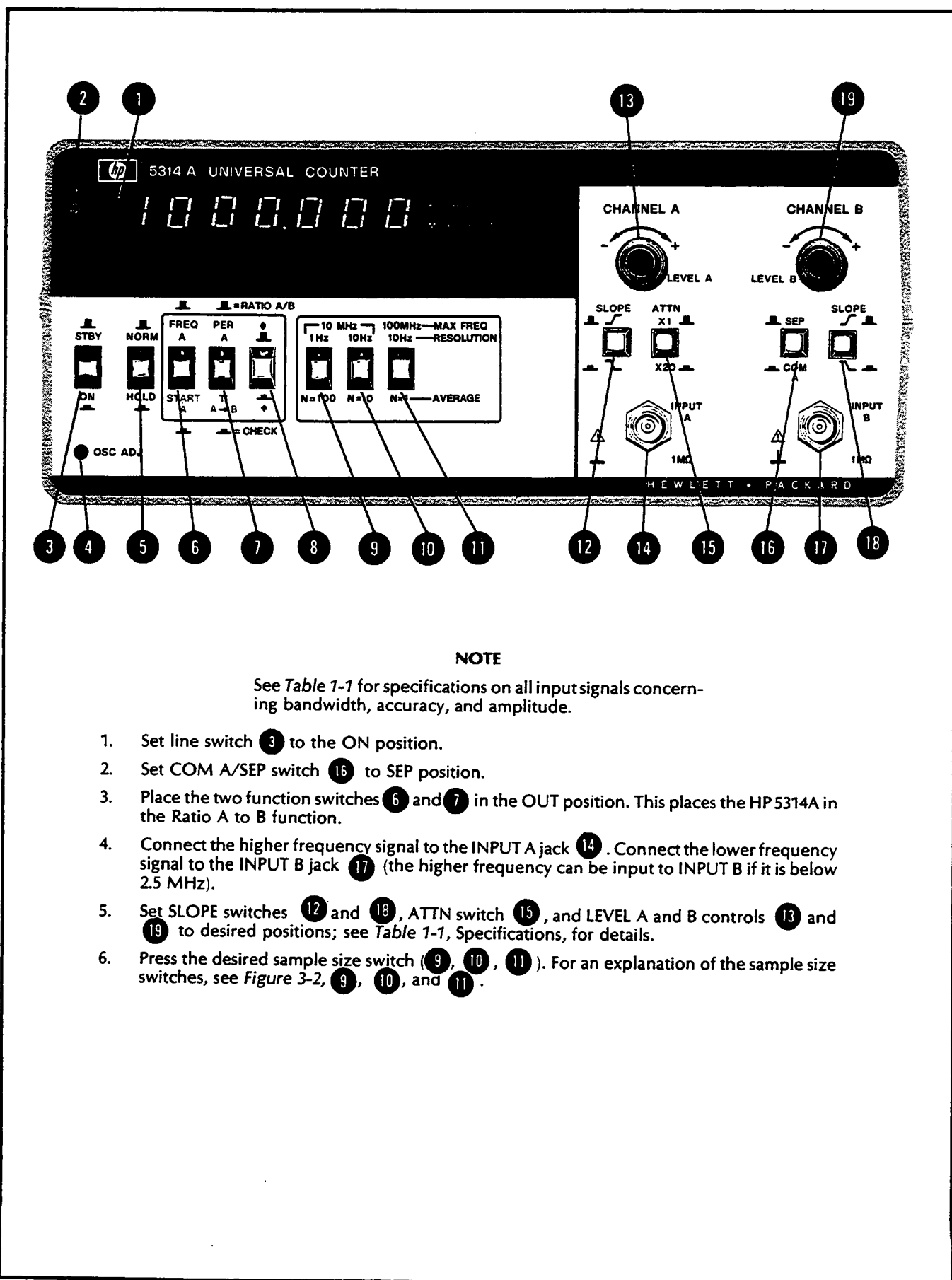

NOTE

See Table 1-1 for specifications on all input signals concerning bandwidth, accuracy, and amplitude.

1. Set line switch **3** to the ON position.
2. Set COM A/SEP switch **16** to SEP position.
3. Place the two function switches **6** and **7** in the OUT position. This places the HP 5314A in the Ratio A to B function.
4. Connect the higher frequency signal to the INPUT A jack **14**. Connect the lower frequency signal to the INPUT B jack **17** (the higher frequency can be input to INPUT B if it is below 2.5 MHz).
5. Set SLOPE switches **12** and **18**, ATTN switch **15**, and LEVEL A and B controls **13** and **19** to desired positions; see Table 1-1, Specifications, for details.
6. Press the desired sample size switch (**9**, **10**, **11**). For an explanation of the sample size switches, see Figure 3-2, **9**, **10**, and **11**.

Figure 3-7. Ratio Measurement Setup

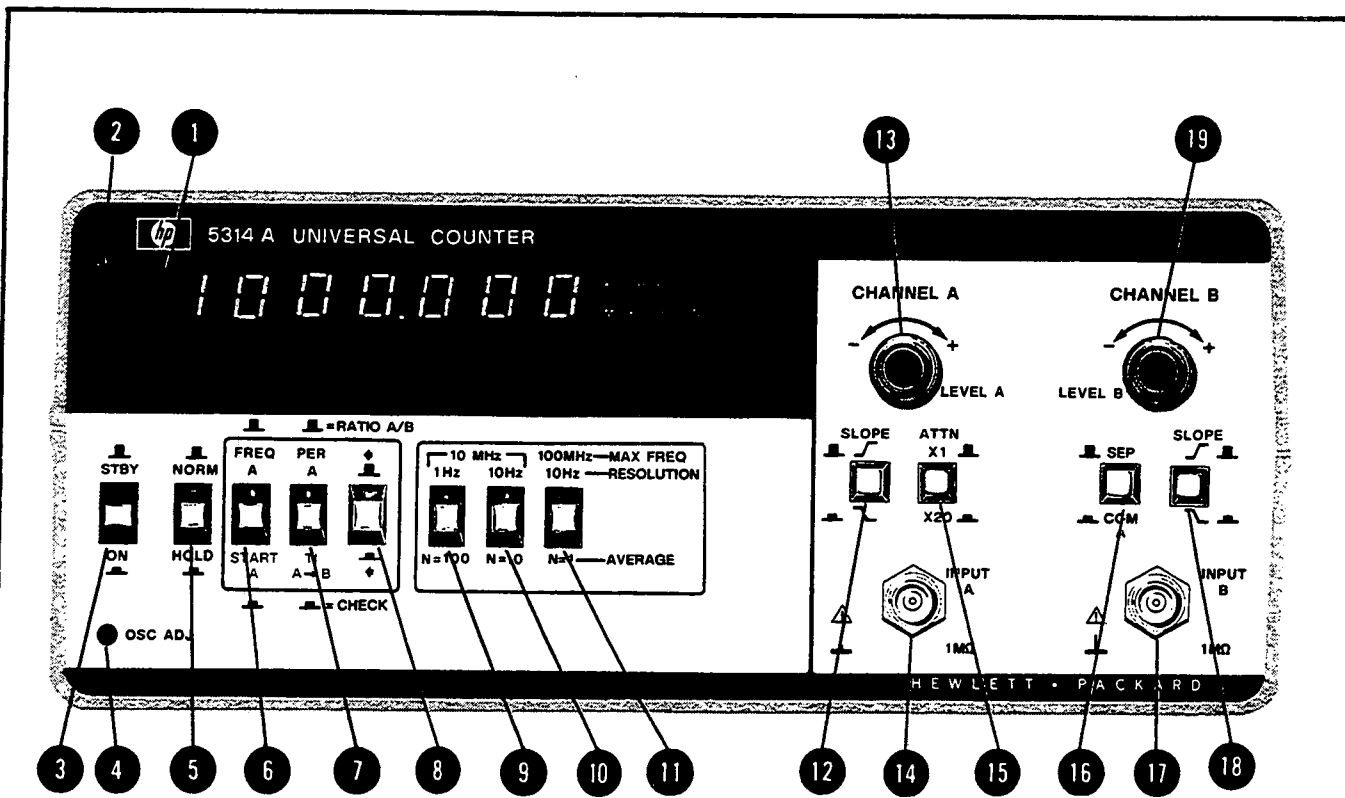

NOTE

See Table 1-1 for specifications on all input signals concerning bandwidth, accuracy, and amplitude.

1. Set line switch **1** to the ON position.
2. Set COM A/SEP switch **16** to SEP position.
3. Press the FREQ A/START A switch **6** IN.
4. Press the blue shift key **8** (IN position). This selects the bottom function of switch **6**
5. Set SLOPE **12**, ATTN **15**, and LEVEL A **13** to desired positions; see Table 1-1, Specifications, for details.
6. Connect the input signal to INPUT A jack **14**. For input frequencies higher than 10 MHz, the 100 MHz/10 Hz resolution switch **11** (prescale by 10) MUST be pressed (IN position).

Figure 3-8. Totalize Measurement Setup

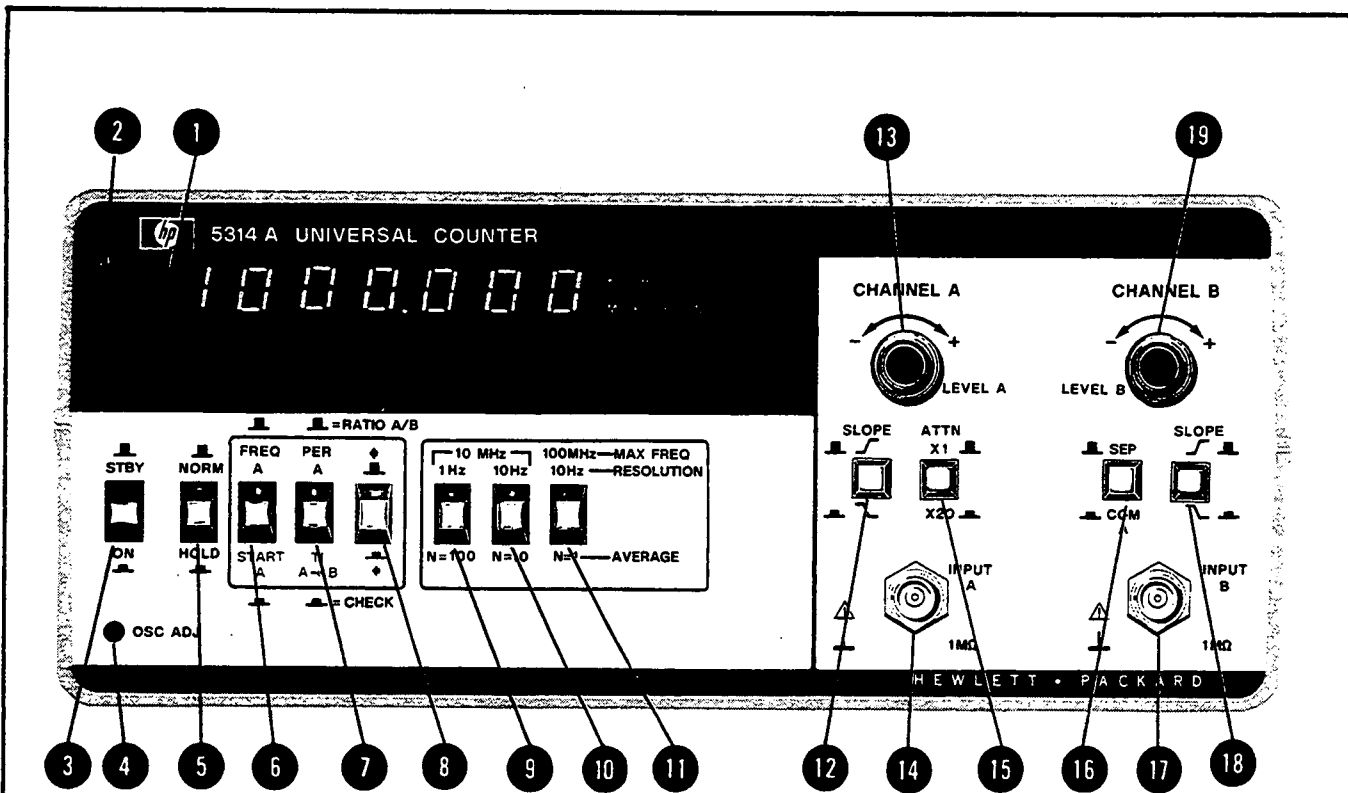

NOTE

This operator's check checks for proper operation of the counter chip A1U2, the function and resolution switches, and the display. This procedure does not check the operation of the two input amplifiers. See Figure 4-1, Operation Verification, for a more complete operational check.

1. Set the line switch **3** to the ON position.
2. Depress both function switches **6** and **7** (IN position). This places the HP 5314A in the self-check mode.
3. Place resolution switch **9** (1 Hz/N=100) in the IN position. The HP 5314A should display

0000.000

 with the overflow LED **1** ON and the instrument gating once every second.
4. Place resolution switch **10** (10 Hz/N=10) in the IN position. The HP 5314A should display

10000.00

 with the overflow LED OFF and a 100-millisecond gate time.
5. Place resolution switch **11** (10 Hz/N=1) in the IN position. The HP 5314A should display

00000.00

 with the overflow LED **1** ON and a 1-second gate time.
6. Place both resolution switches **9** and **11** in the IN position. The HP 5314A should display

100000.0

 with the overflow LED **1** OFF and a 100-millisecond gate time.
7. Place both resolution switches **10** and **11** in the IN position. The HP 5314A should display

100000.

 with a 10-millisecond gate time.

Figure 3-9. Operator's Check

SECTION IV PERFORMANCE TESTS

4-1. INTRODUCTION

4-2. The two procedures in this section test the instrument's electrical performance using the specifications of *Table 1-1* as performance standards. The first test is an operation verification which checks all major functions of the HP 5314A. The second test is the full performance test which checks all specifications.

4-3. EQUIPMENT REQUIRED

4-4. Equipment required for the complete test and operation verification is listed in *Table 1-2*. Any equipment which satisfies the critical specifications given in the table may be substituted for the recommended model.

4-5. OPERATION VERIFICATION

4-6. The abbreviated checks given in *Table 4-1* can be performed to give a high degree of confidence that the HP 5314A is operating properly without performing the complete performance test. The operation verification should be used for incoming QA, routine maintenance, and after instrument repair.

4-7. PERFORMANCE TEST

4-8. The performance test is given in *Table 4-2*. The performance test verifies all specifications listed in *Table 1-1*. Depending on the use and environmental conditions, the instrument should be checked using the performance test at least once a year.

4-9. TEST RECORD

4-10. Results of the operation verification may be tabulated on the operation verification test card located at the end of *Table 4-1*. Results of the performance tests may be tabulated on the performance check test card located at the end of *Table 4-2*.

Table 4-1. Operation Verification

I. SELF TEST	
Perform the self test procedure per <i>Figure 3-9</i> . Mark the results on the test card.	
II. FREQUENCY RESPONSE AND SENSITIVITY	
A. CHANNEL A	
Specification: 10 Hz—100 MHz, 25 mV rms	
1. Set the HP 5314A front panel controls as follows:	
FUNCTION	FREQ A
RESOLUTION	1 Hz
BOTH SLOPES	
BOTH LEVELS	Midrange
ATTN	X1
SEP/COM A	SEP
2. Connect an HP 3314A test oscillator to the HP 5314A INPUT A with a cable and 50-ohm feed-through. Set the HP 3314A for 500 Hz and 5 MHz at 25 mV rms (~70 mV p-p). Replace the HP 3314A with an HP 8656A signal generator. Press resolution switch 10 Hz prescale (N=1). Set the HP 8656A for 50 MHz and 100 MHz at 25 mV rms (~70 mV p-p). The counter should display the specified frequencies. Mark the results on the test card.	

Table 4-1. Operation Verification (Continued)

B. CHANNEL B

Specification: 10 Hz—2.5 MHz, 25 mV rms

1. Repeat step A1. Set the HP 5314A SEP/COM A switch to COM A. Set both function switches FREQ A and PER A OUT.
2. Connect an HP 3314A to the HP 5314A INPUT A with a cable and 50-ohm feedthrough. Set the HP 3314A for 500 Hz and 2.5 MHz at 25 mV rms (~70 mV p-p). The HP 5314A should display "1.00" at both specified frequencies. Mark the results on the test card.

III. PERIOD

Specification: 10 Hz—2.5 MHz, 25 mV rms

- A. Repeat Test II, Step A1. Set the HP 5314A function switch PER A IN (make sure the HP 5314A blue key is OUT).
- B. Connect an HP 3314A to the HP 5314A INPUT A with a cable and 50-ohm feedthrough. Set the HP 3314A for 500 Hz and 2.5 MHz at 25 mV rms (~70 mV p-p). The HP 5314A should display 2 milliseconds and 0.400 microseconds, respectively. Mark the results on the test card.

IV. TIME INTERVAL

Specification: 250 ns—1 s, 25 mV rms

- A. Set the HP 5314A front panel controls as follows:

FUNCTION	TI A→B
RESOLUTION	N=1
BLUE key	IN
CHANNEL A SLOPE	↗
ATTN	X1
SEP/COM A	COM A
CHANNEL B SLOPE	↘
BOTH LEVELS	Midrange

- B. Connect an HP 3314A to the HP 5314A INPUT A with a cable and 50-ohm feedthrough. Set the HP 3314A for 1 MHz at 100 mV rms (~285 mV p-p). The HP 5314A should display 0.5 microseconds ±100 nanoseconds. Mark the results on the test card.

V. RATIO

Specifications:

Channel A: 10 Hz—10 MHz, 25 mV rms
Channel B: 10 Hz—2.5 MHz, 25 mV rms

- A. Set the HP 5314A front panel controls as follows:

FUNCTION	RATIO A/B
RESOLUTION	N=100
BOTH SLOPES	
BOTH LEVELS	Midrange
ATTN	X1
SEP/COM A	SEP

- B. Connect the HP 5314A, HP 3314A, and HP 3312A as shown in the following diagram:

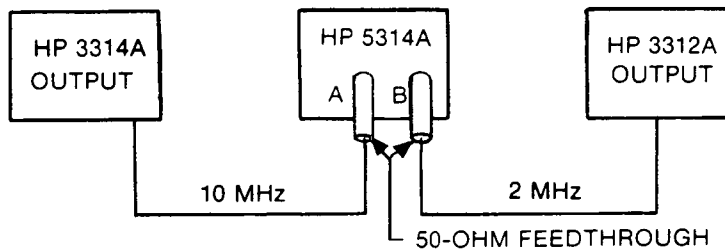

Ratio Test Setup

- C. Set the HP 3314A for 10 MHz at 25 mV rms. Set the HP 3312A function generator to 2 MHz at 25 mV rms (square wave). The HP 5314A should display 5.00. Mark the results on the test card.

OPERATION VERIFICATION TEST CARD

HEWLETT-PACKARD MODEL 5314A
UNIVERSAL COUNTER

Test Performed by _____

Serial No. _____

Date _____

DESCRIPTION	CHECK
I. SELF-CHECK	_____
II. FREQUENCY RESPONSE AND SENSITIVITY	
Channel A: 500 Hz, 5 MHz, 50 MHz 100 MHz	_____
Channel B: 500 Hz, 2.5 MHz	_____
III. PERIOD	
2 milliseconds	_____
0.400 milliseconds	_____
IV. TIME INTERVAL AND TIME INTERVAL AVERAGE	
Time Interval: 0.5 milliseconds at 100 mV (~285 mV p-p)	_____
V. RATIO A/B	
Ratio A/B as per Test V, step c	_____

Table 4-2. In-Cabinet Performance Test

I. SELF TEST

Perform the self test procedure per Figure 3-9. Mark the results on the test card.

II. FREQUENCY RESPONSE AND SENSITIVITY

A. CHANNEL A

Specification: 10 Hz—100 MHz, 25 mV rms

1. Set the HP 5314A front panel controls as follows:

```

FUNCTION ..... FREQ A
RESOLUTION ..... 1 Hz
BOTH SLOPES ..... f
ATTN ..... X1
SEP/COM A ..... SEP
BOTH LEVELS ..... Midrange
    
```

2. Connect an HP 3314A to the HP 5314A INPUT A with a cable and 50-ohm feedthrough. Vary the HP 3314A from 10 Hz to 10 MHz, maintaining a 25 mV rms signal level. The counter should display the correct frequencies. Mark the results on the test card.
3. Connect an HP 8656A signal generator to the HP 5314A INPUT A with a cable and 50-ohm feedthrough. Press the prescaled 10 Hz (N=1) resolution switch IN. Vary the HP 8656A signal generator from 10 MHz to 100 MHz, maintaining a 25 mV rms signal level. The counter should display the correct frequencies. Mark the results on the test card.

B. CHANNEL B

Specification: 10 Hz—2.5 MHz, 25 mV rms

1. Repeat step A1. Set the HP 5314A SEP/COM A switch to COM A. Set all three function switches OUT.
2. Connect an HP 3314A to the HP 5314A INPUT A with a cable and 50-ohm feedthrough. Vary the HP 3314A from 10 Hz to 2.5 MHz, maintaining a 25 mV rms signal level. The counter should display "1.00" throughout the specified frequencies. Mark the results on the test card.

III. PERIOD

Specification: 10 Hz—2.5 MHz, 25 mV rms

- A. Repeat Test II, Step A1. Set the HP 5314A function switch PER A IN (FREQ A switch OUT). Make sure the HP 5314A blue key is OUT.
- B. Connect an HP 3314A to the HP 5314A INPUT A with a cable and 50-ohm feedthrough. Vary the HP 3314A from 10 Hz to 2.5 MHz maintaining a 25 mV rms signal level. The counter should display the correct period of all frequencies in this range. Mark the results on the test card.

IV. TIME INTERVAL

Specification: 250 ns—1 s, 25 mV rms

- A. Set the HP 5314A front panel controls as follows:

```

FUNCTION ..... TI A—B
BLUE key ..... IN
RESOLUTION ..... N=1
CHANNEL A SLOPE ..... f
CHANNEL B SLOPE ..... f
ATTN ..... X1
SEP/COM A ..... COM A
BOTH LEVELS ..... Midrange
    
```

- B. Connect an HP 3314A to the HP 5314A INPUT A with a cable and 50-ohm feedthrough. Set the HP 3314A for 1 MHz at 100 mV rms (~285 mV p-p). The HP 5314A should display 0.5 microseconds ±100 nanoseconds. Mark the results on the test card.

Table 4-2. In-Cabinet Performance Test (Continued)

V. RATIO

Specifications:

Channel A: 10 Hz—10 MHz, 25 mV rms

Channel B: 10 Hz—2.5 MHz, 25 mV rms

- A. Set the HP 5314A front panel controls as follows:

FUNCTION RATIO A/B
RESOLUTION N=100
BOTH SLOPES
BOTH LEVELS Midrange
ATTN X1
SEP/COM A SEP

- B. Connect the HP 5314A, HP 3314A, and HP 3312A as shown in the following diagram:

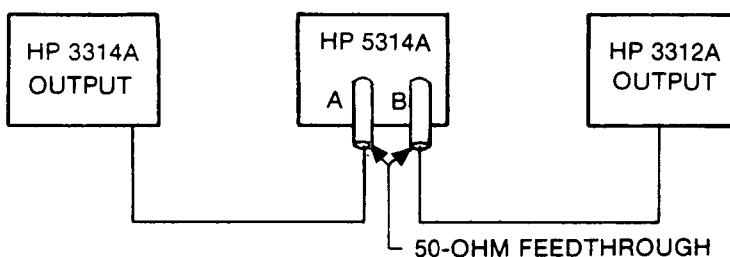

- C. Set the HP 3314A for 10 MHz at 25 mV rms. Set the HP 3312A function generator to 2 MHz at 25 mV rms (square wave). The HP 5314A should display 5.00. Mark the results on the test card.

VI. TOTALIZE

Specification: 10 Hz—10 MHz, 25 mV rms

- A. Set the HP 5314A front panel controls as follows:

NORM/HOLD NORM
FUNCTION START A
BLUE key IN
RESOLUTION 1 Hz
BOTH SLOPES 
ATTN X1
SEP/COM A SEP
BOTH LEVELS Midrange

- B. Set the HP 3314A to 10 Hz at 25 mV rms. Connect the HP 3314A to the HP 5314A INPUT A with a cable and 50-ohm feedthrough. Observe the HP 5314A display upcounting at a 10 Hz rate. Press the NORM/HOLD switch IN. Notice the display stops upcounting. Release the NORM/HOLD switch (OUT position). Notice the updated display and a resume in counting. Set the HP 3314A to 10 MHz at 25 mV rms. The HP 5314A display should be counting with the OVFL indicator lit. Mark the results on the test card.

PERFORMANCE TEST RECORD

HEWLETT-PACKARD MODEL 5314A UNIVERSAL COUNTER		Repair/Work Order No. _____
Serial Number: _____		Temperature: _____
Test Performed By: _____		Relative Humidity: _____
Date: _____		Post Calibration Test: <input type="checkbox"/>
Notes: _____		Pre Calibration Test: <input type="checkbox"/>

PARA. NO.	TEST	CORRECT DISPLAY	RESULTS		
			PASS	FAIL	
I.	SELF-TEST Resolution, 1 Hz/N = 100 10 Hz/N = 10 10 Hz/N = 1 100 Hz 1 kHz	0000.000	_____	_____	
		10000.00	_____	_____	
		00000.00	_____	_____	
		100000.0	_____	_____	
		100000.	_____	_____	
		_____	_____	_____	
II.	FREQUENCY RESPONSE AND SENSITIVITY CHANNEL A: 10 Hz — 10 MHz @ 25 mV rms 10 MHz — 100 MHz @ 25 mV rms CHANNEL B: 10 Hz — 2.5 MHz @ 25 mV rms	Stable Count	_____	_____	
		Stable Count	_____	_____	
		1.00	_____	_____	
		_____	_____	_____	
III.	PERIOD 10 Hz — 2.5 MHz @ 25 mV rms	Correct Period	_____	_____	
IV.	TIME INTERVAL Time Interval 0.5 microseconds @ 100 mV rms (~285 mV p-p)	0.5 μs	MINIMUM	ACTUAL	MAXIMUM
			.400	_____	.600
V.	RATIO Ratio A/B	5.00	PASS	FAIL	
			_____	_____	
VI.	TOTALIZE Totalize A: 10 Hz Up Count Up Count Stops Display Update/Resume Count Display Update	10 Hz Up Count Rate	_____	_____	
		Stable Count	_____	_____	
		Updated Display 10 Hz Up Count Rate	_____	_____	
		Count with OVFL	_____	_____	
		_____	_____	_____	

SECTION V ADJUSTMENTS

5-1. INTRODUCTION

5-2. This section describes the two adjustments that may be made to the HP 5314A. First, the power transformer primary is switchable to allow selection of two different nominal line voltages and second, the time base oscillator frequency is adjustable. The HP 5314A top cover must be removed to change the power transformer primary (line voltage change) as directed in *Table 5-1*. The time base oscillator frequency may be adjusted via an adjustment window located in the lower left-hand corner of the front panel. Two methods for adjusting the time base frequency are given in *Table 5-2*. The first method uses an external input, with the HP 5314A in frequency mode. The second method compares (using an oscilloscope) the buffered internal 10 MHz time base with an external house standard.

5-3. Adjustments for Options 001 and 002 are described in *Tables 5-3* and *5-4*, respectively. *Table 5-3* describes how to adjust the Temperature Compensated Crystal Oscillator (TCXO) frequency. *Table 5-4* describes how to adjust the automatic battery charger's cutoff voltage. Adjustments for both Options 001 and 002 require access to the inside of the HP 5314A.

5-4. EQUIPMENT REQUIRED

5-5. The test equipment required for the adjustment procedures is listed in *Table 1-3*, Recommended Test Equipment. Substitute equipment may be used if it meets or exceeds the critical specifications.

5-6. ADJUSTMENT LOCATIONS

5-7. Adjustment locations are identified in the component locators in Section VIII and in the top internal view of the HP 5314A as shown in *Figure 8-7*.

5-8. SAFETY CONSIDERATIONS

5-9. This section contains warnings and cautions that must be followed for your protection and to avoid damage to the equipment.

WARNING

MAINTENANCE DESCRIBED HEREIN IS PERFORMED WITH POWER SUPPLIED TO THE INSTRUMENT, AND PROTECTIVE COVERS REMOVED. SUCH MAINTENANCE SHOULD BE PERFORMED ONLY BY SERVICE-TRAINED PERSONNEL WHO ARE AWARE OF THE HAZARDS INVOLVED (FOR EXAMPLE, FIRE AND ELECTRICAL SHOCK). WHERE MAINTENANCE CAN BE PERFORMED WITHOUT POWER APPLIED, THE POWER SHOULD BE REMOVED.

BEFORE ANY REPAIR IS COMPLETED, ENSURE THAT ALL SAFETY FEATURES ARE INTACT AND FUNCTIONING, AND THAT ALL NECESSARY PARTS ARE CONNECTED TO THEIR PROTECTIVE GROUNDING MEANS.

Table 5-1. Input Line Voltage Adjustment

WARNING

THE POWER CORD SHOULD BE REMOVED FROM THE REAR OF THE HP 5314A BEFORE STARTING THIS ADJUSTMENT PROCEDURE.

1. Turn the HP 5314A upside down and remove the four screws near the corners of the cabinet bottom.
2. Holding the top and bottom covers together, turn the HP 5314A right-side up and carefully lift the top cover. This exposes the line voltage selector switch located on the A2 (05314-60006) power supply assembly (large pc assembly located in the rear of the cabinet).
3. The two position switch may now be properly set to match the input voltage (115 for 86V to 126V input or 230 for 172V to 252V input).
4. Replace the top cover and carefully turn the unit upside down. Replace and tighten the four screws, one in each corner, of the cabinet bottom.

NOTE

The line voltage selector switch automatically selects the correct line input fuse configuration (the two fuses are located on the A2 assembly and are in series for 230V operation and in parallel for 115V operation).

Table 5-2. Time Base Frequency Adjustment

NOTE

If this adjustment is to be considered valid, the HP 5314A must have a half-hour warm-up and the line voltage must be within +5% to -10%.

METHOD #1

1. Apply an external signal of known frequency (i.e., house standard) and suitable amplitude (minimum 25 mV rms) to the Channel A input of the HP 5314A.
2. Set the HP 5314A front panel controls as follows:

ON/OFF	ON
NORM/HOLD	NORM
FUNCTION	FREQ A
BLUE Key	OUT
RESOLUTION	1 Hz
CHANNEL A	
LEVEL A	0V (center position)
SLOPE	+ (UP)
ATTN	X1
CHANNEL B	
LEVEL B	0V (center position)
SLOPE	+ (UP)
SEP/COM A	SEP

The approximate input frequency should be in the display with an update once a second.

3. Locate the OSC ADJ window in the lower left-hand corner of the front panel. Insert a plastic tuning wand through the window and turn the adjustor (A1C2) slowly until the display shows the input frequency. The internal time base frequency is now correctly adjusted.

Table 5-2. Time Base Adjustment (Continued)

METHOD #2

The second method requires access to the inside of the HP 5314A. However, it accomplishes a more accurate adjustment of the time base frequency than Method #1.

NOTE

The power cord should be removed while performing the first four steps.

1. Turn the HP 5314A upside down and remove the four screws near the corners of the cabinet bottom.
2. Holding the top and bottom covers together, turn the HP 5314A right-side up and carefully lift the top cover.
3. Carefully grasp the combination front panel and A1 board assembly and lift until it clears the grooves.
4. Swing the right-side of the assembly (while looking toward the rear of the unit) away from the cabinet (toward you). Press the power switch to turn on the HP 5314A.
5. Install the line cord and the HP 5314A should come on (the unit will be on already if it contains the optional battery pack and the battery is charged).
6. Connect an oscilloscope to TP P of the A1 assembly (test point located near pin 40 of IC U2). This is the buffered 10 MHz internal oscillator.
7. Connect a house-standard signal to the EXT trigger input of an oscilloscope. Refer to the diagram below.

Every few months, the oscillator should be checked to a house standard. When adjustment is required, use the oscilloscope method shown below. Using the appropriate sweep speed, adjust the oscillator until the movement of the pattern is stopped.

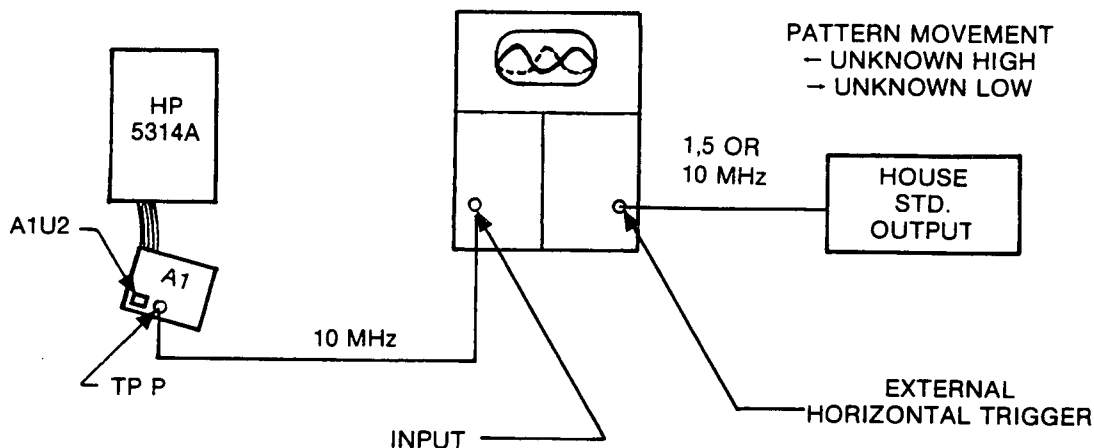

Oscillator Adjustment Interconnections

8. Set the controls of the oscilloscope as follows:

COUPLING	AC
INPUT IMPEDANCE	1 Meg
HORIZONTAL TRIGGER	EXT
TIME BASE	0.1 μ s/div.

9. Adjust the vertical gain for a full screen waveform. The waveform should be moving either to the left or to the right.
10. Adjust A1C2 (variable capacitor located in the lower left-hand corner of the A1 assembly) until the waveform is stationary. The accuracy of the frequency adjustment can be determined by referring to the table at the top of the next page.

Table 5-2. Time Base Adjustment (Continued)

Movement	SWEEP SPEED			NOTES
	1 μ scm	0.1 μ s/cm	0.01 μ s/cm	
1 cm/s	1×10^{-6}	1×10^{-7}	1×10^{-8}	TIME SCOPE TRACE MOVEMENT WITH SECOND HAND OR WATCH OR CLOCK
1 cm/10 s	1×10^{-7}	1×10^{-8}	1×10^{-9}	
1 cm/100 s	1×10^{-8}	1×10^{-9}	1×10^{-10}	

The time base frequency adjustment is now complete. Mount the combination front panel/A1 assembly back into the cabinet bottom. Making sure the cables are properly routed, replace the top cover. Turn the HP 5314A upside down. Install and tighten the four screws, one in each corner, in the cabinet bottom.

Table 5-3. Option 001 Adjustment

NOTE

If this adjustment is to be considered valid, the HP 5314A must have a half-hour warm-up and the line voltage must be within +5% to -10% of nominal.

There are two methods of adjustment. The preliminary instructions apply to both methods and must be performed regardless of which method is chosen. The first method uses a house-standard signal applied to the channel A input with the HP 5314A making a frequency measurement. The second method compares a house-standard signal with the HP 5314A internal time base using an oscilloscope.

PRELIMINARY

1. Remove the power cord from the rear of the HP 5314A.
2. Turn the HP 5314A upside down and remove the four screws near the corners of the cabinet bottom.
3. Holding the top and bottom covers together, turn the HP 5314A right-side up and carefully lift the top cover.
4. Install the line cord.

METHOD #1

1. Apply an external house-standard signal (minimum 25 mV rms) to the Channel A input of the HP 5314A.
2. Set the HP 5314A front panel controls as follows:
 - ON/OFF ON
 - NORM/HOLD NORM
 - FUNCTION FREQ A
 - RESOLUTION 1 Hz
 - CHANNEL A
 - LEVEL A 0V (center position)
 - SLOPE + (UP)
 - ATTN X1
 - CHANNEL B
 - LEVEL B 0V (center position)
 - SLOPE + (UP)
 - SEP/COM A SEP

The approximate input frequency should be displayed with an update once a second.

Table 5-3. Option 001 Adjustment (Continued)

The time base frequency is now properly adjusted. Replace the top cover and turn the HP 5314A upside down. Replace and tighten the four screws in the cabinet bottom.

METHOD #2

1. Carefully grasp the combination front panel and A1 board assembly and lift until it clears the grooves.
2. Swing the right-side of the assembly away from the cabinet.
3. Press the power switch to turn the instrument ON.
4. Connect an oscilloscope to TP P of the A1 assembly (test point located near pin 40 of IC U2). This is the buffered 10 MHz time base.
5. Connect a house-standard signal to the EXT trigger input of the oscilloscope. Refer to the diagram below.

Every few months the oscillator should be checked to a house standard. When adjustment is required, use the oscilloscope method below. Using the appropriate sweep speed, adjust the oscillator until the movement of the pattern is stopped.

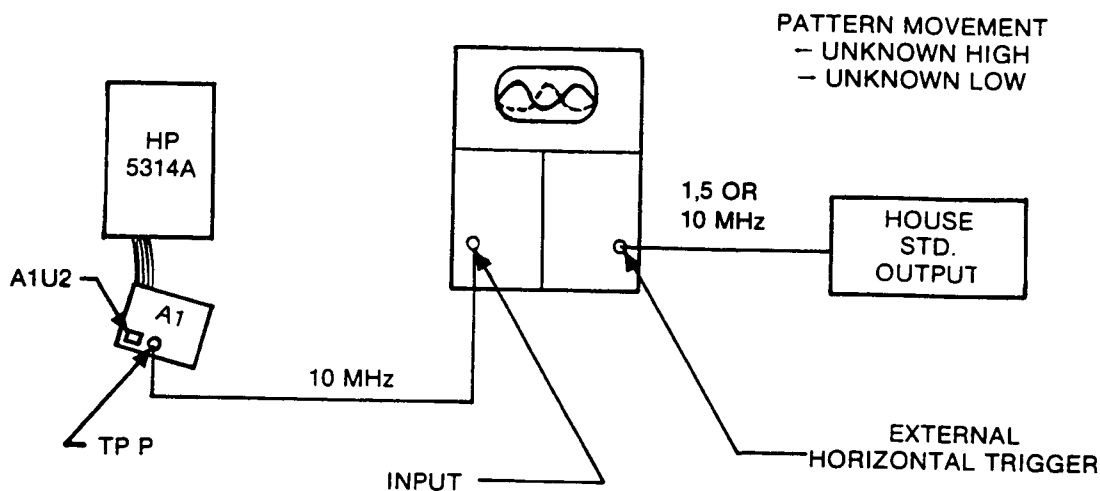

Oscillator Adjustment Interconnections

6. Set the controls of the oscilloscope as follows:

COUPLING	AC
INPUT IMPEDANCE	1 Meg
HORIZONTAL TRIGGER	EXT
TIME BASE	0.1 μ s/div.
7. Adjust the vertical gain for a full screen waveform. The waveform should be moving either to the left or to the right.
8. Locate the A4 assembly (TCXO) which is mounted on the A2 power supply assembly. The frequency adjustment is a screw-type adjustor located on the top of the TCXO. Using a plastic tuning wand, adjust the TCXO frequency until the correct reading (the exact frequency of the input house-standard) is in the HP 5314A display.

Table 5-3. Option 001 Adjustment (Continued)

Movement	SWEEP SPEED			NOTES
	1 μ s/cm	0.1 μ s/cm	0.01 μ s/cm	
1 cm/s	1×10^{-6}	1×10^{-7}	1×10^{-8}	TIME SCOPE TRACE MOVEMENT WITH SECOND HAND OR WATCH OR CLOCK
1 cm/10 s	1×10^{-7}	1×10^{-8}	1×10^{-9}	
1 cm/100 s	1×10^{-8}	1×10^{-9}	1×10^{-10}	

The time base frequency adjustment is now complete. Mount the combination front panel/A1 assembly back into the cabinet bottom. Making sure the cables are properly routed, replace the top cover. Turn the HP 5314A upside down. Install and tighten the four screws, one in each corner, in the cabinet bottom.

Table 5-4. Option 002 Charger Cutoff Voltage Adjustment

This adjustment set the voltage at which the 0.5 amp charging current to the battery is terminated. It is preset at the factory and normally requires no further adjustment. However, readjustment is necessary after a repair to the A3 assembly or after field installation of Option 002.

1. Remove the power cord from the rear of the HP 5314A.
2. Turn the HP 5314A upside down and remove the four screws near the corners of the cabinet bottom.
3. Holding the top and bottom covers together, turn the HP 5314A right-side up and carefully lift the top cover.
4. Disconnect the red and black cables from the battery.
5. Insert the line cord and turn the HP 5314A ON.
6. Connect a low voltage power supply to the A3 assembly charger cables (positive lead to red cable and negative lead to black cable).
7. Turn the pot on the A3 assembly (A3R12) fully clockwise.
8. Adjust the power supply to 0 volts, then increase it to +6.5 volts \pm 5 millivolts.
9. Connect a voltmeter between ground and A3U1(7).
10. Turn the pot (A3R12) counterclockwise slowly until the voltage rises above 5 volts (typically 9–13 volts).
11. Disconnect the low voltage power supply from the red and black cables.
12. Turn the HP 5314A to STBY and remove the line cord.
13. Connect the red and black charger cable to the positive and negative posts of the battery, respectively.
14. Replace the handle and top cover.
15. Turn the unit upside down. Install and tighten the four screws (one in each corner) of the cabinet bottom.

Adjustment of the A3 assembly is now complete.

SECTION VI REPLACEABLE PARTS

6-1. INTRODUCTION

6-2. This chapter contains information for ordering parts. The following replaceable parts lists are included.

Table 6-1	Reference Designations and Abbreviations
Table 6-2	Replaceable Parts
Table 6-3	Manufacturer's Codes

6-3. REFERENCE DESIGNATIONS

6-4. *Table 6-1* lists the abbreviations and reference designations used in the parts lists, block diagrams, and throughout the manual.

6-5. REPLACEABLE PARTS

6-6. Table 6-2 is the list of replaceable parts and is organized as follows:

1. Electrical assemblies in alphanumerical order by reference designation.
2. Chassis-mounted electrical parts in alphanumerical order by reference designation.
3. Chassis-mounted mechanical parts in alphanumerical order by reference designation.

6-7. The information given for each part consists of the following:

1. Reference Designation
2. Hewlett-Packard part number.
3. Part number check digit (CD).
4. Total quantity (QTY) in instrument. The total quantity is given once and at the first appearance of the part number in the list.
5. Description of the part.
6. Typical manufacturer's part number for the part.

6-8. HOW TO ORDER A PART

6-9. Hewlett-Packard wants to keep your parts ordering process as simple and efficient as possible. Think of the process as having the following steps:

- Identifying the part and the quantity that you want.
- Determining the ordering method to be used and contacting Hewlett-Packard.

6-10. Parts Identification

6-11. To identify the part(s) you want, first refer to the replaceable parts lists (*Tables 6-2 and 6-3*) in this chapter.

6-12. When ordering from Hewlett-Packard, the important numbers to note from the Parts List are the HP Part Number and part-number check digit (in the "CD" column), and the quantity of the part you want.

6-13. If the part you want is NOT identified in the manual, you can call on Hewlett-Packard for help (see the following section ("Contacting Hewlett-Packard"). Please have the following information at hand when you contact HP for help:

- Instrument Model Number (example "HP 5314A").
- Complete instrument Serial Number (example "1234A56789"). Information about where to find the serial number is given in the preface of this manual in the "HOW TO USE THIS MANUAL" section.
- Description of the part and its use.
- Quantity of the part required.

6-14. Contacting Hewlett-Packard

6-15. Depending on where you are in the world, there are one or more ways in which you can get parts or parts information from Hewlett-Packard.

- Outside the United States, contact your local HP sales office. HP sales offices are listed at the back of this manual.
- Within the United States, we encourage you to order replacement parts or request parts information directly by telephone or mail from the HP Support Materials Organization, using the telephone numbers or address listed below. (You can also contact your local HP sales office. HP sales offices are listed at the back of this manual.)

6-16. By telephone:

- a. For Parts Ordering, use our toll-free number (800) 227-8164, Monday through Friday (except Holidays), 6 am to 5 pm (Pacific Time).
- b. If you need a part in a hurry, an extra-cost Hotline phone ordering service is available, 24 hours a day. Use the toll free number above at the times indicated; at other times, use (415) 968-2347.
- c. For Parts Identification Assistance, call us at (916) 783-0804. Our Parts Identification hours are from Monday through Friday, 6 am to 5 pm (Pacific Time).

6-17. For mail correspondence, use the address below:

Hewlett-Packard
Support Materials Roseville
P.O. Box 1145
Roseville, Ca 95661-1145

6-18. CABINET PARTS AND HARDWARE:

6-19. To locate and identify miscellaneous cabinet parts, refer to *Figure 6-1*. This figure provides an exploded view of the cabinet, with the parts identified by reference designations; the reference designations correspond with the ones in *Table 6-3*.

Table 6-1. Reference Designations and Abbreviations

REFERENCE DESIGNATIONS

A = assembly	DS = annunciator; signaling device	audio	LS = audible alarm; audible signaling device; buzzer; transducer	TB = terminal board
AT = attenuator, isolator; termination	FL = miscellaneous electrical part		M = metre	TC = thermocouple
B = battery	FUSE = fuse		M/P = miscellaneous mechanical part	TP = test point
BT = battery	HW = hardware		P = electrical connector, movable	U = integrated circuit; microcircuit
C = capacitor	HY = circulator		Q = transistor; SCR; triode thyristor	V = electron tube
CP = coupler	J = electrical connector stationary		R = resistor	VR = voltage regulator; breakdown diode
CR = diode; diode thyristor; varactor	K = portion, jack		RT = thermistor	W = cable; transmission path; wire; jumper
DC = directional coupler	L = coil; inductor		S = switch	X = socket
DL = delay line			T = transformer	Y = crystal unit-piezo-electric
				Z = tuned cavity; tuned circuit

ABBREVIATIONS

A = ampere	HDW = hardware	nF = nanofarad	SPDT = single-pole, double-throw
ac = alternating current	HF = high frequency	NI PL = nickel plate	SPG = spring
ACCESS = accessory	HG = mercury	N/O = normally open	SPL = special
ADJ = adjustment	HI = high	NOM = nominal	SPST = single-pole, single-throw
A/D = analog-to-digital	HP = Hewlett-Packard	NORM = normal	SR = split ring
AF = audio frequency	HPF = high pass filter	NPN = negative-positive-negative	SSB = single sideband
AFC = automatic frequency control	HR = hour (used in parts list)	NPO = negative-positive zero (zero temperature coefficient)	SSS = stainless steel
AGC = automatic gain control	HV = high voltage	NRFR = not recommended for field replacement	STL = steel
AL = aluminum	Hz = hertz	ns = nanosecond	SQ = square
ALC = automatic level control	IC = integrated circuit	NSR = not separately replaceable	SWR = standing-wave ratio
AM = amplitude modulation	ID = inside diameter	nW = nanowatt	SYNC = synchronize
AMPL = amplifier	IF = intermediate frequency	OBD = order by description	T = timed (slow-blow fuse)
APC = automatic phase control	IMPG = impregnated	OD = outside diameter	TA = tantalum
ASSY = assembly	in = inch	OH = oval head	TC = temperature compensating
AUX = auxiliary	INCD = incandescent	OP AMPL = operational amplifier	TD = time delay
AVG = average	INCL = include(s)	OPT = option	TERM = terminal
AWG = american wire gauge	INP = input	OSC = oscillator	TFT = thin-film transistor
BAL = balance	INS = insulation	OX = oxide	TGL = toggle
BCD = binary-coded decimal	INT = internal	oZ = ounce	THD = thread
BD = board	kg = kilogram	Ω = ohm	THRU = through
BE CU = beryllium copper	kHz = kilohertz	p = peak (used in parts list)	TI = titanium
BFO = beat frequency oscillator	kΩ = kilohm	P AM = pulse-amplitude modulation	TOL = tolerance
BH = binder head	kV = kilovolt	PC = printed circuit	TRIM = trimmer
BKDN = breakdown	lb = pound	PCM = pulse-code modulation; pulse-count modulation	TSTR = transistor
BP = bandpass	LC = inductance-capacitance	PDM = pulse-duration modulation	TTL = transistor-transistor logic
BPF = bandpass filter	LED = light-emitting diode	pF = picofarad	TV = television
BRS = brass	LF = low frequency	PH BRZ = phosphor bronze	TVI = television interference
BWO = backward wave oscillator	LG = long	PHL = phillips	TWT = traveling wave tube
CAL = calibrate	LH = left hand	PIN = positive-intrinsic-negative	U = micro (10 ⁻⁶) (used in parts list)
ccw = counterclockwise	LIM = limit	PIV = peak inverse voltage	UF = microfarad (used in parts list)
CER = ceramic	LIN = linear taper (used in parts list)	PK = peak	UHF = ultra-high frequency
CHAN = channel	lin = linear	PLL = phase lock	UNREG = unregulated
cm = centimeter	LK WASH = lock washer	PLO = phase lock loop	V = volt
CMO = cabinet mount only	LO = low; local oscillator	PM = phase modulation	VA = voltampere
COEF = coefficient	LOG = logarithmic taper (used in parts list)	PNP = positive-negative-positive	Vac = volts ac
COM = common	log = logarithmic	P/O = part of	VAR = variable
COMP = composition	LPF = low pass filter	POLY = polystyrene	VCO = voltage-controlled oscillator
COMPL = complete	LV = low voltage	PORC = porcelain	Vdc = volts dc
CONN = connector	m = metre (distance)	POS = positive; position(s) (used in parts list)	VDCW = volts, dc, working (used in parts list)
CP = cadmium plate	mA = milliampere	POSN = position	V(F) = volts, filtered
CRT = cathode ray tube	MAX = maximum	POT = potentiometer	VFO = variable-frequency oscillator
CTL = complementary transistor logic	MΩ = megohm	PP = peak-to-peak (used in parts list)	VHF = very-high frequency
CW = continuous wave	MEG = meg (10 ⁶) (used in parts list)	PREAMPL = preamplifier	Vpk = volts peak
cw = clockwise	MET FILM = metal film	PRF = pulse-repetition frequency	Vp-p = volts peak-to-peak
D/A = digital-to-analog	MET OX = metal oxide	PRR = pulse-repetition rate	Vrms = volts rms
dB = decibel	MF = medium frequency; microfarad (used in parts list)	PT = point	VSWR = voltage standing wave ratio
dBm = decibel referred to 1mW	MFR = manufacturer	PTM = pulse-time modulation	VTO = voltage-tuned oscillator
dc = direct current	mg = milligram	PWM = pulse-width modulation	VTVM = vacuum-tube voltmeter
deg = degree (temperature interval or difference)	mHz = megahertz	PWV = peak working voltage	V(X) = volts, switched
° = degree (plane angle)	mH = millihenry	RC = resistance capacitance	W = watt
°C = degree Celsius (centigrade)	mho = conductance	RECT = rectifier	W/ = with
°F = degree Fahrenheit	MIN = minimum	REF = reference	WIV = working inverse voltage
°K = degree Kelvin	min = minute (time)	REG = regulated	WW = wirewound
DEPC = deposited carbon	MINAT = miniature	REPL = replaceable	W/O = without
DET = detector	mm = millimeter	RF = radio frequency	YIG = yttrium-iron-garnet
diam = diameter	MOD = modulator	RFI = radio frequency interference	Zo = characteristic impedance
DIA = diameter (used in parts list)	MOM = momentary	RH = round head; right hand	
DIFF AMPL = differential amplifier	MOS = metal-oxide semiconductor	RLC = resistance-inductance-capacitance	
div = division	ms = millisecond	RMO = rack mount only	
DPDT = double-pole, double-throw	MTG = mounting	rms = root-mean-square	
DR = drive	MTR = meter (indicating device)	RND = round	
DSB = double sideband	MUX = multiplexer	ROM = read-only memory	
DTL = diode-transistor logic	mV = millivolt	R&P = rack and panel	
DVM = digital voltmeter	mVdc = millivolt, dc	RWV = reverse working voltage	
ECL = emitter-coupled logic	mVpk = millivolt, peak	S = scattering parameter	
EMF = electromotive force	mVp-p = millivolt, peak-to-peak	s = second (time)	
EDP = electronic data processing	mVrms = millivolt, rms	.. = second (plane angle)	
ELECT = electrolytic	mW = milliwatt	S-B = slow-blow fuse (used in parts list)	
ENCAP = encapsulated	MY = mylar	SCR = silicon controlled rectifier; screw	
EXT = external	μA = microampere	SE = selenium	
F = farad	μF = microfarad	SECT = sections	
FET = field-effect transistor	μH = microhenry	SEMICON = semiconductor	
F/F = flip-flop	μho = microhm	SHF = super-high frequency	
FH = flat head	μs = microsecond	SI = silicon	
FIL H = fillister head	μV = microvolt	SIL = silver	
FM = frequency modulation	μVdc = microvolt, dc	SL = slide	
FP = front panel	μVpk = microvolt, peak	SNR = signal-to-noise ratio	
FREQ = frequency	μVp-p = microvolt, peak-to-peak		
FXD = fixed	μVrms = microvolt, rms		
g = gram	μW = microwatt		
GE = germanium	nA = nanoampere		
GHz = gigahertz	NC = no connection		
GL = glass	NC/C = normally closed		
GND = ground(ed)	NE = neon		
H = henry	NEG = negative		
h = hour			
HET = heterodyne			
HEX = hexagonal			
HD = head			

NOTE

All abbreviations in the parts list will be in upper case.

MULTIPLIERS

Abbreviation	Prefix	Multiple
T	tera	10 ¹²
G	giga	10 ⁹
M	mega	10 ⁶
k	kilo	10 ³
da	deka	10
d	deci	10 ⁻¹
c	centi	10 ⁻²
m	milli	10 ⁻³
μ	micro	10 ⁻⁶
n	nano	10 ⁻⁹
p	pico	10 ⁻¹²
f	femto	10 ⁻¹⁵
a	atto	10 ⁻¹⁸

Table 6-2. Replaceable Parts

Reference Designation	HP Part Number	C D	Qty	Description	Mfr Code	Mfr Part Number
A1A1	05314-60008		1	BD ASSY, MAIN (SERIES 2538A)	28480	05314-60008
A1C1	0160-2055	9	6	CAPACITOR-FXD .01UF +80-20% 100VDC CER	28480	0160-2055
A1C2	0121-0475	1	1	CAPACITOR-V TRMR POLYP 2-22PF 100V	D2540	2222 808 11229
A1C3	0180-0562	1	1	CAPACITOR-FXD 33UF +20% 10VDC TA	56289	199D1120
A1C4*	0160-4386	3	0	CAPACITOR-FXD 33PF +5% 200VDC CER 0+-30	28480	0160-4386
A1C4*	0160-4387	4	0	CAPACITOR-FXD 47PF +5% 200VDC CER 0+-30	28480	0160-4387
A1C4*	0160-4494	4	1	CAPACITOR-FXD 39PF +5% 200VDC CER 0+-30	28480	0160-4494
A1C5*	0160-4387	4	1	CAPACITOR-FXD 47PF +5% 200VDC CER 0+-30	28480	0160-4387
A1C5*	0160-4527	4	1	CAPACITOR-FXD 56PF +5% 200VDC CER 0+-30	28480	0160-4527
A1C6	0160-2055	9		CAPACITOR-FXD .01UF +80-20% 100VDC CER	28480	0160-2055
A1C7	0160-2055	9		CAPACITOR-FXD .01UF +80-20% 100VDC CER	28480	0160-2055
A1C8	0160-3875	3	1	CAPACITOR-FXD 22PF +5% 200VDC CER 0+-30	28480	0160-3875
A1C9	0160-3876	4	3	CAPACITOR-FXD 47PF +20% 200VDC CER	28480	0160-3876
A1C10	0180-2929	8	1	CAPACITOR-FXD 68UF +10% 10VDC TA	28480	0180-2929
A1C11	0180-0106	9	4	CAPACITOR-FXD 60UF +20% 6VDC TA	56289	150D606X0006B2
A1C12	0160-3876	4		CAPACITOR-FXD 47PF +20% 200VDC CER	28480	0160-3876
A1C13	0160-2055	9		CAPACITOR-FXD .01UF +80-20% 100VDC CER	28480	0160-2055
A1C14	0180-4135	7	2	CAPACITOR-FXD 33UF 10% 10V TA	12340	T322D336K010AS
A1C15	0180-0106	9		CAPACITOR-FXD 60UF +20% 6VDC TA	56289	150D606X0006B2
A1C16	0160-4511	6	2	CAPACITOR-FXD 220PF +5% 200VDC CER	28480	0160-4511
A1C17	0180-0210	6	3	CAPACITOR-FXD 3.3UF +20% 15VDC TA	56289	150D335X0015A2
A1C18	0160-3876	4		CAPACITOR-FXD 47PF +20% 200VDC CER	28480	0160-3876
A1C19	0160-4424	0	2	CAPACITOR-FXD .047UF +20% 500VDC CER	51642	400-500-X7R-473M
A1C20	0160-0571	0	1	CAPACITOR-FXD 470PF +20% 100VDC CER	28480	0160-0571
A1C21	0160-3876	4		CAPACITOR-FXD 47PF +20% 200VDC CER	28480	0160-3876
A1C22	0180-0106	9		CAPACITOR-FXD 60UF +20% 6VDC TA	56289	150D606X0006B2
A1C23	0160-2055	9		CAPACITOR-FXD .01UF +80-20% 100VDC CER	28480	0160-2055
A1C24	0180-4135	7		CAPACITOR-FXD 33UF 10% 10V TA	12340	T322D336K010AS
A1C25	0180-0106	9		CAPACITOR-FXD 60UF +20% 6VDC TA	56289	150D606X0006B2
A1C26	0160-4511	6		CAPACITOR-FXD 220PF +5% 200VDC CER	28480	0160-4511
A1C27	0180-0210	6		CAPACITOR-FXD 3.3UF +20% 15VDC TA	56289	150D335X0015A2
A1C28	0160-4424	0	2	CAPACITOR-FXD .047UF +20% 500VDC CER	51642	400-500-X7R-473M
A1C29	0160-0576	5	1	CAPACITOR-FXD .1UF +20% 50VDC CER	28480	0160-0576
A1C30	0160-2055	9		CAPACITOR-FXD .01UF +80-20% 100VDC CER	28480	0160-2055
A1C31 - C44				NOT ASSIGNED		
A1C45 - C47	0160-4040		3	CAPACITOR-FXD 1000PF 5% 100V CER	12340	C320C102J1G5CA
A1CR1 - CR9	1901-0050	3	9	DIODE-SWITCHING 80V 200MA 2NS DO-35	9N171	1N4150
				NOTE DIODE A1CR4 IS REQUIRED IN ANY INSTRUMENT WITH TCXO OPTION 001. IF OPTION 001 IS ADDED IN THE FIELD, A1CR4 MUST ALSO BE ADDED.		
A1DS1 - DS7	1990-0730	3	7	DISPLAY-NUM SEG 1-CHAR 3-H RED	28480	5082-7611
A1DS8	1990-0486	6	1	LED-LAMP RED	28480	HLMP-1301
A1J1 - J2	1250-1594	1	2	CONNECTOR-RF BNC FEM SGL-HOLE RR 50-OHM	28480	1250-1594
A1MP1 - MP3				NOT ASSIGNED		
A1MP4 - MP6	0890-0324	8	3	TUBING-FLEX .032-ID TFE .012-WALL	28480	0890-0324
A1MP7	1251-4707	6	1	CONNECTOR-SGL CONT PIN .031-IN BSC-SZ	28480	1251-4707
A1MP8 - MP13	0370-2486	5	6	PUSHBUTTON, JADE GRAY	28480	0370-2486
A1MP14	0370-2625	4	1	PUSHBUTTON WHITE	28480	0370-2625
A1MP15	0370-2917	7	1	PUSHBUTTON, BLUE	28480	0370-2917
A1MP16 - MP19	5040-8816	3	4	SWITCH CAP, MINT GRAY	28480	5040-8816
A1Q1 - Q6	1853-0015	7	7	TRANSISTOR PNP SI PD=200MW FT=500MHZ	28480	1853-0015
A1Q7	1853-0354	7	1	TRANSISTOR PNP SI TO-92 PD=350MW	04713	SPS6837
A1Q8	1855-0267	5	2	TRANSISTOR J-FET N-CHAN D-MODE TO-92 SI	28480	1855-0267
A1Q9	1853-0015	7		TRANSISTOR PNP SI PD=200MW FT=500MHZ	28480	1853-0015
A1Q10	1855-0267	5		TRANSISTOR J-FET N-CHAN D-MODE TO-92 SI	28480	1855-0267
A1R1	0757-0416	7	7	RESISTOR 511 1% .125W F TC=0+-100	24546	CT4-1/8-TO-511R-F
A1R2	0757-0416	7		RESISTOR 511 1% .125W F TC=0+-100	24546	CT4-1/8-TO-511R-F
A1R3	0757-0401	0	3	RESISTOR 100 1% .125W F TC=0+-100	24546	CT4-1/8-TO-101-F
A1R4	1810-0365	0	1	NETWORK RESISTOR 6-SIP 2.2K OHM X 5	11236	750-61-R2.2K
A1R5	0757-0416	7		RESISTOR 511 1% .125W F TC=0+-100	24546	CT4-1/8-TO-511R-F

SEE INTRODUCTION TO THIS SECTION FOR ORDERING INFORMATION
*INDICATES FACTORY SELECTED VALUE

Table 6-2. Replaceable Parts (Continued)

Reference Designation	HP Part Number	C D	Qty	Description	Mfr Code	Mfr Part Number
A1R6	0699-0073	8	2	RESISTOR 10M 1% .125W F TC=0+150	28480	0699-0073
A1R7	0757-0416	7		RESISTOR 511 1% .125W F TC=0+100	24546	CT4-1/8-TO-511R-F
A1R8	0757-0401	0		RESISTOR 100 1% .125W F TC=0+100	24546	CT4-1/8-TO-101-F
A1R9	0698-3132	4	6	RESISTOR 261 1% .125W F TC=0+100	24546	CT4-1/8-TO-2610-F
A1R10	0757-0416	7		RESISTOR 511 1% .125W F TC=0+100	24546	CT4-1/8-TO-511R-F
A1R11	0698-3132	4		RESISTOR 261 1% .125W F TC=0+100	24546	CT4-1/8-TO-2610-F
A1R12	0698-3132	4		RESISTOR 261 1% .125W F TC=0+100	24546	CT4-1/8-TO-2610-F
A1R13	0757-0401	0		RESISTOR 100 1% .125W F TC=0+100	24546	CT4-1/8-TO-101-F
A1R14	0698-3132	4		RESISTOR 261 1% .125W F TC=0+100	24546	CT4-1/8-TO-2610-F
A1R15	0757-0416	7		RESISTOR 511 1% .125W F TC=0+100	24546	CT4-1/8-TO-511R-F
A1R16	0757-0416	7		RESISTOR 511 1% .125W F TC=0+100	24546	CT4-1/8-TO-511R-F
A1R17	1810-0203	5	2	NETWORK RESISTOR 8-SIP 470.0 OHM X 7	11236	750-81-R470
A1R18	1810-0400	4	2	NETWORK RESISTOR 8-SIP MULTI-VALUE	28480	1810-0400
A1R19	0698-8812	7	1	RESISTOR 1 1% .125W F TC=0+100	28480	0698-88-1
A1R20	0757-0346	2	2	RESISTOR 10 1% .125W F TC=0+100	28480	0757-0346
A1R21	1810-0401	5	2	NETWORK RESISTOR 7-SIP MULTI-VALUE	28480	1810-0401
A1R22	0698-3458	7	2	RESISTOR 348K 1% .125W F TC=0+100	28480	0698-3458
A1R23	0757-0407	6	2	RESISTOR 200 1% .125W F TC=0+100	24546	CT4-1/8-TO-201-F
A1R24	0757-0428	1	2	RESISTOR 1.62K 1% .125W F TC=0+100	24546	CT4-1/8-TO-1621-F
A1R25	0698-4009	6	1	RESISTOR 50K 1% .125W F TC=0+100	24546	CT4-1/8-TO-5002-F
A1R26	0698-3132	4		RESISTOR 261 1% .125W F TC=0+100	24546	CT4-1/8-TO-2610-F
A1R27	0698-8827	4	2	RESISTOR 1M 1% .125W F TC=0+100	28480	0698-8827
A1R28	0698-3442	9	2	RESISTOR 237 1% .125W F TC=0+100	24546	CT4-1/8-TO-237R-F
A1R29	2100-4046	7	2	RESISTOR-VAR SS 20K 10% LIN 1 TRN	28480	2100-4046
A1R30	1810-0203	5		NETWORK RES 8-SIP 470.0 OHM X 7	11236	750-81-R470
A1R31	1810-0400	4		NETWORK RESISTOR 8-SIP MULTI-VALUE	28480	1810-0400
A1R32	0757-0346	2		RESISTOR 10 1% .125W F TC=0+100	28480	0757-0346
A1R33	0698-8812	7		RESISTOR 1 1% .125W F TC=0+100	28480	0698-8812
A1R34	1810-0401	5		NETWORK RESISTOR 7-SIP MULTI-VALUE	28480	1810-0401
A1R35	0698-3458	7		RESISTOR 348K 1% .125W F TC=0+100	28480	0698-3458
A1R36	0757-0407	6		RESISTOR 200 1% .125W F TC=0+100	24546	CT4-1/8-TO-201-F
A1R37	0757-0428	1		RESISTOR 1.62K 1% .125W F TC=0+100	24546	CT4-1/8-TO-1621-F
A1R38	2100-4046	8		RESISTOR-VAR SS 20K 10% LIN 1 TRN	28480	2100-4046
A1R39	0698-3442	9		RESISTOR 237 1% .125W F TC=0+100	24546	CT4-1/8-TO-237R-F
A1R40	0698-3442	9				
A1R41	0698-8827	4		RESISTOR 1M 1% .125W F TC=0+100	28480	0698-8827
A1R42	0699-0073	8		RESISTOR 10M 1% .125W F TC=0+150	28480	0699-0073
A1R43	0757-1093	8	1	RESISTOR 3K 1% .125W F TC=0+100	24546	CT4-1/8-TO-3001-F
A1S1 - S5	3101-2124	2	9	SWITCH PB DPDT ALTNG .25A 115VAC	28480	3101-2124
A1S6 - S8	3101-2186	6	1	SWITCH PB 3-STATION 10MM C-C SPACING	28480	3101-2186
A1S9 - S12	3101-2124	2		SWITCH PB DPDT ALTNG .25A 115VAC	28480	3101-2124
A1U1	1820-1470	1	1	IC MUXR/DATA-SEL TTL LS 2-TO-1 LINE QUAD	01295	SN74LS157N
A1U2	1820-2187	9	1	IC COUNTER CMOS 2-INP	32293	ICM7226A
A1U3	1820-1383	5	1	IC COUNTER ECL BCD POS-EDGE-TRIG	04713	MC10138L
A1U4	1820-0694	9	1	IC GATE TTL S EXCL-OR QUAD 2-INP	01295	SN74S86N
A1U5	1820-1224	3	2	IC RECEIVER ECL LINE RECEIVER TPL 2-INP	04713	MC10216P
A1U6	1820-1224	3		IC RECEIVER ECL LINE RECEIVER TPL 2-INP	04713	MC10216P
A1W1	8159-0005	0	1	RESISTOR ZERO OHMS 22 AWG LEAD DIA	28480	8159-0005
A1XDS1 - DS7	1200-0805	0	7	SOCKET-DSPL 14-CONT DIP DIP-SLDR	28480	1200-0805
A1XDS8	0500-20017	7	1	SPACER-LED SINGLE	28480	05000-20017
A1XU2	1200-0654		1	SOCKET-IC 40-CONT DIP-SLDR	28480	1200-0552
A1XU4	1200-0679	6	1	SOCKET-IC 14-CONT DIP DIP-SLDR	28480	1200-0679
A1Y1	0410-1188	8	1	CRYSTAL-QUARTZ 10.000 MHZ HC-35/U-HLDR	28480	0410-1188
	0361-0079	9	2	RIVET SEMI-TUB OVH .123 DIA .312 LG	28480	0361-0079
	3050-0016		4	WASHER-FL MTLN NO. 6 .147-IN-ID	00000	ORDER BY DESCRIPTION
	5040-8816		4	SWITCH CAP. MINT GRAY	00000	5040-8816
	05314-80001		1	LABEL-LINE FUSE	28480	05314-80001

SEE INTRODUCTION TO THIS SECTION FOR ORDERING INFORMATION
*INDICATES FACTORY SELECTED VALUE

Table 6-2. Replaceable Parts (Continued)

Reference Designation	HP Part Number	C D	Qty	Description	Mfr Code	Mfr Part Number
A2	05314-60006		1	POWER SUPPLY BOARD ASSEMBLY (SERIES 2536)	28480	05314-60102
A2C1	0180-2101	8	1	CAPACITOR-FXD 4000UF +75-10% 15VDC AL	28480	0180-2101
A2C2	0160-2055	9	2	CAPACITOR-FXD .01UF +80-20% 100VDC CER	28480	0160-2055
A2C3	0180-1701	2	1	CAPACITOR-FXD 6.8UF +20% 6VDC TA	56289	150D685X0006A2
A2C4	0160-2055	9	2	CAPACITOR-FXD .01UF +80-20% 100VDC CER	28480	0160-2055
A2C5	0180-0210	6	2	CAPACITOR-FXD 3.3UF +20% 15VDC TA	56289	150D335X0015A2
A2 C6	0180-0210	6	2	CAPACITOR-FXD 3.3UF +20% 15VDC TA	56289	150D335X0015A2
A2CR1	1901-0731	7	4	DIODE-POWER RECT 400V 1A	14433	1N4004G
A2CR2	1901-0731	7	4	DIODE-POWER RECT 400V 1A	14433	1N4004G
A2CR3	1901-0050	3	2	DIODE-SWITCHING 80V 200MA 2NS DO-35	9N171	1N4150
A2CR4	1901-0050	3	2	DIODE-SWITCHING 80V 200MA 2NS DO-35	9N171	1N4150
A2CR5	1901-0731	7	4	DIODE-POWER RECT 400V 1A	14433	1N4004G
A2CR6	1901-0731	7	4	DIODE-POWER RECT 400V 1A	14433	1N4004G
A2CR7	1902-0551	1	1	DIODE-ZNR 6.2V 5% PD=1W IR=10UA	28480	1902-0551
A2F1	2110-0234	8	2	FUSE (INCH) .1A 250V TD FE UL LIST	28480	2110-0234
A2F2	2110-0234	8	2	FUSE (INCH) .1A 250V TD FE UL LIST	28480	2110-0234
A2H1	2200-0105	4	1	SCREW-MACH 4-40 .312-IN LG PAN-HD POZI	00000	ORDER BY DESCRIPTION
A2H2	2260-0009	3	1	NUT-HEX W/LKWR 4-40-THD .094-IN-THK	00000	ORDER BY DESCRIPTION
A2J1	1251-3811	1	1	CONNECTOR PC EDGE 6-CONT/ROW 1-RO2	28480	1251-3811
A2J2	1251-4741	8	1	CONNECTOR-AC POST-TYPE 9-CONT	28480	1251-4743
A2MP1	1205-0350	0	1	HEAT SINK SGL PLASTIC POWER CS	28480	1205-0350
A2MP2	1400-0482	3	2	CABLE TIE .062-3 DIA .14=WD NYL	28480	1500-0482
A2MP3	1400-0482	3	2	CABLE TIE .062-3 DIA .14=WD NYL	28480	1500-0482
A2Q1	1854-0477	7	1	TRANSISTOR NPN 2N2222ASI TO-18 PD=500MW	04713	2N2222A
A2Q2	1853-0371	8	1	TRANSISTOR PNP 2N6107 SI PD=1.8W	3L585	2N6107
A2R1	0757-0442	9	3	RESISTOR 10K 1% .125W F TC=0+100	24546	CT4-1/8-TO-1002-F
A2R2	0757-0462	3	1	RESISTOR 75K 1% .125W F TC=0+100	24546	CT4-1/8-TO-7502-F
A2R3	0757-0443	0	1	RESISTOR 11K 1% .125W F TC=0+100	24546	CT4-1/8-TO-1102-F
A2R4	0757-0440	7	1	RESISTOR 7.5K 1% .125W F TC=0+100	24546	CT4-1/8-TO-7501-F
A2R5	0757-0283	6	2	RESISTOR 2K 1% .125W F TC=0+100	24546	CT4-1/8-TO-2001-F
A2R6	0698-3437	2	1	RESISTOR 133 1% .125W F TC=0+100	24546	CT4-1/8-TO-133R-F
A2R7	0757-0442	9	3	RESISTOR 10K 1% .125W F TC=0+100	24546	CT4-1/8-TO-1002-F
A2R8	0757-0442	9	3	RESISTOR 10K 1% .125W F TC=0+100	24546	CT4-1/8-TO-1002-F
A2R9	0757-0283	6	2	RESISTOR 2K 1% .125W F TC=0+100	24546	CT4-1/8-TO-2001-F
A2S1	3101-2299	2	1	SWITCH-SLIDE DPDT STD 5A 250VAC SLDR LUG	28480	3101-2299
A2T1	9100-4129	5	1	TRANSFORMER-POWER 86/86V 48-60 HZ	28480	9100-4129
A2U1	1826-0544	0	1	IC V RGLTR V-REF FXD 2.5V 8-DIP C PKG	28480	1826-0544
A2U2	1826-0346	0	1	IC OP AMP GP DUAL 8-DIP-P PKG	27014	LM358N
A2XA4	0380-0906	1	2	STANDOFF RIVET-ON .1-IN-LG 6-32-THD	28480	0380-0906
A2XF1	2110-0269	0	4	FUSEHOLDER CLIP-TYPE .25D FUSE	28480	2110-0269
A2XF2	2110-0269	0	4	FUSEHOLDER CLIP-TYPE .25D-FUSE	28480	2110-0269

SEE INTRODUCTION TO THIS SECTION FOR ORDERING INFORMATION
*INDICATES FACTORY SELECTED VALUE

Table 6-2. Replaceable Parts (Continued)

Reference Designation	HP Part Number	C D	Qty	Description	Mfr Code	Mfr Part Number
OPTION 002 BATTERY WITH BUILT-IN CHARGER						
A3	05314-60003	4	1	BATTERY PACK BOARD ASSEMBLY (SERIES 2036)	28480	05314-60003
A3BT1	1420-0253	8	1	BATTERY 6V 5A-HR PB-ACID Q-DISC	041417	0800-0011
A3C1	0160-2055	9	2	CAPACITOR-FXD .01UF +80-20% 100VDC CER	28480	0160-2055
A3C2	0160-2055	9		CAPACITOR-FXD .01UF +80-20% 100VDC CER	28480	0160-2055
A3C3	0160-3879	7	1	CAPACITOR-FXD .01UF +20% 100VDC CER	28480	0160-23879
A3CR1	1901-0782	8	1	DIODE-SCHOTTKY 1N5821 30V 3A	04713	1N5821
A3CR2	1901-1080	1	1	DIODE-SCHOTTKY 20V 1A	04713	1N5817 (RELAXED)
A3CR3	1901-0040	1	5	DIODE-SWITCHING 30V 50MA 2NS DO-35	9N171	1N4148
A3CR4	1901-0040	1		DIODE-SWITCHING 30V 50MA 2NS DO-35	9N171	1N4148
A3CR5	1901-0040	1		DIODE-SWITCHING 30V 50MA 2NS DO-35	9N171	1N4148
A3CR6	1901-0040	1		DIODE-SWITCHING 30V 50MA 2NS DO-35	9N171	1N4148
A3CR7	1901-0460	9	1	DIODE-STABISTOR 30V 150MA DO-7	03508	STB523-A
A3CR8	1901-0040	1		DIODE-SWITCHING 30V 50MA 2NS DO-35	9N171	1N4148
A3F1	2110-0003	0	1	FUSE 3A 250V NTD 1.25X.25UL	75915	312003
A3H1	2200-0105	4	1	SCREW-MACH 4-40 .312-IN-LG PAN-HD POZI	00000	ORDER BY DESCRIPTION
A3H2	2260-0009	3	1	NUT-HEX W/LKWR 4-40 THD .094-THK	00000	ORDER BY DESCRIPTION
A3MP1	05314-00002	7	1	BRACKET, BATTERY K=0229N	28480	05314-00002
A3Q1	1853-0016	8	2	TRANSISTOR PNP SI TO-92 PD=300MW	28480	1853-0016
A3Q2	1853-0016	8		TRANSISTOR PNP SI TO-92 PD=300MW	28480	1853-0016
A3Q3	1853-0371	8	1	TRANSISTOR PNP SN6107 SI PD=1.8W	3L585	2N6107
A3Q4	1854-0477	7	1	TRANSISTOR NPN 2N2222A SI TO-18 PD=500MW	04713	2N2222A
A3R1	0757-0397	3	1	RESISTOR 68.1 1% .125W F TC=0+100	24546	CT4-1/8-TO-684R1-F
A3R2	0757-0442	9	2	RESISTOR 10K 1% .125W F TC=0+100	24546	CT4-1/8-TO-1002-F
A3R3	0757-0283	6	4	RESISTOR 2K 1% .125W F TC=0+100	24546	CT4-1/8-TO-2001-F
A3R4	0757-0283	6		RESISTOR 2K 1% .125W F TC=0+100	24546	CT4-1/8-TO-2001-F
A3R5	0698-3437	2	1	RESISTOR 133 1% .125W F TC=0+100	24546	CT4-1/8-TO-133R-F
A3R6	0757-0283	6		RESISTOR 2K 1% .125W F TC=0+100	24546	CT4-1/8-TO-2001-F
A3R7	0757-0283	6		RESISTOR 2K 1% .125W F TC=0+100	24546	CT4-1/8-TO-2001-F
A3R8	0757-0442	9		RESISTOR 10K 1% .125W F TC=0+100	24546	CT4-1/8-TO-1002-F
A3R9	0757-0441	8	1	RESISTOR 8.25K 1% .125W F TC=0+100	24546	CT4-1/8-TO-8251-F
A3R10	0757-0465	6	1	RESISTOR 100K 1% .125W F TC=0+100	24546	CT4-1/8-TO-1003-F
A3R11	0757-0439	4	1	RESISTOR 6.81K 1% .125W F TC=0+100	24546	CT4-1/8-TO-6811-F
A3R12	2100-0567	0	1	RESISTOR-TRMR 2K 10% C TOP-ADJ 1-TRN	28480	2100-0567
A3R13	0811-3290	7	1	RESISTOR .1 5% 2W PW TC=0+800	28480	0811-3290
A3RT1	0837-0159	5	1	THERMISTOR 33K-OHM TC=+.7%/C=DEG	01295	TM1/8 333K
A3U1	1826-0346	0	1	IC OP AMP GP DUAL 8-DIP-P PKG	27014	LM358N
A3W1	05315-60102	5	1	CABLE ASSEMBLY, POSITIVE LEAD	28480	05315-60102
A3W2	05315-60103	6	1	CABLE ASSEMBLY, NEGATIVE LEAD	28480	05315-60103
A3 MISCELLANEOUS PARTS						
A3XF1	1205-0350	0	1	HEAT SINK SGL PLASTIC-POWER CS	28480	1205-0350
	2110-0269	0	1	FUSEHOLDER-CLIP TYPE .25D-FUSE	28480	2110-0269
	1205-0350	0	1	HEATSINK PL POWER		
	1400-0249	0	1	CLIP-HDR-CABLE TIE		

SEE INTRODUCTION TO THIS SECTION FOR ORDERING INFORMATION
*INDICATES FACTORY SELECTED VALUE

Table 6-2. Replaceable Parts (Continued)

Reference Designation	HP Part Number	C D	Qty	Description	Mfr Code	Mfr Part Number
				OPTION 001 HIGH STABILITY TIMEBASE (TCXO)		
A4	05314-60004	5	1	TCXO BOARD ASSEMBLY		
A4C1	0160-4554	7	2	CAPACITOR-FXD .01UF +20% 50VDC CER	28480	0160-4554
A4C2	0160-4554	7		CAPACITOR-FXD .01UF +20% 50VDC CER	28480	0160-4554
A4R1	0757-0444	1	1	RESISTOR 12.1K 1% .125W F TC=0+100	24546	CT4-1/8-TO-1212-F
A4R2	0757-0441	8	1	RESISTOR 8.25K 1% .125W F TC=0+100	24546	CT4-1/8-TO-8251-F
ARR3	0698-3444	1	1	RESISTOR 316 1% .125W F TC=0+100	24546	CT4-1/8-TO-316R-F
A4R4	0757-0441	8		RESISTOR 8.25K 1% .125W F TC=0+100	24546	CT4-1/8-TO-8251-F
A4W1	05314-60102	4	1	CABLE, COAX	28480	05314-60102
A4Y1	0960-0612	6	1	CRYSTAL OSCILLATOR 10.0 MHZ; 0-55 DEG C	28480	0960-0612
				A4 MISCELLANEOUS PARTS		
	1400-0957	7	1	BRACKET-RTANG .475-LG X .183-LG .25-WD	28480	1400-0957

SEE INTRODUCTION TO THIS SECTION FOR ORDERING INFORMATION
*INDICATES FACTORY SELECTED VALUE

Table 6-2. Replaceable Parts (Continued)

Reference Designation	HP Part Number	C D	Qty	Description	Mfr Code	Mfr Part Number
CHASSIS AND MISCELLANEOUS PARTS						
A3BT1	1420-0253	8	1	BATTERY, 6V 5A-HR PB ACID QDISC (OPT 002)	28480	1420-0253
A3MP1	05314-00002	7	1	BRACKET-BATTERY (OPEION 002)		
A4H1	0380-0013	1	1	SPACER RND 1-IN-LG .18-IN-ID (OPT 001)	28480	0380-0013
A4H2	2360-0115	4	1	SCREW-MACH 6-32 .312-IN LG PAN-HD-POZI (OPT 001)	00000	ORDER BY DESCRIPTION
A4H3	2360-0219	9	1	SCREW-MACH 6-32 1.375-IN-LG PAN-HD-POZI (OPT 001)	00000	ORDER BY DESCRIPTION
MP1	4040-1126	3	1	SHELL, TOP	28480	4040-1126
MP2	4040-1463	1	1	SHELL, BOTTOM	28480	4040-1463
MP3	5040-8058	5	1	HANDLE	28480	5040-8058
MP4	5040-8044	9	4	SPACER	28480	5040-8044*
MP5	05314-40003	2	1	WINDOW, RED	28480	05314-40003
MP6	05314-00001	6	1	PANEL, FRONT	28480	05314-00001
MP7	5040-7223	4	2	FOOT	28480	5040-7223
MISCELLANEOUS PARTS						
	0370-1005	2	2	KNOB-BASE PTR 3/8 JGK .125-IN-ID	28480	0370-1005
	3050-0020	4	2	WASHER FL NM 5/16-IN .375-IN-ID	00000	ORDER BY DESCRIPTION
	7120-4369	5	1	LABEL, WARNING - FUSE	28480	7120-4369
	7120-4835	0	1	LABEL, CANADIAN STDS ASSOC.	28480	7120-4369
	7120-5370	0	1	LABEL, HANDLE	28480	7120-5370
	7121-0270	1	1	LABEL, VDE	28480	7121-0270
	8120-1378	1	1	CABLE, POWER	28480	8120-1378

SEE INTRODUCTION TO THIS SECTION FOR ORDERING INFORMATION
*INDICATES FACTORY SELECTED VALUE

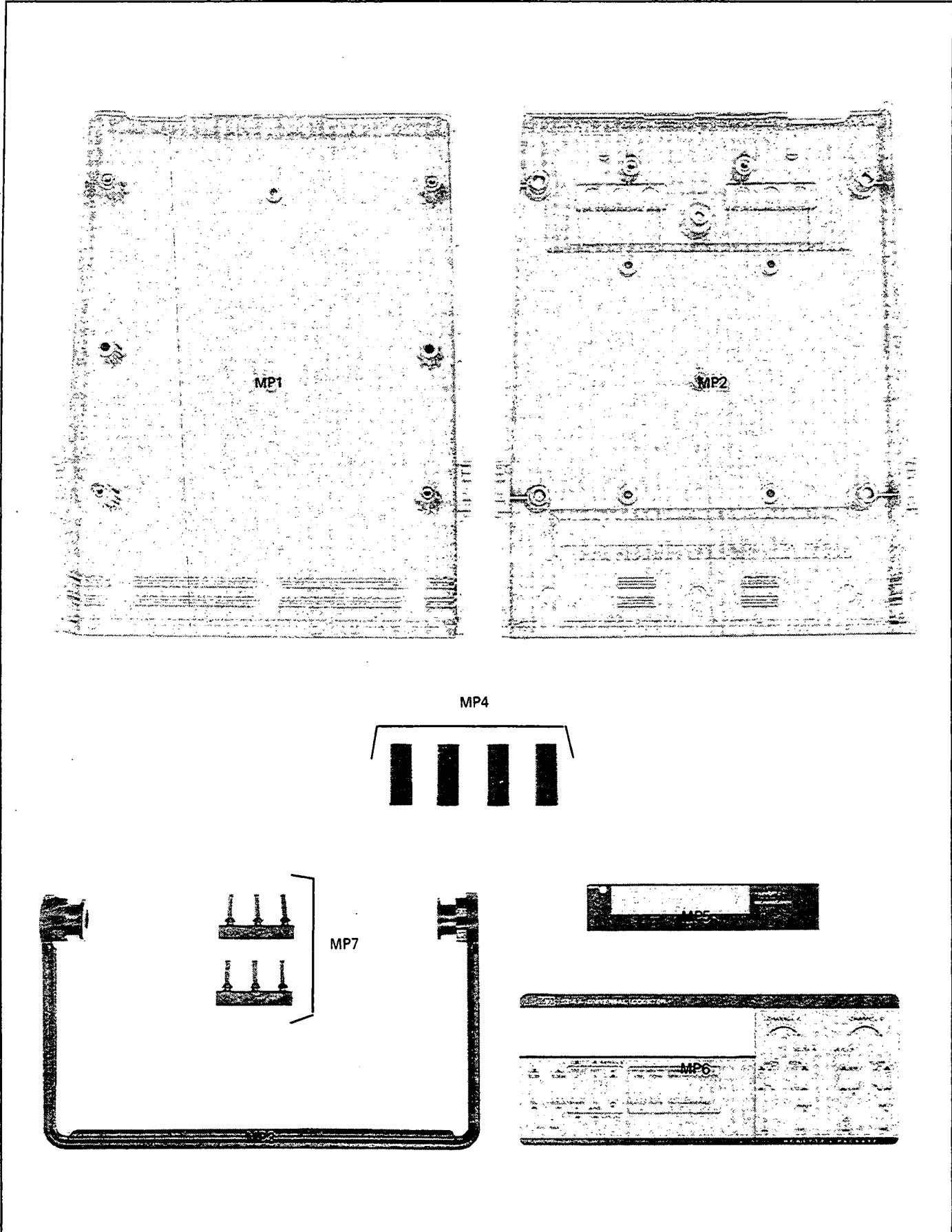

Figure 6-1. Mechanical Parts Layout

Table 6-3. Manufacturers Code List

MFR CODE	MANUFACTURER NAME	ADDRESS			ZIP CODE
D2540	VALVO GMBH	HAMBURG		GM	2000
00000	ANY SATISFACTORY SUPPLIER	EL PASO	TX	US	80035
01295	TEXAS INSTRUMENTS	DALLAS	TX	US	79935
01417	CHRYSLER CORP DEFENSE OPN DIV	DETROIT	MI	US	48203
03508	GE CO SEMICONDUCTOR PROD DEPT	AUBURN	NY	US	13201
04713	MOTOROLA INC SEMI-COND PROD	PHOENIX	AZ	US	85008
11236	CTS CORP BERNE DIV	BERNE	IN	US	46711
14433	ITT SEMICONDUCTORS DIV	TUSTIN	CA	US	92680
24546	CORNING ELECTRONICS	SANTA CLARA	CA	US	95050
27014	NATIONAL SEMICONDUCTOR CORP	SANTA CLARA	CA	US	95052
28480	HEWLETT-PACKARD CO CORPORATE HQ	PALO ALTO	CA	US	94304
3L585	RCA CORP SOLID STATE DIV	SOMERVILLE	NJ	US	08876
32293	INTERSIL INC	CUPERTINO	CA	US	95014
51642	CENTRE ENGINEERING INC	STATE COLLEGE	PA	US	16801
56289	SPRAGUE ELECTRIC CO	NORTH ADAMS	MA	US	01247
75915	LITTLEFUSE INCORPORATED	DES PLAINES	IL	US	60016
9N171	UNITRODE CORPORATION	LEXINGTON	MA	US	02173

SECTION VII MANUAL CHANGES

7-1. INTRODUCTION

7-2. This section contains information for adapting this manual to instruments with serial prefixes other than that listed on the title page. Refer to Section 1 for additional important information about serial number coverage.

7-3. MANUAL CHANGES

7-4. Newer Instruments

7-5. Instruments having serial number prefixes higher than those listed on the title page of this manual are covered with a "Manual Changes" sheet included with this manual. If this change sheet is missing the information can be supplied by any Hewlett-Packard Sales and Service Office listed at the back of this manual.

7-6. Older Instruments

7-7. If your instrument's serial number prefix is lower than that listed in this manual, this manual must be modified to correctly apply to your instrument. To determine which changes must be made to this manual, locate your instrument's serial number prefix in *Table 7-1 Manual Backdating*, then make the indicated changes.

Table 7-1. Manual Backdating

IF YOUR HP 5314A HAS SERIAL PREFIX	THEN MAKE THE FOLLOWING CHANGES TO THIS MANUAL
2714A	1
2604A	2
2538A & Instrument Serial Numbers 2536A12971 & above	3
2536A	1, through 4
2036A & Instrument Serial # 2036A07961 & above	1 through 5
2036A & Instrument Serial Numbers 2036A07721 & above	1 through 6
2032A	1 through 7
2024A	1 through 8
2016A	1 through 9
1908A	1 through 10
Instrument Serial Numbers 1884A00701 through 1884A00900	1 through 11
1884A	1 through 12
1836A	1 through 13
1828A	1 through 14
1816A	1 through 15

CHANGE 1 Series 2714A

Section 6, Table 6-2. A1 Main Board Assembly Replaceable Parts:

Change A1C31 - C33 from 0160-4822 (1000PF) to 0160-4040 CAPACITOR-FXD 1000PF ±5% 100VDC CER.

Delete A1MP7, CONNECTOR-SINGLE CONT.

Delete A1MP4 through MP6, TUBING-FLEX.

CHANGE 2 Series 2604A

Page 6-4/6-6, Table 6-2. A1 Main Board Assembly Replaceable Parts

Change A1C31 – C33 from 0160-4040 (1000PF) to 0160-4822 CAPACITOR-FXD 1000PF ±5% 100VDC CER, 28480, 0160-4822.

Add A1MP4 – MP6, 0890-0324, Qty 3, TUBING-FLEX .032-ID TFT .012-WALL, 28480, 0160-4822.

Add A1MP7, 1251-4707, Qty 1, CONNECTOR-SGL CONT PIN .031-IN-BSC-SZ, 28480, 1251-4707.

CHANGE 3 Series 2538A

Page 6-7. Table 6-2. A4 Option 001 TCXO Board Replaceable Parts.

Delete resistor A4R3.

Page 8-27. Figure 8-10. A3 Battery Charger Assembly, Option 002 A4 TCXO Assy, Option 004.

Delete A4R3.

Replace A4 component locator with the component locator shown in Figure 7-5.

CHANGE 4 Series 2536A & Instrument Serial Numbers 2536A12971 and Above

Page 6-4. Table 6-2. A1 Main Board Assembly Replaceable Parts

Change A1 (05314-60008) series to 2536A.

Delete A1C31 – C33.

Delete MP4 – MP7.

Page 8-23. Figure 8-8. A1 Counter Assembly Schematic Diagram

Change A1 (05314-60008) Schematic Diagram to series 2536A.

Delete C31 – C33.

Change C1 – C33 to C1 – C28 on Reference Designations Table.

CHANGE 5 Series 2036A and Instrument Serial Numbers 2036A07961 and Above

Page 6-4. Table 6-2. A1 Main Board Assembly Replaceable Parts.

Change A1Q8 and A1Q10 to 1853-0015, TRANSISTOR PNP.

Change A1U4 to 1820-1211, IC TTL EXCLUSIVE OR, QUAD 2-INPUT.

Page 8-24. Part of Figure 8-9. A2 Power Supply Assembly Component Locator.

Replace the component locator with the one shown in Figure 7-4.

CHANGE 6 Series 2036A and Instrument Serial Numbers 2036A07721 and Above

Page 6-7. Table 6-2. A4 Option 001 TCXO Board Replaceable Parts
Change A4 (05314-60004) to series 2032A.
Change A4C1 to 0160-2055, .01 uF.
Delete A4C2, A4R1, A4R2.

Page 8-27. Figure 8-10. Option 001 A4 TCXO Assembly
Delete C2,, R1, R2.

CHANGE 7 Series 2032A

Page 6-4. Table 6-2. A1 Main Board Assembly Replaceable Parts
Change A1 (05314-60005) series to 2032A.
Change A1DS8 to 1990-0486 Yellow LED.
Change A1DS1 through A1DS7 to 1990-0658 Yellow LED.
Delete XU4, 14 pin Socket.

Page 6-6. Table 6-2. A2 Power Supply Board Replaceable Parts
Change A2U1 to 1826-0467.

CHANGE 8 Series 2024A

Page 6-6. Table 6-2. Option 002 A3 Battery Pack Board Assembly Replaceable Parts
Change A3 (05314-60003) Series to 2024A.
Delete A3C3.

Page 6-7. Table 6-2. Option 001 TCXO A4 Board Assembly Replaceable Parts
Change A4 (05314-60004) Series to 2024A.
Change A4Y1 to 0960-0394.

Page 8-27. Figure 8-10. A3 Battery Charger Assembly Option 002
Change A3 (05314-60003) Series to 2024A.
Delete C3.
Change A4 (05314-60004) Series to 2024A.

CHANGE 9 Series 2016A

Page 6-4. Table 6-2. A1 Main Board Assembly Replaceable Parts
Change A1 (05314-60005) to Series 2016A.
Change A1C10 to 0180-0210, 3.3 uF.
Delete asterisk from A1R20.

Page 8-23. Figure 8-8. A1 Counter Assembly Schematic
Change A1 (05314-60005) to Series to 2016A.
Change C10 to 3.3 uF.
Delete asterisk from R20.

CHANGE 10 Series 1908A

Page 6-7. Table 6-2. Option 001 TCXO A4 Board Replaceable Parts
Change A4 (05314-60004) to Series 1908A.
Delete A4R1.
Page 8-27. Figure 8-10. Option 001. TCXO A4 Assembly
Change A4 (05314-60004) Series to 1908A.
Delete R1.

CHANGE 11 Instrument Serial Numbers 1884A00710 through 1884A00900

Page 6-6. Table 6-2. Option 002 A3 Battery Pack Board Replaceable Parts
Change A3CR1 to 1901-0676.

CHANGE 12 Series 1884A

Page 6-4. Table 6-2. A1 Main Board Assembly Replaceable Parts
Change A1 (05314-60005) to Series 1884A.
Delete A1R42.
Page 8-23. Figure 8-8. A1 Counter Assembly Schematic Diagram
Change A1 (05314-60005) to Series 1844A.
Delete R42.

CHANGE 13 Series 1836A

Page 6-4. Table 6-2. A1 Main Board Assembly Replaceable Parts
Change A1 (05314-60005) to Series 1836A.
Change A1R29 and A1R38 to 2100-3471.

CHANGE 14 Series 1828A

Page 6-4. Table 6-2. A1 Main Board Assembly Replaceable Parts
Change A1(05314-60005) to Series 1828A.
Add A1CR4,1901-0040.
Change A1R1 to 2k ohms, 0757-0283
Page 6-5. Table 6-2. A2 Power Supply Board Replaceable Parts
Change A2 (05314-60006) to 05314-60002 Series 1828A.
Change A2T1 to 9100-4103.
Page 8-23. Figure 8-8. A1 Counter Assembly Schematic Diagram
Change A1 (05314-60005) to Series 1828A.
Change R1 to 2k ohms.
Add A1CR4 between U2 pin 1 and U2 pin 30.
Page 8-24. Part of Figure 8-9. A2 Power Supply Assembly Component Locator.
Replace the component locator with the one shown in Figure 7-3.

Page 8-25. Figure 8-9. A2 Power Supply Schematic Diagram
Change A2 (05314-60006) to 05314-60001 Series 1828A.
Change A2T1 pin 7 to pin 8, pin8 to pin 7, and pin 9 to pin 8
Add pin 6 to grounded center tap on A2T1 secondary adjacent to polarity dot.

CHANGE 15 Series 1816A

Page 6-4. Table 6-2. A1 Main Board Assembly Replaceable Parts
Change A1 (05314-60005) to 05314-60001 Series 1816A.

Page 6-7. Table 6-2. Miscellaneous Parts
Change MP5 to 05314-60001.

Page 8-22. Figure 8-8. A1 Schematic Diagram
Replace A1 component locator with the one shown in Figure 7-1.

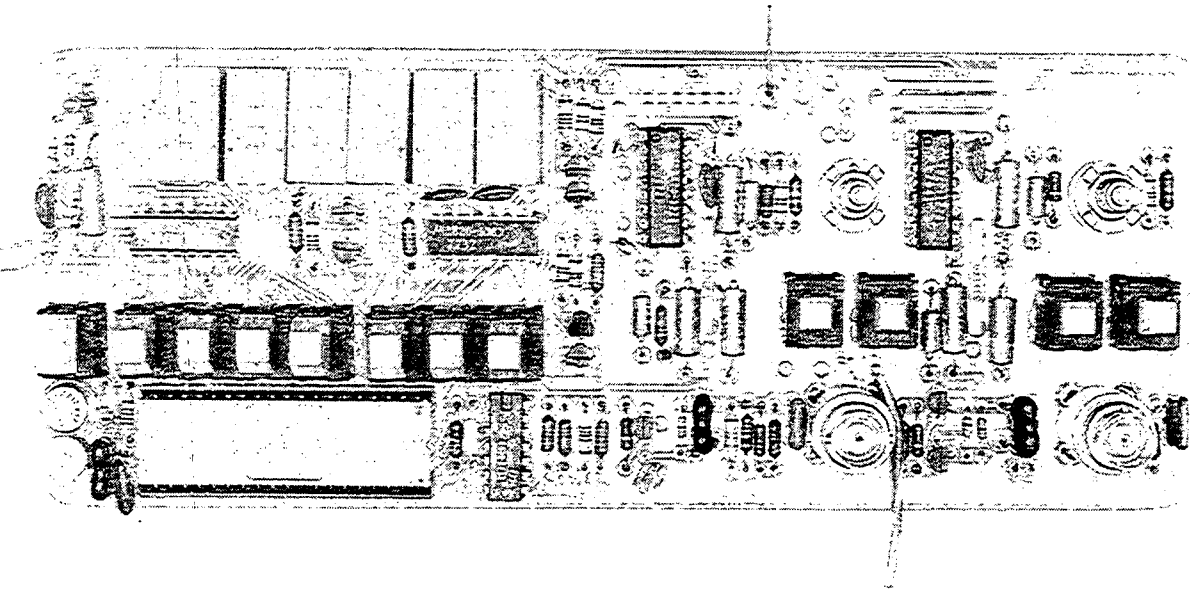

Figure 7-1. A1 Component Locator Series 1816A

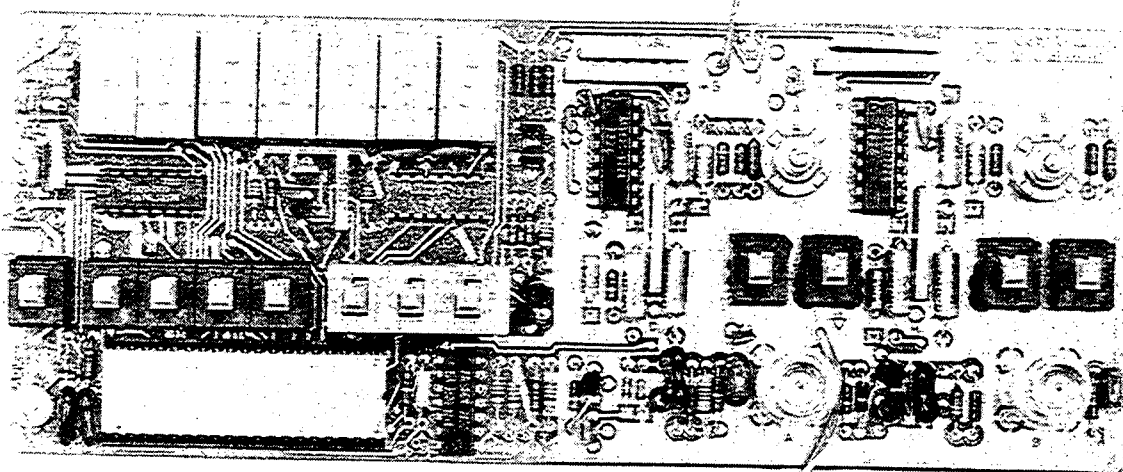

Figure 7-2. A1 Assembly Component Locator Series 1828A

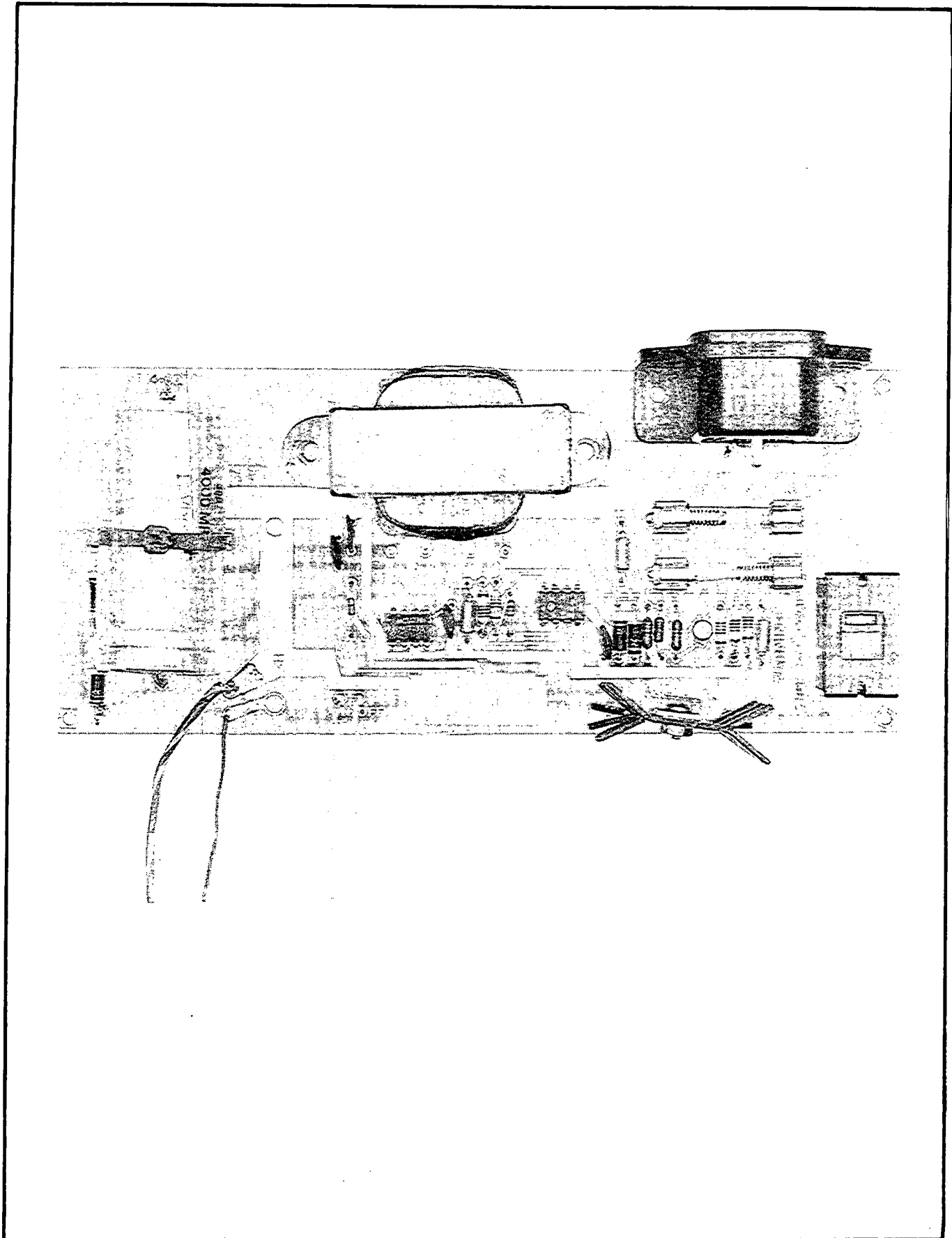

Figure 7-3. A2 Power Supply Assembly Component Locator Series 1828A

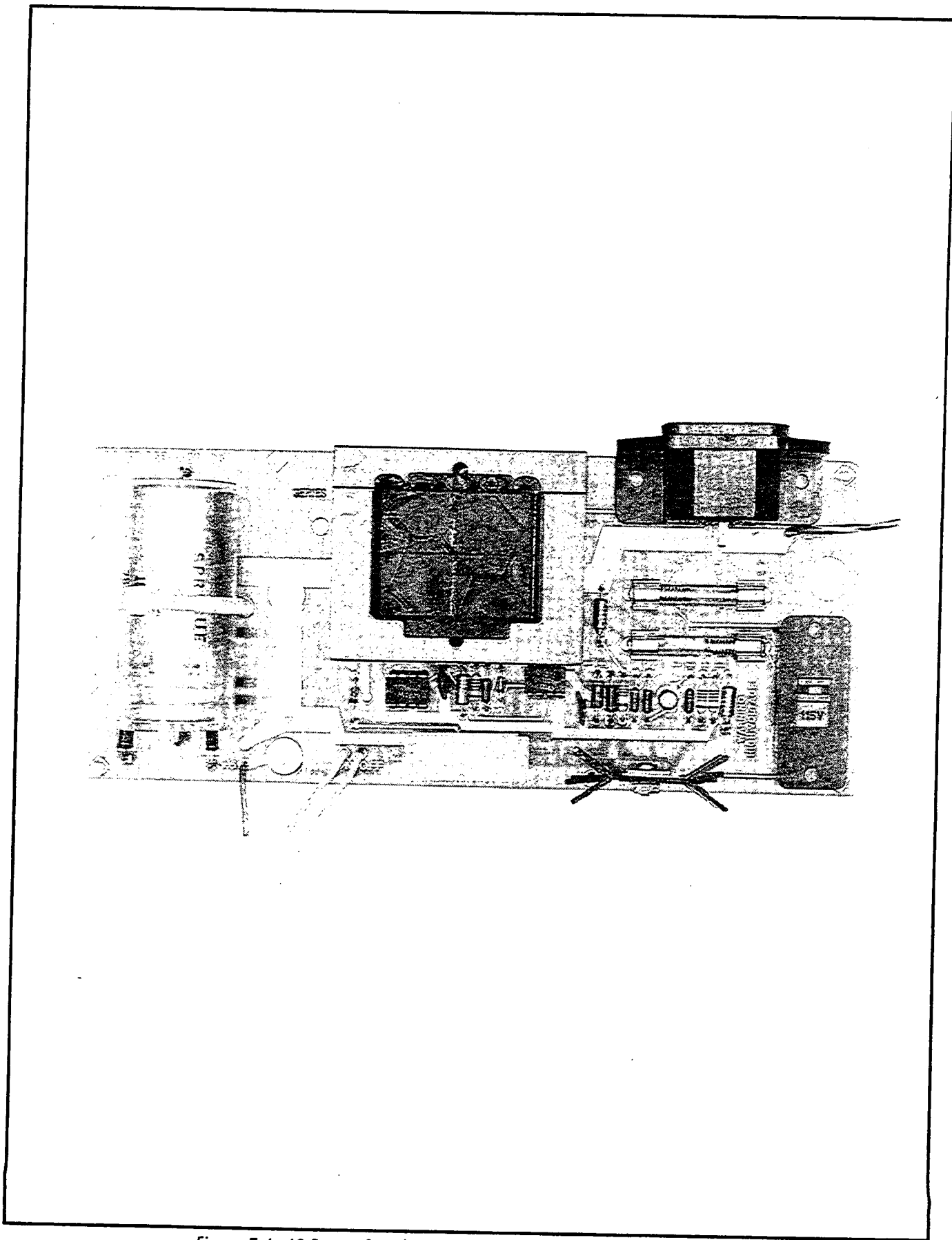

Figure 7-4. A2 Power Supply Assembly Component Locator Series 1836A

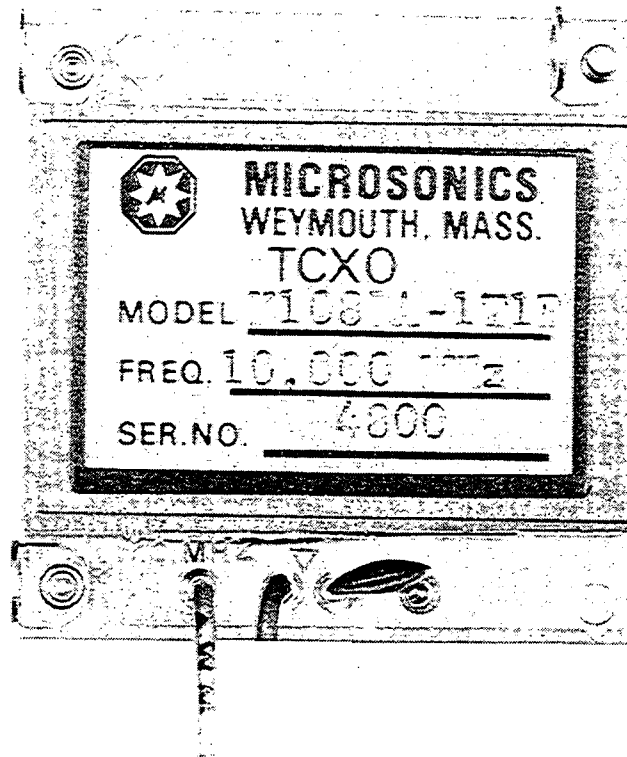

Figure 7-5. A4 TCXO Assembly Component Locator Series 1828A

SECTION VIII SERVICE

WARNING

LINE VOLTAGE IS EXPOSED WITHIN THE HP 5314A EVEN WHEN THE POWER SWITCH IS IN THE STBY POSITION. REMOVAL OF THE POWER CORD IS REQUIRED TO FULLY UNPOWER THE INSTRUMENT.

8-1. INTRODUCTION

8-2. This section contains information needed to service the HP Model 5314A. The information includes: theory of operation, troubleshooting, recommended test equipment, schematic diagram notes, safety considerations, fuse replacement, block diagram theory, detailed circuit theory, service aids, block diagrams, component locators, and schematic diagrams.

8-3. THEORY OF OPERATION

8-4. There are two theys of operation. The first is a block theory. That is, an overview of the HP 5314A is presented. The block theory is assembled to follow the block diagrams in *Figures 8-2 through 8-5*. The second is a detailed theory. It describes in detail, the circuit operation of all assemblies, both standard and optional. All reference is made to the schematic diagrams in *Figures 8-8 through 8-10*.

8-5. TROUBLESHOOTING

8-6. Troubleshooting for the HP 5314A is performed by selectively isolating and verifying the proper operation of the various circuit sections. This is accomplished in an indicated sequence, through a series of five test procedures, keyed to the troubleshooting block diagram in *Figure 8-6*.

8-7. RECOMMENDED TEST EQUIPMENT

8-8. Test equipment and test equipment accessories required to maintain the HP 5314A are listed in *Table 1-3*. Equipment other than that listed may be used if it meets the listed critical specifications.

8-9. SCHEMATIC DIAGRAM NOTES

8-10. *Figure 8-1* shows the symbols used on the schematic diagrams. *Figure 8-1* also shows the method of assigning reference designators, assembly numbers, and subassembly numbers.

8-11. Reference Designations

8-12. Assemblies such as printed circuit boards are assigned numbers in sequence, A1, A2, etc., as shown in *Table 8-1*. As shown in *Figure 8-1*, subassemblies within an assembly are given a subordinate A number. For example, rectifier subassembly A1, has the complete designator A25A1. For individual components, the complete designator is determined by adding the assembly number and subassembly number, if any. For example, CR1 on the rectifier assembly is designated A25A1CR1.

Table 8-1. Assembly Designations

Reference Designations	Description	HP Part Number
A1	Counter Assembly	05314-60008
A2	Power Supply Assembly	05314-60006
A3	Battery Charger Assembly (Option 002)	05314-60003
A4	TCXO Assembly (Option 001)	05314-60004

8-13. Identification Markings on Printed Circuit Boards

8-14. HP printed circuit boards (see *Figure 8-1*) have four identification numbers; an assembly part number, a series number, a revision letter, and a production code. The assembly part number has 10 digits (such as 05314-60005) and is the primary identification. All assemblies with the same part number are interchangeable. When a production change is made on an assembly that makes it incompatible with previous assemblies, a change in part number is required. The series number (such as 1828A) is used to document minor electrical changes. As changes are made, the series number is incremented. When replacement boards are ordered, you may receive a replacement with a different series number. If there is a difference between the series number marked on the board and the schematic in this manual, a minor electrical difference exists. If the number on the printed circuit board is lower than that on the schematic, refer to Section VII for backdating information. If it is higher, refer to the yellow looseleaf manual change sheets for this manual. If the manual change sheets are missing, contact your local HP Sales and Service Office. See the listing on the back cover of this manual.

8-15. Revision letters (A, B, etc.) denote changes in printed circuit layout. For example, if a capacitor type is changed (electrical value may remain the same) and requires different spacing for its leads, the printed circuit board layout is changed and the revision letter is incremented to the next letter. When a revision letter changes, the series number is also usually changed. The production code is the four-digit, seven-segment number used for production purposes.

8-16. SAFETY CONSIDERATIONS

8-17. Although the HP 5314A has been designed in accordance with international safety standards, this manual contains information, cautions, and warnings which must be followed to insure safe operation and to retain the HP 5314A in safe operating condition (also see Sections II, III, V). Service and adjustments should be performed only by qualified service personnel.

WARNING

ANY INTERRUPTION OF THE PROTECTIVE (GROUNDING) CONDUCTOR (INSIDE OR OUTSIDE THE UNIT) OR DISCONNECTION OF THE PROTECTIVE EARTH TERMINAL IS LIKELY TO MAKE THE UNIT DANGEROUS.

8-18. Any adjustment, maintenance, and repair of the opened HP 5314A under voltage should be avoided as much as possible, and when inevitable, should be carried out only by a skilled person who is aware of the hazard involved. Capacitors inside the HP 5314A may still be charged even if the unit has been disconnected from its source of power.

WARNING

LINE VOLTAGE IS EXPOSED WITHIN THE HP 5314A EVEN WHEN THE POWER SWITCH IS IN STBY. REMOVAL OF THE POWER CORD IS NECESSARY TO FULLY UNPOWER THE UNIT.

8-19. Make sure that only fuses with the required rated current and of the specified type (normal blow, time delay, etc.) are used for replacement. The use of repaired fuses and the short-circuiting of fuseholders must be avoided. Whenever it is likely that this protection has been impaired, the HP 5314A must be made inoperative and be secured against any unintended operation.

8-20. FUSE REPLACEMENT

8-21. There are two fuses in the standard HP 5314A. These are the line input fuses located on the A2 power supply assembly. There is an additional third fuse in the HP 5314A with Option 002. This fuse is located on the Option 002 A3 assembly. Instructions for changing these three fuses are given in the following paragraphs.

8-22. Line Input Fuse Replacement

CAUTION

Make sure that only fuses with the required rate current and of the fast-blow type are used for replacement. The use of repaired fuses and the short-circuiting of fuse holders must be avoided.

8-23. The following instructions are given for line fuse replacement:

1. Turn the HP 5314A OFF and remove the line input power cord.
2. Turn the HP 5314A upside down and remove the four screws near the corners of the cabinet bottom.
3. Holding the top and bottom covers together, turn the HP 5314A right-side up and carefully lift the top cover. This exposes the two line input fuses located on the A2 assembly (assembly in the rear of the instrument).
4. Remove and replace the defective fuse with a 0.06 Amp fast-blow type fuse.
5. Replace the top cover and carefully turn the unit upside down. Replace and tighten the four screws, one in each corner of the cabinet bottom.

8-24. Option 002 Fuse Replacement

8-25. HP 5314A instruments with Option 002 contain a 3 Amp fuse in addition to the two line input fuses. This fuse is located on the Option 002 A3 assembly. This fuse protects the battery pack from damage in case of a possible short-circuit. The following instructions are given for Option 002 fuse replacement:

1. Turn the HP 5314A OFF and remove the line input power cord.
2. Turn the HP 5314A upside down and remove the four screws from the cabinet bottom.
3. Holding the top and bottom covers together, turn the HP 5314A right-side up and carefully lift the top cover. This exposes the Option 002 A3 assembly.
4. Remove and replace the defective fuse with a 3 Amp fast-blow type fuse.
5. Replace the top cover and carefully turn the unit upside down. Replace and tighten the four screws, one in each corner of the cabinet bottom.

SYMBOLS

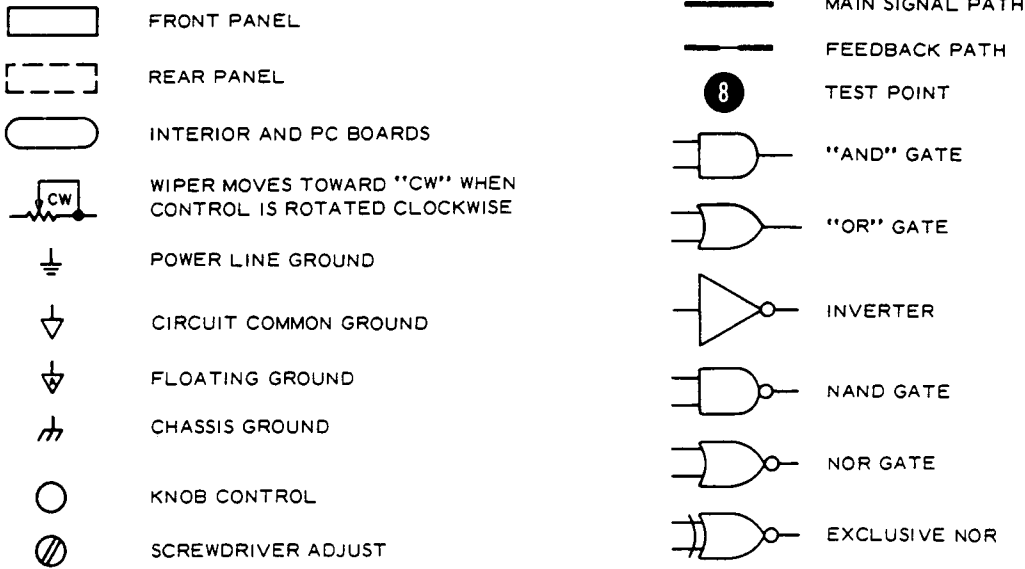

PRINTED CIRCUIT BOARD IDENTIFICATION

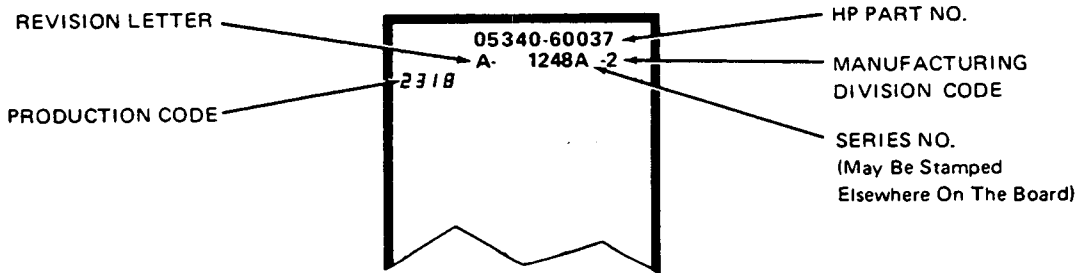

REFERENCE DESIGNATIONS

REFERENCE DESIGNATIONS WITHIN ASSEMBLIES ARE ABBREVIATED. ADD ASSEMBLY NUMBER TO ABBREVIATION FOR COMPLETE DESCRIPTION. JACKS ARE THE STATIONARY CONNECTORS AND PLUGS ARE THE MORE MOVEABLE OF TWO CONNECTORS.

<u>ASSEMBLY</u>	<u>ABBREVIATION</u>	<u>COMPLETE DESCRIPTION</u>
A25	C1	A25C1
A25A1	CR1	A25A1CR1
NO PREFIX	J3	J3

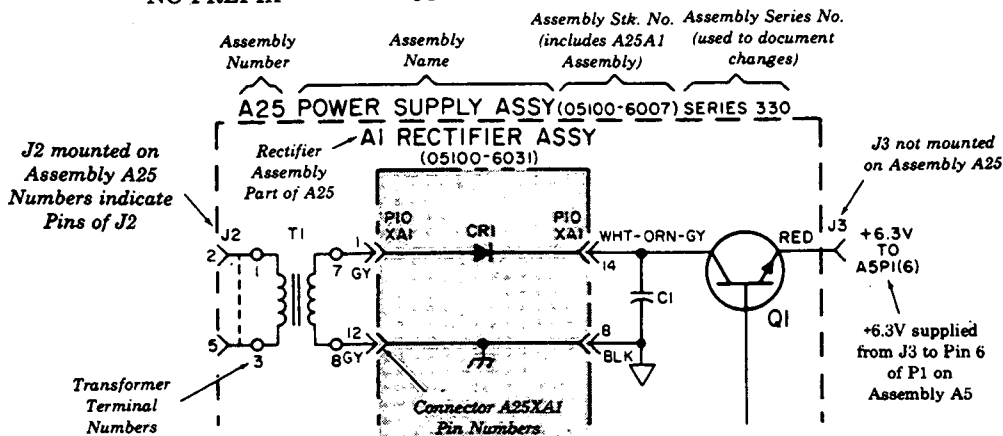

Figure 8-1. Schematic Diagram Notes

8-26. THEORY OF OPERATION

8-27. Introduction

8-28. The HP 5314A is a multifunction counter using a single LSI integrated circuit. The theory of operation is organized such that a block diagram is shown along with the block theory, immediately followed by the detailed theory. The block theory is structured to follow the block diagram. The detailed theory is referenced to the schematic diagrams found at the end of this section. There are four block diagrams, shown in *Figure 8-2* through *8-5*, as follows:

1. The HP 5314A overall block diagram.
2. The LSI counter chip (A1U2).
3. The power supply.
4. The optional battery pack charger.

8-29. HP 5314A Overall Block Theory of Operation

8-30. The A and B input amplifiers condition the measured input signals and insure the subsequent digital circuits receive pulses of uniform rise and fall time. The signal on Channel B is applied directly to the counter IC. Channel A is similar to Channel B except a signal path through a $\div 10$ prescaler is also provided. The output of the counter drives the display through segment and digit drive lines. The digit drive lines are also used in conjunction with the front panel switches to select the proper function, range, and decimal point location. The power supply delivers +5 volts to the circuits and provides unregulated voltage to the battery charger connector for use with Option 002.

8-31. Detailed A1 Assembly Theory

8-32. INPUT AMPLIFIERS. The signal is applied through a BNC input connector (J1) through coupling capacitor C19. The compensated attenuator is made of R27, R25, and C18, and allows selection of X1 or X20 through the use of switch SW10. The network made up of R22, R23, C16, and diodes CR7 and CR6 make up the protection circuitry. The high input impedance is accomplished by the impedance converter made up of Q7 and Q8, and their associated biasing resistors. The signal is now amplified to an acceptable level by the first two stages of U5. The first stage provides a trigger level adjustment by allowing the reference level input to be shifted by approximately ± 400 mV using R29. The second stage of U5 provides some peaking at high frequencies to compensate for the roll off at the input impedance converter. The final stage of U5 is a Schmitt trigger which takes the amplified analog signal and digitizes it. The signal out of the impedance converter of Channel A goes to the amplifier U5, and can be switched into Channel B by using SW11 the SEP/COM A (separate/common A) switch.

8-33. Channel B is similar to Channel A with a few exceptions. A signal applied to Channel B is supplied with no attenuation through the protection circuitry made of R36, R35, C26, CR9, and CR8. The impedance converter is made up of Q9 and Q10 and their associated bias resistors. The Channel B signal is then amplified by the 3 stages of U6. The first stage provides an adjustable trigger level by setting R38. The second stage, rather than being peaked, is rolled off above 10 MHz as the Channel B is usable only to 2.5 MHz. The last stage is the Schmitt trigger without the high frequency compensation. The digital signal out of the Schmitt trigger must be translated to be compatible with TTL circuitry which follows. This is done by Q4 and Q3. The slope selection is done by U4C in conjunction with switch SW12. The Channel B signal is then applied to U2.

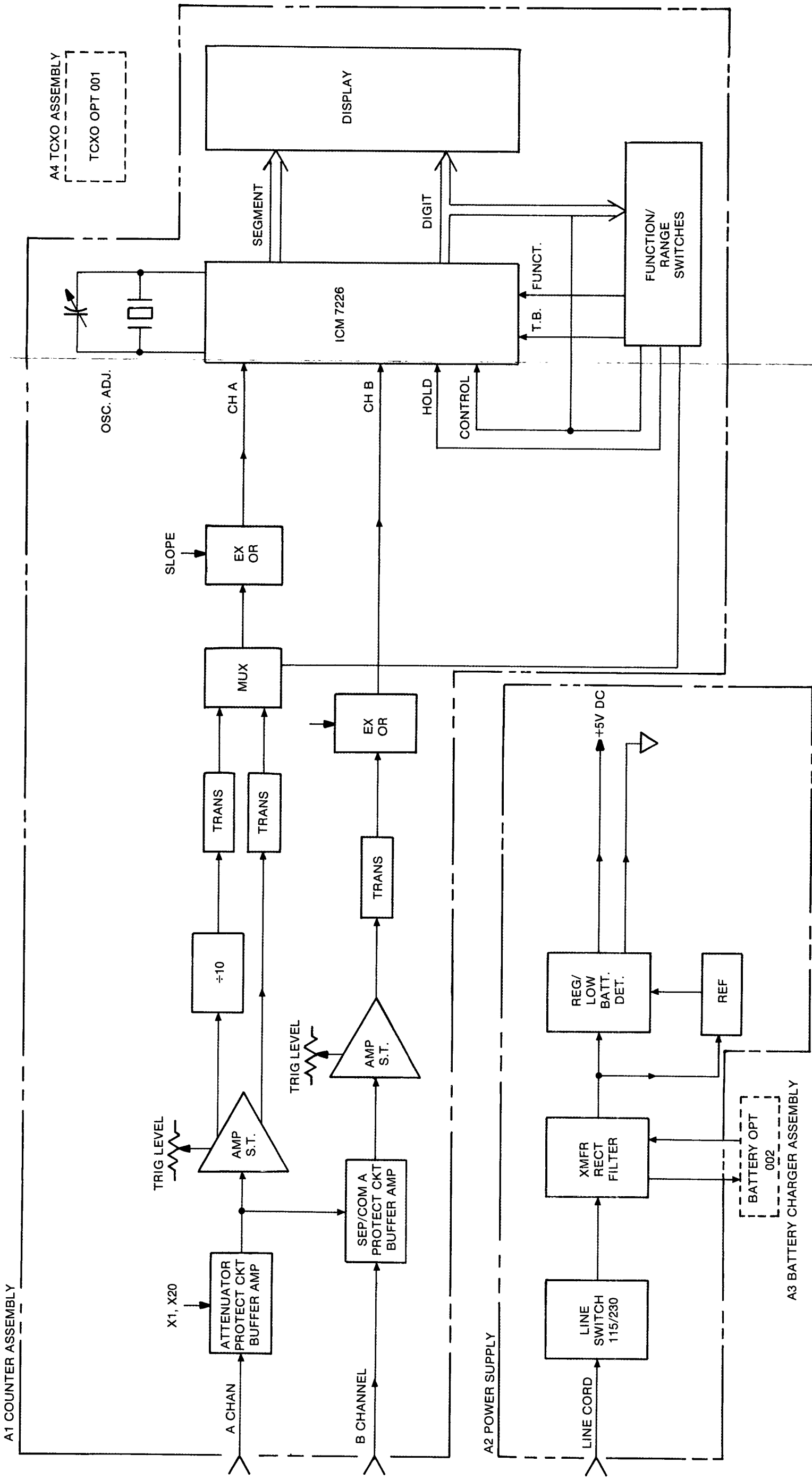

Figure 8-2. HP 5314A Overall Block Diagram

8-34. CHANNEL A PRESCALE SELECT CIRCUIT. The output of the Channel A amplifier goes to the input of U2 by taking one of two paths selected by the front panel switches. The first path is through the level translator Q5 and Q6. The multiplexer (U1C) selects the input on pin 13. The slope selection is made in U4 in conjunction with switch SW9. The signal is then applied to U2.

8-35. This is the normal signal path for most functions. When frequency A is selected and the 100 MHz/10 Hz max frequency/resolution button is pushed, then the multiplexer (U1) directs the signal on pin 14 through the slope select logic and on to U2. This signal has come from amplifier U5 through a ÷10 prescale decade and a level translator Q1 and Q2. Therefore any time the FREQ A button is pushed in conjunction with the 100 MHz/10 MHz button, the prescaler will be switched. The other sections of the U1 multiplexer provides proper location of the decimal point when in the prescale mode.

8-36. LSI COUNTER CHIP. Integrated circuit A1U2 provides the circuitry to implement a full universal counter. The functions that can be performed are FREQUENCY, PERIOD, TIME INTERVAL, START A (TOTALIZE), RATIO A/B and CHECK. U2 also contains the logic to strobe the data into the display.

8-37. Function, Range, Control Inputs. In order to set the proper function and range, it is necessary to connect the proper digit drive line to the function or range input of U2. Since the digit drive lines are strobed consecutively starting from the most significant digit to the least significant digit, it is where the pulse occurs in time, which determines what function or range the instrument is in. As an example, connecting digit driver D0 to the function input causes U2 to be set up to measure frequency on Channel A. Connecting the same digit drive line to the range input sets the gate time to 0.01 seconds. A third input to U2 is called control and selects additional modes of operation. The operation of the function, range, and control inputs are shown in Table 8-2.

8-38. Display Strobe. The display consist of seven 7-segment common anode display digits with an overflow LED indicator. Each digit hs a decimal point with the most significant digit's decimal point used as a gate indicator.

8-39. In order to light a particular digit it is necessary to pull the anode of the digit high and sink current in the appropriate cathodes to light the desired number in that digit. Therefore, it is possible to tie all the corresponding segments (cathodes) together as the anode determines which digit is being addressed. U2 first addresses the most significant digit and strobes in the proper number, then the next MSD will be addressed and the proper number strobed in and so on. A complete display strobe cycle is executed in 2 milliseconds or at a 500 Hz rate. The overflow is driven from the eighth unused digit.

Table 8-2. Function/Range versus Digit Drive

Digit	Function	Range Gate Time/N	Control
D0	FREQUENCY	0.01 s/1	EXT OSC Enable
D1	RATIO A/B	0.1 s/10	1 MHz REF Select
D2	CHECK	1 s/100	EXT Decimal Pt. Enable
D3	START A	10 s/1000	BLANK Display
D4	TIME INTERVAL	EXT Range Input Enable	Test
D5	----	----	----
D6	----	----	----
D7	PERIOD	----	DISPLAY

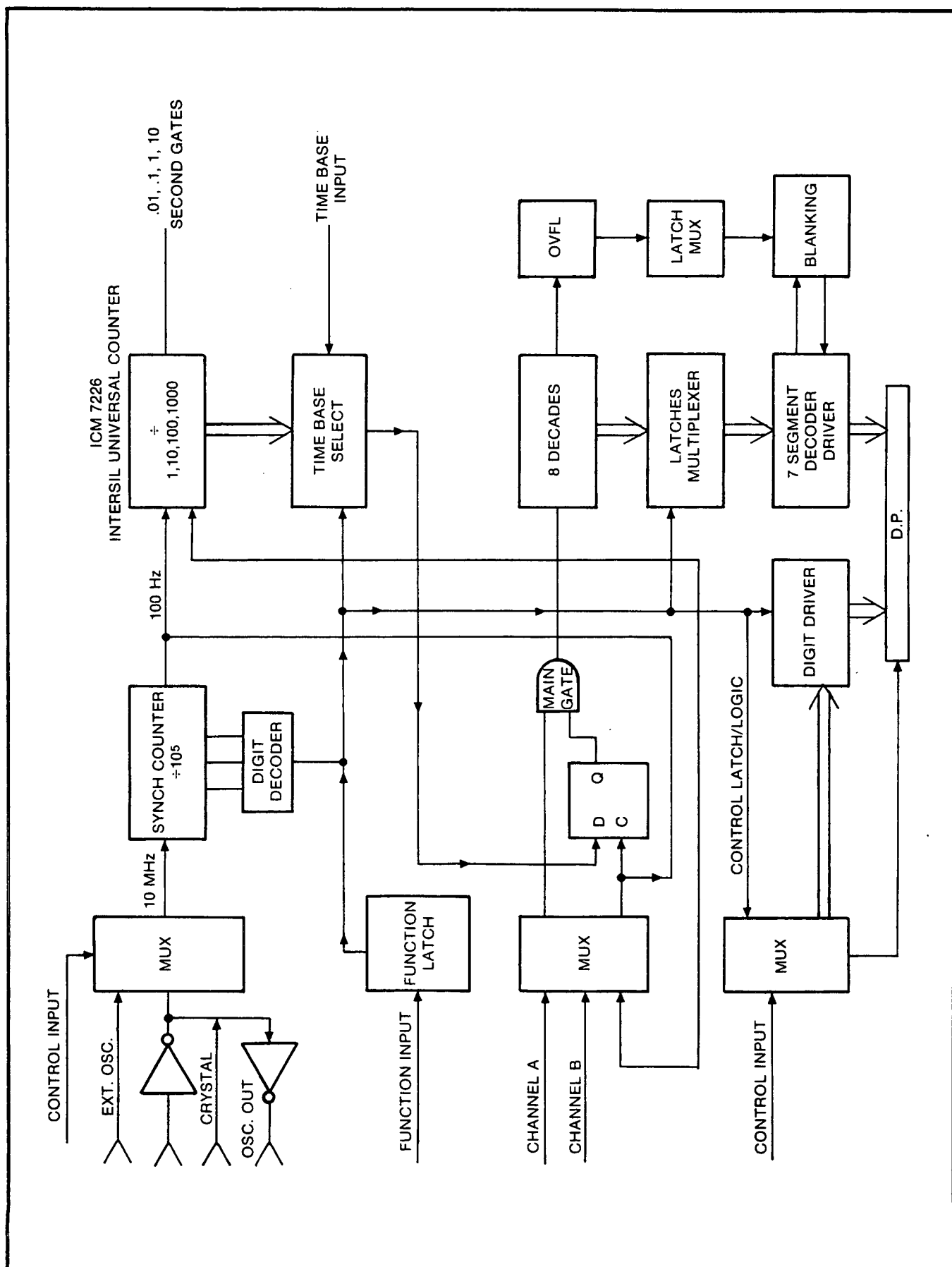

Figure 8-3. LSI Counter (A1U2) Block Diagram

8-40. **Decimal Point Control.** The circuitry in U2 determines the function, range, and control status and automatically positions the decimal point. The decimal point is strobed in exactly the same manner as the segments of the digits. When the prescaler decade is switched in, by selecting **FREQ A** and 100 MHz/10 Hz max. frequency/resolution, it is necessary to move the decimal point one-digit to the right. This is done by connecting digit D2 (EXT decimal point enable) to the control input through multiplexer U1. This allows pin 20 (EXT decimal point input) to be used to strobe the decimal point into the proper position.

8-41. **REFERENCE OSCILLATOR.** The oscillator is made up of the 10 MHz crystal Y1 and the trimmer capacitors C2, C4, and C5, and bias resistor R6. The active elements are internal to U2. The buffered oscillator is brought out on pin 38 and is connected to the EXT OSC input on pin 33. It is therefore necessary to program the control input to the EXT oscillator input mode by connecting D0 to the control input. This is done through isolation diode CR4. If the temperature compensated crystal oscillator is used, the jumper between pins 33 and 38 is removed and the TCXO output is connected between ground and pin 33, EXT OSC input.

8-42. **GATE LAMP.** The gate lamp is used to give an indication that the counter is in the process of making a measurement. The gate lamp is on whenever the gate is open and the counting decades are accumulating pulses. When making measurements where the gate is only open for a short time such as time interval or single-shot period measurements, the gate signal is not on long enough to light the gate indicator. Therefore, the reset pulse is also connected to the gate indicator to provide an indication that measurements are being made. The reset pulse occurs about 140 milliseconds after the measurement is over.

8-43. **POWER, HOLD, FUNCTION, AND RANGE SWITCHES.** Switch SW1 connects unregulated voltage from the power supply board back to the regulator on the power supply board. Switch SW2 in the normal (NORM) position applies ground to the hold input pin 39 of U2. When SW2 is depressed, a positive voltage generated by CR3 and C1 is applied to the hold input. This terminates any measurement in progress and holds the previous reading in the display. Upon releasing the hold button, a new measurement will begin. Switches SW3, 4, and 5 connect the proper digit drive lines to the function input. Switch SW5 acts like a shift key allowing switches SW3 and SW4 to select two functions. When both SW3 and SW4 are in or out the functions CHECK or RATIO A/B are respectively selected. In this situation the shift key SW5 has no affect.

8-44. Switches SW6, 7, and 8 select the proper digit drive line to be connected to the range input. SW8 provides the special function of connecting ground to U3 ($\div 10$ prescaler) only when SW3 is also in. This same line is also applied to the multiplexers as the control signal. Switches SW6, 7, and 8 are connected to provide more range positions than those shown on the front panel. The useful switch positions are shown below in *Table 8-3*.

Table 8-3. Useful Resolution Switch Positions (Shaded buttons indicate button IN)

Switch Position			Prescale	Freq Gate Time	Freq. Res.	No. of Avg.
SW6	SW7	SW8				
<input type="checkbox"/>	<input type="checkbox"/>	<input type="checkbox"/>	OFF	10 s	0.1 Hz	N=1000
<input checked="" type="checkbox"/>	<input type="checkbox"/>	<input type="checkbox"/>	OFF	1 s	1 Hz	N=100
<input type="checkbox"/>	<input checked="" type="checkbox"/>	<input type="checkbox"/>	OFF	0.1 s	10 Hz	N=10
<input type="checkbox"/>	<input type="checkbox"/>	<input checked="" type="checkbox"/>	ON	1 s	10 Hz	n=1
<input checked="" type="checkbox"/>	<input type="checkbox"/>	<input checked="" type="checkbox"/>	ON	0.1 s	100 Hz	n=1
<input type="checkbox"/>	<input checked="" type="checkbox"/>	<input checked="" type="checkbox"/>	ON	0.01 s	1 kHz	n=1

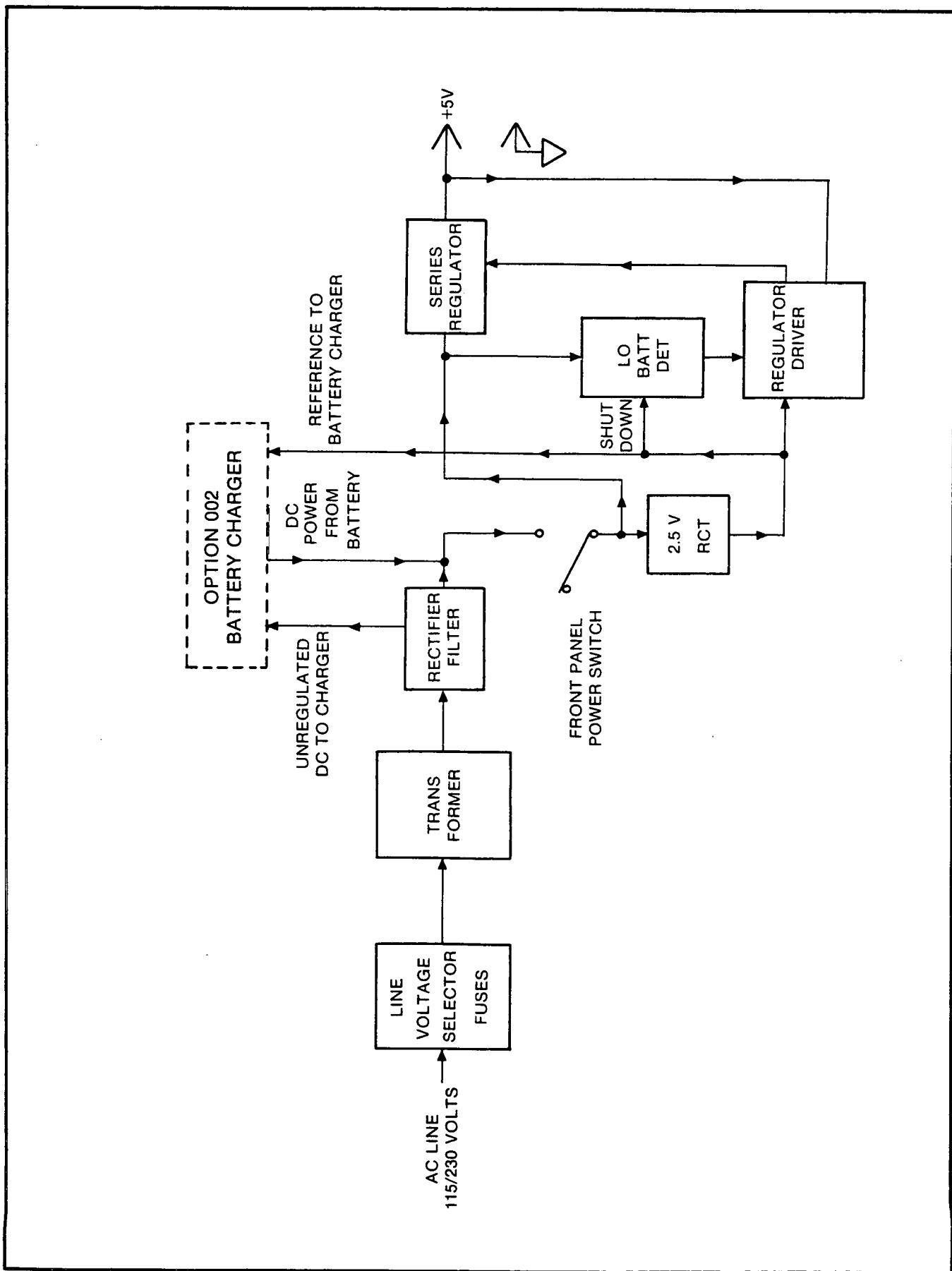

Figure 8-4. HP 5314A Power Supply Block Diagram

8-45. Power Supply Block Theory

8-46. The power supply contains circuitry to operate the instrument when the front panel STBY switch is pushed to ON, or charge the battery when in standby (STBY) if Option 002 is installed. Input line voltages can range from 86 to 126 volts in the 115V position of the power selector switch and 172V to 252 in the 230-volt position. The outputs provided by the power supply are regulated +5 volts at 0.5 amps, unregulated +8 to +10 volts for charging the battery and +2.5V reference to be used by the battery charger (Option 002).

8-47. Detailed A2 Assembly Theory

8-48. Line power is applied to the primary side of T1 power transformer through the line selector switch and fuses F1 and F2. The line selector switch configures the dual primary for 115-volt or 230-volt operation by connecting the windings in parallel or series, respectively. The fuses need not be changed when the line voltage selector switch is changed. The secondary of the power transformer contains a full wave rectifier and filter made up of CR2, CR1, and C1. The unregulated dc at this point is supplied to the battery charger board. The dc also passes through two isolation diodes CR5 and CR6.

8-49. These diodes keep current from coming back out of the battery and into the charger circuitry. The dc line is broken at this point by the standby (STBY) switch located on the A1 assembly. When the switch is ON, power is supplied to the 2.5 volt regulator U1, the output regulator driver and series pass transistor, and the low voltage detector. The regulated +5 volts output is generated using a conventional series pass linear regulator. The output voltage is divided-by-2 using R7 and R8. Under normal conditions this will produce 2.5 volts at the output of the divider which is applied to an operational amplifier U2 pin 2. This voltage is compared with the 2.5 volts generated by the reference U1. The output of the opamp will control the current in Q1 which controls the series pass transistor Q2. The other half of U2 is used as a low battery detector. When the HP 5314A is operating under battery power, an attenuated version of the battery voltage is present on U2 pin 6. This voltage is compared with the 2.5 volt reference which is applied to pin 5 of U2. When the battery voltage is high, the output of U2 is low and CR4 is reversed biased. When the battery voltage gets low, indicating low capacity, pin 7 of U2 will go high. This pulls pin 2 of U2 high and turns off the output transistor Q2. Positive feedback is applied around the low battery detector to provide hysteresis. This ensures that once the detector has shut the HP 5314A off, it will stay off. Capacitor C5 delays the 2.5-volt reference on pin 5 ensuring that when the instrument is turned on, it comes on then shuts down if necessary.

8-50. Option 002 Battery Charger Block Theory

8-51. The battery charger has circuitry that supplies 10 mA to the battery whenever the instrument has line power coming in. If the instrument is in the standby position, the battery is charged at a 0.5 amp rate until it is fully charged. When the battery is fully charged, a circuit detects this and discontinues the 0.5 amp current and resumes the 10 mA float current. See Table 8-4 for power switch operation in an HP 5314A with Option 002.

Table 8-4. Option 002 Power Switch Operation

AC Line Cord	Power Switch	Battery-Pack Operation
Connected	STBY	Two-step battery charging cycle active.
Connected	ON	Counter operates from ac power; charge circuitry provides a 10 mA trickle charge to battery to maintain charge level.
Disconnected	STBY	None.
Disconnected	ON	Counter operates from battery power; Auto-Shut Down circuitry operative.

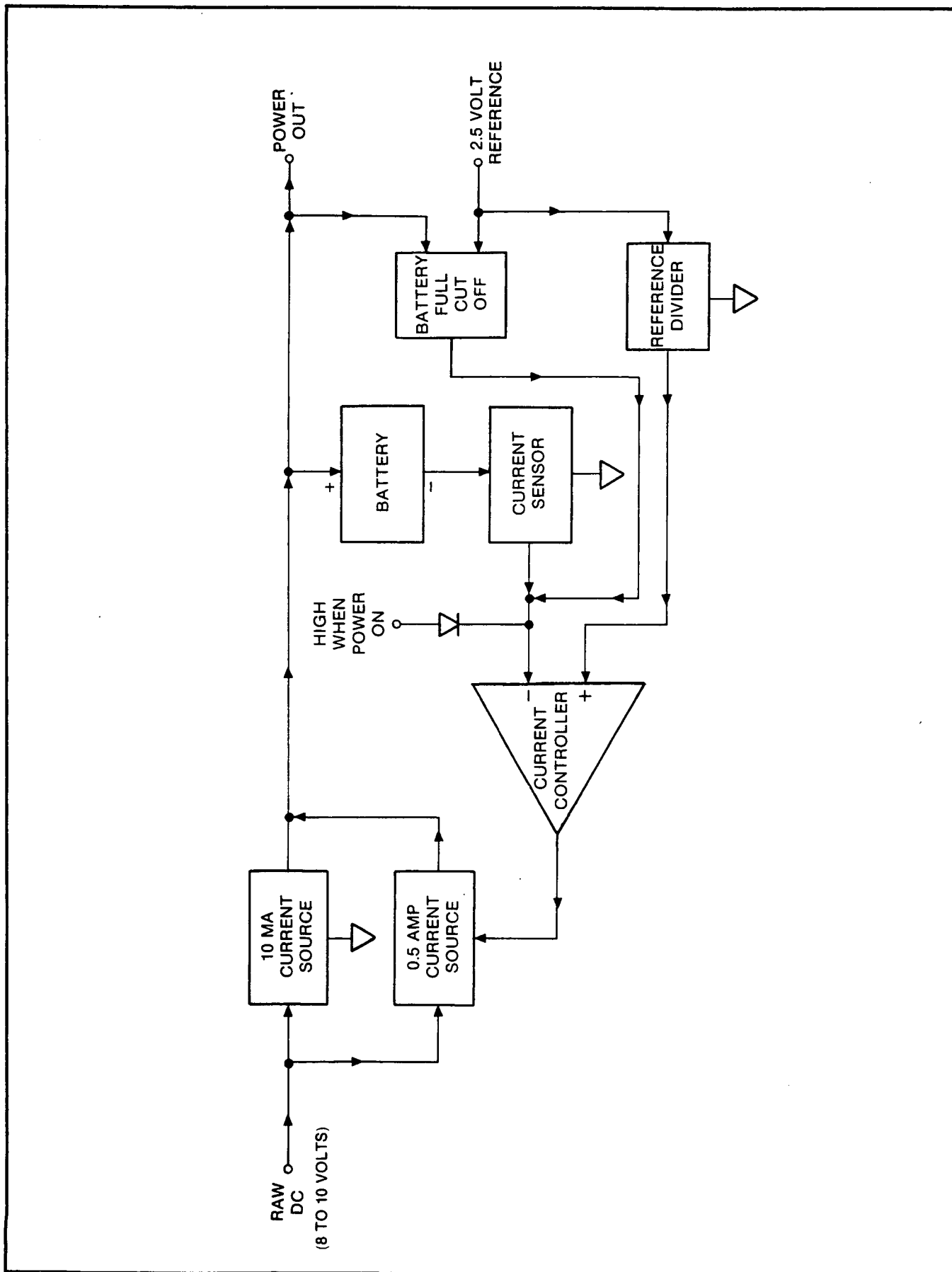

Figure 8-5. HP 5314A Optional Battery Pack Block Diagram

8-52. Detailed Option 002 A3 Assembly Theory

8-53. Power comes on to this board at pin 1. The components R1, R2, Q1, and Q2 provide continuous 10 mA to the battery from the collector of Q1. R13 is the current sensor and R4 is used to isolate the sensor from pin 2 of the IC. The 2.5-volt reference comes on to the board at pin 5 and is divided down to 50 mV by R10 and R6 (50 mV is the voltage developed by the current sensor). The OP amp (consisting of pins 1, 2, and 3), in conjunction with Q3, Q4, R3, and R5, is used to control the 0.5 amp used to charge the battery.

8-54. CR2 is used so the battery does not power this circuitry when the instrument is unplugged. CR1 is used so that power only leaves the board at pin 2. When the instrument is on, pin 3 goes high which discontinues the 0.5 amp current used to charge the battery. In the standard HP 5314A, the 2.5-volt reference is turned off when the switch is in STBY, so power is provided through CR4 to the reference input at pin 4 needed for Option 002.

8-55. The remaining components comprise the circuit to shut off the 0.5 amp current when the battery has a full charge. R9 and R11 and the 2 K Ω potentiometer (R12) comprise the voltage divider to determine the correct voltage where the 0.5 amps should be discontinued. CR7 and the 33 K Ω thermistor are used to track the temperature changes inside the instrument. R7 pulls pin 7 to approximately 60 mV above ground when the opamp goes low. When the battery is not fully charged, pin 7 will be low (because the voltage at pin 5 will be less than 2.5-volt reference at pin 6). The 2 K Ω pot is adjusted so that the full charge cutoff happens when there is 7.5 volts across the battery at room temperature. Now the thermistor and CR8 are out of the circuit, which causes pin 5 to go even higher. Pin 7 will not go low now until pin 5 goes below 2.5 volts. This will happen when approximately 7.05 volts is across the battery. CR5, CR6, and R8 are used to insure that the previously described circuitry has no affect on pin 2 of the IC. (Recall that pin 2 is sensing 50 mV and pin 7 goes down to 60 mV.)

8-56. TROUBLESHOOTING TEST PROCEDURES

8-57. The following test procedures are designed to effectively verify the proper operation of isolated subsections of the HP 5314A. Refer to the troubleshooting block diagram in *Figure 8-6* to determine the circuits tested by each procedure. Although each procedure may be performed independently, it is recommended that they be performed in the numerical sequence as given in *Table 8-5*.

8-58. Throughout the five troubleshooting test procedures, alphabetical test points from D to S are referenced. These test points appear on the A1 schematic diagram in *Figure 8-8*. They are enveloped within black circles located at various points throughout the schematic diagram. *Table 8-5* lists the test points and the signals present at each.

Table 8-5. Block Diagram Sections versus Test Procedures

Figure 8-6 Sections	Test Procedure				
	1	2	3	4	5
A	X	X	X	X	X
B		X		X	X
C			X		X
D				X	X

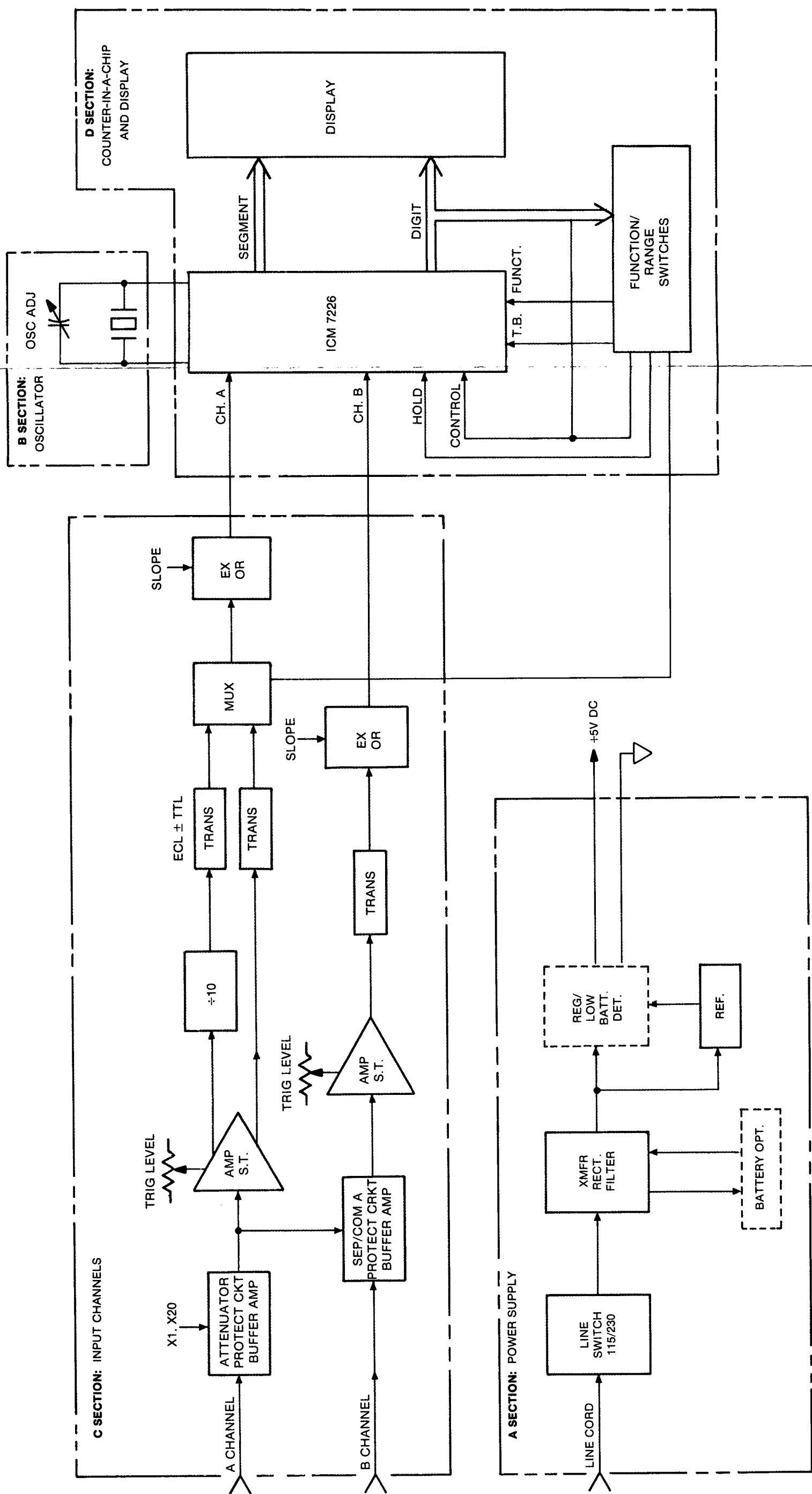

Figure 8-6. HP 5314A Troubleshooting Block Diagram

Table 8-6. A1 Test Point Signal Descriptions

Test Point	Description
TP D:	Channel A Input to wideband amplifier-collector of A1Q7
TP E&F:	Channel A Schmitt trigger outputs A1U5(15, 14)
TP G:	Channel A Input to Counter-in-a-chip A1U2(40)
TP H:	Channel B Input to wideband amplifier-collector of A1Q9
TP J&K:	Channel B Schmitt trigger outputs A1U6(15, 14)
TP L:	Channel B Input to Counter-in-a-chip A1U2(2)
TP M:	"FUNCTION" input to A1U2(4)
TP N:	"TIME BASE" input to A1U2(21)
TP P:	"EXT OSC INPUT" A1U2(33)
TP Q:	"CONTROL" input A1U2(1)
TP R:	"OVFL" output A1U2(22)
TP S:	+5 Volts
TP T:	↓ (GND)

8-59. Procedure #1: Testing of 5314A Power Supply

8-60. To verify proper operation of the HP 5314A power supply, check Test Point S on the A1 motherboard. It should be +5V ±75 mV. This is the only supply voltage in the HP 5314A, and it is not adjustable.

8-61. Procedure #2: Testing of 5314A Reference Oscillator

8-62. Check for the presence of the 10 MHz Reference Oscillator at Test Point P, A1U2(33); see following figure for a typical waveform:

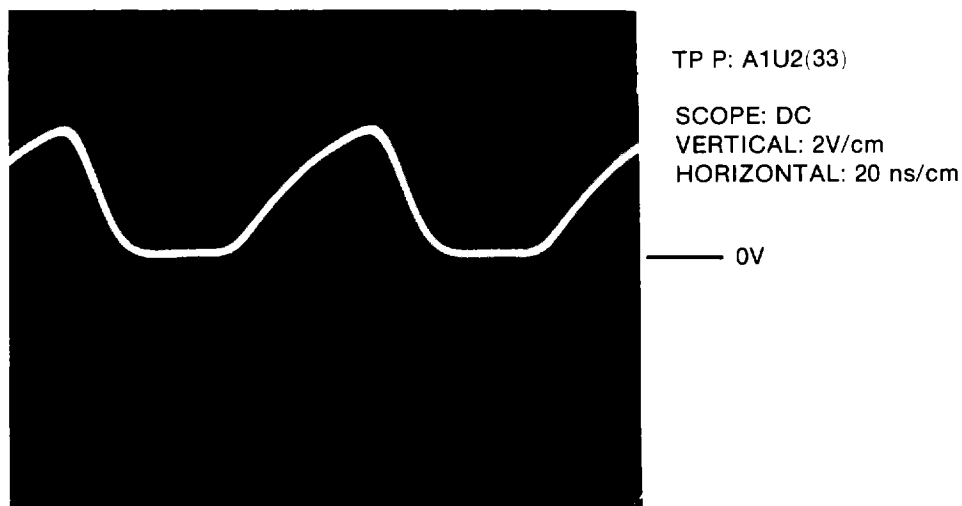

If the 10 MHz reference oscillator is not present, check A1Y1, R6, C2, C5, and U2.

8-63. Procedure #3: Testing Input Channels

8-64. To verify proper operation of the HP 5314A input channels, apply a 10 MHz signal at 100 mV rms (~280 mV p-p) to INPUT A, then to INPUT B. Check that the proper waveform exists at TP G [A1U4(6)] and at TP L [A1U4(8)]. If they are not present, trace back the signal. The following eight photographs show the signal which should be present at the corresponding test points.

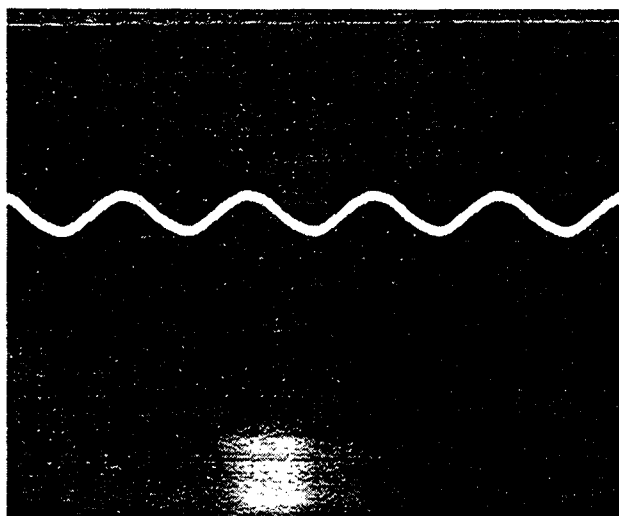

TP D: Collector of A1Q7

SCOPE: DC

VERTICAL: 0.5V/cm

HORIZONTAL: 50 ns/cm

0V

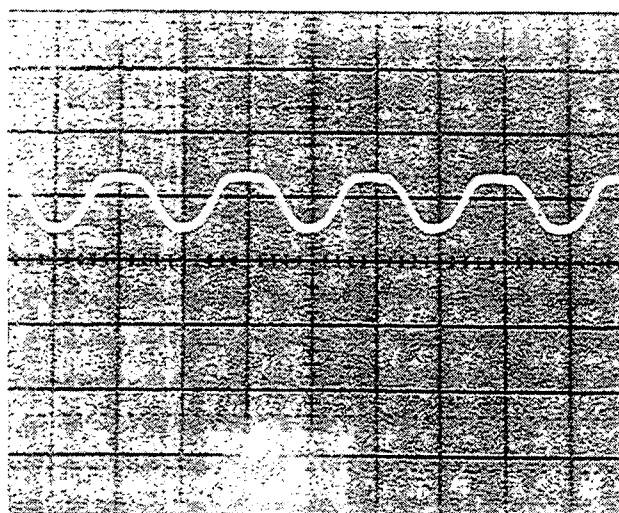

TP E: A1U5(15)

SCOPE: DC

VERTICAL: 1V/cm

HORIZONTAL: 50 ns/cm

0V

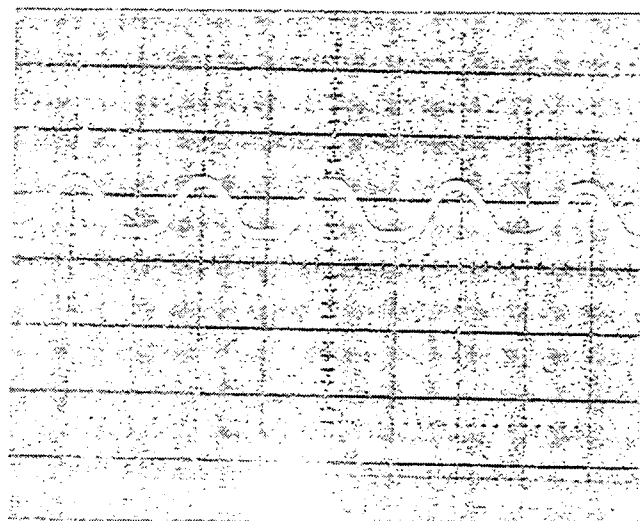

TP F: A1U5(14)

SCOPE: DC
VERTICAL: 1V/cm
HORIZONTAL: 50 ns/cm

0V

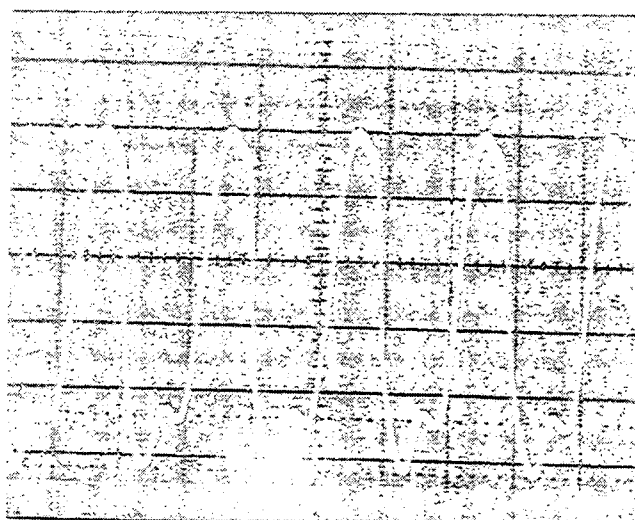

TP G: A1U4(6)

SCOPE: DC
VERTICAL: 1V/cm
HORIZONTAL: 50 ns/cm

0V

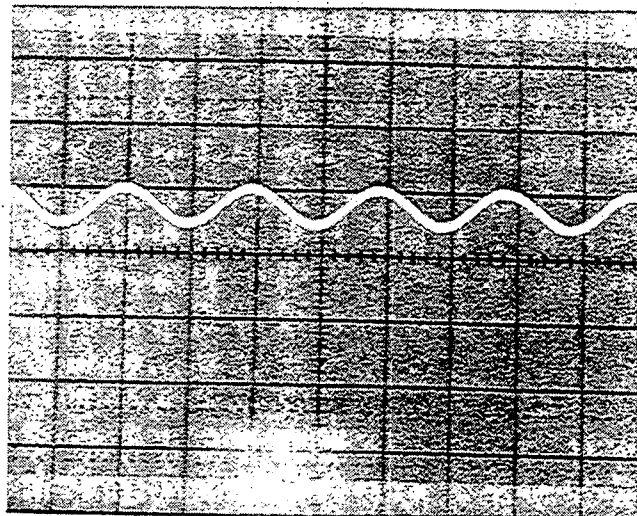

TP H: Collector of A1Q9

SCOPE: DC
VERTICAL: 0.5V/cm
HORIZONTAL: 50 ns/cm

0V

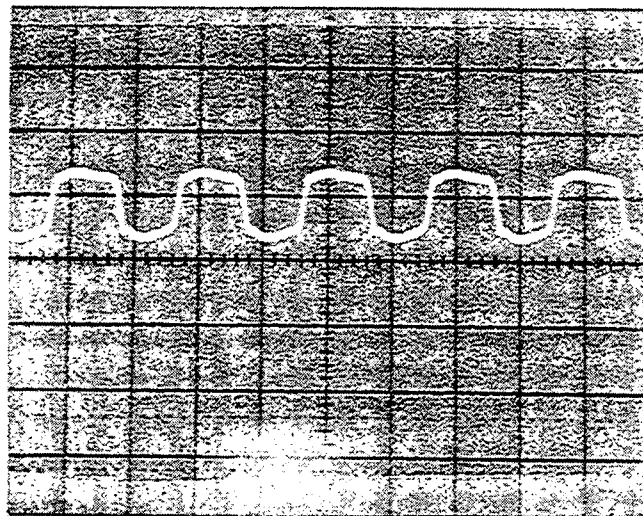

TP J: A1U6(15)

SCOPE: DC
VERTICAL: 1V/cm
HORIZONTAL: 50 ns/cm

— 0V

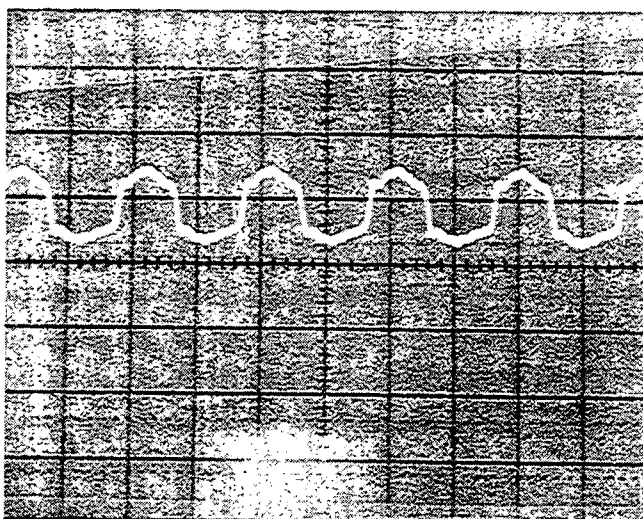

TP K: A1U6(14)

SCOPE: DC
VERTICAL: 1V/cm
HORIZONTAL: 50 ns/cm

— 0V

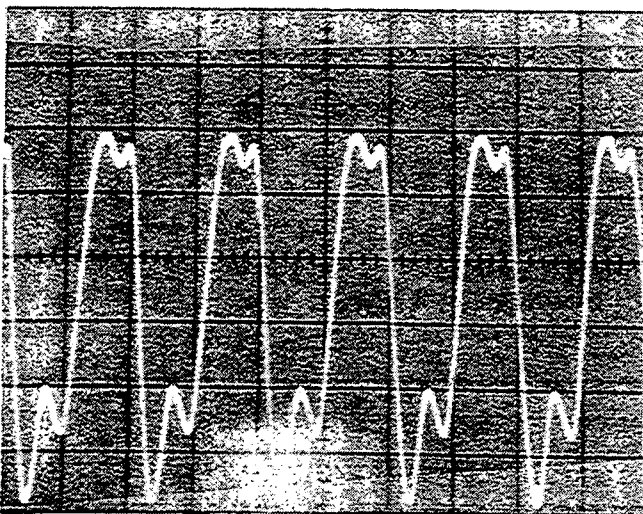

TP L: A1U4(8)

SCOPE: DC
VERTICAL: 1V/cm
HORIZONTAL: 50 ns/cm

— 0V

8-65. Procedure #4: Testing of ICM 7226 [Counter-in-a-Chip] and Display

8-66. To verify the proper operation of A1U2 (counter-in-a-chip) and the displays and the front panel switches, set the 5314A to SELF-CHECK mode; set resolution to 10 Hz (N=10). The display should be as follows:



with "GATE" light blinking. If the counter fails to pass this test, check the DIGIT DRIVER lines from A1U2; connect A1U2(22) (TP R) to oscilloscope Channel A input. Adjust oscilloscope time base vernier so that the total period of pulses occupy 8 centimeters of the oscilloscope screen. The Digit Driver displayed is D7 in Channel A. Connect to oscilloscope Channel B Digit Drivers D0 to D6 and the corresponding pulses should coincide with the positions as illustrated in the figure below (see Table 8-7).

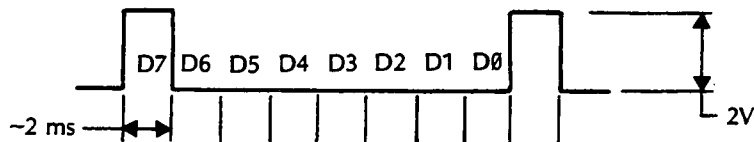

To verify that proper time base pulse has been selected per front panel switches, connect oscilloscope's Channel B to A1U1(4) or A1U2(20) (see Table 8-7).

Table 8-7. Multiplexed Digit Driver Output

FUNCTION INPUT	Function	Digit
FUNCTION INPUT	FREQUENCY	D0
	PERIOD	D7
	RATIO	D1
	TIME INTERVAL	D4
	UNIT COUNTER	D3
	OSCILLATOR FREQUENCY	D2
	RANGE INPUT (Time Base Selection)	100 Hz 0.01 s/1 CYCLE
10 Hz 0.1 s/10 CYCLES		D1
1 Hz 1 s/100 CYCLES		D2
0.1 Hz 10 s/1K CYCLES		D3
EXTERNAL RANGE		D4
INPUT ENABLED		
CONTROL INPUT	BLANK DISPLAY	D3 HOLD
	DISPLAY TEST	D7
	1 MHz SELECT	D1
	EXTERNAL OSCILLATOR	D0
	INPUT ENABLE	
	EXTERNAL DECIMAL POINT	D2
	INPUT ENABLE	
TEST	D4	

8-67. Procedure #5: 20 MHz Mode

8-68. Apply a 20 MHz signal at 100 mV rms (~280 mV p-p) to the HP 5314A INPUT A with a 50-ohm feedthrough. Set the HP 5314A to FREQ A mode, with a resolution of 10 Hz (N=1), ATTN X1/X20 in X1, and LEVEL A about midrange. Verify that counter counts 20 MHz ±1 count.

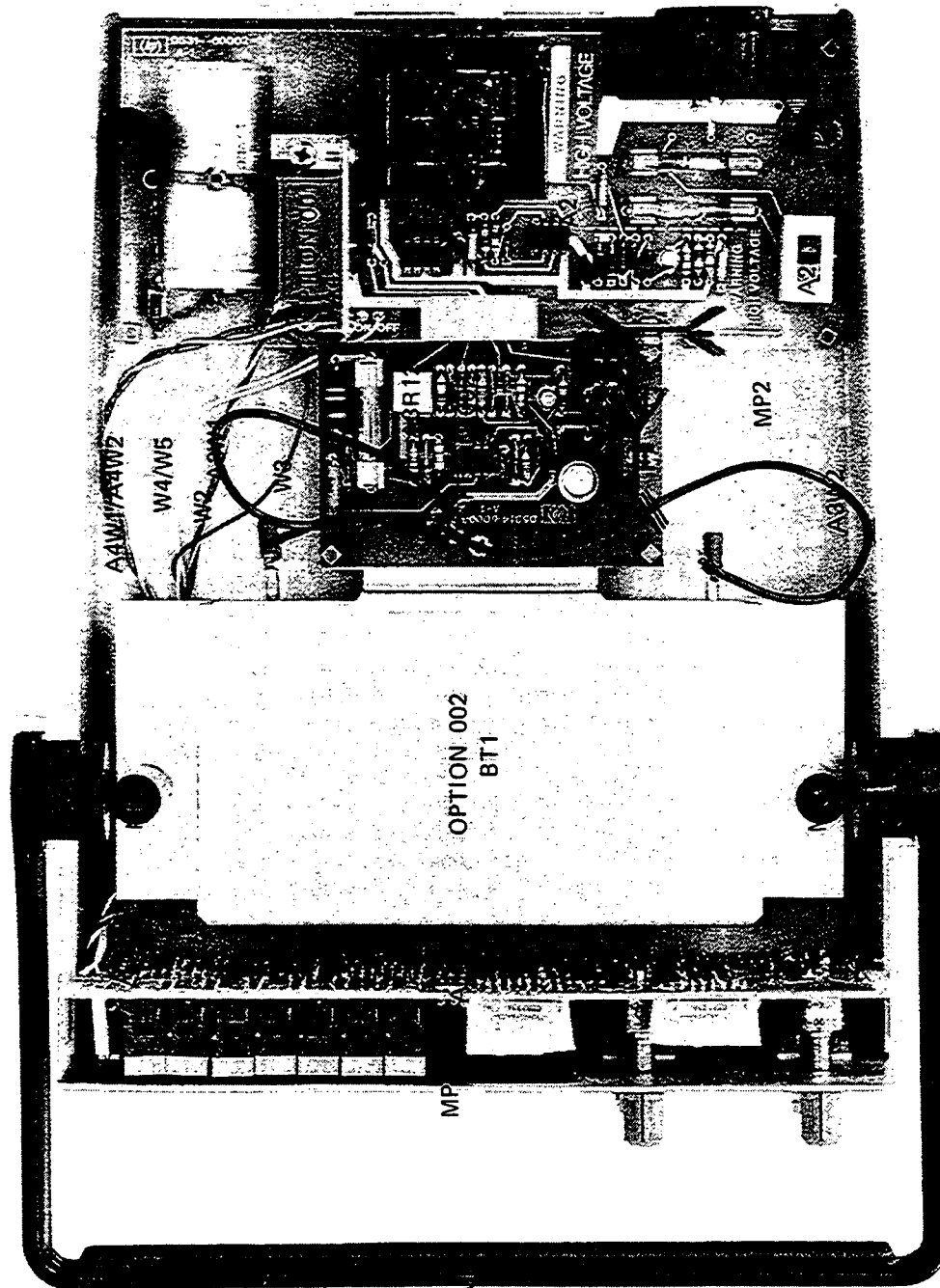
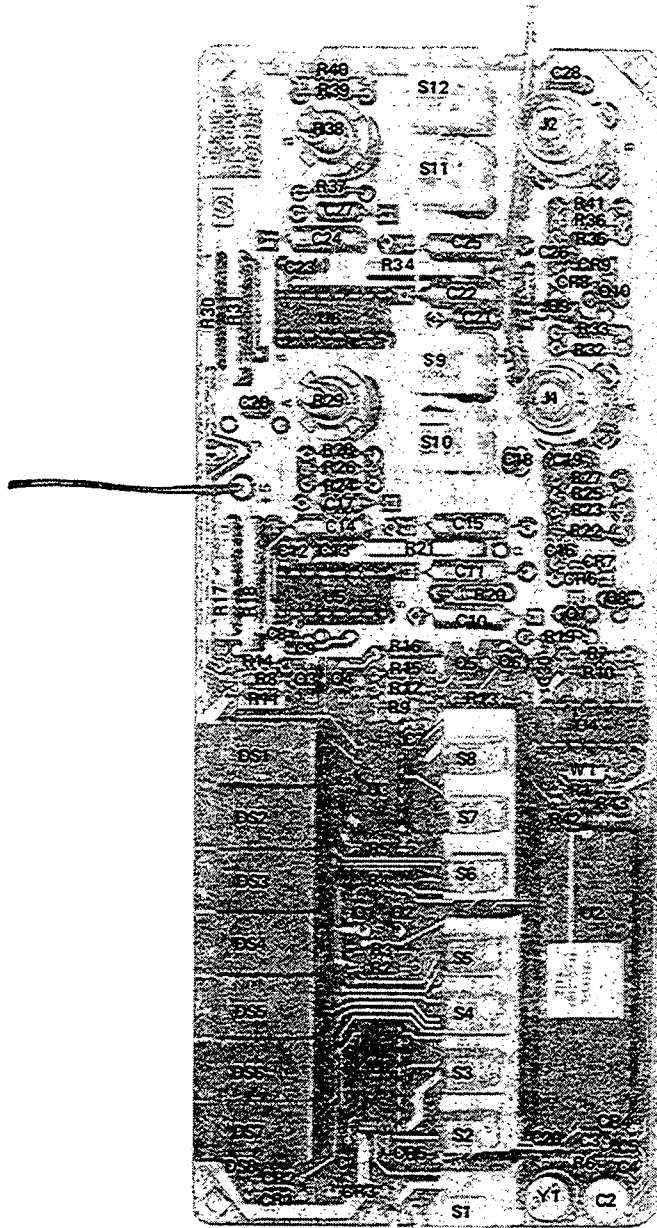
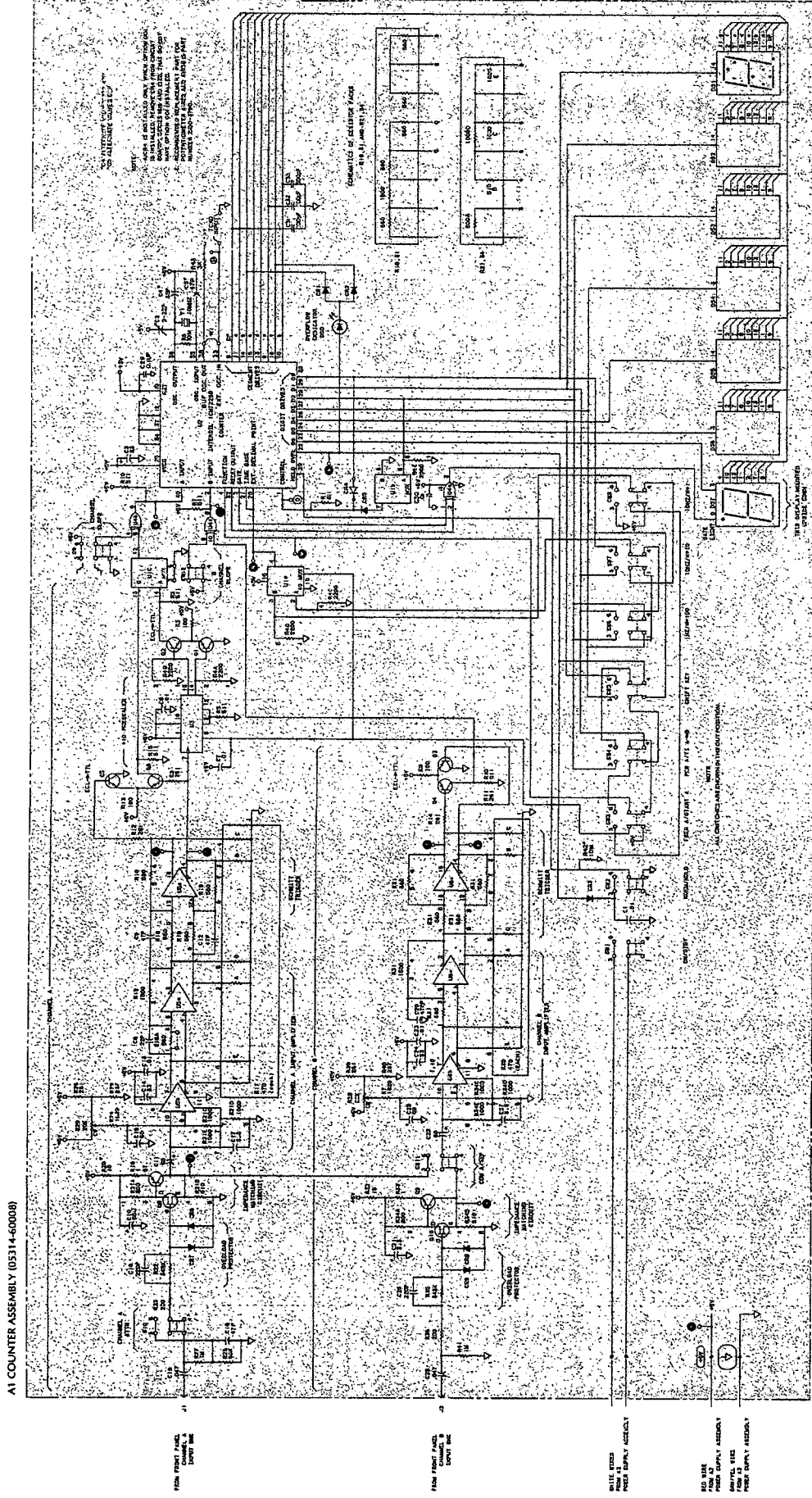

Figure 8-7. Top Internal View



Part of Figure 8-8. A1 Counter Assembly Component Locator



A1 COUNTER ASSEMBLY (DS314-60008)

NOTES

1. REFERENCE DESIGNATIONS WITHIN THIS ASSEMBLY ARE ABBREVIATED. ADD ASSEMBLY NUMBER TO ABBREVIATION FOR COMPLETE DESCRIPTION.
2. UNLESS OTHERWISE INDICATED:
RESISTANCE IN OHMS,
CAPACITANCE IN FARADS,
INDUCTANCE IN HENRIES
3. ASTERISK (*) INDICATES SELECTED COMPONENT, AVERAGE VALUES SHOWN

REFERENCE DESIGNATIONS	VALUE
A1C1 - C30	
A1C45 - C47	
CR1 - CR9	
DS1 - DS8	
J1 - J2	
Q1 - Q10	
R1 - R43	
S1 - S12	
U1 - U6	
W1	
Y1	

Table of Active Elements

REFERENCE DESIGNATIONS	HP PART NUMBER	MFG PART NUMBER
CR1 - CR9	1901-0050	1901-0050
DS1 - DS7	1990-0730	1990-0730
DS8	1990-0486	1990-0486
Q1 - Q6	1853-0015	1853-0015
Q7	1853-0354	1853-0354
Q8	1855-0267	1855-0267
Q9	1853-0015	1853-0015
Q10	1855-0267	1855-0267
U1	1820-1470	SN74LS157N
U2	1820-2187	ICM7226A
U3	1820-1383	MC10138L
U4	1820-0694	SN74S86N
U5 - U6	1820-1224	MC10216P
Y1	0410-1188	0410-1188

Figure 8-8. A1 Counter Assembly
8-23

Figure 8-8
A1 COUNTER ASSEMBLY

(See Page 8-23)

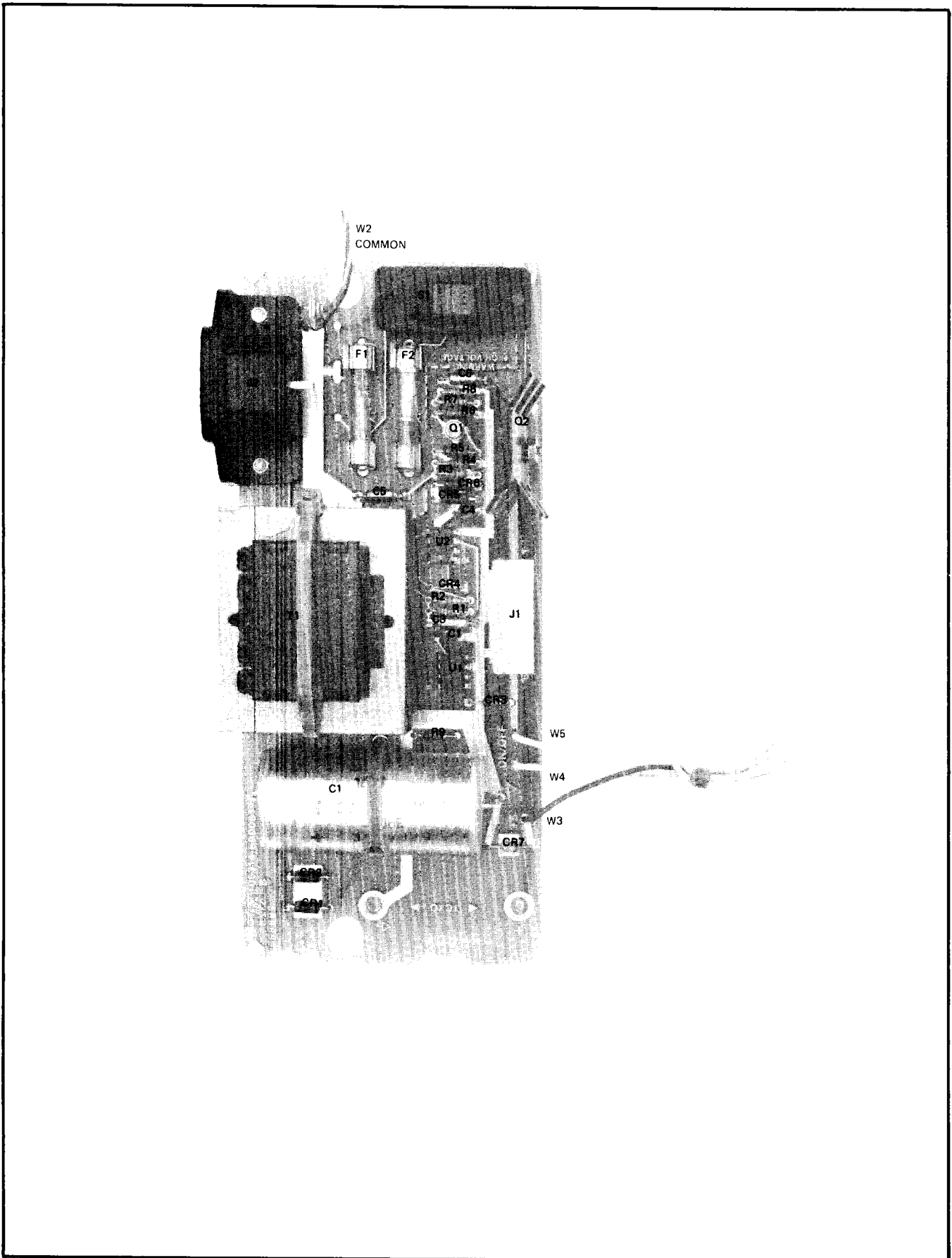

Part of Figure 8-9. A2 Power Supply Assembly Component Locator

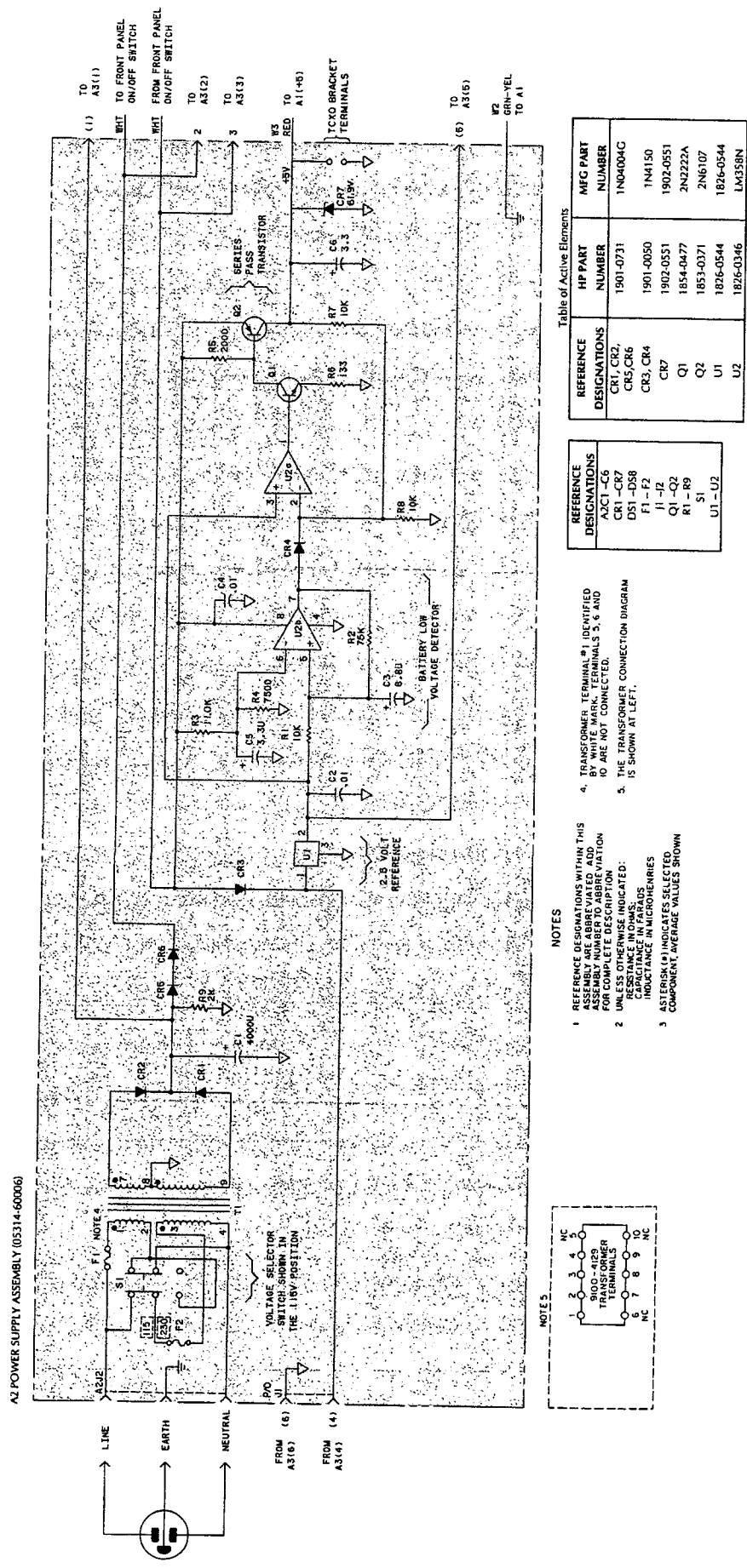

Figure 8-9. A2 Power Supply Assembly
8-25

Figure 8-9
A2 POWER SUPPLY ASSEMBLY

(See Page 8-25)

MP1

RECHARGEABLE BATTERY

SEE SERVICE MANUAL FOR BATTERY OPTION OPERATION, TEST AND CALIBRATION PROCEDURE

CAUTION -DO NOT SHORT CIRCUIT BATTERY
-DO NOT STORE BATTERY IN LOW CHARGE STATE

FOR MAXIMUM BATTERY LIFE

-AVOID PARTIAL RECHARGE
-RECHARGE BATTERY AS SOON AS POSSIBLE AFTER FULL DISCHARGE

+
POS

-
NEG

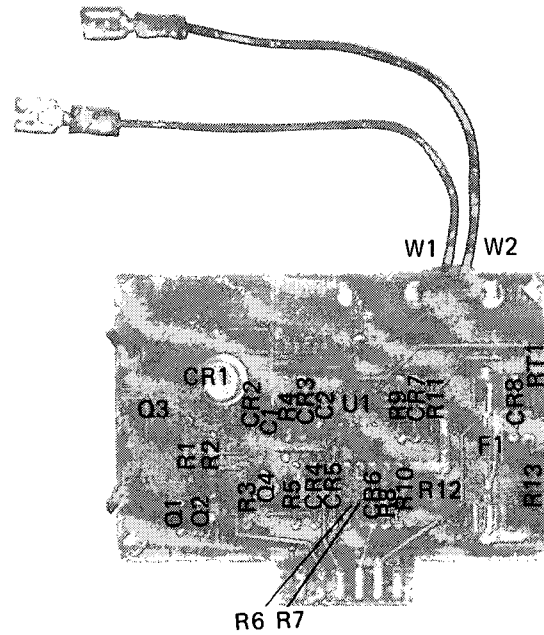

BT1



Part of Figure 8-10. A3 Battery Charger, Option 002 Component Locator

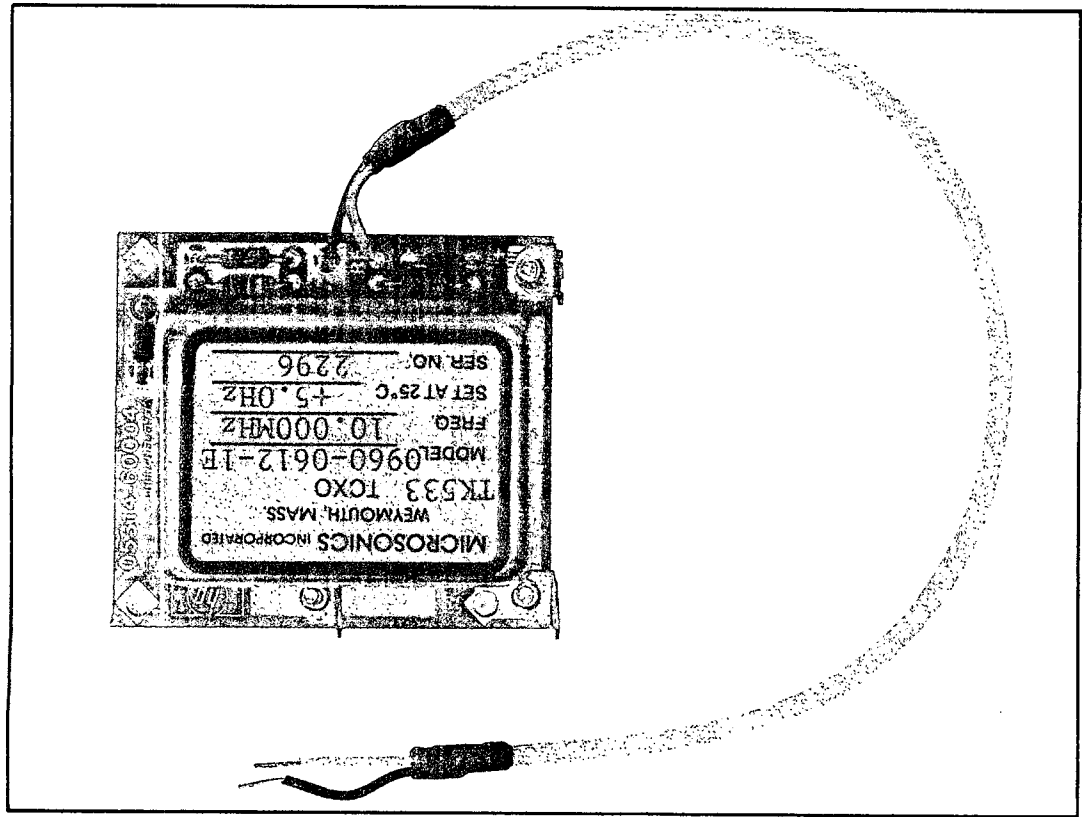

Part of Figure 8-10. A4 TCXO Assembly Component Locator

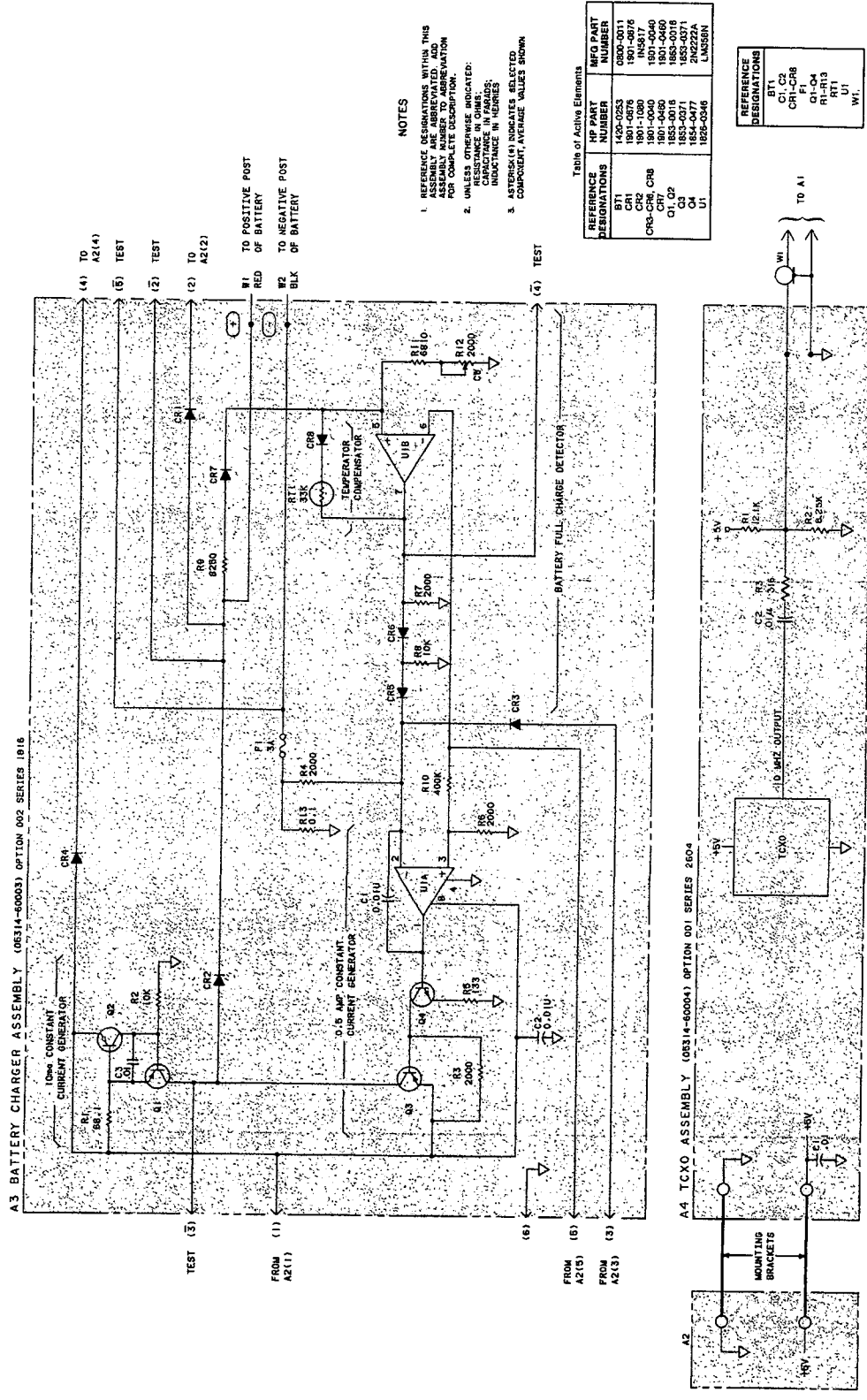
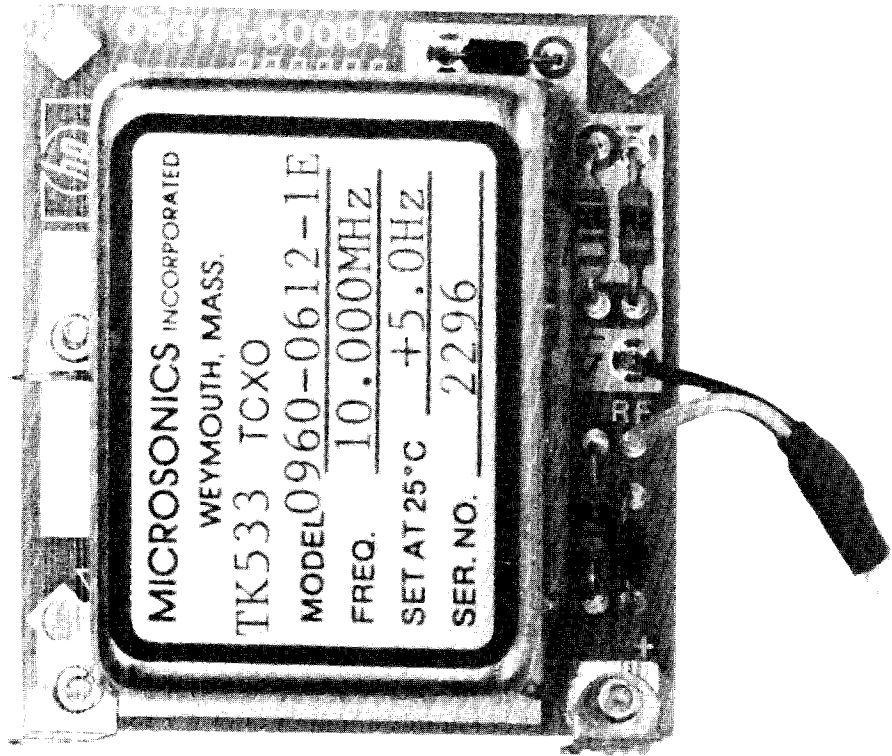

Figure 8-10. A3 Battery Charger Assembly, Option 002
A4 TCXO Assembly, Option 001
8-27



Part of Figure 8-10. A4 TCXO Assembly Component Locator

Figure 8-10
A3 BATTERY CHARGER ASSEMBLY, OPTION 002
A4 TCXO ASSEMBLY, OPTION 001

(See Page 8-27)

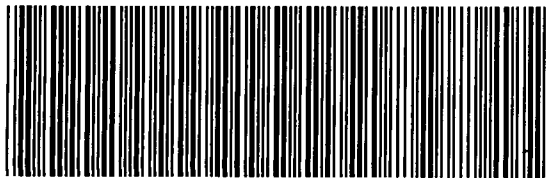

Manual Part Number: 05314-90015

Printed SEPTEMBER 1993
Printed In U.S.A.