

OPERATING MANUAL

5316A 100 MHz Universal Counter

First Edition — May 1981

©Copyright 1981
by
HEWLETT-PACKARD COMPANY
5301 Stevens Creek Boulevard
Santa Clara, California 95050

MANUAL PART NUMBER 05316-90005



HEWLETT
PACKARD

CERTIFICATION

Hewlett-Packard Company certifies that this product met its published specifications at the time of shipment from the factory. Hewlett-Packard further certifies that its calibration measurements are traceable to the United States National Bureau of Standards, to the extent allowed by the Bureau's calibration facility, and to the calibration facilities of other International Standards Organization members.

WARRANTY

This Hewlett-Packard instrument product is warranted against defects in material and workmanship for a period of one year from date of shipment. During the warranty period, Hewlett-Packard Company will, at its option, either repair or replace products which prove to be defective.

For warranty service or repair, this product must be returned to a service facility designated by HP. Buyer shall prepay shipping charges to HP and HP shall pay shipping charges to return the product to Buyer. However, Buyer shall pay all shipping charges, duties, and taxes for products returned to HP from another country.

HP warrants that its software and firmware designated by HP for use with an instrument will execute its programming instructions when properly installed on that instrument. HP does not warrant that the operation of the instrument, or software, or firmware will be uninterrupted or error free.

LIMITATION OF WARRANTY

The foregoing warranty shall not apply to defects resulting from improper or inadequate maintenance by Buyer, Buyer-supplied software or interfacing, unauthorized modification or misuse, operation outside of the environmental specifications for the product, or improper site preparation or maintenance.

NO OTHER WARRANTY IS EXPRESSED OR IMPLIED. HP SPECIFICALLY DISCLAIMS THE IMPLIED WARRANTIES OF MERCHANTABILITY AND FITNESS FOR A PARTICULAR PURPOSE.

EXCLUSIVE REMEDIES

THE REMEDIES PROVIDED HEREIN ARE BUYER'S SOLE AND EXCLUSIVE REMEDIES. HP SHALL NOT BE LIABLE FOR ANY DIRECT, INDIRECT, SPECIAL, INCIDENTAL, OR CONSEQUENTIAL DAMAGES, WHETHER BASED ON CONTRACT, TORT, OR ANY OTHER LEGAL THEORY.

ASSISTANCE

Product maintenance agreements and other customer assistance agreements are available for Hewlett-Packard products.

For any assistance, contact your nearest Hewlett-Packard Sales and Service Office. Addresses are provided at the back of this manual.

TABLE OF CONTENTS

Section	Title	Page
I	GENERAL INFORMATION	1-1
	1-1. Introduction	1-1
	1-4. Description	1-1
	1-9. Specifications	1-1
	1-11. Options	1-5
	1-16. Safety Considerations	1-5
	1-18. Instrument Identification	1-5
	1-20. Accessories	1-5
	1-22. Recommended Test Equipment	1-6
II	INSTALLATION	2-1
	2-1. Introduction	2-1
	2-3. Unpacking and Inspection	2-1
	2-5. Preparation for Use	2-1
	2-6. Power Requirements	2-1
	2-8. Line Voltage Selection	2-1
	2-14. Power Cable	2-2
	2-16. Operating Environment	2-2
	2-19. Storage and Shipment	2-2
	2-20. Environment	2-2
	2-23. Packaging	2-3
	2-26. Field Installation of Options	2-3
	2-28. Part Numbers for Ordering Option Kits	2-4
	2-30. Option 001 TCXO Installation	2-4
	2-32. Option 004 Installation	2-5
	2-34. Option 003 Channel C Installation	2-5
III	OPERATION	3-1
	3-1. Introduction	3-1
	3-3. Operating Characteristics	3-1
	3-6. Modes of Operation	3-1
	3-8. FREQ A	3-1
	3-10. PER A	3-2
	3-12. T.I. A→B	3-2
	3-14. T.I. AVG A→B	3-2
	3-17. T.I. DELAY (Hold Off)	3-3
	3-19. RATIO A/B	3-3
	3-21. A BY B	3-3
	3-23. A ARMED BY B	3-4
	3-27. FREQ C (Option 003)	3-6
	3-29. TOT STOP/START	3-6
	3-31. CHECK	3-6
	3-33. Display Check	3-6
	3-35. Panel Features and Controls	3-7
	3-37. Function Selection Controls	3-7
	3-42. Signal Conditioning Controls	3-8
	3-45. Trigger Level/Sensitivity Controls	3-8
	3-47. Display	3-8
	3-49. Operator's Checks	3-10
	3-51. Operating Instructions	3-10
	3-52. Power-Up Self-Check	3-10
	3-55. Measurement Procedures	3-11
	3-57. Frequency, Period, and Ratio Measurements	3-11
	3-58. Time Interval Measurements	3-12
	3-59. Troubleshooting/Error Messages	3-12

TABLE OF CONTENTS (Continued)

Section	Title	Page
III	OPERATION (Continued)	
3-62.	Options	3-13
3-64.	Time Base Options	3-13
3-66.	Channel C Option 003	3-13
3-68.	Operator's Maintenance	3-13
3-71.	Power/Warm Up	3-14
3-73.	Remote Programming via the HP-IB	3-29
3-74.	Introduction	3-29
3-77.	Bus Compatibility	3-29
3-78.	Interface Function	3-29
3-81.	Bus Messages	3-30
3-83.	Address Selection	3-30
3-86.	Front Panel HP-IB Status LEDs	3-32
3-88.	Device Command D	3-32
3-93.	Input Code Format	3-36
3-95.	Output Format	3-36
3-98.	Programming Examples	3-36
3-101.	Special Programming Considerations	3-38

LIST OF TABLES

Table	Title	Page
1-1.	Model 5316A Specifications	1-2
1-2.	Accessories Supplied	1-5
1-3.	Accessories Available	1-6
1-4.	Recommended Test Equipment	1-6
2-1.	Options 001, 004 and 003 Parts List	2-4
3-1.	Display Check	3-7
3-2.	HP-IB Interface Functions	3-29
3-3.	Bus Messages	3-31
3-4.	Address Selection	3-33
3-5.	Output String Format	3-37
3-6.	HP-IB Program Code Set	3-39

LIST OF FIGURES

Figure	Title	Page
1-1.	Model 5316A Universal Counter and Power Cable	1-0
2-1.	5316A Line Voltage Selection	2-2
2-2.	Power Cable HP Part Numbers versus Main Plugs Available	2-3
3-1.	T.I. Average Dead Time	3-2
3-2.	T.I. Delay	3-3
3-3.	Totalize A BY B	3-4
3-4.	A Armed BY B	3-5
3-5.	Trigger Level/Sensitivity Control	3-8
3-6.	Input Amplifier Block Diagram	3-9
3-7.	AC Coupled Measurements	3-11
3-8.	DC Coupled Measurements	3-12
3-9.	Details of Input Connector J1 and Fuse Mounting	3-14
3-10.	Front Panel Features	3-15
3-11.	5316A Rear Panel Features	3-18
3-12.	Operator's Check	3-19
3-13.	Frequency A/Period A Measurements	3-20
3-14.	Time Interval Measurement	3-21
3-15.	Time Interval Delay Measurement	3-22
3-16.	Time Interval Average A-B	3-23
3-17.	Ratio A/B Measurements	3-24
3-18.	A BY B Measurements	3-25
3-19.	FREQ A Armed by B Measurements	3-26
3-20.	Totalize Measurements	3-27
3-21.	Frequency C Measurements	3-28
3-22.	5316A Address Switches (20)	3-32

PREFACE

This manual is designed to present the information required by the user to effectively operate and maintain the 5316A Universal Counter.

It is divided into sections, each relating to a specific topic. As much as possible the sections are self-contained. It is the intention of this manual to allow for the quick location of desired information, while still providing the overall depth of detail required. Some sections provide the learning and working information, and will be used frequently. Other sections are dedicated to general and introductory types of information, and are intended to be used only for reference. Where applicable, photos, illustrations, and diagrams foldout allowing the user access to related information throughout the manual.

In limiting the depth of coverage in this manual, a certain amount of previous knowledge on the part of the reader must be assumed. A variety of additional related documentation is available. These materials address in depth the specific areas of interest, and should be used, whenever necessary, to supplement this manual. Users unfamiliar with HP-IB or Logic Symbology, for example, may want to refer to the 5316A Documentation Map to find additional sources of information.

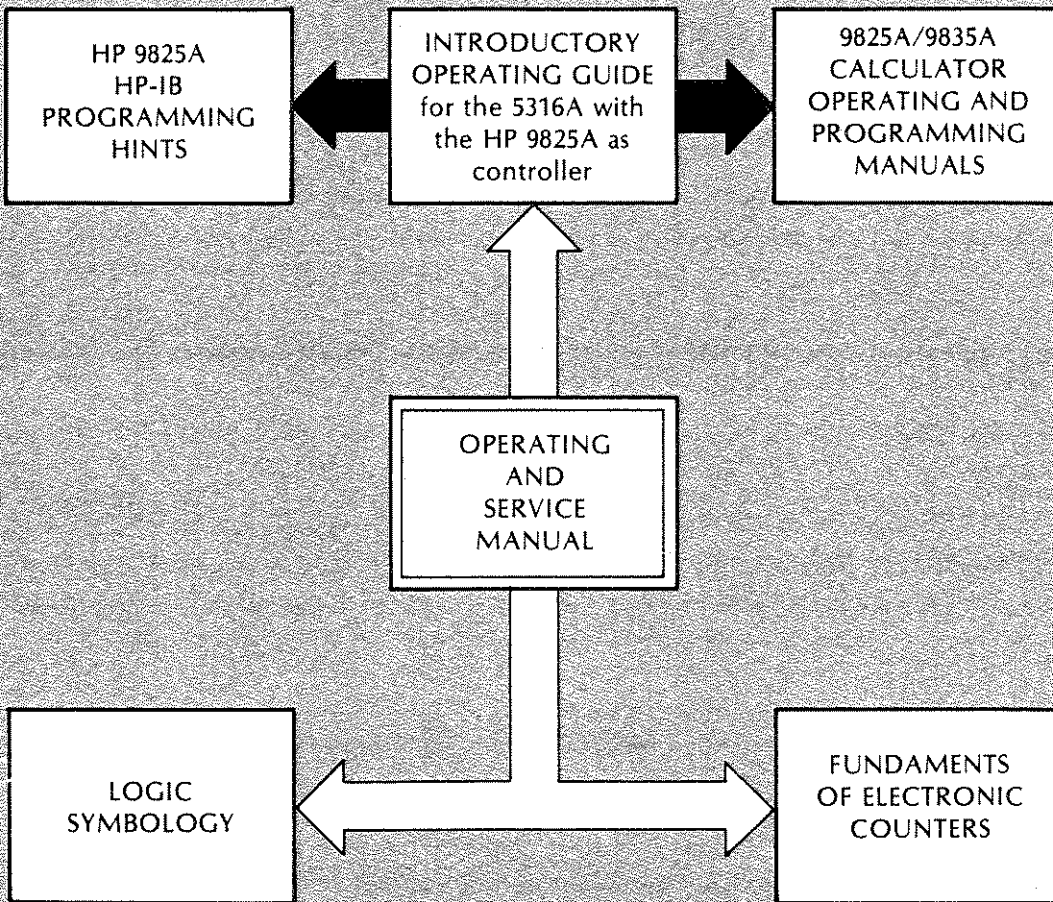

5316A/9825A INTRODUCTORY OPERATING GUIDE — Provides basic HP-IB interconnection information, remote programming examples and applications; specifically for the HP 5316A Universal Counter, using the HP 9825A as controller.

5316A OPERATING AND SERVICE MANUAL — Provides primary operating instructions and service information.

FUNDAMENTALS OF ELECTRONIC COUNTERS (AN 200) — Provides the basic concepts, techniques and underlying principles of electronic counters.

HP LOGIC SYMBOLOGY TRAINING MANUAL — Instructional training and definition of new Logic Symbology.

HP 9825A HP-IB PROGRAMMING HINTS — Includes a variety of HP-IB related documents, including general bus theory and instrument specific programming examples.

9825A/9835A OPERATING AND PROGRAMMING MANUALS — Provides programming instructions for the 9825A and 9835A calculators — (Two separate manuals).

SAFETY CONSIDERATIONS

GENERAL

This is a Safety Class I instrument. This instrument has been designed and tested according to IEC Publication 348, "Safety Requirements for Electronic Measuring Apparatus".

This manual contains information, cautions, and warnings which must be followed by the service person to ensure safe operation and to retain the instrument in safe condition.

WARNINGS

SAFETY

If this instrument is to be energized via an autotransformer for voltage reduction, make sure the common terminal is connected to the earthed pole of the power source.

BEFORE SWITCHING ON THIS INSTRUMENT, the protective earth terminals of this instrument must be connected to the protective conductor of the (mains) power cord. The mains plug shall only be inserted in a socket outlet provided with a protective earth contact. The protective action must not be negated by the use of an extension cord (power cable) without a protective conductor (grounding).

Make sure that only fuses with the required rated current and of the specified type (normal blow, time delay, etc.) are used for replacement. The use of repaired fuses and the short-circuiting of fuse holders must be avoided.

Whenever it is likely that the protection offered by fuses has been impaired, the instrument must be made inoperative and be secured against any unintended operation.

GROUNDING

Any interruption of the protective (grounding) conductor (inside or outside the instrument) or disconnecting the protective earth terminal is likely to make this instrument dangerous. Intentional interruption is prohibited.

HIGH VOLTAGE

Warning — These servicing instructions are for use by qualified personnel only. To avoid dangerous electric shock, do not perform any servicing other than that contained in the operating instructions unless you are qualified to do so.

CAUTIONS

LINE VOLTAGE SELECTION

BEFORE SWITCHING ON THIS INSTRUMENT, make sure the instrument is set to the voltage of the power source. Verify that the power module is matched to the available line voltage. Verify that the correct fuse is installed.

GROUNDING

BEFORE SWITCHING ON THIS INSTRUMENT, ensure that all devices connected to this instrument are connected to the protective (earth) ground. (Grounding one conductor of a two-conductor outlet is not sufficient.)

ATTENTION

This symbol: , which appears on the instrument means: Read the instruction manual before operating the instrument. If the instrument is operated without reading the instructions, it may not operate correctly.

Model 5316A
General Information



5316A UNIVERSAL COUNTER

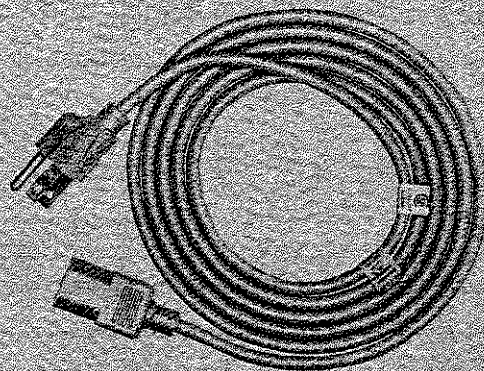

**POWER CORD
PART NO. 8120-1378**

Figure 1-1. Model 5316A Universal Counter and Power Cable

SECTION I GENERAL INFORMATION

1-1. INTRODUCTION

1-2. This manual provides information pertaining to the installation, operation, programming, testing, adjustments, and maintenance of the HP Model 5316A Universal Counter, shown in *Figure 1-1*.

1-3. This manual is divided into eight sections, each covering a particular topic for the operation of the HP Model 5316A Universal Counter. The topics by section number are:

Section	Topic
I	General Information
II	Installation
III	Operation and Programming
IV	Performance Tests
V	Adjustments
VI	Replaceable Parts
VII	Manual Changes
VIII	Service

A three-section users manual is provided with the 5316A. These three sections duplicate the first three sections of the eight-section manual. We suggest that you keep the users manual with the 5316A.

1-4. DESCRIPTION

1-5. The Hewlett-Packard Model 5316A is a universal counter, measuring signals over a range of DC to 100 MHz. The 5316A measures Frequency, Period, Time Interval, Time Interval Average, Time Interval Holdoff (delay), and Ratio. A Totalize function with manual or external gating is also provided. All measurements except Totalize are displayed in engineering notation with up to eight digits of resolution. In addition, the 5316A may be programmed via the Hewlett Packard Interface Bus (HP-IB).

1-6. Two independent input channels are provided for time interval measurements. Each input channel has an Attenuator (X1, X20), Trigger Slope selector, Trigger Level/Sensitivity control, three-state trigger lamps, and front panel Trigger Level Monitoring jacks. A front panel selectable Low-Pass Filter is provided for Channel A.

1-7. Four options extend the capabilities of the 5316A. Option 001 TCXO and Option 004 Oven Oscillator offer improved time base stability. Option 003 Channel C allows frequency measurements in the range of 50 MHz to 1 GHz. Option 006 Offset/Normalizer allows active mathematical modifications to the 5316A display. Complete specifications are given in *Table 1-1*.

1-8. The 5316A is designed for rack mounting or stacking and features a metal cabinet to minimize EMI.

1-9. SPECIFICATIONS

1-10. The instrument specifications are listed in *Table 1-1*. These specifications are the performance standards or limits against which the instrument may be tested.

Table 1-1. Model 5316A Specifications

**INPUT CHARACTERISTICS
(Channel A and Channel B)**

Range:
DC coupled, 0 to 100 MHz.
AC coupled, 30 Hz to 100 MHz.

Sensitivity:
10 mV rms sine wave to 10 MHz.
25 mV rms sine wave to 100 MHz.
75 mV peak-to-peak pulse at minimum pulse width of 5 ns.
Sensitivity can be varied continuously up to 500 mV rms **NOMINAL** by adjusting sensitivity control. In sensitivity mode, trigger level is automatically set to 0V **NOMINAL**.

Dynamic Range:
30 mV to 5V peak-to-peak, 0 to 10 MHz.
75 mV to 5V peak-to-peak, 10 to 100 MHz.

Signal Operating Range: +2.5V dc to -2.5V dc.

Coupling: AC or DC, switchable.

Filter: Low pass, switchable in or out of Channel A.
3 dB point of **NOMINALLY** 100 kHz.

Impedance:
1 MΩ **NOMINAL** shunted by less than 40 pF.

Attenuator: X1 or X20 **NOMINAL**.

Trigger Level: Variable between +2.5V dc and -2.5V dc.

Slope: Independent selection of + or - slope.

Common Input: All specifications are the same for Common A except the following:
Sensitivity: 20 mV rms sine wave to 10 MHz.
50 mV rms sine wave to 100 MHz, 150 mV peak-to-peak.
Dynamic Range: 60 mV to 5V peak-to-peak 0-10 MHz,
150 mV to 5V peak-to-peak 10-100 MHz.
Impedance: 500 kΩ **NOMINAL** shunted by less than 70 pF.

Damage Level:

AC & DC × 1:	
DC to 2.4 kHz	250V (DC + AC rms)
2.4 kHz to 100 kHz	(6 × 10 ⁵ V rms × Hz)/FREQ
>100 kHz	6V rms
AC & DC × 20:	
DC to 28 kHz	500V (DC + AC peak)
28 kHz to 100 kHz	(1 × 10 ⁷ V rms × Hz)/FREQ
>100 kHz	100V rms

FREQUENCY (Channel A)

Range: .1 Hz to 100 MHz.

LSD Displayed: 10 Hz to 1 nHz depending upon gate time and input signal. At least 7 digits displayed per second of gate time.

Resolution:
For FREQ < 10 MHz;
$$\pm \text{LSD} \pm 1.4 \times \frac{\text{Trigger Error}}{\text{Gate Time}} \times \text{FREQ}$$

For FREQ ≥ 10 MHz; ±LSD††

Accuracy: ± Resolution ± (time base error) × FREQ

RATIO

Range: .1 Hz to 100 MHz, both channels.

LSD:
$$\frac{2.5 \times \text{Period}}{\text{Gate Time}} \times \text{Ratio (rounded to nearest decade)}$$

where "Period" is the period of the highest frequency input signal.

Resolution:
FREQ A > FREQ B
$$\pm \text{LSD} \pm \frac{\text{B Trigger Error}}{\text{Gate Time}} \times \text{Ratio}$$

FREQ B > FREQ A
$$A = \frac{2.5 \times \text{Period A}}{\text{Gate Time}} \times \text{Ratio (Rounded to nearest decade)}$$

$$\pm A \pm \frac{\text{B Trigger Error}}{\text{Gate Time}} \times \text{Ratio}$$

Accuracy: Same as resolution.

TOTALIZE

Manual:
Range: 0 to 100 MHz.

A Gated By B:
Totalizes input A between two events of B. Instrument must be reset to make new measurement. Gate opens on A slope, closes on B slope.

Range: 0 to 100 MHz.

Resolution: ±1 count.

Accuracy: ±1 count ± B Trigger Error × Frequency A.

PERIOD

Range: 10 ns to 10⁵ s.

LSD Displayed: 100 ns to 1 fs depending upon gate time and input signal. At least 7 digits displayed per second of gate time.

Resolution:
For PER > 100 ns;
$$\pm \text{LSD} \pm 1.4 \times \frac{\text{Trigger Error}}{\text{Gate Time}} \times \text{PER}$$

For PER ≤ 100 ns; ±LSD††

Accuracy: ± Resolution ± (time base error) × PER.

†Best Case Resolution for 1 Second Gate

	100 Hz	1 kHz	10 kHz	100 kHz	1 MHz	10 MHz	100 MHz
50 mV rms	±.0004 Hz	±.00048 Hz	±.0014 Hz	±.01 Hz	±.1 Hz	±1 Hz	±10 Hz
100 mV rms	±.0002 Hz	±.00029 Hz	±.0012 Hz	±.01 Hz	±.1 Hz	±1 Hz	±10 Hz
500 mV rms	±.00005 Hz	±.00014 Hz	±.0011 Hz	±.01 Hz	±.1 Hz	±1 Hz	±10 Hz
1V rms	±.00003 Hz	±.00012 Hz	±.0010 Hz	±.01 Hz	±.1 Hz	±1 Hz	±10 Hz

This chart shows best case frequency resolution versus input sine wave rms amplitude. This is best case because noise from the signal source is assumed to be zero; the trigger error is produced only by the counter's noise (i.e., 120 μV rms).

††Due to arithmetic truncation, quantization error will be ±1 or ±2 counts of the LSD (Least Significant Digit) as follows:

±2 counts of LSD if $\frac{\text{LSD}}{\text{FREQ or PER}} < 1 \times 10^{-7}$, FREQ < 10 MHz

±1 count of LSD if $\frac{\text{LSD}}{\text{FREQ or PER}} < \frac{1}{\text{Gate Time}}$, FREQ ≥ 10 MHz

±1 count of LSD for all other cases.

Table 1-1. Model 5316A Specifications (Continued)

TIME INTERVAL

Range: 100 ns to 10⁵ s.
LSD Displayed: 100 ns.
Resolution: ± LSD ± Start Trigger Error ± Stop Trigger Error.
Accuracy: ± Resolution ± (time base error) × T.I.

TIME INTERVAL AVERAGE

Range: 0 ns to 10⁵ s.
LSD Displayed: 100 ns to 10 ps depending upon gate time and input signal. See table in Definitions section.

Resolution:
$$\pm \text{LSD} \pm \frac{\text{Start Trigger Error}}{\sqrt{N}} \pm \frac{\text{Stop Trigger Error}}{\sqrt{N}}$$

Accuracy: ± Resolution ± (time base error) × T.I. ± 4 ns.
Number of Intervals Averaged (N): N = Gate Time × FREQ
Minimum Dead Time (stop to start): 200 ns.

TIME INTERVAL DELAY (Holdoff)

Front panel gate time knob inserts a variable delay of **NOMINALLY** 500 μs to 20 ms between START (Channel A) and enabling of STOP (Channel B). Electrical inputs during delay time are ignored. Delay time may be measured by simultaneously pressing T.I. Average, T.I. Delay, and Blue Shift key. Other specifications of T.I. Delay are identical to Time Interval.

TIME BASE

Frequency: 10 MHz.
Aging Rate: <3 × 10⁻⁷/mo.
Temperature: ≤5 × 10⁻⁶, 0 to 50°C.
Line Voltage: ≤1 × 10⁻⁷ for ±10% variation.
Oscillator Output: 10 MHz, 50 mV p-p into 50Ω.
External Frequency Standard Input: 1, 5, 10 MHz, 1V rms into 500Ω, on rear panel; 6V rms maximum.

GENERAL

Trigger Level Output: ±5% ±15 mV, over ±2.0V dc range at front panel test connectors.
Check: Counts internal 10 MHz reference frequency over gate time range **NOMINALLY** 500 μs to 30 ms.
Error Light: LED warning light activated if logic error is found during instrument turn-on self-check.
Display: 8-digit LED display, with engineering units annunciator.
Overflow: Only frequency and totalize measurements will overflow. In case of overflow, eight least significant digits will be displayed and front panel overflow LED will be actuated. All other measurements which would theoretically cause a display of more than eight digits will result in the display of the eight most significant digits.
Gate Time: Continuously variable, **NOMINALLY** from 60 ms to 10 s or 1 period of the input, whichever is longer. For FREQ A, a shorter gate time of 500 μs–30 ms is selectable by simultaneously pressing T.I. Delay and Totalize keys.
Sample Rate: Up to seven readings per second **NOMINAL** except in time interval mode, where it is continuously variable **NOMINALLY** from four readings per second to 1 reading every 10 seconds via Gate Time control.
Operating Temperature: 0° to 50°C.
Power Requirements: Selectable 100, 120, 220, or 240V (+5%, -10%) 48–66 Hz; 30 VA maximum.
Dimensions: 212 mm W × 88 mm H × 415 mm D (8 3/8 × 3 1/2 × 16 1/2 in.).

Weight: Net, 3.9 kg (8 lbs. 10 oz.); Shipping, 6.3 kg (14 lbs.).
Rack and stack metal case with rear panel, switchable AC power line module.
Rack Mount Kit: 5061-0072 recommended.

HP INTERFACE BUS (HP-IB)

Data Output
Format: (alpha character) ± (Reading) (Exponent) ± (2 digits).
Data Output Rate: ~7 Readings/second max. (10 in short G.T.)
Talk Only Mode: Selectable by rear panel switch.

Operating Commands
5316A: Reset, Initialize (to FREQ A), Wait State ON/OFF, Service Request Enabled/Disabled, Gate Time Range.
HP-IB: Group Execute Trigger, Device Clear, Selected Device Clear, Interface Clear, Local, Remote, Local Lockout, Read Status (Serial Poll Enable).

Programmable Controls and Functions
Frequency Functions: FREQUENCY A, FREQ A ARMED BY B, TOTALIZE, A GATED BY B, RATIO A/B, and FREQ C.
Period Function: Period A.
Time Interval Functions: Time Interval A–B, Time Interval Average A–B, Time Interval Delay.
Trigger Level Commands: Set Channel A Slope (±), set Channel B Slope (±), A Trigger Level: ±X.XX, B Trigger Level: ±X.XX.
Gate Time Command: Sets Gate Time Range.
Miscellaneous Functions: Gate Time Check, Display Test, 10 MHz Check, Interface Test.

OPTIONS

OPTION 001: High Stability Time Base (TCXO)
Frequency: 10 MHz.
Aging Rate: <1 × 10⁻⁷/mo.
Temperature: <1 × 10⁻⁶, 0° to 40°C.
Line Voltage: <1 × 10⁻⁸ for ±10% variation.

OPTION 003: C Channel
Input Characteristics
Range: 50 to 1000 MHz, prescaled by 10.
Sensitivity: 15 mV rms sine wave (-23.5 dBm) to 650 MHz, 75 mV rms sine wave (-9.5 dBm) to 1000 MHz. Sensitivity can be decreased continuously by up to 20 dB **NOMINAL**, 50 to 500 MHz and 10 dB **NOMINAL**, 500 to 1000 MHz by adjusting sensitivity control. Trigger level is fixed at 0V **NOMINAL**.
Dynamic Range:
15 mV to 1V rms (36 dB), 50 to 650 MHz.
75 mV to 1V rms (20 dB), 650 to 1000 MHz.
Signal Operating Range: +5V dc to -5V dc.
Coupling: AC
Impedance: 50Ω **NOMINAL (VSWR, 12.5:1 TYPICAL)**.
Damage Level: ±8V (DC + AC peak), fuse protected. Fuse located in BNC connector.

Frequency
Range: 50 to 1000 MHz.
LSD Displayed: 100 Hz to 1 Hz depending upon gate time. At least 7 digits per second of gate time.
LSD, Resolution and Accuracy: Same formulas as for Frequency A except "Gate Time" term becomes "(Gate Time)/10".

Table 1-1. Model 5316A Specifications (Continued)

OPTIONS (Continued)

OPTION 004: Oven Oscillator

- Frequency:** 10 MHz.
- Aging Rate:** $<5 \times 10^{-8}$ /month after 7 days of continuous operation. $<3 \times 10^{-7}$ /year after 180 days continuous operation.
- Warm-up:** $\pm 5 \times 10^{-8}$ of final value after 20 minutes.
- Temperature:** $\pm 2 \times 10^{-8}$, 0° to 50°C.
- Oscillator Output:** 50 mV p-p into 50Ω.

DEFINITIONS:

- Resolution:** Smallest discernible change of measurement result due to a minimum change in the input.
- Accuracy:** Deviation from the actual value as fixed by universally accepted standards of frequency and time.
- Least Significant Digit (LSD) Displayed:**

Frequency:

$$\frac{2.5 \times 10^{-7}}{\text{Gate Time}} \times \text{FREQ, for FREQ} < 10 \text{ MHz}$$

$$\frac{2.5}{\text{Gate Time}} \text{ for FREQ} \geq 10 \text{ MHz}$$

Period:

$$\frac{2.5 \times 10^{-7}}{\text{Gate Time}} \times \text{PER, for PER} > 100 \text{ ns}$$

$$\frac{2.5}{\text{Gate Time}} \times \text{PER}^2, \text{ for PER} \leq 100 \text{ ns}$$

All above calculations should be rounded to nearest decade (i.e., 5 Hz will become 10 Hz and .4 ns will be .1 ns).

NOTE

Time Interval Average is a statistical process. LSD displayed is calculated for 1 standard deviation (σ) confidence level.

Trigger Error:

$$\frac{\sqrt{(120 \times 10^{-6} \text{V})^2 + e_n^2}}{\text{(Input slew rate in V/s at trigger point)}} \text{ seconds rms}$$

Typical where e_n is the rms noise voltage of the input for a 100 MHz bandwidth.

Time Interval Average:

	LSD
1 to 25 intervals	100 ns
25 to 2500 intervals	10 ns
2500 to 250,000	1 ns
250,000 to 25,000,000 intervals	100 ps
>25,000,000 intervals	10 ps

1-11. OPTIONS

1-12. The options available for the 5316A are listed below. There are no field retrofit kits available for these options. All options should be requested at the time of the initial order. However, Section II contains the necessary information required to install Option 001 TCXO, Option 004 Oven Oscillator, and Option 003, Channel C. Options 001 and 004 requires the standard A7 assembly be replaced by the appropriate option (Option 004 adds an A13 assembly). Option 003 requires the addition of the A9 assembly and a new front panel. All parts must be ordered as separate items and then installed as described in Section II. Option 006 is described in its own manual. Full descriptions of Options 001, 003, and 004 begin with paragraph 3-62.

Option	Description
001	High Stability Time Base (TCXO)
003	Channel C 1 GHz
004	Oven Oscillator
006	Offset/Normalizer

1-13. Option 001 TCXO is a Temperature Compensated Crystal Oscillator that directly replaces the standard A7 oscillator assembly. Option 004 Oven Oscillator provide increased temperature stability over the TCXO. Specifications are listed in *Table 1-1*.

1-14. Option 003 Channel C allows frequency measurements to 1 GHz. Specifications are listed in *Table 1-1*.

1-15. Option 006 Offset/Normalizer allows the operator to make active mathematical modifications to the display of the 5316A. Option 006 is described in its own operation and service manual, HP Part Number 05315-90011, plus Addendum 05315-90019.

1-16. SAFETY CONSIDERATIONS

1-17. The 5316A Universal Counter is a Safety Class I instrument, designed according to International Safety Standards. This operating manual contains information, cautions, and warnings which must be followed by the user to ensure safe operation and keep the instrument in safe condition.

1-18. INSTRUMENT IDENTIFICATION

1-19. Hewlett-Packard instruments have a 2-section, 10-character serial number (0000A00000), which is located on the rear panel. The four-digit serial prefix identifies instrument changes. If the serial prefix of your instrument differs from that listed on the title page of this manual, there are differences between this manual and your instrument. Instruments having higher serial prefixes are covered with a "Manual Changes" sheet included with this manual. If the change sheet is missing, contact the nearest Hewlett-Packard Sales and Service Office listed at the back of this manual. Instruments having a lower serial prefix than that listed on the title page are covered in Section VII.

1-20. ACCESSORIES

1-21. *Table 1-2* lists accessory equipment supplied and *Table 1-3* lists accessories available.

Table 1-2. Accessories Supplied

Description	HP Part Number
Detachable Power Cord, 229 cm (7½ feet)	8120-1378

Table 1-3. Accessories Available

Description	HP Part Number
Rack Mount Kit	5061-0072

1-22. RECOMMENDED TEST EQUIPMENT

1-23. The test equipment listed in Table 1-4 is recommended for use during performance tests, adjustments, and troubleshooting. Substitute test equipment may be used if it meets the required characteristics listed in the table.

Table 1-4. Recommended Test Equipment

Instrument	Critical Specifications	Recommended Model	Use*
Oscilloscope	100 MHz Bandwidth	HP 1740A	P,A,T
Synthesizer/Generator	0.1—10 MHz	HP 3325A	P,A,T
Signal Generator	10—100 MHz	HP 8654A	P,A,T
Synthesized Generator	1000 MHz	HP 8660C/86602A	P,A,T
DC Voltmeter	20V Range, 0.05V Resolution	HP 3465A	P,A,T
Counter	10 MHz, .1 Hz Resolution	HP 5345A	A
50Ω Feedthrough	BNC Type	HP 10100C	P,A,T
Tee Connector	BNC Type	HP 1250-0781	P,A,T
Power Splitter	DC—18 GHz	HP 11667A	P
Cables (3)	4 BNC 50Ω	HP 11170C	P,A,T
Controller	IEEE 488-1978	HP 9825A/B	P,A,T,
Signature Analyzer		HP 5004A/5005A	T

*P = Performance Tests, A = Adjustments, T = Troubleshooting.

**9825A requires the 98210A Advanced Programming-String Variable ROM, the 98213A/14A or 16A General Extended I/O ROM, and a 98034A HP-IB Interface Card. A 9825B and 98034A may be used in place of the above system.

SECTION II INSTALLATION

2-1. INTRODUCTION

2-2. This section contains information for unpacking, inspection, storage, and installation.

2-3. UNPACKING AND INSPECTION

2-4. If the shipping carton is damaged, inspect the instrument for visible damage (scratches, dents, etc.). If the instrument is damaged, notify the carrier and the nearest Hewlett-Packard Sales and Service Office immediately (offices are listed at the back of this manual.) Keep the shipping carton and packing material for the carrier's inspection. The Hewlett-Packard Sales and Service Office will arrange for repair or replacement of your instrument without waiting for the claim against the carrier to be settled.

2-5. PREPARATION FOR USE

2-6. Power Requirements

2-7. The HP 5316A requires a power source of 100-, 120-, 220-, or 240-volt ac, +5%, -10%, 48 to 66 Hz single phase. Power consumption is approximately 15 watts. See Section I, Specifications for description.

2-8. Line Voltage Selection

CAUTION

Before connecting the instrument to ac power lines, be sure that the voltage selector is properly positioned as described below.

2-9. The 5316A is equipped with a power connector module that has a plug-in printed-circuit card line voltage selector to choose 100-, 120-, 220-, or 240-volt ac operation (see *Figure 2-1*). Before applying power, the selector card must be set to the correct position and the correct fuse must be installed as described below.

2-10. Power line connections are selected by the position of the plug-in card in the module. When the card is plugged into the module, the only visible markings on the card indicate the line voltage to be used. The correct value of line fuse, with 250-volt rating, must be installed after the card is inserted.

2-11. To convert from one line voltage to another, the power cord must be disconnected from the power module before the sliding window covering the fuse and card compartment can be moved to expose the fuse and circuit card.

2-12. Pull on the fuse lever to remove the fuse and then pull the card out of the module. The fuse lever must be held to one side to remove and insert the card. Insert the card so the marking that agrees with the line voltage to be used is visible.

2-13. Return fuse lever to normal position, insert correct fuse, slide plastic window over the compartment, and connect the power cord to complete the conversion.

NOTE

For operation from 100V ac or 120V ac use a .3A slo-blo fuse. For 220V ac or 240V ac operation, use a .15A slo-blo fuse.

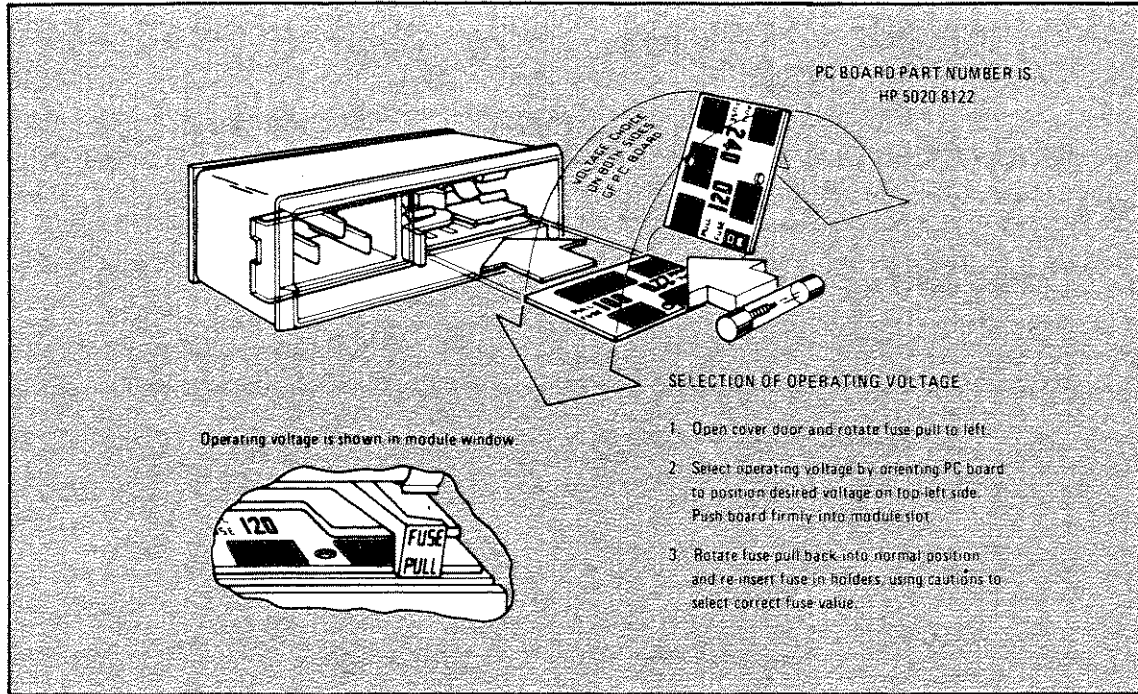

Figure 2-1. 5316A Line Voltage Selection

2-14. Power Cable

WARNING

BEFORE CONNECTING ELECTRIC POWER TO THIS INSTRUMENT, THE PROTECTIVE EARTH TERMINALS OF THIS INSTRUMENT MUST BE CONNECTED TO THE PROTECTIVE CONDUCTOR OF THE (MAINS) POWER CORD. THE MAIN PLUG SHALL ONLY BE INSERTED IN A SOCKET OUTLET PROVIDED WITH A PROTECTIVE EARTH CONTACT. THE PROTECTIVE ACTION MUST NOT BE NEGATED BY THE USE OF AN EXTENSION CORD (POWER CABLE) WITHOUT A PROTECTIVE CONDUCTOR (GROUNDING).

2-15. The 5316A is shipped with a three-wire power cable. When the cable is connected to an appropriate ac power source, this cable connects the chassis to earth ground. The type of power cable plug shipped with each instrument depends on the country of destination. Refer to *Figure 2-2* for the part numbers of the power cable and plug configurations available.

2-16. Operating Environment

2-17. TEMPERATURE. The 5316A may be operated in temperatures from 0°C to 50°C.

2-18. ALTITUDE. The 5316A may be operated at altitudes up to 4,600 metres (15,000 feet).

2-19. STORAGE AND SHIPMENT

2-20. Environment

2-21. The instrument may be stored or shipped in environments with the following limits:

Temperature -40°C to +75°C
Altitude 7,620 metres (25,000 feet)

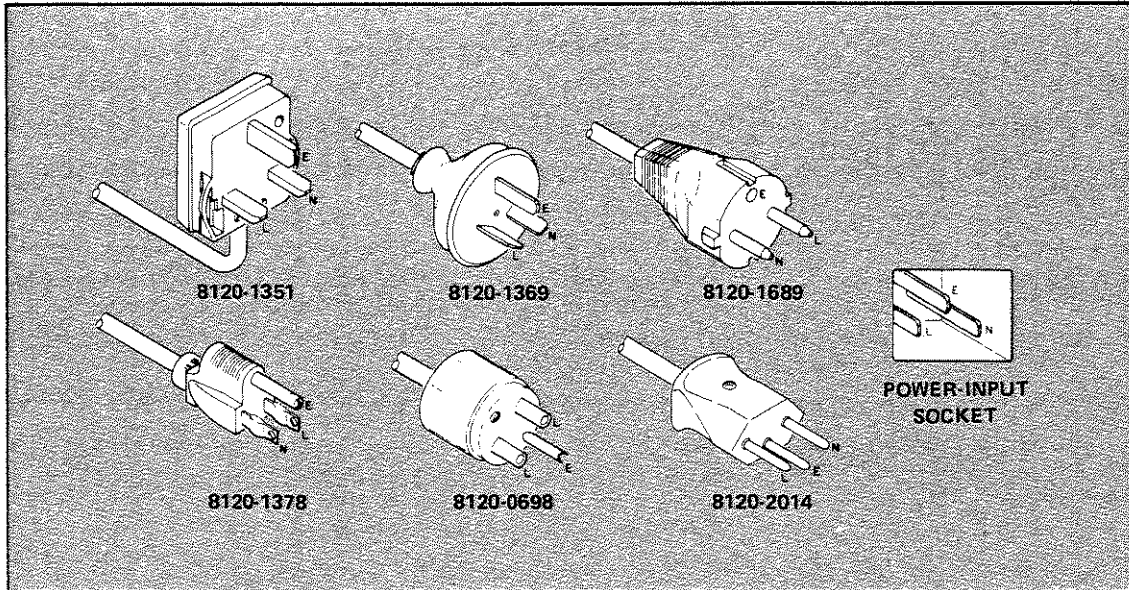

Figure 2-2. Power Cable HP Part Numbers versus Main Plugs Available

2-22. The instrument should also be protected from temperature extremes which cause condensation within the instrument.

2-23. Packaging

2-24. ORIGINAL PACKAGING. Containers and materials identical to those used in factory packaging are available through Hewlett-Packard offices. If the instrument is being returned to Hewlett-Packard for servicing, attach a tag indicating the type of service required, return address, model number, and full serial number. Also, mark the container FRAGILE to ensure careful handling. In any correspondence, refer to the instrument by model number and full serial number.

2-25. OTHER PACKAGING. The following general instruction should be used for repacking with commercially available materials:

- a. Wrap instrument in heavy paper or plastic. (If shipping to Hewlett-Packard office or service center, attach a tag indicating type of service required, return address, model number, and full serial number.)
- b. Use strong shipping container. A double-wall carton made of 350-pound test material is adequate.
- c. Use a layer of shock-absorbing material 70 to 100 mm (3- to 4-inch) thick around all sides of the instrument to provide firm cushioning and prevent movement inside container. Protect control panel with cardboard.
- d. Seal shipping container securely.
- e. Mark shipping container FRAGILE to ensure careful handling.
- f. In any correspondence, refer to instrument by model number and full serial number.

2-26. FIELD INSTALLATION OF OPTIONS

2-27. The following paragraphs provide instructions for the installation of Option 001 (TCXO), Option 004 (Oven Oscillator), and Option 003 (Channel C). Any of the options may be installed after the purchase of the 5316A by ordering the appropriate parts in Table 2-1 and performing the installation procedure listed in paragraphs 2-30 through 2-35.

Table 2-1. Options 001, 004, and 003 Parts Lists

OPTON 001 TCXO	
A7 TCXO ASSEMBLY	05316-60007
OPTION 004 OVEN OSCILLATOR	
Oven Oscillator Assembly Kit	05316-60104
4-40 .187" Pan Head Pozidriv Screws (3 ea.)	2200-0179
6-32 .250" Pan Head Pozidriv Screws (3 ea.)	2360-0113
OPTION 003 CHANNEL C	
Special BNC Connector	05305-60205
Connector Body	05305-20104
Teflon Insulator	05305-20105
Hex Nut	0590-0038
Lockwasher	1250-0632
Connector	05305-60206
Fuse .125A	2110-0301
Front Panel	05316-00005
Channel C Assembly A9	05315-60009
Screws 6-32 X .250" Pan Head Pozidriv (4 ea.)	2360-0113

WARNING

TO PREVENT ELECTRICAL SHOCK, REMOVE ALL POWER FROM THE INSTRUMENT BEFORE REMOVING TOP COVER.

2-28. Part Numbers for Ordering Option Kits

2-29. To obtain the necessary parts for installation of an option, order by part number as listed in Table 2-1 (refer to Section VI for ordering information):

2-30. Option 001 TCXO Installation

2-31. Option 001 Temperature Compensated Crystal Oscillator (TCXO) replaces the standard reference oscillator which plugs into a connector (J10) on the A1 motherboard. To install Option 001, proceed as follows:

- a. Remove the AC power cord.
- b. Remove the top cover by removing the screw located at the rear top of the cover. This screw also secures the strap handle to the top cover. Slide the cover backward and remove.
- c. Remove the two Pozidriv screws securing the A7 standard reference oscillator to the A1 Motherboard.
- d. Remove the A7 standard reference oscillator.
- e. Insert the Option 001 TCXO into J10 located on the motherboard. This is the same jack previously occupied by the standard reference oscillator.
- f. Secure the Option 001 TCXO using the two posidriv screws previously securing the standard reference oscillator.
- g. Perform the "Operator's Checks" listed in Figure 3-12.
- h. Go to Section V, A7 Option 001 TCXO Adjustment, paragraph 5-22.
- i. Replace the top cover.

2-32. Option 004 Installation

2-33. Option 004 Oven oscillator consists of two sections, a voltage regulator assembly that replaces the standard A7 assembly and an oven oscillator module (A13) that is mounted to the left side frame. A cable connects the regulator assembly and the module to supply power to the oscillator and route the 10 MHz output back to the A1 Motherboard via the A7 regulator assembly. To install Option 004 Oven oscillator, proceed as follows:

- a. Remove the AC power cord.
- b. Remove the top cover by removing the screw located at the rear top of the cover. This screw also secures the strap handle to the top cover. Slide the cover backward and remove.
- c. Remove the bottom cover by rotating the screw located at the rear of the cover counterclockwise. As the screw is rotated the cover will begin to slide backwards and away from the rear frame. When the screw comes free, slide the cover backwards until it can be freely removed.
- d. Remove the two Pozidriv screws securing the standard A7 assembly to the A1 Motherboard.
- e. Remove the A7 assembly.
- f. Insert the A7 regulator assembly into J10 on the A1 Motherboard. This is the same jack previously occupied by the standard oscillator.
- g. Secure the A7 regulator assembly with the same screws previously securing the standard oscillator.
- h. Orient the oscillator module so the label is facing the front of the 5316A, the power supply and output pins are facing the rear, and the portion of the bracket that wraps around the module is against the left frame.
- i. Looking at the left frame of the 5316A, note the 17 holes that run along the top of the frame. Position the oscillator/bracket so the top two holes of the bracket align with the 7th and 9th holes of the frame, as counted from the rear of the 5316A. Note the hole at the bottom of the bracket aligns with the 9th hole as counted from the rear. Secure the bracket to the side frame with three (3) 6-32 1/4" screws. See *Figure 5-8*.
- j. Center trimmer A7R2 (located at the top of the regulator assembly).
- k. Apply power to the 5316A. Select the CHECK mode. Set the Gate Time control fully counterclockwise, but not HOLD.
- l. The 5316A should display 10 MHz with the Gate Lamp flashing. If this does not occur, remove power and check all connections. The most likely place for mistakes are the connections to the oscillator module. If all connections are correct, but the oscillator still does not operate, then go to Section VIII, Troubleshooting, for the Option 004 Oven Oscillator.
- m. If the 5316A is operating properly, go to Section V, Adjustments, for the Option 004 Oven Oscillator, paragraph 5-26.
- n. This completes the installation of the Option 004 Oven Oscillator.

2-34. Option 003 Channel C Installation

2-35. To install Option 003 proceed as follows:

- a. Remove the AC power cord.
- b. Remove the top cover by removing the screw located at the rear top of the cover. This screw also secures the strap handle to the top cover. Slide the cover backwards and remove.
- c. Disconnect the secondary of transformer T1 from the motherboard at J7. J7 is located in front of transformer T1.

- d. Remove the three screws on the right side frame of the instrument securing the support bracket (also a heat sink for the power supply regulators) and A6 Digital-to-Analog Converter to the right-side frame. Remove the cable connecting the A6 Digital-to-Analog Converter to the A3 Input Switch assembly. Remove the A6 Digital-to-Analog Converter.
- e. Remove the screw located at the front of the A12 HP-IB Interface assembly securing this assembly to a spacer mounted to the A1 Motherboard.
- f. Remove the screw located at the lower center of the rear panel securing the A1 Motherboard to the rear panel.
- g. Remove the gray trim strip from the top of the front frame and remove the three screws securing the front panel to the front frame.
- h. Remove the three screws located on the bottom of the front frame securing the front panel to the front frame. The front two feet must be removed to access these screws.
- i. Disconnect the ribbon cable connecting the A12 HP-IB Interface to the A1 Mother-board (J8).
- j. On the rear panel, remove the nut securing the INT/EXT BNC to the rear panel.
- k. Remove the A1 Motherboard from the cabinet frame by gently pushing at the rear of the A4 Input Amplifier assembly and the heat sink until the motherboard can be freely removed.
- l. Remove the two LEVEL/SENS knobs and GATE TIME knob from the front panel.
- m. Remove the two 1/4-inch nuts securing the trigger level nuts to the front panel.
- n. Remove the two hex nuts securing the CHANNEL A and CHANNEL B BNC's to the front panel.
- o. Remove the 1/4-inch hex nut on the left-side (back) of the A2 assembly, and pull the front panel straight forward, until clear. Note the spacer between the front panel and the A2 assembly. Disconnect the two front panel trigger level slide-on connectors from A3.
- p. Remove the four Pozidriv screws securing the A4 assembly to the A1 Motherboard. Remove the combination A3/A4 assembly by gently lifting on the rear edge of the A4, until the pins come free of the A1 Motherboard Connector A1J4.
- q. Position the A9 Channel C assembly, component side up and protruding pins toward the rear of the instrument, over the A1 Motherboard Connector A1J3. Install by gently pressing the row of pins into connector A1J3 until the assembly rests on the spacers mounted on A1. Secure the A9 assembly with four Pozidriv screws (6-32 x .250").
- r. Install the special input BNC (supplied) in the INPUT C position (center) of the 5316A replacement front panel (supplied) as illustrated in Section III, *Figure 3-9*.
- s. Connect the brass SMC connector on A9W1 to the INPUT C BNC and tighten.
- t. Go to A9 Option 003 Channel C Adjustment, paragraph 5-28.
- u. Reassemble the instrument by essentially performing the reverse of steps a. through p.

SECTION III OPERATION

3-1. INTRODUCTION

3-2. This section provides operating information for the 5316A Universal Counter. Descriptions of all front panel controls, connectors, and indicators, as well as an operator's check, operating instructions, and operator's maintenance, are provided.

3-3. OPERATING CHARACTERISTICS

3-4. The 5316A is a 100 MHz/100 ns full universal counter, capable of Frequency, Period, Time Interval, Ratio, and Totalize measurements. To maximize resolution, the 5316A uses a reciprocal counting technique for frequencies below 10 MHz, automatically switching to conventional frequency counting for frequencies above 10 MHz. The gate time is continuously adjustable from 60 ms to 10 s, via the front panel. The internal microcomputer performs the calculations, and automatically takes into account the selected gate time. The display is given in engineering notation (i.e., exponents of blank, ± 3 , ± 6 , or ± 9 , except in totalize modes). The input amplifiers are optimized for both time interval and frequency measurements. In addition, the 5316A may be programmed via the HP-IB. The rear panel external reference input can accept 1, 5, or 10 MHz as the reference due to a time base multiplier (injection-lock-multiplier). With the addition of Option 001 TCXO or Option 004 Oven Oscillator, increased temperature stability is gained, and this increased stability allows extended calibration periods.

3-5. When Option 003 Channel C is installed, the frequency counting range of the counter is extended to 1 GHz. Signals on Input C are prescaled by 10, then routed to the Channel C input of the MRC (Multiple Register Counter) integrated circuit on the 5316A motherboard. The input sensitivity can be decreased, continuously, up to 20 dB nominally (in the range of 50 to 500 MHz) and 10 dB nominally (in the range of 500 to 1000 MHz).

3-6. MODES OF OPERATION

3-7. The 5316A provides 10 modes of operation and two CHECK functions. The resolution and accuracy for each mode except A Armed by B is provided in *Table 1-1*. The modes of operation are described in the following paragraphs:

FREQ A	A BY B (Gated Totalize)
PER A	FREQ A ARMED BY B
T.I. A-B	FREQ C (Option 003)
T.I. AVG. A-B	TOT (Manual Totalize START/STOP)
T.I. DELAY (Holdoff)	CHECK
RATIO A/B	Display Check

3-8. FREQ A

3-9. Frequency measurements are made by connecting a signal (up to 100 MHz) to INPUT A, and pressing the FREQ A function (with the Blue Shift key OUT). Select the appropriate input signal conditioning and adjust the LEVEL/SENS control (with TRIGGER LEVEL/SENSITIVITY key to TRIGGER LEVEL) to the optimum trigger point. The optimum trigger point may be determined by centering the LEVEL/SENS control within the triggering range, and triggering is indicated by the flashing TRIGGER light. The actual trigger voltage may be determined by monitoring the TRIGGER LEVEL OUT on the front panel. The voltage at these points will be within $\pm 5\% \pm 15$ mV of the actual trigger voltage over a ± 2.0 volt range. The GATE TIME control determines the resolution of the measurement, and may be

displayed by pressing the GATE TIME function key and Blue Shift key. The gate time range when FREQ A is pressed is 60 ms to 10 s, typical. However a gate time range of 500 μ s to 30 ms is available by pressing T.I. DELAY and TOT STOP/START simultaneously. When the Blue Shift key is OUT, the 5316A will be in FREQ A. When the Blue Shift key is IN, the 5316A will be in PER A. PER A is discussed in the following paragraph.

3-10. PER A

3-11. The Period A mode allows signal period measurements to be made over a range of 10⁵ s to 10 ns into INPUT A. Select the appropriate input signal conditioning, and Trigger Level/Sensitivity. The gate time range is 60 ms to 10 s, typical, when PER A is pressed. However, a shorter gate time is also available for PER A (500 μ s to 30 ms) as described in FREQ A, paragraph 3-9.

3-12. T.I. A-B

3-13. T.I. A-B measures the time interval between a START signal at INPUT A and a STOP signal at INPUT B. If both the START and STOP signals are derived from the same signal, connect the signal to INPUT A and set the SEP/COM A key to the COM A position (IN). Separate Slope and Level/Sensitivity controls for each channel allow variable triggering on either positive or negative going slope. A single-shot time interval measurement may be made over a range of 100 ns to 10⁵ s.

3-14. T.I. AVG A-B

3-15. The T.I. Average mode provides greater resolution of time interval measurements than single-shot T.I. mode provides. In the T.I. AVG mode, the gate time control varies the number of events of time intervals averaged (approximately GATE TIME \times REPRATE). The resolution of the measurement is improved by the \sqrt{N} , where N is the number of time intervals averaged. A limited range of negative T.I. measurements (i.e., B triggers before A) are possible in T.I. AVG mode.

3-16. In the T.I. AVG mode, there must be at least 200 ns dead time. Dead time is the time between the preceding time interval stop event and the current time interval start event, as shown in Figure 3-1. This means that in T.I. AVG mode, the repetition rate must be less than 5 MHz. Also time interval averaging of high stability (synthesized) sources is not recommended because the displayed result may not be accurate. Proper averaging requires that there be no coherence between the source and the counter time base oscillator.

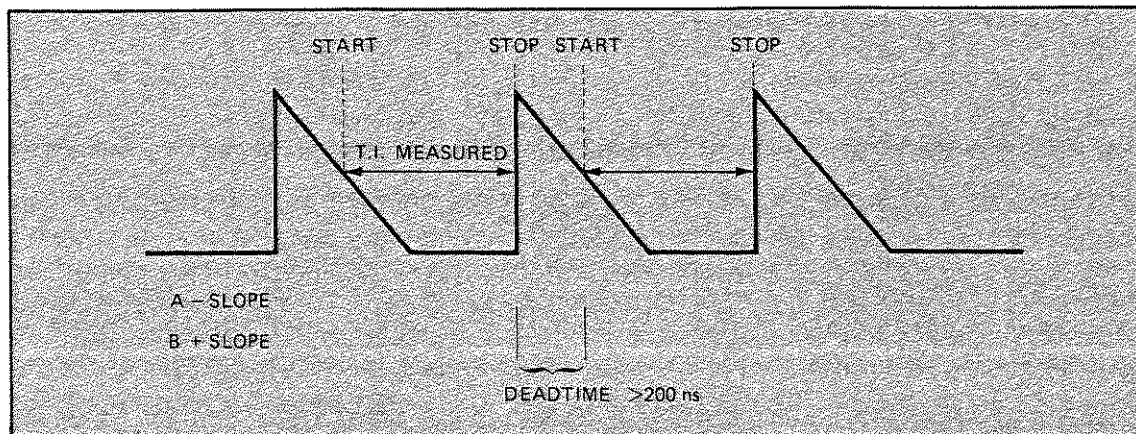

Figure 3-1. T.I. Average Dead Time

3-17. T.I. DELAY (HOLD OFF)

3-18. The T.I. DELAY mode of operation is similar to T.I. A→B, but with the following additional control: The front panel GATE TIME control inserts a variable delay (from 500 μ s to 30 ms nominal) between the START (INPUT A) event and the enabling of the STOP (INPUT B) event. Potential STOP events are ignored during the specified delay or holdoff. The amount of delay time may be continuously measured and displayed by simultaneously pressing the T.I. A→B, T.I. DELAY, and Blue Shift keys. *Figure 3-2* illustrates the T.I. DELAY function. It should be noted that both START and STOP Slopes are positive in this illustration.

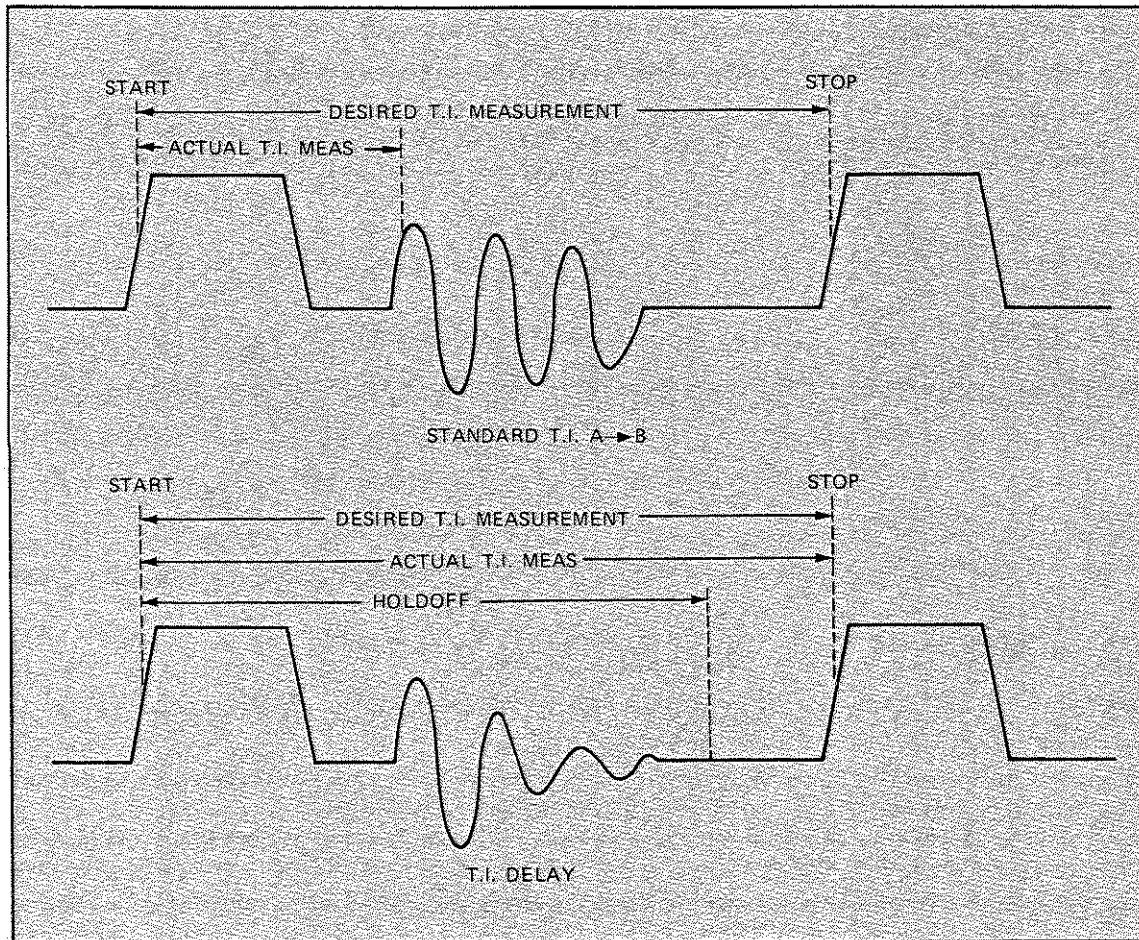

Figure 3-2. T.I. DELAY

3-19. RATIO A/B

3-20. The RATIO A/B mode of operation measures and displays the frequency ratio of signals on INPUT A to signals on INPUT B. The GATE TIME control determines the resolution by selecting the number of cycles of the INPUT B signal over which the ratio A/B is measured. Increasing the gate time (towards MAX) or increasing the frequency of INPUT A results in an increased resolution of the measurement. Frequencies up to 100 MHz are allowed on both channels.

3-21. A BY B

3-22. A BY B (A gated by B) is a totalize mode of operation (see *Figure 3-3*) in which events on INPUT A (up to 100 MHz) are counted for a duration determined by INPUT B. The gate is "OPENED" on the slope of Input B selected by the Channel A Slope switch, and "CLOSED" on

the slope of Input B selected by the Channel B Slope switch. This allows any one of four discrete gate durations from a given signal on Input B. The Channel A Slope switch also determines which slope of the events signal (on INPUT A) is counted. A BY B is a single-shot mode of operation. The RESET button must be pressed to clear the display and allow the initiation of a new measurement.

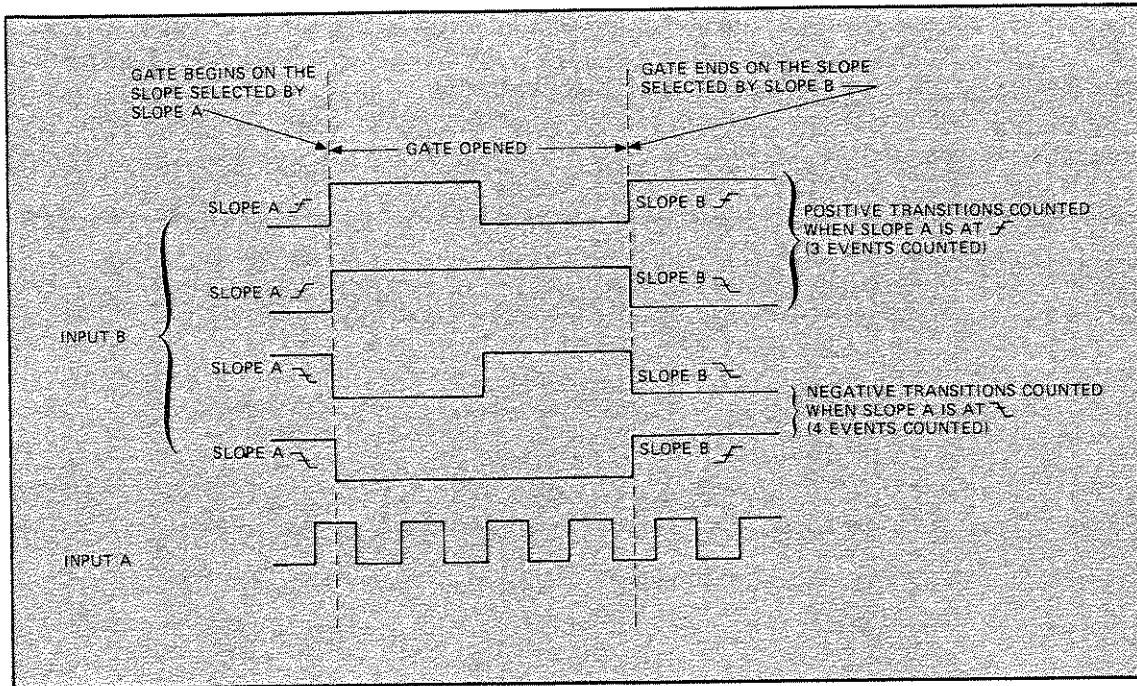

Figure 3-3. Totalize A BY B

3-23. A ARMED BY B

3-24. The 5316A has a measurement function, Frequency A, Averaged, Armed By B, for frequency averaging. Called "A ARMED BY B", this function allows the 5316A to average together multiple frequency measurements. To do this a sampling signal synchronized with and of pulse width less than the frequency bursts must be applied to the Channel B input. This signal performs two functions: one, it tells the the 5316A when to count the incoming bursts and when to ignore the dead time between bursts; and two, it opens the 5316A gate. The measurement interval is set from the front panel and its length determines the number of bursts to be averaged. Figure 3-4 shows an example of function A Armed By B. In this example, 1MHz bursts, 10 μ s wide, at a 10 kHz repetition rate are applied to Channel A input. A sampling signal of equal repetition rate and shorter pulse width is applied to Channel B. This sampling signal must be synchronized with the Channel A frequency burst signal. When the first burst occurs, the sampling signal at Channel B opens the gate, and tells the 5316A to begin counting the events at Channel A. When the sampling signal disappears, the 5316A stops counting the events at Channel A. If the gate is still open and another burst occurs, the 5316A will add these "new" events to the previous events counted. This will continue until the measurement interval runs out. On the next sampling pulse, after the gate closes, the 5316A will compute the average frequency of the signal during the burst (in this example 1 MHz). A final sampling pulse **must** occur after the measurement interval ends to terminate the measurement. The events that occurred during this final pulse are not averaged in.

3-25. The length of the measurement interval and signal repetition rate determine how many bursts will be averaged. Faster burst repetition rates allow shorter measurement intervals for a given number of averages. The main limit is that no more than 100 million "events" can be counted (either input frequency cycles or time base counts). In the case of Figure 3-4, each burst contains 10 "events", with 10

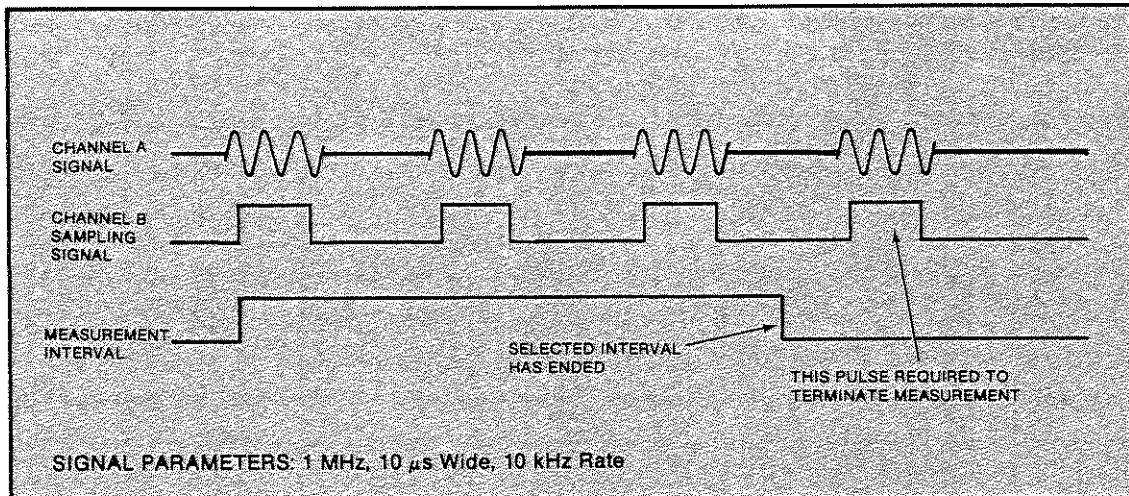

Figure 3-4. A ARMED BY B

thousand occurring in 1 second for 100 thousand "events" per second. Since 100 million events is the limit, the 5316A could average for 1000 seconds before the events counter would overflow. And, since the measurement interval determines the number of averages, a 1000-second measurement interval would be necessary before the events count or time base count would overflow. This, of course, is longer than that obtainable from the 5316A (maximum measurement interval of ~10 seconds). A specific case where the 5316A would overflow would be a 50 MHz signal pulsed for 200 ns at a 2 MHz rate. In this case 10 "events" occur during each burst, with 2 million bursts per second, or 20 million "events" in 1-second. So, the 5316A would overflow in 5 seconds, thus the gate time must be less than 5 seconds, and 10 million bursts would be averaged. If the 100 million events limit is exceeded the displayed answer will be inaccurate.

3-26: A ARMED BY B has two modes (two different measurement interval ranges) and is not labeled on the front panel. For a measurement interval range of 500 μ s-30 ms, press T.I. DELAY and RATIO A/B together. The measurement interval may be displayed by selecting the GATE TIME mode for the LONG interval or by pressing T.I. A-B, T.I. DELAY, and Blue Shift key simultaneously for the SHORT interval. For a measurement interval range of 60 ms to 10 seconds, press FREQ A and TOT STOP together. The Channel A Trigger Slope is set by the front panel Channel A Slope switch. The sampling signal enable slope (begin counting) is determined by the Blue Shift key. In the OUT position the counting will be enabled on the sampling signal positive slope. In the IN position, the counting will be enabled on the sampling signal negative slope. The gate will also be opened on the same slope as determined by the Blue Shift key. The disable slope is determined by the Channel B front panel slope switch. The measurement interval is controlled, as normal, by the front panel GATE TIME control. The gate will close once the selected time has passed. There is no problem if the gate should close in the middle of counting a burst. The following limits do exist in this mode.

1. 200 ns minimum dead time between bursts.
2. 100 ns minimum burst width.
3. The enable slope can only be negative when using the short measurement interval (500 μ s-30 ms), but can be positive or negative when under remote control.

Resolution increases with the square root of the number of samples averaged, N.

$$\text{Resolution} \sim \frac{(10^{-7}) \times (\text{INPUT FREQ})}{(\text{Sampling Signal Width}) \times (\sqrt{N})} \quad \text{Hz}$$

$$N \sim \frac{\text{Measurement Interval}}{\text{Gate signal repetition rate}}$$

From Figure 3-4, the sampling signal is 10 μ s wide at a 10 kHz repetition rate with a measurement interval of 1-second. With a single-shot measurement:

$$\text{resolution} = \frac{100 \times 10^{-9}}{10 \times 10^{-6}} \times \frac{1 \times 10^6}{\sqrt{N}} = 10^4 \text{ or } 10 \text{ kHz resolution}$$

but with average $N = 10000$ (1 s measurement interval):

$$\text{resolution} = \frac{100 \times 10^{-9}}{10 \times 10^{-6}} \times \frac{10^6}{\sqrt{10000}} = 100 \text{ Hz (100 times better)}$$

Accuracy: The actual measurement interval is shorter than the correct value by about 1 ns. With short sample pulse widths and large N values the displayed answer will not be perfectly accurate:

$$\text{Ultimate accuracy} = \frac{10^{-9}}{\text{measurement interval}} \times (\text{Input FREQ})$$

With a 10 μ s sample pulse width, accuracy can be as good as 100 Hz if enough events are averaged.

3-27. FREQ C (Option 003)

3-28. To make a frequency measurement on a CW signal in the range of 50 MHz to 1 GHz, select FREQ C function and apply the signal to INPUT C.

CAUTION

Make sure that the amplitude of the signal does not exceed the 1V rms dynamic range.

Set the GATE TIME control to MIN (but not hold). Set the SENS C control to MIN. Slowly move the SENS C control in a clockwise direction (toward MAX) until the counter begins to gate. This represents the optimum trigger sensitivity. To increase the displayed resolution, move the GATE TIME control toward MAX.

NOTE

The Trigger Lights for INPUT A and INPUT B are inoperative and extinguished when functions FREQ C or GATE TIME are selected. This is normal. However pressing either Channel A or B Slope switches will reset the counter.

3-29. TOT STOP/START

3-30. Totalize STOP/START is a manually gated, Totalize mode of operation. Pressing the Blue Shift key (IN position) opens the main gate, allowing INPUT A events to be counted. Pressing the Blue Shift key again (OUT position) closes the gate, stopping the count. The count is continuously displayed, and cumulative from gate cycle to gate cycle. The RESET button clears the counter and resets the display to zero.

3-31. CHECK

3-32. The Check function applies 10 MHz from the internal (or external) reference oscillator to the Multiple Register Counter (MRC). It is used to verify the basic operation of the counter, GATE light and GATE TIME control.

3-33. Display Check

3-34. The Display Check is an unlabeled function, which cycles the display through a routine that exercises all digits and most annunciators. With the POWER switch to ON, and all function switches to the "OUT" position, a rolling display, corresponding to Table 3-1, will result.

Table 3-1. Display Check

Digit Displays (7-segment)	OVFL	ERROR	-	Hz	S	GATE	Decimal Point Position		
							1	2	3
0							*		
1	*		*					*	
2	*				*				*
3	*		*		*				
4	*			*					
5	*	*	*	*					
6	*			*	*				
7	*		*	*	*				
8	*					*			
9	*		*			*			
BLANK	*		*	*	*	*			

3-35. PANEL FEATURES AND CONTROLS

3-36. The following paragraphs describe the features and controls of function selection, signal conditioning, and display sections of the front panel. Front and rear panel controls are individually located and described in *Figures 3-10* and *3-11*.

3-37. FUNCTION SELECTION CONTROLS

3-38. The function selection controls section of the front panel contains the POWER (STBY/ ON), and RESET/LOCAL keys, the "Function" keys group (within the border outline) and Gate Time/Delay control.

3-39. The POWER key sets the 5316A either to ON or STBY (standby). In the ON position (IN) power is supplied to the entire instrument. In the STBY position (OUT) the unregulated voltages are disconnected from the power supply voltage regulators. The RESET/LOCAL key clears and updates the display for continuous measurement modes, and resets the counter in Totalize modes. Also see Remote Programming via the HP-IB paragraph 3-73.

3-40. Each of the keys within the outlined function group can select one of two functions, as follows: With the Blue Shift key in the "OUT" position, the keys select the function labeled above (e.g., FREQ A, T.I. A→B, etc.). With the Blue Shift key in the IN position, the keys select the function labeled in blue below (e.g., PER A, T.I. AVG A→B, etc.).

3-41. The GATE TIME/DELAY control determines the amount of gate time per measurement, continuously adjustable over a range of 60 ms to 10 s. The selected gate time may be displayed by pressing the GATE TIME function key, and the Blue Shift keys. In the T.I. DELAY mode of operation, the control determines the amount of time the start channel is held off or "delayed" (see paragraph 3-17). The amount of "delay" may be displayed by pressing the T.I. A→B, T.I. DELAY, and Blue Shift key simultaneously. In the T.I. A→B mode of operation, the GATE TIME/DELAY control determines the "sample rate".

3-42. SIGNAL CONDITIONING CONTROLS

3-43. A full complement of signal conditioning controls are provided for each channel (A and B) input (see Figure 3-6). These controls allow the selection of Attenuation (X1, X20), Slope (positive or negative) and input coupling (AC or DC). The SEP/COM A switch allows the selection of separate Channel A and B input in the SEP position. The COM A position disconnects the Channel B Input BNC, and connects both Channel A and Channel B input amplifiers to the Channel A input.

3-44. A low pass filter for Channel A input is provided. With the FILTER NORM key in the 100 kHz (IN) position, frequencies above 100 kHz are effectively attenuated. With the FILTER NORM key in the Normal (OUT) position there is no effect.

3-45. TRIGGER LEVEL/SENSITIVITY CONTROLS

3-46. The Trigger Level/Sensitivity controls provided for each channel operate as follows: With the TRIGGER LEVEL/SENSITIVITY key in the "OUT" position, the LEVEL/SENS control adjusts the trigger level, (over a range of ± 2.5 volts dc in ATTN X1, or ± 50 volts dc in ATTN X20). With the TRIGGER LEVEL/SENSITIVITY key in the "IN" position, the LEVEL/SENS control adjusts the input sensitivity from MAX (10 mV up to 10 MHz, 25 mV up to 100 MHz) with control fully clockwise to MIN (greater than 500 mV) with control fully counterclockwise (see Figure 3-5). The trigger levels may be monitored at the front panel TRIGGER LEVEL jacks. The voltage at this point is $\pm 5\% \pm 15$ mV of the actual voltage over the range of ± 2.0 V.

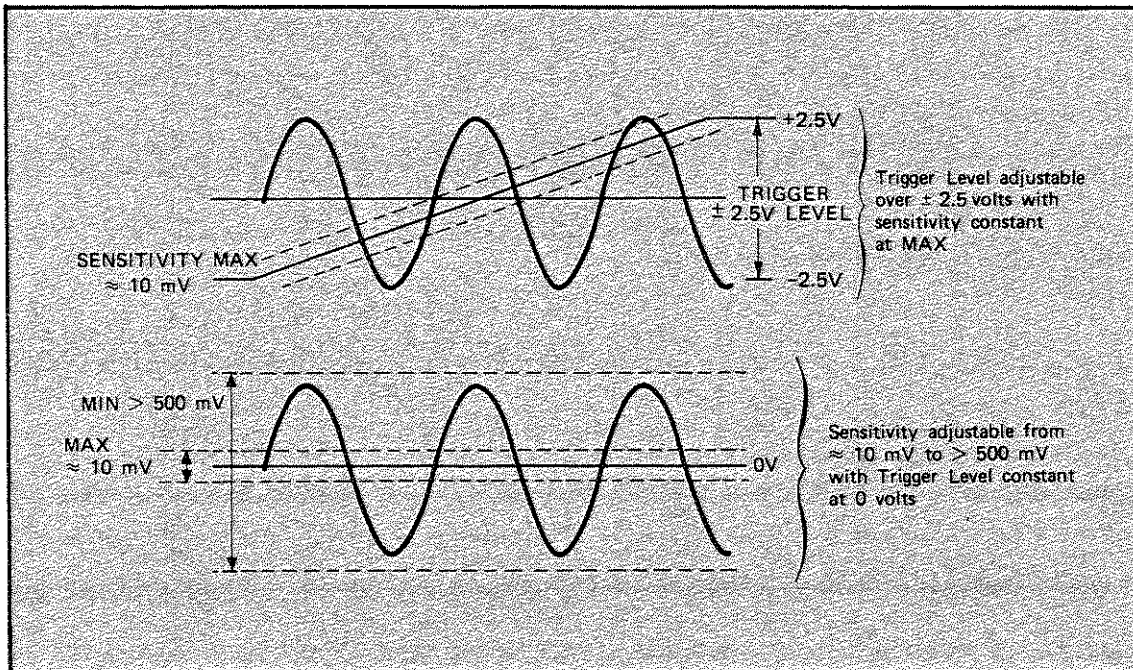

Figure 3-5. Trigger Level/Sensitivity Control

3-47. DISPLAY

3-48. The 5316A counter display consists of nine LEDs, providing eight digits of resolution and a one-digit exponent. All measurements (except Totalize modes) are displayed in engineering notation [i.e., exponents of blank (none), ± 3 , ± 6 , or ± 9 (+ is not displayed)] with automatic decimal point location. Annunciators for indicating the measurement units Hz, for Hertz, and s, for seconds are provided. The OVFL annunciator indicates that the leftmost significant digits have overflowed

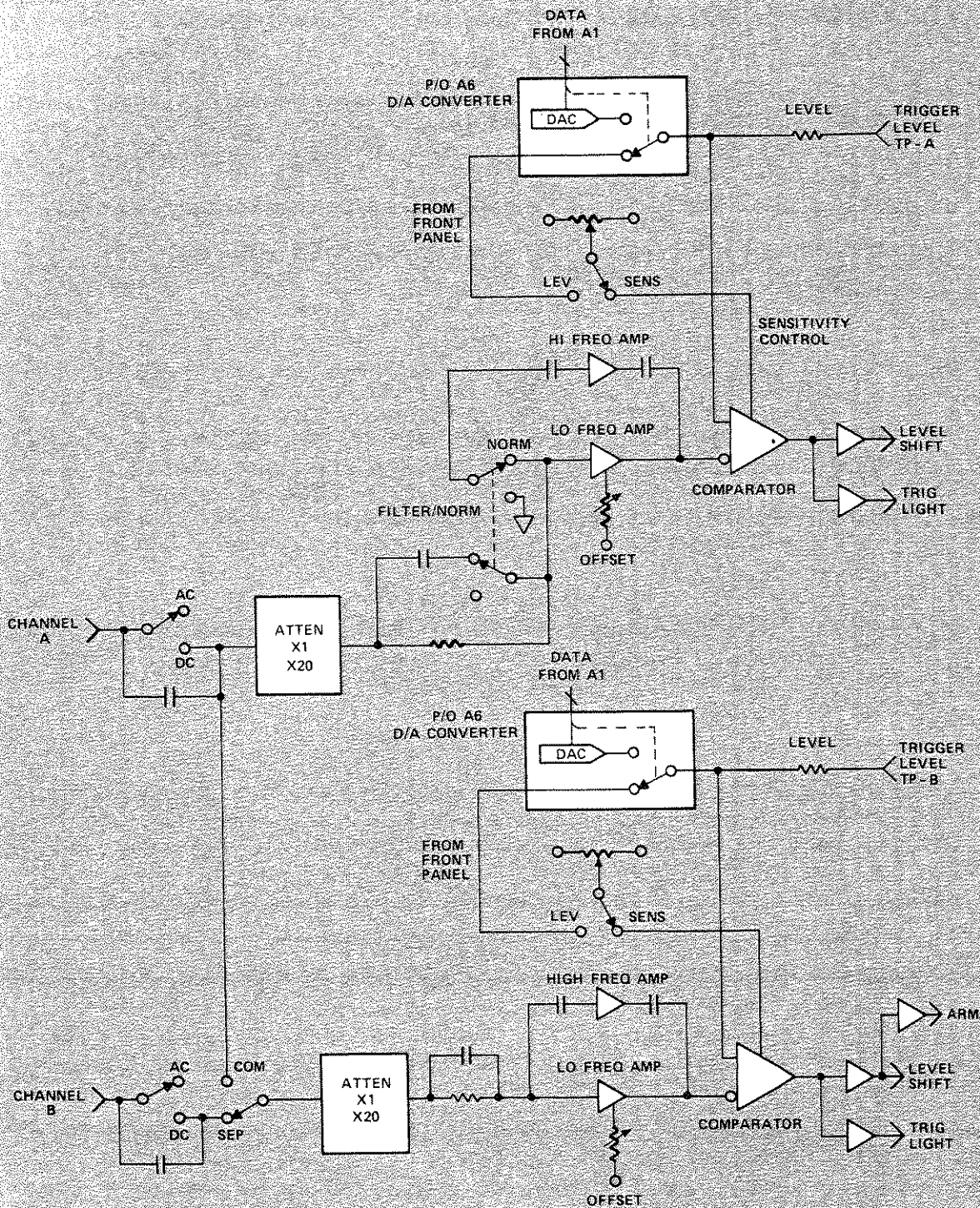

Figure 3-6. Input Amplifier Block Diagram

the display. The GATE annunciator indicates the counter has been triggered and a measurement is in progress. The ERROR annunciator indicates a failure during power-up self-check (see paragraph 3-59). The ADRSD and REMOTE lamps annunciators indicate the instrument's status during remote control (see Paragraph 3-86).

3-49. OPERATOR'S CHECKS

3-50. A procedure for verifying the basic operation of the 5316A is provided in *Figure 3-12*. This check utilizes the instrument's self-calibration cycle and visual verification of front panel controls by front panel indicators. No additional equipment is required.

NOTE

This check is not intended to verify the accuracy or performance specifications of the instrument.

3-51. OPERATING INSTRUCTIONS

WARNING

BEFORE THE INSTRUMENT IS SWITCHED ON, ALL PROTECTIVE EARTH TERMINALS, EXTENSION CORDS, AUTOTRANSFORMERS, AND DEVICES CONNECTED TO IT SHOULD BE CONNECTED TO A PROTECTIVE EARTH GROUNDED SOCKET. ANY INTERRUPTION OF THE PROTECTIVE EARTH GROUNDING WILL CAUSE A POTENTIAL SHOCK HAZARD THAT COULD RESULT IN PERSONAL INJURY.

WARNING

ONLY FUSES WITH THE REQUIRED RATED CURRENT AND SPECIFIED TYPE SHOULD BE USED. DO NOT USE REPAIRED FUSES OR SHORT CIRCUITED FUSE-HOLDERS. TO DO SO COULD CAUSE A SHOCK OR FIRE HAZARD.

CAUTION

Before the instrument is turned on, it must be set to the voltage of the power source, or damage to the instrument could result.

3-52. POWER-UP SELF-CHECK

3-53. When the 5316A is turned on, a power-up reset and self-check cycle is automatically initiated. This is approximately a 2-second cycle, indicated by the following display:

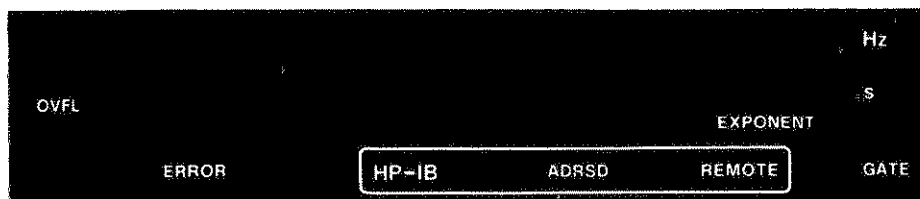

NOTE: Error LED may or may not light during Power-Up Self-Check

3-54. During this cycle, the microcomputer performs a check sum of the internal program in ROM and a bit pattern is written into RAM. Then it performs a partial check of the MRC and I/O ports, and performs a U1-U10 (3870-6801) link test between the microcomputers. Any failure during the cycle will produce a numbered error (for a U1 microcomputer, MRC or I/O failure), or a flashing of the HP-IB status LEDs (for a U1-U10 microcomputer link test failure). If a numbered error occurs, the ERROR LED will remain lit. Refer to Error Messages, paragraph 3-59. If the 5316A is placed into STANDBY and then immediately placed in ON again, the display will illuminate random segments during the power-up cycle. This is normal.

3-55. MEASUREMENT PROCEDURES

3-56. Figures 3-13 through 3-21 show general operating procedures with the HP Model 5316A Universal Counter in typical measurement setups. Description numbers match the locator illustrations. The following paragraphs provide recommended operating guidelines, to assist in making the most accurate measurement possible.

3-57. Frequency, Period, and Ratio Measurements

1. For cw sine wave or symmetrical waveforms (triangle, square, etc.) use ac coupling and the sensitivity mode.
2. For asymmetrical waveforms (pulse trains, TTL, ECL signals, ramps, etc.) use a combination of dc coupling, Trigger Level, and fixed attenuator. AC coupling these types of signals tends to distort them slightly, due to the charging of the capacitor. More important, the position of the signal on the zero preset trigger level is determined by the average dc level of the input. Depending on the pulse width and duty cycle, this dc average may be low enough to allow the base line noise to trigger the counter, producing false counts (see Figure 3-7). DC coupling fixes the dc level of the input signal, which allows the adjustable Trigger Level to be positioned at the optimum point. Set the Trigger Level control to the approximate center of the triggering range indicated by the trigger light (see Figure 3-8) The actual dc trigger level may be monitored at the front panel test point. When programming via the HP-IB, it may be set directly.

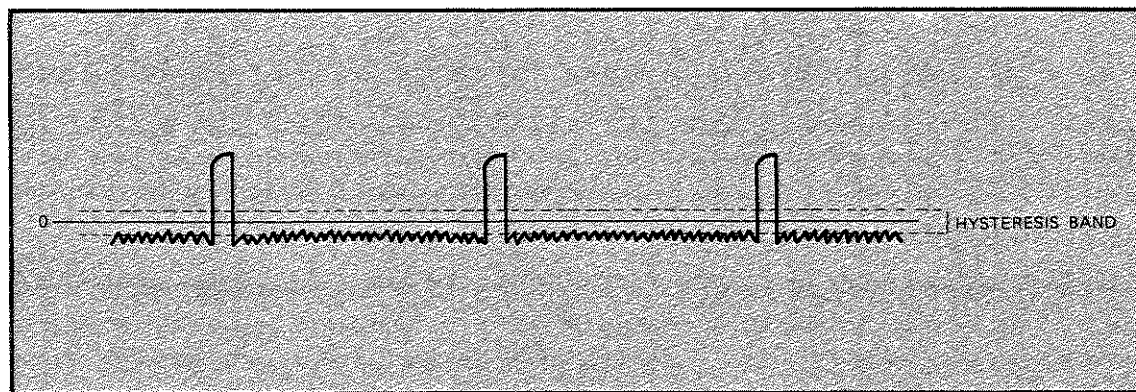

Figure 3-7. AC Coupled Measurements

3. When input loading is a problem (i.e., 1 M Ω load or cable capacitance) or when a more convenient method of probing is desirable, use a 10:1 scope probe. A probe is recommended for all logic applications.
4. For sine wave measurements <100 kHz, always use the low pass filter, selectable on the front panel. Normally the input signal is integrated over the entire 100 MHz bandwidth. Use of the Filter effectively removes noise and harmonics (above 100 kHz), that may affect the correct measurement.

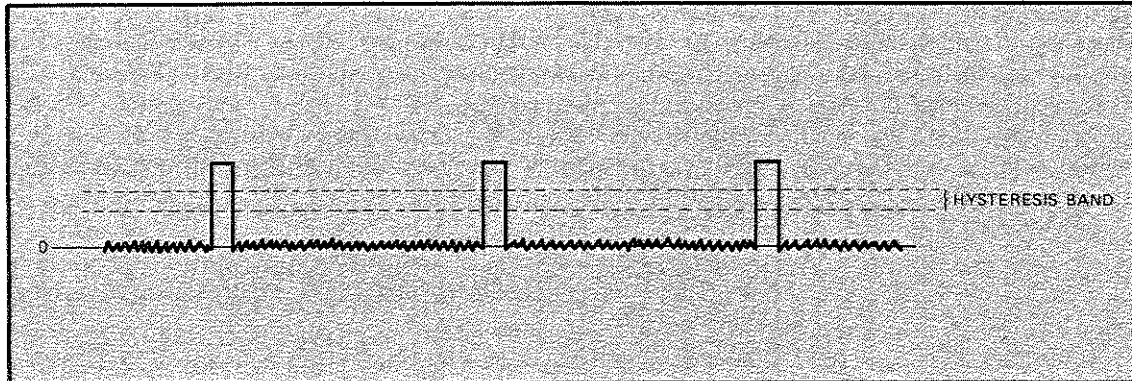

Figure 3-8. DC Coupled Measurements

5. Be very careful with input levels at higher frequencies (greater than 5 MHz). The counter front end is protected to 6 volts rms at these frequencies.

WARNING

WHEN MEASURING POWER LINE FREQUENCIES, BE EXTREMELY CAREFUL AND ALWAYS USE A STEP-DOWN ISOLATION TRANSFORMER (WITH ≈10V OUTPUT). THE COUNTER'S PANEL IS TYPICALLY AT SIGNAL GROUND, SO NEVER TRY TO MEASURE THE 50 OR 60 Hz LINE WITHOUT AN ISOLATION TRANSFORMER.

3-58. Time Interval Measurements

1. To insure waveform fidelity during T.I. measurements, always use dc coupling.
2. Measurements of pulse width, and time between pulses, are more conveniently made in the COM A (common) position.
3. T.I. Average measurements of high stability (synthesized) sources are not recommended. The displayed result may not be accurate. Proper averaging requires that there be no coherence between the source and the counter time base oscillator. (See Application Note 162-1, Time Interval Averaging.)
4. In general, use the GATE TIME control to vary the amount of resolution displayed. This control does not affect accuracy. It basically trades off longer measurement time for more resolution.

3-59. TROUBLESHOOTING/ERROR MESSAGES

3-60. Two different type error messages exist in the 5316A. First is the numbered errors. Failures in the power-up self-check will result in the momentary display of one of these messages. The ERROR LED will remain on until the error is cleared and the instrument reset. The three error messages are:

ERROR	MESSAGE
E1	Possible failure in microcomputer A1U1 (3870)
E2	Possible failure in I/O ports
E3	Possible failure in A1U2 (MRC); rear panel oscillator switch in the EXT position with no external signal; or a failure in the A7 oscillator assembly.

If the ERROR annunciator is lit, verify the error number (1, 2, or 3) by repeating the power-up self-check, and refer to Section VIII, Troubleshooting, paragraph 8-45, step h. Power-up self-check is initiated when the POWER switch is placed from STBY to ON.

3-61. The two HP-IB status annunciators indicate a failure in the following ways:

- Flashing in-phase Possible failure in the HP-IB microcomputer A1U10 (6801).
- Flashing out-of-phase Possible A1U1-U10 (3870-6801) link failure or defective HP-IB microcomputer A1U10 (6801).

If one of these failures occur when the POWER switch is placed in ON from STBY, refer to Section VIII, Troubleshooting, paragraph 8-45, step m.

3-62. OPTIONS

3-63. The operating characteristics of the 5316A are affected by the addition of any of the options described in the following paragraphs.

3-64. Time Base Options

3-65. Option 001 provides a Temperature Compensated Crystal Oscillator (TCXO) which results in higher accuracy. The TCXO is a 10 MHz oscillator, capable of making minor frequency corrections to compensate for offsets due to temperature variations. Option 004 Oven Oscillator provides increased temperature stability and accuracy over Option 001. See *Table 1-1* for complete specifications of Options 001 and 004.

3-66. Channel C Option 003

3-67. Option 003 extends the frequency counting range of the 5316A from 100 MHz (in Channel A) to 1 GHz (in Channel C). The input sensitivity and gate time are adjustable via front panel controls. See *Table 1-1* for complete specifications of Option 003.

3-68. OPERATOR'S MAINTENANCE

3-69. The only maintenance the operator should normally perform is the replacement of the primary power fuse. This fuse is located within the Line Module Assembly. For instructions on how to change the fuse, refer to paragraph 2-8, Line Voltage Selection.



Make sure that only fuses with the required rated current and of the slow-blow type are used for replacement. The use of repaired fuses and the short-circuiting of fuse-holders must be avoided.

3-70. When Option 003 Channel C is installed, the operator may be required to replace the input BNC fuse. This is a 1/8A fuse (HP Part No. 2110-0301) which is located within the INPUT C BNC connector (see *Figure 3-9* for details). To replace the fuse, disconnect the power cord, unscrew the special BNC barrel (P/N 05305-60205) and, with needle-nose pliers, remove and replace the fuse. Reinstall the BNC barrel, and tighten using a BNC cable connector. Be careful not to overtighten.

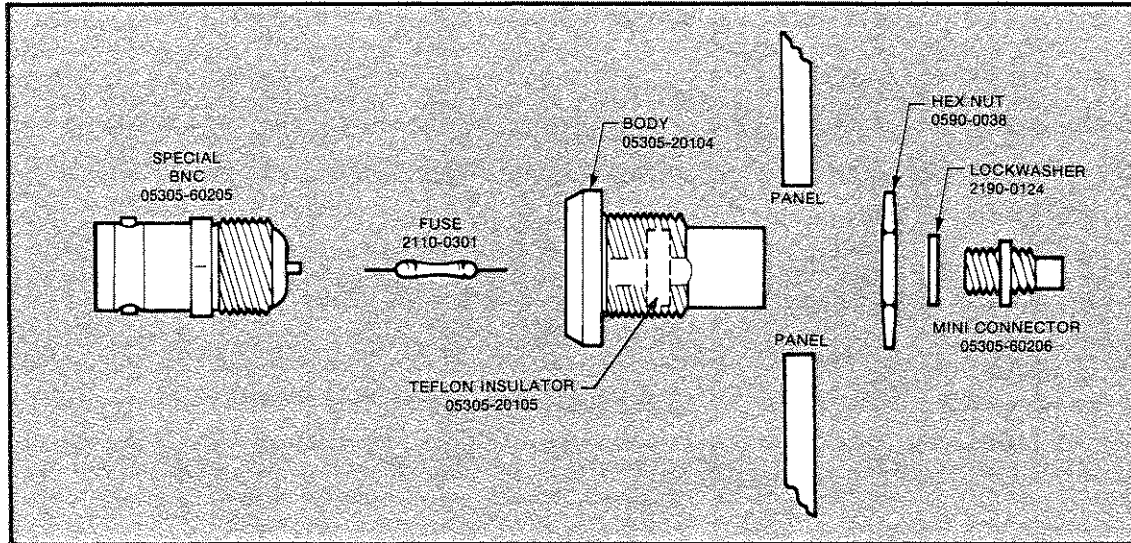

Figure 3-9. Details of Input Connector J1 and Fuse Mounting

3-71. POWER/WARM UP

3-72. The HP Model 5316A requires a power source of 100-, 120-, 220-, or 240-volt ac, +5%, -10%, 48 to 66 Hz single phase. The selection of line voltage and input power fuse is described in Section II, paragraph 2-8, Line Voltage Selection.

WARNING

POWER IS ALWAYS PRESENT AT THE LINE SWITCH AND TRANSFORMER, AND UNREGULATED DC IS PRESENT WHENEVER THE LINE CORD IS ATTACHED. UNPLUGGING THE POWER CORD IS NECESSARY TO REMOVE ALL POWER FROM THE INSTRUMENT.

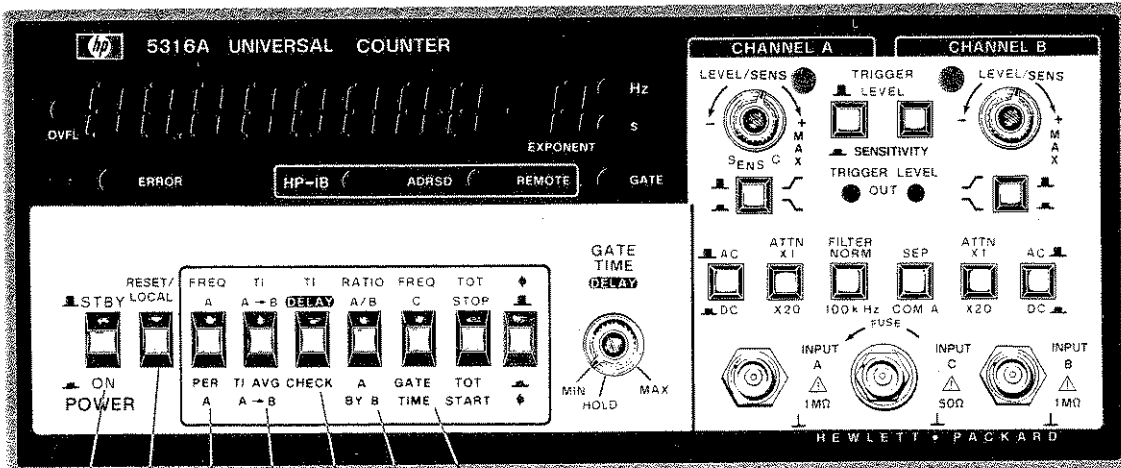

- 1
- 2
- 3
- 4
- 5
- 6
- 7

- 1 **STBY/ON.** Supplies power to entire machine in the ON position. Removes power from the voltage regulators when in the STBY (Standby) position.
- 2 **RESET.** Clears and updates display in continuous measurement modes, resets counter to zero in Totalize modes. Also returns operation to Local control.
- 3 **FREQ A.** Selects Frequency modes of operation (with Blue Shift key out), for signals on Input A.
PER A. Selects Period mode of operation (with Blue Shift key in), for signal on Input A.
- 4 **T.I. A-B.** Selects Time Interval mode of operation (with Blue Shift key out) measuring time differences from Start signal on INPUT A to Stop signal on INPUT B (when in SEP).
T.I. AVG A-B. Selects Time Interval Average mode of operation (with Blue Shift key in), measuring time difference from Start signal on INPUT A to Stop signal on INPUT B (when in SEP).
- 5 **T.I. DELAY.** Selects Time Interval mode of operation (with Blue Shift key out), measuring time differences from Start signal on INPUT A to Stop signal on INPUT B (when in SEP) with the triggering of the Stop signal DELAYED (held off) for a period of time determined by GATE TIME DELAY control.
CHECK. Applies 10 MHz from reference oscillator to MRC (with Blue Shift key in), to verify operation of MRC, display and GATE TIME control, microcomputer, etc.
- 6 **RATIO A/B.** Selects Ratio mode of operation (with Blue Shift key out), measuring the ratio of the signal frequency at INPUT A to the signal frequency at INPUT B.
A BY B. Selects a "gated" Totalize mode of operation (with Blue Shift key in), in which the signal frequency of INPUT A is totalized for a gate duration determined by the signal on INPUT B.
- 7 **FREQ C.** Enables the Frequency C INPUT (Option 003) module (with the Blue Shift key out).
GATE TIME. Continuously measures and displays the gate time determined by the GATE TIME control (with Blue Shift key in).

NOTE

The trigger lights are disabled and extinguished when either FREQ C or GATE TIME is selected.

Figure 3-10. Front Panel Features

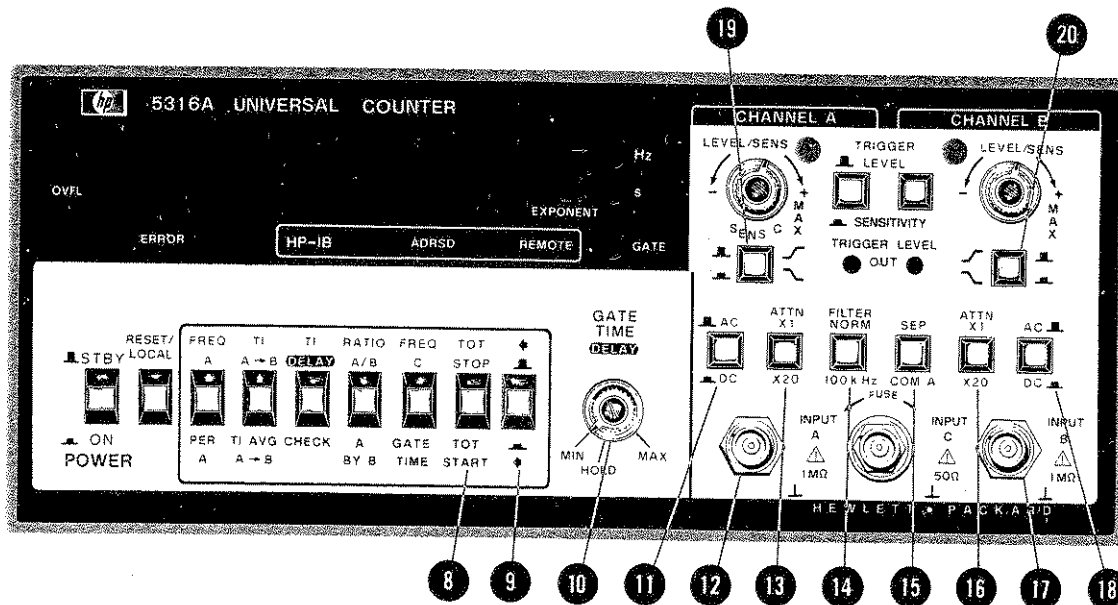

- 8 **TOT, STOP/START.** Selects Totalize mode of operation, manually controlled by the Blue Shift key. With the Blue Shift key in, totalizing of signal frequency on INPUT A starts. With the Blue Shift key out, Totalize accumulation stops and holds. RESET must be pressed to zero the display.
- 9 **Blue Shift.** Used in conjunction with six dual purpose function keys (3, 4, 5, 6, 7, 8) to select the function labeled above or below the key. With the Blue Shift key in, functions labeled above the keys are enabled, with the Blue Shift key out, functions labeled below the keys are enabled.
- 10 **GATE TIME/DELAY.** For FREQUENCY, PERIOD, RATIO AND T.I. AVERAGE modes, provides continuously variable measurement time from, nominally, 60 ms to 10 s (minimum = 1 period of the input signal). For T.I. mode, varies the time between measurements. For T.I. DELAY mode, provides continuously variable delay time between START and STOP enable.
HOLD. Single measurement with minimum gate time. Requires pushing RESET key to initiate new measurement.
- 11, 18 **AC/DC.** Selects ac or dc coupling for corresponding input signal. When in COM A, only Channel A determines coupling.
- 12, 17 **INPUT A, B.** Input BNC's for channels A and B.
- 13, 16 **ATTN, X1/X20.** Selects attenuation of signal on corresponding input channels. X1 position connects input signal directly to input amplifiers; X20 position attenuates input signal by a factor of 20 (nominal).
- 14 **FILTER, NORM/100 kHz.** Inserts a low pass filter configuration into the INPUT A channel, attenuating frequencies above 100 kHz.
- 15 **SEP/COM A.** Input amplifier control, selects independent operation of inputs A and B in SEP (separate) position. In COM A (Common A) position, the signal at Input A is also applied to Input B, with the B input BNC disconnected from input circuitry. Input B coupling is the same as Input A.
- 19, 20 **SLOPE.** Selects triggering on either positive \nearrow or negative \searrow slope of the corresponding input channel.

Figure 3-10. Front Panel Features (Continued)

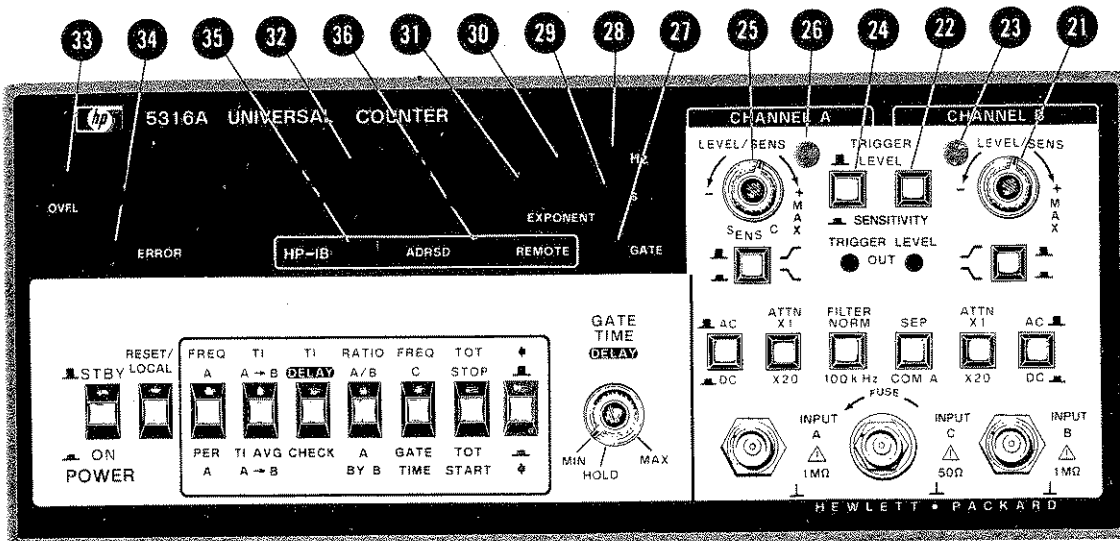

- 25 **LEVEL/SENS.** When in TRIGGER LEVEL, controls the voltage at which CHANNEL A input will trigger, variable over ± 2.5 volts X ATTN setting. When in SENSITIVITY, varies the sensitivity from MAX (≈ 10 mV) up to 500 mV. In FREQ C, controls the input sensitivity for INPUT C from MAX (≈ 15 mV up to 650 MHz, 75 mV up to 1 GHz) up to MIN (20 dB NOMINAL).
- 26 **LEVEL/SENS.** When in TRIGGER LEVEL, controls the voltage at which corresponding CHANNEL B input will trigger, variable over ± 2.5 volt X ATTN setting. When in SENSITIVITY, varies the sensitivity from MAX (≈ 10 mV) up to 500 mV.
- 22, 24 **TRIGGER LEVEL/SENSITIVITY.** Sets the function of corresponding LEVEL/SENS control to either Trigger Level or Sensitivity mode. In TRIGGER LEVEL mode, sensitivity is preset to maximum. In SENSITIVITY mode, trigger level is preset to 0 volts.
- 23, 26 **TRIGGER LIGHT.** 3-state trigger lights; blinks when channel is triggering; OFF when input signal is below trigger level setting; ON when input signal is above trigger level setting.
- 27 **GATE.** Gate light (when ON), indicates the counter's main gate is open and a measurement is in progress.
- 28 **Hz.** Hz (Hertz) annunciator, indicates displayed data is in frequency domain, in units of Hertz.
- 29 **S.** (seconds) annunciator, indicates displayed data is in time domain, in units of seconds.
- 30 **EXPONENT.** Displays the value of the exponent of the measurement. Measurements are displayed in engineering notation, with exponents of blank (\emptyset), ± 3 , ± 6 , ± 9 .
- 31 **EXPONENT SIGN.** Indicates the polarity of the displayed exponent; ON (-) if negative, OFF if positive.
- 32 **DISPLAY.** Eight-digit red LED display.
- 33 **OVFL.** OVFL (Overflow) annunciator indicates that one of more of the most significant digits are not displayed.
- 34 **ERROR.** Lights and remains lit when an error is detected during power-up.
- 35 **ADRSD.** Lights when the 5316A is addressed to Talk or Listen. See Paragraph 3-87.
- 36 **REMOTE.** Lights when the 5316A is under remote control. See Paragraph 3-87.
- 37 **TRIGGER LEVEL OUT CHANNEL A.** This allows the monitoring of the Channel A trigger level. The dc voltage is equal to the Channel A trigger level.
- 38 **TRIGGER LEVEL OUT CHANNEL B.** This allows the monitoring of the Channel B trigger level. The dc voltage is equal to the Channel B trigger level.

Figure 3-10. Front Panel Features (Continued)

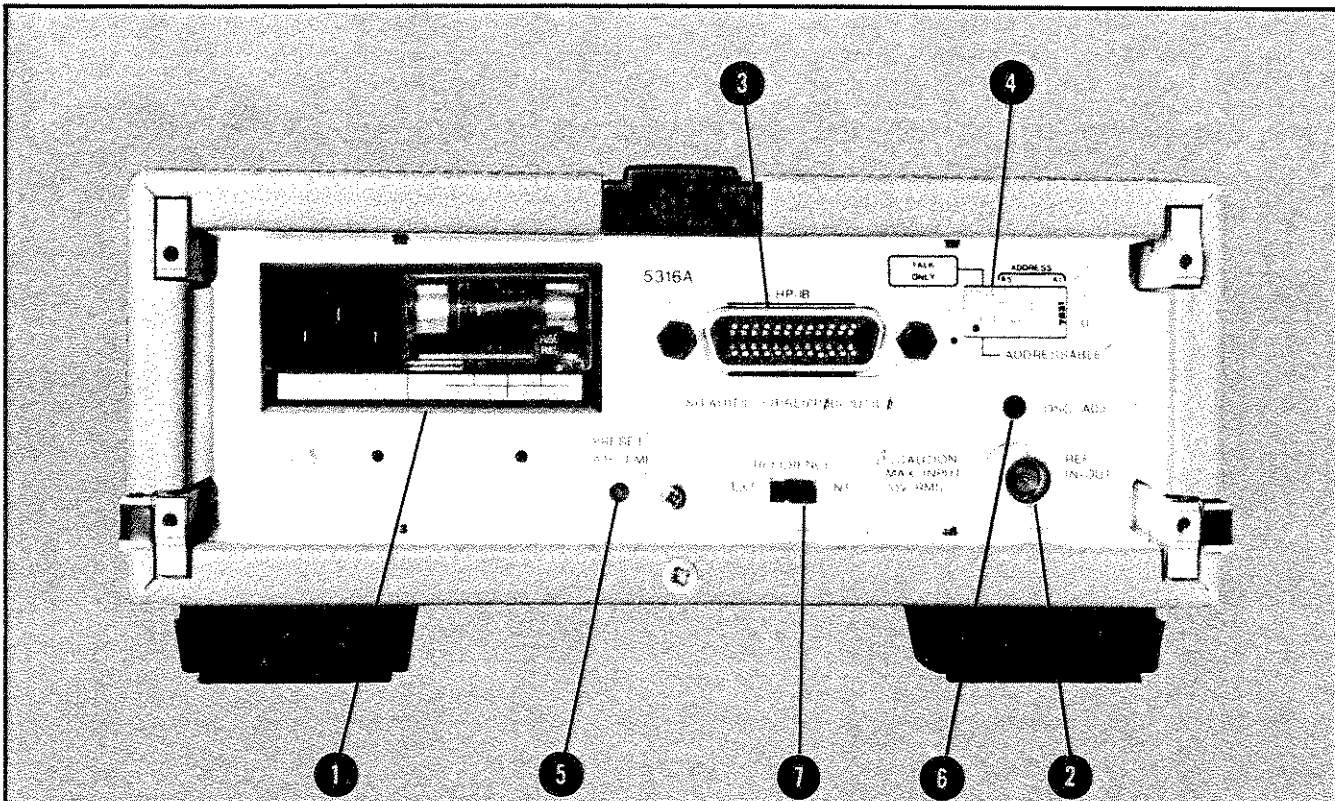

- 1 AC power input module permits operation from 100, 120, 220, or 240 volts ac. The number visible in the window indicates nominal line voltage to which instrument must be connected (see Figure 2-1). Protective grounding conductor connects to the instrument through this module.

WARNING

ANY INTERRUPTION OF THE PROTECTIVE (GROUNDING) CONDUCTOR INSIDE OR OUTSIDE THE INSTRUMENT OR DISCONNECTING OF THE PROTECTIVE EARTH TERMINAL IS LIKELY TO MAKE THE INSTRUMENT DANGEROUS. (See Section II.)

- 2 **REFERENCE INPUT/OUTPUT JACK (J8).** When 7, in the EXT position this allows the 5316A to be operated with an external frequency reference. The 5316A does not actually use the external input signal for a time base but locks-on to the signal with an injection-lock-multiplier. The external signal must be 1, 5, or 10 MHz at 500 mV rms across 500 ohms. When 7 in the INT position, the internal 10 MHz standard operates the counter, and the jack is the internal 10 MHz standard output signal at 50 mV p-p.
- 3 **HP-IB INTERFACE CONNECTOR (24 pin).** Used to convey data and programming information. IEEE-1978 compatible. See paragraph 3-73.
- 4 **HP-IB ADDRESS SWITCHES.** Selects the LISTEN/TALK address and ADDRESSABLE/TALK ONLY mode for remote control. See paragraph 3-83.
- 5 **PRESET GATE TIME.** Essentially the same as the front panel GATE TIME control without the HOLD position. Selectable only during remote programming. See paragraph 3-92c.
- 6 **OSCILLATOR ADJ.** This allows the adjustment of the internal reference oscillator.

Figure 3-11. 5316A Rear Panel Features

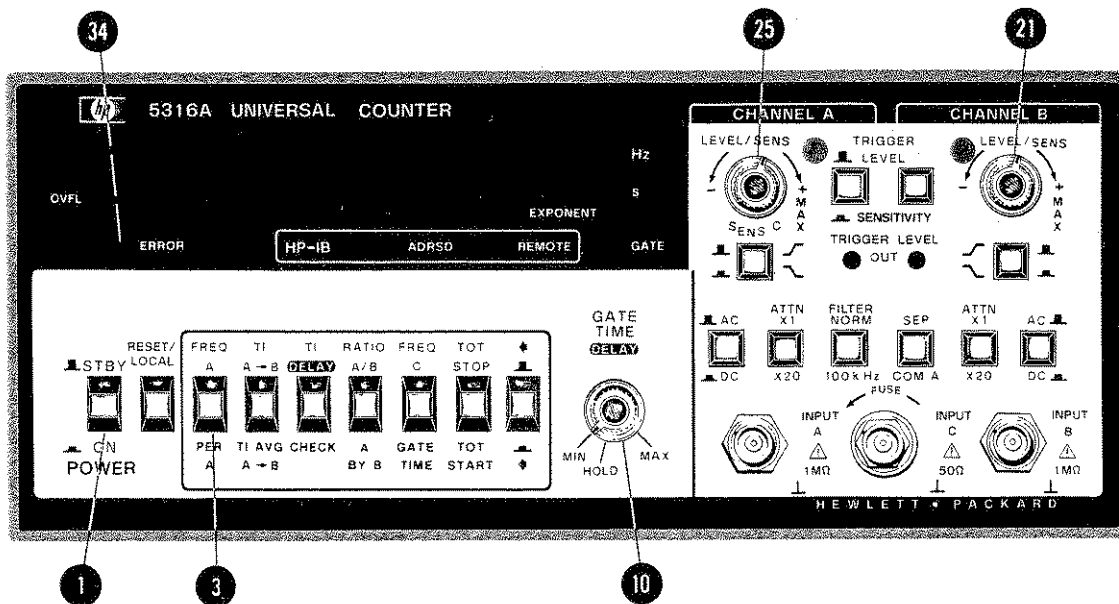

1. Before switching on the instrument, ensure that the power transformer primary is matched to the available line voltage, the correct fuse is installed and the safety precautions are taken. Refer to Power Requirements, Line Voltage Selection, Power Cables, and associated warnings and cautions in Section II of this manual.
2. Press FREQ A/PER A switch **3**, and adjust LEVEL/SENS controls **21** **25** fully ccw. Set All other switches to the OUT position.
3. Adjust GATE TIME control **10** to minimum.
4. Set POWER switch **1** to the ON position and observe the power-up self-check. Verify all segments of the display; decimal point after MSD; and the OVFL, Hz, S, and GATE annunciators light momentarily, followed by a display of 000. Verify both trigger lights are lit.

NOTE

When the instrument is first turned on, the microcomputer performs a self-check. If, during the self-check, an error is detected, a numbered error message will be displayed and will light the ERROR LED, or the HP-IB status LEDs will flash. Verify the error, by repeating the power-up self-check and referring to paragraph 3-59, Error Messages.

5. Verify the Display Check routine by placing all function select switches in the OUT position. This may be accomplished by pressing any gray colored function switch partially in, thus releasing a function switch that is locked in. Observe the cycling of the display from all zero's to all one's, two's, three's. . . etc., to all blank. Refer to paragraph 3-33.

NOTE

The Display Check routine is an unlabeled function, used to verify the operation, digits and most annunciators in the Display assembly.

Figure 3-12. Operator's Check

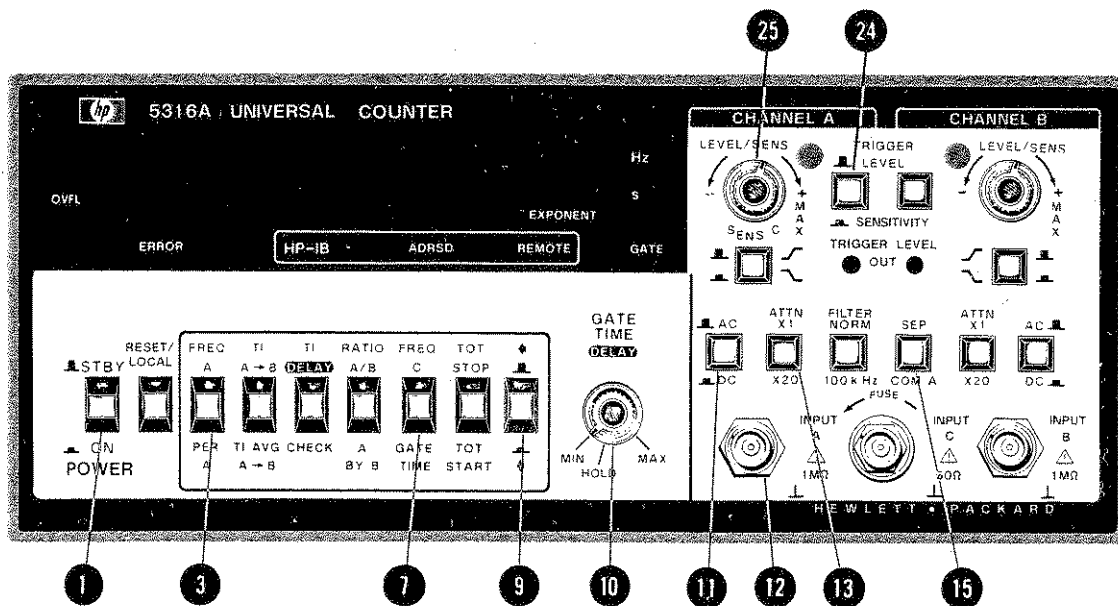

NOTE

For specifications concerning bandwidth, accuracy, and amplitude on input signals, refer to *Table 1-1*.

1. Set POWER switch **1** to the ON position.
2. Set SEP/COM A switch **15** to SEP position.
3. Connect the input signal to INPUT A jack **12**.
4. Press FREQ A/PER A switch **3**, and set the Blue Shift key **9** in the out position for FREQ A, or the in position for Period A.
5. Set AC/DC **11**, ATTN **13** and Slope **19** switches to appropriate positions.
6. Set GATE TIME control **10** to MIN.
7. Set TRIGGER LEVEL/SENSITIVITY switch **24** to SENSITIVITY position, and LEVEL/SENS control **25** fully ccw. This sets the trigger level at 0 volts (nominally) and sensitivity to minimum.
8. Adjust the LEVEL/SENS control **25** in a clockwise direction until a stable reading is obtained.
9. Adjust the GATE TIME control **10** for desired resolution. The gate time may be displayed by pressing the GATE TIME switch **7** and the Blue Shift key **9**.

Figure 3-13. Frequency A/Period A Measurements

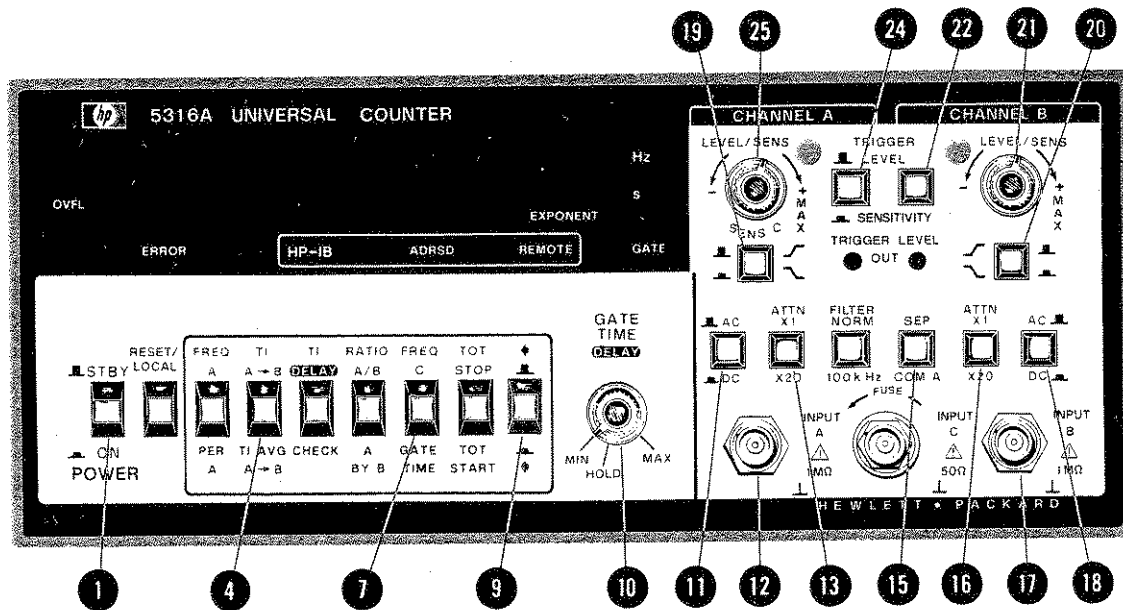

NOTE

For specifications concerning bandwidth, accuracy, and amplitude on input signals, refer to Table 1-1.

1. Set POWER switch **1** to the ON position.
2. Set GATE TIME control **10** to min.
3. If the Start and Stop signals are from separate sources, connect the Start signal to INPUT A jack **12**, the Stop signal to INPUT B jack **17**, and set the SEP/COM A switch **15** to SEP position. If the Start and Stop signals are from a common source, connect to INPUT A jack **12** and set the SEP/COM A switch **15** to COM A position.
4. Press T.I. A→B switch **4**, and insure the Blue Shift key **9** is in the out position, to select Time Interval function.
5. Set AC/DC **11** **18**, ATTN **13** **16**, and Slope **19** **20** switches to desired positions.

NOTE

When the SEP/COM A switch is set to COM A, only the CHANNEL A AC/DC switch **11** is effective. However, all Attenuator, Slope, and LEVEL/SENS controls are effective.

6. Set TRIGGER LEVEL/SENSITIVITY switches **22** **24** to TRIGGER LEVEL position. This sets the sensitivity to maximum (≤ 10 mV for frequencies ≤ 10 MHz) and allows variable selection of trigger levels.
7. Adjust the LEVEL/SENS controls **21** **25** for optimum triggering, usually the middle of the range over which the trigger light flashes.
8. Adjust the GATE TIME control **10** for the desired sample rate, variable nominally from 60 ms to 10 s. The selected gate time may be displayed by pressing the GATE TIME switch **7** and the Blue Shift key **9**.

NOTE

The first measurement is not displayed until the gate time delay is up. For slow sample rates, use HOLD and the RESET switch.

Figure 3-14. Time Interval Measurement

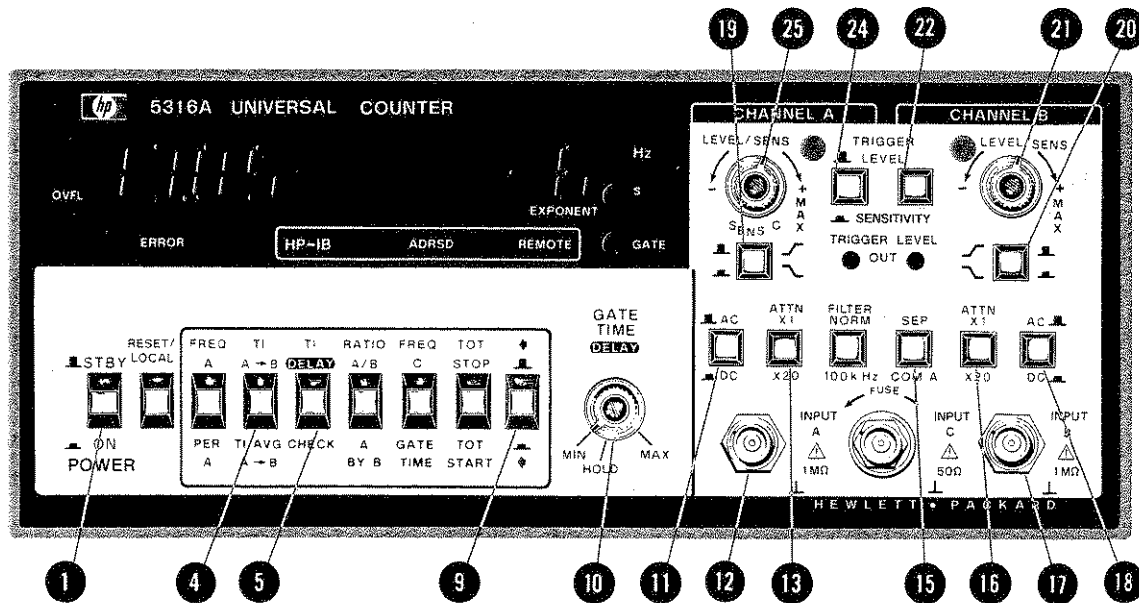

NOTE

For specifications concerning bandwidth, accuracy, and amplitude on input signals, refer to Table 1-1.

1. Set POWER switch 1 to the ON position.
2. If the Start and Stop signals are from separate sources, connect the Start signal to INPUT A jack 12, the Stop signal to INPUT B jack 17, and set the SEP/COM A switch 15 to SEP position. If the Start and Stop signals are from a common source, connect that source to INPUT A jack 12 and set the SEP/COM A switch 15 to COM A position.
3. Press T.I. DELAY switch 5, and insure the Blue Shift key 9 is in the out position, to select Time Interval function.
4. Set AC/DC 11 18, ATTN 13 16, and Slope 19 20 switches to desired positions.

NOTE

When the SEP/COM A switch is set to COM A, only Channel A AC/DC switch 11 is effective. However, all ATTENUATOR, SLOPE, and LEVEL/SENS controls are effective.

5. Set TRIGGER LEVEL/SENSITIVITY switches 22 24 to TRIGGER LEVEL position. This sets the sensitivity to maximum (≤ 10 mV) and allows variable selection of trigger levels.
6. Adjust the LEVEL/SENS controls 21 25 for optimum triggering (i.e., the middle of the range over which the trigger light flashes).
7. Adjust the GATE TIME/DELAY control 10, for the desired holdoff, (variable nominally from $500 \mu\text{s}$ to 30 ms) between the Start on Channel A and the enabling of Stop on Channel B. Inputs during the delay time are ignored. The selected delay time may be displayed by pressing T.I. A→B 4, T.I. DELAY 5 and Blue Shift key 9.

Figure 3-15. Time Interval Delay Measurement

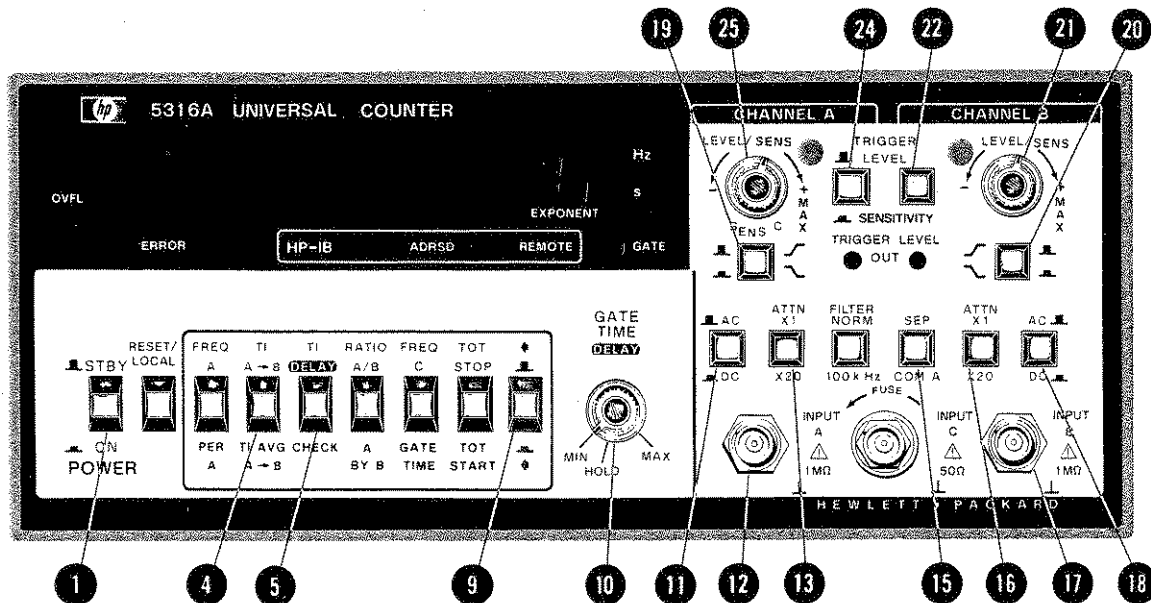

NOTE

For specifications concerning bandwidth, accuracy, and amplitude on input signals, refer to Table 1-1.

1. Set POWER switch 1 to the ON position.

NOTE

There must be at least 200 ns between the Stop pulse and the next Start pulse. When measuring the time interval between the same polarity slope of two pulses from a single source, the PER A mode should be used.

2. If the Start and Stop signals are from separate sources, connect the Start signal to INPUT A jack 12, the Stop signal to INPUT B jack 17, and set the SEP/COM A switch 15 to SEP position. If the Start and Stop signals are from a common source, connect to that source INPUT A jack 12 and set the SEP/COM A switch 15 to COM A position.
3. Press T.I. A-B switch 4, and the Blue Shift key 9, to select time interval average function.
4. Set AC/DC 11 18, ATTN 13 16, and Slope 19 20 switches to desired positions.

NOTE

When the SEP/COM A switch is set to COM A, only the Channel A AC/DC switch 11 is effective. However, all ATTENUATOR, SLOPE, and LEVEL/SENS controls are effective.

5. Set TRIGGER LEVEL/SENSITIVITY switches 22 24 to TRIGGER LEVEL position. This sets the sensitivity to maximum (≤ 10 mV) and allows variable selection of trigger levels.
6. Adjust the LEVEL/SENS controls 21 25 for optimum triggering (i.e., the middle of the range over which the trigger light flashes).
7. Adjust the GATE TIME control 10 for the desired resolution. The selected gate time may be displayed by pressing the GATE TIME switch 7 and the Blue Shift key 9.

NOTE

The T.I. Average A-B mode of operation will measure time intervals from 10^5 seconds to 0 ns, with up to 10 ps resolution. A display of up to “-” 1 or 2 ns, indicating a negative time interval (i.e., Channel B event occurred before Channel A event) is possible.

Figure 3-16. Time Interval Average A-B

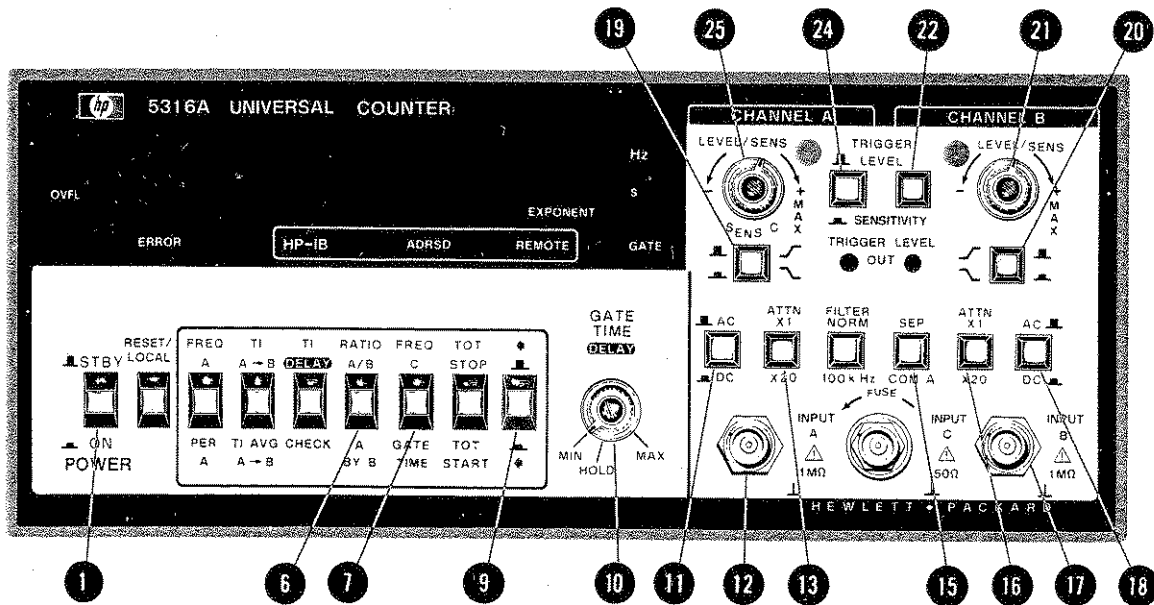

NOTE

For specifications concerning bandwidth, accuracy, and amplitude on input signals, refer to *Table 1-1*.

1. Set POWER switch **1** to the ON position.
2. Set SEP/COM A switch **15** to SEP position.
3. Connect the input signals to INPUT A **12** and INPUT B **17**. Connect the higher frequency signal to INPUT A. Connect the lower frequency signal to INPUT B. The ratio displayed will be greater than 1.
4. Press RATIO A/B **6**, and insure the Blue Shift key **9** is in the out position.
5. Set AC/DC **11 18**, ATTN **13 16**, and Slope **19 20** switches to desired positions.
6. Set TRIGGER LEVEL/SENSITIVITY switches **22 24** to SENSITIVITY position and LEVEL/SENS controls **21 25** fully ccw. This sets the trigger level at 0 volts (nominally) and sensitivity to minimum (>500 mV).
7. Adjust each LEVEL/SENS control **21 25** in a clockwise direction slightly beyond the point the corresponding trigger light flashes. If signals are less than 250 mV rms, the LEVEL/SENS controls may be fully cw.
8. Adjust the GATE TIME control **10** for desired resolution. The selected gate time, variable nominally from 60 ms to 10 s, may be displayed by pressing the GATE TIME switch **7** and the Blue Shift key **9**.

Figure 3-17. Ratio A/B Measurements

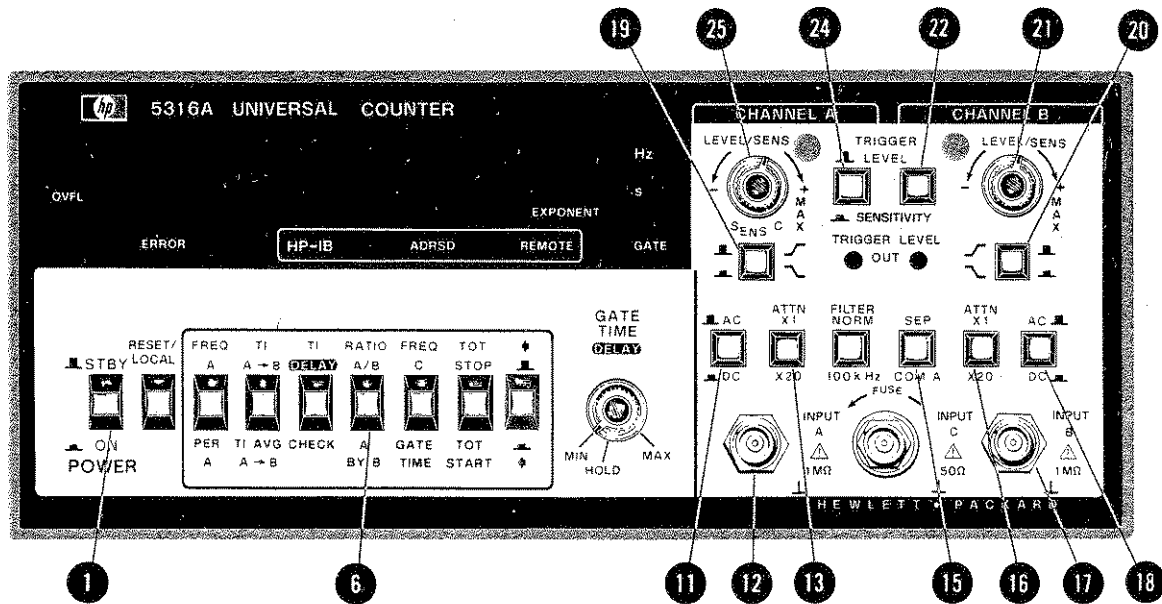

NOTE

For specifications concerning bandwidth, accuracy, and amplitude on input signals, refer to Table 1-1.

1. Set POWER switch 1 to the ON position.
2. Set SEP/COM A switch 15 to SEP position.
3. Connect the signal, either sine wave or pulses, to be totalized to INPUT A jack 12 and the gate control signal to INPUT B jack 17.

NOTE

This mode will totalize inputs on Channel A for the time between two events on Channel B. The Gate will open on the A Slope setting and close on the B Slope setting. A reset is required to make a new measurement.

4. Press A BY B switch 6 and the Blue Shift key 9 to select the Totalize A BY B function.
5. Set AC/DC 11 18, ATTN 13 16 and Slope 19 20 switches to desired positions.
6. Set TRIGGER LEVEL/SENSITIVITY switches 22 24 to SENSITIVITY position and LEVEL/SENS 21 25 fully ccw. This sets the trigger level at 0 volts (nominally) and sensitivity to minimum (500 mV).
7. Adjust each LEVEL/SENS 21 25 in a clockwise direction slightly beyond the point the corresponding trigger light flashers. If signals are less than 250 mV rms, the LEVEL/SENS controls may be fully cw.
8. This function operates in a single-shot mode. The RESET key must be pressed to initiate a new measurement.

Figure 3-18. A BY B Measurements

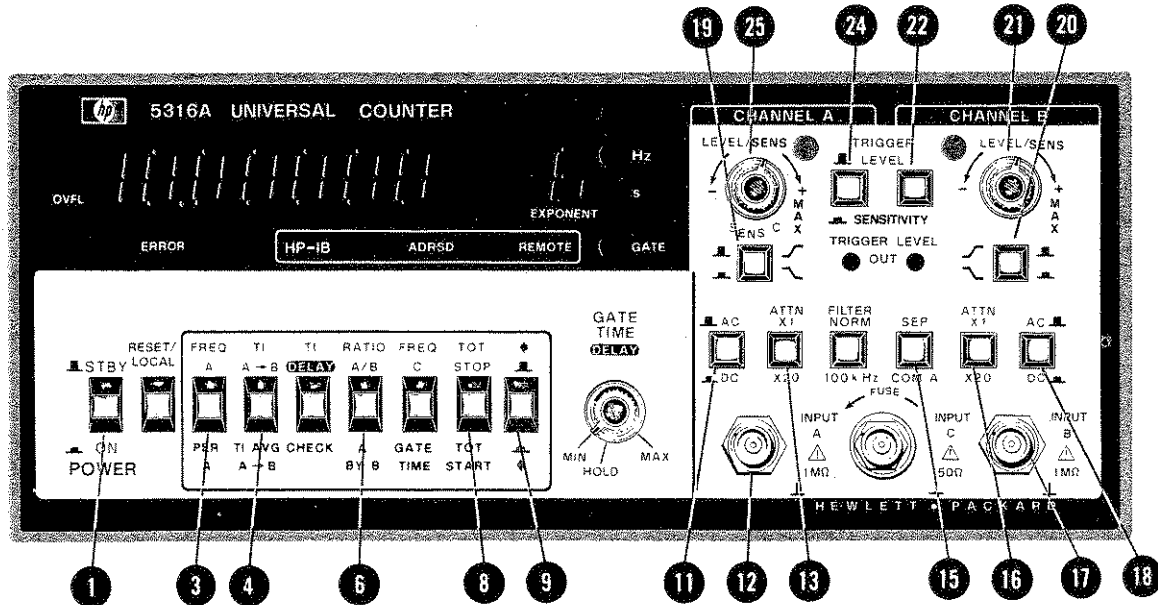

1. Set POWER switch **1** to the ON position.
2. Set SEP/COM A switch **15** to SEP position.
3. Connect the frequency burst signal to be averaged to INPUT A jack **12** and the sampling signal to INPUT B jack **17**. The sampling signal must be synchronized with, and of pulse width less than the burst.

NOTE

This mode will average together multiple frequency bursts and display the average frequency of the signal within the burst. *Due to the complexity of this function it is recommended that the user thoroughly read paragraph 3-23 before attempting to use this function.*

4. Press T.I. DELAY, CHECK switch **4** and RATIO A/B, A BY B switch **6** together for a gate time of 500 μ s-30 ms or FREQ A, PER A switch **3** and TOT STOP, TOT START switch **8** for a gate time of 60 ms-10 s.
5. Set AC/DC **11** **18**, ATTN **13** **16** to the desired positions.
6. Set the Blue Shift key **9** for the desired sampling/measurement interval enable slope: OUT for a positive enable slope, IN for a negative enable slope (negative slope only using SHORT measurement interval).
7. Set the A Channel SLOPE switch **19** to the desired trigger slope. Set the B Channel SLOPE switch **20** for the desired disable slope.
8. Set the TRIGGER/SENSITIVITY switches **22** **24** to SENSITIVITY position and LEVEL/SENS controls **21** **25** fully ccw. This sets the trigger level at 0 volts (nominally) and sensitivity to minimum (500 mV).
9. Adjust each LEVEL/SENS **21** **25** in a clockwise direction slightly beyond the point the corresponding trigger light flashes. If the signals are less than 250 mV, the LEVEL/SENS controls may be fully cw.

Figure 3-19. FREQ A Armed by B Measurements

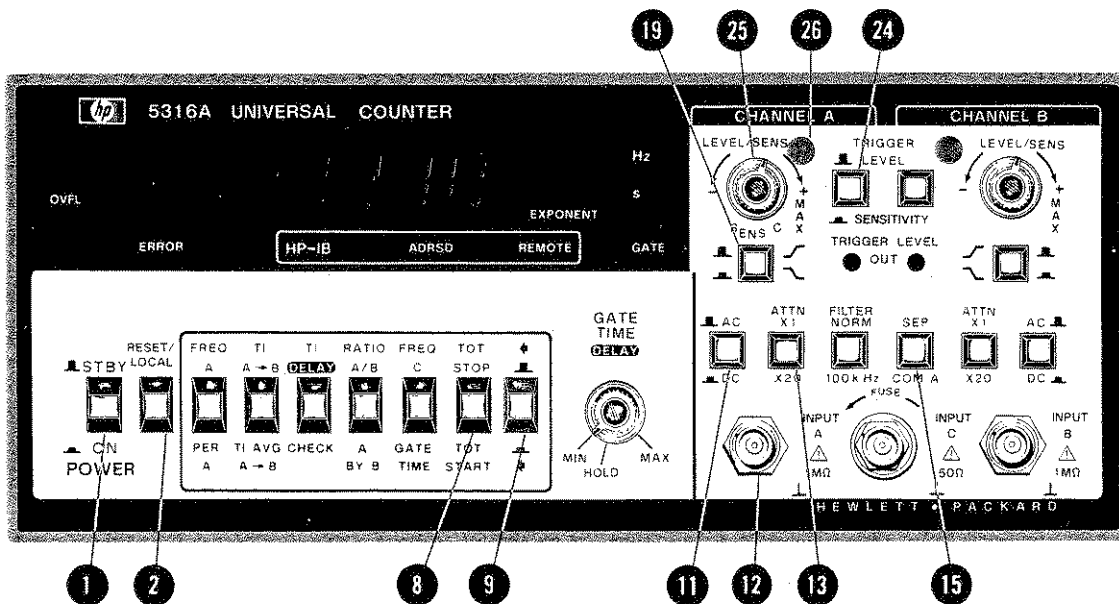

NOTE

For specifications concerning bandwidth, accuracy, and amplitude on input signals, refer to *Table 1-1*.

1. Set POWER switch **1** to the ON position.
2. Set SEP/COM A switch **15** to SEP position.
3. Connect the signal to be totalized to INPUT A jack **12**.

NOTE

This mode will totalize inputs on Channel A for the period of time manually selected using front panel switches.

4. Press TOT switch **8**. The Blue Shift key **9** must be in the out position.
5. Set AC/DC **11**, ATTN **13** and Slope **19** switches to desired positions.
6. Set TRIGGER LEVEL/SENSITIVITY switch **24** to SENSITIVITY position and LEVEL/SENS **25** fully ccw. This sets the trigger level at 0 volts (nominally) and sensitivity to minimum (500 mV).
7. Adjust the LEVEL/SENS control **25** in a clockwise direction slightly beyond the point the Channel A trigger light **26** flashes.
8. Press RESET **2** to clear display.
9. Press Blue Shift key **9** IN to START totalize measurement, and press again (OUT position) to STOP totalize. Repeat this procedure to accumulate counts, press RESET **2** to clear display and enable a new measurement.

Figure 3-20. Totalize Measurements

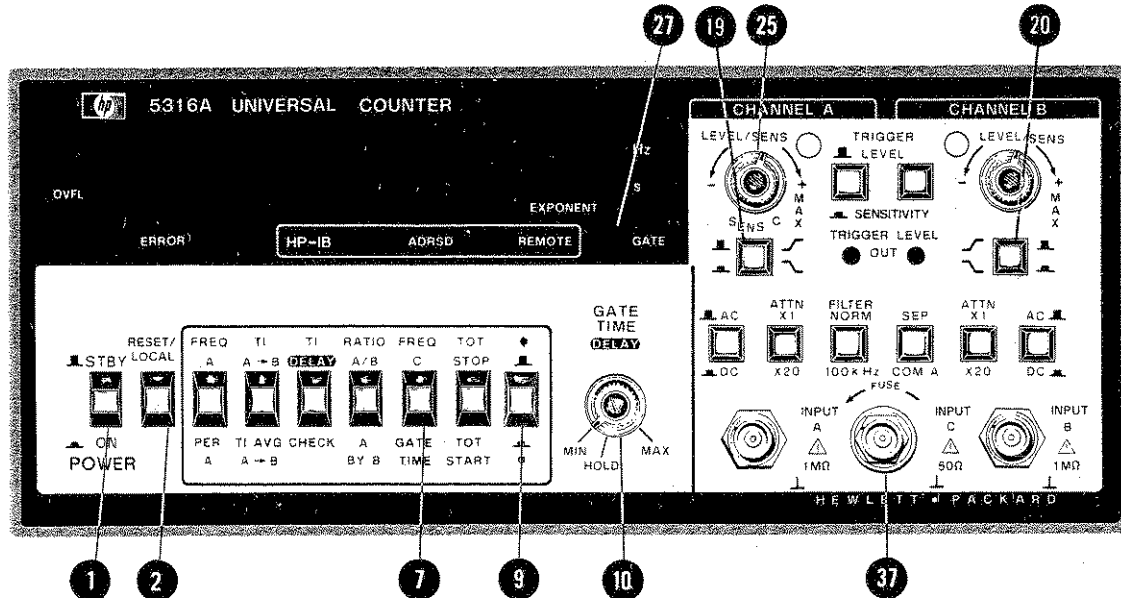

CAUTION

Make sure that the amplitude of the signal does not exceed the 1V rms dynamic range.

NOTE

For specifications concerning bandwidth, accuracy, and amplitude on input signals, refer to Table 1-1.

1. Set POWER switch **1** to the ON position, and press FREQ C/GATE TIME **7**.
2. Set GATE TIME control **10** to MIN.
3. Connect the input signal to INPUT C jack **37**.
4. Set SENS C control **25** to MIN. Slowly rotate the control in a cw direction until the GATE light **27** just turns on.
5. Adjust the GATE TIME control **10** for the desired resolution. The actual gate time may be displayed by pressing the GATE TIME function switch **7** and the Blue SHIFT **9**. Moving the GATE TIME control **10** fully ccw into detent will HOLD the measurement display. In HOLD, single-shot measurements with minimum gate time can be made by pressing the RESET **2** key.

NOTE

The only controls active in FREQ C function mode are GATE TIME **10**, RESET **2**, and SENS C **25**. However, pressing either Channel A **19** or B **20** scope switches will reset the counter.

6. The input connector for INPUT C **37** is a special fused BNC. The in-line fuse within the connector is accessible from the front panel. Refer to the Operator's Maintenance, paragraph 3-70, for replacement of fuse.

Figure 3-21. Frequency C Measurement

3-73. REMOTE PROGRAMMING VIA THE HP-IB

3-74. Introduction

3-75. The 5316A Universal Counter is compatible with the Hewlett-Packard Interface Bus (HP-IB). Remote programming is installed as standard equipment and allows the counter to respond to remote control instructions and to output measurement data via the HP-IB. At the simplest level, with no system controller, the 5316A can output data, in the talk only mode, to other devices such as a printer or a digital-to-analog converter. In more sophisticated systems, a computing or other type of controller can remotely program the 5316A to perform a specific type of measurement, trigger the measurement, and output the results.

NOTE

HP-IB is Hewlett-Packard's implementation of IEEE Std. 488-1978, "Standard Digital Interface for Programmable Instrumentation".

3-76. The operator must be familiar with the selected controller (e.g., the 9825A, 9830A, or 9835/45A calculators), the HP-IB, and the manual operation and functional capabilities of the 5316A. The following HP manuals should provide useful background information:

- HP-IB User Guide, 9830A (P/N 59300-90002)
- Hewlett-Packard 9825A Calculator General I/O Programming (P/N 09825-90024)
- Hewlett-Packard 9825A Calculator Extended I/O Programming (P/N 09825-90025)
- Hewlett-Packard 9835A Operating and Programming Guide (P/N 09835-90000)
- Hewlett-Packard 9835A I/O ROM Programming Manual (P/N 09835-90060)
- Hewlett-Packard 9845A Operating and Programming Guide (P/N 09845-90060)
- Condensed Description of the Hewlett-Packard Interface Bus (P/N 59401-90030)
- HP-IB Programming Hints For Selected Instruments (P/N 59300-90005)
- 9825A/5316A Introductory Operating Guide (P/N 5952-7586)
- Hewlett-Packard 9825A Calculator Operating and Programming Manual P/N (09825-90000)
- Hewlett-Packard 9825A String Variable Programming (P/N 09825-90020)

3-77. BUS COMPATIBILITY

3-78. Interface Function

3-79. The capability of a device connected to the bus is specified by its interface functions. These functions provide the means for a device to receive, process, and send messages over the bus. Table 3-2 lists the 5316A interface functions using the terminology of the IEEE 488-1978 standard. These functions are also listed below the rear panel HP-IB connector, as follows:

SH1, AH1, T1, L2, SR1, RL1, PP0, DC1, DT1, C0

The number following the interface function code indicates the particular capability of that function.

Table 3-2. HP-IB Interface Functions

INTERFACE FUNCTION SUBSET IDENTIFIER	INTERFACE FUNCTION DESCRIPTION
SH1	Complete source handshake capability.
AH1	Complete acceptor handshake capability.
T1	Talker (basic talker, serial poll, and talk only mode capabilities)
L2	Listener (basic listener without listen only)
SR1	Service request capability.
RL1	Complete remote/local capability.
PP0	No parallel poll capability.
DC1	Complete device clear capability.
DT1	Device trigger capability.
C0	No controller capability.



3-80. The 5316A operates (as listed in *Table 3-2*) as both a talker and listener. The 5316A output format is the same regardless of the mode (talk only/addressable).

- a. TALK: The 5316A can be addressed to Talk by a controller or by the TALK ONLY switch for use in system without a controller. When addressed as a Talker, the 5316A will send data out to other devices on the bus. This data is the result of a measurement in progress when addressed, or the next measurement, depending on the function selected. The Talk Only switch and the HP-IB address switches are located on the rear panel. (See *Figure 3-11*).

NOTE

To remove the 5316A from the TALK ONLY mode, set the ADDRESSABLE/TALK ONLY switch to ADDRESSABLE and press RESET (front panel). When RESET is pressed the 5316A will exit the TALK ONLY mode.

- b. LISTEN: When addressed as a Listener, the instrument can accept any number of commands from the controller via the bus. These commands are used to program the instrument operation.
- c. SERVICE REQUEST (SRQ): SRQ can be sent active on the bus at the end of the measurement. The 5316A has the capability to request service asynchronously from the controller in charge of the bus. See "SR" described in Binary Command section, paragraph 3-91.
- d. REMOTE/LOCAL: Normally the 5316A is under front panel (local) control. In order to program the 5316A, it must be placed into Remote. Once in Remote, the programmable functions cannot be affected by front panel control, except the RESET/LOCAL key, which may be used manually to return the 5316A to local control. The RESET/LOCAL key may be disabled with Local-Lockout (LLO). In LLO, the bus command GTL (Go To Local) must be sent to disable LLO.
- e. PARALLEL POLL: The 5316A does not respond to a parallel poll.
- f. DEVICE CLEAR: When a group or selected device clear is received, the instrument resets and makes a new measurement.
- h. DEVICE TRIGGER: When a device trigger is received, the 5316A will reset and make a new measurement.
- i. CONTROLLER: The 5316A cannot act as a controller.

3-81. BUS MESSAGES

3-82. Through bus messages, devices on the bus can exchange control and measurement information. There are 12 basic messages which can be sent over the interface. *Table 3-3* lists each bus message, giving a description of the 5316A response, and examples of the various controllers' implementations of the messages.

3-83. Address Selection

3-84. To use the 5316A in an HP-IB system, first set the rear panel address switches to the desired address. The leftmost switch sets the counter to the ADDRESSABLE mode or the TALK ONLY mode. The ADDRESSABLE mode is used whenever a calculator or other controller is used within the system. TALK ONLY mode is used when the counter is operating under its own control (no controller on bus) and sends its measured result to another device on the bus, such as a printer set to LISTEN ALWAYS.



Table 3-3. Bus Messages

HP-IB MESSAGE	DESCRIPTION/RESPONSE	SAMPLE 9825A (address = 20)	SAMPLE 9835A/45A (address = 20)
DATA	A WAY TO SEND COMMANDS TO 5316A AND RECEIVE MEASUREMENT DATA.	wrt 720, "FN1" red 720, A	OUTPUT 7, 20; "FN1" ENTER 7, 20; A
TRIGGER	STARTS NEW MEASUREMENT. IF THE 5316A IS IN LOCAL, IT WILL REMAIN IN LOCAL AND NO TRIGGER OCCURS.	trg 7	TRIGGER 7
	STARTS NEW MEASUREMENT. IF THE 5316A IS IN LOCAL, THE 5316A WILL GO INTO REMOTE.	trg 720	TRIGGER 7, 20
CLEAR	STARTS NEW MEASUREMENT (ACTS AS RESET).	clr 7 clr 720	CLEAR 7 CLEAR 7, 20
REMOTE	FRONT PANEL FUNCTION AND SLOPE SWITCHES ARE DISABLED; COUNTER DEFAULTS TO FREQUENCY A, ALL SLOPES TO POSITIVE UNLESS PREVIOUSLY PROGRAMMED.	rem 7 rem 720	REMOTE 7 REMOTE 7, 20
LOCAL	RETURNS TO LOCAL (FRONT PANEL) OPERATION.	lcl 7 lcl 720	LOCAL 7 LOCAL 7, 20
LOCAL LOCKOUT	DISABLES FRONT PANEL RESET; ONLY CONTROLLER CAN RETURN 5316A TO LOCAL. NOTE: IF IN REMOTE, FRONT PANEL FUNCTION AND SLOPE SWITCHES ARE ALSO DISABLED.	llo 7	LOCAL LOCKOUT 7
GOTO LOCAL AND CLEAR LOCAL LOCKOUT	5316A RETURNS TO LOCAL (FRONT PANEL) CONTROL; LOCAL LOCKOUT CLEARED.	lcl 7	LOCAL 7
SERVICE REQUEST	5316A WILL REQUEST SERVICE AT END OF MEASUREMENT IF SRQ AND WAIT STATE	rds (720) DEVICE STATUS	STATUS 7, 20
STATUS BYTE	PRESENTS STATUS INFORMATION. BIT 7 IS SET IF SERVICE IS REQUESTED.	rds (7) BUS STATUS	STATUS 7
STATUS BIT	NOT APPLICABLE.		
PASS CONTROL	NOT APPLICABLE.		
ABORT	TERMINATES THE BUS COMMUNICATIONS; TELLS ALL DEVICES TO UNLISTEN; 5316A ADRSD LIGHT WILL GO OFF.	cli 7	ABORTIO 7



3-85. The five rightmost switches, A₅ through A₁, set the TALK and LISTEN addresses of the 5316A when it is used in the ADDRESSABLE mode. Table 3-4 shows all possible address settings and the corresponding ASCII codes for talk and listen. The 5316A is factory set to address 20 as shown in Figure 3-22.

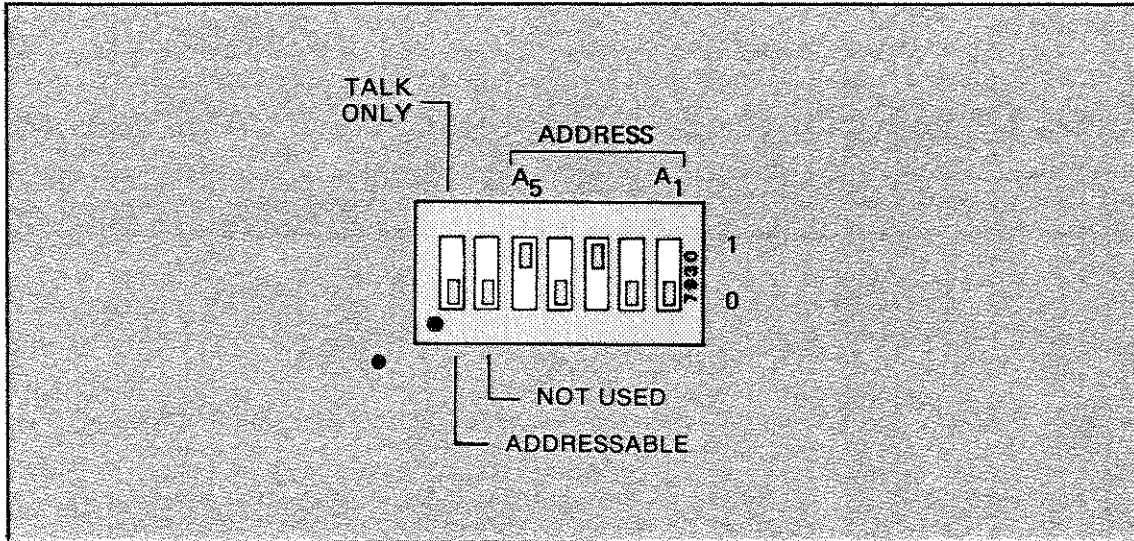

Figure 3-22. 5316A Address Switches (20)

3-86. Front Panel HP-IB Status LEDs

3-87. The two HP-IB Status LEDs on the front panel are to indicate if the counter is in REMOTE and/or ADDRESSED. The REMOTE light is on when the 5316A is in the remote mode. The ADRSD light is on when the 5316A is addressed to talk or listen. When the 5316A goes to local mode, the front panel REMOTE indicator goes off. The ADRSD indicator stays illuminated if the 5316A is still addressed. When in the TALK ONLY mode the ADRSD LED is always illuminated.

NOTE

The TALK ONLY mode may be entered by the rear panel switch, but can be exited only by setting the switch to ADDRESSABLE and pressing the front panel RESET key.

3-88. Device Command D

3-89. A device command is a string or sequence of two or more ASCII-coded bytes (upper or lower case), ending with a delimiter. (A delimiter is either a comma, semicolon, space, carriage return, or linefeed.) This command causes the counter to perform a specific function. For the 5316A these commands can be classified as either Terse, Binary, or Numeric commands.

3-90. TERSE COMMANDS: A sequence of two ASCII-coded alphabetic characters NOT followed by a numeric or binary number.

RE	Reset	Causes display to blank and a new measurement to be made. All functions and parameters remain the same. RESET (RE) also occurs after the 5316A is placed into Remote. The "RE" command is equivalent to the bus Device Clear and Trigger commands. The RESET (RE) command may be used to initiate a new measurement.
----	-------	--



Table 3-4. Address Selection

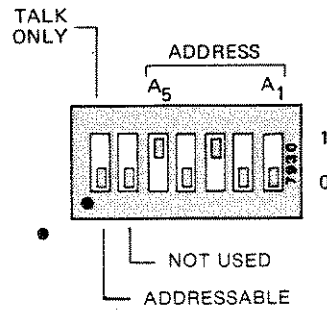

Address "20" Shown

NOTE

Select the listen address from the table below and set the address switches to the corresponding positions.

ASCII CODE CHARACTER	ADDRESS SWITCHES					5-BIT DECIMAL CODE	
	LISTEN	A5	A4	A3	A2		A1
SP		0	0	0	0	0	00
		0	0	0	0	1	01
"		0	0	0	1	0	02
#		0	0	0	1	1	03
\$		0	0	1	0	0	04
%		0	0	1	0	1	05
&		0	0	1	1	0	06
'		0	0	1	1	1	07
(0	1	0	0	0	08
)		0	1	0	0	1	09
*		0	1	0	1	0	10
+		0	1	0	1	1	11
,		0	1	1	0	0	12
-		0	1	1	0	1	13
.		0	1	1	1	0	14
/		0	1	1	1	1	15
0		1	0	0	0	0	16
1		1	0	0	0	1	17
2		1	0	0	1	0	18
3		1	0	0	1	1	19
4		1	0	1	0	0	20
5		1	0	1	0	1	21
6		1	0	1	1	0	22
7		1	0	1	1	1	23
8		1	1	0	0	0	24
9		1	1	0	0	1	25
:		1	1	0	1	0	26
;		1	1	0	1	1	27
<		1	1	1	0	0	28
=		1	1	1	0	1	29
>		1	1	1	1	0	30

Address "21" is address for 98034A and cannot be used.



IN Initialize Causes the 5316A to go to the default state: Function goes to FREQUENCY A, A and B slopes go to +, and all of the Binary commands go to the 0 state. For example, Initialize (IN) sets the following codes:

FN1AS0BS0TR0WA0SR0GA0

The 5316A will blank the display and make a new measurement in FREQ A. (NOTE: Even if the 5316A was in FREQ A already, "IN" will still set the Binary commands to 0 and make a new measurement. Initialize is commonly sent as the leading code in a command string. This will clear all functions (to default states) and then only the codes following in the command string change the operating mode from the default states..

3-91. BINARY COMMANDS: A sequence of two ASCII-coded alphabetic characters followed by either a '0' or a "1". Blue indicates the default state.

AS0 Channel A triggers on POSITIVE slope of signal.

AS1 Channel A triggers on NEGATIVE slope of signal.

BS0 Channel B triggers on POSITIVE slope of signal.

BS1 Channel B triggers on NEGATIVE slope of signal.

TR0 The A and B trigger levels are set by front panel controls.

TR1 The A and B trigger levels are set by the internal D-to-A Converters. If no numeric values are specified after a TR1 the DACs go to nominal zero volts DC. (See Numeric Commands paragraph 3-92b).

WA0 Continuous gating mode; output only if addressed to talk.

WA1 Gate once, wait for talk address; output data; then make new measurement.

In the Wait state (WA1), the 5316A will make a measurement and hold the data until it has been addressed to talk. At that time, it will output the data and then make a new measurement. None of the functions or parameters are changed. Note that WA1 allows you to make a measurement and then get the data from that measurement. Simply addressing it to Talk, in WA0, will send you the results of the next measurement completed. WA0 will continue gating and not hold the measurement.

SR0 5316A WILL NOT pull SRQ at end of measurement.

SR1 5316A WILL pull SRQ at end of measurement.

The 5316A will request service only to indicate that a measurement is complete and the data is available. Service Request will occur only if:

1. the "SR1" command has been sent.
2. the WAIT state (WA1) has been enabled.

Reading a device status will return the value 64 (seventh bit active) indicating that service has been requested. The service request line is cleared when the 5316A is addressed to TALK or when the status is read. Even though SRQ is cleared during a read device status, the status will remain "64" until the data is read or a front panel RESET is sent.

Once the data is read (when service has been requested) SRQ will go inactive and the 5316A will start a new measurement. The service request can only be cleared by reading the measurement data.



3-92. NUMERIC COMMANDS: A sequence of two ASCII-coded alphabetic characters followed by a sequence of bytes representing a decimal number and a delimiter. **Blue** indicates the default states.

a. Measurement Functions:

- FN0 ROLLING DISPLAY TEST
- FN1 **FREQUENCY A**
- FN2 TIME INTERVAL A → B
- FN3 TI DELAY
- FN4 RATIO A/B
- FN5 FREQUENCY C
- FN6 TOTALIZE STOP
- FN7 PERIOD A
- FN8 TIME INTERVAL AVERAGE A → B
- FN9 CHECK 10.00 MHz
- FN10 A GATED BY B (trigger slope controlled by front panel or by commands AS and BS).
- FN11 READ GATE TIME
- FN12 TOTALIZE START
- FN13 FREQUENCY A, AVERAGED, ARMED BY B
FN13 sets the Channel B START arming slope to positive trigger. The STOP slope is determined by sending BS0 or BS1. The Channel A slope is determined by AS0 or AS1. See paragraph 3-23 for a detailed description of this function.
- FN14 FREQUENCY A, AVERAGED, ARMED BY B
Same as FN13 except the B START arming slope is negative. The B STOP arming slope and Channel A slopes are still determined by BS0 or BS1 and AS0 or AS1, respectively. See paragraph 3-23.

FUNCTION 13 AND 14 A ARMED BY B CODE TABLE

TRIGGER ON A SLOPE	BEGIN ON B SLOPE	END ON B SLOPE	CODE STRING
POS	POS	POS	FN13AS0BS0
NEG	POS	POS	FN13AS1BS0
POS	NEG	POS	FN14AS0BS0
NEG	NEG	POS	FN14AS1BS0
POS	POS	NEG	FN13AS0BS1
NEG	POS	NEG	FN13AS1BS1
POS	NEG	NEG	FN14AS0BS1
NEG	NEG	NEG	FN14AS1BS1

FN16 HP-IB INTERFACE TEST (Used only in the HP-IB verification in Section IV)

b. Programming Trigger Levels:

Commands of the form AT [value] and BT [value] set the D-to-A converters to DC voltages such that the trigger levels of the A (and B) channels are the value (in volts) specified. Note that TR1 must also be sent at the beginning of the DAC programming sequence. (TR1 enables the AT/BT command and need be sent only once.) The trigger level voltage range is +2.50V dc to -2.50V dc, in steps of 0.01V dc. The trigger level voltages may be monitored at the front panel TRIGGER LEVEL jacks. The measurement error at these points is ±5% of the actual voltage ±15 mV over the range of ±2.0V dc. For example all three of the following formats set the Channel A trigger level to 0V dc:

- AT 0 (Here the space is ignored)
- AT0.00
- AT +00



Channel B is exactly the same. To set Channel B to $-1.53V$:

BT-1.53

Unless specified as negative, the polarity is assumed to be positive.

Sending trigger level commands (AT and/or BT) will cause the 5316A to reset.

c. Programming Gate Time:

GA There are 2 gate time ranges available. The LONG gate time range is 60 ms-10 s, typical. The SHORT gate time range is 500 μ s-30 ms, typical. These two gate time ranges can be controlled by either the front knob or rear panel adjustment (see *Figure 3-11*). The rear panel gate time control is essentially the same as the front panel GATE TIME control WITHOUT the HOLD position. Commands for the gate time ranges are as follows. **Blue** indicates the default states.

- GA0** Gate time range is LONG, controlled by front knob.
- GA1 Gate time range is SHORT, controlled by front knob.
- GA2 Gate time range is LONG, controlled by rear panel adjustment.
- GA3 Gate time range is SHORT, controlled by rear panel adjustment.

NOTE

Placing the GATE TIME/DELAY control in the HOLD position will cause the bus to stop all operations whenever an attempt is made to read data from the 5316A. When a read data statement is sent, the 5316A cannot send out its data until the GATE TIME/DELAY control is removed from the HOLD position.

3-93. INPUT CODE FORMAT

3-94. The 5316A will accept the program codes in either upper case or lower case. For example (in 9825A HPL language):

wrt 720,"INFN7WA1SR1" OR wrt 720,"infn7wa1sr1"

Either way will produce the same results. Depending on the controller, this feature can help speed the writing of programs.

3-95. OUTPUT FORMAT

3-96. After a measurement is complete, the 5316A will output the data to the HP-IB. The output string contains 19 characters, followed by a carriage return and line feed. *Table 3-5* shows the output format of the string.

3-97. The measurement data output speed for the 5316A is approximately:

- a. Seven measurements/second in the LONG gate time mode with the GATE TIME control fully counterclockwise (shortest LONG gate time), but not in HOLD.
- b. Ten measurements/second in the SHORT gate time mode with the GATE TIME control in the fully counterclockwise position (shortest SHORT gate time), but not HOLD.

3-98. PROGRAMMING EXAMPLES

3-99. The examples listed in this section assume a 5316A address setting of 10100. The 5316A is addressed to talk and listen by using the code 720, where 20 is the 5316A address and 7 is the interface select code of the 98034A. The ASCII characters for these same switch settings are "T" for a talk address and "4" for a listen address; these characters would be used if the controller were an HP 9830A calculator (or 9825A when using the 'cmd' statement).



Table 3-5. Output String Format

1	2	3	through	15	16	17	18	19	20	21
F	+	X spaces, 1 digit, dp, 11-X digits		E	+	-	D	D	CR	LF
T										
O										
X										
SP										

Position 1 (ALPHA CHARACTER):

- F for frequency measurement (FN1, 5, 9, 13, and 14)
- T for time measurement (FN2, 3, 7, 8 and 11)
- O for overflow
- X for error (indicates the same error as front panel ERROR LED). See Section VIII, Troubleshooting.
- SP (space) for all other modes and functions (FN10, 11, 12)

Positions 3 through 15:

In these positions, X spaces followed by a single digit, a decimal point, and 11-X digits (depending on the resolution). The decimal point may appear at any position between 4 and 15.

Position 16 through 21:

The "E" to signify EXPONENT followed by the exponent polarity (+ or -), two exponent digits, and carriage return and linefeed.

3-100. The following programs demonstrate the programming of the 5316A. Examples 1 and 2 are for the 9825A. Examples 3 and 4 are the same as 1 and 2 respectively, but are written for the 9835A/9845A.

EXAMPLE 1 SIMPLE FREQUENCY MEASUREMENT 9825A

0:	wrt 720,"FN1"	SET THE 5316A TO FREQUENCY A MODE
1:	red 720,A	READ DATA INTO A
2:	dsp A;wait 500	DISPLAY CONTENTS OF A, WAIT 500 ms
3:	gto 1	GO TO LINE 1
4:	stp	STOP

EXAMPLE 2 PERIOD MEASUREMENT USING REMOTE TRIGGER LEVELS 9825A

0:	dim A\$(19)	DIMENSION A\$ TO 19 CHARACTER LONG
1:	wrt 720,"fn7wa1tr1at-.25"	SET THE 5316A TO: PERIOD, WAIT TO OUTPUT, TRIGGER LEVEL SET BY D/A CONVERTER, CHANNEL A TRIGGER LEVEL SET TO -.25V dc
2:	red 720,A\$	READ DATA INTO A\$
3:	dsp A\$; wait 1000	DISPLAY A\$;WAIT 1 SECOND
4:	gto 2	GOTO LINE 2
5:	end	END PROGRAM

EXAMPLE 3 SIMPLE FREQUENCY MEASUREMENT 9835A/9845A

10	OUTPUT 7,20;"FN1"	SET THE 5316A TO: FREQUENCY A MODE
20	ENTER 7,20;A	READ DATA INTO A
30	DISP A	DISPLAY CONTENTS OF A
40	WAIT 500	WAIT 500 ms
50	GOTO 20	GOTO LINE 20
60	STOP	STOP



EXAMPLE 4 PERIOD MEASUREMENT USING REMOTE TRIGGER LEVELS 9835A/9845A

10	OPTION BASE 1	ALL SUBSCRIPTS START AT 1
20	DIM A\$ [19]	DIMENSION A\$ TO 19 CHARACTERS LONG
30	OUTPUT 7,20; "FN7WA1TR1AT-.25"	SET THE 5316A TO: PERIOD, WAIT TO OUTPUT, TRIGGER LEVEL SET BY D/A CONVERTER, CHANNEL A TRIGGER LEVEL SET TO -.25V dc
40	ENTER 7,20; A\$	READ DATA INTO A\$
50	DISP A\$	DISPLAY A\$
60	WAIT 1000	WAIT 1 SECOND
70	GOTO 40	GOTO LINE 40
80	END	END PROGRAM

See Output Format Paragraph 3-95.

3-101. Special Programming Considerations

3-102. To clarify the programming of the 5316A, the following considerations should be noted:

1. If the 5316A is currently in REMOTE and new commands are sent, the 5316A will reset and begin a new measurement.
2. If the 5316A is sent back to local from remote and then returned to remote again, all previous remote functions (slopes, trigger levels, output mode, etc.) will be retained and reactivated. The gate time, however, is dominated by the locally selected range and must be programmed again if different.
3. If a trigger command (group or select) is sent to the 5316A while under remote control, and the 5316A is currently making a measurement, a new measurement will begin but the gate time is shortened. The gate time will be *approximately* the amount of time remaining from the interrupted measurement. The resolution obtained will be correct for the shortened gate time.
4. If a slope command is sent to the 5316A and no previous function command was sent, the 5316A will default to Frequency A.
5. If new commands are sent to the 5316A while it is waiting to output data (WA1 is active), the new commands will not become active until the data is read from the counter (5316A addressed to talk).
6. The 5316A will remember the trigger level values set during remote control when sent to local. However, if the front panel Reset is pressed while in Local, the trigger level values stored will default to nominal zero and the Trigger Level/DAC selection will default to TR0 (front panel control).
7. When writing instructions, the 5316A will generally ignore the delimiters in the instruction string, as long as they occur BETWEEN complete instructions.
8. To enable Service Request, BOTH WA1 and SR1 must be sent. WA1 can be used alone if Service Request is not desired.



Table 3-6. HP-IB Program Code Set

RE	Reset	Display blanks and a new measurement is made.	
IN	Initialize	5316A goes to default state, which is the same as sending the following codes: FN1 AS0 BS0 TR0 WA0 SR0 GA0 (noted in blue)	
AS0	A channel triggers on POSITIVE slope of signal.		
AS1	A channel triggers on NEGATIVE slope of signal.		
BS0	B channel triggers on POSITIVE slope of signal.		
BS1	B channel triggers on NEGATIVE slope of signal.		
WA0	Continuous gating mode, output only if addressed.		
WA1	Gate once, wait for talk address to output data, then make new measurement.		
SR0	5316A WILL NOT pull SRQ at end of measurement.		
SR1	5316A WILL pull SRQ at end of measurement (must be in wait state WA1).		
GA0	Gate time range is LONG, controlled by front knob.		
GA1	Gate time range is SHORT, controlled by front knob.		
GA2	Gate time range is LONG, controlled by rear panel adjustment.		
GA3	Gate time range is SHORT, controlled by rear panel adjustment. Long gate time range — 60 ms to 10 s, typical. Short gate time range — 500 μ s to 30 ms, typical.		
TR0	The A and B trigger levels are set by front panel controls.		
TR1	Enables the A and B trigger levels to be set remotely via HP-IB. If no numeric AT or BT command is sent, trigger level is zero volts DC nominal. AT (value) A Channel Trigger Level BT (value) B Channel Trigger Level Trigger levels can be set from -2.50V dc to +2.50V dc in steps of 0.01V dc. Format for the voltage value can be any of X, X.XX, +X.X, -X, -X.X, +X.XX, -X.XX, X.X, or +X.		
		Measurement Functions:	
		FN0 ROLLING DISPLAY TEST	
		FN1 FREQUENCY A	
		FN2 T.I. A-B	
		FN3 T.I. DELAY	
		FN4 RATIO A/B	
		FN5 FREQUENCY C	
		FN6 TOTALIZE STOP	
		FN7 PERIOD A	
		FN8 T.I. AVERAGE A-B	
		FN9 CHECK 10.00 MHz	
		FN10 A GATED BY B (trigger slope controlled by commands AS and BS or by front panel).	
		FN11 GATE TIME	
		FN12 TOTALIZE START	
		FN13 FREQUENCY A, AVERAGED, ARMED BY B FN13 sets the B channel START arming slope to positive trigger. The STOP slope is determined by sending BS0 or BS1. The A channel slope is determined by AS0 or AS1.	
		FN14 FREQUENCY A, AVERAGED, ARMED BY B Same as FN13 except the B channel START arming slope is negative.	
		FN16 HP-IB INTERFACE TEST (Used in the HP-IB verification in Section IV).	
		DATA OUTPUT SPEED:	
		7 readings/second maximum — Long Gate Time.	
		10 readings/second maximum — Short Gate Time.	
		Note: As soon as a command is sent to the 5316A a new measurement is triggered.	
		Placing the GATE TIME/DELAY control in the HOLD position will cause the bus to stop all operations whenever an attempt is made to read data from the 5316A.	