

Errata

Title & Document Type: [REDACTED]

Manual Part Number: 05334-90047

Revision Date: December 1993

HP References in this Manual

This manual may contain references to HP or Hewlett-Packard. Please note that Hewlett-Packard's former test and measurement, semiconductor products and chemical analysis businesses are now part of Agilent Technologies. We have made no changes to this manual copy. The HP XXXX referred to in this document is now the Agilent XXXX. For example, model number HP8648A is now model number Agilent 8648A.

About this Manual

We've added this manual to the Agilent website in an effort to help you support your product. This manual provides the best information we could find. It may be incomplete or contain dated information, and the scan quality may not be ideal. If we find a better copy in the future, we will add it to the Agilent website.

Support for Your Product

Agilent no longer sells or supports this product. You will find any other available product information on the Agilent Test & Measurement website:

www.tm.agilent.com

Search for the model number of this product, and the resulting product page will guide you to any available information. Our service centers may be able to perform calibration if no repair parts are needed, but no other support from Agilent is available.



Operating &
Programming Manual

HP 5334A/B
Universal Counter

ED REPR...
ON AUTHORIZED REPR... AUTHORIZED REPR... AUTH...
IZED REPR...
TION AUTH...
ORIZED REPR...
DUCTION AUTH...
ED REPRODUCTION AUTHORIZED REPR... A
ORIZED REPR... AUTHORIZED REF

MANUALS

PLUG

HP 5334A/B UNIVERSAL COUNTERS

OPERATING AND PROGRAMMING MANUAL

**SERIAL NUMBER PREFIX: 2938A (HP 5334A),
2937A (HP 5334B)**

This manual applies directly to HP 5334As with Serial Number Prefix 2938A and HP 5334Bs with Serial Prefix 2937A.

The manual for an HP 5334A/B with a serial number prefix higher than the ones listed above will include a "Manual Changes" supplement which will describe what changes, if any, need to be made to the manual to make it match the instrument it accompanies. For serial prefixes below the ones indicated in the above paragraph, refer to Section VII of the appropriate Service Manual for backdating.

©HEWLETT-PACKARD COMPANY 1987, 1990, 1991, 1992, 1993
5301 STEVENS CREEK BLVD, SANTA CLARA, CA 95051-7299

MANUAL PART NUMBER : 05334-90047

Printed: DECEMBER 1993



CERTIFICATION

Hewlett-Packard Company certifies that this product met its published specifications at the time of shipment from the factory. Hewlett-Packard further certifies that its calibration measurements are traceable to the United States National Institute of Standards and Technology (formerly National Bureau of Standards), to the extent allowed by that organization's calibration facility, and to the calibration facilities of other International Standards Organization members.

WARRANTY

This Hewlett-Packard instrument product is warranted against defects in material and workmanship for a period of one year from date of shipment. During the warranty period, Hewlett-Packard Company will, at its option, either repair or replace products which prove to be defective.

For warranty service or repair, this product must be returned to a service facility designated by HP. Buyer shall prepay shipping charges to HP and HP shall pay shipping charges to return the product to Buyer. However, Buyer shall pay all shipping charges, duties, and taxes for products returned to HP from another country.

HP warrants that its software and firmware designated by HP for use with an instrument will execute its programming instructions when properly installed on that instrument. HP does not warrant that the operation of the instrument, or software, or firmware will be uninterrupted or error free.

LIMITATION OF WARRANTY

The foregoing warranty shall not apply to defects resulting from improper or inadequate maintenance by Buyer, Buyer-supplied software or interfacing, unauthorized modification or misuse, operation outside of the environmental specifications for the product, or improper site preparation or maintenance.

NO OTHER WARRANTY IS EXPRESSED OR IMPLIED. HP SPECIFICALLY DISCLAIMS THE IMPLIED WARRANTIES OF MERCHANTABILITY AND FITNESS FOR A PARTICULAR PURPOSE.

EXCLUSIVE REMEDIES

THE REMEDIES PROVIDED HEREIN ARE BUYER'S SOLE AND EXCLUSIVE REMEDIES. HP SHALL NOT BE LIABLE FOR ANY DIRECT, INDIRECT, SPECIAL, INCIDENTAL, OR CONSEQUENTIAL DAMAGES, WHETHER BASED ON CONTRACT, TORT, OR ANY OTHER LEGAL THEORY.

ASSISTANCE

Product maintenance agreements and other customer assistance agreements are available for Hewlett-Packard products.

For any assistance, contact your nearest Hewlett-Packard Sales and Service Office. Addresses are provided at the back of this manual.

SAFETY CONSIDERATIONS

GENERAL

This product and related documentation must be reviewed for familiarization with safety markings and instructions before operation.

This product is a Safety Class I instrument (provided with a protective earth terminal).

BEFORE APPLYING POWER

Verify that the product is set to match the available line voltage and the correct fuse is installed. Refer to instructions in this appendix.

SAFETY EARTH GROUND

An uninterruptible safety earth ground must be provided from the mains power source to the product input wiring terminals or supplied power cable.

SAFETY SYMBOLS



Instruction manual symbol; the product will be marked with this symbol when it is necessary for the user to refer to the instruction manual.



Indicates hazardous voltages.

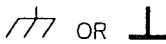

Indicates terminal is connected to chassis when such connection is not apparent.



Alternating current.



Direct current.

WARNING

The **WARNING** sign denotes a hazard. It calls attention to a procedure, practice, or the like, which, if not correctly performed or adhered to, could result in personal injury. Do not proceed beyond a **WARNING** sign until the indicated conditions are fully understood and met.

CAUTION

The **CAUTION** sign denotes a hazard. It calls attention to an operating procedure, practice, or the like, which, if not correctly performed or adhered to, could result in damage to or destruction of part or all of the product. Do not proceed beyond a **CAUTION** sign until the indicated conditions are fully understood and met.

SAFETY INFORMATION

WARNING

Any interruption of the protective grounding conductor (inside or outside the instrument) or disconnecting the protective earth terminal will cause a potential shock hazard that could result in personal injury. (Grounding one conductor of a two conductor outlet is not sufficient protection.)

Whenever it is likely that the protection has been impaired, the instrument must be made inoperative and be secured against any unintended operation.

If this instrument is to be energized via an autotransformer (for voltage reduction) make sure the common terminal is connected to the earthed pole terminal (neutral) of the power source

Instructions for adjustments while covers are removed and for servicing are for use by service-trained personnel only. To avoid dangerous electric shock, do not perform such adjustments or servicing unless qualified to do so.

For continued protection against fire, replace the line fuse(s) only with 250V fuse(s) of the same current rating and type (for example, normal blow, time delay). Do not use repaired fuses or short circuited fuseholders.

When measuring power line signals, be extremely careful and always use a step-down isolation transformer whose output voltage is compatible with the input measurement capabilities of this product. This product's front and rear panels are typically at earth ground, so **NEVER TRY TO MEASURE AC POWER LINE SIGNALS WITHOUT AN ISOLATION TRANSFORMER.**

ACOUSTIC NOISE EMISSION:

LpA 56dB at operator position, at normal operation, tested per ISO 7779. All data are the results from type test

GERAeUSCHEMISSION:

LpA 56dB am Arbeits platz, normaler Betrieb, gepuert nach DIN 45635 Teil 19 Die Angaben behruhen auf Ergebnissen von Typpruellungen.

TABLE OF CONTENTS



Section	Title	Page
I	GENERAL INFORMATION	1-1
	1-1. Introduction	1-1
	1-3. Manual Summary	1-1
	 1-6. Specifications	1-1
	1-8. Safety Considerations	1-1
	1-10. General	1-2
	1-12. Instrument and Manual Identification	1-7
	1-14. Description of Instrument	1-7
	1-18. Accessories	1-8
	1-20. Options	1-8
	1-24. Recommended Test Equipment	1-9
II	INSTALLATION	2-1
	2-1. Introduction	2-1
	2-3. Unpacking and Inspection	2-1
	 2-5. Preparation for Use	2-1
	2-6. Operating Environment	2-1
	2-10. Power Requirements	2-1
	2-12. Line Voltage and Fuse Selection	2-1
	2-18. Power Cable	2-3
	2-20. Hewlett-Packard Interface Bus	2-3
	2-21. HP-IB Interconnections	2-3
	2-23. Cable Length Restrictions	2-3
	2-25. Address Selection	2-4
	2-27. HP-IB Descriptions	2-4
	2-29. Storage and Shipment	2-4
	2-30. Environment	2-4
	2-33. Packaging	2-4
III	OPERATION AND PROGRAMMING	3-1
	3-1. Introduction	3-1
	3-4. Operating Characteristics	3-1
	3-8. Basic Circuits and Measurements	3-2
	3-11. Input Characteristics and Signal Conditioning	3-2
	3-13. Range	3-3
	3-18. Sensitivity	3-4
	3-24. AC-DC Coupling	3-6
	3-26. Trigger Level	3-7
	3-33. Slope Control	3-8
	3-35. Input Impedance	3-9
	3-37. Attenuators	3-9
	3-40. Damage Level	3-9
	3-42. Separate/Common A Input	3-9
	3-47. 100 kHz Filter	3-9
	3-49. Arming Input	3-10
	3-51. How to Make Measurements	3-10
	3-54. Frequency Measurements	3-11
	3-60. Period Measurements	3-11
	3-63. Time Interval Measurements	3-11
	3-69. Time Interval Delay Measurements	3-12

TABLE OF CONTENTS (Continued)

Section	Title	Page
III	OPERATION AND PROGRAMMING (Continued)	
3-71.	Ratio Measurements	3-13
3-74.	Totalize Measurements	3-13a
3-77.	Voltage Measurements (applies only to HP 5334A with Option 020)	3-14
3-79.	Pulse Width Measurements	3-14
3-82.	Rise/Fall Time Measurements	3-14
3-85.	Peak Voltage Measurements	3-15
3-88.	Initial Power-Up Checks and Self-Diagnostics	3-16
3-92.	Front Panel Controls, Indicators, and Connectors	3-17
3-94.	POWER (STANDBY/ON) Key	3-17
3-97.	RESET/LOCAL Key	3-17
3-99.	Front Panel Controls	3-18
3-103.	Front Panel MEMORY (applies to HP 5334A only)	3-18
3-105.	GATE Group	3-18
3-107.	GATE TIME/DELAY Key	3-18
3-111.	SINGLE CYCLE key	3-19
3-113.	100-GATE AVERAGE Key	3-19
3-115.	MATH/MEMORY Group	3-19
3-117.	SELECT/ENTER key	3-20
3-124.	DISABLE Key	3-21
3-126.	STORE Key (HP 5334A only)	3-21
3-130.	RECALL Key (HP 5334A only)	3-22
3-135.	FUNCTION/DATA Group	3-23
3-137.	FREQ A Key	3-24
3-139.	PERIOD A Key	3-24
3-141.	RATIO A/B Key	3-24
3-143.	PULSE WIDTH A Key	3-25
3-145.	FREQ B Key	3-25
3-147.	T.I. A-B Key	3-25
3-150.	RISE/FALL TIME A Key	3-26
3-152.	FREQ C Key	3-26
3-154.	T.I. A-B/DELAY Key	3-26
3-156.	TOT START A Key	3-26
3-158.	TOT STOP A Key	3-26
3-160.	DVM Key (Option 020, for HP 5334A only)	3-26
3-162.	INPUT Group	3-27
3-164.	TRIGGER Light	3-27
3-166.	TRIGGER LEVEL/SENS Control	3-27
3-168.	SENS Key	3-28
3-178.	READ LEVELS Key	3-30
3-180.	SLOPE/START ARM/STOP ARM Keys	3-30
3-182.	AC Key	3-31
3-184.	X10 ATTN Key	3-31
3-186.	50 Ohm Z Key	3-31
3-188.	100 kHz FILTER A Key	3-31
3-190.	COM A Key	3-31
3-192.	AUTO TRIG Key	3-31
3-195.	EXT ARM SELECT Key	3-32
3-200.	INPUT A,B	3-36

TABLE OF CONTENTS (Continued)

Section	Title	Page
III	OPERATION AND PROGRAMMING (Continued)	
3-202.	ARM INPUT	3-36
3-204.	INPUT C (Option 030)	3-36
3-206.	Front Panel Display and Annunciators	3-37
3-208.	Rear Panel Controls and Connectors	3-41
3-210.	HP 5334A AC Power Input Module	3-41
3-212.	HP 5334B AC Power Input Circuit	3-41
3-214.	GATE OUT Connector (HP 5334A Only)	3-41
3-216.	TIME BASE IN/OUT Connector	3-41
3-218.	TIME BASE ADJ Control	3-41
3-220.	TIME BASE INT/EXT Switch	3-42
3-222.	HP-IB Interface Connector	3-42
3-224.	Arm Trigger Level Control (HP 5334A Only)	3-42
3-226.	Rear Panel INPUT Connectors (Option 060)	3-42
3-229.	Option 010 Oven Oscillator Control (HP 5334A Only)	3-42
3-231.	Address Switch (HP 5334B Only)	3-42
3-233.	Operator's Maintenance	3-42
3-235.	Replacing C-Channel Fuse (HP 5334A only)	3-43
3-237.	Power-Up/Warm-up	3-43
3-240.	Operator's Checks	3-44
3-242.	Power-Up Self-Check	3-44
3-246.	Diagnostic Sequence	3-45
3-250.	Preset and Lockout Conditions	3-46
3-252.	Error Indications	3-47
3-255.	Error Examples	3-49
3-257.	Detailed Operating Instructions	3-51
3-260.	Remote Programming via HP-IB	3-67
3-263.	HP-IB Description	3-67
3-266.	Interface System Terms	3-67
3-268.	Major Interface Functions	3-68
3-272.	Interface Capabilities	3-68
3-277.	Front Panel Interface Status LEDs	3-70
3-279.	Address Selection	3-70
3-286.	Interface Commands	3-72
3-289.	Device Independent Commands	3-72
3-292.	Meta Messages	3-75
3-298.	Meta Message Response	3-75
3-299.	SRQ and Status Byte	3-76
3-304.	Service Request Mask	3-77
3-306.	Device Dependent Commands	3-78
3-308.	Device Command Definitions	3-78
3-310.	Numeric Entry	3-79
3-312.	Programming Commands	3-79
3-315.	Command Group Descriptions	3-80
3-320.	Miscellaneous and Special Functions	3-80
3-333.	Output Formats	3-84
3-344.	High Speed Output Data	3-86
3-352.	Error Handling	3-87
3-357.	Preset and Disallowed Conditions	3-88
3-359.	Programming Examples	3-91

TABLE OF CONTENTS

Section	Title	Page
IV	PERFORMANCE TESTS	4-1
4-1.	Introduction.....	4-1
4-3.	Equipment Required	4-1
4-5.	Operational Verification/Performance Test Record	4-1
4-7.	Calibration Cycle.....	4-1
4-10.	Test Procedures	4-1
4-12.	Operational Verification Tests	4-2
4-15.	Preliminary Procedure.....	4-2
4-16.	Power-up Self-Test/Diagnostic Mode.....	4-3
4-17.	Read Levels	4-4
4-18.	Ratio A/B	4-5
4-19.	Frequency	4-6
4-20.	Input Signal Conditioning Check	4-6
4-21.	T.I. A→B	4-8
4-22.	Auto Trigger.....	4-9
4-23.	CMOS RAM (HP 5334A Only).....	4-10
4-23.	Channel C (Option 030)	4-10
4-24.	DVM (Options 020 and 050 HP — 5334A Only).....	4-10
4-25.	Channel C (Options 030 and 050 — HP 5334A)	4-10
4-26.	Channel C (Option 030 — HP 5334B)	
4-27.	Performance Tests	4-12
4-30.	Preliminary Procedure.....	4-12
4-31.	Channel A Frequency Response and Sensitivity Test, 10 Hz-20 MHz.....	4-13
4-32.	Channel B Frequency Response and Sensitivity Test, 10 Hz-20 MHz.....	4-16
4-33.	Channel A Frequency Response and Sensitivity Test, 80 MHz-100 MHz.....	4-18
4-34.	Channel B Frequency Response and Sensitivity Test, 80 MHz-100 MHz.....	4-20
4-35.	Channel A Frequency Response and Sensitivity Test, 80 MHz-100 MHz.....	4-21
4-36.	Channel B Frequency Response and Sensitivity Test, 80 MHz-100 MHz.....	4-23
4-37.	Period A Test	4-24
4-38.	Pulse Width A Test	4-26
4-39.	Time Interval A to B Test	4-26
4-40.	Time Interval A to B Delay Test	4-27
4-41.	Ratio A/B Test.....	4-28
4-42.	Rise/Fall Time A Test	4-29
4-43.	DVM Accuracy Test (Options 020 and 050 — HP 5334A only).....	4-31
4-44.	Channel C Frequency Response and Sensitivity Test.....	4-33
4-45.	HP-IB Verification Test	4-37

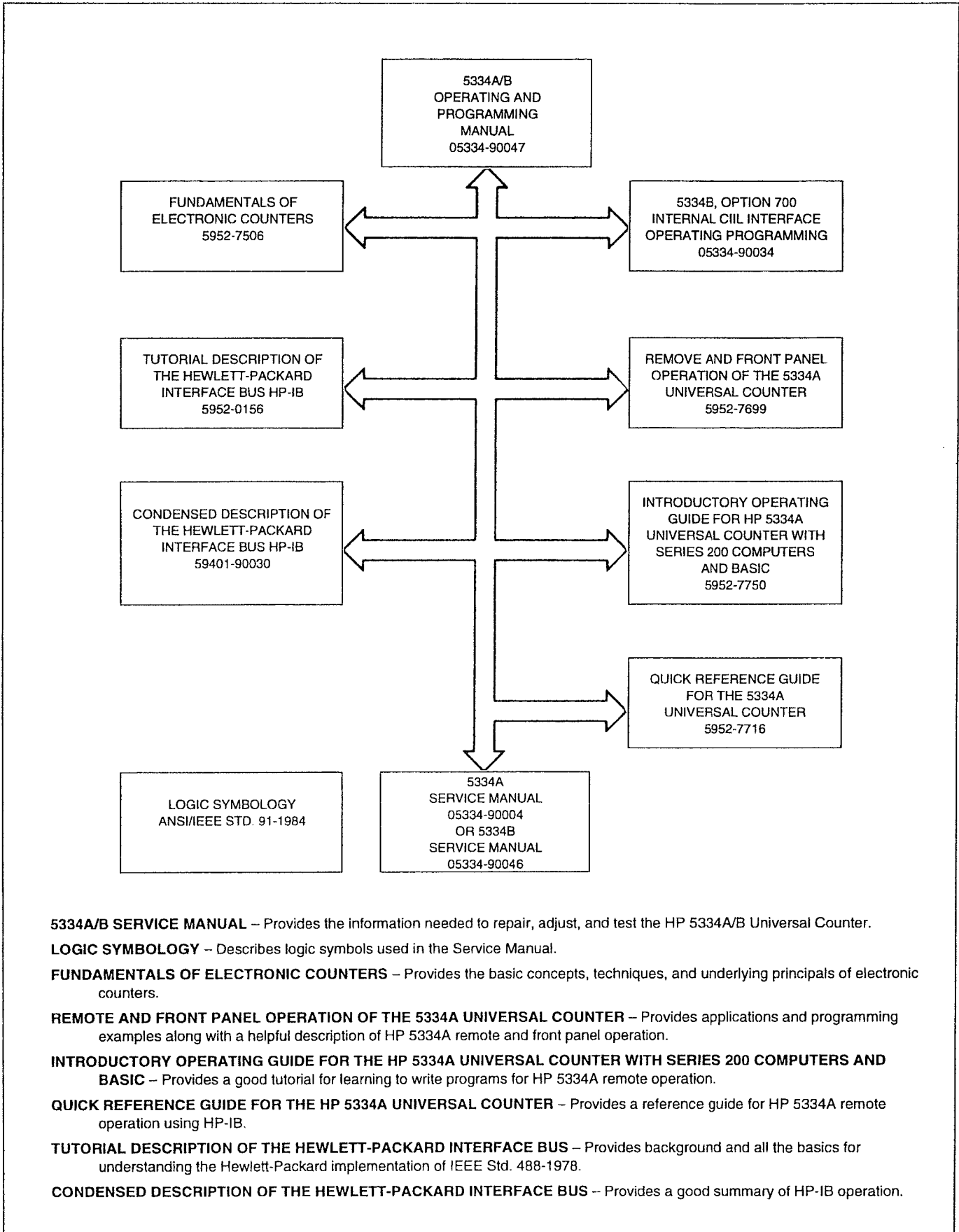

5334A/B SERVICE MANUAL – Provides the information needed to repair, adjust, and test the HP 5334A/B Universal Counter.

LOGIC SYMBOLOLOGY – Describes logic symbols used in the Service Manual.

FUNDAMENTALS OF ELECTRONIC COUNTERS – Provides the basic concepts, techniques, and underlying principals of electronic counters.

REMOTE AND FRONT PANEL OPERATION OF THE 5334A UNIVERSAL COUNTER – Provides applications and programming examples along with a helpful description of HP 5334A remote and front panel operation.

INTRODUCTORY OPERATING GUIDE FOR THE HP 5334A UNIVERSAL COUNTER WITH SERIES 200 COMPUTERS AND BASIC – Provides a good tutorial for learning to write programs for HP 5334A remote operation.

QUICK REFERENCE GUIDE FOR THE HP 5334A UNIVERSAL COUNTER – Provides a reference guide for HP 5334A remote operation using HP-IB.

TUTORIAL DESCRIPTION OF THE HEWLETT-PACKARD INTERFACE BUS – Provides background and all the basics for understanding the Hewlett-Packard implementation of IEEE Std. 488-1978.

CONDENSED DESCRIPTION OF THE HEWLETT-PACKARD INTERFACE BUS – Provides a good summary of HP-IB operation.

PREFACE

This manual is designed to present the information required by the user to effectively operate and program the HP 5334A/B Universal Counter.

It is divided into sections, each relating to a specific topic. As much as possible the sections are self-contained. It is the intention of this manual to allow for quick location of desired information, while still providing the overall depth of detail required. Some sections provide the learning and working information and will be used frequently. Other sections are dedicated to general and introductory types of information and are intended to be used only for reference. Where applicable, photos, illustrations, and diagram foldouts have been placed throughout the manual. In limiting the depth of coverage in this manual, a certain amount of previous knowledge on the part of the reader must be assumed. A variety of additional related documentation is available. These materials address in depth the specific areas of interest and should be used, whenever necessary, to supplement this manual. Users unfamiliar with HP-IB or Logic Symbolology, for example, may want to refer to the HP 5334A/B Documentation Map to find additional sources of information.

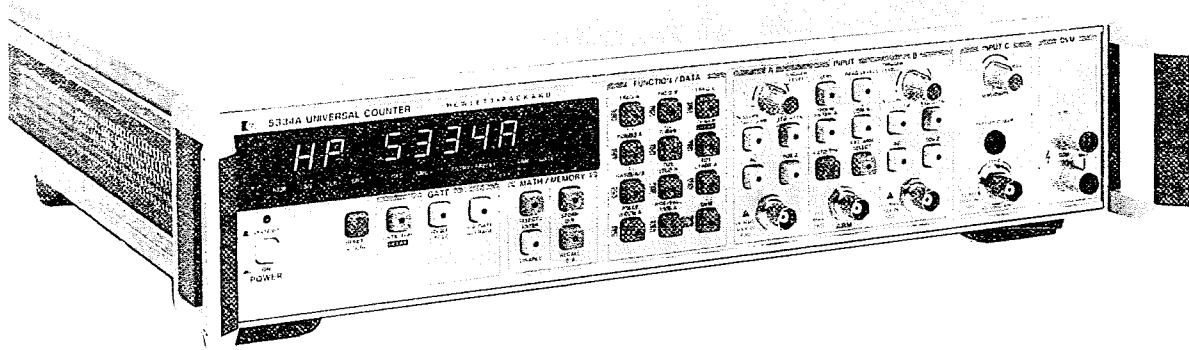

HP 5334A

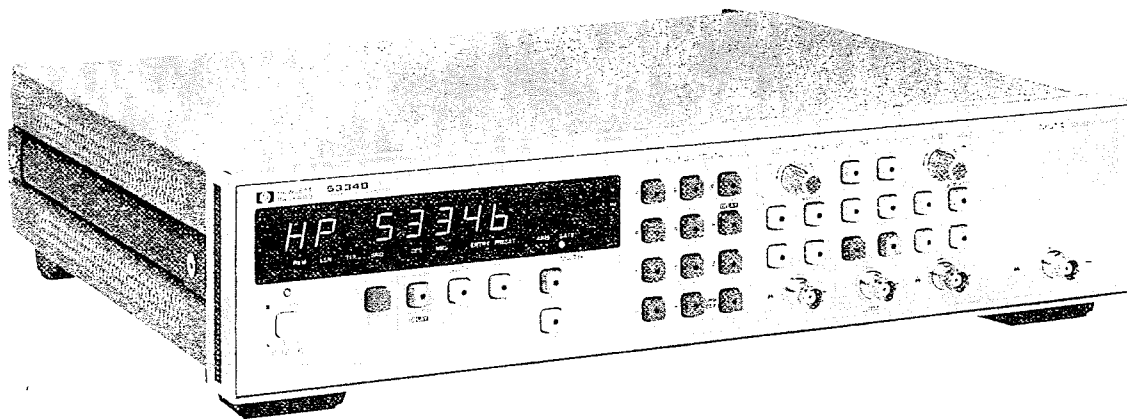

HP 5334B

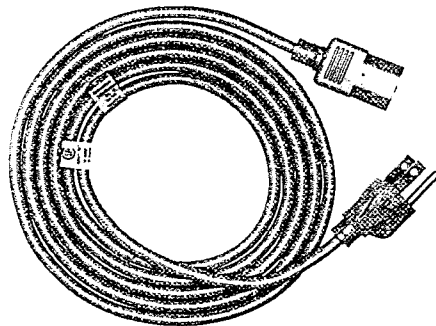

HP 8170-1378
POWER CORD
(1 EACH)

Figure 1-1. Model 5334A/B Universal Frequency Counters and Accessories

SECTION I GENERAL INFORMATION

1-1. INTRODUCTION

1-2. This manual contains the information necessary to install, operate, and program the Hewlett-Packard Model 5334A/B Universal Counters. The counters are shown in *Figure 1-1* with supplied accessories.

1-3. MANUAL SUMMARY

1-4. This manual is divided into four sections, each covering a particular topic for the operation and programming of the HP 5334A/B. The information contained in each section is described below:

SECTION I, GENERAL INFORMATION: describes the instrument documented by this manual and covers instrument identification, options, accessories, specifications, recommended test equipment, and other basic information.

SECTION II, INSTALLATION: provides information concerning initial inspection, preparation for use (including address selection for remote operation), and storage and shipment.

SECTION III, OPERATION AND PROGRAMMING: provides information pertaining to operating characteristics, making measurements, panel features, operating features, operator's checks, basic operating instructions for local operation, and programming information for remote operation via the Hewlett-Packard Interface Bus (HP-IB).

SECTION IV, PERFORMANCE TESTS: provides abbreviated procedures for operational verification which give the operator a high degree of confidence that the counter is operating properly; and performance tests, which provides the information required to check performance of the instrument against the critical specifications in *Table 1-1*. Also, an HP-IB verification test using the HP Series 200/300 compatible controller is provided in Section IV.

1-5. Additional copies of this manual and the Service Manual can be ordered through your nearest Hewlett-Packard Sales office.



1-6. SPECIFICATIONS

1-7. Instrument specifications are listed in *Table 1-1*. These are the performance standards, or limits against which the instrument may be tested including typical characteristics as additional information for the user.

1-8. SAFETY CONSIDERATIONS

1-9. The HP 5334A/B Universal Counters are Safety Class I instruments (provided with a protective earth terminal), designed according to international safety standards. Safety information pertinent to the operation and servicing of this instrument is located in appropriate sections of this manual including cautions and warnings which must be followed by the user to ensure safe operation and keep the instrument in safe condition.

1-10. General

1-11. The HP 5334A/B and related documentation must be reviewed for familiarization with safety markings and instructions before operation. **Before applying power**, verify that the product is set to match the available line voltage and the correct fuse is installed. Refer to Section II, Installation.

Table 1-1. HP Model 5334A/B Specifications

(Apply to both HP 5334A and B unless otherwise noted.)

INPUT CHARACTERISTICS

CHANNEL A and CHANNEL B

Range:

dc coupled. 0 to 100 MHz
ac coupled. 1 M Ω , 30 Hz to 100 MHz
50 Ω , 1 MHz to 100 MHz

Sensitivity:

15 mV rms sine wave to 20 MHz
35 mV rms sine wave to 100 MHz
100 mV peak-to-peak at a minimum pulse width of 5 ns
Sensitivity can be continuously varied to 150 mV rms, NOMINAL, using the TRIGGER LEVEL/SENS control in sensitivity mode. In this mode, trigger levels are automatically set to 0V NOMINAL

Dynamic Range (X1):

45 mV to 5V peak-to-peak, to 20 MHz
100 mV to 2.5V peak-to-peak, to 100 MHz

Signal Operating Range, DC: $\pm 5V$ dc (X ATTN)

Trigger Level:

Range:

Manual (Auto Trigger OFF): Continuously adjustable over ± 5 1V, displayed by Read Levels in 20 mV steps. In X10, ± 5 1V displayed in 200 mV steps

Preset: 0V NOMINAL in Sensitivity Mode

Auto Trigger: See Automatic Measurements Section

Accuracy (Read Levels):

X1. ± 30 mV $\pm 1\%$ of trigger level reading
X10. ± 300 mV $\pm 1\%$ of trigger level reading (NOMINAL).

Coupling: ac or dc, switch selectable

Trigger Slope: Independent selection of + or - slope

Impedance Γ : 1 M Ω NOMINAL shunted by <60 pF or 50 Ω NOMINAL, switch selectable

Attenuator:

Manual: X1 or X10 NOMINAL, switch selectable

Auto: Attenuator automatically switched when in Auto Trigger mode. See Automatic Measurements Section

Low Pass Filter: 100 kHz NOMINAL, switchable in or out of Channel A

Damage Level:

50 Ω , 5V rms
1 M Ω , X1.
0 to 3.5 kHz: 200V (dc + peak ac)
3.5 kHz to 100 kHz: 5×10^5 V rms Hz/FREQ.
>100 kHz: 5V rms
1 M Ω , X10.
0 to 35 kHz: 200V (dc + peak ac)
35 kHz to 100 kHz: 5×10^6 V rms Hz/FREQ.
>100 kHz: 50V rms

Common Input: All specifications are the same as for separate operation except for the following.

Sensitivity:

15 mV rms sine wave to 20 MHz
75 mV rms sine wave to 100 MHz
210 mV peak-to-peak at a minimum pulse width of 5 ns

Dynamic Range (X1):

45 mV to 5V peak-to-peak to 20 MHz
210 mV to 2.5V peak-to-peak to 100 MHz

Impedance Γ : 500 k Ω NOMINAL shunted by <85 pF or 50 Ω NOMINAL

EXTERNAL ARM

Front panel ARM input can be used to determine Start and/or Stop point of a measurement. External Arm can be used with all measurements except DVM (HP 5334A) and Read Levels

Minimum Start to Stop Time: 50 ns

Maximum Transition Time: 1 μ s

Sensitivity: 500 mV peak-to-peak

Signal Operating Range: -5 Vdc to $+5$ Vdc

Dynamic Range: 500 mV to 10V peak-to-peak

Arm Trigger Level:

HP 5334A: Adjustable from $-4V$ to $+4V$ by rear panel control

HP 5334B: Fixed at 1.5V

Slope: Independent selection of START and STOP ARM slopes, +, -, or OFF

Arm Set-up Time: Typically 20 ns for all measurements except Totalize. Typically 100 ns for Totalize

Impedance Γ : dc Coupled, 1 k Ω NOMINAL shunted by <30 pF

Damage Level: ± 15 V (dc + peak ac)

FREQUENCY A and FREQUENCY B

Range: 001 Hz to 100 MHz.

LSD $\text{\textcircled{1}}$: $\frac{4 \text{ ns}}{\text{Gate Time}} \times \text{FREQ.}$

Resolution: (see Graph 1)

$\pm \text{LSD} \pm \frac{(1.4 \times \text{Trigger Error} \text{\textcircled{2}} + 1 \text{ ns rms})}{\text{Gate Time}} \times \text{FREQ.}$

Accuracy: \pm Resolution \pm Timebase Error $\text{\textcircled{2}}$

PERIOD A

Range: 10 ns to 10^3 s

LSD $\text{\textcircled{1}}$: $\frac{4 \text{ ns}}{\text{Gate Time}} \times \text{PER}$

Resolution: (see Graph 1)

$\pm \text{LSD} \pm \frac{(1.4 \times \text{Trigger Error} \text{\textcircled{2}} + 1 \text{ ns rms})}{\text{Gate Time}} \times \text{PER}$

Accuracy: \pm Resolution \pm Timebase Error $\text{\textcircled{2}}$

Table 1-1. HP Model 5334A/B Specifications (Continued)

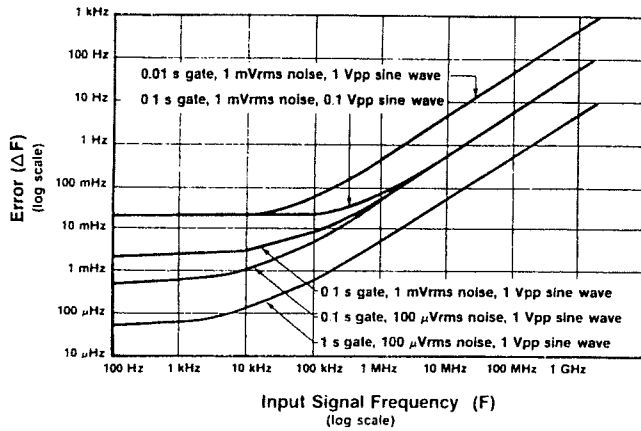

Graph 1. Frequency Resolution Error: Noise on the input signal and internal uncertainties affect Frequency and Period measurements. For Period, invert the period (P) of

the input signal ($F = \frac{1}{P}$), and find frequency

error (ΔF). Period error (ΔP) = $(\frac{\Delta F}{F}) \times P$

TIME INTERVAL A to B

Range: -1 ns to 10³s (single-shot), 10s (100 GATE AVERAGE)

LSD (1): 1 ns (100 ps using 100 GATE AVERAGE)

Resolution: ± LSD ± Start Trigger Error (2) ± Stop Trigger Error (3) ± 1 ns rms **

Accuracy: ± Resolution ± Timebase Error (4) ± Trigger Level Timing Error (5) ± Trigger Level Setting Error (6) ± 2 ns*

TIME INTERVAL DELAY

Used with Time Interval A to B, a selectable delay can be inserted between START (Channel A trigger) and STOP (Channel B trigger). Electrical inputs during delay are ignored. Specifications are the same as for Time Interval A to B.

Delay Range: 1 ms to 99 999 s (1 ms steps)

Delay Accuracy: ±100 μs ± 0.05% X DELAY TIME

RATIO A/B

Range: 0.01 Hz to 100 MHz both channels

LSD (1): 4 X RATIO/FREQ A X Gate Time

Resolution: ± LSD ± $\frac{B \text{ Trigger Error (2)}}{\text{Gate Time}} \times \text{RATIO}$

Accuracy: Same as Resolution

Specified for higher frequency input connected to Channel A

TOTALIZE A

Range: 0 to 10¹²-1

LSD Displayed: 1 count of input signal

Resolution: ±LSD

Accuracy: ±LSD

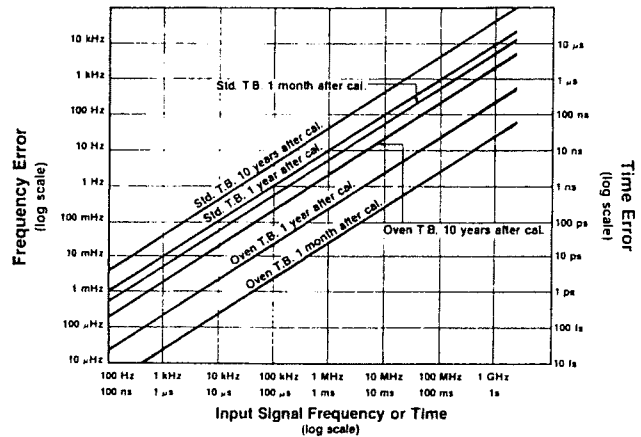

Graph 2. Timebase Error: Crystal environment and aging affects all measurements.

† Resistance values are measured at dc and capacitance values at 10 MHz

* This is a systematic error due to differential channel delay (matching Channel A and B) which can be eliminated by proper measurement technique; i.e., numerical offset or different cable lengths

** 100 ps rms using 100 GATE AVERAGE

AUTOMATIC MEASUREMENTS

These features are specified from 100 Hz to 20 MHz unless noted. Minimum width at peak of signal: 5 ns. Auto Trigger and Auto Attenuation automatically engaged for Rise/Fall Time, Pulse Width, and AC/DC Voltage measurements.

AUTO ATTENUATION

Enabled simultaneously with Auto Trigger. (Voltage values are NOMINAL, measured with 50Ω termination).

X10 attenuator enabled when: either peak is greater than ± 5.1V OR difference between maximum and minimum peaks exceeds 5.1V

X1 attenuator enabled when: maximum and minimum peak amplitudes are less than ± 4.6V AND difference between maximum and minimum peaks is less than 4.4V

AUTO TRIGGER

DC Coupled: 100 Hz to 100 MHz.

AC Coupled: 1 MΩ: 100 Hz to 100 MHz
50 Ω: 1 MHz to 100 MHz.

Minimum Amplitude: 100 mV rms sine wave, 280 mV peak-to-peak.

Trigger Level Accuracy: ±30 mV (X ATTN).

For Rise/Fall Time, ±40 mV (X ATTN)

Auto Trigger is disabled for Totalize, Frequency C, DVM (HP 5334A), and Read Trigger Levels

Table 1-1. HP Model 5334A/B Specifications (Continued)

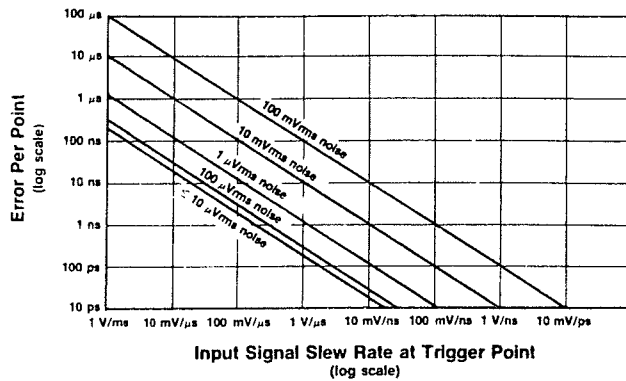

Graph 3. Input Noise Trigger Error. Noise on the input signal affects both the Start and Stop points of all time interval measurements

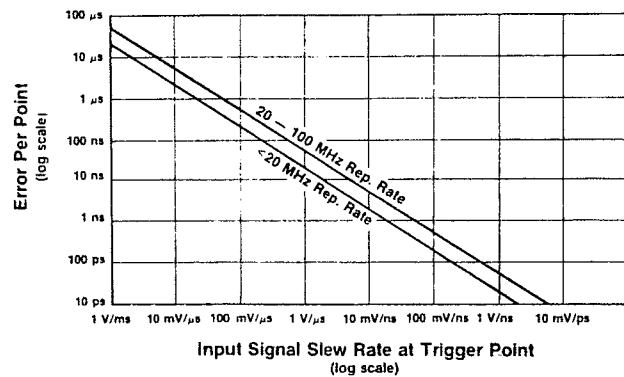

Graph 4. Trigger Level Timing Error. Affects the Start and Stop points of all time interval measurements. Total error is the larger of the two trigger point errors.

RISE/FALL TIME A

- Range:** 30 ns to 10 ms.
 - Minimum Amplitude:** 500 mV peak-to-peak
 - Dynamic Range:** 500 mV to 40V peak-to-peak
 - LSD** ①: 1 ns (100 ps using 100 GATE AVERAGE)
 - Resolution:** ± LSD ± Start Trigger Error ③ ± Stop Trigger Error ③ ± 1 ns rms
 - Accuracy:**
 - ± Resolution ± Trigger Level Timing Error ④
 - ± Trigger Level Setting Error at 10% point ⑤
 - ± Trigger Level Setting Error at 90% point ⑤
 - ± Timebase Error ② ± 2 ns *
- Typically within 3% for triangular, trapezoidal, and pulse waveforms, 1V to 5V (X ATTN) peak-to-peak

PULSE WIDTH A

- Range:** 5 ns to 10 ms.
 - LSD** ①: 1 ns (100 ps using 100 GATE AVERAGE)
 - Resolution:** ± LSD ± Start Trigger Error ③ ± Stop Trigger Error ③ ± 1 ns rms. **
 - Accuracy:**
 - ± Resolution ± Trigger Level Timing Error ④
 - ± Trigger Level Setting Error ⑤
 - ± Timebase Error ②
- Typically within 2% for triangular and pulse waveforms, 1V to 5V (X ATTN) peak-to-peak

AC/DC VOLTAGE

- AC maximum and minimum peaks or dc level of Channel A or Channel B input are displayed by Read Level function
- Frequency Range:** dc, 100 Hz to 20 MHz
 - Dynamic Range:** ac. 0V to 40V peak-to-peak, dc. ±51 volts
 - Resolution:** X1: 20 mV, X10: 200 mV
 - AC Accuracy:** ± Resolution ± 10% of difference between maximum and minimum peak displayed
- Typically within 3% for a sine wave >500 mV peak-to-peak
- DC Accuracy (mean value of display):**
 - X1: ± 35 mV ± 0.5% of reading
 - X10: ± 300 mV ± 2% of reading

MATH

All measurements except for Totalize and Read Levels may be operated upon by MATH functions. Math values are toggled on or off using the DISABLE key. Offset and Normalize may be used independently or together as follows.

Display = (Measurement/Normalize) + Offset

Entry Range: ± 1 X 10⁻¹⁰ to ± 9.9999999999 X 10⁹

At power-up, Offset = 0 and Normalize = 1.

GENERAL

TIMEBASE

- Standard Crystal:**
 - Frequency:** 10 MHz
 - Aging Rate:** <3 × 10⁻⁷ per month.
 - Temperature:** <5 × 10⁻⁶, 0° to 50°C.
 - Line Voltage:** <1 × 10⁻⁷ for 10% change.
- High Stability Crystal:** See Option 010.
- External Input:** Rear panel BNC accepts 10 MHz, 500 mV to 5V rms into 1 kΩ NOMINAL shunted by <20 pF
- Timebase Output:** 10 MHz, >500 mV rms sine wave into 50Ω via rear panel

GATE TIME

- Range:** 1 ms to 99 999 seconds in 1 ms increments
- Automatically set to 300 ms at power up
- LSD:** 1 ms
- Resolution:** ± LSD
- Accuracy:** ±100 μs ± (0.05% × GATE TIME) + up to one period of input signal

TIME BETWEEN MEASUREMENTS:

- Auto Trigger on. 1s NOMINAL
- Auto Trigger off. 80 ms NOMINAL
- 100 GATE AVERAGE:** 100 gates accumulated and average displayed. This adds an additional digit of resolution. It can be used with all functions except Totalize, DVM (HP 5334A), and Read Levels

SINGLE CYCLE: When enabled, one measurement is taken with each push of RESET key

Table 1-1. HP Model 5334A/B Specifications (Continued)

MEMORY (HP 5334A only): Ten measurement set-ups, including trigger levels, may be stored in memory and subsequently re-called. When a measurement setup has been recalled, the trigger level equals the stored value (trigger level controls are inactive). The trigger level can be toggled between the stored value and front panel trigger level control using DACS ON/OFF function.

With instrument in STBY or ac power removed, the internal battery will supply the nonvolatile memory for typically 60 days.
RESET: Begins a new measurement cycle, clears front panel data entry modes and error failure messages.
PRESET: PRESET LED indicates that front panel trigger level/sensitivity controls are inactive.

GATE OUTPUT (HP 5334A only): Rear panel BNC drives TTL levels into 1 k Ω . Level is high while gate is open during all measurements except Totalize, DVM, and Read Levels.
DISPLAY: 9-digit LED display in engineering format plus one digit exponent. Range is $\pm 10^{-17}$ to $\pm 9.99999999 \times 10^{19}$.

OPERATING TEMPERATURE: 0 to 50° C.
POWER REQUIREMENTS: 47.5 – 440 Hz, 90 – 126.5V; 47.5 – 66 Hz, 198 – 225V; 50 VA maximum.

WEIGHT: Net, 5.3 kg (11 lb 12 oz); Shipping 8.1 kg (17 lb 12 oz).
DIMENSIONS: 89mm H x 422 mm W x 346 mm D (3 1/2 in. H x 16 5/8 in. D), excluding bottom feet, front handles, and rear feet.

HEWLETT-PACKARD INTERFACE BUS

PROGRAMMABLE CONTROLS: All front panel controls and functions, except Option 030 Channel C sensitivity and power on/stby switch.

TRIGGER LEVEL: Set channel A or B from -5.1V to +5.1V in 20 mV steps (X ATTN).

Accuracy:

- X1: ± 30 mV $\pm 1\%$ of trigger level reading.
- X10: ± 300 mV $\pm 1\%$ of trigger level reading.

OTHER: Initialize, Transmit Error, High-Speed Output, Transmit Calibration Data, Device ID, and SRQ Mask.

DATA OUTPUT:

- Normal Operation:** Format: 19 characters plus CR and LF. Max. Rate: 10 readings/second.
- High Speed Output Mode:** Format: 8 bytes of count data and Interpolator Start and Stop counts. Max. Rate: 140 readings/second, 55 readings/second with Opt. 700.
- Talk Only Mode:** Selected by entering an address of 50 (HP 5334A), 31 (HP 5334B).

INTERFACE FUNCTIONS: SH1, AH1, T5, TE0, L4, LE0, SR1, RL1, PP0, DC1, DT1, CO, E2.

OPTIONS

- Option 010:** High Stability Timebase (Oven).
Frequency: 10 MHz
Long Term (Aging Rate):

- A. $< 5 \times 10^{-10}$ per day after 24-hour warm-up when:
 1. oscillator off-time was less than 24 hours.
 2. oscillator aging rate was $< 5 \times 10^{-10}$ per day prior to turn off.
- B. $< 5 \times 10^{-10}$ per day in less than 30 days of continuous operation for off-time greater than 24 hours.
- C. $< 1 \times 10^7$ per year for continuous operation.

Short Term Stability: $< 5 \times 10^{-10}$ rms for a 1 second average.
Temperature: $< 7 \times 10^{-9}$, 0 to 50°C.

Line Voltage: $< 5 \times 10^{-10}$ for 10% change (2 minutes after change).

Warmup: Within $< 5 \times 10^{-9}$ of final value (see below) 10 min. after turn-on when:

1. oscillator is operated in a 25°C environment with 20 Vdc Oven Supply voltage applied.
2. oscillator off time was less than 24 hours.
3. oscillator aging rate was $< 5 \times 10^{-10}$ per day prior to turn-off.
4. Final value is defined as oscillator frequency 24 hours after turn-on.

OPTION 020 (HP 5334A only) DC Digital Voltmeter.

Range: 4 digits autoranging, and autopolarity in $\pm 10V$, $\pm 100V$, $\pm 1000V$ ranges.

Sensitivity: 100 μ V for $\pm 1V$ reading. 1 mV for $\pm 10V$ reading. 100 mV for $\pm 1000V$ reading.

LSD: Same as Sensitivity.

Accuracy: 60 days, 24° $\pm 5^\circ$ C.

- 10V Range: $\pm 0.045\%$ of reading ± 8 mV
- 100V Range: $\pm 0.045\%$ of reading ± 80 mV.
- 1000V Range: $\pm 0.060\%$ of reading ± 200 mV

Temperature Coefficient:

- 10V Range: $\pm (0.0055\%$ of reading $\pm 0.5mV)/^\circ$ C
- 100V Range: $\pm (0.0055\%$ of reading $\pm 5mV)/^\circ$ C
- 1000V Range: $\pm (0.008\%$ of reading $\pm 5mV)/^\circ$ C

Input Type: Floating Pair.

Input Resistance: 10 M Ω $\pm 1\%$

Maximum Input: High to Low $\pm 1000V$ in all ranges. Low to chassis ground: ± 500 in all ranges.

Response Time: 800ms to within 1% of final value, within one range.

Normal Mode Rejection: 30 dB at 50/60 Hz.

Effective Common Mode Rejection (1k Ω unbalance): ≥ 110 dB at 50/60 Hz.

Filter: Single pole from 10 Hz NOMINAL

OPTION 030: 1300 MHz C Channel.

Input Characteristics:

Range: 90 MHz to 1300 MHz

Sensitivity:

- 15 mV rms (-23.5 dBm) sine wave, 90 MHz to 1000 MHz.
- 75 mV rms (-9.5 dBm) sine wave, >1000 MHz to 1300 MHz.

Graph 5. Trigger Level Setting Error: Affects both the Start and Stop points of all time interval measurements.

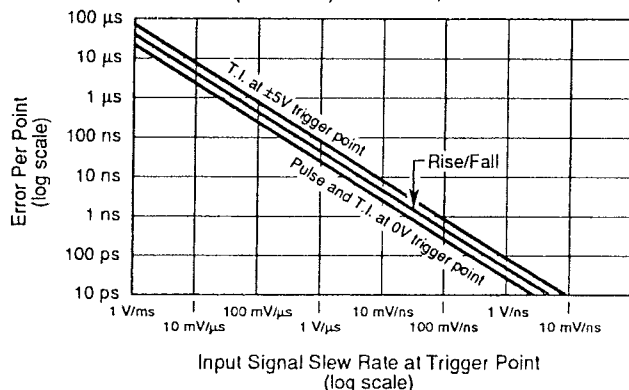

Table 1-1. HP Model 5334A/B Specifications (Continued)

HP 5334A only: Sensitivity can be decreased continuously by up to 20 dB NOMINAL from 90 MHz to 1000 MHz, and 14 dB NOMINAL from 1000 MHz to 1300 MHz using the sensitivity control

Dynamic Range:

HP 5334A:

15 mV rms to 500 mV rms (30.5 dB), 90 MHz to 200 MHz
15 mV rms to 1V rms (36.5 dB), 200 MHz to 1000 MHz
75 mV rms to 1V rms (22.5 dB), 1000 MHz to 1300 MHz

HP 5334B:

15 mV rms to 5V rms (50.5 dB), 90 MHz to 1000 MHz
75 mV rms to 5V rms (36.5 dB), 1000 MHz to 1300 MHz

Signal Operating Range:

HP 5334A: -5 Vdc to +5 Vdc

HP 5334B: -50 Vdc to +50 Vdc

Trigger Level: Fixed at 0V, NOMINAL

Impedance: ac coupled, 50Ω NOMINAL

Damage Level:

HP 5334A: ±8V (dc + peak ac), fuse protected Fuse located in BNC connector.

HP 5334B: ±50 Vdc + 5 Vrms

Frequency C:

Range: 90 MHz to 1300 MHz

LSD①, Resolution, and Accuracy are the same as Frequency A

Probe Power (HP 5334A only): Compatible with HP 10855A Preamp

OPTION 050 (HP 5334A only): Both DC Voltmeter, Option 020, and 1300 MHz C Channel, Option 030 Specifications are the same as for options ordered separately

OPTION 060: Rear Inputs

Channel A and B, and Arm inputs are rear terminals in parallel with front inputs. Option 020 (HP 5334A only), 030 and 050 (HP 5334A only) inputs are at the rear panel only. Channel A and B separate input capacitance is increased by 50 pF. Arm input capacitance is increased by 45 pF. Channel A and B input sensitivity is decreased to 50 mV rms from 20 MHz to 100 MHz (measured at rear panel with front panel terminated in 50Ω or front panel with rear panel terminated in 50Ω).

OPTION 700 (HP 5334B only): Internal CIIL Interface

Measurement Functions Provided:

Frequency A, B, and C, Period A, Time Interval A to B, Ratio A/B, Totalize A, Rise/Fall Time A, Pulse Width A, Read Levels A and B (AC/DC Voltage and Trigger)

Programmable Controls:

Channel A and B. Trigger Level, Auto Trigger, Coupling, Trigger Slope, Impedance, Attenuator, Common External Arm, External Arm Select, Slope, General: Gate Time

Maximum Data Output Rate:

2.5 readings/second

CIIL Operating Codes:

FNC, SET, SRX, SRN, INX, FTH, CLS (+), OPN(+), RST, CNF, IST, STA, GAL

MATE Interface Standard:

2806763 Rev B

+ Since the HP 5334B input channels are always internally connected, the OPN and CLS codes are accepted but no action is taken

DEFINITIONS

① **LSD:** Unit value of Least Significant Digit. Calculations should be rounded to the nearest decade (i.e. 5 Hz becomes 10 Hz and 4 ns becomes 1 ns)

LSD Displayed: There is a 9 digit mantissa maximum for the front panel display. If truncation is required the most significant digits are displayed. Up to a 12 digit mantissa is available over HP-IB.

② **Timebase Error:** Maximum fractional frequency change in timebase frequency due to all errors, (e.g., aging, temperature, line voltage, etc.) multiplied by the measurement result (see Graph 2).

③ **Trigger Error:** (see Graph 3)

$$\frac{\sqrt{e_i^2 + e_n^2}}{\text{Input Slew Rate in V/s at Trigger point}} \text{ seconds rms}$$

Where e_i = Effective rms noise of counter's input channel (250 μV TYPICAL)

e_n = rms noise of the input signal for a 100 MHz bandwidth.

④ **Trigger Level Timing Error:** (see Graph 4)

$$\frac{1/2 \text{ hysteresis band}}{\text{Input slew rate at start trigger point } \textcircled{6}} \text{ or } \frac{1/2 \text{ hysteresis band}}{\text{Input slew rate at stop trigger point } \textcircled{6}} \text{ whichever is the larger error}$$

⑤ **Trigger Level Setting Error:** (see Graph 5)

Rise/Fall Time measurements:

$$\frac{\pm 40 \text{ mV}}{\text{Input slew rate at trigger point } \textcircled{6}}$$

Pulse Width and Time Interval measurements:

$$\pm \frac{30 \text{ mV} \pm 1\% \text{ of trigger level reading (TI only)}}{\text{Input slew rate at start trigger point } \textcircled{6}}$$

$$\pm \frac{30 \text{ mV} \pm 1\% \text{ of trigger level reading (TI only)}}{\text{Input slew rate at stop trigger point } \textcircled{6}}$$

⑥ **Trigger Point and Hysteresis:**

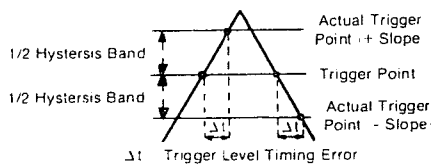

Auto trigger disabled: trigger point = trigger level reading.

Auto trigger enabled.

For all measurements except Rise/Fall Time, trigger points =

$$\frac{\text{Maximum peak} + \text{Minimum peak}}{2} (X \text{ ATTN})$$

For Rise/Fall Time, 10% trigger point =

$$(.1 (\text{maximum peak}) + .9 (\text{minimum peak})) (X \text{ ATTN})$$

90% trigger point =

$$(.9 (\text{maximum peak}) + .1 (\text{minimum peak})) (X \text{ ATTN})$$

(AC/DC Voltage function is used to measure peaks)

1-12. INSTRUMENT AND MANUAL IDENTIFICATION

1-13. The instrument serial number is located on the heat sink next to the power input module on the rear panel of the instrument. Hewlett-Packard instruments have a 10-character serial number in the form: 0000A00000. The first four digits and the letter are the serial prefix. The last five digits are suffix. The prefix is the same for all identical instruments; the prefix is changed only to identify changes to the instrument. The suffix is assigned sequentially and is different for each instrument. If the serial prefix of your instrument differs from that listed on the title page of this manual, there are differences between this manual and your instrument. Instruments having a higher serial prefix are covered in a "Manual Changes" sheets included with this manual. If the change sheet is missing, contact the nearest Hewlett-Packard Sales and Service Office listed at the back of this manual. Instruments having a lower serial prefix than that listed on the title page are covered in Section VII of the Service Manual.

1-14. DESCRIPTION OF INSTRUMENT

1-15. The HP 5334A and HP 5334B are Universal Counters capable of measuring up to 100 MHz. With the optional C Channel this capability is extended to 1.3 GHz. The instrument's basic measurement functions include Frequency, Period, Time, Time Delay, Ratio, and Totalize. The resident Multiple Register Counter (MRC) and three single chip microprocessors used to generate data, compute and display answers, expand the usefulness of the counter by providing post measurement data manipulation. This allows the additional power and convenience of user-defined measurement function keys for Math Functions, Pulse Width, Rise/Fall Time, and voltage peaks of the input signal; and the Model HP 5334A includes a nonvolatile memory that provides the capability to save and recall up to nine different front panel setups (the Model HP 5334B does not contain the nonvolatile memory feature).

1-16. Full HP-IB programmability is a standard feature of the HP 5334A/B Universal Counter. All front-panel features including gate time, trigger levels and sensitivity may be selected via HP-IB. HP-IB provides remote control of programming and data output. With the optional Modular Automatic Test Equipment (MATE) Processor circuit the HP 5334B is allowed to respond to an additional control language called Control Interface Intermediate Language (CIIL). Note that the Option 700 MATE circuit is not available with the HP 5334A.

1-17. The differences between the HP 5334A and HP 5334B are listed in *Table 1-2*.

Table 1-2. Differences Between the HP 5334A and HP 5334B

MODEL NUMBER	HP 5334A	HP 5334B
MEMORY (STORE/RECALL)	X	
GATE OUTPUT (Rear Panel)	X	
External Arm Trigger Level Adjustment (Rear panel)	X	
External Fine Adjustment for Option 010 Oven Oscillator (10811)	X	
OPTIONS:		
Option 030 C Channel Input	X	X
C Channel Probe Power	X	
C Channel Fuse	X	
Option 020 DVM	X	
Option 700 MATE		X
Option 050 Combination of Option 020 DVM and Option 030 C Channel	X	

1-18. ACCESSORIES

1-19. *Table 1-3* lists accessory equipment supplied with the HP 5334A/B Universal Counter and *Table 1-4* lists accessories available.

Table 1-3. Accessory Equipment Supplied

DESCRIPTION	HP PART NUMBER
Detachable Power Cord (229 cm [7-1/2 feet] long)	8120-1378

Table 1-4. Accessories Available

DESCRIPTION	HP PART NUMBER
2 -- 1300 MHz Preamplifiers	10855A
Probe Power Supply (drives 10855As)	1122A
Low Pass Filter Kit	10856A
Probes:	
500 MHz Active Probe	1120A
Time Interval Probes	5363B
700 Mhz Resistive Divider Probe Kit	10020A

1-20. OPTIONS

1-21. The options available for the HP 5334A/B Universal Counter are listed and described below. Specifications for the options are given in *Table 1-1*. If an option is included in the initial order, it will be installed at the factory and ready for operation upon receipt of the instrument. For field installation of Options 010, 020, 030 (HP 5334A only; see Note below), 050, and 060, refer to Section VI for part ordering information and to Section VIII for installation instructions. Both sections VI and VIII are part of the Service Manual.

Hardware Options

- 010 High Stability Time Base (Oven Oscillator)
- 020 1000V Floating Digital Voltmeter Module (HP 5334A only)
- 030 1.3 GHz C-Channel Input Module
- 050 Combination, Options 020 and 030 (HP 5334A only)
- 060 Rear Panel Inputs (Channel A, B, ARMING; and for C instruments with Opt. 030)
- 907 Front Handles, HP 5334B only (5062-3988)
- 908 Rack Mount (5062-3974)
- 909 Front Handles and Rack Mount Kit, HP 5334B only (5062-3975)
- 910 Extra Manual (One set of Operating/Programming and Service Manuals)
- 913 Rack Mount Kit for use with supplied Front Handles, HP 5334A only (5062-4069)

Support Options

- W30 Three-year customer return repair coverage
- W32 Three-year customer return calibration coverage
- W34 Three-year customer return Standard Compliant Calibration Service (5334B only)
- W50 Five-year customer return repair coverage (5334B only)
- W52 Five-year customer return calibration coverage (5334B only)
- W54 Five-year customer return Standard Compliant Calibration service (5334B only)

Support options are available only at time of purchase. Service contracts are available from Hewlett-Packard for instruments which did not include support options at time of purchase. For information, contact your nearest Hewlett-Packard Sales and Support office (offices are listed at the back of this manual).

1-23. The options installed at the factory are noted on the rear panel of the counter.

NOTE

To retrofit Option 030 C-Channel Input on HP 5334Bs, contact the nearest Hewlett-Packard Sales and Service Office listed at the back of this manual.

1-24. RECOMMENDED TEST EQUIPMENT

1-25. *Table 1-5* lists the test equipment required for testing, adjusting, and servicing the Universal Counter. The Critical Specifications column describes the essential requirements for each piece of test equipment. Other equipment can be substituted if it meets or exceeds these critical specifications.

Table 1-5. Recommended Test Equipment

INSTRUMENT	CRITICAL SPECIFICATIONS	RECOMMENDED MODEL	USE ¹
DC Standard	Voltage: 0 to 400 Volts Accuracy: 0.0025%	FLUKE 343	A,P
Frequency Standard	Frequency, 10 MHz, Accuracy $>1 \times 10^{-10}$	HP 5061B or HP 5065A	A
Digital Multimeter	Resolution: 100 μ V Range: 100 mV to 100V	HP 3468A	A,T
Function Generator	Frequency Range: 20 MHz Output Level: 0-100 mV rms Resolution: 0.01 Hz	HP 3325A/B	A,P,T
Oscilloscope	Bandwidth: 200 MHz External Trigger	HP 1715A or Equivalent	A,T
Signal Generator	Frequency Range: 990 MHz Output Level: 0-40 mV rms	HP 8656B	A
Signal Generator	Frequency Range: 1300 MHz Output Level: 0-500 mV rms Resolution: 1 Hz	HP 8660A/C*	A,P
Signature Analyzer		HP 5006A	T
Power Meter	Frequency Range: 990 MHz	HP 436A	A
Power Sensor		HP 8481A	A
10 dB Attenuator		HP 8491A, Option 010	A,P
Connectors: BNC(m) to N(m) N(f) to BNC(f) N(m) to BNC(f)		HP 1250-0082 HP 1250-1474 HP 1250-0780	A,P A,P A,P
Controller		HP 9000 Series 200/300	P,T
HP-IB Interface Cable		HP 10833A/D	P,T
* Requires either HP 86602B or HP 86603A Plug-In and the Frequency Extension Module HP 11661B			
¹ A=Adjustments P=Performance Tests T=Troubleshooting			

(This page intentionally left blank)

SECTION II INSTALLATION

2-1. INTRODUCTION

2-2. This section contains information for unpacking, initial inspection, preparation for use, installation, storage, and shipment for the HP 5334A/B Universal Counter.

2-3. UNPACKING AND INSPECTION

2-4. Inspect the shipping containers for damage. If the shipping containers or cushioning material is damaged, it should be kept until the contents of the shipment have been checked for completeness and the instrument has been checked mechanically and electrically. If the contents are incomplete, or if there is mechanical damage or defect, notify the nearest carrier as well as the Hewlett-Packard Sales and Service Office (offices are listed at the back of this manual). Keep the shipping materials for carrier's inspection. The HP office will arrange for repair or replacement without waiting for claim settlement.



2-5. PREPARATION FOR USE

2-6. Operating Environment

2-7. TEMPERATURE. The instrument may be operated in temperatures from 0°C to +50°C.

2-8. HUMIDITY. The instrument may be operated in environments with humidity up to 90% RH at 35°C. However, it should be protected from temperature extremes which cause condensation in the instrument. Option 020, DVM, of the HP 5334A, may be operated in environments with humidity up to 80%.

2-9. ALTITUDE. The instrument may be operated at altitudes up to 4,600 metres (15,000 feet).

2-10. Power Requirements

2-11. The HP 5334A/B requires a power source of 100-, or 115/120-volt ac, +5%, -10%, 47.5 to 440 Hz single phase; 220- or 230/240-volt ac, +5%, -10% at 47.5 to 66 Hz single phase. Power consumption for the instrument is less than 50 volt-amperes.

2-12. Line Voltage and Fuse Selection

WARNING

BEFORE CONNECTING THIS INSTRUMENT TO THE AC MAINS, ITS PROTECTIVE EARTH TERMINALS MUST BE CONNECTED THROUGH THE PROTECTIVE CONDUCTORS OF THE AC CABLES TO SOCKET OUTLETS PROVIDED WITH PROTECTIVE EARTH CONTACTS. DO NOT NEGATE THE EARTH-GROUNDING PROTECTION BY USING EXTENSION CABLES, POWER CABLES, OR AUTOTRANSFORMERS WITHOUT PROTECTIVE GROUND CONDUCTORS. FAILURE TO GROUND THE INSTRUMENT CAN RESULT IN PERSONAL INJURY. REFER TO PARAGRAPH 2-18.



BEFORE SWITCHING ON THIS INSTRUMENT, make sure it is adapted to the voltage of the ac power source. You must set the voltage selector card correctly to adapt the HP 5334A/B to the power source as described in paragraph 2-13. Failure to set the ac power input of the instrument to the correct voltage level could cause damage to the instrument when plugged in.

2-13. **LINE VOLTAGE REQUIREMENTS.** The HP 5334A is equipped with a power module (on the rear panel) that contains a printed-circuit line voltage selector to select 100-, 120-, 220-, or 240-volt ac operation as shown in *Figure 2-1*. The HP 5334B rear panel contains two Power and Line Voltage Select Slide switches to select 100-, 115-, or 230-volt ac operation as shown in *Figure 2-2*. Before applying power, the pc selector or slide switches must be set to the correct position and correct fuse must be installed as described below.

2-14. **HP 5334A LINE VOLTAGE SELECTION.** Power line connections are selected by the position of the plug-in circuit card in the module. When the card is plugged into the module, the only visible markings on the card indicate line voltage to be used. The correct value of line fuse, with a 250-volt rating, must be installed after the card is inserted. This instrument uses a 0.5A fuse (HP Part Number 2110-0202) for 100/120-volt operation; a 0.25A fuse (HP Part Number 2110-0201) for 220/240-volt operation.

2-15. To convert from one line voltage to another, the power cord must be disconnected from the power module before the sliding window covering the fuse and card compartment can be moved to expose the fuse and circuit card. See *Figure 2-1*.

2-16. **HP 5334B LINE VOLTAGE SELECTION.** Power line connections are selected by various combinations of settings of the two slide switches. The combinations of switch settings and their selected line voltages are shown on the HP 5334B rear panel under "LINE SELECT", see *Figure 2-2*. The correct value of line fuse, with a 250-volt rating, must be installed after setting the switches. This instrument uses a 0.50A fuse (HP Part Number 2110-0202) for 100/120-volt operation; a 0.25A fuse (HP Part Number 2110-0201) for 220/240-volt operation.

2-17. To convert from one line voltage to another, **BE SURE** to disconnect the power cord from the power LINE socket before changing the setting of a slide switch.

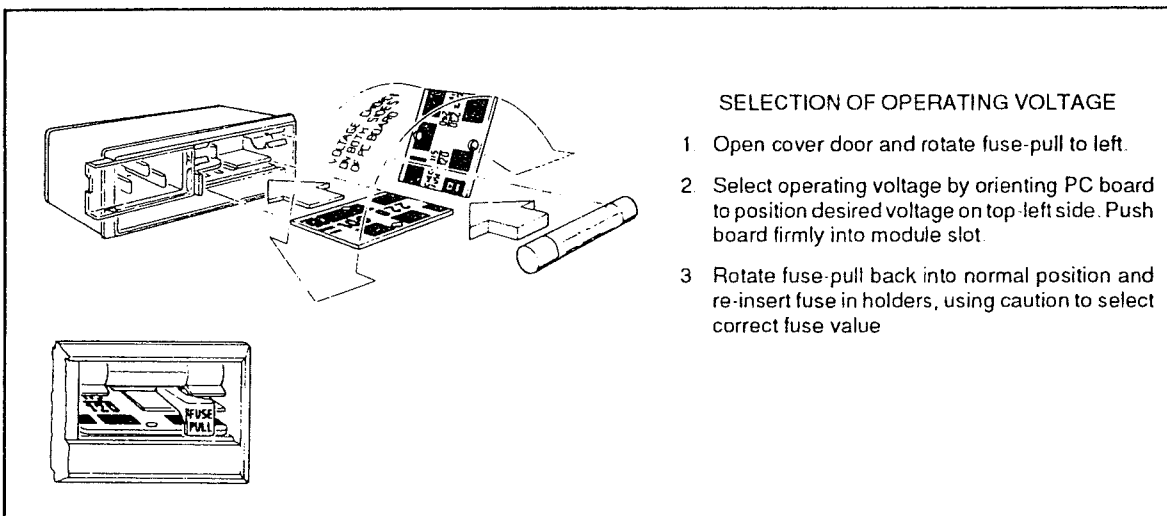

Figure 2-1. HP 5334A Voltage Selection with Power Module PC Board

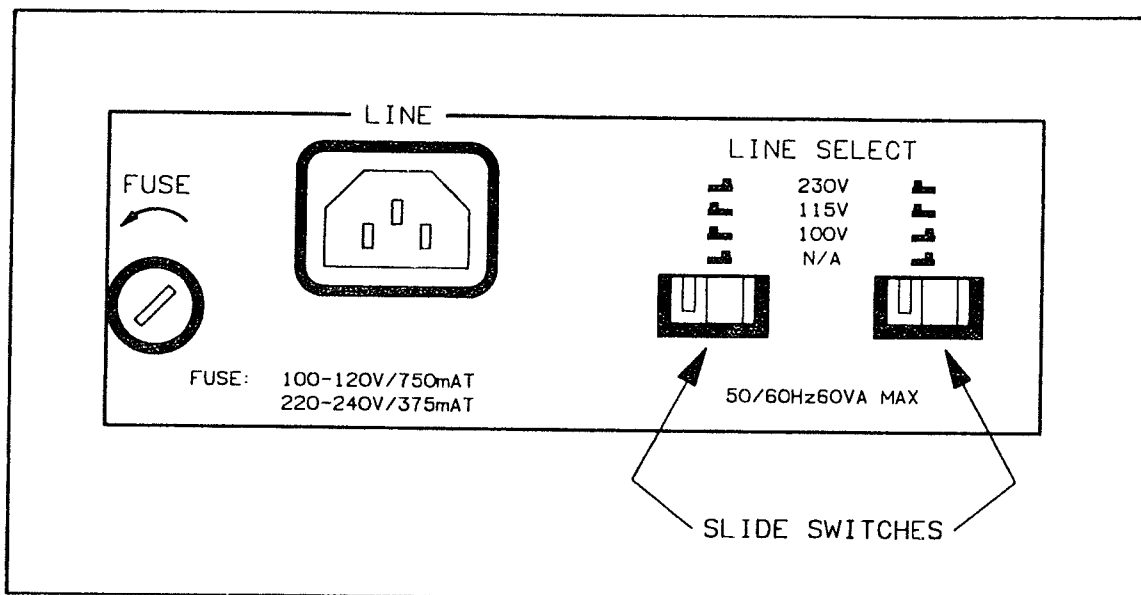

Figure 2-2. HP 5334B Voltage Selection with Slide Switches

2-18. Power Cable

2-19. The HP 5334A/B is shipped with a three-wire power cable. When the cable is connected to an appropriate ac power source, this cable connects the chassis to earth ground. The type of power cable plug shipped with each instrument depends on the country of destination. Refer to Table 2-1 for the part numbers of the power cable and plug configurations available.

2-20. HEWLETT-PACKARD INTERFACE BUS

2-21. HP-IB Interconnections

2-22. Interconnections data concerning the rear panel HP-IB connector is provided in Figure 2-3. This connector is compatible with the HP 10833A/B/C/D HP-IB cables. The HP-IB system allows interconnection of up to 15 (including the controller) HP-IB compatible instruments. The HP-IB cables have identical "piggyback" connectors on both ends so that several cables can be connected to a single source without special adapters or switch boxes. System components and devices may be connected in virtually any configuration desired. There must be, of course, a path from the desktop computer (or other controller) to every device operating on the bus. As a practical matter, avoid stacking more than three or four cables on any one connector. If the stack gets too large, the force on the stack produces great leverage which can damage the connector mounting. Be sure each connector is firmly (finger tight) screwed in place to keep it from working loose during use.

2-23. Cable Length Restrictions

2-24. To achieve design performance with HP-IB, proper voltage levels and timing relationships must be maintained. If the system cable is too long, the lines cannot be driven properly and the system will fail to perform properly. Therefore, when interconnecting an HP-IB system, it is important to observe the following rules:

- a. The total cable length for the system must be less than or equal to 20 metres (65.6 feet).
- b. The total cable length for the system must be equal to or less than 2 metres (6.6 feet) times the total number of devices connected to the bus.
- c. The total number of instruments connected to the bus must not exceed 15.

2-25. Address Selection

2-26. The HP 5334A HP-IB instrument address is input via the front panel using the MATH/MEMORY keys and the FUNCTION/DATA keys. The HP 5334B HP-IB instrument address is input via the address switch, located on the rear panel. Instructions for selecting the address are provided in Section III of this manual along with programming codes. When the instrument is turned on, the setting of the address is momentarily displayed in decimal form.

2-27. HP-IB Descriptions

2-28. A description is provided in Section III of this manual. A study of this information is necessary if the user is not familiar with the HP-IB concept. Additional information concerning the design criteria and operation of the bus is available in IEEE Standard 488-1978, titled *Standard Digital Interface for Programming Instrumentation*.

2-29. STORAGE AND SHIPMENT

2-30. Environment

2-31. The instrument may be stored or shipped in environments within the following limits:

TEMPERATURE	-40°C to +75°C
HUMIDITY	up to 90% RH at 60°C
ALTITUDE	7,620 metres (25,000 feet)

2-32. The instrument should also be protected from temperature extremes which cause condensation within the instrument.



2-33. Packaging

2-34. ORIGINAL PACKAGING. Containers and materials identical to those used in factory packaging are available through Hewlett-Packard for servicing; attach a tag indicating the type of service required, return address, model number, and full serial number. Also, mark the container FRAGILE to ensure careful handling. In any correspondence, refer to the instrument by model number and full serial number.

2-35. OTHER PACKAGING. The following general instructions should be used for repacking with commercially available materials:

- a. Wrap instrument in heavy paper or plastic. (If shipping to Hewlett-Packard office or service center, attach tag indicating type of service required, return address, model number, and full serial number.)
- b. Use strong shipping container. A double-wall carton made of 2.4 MPa (350 psi) test material is adequate.
- c. Use a layer of shock-absorbing material 70 to 100 mm (3- to 4-inch) thick around all sides of the instrument to provide firm cushioning and prevent movement inside container. Protect control panel with cardboard.
- d. Seal shipping container securely.
- e. Mark shipping container FRAGILE to ensure careful handling.
- f. In any correspondence, refer to instrument by model number and full serial number.

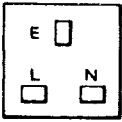
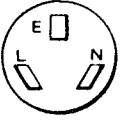
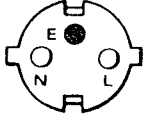
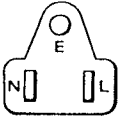
Table 2-1. AC Power Cables Available

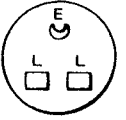
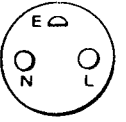
PLUG TYPE	CABLE HP PART NO.	*C D	PLUG DESCRIPTION	CABLE LENGTH (INCHES)	CABLE COLOR	FOR USE IN COUNTRY
250V 	8120-1351 8120-1703	0 6	Straight **BS1363A 90°	90 90	Mint Gray Mint Gray	United Kingdom, Cyprus, Nigeria Rhodesia, Singapore
250V 	8120-1369 8120-0696	0 4	Straight **NZSS198/ASC112 90°	79 87	Gray Gray	Australia, New Zealand
250V 	8120-1689 8120-1692	7 2	Straight **CEE7-Y11 90°	79 79	Mint Gray Mint Gray	East and West Europe, Saudi Arabia, Egypt, So Africa, India (Unpolarized in many nations)
125V 	8120-1348 8120-1398 8120-1754 8120-1378 8120-1521 8120-1676	5 5 7 1 6 2	Straight **NEMA5-15P 90° Straight **NEMA5-15P Straight **NEMA5-15P 90° Straight **NEMA5-15P	80 80 36 80 80 30	Black Black Black Jade Gray Jade Gray Jade Gray	United States, Canada, Japan (100V or 200V), Mexico, Philippines, Taiwan
250V 	8120-2104	3	Straight **SEV1011 1959-24507 Type 12	79	Gray	Switzerland
250V 	8120-0698	6	Straight **NEMA6-15P			United States, Canada
220V 	8120-2956 8120-2957	2 3	Straight **DHCK 107 90°	79 79	Gray Gray	Denmark

*CD = Check Digit (refer to Section VI).

**Part number shown for plug is industry identifier for plug only. Number shown for cable is HP Part Number for complete cable including plug.

E = Earth Ground L = Line N = Neutral

PIN	LINE
1	DIO1
2	DIO2
3	DIO3
4	DIO4
13	DIO5
14	DIO6
15	DIO7
16	DIO8
5	EOI
17	REN
6	DAV
7	NRFD
8	NDAC
9	IFC
10	SRQ
11	ATN
12	SHIELD-CHASSIS GROUND
18	P/O TWISTED PAIR WITH PIN 6
19	P/O TWISTED PAIR WITH PIN 7
20	P/O TWISTED PAIR WITH PIN 8
21	P/O TWISTED PAIR WITH PIN 9
22	P/O TWISTED PAIR WITH PIN 10
23	P/O TWISTED PAIR WITH PIN 11
24	ISOLATED DIGITAL GROUND

} THESE PINS
ARE
INTERNALLY
GROUNDED

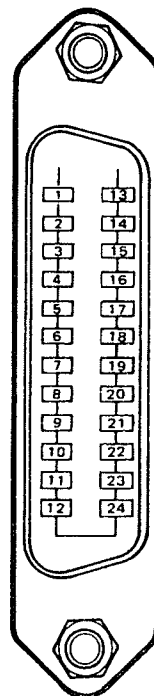

CAUTION

The 5334A contains metric threaded HP-IB cable mounting studs as opposed to English threads. Metric threaded HP 10833A, B, C, or D HP-IB cable lock screws must be used to secure the cable to the instrument. Identification of the two types of mounting studs and lock screws is made by their color. English threaded fasteners are colored silver and metric threaded fasteners are colored black. DO NOT mate silver and black fasteners to each other or the threads of either or both will be destroyed. Metric threaded HP-IB cable lock screw illustration and part number follow.

LOCKSCREW
1390-0360

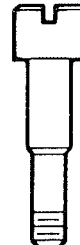

Logic Levels

The Hewlett-Packard Interface Bus logic levels are TTL compatible, i.e., the true (1) state is 0.0V dc to 0.4V dc and the false (0) state is +2.5V dc to +5.0V dc.

Programming and Output Data Format

Refer to Section III, Operation

Mating Connector

HP 1251-0293; Amphenol 57-30240.

Mating Cables Available

HP 10833A, 1 metre (3.3 ft.), HP 10833B, 2 metres (6.6 ft.)
HP 10833C, 4 metres (13.2 ft.), HP 10833D, 1/2 metre (1.6 ft.)

Cabling Restrictions

1. A Hewlett-Packard Interface Bus System may contain no more than 2 metres (6.6 ft.) of connecting cable per instrument.
2. The maximum accumulative length of connecting cable for any Hewlett-Packard Interface Bus System is 20.0 metres (65.6 ft.).
3. The maximum number of instruments in one system is fifteen.

Figure 2-3. Hewlett-Packard Interface Bus Connection

SECTION III

OPERATION AND PROGRAMMING

3-1. INTRODUCTION

3-2. This section provides complete operating and programming information for the HP Model 5334A/B Universal Counter. Operating characteristics, and various modes of operation are explained. Descriptions of all front and rear panel controls, connectors and indicators are provided, including detailed instructions for operation, programming, and operator's checks.

3-3. The information contained in this section is as follows:

- Operating Characteristics, paragraph 3-4.
- How to Make Measurements, paragraph 3-51.
- Initial Power-Up Checks and Self-Diagnostics, paragraph 3-88.
- Front Panel Controls, Indicators, and Connectors, paragraph 3-92.
- Front Panel Display and Annunciators, paragraph 3-206.
- Rear Panel Controls and Connectors, paragraph 3-208.
- Operator's Maintenance, paragraph 3-233.
- Operator's Checks, paragraph 3-240 (Quick procedures to verify the instrument is operating properly).
- Preset and Lockout Conditions, paragraph 3-250.
- Error Indications, paragraph 3-252.
- Error Examples, paragraph 3-255.
- Detailed Operating Instructions, paragraph 3-257.
- Remote Programming via HP-IB, paragraph 3-260.
- Interface Commands, paragraph 3-286.
- Programming Commands, paragraph 3-312.
- Programming Examples, paragraph 3-359.

3-4. OPERATING CHARACTERISTICS

3-5. The HP 5334A/B is a universal counter, provided with 100 MHz frequency range, 2 ns single-shot time interval resolution, and frequency and period measurement resolution of nine digits per second of gate time. The gate time is continuously adjustable, in millisecond increments, from 1 millisecond to 99.999 seconds. An internal microcomputer performs the measurement calculations, automatically taking into account the selected gate time. Most measurements are displayed in engineering notation (i.e., exponents of blank (0), ± 3 , ± 6 , or ± 9).

3-6. The HP 5334A/B is a fully HP-IB (IEEE Std. 488-1978) programmable instrument, capable of the following basic measurements:

- Frequency
- Period
- Time Interval
- Time Interval Delay
- Ratio
- Totalize
- Voltage (Option 020 — HP 5334A only)
- Pulse Width
- Rise/Fall Time
- Peak Voltage Levels

3-7. In addition to the basic measurement functions, three built-in microprocessors provide convenience features such as:

- Math Functions (offset and normalize) give the user the capability of manipulating measurement data. Refer to paragraph 3-116.
- Voltage Peaks and Trigger Levels of the A and B input signals are available by pressing a key on the front panel. Refer paragraph 3-178.
- Nonvolatile Memory (HP 5334A only) gives the capability of storing and recalling up to 10 different front panel setups. Refer to paragraph 3-102, 3-126, and 3-130.

3-8. Basic Circuits and Measurements

3-9. To maximize accuracy and resolution the HP 5334A/B uses a reciprocal counting technique and analog interpolation. Since the HP 5334A/B is a reciprocal counter, it always makes a period measurement of the input signal. If a frequency measurement is desired, the counter computes and displays the frequency by taking the reciprocal of the period measurement. The period measurement characteristic of the HP 5334A/B inherently produces high resolution at all frequencies over the entire 100 MHz bandwidth. A basic block diagram of a reciprocal counter is shown in *Figure 3-1*.

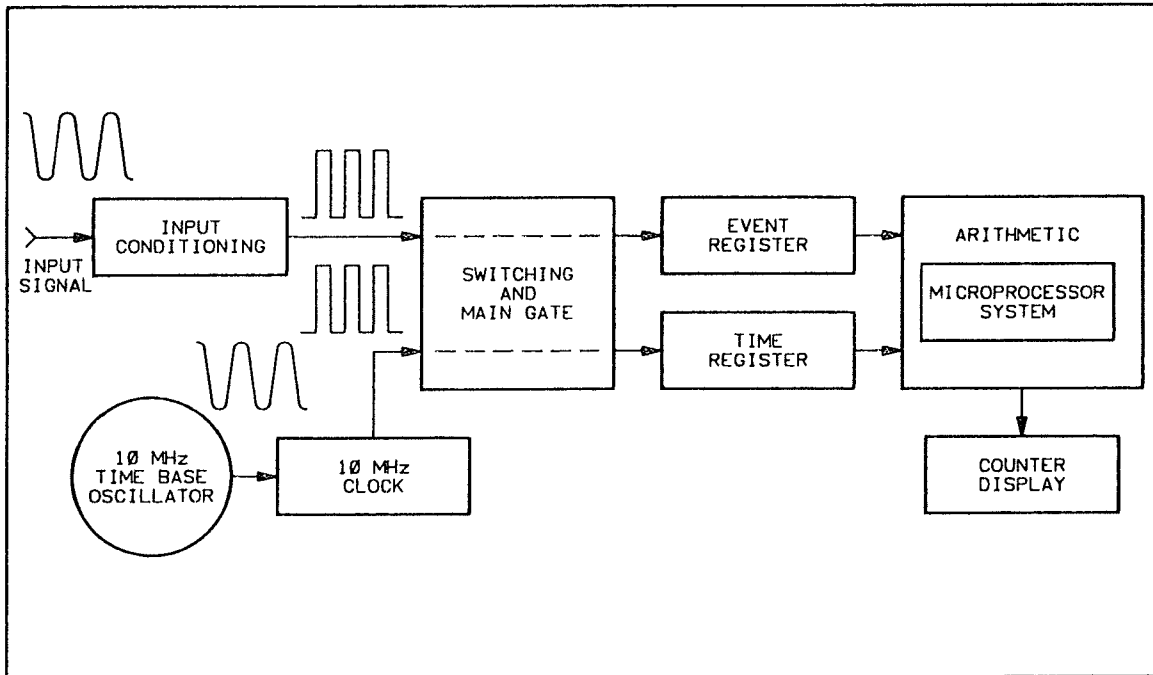

Figure 3-1. Simplified Block Diagram of the Reciprocal Counter

3-10. With the addition of Option 010 Oven Oscillator, temperature stability and aging rate are improved, allowing extended calibration periods. When Option 030 C-Channel input is installed, the frequency counting range of the counter is extended to 1.3 GHz.

3-11. Input Characteristics and Signal Conditioning

3-12. The HP 5334A/B has two independent input channels, featuring matched 100 MHz input amplifiers. Each channel includes a full complement of input signal conditioning controls. The major elements of the circuitry for each input channel are the attenuator, amplifier, and input trigger. The input trigger converts the analog output of the input amplifier to a pulse train, compatible with the counter's Multiple Register Counter (MRC). The data accumulated by the

MRC is used by the counter's internal microprocessors to compute and format measurements for display. The counter's input characteristics described in the following paragraphs are:

- Range
- Sensitivity
- AC-DC Coupling
- Trigger Level
- Slope Control
- Input Impedance
- Attenuators
- Damage Level
- Separate/Common Input
- 100 kHz Filter
- Arming Input

Specifications for the input characteristics of the HP 5334A/B are given in *Table 1-1*.

3-13. RANGE

3-14. Range defines the frequency range over which the input amplifier sensitivity is specified. The range varies with the selected coupling and input impedance. Although the specification states that the input amplifier has a range from dc to 100 MHz, the range may be different for measurements in each operating mode. Consult the individual RANGE (Signal Operating and/or Dynamic) specifications under the appropriate OPERATING MODE in *Table 1-1*.

3-15. SIGNAL OPERATING RANGE. Signal operating range defines the maximum positive and negative voltages within which the peak-to-peak signal can reliably operate. If the signal peaks extend beyond the specified signal operating range, as shown *Figure 3-2* (bottom), one or more operating modes may give incorrect results; for example, frequency miscounting or time interval inaccuracies.

3-16. DYNAMIC RANGE. Dynamic range is the minimum to maximum allowable peak-to-peak signal range, specified with the trigger level set at midpoint of the input signal and centered within trigger level range. The instrument's dynamic range is limited by the input amplifier's linear range of operation. If the input signal exceeds this range, as shown in *Figure 3-2* (top), the input amplifier may saturate, causing transitions of the input to be missed.

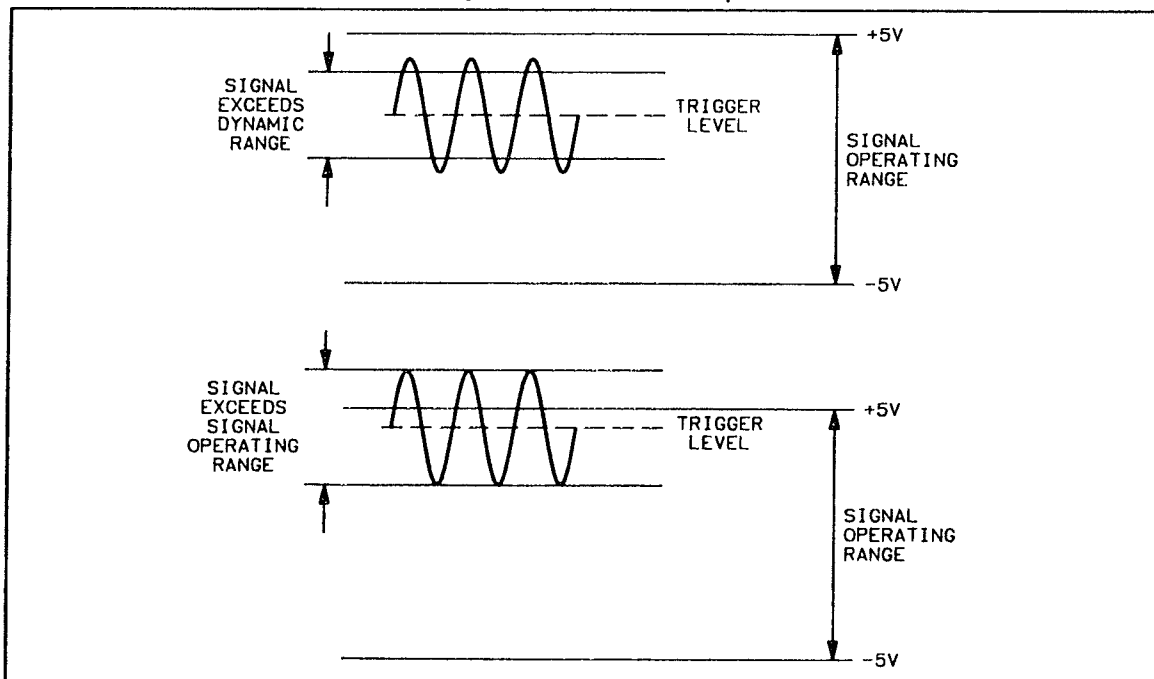

Figure 3-2. Invalid Input Signal Conditions

3-17. The dynamic range puts a further restriction on the allowable signal peaks as specified by the signal operating range. For optimum performance, the signal peaks must stay within the signal operating range specification, and the peak-to-peak value must stay within the maximum dynamic range specification, as shown in *Figure 3-3*.

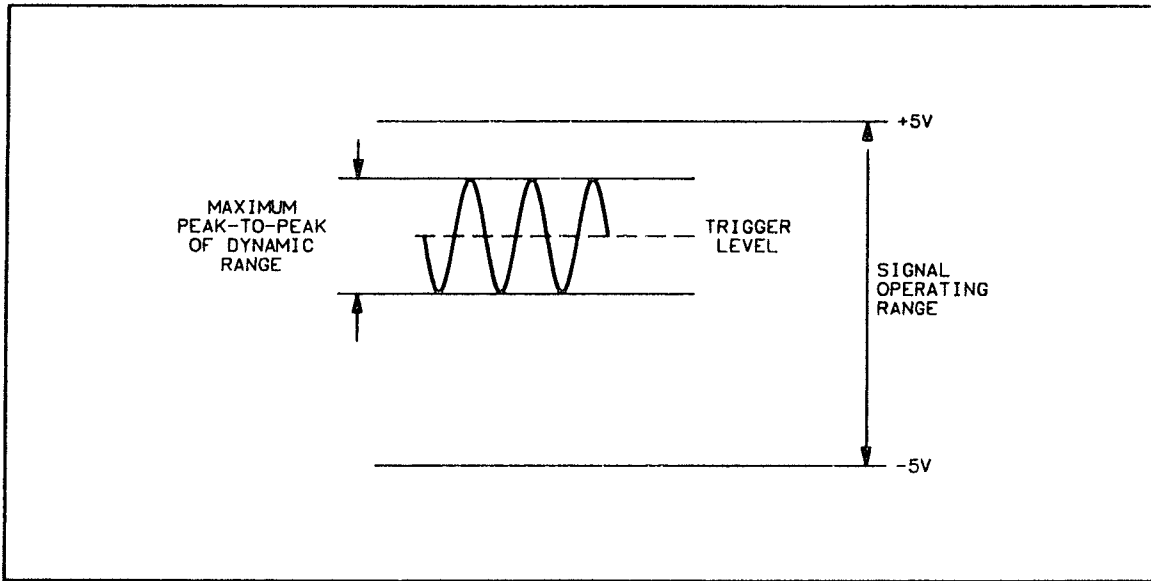

Figure 3-3. Valid Input Signal Conditions

3-18. SENSITIVITY

3-19. Sensitivity is the lowest amplitude signal at a particular frequency that the counter will count. The amplifier gain and the voltage difference between the input trigger hysteresis levels determine the counter's sensitivity. Sensitivity is specified with the trigger level set at a value equal to the midpoint of the input signal. The input waveform must cross both upper and lower hysteresis levels to generate a count, as shown in *Figure 3-4*.

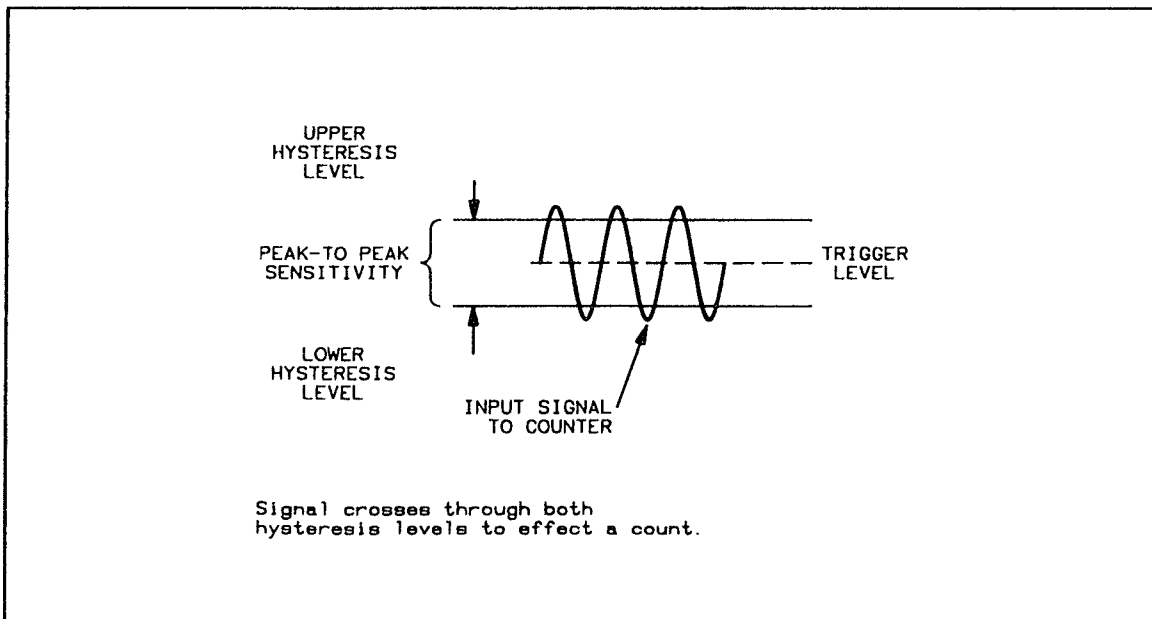

Figure 3-4. Acceptable Peak-to-Peak Amplitude

3-20. If the signal peaks do not exceed beyond both hysteresis limits the input signal will not generate a count. For example, the peak-to-peak amplitude is insufficient, or the trigger level is set above or below the midpoint of the input signal, as shown in *Figures 3-5 and 3-6*.

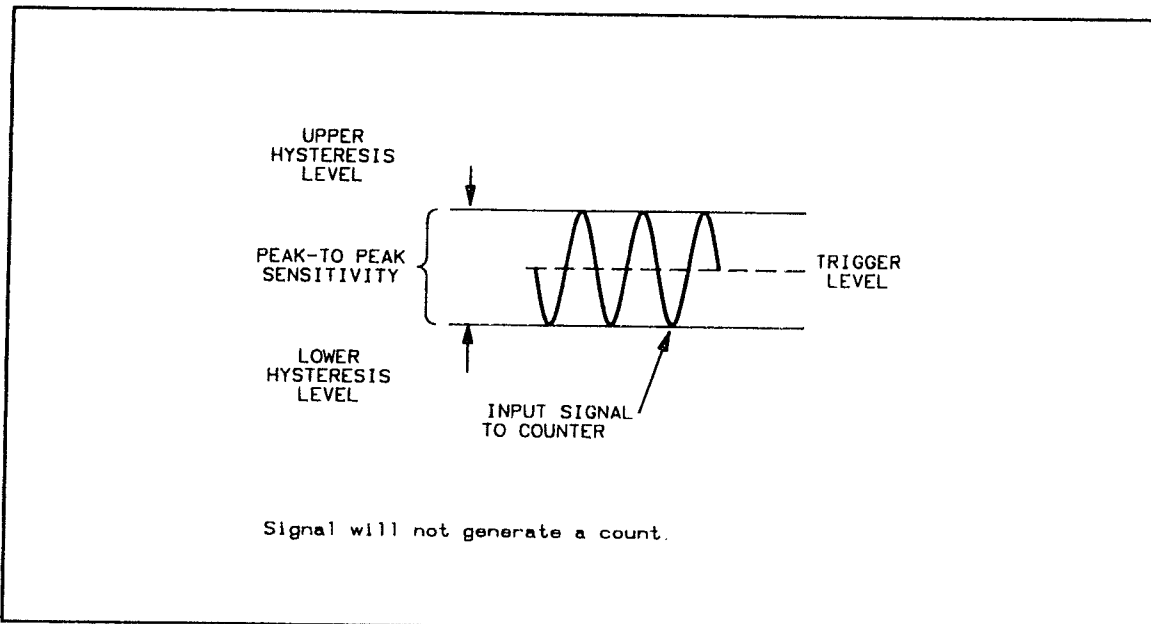

Figure 3-5. Insufficient Peak-to-Peak Amplitude

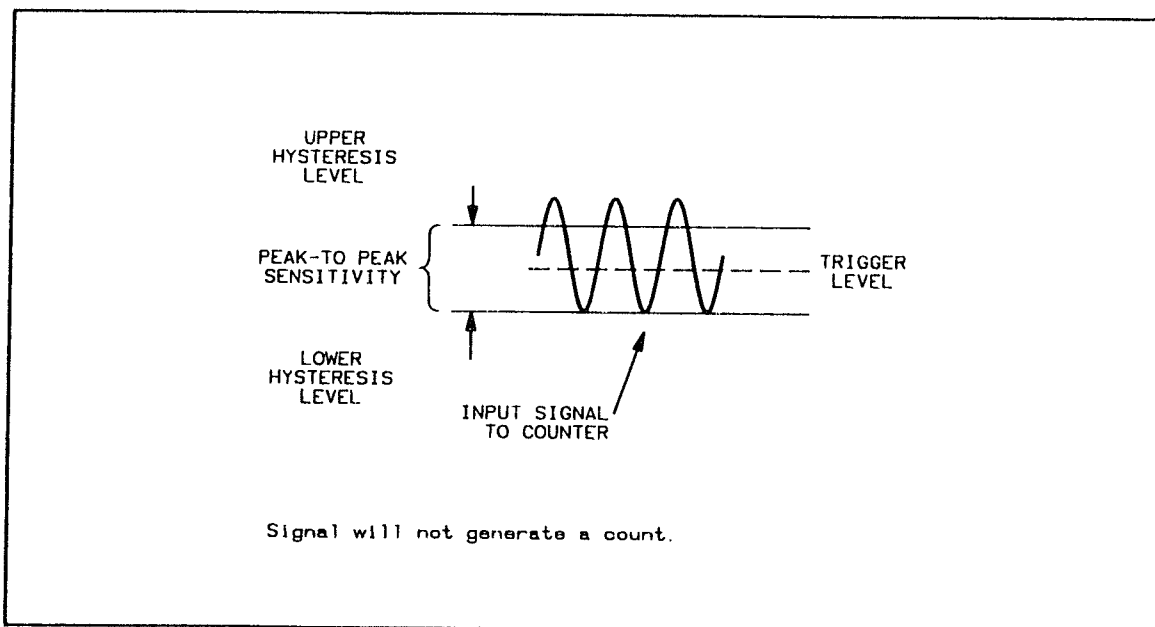

Figure 3-6. Trigger Level Set Below Midpoint of Input Signal

3-21. The sensitivity specification is given in terms of volts rms for applications that involve measuring a sine-wave signal, though it should be noted that a different waveform with the same rms voltage may not trigger a count.

3-22. Since the counter input does not respond to the rms value of the waveform but only to the peak-to-peak value, the sensitivity specification is also given for volts peak-to-peak with a minimum pulse width.

3-23. The sensitivity of the HP 5334A/B can be varied continuously by adjusting the sensitivity control. In the SENSITIVITY mode the trigger level is preset at zero volts nominal. Note, at minimum sensitivity, the hysteresis window is increased requiring a larger peak-to-peak voltage to generate a count, as shown in *Figure 3-7*. Optimum sensitivity depends on measurement application; and other factors such as noise, and interfering signals.

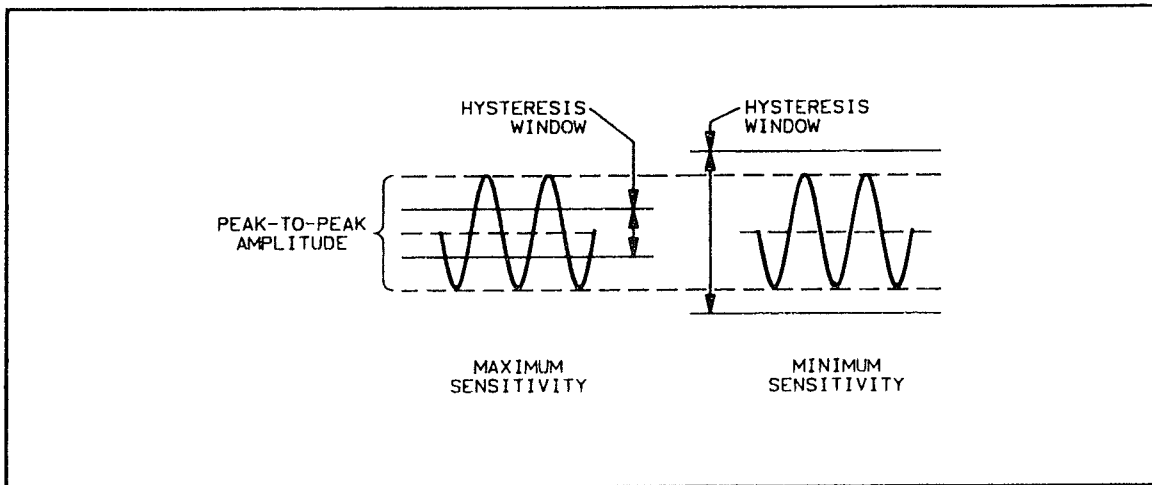

Figure 3-7. Varying the Sensitivity Control Changes the Hysteresis Window

3-24. AC-DC COUPLING

3-25. Selectable ac or dc coupling is provided for each input channel. For signals with a dc content that exceeds the hysteresis limits of the input trigger, ac coupling should be used. *Figure 3-8* demonstrates the hysteresis limits, and the use of ac coupling.

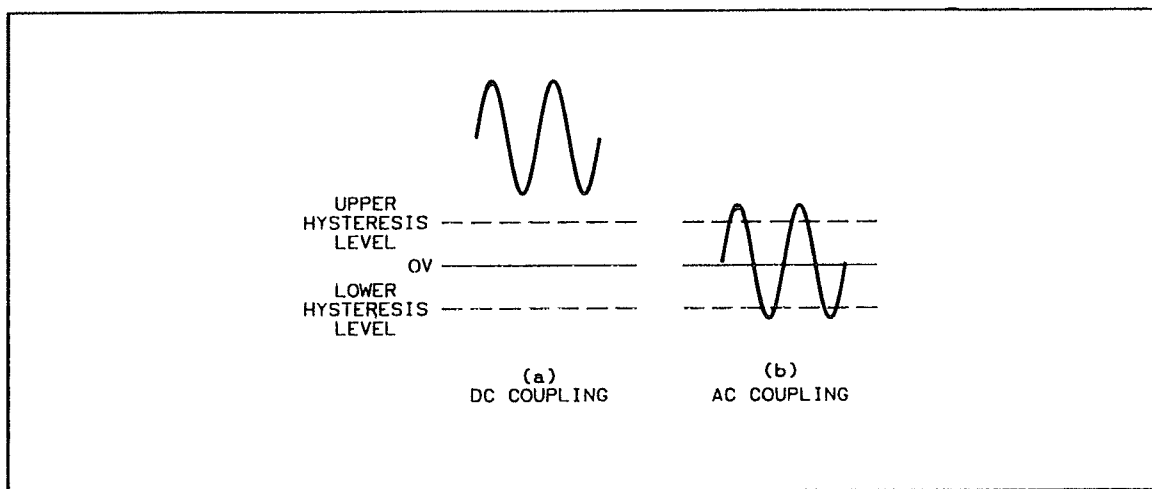

Figure 3-8. AC-DC Coupling

NOTE

An input signal with dc content shown (a) would not be counted unless ac coupling as shown in (b), was used to remove the dc content.

3-26. TRIGGER LEVEL

3-27. Trigger level is the voltage at the center of the hysteresis window. The actual trigger points are typically at the upper hysteresis level (+ slope) and at the lower hysteresis level (- slope), as shown in *Figure 3-9*.

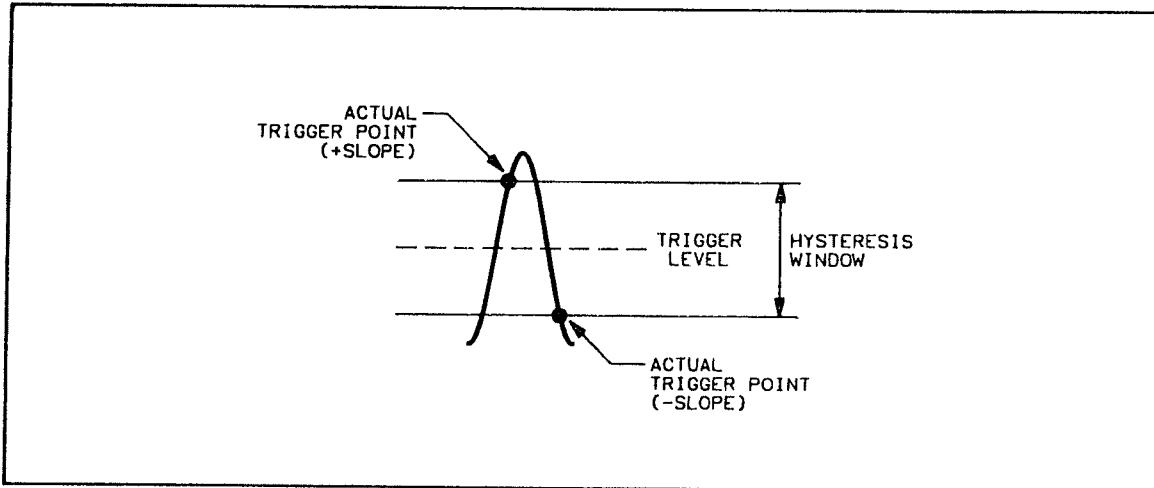

Figure 3-9. Trigger Level and Actual Trigger Point

3-28. One use of the trigger level control is to shift the hysteresis levels above (b) or below (c), ground, to enable counting positive or negative pulse trains, respectively, as indicated in *Figure 3-10*.

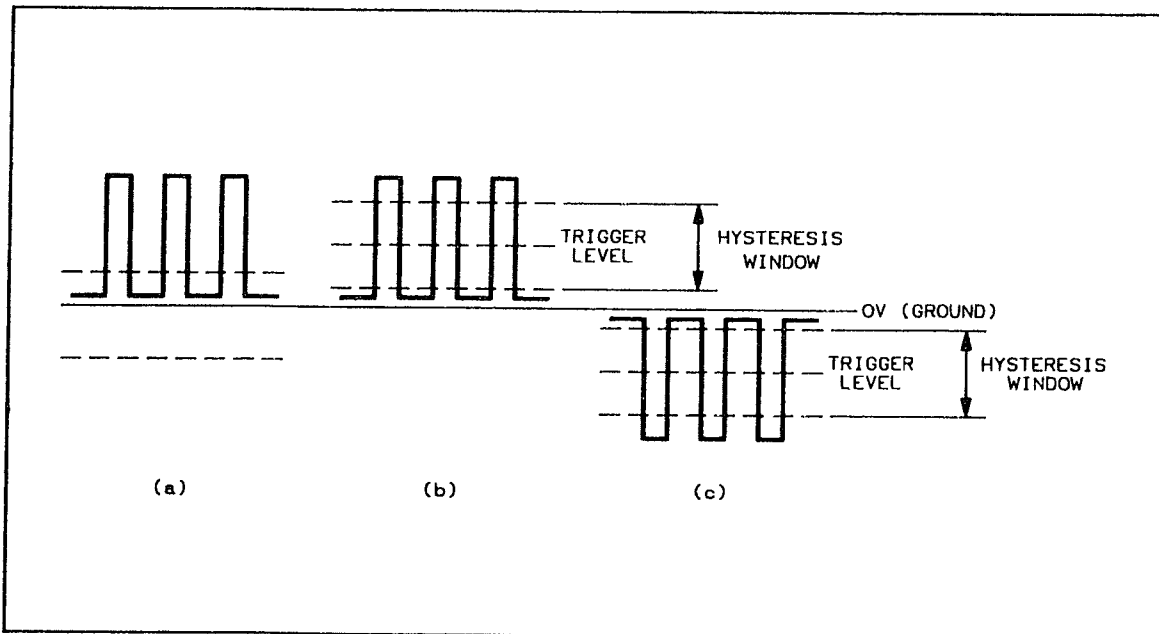

Figure 3-10. Trigger Level Control Shifts Hysteresis Window

NOTE

The signal (a) will not be counted. Using the trigger level control to shift the hysteresis levels above ground (b), or below ground (c), enables a count.

3-29. The HP 5334A/B is provided with:

- a. Continuously adjustable trigger level controls.
- b. Selectable AUTO TRIGGER.
- c. Front panel programmable trigger levels (for HP 5334A only), set via the internal trigger level controls (DACS).

3-30. **ADJUSTABLE TRIGGER LEVEL CONTROLS.** The trigger levels are adjustable over the entire dynamic range of the counter when both AUTO TRIGGER, and DACS are off. This arrangement ensures that any signal of sufficient amplitude and within the dynamic range, can be counted. The triggering range of the input signal is indicated by the flashing TRIGGER light. Optimum trigger point is usually determined by positioning the trigger level control within the triggering range. If you are operating an HP 5334A then refer to paragraphs 3-170 through 3-177 for information regarding the DACS.

3-31. **SELECTABLE AUTO TRIGGER.** When AUTO TRIGGER is selected the trigger levels are controlled by the amplitude of the input signal, and automatically set in accordance with the measurement application. With AUTO TRIGGER on, the TRIGGER lights will flash continuously, and the front panel controls will be disabled.

3-32. **PROGRAMMABLE TRIGGER LEVELS (HP 5334A ONLY).** The trigger level settings are programmed into memory, whenever a front panel setup is stored. The stored trigger levels are programmed into the internal trigger level controls (DACS) when the setup is recalled; and the front panel controls are disabled. For further information on programming and setting the trigger levels via the 5334A front panel, refer to paragraph 3-170 and *Table 3-1*.

3-33. SLOPE CONTROL

3-34. The slope control determines which edge of the input signal will trigger the count. With the positive (+) slope selected a signal going from one voltage level to a more positive level, regardless of polarity, will generate a trigger pulse at the upper hysteresis limit. With the negative (-) slope selected, the negative going edge of the signal will generate a trigger pulse at the lower hysteresis limit. Trigger points for positive and negative slopes are shown in *Figure 3-11*. For some operating modes the HP 5334A/B the slope control has other uses (for example, for rise/fall time, the slope is used to specify whether rise or fall time is being measured).

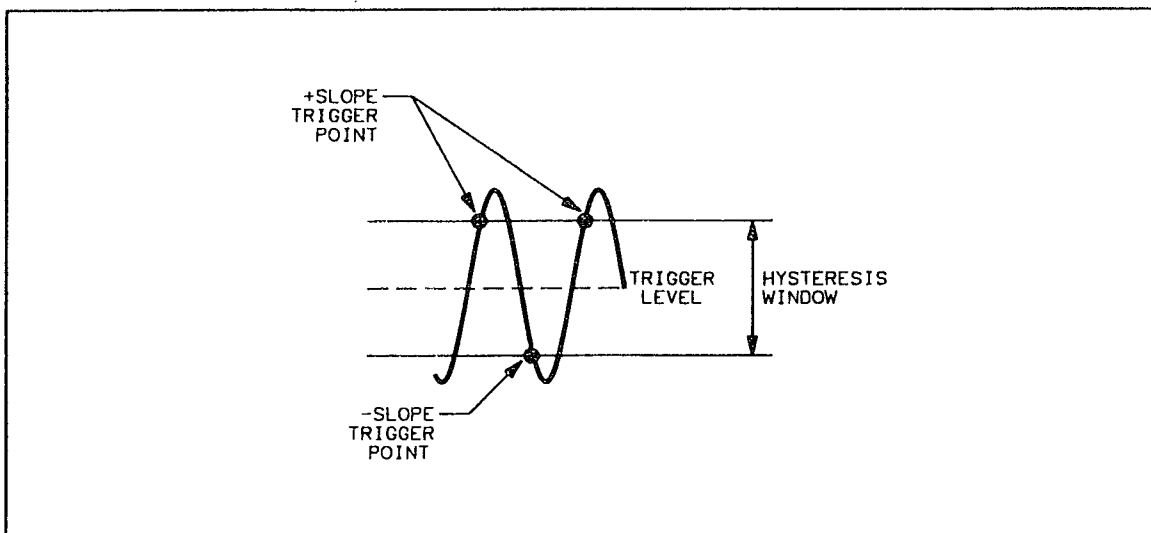

Figure 3-11. Positive and Negative Trigger Points

3-35. INPUT IMPEDANCE

3-36. Each input has a selectable impedance of 1 M Ω or 50 Ω . With 1 M Ω impedance, the input is shunted by <60 pF. At the higher frequencies the 50 Ω nominal input impedance is usually preferred, since the inherent shunt capacitance of high impedance inputs rapidly reduces input impedance. For the lower frequencies, the 1 M Ω input impedance may be selected. The input impedance becomes 500 k Ω in the 1 M Ω position when COMMON input is enabled, (shunted by 85 pF maximum). In the 50 Ω position, the impedance remains 50 Ω for COMMON input.

3-37. ATTENUATORS

3-38. Attenuators are used to reduce the amplitude of the input signal and prevent overloading without introducing appreciable phase or frequency distortion. Step attenuators with selectable attenuation positions of X1 or X10 are provided in the HP 5334A/B. For signals that exceed the 5 Vp-p dynamic range of the input, X10 attenuation reduces the signal by a factor of 10. When X10 attenuation is selected the trigger level reading is multiplied by 10.

3-39. Attenuation is automatic when AUTO TRIGGER is selected. The X10 attenuator is automatically enabled when the signal exceeds the dynamic range or signal operating range. When the signal is within both limits X1 attenuation is enabled. Refer to *Table 1-1* for exact specifications on auto-attenuation.

3-40. DAMAGE LEVEL

3-41. Damage level is the maximum input voltage the counter can withstand without danger of input failure. The damage level value varies with input impedance, attenuator setting, and coupling selection. Refer to the damage level specifications in *Table 1-1*. For accurate measurements, the input signals must stay within the dynamic range and the signal operating range of the counter.

3-42. SEPARATE/COMMON A INPUT

3-43. Two separate inputs are provided on the standard Model HP 5334A/B. The A and B inputs are identical in specification. Identical controls are provided for each input to allow maximum versatility and accuracy. The COM A key, located between the two inputs, controls the selection of separate or common input. All specifications are the same for separate or common operation, except sensitivity and impedance. Refer to *Table 1-1* for detailed specifications.

3-44. In the SEPARATE position, the A and B inputs and controls operate independently of each other for applications in time interval, ratio, or other operations where signals applied to the A and B inputs are from different sources.

3-45. In the COMMON position, the INPUT B connector is disconnected and the A and B input amplifiers are connected together at INPUT A. The channel A coupling, and impedance controls, condition the input signal to both channel A and B input amplifiers. The input impedance becomes 500 k Ω in the 1 M Ω position when COMMON input is enabled, (shunted by 85 pF maximum). In the 50 Ω position, the impedance remains 50 Ω for COMMON or SEPARATE input. The signal operating range, dynamic range and damage level remain unchanged.

3-46. The A and B input amplifiers have independent LEVEL and SLOPE controls in both SEPARATE and COMMON mode of operation (provided AUTO TRIG is turned off).

3-47. 100 kHz FILTER

3-48. The HP 5334A/B is provided with a low pass 100 kHz filter for input signals applied to channel A. The filter is tuned so that signals about 100 kHz are attenuated by approximately 3 dB,

and all frequencies above 100 kHz are attenuated greater than 3 dB. Use the filter (100 kHz FILTER A enabled) to effectively attenuates noise and harmonics (above 100 kHz), which may affect the correct measurement.

3-49. ARMING INPUT

3-50. The HP 5334A/B may be armed (made ready to start or stop a measurement) by GATE TIME control, or the input signal (ARMING OFF); or externally armed by a signal not directly involved in the measurement (ARMING ON). Further information on external arming may be found in paragraphs 3-195 through 3-199. The external ARM input allows the operator to choose the point, on a waveform, at which the start and/or stop of a measurement occurs. Refer to *Table 1-1* for specifications on the ARMING INPUT. *Figure 3-12* illustrates using external arming to measure frequency at various points along a modulated signal.

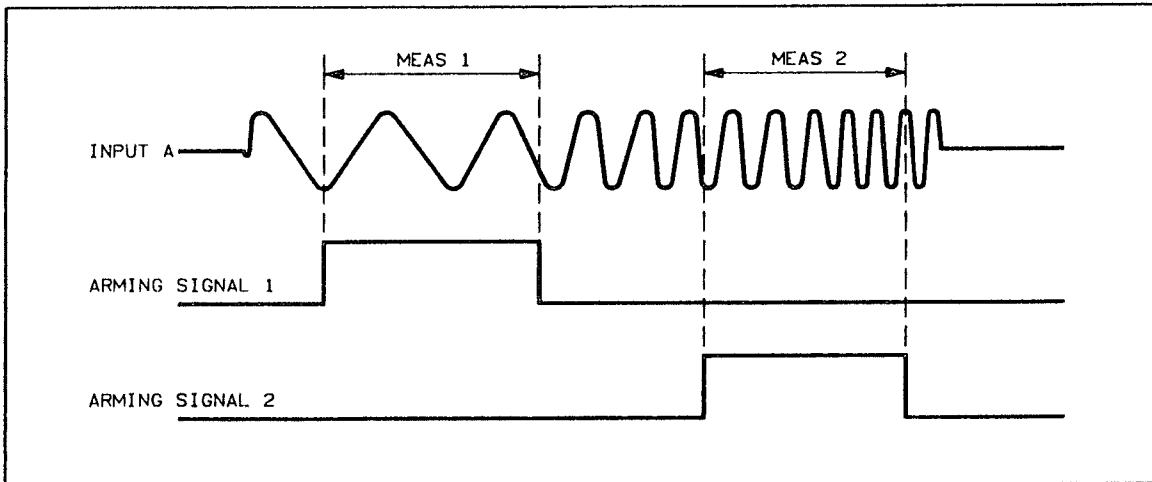

Figure 3-12. Use of External Arming to Measure Frequency

NOTE

The STOP ARM can be turned off, allowing the gate time control to arm the stop, if the appropriate pulse width cannot be generated by the arming signal source.

3-51. HOW TO MAKE MEASUREMENTS

3-52. The following paragraphs describe how the counter performs in each of the following ten measurement modes:

- Frequency
- Period
- Time Interval
- Time Interval Delay
- Ratio
- Totalize
- Voltage (Option 020 — HP 5334A only)
- Pulse Width
- Rise/Fall Time
- Peak Voltage

3-53. For each measurement mode of the counter, Range, Least Significant Digit displayed (LSD displayed), Resolution, and Accuracy are described, and specified in *Table 1-1*.

3-54. Frequency Measurements

3-55. See *Figures 3-46 and 3-47* for details of Frequency measurements. The HP 5334A/B makes frequency measurements on input signals within the ranges of 1 mHz to 100 MHz, and 90 MHz to 1.3 GHz. Input signals up to 100 MHz are received through standard input Channels A and/or B. Higher frequencies (90 MHz to 1.3) are measured through Option 030, Channel C input.

3-56. Frequency measurements are made by connecting a signal to one of the inputs, pressing the corresponding function key (i.e., FREQ A, FREQ B, FREQ C), and selecting the appropriate input signal conditioning. For low amplitude signals on inputs A and B, the sensitivity mode may be enabled by pressing the SENS key on. In this mode the trigger level is preset at zero volts, and the sensitivity can be varied by adjusting the TRIGGER LEVEL/SENS control.

3-57. For channel A and B frequency measurements, if SENS and AUTO TRIG are turned OFF, the TRIGGER LEVEL/SENS control may be adjusted to the optimum trigger point. Triggering range is indicated by the flashing TRIGGER light. Optimum trigger point is usually midrange over which the trigger light flashes. The trigger level may be determined by pressing the READ LEVELS key. Trigger level controls may be readjusted while in the READ LEVELS mode. The voltage displayed will be within the accuracy and resolution specified in *Table 1-1*, over a ± 5 -volt range.

3-58. The GATE TIME setting determines the resolution of the frequency measurement; and may be displayed by pressing the GATE TIME key. The gate time range is one millisecond to 99.999 seconds in millisecond increments. Note, maximum resolution displayed is nine digits, with one second of gate time. One millisecond of gate time will display six digits of resolution.

3-59. On power-up, the HP 5334A/B initializes to the FREQ A function with the GATE TIME set at 300 milliseconds, automatic trigger ON (AUTO TRIG), and automatic attenuation ON (X1/X10 ATTN). A periodic signal connected to INPUT A will self-arm the counter, and measurements will begin immediately (provided the signal is within input specifications, and within the restrictions set by the signal conditioning controls).

3-60. Period Measurements

3-61. See *Figure 3-48* for details of Period measurements. The HP 5334A/B allows signal period measurements to be made over a range of 10 nanoseconds to 1,000 seconds through the INPUT A connector. Measurements displayed will be within the accuracy and resolution specified in *Table 1-1*.

3-62. Period measurements are made by connecting a signal to INPUT A, pressing the PERIOD A key, and selecting the appropriate input signal conditioning. The TRIGGER LEVEL/SENS control may be adjusted as described previously under FREQUENCY mode measurements. The gate time range is one millisecond to 99.999 seconds in millisecond increments; and may be displayed by pressing the GATE TIME key. Period averaging is automatic, whenever the gate time is set greater than the period of the input signal. The number of periods average is determined by the GATE TIME setting and the input period.

3-63. Time Interval Measurements

3-64. See *Figure 3-49* for details of Time Interval measurements. The Time Interval mode of the HP 5334A/B measures the length of time between a START signal at INPUT A and a STOP signal at INPUT B, as shown in *Figure 3-13*. The START and STOP signals may be derived from separate signal sources, or they may be from a single source. Independent SLOPE and TRIGGER LEVEL/SENS controls for the START and STOP signals allow variable triggering on either positive or negative going slopes. A single-shot time interval measurement may be made over a range of (minus) 1 nanosecond to 1,000 seconds. The minimum START/STOP pulse width is 5 nanoseconds.

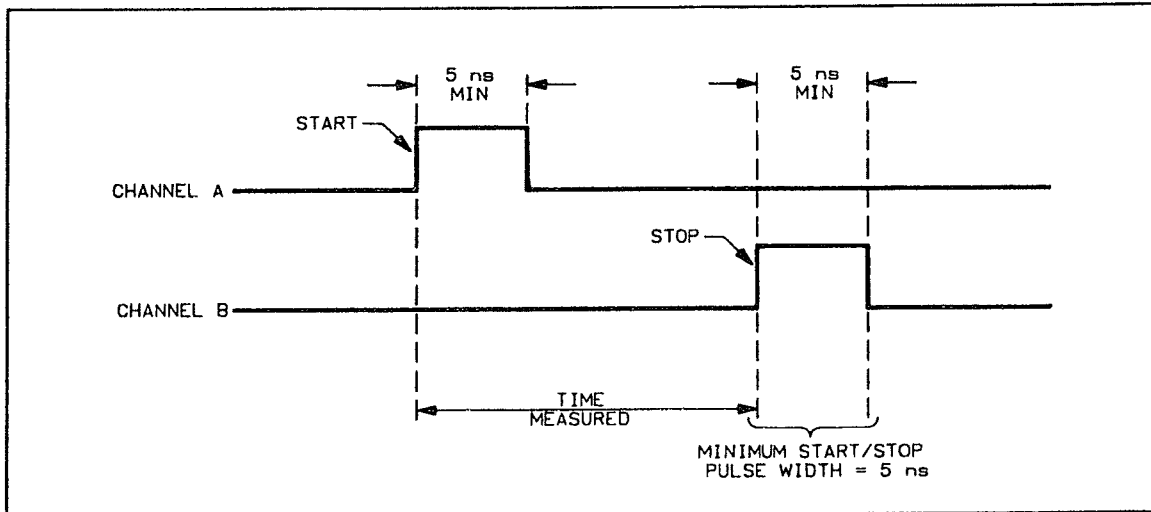

Figure 3-13. Time Interval Measurement

3-65. When using separate sources for the START and STOP signals, the START signal connects to INPUT A, the STOP signal connects to INPUT B, and the COM A key must be in the SEPARATE position. The appropriate input signal conditioning may then be selected. When both the START and STOP signals are derived from the same signal, the signal connects to INPUT A, and the COM A key must be set to the COMMON position (LED on). The controls may be adjusted, as described for separate signal sources.

3-66. The position of the corresponding SLOPE key, determines whether the trigger point for the START or STOP signal will be on the rising or falling edge. If the signals are not repetitive, AUTO TRIG should be turned off. Then, the TRIGGER LEVEL/SENS controls may be adjusted to the desired trigger points. Triggering is indicated by the flashing TRIGGER lights. Trigger level controls must be set within the triggering range to generate a count. The trigger levels may be determined by pressing the READ LEVELS key. The voltages displayed will be within the accuracy and resolution specified in Table 1-1.

3-67. Actual gate time is controlled by the measured time interval. The HP 5334A/B makes single-shot time interval measurements and displays them continuously from gate cycle. The gate time settings control the time between measurements. When the SINGLE CYCLE gate key is enabled, each time the RESET key is pressed, a single measurement is made and displayed. Pressing the SINGLE CYCLE gate key again, returns the HP 5334A/B to the normal Time Interval mode.

3-68. Time Interval Averaging is done by pressing the 100-GATE AVERAGE key, while in the Time Interval mode. Time Interval Average provides greater resolution of measurements than single-shot measurements provide. See Figure 3-51 for details of Time Interval Averaging measurements.

3-69. Time Interval Delay Measurements

3-70. See Figure 3-50 for details of Time Interval Delay measurements. The Time Interval Delay mode of operation is similar to Time Interval mode, but with the following additional control: the front panel GATE TIME control inserts a variable delay between the START (INPUT A) event and the enabling of the STOP (INPUT B) event, as shown in Figure 3-14. Potential STOP events are ignored during the specified delay. The delayed time interval may be continuously measured and displayed by pressing the T.I.→B DELAY function key. GATE TIME DELAY is the same as the gate time setting, and may be displayed by pressing the GATE TIME DELAY key while in the Time Interval Delay mode. The gate time delay is adjustable over a range of one millisecond to 99.999 seconds in millisecond increments.

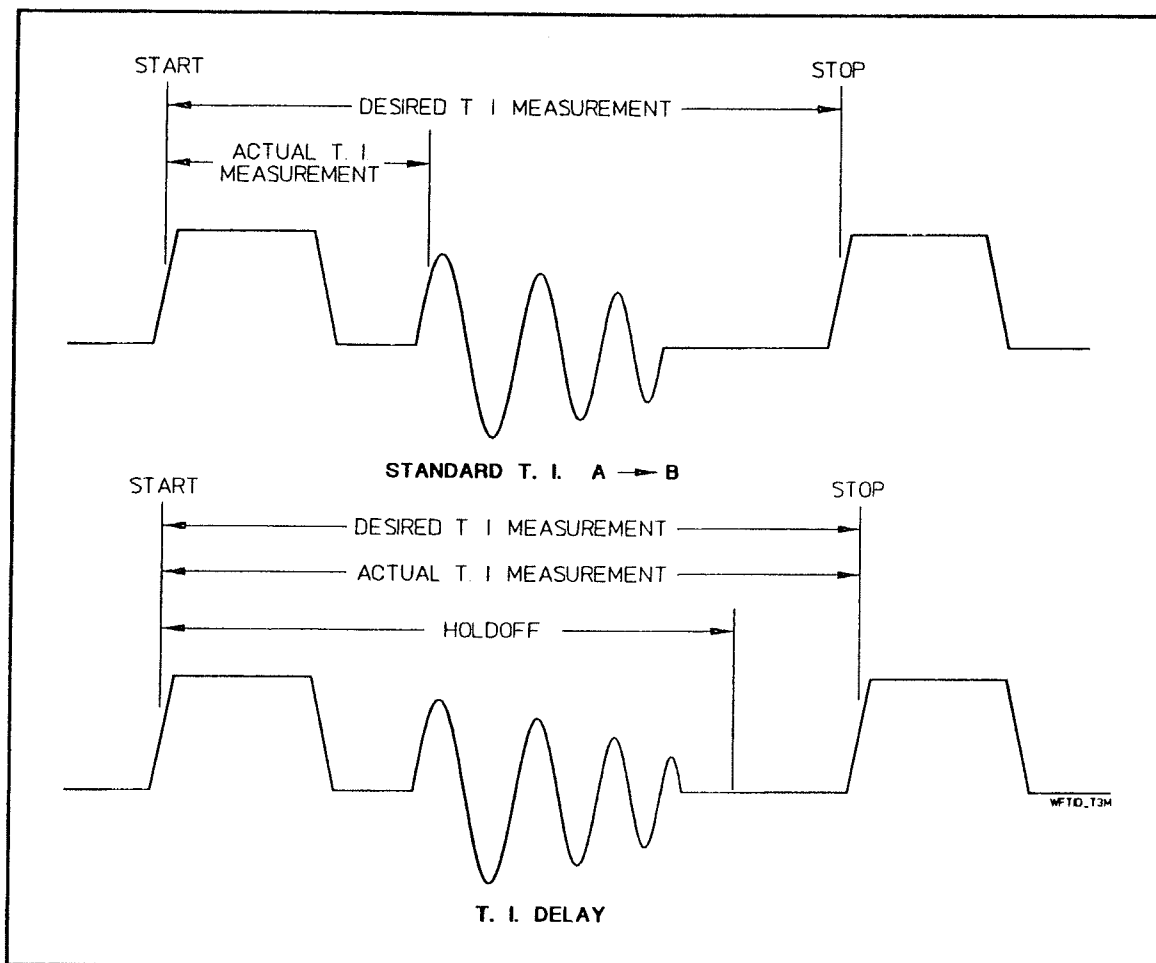

Figure 3-14. Time Interval Delay Measurement

3-71. Ratio Measurements

3-72. See Figure 3-52 for details of Ratio measurements. The Ratio mode of operation provides measurement of the ratio between two frequencies. The HP 5334A/B measures and displays the frequency ratio of signals on INPUT A in relation to signals on INPUT B. Both input channels have 35 mV rms sensitivity up to 100 MHz. For ratio displays greater than 1, the higher frequency is connected to Channel A. Although the HP 5334A/B can measure and display ratios of less than 1, it is recommended that the higher frequency be connected to INPUT A.

3-73. Frequency ratio measurements are made by connecting signals to input channels A and B, pressing the RATIO A/B function key, and selecting the appropriate input signal conditioning. The GATE TIME control determines the resolution by selecting the number of cycles of the INPUT B signal over which the ratio is measured. Increasing the gate time or increasing the signal frequency at INPUT A results in greater resolution of the measurement.

3-73a. The RATIO A/B mode works by counting channel A and channel B events. Channel B is used to start and stop the counting. The gate time is used to determine how long a holdoff will be used before a channel B input signal will be used to end the measurement.

Example: Let's say that a 10-MHz signal is put into the Channel A input and a 1-MHz signal goes into the B channel. The gate time is set to 0.3 seconds.

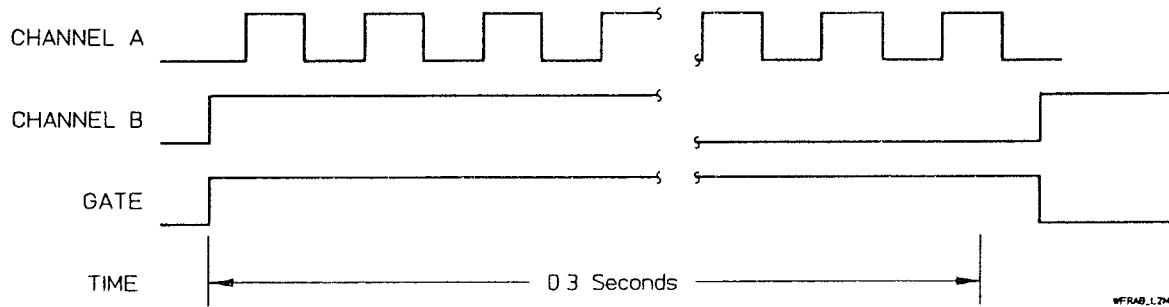

Notice that the measurement is completed by the first channel B event after the gate time interval.

In the 0.3 second gate time, about 3×10^6 channel A events occur while about 3×10^5 channel B events occur. The ratio between these two numbers is equal to 10. Notice that no information about the timebase oscillator is used to determine the ratio.

3-74. Totalize Measurements

3-75. See *Figure 3-53* for details of Totalize measurements. The Totalize mode of operation displays the number of counts (events) received through INPUT A, while the gate is open. The count is continuously displayed, accumulated from input cycle to input cycle. Totalize is manually gated and is independent of the GATE TIME setting. External arming may also be used to START and STOP totalize measurements.

3-76. Pressing the TOT START A function key opens the main gate, allowing the number of INPUT A events to be counted. Pressing the TOT STOP A function key closes the gate, and stops the count. You may continue counting, without resetting the previous total, by pressing the TOT START A key again. The RESET key clears the count and resets the display to zero. Pressing any front panel key will reset the count to zero also.

(This page intentionally left blank)

3-77. Voltage Measurements (applies only to HP 5334A with Option 020)

3-78. See *Figure 3-56* for details of dc Voltage measurements. Operating the HP 5334A in the Voltage mode requires the Option 020 DVM input module. The module contains HI (red) and LO (black) input connectors for fully the floating, autoranging Digital Voltmeter. There is no need for predetermined gate times. Gate time is automatically set at 100 ms when the Voltage mode is enabled. The voltmeter measures dc inputs up to ± 1000 volts. It automatically selects the $\pm 10V$, $\pm 100V$, or $\pm 1000V$ range and polarity, depending on the input voltage. The sensitivity is 100 μS to 100 mV, depending on the range. Pressing the DVM function key enables the operation of the Voltage mode.

3-79. Pulse Width Measurements

3-80. See *Figure 3-54* for details of Pulse Width measurements. The HP 5334A/B provides automatic Pulse Width measurements, shown in *Figure 3-15*, through the INPUT A connector, for repetitive signals over a pulse width range of 5 nanoseconds to 10 milliseconds. Pulse Width measurements are specified for trigger levels as 50% amplitude of the input signal in *Table 1-1*. Pressing the the 100-GATE AVERAGE key increases the number of digits of resolution displayed.

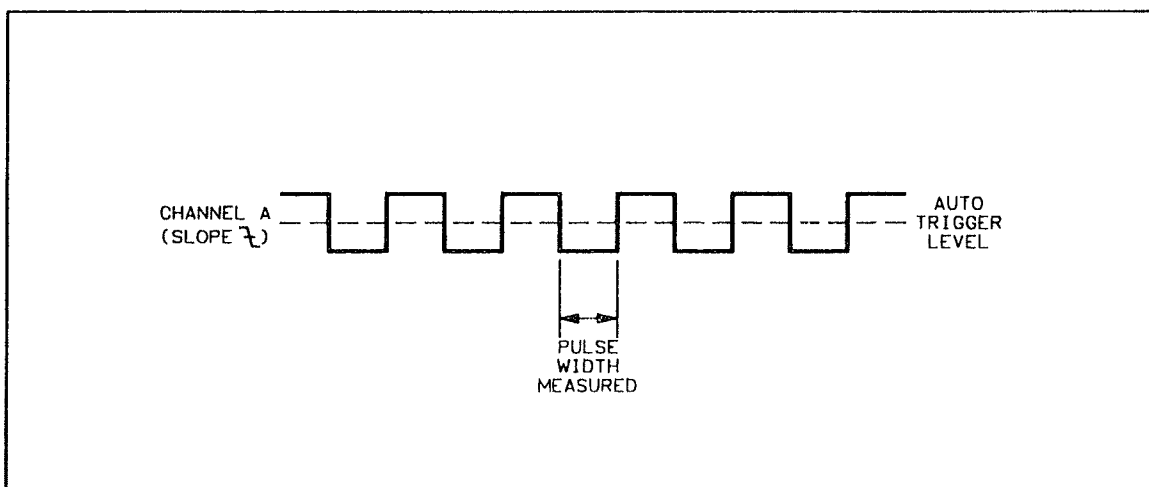

Figure 3-15. Pulse Width Measurement

3-81. Pulse Width measurements are made by connecting a signal to INPUT A, pressing the PULSE WIDTH A function key, and selecting the appropriate input signal conditioning. AUTO TRIG is automatically set on, to trigger at the 50% point of the signal. The channel A SLOPE key position determines whether positive or negative pulse width measurements will be made. Measurements are continuously displayed from gate cycle to gate cycle. Actual gate time is controlled by the input pulse width. The gate time setting controls the time between measurements.

3-82. Rise/Fall Time Measurements

3-83. See *Figure 3-55* for details of Rise/Fall Time measurements. The Rise/Fall time mode of operation automatically configures the counter to perform either rise or fall time measurements, through the INPUT A connector, shown in *Figure 3-16*. The input is automatically set to COM A, and triggering to AUTO TRIG. In this mode, AUTO TRIG automatically locates the 10% and 90% points of the input signal, and sets the trigger levels accordingly. RISE TIME is measured when the SLOPE A control is set positive; FALL TIME, when SLOPE A is set negative. For rise and fall time measurements the input signal must be continuous. AUTO TRIG and COM A cannot be disabled when the HP 5334A/B is operating in the Rise/Fall Time mode. Actual gate time is controlled by the rise/fall time interval. Gate time setting determines the time between measurements.

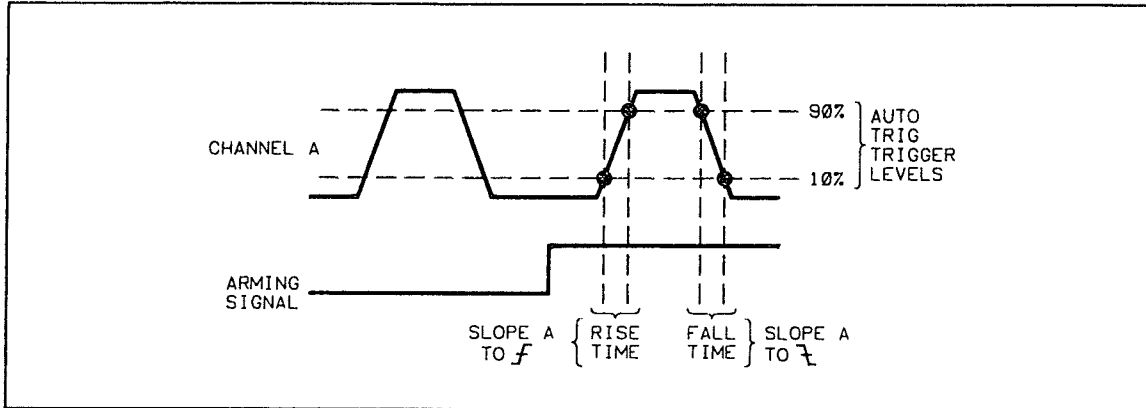

Figure 3-16. Rise/Fall Time Measurements

3-84. Rise/fall time measurements are made by connecting a signal to INPUT A, pressing the RISE/FALL TIME A function key, and selecting the appropriate input signal conditioning. COM A and AUTO TRIG are automatically set on; the SLOPE A key may be set for either RISE TIME or FALL TIME. Measurements are continuously displayed from gate cycle to gate cycle. Pressing the 100-GATE AVERAGE key increases the number of digits of resolution displayed.

3-85. Peak Voltage Measurements

3-86. See Figures 3-58 and 3-59 for details of Peak Voltage measurements. The HP 5334A/B measures peak voltages of periodic signals received through input Channels A and/or B, and positive and negative dc voltage levels. Peak Voltage measurements are specified (Table 1-1) with AUTO TRIG on, over a frequency range of 100 Hz to 20 MHz. The measurement range is $\pm 40V$ for positive and negative peaks. Auto attenuation automatically enables X10 ATTN when either peak exceeds $\pm 5.1V$, or when the difference between the upper and lower peaks is greater than $\pm 5.1V$. Upper and lower peaks of INPUT A or INPUT B are displayed when the HP 5334A/B is operating in the Peak Voltage mode.

3-87. The Peak Voltage mode is enabled with the READ LEVELS function key. Pressing the READ LEVELS key once displays the trigger levels of the A (left three digits) and B (right three digits) input channels. Pressing the READ LEVELS key twice displays the upper (left three digits) and lower (right three digits) peak levels of the INPUT A signal, shown in Figure 3-17. To display the upper and lower peaks of the INPUT B signal, press the READ LEVELS key a third time; a fourth time exits the Peak Voltage mode, and returns the counter to the previous mode of operation. DC voltage measurements are made in the same manner as the ac peak-to-peak measurements (see Table 1-1. Specifications, for maximum dc voltage); except that the input dc voltage reading will be displayed twice.

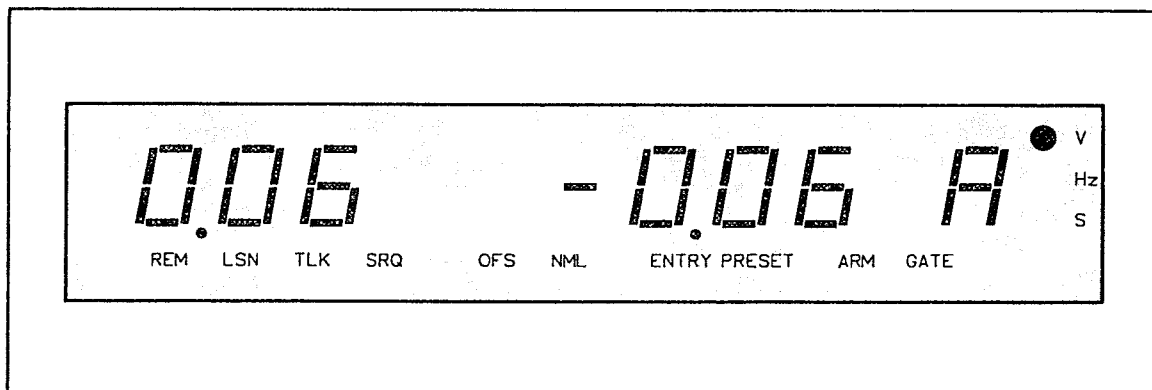

Figure 3-17. Channel A Peak Voltage Measurement Display

3-88. INITIAL POWER-UP CHECKS AND SELF-DIAGNOSTICS

3-89. When power is applied to the HP 5334A/B, an automated internal check is made to several major components, including the microprocessors and related circuitry. During the power-up cycle, all front panel display indicators will light momentarily, followed by momentary display of the instrument model number shown in *Figure 3-18* ("HP 5334b" will be displayed on the HP 5334B), then the momentary display of the instrument's decimal HP-IB address (e.g., Addr 03). The ARM and GATE lights will toggle back and forth briefly, then on successful completion of all tests, a "PASS" message will be displayed momentarily. During the power-up cycle the HP 5334A/B checks the following:

- a. The three microprocessors: Executive μ P, Measurement μ P, and HP-IB μ P, perform a ROM and RAM check.
- b. The Measurement μ P performs a limited I/O port check. The GATE and ARM annunciators flash if the tests pass up to this point.
- c. Communication is checked between the Executive and the Measurement microprocessors, and between the Executive and HP-IB microprocessors.
- d. The counter is checked for a timebase oscillator.
- e. The HP-IB address is read from the CMOS RAM and checked for validity.
- f. A front panel display check is performed, during which all front panel LED's are turned on, except STANDBY, and the trigger lights.

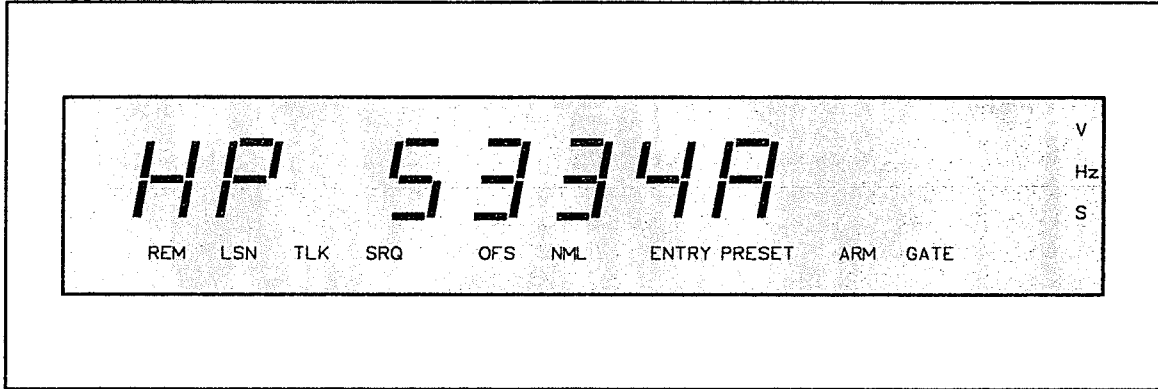

Figure 3-18. Intermediate Power-up Display

3-90. Any failures during the power-up cycle will produce a display of a numbered error or fail message. Fail messages generally indicate a hardware failure within the HP 5334A/B, and error messages indicate the user has attempted a disallowed operation or key sequence. If an error (5.0X through 5.2), or a failed message is displayed, pressing the RESET key will clear the display, and return the counter to the next test in the power-up sequence. Refer to Error Indications, paragraph 3-252 and *Table 3-3* and 3-4.

3-91. After the power-up sequence, the counter will initialize itself. All gate, math/memory (5334A only), and input signal conditioning keys will be off; the function will be *FREQ A*, with *AUTO TRIG* and auto-attenuation on; gate time setting will be 300 milliseconds; math offset value will be set at 0, and normalize value at +1. The trigger levels are set automatically, according to the input signals, and the internal control of trigger and sensitivity levels is disabled (*dACS OFF*; 5334A only). If you are operating an HP 5334A then refer to paragraphs 3-170 through 3-177 for

information regarding the DACs. Various aspects of the performance of the HP 5334A/B are tested dynamically during normal operation of the instrument, as describe below:

- a. In most cases, whenever two front panel keys are pressed simultaneously, Error 3.0 is displayed. If one key sticks and another is pressed, it will be detected immediately.
- b. If either the Measurement or HP-IB microprocessor stops operating, it will be detected whenever the counter attempts a data transfer, and the appropriate error message will be sent to the display immediately.
- c. If the Front Panel is inoperative, an error message can be obtained via HP-IB.
- d. The CMOS RAM is checked whenever a STORE or a RECALL operation is performed. Refer to paragraphs 3-126 through 3-134 for further details on STORE and RECALL. Note that the CMOS RAM and its STORE/RECALL functions are available in the HP 5334A only.
- e. Depending upon the configuration of the instrument, if the oscillator stops operating, the display will either freeze until another key is pressed, which causes the message "NO OSC" to be displayed, or this message will be displayed immediately.

3-92. FRONT PANEL CONTROLS, INDICATORS, AND CONNECTORS

3-93. *Figure 3-38* shows the front panel controls, indicators and connectors. Each of the main sections is described in general terms. Each control, indicator, and connector is described in complete detail in the following paragraphs.

3-94. POWER (STANDBY/ON) Key

3-95. When the POWER switch is in the ON position, power is supplied to the entire instrument. The STANDBY position removes normal operating power to the instrument, but supplies power for the Option 010 high stability oscillator oven to maintain a constant temperature for the crystal. The STANDBY indicator will remain on when the power switch is in the standby position. Therefore, the input to the main power transformer, plus the unregulated dc voltage to the oscillator oven circuitry is always energized whenever power is connected, whether the POWER switch is in STANDBY or ON.

WARNING

THE AC POWER CIRCUITS TO TRANSFORMER T1, THE STANDBY LED AND THE UNREGULATED DC VOLTAGE ARE STILL ON, EVEN WHEN THE POWER SWITCH IS IN STANDBY. CONTACT WITH THESE CIRCUITS CAN RESULT IN PERSONAL INJURY OR DAMAGE TO EQUIPMENT.

3-96. Note that the HP 5334A is provided with an internal battery (not available for HP 5334B) for continuous memory storage of up to 10 separate front panel setups. The battery is recharged only when the power switch is in the ON position.

3-97. RESET/LOCAL Key

3-98. The RESET key clears and updates the display in continuous measurement modes, and SINGLE CYCLE gate modes; resets the internal count to zero; and resets the counter to zero in the TOTALIZE mode. Pressing RESET/LOCAL when the counter is operating in REMOTE, will return the counter to the LOCAL mode of operation, if the HP-IB LOCAL LOCKOUT command is not on.

3-99. Front Panel Controls

3-100. The keyboard is divided into several groups, according to the purpose of the keys. From the left (see *Figure 3-38*) are GATE, MATH/MEMORY (MATH only; for HP 5334B), FUNCTION/DATA, INPUT; and if installed, INPUT C (Option 030), and DVM (Option 20 — HP 5334A only).

3-101. With some exceptions, each group operates fairly independently of the others. The operation of each front panel key is discussed in detail in the following paragraphs.

3-102. Operation of the individual keys is relatively straightforward. The LEDs (Light Emitting Diodes), in the center of most keys, indicate the key status. When the LED is on, it indicates the key's labeled function is active or in effect. When the LED is off, it indicates the key's labeled function is disabled or inactive. Many keys operate in this toggle (on/off) fashion.

3-103. Front Panel MEMORY (applies to HP 5334A only)

3-104. To avoid having to reenter math constants, signal conditioning setups, etc., whenever switching between two or more functions repetitively, the Front Panel MEMORY has ten storage registers. This allows you to set up to 10 function modes, each with its own front panel setup. The GATE TIME setting, TRIGGER LEVEL setting, and key setups for each of the keys in the GATE, MATH/MEMORY, FUNCTION/DATA, and INPUT sections can be stored in memory and recalled. Refer to paragraphs 3-126 and 3-130 for details.

3-105. GATE Group

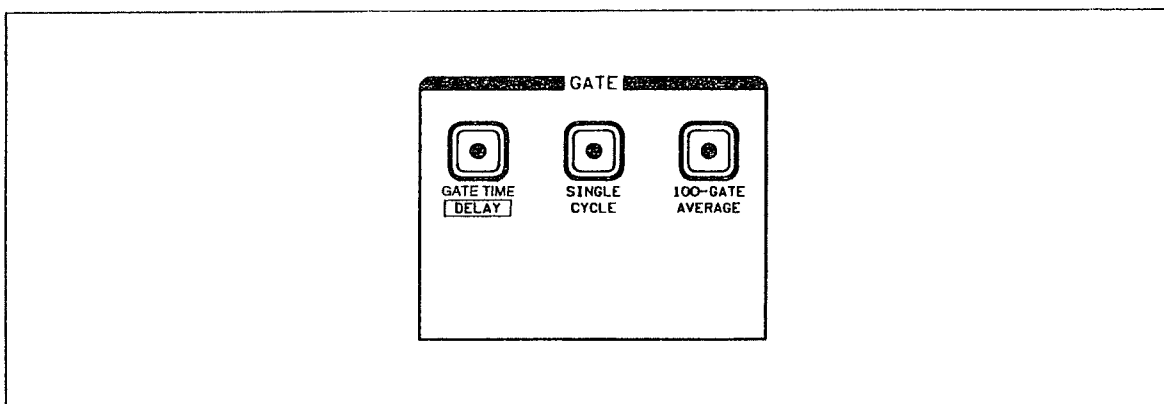

Figure 3-19. GATE Group

3-106. The GATE group keys toggle ON/OFF each time a key is pressed.

3-107. GATE TIME/DELAY KEY

3-108. GATE TIME/DELAY control key displays the current gate time (or delay time) setting, and enables the GATE TIME ENTRY mode. Each time the key is pressed it will toggle on or off. When the GATE TIME key is enabled, the key indicator will remain on, the current gate time will be displayed, and the ENTRY light will flash, indicating that entry may be made. The desired setting (1 ms to 99.999 s) is entered from the keyboard in decimal form, scientific notation, or engineering notation, by pressing the FUNCTION/DATA keys (digits and special functions are labeled to the left of each key). As each key is pressed, the corresponding digit will be displayed, as shown in *Figure 3-20* (e.g., the keystrokes are 0, ., 4, 5, 6). Only RESET/LOCAL, GATE TIME, and FUNCTION/DATA keys are optional during GATE TIME ENTRY. All other keys are nonfunctional, and will display, "Error 2.0", if pressed.

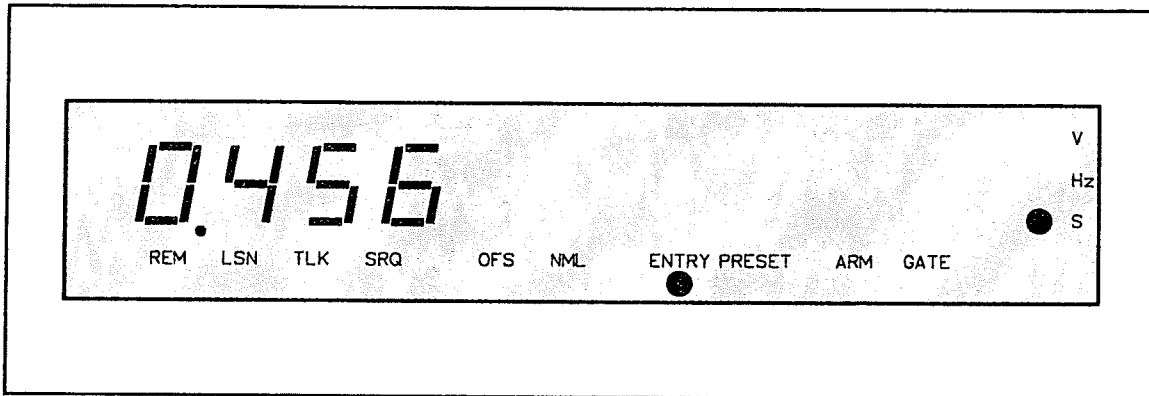

Figure 3-20. GATE TIME Selection Display

3-109. After the desired gate time has been entered, pressing the GATE TIME/DELAY key again will store the selected setting in memory, and return the counter to the previous mode of operation. If the displayed gate time is acceptable, no input is necessary. Pressing the GATE TIME/DELAY key again, will retain the current gate time setting and return the HP 5334A/B to the previous mode of operation.

3-110. For FREQUENCY, PERIOD, and RATIO modes, the GATE TIME/DELAY provides a continuously variable gate time from one millisecond to 99.999 seconds, in millisecond increments (actual minimum measurement time is one period of the input signal). For time interval modes, such as T.I.→B, PULSE WIDTH A, and RISE/FALL TIME A, the gate time setting varies the time between measurements. For T.I. DELAY mode, the gate time setting provides a continuously variable delay between START and STOP enable.

3-111. SINGLE CYCLE key

3-112. When the SINGLE CYCLE gate mode is enabled, the key indicator remains on, and the counter makes and display a single measurement. While the SINGLE CYCLE gate mode is enabled, each time RESET key is pressed the counter updates and displays another single measurement. Each time the SINGLE CYCLE gate key is pressed, it toggles on or off.

3-113. 100-GATE AVERAGE Key

3-114. The 100-GATE AVERAGE key selects the Measurement Averaging mode of operation. Each time the key is pressed it toggles on and off. When the 100-GATE AVERAGE mode is enabled, the key indicator remains on, and measurement modes, except the TOTALIZE mode. (Refer to paragraph 3-74 for further information on gate time control in the TOTALIZE mode of operation.) If the 100-GATE AVERAGE and SINGLE CYCLE modes are both enabled, the counter makes and displays a single, 100-gate average measurement.

3-115. MATH/MEMORY Group

3-116. In the MATH/MEMORY section the keys toggle ON or OFF, with the exception of the MATH SELECT/ENTER key. When the memory (5334A only, as shown in Figure 3-21) STORE or RECALL key is ON, the counter is in a data entry mode, indicated by the flashing ENTRY light in the display. The MATH SELECT/ENTER key has two data entry modes; the first permits an offset value to be entered; the second allows entry of a normalize value. (SELECT/ENTER key activates an operational stack similar to that of the READ LEVELS key.) Pressing the key a third time exits the MATH SELECT entry mode, and returns the counter to the previous mode of operation. When not in the data entry mode, the DISABLE function toggles between ON and OFF with each press of the key.

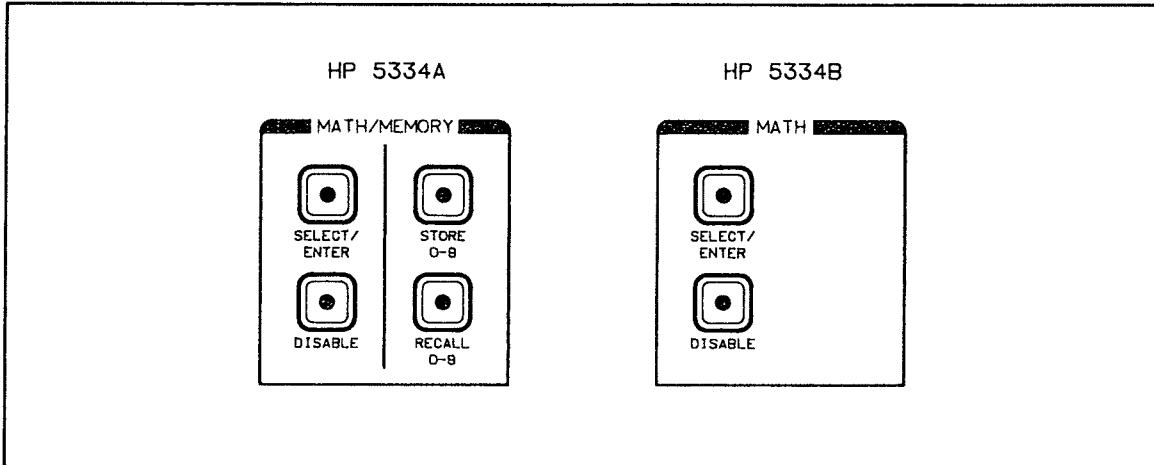

Figure 3-21. MATH/MEMORY Group

3-117. SELECT/ENTER Key

3-118. The math SELECT/ENTER key allows the user to perform a number of mathematical operations on the measurement before it is displayed. OFFSET (OFS), and NORMALIZE (NML) allows for the addition (or subtraction), and division (or multiplication), respectively, of the measurement by user specified constants. Modification of the display by the math operations is represented by the following relationship:

$$\text{Display} = \frac{\text{Measurement}}{\text{NORMALIZE}} + \text{OFFSET}$$

3-119. The OFFSET operation is performed after normalization. Any single or combination of these operations can be selected. This provides the user extensive control over the resultant display. It can be used, for example, to subtract systematic errors or display percentage differences.

3-120. The values for the user specified constants are entered from the keyboard. Pressing the Math SELECT/ENTER key once, displays the current OFFSET value, and enables the OFFSET ENTRY mode. The key indicator and the OFS light will remain on, and the ENTRY light will flash, indicating an OFFSET value may be entered. In Figure 3-22, the display shows the default "0" offset value.

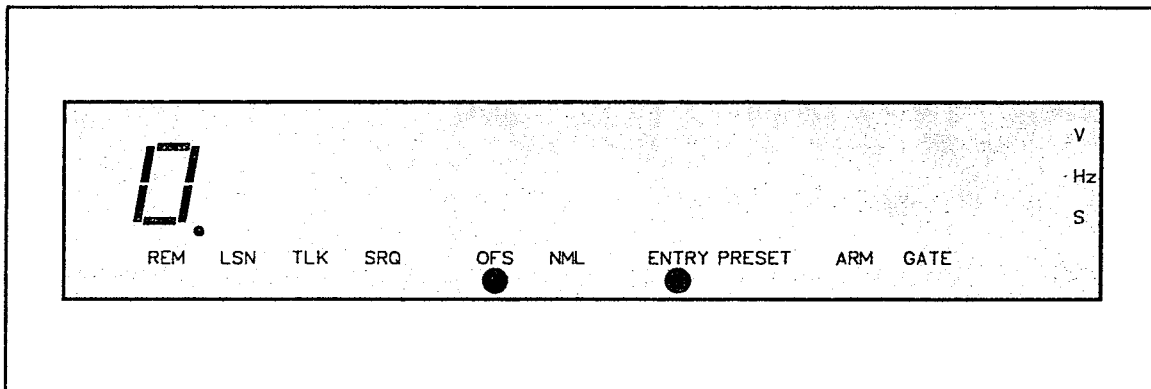

Figure 3-22. OFFSET ENTRY Display

3-121. During the OFFSET ENTRY mode, the FUNCTION/DATA keys respond to the digits and special functions labeled to the left of each key (see Figure 3-26, FUNCTION/DATA Group). As

each key is pressed, the corresponding digit or special function will be displayed. All other MATH/MEMORY keys, GATE and INPUT keys are nonfunctional, and will display "Error 2.0", if pressed. For a negative mantissa, the CHS/EEX key must be pressed first. After any digit has been pressed, the CHS/EEX key refers only to the exponent. The Math SELECT/ENTER key must be pressed a second time, to store a newly entered OFFSET value.

3-122. Pressing the Math SELECT/ENTER key a second time, displays the current NORMALIZE value, and stores any newly entered OFFSET value. (Default normalize value is +1.) If no OFFSET value was entered, the displayed value will remain in memory. The key indicator and the NML light will remain on, and the ENTRY light will flash, indicating a NORMALIZE value may be entered. During the NORMALIZE ENTRY mode, the front panel keys operate in the same manner as the offset entry mode. To store a newly entered NORMALIZE value, the math SELECT/ENTER key must be pressed a third time.

3-123. Pressing the Math SELECT/ENTRY key a third time, exits all math entry modes, stores any newly entered NORMALIZE value, and returns the counter to the previous mode of operation. If no NORMALIZE value was entered, the displayed value will remain in memory. Pressing the RESET/LOCAL key at any time during a math entry mode, will exit all math entry modes immediately, and return the counter to the previous mode of operation. Current entries will not be stored if the math entry mode is exited with the RESET/LOCAL key.

3-124. DISABLE Key

3-125. When the counter is not in a math entry mode, the math DISABLE key permits the overall math operations to be disabled and then reestablished without having to reenter constants. Each time the key is pressed it toggles on or off. When the Math DISABLE key is on, the key indicator remains on, and all math operations are disabled. When the key is turned off, any previously entered math constants will be reenabled. Math operations are automatically disabled whenever the function selection is changed (i.e., FREQ A, PERIOD A, etc.).

3-126. STORE Key (HP 5334A Only)

3-127. The Memory STORE key permits up to 10 complete front panel setups to be stored. Battery power retains data for 60 days, typically, with the instrument in STANDBY or AC power removed. Setups will be stored indefinitely with the power on. All 10 storage locations are completely independent. Math constants, Gate Time, Arming, and all other front panel key states are included in any stored setup. Additionally, the Trigger Level or Sensitivity Level settings are digitized and stored. Storage register numbers are entered from the keyboard.

3-128. Entry begins by enabling the STORE key. The key indicator will remain on, and ENTRY light will flash, indicating an entry is expected. A "store register" prompt will be displayed, as shown in *Figure 3-23*. An entry is completed by pressing one of the numeric DATA keys (0-9), at which time the entire front panel setup is stored at the indicated location, and the counter returns to the previous mode of operation.

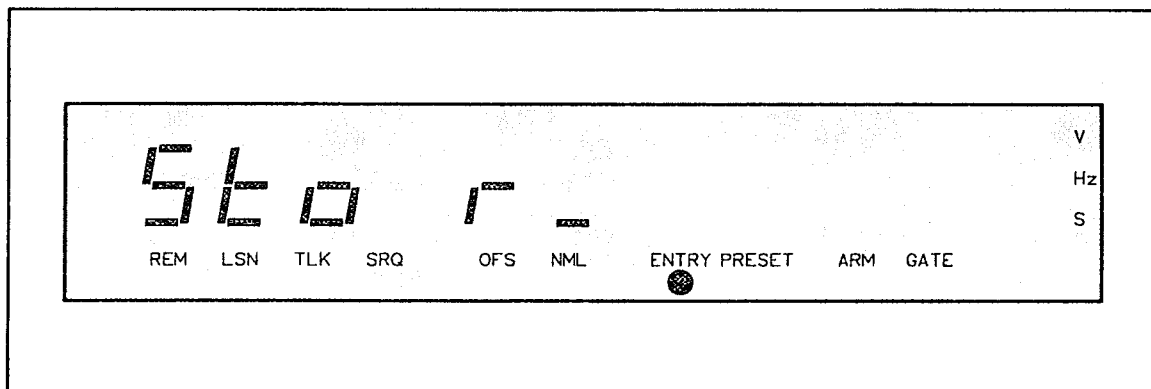

Figure 3-23. HP 5334A STORE ENTRY Mode Display

3-129. Each time the STORE key is pressed, it toggles on or off. When the STORE ENTRY mode is enabled, only the STORE, RESET/LOCAL, and numeric data keys in the FUNCTION/DATA group are operational. All other front panel keys are nonfunctional, and will display "Error 2.0" if pressed. If STORE or RESET/LOCAL is pressed while in the STORE ENTRY mode, the entry mode will be exited; the counter will return to the previous mode of operation; and the front panel setup will not be saved. To save a front panel setup, press the STORE key then one of the DATA keys.

3-130. RECALL Key (HP 5334A Only)

3-131. The Memory RECALL key permits one of ten previously stored panel setups to be recalled into the front panel, allows the HP 5334A HP-IB address to be displayed and/or changed, and allows the previously stored trigger and sensitivity levels to be reset. Register numbers are entered from the keyboard. Pressing the RECALL key enables the RECALL ENTRY mode. The key indicator will remain on, and the ENTRY light will flash, indicating an entry is expected. The RECALL is completed by pressing one of the numeric DATA keys (0-9). The complete setup (stored at the indicated location) will be recalled to the front panel, including the function. The counter will then resume making measurements and displaying the results.

NOTE

The trigger and sensitivity levels are set internally when a setup is recalled, and the TRIGGER LEVEL/SENS controls are not operational. To return to front panel control of the trigger and sensitivity levels, refer to instructions in paragraph 3-174.

3-132. Each time RECALL key is pressed, it toggles on or off. When the RECALL ENTRY mode is enabled, only RECALL, RESET/LOCAL, and the keys in the FUNCTION/DATA group are operational. All other front panel keys are nonfunctional, and will display "Error 2.0", if pressed. If RECALL or RESET/LOCAL is pressed while in the RECALL ENTRY mode, the entry mode will be exited; the counter will return to the previous mode of operation; and the front panel setup will not be recalled. To recall a front panel setup, press the RECALL key then one of the numeric DATA keys (0-9). Refer to *Figure 3-24* for the RECALL ENTRY mode display.

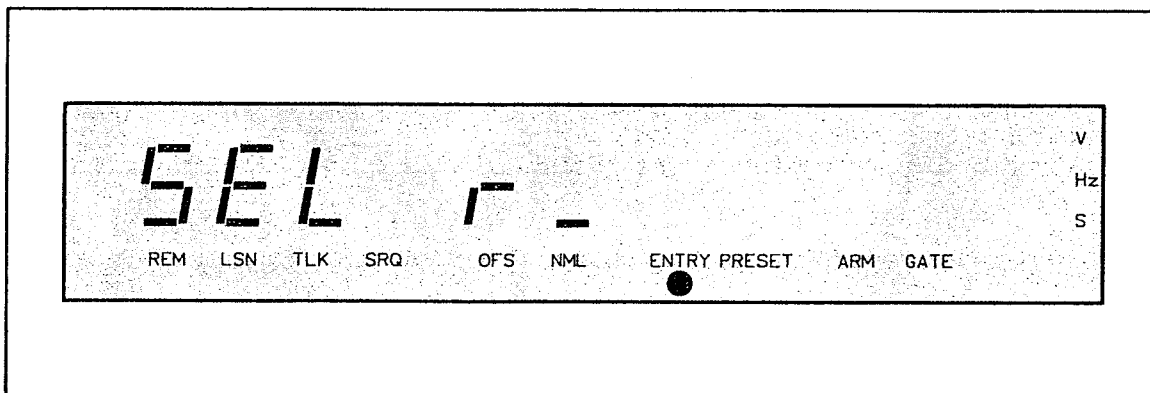

Figure 3-24. HP 5334A RECALL ENTRY Mode Display

3-133. When the RECALL key is on, pressing the decimal point |.| will display the HP 5334A HP-IB address, and enable the ADDRESS ENTRY mode. The HP-IB address may be changed at this time. (Refer to paragraph 3-282, Setting the HP 5334A Address, for further instructions.) Pressing the RESET/LOCAL key will exit the ADDRESS ENTRY mode, without changing the current address

setting. During the ADDRESS ENTRY mode only the STORE, RECALL, RESET/LOCAL, and numeric DATA keys in the FUNCTION/DATA group are operational. All other front panel keys are nonfunctional, and will display "Error 2.0", if pressed.

3-134. When the RECALL ENTRY mode is enabled, pressing the CHS/EEX key will display the current DACS setting (ON or OFF), and enable the DACS ENTRY mode, shown in *Figure 3-25*. Pressing the CHS/EEX key again will display the alternate DACS setting. Each time the CHS/EEX key is pressed the display will alternate between "dACS On" or "dACS OFF". The DACS setting may be changed at this time, by pressing the STORE key when the desired setting is displayed. Pressing the RESET/LOCAL key will exit the DACS ENTRY mode, without changing the current DACS setting. During the DACS ENTRY mode only the STORE, RECALL, CHS/EEX, and RESET/LOCAL keys are operational. All other keys are nonfunctional, and will display "Error 2.0" if pressed. (Refer to paragraph 3-170, for further information on setting the DACS.)

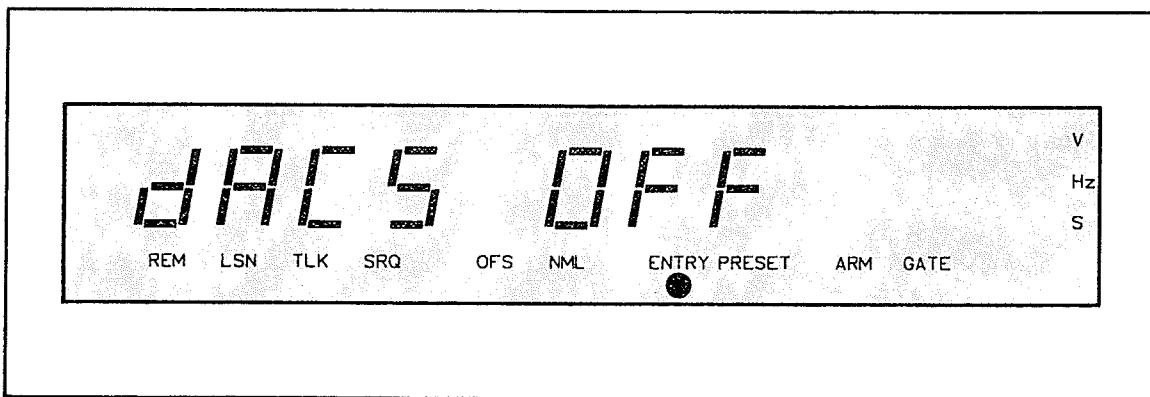

Figure 3-25. HP 5334A DACS ENTRY Mode Display

3-135. FUNCTION/DATA Group

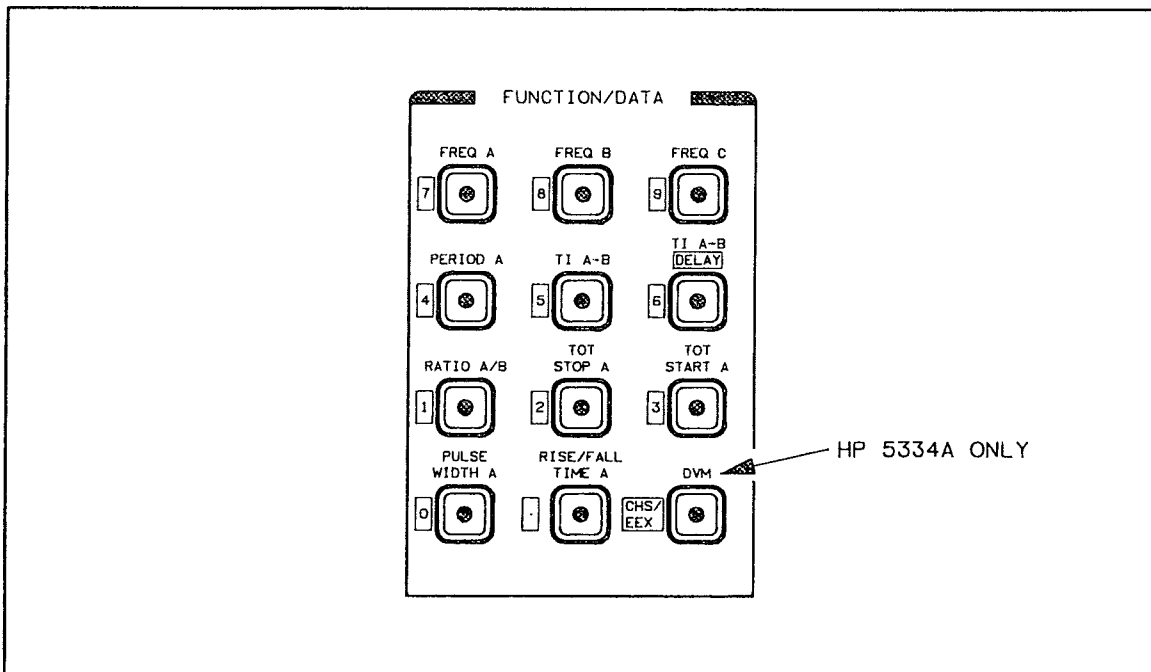

Figure 3-26. FUNCTION/DATA Group

3-136. Function selection for the HP 5334A/B is performed by pressing one key per function in the FUNCTION/DATA group. Twelve (eleven for HP 5334B; no DVM function) function modes (labeled in black above each key) are directly accessible via the front panel. Only one function may be enabled at a time. Pressing another function key automatically disables the previous function. Pressing the RESET key starts a new measurement, but does not affect any current function selection or key setups. To disabled a current function, another function key must be pressed. The key indicator (LED) identifies which function is active. During a data entry mode (i.e., MATH/MEMORY, or GATE TIME), the key functions are reassigned to the numeric or special entry values labeled to the left of each key.

3-137. **FREQ A Key**

3-138. The FREQ A key selects the Frequency mode of operation for signals received through Input A. The FREQ A mode allows measurements on frequencies from 1 mHz to 100 MHz. On power-up, the HP 5334A/B assumes the FREQ A function with the GATE TIME set at 300 milliseconds, automatic trigger ON (AUTO TRIG), and automatic attenuation ON (X1/X10 ATTN). Any periodic signal connected to INPUT A at this time, will self-arm the counter, and measurements will begin immediately (provided the signal is within input specifications, and within the restrictions set by the signal conditioning controls). The displayed resolution is controlled by the GATE TIME setting.

3-139. **PERIOD A Key**

3-140. The PERIOD A key selects the Period mode of operation for signals received through Input A. The PERIOD A mode allows period measurements from 10 nanoseconds to 1,000 seconds. The HP 5334A/B automatically averages period measurements whenever the GATE TIME setting is greater than the period of the signal being measured. The number of periods averaged is determined by the GATE TIME setting and the period of the input signal.

3-141. **RATIO A/B Key**

3-142. The RATIO A/B key selects the Ratio mode of operation, measuring the ratio of the signal frequency at Input A to the signal frequency at Input B. The higher frequency can be applied to either input channel, since the HP 5334A/B can display ratios of less than 1. However, it is recommended that the higher frequency be applied to Channel A for measurements and displays greater than 1, as shown in *Figure 3-27*. The GATE TIME setting determines the resolution by selecting the number of cycles of the INPUT B signal over which the ratio is measured. Increasing the gate time or increasing the signal frequency at INPUT A results in greater resolution of the measurement.

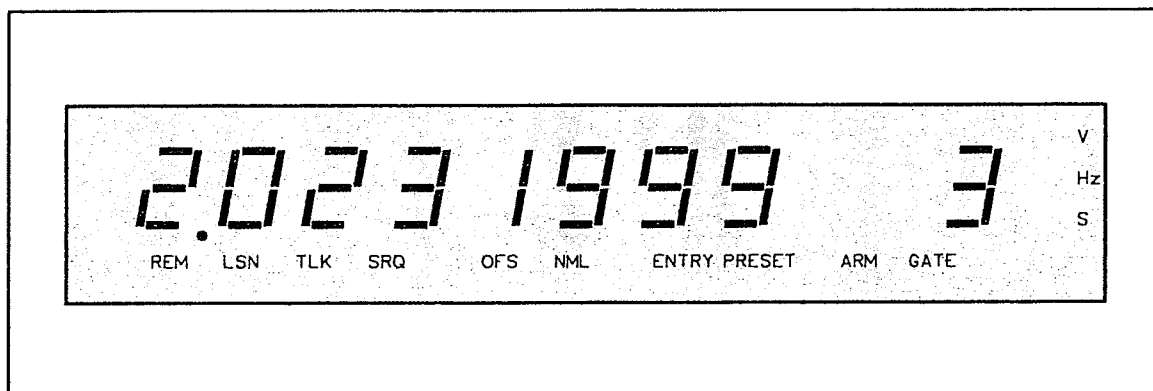

Figure 3-27. Ratio Measurement Display

3-143. PULSE WIDTH A Key

3-144. The PULSE WIDTH A key selects the Pulse Width mode of operation for signals received through Input A. AUTO TRIG is automatically enabled, to trigger at the 50% point of the input signal. (AUTO TRIG cannot be disabled in this mode.) The Pulse Width mode allows measurements of input signals with a minimum pulse width of 5 nanoseconds. The A Channel SLOPE control key can be set to measure positive or negative pulses. Gate time is controlled by the input pulse width. Pressing the 100-GATE AVERAGE key, while in the Pulse Width mode, increases the number of digits of resolution displayed, as shown in *Figure 3-28*.

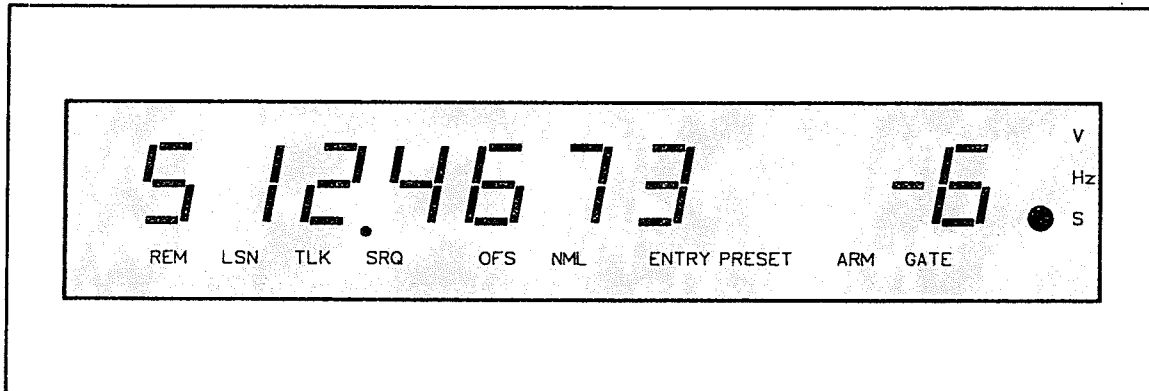

Figure 3-28. Pulse Width Measurement Display

3-145. FREQ B Key

3-146. The FREQ B key selects the Frequency mode of operation for signals received through Input B. The FREQ B mode allows measurements on frequencies from 1 mHz to 100 MHz. When the FREQ B mode is selected, a periodic signal connected to Input B will self-arm the counter, and measurements will begin immediately (provided the signal is within input specifications, and within the restrictions set by the signal conditioning controls). The displayed resolution is controlled by the GATE TIME setting.

3-147. T.I. A-B Key

3-148. The T.I. A-B key selects the Time Interval mode of operation, measuring elapsed time between a Start signal on Input A and a Stop signal on Input B. Independent SLOPE and TRIGGER LEVEL/SENS controls for the START and STOP signals allow variable triggering on either positive or negative going slopes. Time Interval measurement may be made over a range of -1 nanosecond to 1000 seconds. The minimum START/STOP pulse width is 5 nanoseconds. Gate time is controlled by the measured time interval. *Figure 3-29* shows a T.I. measurement display, where the stop signal occurs before the start signal.

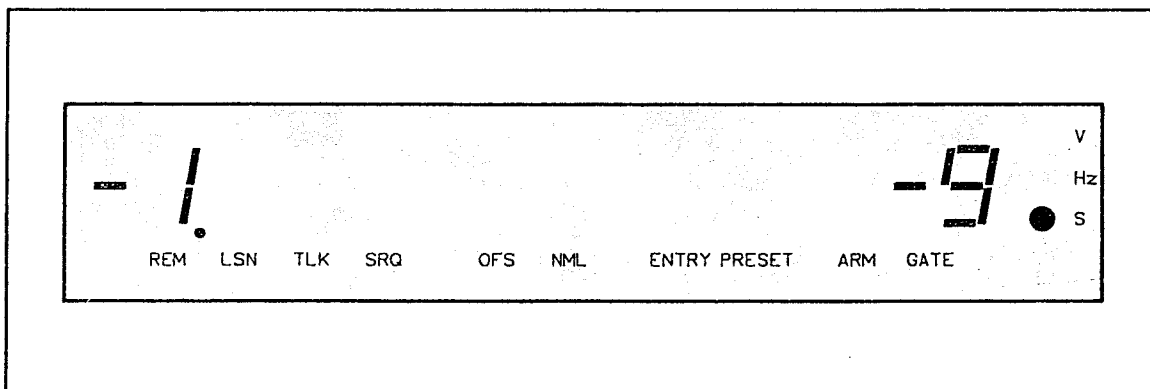

Figure 3-29. T.I. Measurement Display

3-149. Time Interval Averaging is done by pressing the 100-GATE AVERAGE key, while in the Time Interval mode. Time Interval Average provides greater resolution of measurements than single-shot measurements provide.

3-150. RISE/FALL TIME A Key

3-151. The RISE/FALL TIME A key selects the Rise/Fall Time mode of operation, and automatically configures the counter to perform either rise or fall time measurements through INPUT A. The input is automatically set to COM A and triggering to AUTO TRIG. In this mode, AUTO TRIG automatically locates the 10% and 90% points of the input signal, and sets the trigger levels accordingly. Rise/Fall Time measurements require a periodic signal. AUTO TRIG and COM A cannot be disabled when the HP 5334A/B is operating in the Rise/Fall Time mode. Gate time is controlled by the rise/fall time interval.

3-152. FREQ C Key

3-153. The FREQ C key selects the Frequency mode of operation for signals received through INPUT C. Operation in the FREQ C mode requires the Option 030 Channel C input module, and allows measurements on frequencies from 90 MHz to 1.3 GHz. INPUT C prescales signals by a factor of 20, however, there is no loss of resolution. When the FREQ C mode is selected, the Channel A and B INPUT section is disabled. Measurements through INPUT C respond to all other controls the same as FREQ A measurements.

3-154. T.I. A→B/DELAY Key

3-155. The T.I. A→B/DELAY key selects the Time Interval mode of operation, measuring elapsed time between a Start signal on INPUT A and a Stop signal on INPUT B. Triggering of the Stop signal is DELAYED for a period of time determined by the Gate Time Delay setting. Potential Stop events are ignored during the specified delay.

3-156. TOT START A Key

3-157. The TOT START A key selects the Totalize mode of operation, and starts a continuous count and display of the number of events received through INPUT A. The count is accumulated from input cycle to input cycle. The Totalize mode is manually gated from the front panel, and is independent of the gate time setting. RESET clears the count and sets the display back to zero. Pressing any key in the input group will reset the count to zero.

3-158. TOT STOP A Key

3-159. The TOT STOP A key Stops and holds the count when the counter is operating in the Totalize mode. Counting continues without resetting the previous total, when the TOT START A key is pressed again. RESET clears the counter and resets the display to zero. Pressing any key in the input group will reset the count to zero.

3-160. DVM Key (Option 020, for HP 5334A only)

3-161. The DVM key selects the Voltage mode of operation, which provides dc voltage measurements of signals received through the Option 020 DVM input module. The DVM is fully floating and autoranging. Gate time is internally set at 100 ms when the Voltage mode is enabled; GATE TIME entry, AUTO TRIG and EXT ARM SELECT are automatically disabled.

3-162. INPUT Group

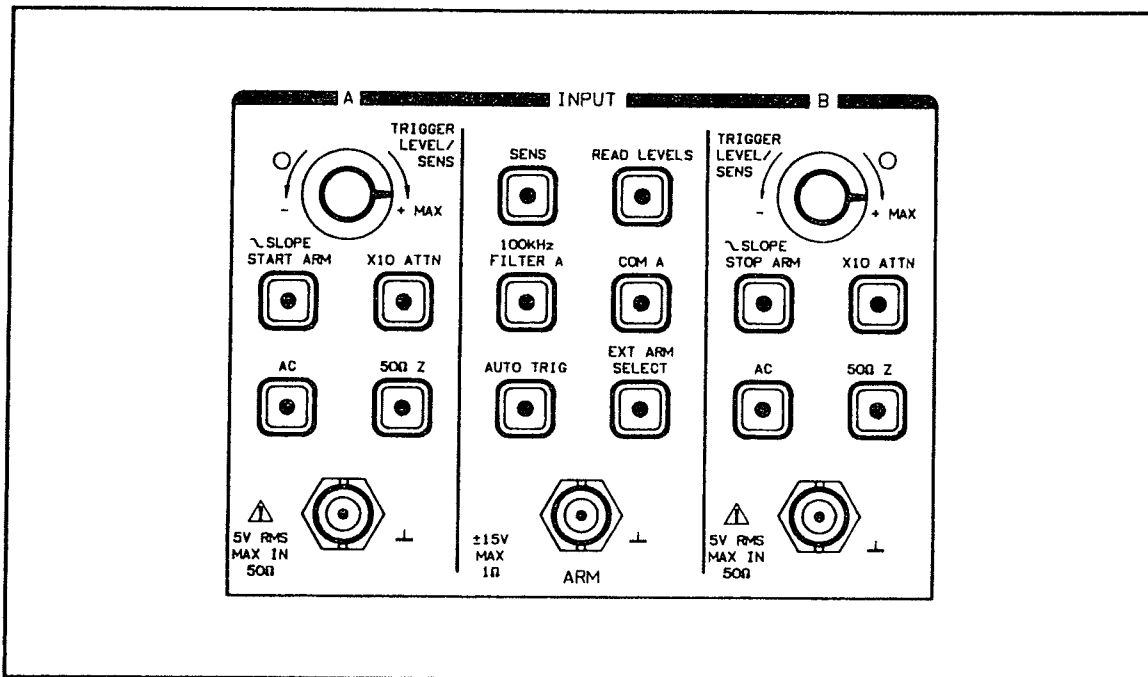

Figure 3-30. INPUT Group

3-163. The INPUT group keys toggle ON/OFF each time the key is pressed, with the exception of the READ LEVELS key. When the READ LEVELS key is pressed, the counter displays one of three internal registers. (Refer to paragraph 3-87, for information on the contents of the registers.) The registers are positioned to form an operational stack. Once activated, each time the READ LEVELS key is pressed, the stack will roll up to display the next register. After the third register has been displayed, pressing the READ LEVELS key will return the counter to the previous mode of operation. Note that the RESET key will NOT disable the READ LEVELS key.

3-164. TRIGGER Light

3-165. The tri-state TRIGGER LED (Light Emitting Diode) flashes when the corresponding channel is triggering; is OFF when the input signal is below the trigger level setting; and ON when the input signal is above the trigger level setting.

3-166. TRIGGER LEVEL/SENS Control

NOTE

Any references to DACS apply to the HP 5334A only.

3-167. The TRIGGER LEVEL/SENS control sets the voltage level at which corresponding input channel will trigger (with AUTO TRIG, SENS and DACS turned off), and is variable over ± 5 volts in X1 ATTN. When the SENS key is enabled, the TRIGGER LEVEL/SENS control varies the sensitivity of the corresponding input from MAX to MIN, as shown in Figure 3-31. When AUTO TRIG is on, the trigger levels are controlled by the input signal, and automatically set according to the measurement application. The front panel TRIGGER LEVEL/SENS controls are disabled when AUTO TRIG is ON, or when DACS are ON; and the trigger levels are controlled internally. If you are operating an HP 5334A then refer to paragraphs 3-170 and 3-171 for further details on selecting

the internal trigger levels via the DACS. After the HP 5334B's TRIGGER LEVEL/SENS has been operating in the AUTO TRIG mode, the following steps must be performed to regain front panel control of the TRIGGER LEVEL/SENS control:

1. Press RESET/LOCAL.
2. Press READ LEVELS key (described in paragraph 3-178) three times (this will cycle the 5334B out of the READ LEVELS mode). The TRIGGER LEVEL/SENS knob should now control the trigger and sensitivity levels.

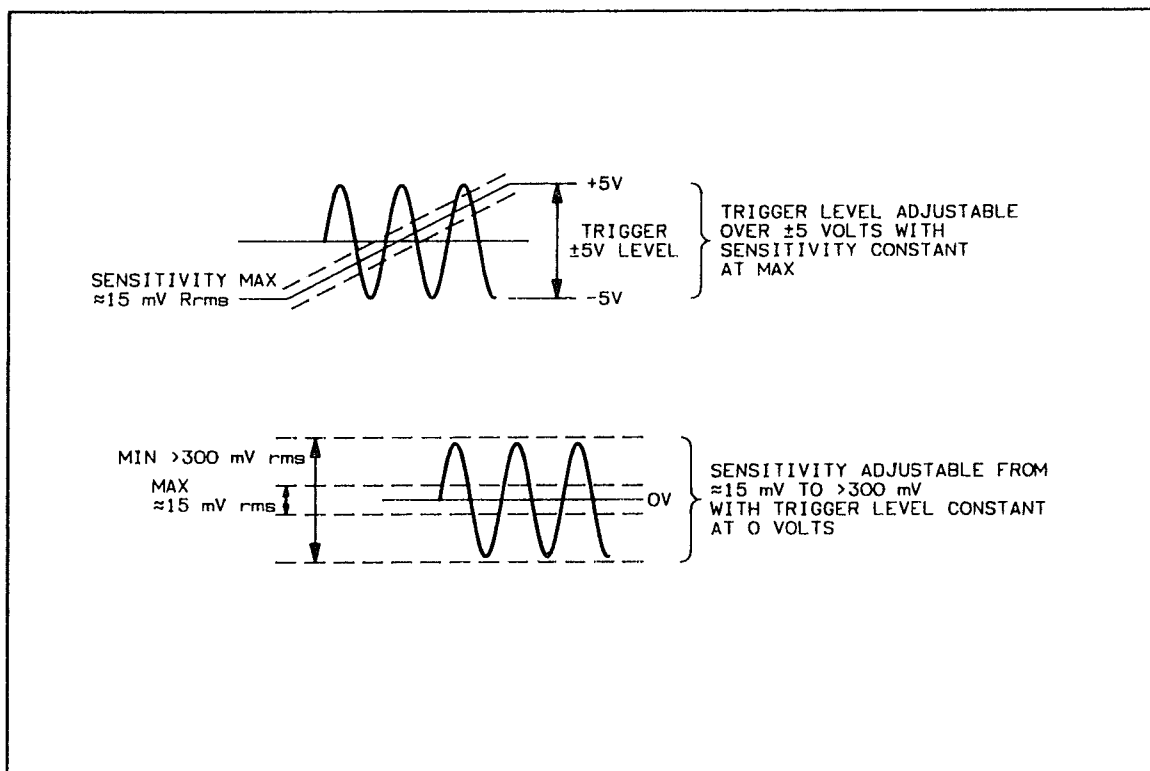

Figure 3-31. Trigger Level/Sensitivity Control Application

3-168. SENS Key

3-169. The SENS key sets the function of the corresponding TRIGGER LEVEL/SENS control to either Trigger Level or Sensitivity mode. In the Trigger Level mode (blue key indicator OFF), sensitivity is preset to MAX, and trigger levels are variable. In Sensitivity mode (blue key indicator ON), trigger level is preset to 0 volts, and the sensitivity is variable. Refer to Figure 3-31.

3-170. PROGRAMMING 5334A TRIGGER/SENS LEVELS VIA THE FRONT PANEL. Before the desired trigger levels can be selected, AUTO TRIG must be OFF, SENS must be OFF, and DACS must be OFF (i.e., the internal control of trigger/sensitivity levels is disabled as described in paragraph 3-174). Compatible settings are shown in Table 3-1. Then, the trigger levels may be varied over the entire dynamic range of the counter by adjusting the TRIGGER LEVEL/SENS controls. The triggering range of the input signal is indicated by the flashing TRIGGER Light. Optimum trigger point is usually at the midpoint of the range over which the trigger light flashes. (Refer to paragraph 3-166 and 3-168 for details on adjusting the sensitivity levels.)

Table 3-1. HP 5334A Trigger/Sensitivity Level Settings

COMPATIBLE SETTINGS			RESULTS		
AUTO TRIG	DACS	SENS	TRIGGER LEVELS	HYSTERESIS	SENSITIVITY
OFF	OFF	OFF	Front Panel Controls	MIN	MAX
OFF	OFF	ON	0 volts	Front Panel Controls	Front Panel Controls
OFF	ON	OFF	Internal Controls	MIN	MAX
OFF	ON	ON	0 volts	Internal Controls	Internal Controls
ON	OFF	OFF	AUTO	MIN	MAX
DISALLOWED SETTINGS					
ON	OFF	ON	X	X	X
ON	ON	OFF	X	X	X
ON	ON	ON	X	X	X

3-171. For selecting specific trigger level voltages, it is recommended that the trigger levels be determined by pressing the READ LEVELS key, then adjusting the controls to the desired voltages. The voltages displayed will be within the accuracy, resolution, and range specified in Table 1-1.

3-172. After the trigger level controls have been adjusted, the dc voltages are programmed into memory by pressing STORE, then the selected register number (0-9). Refer to paragraph 3-126 for details on the operation of the STORE key. Note, the entire front panel setup will be stored in addition to the sensitivity and trigger levels, including the function (i.e., READ LEVELS, FREQ A, etc.).

3-173. The store trigger levels and sensitivity levels are programmed into the instrument by pressing RECALL, then the register number (0-9). The dc voltages for the INPUT A and B trigger levels and sensitivity levels will be set internally, and the front panel will display "dACS ON" if the current status of the DACS is called up (as described in paragraph 3-134). Refer to paragraph 3-130 for details on the operation of the RECALL key. Note that the entire front panel setup will be recalled in addition to the sensitivity and trigger levels, including the function (i.e., READ LEVELS, FREQ A, etc.). The front panel TRIGGER LEVEL/SENS controls will be disabled.

3-174. RETURNING 5334A TRIGGER/SENS LEVEL CONTROL TO FRONT PANEL (dACS OFF). To return to front panel operation of the TRIGGER LEVEL/SENS controls, the Internal Control (DACS) must be disabled. Internal Control is turned OFF by pressing RECALL, pressing CHS/EEX once or twice to display "dACS OFF", then pressing STORE. The counter will return to the previous mode of operation, and the front panel TRIGGER LEVEL/SENS controls will then be enabled. Paragraph 3-167 describes how to return TRIGGER LEVEL/SENS control to the front panel of the **HP5334B**.

3-175. CONTROLLING 5334A TRIGGER/SENS LEVELS INTERNALLY (dACS ON). Internal Control may be used to set the trigger/sensitivity levels for most measurement modes, except PULSE WIDTH A, RISE/FALL TIME A, and PEAK VOLTAGE. Pressing RECALL, then CHS/EEX will display the current Internal Control (DACS) status. Pressing RESET/LOCAL will exit the DACS entry mode, without changing the current status. Refer to paragraph 3-130 for further details on the RECALL operation, and the DACS entry mode. During measurements, the trigger/sensitivity levels are controlled internally, by setting "dACS On".

3-176. Internal Control is enabled by pressing RECALL, pressing CHS/EEX once or twice to display "dACS On" (shown in Figure 3-32), then pressing STORE. The counter will then return to

the previous mode of operation, but the trigger and sensitivity levels will be those settings from the last time the DACS were enabled. Those sensitivity and trigger levels will be set internally, and the front panel TRIGGER LEVEL/SENS controls will be disabled. (Refer to paragraph 3-170 for details on programming trigger levels via the front panel.)

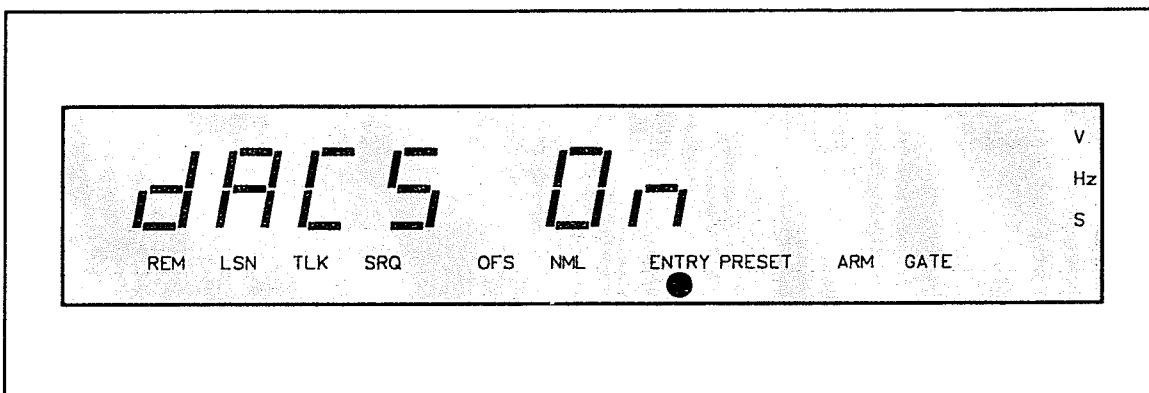

Figure 3-32. DACS ON Display

3-177. When the Internal Controls are enabled manually, as described in the previous paragraph, the last recall operation determines the trigger level values stored in the Internal Controls. To return to front panel operation of the TRIGGER LEVEL/SENS controls, Internal Control must be turned off, as described in paragraph 3-174.

3-178. READ LEVELS Key

3-179. The READ LEVELS key selects the Peak Voltage mode of operation, measuring trigger levels, and peak voltages of periodic signals and dc voltages received through input channels A and/or B. Each time the READ LEVELS key pressed, the counter displays the values stored in one of three stacked registers: The trigger levels of the A and B input channels; the upper and lower peaks of the signal at INPUT A; and the upper and lower peaks of the signal at INPUT B, shown in Figure 3-33. Pressing the READ LEVELS key a fourth time exits the Peak Voltage mode, and returns the counter to the previous mode of operation. When using the READ LEVELS function to measure a dc voltage at the appropriate input channel the A and/or B channel readings will be displayed twice.

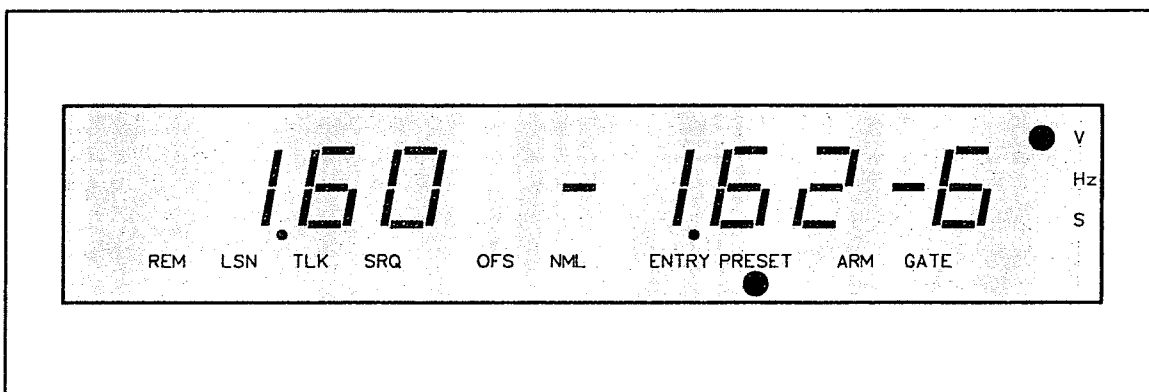

Figure 3-33. Channel B Peak Voltage Measurement Display

3-180. SLOPE/START ARM/STOP ARM Keys

3-181. The SLOPE key selects triggering on either the positive or negative slope of the input signals received through the corresponding input channel. When the LED (inside the key) is OFF, it indicates the positive slope is selected. When the LED is ON, it indicates the key's labeled

function (negative slope) is in effect. For external arming, the A channel SLOPE key selects the START ARM state, and the B channel SLOPE key selects the STOP ARM state, refer to paragraph 3-195, for further information on using START ARM and STOP ARM in the external arming mode.

3-182. AC Key

3-183. The AC key selects ac coupling (key indicator ON), or dc dc coupling (key indicator OFF) for the corresponding input signal. When in COM A, the channel A selection determines coupling for both the A and B input channels.

3-184. X10 ATTN Key

3-185. The X10 ATTN key selects the attenuation of signals at the corresponding input channels. The X1 position (key indicator OFF) connects the input signal directly to the input amplifiers; X10 position (key indicator ON) attenuates the input signal by a factor of 10. When AUTO TRIG is on, attenuation is automatically controlled by the input signal voltage and cannot be changed manually.

3-186. 50 Ohm Z Key

3-187. The 50 Ω Z key selects the input impedance for the corresponding input channels. When the key LED is ON it indicates the 50-ohm impedance is selected, and 1-Megohm impedance is selected when the key indicator is OFF. When in COM A, the channel A selection determines impedance for both the A and B input channels.

3-188. 100 kHz FILTER A Key

3-189. The 100 kHz FILTER A key inserts a low pass filter configuration into INPUT A, attenuating frequencies above 100 kHz by greater than 3 dB. When the 100 kHz FILTER is enabled, the key indicator is ON. When the filter is turned OFF, the counter then resumes normal operation over the entire 100 MHz bandwidth. FILTER A is disallowed in the RISE/FALL TIME mode.

3-190. COM A Key

3-191. The COM A key selects Separate or Common input amplifier control. In the COM A position (indicated when the key LED is ON), the signal at INPUT A is also applied to INPUT B; INPUT B connector is disconnected from the input circuitry; and coupling and impedance selection is controlled by channel A. In the Separate position (indicated when the key LED is OFF), the A and B inputs and controls operate independently of each other. COM A is automatically set (and cannot be disabled) when the HP 5334A/B is operating in the RISE/FALL TIME mode.

3-192. AUTO TRIG Key

3-193. The AUTO TRIG key selects the Automatic Triggering mode of operation. When AUTO TRIGGER is selected (key LED on) the trigger level is controlled by the input signal and is automatically set according to the measurement application. Attenuation is automatic when AUTO TRIG is selected; the X10 attenuator is enabled when the signal exceeds the dynamic range or the signal operating range; when the signal is within both limits, X1 attenuation is enabled. Attenuation and trigger levels cannot be controlled manually when AUTO TRIG is ON.

3-194. AUTO TRIG is automatically enabled when the HP 5334A/B is operating in the RISE/FALL TIME mode; in this mode, AUTO TRIG sets the trigger levels at the 10% and 90% points of the input signal. In the PULSE WIDTH mode AUTO TRIG is automatically enabled, to trigger at the 50% point of the input signal. In the PEAK VOLTAGE mode AUTO TRIG finds the upper and lower peak levels of the input signal. AUTO TRIG cannot be disabled and trigger levels cannot be adjusted manually when the counter is operating in either of these modes.

3-195. EXT ARM SELECT Key

3-196. External arming can be used to specify the start and/or stop of a measurement, by a signal that is not directly involved in the measurement. When external arming is enabled, a signal must be connected to the ARM input connector to arm the gate to open and/or close. Pressing the EXT ARM SELECT key displays the arming status, shown in Figure 3-34, and allows the START ARM (open gate) and/or STOP ARM (close gate) states to be changed.

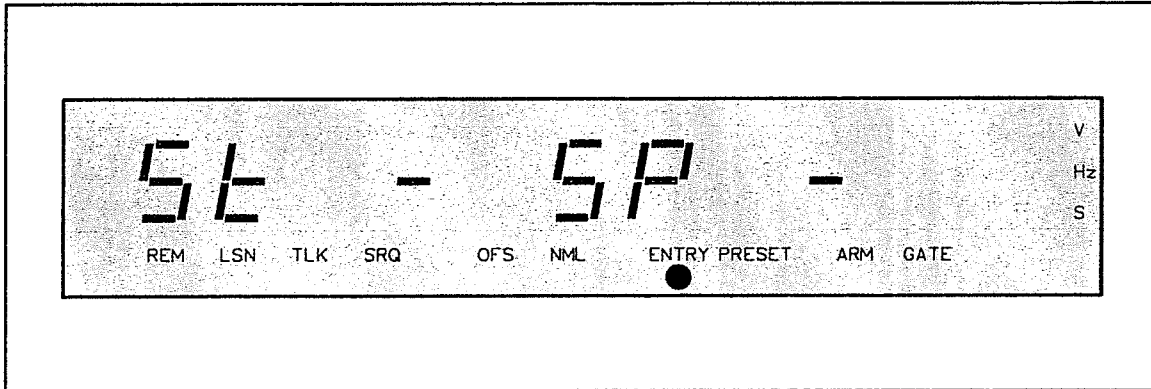

Figure 3-34. EXTERNAL ARM SELECT Entry Mode Display, Arming Off

3-197. The arming status is represented as "St" (START ARM) and "SP" (STOP ARM). The states are defined by " - " (arming off), shown in Figure 3-34; and " 7 " (arming set on negative slope), and " J " (arming set on positive slope) as shown Figure 3-35 slope). The channel A SLOPE key controls the START ARM, and the channel B SLOPE key controls the STOP ARM.

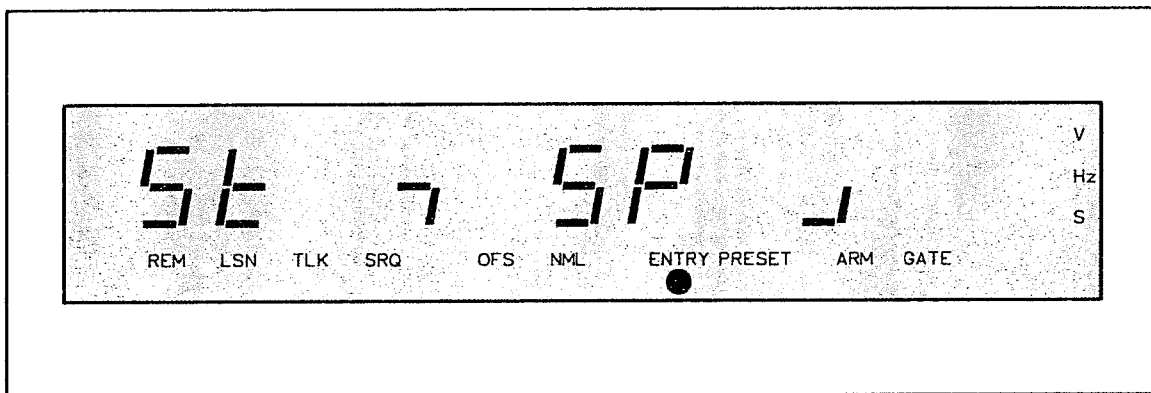

Figure 3-35. EXTERNAL ARM SELECT Display, Arming States Selected

3-198. Pressing the START ARM or STOP ARM key while the EXT ARM SELECT key is enabled, will change the corresponding arming state. After the desired states have been selected, the EXT ARM SELECT key must be pressed again, to record the changes. Pressing the RESET/LOCAL key will exit the entry mode, without changing the arming status. If either slope has been set on, the EXT ARM SELECT key LED will remain on to indicate external arming is enabled. Any combination of these three states can be selected to arm the counter. To DISABLE arming, the START ARM and STOP ARM must both be set to " - ", arming off.

3-199. The EXT ARM SELECT key displays the arming status, and allows the START ARM and/or STOP ARM states to be changed. The EXT ARM SELECT key operates as follows:

- a. When START ARM and STOP ARM are both set to “ — ”, the arming off position:
 1. Each time the EXT ARM SELECT key is pressed, it toggles ON or OFF.
 2. The LED inside the key turns ON or OFF, respectively.
 3. When the EXT ARM SELECT key is ON, it enables the ARM ENTRY mode; OFF, returns the counter to the previous mode of operation.

NOTE

Pressing the EXT ARM SELECT key does NOT enable external arming. The counter will not make any measurements while the EXT ARM SELECT key is in the ARM ENTRY mode. The EXT ARM SELECT key allows external arming to be enabled or disabled, as determined by the START/STOP ARM status.

- b. When the EXT ARM SELECT key is ON, and the ARM ENTRY mode is enabled:
 1. The key indicator remains ON.
 2. The counter displays, “St” for start arm, “SP” for stop arm, and the current start/stop arm states (see *Figure 3-35*).
 3. The ENTRY light flashes, indicating the arming states may be changed (see *Figure 3-35*).

NOTE

Figure 3-35 shows the EXT ARM SELECT entry mode display, with the START ARM set negative, and the STOP ARM set positive.

4. If neither state is changed, pressing the EXT ARM SELECT key will keep the displayed states in memory (5334A only), and return the counter to the previous mode of operation.
- c. During the ARM ENTRY mode:
 1. The arming states are represented as follows:
 - “ — ” indicates arming is off.
 - “ 7 ” indicates arming set on negative slope.
 - “ ˘ ” indicates arming set on positive slope.

NOTE

The various modes of arming are determined by the status of the START ARM and the STOP ARM. (Refer to Arming Modes, Figure 3-36.)

2. The Input A SLOPE key controls the START ARM (St).
3. The Input B SLOPE key controls the STOP ARM (SP).
4. Pressing either SLOPE key at this time, changes the corresponding arming state.

NOTE

Only the EXT ARM SELECT, START ARM, STOP ARM, and RESET/LOCAL keys are operational. All other front panel keys are non-functional, and will display "Error 2.0", if pressed.

The HP 5334A rear panel contains a Arm Trigger Level potentiometer for adjusting the arming signal trigger level from -4V to +4V. The HP 5334B does not have this type of adjustment; instead the arming signal trigger level is preset to +1.5V.

5. After the desired states have been selected, the EXT ARM SELECT key must be pressed again to record any changes, and return the counter to a measurement mode of operation.
 6. Pressing the RESET/LOCAL key during the ARM ENTRY mode, will immediately exit the entry mode, and return the counter to the previous mode of operation. However, any changes to the arming states will not be recorded.
- d. When external arming is enabled (i.e., either SLOPE key is set to an ON position):
1. The EXT ARM SELECT key LED remains ON.
 2. The ARM light in the display turns ON when the counter is armed to START/STOP a measurement, and waiting for an input signal edge.
 3. Each time the EXT ARM SELECT key is pressed, the ARM ENTRY mode turns on or off, however, the key LED does not turn OFF.
 4. The ARM ENTRY mode operates in the same manner as previously discussed paragraph c.
 5. External arming is disabled by enabling the ARM ENTRY mode, and setting the START ARM and STOP ARM states back to " - " (arming off). The EXT ARM SELECT key must be pressed again to record the status change.

NOTE

The START ARM and STOP ARM must BOTH be set back to ARMING OFF to DISABLE arming.

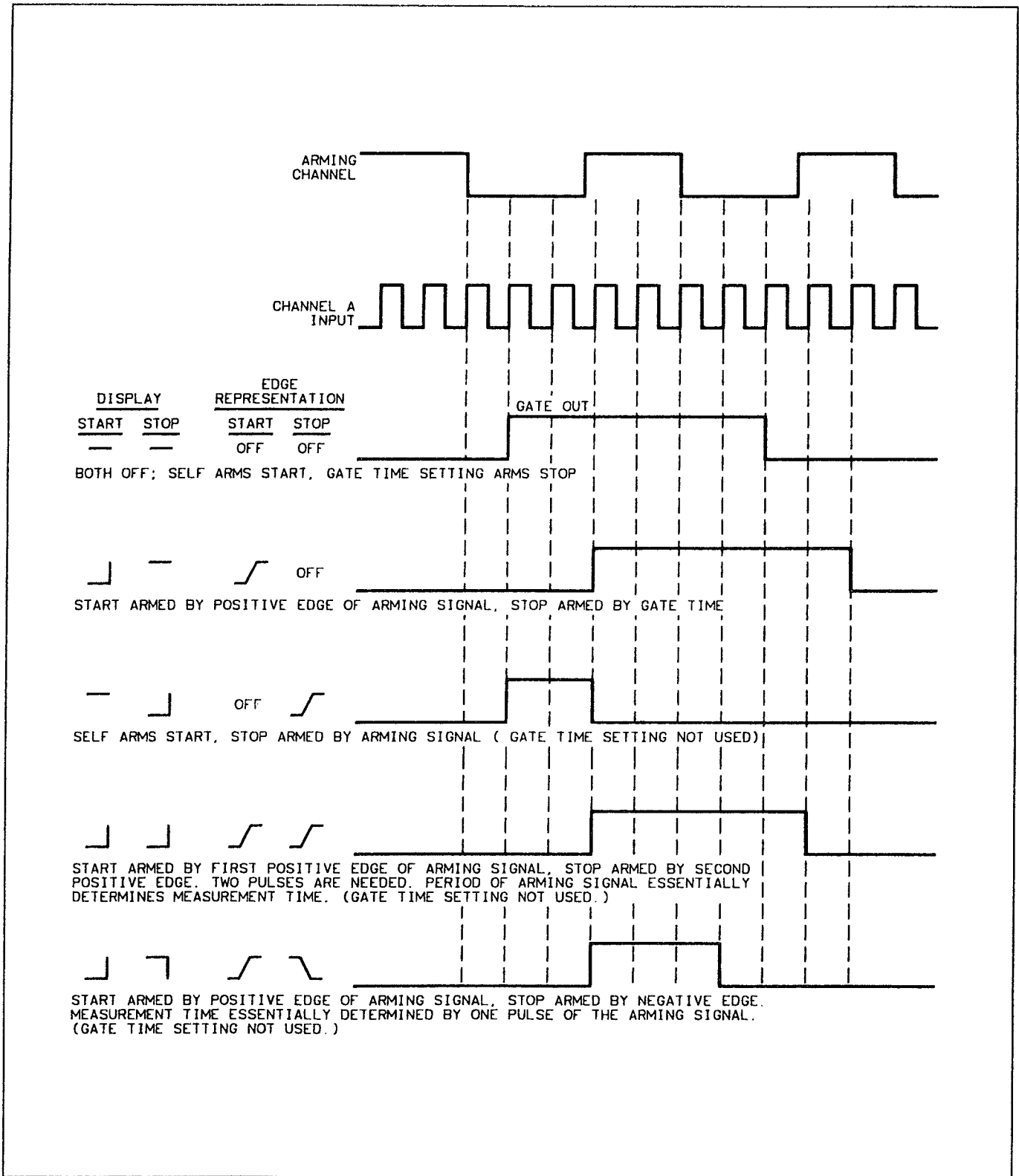

Figure 3-36. Arming Modes

NOTE: If the width of the arming signal is much less than the width of the time interval on the input channel, the gate will start at the first edge on the input channel after the arming signal and extend to the next edge on that input channel.

3-200. INPUT A,B

3-201. BNC connectors are used at the point of entry to connect signals to the corresponding input channels. INPUT A and B are used for all functional modes of operation, except **FREQ C**, and **DVM** (HP 5334A only).

3-202. ARM INPUT

3-203. The ARM INPUT uses a BNC connector at the point of entry for an external arming signal. This input can be used to specify the **START** and/or **STOP** of most measurements.

3-204. INPUT C (Option 030)

3-205. The INPUT C module, as shown in *Figure 3-37* contains the C-Channel input BNC, **SENSITIVITY** control (HP 5334A only), and **PREAMP POWER** jack (HP 5334A only). The input connector is a special fused BNC, HP 5334A only (refer to paragraph 3-235, for fuse replacement instructions). The **SENSITIVITY** control varies the C Channel input sensitivity (refer to specifications, *Table 1-1*). The 5334A's C Channel **PREAMP POWER** jack allows the use of an optional high frequency broadband preamplifier, such as the HP 10855A. Since the 5334B's C Channel does not provide a **PREAMP POWER** jack, an HP 1122A Probe Power Supply may be used. The HP 1122A has the capability to drive up to four HP 10855As. The **GATE TIME** control operates in channel C as it does with channel A or B.

NOTE

The **PREAMP POWER** jack supplies $\approx +15V$ dc and a ground output. This connector will not support a three-wire type power probe.

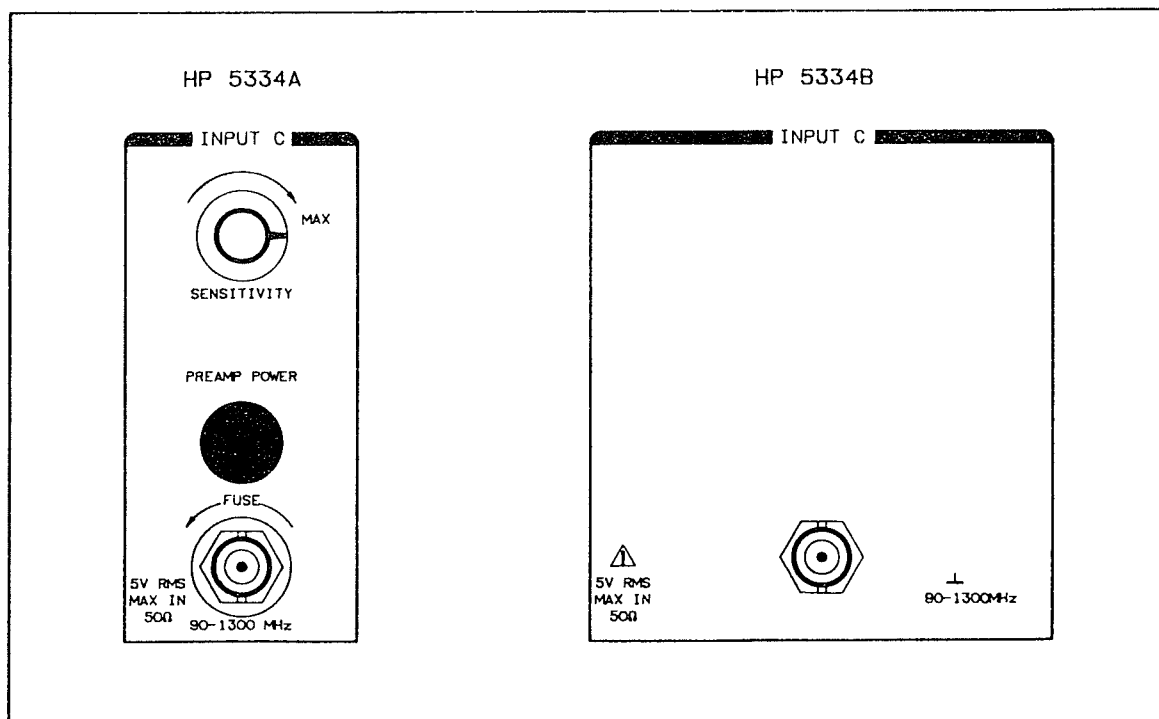
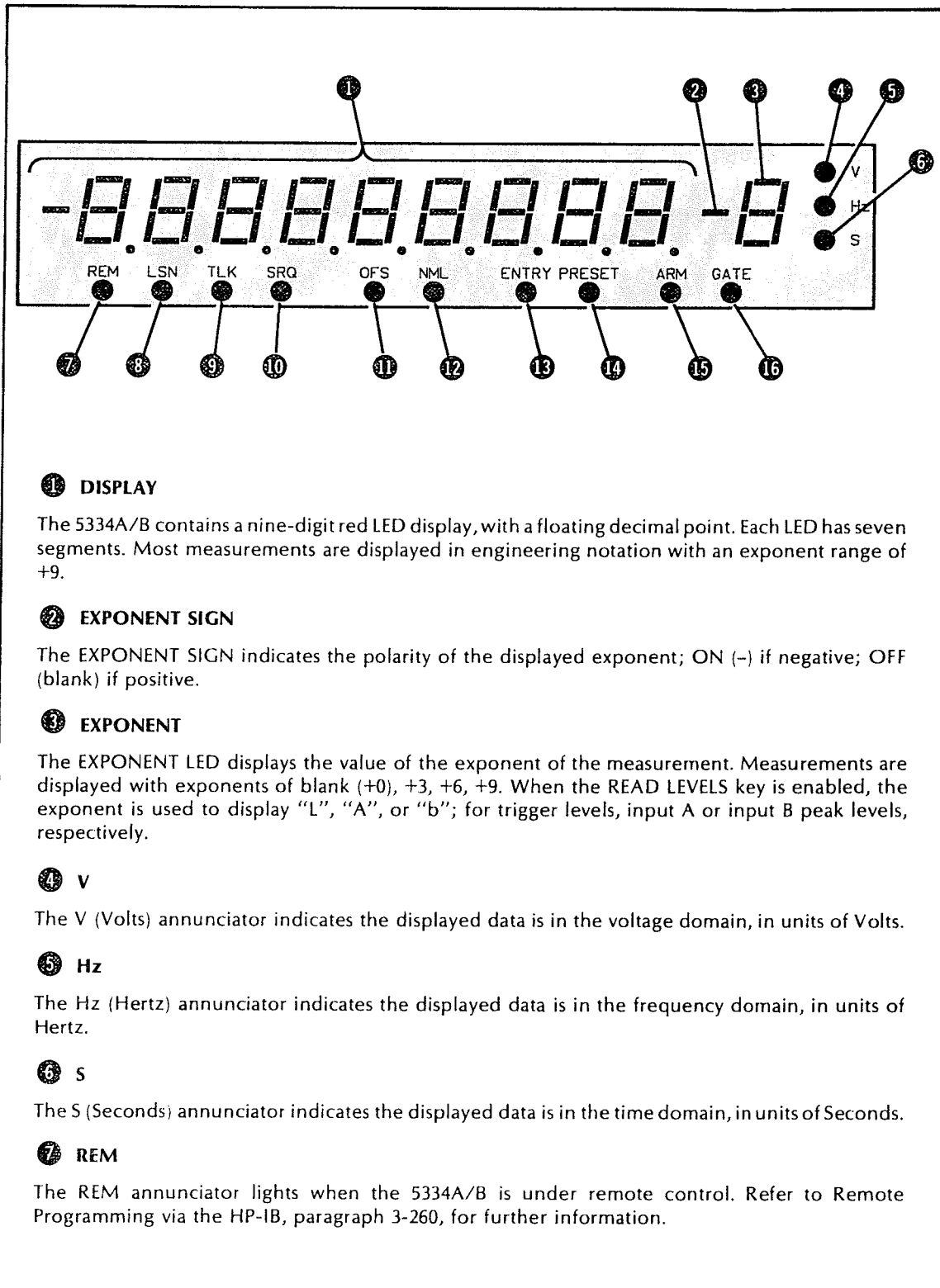

Figure 3-37. HP 5334A and HP 5334B C-Channels

3-206. FRONT PANEL DISPLAY AND ANNUNCIATORS

3-207. The front panel Display and Annunciators are shown and described in *Figure 3-38, Front Panel Display and Annunciators.*



1 DISPLAY

The 5334A/B contains a nine-digit red LED display, with a floating decimal point. Each LED has seven segments. Most measurements are displayed in engineering notation with an exponent range of +9.

2 EXPONENT SIGN

The EXPONENT SIGN indicates the polarity of the displayed exponent; ON (-) if negative; OFF (blank) if positive.

3 EXPONENT

The EXPONENT LED displays the value of the exponent of the measurement. Measurements are displayed with exponents of blank (+0), +3, +6, +9. When the READ LEVELS key is enabled, the exponent is used to display "L", "A", or "b"; for trigger levels, input A or input B peak levels, respectively.

4 V

The V (Volts) annunciator indicates the displayed data is in the voltage domain, in units of Volts.

5 Hz

The Hz (Hertz) annunciator indicates the displayed data is in the frequency domain, in units of Hertz.

6 S

The S (Seconds) annunciator indicates the displayed data is in the time domain, in units of Seconds.

7 REM

The REM annunciator lights when the 5334A/B is under remote control. Refer to Remote Programming via the HP-IB, paragraph 3-260, for further information.

Figure 3-38. Front Panel Display and Annunciators

8 LSN

The LSN annunciator lights when the 5334A/B is addressed to listen. Refer to Remote Programming via the HP-IB, paragraph 3-260, for further information.

9 TLK

The TLK annunciator lights when the 5334A/B is addressed to talk, or when it is being used in the TALK ONLY mode. Refer to Remote Programming via the HP-IB, paragraph 3-260, for further information.

10 SRQ

The SRQ annunciator lights when the 5334A/B sends a service request to the controller in charge of the HP-IB. Refer to Remote Programming via the HP-IB, paragraph 3-260, for further information.

11 OFS

The OFS annunciator lights when the mathematical operation (addition) has been performed on the measurement displayed, other than the default (0 OFFSET); or when the counter is in the math entry mode, indicating an OFFSET value may be entered.

12 NML

The NML annunciator lights when the mathematical operation (division) has been performed on the measurement displayed, other than the default (+1 NORMALIZE); or when the counter is in the math entry mode, indicating a NORMALIZE value may be entered.

13 ENTRY

The ENTRY annunciator flashes when the instrument is in a data entry mode, and is waiting for a user specified constant to be entered. For example, when the MATH SELECT/ENTER, EXT ARM SELECT, MEMORY STORE or RECALL, or the GATE TIME function key is enabled. When an error or fail message is displayed, while in a data entry mode, the ENTRY light remains on steadily.

14 PRESET

The PRESET annunciator lights whenever AUTO TRIG, or the DACS are on (5334A only) and the trigger/sensitivity levels are set internally. The TRIGGER LEVEL/SENS controls are disabled when PRESET is on.

15 ARM

The ARM annunciator lights whenever the counter is externally armed (made ready) to start and/or stop a measurement, and waiting for an input signal edge.

16 GATE

The GATE annunciator shows the status of the counter's gate. Before a measurement starts, this light is off, indicating the gate is closed. During a measurement, the light is on, indicating the gate is open. When the gate duration is ≤ 100 ms, the gate light will remain on for a minimum of ≈ 100 ms.

Figure 3-38. Front Panel Display and Annunciators (Continued)

Option 030

Option 060 with Option 020
DVM Installed.

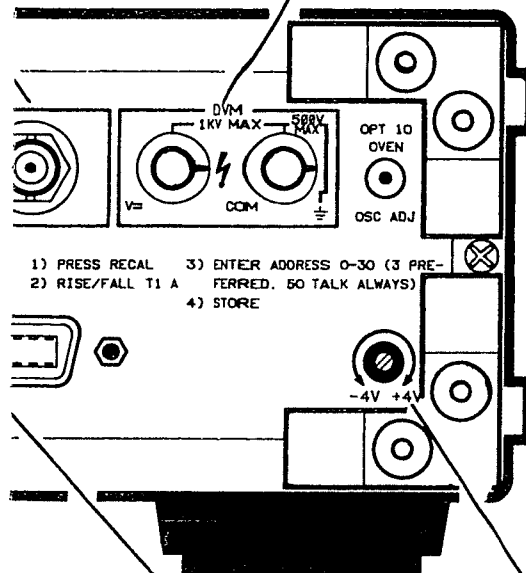

HP-IB Connector.

Arm Trigger
Level Control.

Switch.
Output
Level.

Option 060 with Option 030
C-Channel Installed.

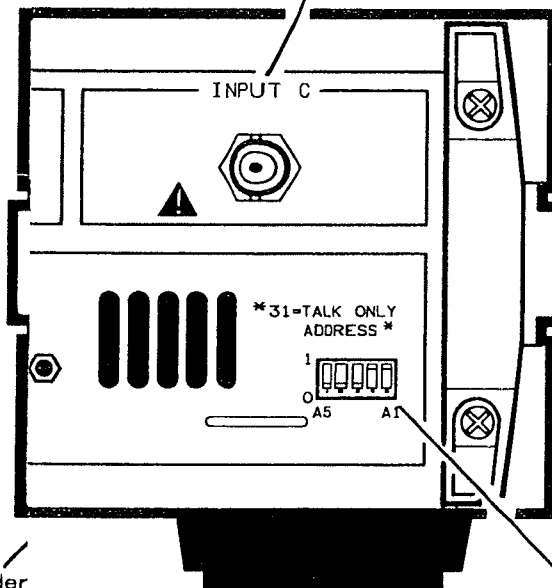

Fuse Holder
Connector.

HP-IB Address Switch.

Figure 3-40. R

Figure 3-39
FRONT PANEL FEATURES, CONTROLS,
INDICATORS, AND CONNECTORS

(See Page 3-39)

 *Figure 3-40*
REAR PANEL FEATURES, CONTROLS, AND CONNECTORS

3-208. REAR PANEL CONTROLS AND CONNECTORS

3-209. A number of signal inputs, outputs, and controls are provided on the rear panel, including the optional rear panel inputs for Channel A, Channel B, Arming, Channel C, and the DMV (HP 5334A only). These features are shown in *Figure 3-40*. The following paragraphs provide a detailed description of the function of each panel feature.

3-210. HP 5334A AC Power Input Module

3-211. The AC Power Module permits operation from 100-, 120-, 220-, or 240-volt ac. The power module contains a printed circuit line voltage selector card, which must be positioned to agree with the voltage of the power source. When the card is plugged into the module, the number visible in the module window indicates the nominal line voltage to which the instrument must be connected. The correct value line fuse must be installed after the card is inserted (see Section II, Line Voltage Requirements, paragraph 2-13, and *Figure 2-1* for more information). The protective grounding conductor connects to the instrument through this module.



ANY INTERRUPTION OF THE PROTECTIVE (GROUNDING) CONDUCTOR, INSIDE OR OUTSIDE THE INSTRUMENT OR DISCONNECTING OF THE PROTECTIVE EARTH TERMINAL WILL CAUSE A POTENTIAL SHOCK HAZARD THAT COULD RESULT IN PERSONAL INJURY AND/OR DAMAGE TO THE INSTRUMENT.

3-212. HP 5334B AC Power Input Circuit

3-213. The AC Power Input Circuit permits operation from 100-, 115-, or 230-volt ac. The ac power circuit contains two slide switches, which must be positioned to agree with the voltage of the power source. The nominal line voltage to which the instrument must be connected is indicated by the illustrated switch setting combinations shown on the rear panel under "LINE SELECT", see *Figure 2-2*.

3-214. GATE OUT Connector (HP 5334A Only)

3-215. GATE OUT is a BNC output connector that permits the activity of the counter's internal gate to be monitored. When the gate is open (indicated by the GATE LED in the Front Panel display) the GATE OUT generates a TTL high. This output can be connected to an oscilloscope to provide a visual indication of when a measurement occurs, or the duration of a measurement.

3-216. TIME BASE IN/OUT Connector

3-217. Time Base IN/OUT is a BNC connector that can be used as an input or output, depending on the position of the Time Base INT/EXT switch. When used as an Output, the connector provides a sine wave signal from the HP 5334A/B internal 10 MHz time base that may be used as a reference for other instruments. If the reference to the HP 5334A/B is provided from another source, the IN/OUT connector can be used as an Input, and will accept a 10 MHz signal.

3-218. TIME BASE ADJ Control

3-219. The Time Base ADJ control allows the adjustment of the internal reference oscillator, without requiring removal of the instrument covers.

3-220. TIME BASE INT/EXT Switch

3-221. The Time Base INT/EXT switch sets the function of the corresponding Time Base IN/OUT connector to either INPUT or OUTPUT mode. When the switch is in the INT (internal) position the connector is in the Output mode; in the EXT (external) position the connector is in the Input mode (to accept an external reference).

3-222. HP-IB Interface Connector

3-223. The HP-IB 24 pin Interface connector is used to convey data and programming information. Refer to paragraph 3-260, Remote Programming Via HP-IB, for further information.

3-224. Arm Trigger Level Control (HP 5334A Only)

3-225. The ARM TRIGGER LEVEL control allows the adjustment of the arming signal trigger level from -4V to +4V. This control simultaneously adjusts the trigger level for both the START ARM and the STOP ARM; they cannot be adjusted independently.

3-226. Rear Panel INPUT Connectors (Option 060)

3-227. Front and Rear Panel PARALLEL inputs are provided for Channels A, B, and Arming. This offers the convenience of connecting signals to these inputs through either the front or rear panel. Only rear panel input are provided for Channel C, and/or the DVM, for instruments that have one or both of these options. BNC connectors are used at the point of entry to connect signals to the corresponding inputs.

3-228. All Optional rear panel inputs are used for the same functional modes of operation as the front panel inputs. All signal conditioning, gate math/memory, and function controls for these inputs remain on the front panel.

3-229. Option 010 Oven Oscillator Control (HP 5334A Only)

3-230. A hole is provided on the rear panel of the HP 5334A to allow external fine adjustment of the Option 010 Oven Oscillator (10811), as shown in *Figure 3-40*.

3-231. Address Switch (HP 5334B Only)

3-232. The HP 5334B is equipped with an HP-IB Address switch, located in the rear panel, as shown in *Figure 3-40*. The instrument's HP-IB address is set to "03" at the factory but can be set by the user to addresses "00" to "30". Refer to paragraph 3-284 for further details on HP-IB address setting of the 5334B.

3-233. OPERATOR'S MAINTENANCE

3-234. The only maintenance the operator should normally perform is replacement of the primary power fuse (when necessary) located within the AC Power Module. For instructions on how to change the fuse, refer to Section II, Line Voltage and Fuse Selection.



For continued protection from fire hazards, be sure that only slow-blow type fuses with the required current and voltage ratings are used for replacement. Do not use repaired fuses or short-circuited fuse-holders.

3-235. Replacing C-Channel Fuse (HP 5334A only)

3-236. When Option 030 C-Channel is installed, the operator may be required to replace the C-Channel input BNC fuse. This is a 1/8A fuse (HP Part Number 2110-0301) which is located within the INPUT C BNC connector (see *Figure 3-41* for details). To replace the fuse:

- a. Disconnect the power cord.
- b. Unscrew the special BNC barrel (HP Part Number 05305-60205).
- c. With needle-nose pliers, remove and replace the fuse.
- d. Reinstall the BNC barrel, and tighten using a BNC cable connector —Be careful not to overtighten.

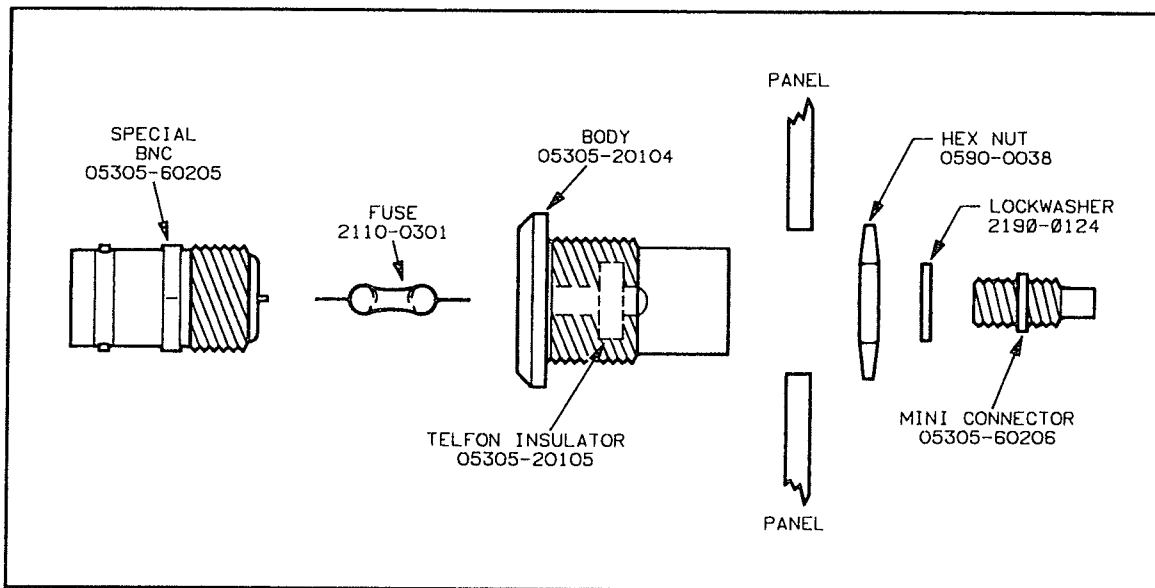

Figure 3-41. Details of INPUT C BNC Connector and Fuse Mounting (5334A Only)

3-237. Power-Up/Warm-up

3-238. The HP 5334A/B has a two-position power switch, STANDBY and ON. For the HP 5334A/B Option 010 High Stability Time Base, it is important that the instrument remain connected to the power source in the STANDBY mode when not in use. This supplies power to the standby LED, and to the crystal oscillator oven, maintaining a constant oven temperature, thus eliminating the need for a warm-up period. When the STANDBY mode is not used, and power is disconnected from the instrument, allow 30 minutes from the application of external power in the ON mode for the instrument (crystal oven) to warm-up.

WARNING

POWER IS ALWAYS PRESENT AT THE LINE SWITCH (STANDBY LED) AND TRANSFORMER, AND UNREGULATED DC IS PRESENT WHENEVER THE LINE CORD IS CONNECTED TO THE POWER SOURCE. DISCONNECTING THE POWER CORD IS NECESSARY TO REMOVE ALL POWER FROM THE INSTRUMENT.

3-239. The HP 5334A is provided with an internal battery, for front panel continuous memory (this feature is not available for the HP 5334B). The battery is recharged only when the POWER key is in the ON position.

3-240. OPERATOR'S CHECKS

3-241. The following procedures will verify the basic operation of the HP 5334A/B Universal Counter. These checks are not intended to verify the overall accuracy or performance specifications of the instrument. They should, however, provide the operator with a quick method of determining that the counter is operating properly. Operator's checks are provided in two levels (The operator should perform both tests):

- a. Power-up Self-check.
- b. Diagnostic Sequence.



Before switching on the instrument, ensure the following:

1. **The transformer primary is matched to the available line voltage, paragraph 3-210 (HP 5334A) or paragraph 3-212 (HP 5334B).**
2. **The correct fuse is installed, paragraph 3-233.**
3. **All safety precautions and warnings have been observed, Section I and II.**

3-242. Power-Up Self-Check

3-243. To perform the Power-Up Self-Check after the HP 5334A/B has been turned ON, cycle the POWER switch to STANDBY, then back to ON. When the POWER is cycled back ON, an internal check is made of the display, and the microprocessors and related circuitry. During this cycle, all front panel display segments and indicators will light momentarily, followed by the momentary display of the instrument model number, then the momentary display of the instrument's decimal HP-IB address (e.g., Addr 03). The ARM and GATE lights will toggle back and forth, followed by the momentary display of the "PASS" message, when all tests have successfully completed, as shown in *Figure 3-42*.

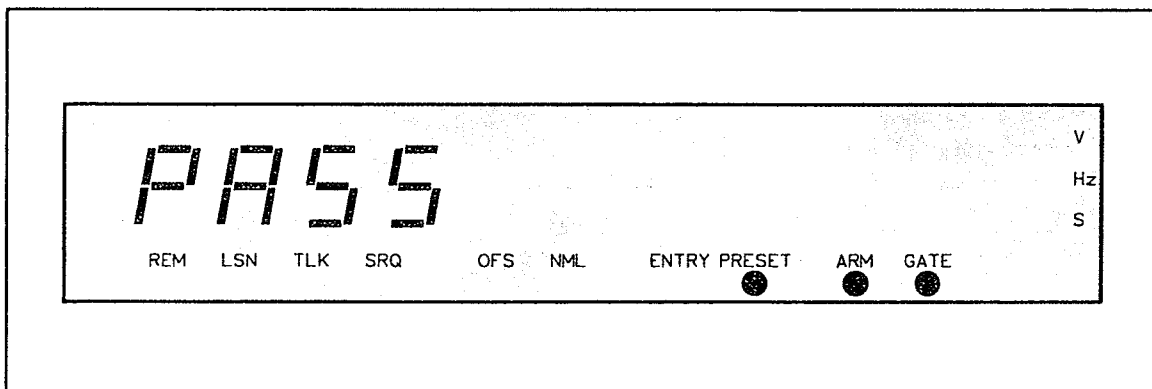

Figure 3-42. Self-Check PASS Display

3-244. After the power-up sequence, the counter will initialize itself. All gate, math/memory, and input signal conditioning keys will be OFF; the function will be **FREQ A**, with **AUTO TRIG** and auto-attenuation **ON**, and the gate time setting at 300 milliseconds; math offset value will be set at +0, and normalize at +1; internal trigger levels controls will be set at 0 volts, and dACS will be OFF.

3-245. Any failures during the power-up cycle will produce a display of a numbered error or fail message. Fail messages generally indicate a hardware failure within the HP 5334A/B, and error messages indicate the user has attempted a disallowed operation or key sequence. If a fail message is displayed, press the **RESET** key to clear the display, and return the counter to the next test in the power-up sequence. Refer to Error Indications, paragraph 3-252, and *Tables 3-3 and 3-4*.

3-246. Diagnostic Sequence

3-247. The Diagnostic Sequence is a continuous cycle which will repeat until manually reset. During the Diagnostic Sequence an internal check is made of several major components, including the microprocessors and related circuitry, such as:

- a. Executive, Measurement, and HP-IB Microprocessor ROMs and RAMs.
- b. Communication between the Executive and HP-IB Microprocessors, and between the Executive and Measurement Microprocessors.
- c. Front Panel Display.
- d. The HP-IB Address is read from the CMOS RAM and verified.
- e. MRC Registers.

3-248. When all tests have successfully completed the HP 5334A/B will display a "PASS" message. If an **ERROR** or **FAIL** message is displayed, during the test cycle, press the **RESET** key to clear the display; and return the counter to the next test in the Diagnostic Sequence. Refer to Error Indications, paragraph 3-252, and *Tables 3-3 and 3-4*.

3-249. To perform the Diagnostic Sequence, cycle the **POWER** key to **STANDBY** and back to **ON**, while pressing the **RESET** key (press both these keys simultaneously). Hold the **RESET** key until the "diag" message is displayed. Verify, during this cycle, all front panel display segments and indicators turn **ON** and **OFF** momentarily, except **STANDBY**, and the **A** and **B** **INPUT** trigger lights, as shown in *Figure 3-43*. The **ARM** and **GATE** lights toggle back and forth during the display of the "PASS" message, if all tests have successfully completed. The momentary display of the "diag" message is then repeated. To exit the Diagnostic Sequence, recycle the **POWER** switch to **STANDBY** and back to **ON**.

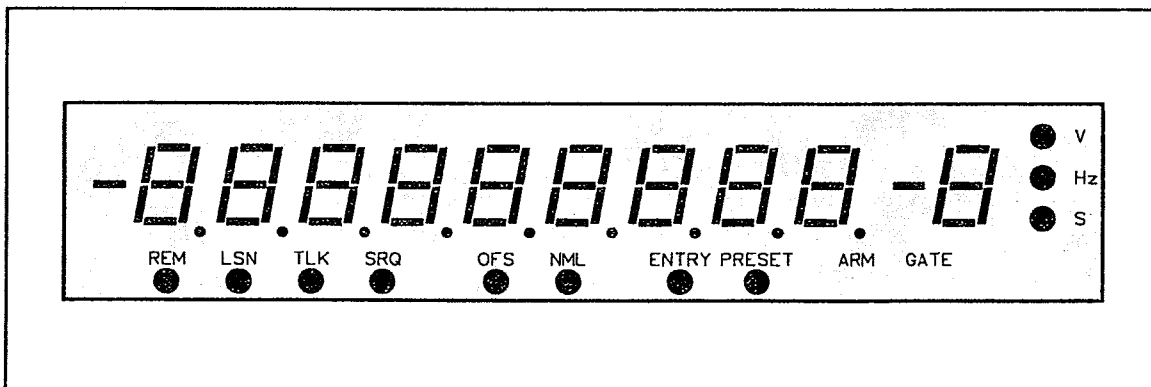

Figure 3-43. Display Check

3-250. PRESET AND LOCKOUT CONDITIONS

3-251. As each HP 5334A/B front panel key is pressed, various parameter settings are controlled internally. These are referred to as Preset and Lockout conditions. The Preset conditions are the parameters and/or key settings that are enabled on initial selection of each key. The Lockout conditions are the parameters and/or key settings that are disallowed after initial selection of each key. Attempting to perform a disallowed key stroke, or key sequence, in a given mode of operation, will produce a displayed error message. Error Messages are described in paragraph 3-252. Preset and Lockout condition are listed in *Table 3-2*.

Table 3-2. Preset and Lockout Conditions

MODE	PRESET CONDITIONS		LOCKOUT CONDITIONS
	PARAMETER	SETTING	SETTING
RISE/FALL TIME A	SINGLE CYCLE	OFF	none
	100-GATE AVERAGE	OFF	none
	EXT ARM SELECT	OFF	none
	MATH DISABLE	ON	none
	AUTO TRIG	ON	OFF
	X10 ATTN controlled by AUTO TRIG		ON/ OFF
	SENS	OFF	ON
	DACS (5334A only)	OFF	ON
	COM A *	ON	OFF
	INPUT B SLOPE controlled by INPUT A		+SLOPE/ -SLOPE
INPUT B COUPLING controlled by INPUT A		AC/ (DC)	
INPUT B IMPEDANCE controlled by INPUT A		50Ω Z/ (1MΩ Z)	
	FILTER A	OFF	ON
	*NOTE INPUT B SLOPE, COUPLING, and IMPEDANCE are set to corresponding INPUT A settings via COM A.		
DVM (Voltage) (HP 5334A only)	SINGLE CYCLE	OFF	ON
	100-GATE AVERAGE	OFF	ON
	EXT ARM SELECT disallowed in DVM mode		ON/ OFF
	MATH DISABLE	ON	none
	AUTO TRIG	OFF	ON
	GATE TIME ENTRY (100 ms) controlled by DVM		ON
TRIGGER LEVELS	SINGLE CYCLE	OFF	none
	100-GATE AVERAGE	OFF	ON
	EXT ARM SELECT disallowed in TRIG LEVEL		ON/ OFF
READ LEVELS	MATH DISABLE	ON	OFF
	AUTO TRIG	OFF	ON
	GATE TIME ENTRY disallowed in TRIG LEVEL		ON

Table 3-2. Preset and Lockout Conditions (Continued)

MODE	PRESET CONDITIONS		LOCKOUT CONDITIONS
	PARAMETER	SETTING	SETTING
A,B PEAK VOLTAGE	SINGLE CYCLE	OFF	none
	100-GATE AVERAGE	OFF	ON
	EXT ARM SELECT disallowed in PEAK LEVEL		ON/ OFF
READ LEVELS	MATH DISABLE	ON	OFF
	AUTO TRIG	ON	OFF
	X10 ATTN controlled by AUTO TRIG		ON/ OFF
	SENS	OFF	ON
	DACS (5334A only) GATE TIME ENTRY disallowed in PEAK LEVEL	OFF	ON ON
AUTO TRIG (ON)	X10 ATTN controlled by AUTO TRIG		ON/ OFF
	SENS	OFF	none
	Note, if SENS is turned ON, AUTO TRIG is turned OFF.		
	DACS (5334A only)	OFF	none
	Note, if DACS are turned ON, AUTO TRIG is turned OFF.		
	TRIGGER (set internally)		(controls disabled)
	LEVEL/SENS		
COM A (ON)	AC/ INPUT B coupling controlled by INPUT A		ON/ OFF
	DC		ON/ OFF
	50Ω Z/INPUT B impedance controlled by INPUT A (1 MΩ Z)		
SENS (ON)	AUTO TRIG	OFF	none
	Note, if AUTO TRIG is turned ON, SENS is turned OFF.		
DACS (ON) (5334A only)	AUTO TRIG	OFF AU0	none
	Note, if AUTO TRIG is turned ON, DACS are turned OFF.		
	TRIGGER (set internally)		(controls disabled)
	LEVEL/SENS		

3-252. ERROR INDICATIONS

3-253. Under certain conditions the HP 5334A/B will display either an Error or a Fail message. These messages typically occur during the Power-Up cycle, as shown in *Figures 3-44* and *3-45*. The fail messages generally indicate a hardware related problem. Error messages usually indicate that the user has attempted a disallowed operation or incorrect sequence, either through the keyboard or the HP-IB. *Table 3-3* lists the Error Messages, and *Table 3-4* lists the Fail Messages.

3-254. Error messages 1.0 to 2.4, as shown in *Figure 3-45*, are displayed momentarily and automatically cleared, when the counter is in local operation. Error messages 4.0 to 4.4 are only generated in remote operation. Refer to paragraph 3-352 for details on HP-IB Error Handling. Error messages 5.0X to 5.2, and Fail messages may be cleared by pressing the RESET/LOCAL key. All keys are disabled when a fail message or an error message 5.0X through 5.2 is displayed, except RESET/LOCAL and POWER. If a displayed Error or Fail message cannot be cleared, refer to the troubleshooting information in Section VIII of the Service Manual.

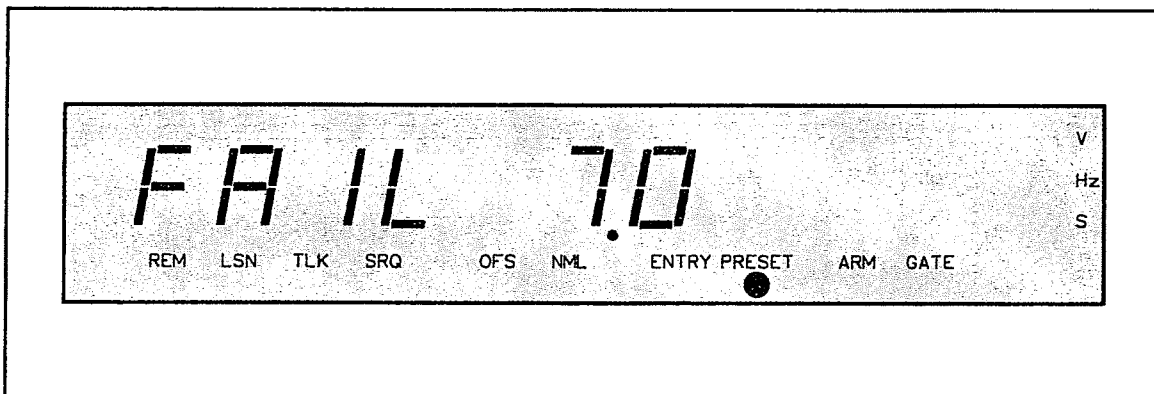

Figure 3-44. FAIL Message Display

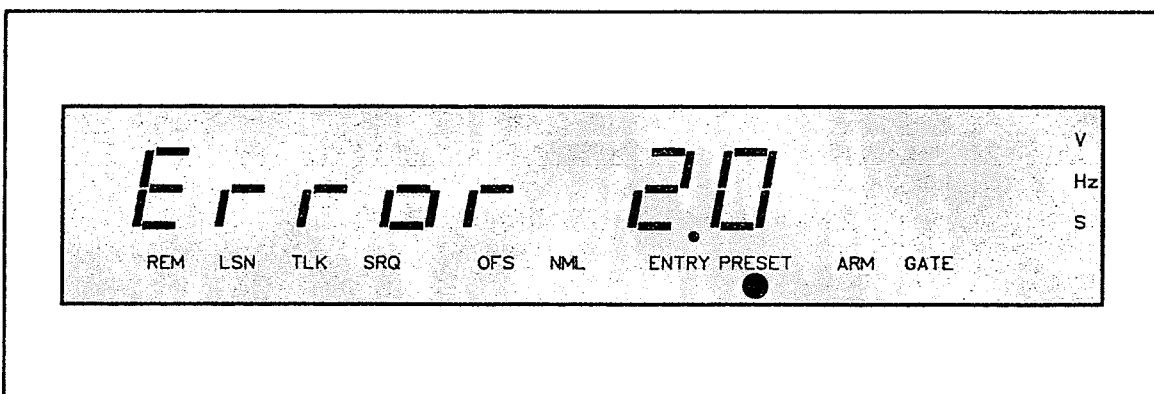

Figure 3-45. Error Message Display

Table 3-3. Error Messages

TYPE	DISPLAY	MESSAGE DESCRIPTION
FRONT PANEL SETUP	0.0	No Error (used via HP-IB only)
	1.0	Parameter disallowed in present mode
	1.1	Attenuators controlled by AUTO TRIG
	1.2	50-ohm B, AC B settings preset by COM A
	1.3	Slope B set by Slope A in Rise/Fall mode
	1.4	Parameter disallowed in High Speed mode (HP-IB)
DATA ENTRY	1.5	Calibration data unaccessible in present mode (HP-IB)
	2.0	Invalid key entry
	2.1	Data outside valid range
	2.2	Data exceeds maximum resolution
	2.3	Mantissa digit buffer full
KEYBOARD	2.4	Decimal point previously entered
	3.0	Multiple key closures
HP-IB PROGRAMMING	4.0	Mnemonic not recognizable
	4.1	Numeric syntax error
	4.2	Alpha character expected
	4.3	Data exceeds valid range
	4.4	Attention (ATN) asserted in Talk-Only mode
SETUP MEMORY (5334A only)	5.0X	Store instrument setup operation failed (X = register number: 0-9)
	5.1X	Recall instrument setup operation failed (X = register number: 0-9)
	5.2	HP-IB address cannot be recalled at power-up; address defaults to 03

Table 3-4. Failure Messages

TYPE	DISPLAY	MESSAGE DESCRIPTION
EXECUTIVE PROCESSOR	6.0	Internal ROM (U19) failure
	6.1	Internal RAM (U19) failure
MEASUREMENT PROCESSOR, MRC	7.0	Internal ROM (U29)
	7.1	MRC (U20) register problem (E≠T or E=T=0)
	7.2	(U29) I/O Port 5 failure
	7.3	(U29) I/O Port 1 failure
	7.4	(U29) I/O Port 0 failure
HP-IB PROCESSOR	7.5	(U29) I/O Port 4 failure
	8.0	ROM (U17) failure
PROCESSOR DATA COMMUNICATIONS	8.1	ROM (U17) failure
	9.0	Executive Processor (U19) not responding
	9.1	Measurement Processor (U29) not responding
	9.2	HP-IB Processor (U17) not responding
	9.3	Exec/Meas CPU data communications failure
9.4	Inter-processor handshake failure	

NOTE

For the remote control of the TOTALIZE function with external arming, you must set the external arm **after** FN9, the TOTALIZE START command.

Example: OUTPUT 703; "FN9, XA1, XA0"

↑
Measurement Starts Here

3-255. ERROR EXAMPLES

3-256. The following paragraphs demonstrate several key sequences that will produce an Error Message, and include an explanation of the message displayed.

- a. Press |RISE/FALL TIME A| function key:
 1. Press |COM A| or |AUTO TRIG|
DISPLAY: Error 1.0
CAUSE: COM A and AUTO TRIG cannot be disabled in RISE/FALL TIME mode.
 2. Press |X10 ATTN|
DISPLAY: Error 1.1
CAUSE: Attenuation is controlled by AUTO TRIG.
 3. Press INPUT B |50Ω Z| OR |AC|
DISPLAY: Error 1.2
CAUSE: INPUT B impedance and coupling are controlled by corresponding INPUT A key settings, via COM A.
 4. Press INPUT B |SLOPE|
DISPLAY: Error 1.3
CAUSE: INPUT A SLOPE determines whether RISE or FALL TIME is measured, and sets the INPUT B SLOPE accordingly.

- b. Press |GATE TIME| key, to enable data entry mode:
 1. Press |SINGLE CYCLE| key.
DISPLAY: Error 2.0
CAUSE: Only RESET/LOCAL, GATE TIME, and FUNCTION/DATA keys are operational during GATE TIME ENTRY. All other keys are nonfunctional.

2. Press | 9 |, | 9 |, | 9 |, | **CHS/EEX** |, | 9 |

Press | **GATE TIME** |
DISPLAY: Error 2.1
CAUSE: Gate time may be set from 1 ms to 99.999 s; 9,999E+9 exceeds the valid gate time range.
RESULT: Gate time will default to previous setting, and allow reentry.
 3. Press | 4 |, | 5 |, | 6 |, | **CHS/EEX** |, | 5 |

Press | **GATE TIME** |
DISPLAY: Error 2.2
CAUSE: Gate time cannot be set at increments less than 1 ms; 4.56 ms (456E-5) exceeds maximum resolution.
RESULT: Digits that exceed the maximum resolution (.56), will be truncated to display: "400.-5", and allow reentry. Small zeroes represent non-significant digits.
 4. Press | 9 |, | 9 |, | 9 |, | 9 |, | 9 |, | 9 |, | 9 |, | 9 |, | 9 |, | 9 |
DISPLAY: Error 2.3
CAUSE: Display buffer cannot accept more than nine digits.

Press | **GATE TIME** |
DISPLAY: Error 2.1 (See step b, 2)
RESULT: Gate time will default to previous setting, and allow reentry.
 5. Press | 9 |, | . |, | 9 |, | . |
DISPLAY: Error 2.4
RESULT: counter will redisplay 9.9 s, and allow reentry.
 6. Press | **FREQ A** | and | **FREQ B** | simultaneously.
DISPLAY: Error 3.0
CAUSE: May result if more than one key is pressed at a time; or if a key sticks, and another is pressed.
 7. Press | **RESET/LOCAL** | key to exit GATE TIME ENTRY mode.
- c. The following example (applies to HP 5334A only) may result, if a valid 5334A front panel setup is not stored in the selected register; or if the recall operation cannot be completed due to a hardware failure.
1. Press | **RECALL** | memory key.
 2. Press any digit; i. e., 8.
DISPLAY: Error 5.18
CAUSE: Recall operation cannot be completed (i.e., no front panel setup stored at selected register).

NOTE

If Error 5.1X results, try storing a front panel setup, to determine whether it is due to a hardware failure. Refer to paragraph 3-252, Error Indications.

3-257. DETAILED OPERATING INSTRUCTIONS

3-258. The following paragraphs provide detailed operating instructions for the various functions of the instrument. Step-by-step procedures are included in tabular form to allow you to become familiar with all of the basic functions. For further information on operating the HP 5334A/B, refer to the following:

- a. Detailed description of the performance, and function of the counter's signal conditioning and input controls (such as, sensitivity, coupling selection, trigger level control, impedance selection, and attenuation), paragraph 3-11, Input Characteristics and Signal Conditioning.
- b. Detailed description of how the HP 5334A/B performs in each measurement mode, and application of the input signal conditioning controls within each measurement mode, paragraph 3-51, How to Make Measurements.
- c. Overall description of the performance of the counter's display, keyboard, front panel memory, gate time selection, time base, and auxiliary features, paragraph 3-92, Front Panel Controls, Indicators, and Connectors.
- d. Detailed description of the operation, and function of each front panel key, control, and feature, paragraph 3-92, Front Panel Controls, Indicators, and Connectors.
- e. Detailed description of the operation, and function of each rear panel feature, paragraph 3-208, Rear Panel Controls and Connectors.
- f. Detailed operating procedures for each measurement mode, *Figures 3-46 through 3-60*.

3-259. Within each specific measurement mode (e.g., *FREQ A*, *PERIOD A*), a considerable amount of flexibility is present for both the type of input signal and measurement technique. The intent of the following figures and text is to provide instructional procedures for each major functional mode. These operating guidelines should assist in making the most useful and accurate measurement possible.

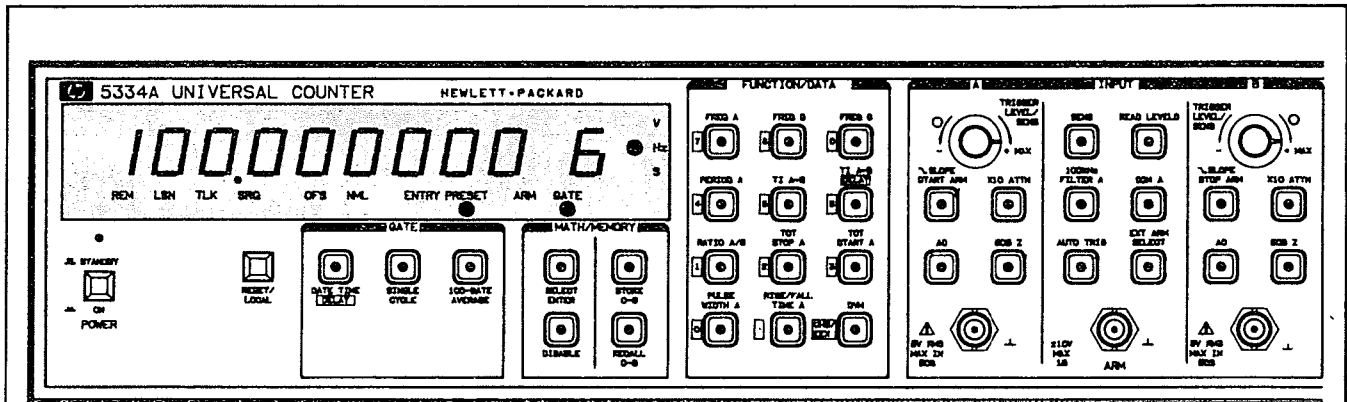

NOTE

For specifications concerning bandwidth, accuracy, and amplitude on input signals, refer to *Table 1-1*.

1. Press POWER switch to ON position.
2. Press COM A key to (SEPARATE) position (LED OFF) for separate inputs; COMMON position (LED ON) for common inputs.
3. Connect signal to INPUT A or INPUT B jack.
4. Press corresponding function key (FREQ A, FREQ B).
5. Press AC/(DC), 50Ω Z/(1MΩ), and SLOPE keys to appropriate positions.
6. Press SENS key to SENSITIVITY position (LED ON); rotate TRIGGER LEVEL/SENS control fully ccw. This sets the trigger level at 0 volts (nominally) and sensitivity to minimum.
7. Adjust TRIGGER LEVEL/SENS control in a clockwise direction until a stable measurement is displayed.
8. Adjust GATE TIME setting for preferred resolution. Gate time is displayed by pressing the GATE TIME key. Setting selection is entered from the keyboard, by pressing appropriate FUNCTION/DATA keys, while GATE TIME key is enabled (LED ON). Be sure to press GATE TIME key again to store selected setting in memory, and return to frequency measurement mode. Refer to GATE TIME/DELAY, paragraph 3-107.
9. To manually adjust TRIGGER LEVEL, turn AUTO TRIG off (LED OFF), and press SENS key to TRIGGER LEVEL position (LED OFF). Adjust TRIGGER LEVEL/SENS control to optimum trigger point, usually midrange over which trigger light flashes. NOTE, when AUTO TRIG is off, appropriate attenuation must be selected manually, and sensitivity is set to maximum.

PRESET AND LOCKOUT CONDITIONS

Preset conditions on initial selection of FREQ A, FREQ B:			Lockout conditions during FREQ A, FREQ B mode:	
MODE	SETTING	EQUIVALENT HP-IB COMMAND	SETTING	EQUIVALENT HP-IB COMMAND
SINGLE CYCLE	OFF	G50	no lockout	
100-GATE AVERAGE	OFF	GV0	no lockout	
EXT ARM SELECT	OFF	XA2, XO2	no lockout	
MATH DISABLE	ON	MD1	no lockout	

Figure 3-46. Frequency Measurements

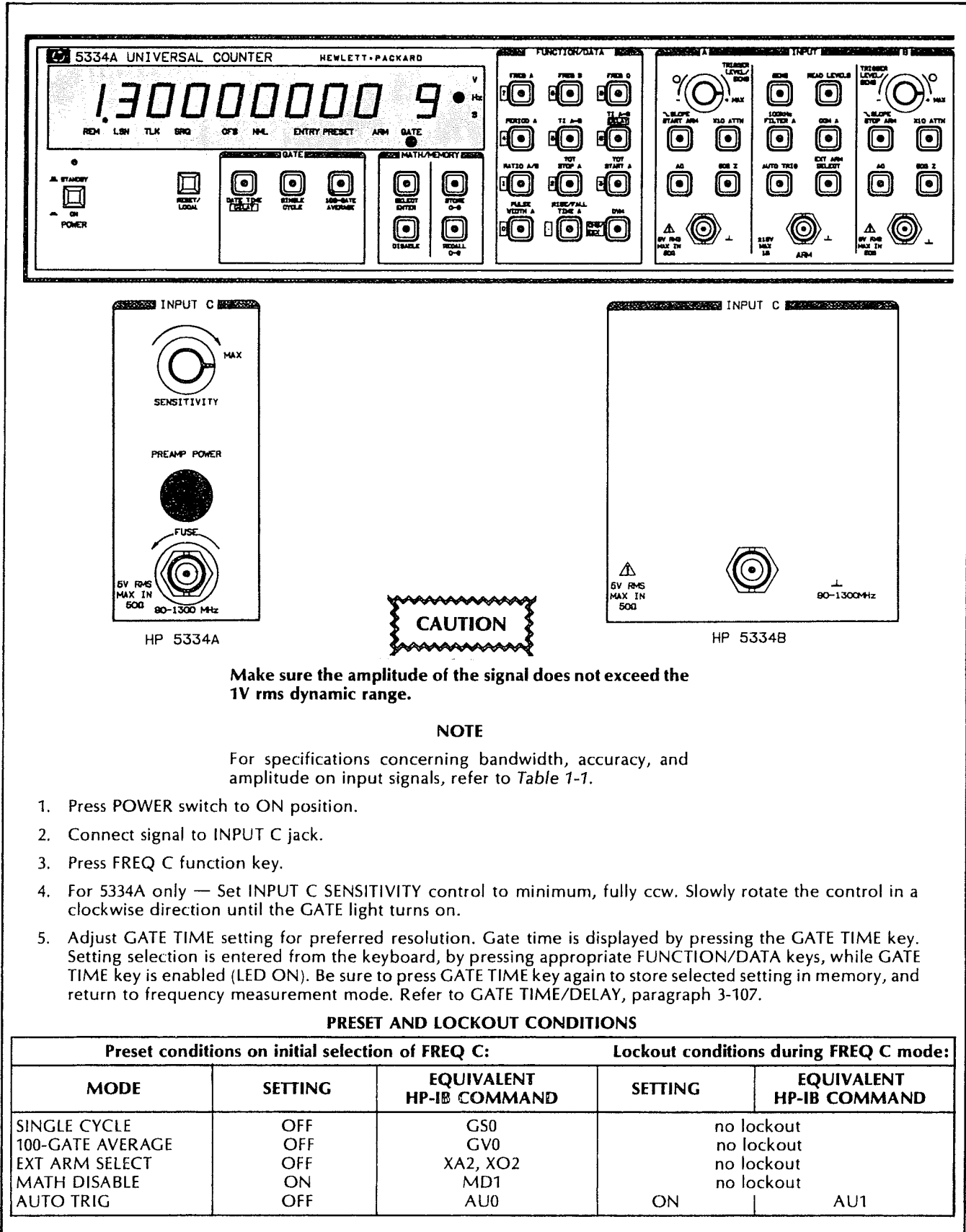
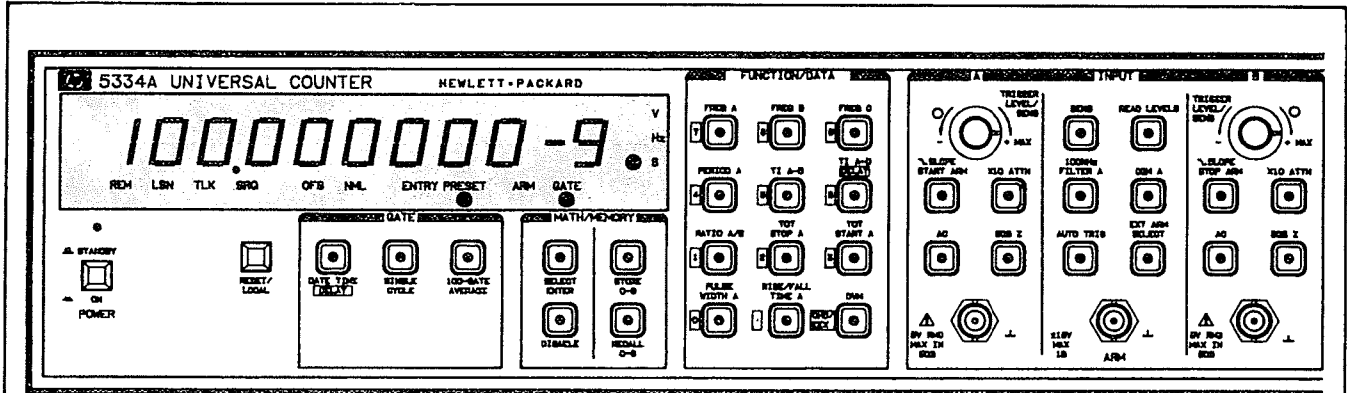

Figure 3-47. Frequency C Measurements



NOTE

For specifications concerning bandwidth, accuracy, and amplitude on input signals, refer to *Table 1-1*.

1. Press POWER switch to ON position.
2. Press COM A key to (SEPARATE) position (LED OFF).
3. Connect signal to INPUT A jack.
4. Press PERIOD A function key.
5. Set AC/(DC), 50Ω Z/(1MΩ), and SLOPE keys to appropriate positions.
6. Press SENS key to SENSITIVITY position (LED ON); rotate TRIGGER LEVEL/SENS control fully ccw. This sets the trigger level at 0 volts (nominally) and sensitivity to minimum.
7. Adjust TRIGGER LEVEL/SENS control in a clockwise direction until a stable measurement is displayed.
8. Adjust GATE TIME setting for preferred resolution. Gate time is displayed by pressing the GATE TIME key. Setting selection is entered from the keyboard, by pressing appropriate FUNCTION/DATA keys, while GATE TIME key is enabled (LED ON). Be sure to press GATE TIME key again to store selected setting in memory, and return to period measurement mode. Refer to GATE TIME/DELAY, paragraph 3-107.
9. To manually adjust TRIGGER LEVEL, turn AUTO TRIG off (LED OFF), and press SENS key to (TRIGGER LEVEL) position (LED OFF). Adjust TRIGGER LEVEL/SENS control to optimum trigger point, usually midrange over which trigger light flashes. NOTE, when AUTO TRIG is off, appropriate ATTN must be selected manually.

PRESET AND LOCKOUT CONDITIONS

Preset conditions on initial selection of PERIOD A:			Lockout conditions during PERIOD A mode:	
MODE	SETTING	EQUIVALENT HP-IB COMMAND	SETTING	EQUIVALENT HP-IB COMMAND
SINGLE CYCLE	OFF	GS0	no lockout	
100-GATE AVERAGE	OFF	GV0	no lockout	
EXT ARM SELECT	OFF	XA2, XO2	no lockout	
MATH DISABLE	ON	MD1	no lockout	

Figure 3-48. Period Measurements

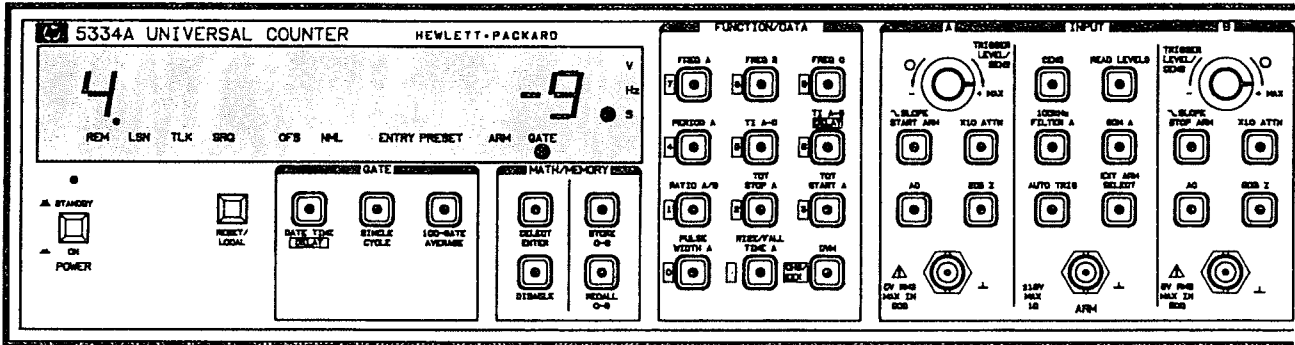

NOTE

For specifications concerning bandwidth, accuracy, and amplitude on input signals, refer to Table 1-1.

1. Press POWER switch to ON position.
2. If Start and Stop signals are from separate sources, connect Start signal to INPUT A jack, Stop signal to INPUT B jack, and press COM A key to (SEPARATE) position (LED OFF). If Start and Stop signals are from a common source, connect signal to INPUT A jack, and press COM A key to COMMON position (LED ON).
3. Press T.I. A→B function key, and press AUTO TRIG off.
4. Press AC/(DC), 50Ω Z/(1MΩ), SLOPE, and X10 ATTN keys to appropriate positions.

NOTE

When the COM A key is in COMMON (LED ON), only the A CHANNEL AC/(DC), and 50 Z/(1M) keys are effective. However, X10(X1) ATTN, SLOPE, and TRIGGER LEVEL/SENS controls operate independently.

5. Press SENS key to (TRIGGER LEVEL) position (LED OFF). This sets the sensitivity to maximum, and allows variable selection of trigger levels.
6. Adjust TRIGGER LEVEL/SENS controls for optimum triggering, usually midrange over which trigger lights flash. Use READ LEVELS to adjust for specific trigger level voltages.
7. Adjust GATE TIME setting for preferred sample rate. Gate time is displayed by pressing the GATE TIME key. Setting selection is entered from the keyboard, by pressing appropriate FUNCTION/DATA keys, while GATE TIME key is enabled (LED ON). Be sure to press GATE TIME key again to store selected setting in memory, and return to time interval measurement mode. Refer to GATE TIME/DELAY, paragraph 3-107.

NOTE

The first measurement is not displayed until the gate time delay has elapsed.

PRESET AND LOCKOUT CONDITIONS

Preset conditions on initial selection of T.I. A→B:			Lockout conditions during TIME INTERVAL mode:	
MODE	SETTING	EQUIVALENT HP-IB COMMAND	SETTING	EQUIVALENT HP-IB COMMAND
SINGLE CYCLE	OFF	GS0		no lockout
100-GATE AVERAGE	OFF	GV0		no lockout
EXT ARM SELECT	OFF	XA2, XO2		no lockout
MATH DISABLE	ON	MD1		no lockout

Figure 3-49. Time Interval Measurements

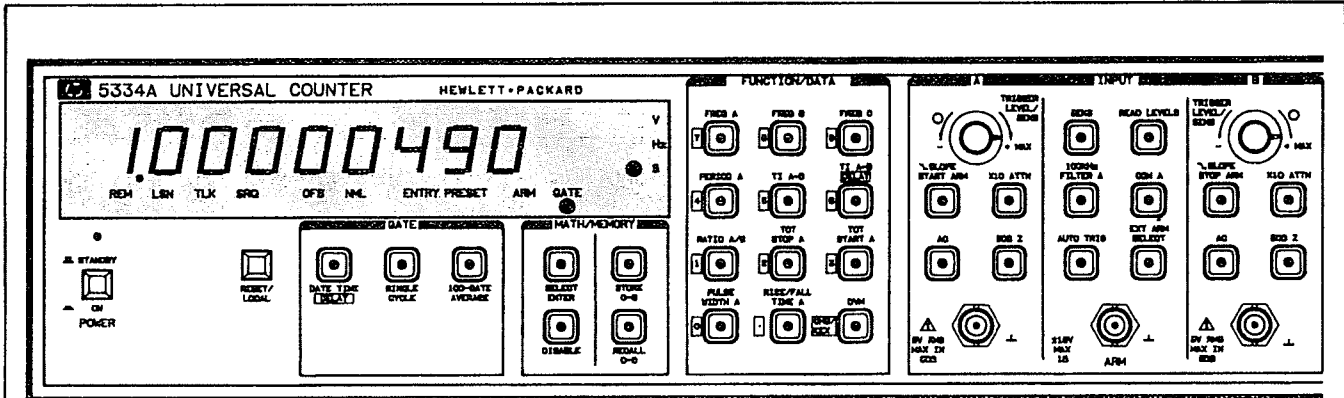

NOTE

For specifications concerning bandwidth, accuracy, and amplitude on input signals, refer to *Table 1-1*.

1. Press POWER switch to ON position.
2. If Start and Stop signals are from separate sources, connect Start signal to INPUT A jack, Stop signal to INPUT B jack, and press COM A key to (SEPARATE) position (LED OFF). If Start and Stop signals are from a common source, connect signal to INPUT A jack, and press COM A key to COMMON position (LED ON).
3. Press T.I. A-B (DELAY) function key, and press AUTO TRIG off.
4. Press AC/(DC), 50Ω Z/(1MΩ), SLOPE, and X10 ATTN keys to appropriate positions.

NOTE

When the COM A key is in COMMON (LED ON), only the A CHANNEL AC/(DC), and 50Ω Z/(1MΩ) keys are effective. However, X10(X1) ATTN, SLOPE, and TRIGGER LEVEL/SENS controls operate independently.

5. Press SENS key to (TRIGGER LEVEL) position (LED OFF). This sets the sensitivity to maximum, and allows variable selection of trigger levels.
6. Adjust TRIGGER LEVEL/SENS controls for optimum triggering, usually midrange over which trigger lights flash. Use READ LEVELS to adjust for specific trigger level voltages.
7. Adjust GATE TIME/(DELAY) setting for preferred delay time between Start on Channel A, and enabling of the Stop signal on Channel B. Potential Stop events are ignored during the specified delay. Delay time is displayed by pressing GATE TIME/(DELAY) key. Setting selection is entered from the keyboard, by pressing appropriate FUNCTION/DATA keys, while GATE TIME/(DELAY) key is enabled (LED ON). Be sure to press GATE TIME/(DELAY) key again to store selected setting in memory, and return to time interval delay, measurement mode. Refer to GATE TIME/DELAY, paragraph 3-107.

NOTE

The first measurement is not displayed until the gate time delay has elapsed.

PRESET AND LOCKOUT CONDITIONS

Preset conditions on initial selection of T.I. A-B (DELAY):			Lockout conditions during TIME INTERVAL DELAY mode:	
MODE	SETTING	EQUIVALENT HP-IB COMMAND	SETTING	EQUIVALENT HP-IB COMMAND
SINGLE CYCLE	OFF	GS0	no lockout	
100-GATE AVERAGE	OFF	GV0	no lockout	
EXT ARM SELECT	OFF	XA2, XO2	no lockout	
MATH DISABLE	ON	MD1	no lockout	

Figure 3-50. Time Interval Delay Measurements

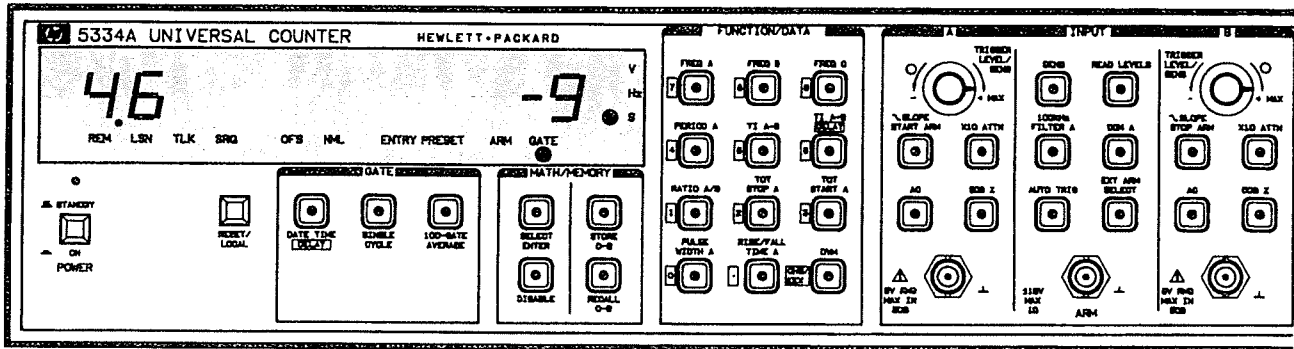

NOTE

For specifications concerning bandwidth, accuracy, and amplitude on input signals, refer to *Table 1-1*.

1. Press POWER switch to ON position.
2. If Start and Stop signals are from separate sources, connect Start signal to INPUT A jack, Stop signal to INPUT B jack, and press COM A key to (SEPARATE) position (LED OFF). If Start and Stop signals are from a common source, connect signal to INPUT A jack, and press COM A key to COMMON position (LED ON).
3. Press T.I. A-B function key, and press AUTO TRIG off.
4. Press AC/(DC), 50Ω Z/(1MΩ), SLOPE, and X10 ATTN keys to appropriate positions.

NOTE

When the COM A key is in COMMON (LED ON), only the A CHANNEL A AC/(DC), and 50Ω Z/(1MΩ) keys are effective. However, X10(X1) ATTN, SLOPE, and TRIGGER LEVEL/SENS controls operate independently.

5. Press SENS key to (TRIGGER LEVEL) position (LED OFF). This sets the sensitivity to maximum, and allows variable selection of trigger levels.
6. Adjust TRIGGER LEVEL/SENS controls for optimum triggering, usually midrange over which trigger lights flash. Use READ LEVELS to adjust for specific trigger level voltages.
7. Adjust GATE TIME setting for preferred sample rate. Gate time is displayed by pressing the GATE TIME key. Setting selection is entered from the keyboard, by pressing appropriate FUNCTION/DATA keys, while GATE TIME key is enabled (LED ON). Be sure to press GATE TIME key again to store selected setting in memory, and return to time interval measurement mode. Refer to GATE TIME/DELAY, paragraph 3-107.
8. Press 100-GATE AVERAGE key.

NOTE

The first measurement is not displayed until the gate has cycled 100 times. Actual time depends on the gate time setting.

PRESET AND LOCKOUT CONDITIONS

Preset conditions on initial selection of T.I. A-B:			Lockout conditions during TIME INTERVAL mode:	
MODE	SETTING	EQUIVALENT HP-IB COMMAND	SETTING	EQUIVALENT HP-IB COMMAND
SINGLE CYCLE	OFF	GS0		no lockout
100-GATE AVERAGE	OFF	GV0		no lockout
EXT ARM SELECT	OFF	XA2, XO2		no lockout
MATH DISABLE	ON	MD1		no lockout

Figure 3-51. Time Interval Averaging

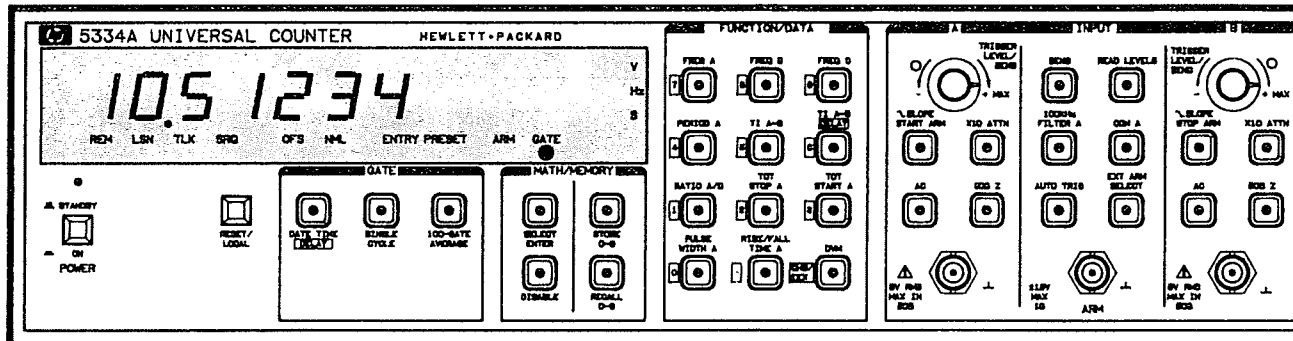

NOTE

For specifications concerning bandwidth, accuracy, and amplitude on input signals, refer to *Table 1-1*.

1. Press POWER switch to ON position.
2. Press COM A key to (SEPARATE) position (LED OFF).
3. Connect signals to INPUT A and INPUT B jacks. For ratio displays greater than 1, connect higher frequency to Channel A. Note, the 5334A/B will display ratios of less than 1, but it is recommended that the higher frequency be applied to Channel A.
4. Press RATIO A/B function key, and press AUTO TRIG off.
5. Press AC/(DC), 50Ω Z/(1MΩ), SLOPE, and X10/(X1) ATTN keys to appropriate positions.
6. Press SENS key to SENSITIVITY position (LED ON); rotate TRIGGER LEVEL/SENS controls fully ccw. This sets the trigger level at 0 volts (nominally) and sensitivity to minimum.
7. Adjust TRIGGER LEVEL/SENS controls in a clockwise direction until a stable measurement is displayed.
8. Adjust GATE TIME setting for preferred resolution. Gate time is displayed by pressing the GATE TIME key. Setting selection is entered from the keyboard, by pressing appropriate FUNCTION/DATA keys, while GATE TIME key is enabled (LED ON). Be sure to press GATE TIME key again to store selected setting in memory, and return to ratio measurement mode. Refer to GATE TIME/DELAY, paragraph 3-107.

PRESET AND LOCKOUT CONDITIONS

Preset conditions on initial selection of RATIO A/B:			Lockout conditions during RATIO mode	
MODE	SETTING	EQUIVALENT HP-IB COMMAND	SETTING	EQUIVALENT HP-IB COMMAND
SINGLE CYCLE	OFF	GS0	no lockout	
100-GATE AVERAGE	OFF	GV0	no lockout	
EXT ARM SELECT	OFF	XA2, XO2	no lockout	
MATH DISABLE	ON	MD1	no lockout	

Figure 3-52. Ratio A/B Measurements

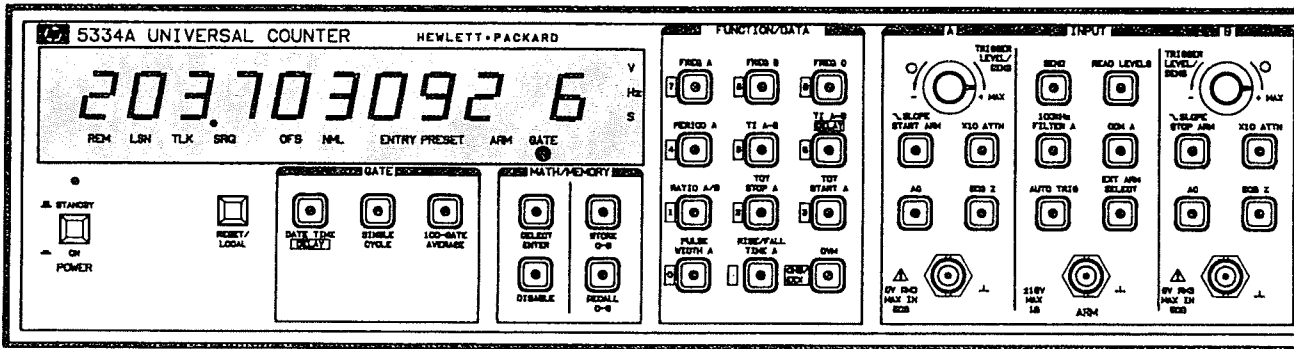

NOTE

For specifications concerning bandwidth, accuracy, and amplitude on input signals, refer to Table 1-1.

1. Press POWER switch to ON position.
2. Press COM A key to (SEPARATE) position (LED OFF).
3. Connect signal to INPUT A jack.

NOTE

This mode will totalize EVENTS on Channel A for the elapsed time between selection of TOT Start and TOT Stop, using the front panel keys.

4. Press TOT START A function key, AUTO TRIG will automatically turn off.
5. Press AC/(DC), 50Ω Z/(1MΩ), SLOPE, and X10/(X1) ATTN keys to appropriate positions.
6. Press SENS key to SENSITIVITY position (LED ON); rotate TRIGGER LEVEL/SENS control fully ccw. This sets the trigger level at 0 volts (nominally) and sensitivity to minimum.
7. Adjust TRIGGER LEVEL/SENS control in a clockwise direction until Channel A trigger light begins to flash.
8. Press RESET to clear display.
9. Press TOT START A to start a totalize measurement; press TOT STOP A to stop totalizing. Repeat this procedure to accumulate counts. Press RESET to clear display and enable a new measurement.

PRESET AND LOCKOUT CONDITIONS

Preset conditions on initial selection of TOT START A:			Lockout conditions during TOTALIZE mode:	
MODE	SETTING	EQUIVALENT HP-IB COMMAND	SETTING	EQUIVALENT HP-IB COMMAND
SINGLE CYCLE	OFF	GS0	ON	GS1
100-GATE AVERAGE	OFF	GV0	ON	GV1
EXT ARM SELECT	OFF	XA2, XO2	no lockout	
MATH DISABLE	ON	MD1	OFF	MD0
AUTO TRIG	OFF	AU0	ON	AU1
GATE TIME ENTRY	controlled by TOT STOP A		ON	GA<n>

Figure 3-53. Totalize Measurements

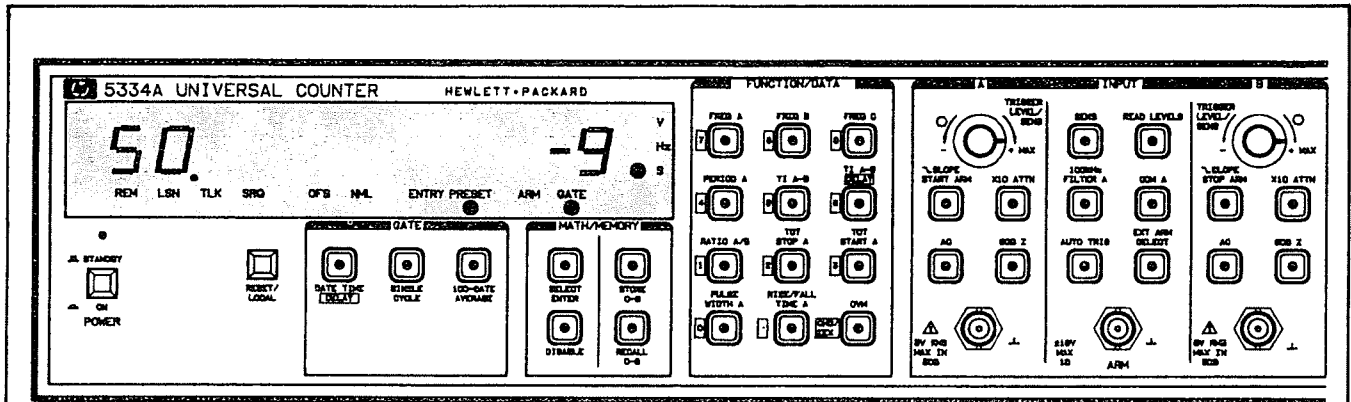

NOTE

For specifications concerning bandwidth, accuracy, and amplitude on input signals, refer to *Table 1-1*.

1. Press POWER switch to ON position.
2. Press COM A key to (SEPARATE) position (LED OFF).
3. Connect signal to INPUT A jack.
4. Press PULSE WIDTH A function key, AUTO TRIG will automatically turn on.
5. Press AC/(DC), and 50Ω Z/(1MΩ) keys to appropriate positions.
6. Press Channel A SLOPE key for positive (LED OFF), or negative (LED ON) pulse measurements.
7. Adjust GATE TIME setting for preferred sample rate. Gate time is displayed by pressing the GATE TIME key. Setting selection is entered from the keyboard, by pressing appropriate FUNCTION/DATA keys, while GATE TIME key is enabled (LED ON). Be sure to press GATE TIME key again to store selected setting in memory, and return to pulse width measurement mode. Refer to GATE TIME/DELAY, paragraph 3-107.

NOTE

The first measurement is not displayed until the gate time delay has elapsed.

PRESET AND LOCKOUT CONDITIONS

Preset conditions on initial selection of PULSE WIDTH A:			Lockout conditions during PULSE WIDTH mode:	
MODE	SETTING	EQUIVALENT HP-IB COMMAND	SETTING	EQUIVALENT HP-IB COMMAND
SINGLE CYCLE	OFF	GS0		no lockout
100-GATE AVERAGE	OFF	GV0		no lockout
EXT ARM SELECT	OFF	XA2, XO2		no lockout
MATH DISABLE	ON	MD1		no lockout
AUTO TRIG	ON	AU1		
X10 ATTN	controlled by AUTO TRIG		OFF	AU0
			ON	AX1, BX1
SENS	OFF	SE0	OFF	AX0, BX0
DACS (5334A only)	OFF	TR0	ON	SE1
				TR1

Figure 3-54. Pulse Width Measurements

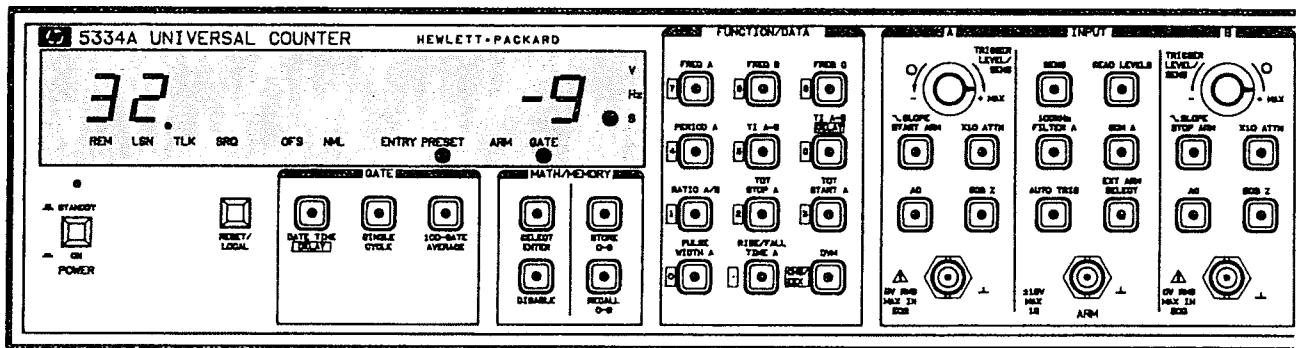

NOTE

For specifications concerning bandwidth, accuracy, and amplitude on input signals, refer to *Table 1-1*.

1. Press POWER switch to ON position.
2. Connect signal to INPUT A jack.
3. Press RISE/FALL TIME A function key, AUTO TRIG and COM A will automatically turn on.
4. Press CHANNEL A AC/(DC), and 50Ω Z/(1MΩ) keys to appropriate positions.
5. Press Channel A SLOPE key: positive (LED OFF) for rise time measurements; negative (LED ON) for fall time measurements.
6. Adjust GATE TIME setting for preferred sample rate. Gate time is displayed by pressing the GATE TIME key. Setting selection is entered from the keyboard, by pressing appropriate FUNCTION/DATA keys, while GATE TIME key is enabled (LED ON). Be sure to press GATE TIME key again to store selected setting in memory, and return to rise/fall time measurement mode. Refer to GATE TIME/DELAY, paragraph 3-107.

NOTE

The first measurement is not displayed until the gate time delay has elapsed.

PRESET AND LOCKOUT CONDITIONS

Preset conditions on initial selection of RISE/FALL TIME A:			Lockout conditions during RISE/FALL TIME mode:	
MODE	SETTING	EQUIVALENT HP-IB COMMAND	SETTING	EQUIVALENT HP-IB COMMAND
SINGLE CYCLE	OFF	GS0		no lockout
100-GATE AVERAGE	OFF	GV0		no lockout
EXT ARM SELECT	OFF	XA2, XO2		no lockout
MATH DISABLE	ON	MD1		no lockout
AUTO TRIG	ON	AU1	OFF	AU0
X10 ATTN	controlled by AUTO TRIG		ON	AX0, BX1
			OFF	AX0, BX0
SENS	OFF	SE0	ON	SE1
DACS (5334A only)	OFF	TR0	ON	TR1
COM A	ON	CO1	OFF	CO0
FILTER A	OFF	FI0	ON	FI1

Figure 3-55. Rise/Fall Time Measurements

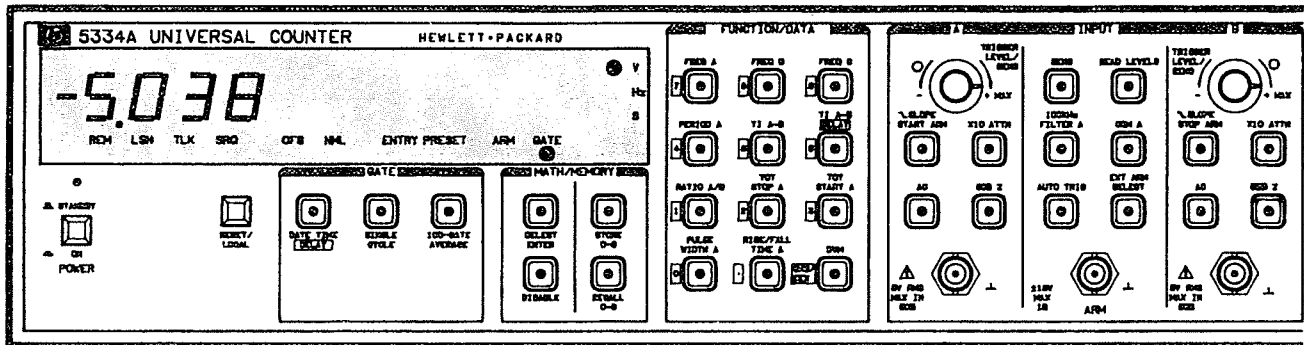

HP 5334A ONLY

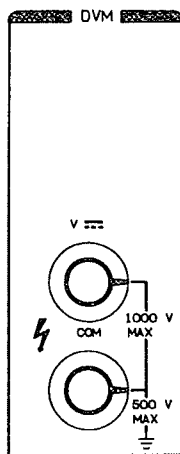

NOTE

For specifications concerning bandwidth, accuracy, and amplitude on input signals, refer to *Table 1-1*.

HP 5334A ONLY

1. Press POWER switch to ON position.
2. Connect signal to DVM INPUT jacks.
3. Press DVM function key, AUTO TRIG will automatically turn off.
4. GATE TIME is internally set at 50 ms, and cannot be set via the front panel.

PRESET AND LOCKOUT CONDITIONS

Preset conditions on initial selection of DVM:			Lockout conditions during DVM mode:	
MODE	SETTING	EQUIVALENT HP-IB COMMAND	SETTING	EQUIVALENT HP-IB COMMAND
SINGLE CYCLE	OFF	GS0	no lockout	
100-GATE AVERAGE	OFF	GV0	no lockout	
EXT ARM SELECT	disabled in DVM mode		ON	XA1-XA3,
			OFF	XO1-XO3
MATH DISABLE	ON	MD1	no lockout	
AUTO TRIG	ON	AU0	ON	AU1
GATE TIME ENTRY	(50 ms) controlled by DVM		ON	GA<n>

Figure 3-56. (DVM) Voltage Measurements (5334A Only)

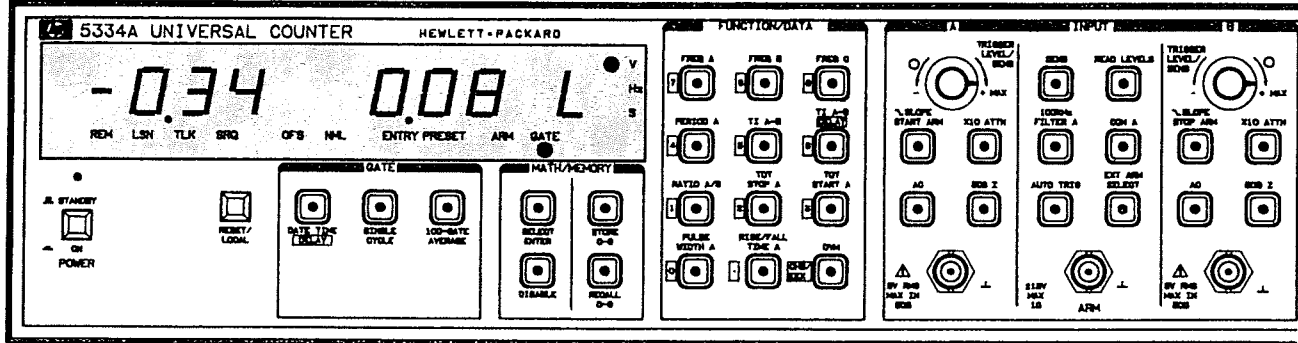

NOTE

For specifications concerning bandwidth, accuracy, and amplitude on input signals, refer to *Table 1-1*.

1. Press POWER switch to ON position.
2. Press COM A key to (SEPARATE) position (LED OFF).
3. Connect signal to INPUT A and/or INPUT B jack.
4. Press desired function key.
5. Press AC/(DC), 50Ω Z/(1MΩ), and SLOPE keys to appropriate positions.
6. Adjust TRIGGER LEVEL/SENS control within range over which trigger light flashes, if desired. NOTE, when AUTO TRIG is off, appropriate attenuation must be selected manually.
7. Adjust GATE TIME setting, if required. Gate time is displayed by pressing GATE TIME key. Setting selection is entered from the keyboard, by pressing appropriate FUNCTION/DATA keys, while GATE TIME key is enabled (LED ON). Be sure to press GATE TIME key again to store selected setting in memory, and return to frequency measurement mode. Refer to GATE TIME/DELAY, paragraph 3-107.
8. Press READ LEVELS key. Readjust TRIGGER LEVEL/SENS control to specific voltage level, according to measurement application.

PRESET AND LOCKOUT CONDITIONS

Preset conditions on initial selection of TRIGGER LEVELS:			Lockout conditions during TRIGGER LEVELS mode:	
MODE	SETTING	EQUIVALENT HP-IB COMMAND	SETTING	EQUIVALENT HP-IB COMMAND
SINGLE CYCLE	OFF	GS0	no lockout	
100-GATE AVERAGE	OFF	GV0	ON	GV1
EXT ARM SELECT	disabled in TRIG LEVELS		ON	XA1-XA3
MATH DISABLE	ON	MD1	OFF	XO1-XO3
AUTO TRIG	OFF	AU0	ON	MD0
GATE TIME ENTRY	disabled in TRIG LEVELS		ON	AU1
			ON	GA<n>

Figure 3-57. Trigger Level Measurements

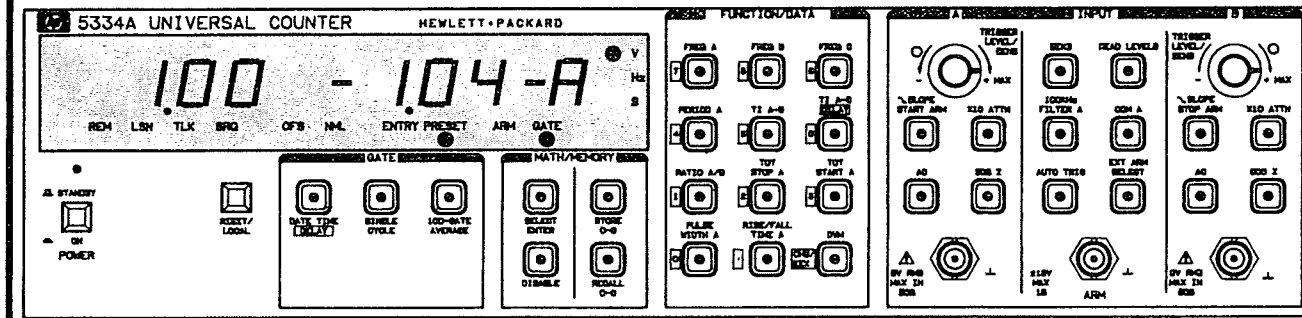

NOTE

For specifications concerning bandwidth, accuracy, and amplitude on input signals, refer to *Table 1-1*.

1. Press POWER switch to ON position.
2. Press COM A key to (SEPARATE) position (LED OFF).
3. Connect signal to INPUT A jack.
4. Press FREQ A function key.
5. Press AC/(DC), 50Ω Z/(1MΩ), and SLOPE A key to appropriate positions.
6. Adjust GATE TIME setting, if required. Gate time is displayed by pressing the GATE TIME key. Setting selection is entered from the keyboard, by pressing appropriate FUNCTION/DATA keys, while GATE TIME key is enabled (LED ON). Be sure to press GATE TIME key again to store selected setting in memory, and return to frequency measurement mode. Refer to GATE TIME/DELAY, paragraph 3-107.
7. Press READ LEVELS key two times. Upper and lower peak levels will be displayed.

PRESET AND LOCKOUT CONDITIONS

Preset conditions on initial selection of PEAK LEVELS:			Lockout conditions during PEAK LEVELS mode:	
MODE	SETTING	EQUIVALENT HP-IB COMMAND	SETTING	EQUIVALENT HP-IB COMMAND
SINGLE CYCLE	OFF	GS0	no lockout	
100-GATE AVERAGE	OFF	GV0	ON	GV1
EXT ARM SELECT	disabled in PEAK LEVELS		ON	XA1-XA3
			OFF	XO1-XO3
MATH DISABLE	ON	MD1	ON	MD0
AUTO TRIG	ON	AU1	OFF	AU0
X10 ATTN	controlled by AUTO TRIG		ON	AX1, BX1
			OFF	AX0, BX0
SENS	OFF	SE0	ON	SE1
DACS (5334A only)	OFF	TR0	ON	TR1
GATE TIME ENTRY	disabled in PEAK LEVELS		ON	GA<n>

Figure 3-58. Channel A, Peak Voltage Measurements

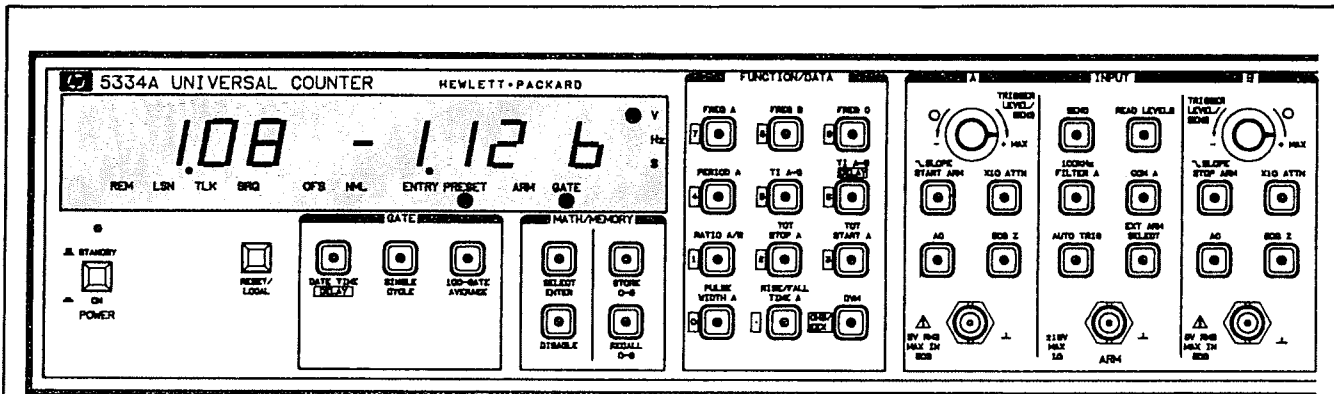

NOTE

For specifications concerning bandwidth, accuracy, and amplitude on input signals, refer to *Table 1-1*.

1. Press POWER switch to ON position.
2. Press COM A key to (SEPARATE) position (LED OFF).
3. Connect signal to INPUT B jack.
4. Press FREQ B function key.
5. Press AC/(DC), 50Ω Z/(1MΩ), and SLOPE B key to appropriate positions.
6. Adjust GATE TIME setting, if required. Gate time is displayed by pressing the GATE TIME key. Setting selection is entered from the keyboard, by pressing appropriate FUNCTION/DATA keys, while GATE TIME key is enabled (LED ON). Be sure to press GATE TIME key again to store selected setting in memory, and return to frequency measurement mode. Refer to GATE TIME/DELAY, paragraph 3-107.
7. Press READ LEVELS key three times. Upper and lower peak levels will be displayed.

PRESET AND LOCKOUT CONDITIONS

Preset conditions on initial selection of PEAK LEVELS:			Lockout conditions during PEAK LEVELS mode:	
MODE	SETTING	EQUIVALENT HP-IB COMMAND	SETTING	EQUIVALENT HP-IB COMMAND
SINGLE CYCLE	OFF	GS0	no lockout	
100-GATE AVERAGE	OFF	GV0	ON	GV1
EXT ARM SELECT	disabled in PEAK LEVELS		ON	XA1-XA3
			OFF	XO1-XO3
MATH DISABLE	ON	MD1	OFF	MD0
AUTO TRIG	ON	AU1	OFF	AU0
X10 ATTN	controlled by AUTO TRIG		ON	AX1, BX1
			OFF	AX0, BX0
SENS	OFF	SE0	ON	SE1
DACS (5334A only)	OFF	TR0	ON	TR1
GATE TIME ENTRY	disabled in PEAK LEVELS		ON	GA<n>

Figure 3-59. Channel B, Peak Voltage Measurements

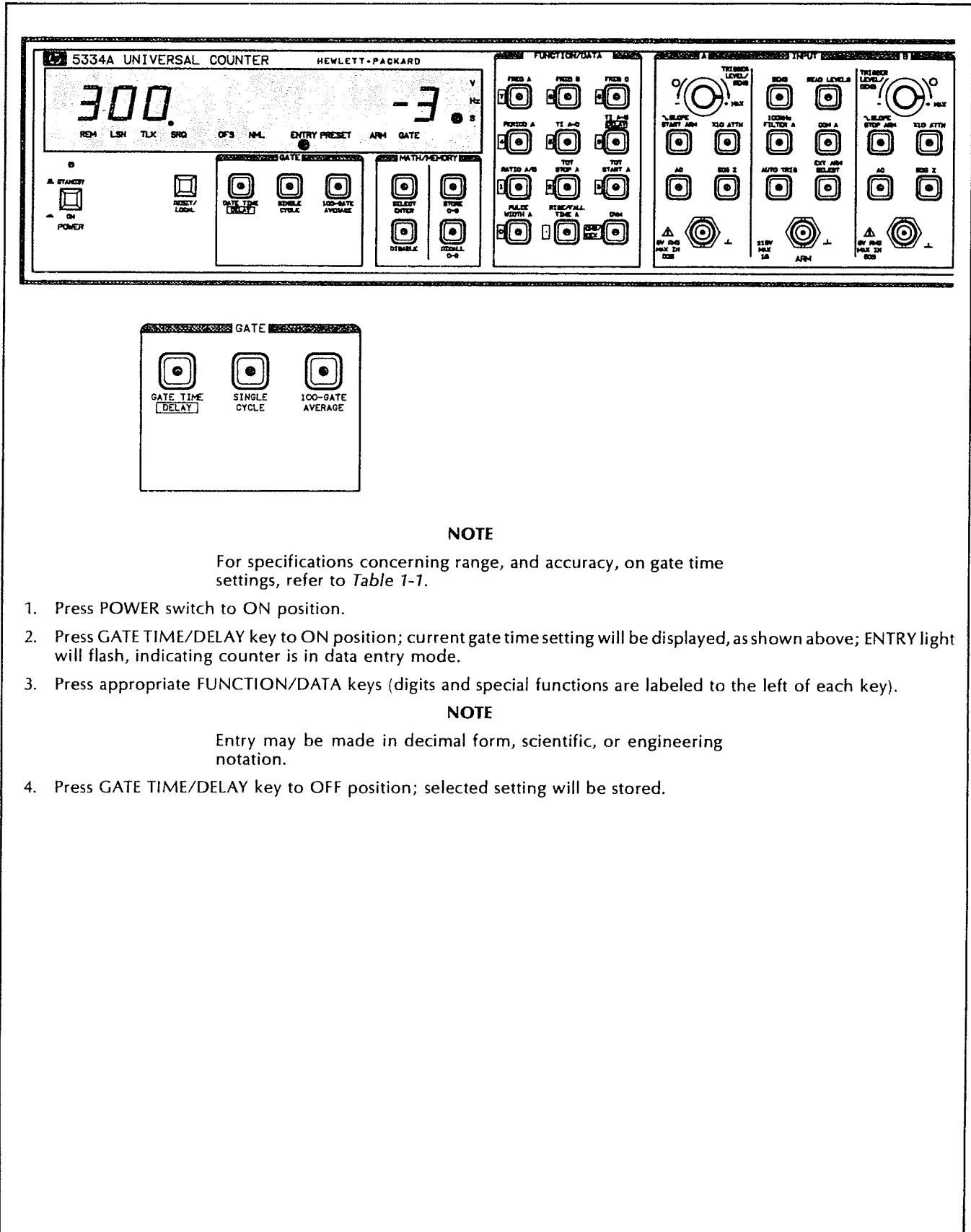

NOTE

For specifications concerning range, and accuracy, on gate time settings, refer to Table 1-7.

1. Press POWER switch to ON position.
2. Press GATE TIME/DELAY key to ON position; current gate time setting will be displayed, as shown above; ENTRY light will flash, indicating counter is in data entry mode.
3. Press appropriate FUNCTION/DATA keys (digits and special functions are labeled to the left of each key).

NOTE

Entry may be made in decimal form, scientific, or engineering notation.

4. Press GATE TIME/DELAY key to OFF position; selected setting will be stored.

Figure 3-60. Gate Time/Delay Setting

3-260. REMOTE PROGRAMMING VIA HP-IB

3-261. The HP 5334A/B Universal Counter is compatible with the Hewlett-Packard Interface Bus (HP-IB). Remote programming is installed as standard equipment and allows the instrument to respond to remote control instructions and output measurement data via the HP-IB. At the simplest level, the HP 5334A/B can output data in the talk only mode to other devices such as a controller or printer. In more sophisticated systems, a computing or other type of controller can remotely program the HP 5334A/B to perform a specific type of measurement, trigger the measurement, and collect the results.

NOTE

HP-IB is Hewlett-Packard's implementation of IEEE Std. 488-1978, *Standard Digital Interface for Programming Instrumentation*, and ANSI Standard MC 1.1.

3-262. To remotely program the counter efficiently, the operator must be familiar with the selected controller, the configured interface, and the local operation and functional capabilities of the HP 5334A/B. Typical controllers for the HP-IB are the HP 9825A/B, HP 9835A, HP 9816A, HP9845A, HP 9000 series 200 and 300, HP 1000, or HP 85A/B. The following HP manuals should provide useful background information:

Hewlett-Packard 85 Owner's Manual and Programming Guide
Hewlett-Packard 9825A Operating and Programming Reference Manual
Hewlett-Packard 9825A I/O Control Reference Manual
Hewlett-Packard 9825B Manual Kit
Hewlett-Packard 9826A BASIC Manual
Hewlett-Packard 9835A/B Operating and Programming Manual
Hewlett-Packard 9845A Operating and Programming Guide
Condensed Description of the Hewlett-Packard Interface Bus
Tutorial Description of the Hewlett-Packard Interface Bus
Hewlett-Packard Series 200 Basic Interfacing Techniques

3-263. HP-IB Description

3-264. The Hewlett-Packard Interface Bus (HP-IB) is a high speed parallel interface bus. All devices on the bus are capable of being addressed at one time. However, only one device may respond at a time. The controller is used to command a specific device to respond, and maintain the flow of data and interface functions.

3-265. The HP-IB system uses a party-line structure (devices share signal lines). A maximum of 15 devices may be connected in an HP-IB system, in virtually any configuration desired. There must be an uninterrupted path to every device operating on the bus.

3-266. INTERFACE SYSTEM TERMS

3-267. The following paragraphs define the terms and concepts used to describe HP-IB system operations.

- a. **Address:** Each device on the interface is assigned an address. The address is used to specify which device will receive information or send information.

- b. **Byte:** A byte is a unit of information consisting of eight binary digits called bits.
- c. **Device:** Any instrument or unit that is HP-IB compatible is called a device.
- d. **Device Independent Command:** A command predefined by the interface standard to have a specified bit pattern and resulting action.
- e. **Device Dependent Command:** A command that is specific to a particular instrument or family of instruments, which is not predefined by the interface standard. Device dependent commands are usually sent as ASCII strings of characters.
- f. **Polling:** Polling is a process typically used by a controller to locate a device that has requested service from the controller. There are two types of polling, Serial Poll and Parallel Poll:
 - 1. Serial Poll. When the controller executes a serial poll, the addressed device sends one byte of operational information called a status byte. If more than one device in the interface is capable of requesting service, each device on the interface must be serial polled until the device that requested service is located.
 - 2. Parallel Poll. The HP 5334A/B does not have parallel poll capability.

3-268. MAJOR INTERFACE FUNCTIONS

3-269. Each device on the interface may have one or more of the following major device capabilities: Controller, Talker, or Listener. The controller has the responsibility of controlling interface activity, and must be equipped with the proper interface module. Controllers transmit all device independent commands to other devices in the interface and usually have Talker and Listener capabilities. Only one device on the interface may be the active controller at any one time. The HP 5334A/B Universal Counter had no controller capabilities.

3-270. Talkers are devices that have the ability to send data or device dependent commands through the interface. Note that a Talker will not actually send data or information until the appropriate command is sent by the controller. The HP 5334A/B Universal Counter has Talker capabilities. When the HP 5334A/B is talking on the interface, or is addressed to talk, the TLK annunciator will turn on. In special situations, a device may be classified as a Talk-Only device, and send information to Listen-Only devices. Such a system would have no controller. For example, the counter can be configured to TALK ONLY and send measurement results to a printer (TALK ONLY Address is 50).

3-271. Listeners are devices with the capability to receive information over the interface. When the HP 5334A/B is "listening", or addressed to listen, the LSN annunciator turns on. Listeners must also be enabled by the controller to receive data or information.

3-272. Interface Capabilities

3-273. The capability of a device connected to the bus is specified by its interface functions. These functions provide the means for a device to receive, process, and send messages over the bus. *Table 3-5* lists the HP 5334A/B interface functions using the terminology of the IEEE 488-1978 standard.

3-274. Device independent commands are standardized and are the same in all instruments. Therefore, the functions these commands perform can be listed on the instrument in a

Table 3-5. HP 5334A/B HP-IB Interface Functions

INTERFACE FUNCTION SUBSET IDENTIFIER	INTERFACE FUNCTION DESCRIPTION
SH1	Complete source handshake capability.
AH1	Complete acceptor handshake capability.
T5	Talker (basic talker, serial poll, has talk only mode, will unaddress talk if addressed listen).
TE0	No extended talker capability.
L4	Listener (basic listener, no listen only mode, will unaddress listen if addressed to talk).
LE0	No extended listener capability.
SR1	Full service request capability.
RL1	Complete remote/local capability.
PP0	No parallel poll capability.
DC1	Full device clear capability.
DT1	Full device trigger capability.
C0	No controller capability.
E2	Tri-state Drivers.

standardized manner. This is known as the capability label. The label is located above the rear panel HP-IB connector, and lists the functions as follows:

SH1, AH1, T5, (TE0), L4, (LE0), SR1, RL1, PP0, DC1, DT1, C0, E2

3-275. The number following the interface function code in *Table 3-5* indicates the particular capability of that function as listed in Appendix C of IEEE Standard 488-1978, and is described briefly in *Table 3-6*, HP 5334A/B Interface Capabilities.

3-276. Nearly all controls on the HP 5334A/B can be programmed remotely, and data from the measurements can be sent to other devices through the HP-IB. The HP 5334A/B operates as both a talker and a listener, as listed in *Table 3-7*. The HP 5334A/B output format is the same regardless of the mode (talk only/addressable). The following paragraphs describe the basic programming capability of the HP 5334A/B Universal Counter.

TALK: The HP 5334A/B can be addressed to Talk by a controller or by entering the TALK ONLY address, 50. When addressed as a Talker, the HP 5334A/B will send data to other devices on the bus. This data is the result of the measurement, or the next measurement, depending on the function selected. Also sends calibration data, error messages, etc.

LISTEN: When addressed as a Listener, the instrument will accept any number of commands from a controller on the bus. These commands are used to program the instrument operation.

SERVICE REQUEST: SRQ will be generated on the interface whenever an enabled status bit is set. The HP 5334A/B has the capability to request service asynchronously from the controller in charge of the bus. See "SM" command described in Service Request Mask, paragraph 3-304.

REMOTE/LOCAL: Normally the HP 5334A/B is under front panel (local) control. To program the HP 5334A/B, it must be placed in Remote. Once in Remote, programmable functions cannot be affected by the front panel controls. The RESET key may be used to manually return to local control only if the Local Lockout (LLO) is off. If Local Lockout is on, the RESET key is ignored, and the bus command LOCAL must be sent to disable LLO.

PARALLEL POLL: The HP 5334A/B does not respond to a parallel poll.

DEVICE CLEAR: When a universal or selected device clear is received, the HP 5334A/B clears most errors (if present), except errors 5.0 through 5.2; clears all input buffers and resets the hardware for a new measurement. The display LED's will flash momentarily. Failure messages are not cleared.

DEVICE TRIGGER: When a device trigger is received, the HP 5334A/B will start a new measurement.

CONTROLLER: The HP 5334A/B cannot be used as a controller.

Table 3-6. HP 5334A/B Interface Capabilities

HP-IB	DESCRIPTION
SH1	The instrument can generate messages.
AH1	The instrument can interpret received messages.
T5	The instrument can function as a talker. In addition, it can operate as a Talker Only instrument and can respond to serial poll. It will unlisten if addressed as a talker.
TE0	The instrument cannot function as an extended talker.
L4	The instrument can function as a listener. In addition, it will untalk itself if addressed as a listener.
LE0	The instrument cannot function as an extended listener.
SR1	The instrument can generate a service request.
RL1	The instrument can operate in both remote and local modes. In addition, it can respond to local lockout.
PP0	The instrument does not support parallel poll.
DC1	The instrument supports both the device clear (DCL) and selected device clear (SDC) commands.
DT1	The instrument can be remotely triggered.
C0	The instrument cannot function as a controller.

3-277. FRONT PANEL INTERFACE STATUS LED'S

3-278. The four Interface Status LED's, on the front panel, indicate the remote status of the HP 5334A/B. The REM LED lights to indicate the HP 5334A/B is under remote control. The TLK LED lights to indicate the HP 5334A/B is addressed to talk (send data). The LSN LED lights to indicate the HP 5334A/B is addressed to listen (receive commands). The SRQ LED lights to indicate a service request condition exists (as determined by a set service request mask bit).

3-279. ADDRESS SELECTION

3-280. To use the HP 5334A/B in an HP-IB system, set the instrument to the desired address, as listed in Table 3-7. The ADDRESSABLE mode is used whenever a calculator or other controller is used with the system, and the HP 5334A/B functions as a talker and listener. The TALK ONLY mode is used when the HP 5334A/B is operating under its own control (no controller on bus) and outputting results to another device on the bus, such as a plotter or a printer. In the TALK ONLY mode the HP 5334A/B functions only in an output condition, and the receiving device must have LISTEN ONLY capability.

3-281. Refer to *Table 3-7* for all possible address settings and the corresponding ASCII codes for talk and listen, in the ADDRESSABLE mode and in the TALK ONLY mode. The HP 5334A/B is factory set to address 03. To set or change the HP 5334A/B address proceed as follows.

3-282. SETTING THE HP 5334A HP-IB ADDRESS. To set the address, press the instrument front panel keys in the order shown:

- | | |
|--|---|
| Press RECALL key.
(MATH/MEMORY group) | The 5334A will display "SEL r___", the ENTRY light will flash, and the RECALL key indicator will light. Refer to paragraph 3-130 for further details on the RECALL key. |
| Press decimal point . key
(FUNCTION/DATA group) | The current address will be displayed (e.g., Addr 03, shown in <i>Figure 3-61</i>). |
| Enter decimal address.
(FUNCTION/DATA group) | Press appropriate digits (e.g., to select Address 05, press 5). The display will reflect the entry (i.e., Addr 05). |
| Press STORE key
(MATH/MEMORY group) | The address will be stored in memory, and the 5334A will return to the previous mode of operation. |

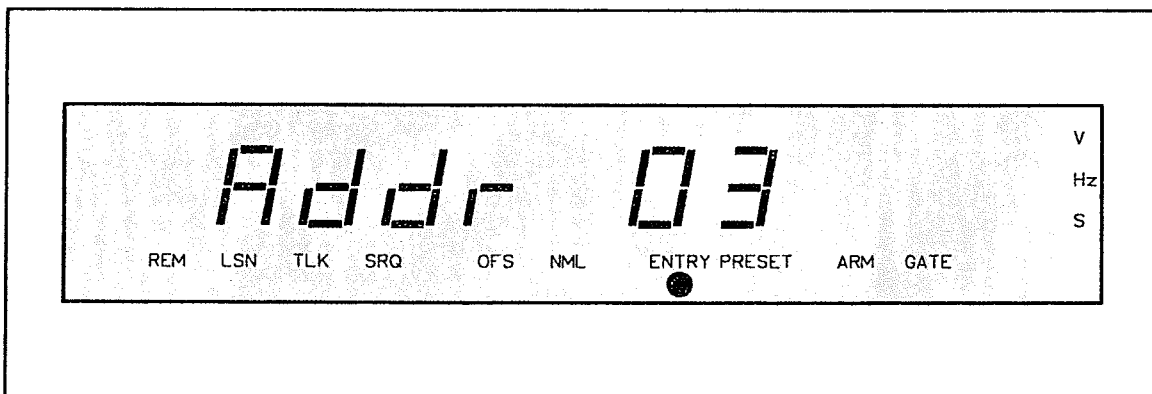

Figure 3-61. HP 5334A/B Address Entry Display

3-283. After selecting the HP 5334A address, be sure to press the front panel STORE key. The address setting will then be read by the microprocessor and stored in memory. This action is required whenever the address setting is changed.

3-284. SETTING THE HP 5334B HP-IB ADDRESS. The address must be selected from the HP 5334B HP-IB Address switch located on the rear panel, in the extreme lower right corner. To set the address, e.g. to 07, press switches A1 through A3 in their "1" (up) position and leave switches A4 and A5 in their "0" (down) position. To verify that the address did change to 07, reinitialize the 5334B, by switching the instrument to STANDBY and then to ON. The display will reflect the entry (i.e., Addr 07).

3-285. The examples used in this section assume an address setting of 03. This number is important when using a controller such as an HP 9826A, HP 9836A, HP 9845A, or HP 85 calculator (since the calculator addresses the HP 5334A/B to talk or listen by using code 703 [the 03 being the HP 5334A/B address]). The ASCII characters for this same address setting are "C" for a talk address and "#" for a listen address. These characters are used when the controller is an HP 9830A calculator.

Table 3-7. Address Selection

SELECTED ADDRESS	ASCII CODE CHARACTER		ADDRESS USAGE MODE
	LISTEN	TALK	
00	SP	@	ADDRESSABLE
01	!	A	ADDRESSABLE
02	"	B	ADDRESSABLE
03	#	C	ADDRESSABLE
04	\$	D	ADDRESSABLE
05	%	E	ADDRESSABLE
06	&	F	ADDRESSABLE
07	'	G	ADDRESSABLE
08	(H	ADDRESSABLE
09)	I	ADDRESSABLE
10	*	J	ADDRESSABLE
11	+	K	ADDRESSABLE
12	,	L	ADDRESSABLE
13	—	M	ADDRESSABLE
14	.	N	ADDRESSABLE
15	/	O	ADDRESSABLE
16	Ø	P	ADDRESSABLE
17	1	Q	ADDRESSABLE
18	2	R	ADDRESSABLE
19	3	S	ADDRESSABLE
20	4	T	ADDRESSABLE
21	5	U	ADDRESSABLE
22	6	V	ADDRESSABLE
23	7	W	ADDRESSABLE
24	8	X	ADDRESSABLE
25	9	Y	ADDRESSABLE
26	:	Z	ADDRESSABLE
27	;		ADDRESSABLE
28	<	\	ADDRESSABLE
29	=		ADDRESSABLE
30	>	~	ADDRESSABLE
50	N/A	N/A	TALK ONLY

3-286. INTERFACE COMMANDS

3-287. The commands the counter recognizes can be separated into two classes: device dependent commands and device independent commands. Device independent commands are defined by the interface standard document and are the same in all instruments. These commands are identified by a three letter mnemonic such as GTL, which represents Go To Local. Device independent commands are sent as encoded bytes on the interface and not as ASCII strings. Thus, these commands cannot be sent using the OUTPUT statement on the HP 85. However, many controllers do incorporate a command of the form SEND7;CMDnnn, where nnn is the decimal equivalent to the bit pattern corresponding to a particular device independent command. A detailed description of Device Independent Commands is given in paragraph 3-289.

3-288. Device dependent commands are unique to the instrument and are defined by the instrument designer. They are normally sent to an instrument as ASCII strings. A detailed description of Device Dependent Commands begins in paragraph 3-306.

3-289. Device Independent Commands

3-290. A list of supported device independent command mnemonics and the full name of each command is provided in Table 3-8. The following paragraph include a description of the function of each command.

Table 3-8. Device Independent Commands

MNEMONICS	COMMAND NAME
ATN	Attention
DCL	Device Clear
EOI	End or Identify
GET	Group Execute Trigger
GTL	Go To Local
IFC	Interface Clear
LADn	Listen Address n
LLO	Local Lockout
MLA	My Listen Address
MTA	My Talk Address
NRE	Not Remote Enable
NULL	Null
REN	Remote Enable
SDC	Selected Device Clear
SPD	Serial Poll Disable
SPE	Serial Poll Enable
TADn	Talk Address n
UNL	Unlisten
UNT	Untalk

3-291. The instrument response to the device independent commands is listed below:

- ATN Alerts the instrument that a device independent message is being sent, so the instrument is ready to accept data on the data lines, and interpret it as commands.
- DCL This command aborts the current measurement, aborts all pending send data commands, resets the gate, and clears the display. It is similar to the front panel RESET/LOCAL key, except that it only clears errors 1.0 through 4.4.
- EOI If Attention is false and the instrument is a listener, EOI acts as a message delimiter, and indicates the last data byte of a multibyte sequence.
- GET If the instrument is addressed to listen, GET aborts the current measurement, and triggers the next measurement immediately. It is equivalent to pressing the RESET key or another function key.
- GTL If the instrument is addressed to listen, GTL returns the instrument to (local) front panel operation. Local lockout is not cleared.
- IFC The instrument untalks and unlistens, initializes to an idle state. (No activity on the bus.)
- LADn If n matches the instrument address, the instrument becomes a listener.
- LLO The front panel RESET/LOCAL key is disabled, if the instrument is in remote.
- MLA MLA is the LADn, that matches the instrument address.
- MTA MTA is the TADn, that matches the instrument address.
- NRE The instrument returns to (local) front panel operation; local lockout is cleared.
- NUL No effect when received by the instrument.

- REN The instrument enters the remote state, and is enabled to respond to interface commands when addressed as a listener.
- SDC If the instrument is a listener, will cause the same response as DCL.
- SPD Terminates serial polling, and returns the instrument to a normal talker state, to output device dependent data rather than status information.
- SPE Establishes serial polling, and enables the instrument to send the serial poll status byte, when addressed to talk.
- TADn If n matches the instrument address, the instrument becomes a talker.
- UNL The instrument is unaddressed, and terminates listening. A single device cannot be unaddressed without unaddressing all listeners.
- UNT Unaddresses the instrument, if currently a talker, and terminates talking. Addressing another talker on the interface automatically unaddresses any current talker.

Table 3-9. Meta Messages

MESSAGE	DESCRIPTION/RESPONSE
DATA	A means to send device dependent command and receive measurement data. UNL, MTA, LADn, data
TRIGGER	Will cause a new measurement to be triggered. UNL, MTA, LADn, GET
CLEAR	Will clear the display, starts new measurement, and clears errors 1.0 through 4.4. UNL, MTA, LADn, SDC
REMOTE	Disables front panel keys (except for Reset/Local). REN, UNL, MTA, LADn
LOCAL	Enables the front panel keys. UNL, MTA, LADn, GTL
LOCAL AND CLEAR LOCKOUT	Enables the front panel keys and clears local lockout.
LOCAL LOCKOUT	Disables the Reset/Local key when in remote. LLO
SERVICE REQUEST	This command is ignored when received by the instrument. It will be sent by the instrument when an enabled service condition is present.
STATUS BYTE	Presents status information. UNL, MLA, TADn, SPE, data, SPD, UNT
STATUS BIT	Not supported.
PASS CONTROL	Not supported.
ABORT	Terminates bus communications by unlistening and untalking all instruments. IFC

3-292. Meta Messages

3-293. To simplify the use of the HP-IB interface, Hewlett-Packard has developed what is called the Meta Message concept. Rather than requiring the user to remember all the device independent messages and their interactions, useful sequences of these commands have been integrated into a single command on many of HP's controllers. For example, to clear the instrument at address 03 using the device independent commands, it is necessary to send the sequence ATN, UNL, MTA, LAD 03, SDC. The HP-85 command, CLEAR703, sends the same sequence with no further user interaction. This greatly simplifies the use of the interface.

3-294. Many of the meta messages implemented on the HP-85 may be sent in either of two forms, with addressing or without addressing. The form with addressing will normally address a particular device to listen. For example, the command REMOTE7 will send a REN without making any device a listener; while the command REMOTE703 will send REN, and then make device at address 03 a listener. In the following tables, the form with addressing is shown.

3-295. Meta messages, their results in the HP 5334A/B, and the typical interface message sequences corresponding to them, are listed in *Table 3-9*. The sequence are typical in that different controllers may send different sequences, while still producing the same results.

3-296. Meta messages and the HP 9825, and HP-85 commands that correspond to them are listed in *Table 3-10*. (Only the addressed form is shown for the commands that support both the unaddressed and addressed forms.) The table assumes the instrument is set at address 03 and the interface is set at select code 7.

Table 3-10. Meta Messages and Controller Commands

MESSAGE	HP 9825	HP-85
DATA	wrt 703; A\$ red 703; A\$	OUTPUT 703; A\$ ENTER 703; A\$
TRIGGER	trg 703	TRIGGER 703
CLEAR	clr 703	CLEAR 703
REMOTE	rem 703	REMOTE 703
LOCAL	lcl 703	LOCAL 703
LOCAL/CLEAR LOCKOUT	lcl 7	LOCAL 7
LOCKOUT	llo 7	LOCAL LOCKOUT 7
SERVICE	rds (7)→A	STATUS 7, 2; A
STATUS BYTE	rds (703)→A	A=SPOLL (703)

3-297. Through meta messages, devices on the bus can exchange control and measurement information. A detailed description of these messages, and the HP 5334A/B response to each message, are provided in the following paragraphs.

3-298. Meta Message Response

DATA: The HP 5334A/B sends measurement data as defined by the device dependent command received from the controller.

TRIGGER: Clears the HP 5334A/B display, and starts a new measurement.

CLEAR: Clears the HP 5334A/B display, and starts a new measurement. Clears errors numbered 1.0 through 4.4, but does not clear errors 5.0X through 5.2 nor any failures.

REMOTE: The HP 5334A/B goes into remote when it receives the REMOTE message on the HP-IB. All front panel controls except the RESET/LOCAL key are ignored. In REMOTE operation, the HP 5334A/B is programmed by the controller via messages sent over the bus. Until changed via the bus, the state of the HP 5334A/B remains as it was prior to receipt of the REMOTE message.

LOCAL: Returns the HP 5334A/B to front panel control; retains state prior to receipt of the LOCAL message.

NOTE

The HP 5334A/B does not respond to any device dependent commands when in LOCAL operation.

LOCAL/CLEAR LOCAL LOCKOUT: Returns the HP 5334A/B to front panel control following a LOCAL LOCKOUT message. Otherwise, the state of the HP 5334A/B remains as it was prior to receipt of the LCLL message.

LOCKOUT: Disables the HP 5334A/B RESET/LOCAL key. The HP 5334A/B remains in remote operation until a LOCAL message is received on the bus. The LOCAL LOCKOUT message can be used to maintain “absolute” programmatic control of the instrument.

SERVICE REQUEST: This message is ignored when received by the instrument. The HP 5334A/B can send a SERVICE REQUEST message (SRQ) to the controller under any or all of the following conditions, as defined by the Service Request Mask. The Service Request Mask must be set prior to the condition. All SRQ conditions can be masked off (disabled) by setting SM0. (See SM Command, paragraph 3-304.)

1. Data Ready. A measurement has been completed and is available for collection.
2. Error. An error condition exists and is displayed.
3. Local. The instrument is in local operation.

STATUS BYTE: The controller can read the HP 5334A/B STATUS BYTE at any time to check selected operating conditions. The assignment of the bits of the HP 5334A/B STATUS BYTE are shown in *Table 3-11*.

ABORT: Terminates any HP-IB activity and returns control to the system controller. Terminates all bus communications by unlistening and untalking all devices. Parameters remain as they were before the ABORT message. Any partially entered HP-IB data message is aborted.

3-299. SRQ and Status Byte

3-300. The counter can send a service request (SRQ) to the controller to indicate the need for attention, and can interrupt the current sequence of events. The Service Request Mask (SM command) must be set prior to the condition. All SRQ conditions can be masked off (disabled) by setting “SM0”. If all SRQ conditions are masked off, none of the following conditions will

generate an SRQ. Typically, SRQ indicates data is ready to transmit and/or an error condition exists. The counter can send an SRQ to the controller under any, or all of the following conditions, as defined by the Service Request Mask.

Data Ready. A measurement has been completed and is available for collection.

Error. An Error or Failure condition exists and is displayed.

Local. The instrument is in local operation.

3-301. In general, the controller can read the counter Status Byte at any time to check selected operating conditions. During remote operation, you may selectively program the Service Request Mask (SMn) to identify the conditions which you feel may require service or data collection.

3-302. Once SRQ has been sent, the controller can identify which condition or conditions caused the Service Request. When the Status Byte is read, conditions that exist will be set to 1, whether or not they were enabled as a condition to generate SRQ. For example; with the HP-85, "A=S POLL (703)" requests the eight-bit binary Status Byte, and sets the variable "A" equal to the value of the Status Byte. Then, if the statement "DISP A" is executed the HP-85 will display the Status Byte. The number returned will be a decimal equivalent to the sum of the different status bits that have been set, as shown in Table 3-11. With the HP 9825A/B, "rds(703)→A" requests the Status Byte, and "dsp A" sends the status to the HP 9825A/B display.

3-303. For example, the instrument sends a request for service (SRQ), and reading the Status Byte returned a value of "81". This (64+16+1=81) signifies: the RQS FLAG is set, the instrument is in local operation, and data is ready. The bits of the Status Byte are set regardless of the Service Request Mask. However, if a bit is masked off, it will not generate an SRQ.

Table 3-11. HP 5334A/B Status Byte

D7	D6	D5	D4	D3	D2	D1	D0
ALWAYS 0	RQS FLAG	NO OSC	LOCAL	FAILURE	ERROR	ALWAYS 0	DATA READY
128	64	32	16	8	4	2	1

3-304. Service Request Mask

3-305. Upon receipt of the Service Request Mask Command (SMn Command), the instrument will load the binary value of "n" into the service request mask register. The SRQ line/RQS bit will be set true ONLY if a bit in the status byte becomes true, and the corresponding bit set in the service request mask. Setting bit 6 (RQS) by itself (SM64), is equivalent to "SM0". Sending the command "SM0" masks off (or disables) all SRQ conditions. To specify the service request mask, send the SM command followed by a decimal number, representative of the binary sum of the bits you want enabled. You may send any number between 0 and 255, although only five bits indicated by (*) are actually used. The binary value of "n" is interpreted as follows:

BIT	DEFINITION	WEIGHT
Bit 7	Always 0	128
Bit 6	RQS	64
Bit 5*	No Oscillator	32
Bit 4*	Instrument in Local	16
Bit 3*	Failure Condition	8
Bit 2*	Error Condition	4
Bit 1	Always 0	2
Bit 0*	Data Ready (see note below)	1

For example, sending the command "SM13" will generate a service request (SRQ), and set Bit 6 (RQS), after an error or failure condition is generated, or when data is ready (8+4+1). The condition or conditions that caused the service request may be determined by reading the Status Byte.

NOTE

To guarantee SRQ at the end of a measurement, use the WA1 command. Bit 0, Data Ready, may not be set at the completion of a measurement, if the instrument is not addressed to talk, unless the instrument is in the Wait to be Addressed mode (WA1).

3-306. Device Dependent Commands

3-307. The counter will accept command strings in either upper or lower case. Spaces, commas and semicolons between commands are interpreted as command terminators. In addition, parity bits are ignored. Depending upon the controller, this can help to speed up programming. The following free format command statements will produce identical results:

```
OUTPUT 703: "FN1,TR1,AT1,FI1,GA2"  
OUTPUT 703: "fn+1 tr1 at 1.00 fi1; ga.2E1"
```

3-308. DEVICE COMMAND DEFINITIONS

3-309. A device command is a sequence of two or more ASCII-coded bytes, sent to the HP 5334A/B over the HP-IB that causes the counter to perform a specific function. Before discussing the individual commands, they will be defined according to type in the following paragraphs:

- a. NUMERIC commands: Type N; a sequence of two ASCII-coded bytes followed by a sequence of bytes representing a free format decimal number and a terminator (see paragraph 3-307). A termination may also be implied with the start of the next command. Numeric entry is discussed in detail in paragraph 3-310.

Equivalent numeric command examples:

```
OUTPUT 703; "MN12.3456"  
OUTPUT 703; "MN1.23456E+01"
```

```
OUTPUT 703; "MN1.23456E1"  
Normalize = 12.3456
```

- b. BINARY command: Type B; a sequence of two ASCII-coded bytes followed by either a 0 or a 1. The 0 indicates the selected function is "OFF" or "FALSE", and the 1 indicates "ON" or "TRUE". The numeric input is processed in the same format as numeric commands, except that the range of values accepted is only 0 and 1.

Binary command examples:

```
OUTPUT 703;"WA1"  
OUTPUT 703;"WA1.23"  
True = 1
```

```
OUTPUT 703;"WA0"  
OUTPUT 703;"WA0.1"  
False = 0
```

- c. INTEGER commands: Type I; a sequence of two ASCII-coded bytes followed by a sequence of bytes representing a decimal number and a terminator. For integer commands, the range depends on the specific command. The number is accepted in free format and converted to an integer. An error is generated if the number is negative, out of range, or if there is no number.

Equivalent integer command examples:

```
OUTPUT 703;"XA2"  
OUTPUT 703;"XA2.89"  
OUTPUT 703;"XA0.2E+1"
```

- d. TERSE commands: Type T; a sequence of two ASCII-coded bytes with no numeric character following them. These commands are executed immediately after the second character is received, and do not require a terminator. For example, the characters "IN" will cause the counter to INitalize all control settings to the default status.
- e. SPECIAL commands: Type I/O; a sequence of two ASCII-coded bytes that may or may not be followed by a sequence of bytes representing a defined value. For example; "SMn" will set the Service Request Mask to number representing the sum of the bits you want enabled; the counter will respond to "ID" by sending the string "HP 5334A/B", followed by CR/LF.

3-310. NUMERIC ENTRY

3-311. Numeric entry follows the code and format guidelines of the IEEE-728 standard for type NR3 numbers. It applies to the numeric portion of any command that requires the entry of a number. This is a "free format" input, with spaces allowed before a numeric character is entered, however, spaces following a numeric character are interpreted as command terminators. A decimal point and an exponent are allowed, but not required. "Free format" entries may be made in decimal, engineering or scientific notation. The maximum number of digits is 12. If a decimal point is entered and more than 12 digits are entered, the excess characters are ignored. If no decimal point is entered, trying to enter more than 12 digits will produce an error. Numeric entry is input in the following format:

```
<n spaces>|sign|<j digits>[.<K digits>|E|sign|<L digits>
```

where:

```
n = 0 to any number  
j = 1 to 12  
K = 0 to any number  
L = 1 or 2 (with any number of leading zeroes)
```

The following command strings are permitted, and are equivalent:

```
OUTPUT 703; "IN,GA1.5,BS1,XA3"  
OUTPUT 703; "INGA+0015E-01BS1.0XA00.0345E+2"
```

3-312. PROGRAMMING COMMANDS

3-313. All local functions are programmable with individual command codes via the interface. In general, all functions operate the same in remote as in local. The HP 5334A/B device commands are described in the following paragraphs, and listed in *Table 3-12*, HP 5334A/B Programming Command Set. The individual commands are organized into groups for ease of description and use.

3-314. Most of the alpha characters, used to represent each function in the command set, are underlined on the front panel of the counter. For example, in the MATH/MEMORY group the “M” for the group label, and the “D” for DISABLE are underlined; the alpha character set for Math Disable is MD.

3-315. Command Group Descriptions

3-316. INPUT GROUP. Most commands in the input group are equivalent to pressing a key, or a sequence of keys on the HP 5334A/B front panel, when the counter is in the local mode of operation. The binary commands in this group are equivalent to a single key stroke, and set the corresponding parameter to “ON” (1), or “OFF” (0). The numeric commands, AT and BT, require a numeric entry that sets the corresponding trigger level to a specific voltage. The integer commands, XA and XO, are equivalent to the local EXT ARM SELECT key sequence.

3-317. FUNCTION/DATA GROUP. All commands in the function/data group represent a corresponding HP 5334A/B front panel key. All function (FNn or FUn) commands are integer commands that require a numeric entry after the alpha characters. The “n” represents the number equivalent to the function selected, as listed in *Table 3-12*. When a function command is received it enables the corresponding measurement mode. To disable a measurement mode, another function command must be sent.

3-318. GATE GROUP. Commands in the gate group are equivalent to pressing a key or a sequence of keys, on the HP 5334A/B front panel, when the instrument is in the local mode. The GS and GV commands, equivalent to a single key stroke, are binary commands that set the corresponding parameter “ON” (1), or “OFF” (0). Numeric commands, GA, require a numeric entry that sets the gate time to a specified value.

3-319. MATH/MEMORY GROUP. Commands in the math/memory group are equivalent to pressing a key or a sequence of keys, on the HP 5334 A/B front panel, in the local mode of operation. The MD command, equivalent to a single key stroke, is a binary command that sets the corresponding parameter “ON” (1), or “OFF” (0). Numeric commands, MN and MO, require a numeric entry that sets the corresponding math operation to a specific value. Integer commands, MR and MS, are equivalent to the local STORE and RECALL key sequences. (The MR and MS commands are not valid for the HP 5334B.)

3-320. Miscellaneous and Special Functions

3-321. HS1: High Speed Output Mode On; high speed mode sends the HP 5334A/B measurement data to the counter in binary form. The data is sent in 8 bytes, terminated by an EOI with the last byte. In this mode the counter is capable of sending measurement data at the rate of 150 measurements per second. When the HS1 command is sent, it places the HP 5334A/B in the high speed output mode. The counter displays the message “FASt dAtA” while high speed measurements are being taken. The high speed output format is discussed in detail in paragraph 3-344.

3-322. HS0 (High Speed Output Mode Off): the HS0 command takes the counter out of the high speed output mode allows it to function in the normal remote state.

3-323. ID (Device Identification): When the ID command is sent, the counter will identify itself to the controller the next time the counter is addressed to talk. The string “HP 5334A/B” will be sent, followed by a carriage return and a line feed. The counter will wait until the device ID is read by the controller, then resume taking measurements.

3-324. IN (Initialize): The IN command causes the instrument to exit its current state and go to the power-on initialized state. If the instrument is in error state, error conditions 1.0 thru 4.4 will be cleared by the “IN” command, however, errors 5.0X through 5.2 and failures will not be cleared.

3-325. The initialized states are set as follows: All gate, math/memory, and input signal conditioning will be OFF; the function will be **FREQ A (FN1)**, with **AUTO TRIG (AU1)** and autoattenuation ON; gate time will be set at 300 milliseconds; math offset value will be set at +0, normalize value at +1; the input A (AT) and input B (BT) trigger levels will be set at 0 volts, and the internal trigger/sensitivity levels will be OFF (daCS OFF).

3-326. **RE (Reset)**: The reset command clears the current measurement and restarts a new measurement. However, unlike the **RESET/LOCAL** key, the **RE** command does NOT clear errors 5.0X through 5.2, nor any failures.

3-327. **SMn (Service Request Mask)**: Upon receipt of the Service Request Mask Command (**SMn**), the instrument will load the binary value of “n” into the service request mask register. The “n” represents the binary sum of the bits (conditions) you want enabled. The **SM** command is discussed in further detail in paragraph 3-304.

3-328. **SM0 (Service Request Mask Off)**: Sending the command “SM0” masks off (or disables) all **SRQ** conditions. When this command is sent no condition will enable a service request.

3-329. **TC (Transmit Calibration Data)**: When the controller sends the **TC** command, the counter sends a string of calibration data, preceded by a “C”, and followed by a carriage return and a line feed. The counter will wait until the calibration data is read, then resume taking measurements. The output format, and the use of calibration data is discussed in paragraph 3-349.

3-330. **TE (Transmit Error)**: When the transmit error command is received, the instrument will send the number of the detected error to the controller. The **TE** command clears the Error bit (bit 2) in the counter’s serial poll byte. It is recommended that “TE” be sent in a string by itself, not at the end of another string. The counter will discontinue normal operation until the error message is read. Note that reading the error code will not clear the error.

3-331. **WA1 (Wait To Be Addressed Mode On)**: **WA1** places the instrument in the Wait To Be Addressed Mode. The wait to be addressed mode forces the instrument to suspend subsequent measurements, and wait for the current measurement to be read by the controller. This mode is especially useful when used with the service request. The instrument will make a measurement, then alert the controller that data is ready by asserting **SRQ** when the measurement is completed. This frees the controller to perform other functions while the measurement is being processed, and ensures that the controller will know when the measurement is available.

3-332. **WA0 (Wait To Be Addressed Mode Off)**: **WA0** takes the instrument out of the wait to be addressed mode, and allows it to function in the normal remote state. In the normal state, measurements are made continuously, whether or not they are read by the controller.

Table 3-12. HP 5334A/B Programming Command Set

COMMAND GROUP	EQUIVALENT KEY/CONTROL	MNEMONIC	DESCRIPTION
INPUT	AC	AA0	Set Input A Coupling to DC
		AA1	Set Input A Coupling to AC
	SLOPE	AS0	Set Input A Slope to positive
		AS1	Set Input A Slope to negative
	TRIGGER LEVEL/SENS	AT<num>	Set Channel A Trigger Level <value>
	AUTO TRIG	AU0	Set AUTO TRIG Off
		AU1	Set AUTO TRIG On
	X10 ATTN	AX0	Set Input A Attenuation to X1
		AX1	Set Input A Attenuation to X10
	50Ω Z	AZ0	Set Input A Impedance to 1M-ohm
		AZ1	Set Input A Impedance to 50-ohm
	AC	BA0	Set Input B Coupling to DC
		BA1	Set Input B Coupling to AC
	SLOPE	BS0	Set Input B Slope to positive
		BS1	Set Input B Slope to negative
	TRIGGER LEVEL/SENS	BT<num>	Set Channel B Trigger Level <value>
	X10 ATTN	BX0	Set Input B Attenuation to X1
		BX1	Set Input B Attenuation to X10
	50Ω Z	BZ0	Set Input B Impedance to 1M-ohm
		BZ1	Set Input B Impedance to 50-ohm
COM A	CO0	Set COMMON inputs off	
	CO1	Set COMMON inputs on	
100 kHz FILTER A	FI0	Set Input A Filter off	
	FI1	Set Input A Filter on	
SENS	SE0	Set Sensitivity Mode Off	
	SE1	Set Sensitivity Mode On	
dACS OFF dACS On	TR0	Set Remote Trigger/Sensitivity Levels Off	
	TR1	Set Remote Trigger/Sensitivity Levels On	
START ARM	XA1	Set External Start Arm Slope to positive	
	XA2	Set External Start Arm Off	
	XA3	Set External Start Arm Slope to negative	
STOP ARM	XO1	Set External Stop Arm Slope to positive	
	XO2	Set External Stop Arm Off	
	XO3	Set External Stop Arm Slope to negative	
FUNCTION/ DATA	FREQ A	FN1	Frequency A
	FREQ B	FN2	Frequency B
	FREQ C	FN3	Frequency C
	PERIOD A	FN4	Period A
	T.I. A-B	FN5	Time Interval A to B
	T.I. A-B [DELAY]	FN6	Time Interval A to B with delay
	RATIO A/B	FN7	Ratio A/B

Table 3-12. HP 5334A/B Programming Command Set (Continued)

COMMAND GROUP	EQUIVALENT KEY/CONTROL	MNEMONIC	DESCRIPTION
FUNCTION/ DATA	TOT STOP A	FN8	Totalize Stop A
	TOT START A	FN9	Totalize Start A
	PULSE WIDTH A	FN10	Pulse Width A
	RISE/FALL TIME A	FN11	Rise/Fall Time A
	DVM	FN12	Voltage Mode
	READ TRIG LEVELS	FN13	Read A and B Channel Trigger Levels
	READ PEAKS A	FN14	Read Channel A \pm Peaks
	READ PEAKS B	FN15	Read Channel B \pm Peaks
		FU1-FU15	SAME AS FN1 through FN15
GATE	GATE TIME [DELAY]	GA<num>	Set Gate Time <value> Gate time range is 0.001 to 99.999s.
	SINGLE CYCLE	GS0 GS1	Set Single Gate Cycle Off Set Single Gate Cycle On
	100-GATE AVERAGE	GV0 GV1	Set 100-Gate Average Off Set 100-Gate Average On
MATH/ MEMORY (5334A)	DISABLE	MD0 MD1	Set Math Disable Off Set Math Disable On
	NORMALIZE	MN<num>	Set Normalize <value> Value Range is $\pm 1E-10$ to $\pm 9.999-999E+9$ (zero is disallowed)
	OFFSET	MO<num>	Set Offset <value> Value Range is $\pm 1E-10$ to $\pm 9.999-999E+9$ (zero is allowed)
	RECALL (5334A) STORE (5334A)	MR0-MR9 MS0-MS9	Recall Setup from Register <0-9> Store Setup into Register <0-9>
MISC AND SPECIAL FUNCTION	none	HS0 HS1	High Speed Output Mode Off High Speed Output Mode On
	none	ID	Device Identification
	POWER-ON	IN	Initialize
	none	RE	Reset
	none	SM<num>	Set SRQ Mask (Refer to Status Byte)
	none	TC	Transmit Calibration Data
	none	TE	Transmit Error (Refer to Error Handling)
	none	WA0 WA1	Wait To Be Addressed Mode Off Wait To Be Addressed Mode On

3-333. Output Formats

3-334. Most HP 5334A/B measurements are output to the HP-IB in scientific notation, while the HP 5334A/B display is given in engineering notation. The output data contains 19 characters which are arranged in the following format:

- Alpha character
- Variable number of spaces (N spaces)
- ± sign
- One digit
- Decimal point
- Variable number of digits (K digits)
- E ± sign
- Two exponent digits
- Carriage return
- Line feed

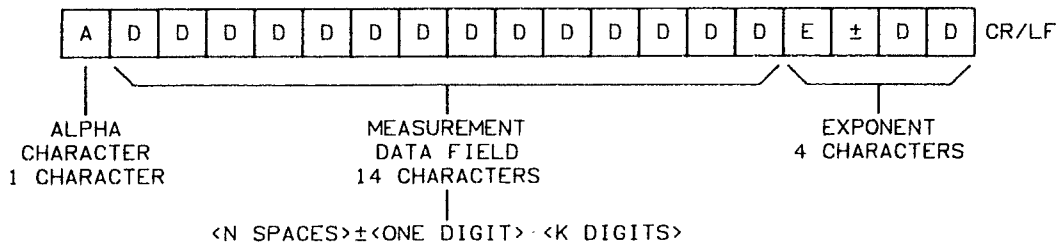

The decimal point is omitted if it is the last character preceding the exponent “E” in the output string. The first digit will be zero only if the data output is zero. At times, the display may contain a number which is equivalent to zero (such as 0E-9). If this is the case, the HP-IB output will be:

$$X \text{ 0E+00} \langle \text{CR/LF} \rangle$$

where X is the alpha character for the type of measurement.

3-335. ALPHA CHARACTER. One of 12 single characters which generally specify the type of measurement. It usually indicates the type of units. The alpha characters are:

- F precedes Frequency measurements; units are Hz (Hertz)
- S precedes Time measurements; units are S (Seconds)
- V precedes Voltage measurements; units are V (Volts)
- R precedes Ratio measurements; no units
- T* precedes Totalize Stop measurements; no units
- t* precedes Totalize Start measurements; no units
- A precedes Channel A trigger level; units are V (Volts)
- B precedes Channel B trigger level; units are V (Volts)
- H precedes Channel A and B upper peak levels

- L precedes Channel A and B lower peak levels
- O precedes measurements that overflow
- C precedes calibration data; no units

*See paragraph 3-342 for Totalize output.

3-336. MEASUREMENT DATA FIELD. The data field consists of a 14-character string. The number begins with the sign, followed by the digits in descending order of significance. The number is right-justified within the data field. To keep the number of characters consistent within the total string, spaces are inserted preceding the sign (\pm).

3-337. EXPONENT. Preceded by an "E" and the sign (\pm), the exponent will always be two digits. The format of the HP-IB output and the display may differ, since the HP-IB output is in scientific notation and the display is in engineering notation.

3-338. TYPICAL OUTPUT STRINGS. The following string illustrates the typical output for a FREQ A measurement of 458.341265 kHz. The output data is always followed by a (CR) carriage return, and a (LF) line feed.

F(sp)(sp)(sp)+4.58341265E+05<CR/LF>

3-339. If there is an overflow (the measurement is incorrect), the following output is sent over the HP-IB (unless the counter is in the High Speed Output mode, or the measurements is in one of the "split display" modes):

0+9.9999999999E+99<CR/LF>

3-340. Three measurement modes have a "split display", and have a different output format that is best illustrated by an example:

Trigger Levels A +2.30,B -2.00<CR/LF>
Peaks A, Peaks B H +40.4,L +2.1<CR/LF>

3-341. In the case of an overflow in Peaks A, or Peaks B (Trigger Levels cannot have an overflow), the format will be:

0+9999999,0+9999999<CR/LF>

3-342. TOTALIZE OUTPUT. When data is output in the Totalize mode, the "T" and the "t" usually represent TOT Stop and TOT Start, respectively. The "t" indicates an interim count or subtotal, and "T" indicates a final count. When totalizing is stopped (FN8), a final count is output. Additional events in the input signal will not continue the count, unless totalizing is restarted with the TOT Start command (FN9). An illustration of the totalize output is given in programming examples, paragraph 3-359. Note, in the talk-only mode only the final count, "T", is output.

3-343. If external arming is enabled, it is possible to stop counting in the TOT Start mode, or to continue counting in the TOT Stop mode. When external arming is used, the TOT Stop command may not stop the count. The stop arm signal will generate the "T" count. Therefore, a final count "T" may be output while the counter is still in the TOT Start mode, and interim counts "t" may be output in the TOT Stop mode.

3-344. High Speed Output Data

3-345. When the HP 5334A/B makes frequency measurement during normal operation, the counter's main gate opens synchronously with the input signal allowing the two internal MRC registers to begin accumulating counts. The MRC Event and Time Registers count pulses from the input signal and the internal time base (clock), respectively, during the time interval that the gate is open. During this same time interval, the interpolator circuitry determines where in relation to the 100-nanosecond time base pulses the counter's gate actually opens and closes. For instance, if the gate opens precisely between two 100-nanosecond pulses, the start interpolator will determine that a 50-nanosecond adjustment is needed. A similar adjustment is made by the stop interpolator for the gate closing.

3-346. At the end of the complete measurement, the data from both interpolators is combined with the count in the MRC Time Register to calculate the precise gate time interval. The counter's built-in microprocessor multiplies the number of accumulated clock pulses by the clock period combined with the interpolator adjustments to get (TIME). Then, computes frequency by dividing EVENTS/TIME, or computes period by dividing TIME/EVENTS. This computation is done automatically by the arithmetic unit of the microprocessor and the results are sent directly to the counter's display.

3-347. Since none of these calculations are done by the counter in the High Speed Output mode, raw data may be output at rates of up to 140 measurements per second. This allows the operator to manipulate or process the raw data with an external calculator to the appropriate form for the desired application. Note, long gate times will slow down the output rate. Data is sent directly to the HP-IB, in eight binary bytes, terminated by an EOI with the last byte. The eight bytes contain the following data:

Byte 1	E5 E4	Contents of the MRC E-register
Byte 2	E3 E2	in BCD (binary coded decimal).
Byte 3	E1 E0	
Byte 4	T5 T4	Contents of the MRC T-register
Byte 5	T3 T2	in BCD.
Byte 6	T1 T0	
Byte 7	ST	Interpolator Start count (binary)
Byte 8	SP	Interpolator Stop count (binary)

Overflow is indicated by E5 = 1111 (binary), or T5 = 1111 (binary).

3-348. The High Speed Output mode is recommended for the experience operator, since after the data is received by the controller it must be translated for the measurement information to be useful. High Speed Output is only applicable in frequency, period, time interval, and ratio measurements.

3-349. The High Speed Output data must be combined with the calibration data to calculate the desired measurement. It is recommended that the calibration data be output first, in the same measurement mode as the high speed data is to be output. Note, interpolation is not required in the ratio mode, therefore, the interpolator counts and the calibration data are not applicable for ratio measurements. Calibration data is output in response to the "TC" command, as follows:

C aaa,bbb,ccc,ddd<CR/LF>

where aaa, bbb, ccc, and ddd each contain three ASCII digits.

3-350. Once the calibration data has been output it may be used for several measurements in the same mode. Calibration data is combined with the high speed data in the following equation to calculate T corrected (TIME):

$$T \text{ corrected} = T + \frac{ST - ccc}{ddd} - \frac{SP - aaa}{bbb}$$

where ST and SP are the Interpolator Start count and Stop count, respectively, and T is the contents of the MRC T-register from the High Speed Output data.

NOTE

Add an offset of 256 to negative numerators between -5 and -256.

Then, T corrected is used to calculate the desired measurement. For example:

$$\text{Time Interval} = T \text{ corrected} \times 100 \text{ ns}$$

$$\text{Frequency (F)} = \frac{E}{T \text{ corrected} \times 100 \text{ ns}}$$

where E is the contents of the MRC E-register from the High Speed Output data.

NOTE

Refer to Programming Examples, paragraph 3-359, for a sample program to translate the high speed output and the calibration data into frequency measurements.

3-351. Ratio measurements are calculated by determining E/T or T/E from the High Speed Output data; where the MRC E-register contains the count from Input B, and the MRC T-register contains the count from Input A.

NOTE

Since **FREQ C** measurements are prescaled by 20, the E-register count must be multiplied by 20 to calculate the actual frequency.

3-352. Error Handling

3-353. Certain conditions will produce an error or failure state in the HP 5334A/B. Fail messages typically occur during the power-up cycle, and generally indicate a hardware related problem. Error messages generally indicate that the user has attempted a disallowed operation. Refer to paragraphs 3-88, Initial Power-up Checks and Self-Diagnostics, and 3-252, Error Indications, for further details on error and failure messages.

3-354. When the HP 5334A/B is operating in remote, all errors and failures produce a static error condition. Normal operation is suspended until the error is cleared. In an error state, the instrument ignores all HP-IB commands, except "IN", "TE", and "ID". Errors 1.0 through 4.4 are cleared by a Device Clear, Selected Device Clear, the "IN" command, and the RESET/LOCAL key.

(Pressing the RESET/LOCAL key will also return the counter to local operation.) Errors 5.0X through 5.2, and Failures are cleared only by the RESET/LOCAL key. Error messages are listed in *Table 3-3*, and Fail messages are listed in *Table 3-4*.

3-355. Error and Failure numbers can be read via the bus by sending the "TE" command. When the "TE" command is received, the instrument will send the error or failure message to the controller, but the instrument will remain in the error or failure number to the HP-85 display:

```
OUTPUT 703;"TE"  
ENTER 703;X$  
DISP X$
```

3-356. The Status Byte, refer paragraph 3-295, contains an error bit and a failure bit to flag an error condition. When an error condition occurs, the flag that is sent reflects the message displayed by the HP 5334A/B. The error flag is cleared when the error is cleared as described previously, or when the "TE" command is received. Note that the "TE" command clears the error flag in the Status Byte, but does not clear the error state. The failure flag is cleared only by pressing the RESET/LOCAL key.

3-357. Preset and Disallowed Conditions

3-358. As each HP 5334A/B function is selected, various parameter settings are controlled internally. These are referred to as PRESET and DISALLOWED conditions. The PRESET conditions are the parameter settings that are enabled on initial selection of each function. The DISALLOWED conditions are the parameter settings that are incompatible after initial selection of each function. Attempting to enable a disallowed parameter, in a given mode of operation, will produce an error condition. Error messages are listed in *Table 3-3*. PRESET and DISALLOWED conditions are listed in *Table 3-13*, including the equivalent HP-IB commands.

3-359. PROGRAMMING EXAMPLES

3-360. The following examples demonstrate the programming capabilities of the HP 5334A/B Universal Counter. The examples are written for an HP Series 200/300 Compatible Controller, using HP Basic 5.xx. A summary of the program operation and a line-by-line description are provided for each example.

3-361. The examples listed in this section assume an HP 5334A/B address setting "03". The counter is addressed to either talk or listen by using the code "703", where "7" is the interface select code, and "03" is the HP 5334A/B address. The command sent with the address determines whether the counter will talk or listen; such as, "OUTPUT 703" addresses the counter to listen, and "ENTER 703" addresses the counter to talk.

NOTE

HP 5334B WITH OPTION 700 (MATE) ONLY

SELECTING THE PROGRAMMING MODE. Option 700 allows the HP 5334B to respond to an additional control language called Control Interface Intermediate Language (CIIL). The instrument will still respond to its native (HP-IB) programming code, but this would only normally be used for troubleshooting and HP-IB operational verification.

The default instruction set for the HP 5334B Option 700 at power-up is determined by the setting of a jumper (J701) in the Option 700 MATE Processor Block Assembly. At J701, short together pins 2 (CIIL) and 3 (Common) for the default CIIL programming mode, or short together pins 3 (Common) and 4 (NAT) for the native (HP-IB) mode. No matter what the jumper setting is, either native or CIIL language can be selected via programming commands. Switching the Counter off and then on restores the language selected by the jumper.

When in CIIL mode, sending the CIIL operation code "GAL", (Go to Alternate Language), switches the HP 5334B to its native (HP-IB) language. When in native language, sending the command "CIIL" to the Counter will cause it to switch to the CIIL programming mode.

For complete CIIL programming information and Error Messages refer to the HP 5334B, Option 700 INTERNAL CIIL INTERFACE OPERATING AND PROGRAMMING MANUAL, HP Part Number 05334-90034.

EXAMPLE 1. IDENTIFYING AND INITIALIZING THE HP 5334A/B

The following example demonstrates how to identify the device at address 03, and how to initialize the counter. The program clears the controller screen, clears the HP 5334A/B, then requests the instrument identification. The response is read into "A\$", then displayed and printed by the controller. The program then sends the "IN" command, which initializes the counter.

The counter responds by setting the initialized states as follows: all gate, math/memory and input signal conditioning will be OFF; the function will be FREQA, with AUTO TRIG and auto-attenuation ON; gate time will be set at 300 milliseconds; math offset value will be set at +0, normalize value at +1; the input A and input B trigger levels will be set at 0 volts, and the internal trigger, sensitivity levels will be OFF.

```

10 CLEAR SCREEN           ! Clear the controller display
20 CLEAR 703             ! Clear device at address 703
30 OUTPUT 703;"ID"      ! Send "ID" command to device at address
40                       ! 03. The "ID" command requests the instrument
50                       ! to return its identification; the 5334A/B will
60                       ! return the string HP 5334A or HP 5334B
70 ENTER 703;A$         ! Read 5334A/B "ID" response into A$
80 DISP A$              ! Send contents of A$ to controller screen
90 PRINT A$             ! Send contents of A$ to default printer
100 OUTPUT 703;"IN"    ! Set 5334A/B to initialized state
110 END

```

EXAMPLE 2. SENDING MEASUREMENTS TO THE CONTROLLER

This program displays each measurement sent to the controller. The program clears the controller screen, initializes the HP 5334A/B to a known state, sets the input to common, and selects the Time Interval Delay mode of operation. The variable, X\$, is dimensioned to 19 characters to accommodate the measurement output string. The next triggered measurement is read into "X\$", then displayed on the controller screen. The program then repeats reading and displaying measurements.

```

10 CLEAR SCREEN           ! Clear the controller screen
20 OUTPUT 703;"IN,CO1, FN6" ! Send "IN,CO1, FN6" commands to the 5334A/B.
30                       ! The command "IN" sets counter to a known
40                       ! state, "CO1" turns COMMON inputs on, and "FN6"
50                       ! sets the measurement to Time interval with
60 OUTPUT 703;"GA1"      ! Delay mode. "GA1" sets delay to one second.
70 DIM X$[19]           ! Dimension "X$" to 19 characters
80 ENTER 703;X$         ! Read 5334A/B measurement into X$
90 DISP X$              ! Send contents of X$ to controller screen
100                      ! The result shown is the time interval delay.
110 GOTO 80             ! Return to line 40
120 END                 ! End program execution

```

EXAMPLE 3. MEASUREMENT AVERAGING

This example displays each measurement average sent to the controller. The program clears the controller screen, initializes the HP 5334A/B to a known state, selects the Pulse Width measurement mode, and selects 100-Gate Average mode. The variable, X\$, is dimensioned to 19 characters to accommodate the measurement output string. The next measurement average is read into "X\$", then displayed on the controller screen. The program then repeats averaging, reading and displaying measurement.

```

10 CLEAR SCREEN           ! Clear the controller screen
20 OUTPUT 703;"IN, FN10, GV1" ! Send "IN, FN10, GV1" commands to the
30                       ! 5334A/B. The command "IN" sets counter to
40                       ! a known state; "FN10" sets counter to Pulse
50                       ! Width mode; "GV1" sets counter to 100-Gate
60                       ! Average mode.
70 DIM X$[19]           ! Dimension "X$" to 19 characters
80 ENTER 703;X$         ! Read 5334A/B measurement into X$
90 DISP X$              ! Send contents of X$ to controller screen
100 GOTO 80             ! Return to line 40
110 END                 ! End program execution

```

EXAMPLE 4. DISPLAYING THE STATUS BYTE

The following example reads the status byte of the 5334A/B by conducting a serial poll at address 03. The value returned is read into variable "A". The program then displays the definition of each bit and the corresponding bit value returned by the serial poll.

```

10  A=SPOLL(703)           ! Conduct a serial poll of the
20                          ! 5334A/B, and read the status
30                          ! byte into "A".
40  PRINT "REQUEST SERVICE = ";BIT(A,6) ! Display "REQUEST SERVICE="
50                          ! followed by the value of bit 6
60                          ! of the status byte.
70  PRINT "NO OSCILLATOR = ";BIT(A,5)  ! Display "NO OSCILLATOR="
80                          ! followed by the value of bit 5
90                          ! of the status byte.
100 PRINT "INSTRUMENT IN LOCAL = ";BIT(A,4) ! Display "INSTRUMENT IN LOCAL="
110                          ! followed by the value of bit 4
120                          ! of the status byte.
130 PRINT "FAILURE OCCURRED = ";BIT(A,3) ! Display "FAILURE OCCURRED="
140                          ! followed by the value of bit 3
150                          ! of the status byte.
160 PRINT "ERROR OCCURRED = ";BIT(A,2)  ! Display "ERROR OCCURRED="
170                          ! followed by the value of bit 2
180                          ! of the status byte.
190 PRINT "DATA READY = ";BIT(A,0)      ! Display "DATA READY=" followed
200                          ! by the value of bit 0 of the
210                          ! status byte.
220 END                          ! End program execution.

```

Running the program produces displays similar to the following:

```

REQUEST SERVICE = 0
NO OSCILLATOR = 0
INSTRUMENT IN LOCAL = 1
FAILURE OCCURRED = 0
ERROR OCCURRED = 0
DATA READY = 0

```

EXAMPLE 5, A) TYPICAL MEASUREMENT FORMAT

This program first dimensions string variable A\$, in the controller, to 19 characters to accommodate the measurement output string. Then sets the counter to its initialized state with a gate time of 500 ms (0.5 seconds). The counter will make a simple Frequency A measurement. The controller will then read the next measurement and cycle is repeated.

```

10  DIM A$(19)             ! Dimension "A$" to 19 characters
20  OUTPUT 703;"IN,GA.5"  ! Send "IN,GA.5" commands to the 5334A/B.
30                          ! The command "IN" initializes counter to
40                          ! known state (FREQ A mode on); "GA.5" sets
50                          ! gate time to 500 msec.
60  ENTER 703;A$          ! Read 5334A/B measurement into A$
70  PRINT A$              ! Send contents of A$ to default printer.
80  GOTO 60               ! Return to line 60.
90  END                   ! End program execution.

```

EXAMPLE 5. B) TYPICAL MEASUREMENT FORMAT

This example demonstrates how the controller can be used to display a measurement every 5 seconds. After a measurement is accepted, the counter waits for the next read command to be executed. During the wait statement although the counter is addressed to talk, it will check to make sure the listening device is ready for data. If the controller is not ready to accept data, the counter will stop trying to output the data and start a new measurement. In this example the HP 5334A/B will continue to make measurements without sending data, until 5 seconds have elapsed. After 5 seconds, the next measurement is read and sent to the controller screen.

```
10 DIM A$[19]           ! Dimension "A$" to 19 characters
20 OUTPUT 703;"IN"      ! Send "IN" command to the 5334A/B.
30                     ! The command "IN" initializes counter to
40                     ! known state (FREQ A mode on)
50 ENTER 703;A$         ! Read 5334A/B measurement into A$
60 PRINT A$            ! Send contents of A$ to default printer
70 WAIT 5              ! Wait 5 seconds
80 GOTO 50             ! Return to line 50.
90 END                 ! End program execution.
```

Note, the check is done only for the first character of a measurement data string. Subsequent characters are automatically sent if the listening device is ready for data.

EXAMPLE 5. C) TYPICAL MEASUREMENT WITH WAIT MODE ON

The "WA1" command tells the HP 5334A/B to wait at the end of each measurement to output the data. During the 5-second wait period the counter will wait until the controller reads the measurement data, before starting the next measurement. When using fast controllers, it is recommended to use the "WA1" command.

```
10 DIM A$[19]           ! Dimension "A$" to 19 characters
20 OUTPUT 703;"IN,WA1,GA.01" ! Send "IN,WA1,GA.01" commands to the 5334A/B.
30                     ! The command "IN" initializes counter to
40                     ! known state (FREQ A mode on);"WA1" places
50                     ! counter in Wait to be Addressed mode;"GA.01"
60                     ! sets the gate time to 10 msec.
70 ENTER 703;A$         ! Read 5334A/B measurement into A$
80 PRINT A$            ! Send contents of A$ to default printer
90 WAIT 5              ! Wait 5 seconds
100 GOTO 70            ! Return to line 70.
110 END                 ! End program execution.
```

Note, with the short gate time (10 ms), the data displayed in this example is about 5 seconds old.

EXAMPLE 6. SEND SRQ WHEN DATA IS READY

This example demonstrates the use of the Wait mode to ensure SRQ when data is ready. The program initializes the counter, sets the gate time to 1s, and enables the Period A measurement mode. The SRQ Mask is set to assert SRQ when data is ready, and the Wait mode is set so that the counter will Wait To Be Addressed to send measurement data. Additionally, if the counter does not have a measurement ready, it is read and displayed and the process is then repeated.

In this example, the controller checks the HP-IB interface for the status of the SRQ line, without disturbing the counter during measurements.

```

10 DIM A$(19)                ! Dimension "A$" to 19 characters
20 OUTPUT 703;"IN,GA1,FN4,SM1,WA1" ! Send "IN,GA1,FN4,SM1,WA1" commands to
30                            ! the 5334A/B counter. "IN" initializes
40                            ! the counter, "GA1" sets gate time to one
50                            ! second, "FN4" places counter in Period
60                            ! A mode, "SM1" sets SRQ mask to assert
70                            ! SRQ when data is ready, "WA1" sets
80                            ! counter in Wait to be Addressed mode.
90 FOR N=1 TO 100            ! Sets up loop for timeout if counter
100                           ! has no data ready.
110 STATUS 7,7;Reg           ! Check controller interface register 7,
120                           ! and read byte contents into "Reg"
130 IF BIT(Reg,10) THEN GOTO 210 ! If Bit 10 in Status Register 7 is True,
140                           ! SRQ has been asserted. Read the data.
150 WAIT .05                 ! If counter has no data, wait 50 msec,
160 NEXT N                   ! then go back and check the Status again
170 DISP "    TIMEOUT **    check signal"
180 BEEP                     ! Alert the user that there is no data
190                           ! after the timeout has elapsed.
200 STOP                    ! Stop program execution
210 ENTER 703;A$            ! Read 5334A/B measurement into A$
220 PRINT A$                ! Send contents of A$ to default printer
230 WAIT 5                  ! Wait 5 seconds
240 GOTO 210                ! Return to 210; get a new measurement
250 END                     ! End program execution.

```

Running the program produces a display similar to the following; removing the signal from the Input after several measurements have been displayed, will time-out and stop the program as shown:

```

S    +1.000000000E-07
S    +9.999999999E-08
S    +1.000000001E-07
S    +1.000000000E-07
S    +1.000000000E-07
S    +1.000000000E-07

```

```

    TIMEOUT *
CHECK SIGNAL

```

EXAMPLE 7. TOTALIZE MEASUREMENTS

This program demonstrates the difference between "t" and "T" outputs during the Totalize mode. The program totalizes counts for approximately 10 seconds. During this time four intermediate counts are printed out at 2,4,6, and 8 seconds. A final count is printed after the Totalize Stop command is executed at ≈10 seconds, then the process is repeated.

```
10 DIM A$(19)           ! Dimension "A$" to 19 characters
20 OUTPUT 703;"IN,TR1"  ! Send "IN,TR1" commands to 5334A/B.
30                     ! "IN" initializes the counter and sets the
40                     ! internal trigger levels to 0 volts; "TR1"
50                     ! sets the internal trigger level controls on
60                     ! (dACs On - needed for 5334A only) and turns
70                     ! AUTO TRIG off.
80 OUTPUT 703;"RE, FN9" ! Send "RE, FN9" commands to 5334A/B.
90                     ! "RE" resets the counter and starts a new
100                    ! measurement, "FN9" sets counter in Totalize
110                    ! Start mode.
120 FOR J=1 TO 4        ! Sets up loop to read and print out four measurements
130 WAIT 2              ! WAIT 2 seconds
140 ENTER 703;A$       ! Read 5334A/B totalize measurement into "A$"
150 PRINT A$           ! Print the value of A$, the accumulated counts.
160 NEXT J             ! Go back to line 120 and repeat the process until
170                    ! the fourth measurement has been read.
180 WAIT 2             ! WAIT 2 seconds
190 OUTPUT 703;"FN8"   ! Send "FN8" command to the 5334A/B. "FN8" sets the
200                    ! counter in the Totalize Stop mode.
210 ENTER 703;A$       ! Read 5334A/B measurement into "A$"
220 PRINT A$           ! Print the value of A$, the total count value
230 PRINT              ! Skip a line ( <CR/LF> )
240 GOTO 80            ! Return to line 80 and repeat the process
250 END                ! End program execution
```

Running the program produces a printout similar to the following:

```
t    +1.6210553E+07
t    +3.3449251E+07
t    +5.0649203E+07
t    +6.7846117E+07
T    +8.5617187E+07

t    +1.6644877E+07
t    +3.3883031E+07
t    +5.1528247E+07
t    +6.8836247E+07
T    +8.6600098E+07

t    +1.6644067E+07
t    +3.3882901E+07
t    +5.1067083E+07
t    +6.8250197E+07
T    +8.6114613E+07

t    +1.6644547E+07
t    +3.3773607E+07
t    +5.0982879E+07
t    +6.8305849E+07
T    +8.6183997E+07
```

EXAMPLE 8. ENTERING MATH CONSTANTS

This program demonstrates one method of using Math constants to manipulate measurement data. The program clears the controller and asks for the offset value, and the normalize value to be entered on the screen. The entered values are sent to the counter with the math commands, and the resultant measurement is read and printed out. The process is then repeated.

```

10 DIM X$(19)           ! Dimension "X$" to 19 characters
20 PRINT "Frequency Offset?" ! Ask for the "offset" value
30 INPUT O              ! Read the entered value into "O"
40 PRINT "Normalize value?" ! Ask for the "normalize value"
50 INPUT N              ! Read the entered value into "N"
60 OUTPUT 703;"IN,MO";O;"MN";N ! Send "IN,MO;O;MN;N" commands to
70                     ! the 5334A/B. "IN" initializes the counter
80                     ! (FREQ A mode); "MO";O sets math offset to
90                     ! the value entered for "O"; "MN";N sets
100                    ! math normalize to the value entered for "N"
110 ENTER 703;X$       ! Read the response into "X$"
120 PRINT "OFFSET      = ";O ! Print "OFFSET =", followed by the value
130                    ! of "O".
140 PRINT "NORMALIZE = ";N ! Print "NORMALIZE =", followed by the value
150                    ! of "N".
160 PRINT              ! Skip a line ( <CR/LF> )
170 PRINT "RESULT     = ";X$ ! Print "RESULT =", followed by the contents
180                    ! of "X".
190 PRINT              ! Skip a line ( <CR/LF> )
200 GOTO 20            ! Return to line 20, and repeat the process.
210 END                ! End program execution.

```

Running the program will product a printout similar to the following:

```

Frequency Offset?
Normalize value?
OFFSET = 100
NORMALIZE = 50

```

```

RESULT = F +2.000999999E+05

```

```

Frequency Offset?
Normalize value?
OFFSET = 1000
NORMALIZE = 100

```

```

RESULT = F +1.009999999E+05

```

```

Frequency Offset?
Normalize Value?
OFFSET = 0
NORMALIZE = 1

```

```

RESULT = F +9.999999999E+06

```

```

Frequency Offset?

```

EXAMPLE 9. CALCULATING SLEW RATE MEASUREMENTS

This program is an example of how 5334A/B can be used to make Slew Rate measurements. The program makes a Rise Time measurement, followed by a Channel A Peak Voltage levels measurement, and uses the data to calculate the Slew Rate of the leading edge of the input signal. Then the Rise Time, Peak-to-Peak Voltage, and Slew Rate are displayed, and the process is repeated. For this example the positive slope of the signal is measured, but the program can be modified to measure the negative slope (Fall Time).

```

10 DIM T$[19]           ! Dimension string variable "T$" to 19 chars.
20 OUTPUT 703;"IN,FN11" ! Send "IN,FN11" commands to 5334A/B.
30                     ! "IN" initializes the counter, "FN11" command
40                     ! enables Rise Time mode.
50 ENTER 703;T$        ! Read rise time measurement into "T$".
60 OUTPUT 703;"FN14"   ! Send "FN14" command to enable Channel A
70                     ! Peak voltage mode.
80 ENTER 703;H,L       ! Read upper peak level into "H" and lower peak
90                     ! level into "L".
100 P=H-L              ! Calculate the p-p voltage (P) by subtracting
110                     ! the lower peak value (L) from the upper peak
120                     ! value (H).
130 T=VAL(T$[2,19])    ! Transfer the numeric value of T$ (rise time)
140                     ! into numeric variable "T".
150 S=.8*P/T           ! Calculate the slew rate (S) by finding 80%
160                     ! of the p-p voltage (P), and dividing by the
170                     ! rise time (T).
180 PRINT "RISE TIME = ";T$[11,19];" SEC "
190                     ! Print "RISE TIME =" followed by the value of
200                     ! T$ (characters 11 through 19), "SEC".
210 PRINT "P-P SIGNAL = ";P;"VOLTS "
220                     ! Print "P-P SIGNAL =", followed by the value of
230                     ! P, "VOLTS".
240 PRINT USING 260;S   ! Print the value of S, using the format "DD.DDE"
250                     ! in line 260.
260 IMAGE "SLEW RATE = ",DD.DDE," VOLTS/SEC"
270                     ! Output "SLEW RATE =", followed by the value of S
280                     ! and "VOLTS/SEC".
290 PRINT              ! Skip 2 lines ( <CR/LF> )
300 PRINT
310 GOTO 20            ! Return to line 20 and repeat the process.
320 END                ! End program execution.

```

Running the program will produce a display similar to the following:

```

RISE TIME = +2.8E-08 SEC
P-P SIGNAL = 2.42 VOLTS
SLEW RATE = 69.14E+06 VOLTS/SEC

```

```

RISE TIME = +2.8E-08 SEC
P-P SIGNAL = 2.42 VOLTS
SLEW RATE = 69.14E+06 VOLTS/SEC

```

```

RISE TIME = 2.8E-08 SEC
P-P SIGNAL = 2.42 VOLTS
SLEW RATE = 69.14E+06 VOLTS/SEC

```

```

RISE TIME = 2.8E-08 SEC
P-P SIGNAL = 2.42 VOLTS
SLEW RATE = 69.14E+06 VOLTS/SEC

```

EXAMPLE 10. TRANSLATING HIGH SPEED DATA OUTPUTS

This program will take 140 readings in the High Speed Output mode, read the calibration data in the same measurement mode, then combine and manipulate the data to determine the frequency and print the results. The controller will alert the user (beep) before the data transfer begins and after the data transfer is complete. This gives the user an idea of how quickly the 5334A/B makes 140 frequency readings in the High Speed Output mode. If either the E or T register overflows, the program will enter a value of +9.99E+99 for the frequency reading. Note that this is only one example for reading, manipulating and displaying High Speed measurement data. The operator may adopt the process to suit the application. Refer to paragraph 3-344 for further details on the High Speed Output data.

```

10    ! PROGRAM:  34B_EX10
20    ! High Speed Output Data Dump for the 5334B
30    ! Universal Frequency Counter
40    ! AI-5/1/91
50    !
60    OPTION BASE 0           ! Array default numbering starts at 0
70    DIM X(140),E(140),T(140) ! Dimension buffer to hold 140 Measurements
80                                ! at 8bytes each
90    DIM X$(1128) BUFFER     ! Dimension measurement array for 1128 bytes
100   ASSIGN @Buf1 TO BUFFER X$ ! Set up the transfer path to the I/O buffer
110   PRINT "Enter 5334A/B address."
120   INPUT A                 ! Accept the counter address
130   ASSIGN @Device TO A;FORMAT OFF ! Assign a variable counter address
140                                ! FORMAT OFF is used to ignore the EOI
150   ! IN Initialize counter, TR1 turns internal trigger control on and
160   ! turns AUTO TRIG off, GA.001 sets the gate time to 1msec for
170   ! fastest output rate, HS1 puts counter into High Speed Output Mode
180   OUTPUT A;"INTRIGA.001HS1" ! Vary the gate time here to see effects
190   OUTPUT A;"TC"           ! Request calibration data from the counter
200   ENTER A;Cal1,Cal2,Cal3,Cal4 ! Receive the cal factors from the counter
210   BEEP
220   PRINT "START DATA TRANSFER..."
230   ! Transfer the contents of the MRC register into "Buf1" and wait
240   ! for 140 records (8-byte measurements) to transfer, ignoring the EOI
250   Starttime=TIMEDATE      ! Timestamp the data throughput
260   TRANSFER @Device TO @Buf1;RECORDS 140,EOR (END),WAIT
270   Stoptime=TIMEDATE
280   Delta=Stoptime-Starttime ! Delta is the total transfer time
290   PRINT "Throughput = ",140 DIV Delta," Meas/sec."
300   PRINT "END DATA TRANSFER..."
310   BEEP                    ! Audible tone alerts user to the end of data
320   PRINT ""                ! transfer.
330   PRINT ""
340   PRINT ""
350   PRINT "PLEASE WAIT ...."
360   PRINT ""
370   FOR J=0 TO 139          ! Sets up loop to manipulate 140 measurements
380     IF INT(NUM(X$(8*J+1,8*J+1)) DIV 16)9 THEN
390       X(J)=9.99E+99      ! If E-register overflows set the measurement
400       GOTO 990          ! equal to 9.99E+99 and go to line 620
410     END IF
420     IF INT(NUM(X$(8*J+4,8*J+4)) DIV 16)9 THEN
430       X(J)=9.99E+99      ! If T-register overflows set the measurement
440       GOTO 990          ! equal to 9.99E+99 and go to line 620
450     END IF
460     FOR I=1 TO 3          ! Sets up loop to manipulate the first three
470       ! bytes of every 8-byte unit of data to
480       ! calculate the number of counts in the
490       ! events register.
500       A$(2*I-1,2*I-1)=CHR$(INT(NUM(X$(I+8*J,I+8*J))/16)+48)

```

EXAMPLE 10 Continued

```

510 ! Manipulates the four most significant (upper) bits of each byte in the
520 ! loop. Takes each 8-byte unit of data from X$, derives the decimal value
530 ! of the first character in the string, determines the integer value of
540 ! the upper bits (divide by 16 is like shifting the original binary number
550 ! four places to the right to drop the lower four bits), converts the
560 ! numeric expression to the appropriate character, and places the
570 ! character in the first position of each 2-character unit read into A$.
580     A$[2*I,2*I]=CHR$(BINAND(NUM(X$[I+8*J,I+8*J]),15)+48)
590 ! Manipulates the four least significant (lower) bits of each byte in the
600 ! loop. Takes each 8-byte unit of data from X$, derives the decimal value
610 ! of the first character in the string, performs a bit-by-bit binary
620 ! "AND" using 15 and the evaluated integer (to cancel out the upper four
630 ! bits), returns the integer result, converts the numeric expression to
640 ! the appropriate character, and places the character in the second
650 ! position of each 2-character unit read into A$.
660     NEXT I           ! Repeat until the third byte has been read into A$
670     E(J)=VAL(A$)     ! Set E(J) equal to the contents of the E-register
680     FOR I=4 TO 6     ! Sets up loop to manipulate the second three bytes
690                       ! of every 8-byte unit of data to calculate the
700                       ! number of counts in the time register.
710         B$[2*I-7,2*I-7]=CHR$(INT(NUM(X$[I+8*J,I+8*J])/16)+48)
720 ! Manipulates the upper four bits of each byte in the loop, using same
730 ! process as defined in line 510, and places the character in the first
740 ! position of each 2-character unit read into B$.
750         B$[2*I-6,2*I-6]=CHR$(BINAND(NUM(X$[I+8*J,I+8*J]),15)+48)
760 ! Manipulates the lower four bits of each byte in the loop, using the same
770 ! process as defined in line 590, and places the character in the second
780 ! position of each 2-character unit read into B$.
790     NEXT I           ! Repeat until the sixth byte has been read into B$
800     T(J)=VAL(B$)     ! Set T(J) equal to the contents of the T-register
810     Start_int=NUM(X$[8*J+7,8*J+7])
820 ! Derives the decimal value of the seventh byte of every 8-bit unit
830 ! of data to determine the number of counts in the start interpolator,
840 ! and reads the value into Start_int.
850     Stop_int=NUM(X$[8*J+8,8*J+8])
860 ! Derives the decimal value of the eighth byte of every 8-bit unit of
870 ! data to determine the number of counts in the stop interpolator,
880 ! and reads the value into Stop_int.
890     IF (Start_int-Cal3)4 THEN Start_int=Start_int+256
900 ! Adds an offset of 256 if Start_int-Cal3 is negative number (-5 to -256)
910     IF (Stop_int-Cal1)4 THEN Stop_int=Stop_int+256
920 ! Adds an offset of 256 if Stop_int-Cal1 is a negative number (-5 to -256)
930     Tc=T(J)+(Start_int-Cal3)/Cal4-(Stop_int-Cal1)/Cal2
940 ! Calculates T corrected using the equation shown in paragraph 3-262,
950 ! and reads the value into Tc.
960     X(J)=E(J)/(Tc*.0000001)
970 ! Calculates Frequency using the equation shown in paragraph 3-262, and
980 ! reads the value into X(J). (Freq = E / (Tcorrected * 100nsec))
990     NEXT J
1000 ! Repeat the process until the last measurement has been calculated.
1010 FOR J=0 TO 139     ! Sets up loop to print 140 measurements
1020     PRINT USING 1030;J+1,X(J)
1030     IMAGE 3D,3X,"Frequency = ",SD.DDDE,XX,"Hz"
1040 NEXT J
1050 PRINT ""
1060 PRINT "Calculations complete!"
1070 END

```

Table 3-13. HP-IB Preset and Disallowed Condition

MODE	PRESET CONDITIONS			DISALLOWED CONDITIONS	
	PARAMETER	SETTING	EQUIVALENT HP-IB COMMAND	SETTING	EQUIVALENT HP-IB COMMAND
FREQ A (FN1) INITIALIZED AT POWER-UP	SINGLE CYCLE 100-GATE AVERAGE EXT ARMING MATH DISABLE GATE TIME (set at 300 ms at power-up only)	OFF OFF OFF ON	GS0 GV0 XA2, XO2 MD1	none none none none	
FREQ B (FN2)	SINGLE CYCLE 100-GATE AVERAGE EXT ARMING MATH DISABLE	OFF OFF OFF ON	GS0 GV0 XA2, XO2 MD1	none none none none	
FREQ C (FN3)	SINGLE CYCLE 100-GATE AVERAGE EXT ARMING MATH DISABLE AUTO TRIG	OFF OFF OFF ON OFF	GS0 GV0 XA2, XO2 MD1 AU0	none none none none ON	AU1
PERIOD A (FN4)	SINGLE CYCLE 100-GATE AVERAGE EXT ARMING MATH DISABLE	OFF OFF OFF ON	GS0 GV0 XA2, XO2 MD1	none none none none	
T.I. A→B (FN5)	SINGLE CYCLE 100-GATE AVERAGE EXT ARMING MATH DISABLE	OFF OFF OFF ON	GS0 GV0 XA2, XO2 MD1	none none none none	
T.I. A→B [DELAY] (FN6)	SINGLE CYCLE 100-GATE AVERAGE EXT ARMING MATH DISABLE	OFF OFF OFF ON	GS0 GV0 XA2, XO2 MD1	none none none none	
RATIO A/B (FN7)	SINGLE CYCLE 100-GATE AVERAGE EXT ARMING MATH DISABLE Calibration Data disallowed in Ratio mode)	OFF OFF OFF ON	GS0 GV0 XA2, XO2 MD1	none none none none	TC
TOT STOP A (FN8) TOT START A (FN9)	SINGLE CYCLE 100-GATE AVERAGE EXT ARMING MATH DISABLE AUTO TRIG GATE TIME ENTRY controlled by TOT STOP A High Speed Mode Wait to be Addressed Mode Calibration Data disallowed in Totalize mode	OFF OFF OFF ON OFF OFF OFF	GS0 GV0 XA2, XO2 MD1 AU0 HS0 WA0	ON ON none OFF ON ON ON	GS1 GV1 MD0 AU1 GA<n> HS1 WA1 TC
PULSE WIDTH A (FN10)	SINGLE CYCLE 100-GATE AVERAGE EXT ARMING SLOPES MATH DISABLE AUTO TRIG X10 ATTN controlled by AUTO TRIG SENS DACS High Speed Mode Calibration Data disallowed in Pulse Width mode	OFF OFF OFF ON ON OFF OFF OFF	GS0 GV0 XA2, XO2 MD1 AU1 SE0 TR0 HS0	none none none none OFF ON/ OFF ON ON ON	AU0 AX1, BX1 AX0, BX0 SE1 TR1 HS1 TC

Table 3-13. HP-IB Preset and Disallowed Condition (Continued)

MODE	PRESET CONDITIONS			DISALLOWED CONDITIONS	
	PARAMETER	SETTING	EQUIVALENT HP-IB COMMAND	SETTING	EQUIVALENT HP-IB COMMAND
RISE/FALL TIME A (FN11)	SINGLE CYCLE	OFF	GS0	none	
	100-GATE AVERAGE	OFF	GV0	none	
	EXT ARMING SLOPES	OFF	XA2, XO2	none	
	MATH DISABLE	ON	MD1	none	
	AUTO TRIG	ON	AU1	OFF	AU0
	X10 ATTN controlled by AUTO TRIG			ON/	AX1, BX1
	SENS	OFF	SE0	OFF	AX0, BX0
	DACS	OFF	TR0	ON	SE1
	COM A*	ON	CO1	ON	TR1
				OFF	CO0
	INPUT B SLOPE controlled by INPUT A			+SLOPE/	BS1
	INPUT B COUPLING controlled by INPUT A			-SLOPE	BS0
	INPUT B IMPEDANCE controlled by INPUT A			AC/	BA1
				(DC)	BA0
FILTER A	OFF	FI0	50Ω Z/	BZ1	
High Speed Mode	OFF	HS0	(1MΩ Z)	BZ0	
Calibration Data disallowed in Rise/Fall Time mode			ON	FI1	
			ON	HS1	
				TC	
*NOTE					
INPUT B SLOPE, COUPLING, and IMPEDANCE are set to corresponding INPUT A settings via COM A.					
DVM (5334A) (FN12)	SINGLE CYCLE	OFF	GS0	ON	GS1
	100-GATE AVERAGE	OFF	GV0	ON	GV1
	EXT ARMING SLOPES	OFF	XA2, XO2	ON+	XA1, XO1
				OFF	XA2, XO2
				ON-	XA3, XO3
	MATH DISABLE	ON	MD1	none	
	AUTO TRIG	OFF	AU0	ON	AU1
	GATE TIME ENTRY (100 ms) controlled by DVM			ON	GA<n>
High Speed Mode	OFF	HS0	ON	HS1	
Calibration Data disallowed in Voltage mode			TC		
READ TRIGGER LEVELS (FN13)	SINGLE CYCLE	OFF	GS0	none	
	100-GATE AVERAGE	OFF	GV0	ON	GV1
	EXT ARMING SLOPES	OFF	XA2, XO2	ON+	XA1, XO1
				OFF	XA2, XO2
				ON-	XA3, XO3
	MATH DISABLE	ON	MD1	OFF	MD0
	AUTO TRIG	OFF	AU0	ON	AU1
	GATE TIME ENTRY disallowed by TRIG LEVEL			ON	GA<n>
High Speed Mode	OFF	HS0	ON	HS1	
Calibration Data disallowed in Trigger Levels mode				TC	
READ PEAKS A (FN14)	SINGLE CYCLE	OFF	GS0	none	
	100-GATE AVERAGE	OFF	GV0	ON	GV1
	EXT ARMING SLOPES	OFF	XA2, XO2	ON+	XA1, XO1
PEAKS B (FN15)				OFF	XA2, XO2
				ON-	XA3, XO3
	MATH DISABLE	ON	MD1	OFF	MD0
	AUTO TRIG	ON	AU1	OFF	AU0
	X10 ATTN controlled by AUTO TRIG			ON/	AX1, BX1
				OFF	AX0, BX0
	SENS	OFF	SE0	ON	SE1
	DACS	OFF	TR0	ON	TR1
GATE TIME ENTRY disallowed in PEAK LEVEL			ON	GA<n>	
High Speed Mode	OFF	HS0	ON	HS1	
Calibration Data disallowed in Peak Levels mode				TC	

Table 3-13. HP-IB Preset and Disallowed Condition (Continued)

MODE	PRESET CONDITIONS			DISALLOWED CONDITIONS	
	PARAMETER	SETTING	EQUIVALENT HP-IB COMMAND	SETTING	EQUIVALENT HP-IB COMMAND
AUTO TRIG ON = (AU1)	X10 ATTN controlled by AUTO TRIG SENS Note, if SENS is turned ON, AUTO TRIG is turned OFF. DACS Note, if DACS are turned ON, AUTO TRIG is turned OFF. TRIGGER LEVEL/SENS	OFF	SE0 TR0 levels set internally	ON/ OFF none none controls disabled	AX1, BX1 XA0, BX0
COM A [ON] (CO1)	AC/ (DC) 50Ω Z/ (1MΩ Z)	INPUT B coupling controlled by INPUT A INPUT B impedance controlled by INPUT A		ON/ OFF ON/ OFF	BA1 BA0 BZ1 BZ0
SENS [ON] (SE1)	AUTO TRIG Note, if AUTO TRIG is turned ON, SENS is turned OFF.	OFF	AU0	none	
DACS [ON] (TR1) (5334A only)	AUTO TRIG Note, if AUTO TRIG is turned ON, DACS are turned OFF. TRIGGER LEVEL/SENS	OFF levels set with AT<num> and BT<num> commands	AU0	none	

(This page intentionally left blank)

SECTION IV PERFORMANCE TESTS

4-1. INTRODUCTION

4-2. The procedures in this section provide three groups of tests to check for proper operation of the HP 5334A/B Universal Counter. The first is a quick method of verifying the basic functioning of the counter when its normal operation is in question. The second is a complete test of the instrument's electrical performance using the specifications of *Table 1-1* as the performance standards. And third is an HP-IB verification test using the HP 9000 Series 200/300 computer as a controller. All tests can be performed without access to the interior of the instrument.

4-3. EQUIPMENT REQUIRED

4-4. Equipment required for the performance tests is listed in *Table 1-4*, Recommended Test Equipment. Any equipment that satisfies the critical specifications given in the table may be substituted for the recommended model(s).

4-5. OPERATIONAL VERIFICATION/PERFORMANCE TEST RECORD

4-6. Results of the operation verification tests may be recorded on a copy of the Operational Verification Test Record which follows the verification tests, *Table 1-4*. The results of the complete performance tests may be recorded on a copy of the Performance Test Record which follows the performance tests, *Table 4-2*.

4-7. CALIBRATION CYCLE

4-8. To maintain the HP 5334A/B in optimum operating condition, depending on the use and environmental conditions, it is suggested that the instrument be checked using the performance tests at least once each year. The Counter's reference oscillator must be checked and adjusted, if necessary, to a house frequency standard before beginning the performance tests. Refer to Adjustment Procedure 5-15 in Section V of the Service Manual. Follow the preliminary instructions in the INTRODUCTION and SAFETY CONSIDERATIONS paragraphs in Section V.

4-9. Additionally, to maintain peak instrument performance between yearly checks, the instruments containing the standard time base crystal oscillator, i.e., all non-Option 010 units, should be adjusted every 3 months to a house frequency standard using Adjustment Procedure 5-15, Reference Oscillator Adjustment in Section V of the Service Manual. Again, refer to the preliminary instructions before beginning the adjustment procedure.

4-10. TEST PROCEDURES

4-11. It is assumed that the person performing the following tests understands how to operate the specified test equipment. Equipment settings, other than those for the Universal Counter, are stated in general terms. It is also assumed that the person performing the tests will supply whatever cables, connectors, and adapters are necessary.

4-12. OPERATIONAL VERIFICATION TESTS

4-13. The tests included here are not as thorough and exhaustive as the performance tests. This group of tests is intended only to serve as a method for giving the operator a high degree of confidence that the instrument is performing properly. No attempt is made to check the specifications of the instrument.

4-14. These tests are useful for incoming QA or as a first check on an instrument suspected of having a problem.

4-15. Preliminary Procedure



Before the Universal Counter is switched on, it must be set to the same line voltage as the power source or damage to the instrument may result. For details, see Power Requirements, Line Voltage Selection, Power Cable, and associated warnings and cautions in Section II of this manual.

NOTE

To avoid confusion, each test procedure begins with a RE-INITIALIZATION of the instrument. This simply means switching the HP 5334A/B to STANDBY and then to ON.

Procedure:

1. Set the HP 5334A/B as follows:

POWER STANDBY
TIME BASE INT (rear panel)

2. Connect the HP 5334A/B as follows:

HP 5334A/B Power Cable to Line Voltage

Observe: STANDBY LED is ON.

3. Do not connect an input signal to the HP 5334A/B.

4-16. POWER-UP SELF-TEST/DIAGNOSTIC MODE

Description: During the power-up sequence, the HP 5334A/B performs a fairly thorough check of major components.

Procedure:

1. Set the HP 5334A/B as follows:

POWER ON

Observe: STANDBY LED goes out.

2. All front panel LEDs light momentarily (except STANDBY LED which does not light and ARM and GATE annunciators which flash alternately).
3. The instrument's model number, "HP 5334A" (or "HP 5334b"), is displayed.

4. The instrument's HP-IB address is displayed. (Address "03" is set at the factory but can be set by the user to addresses "00" to "30").
5. If the instrument successfully executes the power-up self-test routine, the front panel displays "PASS" and then defaults to preset conditions.

Front Panel Preset Conditions:

9 Digit Display	all dashes
Hz annunciator	ON
PRESET annunciator	ON
FREQ A	ON
AUTO TRIG	ON
Channel A and B TRIGGER LEVEL LEDs	Flash Alternately
All Other Indicators	OFF

Test Record: Mark Pass or Fail on the Operational Verification Test Record Card, line 1.

What Checked:

1. The three microcomputers perform a ROM and RAM check.
2. The alternately flashing ARM and GATE annunciators indicate that the Measurement microcomputer passes the ROM/RAM test.
3. The Executive microcomputer runs the front panel display check.
4. The Executive and Measurement microcomputers perform a limited Input/Output port check.
5. The Measurement microcomputer checks for the presence of a time base oscillator.
6. A test of the Multiple-Register Counter (MRC) is made to check for basic operation.
7. A handshake communication test is performed between the Executive and Measurement and the Executive and HP-IB microcomputers.
8. The Executive microcomputer reads the HP-IB address from the CMOS RAM and displays it to the front panel.

For Failures: Any failures during the power-up cycle will disable the counter and produce a display of a numbered Error or Fail message. For a description of failure messages, refer to Error Indications in Section III of this manual.

Additional Comments: The HP 5334A/B can be put into a diagnostic mode where it repeatedly cycles through the power-up self tests. This is accomplished by pressing the RESET/LOCAL key while switching the power ON. The tests are repeated until the power is switched to STANDBY.

NOTE

In the diagnostic mode, neither the instrument model number nor the HP-IB address is displayed.

4-17. READ LEVELS

Description: Checking the operation of the READ LEVELS function can indicate the health of several circuits critical to the operation of the counter.

Procedure:

1. Set the HP 5334A/B as follows:

Reinitialize the 5334A/B.

No Input Signal.

READ LEVELS Trigger Levels

(Press once to display trigger level settings, indicated on the display by an "L" in the place of the exponent value.)

2. Rotate each front panel TRIGGER LEVEL/SENS control fully counterclockwise, then fully clockwise.

Observe: The voltage extremes displayed should be $< -5V$ and $> +5V$, respectively.

3. From the fully clockwise position, slowly rotate each control counterclockwise, then clockwise past the midpoint position where the displayed voltage is approximately 0V.

Observe: Each trigger light should turn on then off as the polarity level changes between +100 mV and -100 mV.

4. Adjust each control for a setting of +2.54V, and then -2.54V.

Observe: These exact settings should be possible with the voltage reading increasing or decreasing in 0.02V steps.

5. Set the HP 5334A/B as follows:

SENS ON

Observe: Both trigger level settings should display 0.00V.

Test Record: Mark Pass or Fail on the Operational Verification Test Record Card, line 2.

What checked:

1. In the READ LEVELS mode, the Digital-to-Analog circuitry and the Measurement microcomputer are operating while the Input Amplifier and Multiple-Register Counter circuitry are inactive.
2. The DAC circuitry and the Measurement Data Bus are operating properly if the $\pm 2.54V$ settings can be obtained.
3. If all tests are passed, the likelihood is high that the DACs, operational amplifier loops, the Read Level comparators, the analog switches (all are DAC circuitry components), and the front panel pots are operating properly.

For Failures: If any failures are encountered in this test, refer to Section VIII of the Service Manual. The Digital-to-Analog Block is a likely candidate as a starting point for troubleshooting. Other circuit blocks involved are the Measurement, Executive, and Front Panel blocks.

4-18. RATIO A/B

Description: This test uses the time base oscillator to drive the A and B input amplifier in a test of the Multiple-Register Counter (MRC).

Procedure:

1. Connect the rear panel TIME BASE oscillator signal to the Channel A Input.
2. Set the HP 5334A/B as follows:

Reinitialize the 5334A/B.

COM A	ON
AUTO TRIG	OFF
TRIGGER LEVEL controls	midpoint setting
CHAN A and B 50 Ω	ON
GATE TIME	1 Second
FUNCTION	RATIO A/B

Observe: The HP 5334A/B front panel displays 1.000 000 0 \pm .000 000 2 and both trigger lights are flashing.

Test Record: Mark Pass or Fail on the Operational Verification Test Record Card, line 3.

What Checked:

1. The operation of the MRC is checked using the ratio function.
2. The 10 MHz oscillator signal at the rear panel BNC connector is verified.

For Failure: Refer to Section VIII of the Service Manual. The Measurement Block contains the MRC (Multiple-Register Counter) and other blocks involved are the Input Amplifier, Executive, Front Panel, and Time Base/Power Supply blocks.

4-19. FREQUENCY

Description: Using this test, a frequency is measured which will exercise the interpolators.

Procedure:

1. Connect the rear panel TIME BASE oscillator signal to the Channel A Input.
2. Set the HP 5334A/B as follows:

Reinitialize the 5334A/B.

Observe: The HP 5334A/B front panel displays 10.000 000 0 MHz \pm 0.2 Hz.

Test Record: Mark Pass or Fail on the Operational Verification Test Record Card, line 4.

What Checked: The interpolators which provide the accuracy of the frequency count are tested. Defective interpolators may cause the reading to vary up to ± 100 Hz.

For Failure: Refer to Section VIII of the Service Manual. The interpolators are part of the Measurement Block. Other blocks involved here are the Input Amplifier, DAC, Executive, Front Panel, and Time Base/Power Supply blocks.

4-20. INPUT SIGNAL CONDITIONING CHECK

Description: This series of checks performs a functional test of the front panel relays and circuitry associated with those relays.

Procedure:

1. Connect the rear panel TIME BASE oscillator signal to the Channel A Input.
2. Set the HP 5334A/B as follows:

Reinitialize the 5334A/B.

AUTO TRIG	OFF
COM A	ON
CHAN A and B 50 Ω	ON
GATE TIME	1 Second

3. Adjust both TRIGGER LEVEL/SENS controls clockwise until trigger lights just go off.
4. Set the HP 5334A/B as follows:

COM A	OFF
CHAN A and B 50 Ω	OFF

Observe: The HP 5334A/B front panel displays 10.000 000 0 MHz \pm 0.2 Hz. Channel A trigger light flashing and Channel B light not flashing.

5. Set the HP 5334A/B as follows:

CHAN A 50 Ω	ON
--------------------------	----

Observe: The HP 5334A/B front panel displays all dashes and Channel A trigger light stops flashing.

6. Set:

CHAN A 50 Ω	OFF
--------------------------	-----

Observe: Condition prior to switching in 50 Ω impedance.

7. Set:

CHAN A X10 ATTN	ON
-----------------------	----

Observe: The HP 5334A/B front panel displays all dashes and Channel A trigger light stops flashing.

8. Set:

CHAN A X10 ATTN OFF

Observe: Condition prior to switching in X10 attenuator.

9. Set:

100 kHz FILTER A ON

Observe: The HP 5334A/B front panel displays all dashes and Channel A trigger light stops flashing.

10. Set:

100 kHz FILTER A OFF

Observe: Condition prior to switching in 100 kHz Filter.

11. Set:

COM A ON
FUNCTION FREQ B

Connect the rear panel TIME BASE oscillator signal to the Channel B Input.

Observe: The HP 5334A/B front panel stops updating and the trigger lights stop flashing.

12. Set:

COM A OFF

Observe: The HP 5334A/B front panel displays 10.000 000 0 MHz \pm 0.2 Hz. Channel B trigger light flashing and Channel A trigger light not flashing.

13. Set:

CHAN B 50 Ω ON

Observe: The HP 5334A/B front panel displays all dashes and Channel B trigger light stops flashing.

14. Set:

CHAN B 50 Ω OFF

Observe: Condition prior to switching in 50 Ω impedance.

15. Set:

CHAN B X10 ATTN ON

Observe: The HP 5334A/B front panel displays all dashes and Channel B trigger light stops flashing.

16. Set:

CHAN B X10 ATTN OFF

Observe: Condition prior to switching in X10 ATTN.

Test Record: Mark Pass or Fail on the Operational Verification Test Record Card, line 5.

What Checked: Relays and circuitry.

For Failures: Refer to Section VIII of the Service Manual. The Input Amplifier and Executive Blocks are the main components of this test. Other blocks involved are DAC, Measurement, and Front Panel blocks.

4-21. T.I. A → B

Description: Slope switch verification.

Procedure:

1. Connect the rear panel TIME BASE oscillator signal to the Channel A Input.
2. Set the HP 5334A/B as follows:

Reinitialize the 5334A/B.

COM A ON
TRIGGER LEVEL controls set to $0V \pm 0.2V$
using READ LEVELS "L" mode
AUTO TRIG OFF
CHAN A and B 50Ω ON
GATE TIME 1 Second
FUNCTION T.I. A → B

Observe: The HP 5334A/B front panel displays $0 \text{ ns} \pm 6 \text{ ns}$.

3. Set both:

Channel A and B to Negative SLOPE ON
(Counter now triggers on negative slope.)

Observe: The HP 5334A/B front panel displays $0 \text{ ns} \pm 6 \text{ ns}$.

4. Set:

Channel A to Negative SLOPE OFF
Channel B to Negative SLOPE ON

Observe: The HP 5334A/B front panel displays $50 \text{ ns} \pm 6 \text{ ns}$.

5. Set:

Channel A to Negative SLOPE ON
Channel B to Negative SLOPE OFF

Observe: The HP 5334A/B front panel displays $50 \text{ ns} \pm 6 \text{ ns}$.

Test Record: Mark Pass or Fail on the Operational Verification Test Record Card, line 6.

What Checked: Time interval measurement and slope switch operation.

For Failures: Refer to Section VIII of the Service Manual. In this case, the Input Amplifier, DAC, Measurement, Executive, Front Panel, and Time Base/Power Supply blocks are involved.

4-22. AUTO TRIGGER

Description: The Measurement microcomputer sends a signal to the DAC block and disables the front panel trigger level controls.

Procedure:

1. Connect the rear panel TIME BASE oscillator signal to the Channel A Input.
2. Set the HP 5334A/B as follows:

Reinitialize the 5334A/B.

GATE TIME 1 Second

Observe: The HP 5334A/B front panel displays 10.000 000 0 MHz \pm 0.2 Hz and both Channel A and B trigger lights are flashing.

3. Rotate Channel A trigger level control.

Observe: There is no effect on the Counter's operation.

4. Set AUTO TRIG to OFF. Rotate Channel A trigger level control.

Observe: Extreme clockwise and counterclockwise control settings will stop the gating and update of the Counter. Trigger light stops flashing.

5. Set AUTO TRIG to ON. Connect the rear panel TIME BASE oscillator signal to Input B. Set FUNCTION to FREQ B.

Observe: The HP 5334A/B front panel displays 10.000 000 0 MHz \pm 0.2 Hz and Channel A and B trigger lights are flashing.

6. Rotate Channel B trigger level control.

Observe: There is no effect on the Counter's operation.

7. Set AUTO TRIG to OFF. Rotate Channel B trigger level control.

Observe: Extreme clockwise and counterclockwise control settings will stop the gating and update of the Counter. Trigger light stops flashing.

Test Record: Mark Pass or Fail on the Operational Verification Test Record Card, line 7.

What Checked: Control lines and DAC circuitry.

For Failures: Refer to Section VIII of the Service Manual. The test involves all of the functional blocks: the Input Amplifier, DAC, Measurement, Executive, Front Panel, and Time Base/Power Supply blocks.

4-23. CMOS RAM (HP 5334A Only)

Description: The CMOS RAM device and support circuitry are checked in a limited way.

Procedure:

1. Reinitialize the HP 5334A.
2. Store a different front panel setup by first selecting the configuration, then pressing the STORE key and finally, "1". Switch the HP 5334A/B to STANDBY and then ON. Press the RECALL key and then "1".

Observe: The front panel setup is exactly as stored in location 1.

3. Repeat the procedure with various front panel setups using storage locations 0-9.

Test Record: Mark Pass or Fail on the Operational Verification Test Record Card, line 8.

What Checked: CMOS RAM and support circuitry.

For Failures: Refer to Section VIII of the Service Manual. The Executive and Front Panel Blocks are the main components of the test.

4-24. DVM (Options 020 and 05 — HP 5334A Only)

Description: Two functional checks are made of the DVM option for the HP 5334A.

Procedure:

1. Place a jumper across the inputs of the DVM to short them together.
2. Set the HP 5334A as follows:

Reinitialize the 5334A.

FUNCTION DVM

Observe: The HP 5334A front panel displays $0V \pm 0.8$ mV.

3. Connect the rear panel GATE OUT signal to the HP 5334A DVM inputs.

Observe: The HP 5334A front panel displays a measurement >50 mV.

Test Record: Mark Pass or Fail on the Operational Verification Test Record Card, line 9.

What Checked: DVM zero and basic measurement capability.

For Failures: Refer to Section VIII of the Service Manual. The DVM, Measurement, Executive, and Front Panel blocks are involved here.

4-25. CHANNEL C (Options 030 and 050 — HP 5334A)

This operational check is for the HP 5334As containing Options 030 and 050.

Description: The Channel C option is checked by simply measuring a frequency within its range of 90 MHz to 1300 MHz.

Equipment: A signal source capable of outputting some frequency from 90 MHz to 1300 MHz.

Procedure:

1. Set the signal source as follows:

Frequency 90 to 1300 MHz
Amplitude 300 mV rms (+2.5 dBm)

2. Set the HP 5334A as follows:

Reinitialize the 5334A.

FUNCTION FREQ C

3. Connect the signal source to the HP 5334A Input C.
4. Adjust the Channel C Sensitivity control as needed to cause the Counter to gate and display a stable reading.

Observe: The HP 5334A front panel displays the generated frequency.

Test Record: Mark Pass or Fail on the Operational Verification Test Record Card, line 10.

What Checked: Basic operation of the Channel C option.

For Failures: Refer to Section VIII of the Service Manual. The Channel C, Measurement, Executive, and Front Panel blocks are involved here.

4-26. CHANNEL C (Options 030 — HP 5334B)

This operational check is for HP 5334B's containing Option 030.

Description: The Channel C option is checked by simply measuring a frequency within its range of 90 MHz to 1300 MHz.

Equipment: A signal source capable of outputting some frequency from 90 MHz to 1300 MHz.

Procedure:

1. Set the signal source as follows:

Frequency 90 to 1300 MHz
Amplitude 300 mV rms (+2.5 dBm)

2. Set the HP 5334B as follows:

Reinitialize the 5334B.

FUNCTION FREQ C

3. Connect the signal source to the HP 5334B Input C.

Observe: The HP 5334B front panel displays the generated frequency.

Test Record: Mark Pass or Fail on the Operational Verification Test Record Card, line 11.

What Checked: Basic operation of the Channel C option.

For Failures: Refer to Section VIII of the Service Manual. The Channel C, Measurement, Executive, and Front Panel blocks are involved here.

Table 4-1. HP 5334A/B Operation Verification Test Record Card

Hewlett-Packard Company Model 5334A/B Universal Counter		Tested By _____	
Serial Number _____		Date _____	
PARAGRAPH NUMBER	TEST	RESULTS	
		PASS	FAIL
4-16.	POWER-UP SELF-TEST/DIAGNOSTIC MODE	1. _____	_____
4-17.	READ LEVELS	2. _____	_____
4-18.	RATIO A/B	3. _____	_____
4-19.	FREQUENCY	4. _____	_____
4-20.	INPUT SIGNAL CONDITIONING CHECK	5. _____	_____
4-21.	T.I. A-B	6. _____	_____
4-22.	AUTO TRIGGER	7. _____	_____
4-23.	CMOS RAM	8. _____	_____
4-24.	DVM (Options 020 and 050 — HP 5334A only)	9. _____	_____
4-25.	CHANNEL C (Options 030 and 050 — HP 5334A)	10. _____	_____
4-26.	CHANNEL C (Option 030 — HP 5334B)	11. _____	_____

4-27. PERFORMANCE TESTS

4-28. The following procedures test the electrical performance of the HP 5334A and 5334B Universal Counters using the specifications in *Table 1-1* as the performance standards. The tests included here are much more specific and rigorous than the operational verification procedures. Use these procedures to ensure that the instrument in question is operating at its highest level at incoming QA, the annual calibration cycle check, or following any of the adjustment procedures.

4-29. The procedures were designed to be performed sequentially in order to fully test the HP 5334A/B.

NOTE

If the performance tests are to be considered valid, the the following conditions must be met:

- a. The Universal Counter must have a 30-minute warmup.
- b. The reference oscillator must be set to a frequency standard. Perform the Reference Oscillator Frequency Adjustment before beginning these tests. This is adjustment 5-15 in Section V, ADJUSTMENTS, of the Service Manual.

NOTE

The \pm resolution limits specified in the following procedures assume that the test equipment being used is calibrated and operating at its performance limits. When this is not the case, problems can occur. For example, noise on an input signal to the Counter will result in the display of what seems to be an inaccurate measurement. This condition must be considered when observed measurements do not agree with the performance test limits.

4-30. Preliminary Procedure



Before the Universal Counter is switched on, it must be set to the same line voltage as the power source or damage to the instrument may result. For details, see Power Requirements, Line Voltage Selection, Power Cable, and associated warnings and cautions in Section II of this manual.

NOTE

To avoid confusion, each test procedure begins with a RE-INITIALIZATION of the instrument. This simply means switching the HP 5334A/B to STANDBY and then to ON.

Procedure:

1. Set the HP 5334A/B as follows:

POWER STANDBY
TIME BASE INT (rear panel)

2. Connect the HP 5334A/B as follows:

5334A/B Power Cable to Line Voltage

Observe: STANDBY LED is ON.

3. The HP 5334A/B Time Base oscillator is used as the reference for the other instruments in these tests.

Connect the HP 5334A/B rear panel TIME BASE signal to both the function generator and the signal generator. Set these instruments to operate on the external time base from the HP 5334A/B *Figure 4-1*.

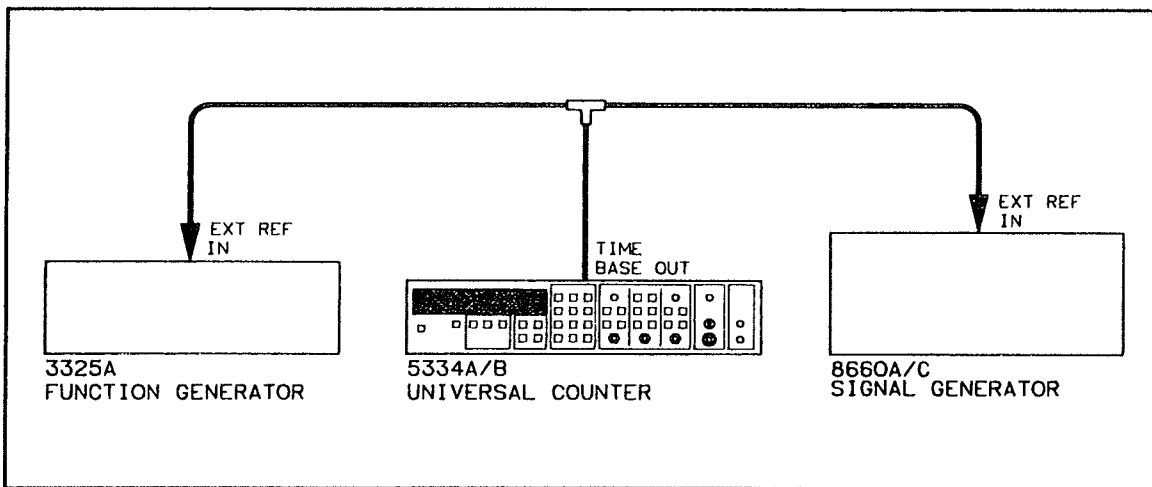

Figure 4-1. Time Base Reference Setup

**4-31. CHANNEL A FREQUENCY RESPONSE AND SENSITIVITY TEST,
10 Hz-20 MHz**

Specification: Refer to *Table 1-1*, HP Model 5334A/B Specifications, for Frequency Response and Sensitivity specifications.

Description: The frequency measuring range of the Counter is tested at minimum sensitivity specifications and four different frequency settings.

Frequencies and conditions tested:

- 10 Hz and 20 MHz, dc coupled, 1 Megohm
- 30 Hz and 20 MHz, ac coupled, 1 Megohm
- 1 MHz and 20 MHz, ac coupled, 50 Ohm

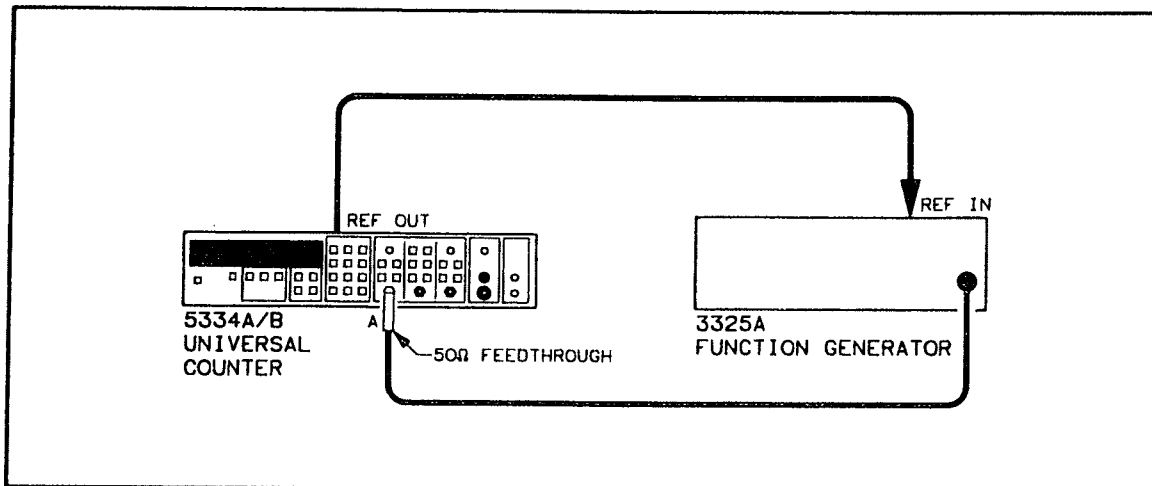

Figure 4-2. Channel A Frequency and Sensitivity Setup, 10 Hz-20 MHz

Equipment:

Function Generator HP 3325A

Procedure:

1. Set the function generator as follows:

Frequency 10 Hz
Amplitude 15 mV rms
Function Sine Wave

2. Set the HP 5334A/B as follows:

Reinitialize the 5334A/B.

FUNCTION FREQ A
SENS ON
CHAN A TRIG/SENS control fully cw

3. Connect the function generator signal to the HP 5334A/B Input A using a 50 Ohm feedthrough connector as shown in Figure 4-2.

VERIFY: The Counter displays 10 Hz \pm 0.03 Hz.

4. Record the measurement on the Performance Test Record Card, line 1.

5. Set the function generator as follows:

Frequency 20 MHz

VERIFY: The Counter displays 20 MHz \pm 0.3 Hz.

6. Record the measurement on the Performance Test Record Card, line 2.

7. Set the function generator as follows:

Frequency 30 Hz

8. Set the HP 5334A/B as follows:

AC ON

VERIFY: The Counter displays 30 Hz \pm 0.03 Hz.

9. Record the measurement on the Performance Test Record Card, line 3.

10. Set the function generator as follows:

Frequency 20 MHz

VERIFY: The Counter displays 20 MHz \pm 0.3 Hz

11. Record the measurement on the Performance Test Record Card, line 4.

12. Set the function generator as follows:

Frequency 1 MHz

NOTE

Remove the 50 Ohm feedthrough connector.

13. Set the HP 5334A/B as follows:

50 Ω ON

VERIFY: The Counter displays 1 MHz \pm 0.04 Hz.

14. Record the measurement on the Performance Test Record Card, line 5.

15. Set the function generator as follows:

Frequency 20 MHz

VERIFY: The Counter displays 20 MHz \pm 0.3 Hz.

16. Record the measurement on the Performance Test Record Card, line 6.

Failure: If any of these tests fail, refer to Section V, Adjustments, paragraphs 5-16 and 5-18 as a first step in troubleshooting.

**4-32. CHANNEL B FREQUENCY RESPONSE AND SENSITIVITY TEST,
10 Hz-20 MHz**

Specification: Refer to *Table 1-1*, HP Model 5334A/B Specifications, for Frequency Response and Sensitivity specifications.

Description: The frequency measuring range of the Counter is tested at minimum sensitivity specifications and four different frequency settings.

Frequencies and conditions tested:

- 10 Hz and 20 MHz, dc coupled, 1 Megohm
- 30 Hz and 20 MHz, ac coupled, 1 Megohm
- 1 MHz and 20 MHz, ac coupled, 50 Ohm

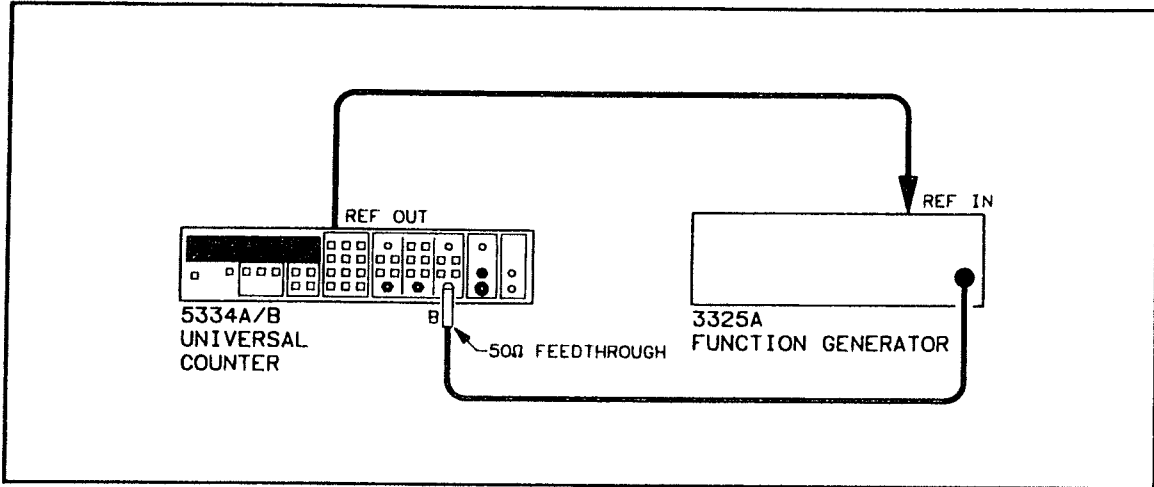

Figure 4-3. Channel B Frequency and Sensitivity Setup, 10 Hz-20 MHz

Equipment:

Function Generator HP 3325A

Procedure:

1. Set the function generator as follows:

Frequency 10 Hz
Amplitude 15 mV rms
Function Sine Wave

2. Set the HP 5334A/B as follows:

Reinitialize the 5334A/B.

FUNCTION FREQ B
SENS ON
CHAN B TRIG/SENS control fully cw

3. Connect the function generator signal to the HP 5334A/B Input B using a 50 Ohm feedthrough connector as shown in Figure 4-3.
4. Repeat the tests of paragraph 4-31 for Channel B and record the measurements on the Performance Test Record Card, lines 7 through 12. Begin the tests at the verification of 10 Hz in paragraph 4-31, step 4.

Failure: If any of these tests fail, refer to Section V, Adjustments, paragraphs 5-17 and 5-19 as a first step in troubleshooting.

4-33. CHANNEL A FREQUENCY RESPONSE AND SENSITIVITY TEST, 80 MHz-100 MHz (For Non-Option 060 instruments)

This test is for instruments that do not contain the Option 060 Rear Panel Inputs, i.e., instruments with Front Inputs only.

Specification: Refer to *Table 1-1, HP Model 5334A/B Specifications, for Frequency Response and Sensitivity specifications.*

Description: The frequency measuring range of the Counter is tested at minimum sensitivity specifications and two different frequency settings.

Frequencies and conditions tested:

- 80 MHz and 100 MHz, dc coupled, 1 Megohm
- 80 MHz and 100 MHz, ac coupled, 1 Megohm
- 80 MHz and 100 MHz, ac coupled, 50 Ohm

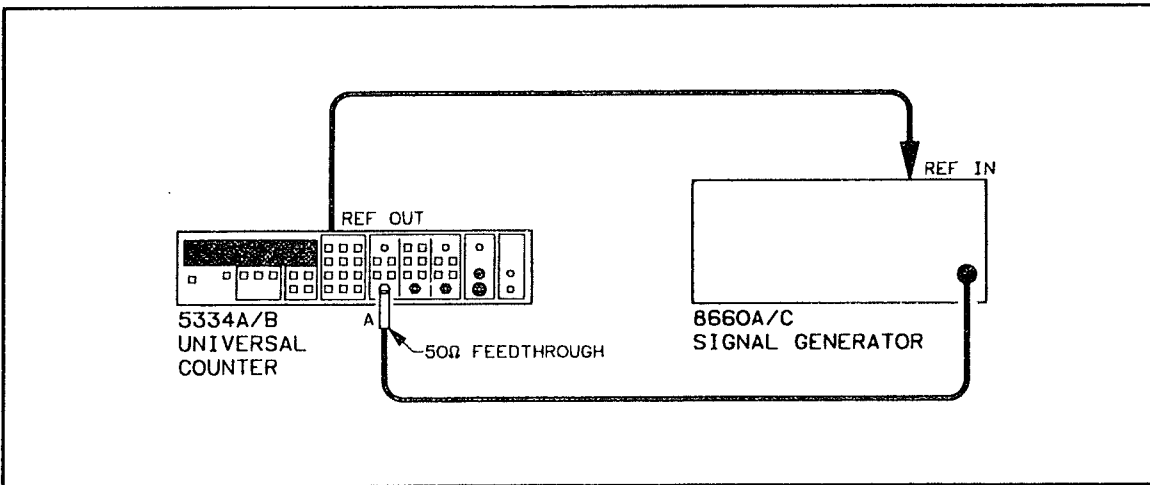

Figure 4-4. Channel A Frequency and Sensitivity Setup, 80 MHz-100 MHz

Equipment:

Signal Generator HP 8660A/C

Procedure:

1. Set the signal generator as follows:

Frequency 80 MHz
Amplitude 35 mV rms

2. Set the HP 5334A/B as follows:

Reinitialize the 5334A/B.

FUNCTION FREQ A
SENS ON
CHAN A TRIG/SENS control fully cw

3. Connect the signal generator to the HP 5334A/B Input A using a 50 Ohm feedthrough connector as shown in *Figure 4-4*.

VERIFY: The Counter displays 80 MHz \pm 2 Hz.

4. Record the measurement on the Performance Test Record Card, line 13.
5. Set the signal generator as follows:

Frequency 100 MHz
Amplitude 35 mV rms

VERIFY: The Counter displays 100 MHz \pm 2 Hz.

6. Record the measurement on the Performance Test Record Card, line 14.
7. Set the signal generator as follows:

Frequency 80 MHz
Amplitude 35 mV rms

8. Set the HP 5334A/B as follows:

AC ON

VERIFY: The Counter displays 80 MHz \pm 2 Hz.

9. Record the measurement on the Performance Test Record Card, line 15.
10. Set the signal generator as follows:

Frequency 100 MHz
Amplitude 35 mV rms

VERIFY: The Counter displays 100 MHz \pm 2 Hz.

11. Record the measurement on the Performance Test Record Card, line 16.
12. Set the signal generator as follows:

Frequency 80 MHz
Amplitude 35 mV rms

NOTE

Remove the 50 Ohm feedthrough connector.

13. Set the HP 5334A/B as follows:

50 Ω ON

VERIFY: The Counter displays 80 MHz \pm 2 Hz.

14. Record the measurement on the Performance Test Record Card, line 17.

15. Set the signal generator as follows:

Frequency 100 MHz
Amplitude 35 mV rms

VERIFY: The Counter displays 100 MHz \pm 2 Hz.

16. Record the measurement on the Performance Test Record Card, line 18.

Failure: If any of these tests fail, refer to Section V, Adjustments, paragraphs 5-16 and 5-18 as a first step in troubleshooting.

**4-34. CHANNEL B FREQUENCY RESPONSE AND SENSITIVITY TEST,
80 MHz-100 MHz (For Non-Option 060 Instruments)**

This test is for instruments that do not contain Option 060 Rear Panel Inputs, i.e., instrument with Front Inputs only.

Specification: Refer to Table 1-1, HP Model 5334A/B Specifications, for Frequency Response and Sensitivity specifications.

Description: The frequency measuring range of the Counter is tested at minimum sensitivity specifications and two different frequency settings.

Frequencies and conditions tested:

- 80 MHz and 100 MHz, dc coupled, 1 Megohm
- 80 MHz and 100 MHz, ac coupled, 1 Megohm
- 80 MHz and 100 MHz, ac coupled, 50 Ohm

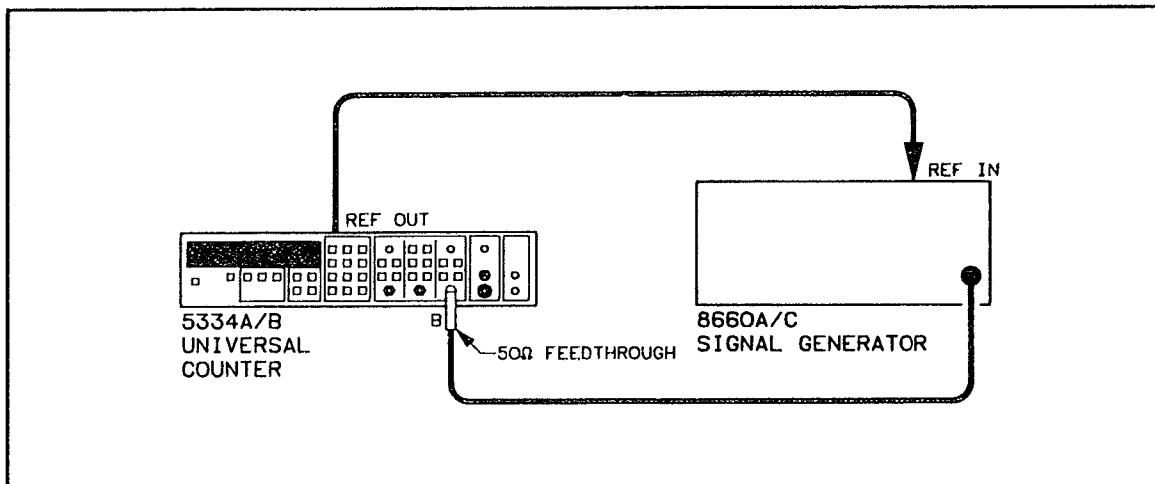

Figure 4-5. Channel B Frequency and Sensitivity Setup, 80 MHz-100 MHz

Equipment:

Signal Generator HP 8660A/C

Procedure:

1. Set the signal generator as follows:

Frequency 80 MHz
Amplitude 35 mV rms

- Set the HP 5334A/B as follows:

Reinitialize the 5334A/B.

```

FUNCTION .....   FREQ B
SENS .....       ON
CHAN B TRIG/SENS control .....   fully cw
    
```

- Connect the signal generator to the HP 5334A/B Input B using a 50 Ohm feedthrough connector as shown in *Figure 4-5*.
- Repeat the tests of paragraph 4-33 for Channel B and record the measurements on the Performance Test Record Card, lines 19 through 24. Begin the tests at the verification of 80 MHz in paragraph 4-33, step 4.

Failure: If any of these tests fail, refer to Section V, Adjustments, paragraphs 5-17 and 5-19 as a first step in troubleshooting.

4-35. CHANNEL A FREQUENCY RESPONSE AND SENSITIVITY TEST, 80 MHz-100 MHz (For Option 060 Instruments)

This test is for instrument that contain the Option 060 Rear Panel Inputs, i.e., instruments with both Front and Rear Inputs.

Specification: Refer to *Table 1-1*, HP Model 5334A/B Specifications, for Option 060 Frequency Response and Sensitivity specifications.

Description: The frequency measuring range of the Counter is tested at minimum sensitivity specifications and two different frequency settings.

Frequencies and conditions tested:

- 80 MHz and 100 MHz, dc coupled, 1 Megohm
- 80 MHz and 100 MHz, ac coupled, 1 Megohm

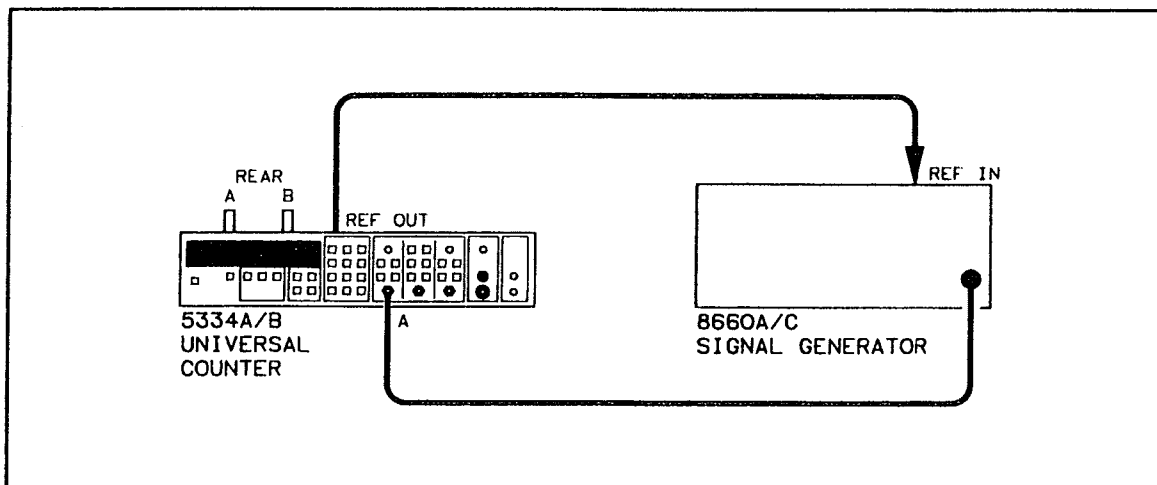

Figure 4-6. Channel A Frequency and Sensitivity Setup for Option 060

Equipment:

Signal Generator HP 8660A/C

Procedure:

1. Set the signal generator as follows:

Frequency 80 MHz
Amplitude 50 mV rms

2. Set the HP 5334A/B as follows:

Reinitialize the 5334A/B.

FUNCTION FREQ A
SENS ON
CHAN A TRIG/SENS control fully cw

3. Connect 50 Ohm feedthroughs or terminations on the rear panel A and B Inputs.
4. Connect the signal generator to the HP 5334A/B front panel Input A as shown in *Figure 4-6*.

VERIFY: The Counter displays 80 MHz \pm 2 Hz.

5. Record the measurement on the Performance Test Record Card, line 25.
6. Set the signal generator as follows:

Frequency 100 MHz
Amplitude 50 mV rms

VERIFY: The Counter displays 100 MHz \pm 2 Hz.

7. Record the measurement on the Performance Test Record Card, line 26.
8. Set the signal generator as follows:

Frequency 80 MHz
Amplitude 50 mV rms

9. Set the HP 5334A/B as follows:

AC ON

VERIFY: The Counter displays 80 MHz \pm 2 Hz.

10. Record the measurement on the Performance Test Record Card, line 27.
11. Set the signal generator as follows:

Frequency 100 MHz
Amplitude 50 mV rms

VERIFY: The Counter displays 100 MHz \pm 2 Hz.

12. Record the measurement on the Performance Test Record Card, line 28.

Failure: If any of these tests fail, refer to Section V, Adjustments, paragraphs 5-16 and 5-18 as a first step in troubleshooting.

**4-36. CHANNEL B FREQUENCY RESPONSE AND SENSITIVITY TEST,
80 MHz-100 MHz (For Option 060 Instruments)**

This test is for instruments that contain the Option 060, i.e., instruments with both Front and Rear Inputs.

Specification: Refer to *Table 1-1*, HP Model 5334A/B Specifications, for Option 060 Frequency Response and Sensitivity specifications.

Description: The frequency measuring range of the Counter is tested at minimum sensitivity specifications and two different frequency settings.

Frequencies and conditions tested:

- 80 MHz and 100 MHz, dc coupled, 1 Megohm
- 80 MHz and 100 MHz, ac coupled, 1 Megohm

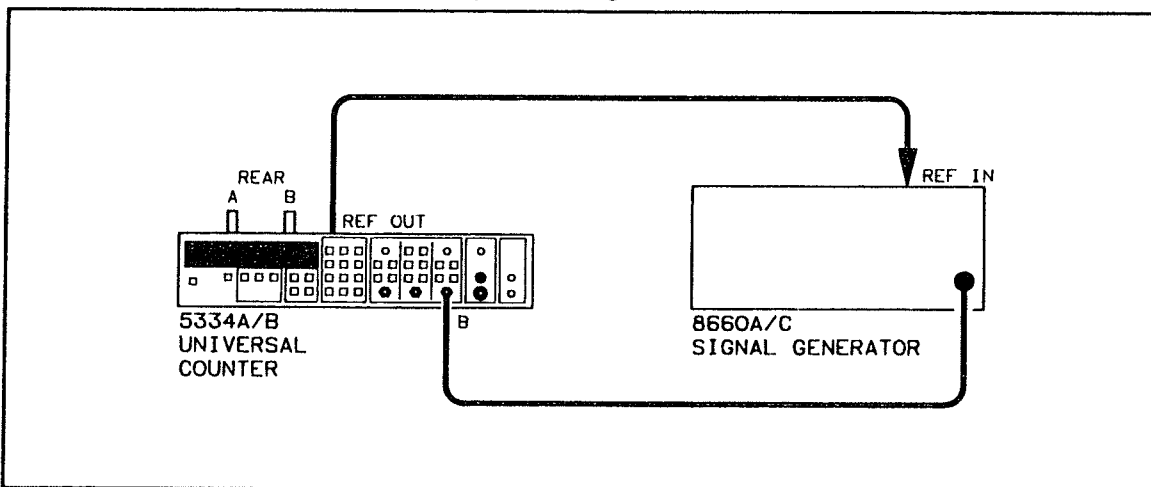

Figure 4-7. Channel B Frequency and Sensitivity Setup for Option 060

Equipment:

Signal Generator HP 8660A/C

Procedure:

1. Set the signal generator as follows:

Frequency 80 MHz
Amplitude 50 mV rms

2. Set the HP 5334A/B as follows:

Reinitialize the 5334A/B.

FUNCTION FREQ B
SENS ON
CHAN B TRIG/SENS control fully cw

3. Connect 50 Ohm feedthroughs or terminations on the rear panel A and B Inputs.
4. Connect the signal generator to the HP 5334A/B front panel Input B as shown in *Figure 4-7*.
5. Repeat the tests of paragraph 4-35 for Channel B and record the measurements on the Performance Test Record Card, lines 29 through 32. Begin the tests at the verification of 80 MHz in paragraph 4-35, step 5.

Failures: If any of these tests fail, refer to Section V, Adjustments, paragraph 5-17 and 5-19 as a first step in troubleshooting.

4-37. PERIOD A TEST

Specification: Refer to *Table 1-1*, HP Model 5334A/B Specifications, for Period A specifications.

Description: The minimum specified period measurement of 10 ns is verified using a 100 MHz input signal.

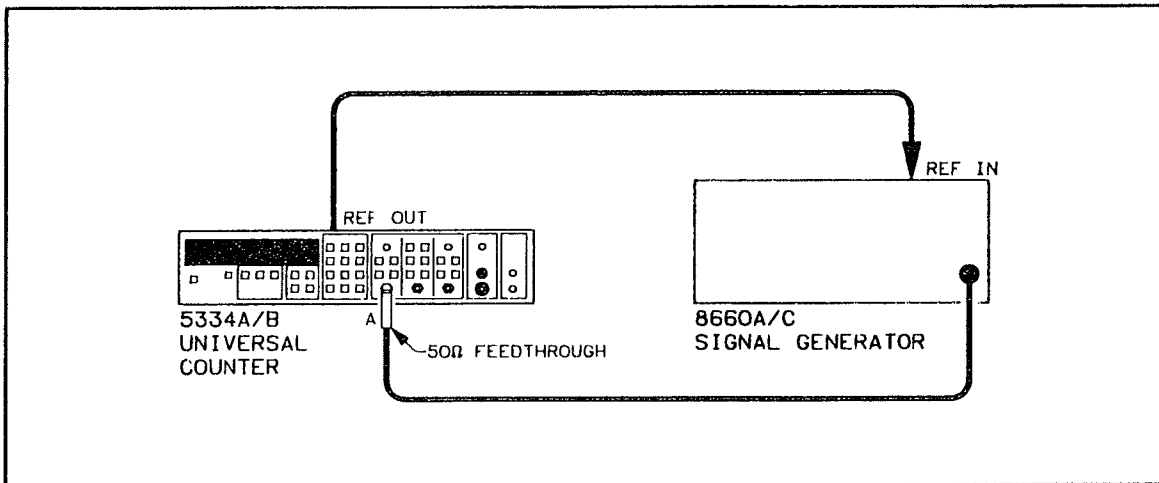

Figure 4-8. Period A Test Setup

Equipment:

Signal Generator HP 8660A/C

Procedure:

1. Set the signal generator as follows:

Frequency 100 MHz
Amplitude 50 mV rms

NOTE
OPTION 060

If the HP 5334A/B has Option 060 (rear panel inputs), terminate the unused Channel A input (front or rear) with a 50 Ohm load.

- Set the HP 5334A/B as follows:

Reinitialize the 5334A/B.

FUNCTION PERIOD A
 GATE TIME 1 Second
 SENS ON
 CHAN A TRIG/SENS control fully cw

- Connect the signal generator output to the HP 5334A/B Input A using a 50 Ohm feedthrough connector as shown in Figure 4-8.

NOTE

Do not use a 50 Ohm feedthrough connector at the Input for Counters with Option 060.

VERIFY: The Counter displays 10 ns \pm .000 000 1 ns.

- Record the Period A measurement on the Performance Test Record Card, line 33.

Failure: If the instrument under test does not meet the test specification, consider performing the adjustments in Section V of the Service Manual as a first step in correcting the problem.

4-38. PULSE WIDTH A TEST

Specification: Refer to Table 1-1, HP Model 5334A/B Specifications, for Pulse Width A specifications.

Description: A pulse width is generated and then measured with the HP 5334A/B to verify the Counter's performance.

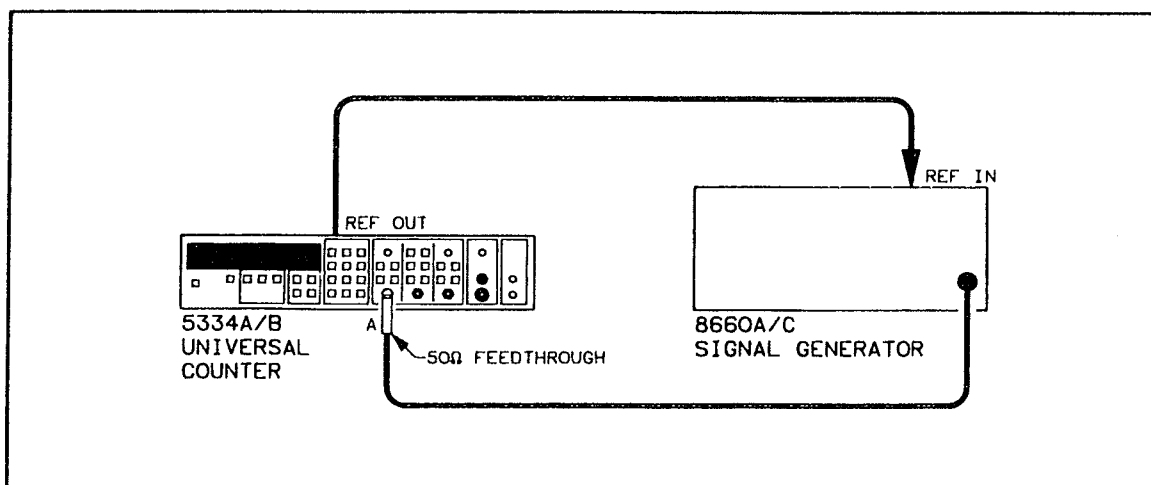

Figure 4-9. Pulse Width A Test Setup

Equipment:

Signal Generator HP 8660A/C

Procedure:

1. Set the signal generator as follows:

Frequency 100 MHz
Amplitude 200 mV rms

2. Set the HP 5334A/B as follows:

Reinitialize the 5334A/B.

FUNCTION PULSE WIDTH A

NOTE

OPTION 060

If the HP 5334A/B has Option 060 (rear panel inputs), terminate the unused Channel A input (front or rear) with a 50 Ohm load.

3. Connect the signal generator output to the HP 5334A/B Input A using a 50 Ohm feedthrough connector as shown in *Figure 4-9*.

NOTE

Do not use a 50 Ohm feedthrough connector at the Input for Counters with Option 060.

VERIFY: The Counter displays $5 \text{ ns} \pm 4 \text{ ns}$.

4. Record the pulse width measurement on the Performance Test Record Card, line 34.

Failure: If the instrument under test does not meet the test specification, consider performing the adjustments in Section V of the Service manual as a first step in correcting the problem.

4-39. TIME INTERVAL A TO B TEST

Specification: Refer to *Table 1-1*, HP Model 5334A/B Specifications, for Time Interval A to B specification.

Description: Time Interval measuring accuracy is verified using a known generated signal.

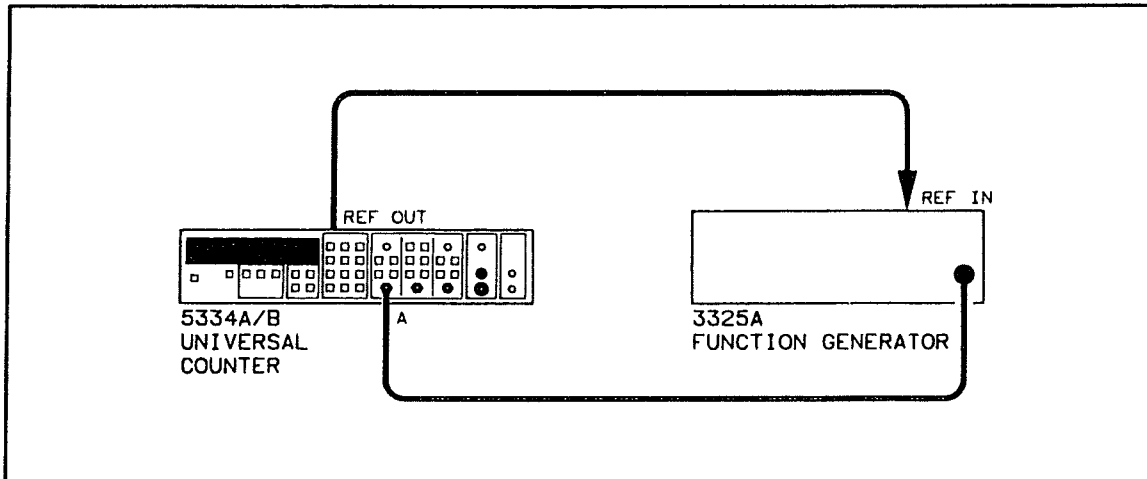

Figure 4-10. Time Interval A to B Test Setup

Equipment:

Function Generator HP 3325A

Procedure:

1. Set the function generator as follows:

Frequency 5 MHz
Amplitude 200 mV p-p
Function Square Wave

2. Set the HP 5334A/B as follows:

Reinitialize the 5334A/B.

FUNCTION T.I. A → B
COM A ON
100 GATE AVERAGE ON
SENS ON
A & B TRIG/SENS controls fully cw
CHAN A and B 50Ω ON
CHAN B Negative SLOPE ON (falling edge)

3. Connect the function generator output to the HP 5334A/B Input A.

VERIFY: The Counter displays 100 ns ± 6 ns.

4. Record the Time Interval measurement on the Performance Test Record, line 35.

Failure: If the instrument under test does not meet the test specification, consider performing the adjustments in Section V of the Service Manual as a first step in correcting the problem.

4-40. TIME INTERVAL A TO B DELAY TEST

Specification: Refer to Table 1-1, HP Model 5334A/B Specifications, for T.I. A to B Delay specification.

Description: Operation of the time interval delay circuitry is verified by introducing a delay into a frequency measurement.

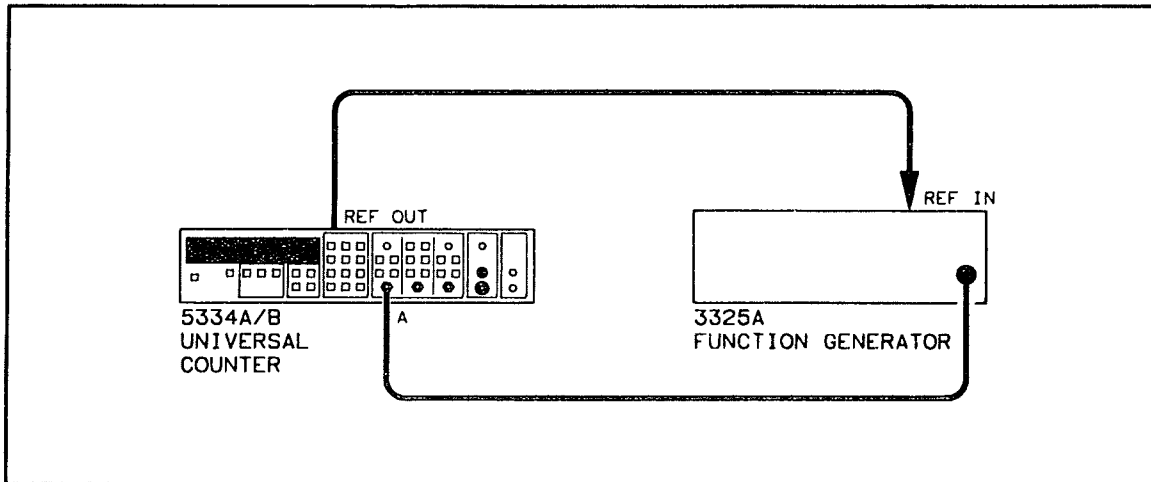

Figure 4-11. Time Interval A to B Delay Test Setup

Equipment:

Function Generator HP 3325A

Procedure:

1. Set the function generator as follows:

Frequency 100 Hz
Amplitude 200 mV p-p
Function Square Wave

2. Set the HP 5334A/B as follows:

Reinitialize the HP 5334A/B.

FUNCTION T.I. A → B DELAY
GATE TIME DELAY 9 ms
SENS ON
A & B TRIG/SENS control fully cw
COM A ON
CHAN A & B 50Ω ON
CHAN B Negative SLOPE ON (falling edge)

3. Connect the function generator output to the HP 5334A/B Input A.
4. Press SINGLE CYCLE on the HP 5334A/B.

VERIFY: The Counter displays 15 ms ± 100 μs.

5. Record the Time Interval Delay measurement on the Performance Test Record, line 36.

Failure: If the instrument under test does not meet the test specification, consider performing the adjustments in Section V of the Service Manual as a first step in correcting the problem.

4-41. RATIO A/B TEST

Specification: Refer to Table 1-1, HP Model 5334A/B Specifications, for Ratio A/B specification.

Description: Two different frequencies are applied to the A and B inputs. The ratio of the A and B inputs will be displayed.

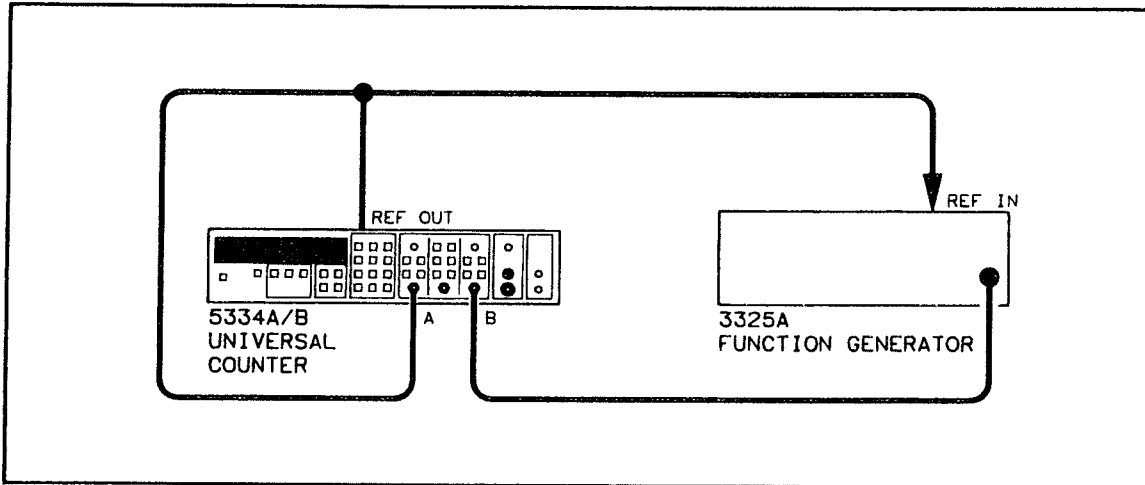

Figure 4-12. Ratio A/B Test Setup

Equipment:

Function Generator HP 3325A

Procedure:

1. Set the function generator as follows:

Frequency 5 MHz
Amplitude 100 mV rms
Function Sine Wave

2. Set the HP 5334A/B as follows:

Reinitialize the HP 5334A/B.

FUNCTION RATIO A/B
SENS ON
A & B TRIG/SENS control fully cw
CHAN A & B 50Ω ON

3. Connect HP 5334A/B TIME BASE signal to Input A and connect the function generator signal to Input B.

VERIFY: The Counter displays $2.000\ 000 \pm 000\ 001$.

4. Record the Ratio A/B measurement on the Test Record Card, line 37.

Failure: If the instrument under test does not meet the test specification, consider performing the adjustments in Section V of the Service Manual as a first step in correcting the problem.

4-42. RISE/FALL TIME A TEST

Specification: Refer to Table 1-1, HP Model 5334A/B Specifications, for the Rise/Fall specifications.

Description: The Rise/Fall time function of the HP 5334A/B is exercised at several different frequencies and slope settings.

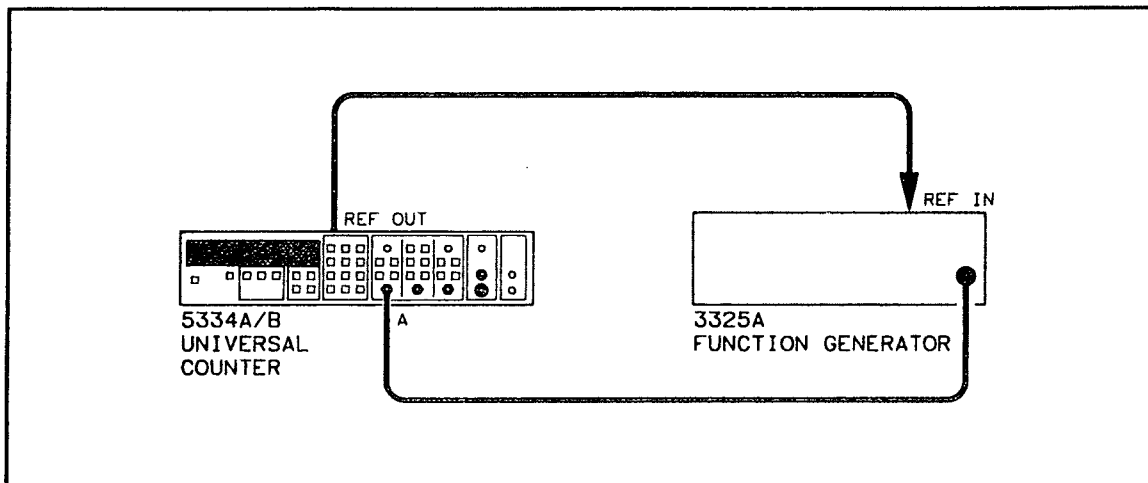

Figure 4-13. Rise/Fall Time A Test Setup

Equipment:

Function Generator HP 3325A

Procedure:

1. Set the function generator as follows:

Frequency 10 MHz
Amplitude 500 mV p-p
Function Sine Wave

2. Set the HP 5334A/B as follows:

Reinitialize the 5334A/B.

FUNCTION RISE/FALL A
CHANNEL A 50Ω ON

3. Connect the function generator signal to the HP 5334A/B Input A.

VERIFY: The Counter displays 30 ns ± 10 ns (Rise Time).

4. Record the rise measurement on the Performance Test Record Card, line 38.

5. Set the HP 5334A/B as follows:

CHAN A Negative SLOPE ON (falling edge)

VERIFY: The Counter displays 30 ns ± 10 ns (Fall Time).

6. Record the fall measurement on the Performance Test Record Card, line 39.

7. Set the function generator as follows:

Frequency 100 Hz
Amplitude 1V p-p
Function Negative Ramp

VERIFY: The Counter displays 8 ms \pm 0.6 ms (Fall Time).

8. Record the fall measurement on the Performance Test Record Card, line 40.

9. Set the function generator as follows:

Function Positive Ramp

10. Set the HP 5334A/B as follows:

CHAN A Negative SLOPE OFF (rising edge)

VERIFY: The Counter displays 8 ms \pm 0.6 ms (Rise Time).

11. Record the rise measurement on the Performance Test Record Card, line 41.

Failure: If the instrument under test does not meet the test specification, consider performing the adjustments in Section V of the Service Manual as a first step in correcting the problem.

4-43. DVM ACCURACY TEST (Options 020 and 050 — HP 5334A only)

Specification: Refer to *Table 1-1*, HP Model 5334A/B Specifications, for DVM specifications.

Description: Accuracy measurements are made on the DVM option of the HP 5334A.

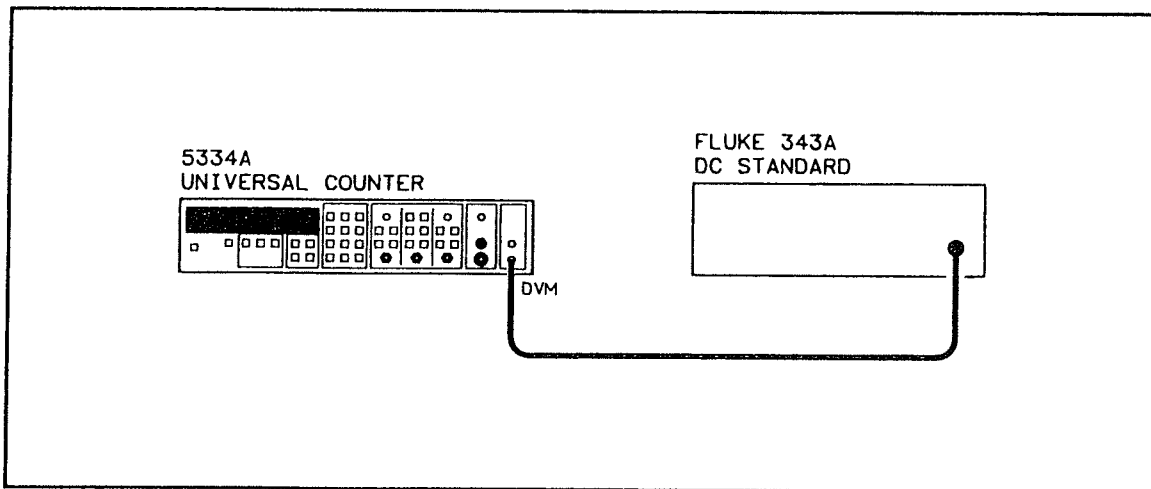

Figure 4-14. DVM Accuracy Test Setup

Equipment:

DC Voltage Standard FLUKE 343A

Procedure:

1. Set the DC Standard as follows:

Voltage 4.0000V

2. Set the HP 5334A as follows:

Reinitialize the 5334A.

FUNCTION DVM

3. Place a jumper across the inputs of the DVM to short them together.

VERIFY: The Counter displays $0V \pm 0.8 \text{ mV}$.

4. Record the DVM measurement on the Performance Test Record Card, line 42.
5. Remove jumper from DVM inputs and connect the DC Standard to the HP 5334A DVM inputs.

VERIFY: The Counter displays $4.000V \pm 0.010V$.

6. Record the DVM measurement on the Performance Test Record Card, line 43.
7. Switch the polarity of the DC input signal.

VERIFY: The Counter displays $-4.000V \pm 0.010V$.

8. Record the DVM measurement on the Performance Test Record Card, line 44.
9. Set the DC Standard as follows:

Voltage 40.000V

VERIFY: The Counter displays $40.00V \pm 0.10V$.

10. Record the DVM measurement on the Performance Test Record Card, line 45.
11. Switch the polarity of the DC input signal.

VERIFY: The Counter displays $-40.00V \pm 0.10V$.

12. Record the DVM measurement on the Performance Test Record Card, line 46.

WARNING

THE FOLLOWING STEP REQUIRES HIGH VOLTAGE. EXTREME CARE SHOULD BE EXERCISED.

13. Set the DC Standard as follows:

Voltage 400.00V

VERIFY: The Counter displays $400.0V \pm 0.4V$.

14. Record the DVM measurement on the Performance Test Record Card, line 47.
15. Switch the polarity of the DC input signal.

VERIFY: The Counter displays $-400.0V \pm 0.4V$.

16. Record the DVM measurement on the Performance Test Record Card, line 48.
17. Reset the DC Standard to 4.0000V.

Failure: Perform Section V, Adjustments, paragraphs 5-23, 5-24, and 5-25.

4-44. CHANNEL C FREQUENCY RESPONSE AND SENSITIVITY TEST — HP 5334A/B

This test is for HP 5334A/Bs containing **Options 030 and 050**.

Specification: Refer to *Table 1-1*, HP Model 5334A/B Specifications, for the Channel C specifications.

Description: Channel C is tested at various frequencies and signal levels.

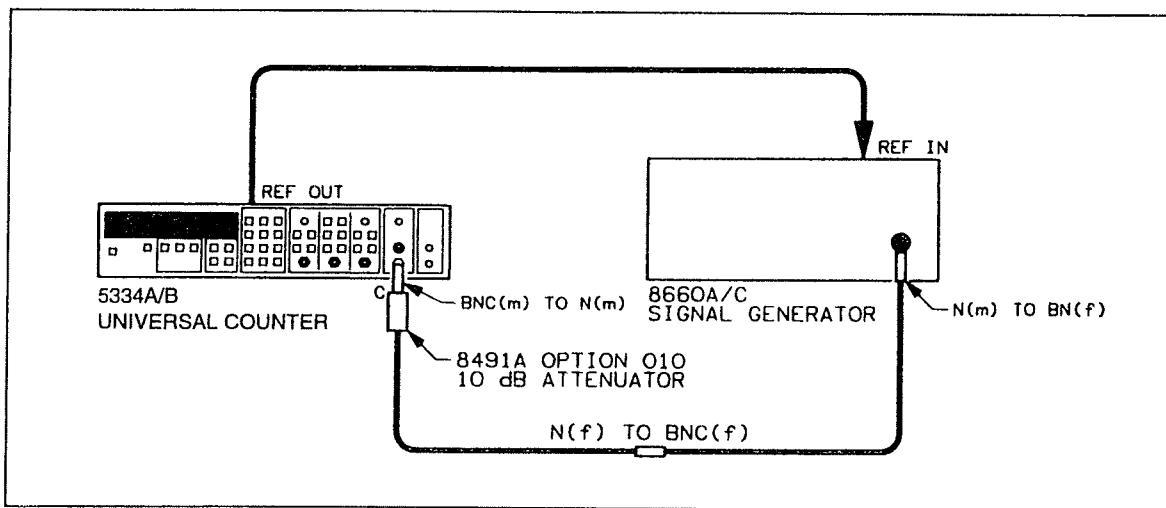

Figure 4-15. HP 5334A/B Channel C Frequency and Sensitivity Setup

Equipment:

Signal Generator	HP 8660A/C
10 dB Attenuator	HP 8491A
Adapter N(m) to BNC(m)	HP 1250-0082
Adapter N(f) to BNC(f)	HP 1250-1474
Adapter N(m) to BNC(f)	HP 1250-0780

Procedure:

1. Set the signal generator as follows:

Frequency 90 MHz
Amplitude -13.5 dBm

NOTE

This amplitude provides 15 mV rms to the Channel C Input when using the 10 dB attenuator.

2. Set the HP 5334A/B as follows:

Reinitialize the 5334A/B

FUNCTION **FREQ C**
CHANNEL C SENSITIVITY control fully cw (5334A only)

3. Connect the signal generator output to the HP 5334A/B Input C through a 10 dB attenuator.

NOTE

The 10 dB attenuator is used here for impedance matching.

VERIFY: The Counter displays 90.0 MHz \pm 2 Hz.

4. Record the measurement on the Performance Test Record Card, line 49.
5. Set the signal generator as follows:

Frequency 1000 MHz
Amplitude -13.5 dBm

NOTE

This amplitude provides 15 mV rms to the Channel C Input when using the 10 dB attenuator.

VERIFY: The Counter displays 200.0 MHz \pm 3 Hz.

6. Record the measurement on the Performance Test Record Card, line 50.
7. Set the signal generator as follows:

Frequency 1000 MHz
Amplitude +0.5 dBm

NOTE

This amplitude provides 15 mV rms to the Channel C Input when using the 10 dB attenuator.

VERIFY: The Counter displays 1000 MHz \pm 20 Hz.

8. Record the measurement on the Performance Test Record Card, line 51.
9. Set the signal generator as follows:

Frequency 1300 MHz
Amplitude +0.5 dBm

NOTE

This amplitude provides 75 mV rms to the Channel C Input when using the 10 dB attenuator.

VERIFY: The Counter displays 1300 MHz \pm 20 Hz.

10. Record the measurement on the Performance Test Record Card, line 52.

Failure: Perform Section V, Adjustments.

Table 4-2. HP 5334A/B Performance Test Record Card

PERFORMANCE TEST RECORD (Page 1 of 3)					
HEWLETT-PACKARD MODEL 5334A/B UNIVERSAL COUNTER			Repair/Work Order No. _____		
Serial Number: _____			Temperature: _____		
Test Performed By: _____			Relative Humidity: _____		
Date: _____			Post Calibration Test: <input type="checkbox"/>		
Notes: _____			Pre Calibration Test: <input type="checkbox"/>		
PARA NO.	TEST DESCRIPTION	LINE NO.	RESULTS		
			MINIMUM	ACTUAL	MAXIMUM
4-31.	CHANNEL A FREQUENCY RESPONSE AND SENSITIVITY TEST, 10 Hz–20 MHz				
	Input conditions				
	15 mV rms 10 Hz	1.	9.07	_____	10.03
	DC coupled				
	1 Megohm 20 MHz	2.	19.999 999 7	_____	20.000 000 3
	15 mV rms 30 Hz	3.	29.97	_____	30.03
4-32.	CHANNEL B FREQUENCY RESPONSE AND SENSITIVITY TEST, 10 Hz–20 MHz				
	Input conditions:				
	15 mV rms 10 Hz	7.	9.07	_____	10.03
	DC coupled				
	1 Megohm 20 MHz	8.	19.999 999 7	_____	19.999 999 3
	15 mV rms 30 Hz	9.	29.97	_____	30.03
4-33.	CHANNEL A FREQUENCY RESPONSE AND SENSITIVITY TEST, 80 MHz–100 MHz (For Non-Option 060 Instruments, i.e., Front Inputs only)				
	Input conditions:				
	35 mV rms 80 MHz	13.	79.99999800	_____	80.00000200
	DC coupled				
	1 Megohm 100 MHz	14.	99 99999800	_____	100.00000200
	35 mV rms 80 MHz	15.	79.99999800	_____	80.00000200
	AC coupled				
	1 Megohm 100 MHz	16.	99.99999800	_____	100.00000200
	35 mV rms 80 MHz	17.	79.99999800	_____	80.00000200
	AC coupled				
	50 ohm 100 MHz	18.	99.99999800	_____	100.00000200

Table 4-2. HP 5334A/B Performance Test Record Card (Continued)

PARA NO.	TEST DESCRIPTION	LINE NO.	RESULTS		
			MINIMUM	ACTUAL	MAXIMUM
4-34.	CHANNEL B FREQUENCY RESPONSE AND SENSITIVITY TEST, 80 Hz–100MHz (For Non-Option 060 Instruments, i.e., Front Inputs only)				
	35 mV rms DC coupled 80 MHz	19.	79.99999800	_____	80.00000200
	1 Megohm 100 MHz	20.	99.99999800	_____	100.00000200
	35 mV rms AC coupled 80 MHz	21.	79.99999800	_____	80.00000200
	1 Megohm 100 MHz	22.	99.99999800	_____	100.00000200
	35 mV rms AC coupled 80 MHz	23.	79.99999800	_____	80.00000200
	50 Ohm 100 MHz	24.	99.99999800	_____	100.00000200
	4-35.	CHANNEL A FREQUENCY RESPONSE AND SENSITIVITY TEST, 80–100 Hz (For Option 060 Instruments, i.e., Front and Rear Inputs)			
50 mV rms DC coupled 80 MHz		25.	79999998.00	_____	80.00000200
1 Megohm 100 MHz		26.	99999998.00	_____	100.00000200
50 mV rms AC coupled 80 MHz		27.	79.99999800	_____	80.00000200
1 Megohm 100 MHz		28.	99.99999800	_____	100.00000200
4-36.	CHANNEL B FREQUENCY RESPONSE AND SENSITIVITY TEST, 80–100 Hz (For Option 060 Instruments, i.e., Front and Rear Inputs)				
	50 mV rms DC coupled 80 MHz	29.	79.99999800	_____	80.00000200
	1 Megohm 100 MHz	30.	99.99999800	_____	100.00000200
	50 mV rms AC coupled 80 MHz	31.	79.99999800	_____	80.00000200
	1 Megohm 100 MHz	32.	99.99999800	_____	100.00000200
4-37.	PERIOD A TEST				
	50 mV rms, 100 MHz, sine wave	33.	9.9999999 ns	_____	10.0000001 ns
4-38.	PULSE WIDTH A TEST				
	200 mV rms, 100 MHz sine wave	34.	1 ns	_____	9 ns
4-39.	TIME INTERVAL A-TO -B TEST				
	200 mV p-p, 5 MHz, square wave	35.	94 ns	_____	106 ns
4-40.	TIME INTERVAL A-TO-B DELAY TEST				
	100 mV rms, 5 MHz, sine wave	36.	14.9 ms	_____	15.1 ms
4-41.	RATIO A/B				
	100 mV rms, 5 MHz, sine wave	37.	1.999999	_____	2.000001

Table 4-2. HP 5334A/B Performance Test Record Card (Continued)

PERFORMANCE TEST RECORD (Page 3 of 3)						
PARA NO.	TEST DESCRIPTION	LINE NO.	RESULTS			
			MINIMUM	ACTUAL	MAXIMUM	
4-42.	RISE/FALL TIME A TEST 500 mV p-p, 100 MHz sine wave					
		(rise)	38.	20 ns	_____	40 ns
		(fall)	39.	20 ns	_____	40 ns
		(fall)	40.	7.4 ms	_____	8.6 ms
4-43.	DVM ACCURACY TEST (5334A only) DC Voltage Standard, 4.0000V	(fall)	41.	7.4 ms	_____	8.6 ms
			42.	-8 mV	_____	+8 mV
			43.	+3.889V	_____	+4.010V
			44.	+3.990V	_____	-4.010V
			45.	+39.90V	_____	+40.10V
			46.	-39.90V	_____	-40.10V
			47.	+399.6V	_____	+400.4V
			48.	-399.6V	_____	-400.4V
4-44.	CHANNEL C FREQUENCY RESPONSE AND SENSITIVITY TEST					
		-13.5 dBm, 90 MHz	38.	89.999998	_____	90.000002
		+13.5 dBm, 200 MHz	39.	199.999997	_____	200.000003
		+0.5 dBm, 1000 MHz	40.	999.999980	_____	1.00000020
	+0.5 dBm, 1300 MHz	41.	1.299999980	_____	1.300000020	

4-45. HP-IB VERIFICATION TEST

4-46. The following test checks the Counter's ability to process or send the HP-IB Messages (Meta Message) described in Table 3-9. During the test all of the Counter's HP-IB data input/output bus, control, and handshake lines are checked. Only the Counter, an HP 85A, or 85B controller, an HP-IB interface with appropriate cabling, and an HP-IB Verification Cassette, HP P/N 59300-10002, Revision K (or later) are needed for the test setup. If desired, an HP 9000 Series 200/300 controller may be used with an HP-IB Verification program written in HP Basic 5.xx. The disc part numbers are 05334-13501 (3.50") and 05334-13502 (5.25").

4-47. The validity of these checks is based on the following assumptions:

- The Counter operates correctly from the front panel. This can be verified by performing the Operational Verification Tests beginning with paragraph 4-12.
- The controller properly executes HP-IB operations.
- The HP-IB interface properly transfers the controller's instructions.

4-48. If the Counter appears to fail any of the HP-IB checks, the validity of the above assumptions should be confirmed before servicing the Counter.

4-49. The select code of the controller's I/O is assumed to be 7. The address of the controller is assumed to be 21. This select code-address combination, (i.e., 721) is necessary to these checks to be valid. The program lines presented here would have to be modified for any other combination.

4-50. If all of these checks are performed successfully, the Counter's HP-IB capability can be considered to be performing properly. These procedures do not check whether or not all of the Counter's program commands are being properly interpreted and executed by the instrument, however, if the front panel operation is confirmed to be working properly and its HP-IB capability operates correctly, then there is a high probability that the Counter will respond properly to all of its program commands.

Table 4-3. HP 5334A/B HP-IB Verification Test Record Card

Hewlett-Packard Company Model 5334A/B Universal Counter		Tested By: _____
Serial Number _____		Date: _____
PARAGRAPH NO.	TEST	Attach Results Here
4-45	HP-IB Test 1. Power-up Preset 2. Remote, Local, Local Lockout 3. Function Select 4. Input Conditioning — Channel A 5. Input Conditioning — Channel B 6. Trigger Levels 7. Gate Time 8. External Arming 9. Math Functions 10. Memory Recall (HP 5334A only) 11. Service Request 12. Status Byte 13. Send Error Code 14. High Speed Output	



Manual Part Number 05334-90047

Printed DECEMBER 1993

