

5342A MICROWAVE FREQUENCY COUNTER

OPERATING AND SERVICE MANUAL

SERIAL PREFIX: 1840A

This manual applies to Serial Prefix 1840A, unless accompanied by a Manual Change Sheet indicating otherwise.

Copyright HEWLETT-PACKARD COMPANY 1979
5301 STEVENS CREEK BLVD., SANTA CLARA, CALIF. 95050

MANUAL PART NUMBER 05342-90013
Microfiche Part Number 05342-90014

Printed: FEB 1979



TABLE OF CONTENTS

Section	Title	Page
I	GENERAL INFORMATION	1-1
	1-1. Introduction	1-1
	1-3. Specifications	1-1
	1-5. Safety Considerations	1-3
	1-7. Instrument Identification	1-3
	1-9. Accessories	1-3
	1-11. Description	1-4
	1-13. Options	1-4
	1-15. Service Equipment Available	1-4
	1-17. Recommended Test Equipment	1-4
II	INSTALLATION	2-1
	2-1. Introduction	2-1
	2-3. Unpacking and Inspection	2-1
	2-5. Installation Requirements	2-1
	2-9. Power Cable	2-2
	2-11. Operating Environment	2-3
	2-15. Storage and Shipment	2-3
	2-16. Environment	2-3
	2-19. Packaging	2-3
	2-22. Field Installation of Options	2-3
	2-24. Part Numbers for Ordering Option Kits	2-4
	2-26. Installation of 10 MHz Oscillator Option 001	2-4
	2-28. Installation of Amplitude Measurement Option 002	2-4
	2-30. Installation of Extended Dynamic Range Option 003	2-7
	2-32. Installation of Digital-to-Analog Conversion (DAC) Option 004	2-7
	2-34. Installation of HP-IB Option 011	2-8
	2-36. HP-IB Interconnections	2-9
	2-39. 5342A Listen Address	2-9
	2-41. HP-IB Descriptions	2-9
III	OPERATION	3-1
	3-1. Introduction	3-1
	3-3. Operating Characteristics	3-1
	3-5. Operating Ranges	3-1
	3-7. Resolution Keys	3-1
	3-10. CHECK, DAC, and ENTER Keys	3-2
	3-12. FREQ Keys	3-2
	3014. Automatic Mode	3-2
	3-16. Manual Mode	3-2
	3-18. Offset Frequencies	3-2
	3-20. Amplitude and Offset Measurements	3-2
	3-22. Digital-to-Analog Converter (DAC) Operation	3-2
	3-24. SET, RESET, RECALL, and CHS Keys	3-2
	3-25. SAMPLE RATE, GATE, and REMOTE	3-2
	3-30. AM Tolerance	3-3
	3-32. FM Tolerance	3-3
	3-34. Automatic Amplitude Discrimination	3-3
	3-36. Maximum Input Signal Power	3-3
	3-39. Input Cable Considerations	3-4

SECTION I GENERAL INFORMATION

1-1. INTRODUCTION

1-1. This manual provides operating and service information for the Hewlett-Packard Model 5342A Microwave Frequency Counter, shown in *Figure 1-1*.

1-3. SPECIFICATIONS

1-4. Specifications of the 5342A are listed in *Table 1-1*.

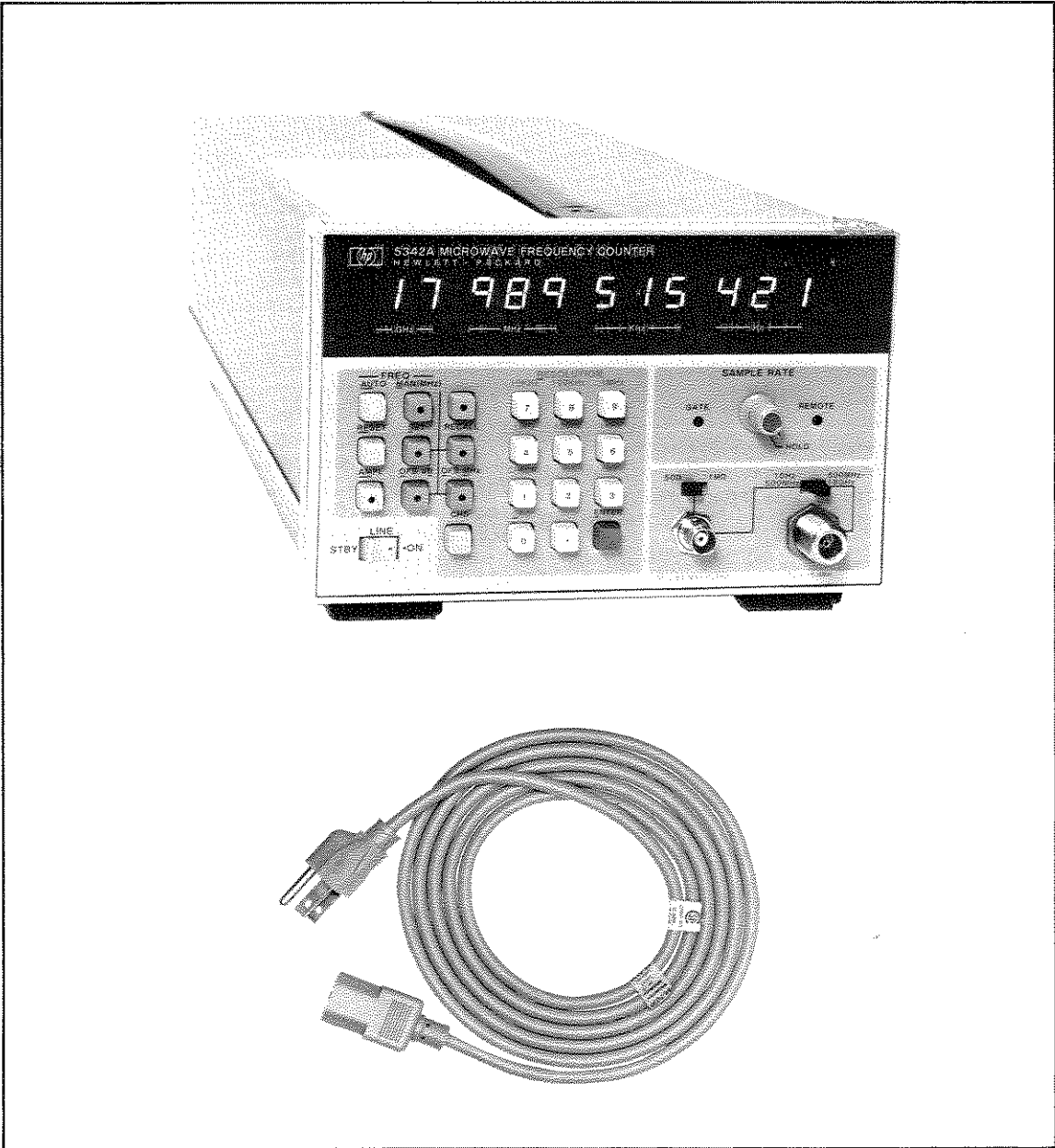

Figure 1-1. Model 5342A Microwave Frequency Counter

Table 1-1. Model 5342A Specifications

INPUT CHARACTERISTICS	
INPUT 1:	
Frequency range: 500 MHz to 18 GHz	
Sensitivity:	
500 MHz to 12.4 GHz -25 dBm	
12.4 GHz to 18 GHz -20 dBm	
Maximum input: +5 dBm (see Options 002, 003 for higher level).	
Dynamic range:	
500 MHz to 12.4 GHz 30 dB	
12.4 GHz to 18 GHz 25 dB	
Impedance: 50 ohms, nominal	
Connector: Precision Type N female	
Damage level: +25 dBm, peak	
Coupling: dc to load, ac to instrument.	
SWR:	
<2:1, 500 MHz—10 GHz	
<3:1, 10 GHz—18 GHz	
FM tolerance: Switch selectable (rear panel)	
FM (wide): 50 MHz p-p worst case.	
CW (normal): 20 MHz p-p worst case.	
For modulation rates from dc to 10 MHz.	
AM tolerance: Any modulation index provided the minimum signal level is not less than the sensitivity specification.	
Automatic amplitude discrimination: Automatically measures the largest of all signals present, providing that signal is 6 dB above any signal within 500 MHz; 20 dB above any signal, 500 MHz—18 GHz.	
Modes of operation:	
Automatic: Counter automatically acquires and displays highest level signal within sensitivity range.	
Manual: Center frequency entered to within ± 50 MHz to true value.	
Acquisition time:	
Automatic mode: Normal FM 530 ms worst case; wide FM 2.4 s worst case.	
Manual mode: 80 ms after frequency entered.	
INPUT 2:	
Frequency range: 10 Hz to 520 MHz Direct Count.	
Sensitivity:	
50 Ω 10 Hz to 520 MHz 25 mV rms.	
1 M Ω 10 Hz to 25 MHz 50 mV rms.	
Impedance: Selectable: 1 M Ω , <50 pF or 50 Ω nominal.	
Coupling: ac	
Connector: Type BNC female.	
Maximum input: 50 Ω 3.5V rms (+24 dBm) or 5V dc fuse protected; 1 M Ω 200V dc +5.0V rms.	
TIME BASE	
Crystal frequency: 10 MHz	
Stability:	
Aging rate: $<1 \times 10^{-7}$ per month.	
Short term: $<1 \times 10^{-9}$ for 1 second average time.	
Temperature: $<\pm 1 \times 10^{-6}$ over the range 0°C to 50°C.	
Line variation: $<\pm 1 \times 10^{-7}$ for 10% change from nominal.	
Output frequency: 10 MHz ≥ 2.4 V square wave (TTL compatible); 1.5V peak-to-peak into 50 Ω available from rear panel BNC.	
External time base: Requires 10 MHz, 2.0V peak-to-peak sine wave or square wave into 1 K Ω via rear panel BNC connector. Switch selects either internal or external time base.	
OPTIONAL TIME BASE (OPTION 001)	
Option 001 provides an oven-controlled crystal oscillator time base, 10544A (see separate data sheet), that results in better accuracy and longer periods between calibration.	
Crystal frequency: 10 MHz	
Stability:	
Aging rate: $<5 \times 10^{-10}$ /day after 24-hour warm-up.	
Temperature: $<7 \times 10^{-9}$ over the range 0°C to 50°C.	
Short term: $<1 \times 10^{-11}$ for 1 second average time.	
Line variation: $<1 \times 10^{-10}$ for 10% change from nominal.	
Warm-up: $<5 \times 10^{-9}$ of final value 20 minutes after turn-on, at 25°C.	
AMPLITUDE MEASUREMENT (OPTION 002)	
Option 002 provides the capability of measuring the amplitude of the incoming sine wave signal, and simultaneously displaying its frequency (MHz) and level (dBm). The maximum operating level and the top end of dynamic range are increased to +20 dBm. Amplitude offset to 0.1 dB resolution may be selected from front panel pushbuttons.	
INPUT 1:	
Frequency range: 500 MHz—18 GHz.	
Dynamic range (frequency and level):	
-22 dBm to +20 dBm 500 MHz to 12.4 GHz	
-15 dBm to +20 dBm 12.4 GHz to 18 GHz	
Maximum operating level: +20 dBm	
Damage level: +25 dBm, peak	
Resolution: 0.1 dB	
Accuracy: ± 1.5 dB (excluding mismatch uncertainty).	
SWR:	
<2:1 (amplitude measurement).	
<5:1 (frequency measurement).	
Measurement time: 100 ms + frequency measurement time.	
Display: Simultaneously displays frequency to 1 MHz resolution and input level. (Option 011 provides full frequency resolution on HP-IB output.)	
INPUT 2: (50Ω impedance only)	
Frequency range: 10 MHz—520 MHz	
Dynamic range (frequency and level):	
-17 dBm to +20 dBm.	
Damage level: +24 dBm, peak	
Resolution: 0.1 dBm.	
Accuracy: 1.5 dB (excluding mismatch uncertainty).	
SWR: <1.8:1	
Measurement time: 100 ms + frequency measurement time.	
Display: Simultaneously displays frequency to 1 MHz resolution and input level.	

Table 1-1. Model 5342A Specifications (Continued)

EXTENDED DYNAMIC RANGE (OPTION 003)	GENERAL
<p>Option 003 provides an attenuator that automatically extends the dynamic range of operation for input 1.</p> <p>INPUT 1: Frequency range: 500 MHz to 18 GHz Sensitivity: 500 MHz to 12.4 GHz -22 dB 12.4 GHz to 18 GHz -15 dBm Maximum operating level: +20 dBm. Dynamic range: 500 MHz to 12.4 GHz 42 dB 12.4 GHz to 18 GHz 35 dB Damage level: +25 dBm, peak SWR: <5:1</p>	<p>Accuracy: ± 1 count \pm time base error. Resolution: Front panel pushbuttons select 1 Hz to 1 MHz. Residual stability: When counter and source use common time base or counter uses external higher stability time base, $<4 \times 10^{-11}$ rms typical. Display: 11-digit LED display, sectionalized to read GHz, MHz, kHz, and Hz. Self-check: Selected from front panel pushbuttons. Measures 75 MHz for resolution chosen. Frequency offset: Selected from front panel pushbuttons. Displayed frequency is offset by entered value to 1 Hz resolution. Sample rate: Variable from less than 20 ms between measurements to HOLD which holds display indefinitely. IF out: Rear panel BNC connector provides 25 MHz to 125 MHz output of down-converted microwave signal. Operating temperature: 0°C to 50°C. Power requirements: 100/120/220/240V rms, +5%, -10%, 48-66 Hz; 100 VA max. Accessories furnished: Power cord, 229 cm (7½ ft.) Size: 133 mm H \times 213 mm W \times 498 mm D (5¼" \times 8⅜" \times 19⅝") Weight: Net 9.1 kg (20 lbs.). Shipping 12.7 kg (28 lbs.).</p>
<p style="text-align: center;">DIGITAL-TO-ANALOG CONVERTER (OPTION 004)</p> <p>Option 004 provides the ability to convert any three consecutive displayed digits into an analog voltage output. A display of 000 produces 0V output; 999 produces 9.99V full scale. Accuracy: ± 5 mV, ± 0.3 mV/°C (from 25°C) Conversion Speed: $<50 \mu\text{s}$ to $\pm 0.01\%$ of full scale reading. Resolution: 10 mV Output: 5 mA. Impedance <1.0 ohm. Connector: Type BNC female on rear panel.</p>	

1-5. SAFETY CONSIDERATIONS

1-6. This product is a Safety Class I instrument (provided with a protective earth terminal). Safety information pertinent to the operation and servicing of this instrument is included in appropriate sections of this manual.

1-7. INSTRUMENT IDENTIFICATION

1-8. Hewlett-Packard instruments have a 2-section, 10-character serial number (0000A00000), which is located on the rear panel. The four-digit serial prefix identifies instrument changes. If the serial prefix of your instrument differs from that listed on the title page of this manual, there are differences between this manual and your instrument. Instruments having higher serial prefixes are covered with a "Manual Changes" sheet included with this manual. If the change sheet is missing, contact the nearest Hewlett-Packard Sales and Service Office listed at the back of this manual. Instruments having a lower serial prefix than that listed on the title page, are covered in Section VII.

1-9. ACCESSORIES

1-10. Table 1-2 lists accessory equipment supplied and Table 1-3 lists accessories available.

Table 1-2. Equipment Supplied

DESCRIPTION	HP PART NUMBER
Detachable Power Cord 229 cm (7½ feet long)	8120-1378

Table 1-3. Accessories Available

DESCRIPTION	HP PART NUMBER
Bail Handle Kit	5061-2002
Rack Mounting Adapter Kit (Option 908)	5061-0057
Rack Mounting Adapter Kit with slot for access to front connectors from rear.	K70-59992A
Transit Case	9211-2682
Service Accessory Kit (refer to paragraph 1-16)	Model 10842A
Microwave Attenuators	Model 8491B, 8494/5/6H
Signature Analyzer	Model 5004A

1-11. DESCRIPTION

1-12. The 5342A Microwave Frequency Counter measures the frequency of signals in the range of 10 Hz to 18 GHz, with a basic sensitivity of -25 dBm. Signals in the frequency range of 10 Hz to 500 MHz are measured by the direct count method. Signals in the frequency range of 500 MHz to 18 GHz are down-converted to an IF by a heterodyne conversion technique for application to the counter circuits. The unique conversion technique employed results in high sensitivity and FM tolerance in addition to automatic amplitude discrimination. The counted IF is added to the local oscillator frequency to determine the unknown frequency for display.

1-13. OPTIONS

1-14. Options available with the 5342A are described in *Table 1-1* and paragraph 3-57. If an option is included in the initial order, it will be installed at the factory and ready for operation upon receipt. If an option is ordered for field installation it will be supplied as a retrofit kit. Refer to Section II for kit part numbers and installation instructions.

1-15. SERVICE EQUIPMENT AVAILABLE

1-16. Extender boards are available for servicing printed circuit assemblies while extended from the instrument. The extender boards allow assemblies to be extended from their plug-in connectors for monitoring with appropriate test equipment. Extender boards for each assembly are supplied in Service Accessory Kit 10842A as described in paragraph 8-46.

1-17. RECOMMENDED TEST EQUIPMENT

1-18. The test equipment listed in *Table 1-4* is recommended for use during performance tests, adjustments, and troubleshooting. Substitute test equipment may be used if it meets the required characteristics listed in the table.

Table 1-4. Recommended Test Equipment

INSTRUMENT	REQUIRED CHARACTERISTICS	USE*	RECOMMENDED MODEL
Oscilloscope	100 MHz bandwidth	T,A,OV,P	HP 1740A
Signal Generator	10 Hz—10 MHz 10 MHz—2.4 GHz 2 GHz—18 GHz	T,A,OV,P	HP 651B HP 8620C/86222A HP 8620C/86290A
Spectrum Analyzer	RF inputs from 1 MHz—500 MHz	T,A,P	HP 141T/8552A/8554B
DC Voltmeter	20V Range, 0.05V Resolution	T,A	HP 3465A
AC Voltmeter	10 MHz-350 MHz	T,A	HP 3406A
AC Voltmeter	100 kHz, 1% accuracy	A (Opt. 002)	HP 3400A
Logic State Analyzer	HP 1740A compatibility	T	HP 1607A (use with HP 1740A)
Signature Analyzer	5342A compatibility	T	HP 5004A
Power Splitter	DC—18 GHz	OV,P	HP 11667A
Logic Pulser	TTL compatibility	T	HP 546A
Current Tracer	1 mA—1 A range	T	HP 547A
Logic Probe	TTL compatibility	T	HP 545A
Step Attenuator	DC—18 GHz 10 dB steps	OV,P	HP 8495B
AP Clips (4)	Clip for 14 pin/16 pin IC's	T	HP P/N 1400-0734
Isolation Transformer	120V IN — Isolated 120V OUT	T	Allied Electronics P/N 705-0048
Extender Boards	2 × 10 pin 2 × 12 pin 2 × 15 pin 2 × 18 pin (2) 2 × 22 pin (2) 2 × 24 pin A 14 Extender A15 Extender	T	HP P/N 05342-60030 HP P/N 05342-60031 HP P/N 05342-60032 HP P/N 05342-60033 HP P/N 05342-60034 HP P/N 05342-60035 HP P/N 05342-60036 HP P/N 05342-60039
Power Meter	10 MHz—18 GHz	A,OV,P	HP 436A
Power Sensor	10 MHz—18 GHz -30 dBm to +20 dBm	A,OV,P	HP 8481A
50Ω Termination	DC—18 GHz	P	HP 909A (Option 012)
Microwave Amplifier	1 GHz, >+20 dBm Output	P (Opt. 002)	HP 489A
Signal Generator	100 MHz, +20 dBm	A (Opt. 002)	HP 8601A
Signal Generator	>100 MHz, >+20 dBm	P,OV, (Option 002)	HP 3312A
Swept Frequency Analyzer	100 MHz—18 GHz	P	HP 8755B
15 MHz—18 GHz Modulator	HP 8755B compatibility	P	HP 11665B
15 MHz-18 GHz Detectors (2 required)	0.1—18 GHz	P	HP 11664A
Oscilloscope Mainframe	HP 8755B compatibility	P	HP 182T
Directional Coupler	2—18 GHz	P	HP 11692D
Directional Coupler	100—500 MHz	P	HP 778D
Signal Generator Mainframe	(Two Microwave sources needed for automatic amplitude discrimination test — see paragraph 4-35)	P	HP 8620C Mainframe
Bus System Analyzer	Control HP-IB lines	T (Opt. 011)	HP 59401A

*T = Troubleshooting
A = Adjustments
OV = Operational Verification
P = Full Performance Testing

SECTION II INSTALLATION

2-1. INTRODUCTION

2-2. This section contains information for unpacking, inspection, storage, and installation.

2-3. UNPACKING AND INSPECTION

2-4. If the shipping carton is damaged, inspect the instrument for visible damage (scratches, dents, etc.). If the instrument is damaged, notify the carrier and the nearest Hewlett-Packard Sales and Service Office immediately (offices are listed at the back of this manual). Keep the shipping carton and packing material for the carrier's inspection. The Hewlett-Packard Sales and Service Office will arrange for repair or replacement of your instrument without waiting for the claim against the carrier to be settled.

2-5. INSTALLATION REQUIREMENTS

CAUTION

Before connecting the instrument to ac power lines, be sure that the voltage selector is properly positioned as described below.

2-6. **LINE VOLTAGE REQUIREMENTS.** The 5342A is equipped with a power module that contains a printed-circuit line voltage selector to select 100-, 120-, 220-, or 240-volt ac operation. Before applying power, the pc selector must be set to the correct position and the correct fuse must be installed as described below.

2-7. Power line connections are selected by the position of the plug-in circuit card in the module. When the card is plugged into the module, the only visible markings on the card indicate the line voltage to be used. The correct value of line fuse, with a 250-volt rating, must be installed after the card is inserted. This instrument uses a 0.75A fuse (HP Part No. 2110-0360) for 100/120-volt operation; a 0.375A fuse (HP Part No. 2110-0421) for 220/240-volt operation.

2-8. To convert from one line voltage to another, the power cord must be disconnected from the power module before the sliding window covering the fuse and card compartment can be moved to expose the fuse and circuit card. See *Figure 2-1*.

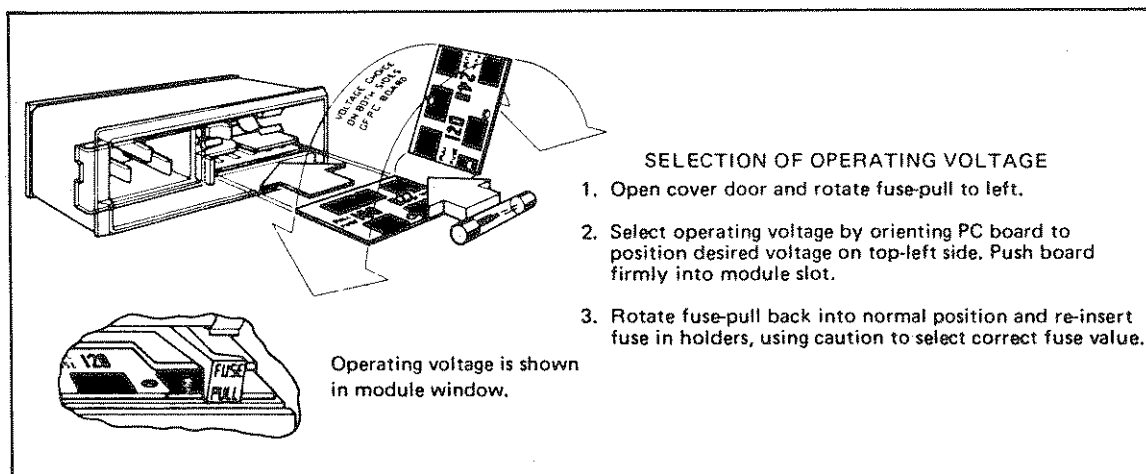

Figure 2-1. Line Voltage Selection

2-9. Power Cable

2-10. The 5342A is shipped with a three-wire power cable. When the cable is connected to an appropriate ac power source, this cable connects the chassis to earth ground. The type of power cable plug shipped with each instrument depends on the country of destination. Refer to *Figure 2-2* for the part numbers of the power cable and plug configurations available.

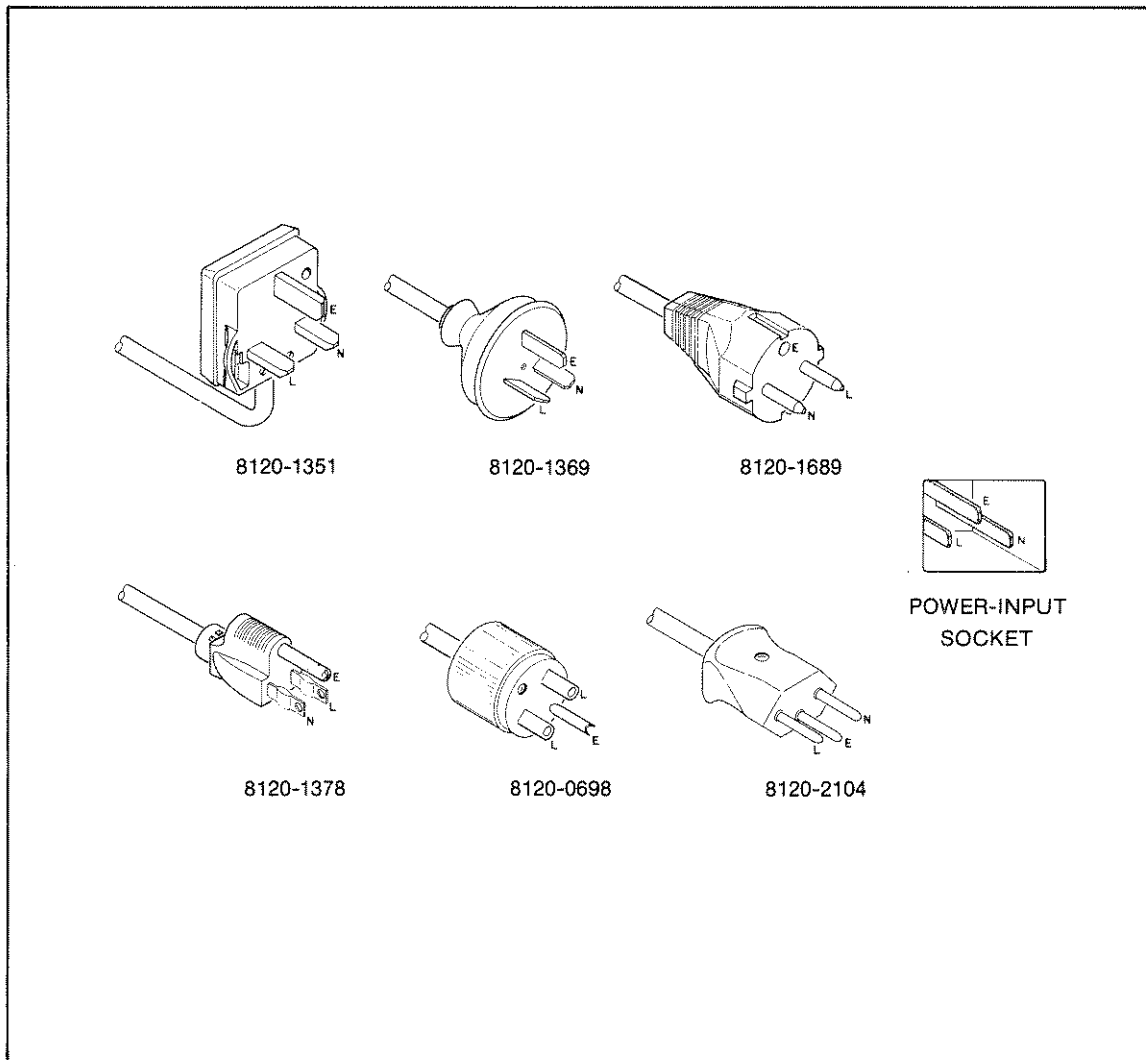

Figure 2-2. Power Cable HP Part Numbers versus Mains Plugs Available

WARNING

BEFORE SWITCHING ON THIS INSTRUMENT, THE PROTECTIVE EARTH TERMINALS OF THIS INSTRUMENT MUST BE CONNECTED TO THE PROTECTIVE CONDUCTOR OF THE (MAINS) POWER CORD. THE MAINS PLUG SHALL ONLY BE INSERTED IN A SOCKET OUTLET PROVIDED WITH A PROTECTIVE EARTH CONTACT. THE PROTECTIVE ACTION MUST NOT BE NEGATED BY THE USE OF AN EXTENSION CORD (POWER CABLE) WITHOUT A PROTECTIVE CONDUCTOR (GROUNDING).

2-11. Operating Environment

2-12. TEMPERATURE. The 5342A may be operated in temperatures from 0°C to +55°C.

2-13. HUMIDITY. The 5342A may be operated in environments with humidity up to 95%. However, it should be protected from temperature extremes which cause condensation in the instrument.

2-14. ALTITUDE. The 5342A may be operated at altitudes up to 4,600 metres (15,000 feet).

2-15. STORAGE AND SHIPMENT

2-16. Environment

2-17. The instrument may be stored or shipped in environments within the following limits:

TEMPERATURE -40°C to +75°C
HUMIDITY Up to 95%
ALTITUDE 7,620 metres (25,000 feet)

2-18. The instrument should also be protected from temperature extremes which cause condensation within the instrument.

2-19. Packaging

2-20. ORIGINAL PACKAGING. Containers and materials identical to those used in factory packaging are available through Hewlett-Packard offices. If the instrument is being returned to Hewlett-Packard for servicing, attach a tag indicating the type of service required, return address, model number, and full serial number. Also, mark the container FRAGILE to ensure careful handling. In any correspondence, refer to the instrument by model number and full serial number.

2-21. OTHER PACKAGING. The following general instructions should be used for repacking with commercially available materials:

- a. Wrap instrument in heavy paper or plastic. (If shipping to Hewlett-Packard office or service center, attach tag indicating type of service required, return address, model number, and full serial number.)
- b. Use strong shipping container. A double-wall carton made of 350-pound test material is adequate.
- c. Use a layer of shock-absorbing material 70 to 100 mm (3- to 4-inch) thick around all sides of the instrument to provide firm cushioning and prevent movement inside container. Protect control panel with cardboard.
- d. Seal shipping container securely.
- e. Mark shipping container FRAGILE to ensure careful handling.
- f. In any correspondence, refer to instrument by model number and full serial number.

2-22. FIELD INSTALLATION OF OPTIONS

2-23. Procedures for field installation of Options 001, 002, 003, 004, and 011 are described in the following paragraphs.

2-24. Part Numbers for Ordering Option Kits

2-25. To obtain the necessary parts for installation of an option, order by part number as listed below (refer to Section VI for ordering information):

Option	Name	Part Number
001	High Stability Time Base	HP Model 10544A
002	Amplitude Measurement	05342-60200 (Kit)
003	Extended Dynamic Range	05342-60201 (Kit)
*004	Digital-to-Analog Converter	05342-60202 (Kit)
001	HP-IB I/O	05342-60019 (HP-IB Assy.) 05342-60029 (HP-IB Input Assy.)

*NOTE

If the instrument in which Option 004 is to be installed has a series number 1812 or lower, the U7 ROM on A14 Microprocessor will have to be replaced. Order U7 ROM Part Number 1818-0706 to replace the old U7 ROM (1818-0331).

2-26. Installation of 10 MHz Oscillator Option 001

2-27. Option 001 consists of oven-controlled crystal oscillator time base 10544A, which has a pc card connector. Option 001 is installed in the same connector on the motherboard as the standard oscillator (A24). See *Figure 8-44*. To install Option 001, proceed as follows:

- Remove the standard oscillator from A24 connector.
- Install Option 001 oscillator into A24 connector.
- Attach Option 001 oscillator to the motherboard by means of two $6/32 \times 5/16$ pan head screws. Install the screws from the bottom of the motherboard using star washers.
- Perform Option 001 oscillator adjustment as described in paragraph 5-32.

2-28. Installation of Amplitude Measurement Option 002

2-29. Option 002 consists of U2 High Frequency Amplitude assembly and A27 Low Frequency Amplitude Assembly modules and the A16 Amplitude Assembly pc board. U2 is connected to the high frequency input of the 5342A, A27 is connected to the low frequency input and both of the modules are connected to the A16 board by the coax wires supplied. See photo of installed option, *Figure 8-22*, and schematic diagram, *Figure 8-39*. To install the components proceed as follows:

NOTE

The parts that comprise this option are listed in *Table 6-5*.

- Remove the top and bottom covers and top plate from instrument.
- Place instrument top down.
- At inside front panel, disconnect cables from A1J1, J1J3, J25J1 (IF OUT INT), and A25J2 (IF OUT EXT).
- Solder one end of the white/red/green 14-inch wire (8120-0483) to AT1 feedthrough capacitor terminal on A25 Preamp assembly.

- e. Install coax assembly 8120-2268 through A22 motherboard from top of instrument at A16 slot. Place the wires through the holes as shown below:

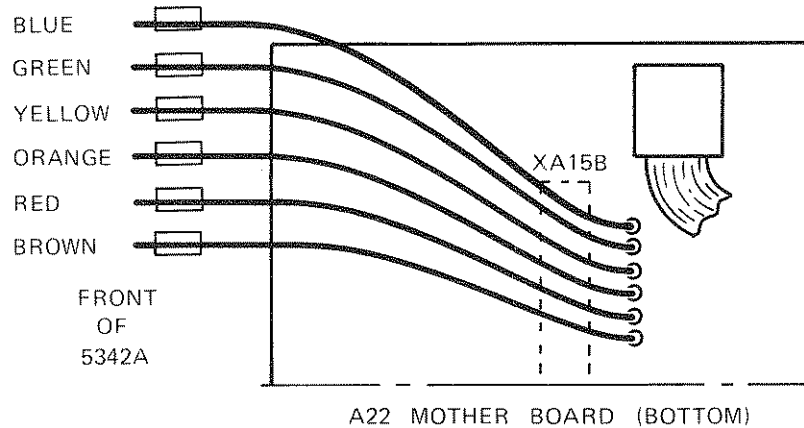

NOTE

Prior to installing A27 Low Frequency Amplitude Assembly, connect the wires as described below.

- f. Solder one end of the black/white/blue 14-inch wire (8120-0471) to C7 feedthrough capacitor terminal on A27.
- g. Place heat shrinkable tubing (0890-0983) over connection at C7.
- h. Place heat shrinkable tubing (0890-0983) over three of the coax wires (red, blue, and green) that were installed in step e. and solder these wires to the terminals listed below:

Coax	Terminal
Red	A27C10
Blue	A27C9
Green	A27C8

- i. Apply heat to shrink the tubing at the connections made in step g and h.
- j. Remove attaching nut from front panel N-type input connector and disconnect rigid coax W1 from J1 on U1 Sampler. Remove W1 from instrument.
- k. Mount A27 Low Frequency Amplitude Assembly in the recessed angle of the casting behind front frame, see *Figure 8-22*. Attach A27 to casting with two pan head screws supplied. Place a star washer under the other screw.
- l. The wire previously soldered to A27C10 has a black ground wire attached. Solder the end of this black wire to the ground lug installed in preceding step.
- m. Solder the free end of white/red/green wire (other end connected to A25AT1 in step d) to A22 motherboard at XA16B, pin 3 (ATT).

NOTE

Prior to installing U2 High Frequency Amplitude Assembly, connect the color-coded wires as shown below. Place heat shrinkable tubing (0890-0983 for coax and 0890-0706 for single wires) over all connections to U2.

Model 5342A
Installation

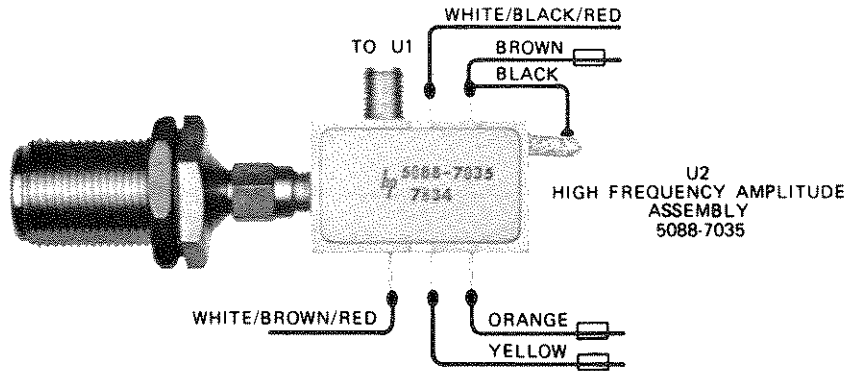

- n. Connect rigid coax (8120-2516) from U2 High Frequency Amplitude Assembly to J1 on Sampler U1. Install U2 input connector through front panel. Fasten with attaching nut.
- o. Solder white/black/red wire (from U2) to A22 motherboard XA16B, pin $\bar{3}$.
- p. Solder white/brown/red wire (from U2) to A22 motherboard XA16B, pin $\bar{4}$.
- q. Harness the coax cables and wires with tie wraps supplied.
- r. Connect cable 05342-60119 from A27J1 to A1J3.
- s. Connect cable A1J3/A27J2 to A27J2.
- t. Reconnect A1J1, J1 (IF OUT INT) and J2 (IF OUT EXT) and harness with tie wrap.
- u. Harness the white cables with tie wraps supplied.

NOTE

The ROM and U2 High Frequency Amplitude Assembly are supplied as a matched pair and are included under one replaceable part number (05342-80005).

- v. Install the ROM (supplied with option) into U3 socket on A16 (05342-60038) board.
- w. Replace resistor R2 on A16 board with a resistor of the value labeled on U2 assembly.
- x. Insert the plug of 8120-2268 cable into mating socket on A16 board (05342-60038) and install A16 into connector XA16.
- y. Perform the Option 002 adjustments listed under paragraph 5-33 through 5-39 of this manual.
- z. Perform the operational verification procedures in paragraphs 4-14, 4-15, and 4-17 of this manual.

NOTE

If the instrument does not meet the specified accuracy of ± 1.5 dB as described in paragraph 4-14, perform the following procedures.

Replace resistor R6 from the A27 Low Frequency Amplitude Assembly and replace with a resistor of a higher or lower value as shown below. For lower power readings increase the value and for higher power readings decrease the value of resistor R6 as follows:

dB Change	R6 Changes (ohms)
0.2	10
0.4	20
0.6	30
0.8	40
1.0	50

2-30. Installation of Extended Dynamic Range Option 003

2-31. Option 003 consists of A16 Extended Dynamic Range Assembly (05342-60037) and U2 Attenuator Assembly (5088-7038). See *Figure 8-22* for location of U2 (Option 002 or 003).

NOTE

The parts that comprise this option are listed at the end of *Table 6-6*.

- a. Remove the top and bottom covers and top plate from instrument.
- b. Place instrument top down.
- c. At inside front panel, disconnect cable from A1J1, A1J3, A25J1 (IF OUT INT), and A25J2 (IF OUT EXT).
- d. Solder one end of the white/red/green 14-inch wire (8120-0483) to AT1 feedthrough capacitor terminal on A25 Preamplifier Assembly.

NOTE

Prior to installing U2 (5088-7038) assembly, connect the color-coded wires as shown below. Place heat shrinkable tubing (0890-0706) over the connections and apply heat.

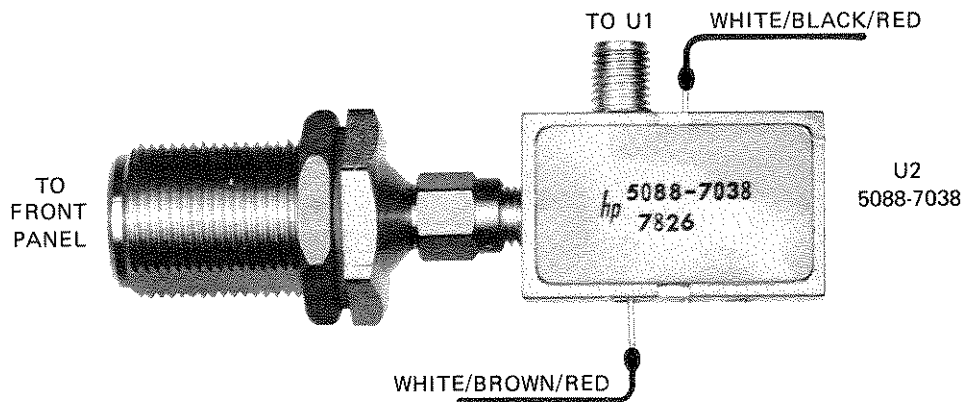

- e. Solder free end of white/red/green wire (other end connected to A25AT1 in step d) to A22 Motherboard at XA16B, pin 3 (ATT).
- f. Solder white/black/red wire (from U2) to A22 Motherboard XA16B, pin $\bar{3}$.
- g. Solder white/brown/red wire (from U2) to A22 Motherboard XA16B, pin $\bar{4}$.
- h. Remove the N-type input connector from front panel and replace with U2 (5088-7038).
- i. Connect rigid coax (supplied) from U2 to J1 on Sampler U1.
- j. Install A16 board (05342-60037) into XA16 connector.
- k. Perform the operational verification procedures in paragraphs 4-13 and 4-16 of this manual.

2-32. Installation of Digital-to-Analog Conversion (DAC) Option 004

2-33. Option 004 consists of an A2 Display Driver Assembly (05342-60028) that contains DAC circuitry added to the standard A2 circuit. Interconnecting wires are included with the Option 004 retrofit kit (05342-60202). Procedures for installation of Option 004 are as follows:

- a. Remove top and bottom covers, front frame and A1–A2 assemblies. Refer to disassembly procedures, paragraph 8-22.
- b. Replace the original A2 board (05342–60002) with Option 004 A2 board (05342–60028) and reassemble unit.
- c. If the series number of the instrument is 1812 or lower, the U7 ROM, 1818-0331 on the A14 Microprocessor board will have to be replaced with U7 ROM, 1818-0706 as described in step d. If instrument has the 1818-0706 ROM, proceed to step e.

CAUTION

ROM U7 is a large-scale MOS IC. Its inputs are susceptible to damage by high voltage and by static charges. Particular care should be exercised when servicing this IC or handling it under conditions where static charges can build up.

- d. Remove top plate from 5342A. Remove A14 Microprocessor and replace ROM U7 part number 1818-0331 with part number 1818-0706. Install A14.
- e. At bottom of 5342A connect coax cable to the connector at the bottom rear of A2 board labeled D/A OUTF. Solder the other end of this cable to the DAC OUT connector on the rear panel.
- f. Connect the white/gray wire to the pin (push-on) labeled LDA at bottom rear of A2 Display Driver board. Solder other end of wire to LDA terminal on A22 Motherboard as shown in figure below.
- g. Connect red wire (+15V) and violet wire (–15V) to the proper terminals (push-on pins) on A2 Display Driver board (see *Figure 8-25*, component locator for location). Connect other end of these wires to terminals on A22 Motherboard as shown in figure below.

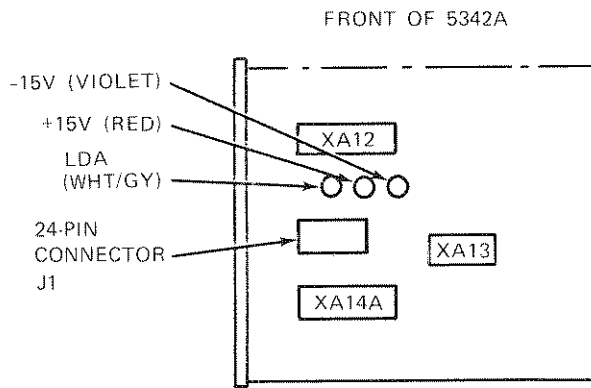

A22 Motherboard, Partial Bottom View

- h. Reassemble instrument and perform operational verification procedures in paragraph 4-27 of this manual.

2-34. Installation of HP-IB Option 011

2-35. Option 011 consist of printed-circuit assembly A15 and interconnection board A29. The interconnection board mounts inside the 5342A rear panel and is connected to A22 Motherboard via a cable strap. Procedures for installation of Option 011 are as follows (see photo of installed option, *Figure 8-22*):

- a. Remove top and bottom covers and top panel from the 5342A.
- b. Insert A15 assembly into A15 slot. See *Figure 8-21* for location.

- c. If 5342A is equipped with Option 001 Oscillator, remove oscillator assembly by removing two attaching screws from A22 Motherboard.

NOTE

In the following step, make sure that the address switch (A29S1) is located as shown in *Figure 8-20*.

- d. Insert the A29 Interconnection board (05342-60019) into the rear panel slots provided (from inside). Screw the two mounting studs (0380-0644) and washers (2100-3171) into the HP-IB connector to attach the board to the rear panel.
- e. Connect the plug of the cable strap from A29 to J2 on A22 Motherboard with arrow on installed plug pointing toward front panel.
- f. Perform the Option 011 HP-IB Verification in paragraph 4-19 of this manual.
- g. Refer to paragraph 2-36 for HP-IB interconnection data and to paragraph 3-69 for programming information.

2-36. HP-IB Interconnections

2-37. HEWLETT-PACKARD INTERFACE BUS. Interconnection data concerning the rear panel HP-IB connector is provided in *Figure 2-3*. This connector is compatible with the HP 10631A/B/C/D HP-IB cables. The HP-IB system allows interconnection of up to 15 (including the controller) HP-IB compatible instruments. The HP-IB cables have identical "piggy back" connectors on both ends so that several cables can be connected to a single source without special adapters or switch boxes. System components and devices may be connected in virtually any configuration desired. There must, of course, be a path from the calculator (or other controller) to every device operating on the bus. As a practical matter, avoid stacking more than three or four cables on any one connector. If the stack gets too large, the force on the stack produces great leverage which can damage the connector mounting. Be sure each connector is firmly (finger tight) screwed in place to keep it from working loose during use.

2-38. CABLE LENGTH RESTRICTIONS. To achieve design performance with the HP-IB, proper voltage levels and timing relationship must be maintained. If the system cable is too long, the lines cannot be driven properly and the system will fail to perform properly. Therefore, when interconnecting an HP-IB system, it is important to observe the following rules:

- a. The total cable length for the system must be less than or equal to 20 metres (65 feet).
- b. The total cable length for the system must be equal to or less than 2 metres (6.6 feet) times the total number of devices connected to the bus.
- c. The total number of instruments connected to the bus must not exceed 15.

2-39. 5342A Listen Address

2-40. The 5342A contains a rear panel HP-IB Instrument address selection switch. There are five switches designated (A₅, A₄, A₃, A₂, A₁) which are used to select the address. Instructions for setting and changing the listen address are provided in Section III of this manual along with programming codes.

2-41. HP-IB Descriptions

2-42. A description of the HP-IB is provided in Section III of this manual. A study of this information is necessary if the user is not familiar with the HP-IB concept. Additional information concerning the design criteria and operation of the bus is available in IEEE Standard 488-1975, titled "*IEEE Standard Digital Interface for Programmable Instrumentation*".

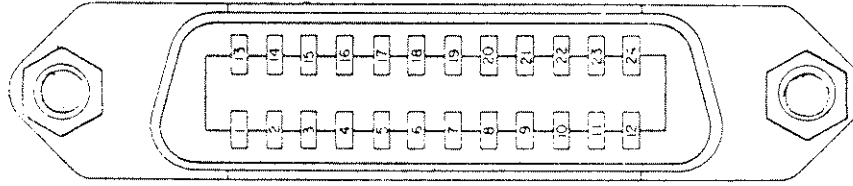

PIN	LINE
1	DIO1
2	DIO2
3	DIO3
4	DIO4
13	DIO5
14	DIO6
15	DIO7
16	DIO8
5	EOI
17	REN
6	DAV
7	NRFD
8	NDAC
9	IFC
10	SRQ
11	ATN
12	SHIELD-CHASSIS GROUND
18	P/O TWISTED PAIR WITH PIN 6
19	P/O TWISTED PAIR WITH PIN 7
20	P/O TWISTED PAIR WITH PIN 8
21	P/O TWISTED PAIR WITH PIN 9
22	P/O TWISTED PAIR WITH PIN 10
23	P/O TWISTED PAIR WITH PIN 11
24	ISOLATED DIGITAL GROUND

THESE PINS
ARE
INTERNALLY
GROUNDED

CAUTION

The 5342A contains metric threaded HP-IB cable mounting studs as opposed to English threads. Metric threaded HP 10631A, B, C, or D HP-IB cable lock screws must be used to secure the cable to the instrument. Identification of the two types of mounting studs and lock screws is made by their color. English threaded fasteners are colored silver and metric threaded fasteners are colored black. DO NOT mate silver and black fasteners to each other or the threads of either or both will be destroyed. Metric threaded HP-IB cable hardware illustrations and part numbers follow.

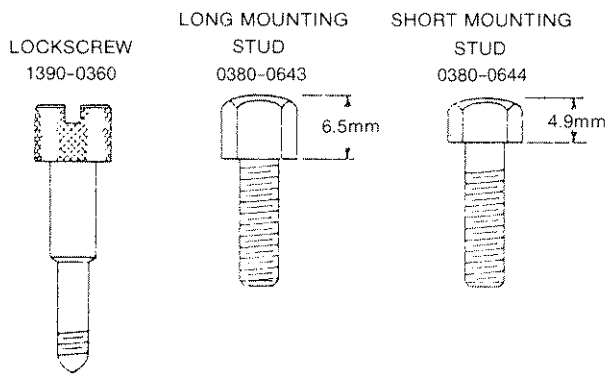

Logic Levels

The Hewlett-Packard Interface Bus logic levels are TTL compatible, i.e., the true (1) state is 0.0V dc to 0.4V dc and the false (0) state is +2.5V dc to +5.0V dc.

Programming and Output Data Format

Refer to Section III, Operation

Mating Connector

HP 1251-0293; Amphenol 57-30240.

Mating Cables Available

- HP 10631A, 0.9 metres (3 ft.), HP 10631B, 1.8 metres (6 ft.)
- HP 10631C, 3.7 metres (12 ft.)
- HP 10631D, 0.5 metres (1.5 ft.)

Cabling Restrictions

1. A Hewlett-Packard interface Bus System may contain no more than 1.8 metres (6 ft.) of connecting cable per instrument.
2. The maximum accumulative length of connecting cable for any Hewlett-Packard Interface Bus System is 20.0 metres (65.6 ft.).

Figure 2-3. Hewlett-Packard Interface Bus Connection

SECTION III OPERATION

3-1. INTRODUCTION

3-2. This section contains operating information including operating characteristics, descriptions of controls and indicators, and operating procedures.

3-3. OPERATING CHARACTERISTICS

3-4. The following paragraphs describe the operating ranges and modes, resolution, sample rate, AM and FM characteristics, and auto-amplitude discrimination. Front panel controls and indicators are described in *Figure 3-1*, rear panel controls and connectors are described in *Figure 3-2*. Operating procedures are explained in *Figure 3-3*. Amplitude measurements (Option 002) are described in *Figure 3-4*. DAC operation (Option 004) is described in *Figure 3-5*.

3-5. Operating Ranges

3-6. There are two basic operating ranges: 10 Hz to 500 MHz and 500 MHz to 18 GHz. Frequencies in the lower range are measured directly while measurements in the 500 MHz to 18 GHz range are made indirectly by a harmonic heterodyne down-conversion technique. Provision is made to select either range by a front-panel slide switch. A separate input connector is provided for each range. When the range switch is in the 10 Hz—500 MHz position, the signal at the BNC connector is routed to the direct count circuits of the 5342A. In this range, input impedance is selectable via the 50 Ω —1 M Ω switch. When the range switch is in the 500 MHz—18 GHz range, the input signal is applied via the front-panel type N connector to the down-conversion circuits of the 5342A.

3-7. Resolution Keys

3-8. The best case resolution is the value represented by the least significant digit (LSD) in the display. In the 5342A, a maximum resolution of 1 Hz can be selected (by the pushbutton keys on the front panel labeled in blue, preceded by the blue key being pressed). The display is divided into four sections for ease of determining GHz, MHz, kHz, and Hz resolution. Half-sized \square 's are used as space fillers within a section to improve interpretation of the display. For example, a signal measured to 100 kHz resolution will be displayed thus:



The two filler \square 's in the kHz section indicate immediately that the \square represents hundreds of kilohertz. The Hz section is blanked.

3-9. The pushbutton keys on the front panel under the RESOLUTION label are used for other purposes when the blue key is not in effect (has not been pressed). When the blue key has not been pressed, the keys are defined by the black number on the keys and are used to enter frequency offsets, manual center frequencies, and amplitude offsets as described in *Figure 3-1*.

3-10. CHECK, DAC, and ENTER keys

3-11. The CHECK, DAC, and ENTER keys are used as described in *Figure 3-1*.

3-12. FREQ Keys

3-13. Two of the pushbutton keys on the front panel under the FREQ label are used to select the automatic or manual mode of operation. The other keys in this section of the keyboard control the use of the RESOLUTION keys. Use of these keys is described in detail in *Figure 3-1*.

3-14. Automatic Mode

3-15. The automatic mode of operation is selected by pressing the AUTO key. Input signals in the 500 MHz—18 GHz range are acquired, measured, and displayed automatically. When power is initially turned on, the 5342A goes into this mode automatically.

3-16. Manual Mode

3-17. The manual mode of operation is selected by pressing the MAN (MHz) key. To operate in this mode, input signals in the 500 MHz—18 GHz range must be known to within 50 MHz and this frequency (called the manual center frequency) must be entered into the display prior to the measurement. Use of the manual mode is described in detail in *Figure 3-3*.

3-18. Offset Frequencies

3-19. It is sometimes desirable to add or subtract a constant to/from a frequency measurement. For example, by measuring a radio IF and knowing the LO, the counter can display the RF input when the LO frequency is entered as a positive offset. It may be easier to tune an oscillator to a specific frequency if the desired frequency is entered as a negative offset and the oscillator tuned until the counter reads zero. Frequency offsets are described in *Figure 3-3*.

3-20. Amplitude and Offset Measurements

3-21. When Amplitude Option 002 is installed, the amplitude is displayed in addition to the frequency of the input signal. The frequency is displayed to 1 MHz resolution in the five leftmost digits and the amplitude is displayed to 0.1 dB resolution in the four rightmost digits of the display. An arbitrary value can be selected as an amplitude offset and can be added to or subtracted from the measured value as described in *Figure 3-4*.

3-22. Digital-to-Analog Converter (DAC) Operation

3-23. When DAC Option 004 is installed, any three consecutive digits of the display can be selected and converted to a corresponding analog voltage output. The voltage is available at the BNC connector on the rear panel (labeled DAC OUT) and is between 0 and 9.99 volts dc. For example, if the selected digits are 000 the output is 0 volts and if the selected digits are 999 the output is 9.99 volts dc. Operating procedures are listed in *Figure 3-5*.

3-24. SET, RESET, RECALL, and CHS Keys

3-25. The SET, RESET, RECALL, and CHS keys allow offsets and center frequencies to be entered, reset the measurement process, recall previous values, and change the sign of offsets as described in *Figure 3-3*.

3-26. SAMPLE RATE, GATE, and REMOTE

3-27. The SAMPLE RATE control adjusts the deadtime between the end of one measurement and the start of the next measurement. The duration of the measurement is determined by the

resolution selected. The SAMPLE RATE is variable between <20 ns and HOLD. In HOLD position the display will hold the measurement displayed indefinitely.

3-28. The GATE indicator is lit during the measurement interval (gate time) when the counter's gate is open and accumulating counts.

3-29. The REMOTE indicator is lit when the 5342A is in remote operation (Option 011 installed).

3-30. AM Tolerance

3-31. The 5342A will measure carrier frequencies containing amplitude modulation to any modulation index provided the minimum voltage of the signal is not less than the sensitivity specification of the 5342A.

3-32. FM Tolerance

3-33. The 5342A will measure carrier frequencies which are modulated in frequency such as a microwave radio carrier. The FM tolerance is the worst case FM deviation which can be present without affecting the counter's ability to acquire the signal. If the deviations about the carrier are symmetrical, then the counter averages out the deviations to measure the actual carrier frequency. The FM tolerance is determined by the position of the CW-FM switch on the rear panel. The CW position provides FM tolerance of 20 MHz peak-to-peak. The FM position provides a tolerance of 50 MHz peak-to-peak but results in slower acquisition time (2.4 seconds compared to 530 milliseconds for CW position).

NOTE

Most measurements should be made with the rear panel FM/CW switch in CW position. The FM position should be used only when the input signal has significant amounts of FM (>20 MHz p-p). Incorrect measurements may result if the FM position is used with a stable input (non-FM) signal which has been locked to the counter's time base.

3-34. Automatic Amplitude Discrimination

3-35. The automatic amplitude discrimination feature allows the 5342A to acquire and display the highest level signal within its sensitivity range. The highest level signal must be 20 dB greater in amplitude than any other signal present. Typical operation is approximately 10 dB. This feature is useful for discriminating against spurious signals and harmonics.

3-36. MAXIMUM INPUT SIGNAL POWER

CAUTION

Do not exceed +25 dBm (peak) of input power at the type N connector (500 MHz—18 GHz). Damage to the internal sampler may occur. Refer to paragraph 3-37 for detailed explanation.

3-37. The 5342A will function within specifications for 500 MHz—18 GHz signal inputs up to +5 dBm (standard unit). For measuring higher level inputs, refer to the options described in paragraphs 3-61 and 3-63. Under no circumstances should the input level to the 5342A exceed +25 dBm. If the input power exceeds this level, damage to the internal sampler may occur and the sampler is expensive to replace. Measurements from +5 to +25 dBm are not recommended as false readings may occur. When signal levels exceed +5 dBm external attenuators should be used to attenuate the signal. Options 002 and 003 can extend the range to +20 dBm.

3-38. The 10 Hz—500 MHz direct count input BNC connector is fuse-protected for a maximum input level of 3.5V rms (+24 dBm).

3-39. INPUT CABLE CONSIDERATIONS

3-40. Consideration should be given to input cable losses at higher frequencies. For example, a 6-foot section of RG-214/U coaxial cable has about 15 dB loss at 18 GHz. Such losses must be taken into consideration along with the sensitivity specifications given in *Table 1-1*.

3-41. CONTROLS, INDICATORS, AND CONNECTORS

3-42. *Figure 3-1* describes the front panel controls, indicators, and connectors. *Figure 3-2* describes the rear panel connectors and controls.

WARNING

BEFORE THE INSTRUMENT IS SWITCHED ON, ALL PROTECTIVE EARTH TERMINALS, EXTENSION CORDS, AUTOTRANSFORMERS AND DEVICES CONNECTED TO IT SHOULD BE CONNECTED TO A PROTECTIVE EARTH GROUNDED SOCKET. ANY INTERRUPTION OF THE PROTECTIVE EARTH GROUNDING WILL CAUSE A POTENTIAL SHOCK HAZARD THAT COULD RESULT IN PERSONAL INJURY.

ONLY FUSES WITH THE REQUIRED RATED CURRENT AND SPECIFIED TYPE SHOULD BE USED. DO NOT USE REPAIRED FUSES OR SHORT CIRCUITED FUSEHOLDERS. TO DO SO COULD CAUSE A SHOCK OR FIRE HAZARD.

CAUTION

Before the instrument is switched on, it must be set to the voltage of the power source, or damage to the instrument may result. (Refer to paragraph 2-6.)

3-43. OPERATING PROCEDURES

3-44. *Figure 3-3* illustrates operating procedures for the standard 5342A. Self-check procedures are also given in *Figure 3-3*. An operators keyboard check is given in paragraph 3-45. Operating procedures for Amplitude Option 002 are listed in *Figure 3-4*, and for DAC Option 004 in *Figure 3-5*.

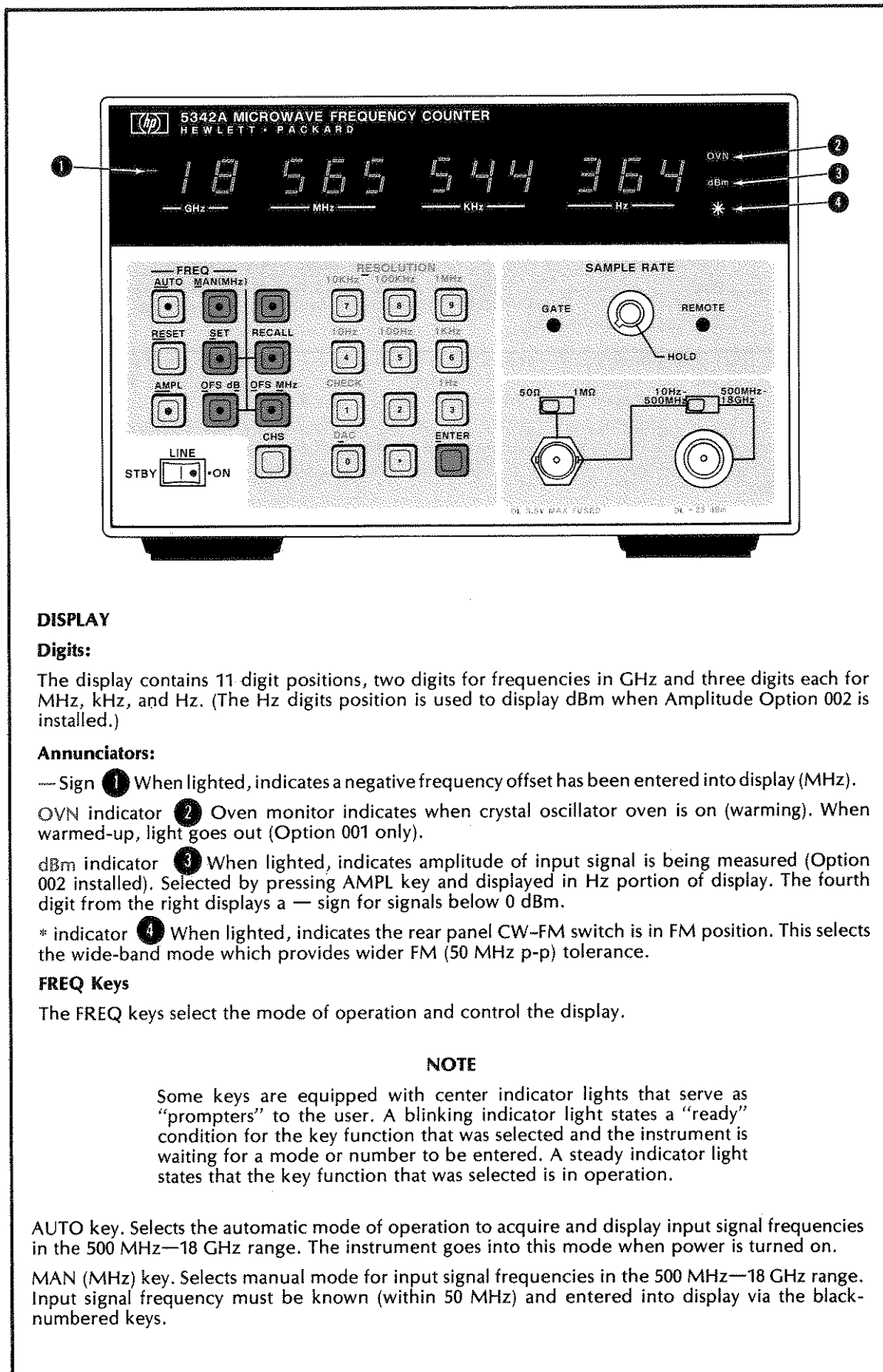

DISPLAY

Digits:

The display contains 11 digit positions, two digits for frequencies in GHz and three digits each for MHz, kHz, and Hz. (The Hz digits position is used to display dBm when Amplitude Option 002 is installed.)

Annunciators:

— Sign **1** When lighted, indicates a negative frequency offset has been entered into display (MHz).

OVN indicator **2** Oven monitor indicates when crystal oscillator oven is on (warming). When warmed-up, light goes out (Option 001 only).

dBm indicator **3** When lighted, indicates amplitude of input signal is being measured (Option 002 installed). Selected by pressing AMPL key and displayed in Hz portion of display. The fourth digit from the right displays a — sign for signals below 0 dBm.

* indicator **4** When lighted, indicates the rear panel CW-FM switch is in FM position. This selects the wide-band mode which provides wider FM (50 MHz p-p) tolerance.

FREQ Keys

The FREQ keys select the mode of operation and control the display.

NOTE

Some keys are equipped with center indicator lights that serve as “prompters” to the user. A blinking indicator light states a “ready” condition for the key function that was selected and the instrument is waiting for a mode or number to be entered. A steady indicator light states that the key function that was selected is in operation.

AUTO key. Selects the automatic mode of operation to acquire and display input signal frequencies in the 500 MHz—18 GHz range. The instrument goes into this mode when power is turned on.

MAN (MHz) key. Selects manual mode for input signal frequencies in the 500 MHz—18 GHz range. Input signal frequency must be known (within 50 MHz) and entered into display via the black-numbered keys.

Figure 3-1. Front Panel Controls and Indicators

Blue key. Pressing this key activates the blue-labeled functions of the RESOLUTION keys.

RESET key. Clears the display and restarts a measurement. Clears any blinking lights in key center indicators.

SET key. Must be pressed prior to selecting OFS dB, OFS MHz or MAN (MHz). The SET condition is indicated by lighted segments $\equiv \equiv$ in the GHz digits of the display. This indicates that a center frequency, offset frequency, or amplitude offset may be entered into the display.

RECALL key. Recalls stored memory information into display. The MAN (MHz), OFS dB, or OFS MHz keys, if **held in** after RECALL is pressed, will result in a display of previously entered or computed information.

NOTE

Information stored in memory (by digit keys) after MAN (MHz) key is pressed is available for display until AUTO mode is selected. Then the center frequency determined by the automatic measurement overrides the manual information.

AMPL key. Selects amplitude mode (when Option 002 is installed). The amplitude of the input signal is displayed in the four rightmost digits of the display to a resolution of 0.1 dBm. The frequency of the input signal is displayed in the five leftmost digits of the display.

OFS dB key. After pressing the SET key, the OFS dB key is pressed prior to entering an offset value in dB via the digit keys. (Digit keys are labeled in black numbers under RESOLUTION.) Indicates selection of amplitude offset mode when lighted and adds amplitude offset to measured amplitude (Option 002).

NOTE

An offset value is an arbitrary value selected for entry into the display to be added or subtracted from a measured value.

OFS MHz key. After pressing the SET key, the OFS MHz key is pressed prior to entering an offset value via the digit keys. (Digit keys are labeled in black numbers under RESOLUTION.) Indicates selection of frequency offset mode when lighted and adds frequency offset to measured frequency.

RESOLUTION keys:

The resolution keys select the display resolution (according to the blue labeling above each key) after the blue key is pressed. The keys are defined by the black number labeled on the key when entering offsets and manual center frequencies.

CHECK key. After pressing the blue key, the CHECK key is pressed to perform a self-check of the instrument. The display will indicate 75 MHz for proper operation. Press RESET to exit self-check.

NOTE

The instrument must not have an **input signal connected** at the 500 MHz—18 GHz input to perform the self-check.

ENTER key. Used to enter digits for manual center frequencies or offsets into memory via black-numbered keys. After the digits have been selected, ENTER key is pressed to signal the end of the digit sequence.

LINE switch. In ON position, applies power to all circuits except the crystal oven (Option 001 installed). The crystal oven connects through a separate transformer, a thermal circuit breaker and fuse directly to the ac line. This allows the oven to maintain its operating temperature and accuracy when the LINE switch is in STBY position, thereby eliminating warmup delays.

SAMPLE RATE control. Adjusts the interval between measurements from 20 ms to HOLD. When rotated to HOLD will hold display indefinitely.

GATE indicator. Indicates when counters main gate is open and a measurement is in progress.

REMOTE indicator. Illuminates when counter is in remote operation.

50 Ω —1 M Ω switch. Selects input impedance for adjacent 10 Hz—500 MHz input connector.

10 Hz—500 MHz, 500 MHz—18 GHz switch. Selects either low or high frequency range input connector.

BNC Input Connector. Accepts 10 Hz—500 MHz input for direct count measurements. Measurements made at this input require that the range switch is set to the 10 Hz—500 MHz position. Sensitivity is listed in Table 1-1.

Type N Input Connector. Input for measurements in the 500 MHz—18 GHz range. Measurements made at this input require that the range switch is set to the 500 MHz—18 GHz position. Sensitivity is listed in Table 1-1.

Figure 3-1. Front Panel Controls and Indicators (Continued)

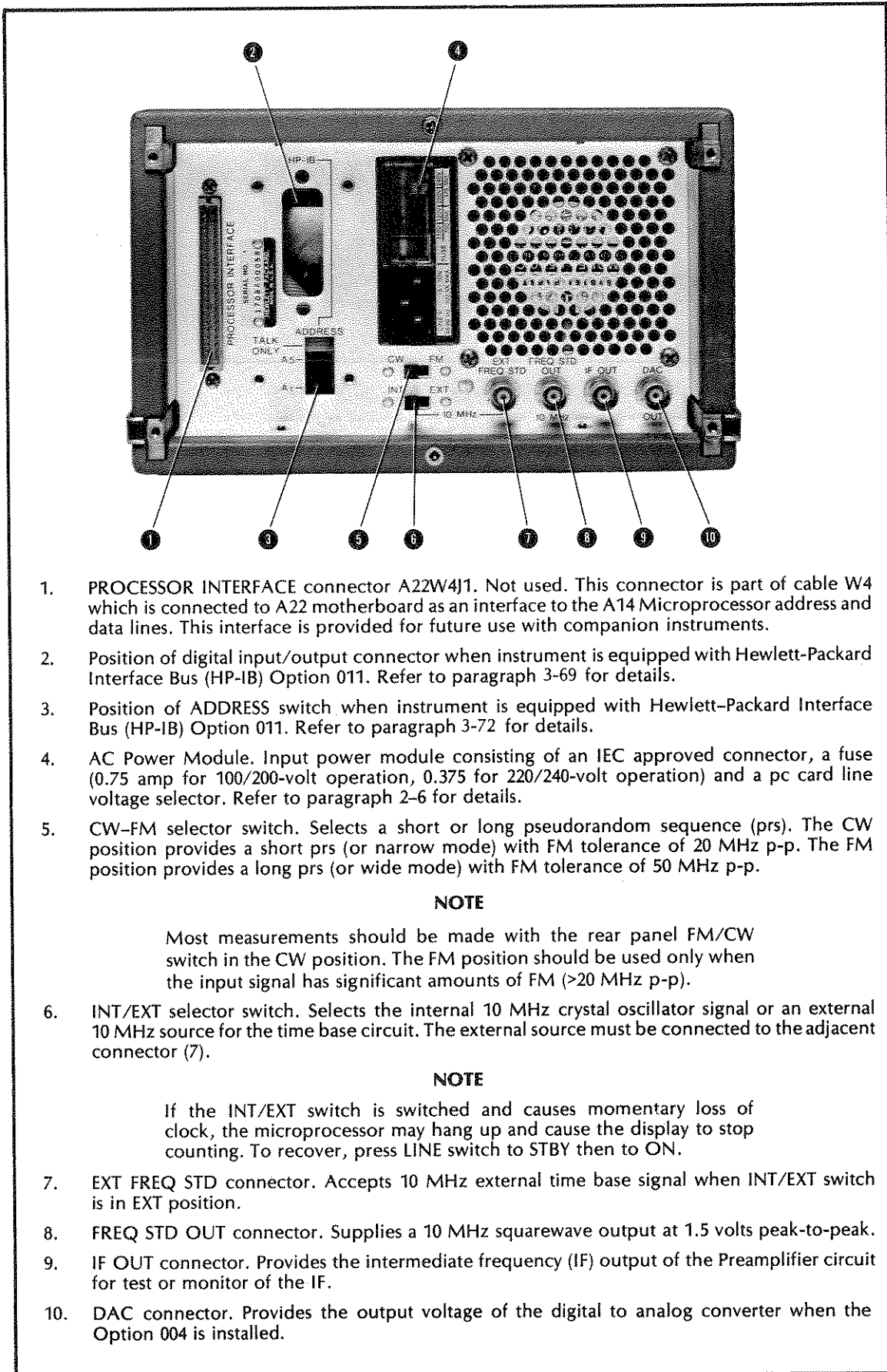

1. PROCESSOR INTERFACE connector A22W4J1. Not used. This connector is part of cable W4 which is connected to A22 motherboard as an interface to the A14 Microprocessor address and data lines. This interface is provided for future use with companion instruments.
2. Position of digital input/output connector when instrument is equipped with Hewlett-Packard Interface Bus (HP-IB) Option 011. Refer to paragraph 3-69 for details.
3. Position of ADDRESS switch when instrument is equipped with Hewlett-Packard Interface Bus (HP-IB) Option 011. Refer to paragraph 3-72 for details.
4. AC Power Module. Input power module consisting of an IEC approved connector, a fuse (0.75 amp for 100/200-volt operation, 0.375 for 220/240-volt operation) and a pc card line voltage selector. Refer to paragraph 2-6 for details.
5. CW-FM selector switch. Selects a short or long pseudorandom sequence (prs). The CW position provides a short prs (or narrow mode) with FM tolerance of 20 MHz p-p. The FM position provides a long prs (or wide mode) with FM tolerance of 50 MHz p-p.

NOTE

Most measurements should be made with the rear panel FM/CW switch in the CW position. The FM position should be used only when the input signal has significant amounts of FM (>20 MHz p-p).

6. INT/EXT selector switch. Selects the internal 10 MHz crystal oscillator signal or an external 10 MHz source for the time base circuit. The external source must be connected to the adjacent connector (7).

NOTE

If the INT/EXT switch is switched and causes momentary loss of clock, the microprocessor may hang up and cause the display to stop counting. To recover, press LINE switch to STBY then to ON.

7. EXT FREQ STD connector. Accepts 10 MHz external time base signal when INT/EXT switch is in EXT position.
8. FREQ STD OUT connector. Supplies a 10 MHz squarewave output at 1.5 volts peak-to-peak.
9. IF OUT connector. Provides the intermediate frequency (IF) output of the Preamplifier circuit for test or monitor of the IF.
10. DAC connector. Provides the output voltage of the digital to analog converter when the Option 004 is installed.

Figure 3-2. Rear Panel Controls and Connectors

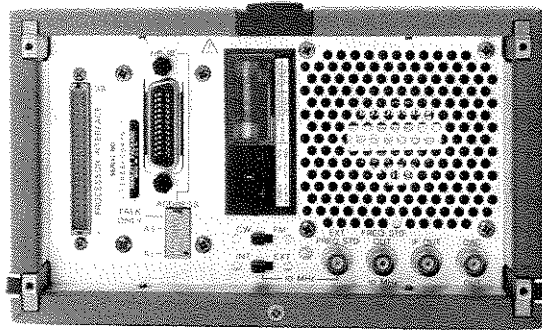
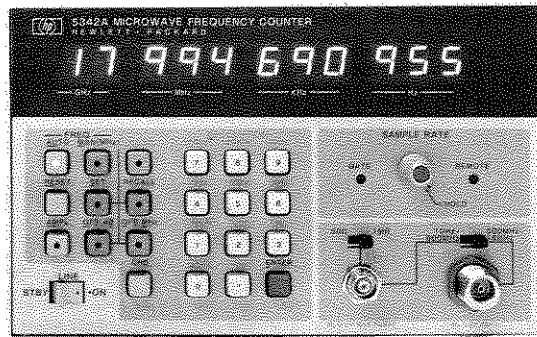

PRELIMINARY PROCEDURES

1. On rear panel:
 - a. Set INT/EXT to INT position.
 - b. Set CW/FM switch to CW. Refer to paragraph 3-33 for detailed description.
 - c. On ac power module, check for proper fuse (0.75 amp for 100/120-volt operation, 0.375 amp for 220/240-volt operation) and check position of pc line voltage selector (refer to paragraph 2-6 for detailed description).
 - d. For remote operation, refer to paragraph 3-69 for explanation of HP-IB programming and address switch settings on rear panel (for 5342A's equipped with Option 011).
2. On front panel, set LINE switch to ON position.

CAUTION

Do not exceed +25 dBm peak of input power at the type N connector (500 MHz—18 GHz). Damage to the internal sampler may occur.

NOTE

When the input signal level to the type N connector exceeds approximately +5 dBm, each digit in the display becomes a minus sign (-) to indicate overload. For Options 002, 003, this threshold is approximately +20 dBm.

CAUTION

The 10 Hz—500 MHz direct count input BNC connector is fuse-protected for a maximum input level of 3.5V rms (+24 dBm).

NOTE

The fuse for the 10 Hz—500 MHz input is located on the A3 Direct Count Amplifier assembly.

Figure 3-3. Operating Procedures

3. Connect input signal to appropriate input connector according to frequency requirements (BNC for 10—500 MHz, type N for 500 MHz—18 GHz) and set frequency range switch accordingly.
4. For input signals connected to BNC connector (10—500 MHz); set the 50 Ω —1 M Ω switch as required. This switch has no effect on input signals connected to the type N connector (500 MHz—18 GHz).
5. Press blue key, then press blue-labeled RESOLUTION key for desired resolution.

NOTE

Half-sized \square 's are used as fillers in the display to facilitate display interpretation.

6. Adjust SAMPLE RATE control for desired interval between measurements.

KEY INDICATORS

Indicator LED's in the center of some keys are used as "prompters" by the operator, as follows:

Blinking Indicator

A blinking LED in a key is a "ready" condition for that key function. It indicates it is waiting for an entry via the keyboard. To clear the condition, press RESET.

Steady Indicator

A steady "on" LED in a key is an indication that the key function is in effect. To clear the condition, press the key. (The AUTO Key is cleared by pressing MAN (MHz) and vice versa.)

SELF-CHECK PROCEDURE

Perform the self-check as follows (no input signal connected and SAMPLE RATE full ccw):

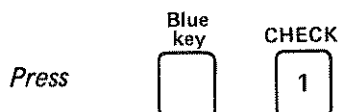

Counter Display:

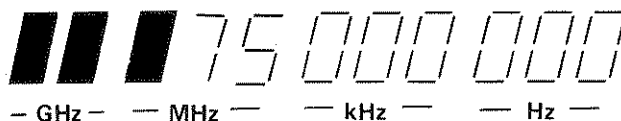

(To exit from CHECK mode, press RESET)

TO SET MANUAL CENTER FREQUENCY

Example — To measure a 4.125 (± 0.050) GHz signal in manual mode, connect signal to type N connector and:



NOTE

The manual center frequency is entered (and displayed) with 1 MHz resolution and must be within 50 MHz of the input signal frequency (connected to 500 MHz—18 GHz connector).

Figure 3-3. Operating Procedures (Continued)

TO ENTER OFFSET FREQUENCY

Example — To add 12.5 MHz to the measured frequency:

Press

Example — To subtract 12.5 MHz from the measured frequency:

Press

TO RECALL OFFSETS OR CENTER FREQUENCY

Example — To recall a center frequency:

Press *Press and hold*

(Displays center frequency to 1 MHz resolution)

Example — To recall an offset frequency:

Press *Press and hold*

(Displays offset)

TO REMOVE OFFSETS

Example — To remove offset from display:

Press

LED in key goes out, function is off and display shows actual measured frequency. (Offset is still stored in memory and can be added to the measurement by pressing OFS MHz again.)

Figure 3-3. Operating Procedures (Continued)

AUTOMATIC OFFSETS

Example — To “hold” a measurement and use it as a negative offset in subsequent measurements:

Rotate SAMPLE RATE cw to HOLD



Rotate SAMPLE RATE ccw to normal

NOTE

The measured frequency will now be negatively offset by the frequency captured when in HOLD.

RESET

Pressing key clears the display and initiates a new measurement without clearing stored values of offset or center frequencies. Clears any blinking (ready state) key indicators, but does not clear steady state indicators. 5342A maintains current operating modes.

Figure 3-3. Operating Procedures (Continued)

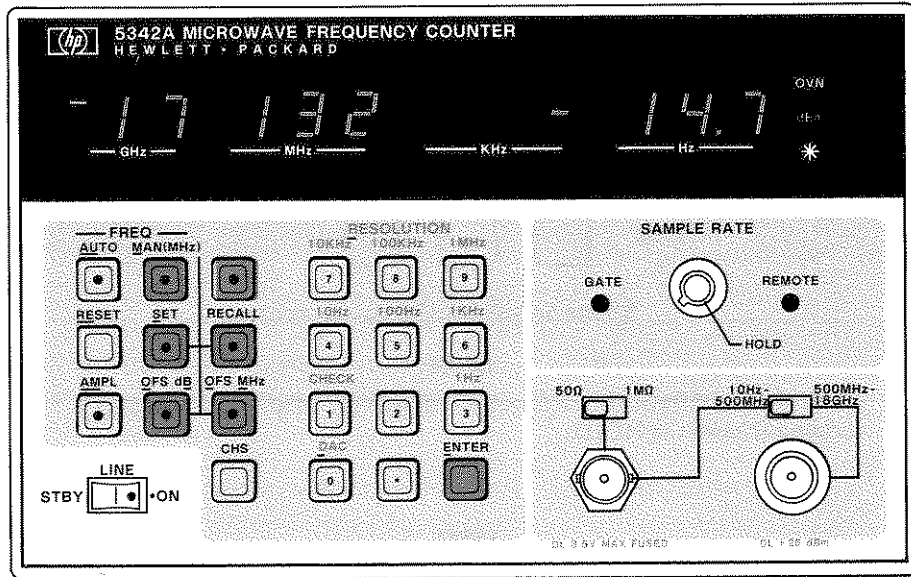

TO MEASURE AMPLITUDE

Example — To simultaneously display frequency to 1 MHz resolution (5 leftmost digits) and amplitude to 0.1 dB resolution (4 rightmost digits):

Press

TO SET AMPLITUDE OFFSET

Example — To add 4.3 dB to the measured amplitude:

Press

Example — To subtract 4.3 dB from the measured amplitude:

Press

Figure 3-4. Amplitude Measurements (Option 002)

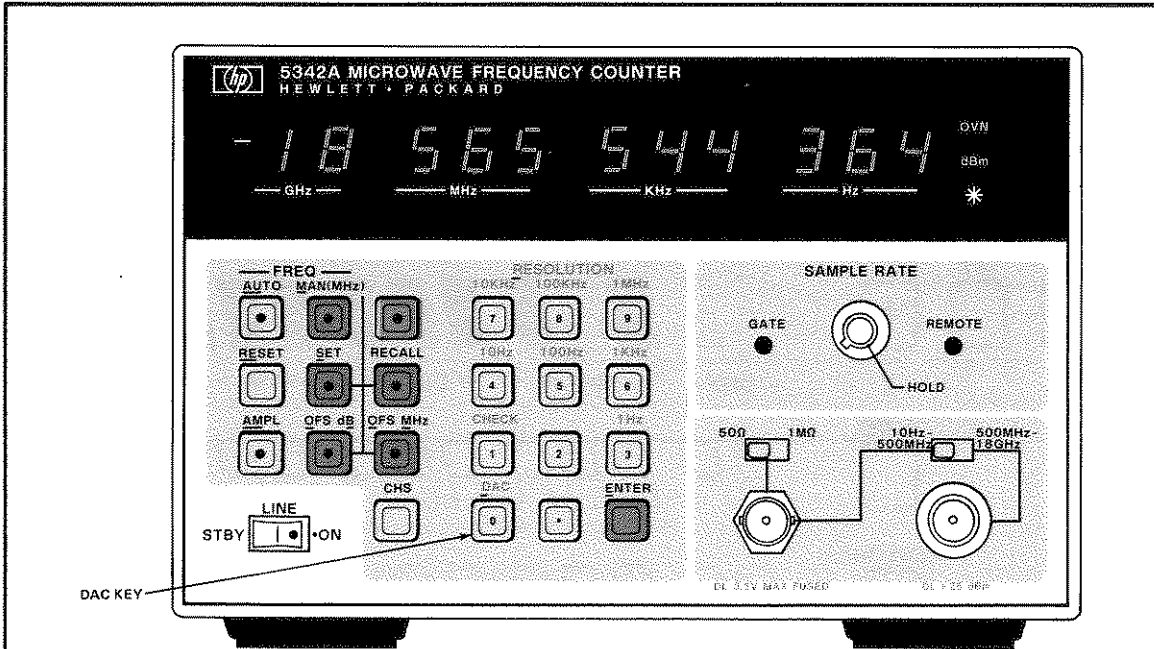

The DAC key is effective only when DAC Option 004 is installed. Selects any three consecutive displayed digits to convert to voltage. The position of the most significant digit of selected digits is determined by the black numbered key. For example.



To select digits as follows:

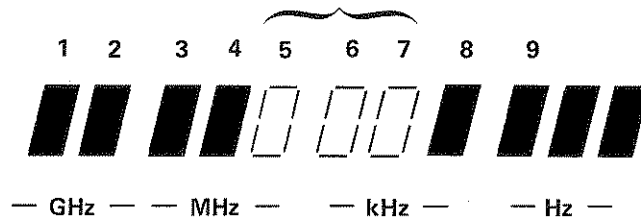

A dc voltage of 0 to 10 volts, corresponding to the selected digits, will be present at the DAC OUT connector on the rear panel. Selected digits 000 produces 0V output, 999 produces 9.99V output.



NOTE

Use the manual mode, minimum required resolution (1 MHz is lowest) and as fast a sample rate as possible to obtain the smoothest output.

Figure 3-5. DAC Operation (Option 004)



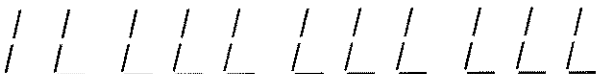

3-45. OPERATOR KEYBOARD CHECK

3-46. Check for proper operation of the keyboard and display by pressing the keys listed and observing display. To exit from keyboard check mode, press RESET.

Press	Display
SET <input type="checkbox"/> SET <input type="checkbox"/> 8 <input type="checkbox"/>	 — GHz — — MHz — — kHz — — Hz —
AUTO <input type="checkbox"/>	
MAN (MHz) <input type="checkbox"/>	
Blue key <input type="checkbox"/>	

NOTE

Do not press RESET key or procedure will need to be started over.

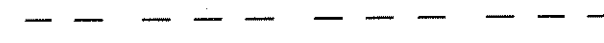
SET <input type="checkbox"/>	
RECALL <input type="checkbox"/>	
AMPL <input type="checkbox"/>	
OFS dB <input type="checkbox"/>	
OFS MHz <input type="checkbox"/>	
CHS <input type="checkbox"/>	

Press

Display

7

77 777 777 777

8

88 888 888 888

9

99 999 999 999

4

44 444 444 444

5

55 555 555 555

6

66 666 666 666

1

11 111 111 111

2

22 222 222 222

3

33 333 333 333

0

00 000 000 000

.

.

ENTER







rr rrr rrr rrr

3-47. ERROR CODE DISPLAYS

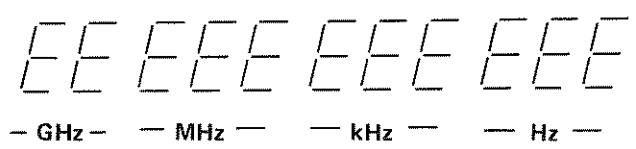
3-48. Error codes are displayed by the 5342A to indicate circuit malfunctions in the instrument and to indicate operator (procedure) errors.

3-49. Instrument Error Displays

3-50. When power is applied to the 5342A, check-sum routines are automatically performed. If a routine fails, an error code is displayed to indicate the circuit fault area as follows:







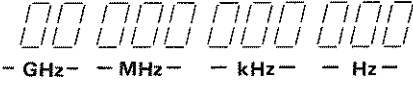

Display	Fault Area
 <p style="text-align: center;">— GHz — — MHz — — kHz — — Hz —</p>	RAM A14U12
	ROM A14U7
	ROM A14U4
	ROM A14U1
	PROM A16U3
	No Conversion complete signal from A16U8(36)

NOTE

If any of the above codes are displayed, refer to the troubleshooting procedures in *Table 8-5*.

3-51. Operator Error Displays

3-52. The display indicates when the applied signal is insufficient or excessive in level or limits, as follows:

Operating Mode	Range Switch	Insufficient Signal Level Display
*Frequency	10 Hz—500 MHz	
*Frequency	500 MHz—18 GHz	
Amplitude (Option 002)	10 Hz—500 MHz	
Amplitude (Option 002)	500 MHz—18 GHz	
Excessive Signal Level Display		
Frequency	500 MHz—18 GHz	
†Amplitude (Option 002)	10 Hz—500 MHz and 500 MHz—18 GHz	
Overrange (due to offset)		
Frequency	10 Hz—500 MHz and 500 MHz—18 GHz	
Amplitude (Option 002)	10 Hz—500 MHz and 500 MHz—18 GHz	
<p>Frequency measurement. In presence of excessive frequency offset, will be all 9's.</p> <p>Out of Frequency Limits (Amplitude)</p>		
Amplitude (Option 002)	10 Hz—500 MHz and 500 MHz—18 GHz	

NOTES:

*Shown for 1 Hz resolution. Digit shifts one position to left for each step decrease in resolution.

†For input signal levels greater than 22.9 dBm, it is possible for the IF detector not to indicate an excessive level condition so that frequency will be displayed (five leftmost digits). However, the amplitude option will cause dashes in the amplitude portion of the display because of excessive level.

(if frequency <10 MHz or frequency >18.4 GHz)

3-53. Limit Errors and Sequence Errors

3-54. A limit error (for example, setting a manual center frequency less than 500 MHz) will be displayed as:

L-Error 
- GHz - MHz - kHz - Hz -

3-55. A sequence error (for example, pressing a digit key before pressing a function key) will be displayed as:

S-Error 
- GHz - MHz - kHz - Hz -

3-56. For detailed descriptions of error codes, refer to *Table 8-5*.

3-57. OPTIONS

3-58. The operating characteristics of the 5342A are affected by the addition of any of the options described in the following paragraphs.

3-59. Time Base Option 001

3-60. Option 001 provides an oven-controlled crystal oscillator time base (Model 10544A) that results in higher accuracy and longer periods between calibration (refer to *Table 1-1*). The oven temperature is maintained when the 5342A LINE switch is in either the ON or the STBY position (provided the instrument is connected to the power mains). When the OVN indicator in the display is lit, the oven is on (warming). When the oven is at the proper temperature, the OVN indicator goes out.

3-61. Amplitude Option 002

3-62. The amplitude option provides the capability of measuring the amplitude of the input signal and simultaneously displaying the frequency (5 leftmost digits) and the amplitude level in dBm (4 rightmost digits). The maximum operating level of +5 dBm for the standard 5342A is extended to +20 dBm for Option 002. The frequency is displayed to a resolution of 1 MHz and the level is displayed to a resolution of 0.1 dBm. The sensitivity of the 5342A with Option 002 is approximately 3 to 5 dB less than the standard 5342A, depending upon frequency.

3-63. Extended Dynamic Range Option 003

3-64. The extended dynamic range option extends the maximum operating level of +5 dBm for the standard 5342A to +20 dBm for Option 003 by insertion of an attenuator at the input (ahead of the sampler). The insertion loss of the attenuator results in a sensitivity decrease of approximately 3 to 5 dB, depending upon the frequency of the signal.

3-65. HP-IB Interface Option 011

3-66. The Hewlett-Packard Interface Bus (HP-IB) Option 011 allows the functions of the 5342A to be controlled remotely and allows measurement data to be output to the bus. Programming information for Option 011 is given in paragraphs 3-69 through 3-80.

3-67. Digital-to-Analog Converter (DAC) Option 004

3-68. The DAC option allows selection of any three consecutive digits in the display and conversion of these digits to an analog voltage. The analog voltage is available at a rear panel connector. The digits are converted to a voltage of from 0 to 10 volts, corresponding to the digits selected. Digits 000 produce 0 volts, digits 999 produce 9.99 volts, fullscale into 15 kilohms.

3-69. HP-IB PROGRAMMING (OPTION 011)

3-70. The capability of a device connected to the HP-IB is specified by its interface functions. Table 3-1 lists the interface functions of the 5342A using the terminology of IEEE Standard 488-1975 (Appendix C). Interface functions provide the means for a device to receive, process, and send messages over the HP-IB. Procedures for verification of proper operation of Option 011 HP-IB are contained in paragraphs 4-19 through 4-26.

Table 3-1. HP-IB Interface Capability

Interface Function Subset Identifier	Interface Function Description
SH1	Complete source handshake capability.
AH1	Complete acceptor handshake capability.
T1	Talker (basic talker, serial poll, talk only mode, does not unaddress to talk if addressed to listen).
L2	Listener (basic listener, no listen only mode, doe not unaddress to listen if addressed to talk).
SR1	Service request capability.
RL1	Complete remote/local capability.
PP0	No parallel poll capability.
DC1	Device clear capability.
DT1	Device Trigger capability.
C0	No controller capability.
E1	One unit load.

3-71. There are 12 basic messages which can be sent over the interface. Table 3-2 lists each bus message, a description of the message, how the 5342A uses that message, and examples of 9825A implementation of the messages.

3-72. The 5342A must be assigned a bus address. Table 3-3 gives the allowable address switch settings.

3-73. Table 3-4 gives the program code set for the 5342A. Frequency and amplitude mode selection, manual center frequency setting, frequency and amplitude offset mode selection, frequency and amplitude offset setting, resolution selection, range selection, FM/CW mode selection, and automatic offsets are all analogous to the corresponding front panel operations described previously.

3-74. There are four sample rate modes T0-T3. In T0, the sample rate is determined by the setting of the front panel SAMPLE RATE control. In T1, the counter is in hold. To trigger a measurement, a trigger message must be sent. In T2, the counter ignores any sample rate run-down and initiates a new measurement as soon as the previous measurement is over. In T3, the counter takes a measurement and holds until the next T3 or trigger message.

Table 3-2. 5342A Bus Message Usage

Message	Description	5342A Use	Sample 9825 Statements (5342A set to Address 02)
Data	Transfers device-dependent information from one device to one or more devices on the bus.	Sends measurement data. See paragraph 3-77 for output format. Accepts program codes. See Table 3-4 for code set.	red 702, A wrt 702, "AUSR4"
Trigger	Causes a group of selected devices to simultaneously initiate a set of device-dependent actions	Starts a new measurement.	trg 7 or trg 702
Clear	Causes an instrument to be set to a predefined state (a certain range, function, etc.).	Same as front panel RESET. Clears internal count and starts new measurement.	clr 7 or clr 702
Remote	Permits selected devices to be set to remote operation, allowing parameters and device characteristics to be controlled by Bus Messages.	5342A goes to remote if REN is true and addressed to listen. In absence of program data, remote operation is according to the state of the front panel settings just prior to going to remote.	rem 702
Local	Causes selected devices to return to local (front panel) operation.	Goes to local front panel control. In absence of front panel data, local operation is according to the state of the remote data just prior to going to local.	lcl 702
Local Lockout	Disables local (front panel) controls of selected devices.	Disables front panel RESET. 5342A remains in remote.	llo 7
Clear Lockout and local	Returns all devices to local (front panel) control and simultaneously clears the Local Lockout Message.	Local lockout cleared and returns to local front panel control	lcl 7
Require Service	Indicates a device's need for interaction with the controller.	Pulls on SRQ to indicate end of a measurement.	rds(7)→A if bit (7, A) (bit 7=1 if SRQ true)
Status Byte	Presents status information of a particular device; one bit indicates whether or not the device currently requires service, the other 7 bits (optional) are used to indicate the type of service required.	In serial poll mode, 5342A outputs decimal 80 (01010000) to indicate end of measurement.	rds (702)→A (if A=80, then 5342A is ready to output)
Status Bit	A single bit of device-dependent status information which may be logically combined with status bit information from other devices by the controller.	Does not use	—
Pass Control	Passes bus controller responsibilities from the current controller to a device which can assume the Bus supervisory role.	Does not use	—
Abort	Unconditionally terminates Bus communications and returns control to the system controller.	Clears Talk, Listen, Serial Poll Enable registers on 5342A HP-IB interface. Front panel annunciators do not change, however.	cli 7

Table 3-3. Address Selection

Rear panel address switch:

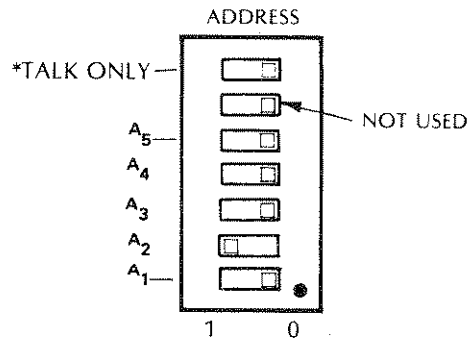

(Shown in addressable mode, and address 02)

*If the 5342A is in TALK ONLY mode and it is desired to return to the addressable mode, set TALK ONLY switch to 0 and press RESET on front panel.

ASCII CODE CHARACTER		ADDRESS SWITCHES					5-BIT DECIMAL CODE
LISTEN	TALK	A ₅	A ₄	A ₃	A ₂	A ₁	
SP	@	0	0	0	0	0	00
!	A	0	0	0	0	1	01
"	B	0	0	0	1	0	02
#	C	0	0	0	1	1	03
\$	D	0	0	1	0	0	04
%	E	0	0	1	0	1	05
&	F	0	0	1	1	0	06
'	G	0	0	1	1	1	07
(H	0	1	0	0	0	08
)	I	0	1	0	0	1	09
*	J	0	1	0	1	0	10
+	K	0	1	0	1	1	11
,	L	0	1	1	0	0	12
-	M	0	1	1	0	1	13
.	N	0	1	1	1	0	14
/	O	0	1	1	1	1	15
0	P	1	0	0	0	0	16
1	Q	1	0	0	0	1	17
2	R	1	0	0	1	0	18
3	S	1	0	0	1	1	19
4	T	1	0	1	0	0	20
5	U	1	0	1	0	1	21
6	V	1	0	1	1	0	22
7	W	1	0	1	1	1	23
8	X	1	1	0	0	0	24
9	Y	1	1	0	0	1	25
:	Z	1	1	0	1	0	26
;	[1	1	0	1	1	27
<	\	1	1	1	0	0	28
=]	1	1	1	0	1	29
>	~	1	1	1	1	0	30

Table 3-4. Option 011 HP-IB Program Code Set

1. FREQUENCY MODE SELECT	
AUTO	AU
MANUAL	M
2. SET MANUAL CENTER FREQUENCY	
SMXXXXXE	(X's represent nonfixed length data string of up to 5 characters. Decimal points cause entire string to be ignored. + signs and spaces are allowable. Number is in MHz and must be less than 18 GHz or will be ignored.)
Example:	SM10000E for 10 GHz center frequency SM775E for 775 MHz center frequency SM+5250E for 5.25 GHz center frequency
3. AMPLITUDE MODE SELECT	
Amplitude off	AM0
Amplitude on	AM1
4. FREQUENCY OFFSET MODE SELECT	
Frequency Offset off	OM0
Frequency Offset on	OM1
5. SET FREQUENCY OFFSET	
SOM±XXXXX.XXXXXXE	(X's represent nonfixed length data string representing offset frequency in MHz. Spaces are ignored.)
Example:	SOM10.7E for 10.7 MHz positive offset SOM-4000.25E for 4.00025 GHz negative offset.
6. AMPLITUDE OFFSET MODE	
Amplitude Offset off	OB0
Amplitude Offset on	OB1
7. SET AMPLITUDE OFFSET	
SOB±XX.XE	(X's represent nonfixed length data string representing offset amplitude in dB. Spaces are ignored.)
Example:	SOB-10.1E for 10.1 dB negative offset SOB3.5E for 3.5 dB positive offset SOB10E for 10 dB positive offset.
8. RESOLUTION	
1 Hz	SR3
10 Hz	SR4
100 Hz	SR5
1 kHz	SR6
10 kHz	SR7
100 kHz	SR8
1 MHz	SR9
9. RANGE	
10 Hz—500 MHz	L
500 MHz—18 GHz	H
10. FM/CW MODE	
CW mode	C
FM mode	F

Table 3-4. Option 011 HP-IB Program Code Set (Continued)

11. SAMPLE RATE	
Front panel sample rate	T0
Hold	T1*
Fast sample (no delay)	T2
Sample then hold	T3
*Send trigger command (trg 7 or trg 702) to start measurement. If 5342A is in remote and addressed to listen and other than Hold (T1), the trigger command causes the 5342A to automatically go to Sample then Hold (T3).	
12. OUTPUT MODE	
Output only when addressed	ST1
Wait until addressed	ST2
13. RESET	
RE	(display is blanked and new measurement initiated. If in Hold (T1), then measurement is not completed but stays in Hold. Does not return control to local.)
14. AUTOMATIC OFFSETS	
Automatic frequency offset	SOMB
Automatic amplitude offset	SOBB
15. CHECK MODE	
SR1	(No input can be present at RF connector. Counter must be in SAMPLE RATE full ccw. Be sure to send RESET command (RE) before making other measurements.)

3-75. In the "output only when addressed" mode, the counter pulls SRQ at the end of a measurement and then checks to see if it has been addressed to talk. If not, SRQ is cleared and it starts the next measurement. If it has been addressed to talk, it outputs the measurement, clears SRQ, and starts the next measurement. In the "wait until addressed" output mode, the counter pulls SRQ at the end of a measurement and waits in a loop until it has been addressed to talk. When it is addressed to talk, it outputs the measurement, clear SRQ and starts the next measurement.

NOTE

If the counter is placed in the HOLD (T1) mode, triggered, then addressed to talk, be sure to use the Wait Until Addressed (ST2) output mode. If not, then for short gate times the measurement may be completed before the controller addresses the counter to talk and the counter will discard the measurement result and hang up the bus.

3-76. The 5342A executes each complete program code as it is received just as if the microprocessor were receiving the data from the front panel keyboard. Program code strings should be in the same order as they would be if being entered from the front panel. When a data byte is sent to the 5342A HP-IB Option 011, the HP-IB interface stores the byte and sends an interrupt to the microprocessor which reads in the byte. If the byte does not complete a program code, then the microprocessor waits for the next byte(s) until a complete code is sent (for example, SR5 is a complete code but SR is not). After a complete code is received, the microprocessor executes the code and begins the measurement. If more codes are in the string, another interrupt is generated. For example, if the string "SR5AU" is sent by the controller, the "S" is the first byte received and stored by the 5342A HP-IB interface. The interface generates an interrupt to the microprocessor and the "S" is read by the MPU. Since S is not a complete code, the microprocessor

waits until the complete code is sent and received. After "R" and then "5" are sent, the microprocessor sets the resolution accordingly and then goes to the beginning of the measurement. When the controller sends "A", an interrupt is generated and "A" is read by the microprocessor. It then waits for the complete code to be sent which in this case is "AU". The microprocessor again goes to the start of the measurement cycle.

NOTE

The following output formats pertain to input signals of specified sensitivity (*Table 1-1*). For less sensitive input signals, refer to paragraph 3-82.

3-77. The 5342A outputs measurement data in the following fixed length formats:

- a. NO OFFSET, FREQUENCY ONLY

SP F SP SP XXXX.XXXXXX E + 06 CR LF
 frequency space carriage return line feed

- b. NO OFFSET, FREQUENCY, AND AMPLITUDE

SP F SP SP XXXXX.XXXXXX E + 06, A SP ±XX.X E + 0 CR LF
 amplitude

- c. OFFSETS in both FREQUENCY and AMPLITUDE

SP FS ±XXXXX.XXXXXX E + 06, AS ±XX.X E + 0 CR LF
 offset offset

- d. OVERLOAD (Amplitude off)

SP F SP SP 99999.999999 E + 09 CR LF
 (caused by excessive input level)

- e. DISPLAY OVERFLOW (Amplitude off)

SP F SP SP 99999.999999 E + 06 CR LF
 (caused by offset which makes display overflow)

- f. OVERLOAD (Amplitude on)

SP F SP SP 99999.999999 E + 09, A SP SP 99.9 E + 0 CR LF
 (caused by excessive input level)

- g. DISPLAY OVERFLOW (Amplitude on)

SP F SP SP XXXXX.XXXXXX E + 06, A SP SP 99.9 E + 0 CR LF
 (caused by offset which makes display overflow)

- h. INSUFFICIENT SIGNAL (Amplitude off)

SP F SP SP 00000.000000 E + 06, CR LF

- i. INSUFFICIENT SIGNAL (Amplitude on)

SP F SP SP 00000.000000 E + 06, A SP + 99.9 E + CR LF

3-78. When the 5342A is in remote, the front panel REMOTE annunciator lights. When the 5342A is addressed to talk, the front panel RECALL pushbutton lamp will light.

3-79. 9825A PROGRAM EXAMPLES

3-80. The following 9825A program examples are illustrative of 5342A programming:

```
0: wrt 702,"AUSR
  7T1ST2"
1: trg 702;rd
  702;A;dsp A;
  wait 500
2: sto 1
3: end
*3802
```

EXAMPLE 1

This program assumes the range switch was set to 0.5—18 GHz before the program was executed. The program puts the 5342A in AUTO, 10 kHz resolution, HOLD, and “wait until addressed” output mode. Program takes a measurement (trg 702) and reads it into the A register. After waiting 500 ms, the program loops back to the next trigger, then read statement.

```
0: wrt 702,"AUSR
  4T2ST1 "
1: rd 702;A;
  cmd 7,"—" ;dsp
  A;wait 500
2: sto 1
3: end
*6699
```

EXAMPLE 2

This program also assumes the range switch was previously set to the 0.5—18 GHz position. The program puts the counter in AUTO mode, 10 Hz resolution, fast sample, and “only if addressed” output mode. The program takes a measurement, unaddresses the 5342A as a talker (cmd 7, “—”) so that the counter will continue making measurements at a fast rate, and waits 500 ms until reading the next measurement.

```
0: wrt 702,"SM10
  000ESR3HFTG8T1"
1: rd 702;A;
  prt A
2: sto 1
3: end
*1870
```

EXAMPLE 3

This program sets a manual center frequency of 10 GHz (input frequency = 10.03 GHz), 1 Hz resolution, 0.5—18 GHz range, FM mode, front panel sample rate control, and “output only if addressed”. Each reading is printed on the 9825A printer.

```
10030069548.00
10030069544.00
10030069539.00
10030069529.00
10030069524.00
10030069514.00
10030069512.00
```

```
0: wrt 702, "AUSR  
3T25T1AM1"  
1: red 702, A, B;  
prt A|prt B  
2: sto 1  
3: end  
#32729
```



```
4230028373.00  
-5.30  
4230028373.00  
-5.30  
4230028367.00  
-5.30  
4230028370.00  
-5.30
```

EXAMPLE 4

This program selects AUTO mode, 1 Hz resolution, fast sample, "output only if addressed", and amplitude "on". The frequency is read into the A register and the amplitude is read into the B register. Notice that although the frequency is displayed only to 1 MHz resolution on the counter, the full 1 Hz resolution is output to the calculator.

```
0: wrt 702, "AUSR  
3T25T1AM180B-  
10.0E"  
1: red 702, A, B;  
prt A|prt B  
2: sto 1  
3: end  
#20921
```



```
4230028349.00  
-15.30  
4230028349.00  
-15.30  
4230028350.00  
-15.30  
4230028342.00  
-15.30
```

EXAMPLE 5

This program measures the same signal as in (4) but enters a -10 dB offset in the amplitude measurement.

EXAMPLE 6

This is the same program as (5) but with a +10 GHz offset.

```
0: wrt 702, "AUSR  
3T2ST1AM1S0B-  
10.0ESOM10000E0  
M1"  
1: red 702, A, B;  
prt A;prt B  
2: sto 1  
3: end  
#6961
```

```
14230028337.00  
-15.30  
14230028335.00  
-15.30  
14230028338.00  
-15.30  
14230028332.00  
-15.30
```

3-81. HP-IB PROGRAMMING NOTES

3-82. The HP-IB output is affected by input signal level as follows:

- a. For input signal levels greater than or equal to specified sensitivity, the 5342A outputs measurement data as described in paragraph 3-77.
- b. For input signal levels less than the actual sensitivity by 0.1 dB or more (or for no input), the counter outputs zeros when addressed to talk.
- c. For input signal levels just on the edge of the counter's actual sensitivity (approximately a 0.1 dB band) the detectors which indicate sufficient signal level for counting may become intermittent resulting in very long acquisition times. The counter's display holds the previous reading during the prolonged acquisition but the counter will not output any data when addressed to talk. This will hang up the program at the read statement.
- d. With the 9825A, use the "time" statement and "on err" statement to branch around the read statement if it takes longer than a specified number of milliseconds to complete an I/O operation. The following example program can be used when there is more than one read statement in the program. If there is only one read statement, then statement 2 could be deleted and the end of statement 7 could simply cause the program to go to the statement after the read (in this case, "goto 6"):

EXAMPLE

```

0: del "ctr":702
1: goto "begin"
2: for "err":loop
  err=1
3: "begin":time
  1000:on err
  at
4: wrt "ctr":
  "RUSR4HCT1"
5: for "ctr":
  read "ctr":A
6: wait 500:ert
  at=err-1
7: for "if err=4
  :0:at:time 1000:
  on err "at"
  goto "er ret"
0: end
+00007
  
```

Since this statement is in line 2, the program jumps to the statement after the read statement.

Error 4 is time out error. Reset time and error jump.

```

0: 200000000000000000
0: 200000000000000000
0: 200000000000000000
0: 200000000000000000
0: 000000000000000000
0: 000000000000000000
0: 000000000000000000
0: 000000000000000000
0: 000000000000000000
0: 200000000000000000
0: 200000000000000000
0: 200000000000000000
0: 200000000000000000
  
```

When the 5342A took more time than 1 second to make the measurement, zeroes are output.

NOTE

For any controller, check SRQ to see if a measurement has been completed. Allow an adequate number of iterations on the SRQ check to permit the counter to complete the measurement and pull SRQ. A flow diagram of such an algorithm is:

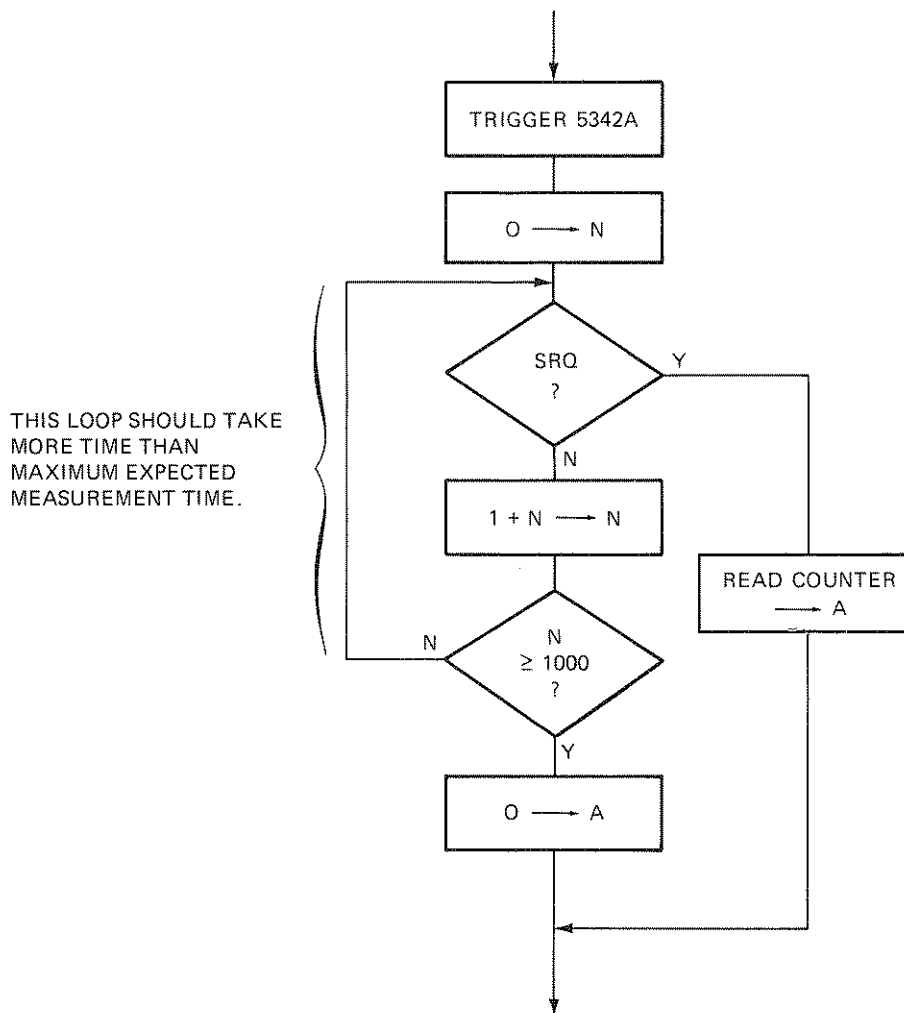

3-83. REMOTE PROGRAMMING OF DIAGNOSTIC MODE 6 (OPTION 002, 011 ONLY)

3-84. In some system applications, it may be desirable to program the 5342A to diagnostic mode 6 so that the counter will constantly present a low SWR and not switch to frequency measurements (higher SWR). The following example shows how this may be done:

EXAMPLE

```
0: dev "ctr":702
1: wrt "ctr":
  "AUAM1SR5T1"
2: wtb "ctr":15,
  2,0,140,1
3: rdb("ctr")+Z:
  idr(Z,1)+Z
4: wtb "ctr":1,
  0,140,1,Z,5
5: trs "ctr":
  wait 5000
6: wtb "ctr":15,
  2,0,140,1
7: rdb("ctr")+Z:
  bend(Z,254)+Z
8: wtb "ctr":1,
  0,140,1,Z,5
9: end
*21719
```

Program counter for AMPL mode

This sets the counter to diagnostic mode 6

Counter must be triggered to enter diagnostic mode 6. For 5 seconds, counter does not switch to frequency.

This resets the counter to amplitude and frequency measurements

