

About this Manual

We've added this manual to the Agilent website in an effort to help you support your product. This manual is the best copy we could find; it may be incomplete or contain dated information. If we find a more recent copy in the future, we will add it to the Agilent website.

Support for Your Product

Agilent no longer sells or supports this product. Our service centers may be able to perform calibration if no repair parts are needed, but no other support from Agilent is available. You will find any other available product information on the Agilent Test & Measurement website, www.tm.agilent.com.

HP References in this Manual

This manual may contain references to HP or Hewlett-Packard. Please note that Hewlett-Packard's former test and measurement, semiconductor products and chemical analysis businesses are now part of Agilent Technologies. We have made no changes to this manual copy. In other documentation, to reduce potential confusion, the only change to product numbers and names has been in the company name prefix: where a product number/name was HP XXXX the current name/number is now Agilent XXXX. For example, model number HP8648A is now model number Agilent 8648A.

MANUAL CHANGES

MANUAL IDENTIFICATION

Model Number: HP 54510A

Date Printed: December 1990

Part Number: 54510-90903

This supplement contains important information for correcting manual errors and or adapting the manual to instruments containing improvements made after the printing of the manual.

To use this supplement:

Make all ERRATA corrections.

Make all appropriate serial number related changes indicated in the table.

Serial Prefix or Number	Make Manual Changes	Serial Prefix or Number	Make Manual Changes
3209A	Change 1		

◆ NEW ITEM

◆ CHANGE 1

This change documents changes made to the instrument to incorporate new firmware, specifically new features such as FFTs (Fast Fourier Transforms) and graphical compare. The new firmware requires new ROMs and thus a new main assembly part number.

To update the service manual, replace the following manual pages with the appropriate pages in this change.

Replace the title page.

Replace the List of Effective Pages, page vi.

Replace pages 1-7 through 1-10 with pages 1-7/8, 1-8A/B, and 1-9/10.

Replace the parts list, page 5-5.

END OF CHANGES

Note

Manual change supplements are revised as often as necessary to keep manuals as current and accurate as possible. Hewlett-Packard recommends that you periodically request the latest edition of this supplement. Free copies are available from all HP offices. When requesting copies quote the manual identification information from your supplement, or the model number and print date from the title page of the manual.



SERVICE MANUAL

HP 54510A Digitizing Oscilloscope

SERIAL NUMBERS

This manual applies directly to instruments
prefixed with serial numbers:

3022A

3209A

For additional information about serial numbers see
INSTRUMENTS COVERED BY THIS MANUAL
in Section 1.

© COPYRIGHT HEWLETT-PACKARD COMPANY/COLORADO SPRINGS DIVISION 1990
1900 GARDEN OF THE GODS ROAD, COLORADO SPRINGS, COLORADO U.S.A.

ALL RIGHTS RESERVED

Manual Part No. 54510-90903
Microfiche Part No. 54510-90803

Printed in U.S.A. December 1990

Revised March 9, 1992

Herstellerbescheinigung

Hiermit wird bescheinigt, dass das Gerät/System

HP 54510A

in Übereinstimmung mit den Bestimmungen von Postverfügung 1046/84 funkentstört ist.

Der Deutschen Bundespost wurde das Inverkehrbringen dieses Gerätes/Systems angezeigt und die Berechtigung zur Überprüfung der Serie auf Einhaltung der Bestimmungen eingeräumt.

Zusatzinformation für Mess- und Testgeräte

Werden Mess- und Testgeräte mit ungeschirmten Kabeln und/oder in offenen Messaufbauten verwendet, so ist vom Betreiber sicherzustellen, dass die Funkentstörbestimmungen unter Betriebsbedingungen an seiner Grundstücksgrenze eingehalten werden.

Manufacturer's declaration

This is to certify that this product HP 54510A meets the radio frequency interference requirements of directive 1046/84. The German Bundespost has been notified that this equipment was put into circulation and was granted the right to check the product type for compliance with these requirements.

Additional Information for Test and Measurement Equipment

Note: If test and measurement equipment is operated with unshielded cables and/or used for measurements on open set-ups, the user must insure that under these operating conditions, the radio frequency interference limits are met at the border of his premises.

Note: This declaration indicates compliance of this product with the German RFI specifications stated in the German Vfg. 1046/84 directive.

CERTIFICATION

Hewlett-Packard Company certifies that this product met its published specifications at the time of shipment from the factory. Hewlett-Packard further certifies that its calibration measurements are traceable to the United States National Institute of Standards and Technology, to the extent allowed by the Institute's calibration facility, and to the calibration facilities of other International Standards Organization members.

WARRANTY

This Hewlett-Packard product is warranted against defects in material and workmanship for a period of three years from date of shipment. During the warranty period, Hewlett-Packard Company will, at its option, either repair or replace products which prove to be defective.

For warranty service or repair, this product must be returned to a service facility designated by HP. Buyer shall prepay shipping charges to HP and HP shall pay shipping charges to return the product to Buyer. However, Buyer shall pay all shipping charges, duties, and taxes for products returned to HP from another country.

HP warrants that its software and firmware designated by HP for use with an instrument will execute its programming instructions when properly installed on that instrument. HP does not warrant that the operation of the instrument or software, or firmware will be uninterrupted or error free.

Limitation of Warranty

The foregoing warranty shall not apply to defects resulting from improper or inadequate maintenance by Buyer, buyer-supplied software or interfacing, unauthorized modification or misuse, operation outside the environmental specifications for the product, or improper site preparation or maintenance.

NO OTHER WARRANTY IS EXPRESSED OR IMPLIED. HP SPECIFICALLY DISCLAIMS THE IMPLIED WARRANTIES OF MERCHANTABILITY AND FITNESS FOR A PARTICULAR PURPOSE.

Exclusive Remedies

THE REMEDIES PROVIDED HEREIN ARE BUYER'S SOLE AND EXCLUSIVE REMEDIES. HP SHALL NOT BE LIABLE FOR ANY DIRECT, INDIRECT, SPECIAL, INCIDENTAL, OR CONSEQUENTIAL DAMAGES, WHETHER BASED ON CONTRACT, TORT, OR ANY OTHER LEGAL THEORY.

ASSISTANCE

Product maintenance agreements and other customer assistance agreements are available for Hewlett-Packard products.

For any assistance, contact your nearest Hewlett-Packard Sales Office. Addresses are provided at the back of this manual.

Safety Considerations

General Operation

This is a Safety Class I instrument (provided with terminal for protective earthing). BEFORE APPLYING POWER verify that the power transformer primary is matched to the available line voltage, the correct fuse is installed, and Safety Precautions are taken (see the following warnings). In addition, note the instrument's external markings which are described under "Safety Symbols."

General Warnings and Cautions

- BEFORE SWITCHING ON THE INSTRUMENT, the protective earth terminal of the instrument must be connected to the protective conductor of the (mains) powercord. The mains plug shall only be inserted in a socket outlet provided with a protective earth contact. The protective action must not be negated by the use of an extension cord (power cable) without a protective conductor (grounding). Grounding one conductor of a two-conductor outlet is not sufficient protection.
- Servicing instructions are for use by service-trained personnel. To avoid dangerous electric shock, do not perform any servicing unless qualified to do so.
- If this instrument is to be energized via an auto-transformer (for voltage reduction) make sure the common terminal is connected to the earth terminal of the power source.
- Any interruption of the protective (grounding) conductor (inside or outside the instrument) or disconnecting the protective earth terminal will cause a potential shock hazard that could result in personal injury.
- Whenever it is likely that the protection has been impaired, the instrument must be made inoperative and be secured against any unintended operation.
- Only fuses with the required rated current, voltage, and specified type (normal blow, time delay, etc.) should be used. Do not use repaired fuses or short circuited fuseholders. To do so could cause a shock or fire hazard.
- Do not operate the instrument in the presence of flammable gasses or fumes. Operation of any electrical instrument in such an environment constitutes a definite safety hazard.
- Do not install substitute parts or perform any unauthorized modification to the instrument.
- Adjustments described in the manual are performed with power supplied to the instrument while protective covers are removed. Energy available at many points may, if contacted, result in personal injury.
- Any adjustment, maintenance, and repair of the opened instrument under voltage should be avoided as much as possible, and when inevitable, should be carried out only by a skilled person who is aware of the hazard involved.
- Capacitors inside the instrument may still be charged even if the instrument has been disconnected from its source of supply.

Safety Symbols



Instruction manual symbol. The product will be marked with this symbol when it is necessary for the user to refer to the instruction manual in order to protect against damage to the product.



Indicates Hazardous Voltages



Earth terminal (sometimes used in manual to indicate circuit common connected to grounded chassis).

Warning



The WARNING sign denotes a hazard. It calls attention to a procedure, practice, or the like, which, if not correctly performed or adhered to, could result in personal injury. Do not proceed beyond a WARNING sign until the indicated conditions are fully understood and met.

Caution



The CAUTION sign denotes a hazard. It calls attention to an operating procedure, practice, or the like, which, if not correctly performed or adhered to, could result in damage to or destruction of part or all of the product. Do not proceed beyond a CAUTION sign until the indicated conditions are fully understood or met.

Printing History

New editions are complete revisions of the manual. Update packages, which are issued between editions, contain additional and replacement pages to be merged into the manual by the customer. The dates on the title page change only when a new edition is published.

A software and/or firmware code may be printed before the date; this indicates the version level of the software and/or firmware of this product at the time of the manual or update was issued. Many product updates and fixes do not require manual changes and, conversely, manual corrections may be done without accompanying product changes. Therefore, do not expect a one to one correspondence between product updates and manual updates.

Edition 1

December 1990

54510-90903

List of Effective Pages

The List of Effective Pages gives the date of the current edition and of any pages changed in updates to that edition. Within the manual, any page changed since the last edition is indicated by printing the date the changes were made on the bottom of the page. If an update is incorporated when a new edition of the manual is printed, the change dates are removed from the bottom of the pages and the new edition date is listed in Printing History and on the title page.

Pages	Effective Date
all	December 1990
Title page, vi, 1-8, 1-8A/B, . . .	
1-9, 5-5	March 1992

Contents

Section 1	General Information	
	Introduction	1-1
	Instruments Covered by Manual	1-1
	Instrument Description	1-1
	Accessories Supplied	1-2
	Accessories Available	1-2
	Options Available	1-2
	Performance Specifications	1-3
	Performance Characteristics	1-4
	Operating Characteristics	1-5
	General Characteristics	1-12
	Recommended Test Equipment	1-13
Section 2	Installation	
	Introduction	2-1
	Initial Inspection	2-1
	Operating Environment	2-1
	Storage and Shipping	2-1
	Packaging	2-1
	Tagging for Service	2-1
	Original Packaging	2-2
	Other Packaging	2-2
	Preparation for Use	2-2
	Power Requirements	2-2
	Line Voltage Selection	2-2
	Power Cable	2-3
	Applying Power	2-3
	Cleaning Requirements	2-3
Section 3	Performance Tests	
	Introduction	3-1
	Testing Interval	3-1
	Equipment Required	3-1
	Self-Test Verification	3-1
	Test Record	3-2
	Operating Hints	3-2
	Clear Display	3-2
	Averaging	3-2
	Performance Test Procedures	3-2
	dc Calibrator Test	3-3
	Input Resistance	3-4
	Voltage Measurement Accuracy	3-5
	Offset Accuracy	3-7
	Bandwidth	3-8
	Time Measurement Accuracy	3-10
	Trigger Sensitivity	3-13
	Oscillator Output Check	3-15

Section 4**Adjustments**

Introduction	4-1
Equipment Required	4-1
Calibration Interval	4-1
Cal RAM Checksum Error	4-1
Key-Down Powerup	4-2
Operating Hints	4-2
Adjustment Procedures	4-2
Power Supply Adjustment	4-3
Main Assembly Adjustments	4-5
Extender Cable Installation	4-5
Default Calibration Load	4-6
High-frequency Pulse Adjustment	4-6
Flatness Adjustment	4-7
Firmware Calibration	4-11
CRT Monitor Assembly Adjustment	4-13

Section 5**Replaceable Parts**

Introduction	5-1
Abbreviations	5-1
Replaceable Parts	5-1
Exchange Assemblies	5-1
Ordering Information	5-2
Direct Mail Order System	5-2

Section 6**Service**

Introduction	6-1
Safety	6-1
Block Level Theory of Operation	6-3
Power Supply Assembly	6-3
CRT Monitor Assembly	6-3
Main Assembly	6-3
Keypad and Knob Assembly	6-3
Attenuators	6-3
Attenuator Theory of Operation	6-5
Main Assembly Theory of Operation	6-5
Acquisition	6-5
System Control	6-9
Selftest Menu	6-12
Service Menu	6-13
Troubleshooting	6-14
Trouble Isolation Flowcharts	6-14
Key-Down Powerup	6-14
Power Supply Voltages Check	6-21
CRT Monitor Signals Check	6-22
Keyboard Signals Check	6-23
Attenuator Troubleshooting	6-24

Service (cont'd)

Assembly Removal and Replacement	6-26
Rear Panel Assembly	6-26
Power Supply Assembly	6-26
Keyboard Assembly	6-27
Fan	6-27
Main Assembly	6-28
Attenuators	6-28
CRT Monitor Assembly	6-29
Feet/Tilt Stand	6-30

Figures

4-1	Power Supply Adjustment Locations	4-3
4-2	Main Assembly Adjustment Locations	4-4
4-3	CRT Test Display	4-13
4-4	Display Adjustment Locations	4-14
5-1	HP 54510A Exploded View	5-4
6-1	Simplified Block Diagram	6-2
6-2	Acquisition Block Diagram	6-4
6-3	System Control Block Diagram	6-8
6-4	Selftest Menu Selections	6-12
6-5	Service Menu Selections	6-13
6-6	Primary Trouble Isolation Flowchart	6-15
6-7	Trouble Isolation Chart for Power Supply	6-16
6-8	Trouble Isolation Chart for Display	6-17
6-9	Trouble Isolation Chart for Keyboard	6-18
6-10	Trouble Isolation Chart for Cal Signals	6-19
6-11	Trouble Isolation Chart for Attenuators	6-20
6-12	Power Supply Test Points	6-21

Tables

1-1	Recommended Test Equipment	1-13
2-1	Power Cord Configurations	2-4
3-1	Performance Test Record	3-17
5-1	Reference Designators and Abbreviations	5-3
5-2	Replaceable Parts	5-5
6-1	Power Supply/Main Assembly Voltages	6-22
6-2	CRT Monitor Input Cable Pin Assignments	6-22
6-3	Keyboard Connector Voltages and Signals	6-23

Contents

Section 1	General Information	
	Introduction	1-1
	Instruments Covered by Manual	1-1
	Instrument Description	1-1
	Accessories Supplied	1-2
	Accessories Available	1-2
	Options Available	1-2
	Performance Specifications	1-3
	Performance Characteristics	1-4
	Operating Characteristics	1-5
	General Characteristics	1-12
	Recommended Test Equipment	1-13

General Information

Introduction

This service manual contains information on installing, testing, adjusting, and servicing the HP 54510A Digitizing Oscilloscope. This section of the manual includes instrument identification, description, accessories, options, specifications, characteristics, and recommended test equipment.

A microfiche part number is listed under the manual part number on the title page of this manual. This number may be used to order 4- by 6-inch microfiche transparencies of the manual. Each microfiche contains up to 96 photo-duplicates of the manual pages. The microfiche package also contains the latest Manual Changes supplement as well as pertinent Service Notes.

Instruments Covered by Manual

On the rear panel of the instrument is a serial number sticker. The serial number is in the form: 0000A00000. It is composed of two parts: the first four digits and letter are the serial prefix, while the last five digits are the suffix. The prefix is the same for all identical instruments, and it changes only when a change has been made to the instrument. The suffix however, is assigned sequentially and is different for each instrument. The contents of this manual apply to instruments with the serial number prefixes listed under SERIAL NUMBERS on the title page.

An instrument manufactured after the printing of this manual may have a serial number prefix different than those listed on the title page. This unlisted serial number prefix indicates the instrument is different from those described in this manual. The manual for this instrument is accompanied by a yellow Manual Changes supplement. This supplement contains the necessary "change information" that explains how to adapt the manual to the newer instrument.

In addition to change information, the supplement contains information for correcting errors in the manual. To keep this manual as accurate as possible, periodically request the latest Manual Change supplement for the instrument manual. The supplement for this manual is identified with the manual part number and print date, both of which appear on the manual title page. Complimentary copies of the supplement are available from Hewlett-Packard.

For information concerning a serial prefix number not listed on the title page or in the Manual Changes supplement, contact your nearest HP office.

Instrument Description

The HP 54510A Digitizing Oscilloscope is a general-purpose oscilloscope with 250-MHz bandwidth. It simultaneously digitizes two input channels, each with 8000 samples of memory. The channels have 1 mV to 5 V/div sensitivity in a 1-2-5 sequence. Channel input impedance is 1 M Ω or 50 Ω , switchable.

The time base provides sweep speeds from 1 ns to 5 s/div in a 1-2-5 sequence. Pan and zoom can be used to expand a displayed waveform for a detailed view.

An external trigger input with 1 M Ω or 50 Ω switchable impedance can be combined with the channel triggers for complex triggering functions.

The HP 54510A has an Autoscale feature, 17 automatic pulse parameter measurements, and easy waveform storage. It has full programmability over the HP-IB, and when set up with a printer or plotter, the HP 54510A provides instant hardcopy output.

Accessories Supplied

The following accessories are supplied with the HP 54510A Digitizing Oscilloscope.

- Two HP 10441A miniature passive probes
- One miniature probe to BNC male adapter (HP 1250-1454)
- One 2.3 meter (7.5 feet) power cord (See section 2 for available power cords)
- One Operating and Programming Manual Set
- One Service Manual

Accessories Available

The following accessories are available for use with the HP 54510A.

- HP 10437A 1:1 50 Ω probe (2m)
- HP 10438A 1:1 probe (1m)
- HP 10439A 1:1 probe (2m)
- HP 10430A 10:1 1 M Ω probe (1m)
- HP 10002A 50:1 1 M Ω (1000 V peak) probe
- HP 10020A Resistive Divider Probe Kit
- HP 1141A/HP 1142A Differential Probe system
- HP 1137A 1000:1 High voltage divider probe
- HP 1133A TV/Video Sync Pod
- HP 5061-6175 Rack Mount Kit
- HP 1494-0015 Rack Mount Slide Kit
- HP 1540-1066 Soft Carrying Case
- HP 9211-2645 Transit Case
- HP 5061-6183 Front Panel Cover
- HP 1180A Tilt-tray Testmobile
- HP 92199B Power Strip

Options Available

The following options are available for the HP 54510A.

- Option 908 - Rack Mount Kit (HP 5061-6175)
- Option 910 - Additional Service Manual and Operating and Programming Manual set
- Option 090 - Deletion of probes

Performance Specifications

The following are performance specifications for the HP 54510A Digitizing Oscilloscope.

Vertical

Bandwidth (-3dB, dc coupled):¹ dc to 250 MHz

Rise Time:² 1.4 ns

Input R (selectable): 1 M Ω \pm 1% or 50 Ω \pm 1%

Maximum Input Voltage³

1 M Ω : \pm 250 V [dc + peak ac (< 10 kHz)]

50 Ω : 5 V_{rms}

Offset Accuracy:⁴ \pm (1% of channel offset + 2% of full scale)

Voltage Measurement Accuracy (dc) ^{4,5}

Dual Cursor: \pm (1.25% of full scale + 0.032 \times V/div)

Single Cursor: \pm (1.25% of full scale + offset accuracy + 0.016 \times V/div)

Horizontal

Delta-t Accuracy⁶

Repetitive (\geq 8 averages): \pm (0.005% \times delta-t + 2E-6 \times delay setting + 100 ps)

Real Time (single acquisition): \pm (0.005% \times delta-t + 2E-6 \times delay setting + 150 ps)

Trigger

Trigger Sensitivity⁴

Internal (dc to 100 MHz): 0.5 division

Internal (100 MHz to 250 MHz): 1.0 division

External (dc to 250 MHz): 100 mV_{p-p} into 50 Ω

Notes:

1. Upper bandwidth reduces by 2.5 MHz for each °C above 35°C. Bandwidth in Repetitive mode is typically greater than 300 MHz.
2. Rise time figures are calculated from: $t_r = 0.35/\text{Bandwidth}$.
3. On ranges \leq 50 mV/div, the maximum overdrive of the input must not exceed 100 V.
4. Magnification is used below 7 mV/div range so vertical resolution and accuracies are correspondingly reduced. Below 7 mV/div, full scale is defined as 56 mV.
5. Voltage measurement accuracy decreases 0.08% of full scale per °C from firmware calibration temperature. This specification is valid for a temperature range \pm 10°C from firmware calibration temperature. Specification applies to both modes; repetitive and real time (single acquisition).
6. Specification applies at the maximum sampling rate. At lower sampling rates the specification is \pm (0.005% \times delta-t + $(2 \times 10^{-6}) \times$ delay setting + 0.15 \times sample interval) for bandwidth limited signals ($t_r = 1.4 \times$ sample interval). Sample interval is defined as 1/(sample rate). Specification also applies to those automatic measurements computing time intervals on pulses with identical slope edges (i.e. pos-pos, neg-neg).

Performance Specifications

The following are performance specifications for the HP 54510A Digitizing Oscilloscope.

Vertical

Bandwidth (-3dB, dc coupled):¹ dc to 250 MHz

Rise Time:² 1.4 ns

Input R (selectable): 1 M Ω \pm 1% or 50 Ω \pm 1%

Maximum Input Voltage³

1 M Ω : \pm 250 V [dc + peak ac (< 10 kHz)]

50 Ω : 5 V_{rms}

Offset Accuracy:⁴ \pm (1% of channel offset + 2% of full scale)

Voltage Measurement Accuracy (dc) ^{4,5}

Dual Cursor: \pm (1.25% of full scale + 0.032 \times V/div)

Single Cursor: \pm (1.25% of full scale + offset accuracy + 0.016 \times V/div)

Horizontal

Delta-t Accuracy⁶

Repetitive (\geq 8 averages): \pm (0.005% \times delta-t + 2E-6 \times delay setting + 100 ps)

Real Time (single acquisition): \pm (0.005% \times delta-t + 2E-6 \times delay setting + 150 ps)

Trigger

Trigger Sensitivity⁴ ¹⁰⁰

Internal (dc to 50 MHz): 0.5 division

Internal (50 MHz to 250 MHz): 1.0 division

External (dc to 250 MHz): 100 mV_{p-p} into 50 Ω

Notes:

1. Upper bandwidth reduces by 2.5 MHz for each °C above 35°C. Bandwidth in Repetitive mode is typically greater than 300 MHz.
2. Rise time figures are calculated from: $t_r = 0.35/\text{Bandwidth}$.
3. On ranges \leq 50 mV/div, the maximum overdrive of the input must not exceed 100 V.
4. Magnification is used below 7 mV/div range so vertical resolution and accuracies are correspondingly reduced. Below 7 mV/div, full scale is defined as 56 mV.
5. Voltage measurement accuracy decreases 0.08% of full scale per °C from firmware calibration temperature. This specification is valid for a temperature range \pm 10°C from firmware calibration temperature. Specification applies to both modes; repetitive and real time (single acquisition).
6. Specification applies at the maximum sampling rate. At lower sampling rates the specification is \pm (0.005% \times delta-t + $(2 \times 10^{-6}) \times$ delay setting + 0.15 \times sample interval) for bandwidth limited signals ($t_r = 1.4 \times$ sample interval). Sample interval is defined as 1/(sample rate). Specification also applies to those automatic measurements computing time intervals on pulses with identical slope edges (i.e. pos-pos, neg-neg).

Performance Characteristics

The following are performance characteristics of the HP 54510A Digitizing Oscilloscope.

Vertical

Switchable Bandwidth Limits

ac-coupled (lower -3 dB frequency): 90 Hz

LF reject (lower -3 dB frequency): 450 Hz

Bandwidth Limit (upper -3 dB frequency): 30 MHz

Number of Channels: 2 (simultaneous acquisition)

Vertical Sensitivity Range: 1 mV/div to 5 V/div

Vertical Gain Accuracy (dc):^{1,2} $\pm 1.25\%$ of full scale

Vertical Resolution:² 8 bits over 8 divisions ($\pm 0.4\%$), 10 bits via HP-IB with averaging ($\pm 0.1\%$)

Maximum Sample Rate: 1 GSa/s

Waveform Record Length:³ 8001 points real time, 501 points repetitive

Input C: 7 pF nominal

Input Coupling: ac, dc

Offset Range:	Vertical Sensitivity	Available Offset
	1 mV - 50 mV/div	± 2 V
	> 50 mV - 250 mV/div	± 10 V
	> 250 mV - 1.25 V/div	± 50 V
	> 1.25 V - 5 V/div	± 250 V

± 12 DIV FROM CENTER SCREEN

Dynamic Range: $\pm 1.5 \times$ full scale from center of screen

Channel-to-channel Isolation (with channels at equal sensitivity):

dc to 50 MHz: 40 dB

50 to 250 MHz: 30 dB

Notes:

- Gain accuracy decreases 0.08% of full scale per °C from firmware calibration temperature. This characteristic is valid for a temperature range $\pm 10^\circ\text{C}$ from firmware calibration temperature. Characteristic applies to both modes; repetitive and real time (single acquisition).
- Expansion is used below 7 mV/div range so vertical resolution and accuracies are correspondingly reduced. Below 7 mV/div full scale is defined as 56 mV.
- Available over HP-IB, waveform record length is:
Real Time- 8000 points
Repetitive- 500 points

Horizontal **Time Base Range:** 1 ns/div to 5 s/div
Time Base Resolution: 20 ps
Delay Range (post-trigger): $10,000 \times (\text{s/div})$
Delay Range:

Time/div Setting	Available Delay
(pretrigger) 100 ns - 5 s/div	$-160 \times (\text{s/div})$
1 ns - 50 ns/div	$-8 \mu\text{s}$

Trigger **Trigger Pulse Width (minimum)**
Internal: 1.75 ns
External: 2.8 ns
Trigger Level Range
Internal: $\pm 1.5 \times$ full scale from center of screen
External: $\pm 2 \text{ V}$

Operating Characteristics

The following are operating characteristics of the HP 54510A Digitizing Oscilloscope.

Vertical **Deflection Factors:** Channels 1 and 2: With single screen selected, deflection factors are adjustable from 1 mV/div to 5 V/div in a 1-2-5 sequence with the knob. Fully calibrated vernier adjustments can be made using direct keypad entry or the knob with the FINE key selected.

Probe Attenuation Factors: Values from 0.9 to 1000 may be entered to scale the oscilloscope for external probes or attenuators attached to the channel inputs. When probe tip calibration is done, this value is calculated automatically.

Input Impedance: 1 M Ω or 50 Ω , selectable for CH1, CH2 and EXT TRIG.

Bandwidth Limit (HF Reject): Provides low pass filter with a -3 dB point at approximately 30 MHz for both triggering and signal display. Can be selected for each vertical input individually.

LF Reject: Provides high pass filter with a -3 dB point at approximately 450 Hz for triggering and vertical signal. Can be selected for each vertical input individually.

ac Coupling: Provides high-pass filter with a -3 dB point at approximately 90 Hz for both triggering and signal display. Can be selected for each vertical input individually.

ECL/TTL Presets: Vertical deflection factor, coupling, offset, and trigger level can be preset independently on both channels for ECL and TTL levels.

Effective Resolution: The maximum sample rate and the number of bits in an oscilloscope's digitizer are too often used for comparing oscilloscopes. These specifications, however, do not describe performance under dynamic signal conditions. Effective Resolution is a figure of merit that describes the digitizing oscilloscope's performance under dynamic conditions, and is measured using the

sinewave curve fit test. This method considers:

- Quantization error
- Non-linearities(including preamp and A/D)
- System noise
- Frequency of input signal

All of these affect the effective resolution of the instrument. Some manufacturers specify effective bits using half-scale sinewaves. While the effective bits performance using half-scale testing is overstated when compared to full-scale testing, Hewlett-Packard publishes both sets of numbers for the 54510A so that, when comparing effective bits performance between digitizing oscilloscopes, a fair comparison can be made. The HP 54510A's typical performance for a single acquisition is shown below:

Frequency	50 kHz	1 MHz	20 MHz	50 MHz	100 MHz	250 MHz
Full scale	7.2	6.7	6.3	5.6	5.0	4.9
Half scale	7.4	7.1	7.0	6.4	6.0	5.2

For more information about effective resolution, please contact your Hewlett-Packard sales office, and ask for Product Note 5180A-2, *Dynamic Performance Testing of A to D Converters*, (pub # 02-5952-7629).

Horizontal Pan and Zoom: Changing the Time/div and/or Delay values once acquisition has been stopped allows access to all 8k points of data that are captured on each acquisition (Real-time mode only.)

Delay Between Channels: Difference in delay between channels can be nulled out to compensate for differences in input cables or probe length. Use "time null cal," found in the Probe Cal menu (see UTIL key).

Reference Location: The reference point can be located at the left edge, center, or right edge of the display. The reference point is defined as the trigger point plus the delay time.

Trigger Modes Edge Trigger: Positive or negative edge can be selected for trigger on channels 1 and 2, or on the external trigger input.

Pattern Trigger: A pattern can be specified using channels 1, 2 and the external trigger input. Each of the inputs can be specified as a *high*, *low*, or *don't care* with respect to the level setting in the edge trigger menu. The trigger can be selected to occur on the last edge to enter the specified pattern or the first edge to exit the specified pattern.

Time Qualified Pattern Trigger: A trigger will occur on the first edge to exit a pattern only if it meets the specified time criteria. The available time qualified modes are (user-specified time is in brackets):

- pattern present < [time]
- pattern present > [time]
- range: pattern present > [time1] and < [time2]

The time settings are adjustable from 20 ns to 160 ms ($\pm 3\% \pm 2$ ns). The time filter recovery time is ≤ 12 ns. In the "pattern present < [time]" mode, the pattern must be present for more than 1.75 ns, (2.8 ns for the external trigger) before the trigger will respond.

Glitch Trigger: Use "pattern present < [time]" with [time] selected such that it is just less than the nominal pulse width of the signal you are analyzing. The minimum glitch width is 1.75 ns, (2.8 ns for the external trigger).

State Trigger: A pattern is specified on any two of the three inputs with the third input used as clock. The user may specify that a trigger will occur on the rising or falling edge of the input specified as the clock, when the pattern is present or not present. Setup time for the pattern with respect to the clock is 10 ns or less and hold time is zero.

Delayed Trigger

Event-Delayed Mode: The trigger can be qualified by an edge, pattern, time qualified pattern, or state. The delay can be specified as a number of occurrences of a rising or falling edge of any of the three inputs. After the delay, an occurrence of a rising or falling edge of any of the three inputs will generate the trigger. The trigger occurrence value is selectable from 1 to 16,000,000. The maximum edge counting rate is 70 MHz.

Time-Delayed Mode: The trigger can be qualified by an edge, pattern, or state. The delay is selectable from 30 ns to 160 ms. After the delay, an occurrence of a rising or falling edge of any of the three inputs will generate the trigger. The trigger occurrence value is selectable from 1 to 16,000,000. The maximum edge counting rate is 70 MHz.

TV Trigger

60 Hz / 525 Lines: Trigger source is selected to be any one of the three inputs. Trigger level is adjustable for the selected trigger source. Polarity is selected for positive or negative synchronizing pulses. A trigger occurs on the selected line and field of a 2/1 interlaced composite video signal. Line numbering is 1 to 263 for field 1 and 1 to 262 for field 2. This TV trigger mode is compatible with broadcast standard M.

50 Hz / 625 Lines: Same as 60 Hz / 525 lines except that line numbering is 1 to 313 for field 1 and 314 to 625 for field 2. This TV trigger mode is compatible with broadcast standards B, C, D, G, H, I, K, K1, L, and N.

User-Defined Mode: Source is selected to be any one of the three inputs. Trigger level is adjustable for the selected source. The trigger is qualified with a high or low pulse that meets a selectable time range. The trigger is an occurrence of a rising or falling edge of the source after the qualifying pulse. The time settings for the qualifier are selectable from 20 ns to 160 ms. The trigger occurrence value is selectable from 1 to 16,000,000.

NOTE: All TV trigger modes require a clamped video signal for stable triggering. Use the HP 1133A TV/Video Sync Pod to provide clamped video output that can be used in conjunction with the HP 54510A's TV triggering capabilities.

Trigger Holdoff: Trigger can be held off either by time or events over the ranges:

- time: 40 ns - 320 ms
- events: 2 - 16,000,000

An event is defined as the specified trigger condition. A separate holdoff setting (time or events) is available for each trigger mode except delayed trigger, which is set to 40 ns.

Noise Reject Trigger: Provides improved triggering on noisy signals by increasing trigger hysteresis (internal trigger only).

Display **Data Display Resolution:** 451 points horizontally by 256 points vertically.

Number of Screens: 1 or 2 screens can be selected. This can provide overlapping channels or memories for comparison, or separate displays on a split viewing area.

Display Modes **Graticules:** The user may choose full grid, axes, frame, or no graticule.

Connect-the-Dots: Provides a continuous display, connecting the sample points with straight lines. *Connect-the-dots* is operative for modes in which a single-valued waveform can be connected, including average, envelope, single, and minimum-persistence modes. *Connect-the-dots* is not available in the variable or infinite persistence mode.

Time Base In Repetitive Mode

Averaging: The number of averages can be specified in powers of 2, up to 2,048. On each acquisition, $1/n$ times the new data is added to $(n-1)/n$ of the previous value at each time coordinate. Averaging operates continuously, except for the HP-IB *digitize* command, for which averaging terminates at the specified number of averages.

Envelope: Provides a display of the running maximum and minimum voltage levels at each horizontal time position.

Minimum Persistence: One waveform data value is displayed in each horizontal time position of the display. The waveform is updated as new data is acquired for a particular horizontal time position.

Variable Persistence: The time that each data point is retained on the display can be varied from 500 ms to 10 seconds, or the points can be displayed indefinitely.

Time Base in Realtime Mode

Single Persistence: One waveform data value is displayed in each horizontal time position. The entire waveform is replaced with each new acquisition.

Infinite Persistence: Waveform data is allowed to continuously accumulate on the screen, and remains until display is cleared.

Oversampling Filter: On time/division settings when less than 500 points are acquired across the screen (≤ 20 ns/div) a built-in digital filter automatically reconstructs the data. This filter is a combination between a $(\sin X)/X$ and a Gaussian filter.

Delta-t / Delta-V **Markers:** Dual voltage markers and dual time markers are available. Voltage markers can be independently assigned to channels, memories, or functions.

Waveform Math Two independent functions are provided for waveform math. The operators are +, -, \times , *vs*, *only*, *inverse*, *integrate*, *differentiate*, and *fft*. The vertical channels or any of the waveform memories can be used as operands for waveform math. Sensitivity and offset for these functions can be adjusted independently.

FFT (Fast Fourier Transforms) Principal Features

Peak Search: Peak search automatically snaps cursors to any two selected peaks located anywhere in the displayed frequency span. You can select peaks from

peak number 1 up to peak number 99. Frequency and dBm are automatically displayed at the bottom of the screen together with the difference in frequency between the two selected peaks. Peak search saves time by eliminating the need to manually set cursors.

Channels or Memories: FFTs can be executed on either of two oscilloscope input channels, or on waveforms stored in any of four nonvolatile memories.

Variable Sensitivity and Offset: Sensitivity and vertical offset (position) are controlled from the front panel to display an optimum view of the spectrum. Sensitivity is calibrated in dB per division; vertical offset is calibrated in dBm.

Selectable Time Record Length: Time record length can be set from 512 points to 8192 points in powers of 2. Increasing time record length improves frequency resolution at the expense of update speed.

Horizontal Magnification and Center Frequency Control: The horizontal magnification feature allows you to set the center of the display to a frequency of interest. The display is magnified about that point so that you get a closer view.

Selectable Windows: Three windows are selectable: hanning, for best frequency resolution and general purpose use; flattop, for best amplitude accuracy; and rectangular, for single-shot signals such as transients and signals where there are an integral number of cycles in the time record.

FFT Operating Characteristics

FFT Frequency Range: dc to 500 MHz (real-time acquisition.) Signals above 250 MHz can be viewed with reduced amplitude accuracy. Amplitude is down typically 8 dB @ 500 MHz.

-3 dB Frequency Range: dc to 250 MHz (analog bandwidth)

Frequency Resolution: 1.22 mHz (milliHz) to 1.95 MHz (real-time acquisition)

Maximum Displayed Frequency: 5 Hz to 500 MHz,selectable (real-time acquisition). Display is from dc to a selectable upper frequency, in steps from 5 Hz to 500 MHz. Maximum frequency displayed is 1/2 the sample rate.

Horizontal Magnify Mode: This mode allows you to specify the frequency that is displayed at center screen, and magnify the frequency-domain display about that point. Magnification increases as the number of time-record samples increases. At the maximum time-record length of 8192 points, magnification reduces the displayed frequency span to about 12% of that in the unmagnified display. Horizontal magnification allows you to zero in on and expand desired portions of the frequency-domain display.

Frequency Accuracy: $\pm \left[\frac{\text{sample freq}}{2 \times 8192} + \frac{\text{signal freq}}{20000} \right]$

Window Characteristics:

Window	Highest Side Lobe (dB)	3dB Bandwidth (bins)	6dB Bandwidth (bins)	Scallop Loss (dB)
Rectangular	-13	0.89	1.21	3.92
Hanning	-32	1.44	2.00	1.42
Flattop	-70	3.38	4.17	0.005

Split display operation: A time-domain waveform and its FFT spectrum can be displayed simultaneously on the top and bottom halves of the screen. Two FFT spectra can be displayed simultaneously in the same way. Two sets of time-domain waveforms and their spectra may also be displayed simultaneously.

FFT Update Time: Update times listed are typical for sweep speeds greater than or equal to 10 μ s/div. Time includes acquisition, window calculation, FFT calculation, and display generation:

Time Record Points	FFT Update Time
512 (repetitive)	0.25 seconds
512 (real-time)	0.42 seconds
1024	0.64 seconds
2048	1.12 seconds
4096	2.14 seconds
8192*	4.32 seconds

*Taken from a zero-padded acquisition record of 8000 points.

Spectrum Displays

Amplitude: Power in dBm
Signal-to-noise Ratio: 55 to 65 dB (typical) Noise floor can be reduced by increasing the number of points in the FFT.

Log Display: Both sensitivity and offset (position) can be set by the user:

Sensitivity Range: 1 dBm/div to 100 dBm/div

Offset Range: -200 dBm to +200 dBm

Waveform Save

The HP 54510A contains four non-volatile waveform memories and two volatile pixel memories. Waveform memories store single-valued waveforms, such as an averaged waveform. If an envelope waveform is stored to a waveform memory, it will automatically be stored with the upper waveform in one waveform memory and the lower waveform in another.

Pixel memories store an entire screen of waveform data. They are useful for storing multiple overlapping waveforms and infinite persistence waveforms. Automatic measurements may be performed on the four non-volatile waveform memories but not on the volatile pixel memories.

Automatic Pulse Parameter Measurements:

The HP 54510A offers 17 automatic pulse parameter measurements from the front panel (shown below) and additional measurements via HP-IB including *All*, *Overshoot*, and *Preshoot*. The standard measurements are performed with 10%, 50%, and 90% voltage thresholds, as defined by IEEE standard 194-1977, "IEEE Standard Pulse Terms and Definitions."

Automatic measurements available on the HP 54510A:

Rise time	Pulse Width +	Volts amp	Volts avg	Preshoot
Fall time	Pulse width -	Volts base	Volts max	(HP-IB only)
Frequency	Duty Cycle	Volts top	Volts min	Overshoot
Period	Delay	Volts p-p	Volts RMS dc	(HP-IB only)
			Volts RMS ac	

User-definable Measurement Thresholds

The HP 54510A allows you to set your own thresholds for automatic measurements. Both the upper and lower thresholds can be set from -25% to 125% , as long as the upper threshold value is always greater than or equal to the lower threshold. The middle threshold is always equal to the mid-value between the upper and lower threshold.

Continuous Measurements: Can be turned on or off. With continuous measurements off, the voltage and time markers are placed on the waveform to indicate where the last measurement was taken.

Measurement Statistics: The maximum, minimum, average, and most recent of continuously updated measurements are calculated and displayed. Any three measurements can be selected for simultaneous display.

Measurement Limit Test: Maximum and minimum limits can be set for any three of the front-panel automatic measurements. These continuously updated measurements are compared to the maximum and minimum limits. If the measurements are found to be outside the defined limits, the waveform can be stored in a memory or the screen can be sent to a hardcopy device. In addition, the HP-IB Service Request line can be set to flag the controller. Measurement limit test can be set to stop after test limits have been exceeded, or to continue testing.

Graphical Compare: The graphical compare mode allows a point-by-point comparison of an input channel to a memory pair (m1 and m2, or m3 and m4). The result is a displayed PASS or FAIL message. The menu allows the choice of input channel and memory pair to be compared. A failure allowance value can be entered to give the effect of trace separation, where needed. On failure, the menu allows for storage of the data with a stop/continue option.

Setup Aids

Autoscale: Pressing the Autoscale button automatically adjusts the vertical and horizontal deflection factors, and the trigger level for a display appropriate to the signals applied to the inputs. The Autoscale feature requires a signal with a duty cycle greater than 0.5% and a frequency greater than 50 Hz. Autoscale is operative only for relatively stable input signals.

Save/Recall: Four front panel setups (1-4) may be saved in non-volatile memory.

Recall Clear: Pressing the RECALL key followed by the CLEAR key resets the HP 54510A to its factory default settings.

Recall 0: If Autoscale, ECL or TTL preset, or recall setup are inadvertently selected, recall 0 restores the instrument to its last state prior to erroneous selection.

Show: Displays instrument status, including volts/div, offset, and trigger condition.

Hardcopy The CRT display, including menus and measurement answers, can be transferred directly to an HP-IB raster graphics printer, including the HP 2225A ThinkJet, HP 2227B QuietJet, or other compatible printers. Hardcopy from HP graphics plotters including the HP 7440A, HP 7470A, HP 7475A, and HP 7550A is also available.

Full HP-IB Programmability The HP 54510A is fully programmable. Instrument settings and operating modes, including automatic measurements, may be remotely programmed via HP-IB (IEEE-488). HP-IB programming complies with IEEE 488.2-1988 "Standard Codes, Formats, Protocols, and Common Commands."

Sequential Single-shot Data Acquisition and Transfer Rate: Using the HP-IB command "Raw Data" the HP 54510A can automatically capture, store, and label a waveform; and re-arm the trigger; and then repeat this process until the HP 54510A's entire 150k RAM (volatile) is filled. Once the specified number of waveforms have been captured and stored, the HP 54510A can transfer the entire block of waveforms to the external computer. Users can specify the number of points to be stored and the number of waveforms to be captured. Repetition rates vary depending on record length and time base setting (slower sampling rates). See figures below.

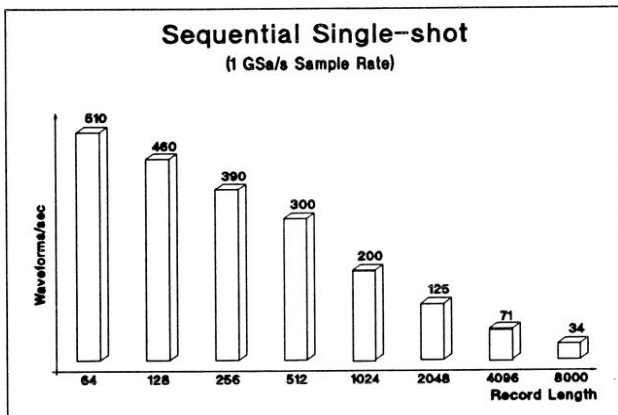

Figure 1.

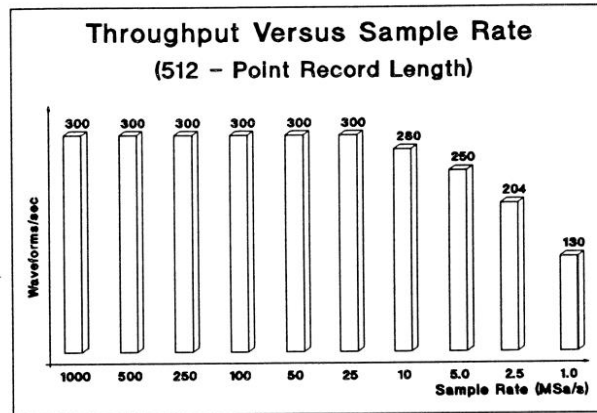

Figure 2.

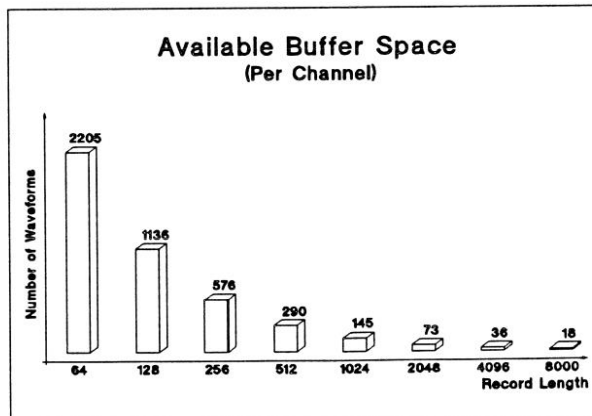

Figure 3.

Data Transfer Rate: Approximately 120 kBytes per second.

Probe Compensation, ac Calibrator Output: A 500 Hz (approx.) square wave is provided for probe compensation. A probe-to-BNC adapter is used to connect the probe to the rear panel Probe Compensation BNC output. During instrument self-calibration, this output is used to provide other calibration signals, as described in the Service Manual.

This same BNC connector is used for trigger output. The utility menu allows the user to switch the BNC from probe compensation and calibration signals to a trigger output pulse. The rising edge, with amplitude from approximately -400 mV to 0 V (when terminated into 50 Ω), is synchronous with system trigger. The falling edge of this pulse occurs approximately at the end of holdoff. The rising edge should be used as the edge synchronous with trigger.

dc Calibrator Output: This output is used for vertical calibration of the HP 54510A, as described in the Service Manual.

Product Support

Built in Self-Test and Calibration Routines: Internal self-test capabilities provide a 90% confidence the instrument is operating properly. External test procedures in the service manual provide a 100% confidence. Self-calibration routines, also selected through the front panel "utility" menu, ensure that the instrument is operating with its greatest accuracy and require no external test equipment.

Low Cost of Ownership: The HP 54510A includes a standard three year, return to HP warranty.

To minimize the mean time to repair and calibration time, the HP 54510A was designed with only one main assembly adjustment per channel. In addition, Hewlett-Packard's board exchange program assures economical and timely repair of units, reducing the cost of ownership.

Reliability: Estimated mean time between failures (MTBF) for the HP 54510A is 30,000 hours. MTBF is computed using an instrument usage of 2,000 hours per year.

Solutions: Hewlett-Packard's System Engineering Organization can help you configure an HP-IB system and provide software support for your application, developing solutions to meet your measurement needs. Contact your HP Sales and Service office for more information.

General Characteristics

Environmental Conditions

Temperature

Operating: 0°C to +55°C (32°F to +131°F)

Non-operating: -40°C to +70°C (-40°F to +158°F)

Humidity

Operating: up to 95% relative humidity (non-condensing) at +40°C (+104°F)

Non-operating: up to 90% relative humidity at +65°C (+149°F)

Altitude

Operating: up to 4,600 meters (15,000 ft)

Non-operating: up to 15,300 meters (50,000 ft)

Vibration

Operating: Random vibration 5-500 Hz, 10 minutes per axis, 0.3 grms.

Non-operating: Random vibration 5-500 Hz, 10 minutes per axis, 2.41 grms.

Resonant search 5 to 500 Hz swept sine, 1 Octave/minute sweep rate, (0.75g), 5 minute resonant dwell at 4 resonances per axis.

Power Requirements

Voltage: 115/230 V ac, -25% to +15%, 48-66 Hz.

Power: 350 VA maximum.

Weight

Net: approximately 10 kg (22 lb).

Shipping: approximately 20 kg (44 lb).

Dimensions

Refer to the outline drawings below.

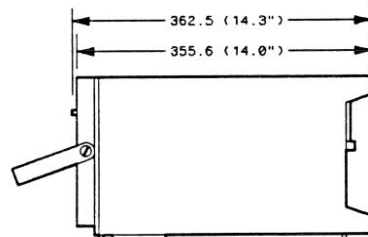
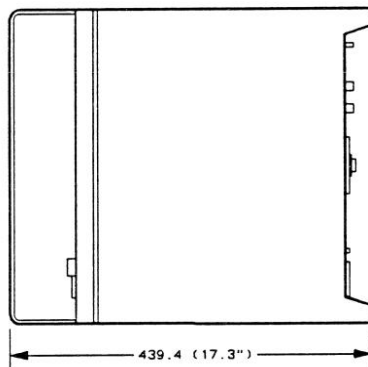

54501E13

NOTES

1. Dimensions are for general information only. If dimensions are required for building special enclosures, contact your HP field engineer.
2. Dimension are in millimetres and (inches).

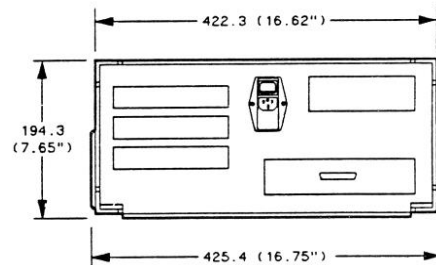

Recommended Test Equipment

Table 1-1 shows a list of the test equipment required to test performance, make adjustments, and troubleshoot this instrument. The table indicates the critical specification of the test equipment and for which procedure the equipment is necessary. Equipment other than the recommended model may be used if it satisfies the critical specification listed in the table.

Table 1-1. Recommended Test Equipment

Equipment Required	Critical Specifications	Recommended Model	Use *
Signal Generator	1 - 250 MHz, sine wave, amplitude 30 - 200 mVrms, time base accuracy 0.25 ppm	HP 8656B, Opt 001	P
Pulse Generator	tr = 1.0 to 1.4 ns, 280 mV _{p-p} , externally triggerable	HP 8161A	P
Power Meter/Power Sensor	1 - 250 MHz, -70 dBm to +44 dBm, ±3% accuracy	HP 436A/HP 8482A	P
DMM	6 1/2 digit (0.1 mV) resolution, dc voltage accuracy 8 ppm/year, 4-wire resistance accuracy ±0.25%	HP 3458A	P, A, T
Power Supply	7 mV - 30 V dc, 0.1 mV accuracy and resolution	HP 6114A	P
Pulse Generator	tr < 1.0 ns	Picosecond Pulse Labs 1110B Driver, 1107B Head	A
Pulse Generator	Square wave, 20 kHz, 400 mV _{p-p} , ≤1% pulse-top flatness deviation	HP 3325B	A
Function Generator	Sine wave, 50 MHz, 15 mV _{p-p}	HP 8116A	A
Power Splitter	50 Ω type N, outputs differ by < 0.15 dB	HP 11667A	P
Oscilloscope	General-purpose	HP 54501A	P, T
Attenuator	BNC 50Ω 6 dB	Mini-Circuits CAT-6	A
Blocking Capacitor	0.18 μF	HP 10240B	P
Cable	Type N (m)(m) - 3 foot	HP 11500A or B	P
Cable (2)	BNC - 3 foot	HP 10503A	P, A, T
Cable (3)	BNC - 9 inch	HP 10502A	P, A, T
Adapter	N (m) to BNC (m)	HP 1250-0082	P
Adapter	N (m) to BNC (f)	HP 1250-0780	P
Adapter	N (f) to BNC (m)	HP 1250-0077	A
Adapter	SMA (m) to BNC (m)	HP 1250-1787	A
Adapter (2)	BNC tee (m)(f)(f)	HP 1250-0781	P, T
Adapter	BNC (f)(f)	HP 1250-0080	T
Adapter (2)	BNC (f) to dual banana (m)	HP 1251-2277	P
Shorting cap	BNC	HP 1250-0774	P
Cable Extender	no substitute	HP 54503-61604	A, T
Resistor	2 Ω, 25 W	HP 0811-1390	T

*. P = Performance Tests, A = Adjustments, T = Troubleshooting

Contents

Section 2

Installation

Introduction	2-1
Initial Inspection	2-1
Operating Environment	2-1
Storage and Shipping	2-1
Packaging	2-1
Tagging for Service	2-1
Original Packaging	2-2
Other Packaging	2-2
Preparation for Use	2-2
Power Requirements	2-2
Line Voltage Selection	2-2
Power Cable	2-3
Applying Power	2-3
Cleaning Requirements	2-3

Installation

Introduction

This section of the manual contains information and instructions for installing the HP 54510A Digitizing Oscilloscope. Included in this section are inspection procedures, power requirements and connection, and packing and shipping information.

Initial Inspection

Inspect the shipping container for damage. If the shipping container or cushioning material is damaged, it should be kept until the contents of the shipment have been checked for completeness and the instrument has been checked mechanically and electrically. Accessories supplied with the instrument are listed in "Accessories Supplied" in section 1 of this manual. The self-test procedure and electrical performance verification functions are described in section 3.

If the contents are incomplete, if there is mechanical damage or defect, or if the instrument does not pass performance verification, notify the nearest HP office. If the shipping container is damaged, or the cushioning materials show signs of stress, notify the carrier as well as the HP office. Keep the shipping materials for the carrier's inspection. The HP office will arrange for repair or replacement at Hewlett-Packard's option without waiting for claim settlement.

Operating Environment

The operating environment for the HP 54510A is described in the "Operating Characteristics" in section 1. Note the non-condensing humidity limitation. Condensation within the instrument cabinet can cause poor operation or malfunction. Protection should be provided against temperature extremes which cause condensation within the instrument.

Storage and Shipping

This instrument may be stored or shipped in environments within the following limitations:

- Temperature: -40°C to 70°C (-40°F to 158°F)
 - Humidity: up to 90% at 65°C (149°F)
 - Altitude: up to 15,300 meters (50,000 feet)
-

Packaging

Tagging for Service

If the instrument is to be shipped to an HP office for service or repair; attach a tag to the instrument identifying owner, address of owner, complete instrument model and serial numbers, and a description of the service required.

Original Packaging

If the original packaging material is unavailable or unserviceable, materials identical to those used in factory packaging are available through HP offices. If the instrument is to be shipped to an HP office for service, attach a tag showing owner, address of owner, complete instrument model and serial numbers, and a description of the service required. Mark the container FRAGILE to ensure careful handling. In any correspondence, refer to the instrument by model number and full serial number.

Other Packaging

The following general instructions should be followed for repacking with commercially available materials.

1. Wrap instrument in heavy paper or plastic.
2. Use strong shipping container. A double-wall carton made of 350 lb test material is adequate.
3. Use a layer of shock-absorbing material 70 to 100 mm (3 to 4 inches) thick around all sides of instrument to firmly cushion and prevent movement inside the container. Protect control panel with cardboard.
4. Seal shipping container securely.
5. Mark shipping container FRAGILE to ensure careful handling.
6. In any correspondence, refer to instrument by model number and full serial number.

Preparation for Use

Power Requirements

The HP 54510A requires a power source of either 115 or 230 Vac, -25% to +15%; 48 to 66 Hz; 350 VA maximum.

Caution

BEFORE CONNECTING POWER TO THIS INSTRUMENT, be sure the line voltage switch on the rear panel of the instrument is set properly and the correct fuse is installed.

Line Voltage Selection

Before applying power, verify that the fuse module is in the correct position for the line voltage to be used.

The fuse module is located in the line filter/power switch module on the rear panel of the instrument. There is one small triangle on the filter module and two on the fuse module; one next to each line voltage choice. If the triangle on the filter is not adjacent to the triangle with the desired voltage on the fuse module, the fuse module position needs to be changed. To do this, gently pry out fuse module with a flat-blade screwdriver. Reinsert the fuse module into the line filter module so the correct line voltage is adjacent to the triangle on the filter module.

Power Cable



BEFORE CONNECTING THIS INSTRUMENT, the protective earth terminal of the instrument must be connected to the protective conductor of the (Mains) power cord. The Mains plug must be inserted in a socket outlet provided with a protective earth contact. The protective action must not be negated by the use of an extension cord (power cable) without a protective conductor (grounding). Grounding one conductor of a two-conductor outlet does not provide an instrument ground.

This instrument is provided with a three-wire power cable. When connected to an appropriate ac power outlet, this cable grounds the instrument cabinet. The type of power cable plug shipped with the instrument depends on the country of destination. Refer to figure 2-1 for power plugs and HP part numbers for the available plug configurations.









Applying Power

After applying power to the HP 54510A, an internal self-test may be performed by following the procedure in section 3. If the message "cal ram checksum error re-cal instrument" is displayed at the top of the screen, refer to the calibration procedures in section 4 of this manual.

Cleaning Requirements

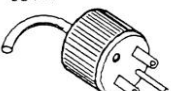
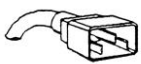
Use **MILD SOAP AND WATER** to clean the instrument cabinet and front panel. Care must be taken not to use a harsh soap which will damage the water-based paint finish of the instrument.

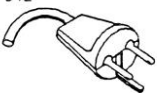
Table 2-1. Power Cord Configurations

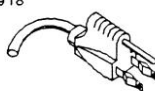
PLUG TYPE	CABLE PART NO.	PLUG DESCRIPTION	LENGTH IN/CM	COLOR	COUNTRY
OPT 900  250V	8120-1351 8120-1703	Straight *BS1363A 90°	90/228 90/228	Gray Mint Gray	United Kingdom, Cyprus, Nigeria, Zimbabwe, Singapore
OPT 901  250V	8120-1369 8120-0696	Straight *NZSS198/ASC 90°	79/200 87/221	Gray Mint Gray	Australia New Zealand
OPT 902  250V	8120-1689 8120-1692 8120-2857	Straight *CEE7-Y11 90° Straight (Shielded)	79/200 79/200 79/200	Mint Gray Mint Gray Coco Brown	East and West Europe, Saudi Arabia, So. Africa, India (Unpolarized in many nations)
OPT 903**  125V	8120-1378 8120-1521 8120-1992	Straight *NEMA5-15P 90° Straight (Medical) UL544	90/228 90/228 96/244	Jade Gray Jade Gray Black	United States, Canada, Mexico, Phillipines, Taiwan
OPT 904**  250V	8120-0698	Straight *NEMA6-15P	90/228	Black	United States, Canada
OPT 905  250V	8120-1396 8120-1625	CEE22-V1 (System Cabinet Use) 250V	30/76 96/244	Jade Gray	For interconnecting system components and peripherals. United States and Canada only
OPT 906  250V	8120-2104 8120-2296	Straight *SEV1011 1959-24507 Type 12 90°	79/200 79/200	Mint Gray Mint Gray	Switzerland
OPT 912  220V	8120-2956 8120-2957	Straight *DHCK107 90°	79/200 79/200	Mint Gray Mint Gray	Denmark
OPT 917  250V	8120-4211 8120-4600	Straight SABS164 90°	79/200 79/200	Jade Gray	Republic of South Africa India
OPT 918  100V	8120-4753 8120-4754	Straight Miti 90°	90/230 90/230	Dark Gray	Japan

Rev. 11NOV88

ART00019

*Part number shown for plug is industry identifier for plug only. Number shown for cable is HP part number for complete cable including plug.

**These cords are included in the CSA certification approval of the equipment.

E=Earth Ground
L=Line
N=Neutral

Contents

Section 3

Performance Tests

Introduction	3-1
Testing Interval	3-1
Equipment Required	3-1
Self-Test Verification	3-1
Performance Test Record	3-2
Operating Hints	3-2
Clear Display	3-2
Averaging	3-2
Performance Test Procedures	3-2
dc Calibrator Test	3-3
Input Resistance	3-4
Voltage Measurement Accuracy	3-5
Offset Accuracy	3-7
Bandwidth	3-8
Time Measurement Accuracy	3-10
Trigger Sensitivity	3-13
Oscillator Output Check	3-15

Performance Tests

Introduction

The procedures in this section test the instruments electrical performance using Performance Specifications given in section 1 as performance standards. Specifications applicable to individual tests are noted at the test for reference.

Testing Interval

The performance test procedures may be performed for incoming inspection of the instrument and should be performed periodically thereafter to ensure and maintain peak performance. The recommended test interval is yearly or every 2,000 hours of operation. Amount of use, environmental conditions, and the user's experience concerning need for testing will contribute to verification requirements.

The calibration cycle is covered in the Adjustment procedures.

Equipment Required

A complete list of equipment required for the performance tests is in table 1-1, Recommended Test Equipment, in section 1. Equipment required for individual tests is listed in the test. Any equipment satisfying the critical specifications listed may be substituted for the recommended model.

Self-Test Verification

To verify system operation with high confidence, without the test equipment and time required for performance tests, perform the self-tests. These internal tests verify many functions on the Main Assembly. The functions tested are the six separate memories and six other system functions.

To start the self-tests, press **UTIL** then **self-test**. A message is displayed with the instruction to remove all inputs to the instrument. Press **test all**, which starts a loop which runs all the self-tests in succession. During execution of the self-tests, the following messages are displayed as each self-test is completed:

PASSED Display RAM	PASSED Acquisition RAM
PASSED System RAM	PASSED Logic Trigger
PASSED Non-Volatile RAM	PASSED Analog Trigger
PASSED Protected Non-Volatile RAM	PASSED Timebase
PASSED System ROM	PASSED D/A Converter
PASSED HP-IB	PASSED A/D Converter

If one of the self-tests fails, **FAILED** is displayed rather than **PASSED**, and a 16-bit diagnostic code is displayed. This code is used by factory service personnel when troubleshooting the Main Assembly. Failure of a self-test indicates a failure on the Main Assembly which must be returned to the factory for service. For more information on service, refer to section 6 of this manual.



The loop test in the **selftest** menu is a troubleshooting aid for factory service only.

Performance Test Record

The results of the performance tests may be tabulated in table 3-1, Performance Test Record, provided at the end of this section. The Performance Test Record lists the performance tests and provides an area to mark test results. The results recorded in the Performance Test Record during initial inspection may be used for later comparisons of the tests during periodic maintenance, troubleshooting, and after repairs or adjustments.

Operating Hints

Some knowledge of operation of the HP 54510A is helpful; however, procedures are written so that little experience is necessary. The following two hints will speed progress of the testing.

Clear Display

When using many averages, it often takes awhile for a waveform display to stabilize after a change. When a control on the HP 54510A is changed, averaging automatically restarts. When just the input signal is changed, the instrument must average new data with the old so it takes longer for the waveform to stabilize. Press CLEAR DISPLAY while changing input signals. The instrument will restart averaging and give a quick indication of the result of the signal change.

Averaging

Averaging is used to assure a stable signal for measurements. It is not necessary to wait for complete stability of the signal (averaging complete) as long as the measurement is well within the limits of the test.

Performance Test Procedures

Performance test procedures start with the next paragraph. Procedures may be done individually or in any order.

Note

Allow the instrument to warm up for at least 30 minutes prior to beginning performance tests.

dc Calibrator Test

The DC CALIBRATOR output on the rear panel is used for self-calibration and probe calibration. Though calibrator accuracy is not specified in the performance specifications, it must be within limits in order to provide accurate self-calibration.

Test Limits 5.000 V \pm 10 mV

Equipment Required The following equipment is required for this test. Procedures are based on the model or part number recommended.

Equipment Required	Critical Specifications	Recommended Model/Part
Digital Multimeter	0.1 mV resolution, better than 8 ppm/yr accuracy	HP 3458A
Cable	BNC	HP 10503A
Adapter	BNC (f) to banana (m)	HP 1251-2277

Procedure

1. Connect the multimeter to the rear panel DC CALIBRATOR output.
2. Press UTIL then **service menu**, then press **cal select** to select **cal select 4** (4. DC cal BNC verify). Press **dac output** to select **0 volt**.
3. The DVM should read close to 0.0000 V. Record the reading to four decimal places. V1 = _____.
4. Press **dac output** to select **5 volt**. The DVM should read near 5.000 V. V2 = _____.
5. Subtract V1 from V2. The difference should be between 4.990 and 5.010 V. Record the reading in the Performance Test Record.
6. Press **exit menu**.



If the difference is not within the limits, repair is necessary. See Troubleshooting in section 6.

Input Resistance

This test checks the input resistance of the vertical inputs. A four-wire measurement is used for accuracy at 50 Ω .

Specification 1 M Ω \pm 1% and 50 Ω \pm 1%

Equipment Required The following equipment is required for this test. Procedures are based on the model or part number recommended.

Equipment Required	Critical Specifications	Recommended Model/Part
Digital Multimeter	Measure resistance (4-wire) better than 0.25% accuracy	HP 3458A
Cables (2)	BNC	HP 10503A
Adapter	BNC Tee (m)(f)(f)	HP 1250-0781
Adapters (2)	BNC (f) to dual banana (m)	HP 1251-2277

- Procedure**
1. Set up the multimeter to make a four-wire resistance measurement.
 2. Use the BNC-to-banana adapters to connect one end of each BNC cable to the four-wire resistance connections on the multimeter, and connect the free ends of the cables to the BNC tee.
 3. Connect the male end of the BNC tee to the channel 1 input of the HP 54510A.
 4. Press **CHAN** and select channel 1 with the top softkey.
 5. Use the impedance softkey (second from bottom) to select 1 M Ω , then 50 Ω DC, and verify resistance readings of 1 M Ω \pm 10 k Ω and 50 Ω \pm 0.5 Ω respectively. Record the readings in the Performance Test Record.
 6. Connect the BNC tee to the channel 2 input.
 7. Select channel 2.
 8. Select 1 M Ω , then 50 Ω DC, and verify resistance readings of 1 M Ω \pm 10 k Ω and 50 Ω \pm 0.5 Ω respectively for channel 2. Record the readings in the Performance Test Record.

Voltage Measurement Accuracy

This test verifies the voltage measurement accuracy of the instrument. The measurement is made in a way that offset errors are not a factor.

Specification Dual Cursor: $\pm(1.25\%$ of full scale + $0.032 \times \text{V/div}$)
Single Cursor: $\pm(1.25\%$ of full scale + offset accuracy + $0.016 \times \text{V/div}$)

Equipment Required The following equipment is required for this test. Procedures are based on the model or part number recommended.

Equipment Required	Critical Specifications	Recommended Model/Part
Power Supply	7 mV to 30 Vdc, 0.1 mV resolution	HP 6114A
Digital Multimeter	Better than 0.1% accuracy	HP 3458A
Cables (2)	BNC	HP 10503A
Adapters (2)	BNC (f) to banana (m)	HP 1251-2277
Adapters (2)	BNC tee (m)(f)(f)	HP 1250-0781
Blocking capacitor	0.18 μF	HP 10240B
Shorting cap	BNC	HP 1250-0774

Procedure A power supply provides a reference voltage for checking measurement accuracy. The supply is monitored for accuracy (especially at low voltages). A dc blocking capacitor is used to filter noise on the input voltage to the oscilloscope.

1. Use the BNC-to-banana adapters, BNC tee, and cables to connect the power supply and DVM, and provide a cable to connect to the oscilloscope.
2. Connect a BNC tee to the channel 1 input of the oscilloscope. Connect the blocking capacitor to the BNC tee and connect the BNC shorting cap to the blocking capacitor.
3. Press RECALL then CLEAR to set HP 54510A to default conditions.

4. Use the following table for the next steps.

Volts/div	Offset	Supply	Tolerance	Limits	
				minimum	maximum
5 V	15 V	30 V	± 0.66 V	29.34 V	30.66 V
5 V	15 V	15 V	± 0.66 V	14.34 V	15.66 V
5 V	15 V	5 V	± 0.66 V	4.34 V	5.66 V
200 mV	600 mV	1.2 V	± 26.4 mV	1.1736 mV	1.2264 mV
200 mV	600 mV	600 mV	± 26.4 mV	573.6 mV	626.4 mV
200 mV	600 mV	200 mV	± 26.4 mV	173.6 mV	226.4 mV
10 mV	30 mV	60 mV	± 1.32 mV	58.68 mV	61.32 mV
10 mV	30 mV	30 mV	± 1.32 mV	28.68 mV	31.32 mV
10 mV	30 mV	10 mV	± 1.32 mV	8.68 mV	11.32 mV
7 mV	21 mV	42 mV	± 0.924 mV	41.076 mV	42.924 mV
7 mV	21 mV	21 mV	± 0.924 mV	20.076 mV	21.924 mV
7 mV	21 mV	7 mV	± 0.924 mV	6.076 mV	7.924 mV

Below 7 mV/div expansion is used and full scale is defined as 56 mV. The ranges from 1 to 6 mV/div are accomplished in firmware and will be within specifications when the 7 mV/div range is within specifications.

5. Initiate a V TOP measurement. Press SHIFT (blue), V TOP, and 1.
6. Press CHAN and set the V/div range and offset per the first line of the table.
7. With supply disconnected from channel input, note the V TOP reading.
_____ mV
8. Set power supply per the first line of the table.
9. Connect the power supply to the channel input and note the V TOP reading.
_____ V
10. Subtract the value in step 7 from the value in step 9. Record the difference in the Performance Test Record.
11. On the same channel, Repeat steps 5 through 9 for the rest of the lines of the table.
12. Press CHAN and set channel 1 off and channel 2 on.
13. Move the blocking capacitor combination to channel 2 and repeat steps 4 through 11 for channel 2.



Voltage measurement errors can be caused by the need for self calibration. Before troubleshooting instrument, perform self calibration, 0. vertical cal, (see "Firmware Calibration", section 4). If self-calibration fails to correct the problem, the cause may be the attenuator or main assembly.

Offset Accuracy This test verifies the offset accuracy.

Specification $\pm(1.0\%$ of channel offset + 2% of full scale)

Equipment Required The following equipment is required for this test. Procedures are based on the model or part number recommended.

Equipment Required	Critical Specifications	Recommended Model/Part
Power Supply	0.5 V to 2 Vdc, ± 1 mV accuracy	HP 6114A
Cable	BNC	HP 10503A
Adapter	BNC (f) to dual banana (m)	HP 1251-2277

- Procedure**
1. Use the banana-to-BNC adapter to connect the BNC cable between the power supply and channel 1 input.
 2. Press RECALL then CLEAR to set HP 54510A to default conditions, then set the following parameters.

Menu	Selection	Setting
TIMEBASE	(mode)	repetitive
DISPLAY	# of avg	32

3. Use the following table for the next steps.

Volts/div	Offset	Supply	Tolerance	Limits
200 mV	2.00000 V	2.00 V	± 52 mV	1.948 to 2.052 V
100 mV	1.00000 V	1.00 V	± 26 mV	0.974 to 1.026 V
50 mV	500.000 mV	500 mV	± 13 mV	487 to 513 mV

4. Press CHAN and set for 200 mV/div and 2.00000 V offset, as in the first line of the table.
5. Set the supply to 2.00 V as in the first line.
6. Press FINE. Readjust offset so the trace is as close to the horizontal center line of the graticule as possible after it has settled (averaging complete).
7. Read the offset voltage. It should be at its original setting, within the limits given in the table. Record the reading in the Performance Test Record.
8. Repeat steps 4 through 7 for the 100 mV and 50 mV ranges using the appropriate range, offset, and supply voltage in the table.
9. Connect the power supply to the channel 2 input.
10. Turn channel 1 off and channel 2 on and repeat steps 3 through 8 for channel 2.



Offset errors can be caused by the need for self calibration. Perform self calibration, 0. vertical cal, (see Adjustments) before troubleshooting instrument. If self calibration fails to correct problem, the cause may be the attenuator or main assembly.

Bandwidth

This test checks the bandwidth of the HP 54510A.

Specification Bandwidth (dc coupled): dc to 250 MHz (realtime)

Equipment Required The following equipment is required for this test. Procedures are based on the model or part number recommended.

Equipment Required	Critical Specifications	Recommended Model/Part
Signal Generator	1 - 250 MHz at \approx 200 mVrms	HP 8656B
Power Meter/Sensor	1 - 250 MHz \pm 3% accuracy	HP 436A/8482A
Power Splitter	outputs differ by $<$ 0.15 dB	HP 11667B
Cable	Type N (m) 24 inch	HP 11500B
Adapter	Type N (m) to BNC (m)	HP 1250-0082

Procedure

1. With the N cable, connect the signal generator to the power splitter input. Connect the power sensor to one output of the power splitter.
2. Using an N-to-BNC adapter, connect the other power splitter output to the channel 1 input.
3. Press RECALL then CLEAR to set default conditions, then set the following parameters.

Menu	Selection	Setting
TIMEBASE	(time/div)	200 ns/div
CHAN 1	(sensitivity)	40 mV/div
	(input R)	50 Ω DC

4. Set the signal generator for 1 MHz at -2.4 dBm. The signal on screen should be two cycles at six divisions amplitude.
5. Press SHIFT (blue), V P-P, and 1 (for channel 1) to make an automatic peak-to-peak measurement.
6. After the measurement settles (averaging complete, about 10 seconds) note the **Vp-p (1)** reading (bottom of screen): $V_{1\text{MHz}} = \underline{\hspace{2cm}}$ mV.
7. Set power meter Cal Factor % to 1 MHz value from the cal chart on the probe, then press dB[REF] to set a 0 dB reference.
8. Change signal generator to 250 MHz and set power meter Cal Factor to 250 MHz % value from chart.
9. Adjust signal generator amplitude for a power reading as close as possible to 0.0 dB(REL). Reading = $\underline{\hspace{2cm}}$.
10. Press TIME BASE and set to 2 ns/div.
11. After the measurement settles (averaging complete) note the **Vp-p (1)** reading: $V_{250\text{MHz}} = \underline{\hspace{2cm}}$ mV.

12. Calculate the response using the formula:

$$\text{response(dB)} = 20 \log_{10} \frac{V_{250\text{MHz}}}{V_{1\text{MHz}}} = 20 \log_{10} \text{_____} = \text{_____ dB}$$

13. Correct the result from step 12 with any difference in the power meter from step 9. Observe signs. For example:

Result from step 12 = -2.3 dB
 Power meter reading = -0.2 dB(REL)
 then true response = (-2.3)-(-0.2) = -2.1 dB

$$(\text{_____}) - (\text{_____}) = \text{_____ dB}$$

14. The result from step 13 should be ≤ -3.0 dB. Record the result in the Performance Test Record.

15. Switch the power splitter from channel 1 to channel 2 input.

16. On the HP 54510A, set the following parameters.

Menu	Selection	Setting
TIMEBASE	(time/div)	200 ns/div
CHAN	1	off
	2	on
	(sensitivity)	40 mV/div
TRIG	(input R)	50Ω DC
	source	2

17. Press SHIFT (blue) then CLEAR, then repeat steps 3 through 14 for channel 2, setting channel 2 parameters where appropriate.



Failure of the bandwidth test can be caused by faulty attenuator or main assembly, or the need for high-frequency pulse response adjustment.

Time Measurement Accuracy

This test uses a precise frequency source to check the accuracy of time measurement functions.

Specification

Delta-t accuracy*

Repetitive (≥ 8 averages): $\pm(0.005\% \times \text{delta-t} + (2 \times 10^{-6}) \times \text{delay setting} + 100 \text{ ps})$

Real Time (single acquisition): $\pm(0.005\% \times \text{delta-t} + (2 \times 10^{-6}) \times \text{delay setting} + 150 \text{ ps})$

*Specification applies at the maximum sample rate. At lower sampling rates the specification should read $\pm(0.005\% \times \text{delta-t} + (2 \times 10^{-6}) \times \text{delay setting} + 0.15 \times \text{sample interval})$ for bandwidth limited signals ($t_r = 1.4 \times \text{sample interval}$). Sample interval is defined as $1/(\text{sample rate})$. Specification also applies to those automatic measurements computing time intervals on identical slope edges (i.e. pos-pos, neg-neg).

Equipment Required

The following equipment is required for this test. Procedures are based on the model or part number recommended.

Equipment Required	Critical Specifications	Recommended Model/Part
Signal Generator	1-40 MHz, timebase accuracy - 0.25 ppm	HP 8656B Opt. 001
Pulse generator	t_r from 1.0 to 1.4 ns, 280 mVp-p, externally triggerable	HP 8161A
Cable	Type N 24 inch	HP 11500B
Cable	BNC	HP 10503A
Adapter	Type N (f) to BNC (m)	HP 1250-0077

Procedure REPETITIVE MODE

This test checks time measurement in repetitive mode with averaging.

1. Set the signal generator to 40 MHz (25.0 ns period) and 100 mV_{rms} and connect it to the channel 1 input.
2. Press **RECALL** and **CLEAR** to set default conditions.
3. Press **CHAN** and set input R to 50Ω DC.
4. Press **AUTOSCALE**, then set the following parameters.

Menu	Selection	Setting
TIMEBASE	(time/div)	50 ns/div
	(mode)	repetitive
CHAN	(sensitivity)	50 mV/div
DISPLAY	# of avg	8

5. Press **DEFINE MEAS**, then with the soft keys set **statistics** to **on**.
6. With the soft keys, select **meas def**, **user defined**, and **measurements**.



Note

Measurement specifications in repetitive mode are valid with eight or more acquisitions averaged. Statistics accumulated before the required number of averaged acquisitions may show the instrument to fail specifications. This is particularly true for **minimum** and **maximum** in this case since they are set by measurements taken with the fewest averages.

If the procedure above is followed exactly, the required number of acquisitions are averaged before statistics are turned on. If however, CLEAR DISPLAY is pressed after statistics are turned on, averaging and statistics are restarted simultaneously and the result is erroneous data collected from the early averages.

If in doubt about the statistical data, after #Avg is complete press DEFINE MEAS, select **meas**, and turn **statistics off** then **on**. This restarts the statistics without restarting averaging and the result is valid data.

7. Press SHIFT (blue) DELAY, 1, and 1.
8. The delay readings should be 25 ns \pm 101.25 ps; **minimum** 24.8988 ns and **maximum** 25.1013 ns. Record the **minimum** and **maximum** readings in the Performance Test Record.
9. Press sixth softkey ("to" key) to select **edge # 2** and enter 5.
10. The delay readings should be 100 ns \pm 105 ps; **minimum** 99.895 ns and **maximum** 100.105 ns. Record the **minimum** and **maximum** readings in the Performance Test Record.
11. Change **edge # 5** to **edge # 11**.
12. The delay readings should be 250 ns \pm 112.5 ps; **minimum** 249.8875 ns and **maximum** 250.1125 ns. Record the **minimum** and **maximum** readings in the Performance Test Record.
13. Change the signal generator frequency to 1 MHz (1.0 μ s period).
14. Press TIMEBASE, and set time/div to 1 μ s/div.
15. Press DEFINE MEAS and change **edge # 11** to **edge # 2**.
16. The delay readings should be 1 μ s \pm 3.05 ns; **minimum** 996.95 ns and **maximum** 1.00305 μ s. Record the **minimum** and **maximum** readings in the Performance Test Record.
17. Change **edge # 2** to **edge # 6**.
18. The delay readings should be 5 μ s \pm 3.25 ns; **minimum** 4.99675 μ s and **maximum** 5.00325 μ s. Record the **minimum** and **maximum** readings in the Performance Test Record.

REAL TIME MODE

This procedure continues from the previous one. A faster transition time is used to make a more precise measurement. The signal is changed to a frequency less sensitive to interference from commonly used frequencies.

1. Change the signal generator frequency to 25.31646 MHz (39.49999 ns period) and amplitude to 800 mV_{rms}.

REAL TIME MODE

This procedure continues from the previous one. A faster transition time is used to make a more precise measurement. The signal is changed to a frequency less sensitive to interference from commonly used frequencies.

1. Change the signal generator frequency to 25.31646 MHz (39.49999 ns period) and amplitude to 800 mV_{rms}.
2. Connect the output of the signal generator to the EXT INPUT of the HP 8161A pulse generator.
3. Set up the pulse generator.
Input Mode = TRIG - EXT INPUT (SWITCH SHOULD BE SET TO 50Ω)
Width = 12.5 ns
Leading Edge = 1.3 ns
Trailing Edge = 1.3 ns - EXT TRIG LEVEL KNOB CENTERED.
High Level = 0.14 V
Low Level = -0.14 V
4. Change the oscilloscope.

Menu	Selection	Setting
TIMEBASE	(time/div)	50 ns/div
	delay	0.00000
	(mode)	real time

5. Press DEFINE MEAS, select **meas def**, and set to key to edge # 11.
6. Press SHIFT (blue), PERIOD, and 1.
7. **Period** should read 39.5 ns ± 152 ps; **minimum** 39.348 ns and **maximum** 39.652 ns. Record the **minimum** and **maximum** readings in the Performance Test Record.
8. **Delay** should read 395 ns ± 170 ps; **minimum** 394.830 ns and **maximum** 395.170 ns. Record the **minimum** and **maximum** readings in the Performance Test Record.
9. Select **meas**, and set **statistics** to off.
10. Press RUN/STOP (to stop acquisition), then press SINGLE once.
11. Press TIMEBASE and set time/div to 1.00 us/div.
12. Press DEFINE MEAS, select **meas def**, and change edge # 11 to edge # 101.
13. **Delay** should read 3.94999 us ± 347.495 ps (3.94952 us to 3.95025 us). Record the reading in the Performance Test Record.
14. Change edge # 101 to edge # 201.
15. **Delay** should read 7.8998 us ± 544.95 ps (7.89925 us to 7.900034 us). Record the reading in the Performance Test Record.



Timing failures are caused by a defective main assembly. Before troubleshooting the oscilloscope however, be sure signal sources are not at fault. While catastrophic failures are usually caused by an instrument failure, marginal timing failures are usually caused by test equipment inaccuracies or operator errors.

2. Connect the output of the signal generator to the EXT INPUT of the HP 8161A pulse generator and connect the output of the pulse generator to the channel input of the oscilloscope.
3. Set up the pulse generator.
 Input Mode = TRIG
 Ext Input = 50 Ω , Trig level - centered
 Delay = 0 ns
 Width = 12.5 ns
 Leading Edge = 1.3 ns
 Trailing Edge = 1.3 ns
 High Level = 0.14 V
 Low Level = -0.14 V
4. Change the oscilloscope.

Menu	Selection	Setting
TIMEBASE	(time/div)	50 ns/div
	delay	0.00000
	(mode)	realtime

5. Press DEFINE MEAS, select **meas def**, and set to key to **edge # 11**.
6. Press SHIFT (blue), PERIOD, and 1.
7. **Period** should read 39.5 ns \pm 152 ps; **minimum** 39.348 ns and **maximum** 39.652 ns. Record the **minimum** and **maximum** readings in the Performance Test Record.
8. **Delay** should read 395 ns \pm 170 ps; **minimum** 394.830 ns and **maximum** 395.170 ns. Record the **minimum** and **maximum** readings in the Performance Test Record.
9. Select **meas**, and set **statistics** to **off**.
10. Press RUN/STOP (to stop acquisition), then press SINGLE once.
11. Press TIMEBASE and set time/div to 1.00 us/div.
12. Press DEFINE MEAS, select **meas def**, and change **edge # 11** to **edge # 101**.
13. **Delay** should read 3.94999 us \pm 347 ps (3.94964 us to 3.95034 us). Record the reading in the Performance Test Record.
14. Change **edge # 101** to **edge # 201**.
15. **Delay** should read 7.89998 us \pm 545 ps (7.89944 us to 7.90053 us). Record the reading in the Performance Test Record.



Timing failures are caused by a defective main assembly. Before troubleshooting the oscilloscope however, be sure signal sources are not at fault. While catastrophic failures are usually caused by an instrument failure, marginal timing failures are usually caused by test equipment inaccuracies or operator errors.

Trigger Sensitivity

This test checks channel and external triggers for sensitivity at rated bandwidth.

Specification Internal - dc to 100 MHz: 0.5 div
- 100 to 250 MHz: 1.0 div

External - dc to 250 MHz: 100 mV_{p-p} into 50 Ω

Equipment Required The following equipment is required for this test. Procedures are based on the model or part number recommended.

Equipment Required	Critical Specifications	Recommended Model/Part
Signal Generator	100 and 250 MHz, 30-80 mV _{rms} output	HP 8656B
Power Meter/Sensor	1 - 250 MHz ±3% accuracy	HP 436A/8482A
Power Splitter	outputs differ by <0.15 dB	HP 11667B
Cable	Type N (m) 24 inch	HP 11500B
Cable	50 Ω BNC 9 inch	HP 10502A
Adapter	Type N (f) to BNC (m)	HP 1250-0077
Adapter	Type N (m) to BNC (m)	HP 1250-0082
Adapter	Type N (m) to BNC (f)	HP 1250-0780

Procedure INTERNAL TRIGGER

1. Press **RECALL** then **CLEAR** to set default conditions, then set the following parameters.

Menu	Selection	Setting
TIMEBASE	(time/div)	5 ns/div
	(mode)	repetitive
CHAN	1	on
	2	off
(both)	(sensitivity)	200 mV/div
	(input R)	50Ω DC
DISPLAY	# of avg	16

2. With an N cable and N-to-BNC adapter, connect signal generator to channel 1 input BNC.
3. Set signal generator to 100 MHz and adjust output level for 0.5 division of vertical deflection. (The ΔV markers can be used to set a 0.5 div reference. Turn ΔV on and set one marker to +50 mV and the other to -50 mV.)
4. Press **TRIG** and adjust **trigger level** for a stable display. The test passes if triggering is stable.
5. Set signal generator frequency to 250 MHz and amplitude for 1 division of vertical deflection.
6. Press **TIMEBASE** and set **time/div** to 1 ns/div.
7. Press **TRIG** and adjust **trigger level** for a stable display. The test passes if triggering is stable.
8. Connect signal generator to channel 2 input BNC.

Trigger Sensitivity

This test checks channel and external triggers for sensitivity at rated bandwidth.

Specification

Internal - dc to ¹⁰⁰50 MHz: 0.5 div
¹⁰⁰ - 50 to 250 MHz: 1.0 div

External - dc to 250 MHz: 100 mV_{p-p} into 50 Ω

Equipment Required

The following equipment is required for this test. Procedures are based on the model or part number recommended.

Equipment Required	Critical Specifications	Recommended Model/Part
Signal Generator	¹⁰⁰ 50 and 250 MHz, 30-80 mV _{rms} output	HP 8656B
Power Meter/Sensor	1 - 250 MHz ±3% accuracy	HP 436A/8482A
Power Splitter	outputs differ by <0.15 dB	HP 11667B
Cable	Type N (m) 24 inch	HP 11500B
Cable	50 Ω BNC 9 inch	HP 10502A
Adapter	Type N (f) to BNC (m)	HP 1250-0077
Adapter	Type N (m) to BNC (m)	HP 1250-0082
Adapter	Type N (m) to BNC (f)	HP 1250-0780

Procedure INTERNAL TRIGGER

1. Press RECALL then CLEAR to set default conditions, then set the following parameters.

Menu	Selection	Setting
TIMEBASE	(time/div) (mode)	5 ns/div repetitive
CHAN	1 2	on off
(both)	(sensitivity) (input R)	200 mV/div 50Ω DC
DISPLAY	# of avg	16

2. With an N cable and N-to-BNC adapter, connect signal generator to channel 1 input BNC.
3. Set signal generator to ¹⁰⁰50 MHz and adjust output level for 0.5 division of vertical deflection. (The ΔV markers can be used to set a 0.5 div reference. Turn ΔV on and set one marker to +50 mV and the other to -50 mV.)
4. Press TRIG and adjust trigger level for a stable display. The test passes if triggering is stable.
5. Set signal generator frequency to 250 MHz and amplitude for 1 division of vertical deflection.
6. Press TIMEBASE and set time/div to 1 ns/div.
7. Press TRIG and adjust trigger level for a stable display. The test passes if triggering is stable.
8. Connect signal generator to channel 2 input BNC.

9. Set up the oscilloscope.

Menu	Selection	Setting
TIMEBASE	(time/div)	5 ns/div
CHAN	1	off
	2	on
TRIGGER	source	2

10. Repeat steps 2 through 7 for channel 2.

EXTERNAL TRIGGER

11. With the N cable, connect the signal generator to the power splitter input. Using an N-to-BNC adapter, connect one splitter output to the channel 1 input. Connect the remaining splitter output to the power meter.
12. Set the signal generator for 250 MHz and 25 μ W as measured on the power meter.
13. Disconnect the power meter from the splitter and with an N-to-BNC adapter and BNC cable connect the splitter to the EXT TRIG input.
14. Press CHAN and select **EXT**. Set external input R to 50 Ω DC
16. Press TRIG and then source (twice) to select **EXT**.
17. Adjust trigger level for a stable display. Test passes if triggering is stable.



Channel trigger sensitivity test failure is caused by a defective main assembly or attenuator. Failure of external trigger sensitivity is caused by the main assembly.

Oscillator Output Check

These tests are optional. The oscillator outputs are not specified in the instrument performance specifications. The values given are typical. Results are not recorded in the Performance Test Record.

Equipment Required

Equipment requirement is not critical and choices are at the discretion of the user. A high quality oscilloscope should be sufficient.

Procedure

1. Use a BNC cable to connect the rear panel AC CALIBRATOR output to the channel 1 input of the HP 54510A under test and press AUTO-SCALE.
2. Make automatic measurements of the signal. Press blue (shift), V P-P, then 1 for amplitude and blue, FREQ, then 1 for frequency.
3. Signal into 1 M Ω should be an approximately 800 mV square wave at approximately 500 Hz. Into 50 Ω the amplitude is approximately 400 mV.
4. Disconnect the AC CALIBRATOR from the channel 1 input and connect it to another oscilloscope.
5. Press UTIL, **service menu**, then **cal select** to select **cal select 3**, (3. oscillator output).
6. Select **processor clock**. The signal should be approximately 983 kHz and 800 mV_{p-p} into 1 M Ω .
7. Select **timebase clock**. The signal should be approximately 10 MHz and 800 mV_{p-p} into 1 M Ω .

Table 3-1. Performance Test Record

	HEWLETT PACKARD	HP 54510A Digitizing Oscilloscope
Serial No. _____		Tested by _____
Recommended Test Interval - 1 Year/2000 hours		Work Order No. _____
Recommended next testing _____		Date _____
		Temperature _____

Test	Limits	Results																																																																	
Calibrator Amplitude	5.000 V 4.990 to 5.010 Vdc	_____																																																																	
Input Resistance	1M Ω 990 k Ω to 1.010 M Ω 50 Ω 49.50 Ω to 50.50 Ω	<table style="width: 100%; border: none;"> <tr> <td style="width: 50%; text-align: center;">CHAN 1</td> <td style="width: 50%; text-align: center;">CHAN 2</td> </tr> <tr> <td style="text-align: center;">_____</td> <td style="text-align: center;">_____</td> </tr> <tr> <td style="text-align: center;">_____</td> <td style="text-align: center;">_____</td> </tr> </table>	CHAN 1	CHAN 2	_____	_____	_____	_____																																																											
CHAN 1	CHAN 2																																																																		
_____	_____																																																																		
_____	_____																																																																		
Voltage Measurement Accuracy	<table style="width: 100%; border: none;"> <tr> <th style="width: 15%;">VOLTS/DIV</th> <th style="width: 15%;">READING</th> <th style="width: 10%;">LIMITS</th> </tr> <tr> <td>5 V</td> <td>30 V</td> <td>29.34 V to 30.66 V</td> </tr> <tr> <td>5 V</td> <td>15 V</td> <td>14.34 V to 15.66 V</td> </tr> <tr> <td>5 V</td> <td>5 V</td> <td>4.34 V to 5.66 V</td> </tr> <tr> <td>200 mV</td> <td>1.2 V</td> <td>1.1736 mV to 1.2264 mV</td> </tr> <tr> <td>200 mV</td> <td>600 mV</td> <td>573.6 mV to 626.4 mV</td> </tr> <tr> <td>200 mV</td> <td>200 mV</td> <td>173.6 mV to 226.4 mV</td> </tr> <tr> <td>10 mV</td> <td>60 mV</td> <td>58.68 mV to 61.32 mV</td> </tr> <tr> <td>10 mV</td> <td>30 mV</td> <td>28.68 mV to 31.32 mV</td> </tr> <tr> <td>10 mV</td> <td>10 mV</td> <td>8.68 mV to 11.32 mV</td> </tr> <tr> <td>7 mV</td> <td>42 mV</td> <td>41.076 mV to 42.924 mV</td> </tr> <tr> <td>7 mV</td> <td>21 mV</td> <td>20.076 mV to 21.924 mV</td> </tr> <tr> <td>7 mV</td> <td>7 mV</td> <td>6.076 mV to 7.924 mV</td> </tr> </table>	VOLTS/DIV	READING	LIMITS	5 V	30 V	29.34 V to 30.66 V	5 V	15 V	14.34 V to 15.66 V	5 V	5 V	4.34 V to 5.66 V	200 mV	1.2 V	1.1736 mV to 1.2264 mV	200 mV	600 mV	573.6 mV to 626.4 mV	200 mV	200 mV	173.6 mV to 226.4 mV	10 mV	60 mV	58.68 mV to 61.32 mV	10 mV	30 mV	28.68 mV to 31.32 mV	10 mV	10 mV	8.68 mV to 11.32 mV	7 mV	42 mV	41.076 mV to 42.924 mV	7 mV	21 mV	20.076 mV to 21.924 mV	7 mV	7 mV	6.076 mV to 7.924 mV	<table style="width: 100%; border: none;"> <tr> <td style="width: 50%; text-align: center;">CHAN 1</td> <td style="width: 50%; text-align: center;">CHAN 2</td> </tr> <tr> <td style="text-align: center;">_____</td> <td style="text-align: center;">_____</td> </tr> <tr> <td style="text-align: center;">_____</td> <td style="text-align: center;">_____</td> </tr> <tr> <td style="text-align: center;">_____</td> <td style="text-align: center;">_____</td> </tr> <tr> <td style="text-align: center;">_____</td> <td style="text-align: center;">_____</td> </tr> <tr> <td style="text-align: center;">_____</td> <td style="text-align: center;">_____</td> </tr> <tr> <td style="text-align: center;">_____</td> <td style="text-align: center;">_____</td> </tr> <tr> <td style="text-align: center;">_____</td> <td style="text-align: center;">_____</td> </tr> <tr> <td style="text-align: center;">_____</td> <td style="text-align: center;">_____</td> </tr> <tr> <td style="text-align: center;">_____</td> <td style="text-align: center;">_____</td> </tr> <tr> <td style="text-align: center;">_____</td> <td style="text-align: center;">_____</td> </tr> <tr> <td style="text-align: center;">_____</td> <td style="text-align: center;">_____</td> </tr> <tr> <td style="text-align: center;">_____</td> <td style="text-align: center;">_____</td> </tr> </table>	CHAN 1	CHAN 2	_____	_____	_____	_____	_____	_____	_____	_____	_____	_____	_____	_____	_____	_____	_____	_____	_____	_____	_____	_____	_____	_____	_____	_____
VOLTS/DIV	READING	LIMITS																																																																	
5 V	30 V	29.34 V to 30.66 V																																																																	
5 V	15 V	14.34 V to 15.66 V																																																																	
5 V	5 V	4.34 V to 5.66 V																																																																	
200 mV	1.2 V	1.1736 mV to 1.2264 mV																																																																	
200 mV	600 mV	573.6 mV to 626.4 mV																																																																	
200 mV	200 mV	173.6 mV to 226.4 mV																																																																	
10 mV	60 mV	58.68 mV to 61.32 mV																																																																	
10 mV	30 mV	28.68 mV to 31.32 mV																																																																	
10 mV	10 mV	8.68 mV to 11.32 mV																																																																	
7 mV	42 mV	41.076 mV to 42.924 mV																																																																	
7 mV	21 mV	20.076 mV to 21.924 mV																																																																	
7 mV	7 mV	6.076 mV to 7.924 mV																																																																	
CHAN 1	CHAN 2																																																																		
_____	_____																																																																		
_____	_____																																																																		
_____	_____																																																																		
_____	_____																																																																		
_____	_____																																																																		
_____	_____																																																																		
_____	_____																																																																		
_____	_____																																																																		
_____	_____																																																																		
_____	_____																																																																		
_____	_____																																																																		
_____	_____																																																																		
Offset Accuracy	<table style="width: 100%; border: none;"> <tr> <th style="width: 15%;">RANGE</th> <th style="width: 15%;">OFFSET</th> <th style="width: 10%;">LIMITS</th> </tr> <tr> <td>200 mV</td> <td>2.0 V</td> <td>1.948 to 2.052 V</td> </tr> <tr> <td>100 mV</td> <td>1.0 V</td> <td>0.974 to 1.026 V</td> </tr> <tr> <td>50 mV</td> <td>500 mV</td> <td>487 to 513 mV</td> </tr> </table>	RANGE	OFFSET	LIMITS	200 mV	2.0 V	1.948 to 2.052 V	100 mV	1.0 V	0.974 to 1.026 V	50 mV	500 mV	487 to 513 mV	<table style="width: 100%; border: none;"> <tr> <td style="width: 50%; text-align: center;">CHAN 1</td> <td style="width: 50%; text-align: center;">CHAN 2</td> </tr> <tr> <td style="text-align: center;">_____</td> <td style="text-align: center;">_____</td> </tr> <tr> <td style="text-align: center;">_____</td> <td style="text-align: center;">_____</td> </tr> <tr> <td style="text-align: center;">_____</td> <td style="text-align: center;">_____</td> </tr> </table>	CHAN 1	CHAN 2	_____	_____	_____	_____	_____	_____																																													
RANGE	OFFSET	LIMITS																																																																	
200 mV	2.0 V	1.948 to 2.052 V																																																																	
100 mV	1.0 V	0.974 to 1.026 V																																																																	
50 mV	500 mV	487 to 513 mV																																																																	
CHAN 1	CHAN 2																																																																		
_____	_____																																																																		
_____	_____																																																																		
_____	_____																																																																		

Table 3-1. Performance Test Record (cont'd)

Test	Limits	Results	
Bandwidth	down <3.0 dB at 250 MHz	CHAN 1	CHAN 2
		_____	_____
Time		minimum	maximum
Measurement	Repetitive 25 ns 24.8988 to 25.1013 ns	_____	_____
Accuracy	100 ns 99.895 to 100.105 ns	_____	_____
	250 ns 249.8875 to 250.1125 ns	_____	_____
	1 us 996.95 ns to 1.00305 us	_____	_____
	5.0 us ^{4.99675} 4.9675 to 5.00325 us	_____	_____
	Realtime Delay 395 ns 394.830 to 395.170 ns	_____	_____
	Period 39.5 ns 39.348 to 39.652 ns	_____	_____
	Delay 3.94999 us ^{3.949643} 3.94952 to ^{3.950337} 3.95025 us	_____	_____
	Delay 7.8998 us ^{7.899255} 7.89925 to ^{7.900345} 7.90034 us	_____	_____
Trigger	Channels	CHAN 1	CHAN 2
Sensitivity	0.5 div at ¹⁰⁰ 50 MHz	_____	_____
	1.0 div at 250 MHz	_____	_____
	External 100 mV p-p at 250 MHz	_____	_____

Table 3-1. Performance Test Record (cont'd)

Test	Limits	Results	
Bandwidth	down <3.0 dB at 250 MHz	CHAN 1 _____	CHAN 2 _____
Time Measurement Accuracy	Repetitive 25 ns 24.8988 to 25.1013 ns 100 ns 99.895 to 100.105 ns 250 ns 249.8875 to 250.1125 ns 1 us 996.95 ns to 1.00305 us 5.0 us 4.99675 to 5.00325 us Realtime Delay 395 ns 394.830 to 395.170 ns Period 39.5 ns 39.348 to 39.652 ns Delay 3.94999 us 3.94964 to 3.95034 us Delay 7.89998 us 7.89944 to 7.90053 us	minimum _____ _____ _____ _____ _____ _____ _____ _____ _____	maximum _____ _____ _____ _____ _____ _____ _____ _____ _____
Trigger Sensitivity	Channels 0.5 div at 100 MHz 1.0 div at 250 MHz External 100 mV p-p at 250 MHz	CHAN 1 _____ _____ _____	CHAN 2 _____ _____ _____

Contents

Section 4

Adjustments

Introduction	4-1
Equipment Required	4-1
Calibration Interval	4-1
Cal RAM Checksum Error	4-1
Key-Down Powerup	4-2
Operating Hints	4-2
Adjustment Procedures	4-2
Power Supply Adjustment	4-3
Main Assembly Adjustments	4-5
Extender Cable Installation	4-5
Default Calibration Load	4-5
High-Frequency Pulse Adjustment	4-6
Flatness Adjustment	4-7
Firmware Calibration	4-11
CRT Monitor Assembly Adjustment	4-13

Adjustments

Introduction

This section provides hardware and firmware adjustment procedures for the HP 54510A. Primary adjustment groups are the following:

- Power Supply Adjustment
 - Main Assembly Adjustment
 - CRT Monitor Assembly Adjustment.
-

Equipment Required

Equipment required for adjustments is listed in table 1-1, "Recommended Test Equipment", in section 1 of this manual. Any equipment that satisfies the critical specification listed in the table may be substituted for the recommended model. Equipment for individual procedures is listed at the procedure.

Calibration Interval

There are two levels of calibration for the HP 54510A. At the first level, one set of firmware calibrations, those in the self cal menu, should be done by the user or service department under any of the following conditions:

- at six month intervals or every 1,000 hours
- if the ambient temperature changes more than 10°C from the temperature at full calibration
- to optimize measurement accuracy

In this adjustment section default cals are loaded before the self-calibration is performed. Self-calibration can be done without loading default cals. Self-calibration procedures take only cables so the user can perform them. However, it is necessary to UNPROTECT the calibration which may not be allowed in some circumstances. To do these calibrations, follow the "Self Cal Menu Calibrations" procedure in the "Firmware Calibration" later in this section.

At the second level is a full calibration. Full calibration should be done every year, or 2,000 hours, whichever comes first. Full calibration includes all firmware calibration and hardware calibration (with exceptions noted at certain procedures).

The necessary calibration interval will also depend on the user's experience.

For replacement assemblies, adjustments are set at the factory when assemblies are tested. However, some adjustment may be necessary after an assembly has been put into the instrument. Usually the only assembly that requires adjustment is the assembly replaced.

Cal RAM Checksum Error

If power is applied to the instrument and the message "cal ram checksum error re-cal instrument" is displayed, all firmware calibration procedures must be performed. See the Firmware Calibration procedure in this section.

If the instrument does not pass the firmware calibration, perform the entire adjustment procedure in this section. If adjustment cannot be made within specified limits, repair is necessary.

Key-down Powerup

A key-down powerup is a procedure used to reset or preset the instrument to default conditions and prevent previous setups from interfering with the next test. It also simplifies the instrument setup procedure. Depress any front-panel key while cycling power with the rear-panel power switch. Continue to depress the key until the display returns.

Operating Hints

Some knowledge of operation of the HP 54510A is helpful; however, procedures are written so that little experience is necessary. The following hints will speed progress of the procedures.

When using many averages, it often takes awhile for a waveform display to stabilize after a change. When a front panel control on the HP 54510A is changed, averaging automatically restarts. When the input signal or an adjustment is changed, the instrument must average new data with the old so it takes longer for the waveform to stabilize. Press CLEAR DISPLAY while changing input signals or adjustments. The instrument will restart averaging and give a quicker indication of the result of the change.

Adjustment Procedures

The adjustment procedures start with the next paragraphs. Unless specified elsewhere, procedures must be followed in the order given. Display adjustments are optional and independent of other procedures.

Note 

Warm up the instrument for 30 minutes before starting adjustment procedures.

Warning 

Read the Safety Considerations at the beginning of this manual before performing adjustment procedures.

Power Supply Adjustment

Equipment Required

Equipment Required	Critical Specifications	Recommended Model/Part
Digital Voltmeter	Accuracy $\pm 0.05\%$	HP 3458A

Procedure

1. Disconnect power cord from HP 54510A. Refer to figure below for testpoint and adjustment locations.

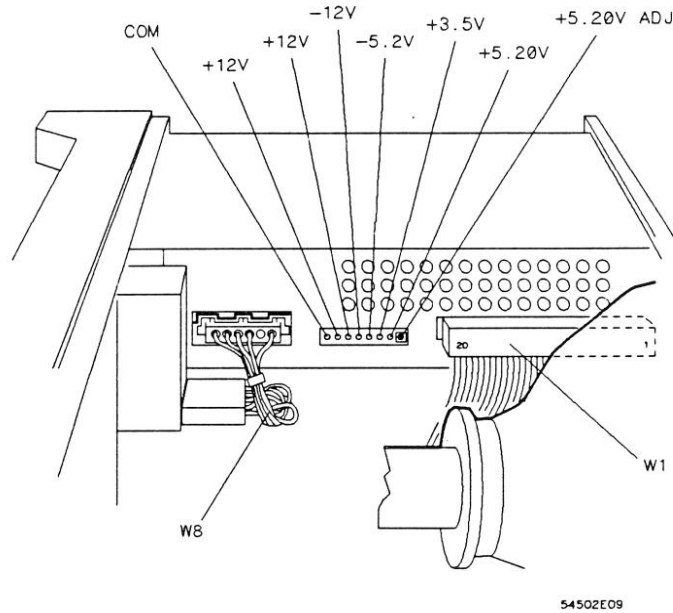

Figure 4-1. Power Supply Adjustment Locations

2. Connect the common lead of the voltmeter to COM test point.
3. Connect the positive lead of the voltmeter to +5.20V test point.
4. Connect the HP 54510A power cord and set power switch to ON.
5. If voltmeter does not read between 5.180 V and 5.220 V, adjust +5.20 ADJ for 5.200 V.

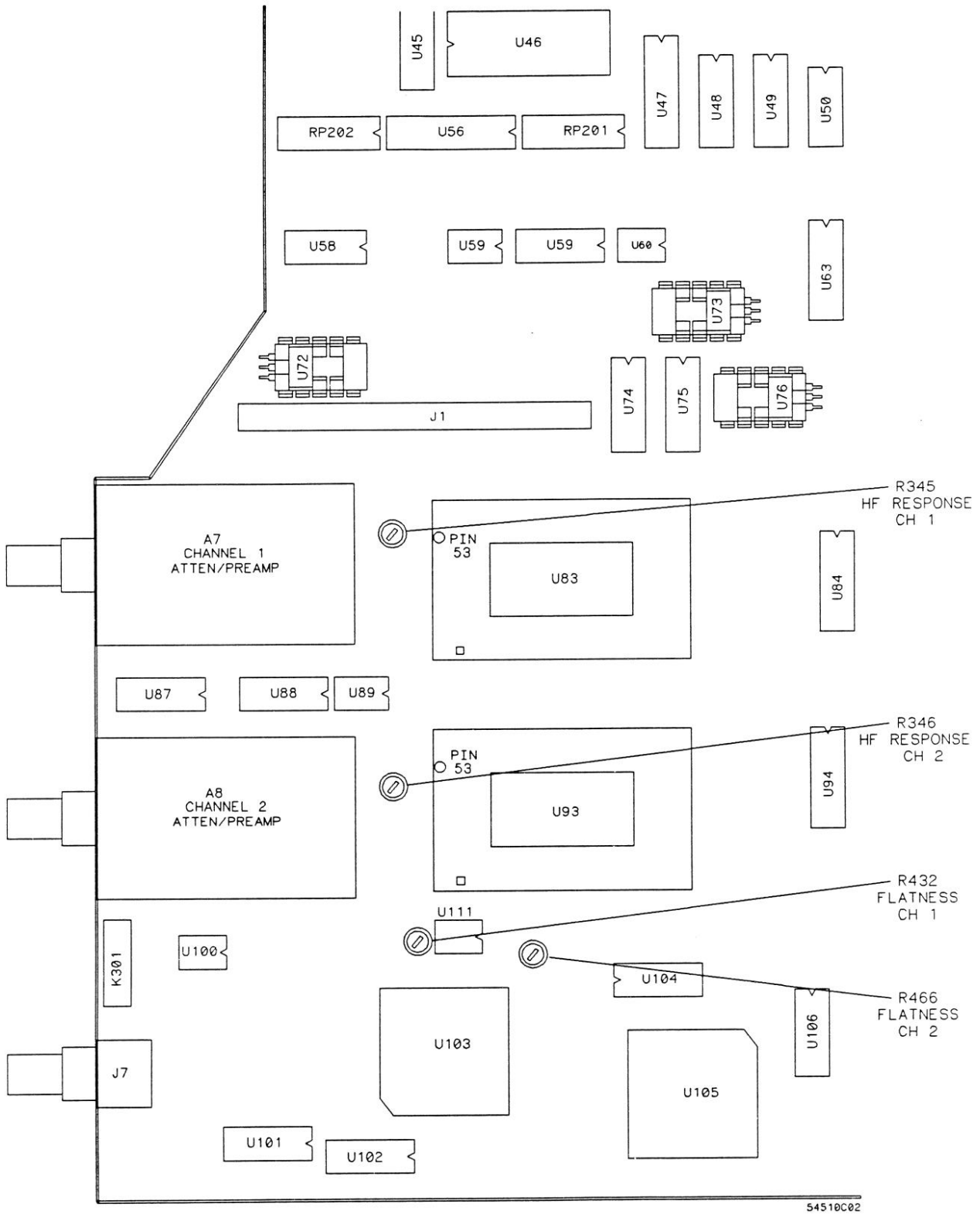

Figure 4-2. Main Assembly Adjustment Locations

Main Assembly Adjustments

Main assembly adjustments adjust the acquisition system of the instrument.

Extender Cable Installation

Main assembly adjustment can be done with the power supply in place. However, moving the supply and using it on the extender cable allows easier access to the adjustments. The extender cable is not supplied with the instrument but must be ordered separately.

Equipment Required: Extender Cable, HP 54503-61604



To prevent the possibility of thermal cut-out of the supply, use an external fan to circulate the air around it.

Procedure

1. Remove the power cord and top cover.
2. Disconnect the power supply cables from the line filter and Main Assembly.
3. Remove the locking pins from the power supply and slide supply out of the cabinet.
4. Connect the Extender Cable between the power supply and Main Assembly.
5. Reconnect the line filter cable to the power supply.
6. Connect the power cable and apply power.

Default Calibration Load

The default calibration factors are loaded to give a known base for the following hardware and firmware calibration.



Once the default cals are loaded, all firmware calibrations must be done. This includes the calibrations in the self cal menu (0. vertical cal and 1. delay) and service menu (0. time null, 1. logic trigger delay cal, and 2. external trigger null).

Since all calibration must be done in order, firmware calibrations will be presented in the proper place in the procedures.

1. Press **UTIL** then **service menu**.
2. Press **cal select** several times to select **cal select 5** (5. default cal).
3. Set the rear panel **CALIBRATION** switch to **UNPROTECTED** (up).
4. Press **start cal**. A caution message will be displayed indicating the cal RAM will be overwritten with default values.
5. Press **continue**. The status message above the menu will indicate default cal has been loaded.
6. Leave the rear panel switch in **UNPROTECTED** position for firmware calibration procedures to be performed later in this section..

High-Frequency Pulse Adjustment

This procedure optimizes pulse response so the instrument will meet the bandwidth specification.



This procedure should not be performed as a part of routine adjustments. Typically, high-frequency pulse adjustment needs to be done only when a channel fails the bandwidth performance test, when an attenuator has been changed, or when the main assembly has been changed (new combination of attenuators and PC board). Only adjust the channels involved with the failure or repair.

Equipment Required

Equipment Required	Critical Specifications	Recommended Model/Part
Pulse Generator	$t_r < 1.0 \text{ ns}$	Picosecond Pulse Labs 1110B Driver/1107B Head
Adapter	SMA 3.5 (m) to BNC (m)	HP 1250-1787

Procedure

Perform this procedure on the necessary channel only. Use the following adjustments on each channel. (See locator, page 4-4, for adjustment locations.)

- Channel 1, resistor R345.
 - Channel 2, resistor R346.
1. Connect pulse generator to channel input.
 2. Press CHAN and set channel input resistance to $50\Omega \text{ DC}$.
 3. Press AUTOSCALE, then set the following parameters.

Menu	Selection	Setting
TIMEBASE	(time/div)	5 ns/div
	(mode)	repetitive
CHAN	(sensitivity)	40 mV/div
DISPLAY	# of avg	16
	(graticule)	grid

4. If pulse edge is not on screen, press TIME BASE and adjust delay.
5. Press CHAN and adjust **offset** to place the flat part of the pulse top over the grid line, one division from top of display.

- Adjust resistor to extend peak over the gridline so that overshoot is 3%, a little less than one vertical minor division, as shown below. (One vertical minor division is about 4% of a six division signal.)

When the resistor is adjusted the gain changes. It may be necessary to use offset to reposition the pulse top to the gridline.

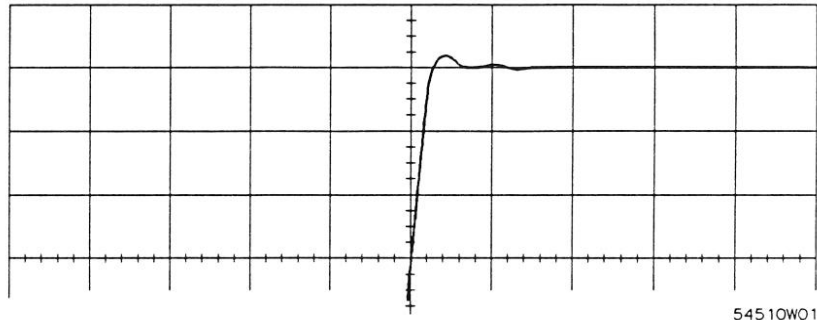

There is no specification for pulse response. However, if overshoot is more than about 3% (about 3/4 minor division), use the resistor to reduce it slightly. If the instrument fails the bandwidth test, use the resistor to increase overshoot slightly.

- Repeat steps 1 through 6 on the other channel if necessary.
- Perform the bandwidth test (Performance Tests) on channels adjusted.
- The Firmware Calibration is the next procedure that is part of a routine calibration. The flatness adjustment is a factory adjustment and should be done next, but only if required after considering the note at the beginning.

Flatness Adjustment

This procedure optimizes pulse-top flatness.

Note

This procedure should not be performed as a part of routine maintenance. Flatness is a factory adjustment and periodic adjustment is unnecessary. Perform only if the adjustments have been mistakenly changed or if recommended by another service procedure.

There are two very early versions of the instrument main assembly and a later version. Which adjustment procedure to use, if any, depends on the version of the main assembly. Refer to figure 4-1 (page 4-4) for the locations of parts and adjustments.

VERSION A. The main assembly does not have the two adjustment potentiometers R432 and R466. No adjustment is necessary. Continue with the Firmware Calibration.

VERSION B. The main assembly has R432 and R466. U111, the IC between the potentiometers, is labeled 1826-1992, OP200GP, or has no markings. Use flatness Procedure 1.

VERSION C. The instrument has R432 and R466. U111, the IC between the potentiometers, is labeled 1826-0521. Use flatness Procedure 2.

Equipment Required

Equipment Required	Critical Specifications	Recommended Model/Part
Equipment for both procedures		
Pulse Generator	Square wave 20 KHz, 400 mV _{p-p} , ≤1% pulse-top flatness deviation	HP 3325B
Cable	BNC 50 Ω 36 inch	HP 10503A
Additional equipment for Procedure 2		
Function Generator	Sine wave, 50 MHz, 15 mV _{p-p}	HP 8116A
Attenuator	BNC 6 dB	
Cable	BNC 50 Ω 36 inch	HP 10503A
Adapter	BNC tee (f)(f)(m)	

Procedure 1

Perform this procedure on the necessary channel only. Use this procedure if U111, the IC between the potentiometers, is labeled 1826-1992, OP200GP, or has no markings. Use the following adjustments on each channel.

- Channel 1, R432
 - Channel 2, R466
1. Connect the pulse generator to the channel input and set the following parameters:
Mode = Square wave
Frequency = 20 kHz
Amplitude = 280 mV_{p-p}
 2. Press RECALL then CLEAR, then set the following parameters on the appropriate channel.

Menu	Selection	Setting
TIMEBASE	(time/div)	10 us/div
	(mode)	repetitive
CHAN	(sensitivity)	40 mV/div
	(input R)	50Ω DC
DISPLAY	(mode)	avg
	# of avg	8
	(graticule)	grid

3. Measure the voltage level of the top of the signal, _____ mV. Press SHIFT (blue), V TOP, then 1.

4. Change the oscilloscope.

Menu	Selection	Setting
TIMEBASE	(time/div)	2 us/div
	delay	500.000 ns
	reference	left
WFORM MATH	display	on
	chan	(as required)
	(mode)	only
	sensitivity	2.5 mV/div
	offset	(V TOP, step 3)

5. Observe the pulse top on the f1 (function 1) trace. Disregarding the noise and ringing, adjust the potentiometer (chan 1 R432, chan 2 R466) for the flattest trace, as shown in the figure below.

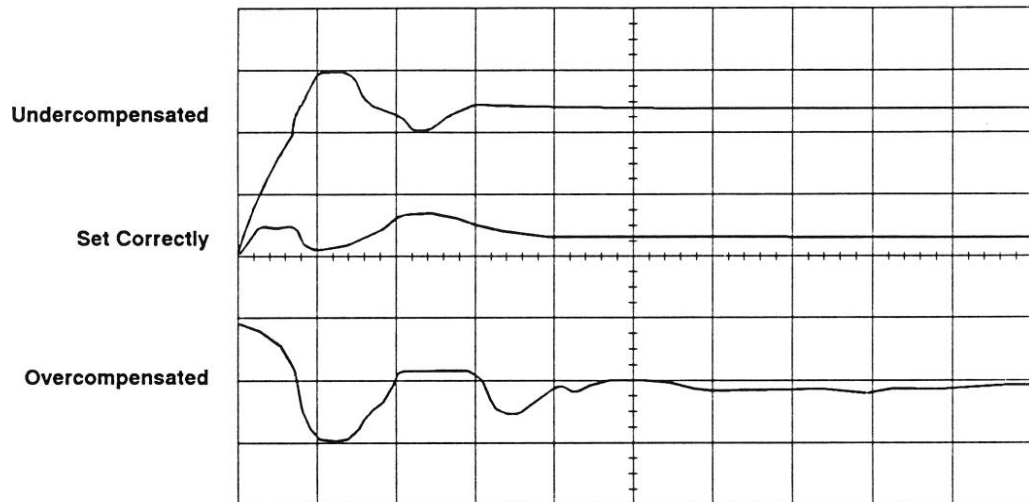

54510W34

The drawing does not show the channel trace at the top of the oscilloscope display. Disregard this trace while adjusting the pulse. One vertical division on the function 1 trace represents about 0.9% of the amplitude of the signal.

Procedure 2

Perform this procedure on the necessary channel only. Use this procedure if U111, the IC between the potentiometers, is labeled 1826-0521. Use the following adjustments on each channel.

- Channel 1, R432
- Channel 2, R466

1. Connect the equipment.

- a. Connect the BNC tee to the channel input of the oscilloscope.
- b. With a BNC cable, connect the pulse generator (square wave) to one input of the BNC tee.
- c. Connect the 6 dB attenuator to the other input of the BNC tee.
- d. With a BNC cable, connect the function generator (sine wave) to the input of the 6 dB attenuator.

- Set up the pulse generator for 100 Hz at 400 mV_{p-p}.
- Set up the function generator for 50 MHz at 15 mV_{p-p}.
- Press **RECALL** then **CLEAR**, then set the following parameters on the appropriate channel.

Menu	Selection	Setting
TIMEBASE	(mode)	repetitive
CHAN	(sensitivity) (input R)	40 mV/div 50Ω DC
DISPLAY	(mode) # of avg (graticule)	avg 16 grid

- Measure the voltage level of the top of the signal, _____ mV. Press **SHIFT** (blue), **V TOP**, then channel number.
- Change the oscilloscope.

Menu	Selection	Setting
TIMEBASE	reference	left
WFORM MATH	display chan (mode) sensitivity offset	on (as required) only 2.5 mV/div (V TOP, step 5)

- Observe the pulse top on the f1 (function 1) trace. Disregarding the noise and ringing, adjust the potentiometer (chan 1 R432, chan 2 R466) for the flattest trace, as shown in the figure below.

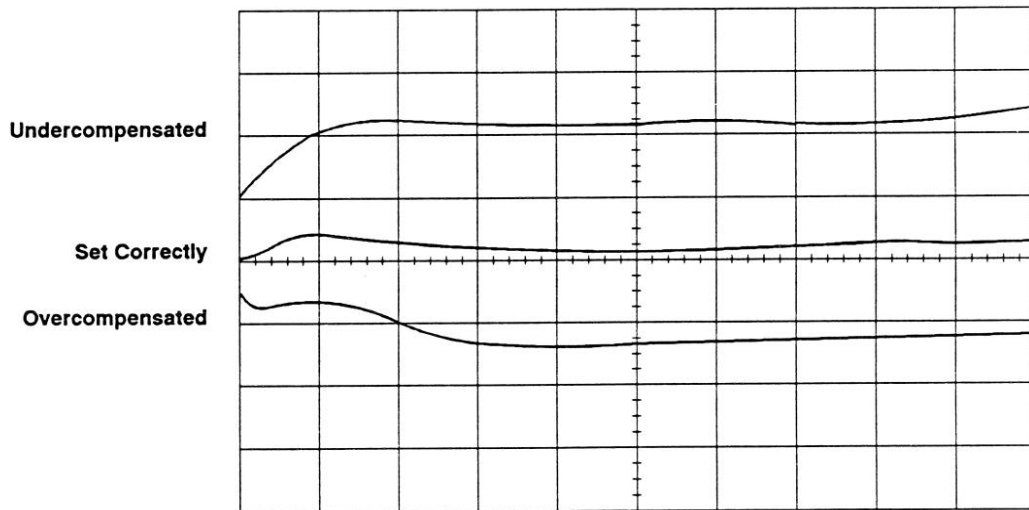

54510W33

The drawing does not show the channel trace at the top of the oscilloscope display. Disregard this trace while adjusting the pulse. One vertical division on the function 1 trace represents about 0.9% of the amplitude of the signal.

Firmware Calibration

Firmware calibration uses signals generated in the instrument to calibrate channel sensitivity, offsets, and trigger parameters.

Equipment Required

Equipment Required	Critical Specifications	Recommended Model/Part
Cable	BNC 50 Ω 36 inch	HP 10503A
Cable (3)	BNC 50 Ω 9 inch (equal length)	HP 10502A
Adapter (2)	BNC tee (m)(f)(f)	HP 1250-0781
Adapter	BNC (f)(f)	HP 1250-0080



Rear panel CALIBRATION switch must be set to UNPROTECTED for these procedures. If the entire adjustment procedures are being performed, switch was set to UNPROTECTED in a previous procedure.



The Firmware Calibration should only be done after the instrument has run for one half hour at ambient temperature with the cover installed.

Self Cal Menu Calibrations

These calibrations can be done without loading default calibration factors. However, defaults have been loaded when these calibrations are part of the entire adjustment procedure.



These calibrations may be done individually but using **all** (when available) and connecting all inputs at once avoids operator interaction between calibrations.

If the entire calibration procedure fails while running **all**, run the calibrations individually. If one input is loading the cal signal (input stuck in 50 Ω for example) calibration will fail for all inputs. Individual calibration will isolate the failure.

1. Perform key-down powerup by cycling HP 54510A power while holding down any front-panel key.
2. Press UTIL then self cal menu. Cal select 0 (0. vertical cal) should be selected.
3. Press channel to select **all**, then press start cal and follow the instructions on the display.
4. After completion of vertical cals, press cal select to select cal select 1 (1. delay).
5. Press channel to select channel 1, then press start cal and follow the instructions on the display.
6. When channel 1 calibration is complete, press channel to select channel 2, then press start cal and follow the instructions on the display.
7. Messages will be displayed as each calibration routine is completed to indicate calibration has passed or failed.

Service Menu Calibrations

1. Press **UTIL** then **service menu**.
2. Press **cal select** to select **cal select 0** (0. time null).
3. Press **start cal** and follow the instructions on the display.
4. When time null has passed, press **cal select** to select **cal select 1** (1. logic trigger delay cal).
5. Press **start cal** and follow the instructions on the display.
6. Press **continue** and the instrument will perform the rest of this calibration automatically.
7. When logic trigger delay cal has passed, press **cal select** to select **cal select 2** (2. external trigger null).
8. Press **start cal** and follow the instructions on the display.
9. After external trigger null has passed, switch rear-panel **CALIBRATION** switch to **PROTECTED** (down).

CRT Monitor Assembly Adjustment

These adjustments optimize the characteristics of the CRT Display.

Note



This procedure should not be performed as a part of routine maintenance. Perform the procedure only when the display has obvious differences from the example in the figure below. Skip parts of the procedure if the display meets the requirement.

1. Display CRT test pattern. Press UTIL then **selftest**. Select **misc** with the top softkey then **cr t test** with the second softkey, then press **start test**.

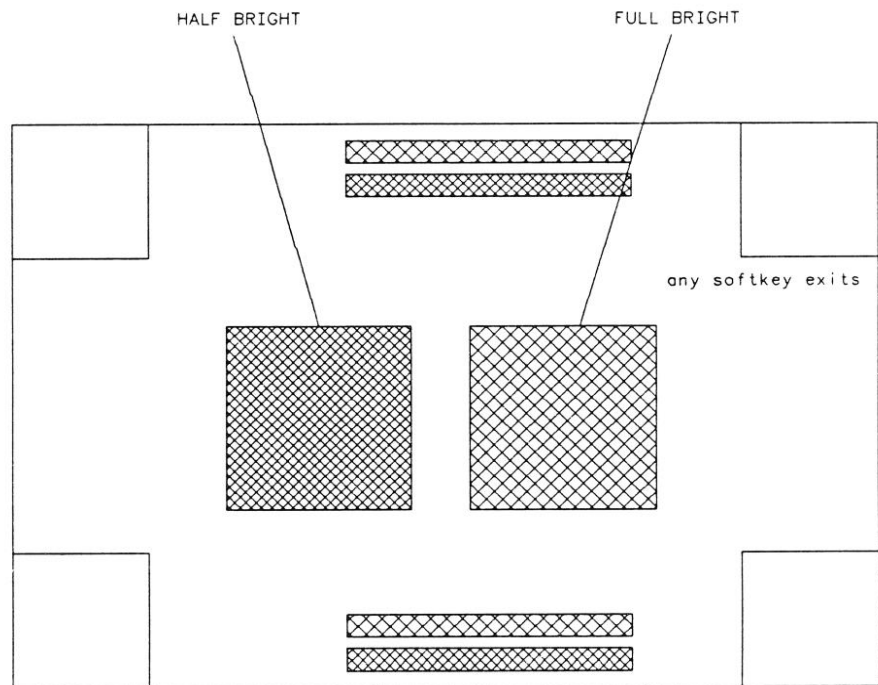

54501B26

Figure 4-3. CRT Test Display

2. Refer to the next figure for adjustment locations.

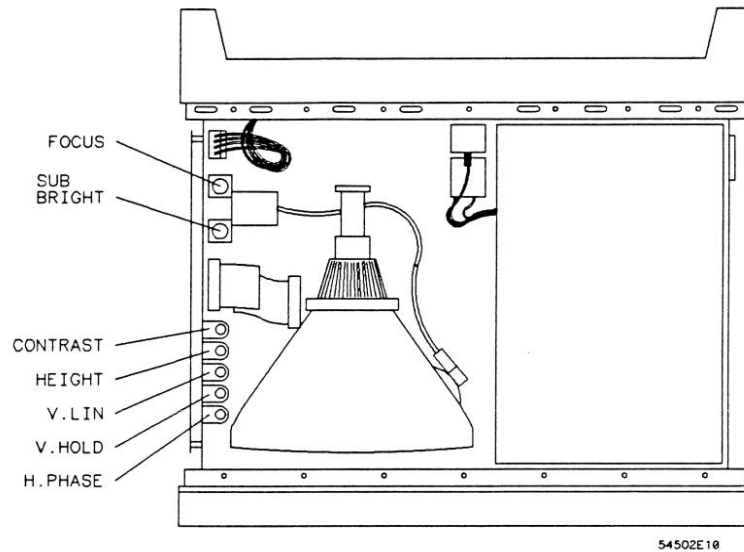

Figure 4-4. Display Adjustment Locations

3. Adjust V.HOLD, if necessary, for vertical synchronization.
4. Set rear-panel INTENSITY to mid-range.
5. Adjust sweep board SUB-BRIGHT to the lowest setting where half-bright blocks on the screen are visible.
6. Turn rear-panel INTENSITY to increase intensity to a comfortable viewing level. The position of the INTENSITY adjustment should be close to 3/4 of its maximum range.
7. Adjust CONT for the best contrast between half- and full-bright blocks on menu, ensuring text is legible in half-bright blocks.
8. Adjust H.PHASE to center display horizontally.
9. Adjust FOCUS control for a sharp percent symbol (%) in the top and bottom blocks of text.
10. Adjust V.LIN for equal height of corner squares. Square height should be approximately 25 mm.
11. Adjust HEIGHT to make the screen top and bottom borders approximately 1 cm.
12. Adjustments V.LIN and HEIGHT interact. Repeat steps 9 and 10 as necessary for a proper display.

Contents

Section 5

Replaceable Parts

Introduction 5-1
Abbreviations 5-1
Replaceable Parts 5-1
Exchange Assemblies 5-1
Ordering Information 5-2
Direct Mail Order System 5-2

Replaceable Parts

Introduction

This section contains information for ordering parts. Service support for this instrument is down to the assembly level. The replaceable parts include assemblies and chassis parts. Figure 5-1 shows an exploded view of the HP 54510A.

Abbreviations

Table 5-1 lists the abbreviations used in the parts list and throughout this manual. In some cases two forms of the abbreviations are used: one in all capital letters, and one in partial or no capital letters. However, elsewhere in the manual, other abbreviation forms may be used with both lowercase and uppercase letters.

Replaceable Parts

Table 5-2 shows a list of replaceable parts and is organized as follows:

1. Exchange assemblies in alphanumerical order by reference designation.
2. Electrical assemblies in alphanumerical order by reference designation.
3. Chassis-mounted parts in alphanumerical order by reference designation.

The information given for each part consists of the following:

- Reference designator.
 - HP part number.
 - Part number Check Digit (CD).
 - Total quantity (Qty) in instrument or on assembly. The total quantity is given once and at the first appearance of the part number in the list.
 - Description of the part.
 - Typical manufacturer of part in an identifying five-digit code. All parts in this list (except hardware) is manufactured by or for Hewlett-Packard, code 28480. No list of manufacturers is provided.
-

Exchange Assemblies

Some parts used in this instrument have been set up for an exchange program. This program allows the customer to exchange a faulty assembly with one that has been repaired, calibrated, and performance-verified by the factory. The cost is significantly less than that of a new part. The exchange parts have a part number in the form XXXXX-695XX.

After receiving the repaired exchange part from Hewlett-Packard, a United States customer has 30 days to return the faulty assembly. For orders not originating in the United States, contact the local HP service organization. If the faulty assembly is not returned within the warranty time limit, the customer will be charged an additional amount. The additional amount will be the difference in price between a new assembly and that of an exchange assembly.

Ordering Information

To order a part in the material list, quote the HP part number, indicate the quantity desired, and address the order to the nearest HP Sales/Service Office.

To order a part not listed in the material list, include the instrument part number, instrument serial number, a description of the part (including its function), and the number of parts required. Address the order to the nearest HP Sales and Service Office.

Direct Mail Order System

Within the USA, Hewlett-Packard can supply parts through a direct mail order system. There are several advantages to this system:

- Direct ordering and shipment from the HP parts center in California, USA.
- No maximum or minimum on any mail order (there is a minimum amount for parts ordered through a local HP office when the orders require billing and invoicing).
- Prepaid transportation (there is a small handling charge for each order).
- No invoices.

In order for Hewlett-Packard to provide these advantages, a check or money order must accompany each order.

Mail order forms and specific ordering information are available through your local HP office. Addresses and telephone numbers are located in a separate document shipped with the manuals.

Table 5-1. Reference Designators and Abbreviations

REFERENCE DESIGNATOR							
A	= assembly	F	= fuse	Q	= transistor;SCR; triode thyristor	U	= integrated circuit; microcircuit
B	= fan;motor	FL	= filter	R	= resistor	V	= electron tube; glow lamp
BT	= battery	H	= hardware	RT	= thermistor	VR	= voltage regulator; breakdown diode
C	= capacitor	J	= electrical connector (stationary portion);jack	S	= switch;jumper	W	= cable
CR	= diode;diode thyristor; varactor	L	= coil;inductor	T	= transformer	X	= socket
DL	= delay line	MP	= misc. mechanical part	TB	= terminal board	Y	= crystal unit(piezo-electric or quartz)
DS	= annunciator;lamp;LED	P	= electrical connector (moveable portion);plug	TP	= test point		
E	= misc. electrical part						
ABBREVIATIONS							
A	= amperes	DWL	= dowel	MFR	= manufacturer	RND	= Round
A/D	= analog-to-digital	ECL	= emitter coupled logic	MICPROC	= microprocessor	ROM	= read-only memory
AC	= alternating current	ELAS	= elastomeric	MINTR	= miniature	RPG	= rotary pulse generator
ADJ	= adjust(ment)	EXT	= external	MISC	= miscellaneous	RX	= receiver
AL	= aluminum	F	= farads;metal film (resistor)	MLD	= molded	S	= Schottky-clamped; seconds(time)
AMPL	= amplifier	FC	= carbon film/ composition	MM	= millimeter	SCR	= screw;silicon controlled rectifier
ANLG	= analog	FD	= feed	MO	= metal oxide	SEC	= second(time);second dary
ANSI	= American National Standards Institute	FEM	= female	MTG	= mounting	SEG	= segment
ASSY	= assembly	FF	= flip-flop	MTLC	= metallic	SEL	= selector
ASTIG	= astigmatism	FL	= flat	MUX	= multiplexer	SGL	= single
ASYNCHRO	= asynchronous	FM	= foam;from	MW	= milliwatt	SHF	= shift
ATTEN	= attenuator	FR	= front	NC	= no connection	SI	= silicon
AWG	= American wire gauge	FT	= gain bandwidth product	NMOS	= n-channel metal-oxide-semiconductor	SIP	= single in-line package
BAL	= balance	FW	= full wave	NPN	= negative-positive-negative	SKT	= skirt
BCD	= binary-code decimal	FXD	= fixed	NPRN	= neoprene	SL	= slide
BD	= board	GEN	= generator	NRFR	= not recommended for field replacement	SLDR	= solder
BFR	= buffer	GND	= ground(ed)	NSR	= not separately replaceable	SLT	= slot(ted)
BIN	= binary	GP	= general purpose	NUM	= numeric	SOLD	= solenoid
BRDG	= bridge	GRAT	= graticule	OBD	= order by description	SPCL	= special
BSHG	= bushing	GRV	= groove	OCTL	= octal	SQ	= square
BW	= bandwidth	H	= henries;high	OD	= outside diameter	SREG	= shift register
C	= ceramic;cermet (resistor)	HD	= hardware	OP AMP	= operational amplifier	SRQ	= service request
CAL	= calibrate;calibration	HDND	= hardened	OSC	= oscillator	STAT	= static
CC	= carbon composition	HG	= mercury	P	= plastic	STD	= standard
CCW	= counterclockwise	HGT	= height	P/O	= part of	SYNCHRO	= synchronous
CER	= ceramic	HLCL	= helical	PC	= printed circuit	TA	= tantalum
CFM	= cubic feet/minute	HORIZ	= horizontal	PCB	= printed circuit board	TBAX	= tubeaxial
CH	= choke	HP	= Hewlett-Packard	PD	= power dissipation	TC	= temperature coefficient
CHAM	= chamfered	HP-IB	= Hewlett-Packard Interface Bus	PF	= picofarads	TD	= time delay
CHAN	= channel	HR	= hour(s)	PI	= plug in	THD	= thread(ed)
CHAR	= character	HV	= high voltage	PL	= plate(d)	THK	= thick
CM	= centimeter	HZ	= Hertz	PLA	= programmable logic array	THRU	= through
CMOS	= complementary metal-oxide-semiconductor	I/O	= input/output	PLST	= plastic	TP	= test point
CMR	= common mode rejection	IC	= integrated circuit	PNP	= positive-negative-positive	TPG	= tapping
CNDCT	= conductor	ID	= inside diameter	POLYE	= polyester	TPL	= triple
CNTR	= counter	IN	= inch	POS	= positive;position	TRANS	= transformer
CON	= connector	INCL	= include(s)	POT	= potentiometer	TRIG	= trigger(ed)
CONT	= contact	INCAND	= incandescent	POZI	= pozidrive	TRMR	= trimmer
CRT	= cathode-ray tube	INP	= input	PP	= peak-to-peak	TRN	= turn(s)
CW	= clockwise	INTEN	= intensity	PPM	= parts per million	TTL	= transistor-transistor
D	= diameter	INTL	= internal	PRCN	= precision	TX	= transmitter
D/A	= digital-to-analog	INV	= inverter	PREAMP	= preamplifier	U	= micro(10-6)
DAC	= digital-to-analog converter	JFET	= junction field-effect transistor	PRGMBL	= programmable	UL	= Underwriters Laboratory
DARL	= darlington	JKT	= jacket	PRL	= parallel	UNREG	= unregulated
DAT	= data	K	= kilo(103)	PROG	= programmable	VA	= voltampere
DBL	= double	L	= low	PSTN	= position	VAC	= volt,ac
DBM	= decibel referenced to 1mW	LB	= pound	PT	= point	VAR	= variable
DC	= direct current	LCH	= latch	PW	= potted wirewound	VCO	= voltage-controlled oscillator
DCCR	= decoder	LCL	= local	PWR	= power	VDC	= volt,dc
DEG	= degree	LED	= light-emitting diode	R-S	= reset-set	VERT	= vertical
DEMUX	= demultiplexer	LG	= long	RAM	= random-access memory	VF	= voltage,filtered
DET	= detector	LI	= lithium	RECT	= rectifier	VS	= versus
DIA	= diameter	LK	= lock	RET	= retainer	W	= watts
DIP	= dual in-line package	LKWR	= lockwasher	RF	= radio frequency	W/O	= without
DIV	= division	LS	= low power Schottky	RGLTR	= regulator	WW	= wirewound
DMA	= direct memory access	LV	= low voltage	RGR	= register	XSTR	= transistor
DPDT	= double-pole, double-throw	M	= mega(106);megohms; meter(distance)	RK	= rack	ZNR	= zener
DRC	= DAC refresh controller	MACH	= machine	RMS	= root-mean-square	oC	= degree Celsius (Centigrade)
DRVR	= driver	MAX	= maximum			oF	= degree Fahrenheit
						oK	= degree Kelvin

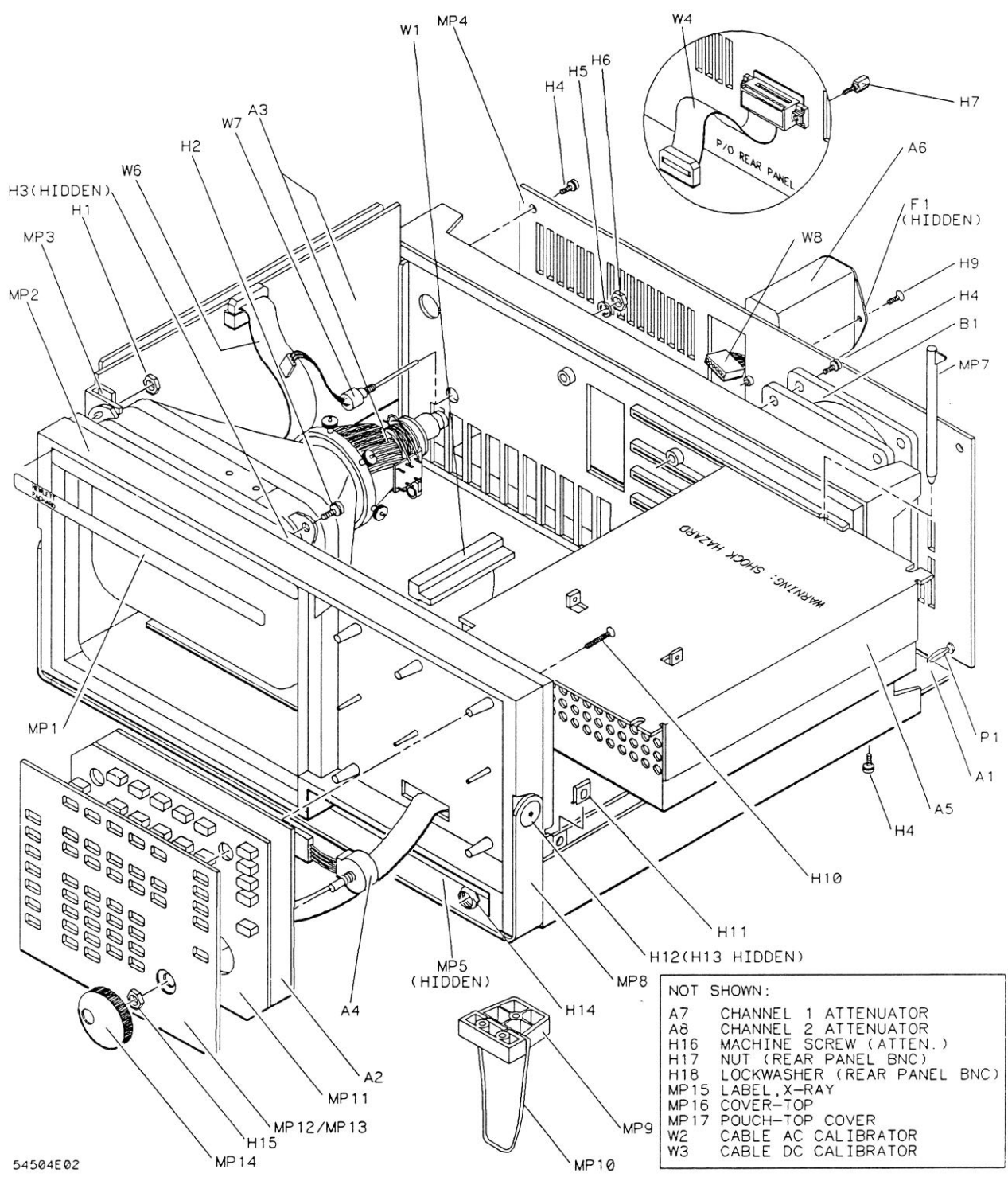

Figure 5-1. HP 54510A Exploded View

Table 5-2. Replaceable Parts

Reference Designator	HP Part Number	CD	Qty	Description	Mfr Code	Mfr Part Number
EXCHANGE ASSEMBLIES						
A1	54510-69502	7	1	MAIN ASSEMBLY (without attenuators)	28480	54510-69502
ELECTRICAL ASSEMBLIES						
A1	54510-66502	1	1	MAIN ASSEMBLY (without attenuators)	28480	54510-66502
A2	54503-66502	8	1	KEYBOARD ASSEMBLY (board and cable only)	28480	54501-66502
A3	2090-0211	6	1	CRT MONITOR ASSEMBLY (board/CRT/yoke)	28480	2090-0211
A4	0960-0753	6	1	ROTARY PULSE GENERATOR (w/cable)	28480	0960-0753
A5	0950-1879	8	1	POWER SUPPLY ASSEMBLY	28480	0950-1879
A6	9135-0325	8	1	LINE FILTER/POWER SWITCH	28480	9135-0325
A7	54503-63401	4	2	ATTENUATOR ASSEMBLY (CH 1)	28480	54503-63401
A8	54503-63401	4		ATTENUATOR ASSEMBLY (CH 2)	28480	54503-63401
CHASSIS PARTS						
B1	3160-0521	3	1	FAN-TUBEAXIAL	28480	3160-0521
F1	2110-0003	0	2	FUSE 3 AMP	28480	2110-0003
H1	0535-0056	3	3	LOCKNUT-HEX M4 (CRT)	00000	ORDER BY DESCRIPTION
H2	0515-0380	2	1	MS M4 10MM-LG PAN-HD (CRT)	00000	ORDER BY DESCRIPTION
H3	0590-1826	1	1	INSERT-THREADED M4 (CRT)	00000	ORDER BY DESCRIPTION
H4	0515-0374	5	20	MS M3 10MM-LG PAN-HD (fan/rear panel/bottom)	00000	ORDER BY DESCRIPTION
H5	2190-0027	6	1	WASHER 0.256 0.478 0.02 (intensity adj.)	00000	ORDER BY DESCRIPTION
H6	2950-0072	3	1	NUTH 1/4-32 0.062-THK (intensity adj.)	00000	ORDER BY DESCRIPTION
H7	0380-1482	0	2	STANDOFF-HEX (HP-IB connector)	00000	ORDER BY DESCRIPTION
H8				NOT USED		
H9	0515-1035	0	22	MS M3 8MM-LG FLAT-HD (feet/cover/pouch)	00000	ORDER BY DESCRIPTION
H10	0515-1134	7	4	MS M3 25MM-LG PAN-HD (keyboard)	00000	ORDER BY DESCRIPTION
H11	0535-0113	8	10	NUT-TINNERMAN M3 (cabinet top and sides)	00000	ORDER BY DESCRIPTION
H12	01650-82401	1	2	SCREW-SHOULDER (handle)	28480	01650-82401
H13	01650-00203	0	2	NUT PLATE (handle)	28480	01650-00203
H14	54503-25701	7	3	NUT-HEX (front panel BNC)	00000	ORDER BY DESCRIPTION
H15	2950-0001	8	1	NUTH 3/8-32 0.093-THK (RPG)	00000	ORDER BY DESCRIPTION
H16	0515-0655	4	4	MS M3 8MM-LG PAN-HD (attenuator)	00000	ORDER BY DESCRIPTION
H17	2950-0054	1	2	NUTH 1/2-28 0.125-THK (rear panel BNC)	00000	ORDER BY DESCRIPTION
H18	2190-0068	5	2	WASHER-IL 0.505 0.630 0.02 (rear panel BNC)	00000	ORDER BY DESCRIPTION
MP1	54510-94301	7	1	LABEL-HP 54510A IDENTIFICATION	28480	54510-94301
MP2	54503-60001	4	1	CABINET ASSY (incl. H3, H11-H13, MP8)	28480	54503-60001
MP3	01650-01202	0	1	BRACKET (CRT monitor board guide)	28480	01650-01202
MP4	5062-7313	9	1	REAR PANEL	28480	5062-7313
MP5	54502-94305	1	1	LABEL (front panel BNC)	28480	54502-94305
MP6				NOT ASSIGNED		
MP7	01650-46101	2	2	LOCKING PIN (power supply)	28480	01650-46101
MP8	01650-04901	2	1	HANDLE-BAIL	28480	01650-04901
MP9	01650-47701	0	2	FOOT-MOLDED	28480	01650-47701
MP10	1460-1345	5	2	TILT STAND	28480	1460-1345
MP11	54503-41901	3	1	KEYPAD-ELASTOMERIC	28480	54503-41901
MP12	54503-45202	5	1	PANEL-KEYBOARD	28480	54503-45202
MP13	54503-94302	9	1	LABEL-KEYBOARD	28480	54503-94302

Table 5-2. Replaceable Parts

Reference Designator	HP Part Number	CD	Qty	Description	Mfr Code	Mfr Part Number
MP14	01650-47401	7	1	KNOB-RPG	28480	01650-47401
MP15	5955-8032	4	1	LABEL- X-RAY	28480	5955-8032
MP16	01650-04101	4	1	COVER-TOP	28480	01650-04101
MP17	01650-84501	7	1	POUCH-ACCESSORY (top cover)	28480	01650-84501
P1	54503-87601	6	1	PLUG-BANANA	28480	54503-87601
W1	54503-61606	7	1	CABLE-DC POWER SUPPLY	28480	54503-61606
W2	54503-61605	6	2	CABLE-AC CALIBRATOR OUT	28480	54503-61605
W3	54503-61605	6		CABLE-DC CALIBRATOR OUT	28480	54503-61605
W4	54503-61602	3	1	CABLE- HP-IB	28480	54503-61602
W5				NOT ASSIGNED		
W6	01650-61601	9	1	CABLE-CRT MONITOR ASSY	28480	01650-61601
W7	01650-61614	4	1	CABLE-INTENSITY ADJUST (with potentiometer)	28480	01650-61614
W8	01650-61602	0	1	CABLE-LINE FILTER	28480	01650-61602
W9	8120-1521	6	1	CABLE-POWER (standard)	28480	8120-1521
W9	8120-1703	6	1	CABLE-POWER (Option 900-UK)	28480	8120-1703
W9	8120-0696	4	1	CABLE-POWER (Option 901-AUSTL)	28480	8120-0696
W9	8120-1692	2	1	CABLE-POWER (Option 902-EUR)	28480	8120-1692
W9	8120-0698	6	1	CABLE-POWER (Option 904-250V USA/CANADA)	28480	8120-0698
W9	8120-2296	4	1	CABLE-POWER (Option 906-SWIT)	28480	8120-2296
W9	8120-2957	4	1	CABLE-POWER (Option 912-DEN)	28480	8120-2957
W9	8120-4600	8	1	CABLE-POWER (Option 917-AFRICA)	28480	8120-4600
W9	8120-4754	3	1	CABLE-POWER (Option 918-JAPAN)	28480	8120-4754
W10	54503-61604	5		CABLE-SERVICE-SUPPLY EXTENDER	28480	54503-61604

Contents

Section 6

Service

Introduction	6-1
Safety	6-1
Block Level Theory Of Operation	6-3
Power Supply Assembly	6-3
CRT Monitor Assembly	6-3
Main Assembly	6-3
Keypad and Knob Assembly	6-3
Attenuators	6-3
Attenuator Theory of Operation	6-5
Main Assembly Theory of Operation	6-5
Acquisition	6-5
System Control	6-9
Selftest Menu	6-12
Service Menu	6-13
Troubleshooting	6-14
Trouble Isolation Flowcharts	6-14
Key-Down Powerup	6-14
Power Supply Voltages Check	6-21
CRT Monitor Signals Check	6-22
Keyboard Signals Check	6-23
Attenuator Troubleshooting	6-24
Assembly Removal and Replacement	6-26
Rear Panel Assembly	6-26
Power Supply Assembly	6-26
Keyboard Assembly	6-27
Fan	6-27
Main Assembly	6-28
Attenuators	6-28
CRT Monitor Assembly	6-29
Feet/Tilt Stand	6-30

Service

Introduction

This section provides troubleshooting, service, and repair information for the HP 54510A Digitizing Oscilloscope. Troubleshooting consists of flowcharts, self-test descriptions and instructions for use, and signal level tables. The troubleshooting information is provided to isolate a faulty assembly. When a faulty assembly has been located, the disassembly/assembly procedures help direct replacement of the assembly.

Safety

Read the Safety Summary at the front of this manual before servicing the instrument. Before performing any procedure, review it for cautions and warnings.



Maintenance should be performed by trained service personnel aware of the hazards involved (for example, fire and electric shock). When maintenance can be performed without power applied, the power cord must be removed from the instrument.

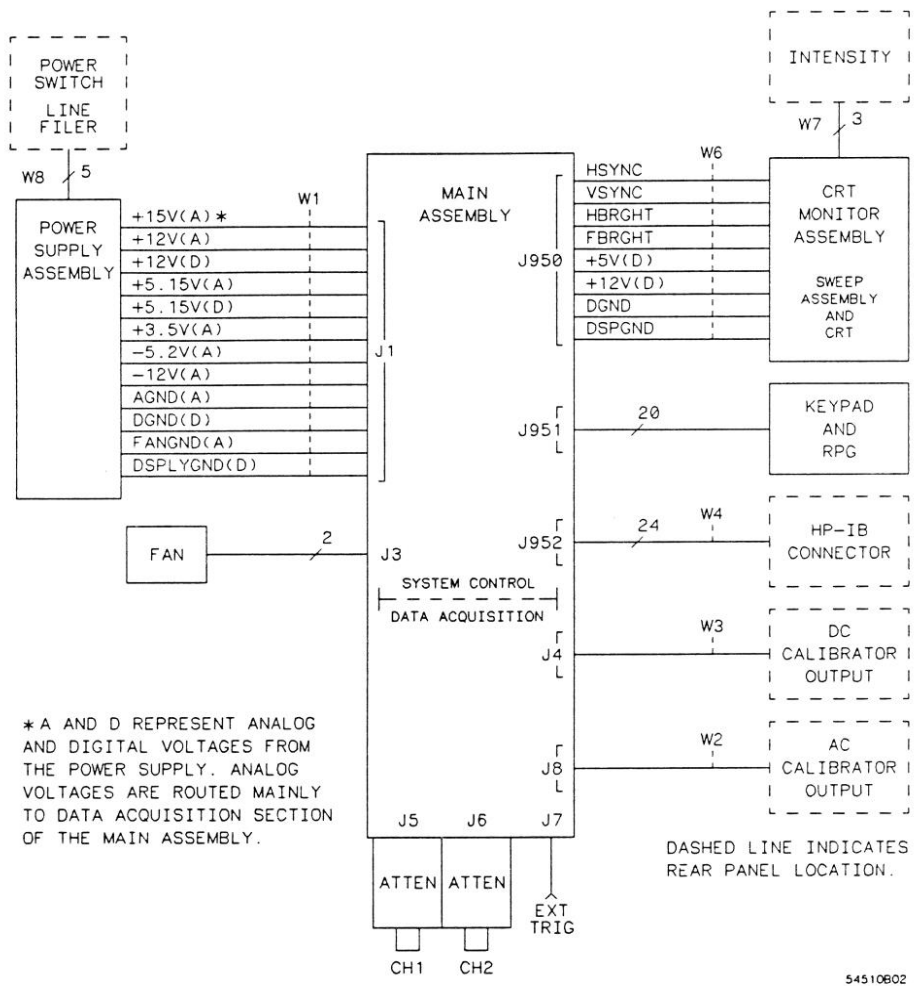

Figure 6-1. Simplified Block Diagram

Block Level Theory of Operation

The HP 54510A is a two-channel digitizing oscilloscope with 250-MHz bandwidth at a 1 GSa/s sample rate. The human interface is a front-panel knob and keypad for instrument control and 9-inch (diagonal) green phosphor CRT for information display. On the rear panel is an HP-IB connector for connection to a printer or controller. Two outputs, BNC connectors, are also available on the rear panel: one for dc calibration and one for ac calibration and probe compensation.

Figure 6-1 shows a simplified block diagram. The instrument consists of four main assemblies and two attenuators. Also shown are rear panel connectors and the Intensity adjustment. This manual supports troubleshooting to assembly level. Theory of operation for the Main Assembly is included as additional information. It is not comprehensive enough for component-level troubleshooting.

Power Supply Assembly

The switching power supply provides 120 W (200 W maximum) for the instrument. The ac input to the power supply is 115 V or 230 V, -25 to $+15\%$. Maximum input power is 350 VA maximum. The ac input frequency is 48 to 66 Hz.

Unfiltered voltages of $+15\text{V}$, -15V , $+12\text{V}$, -12V , $+5.15\text{V}$, and -5.2V are supplied first to the Main Assembly, where they are filtered and distributed throughout the board and to other assemblies. The $+5.15\text{ V}$ supply is adjustable on the supply.

CRT Monitor Assembly

The CRT Monitor Assembly consists of the sweep board circuitry, a 9-inch green phosphor CRT, and the CRT yoke. The assembly requires $+5\text{ V}$ and $+12\text{ V}$ from the power supply via the Main Assembly.

The non-interlacing raster display is controlled by the CPU portion of the Main Assembly. System control provides synchronization and pixel information.

Main Assembly

The Main Assembly contains the acquisition system and system control circuitry. It also provides interfaces for the attenuators, Power Supply assembly, CRT Monitor assembly, keyboard, and HP-IB. The channel inputs are the output of the Attenuator assemblies. The external trigger input is directly to the Main Assembly from a front panel BNC. The user interface is from the front-panel keyboard or with a controller via the HP-IB connector on the rear panel. A more detailed theory of the Main Assembly follows block level theory.

Keypad and Knob Assembly

The elastomeric keypad has 44 keys. Twenty keys are single-function, 17 are dual-function, and the remaining 7 are softkeys with functions that depend on the displayed menu. The keyboard rows are continually scanned. When a key is pressed, the signal is sent as data to the microprocessor, which determines the key pressed. The Rotary Pulse Generator (RPG) is connected to the front-panel knob and supplies pulses to the microprocessor when the knob is turned. The RPG is used to change various settings in the displayed menu. The effect of the RPG can be toggled between coarse and fine by pressing the FINE key.

Attenuators

The attenuators are the channel interface to the front panel. They provide the appropriate impedance matching and all the attenuation and gain changing. They connect directly to the main assembly and are fastened to the main assembly with screws.

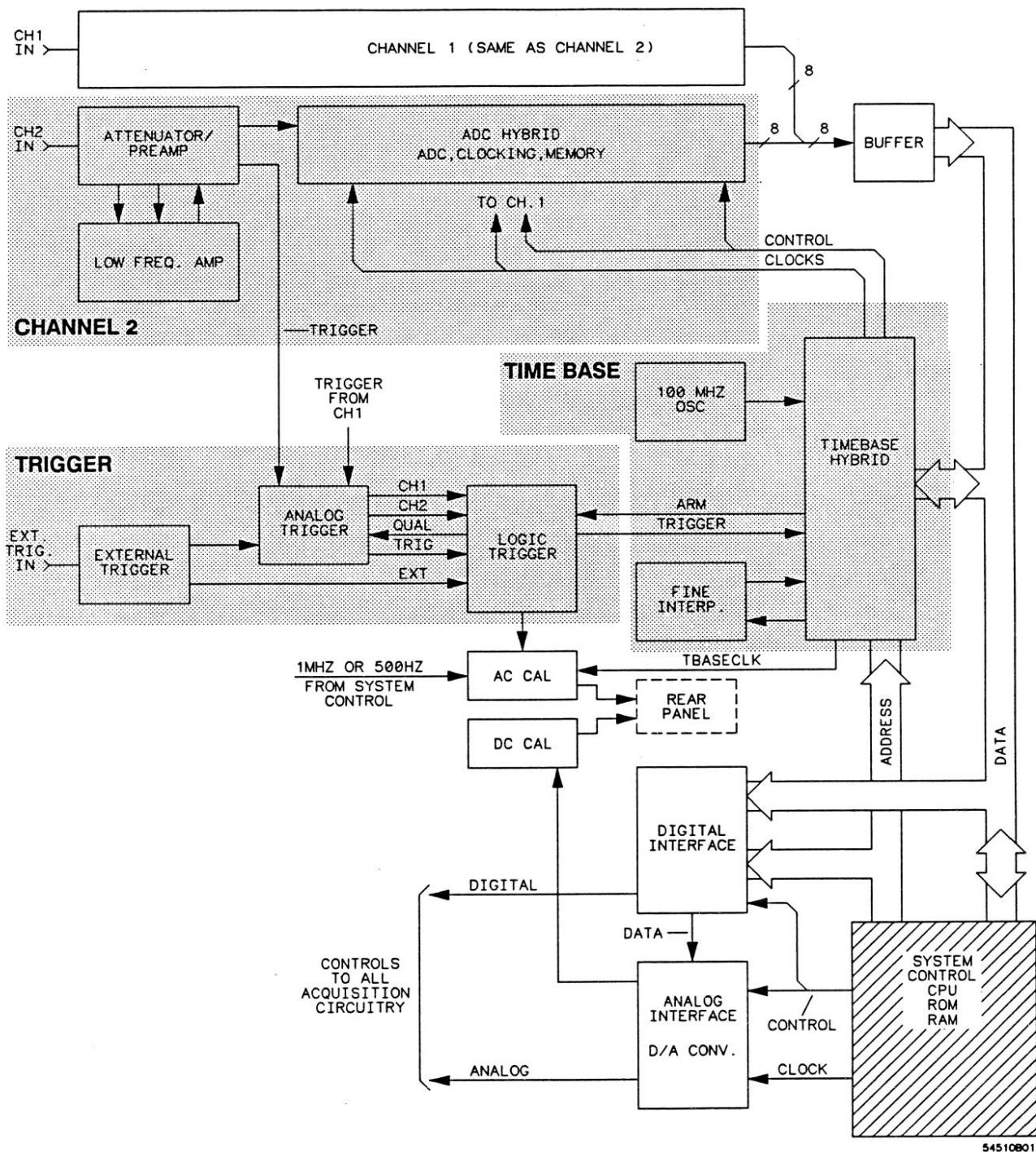

Figure 6-2. Acquisition Block Diagram

Attenuator Theory of Operation

The channel signals are conditioned by the attenuator/preamps, thick film hybrids containing passive attenuators, impedance converters, and a programmable amplifier. The channel sensitivity defaults to the standard 1-2-5 sequence (other sensitivities can be set, also). However, the firmware uses passive attenuation of 1, 5, 25, and 125, with the programmable preamp, to cover the entire sensitivity range.

The input has a selectable 1 M Ω or 50 Ω input impedance. Compensation for the passive attenuators is laser trimmed and not adjustable. After the passive attenuators, the signal is split into high-frequency and low-frequency components. Low frequency components are amplified on the Main Assembly where they are combined with the offset voltage. The ac coupling and-low frequency reject are implemented in the low-frequency amplifier.

The high- and low-frequency components of the signal are recombined and applied to the input FET of the preamp. The FET provides a high input impedance for the preamp. The programmable preamp adjusts the gain to suit the required sensitivity and provides two output signals to the Main assembly. One signal is the same polarity as the input and goes to the trigger circuitry. The other is of opposite polarity and is sent to the ADC hybrid.

Main Assembly Theory of Operation

The Main Assembly consists of a 68000 microprocessor and its associated circuitry, and acquisition circuitry. The main block diagram has been divided into two sections: acquisition and system control. Figure 6-2 shows the acquisition block diagram and figure 6-3 shows the system control block diagram.

Acquisition

The acquisition circuitry provides the sampling, digitizing, and storing of the signals from the channel attenuators. The channels are identical. The external trigger input cannot be displayed. Trigger signals from each channel and the external trigger synchronize acquisition through the time base circuitry. A 100-MHz oscillator and the timebase hybrid provide the base sample rates.

ADC Hybrid

The ADC hybrid provides all of the sampling, digitizing, and waveform storage. The ADC includes a frequency converter which multiplies the input clock from the Timebase hybrid by ten for a maximum sample rate of 1 GHz.

Trigger

There are three main trigger circuits: external trigger, analog trigger, and logic trigger. The External Trigger provides an auxiliary trigger function at the front panel. It has selectable 50 Ω or 1 M Ω impedance and an adjustable trigger level.

Trigger signals from the channel Attenuator/preamps and external trigger are fed to the Analog Trigger where channel trigger levels are set. The Analog Trigger also selects the trigger for certain trigger modes.

The channel and external triggers, and the selected trigger, are sent to the Logic Trigger. It provides the complex triggering functions as well as the interface to the time base.

Time Base

The time base provides the sample clocks and timing necessary for data acquisition. It consists of the 100-MHz reference oscillator and time base hybrid.

The 100-MHz reference oscillator provides the base sample frequency.

The time base hybrid has programmable dividers to provide the rest of the sample frequencies appropriate for the time range selected. The time base uses the time-stretched output of the fine interpolator to time-reference the sampling to the trigger point. The time base has counters to control how much data is taken before (pre-trigger data) and after (post-trigger data) the trigger event. After the desired number of pre-trigger samples has occurred, the Time base hybrid sends a signal to the Logic Trigger (trigger arm) indicating it is ready for the trigger event. When the trigger condition is satisfied, the Logic Trigger sends a signal back to the time base hybrid. The time base hybrid then starts the post-trigger delay counter. When the countdown reaches zero, the sample clocks are stopped and the CPU is signaled that the acquisition is complete.

The Fine Interpolator is a dual-slope integrator that acts as a time-interval stretcher. When the logic trigger receives a signal that meets the programmed triggering requirements, it signals the time base. The time base then sends a pulse to the fine interpolator. The pulse is equal in width to the time between the trigger and the next sample clock. The fine interpolator stretches this time by a factor of approximately 250. Meanwhile, the time base hybrid runs a counter with a clock derived from the sample rate oscillator. When the interpolator indicates the stretch is complete, the counter is stopped. The count represents, with much higher accuracy, the time between the trigger and the first sample clock. The count is stored and used to place the recently acquired data in relationship with previous data.

AC Cal

The AC Cal is a multiplexer circuit that can provide several signals to the Probe Compensation/AC Calibrator output on the rear panel. The signal provided depends on the mode of the instrument. It can be either a probe compensation signal, a pulse representing the trigger event, or signals used for self-calibration.

DC Cal

The DC Cal output, a rear panel signal, is used for self-calibration. It is one output from the 16-channel DAC.

Digital Interface

The Digital Interface provides control and interface between the system control and digital functions in the acquisition circuitry.

Analog Interface

The Analog Interface provides control of analog functions in the acquisition circuitry. It is primarily a 16-channel DAC with an accurate reference and filters on the outputs. It also controls channel offsets and trigger levels, and provides the DC Cal output.

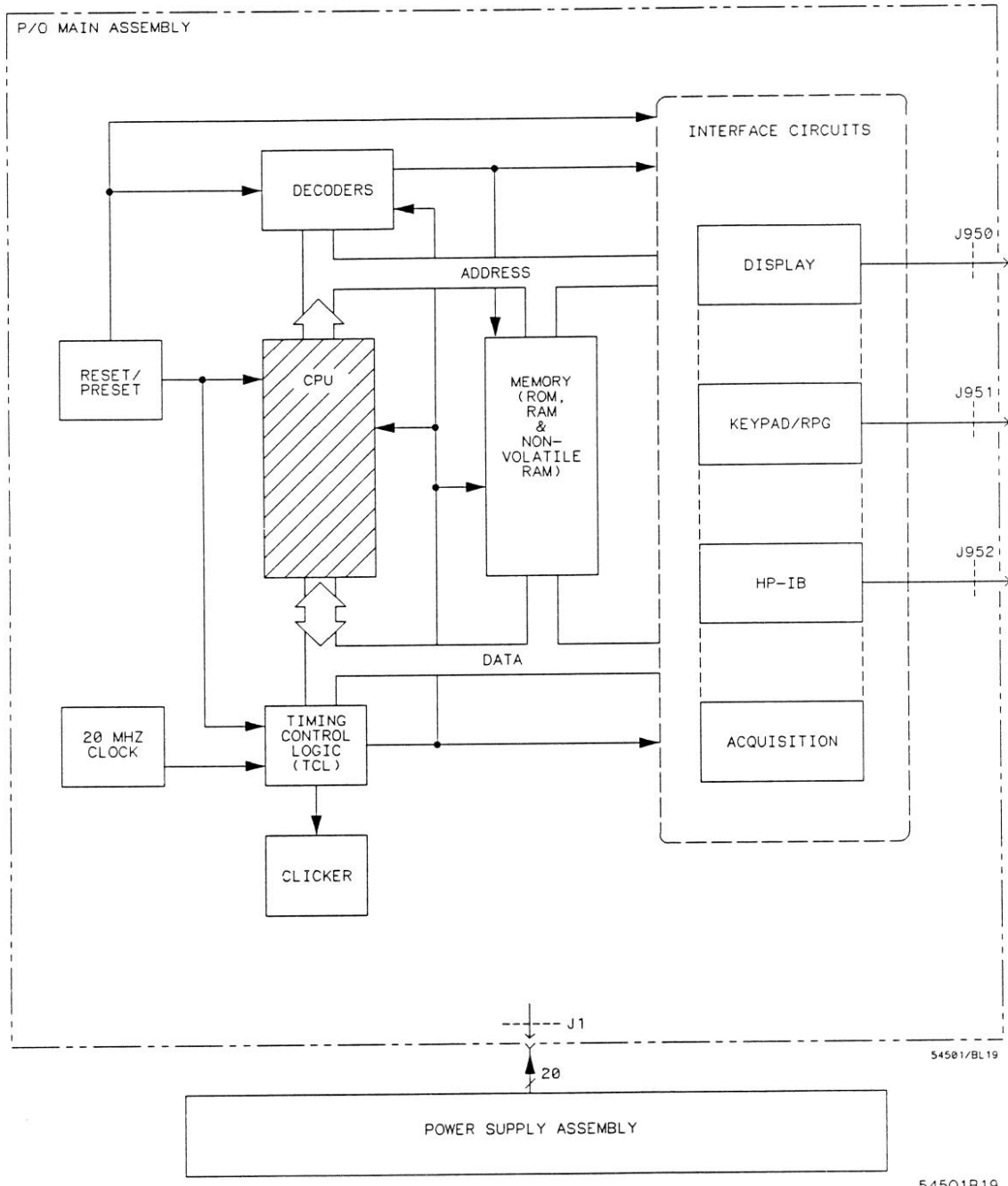

Figure 6-3. System Control Block Diagram

System Control

The system control consists of the microprocessor, ROM, RAM, and the associated circuitry required to control the acquisition section and the CRT Monitor. It includes the HP-IB and keyboard interfaces. Figure 6-3 shows the block diagram for system control.

Central Processing Unit (CPU)

The CPU is a 68000 P10 microprocessor with addressing capability of 16 megabytes (23 address lines/16 data lines). The CPU receives its clock (9.8304 MHz) from the TCL (Timing Control Logic). The TCL provides all timing for the CPU. The CPU drives the read/write line and the address and data strobes.

The CPU supplies a 1-MHz enable clock for synchronization with the CRT Controller (CRTC).

Power

The System Control requires +5 volts dc (relative to digital ground) and +12 volts dc (relative to display ground). System control supplies the display board with +5 volts, +12 volts, display ground and digital ground. The clicker circuit is operated from the +12 display voltage. The remaining system control circuitry is operated from the +5 digital voltage.

Clock

The system control clock (also called 20-MHz clock) is derived from a 19.668-MHz crystal oscillator. This clock is multiplexed and distributed to provide synchronization for the timing control logic, timing for the display circuitry, and a high-frequency signal for the AC Calibrator Output on the rear panel.

Timing Control Logic

Timing Control Logic (TCL) provides timing and control for the System Control.

The TCL circuitry consists of programmable array logic (PALs), various logic gates, and miscellaneous circuitry for arbitrating between display and refresh requests of display and system RAM. The PALs and arbitration circuitry are synchronized with the 20-MHz clock. The rest of the circuitry is asynchronous.

The signals generated by TCL include select lines to the decoders, write-enable to protected non-volatile Static RAM, and all timing and control signals for the interface circuits.

Clicker

The clicker is the sound effect circuit. The clicker sounds when warning or error messages are displayed, when a key on the keypad is pressed, and (with some functions) when the RPG is rotated.

Reset/Preset

The reset/preset circuit provides the Main Assembly with a timeout during power up and power down. It consists of a voltage divider, reference voltage, and comparator. The timeout signal is used in critical time and power sensitive circuitry. The signal goes to the microprocessor, the TCL, decoders, and HP-IB and data acquisition interfaces.

When power is applied, as the +5 V supply crosses the upper threshold of the comparator, the timeout signal of approximately 200 milliseconds is generated and applied to the system control circuitry, assuring the board powers up in a known state.

Similarly, when power is removed, as the +5 V supply crosses the lower threshold of the comparator, the timeout halts the microprocessor and resets all critical timing before the +5 V supply falls below the valid operating region for TTL.

Decoders

The four upper address lines are decoded into functional operations for system ROM, non-volatile static RAM, system RAM, display RAM, keyboard, HP-IB, CRTIC, acquisition control and an operation called "devices."

The devices operation is further decoded to clear the RPG and interrupts on the microprocessor, address the RPG and clicker, and provide a latch to the acquisition control.

The address strobe from the microprocessor and a hardware chip select line from the TCL provide the functional timing for the address decoders.

Memory

Memory for System control is composed of System ROM, System RAM, and non-volatile RAM.

There is 1 MByte of System ROM in two 512 K × 8-bit EPROMS. System ROM is used to store system operating code, look-up tables, constants, default cal factors, etc.

There is 1 MByte of System RAM in four 512 K × 4-bit CMOS dynamic RAM ICs. The System RAM uses the conventional RAS/CAS timing scheme for read/write and refresh. System RAM stores variables, acquisition data for displaying, and provides scratch-pad memory for the microprocessor.

The non-volatile RAM is CMOS static RAM, 128 Kbytes. The static RAM uses a lithium battery as power backup. When the supply falls below an acceptable voltage level, (during power-down) the lithium battery is automatically switched on and write protection is unconditionally enabled to prevent loss of data. The non-volatile static RAM stores menu configurations, calibration factors, and up to four waveforms. Normal power-up of the instrument restores the calibration factors and menu configurations that were in effect before the last power-down. A key-down power-up, in which any key is held down during power-up, does not affect stored calibration factors but does reset the menu configurations to default settings.

Interface Circuits

System Control interfaces with four major functions: the CRT Monitor, front-panel keypad and RPG, HP-IB, and acquisition circuitry.

The **display interface** consists of a CRT Controller (CRTC), display RAM, shift registers, and buffers for address and data lines.

The CRTC provides the horizontal and vertical sync signals for the display and a disable/enable signal for the TCL that is used for generating the timing necessary to address display RAM.

The display RAM is configured in a row/column matrix. Counters track the memory location in display RAM versus positioning the data on the CRT as data is shifted from display RAM to two shift registers. The output of the shift registers is two data streams. One stream is displayed on the CRT as full-bright pixel information and the other as half-bright. A character ROM is not used because all character matrices are stored in System ROM.

The **HP-IB interface** circuitry supports communication with other instruments (printer, controller, automated test equipment, etc.) The circuit consists of three main components. The HP-IB controller provides an interface between the microprocessor system and the HP-IB in accordance with IEEE 488 standards. An 8-bit data buffer and 8-bit control line buffer connect the HP-IB controller to the HP-IB bus.

The HP-IB is a 24-conductor shielded cable carrying 8 data lines, 8 control lines, 7 system grounds, and 1 chassis ground.

The **keypad interface** is interpreted as an 8 by 8 matrix. The eight row lines are driven by an open-collector buffer from 8 lower address lines. The eight column lines are read by a tri-state buffer to the 8 lower data lines. The RPG is read by a counter and flip-flop which are read onto the data bus.

The **acquisition interface** connects the System Control to the acquisition system. The CPU provides data and address lines, control lines, and clocks for the rear panel AC Cal select circuit and 20 MHz to the D/A Converter.

Selftest Menu

The self-tests are used for isolating problems in the HP 54510A. A key-down powerup ensures critical parameters are set to known values to avoid any erroneous results.

To start the tests, cycle power while holding any key depressed. When the display returns, release the key and press **util** then **selftest menu**. The following figure shows the choices in the self-test menu.

The tests may be run individually or, by selecting **test all**, consecutively. After each self-test is completed, a message of **PASSED** or **FAILED** for that self-test is displayed. If failed messages are displayed for components or circuitry on the Main Assembly, it may help to perform the adjustment procedures in section 4, "Adjustments". If the self-tests continue to fail, the Main Assembly must be returned to the Hewlett-Packard for service. Component level troubleshooting is not supported in this manual.

The loop test in the self-test menu is used for HP service only.

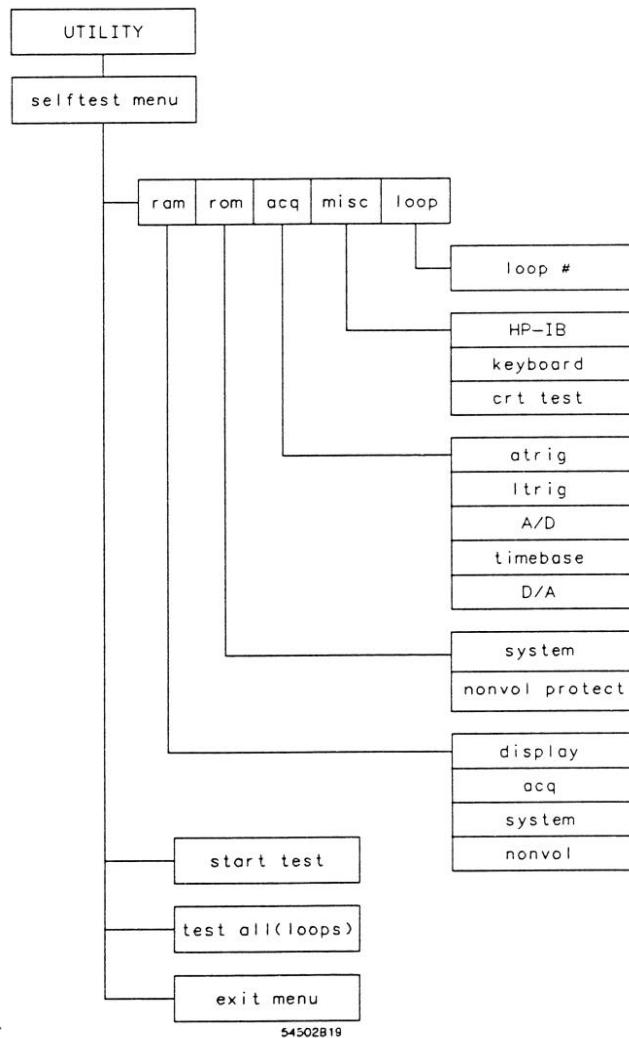

Figure 6-4. Selftest Menu Selections

Service Menu

The service menu contains functions that are used only during service procedures. The figure below diagrams the menu. Service menu use is covered in the appropriate procedures.

The PROTECTED SYSTEM CAL section (cal selects 0, 1, 2) includes firmware calibrations that need to be done only after repair or during routine service.

SETUPS FOR INTERNAL ADJUSTMENT AND FREQ VERIFY (cal selects 3, 4) provide certain signals at the rear panel BNC outputs, for making checks or adjustments.

PROTECTED SYSTEM CAL DEFAULTS (cal select 5) loads baseline firmware calibration factors which are necessary for some adjustment procedures.

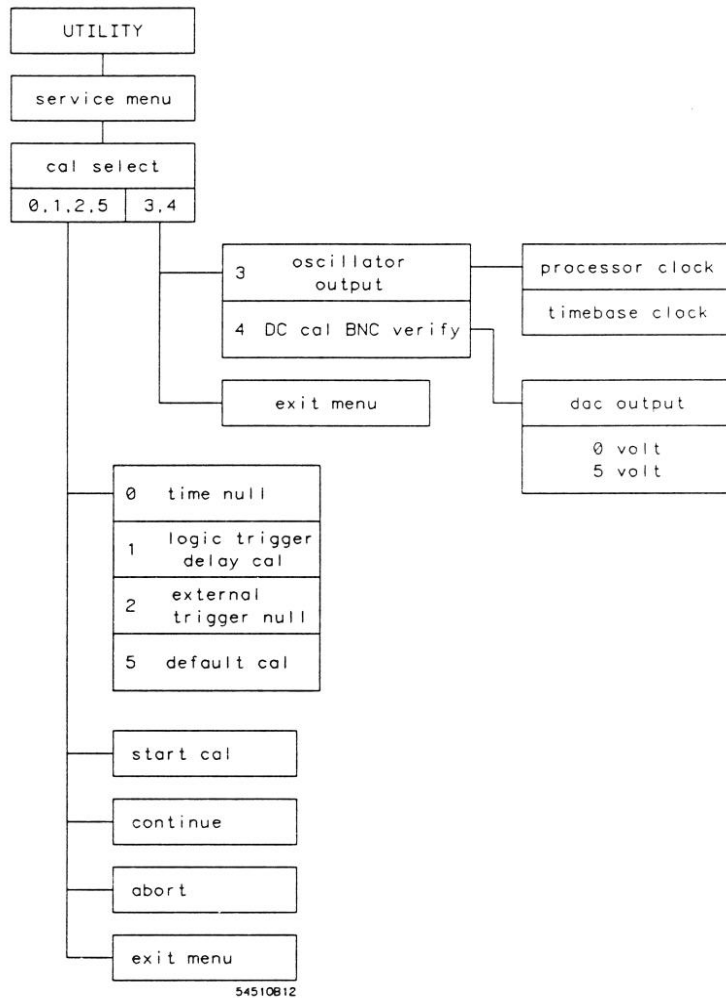

Figure 6-5. Service Menu Selections

Troubleshooting

The service policy of this instrument is replacement of defective assemblies. Some assemblies can be replaced on an exchange basis. This section is used to isolate problems to the assembly level.

Trouble Isolation Flowcharts

The trouble isolation flowcharts are the troubleshooting guide. Start with the flowcharts when repairing a defective instrument.

The flowcharts refer to other tests, tables, and procedures to help isolate trouble. Disassembly procedures are included to direct in replacing faulty assemblies. The circled numbers on charts indicate the next chart to use for isolating a problem.

The flowcharts start on the following page.

Key-Down Powerup

A key-down powerup is a procedure used to reset or preset the instrument to default conditions and prevent previous setups from interfering with the next test. It also simplifies the instrument set up procedure. Press any front-panel key while cycling power with the rear-panel power switch. Continue to press the key until the display returns.

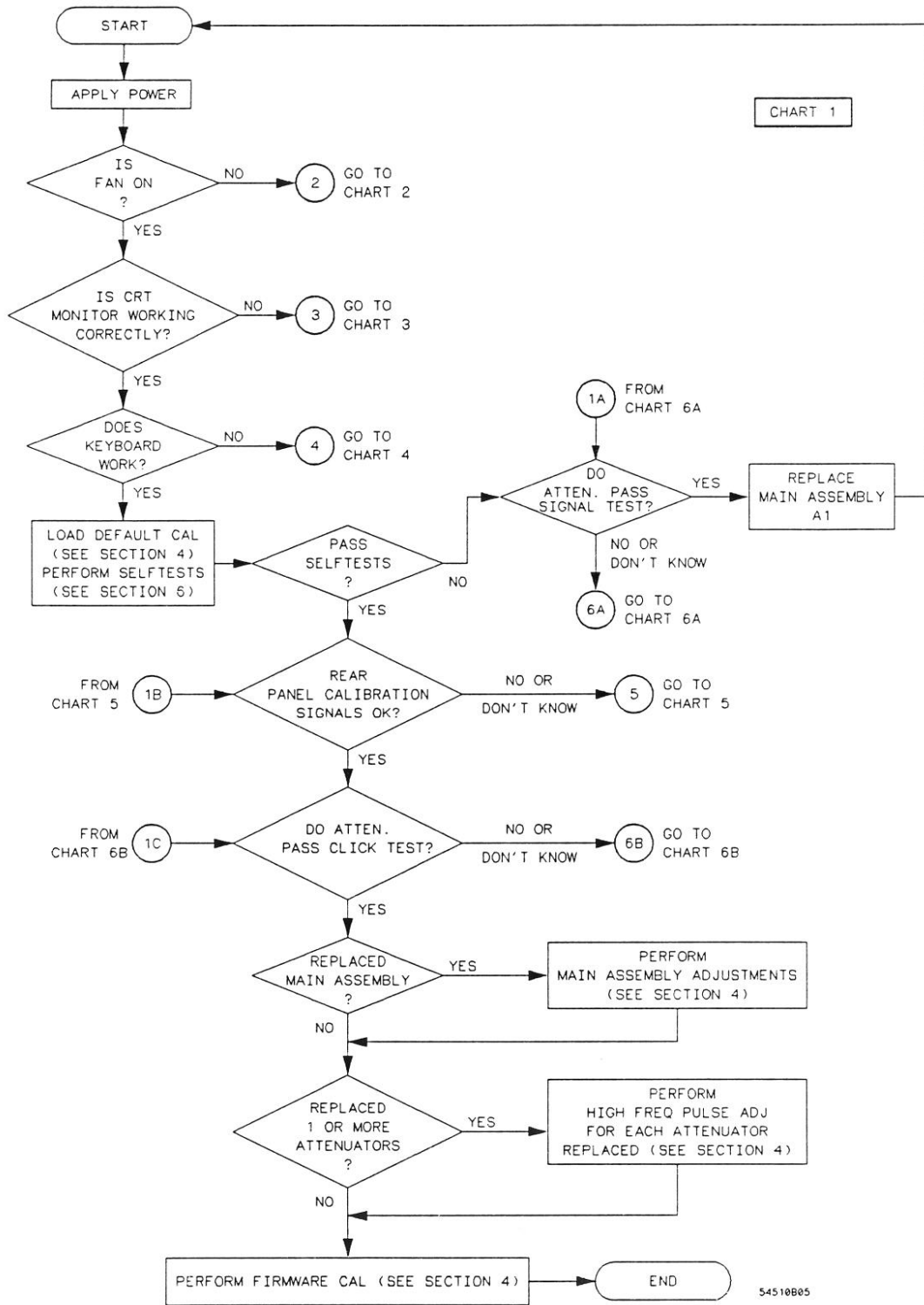

Figure 6-6. Primary Trouble Isolation Flowchart

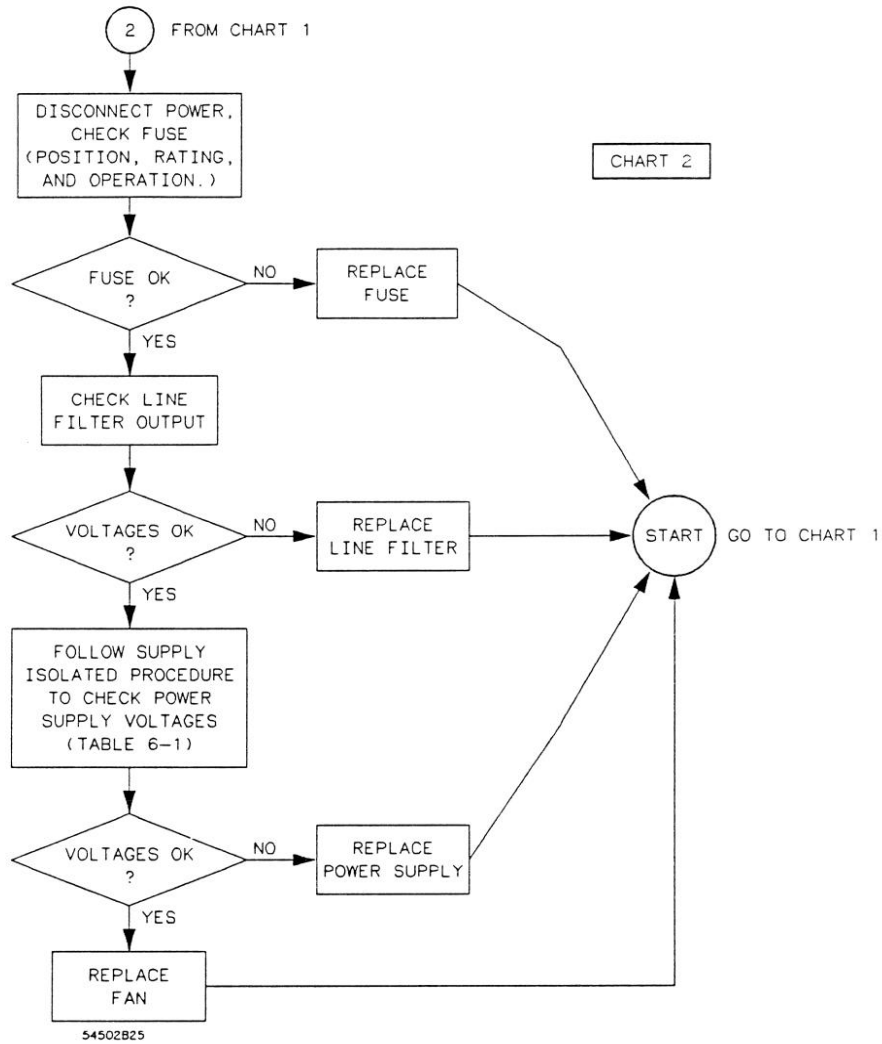

Figure 6-7. Trouble Isolation Chart for Power Supply

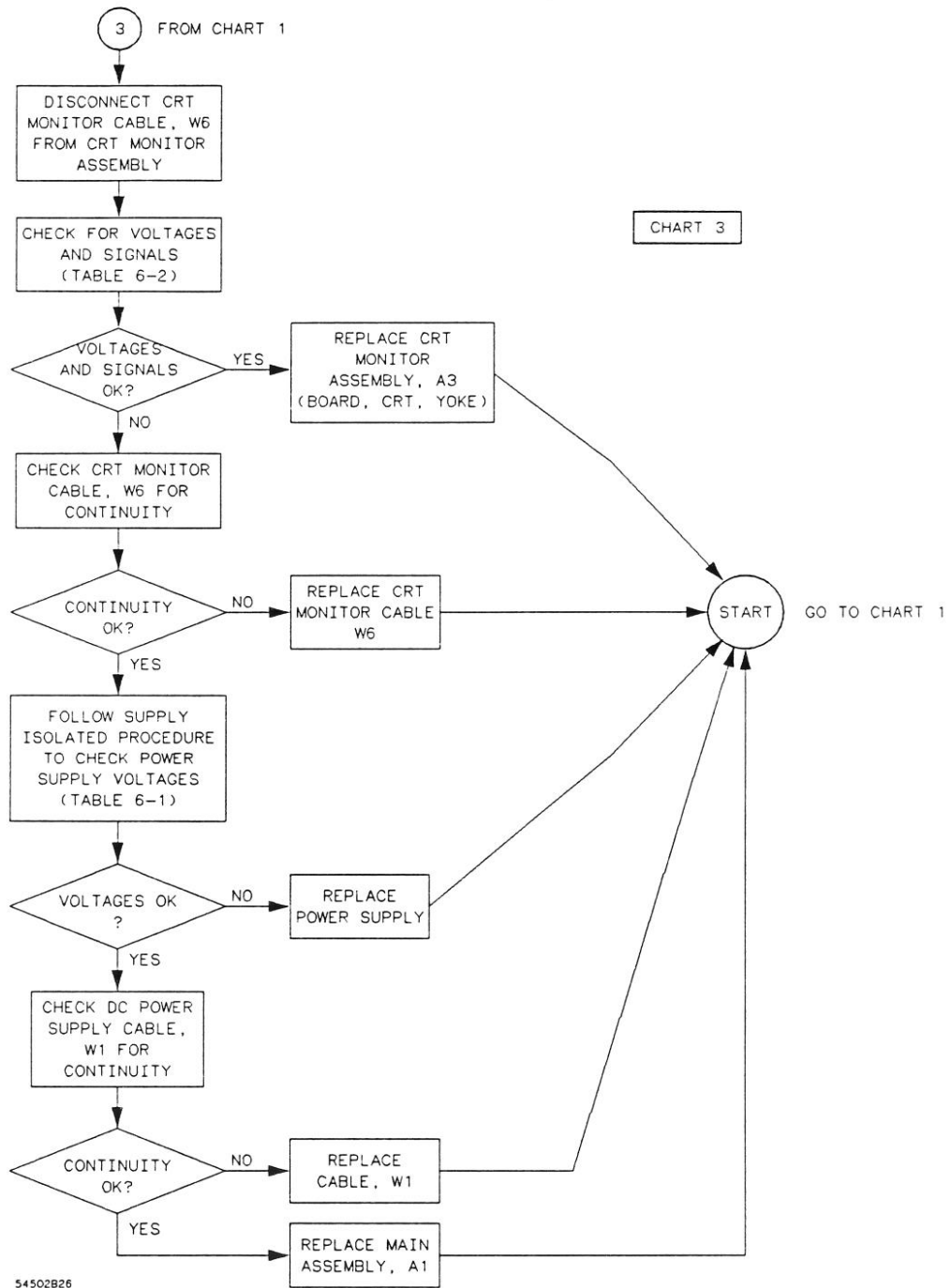

Figure 6-8. Trouble Isolation Chart for Display

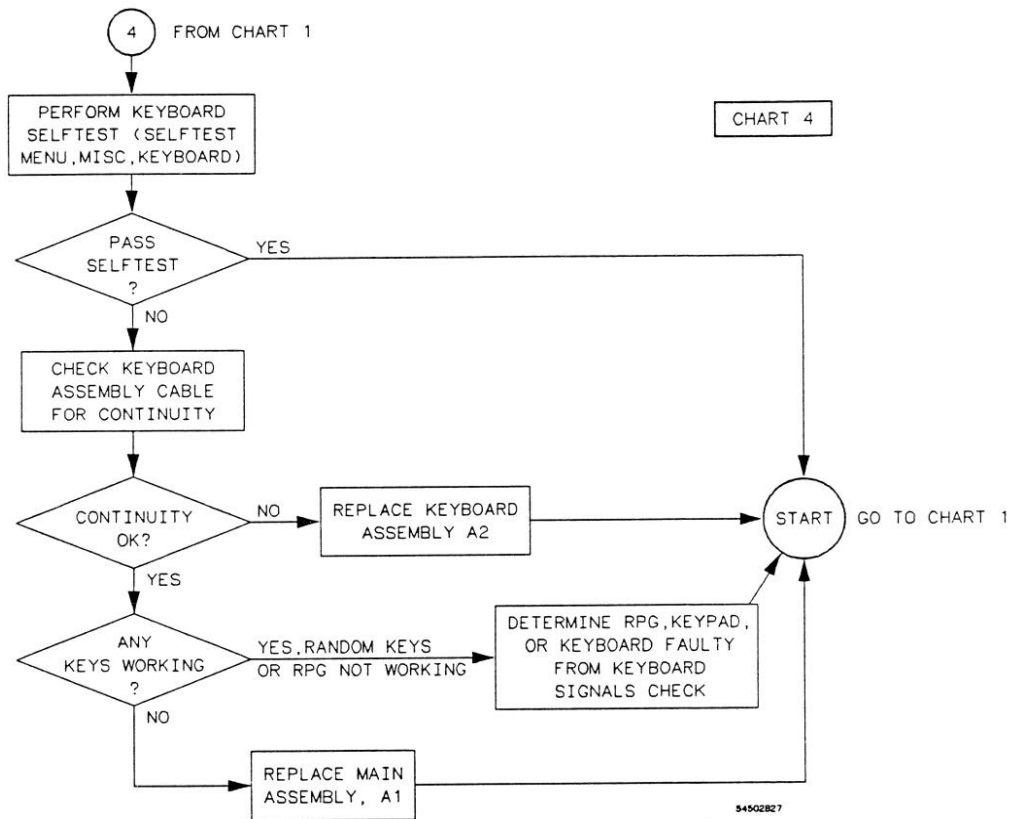

Figure 6-9. Trouble Isolation Chart for Keyboard

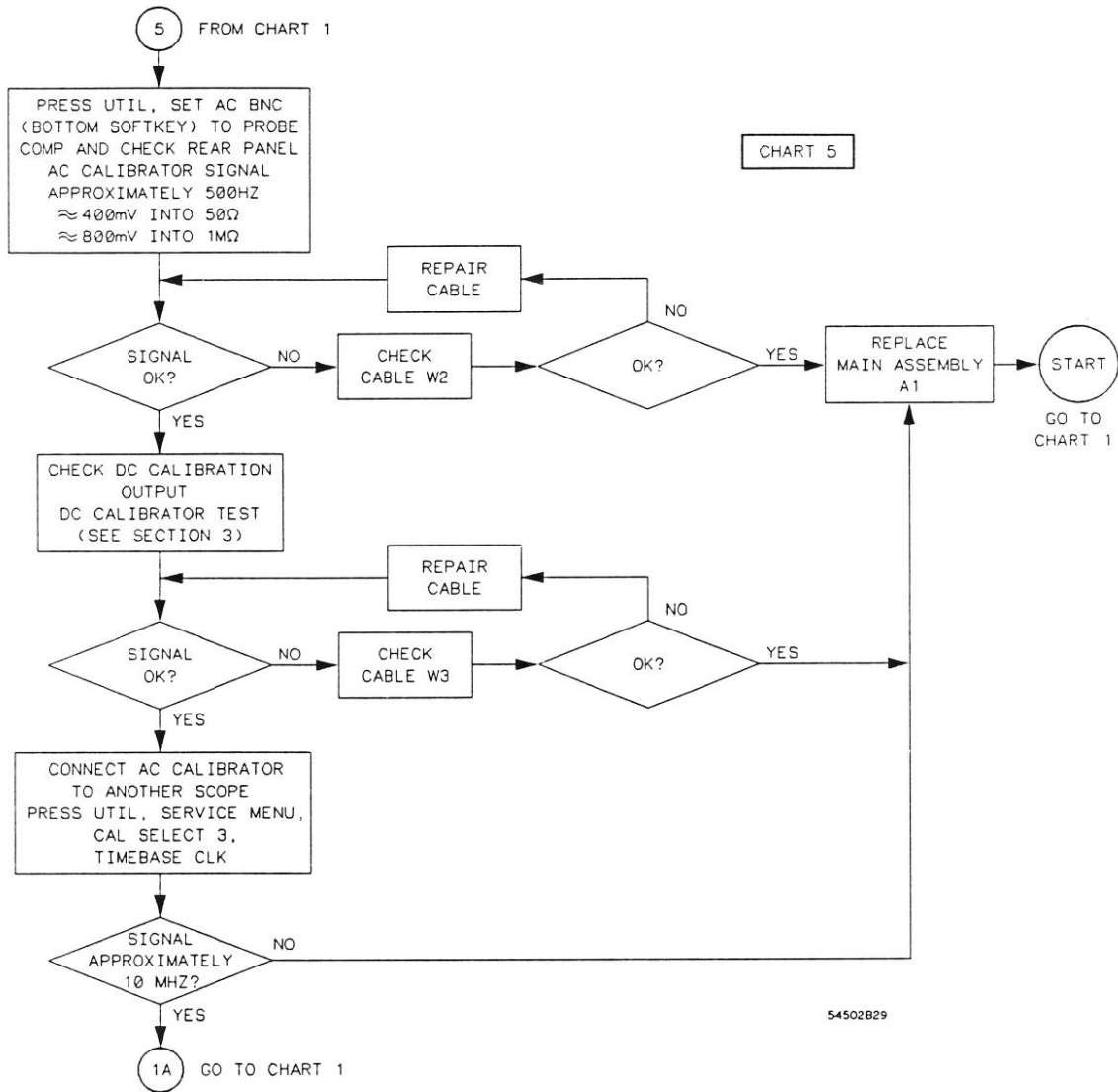

Figure 6-10. Trouble Isolation Chart for Cal Signals

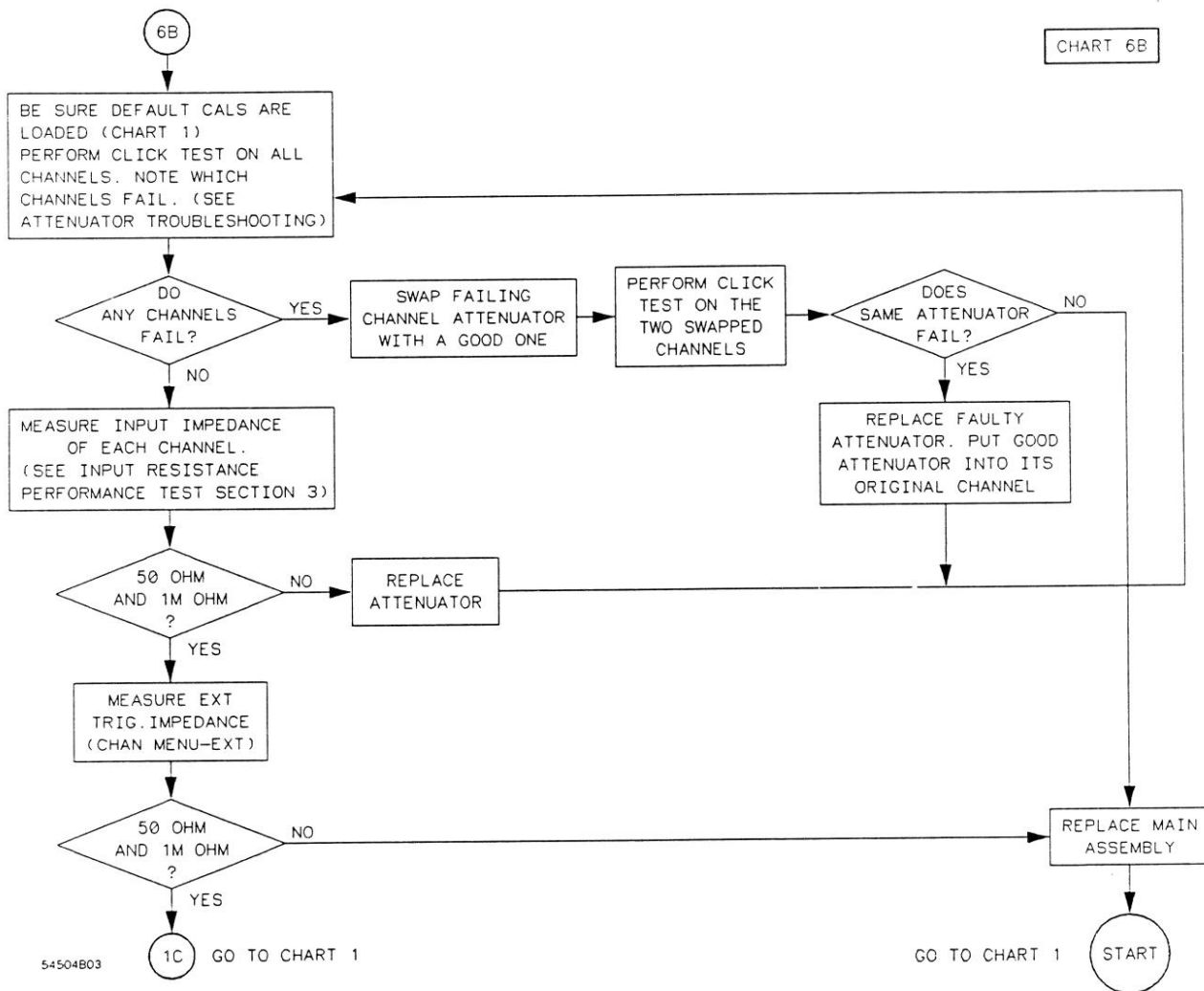
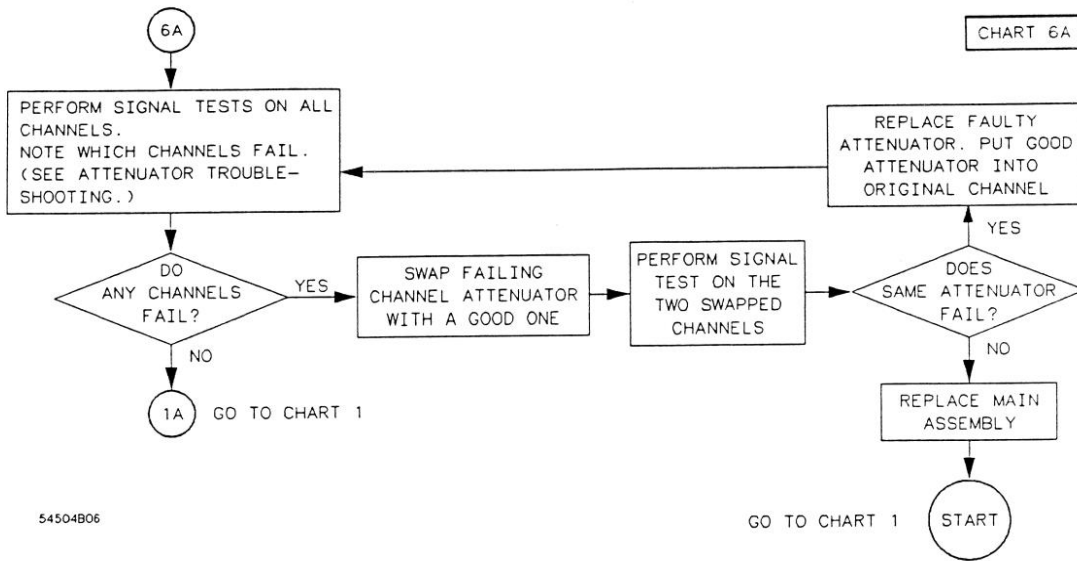

Figure 6-11. Trouble Isolation Chart for Attenuators

Power Supply Voltages Check

The power supply can be checked loaded or unloaded.



This procedure is to be performed only by service-trained personnel who are aware of the hazards involved (such as fire and electrical shock).

Supply Loaded

1. Remove the top cover.
2. Using the figure below, check for the voltages indicated at the testpoints.

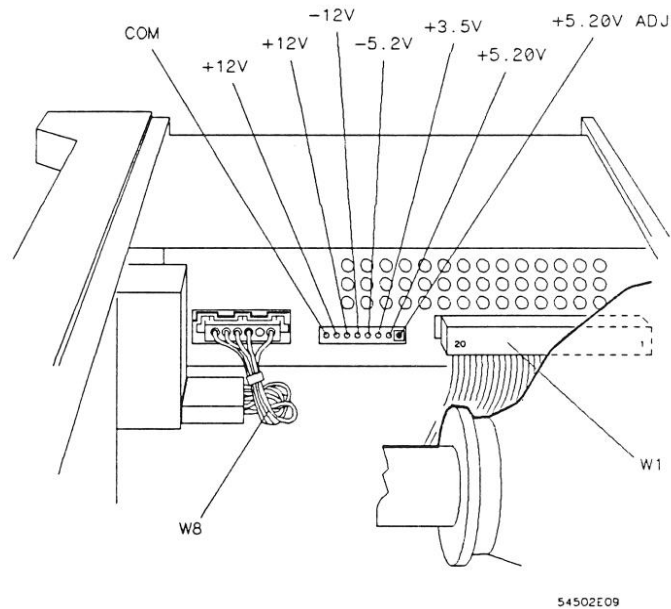

Figure 6-12. Power Supply Test Points

Supply Isolated

Isolate and check the supply with the following steps. Use the figure above for reference.

1. Remove the power cable.
2. Disconnect the supply output cable (W1) at the supply (see figure above).
3. Load +5.20 V supply with a 2-ohm, 25-watt resistor. Use jumper wires to connect one end of the resistor to any of pins 1-4, and the other end to any of pins 5-8.

- Reconnect the power cable and check for voltages at the supply output using values in the following table.

Table 6-1. Power Supply/Main Assembly Voltages

Pin	Signal	Pin	Signal
1	+5.20 V (Analog)	11	-5.2 V (Analog)
2	+5.20 V (Analog)	12	GROUND (Analog)
3	+5.20 V (Digital)	13	+12 V (Analog)
4	+5.20 V (Digital)	14	GROUND (Analog)
5	GROUND (Display)	15	-12 V (Analog)
6	GROUND (Digital)	16	GROUND (Analog)
7	GROUND (Digital)	17	+12 V (Display)
8	GROUND (Analog)	18	-5.2 V (Analog)
9	+3.5 V (Analog)	19	+15.5 V (Fan)
10	GROUND (Analog)	20	GROUND (Fan)



The ground planes (digital, analog, and display) are connected on the power supply but are separate on the main assembly. When measuring on the main assembly, the supplies must be measured with reference to the respective ground.

CRT Monitor Signals Check

This test checks for the signals between the main assembly and the CRT Monitor.

- Remove the top cover.
- Check the CRT Monitor input cable for the signals and supplies listed in the table below. The cable is the wide ribbon cable connecting the monitor to the Main Assembly.
- The video signals FB (Full-bright) and HB (Half-bright) are at TTL levels. Check for activity on their respective lines. The table includes a truth table for these signals.

Table 6-2. CRT Monitor Input Cable Pin Assignments

Pin	Signal	Pin	Signal	FB	HB	Video
1	+5 V (Digital)	2	+12 V (Display)	0	0	OFF
3	GROUND (Display)	4	GROUND (Display)	0	1	HALF
5	+12 V (Display)	6	GROUND (Display)	1	0	FULL
7	+12 V (Display)	8	GROUND (Display)	1	1	FULL
9	+12 V (Display)	10	HSYNC			
11	VSYNC	12	+12 V (Display)			
13	GROUND (Digital)	14	GROUND (Digital)			
15	GROUND (Display)	16	FB (Full-bright)			
17	GROUND (Display)	18	HB (Half-bright)			
19	GROUND (Display)	20	+5 V (Digital)			

Keyboard Signals Check

Use the following steps to isolate a faulty elastomeric keypad or keyboard when random keys are not operating.

1. Remove the power cable.
2. Without disconnecting the keyboard cable, use the keyboard removal procedure in this section to loosen the keyboard. Leave the keyboard in place in front of the instrument.
3. Replace the power supply.
4. Apply power with a key-down powerup.
5. Run the keyboard selftest. Press UTIL then **selftest menu**, select **misc** then **keyboard**, then press **start test** and press all keys.
6. Allow the keyboard assembly to fall forward from the front panel. Separate the elastomeric keypad and keyboard panel from the PC board.
7. Short the PC board trace (with a paper clip or screwdriver) of the non-operating key and look for an appropriate response on display.
8. If the display responds as if a key were pressed, replace the elastomeric keypad.
9. If the display does not respond as if a key were pressed, replace the keyboard.

Be aware of keyboard cable routing note in keyboard removal/replacement procedure.

The following information is supplemental for keyboard troubleshooting.

The ROW (scan) signal is a low duty-cycle pulse, approximately 60 Hz. It is continually present on pins 11 through 18 of the keyboard cable. Because of the resistance of the keypad contacts, the signal does not appear the same on the COLUMN (data) pins, 3 through 10, when keys are pressed. Refer to the following table for signals going to and from the keyboard.

Table 6-3. Keyboard Connector Voltages and Signals

Pin	Signal	Pin	Signal
1	RPGA	2	RPGB
3	COLUMN 1 (Data)	4	COLUMN 2 (Data)
5	COLUMN 3 (Data)	6	COLUMN 4 (Data)
7	COLUMN 5 (Data)	8	COLUMN 6 (Data)
9	COLUMN 7 (Data)	10	COLUMN 8 (Data)
11	ROW 8 (Scan)	12	ROW 7 (Scan)
13	ROW 6 (Scan)	14	ROW 5 (Scan)
15	ROW 4 (Scan)	16	ROW 3 (Scan)
17	ROW 2 (Scan)	18	ROW 1 (Scan)
19	+5 V (Digital)	20	GROUND (Digital)

Attenuator Troubleshooting

The attenuators consist of a solenoid selected input resistance, four passive attenuation ranges driven by solenoids (1:1, 5:1, 25:1, 125:1), a FET, and a programmable preamplifier.

Defective attenuators can cause a variety of symptoms.

- Wrong input resistance
- Low bandwidth/slow risetime
- Signal distortion
- Calibration failures
- Selftest failures

The attenuator and main assembly combination affects the pulse response adjustment. As a result, any attenuator replacements, or attenuators permanently swapped into a different channel, require High Frequency Pulse Adjustment of the affected channels. (see section 4, "Adjustment Procedures")

Firmware Calibration should also be done after attenuator replacement (see section 4, "Adjustment Procedures").

Attenuator Signal Test

An attenuator can affect self-testing because some self-test signals are fed to the offset input in the low-frequency amplifier of the attenuator. If the attenuator fails, the signals may not pass through the amplifier. The following test checks the attenuator signal path. Because the low-frequency path of the attenuator is on the Main Assembly, failure to pass a signal could be related to a problem on the Main Assembly.

This test uses the probe compensation output from the rear panel. It is approximately 500 Hz and 50% duty cycle and when terminated with 1 Mohm has an upper level of about 0 V and lower level about -800 mV. If terminated with 50Ω the signal lower level is about -400 mV.

1. Press RECALL, then press CLEAR.
2. Connect the rear panel AC CALIBRATOR output to the channel to be tested.
3. Set the following parameters for the channel being tested.

Menu	Selection	Setting
TIMEBASE	(time/div)	500 us
CHAN	(sensitivity)	200 mV/div
	offset	-400 mV
TRIG	source	as required
	level	-400 mV

4. With another oscilloscope, check the signal at the input, pin 53, of the ADC hybrid.

The adjustment locator (figure 4-2 page 4-4) may be used for reference. The ADC hybrid in channel 1 is U83 and in channel 2 it is U93. As viewed on figure 4-2, pin 53 is in the upper-left corner of the IC, the top pin along the left side of the IC.

The signal at the ADC hybrid input should be approximately 260 mVp-p with -560 mV near the center. There may be a small amount of noise on the signal

(about 10 mV). If the signal is good, the attenuator should pass the self-tests. If there is no signal or an incorrect signal, the problem may be the attenuator or the low-frequency amplifier. Return to the attenuator troubleshooting flowchart. Swap the attenuators and retry the test.

A major attenuator failure, such as that caused by overvoltage at the input, may cause an attenuator to oscillate. With no signal input, there may be a signal output which swings between the upper and lower limits. The oscillation can couple into an adjacent channel and that channel will appear to fail as well. The signal out of the adjacent channel will be the same frequency, but have a smaller amplitude than that from the failed channel.

Attenuator Click Test

The solenoids for the passive attenuators can be heard switching when the vertical sensitivity is changed. The fine mode of the RPG will give the most accurate indication of when a solenoid switches. However, the gain calibration will give different switching points to different attenuator assemblies. Individual attenuator assemblies will not necessarily switch at the same sensitivities. Also, there are different sets of calibration factors for certain time/div ranges so the passive attenuator changeover may depend on the sweep speed. They usually switch near the following:

- 45 to 50 mV/div
- 235 to 250 mV/div
- 1.15 to 1.25 V/div

Solenoid switching will be heard when going either direction through the transitions.

The input resistance solenoid can be heard when the input resistance is changed (CHAN menu).

Attenuator swapping is the best method of finding a faulty attenuator. Swap suspect and good attenuators and re-run the tests.

Assembly Removal and Replacement

This section contains the procedures for removal and installation of major assemblies. Read the Safety Summary at the front of this manual before servicing the instrument.



Hazardous voltages exist on the power supply, CRT, and the display sweep board. To avoid electrical shock, adhere closely to the following procedures. Also, after disconnecting the power cable, wait at least three minutes for the capacitors on the power supply and sweep boards to discharge before servicing this instrument.



Never remove or install any assembly with the instrument power ON. Component damage can occur.

Rear Panel Assembly

Use the following steps to remove and replace the rear panel assembly.

1. Disconnect the power cable.
2. Remove the top cover.
3. Detach the line filter cable (W8) from the power supply.
4. Remove the eight pan-head screws at the edges of the rear panel.
5. Pull the rear panel straight away from the instrument about three inches. Note the banana connector at the bottom corner of the rear panel. During reassembly, be sure it inserts into the clip on the main assembly.
6. Remove the HP-IB ribbon cable from the main assembly.
7. For reassembly, note which calibrator output goes to which connector on the main assembly. Remove the calibrator output cables at the main assembly.
8. Separate the rear panel from the cabinet.
9. Replace the rear panel by reversing this procedure.

Power Supply Assembly

Use the following steps to remove the power supply assembly.

1. Disconnect the power cable.
2. Remove the top cover.
3. Remove the cable (W1) that connects the power supply to the main assembly.
4. Disconnect the line filter cable (W8) at the power supply.
5. Remove the two locking pins that secure the power supply at right front and rear corners of the the cabinet. Pull pins up and out.
6. Slide the supply out through the side of the cabinet.
7. To replace the supply, reverse this procedure.

Keyboard Assembly

Use the following procedure to remove and replace the keyboard assembly. When necessary, refer to other removal procedures.

1. Disconnect the power cable.
2. Remove the power supply.

Note

Before going further, note the routing of the keyboard cable. It should be routed next to the front panel to just under the CRT, then directly to the rear of the instrument where it connects to the main assembly. It should be kept close to the main assembly for its entire length. Avoid routing the cable between the power supply and the acquisition circuitry on the main assembly.

3. From the back side of the front panel, remove the four screws securing keyboard assembly to front of the cabinet.
4. When the knob is pulled, the keyboard assembly (label, keyboard panel, keypad, PC board, RPG and knob) will come off front panel as one unit.

Use the following steps to disassemble the keyboard assembly.

5. Disconnect the RPG cable from PC board.
6. Separate the PC board, keypad, and keyboard panel/label.
7. The Knob has a force fit on the RPG shaft. To remove, pull straight off.
8. Remove the 3/8" nut from the RPG, then the RPG from the keyboard panel.
9. The Keyboard label uses self-stick adhesive. If it must be removed, peel it off.
10. If it is necessary to replace the PC board, it is necessary to loosen the rear panel and disconnect the keyboard cable from the main assembly. Follow steps 3-5 of rear panel procedure.
11. Replace keyboard assembly by reversing this procedure. Be sure the keyboard cable is routed properly when reassembling the instrument. (See note above.)

Fan

Use the following procedure to remove and replace the fan. When necessary, refer to other removal procedures.

1. Disconnect the power cable.
2. Remove the top cover.
3. Disconnect the fan cable from the main assembly.
4. Remove the line filter cable at the power supply.
5. Remove the eight pan-head screws at the edges of the rear panel.
6. Pull the rear panel straight back until the banana plug clears the clip on the main assembly.
7. Lay rear the panel down at rear of the instrument. It is not necessary to completely remove the rear panel.

8. For reassembly, note orientation of the fan cable. Remove the fan by removing the four screws securing it to the cabinet.
9. To install the fan, reverse this procedure.



When replacing the fan, be sure air flow at the fan is from outside into the instrument. Check the flow arrows on the fan and check for proper flow once power is applied to the instrument.

Main Assembly

Use the following procedure to remove and replace the main assembly. When necessary, refer to other removal procedures.



ELECTROSTATIC DISCHARGE can damage electronic components. Use grounded wriststraps and mats when servicing the main assembly.

1. Disconnect the power cable.
2. Remove the top cover.
3. Remove the power supply assembly.
4. Disconnect power supply, display, and fan cables from main assembly.
5. Remove rear panel.
6. Disconnect keyboard cable from main assembly.
7. Carefully place instrument on its side.
8. From the bottom of the instrument, remove eight screws that secure main assembly to cabinet.
9. Remove the nuts holding BNCs to front panel.
10. Set instrument in the normal position.
11. Slide main assembly out of the cabinet to the rear.
12. Replace main assembly by reversing this procedure.

Attenuators

Use the following procedure to remove and replace an attenuator assembly. When necessary, refer to other removal procedures.



ELECTROSTATIC DISCHARGE can damage electronic components. Use grounded wriststraps and mats when servicing the attenuators.

Attenuators are not part of the main assembly. If the Main assembly is replaced, the attenuators will have to be moved to the replacement assembly.

1. Remove rear panel, power supply and main assembly.

2. From the bottom of the main assembly, remove two screws that secure the Attenuator.
3. A 24-pin connector, located at the rear of and inside the Attenuator, connects it to the PC board. With a gentle rocking or prying motion, lift the Attenuator from the PC board.

A small flat-blade screwdriver, prying at the rear between Attenuator and PC board, will help control Attenuator removal.

CRT Monitor Assembly

The sweep board, CRT, and CRT yoke are all parts of one HP part number. They have been adjusted as a unit and should be replaced as a unit, rather than individually. Do not remove the yoke from the CRT.

When necessary, refer to other removal procedures.

1. Remove rear panel, power supply, and main assembly.

Caution

Discharge the post accelerator lead to the CRT mounting band only. Components will be damaged if the post accelerator is discharged to other areas.

2. Connect a jumper lead between the mounting band of the CRT and shaft of a screwdriver.
3. Discharge CRT, by placing grounded screwdriver under protective rubber cap of post accelerator lead and momentarily touching screwdriver to metal clip of post accelerator lead.

Caution

The CRT may charge up by itself even while disconnected. Discharge the CRT before handling. Use a jumper lead to short the CRT post accelerator terminal to the CRT mounting band.

4. Disconnect post accelerator lead from CRT by firmly squeezing rubber cap until metal clip disengages from CRT.
5. Detach the following cables at the sweep board or CRT.
 - Intensity cable, W7
 - CRT Monitor ribbon cable, W6
 - Two CRT yoke cables
 - CRT base cable
6. Slide sweep board up and out of cabinet slot. When installing sweep board, it may be necessary to press on center of the outer shield of sweep board to allow the board to clear cabinet support rib.
7. Carefully place instrument in front-panel-down position.
8. Remove the three nuts securing CRT to front panel.
9. Remove sweep board guide.
10. Remove the pan-head screw securing CRT to front panel.

11. Remove CRT. When reinstalling CRT, place it with the post accelerator terminal toward the inside of the instrument, away from the sweep board.
 12. To install CRT monitor Assembly, reverse this procedure.
-



After replacement of CRT monitor assembly, and only if necessary, perform the CRT monitor assembly Adjustment procedures in section 4 of this manual.

Feet/Tilt Stand

Use the following procedure to remove and replace the feet and tilt stand. When necessary, refer to other removal procedures.

1. Remove rear panel, power supply, main assembly and CRT Monitor assembly.
2. Remove the three screws securing each foot/tilt stand to the bottom of the cabinet.
3. To install feet/tilt stand, reverse this procedure.