

**8501A**  
**STORAGE-NORMALIZER**

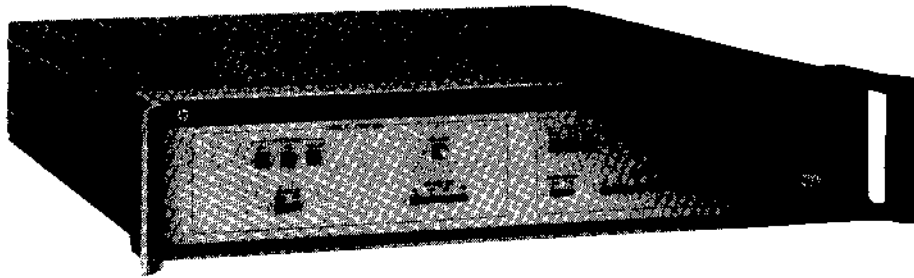

**HEWLETT  
PACKARD**



HP 8501A

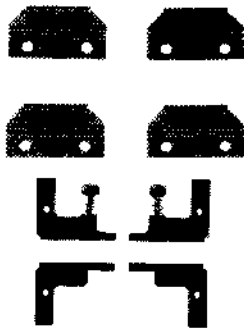

LOCK FEET KIT  
5061-0099

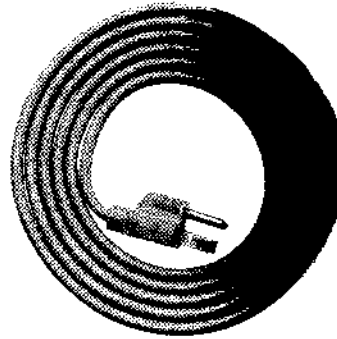

LINE POWER CABLE  
(See Figure 2-5  
for HP Part Number)



NORMALIZER/PROCESSOR  
INTERCONNECT CABLE  
08501-60067

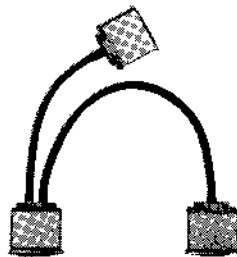

LABELING INTERCONNECT  
CABLE  
08501-60068

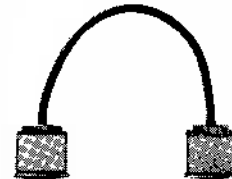

HP-IB INTERCONNECT  
CABLE  
10631A

Figure 1-1. Model 8501A Storage-Normalizer with Accessories Supplied

## SECTION I GENERAL INFORMATION

### 1-1. INTRODUCTION

1-2. This Operating and Service Manual contains information required to install, operate, test, adjust, and service the Hewlett-Packard Model 8501A Storage-Normalizer. Figure 1-1 shows the instrument and accessories supplied. This section covers instrument identification, description, options, accessories, specifications, and other basic information.

1-3. Supplied with this manual is an Operating Information Supplement. The Supplement is a copy of the first three sections of the manual, and should be kept with the instrument for use by the operator. Additional copies of the Operating Information Supplement can be ordered separately through your nearest Hewlett-Packard office. The part number is listed on the title page.

### 1-4. OPERATING CHARACTERISTICS

1-5. Instrument operating characteristics are listed in Table 1-1. These operating characteristics are not specifications but are typical characteristics included as information for the user.

### 1-6. SAFETY CONSIDERATIONS

#### 1-7. General

1-8. This is a Safety Class I instrument and has been manufactured and tested according to international safety standards.

#### 1-9. Safety Symbols

 Instruction manual symbol: The apparatus will be marked with this symbol when it is necessary for the user to refer to the instruction manual in order to protect the apparatus against damage.

 Indicates dangerous voltages

 Earth Terminal

**WARNING**

The WARNING sign denotes a hazard. It calls attention to a procedure, practice, or the like, which, if not correctly performed or adhered to, could result in injury or loss of life. Do not proceed beyond a WARNING sign until the indicated conditions are fully understood and met.

**CAUTION**

The CAUTION sign denotes a hazard. It calls attention to an operating procedure, practice, or the like, which, if not correctly performed or adhered to, could result in damage to or destruction of part or all of the equipment. Do not proceed beyond a CAUTION sign until the indicated conditions are fully understood and met.

#### 1-10. Operation

1-11. Before applying power, the following cautions should be observed:

**CAUTION**

**BEFORE SWITCHING ON THIS INSTRUMENT, make sure instrument's ac input is set to the voltage of the ac power source (see Figure 2-1).**

**BEFORE SWITCHING ON THIS INSTRUMENT, make sure the ac line fuse is of the required current rating and type (normal-blow, time delay, etc.).**

#### 1-12. Service

1-13. Although this instrument has been manufactured in accordance with international safety standards, this manual contains information, cautions, and warnings which must be followed to insure safe operation. Service should be performed only by qualified service personnel, and the following warnings should be observed.

**WARNING**

Any maintenance or repair of the opened instrument under voltage should be avoided as much as possible, and when unavoidable, should be carried out only by a skilled person who is aware of the hazard involved.

Capacitors inside the instrument may still be charged even if the instrument has been disconnected from its source of supply.

Make sure that only fuses with the required rated current and of the specified type (normal blow, time delay, etc.) are used for replacement. The use of repaired fuses and the short-circuiting of fuseholders must be avoided.

When it is likely that the earth ground protection has been interrupted, the instrument must be made inoperative and be secured against any unintended operation.

If this instrument is to be energized via an auto-transformer (for voltage reduction) make sure the common terminal is connected to the earthed pole of the power source.

**BEFORE SWITCHING ON THE INSTRUMENT**, the protective earth terminals of the instrument must be connected to the protective conductor of the mains power cord. The mains plug shall only be inserted in a socket outlet provided with a protective earth contact. The protective action must not be negated by the use of an extension cord (power cord) without a protective conductor (grounding). Grounding one conductor of a two conductor outlet is not sufficient protection.

Any interruption of the protective (grounding) conductor (inside or outside the instrument or disconnecting the protective earth terminal is likely to make this instrument dangerous.

**1-14. INSTRUMENTS COVERED BY MANUAL**

1-15. Attached to the instrument is a serial number plate (Figure 1-2). The serial number is in two parts. The first four digits and the letter are the serial number prefix; the last five digits are the suffix. The prefix is the same for all identical instruments; it changes only when a change is made to the instrument. The suffix, however, is assigned sequentially and is different for each instrument. The contents of this manual apply to instruments with the serial number prefix(es) listed under SERIAL NUMBERS on the title page.

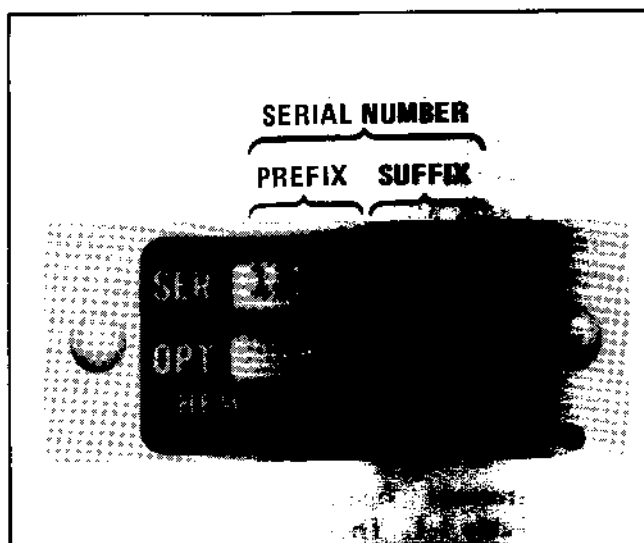

Figure 1-2. Typical Serial Number Plate

1-16. An instrument ~~manufactured~~ after the printing of this manual may have a serial number prefix that is not listed on the title page. This unlisted serial number prefix indicates the instrument is different from those described in this manual. The manual for this newer instrument is accompanied by a yellow Manual Changes supplement. This supplement contains "change information" that explains how to adapt the manual to the newer instrument.

**1-17. DESCRIPTION**

1-18. HP Model 8501A Storage Normalizer is an accessory that increases the measurement capability of the HP 8505A Network Analyzer by offering the following features: (a) Digital Storage; (b) CRT Labeling; (c) Normalization, and (d) Averaging. Digital storage for a flicker free display and CRT labeling of the major control settings provide easy documentation of a measurement. Normaliza-

Table 1-1. Model 8501A Storage-Normalizer Operating Characteristics

**RECTANGULAR DISPLAY:**

**Horizontal Display Resolution:** 500 points displayed full scale (0.2% or full scale) plus 100% overrange. May vary from 500 points above and zero below to zero above and 500 below.

**Vertical Display Resolution:**

**POLAR DISPLAY:**

**Display Resolution:** Two display channels, 250 points per polar display (0.2% of full scale).

**HORIZONTAL INPUT SWEEP RATE:** 100 sec max/10 ms min

**CONVERSION TIME:** 10 ms max for 500  $\pm 2$  data points

**DISPLAY REFRESH TIME:** Approximately 20 ms to 60 ms, depending upon information displayed.

**DISPLAY TRACKING:** Visual offsets between direct 8505A and stored displays are approximately  $\pm \frac{1}{2}$  CRT minor division ( $\pm 1$  mm).

**CHANNEL 1 AND 2 INPUTS:**  $-2.5$  to  $+2.5$ V nominal for full scale.

**INPUT SWEEP VOLTAGE** 0 to 13V nominal.

**EXTERNAL TRIGGER:** High to low transition (standard TTL levels) initiates data processing

**XYZ DISPLAY OUTPUTS:**  
 X – 1V full screen, 83 mV/div (12 div).  
 Y – 1V full screen, 100 mV/div (10 div).  
 Z – – 1 volt blanks display, +2 volts unblanks display. (Signal compatible with HP CRT displays).

**HP-IB INTERFACE CAPABILITIES**

**Input Data:** Data for graphics or other purposes can be sent to the 8501A at a rate of:  
 ASCII mode, 600 points per second.  
 Binary mode, 10000 points per second.

**Output Data:** Data can be read from the 8501A at a rate of:  
 ASCII mode, 800 points per second.  
 Binary mode, 9000 points per second.

**POWER REQUIREMENT:** Selection of 100, 120, 220, or 240V  $\pm 5\% - 10\%$ . 50 to 60 Hz and  $<140$  VA ( $<140$  watts).

**DIMENSIONS:** 426 mm wide, 90 mm high, 534 mm deep  
 (16 $\frac{3}{4}$  in. x 3 $\frac{1}{2}$  in. x 21 in.)

**WEIGHT:** Net, 12.25 kg (27 lb). Shipping, 14 kg (31 lb).

tion is useful in removing frequency response error from the CRT display. The 8501A can digitally average signals to improve the signal-to-noise ratio and magnify the display for greater resolution. With a desk-top computer, such as the 9830A/B or 9825A, graphics capability is added to the 8505A for displaying corrected data, operator messages, or computer programs.

### 1-19. HEWLETT-PACKARD INTERFACE BUS (HP-IB)

1-20. The HP 8501A is factory equipped with a remote programming interface using the Hewlett-Packard Interface Bus (HP-IB). This provides a remote operator with the same control of the instrument available to a manual (local) operator. Remote control is maintained by a system controller (desk-top computer, computer, etc.) that sends commands or instructions to and receives data from the 8501A using the HP-IB. The HP-IB is Hewlett-Packard's implementation of the IEEE Standard 488-1975. A complete general description of the HP-IB is provided in the manual entitled "Condensed Description of the Hewlett-Packard Interface Bus", HP Part No. 59401-90030.

### 1-21. OPTIONS

#### 1-22. Option 907 Front Handle Kit

1-23. Option 907, HP Part Number 5061-0088, contains front handles and necessary hardware for attaching the handles. See Figure 2-4 for installation procedure.

#### 1-24. Option 908 Rack Flange Kit

1-25. Option 908, HP Part Number 5061-0076, contains flanges and hardware required to mount the 8501A in an equipment rack with 482.6 mm (19 inches) horizontal spacing. See Figure 2-4 for installation procedure.

#### 1-26. Option 909 Rack Flange/Front Handle Kit

1-27. Option 909, HP Part Number 5061-0082, consists of one Option 907 Front Handle Kit and one Option 908 Rack Flange Kit (see descriptions above.) See Figure 2-4 for installation procedure.

### 1-28. Option 910 Additional Operating and Service Manuals

1-29. Option 910 provides additional Operating and Service manual(s). The number of additional manuals depends on quantity of Option 910's ordered. To obtain additional Operating and Service manuals after initial shipment, order by manual part number (refer to title page or rear cover of manual).

### 1-30. ACCESSORIES SUPPLIED

1-31. Figure 1-1 shows the HP Model 8501A Storage-Normalizer, line power cable, normalizer interconnect cable, and the HP-IB interconnect cable. The lock feet kit shown may be used to lock the 8501A on top of the 8505A.

### 1-32. EQUIPMENT REQUIRED BUT NOT SUPPLIED

1-33. To use the HP-IB capabilities, a computing controller such as the HP Model 9825A or 9830A/B is needed. An 8505A Network Analyzer without the Model 11864A 8501A/8505A Labeling Interface Kit installed will operate with the 8501A; however, to obtain 8505A CRT annotation, the kit must be installed.

### 1-34. EQUIPMENT AVAILABLE

#### 1-35. Extender Board 08501-60031

1-36. The extender board (HP Part Number 08501-60031) has jumper pins on each trace so that traces may be opened as an aid in servicing.

#### 1-37. Large Screen and Auxiliary CRT Displays

1-38. The use of an external CRT Display, such as HP Models 1304A, 1310A or 1332A, allows the operator to make adjustments on test devices without removing a camera from the 8505A CRT display.

### 1-39. RECOMMENDED TEST EQUIPMENT

1-40. Equipment required for incoming inspection, performance testing and troubleshooting of the Hewlett-Packard Model 8501A Storage-Normalizer is listed in Table 1-2. Other equipment may be substituted if it meets or exceeds the critical specifications listed in the table.

Table 1-2. Recommended Test Equipment

Instrument	Critical Specifications	Recommended Model	Use*
Oscilloscope with Dual Channel Plug-In 10:1 Probe (3 required)	Vertical Bandwidth: dc to 100 MHz Trigger: Internal or External	HP 180C/1801A/1821A	P, A, T
200 MHz Bandpass Filter	Center Frequency =200 MHz Bandwidth =10 MHz (NOTE: Other frequency units may be used; however, 8505A START-STOP frequencies must be set to include passband.)	Telonic Model TBA200-10-4EF1	P
Desk top Computer	HP 9825A: 23K bytes memory, 98210A String-Advanced Programming, 98214A Plotter-General I/O - Extended I/O, 98034A HP-IB Interface, or HP 9830A/B: 8K words memory, I/O ROM String Variable ROM, 59405A-H02-H30 HP-IB interface, or other HP models with proper programming, memory, and interface.	HP 9825A or 9830A/B	P, A, T
Digital Multimeter	Range: DC to 300 volts Accuracy: $\pm 0.4\%$ of reading	HP 3465A	T
Normalizer Interconnect Cable	No substitutes. Supplied with 8501A.	HP 08501-60067	P, A, T
Labeling Interconnect Cable	No substitutes. Supplied with 8501A.	HP 08501-60068	P, A, T
HP-IB Cable (3 required)	No substitutes	HP 10631A	P, A, T
Extender Board	Supplied with 8501A	08501-60021	T
Extender Board	Jumper pins on each trace	08501-60031	T
Network Analyzer	No substitutes	HP 8505A	P, A, T
Signature Analyzer	No substitutes	HP 5004A	T
Logic Pulser	No substitutes	HP 546A	T
Logic Probe	No substitutes	HP 545A	T

\*P =Performance; T =Troubleshooting; A =Adjustment.

## SECTION II INSTALLATION

### 2-1. INTRODUCTION

2-2. This section includes instructions for initial inspection, preparation for use, and storage/shipment instructions for the HP Model 8501A Storage-Normalizer.

### 2-3. INITIAL INSPECTION

2-4. Inspect the shipping container for damage. If the shipping container or cushioning material is damaged, it should be kept until the contents of the shipment have been checked for completeness and the instrument has been checked mechanically and electrically. The contents of the shipment should be as shown in Figure 1-1. Procedures for checking electrical performance are given in Section IV. If the contents are incomplete, if there is mechanical damage or defect, or if the instrument does not pass the electrical performance test, notify the nearest Hewlett-Packard office. If the shipping container is damaged, or the cushioning material shows signs of stress, notify the carrier as well as the Hewlett-Packard office. Keep the shipping materials for carrier's inspection. The HP office will arrange for repair or replacement without waiting for claim settlement.

### 2-5. ENVIRONMENTAL LIMITATIONS

2-6. The operating environment should be within the following limits:

Temperature . . . . . 0°C to +55°C  
 Humidity . . . . . Up to 95% relative  
 Altitude . . . . . 4600 meters (15 000 feet)

### 2-7. PREPARATION FOR USE

#### 2-8. Compatibility with 8505A Network Analyzer

2-9. The 8505A requires modification for use with the 8501A if the LABELING INTERCONNECT receptacles, A2J12 and A3J11, on the rear panel of the 8505A have not been factory installed. See the 11864A Operating and Service manual for instructions on field installation of the Labeling Interface Kit into the 8505A.

### 2-10. Power Requirements

2-11. The Model 8501A requires a power source of 100, 115/120, 220, or 230/240 Vac +5% -10%, 50 or 60 Hz single phase. Power consumption is less than 140 volt-amperes.

### 2-12. Line Voltage and Fuse Selection

**WARNING**

**BEFORE THIS INSTRUMENT IS SWITCHED ON, its protective earth terminals must be connected to the protective conductor of the mains power cable (cord). The mains power cable plug shall only be inserted in a socket outlet provided with a protective earth contact. DO NOT negate the earth-grounding protection by using an extension cable, power cable, or autotransformer without a protective ground conductor. Failure to ground the instrument properly can result in serious personal injury.**

**CAUTION**

**BEFORE SWITCHING ON THIS INSTRUMENT, make sure it is adapted to the voltage of the ac power source. You must set the voltage selector switch correctly to adapt the 8501A to the power source. Failure to set the ac power input of the instrument for the correct voltage level could cause damage to the instrument when it is switched on.**

2-13. Select the line voltage and fuse as follows:

- a. Measure the ac line voltage.
- b. Refer to Figure 2-1. At the instrument's rear-panel power line module, select the line voltage (100V, 115/120V, 220V, or 230/240V) closest to the voltage you measured in step a. Note that the available line voltage must be within +5% or -10% of the line voltage selection as shown below. If it is not, you must use an autotransformer between the ac source and the 8501A.



## SECTION II INSTALLATION

### 2-1. INTRODUCTION

2-2. This section includes instructions for initial inspection, preparation for use, and storage/shipment instructions for the HP Model 8501A Storage-Normalizer.

### 2-3. INITIAL INSPECTION

2-4. Inspect the shipping container for damage. If the shipping container or cushioning material is damaged, it should be kept until the contents of the shipment have been checked for completeness and the instrument has been checked mechanically and electrically. The contents of the shipment should be as shown in Figure 1-1. Procedures for checking electrical performance are given in Section IV. If the contents are incomplete, if there is mechanical damage or defect, or if the instrument does not pass the electrical performance test, notify the nearest Hewlett-Packard office. If the shipping container is damaged, or the cushioning material shows signs of stress, notify the carrier as well as the Hewlett-Packard office. Keep the shipping materials for carrier's inspection. The HP office will arrange for repair or replacement without waiting for claim settlement.

### 2-5. ENVIRONMENTAL LIMITATIONS

2-6. The operating environment should be within the following limits:

Temperature . . . . . 0°C to +55°C  
 Humidity . . . . . Up to 95% relative  
 Altitude . . . . . 4600 meters (15 000 feet)

### 2-7. PREPARATION FOR USE

#### 2-8. Compatibility with 8505A Network Analyzer

2-9. The 8505A requires modification for use with the 8501A if the LABELING INTERCONNECT receptacles, A2J12 and A3J11, on the rear panel of the 8505A have not been factory installed. See the 11864A Operating and Service manual for instructions on field installation of the Labeling Interface Kit into the 8505A.

### 2-10. Power Requirements

2-11. The Model 8501A requires a power source of 100, 115/120, 220, or 230/240 Vac +5% -10%, 50 or 60 Hz single phase. Power consumption is less than 140 volt-amperes.

### 2-12. Line Voltage and Fuse Selection

**WARNING**

**BEFORE THIS INSTRUMENT IS SWITCHED ON, its protective earth terminals must be connected to the protective conductor of the mains power cable (cord). The mains power cable plug shall only be inserted in a socket outlet provided with a protective earth contact. DO NOT negate the earth-grounding protection by using an extension cable, power cable, or autotransformer without a protective ground conductor. Failure to ground the instrument properly can result in serious personal injury.**

**CAUTION**

**BEFORE SWITCHING ON THIS INSTRUMENT, make sure it is adapted to the voltage of the ac power source. You must set the voltage selector switch correctly to adapt the 8501A to the power source. Failure to set the ac power input of the instrument for the correct voltage level could cause damage to the instrument when it is switched on.**

2-13. Select the line voltage and fuse as follows:

- a. Measure the ac line voltage.
- b. Refer to Figure 2-1. At the instrument's rear-panel power line module, select the line voltage (100V, 115/120V, 220V, or 230/240V) closest to the voltage you measured in step a. Note that the available line voltage must be within +5% or -10% of the line voltage selection as shown below. If it is not, you must use an autotransformer between the ac source and the 8501A.

RECEPTACLE FOR PRIMARY POWER CORD

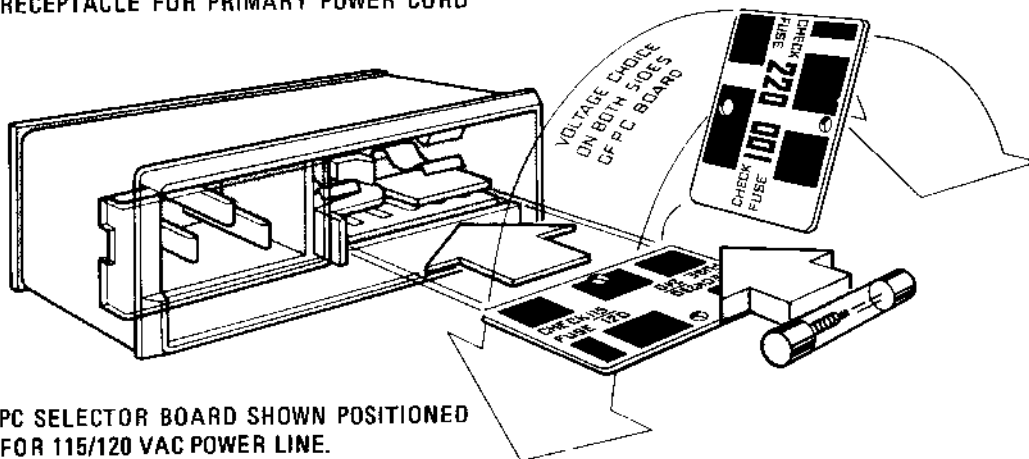

OPERATING VOLTAGE APPEARS IN MODULE WINDOW.

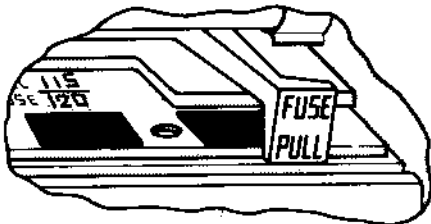

#### SELECTION OF OPERATING VOLTAGE

1. SLIDE OPEN POWER MODULE COVER DOOR AND PUSH FUSE-PULL LEVER TO LEFT TO REMOVE FUSE.
2. PULL OUT VOLTAGE-SELECTOR PC BOARD. POSITION PC BOARD SO THAT VOLTAGE NEAREST ACTUAL LINE VOLTAGE LEVEL IS ON TOP-LEFT SIDE OF BOARD. PUSH BOARD BACK INTO ITS SLOT.
3. PUSH FUSE-PULL LEVER INTO ITS NORMAL RIGHT-HAND POSITION.
4. CHECK FUSE TO MAKE SURE IT IS OF CORRECT RATING AND TYPE FOR INPUT AC LINE VOLTAGE. FUSE RATINGS FOR DIFFERENT LINE VOLTAGES ARE INDICATED BELOW POWER MODULE.
5. INSERT CORRECT FUSE IN FUSEHOLDER.

Figure 2-1. Line Voltage Selection with Power Module P.C. Board

Line Voltage	Selection	Fuse
90 to 105 Vac	100V	1A T
108 to 126 Vac	115/120V	1A T
198 to 231 Vac	220V	500 mA T
216 to 252 Vac	230/240V	500 mA T

- c. Make sure the correct fuse is installed in the fuse holder. The required fuse rating for each line voltage selection is indicated below the power line module.

## 2-14. BENCH USE

2-15. When used with the 8505A Network Analyzer, the 8501A Storage-Normalizer should be positioned on top of the network analyzer. If desired, the 8501A and 8505A can be locked together. To do this proceed as follows:

- Remove the 8505A front frame top trim strip (see Figure 2-2).
- Fasten the four lock links (Part of HP Part Number 5061-0099) to the 8505A front frame using the eight 6-32 pozidrive screws provided (there are eight threaded holes in the front frame). The hook-shaped protrusions of the lock links must extend toward the rear of the 8505A (see Figure 2-2).
- Remove the two bottom rear feet from the 8501A and replace with two lock feet that

contain thumb screws (Part of 5061-0099). There is a left one and a right one. See Figure 2-3 for proper placement.

- Remove the two top rear feet from the 8505A (upper unit) and replace with lower left rear lock foot and lower right rear lock foot. See Figure 2-3 for proper placement.
- Set the 8501A on top of the 8505A with the front edge of the 8501A overhanging the front edge of the 8505A approximately 1/4 inch.
- Slide the 8501A back until its front edge is even with the front edge of the 8505A. This should lock the fronts of the two units together. Make sure they are locked by carefully lifting the front of the 8501A.
- Tighten the thumb screws on the upper rear lock feet of the 8501A into the lower rear lock feet of the 8505A.

## 2-16. Front Handles (Option 907)

2-17. Instruments with Option 907 contain a Front Handles Kit. This kit supplies necessary hardware and installation instructions for mounting front handles on the instrument. Installation instructions are the same as for Option 909 except only the starred parts in Figure 2-4 are used.

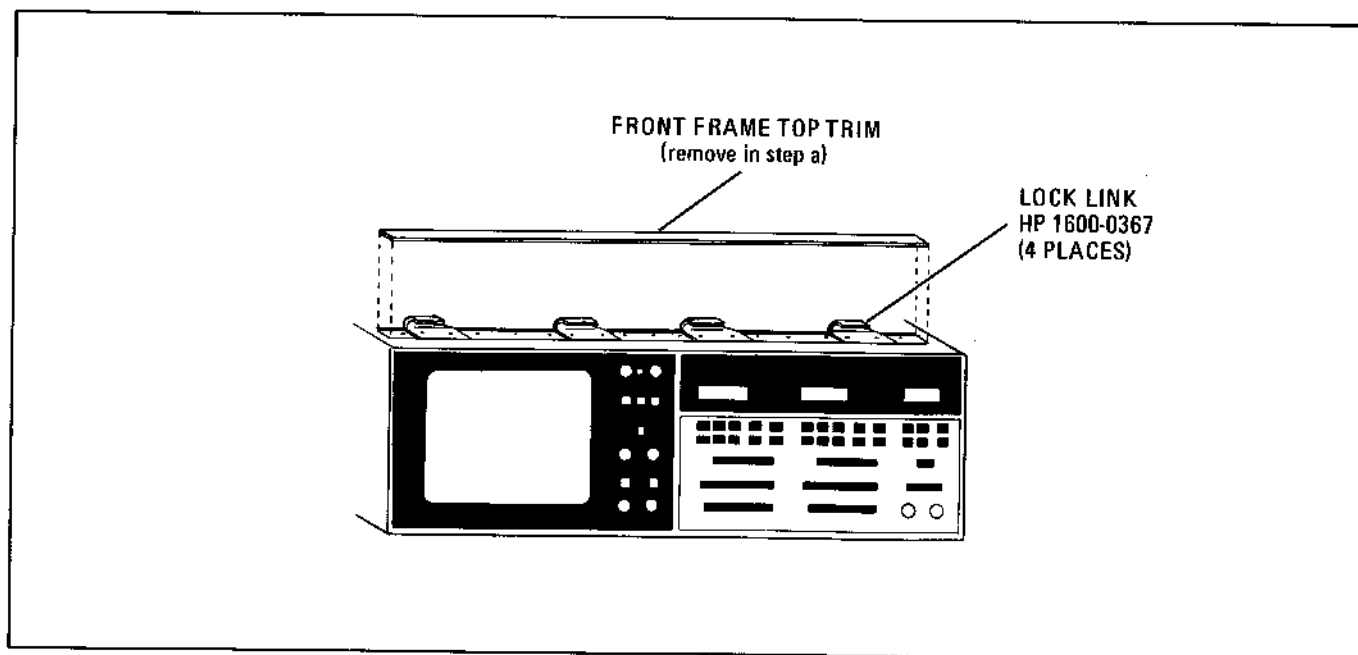

Figure 2-2. Installation of Lock Links on 8505A

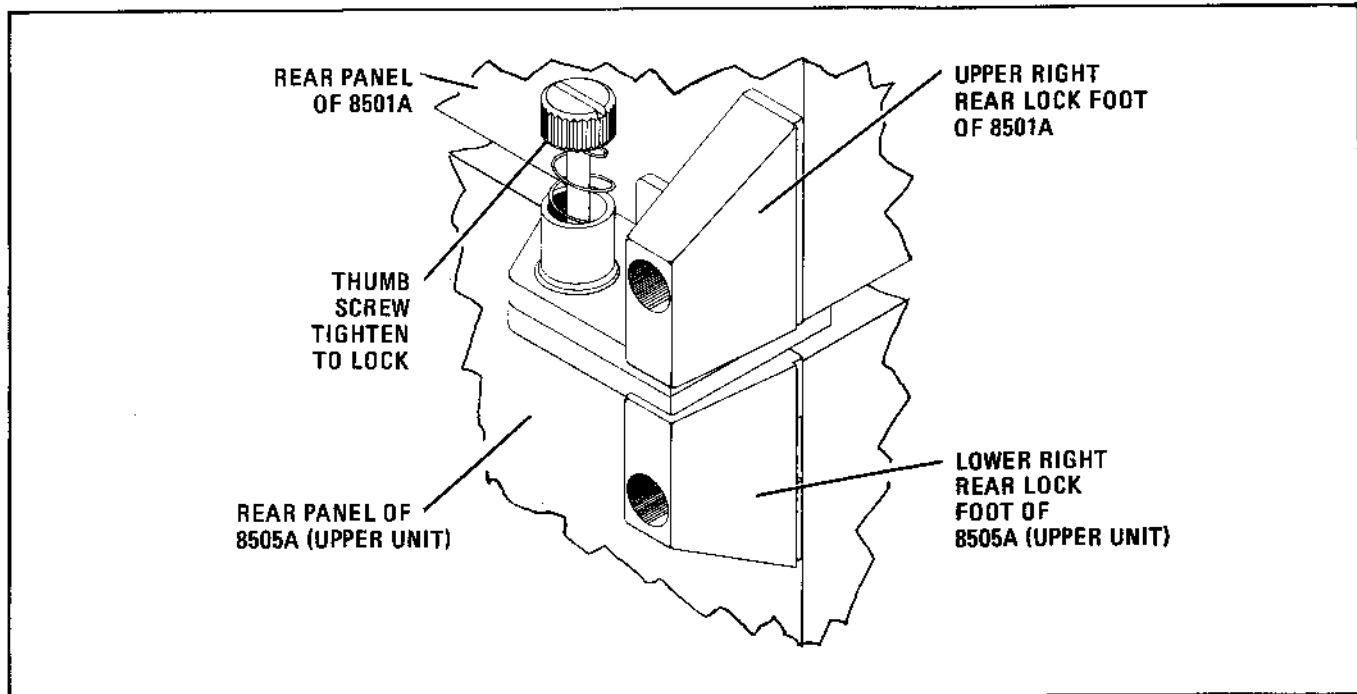

Figure 2-3. Lock Feet, Right Side

**2-18. RACK MOUNTING**

2-19. Two rack mounting kits are available for the 8501A. One, Option 908, is for 8501A's that do not have or need front handles. The other rack mounting kit, Option 909, includes both the rack mounting hardware and the front handles. Parts supplied with the kits are listed in Table 2-1. Installation instructions are given in Figure 2-4.

wire power cable. When connected to an appropriate power line outlet, this cable grounds the instrument cabinet. Figure 2-5 shows the styles of mains plugs available on power cables supplied with HP instruments.

**WARNING**

If this instrument is to be energized through an autotransformer, make sure the common terminal of the autotransformer is connected to the protective

(Continued)

**2-20. CABLE CONNECTIONS**

**2-21. Power Cable**

2-22. In accordance with international safety standards, this instrument is equipped with a three-

Table 2-1. Rack-Mounting Kits for 8501A

Description	HP Part Number	Quantity
OPTION 908		
Rack Flange	5020-8861	2
Machine Screw, Pan Head, 8-32 x 0.375 inch	2510-0193	6
OPTION 909		
Handle Assembly	5060-9898	2
Rack Flange	5020-8873	2
Machine Screw, Pan Head, 8-32 x 0.625 inch	2501-0194	6

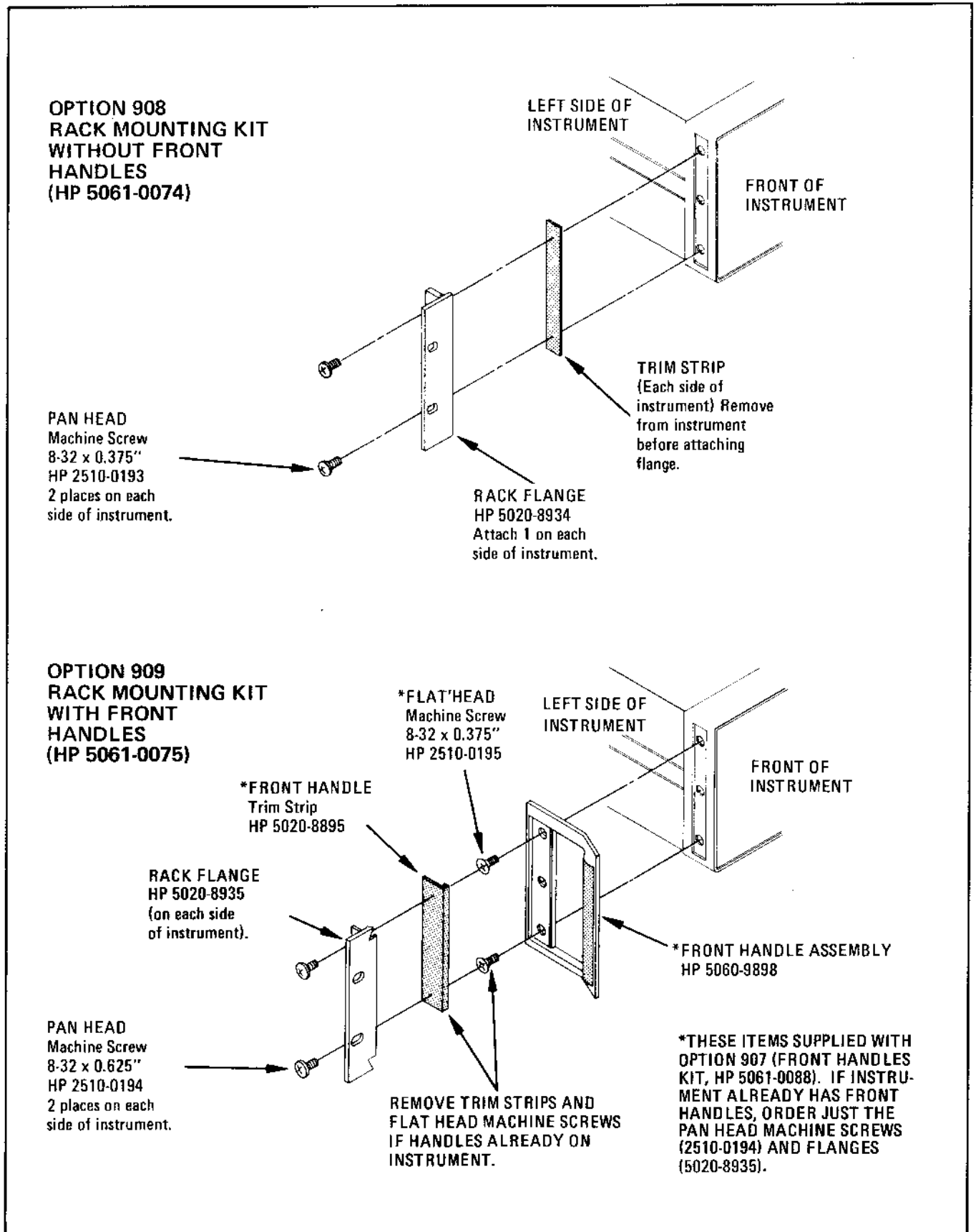

Figure 2-4. Attached Rack Mounting Hardware and Handles

**WARNING** (Cont'd)

earth contact of the power source outlet socket.

Any interruption of the protective ground, inside or outside the 8501A, can make the 8501A an electrical shock hazard.

**2-23. Normalizer Interconnect Cable**

**WARNING**

Any installation procedure performed with the instrument's protective covers removed and with ac power connected must be performed **ONLY** by qualified maintenance service personnel who are aware of the hazards involved.

2-24. The Normalizer Interconnect Cable (HP Part Number 08501-60067) connects from the 8501A rear panel NORMALIZER INTERCONNECT receptacle (J6) to the 8505A rear panel NORMALIZER INTERCONNECT receptacle (A3J1). Signal lines in the Normalizer Interconnect Cable are shown in Figure 2-6.

**NOTE**

In some 8505A's, the NORMALIZER INTERCONNECT receptacle has a metal insert in one of the unused coaxial cable connector holes. Remove this

insert by poking it out from inside the 8505A before you connect the normalizer interconnect cable.

**2-25. Labeling Interconnect Cable**

2-26. The Labeling Interconnect Cable (HP Part Number 08501-60068) connects from the LABELING INTERCONNECT receptacle J4 on the 8501A to the LABELING INTERCONNECT receptacles A3J12 and A2J11 on the 8505A. Signal lines in the Labeling Interconnect Cable are shown in Figure 2-7.

**2-27. HP-IB Cable**

2-28. The HP-IB Cable (HP Part Number 10631A) connects from the HP-IB receptacle (J5) on the 8501A rear panel to any other receptacle on the Hewlett-Packard Interface Bus. Signal lines in the HP-IB cable are shown in Figure 2-8.

**2-29. External Display Connection**

2-30. If the test setup includes an external CRT display, connect the display inputs to the X, Y, and Z BNC connectors (J1, J2, and J3) on the rear panel of the 8501A. For connections between the display and other test instruments, refer to the Operations Section (Section III) of this manual.



**2-31. Mating Connectors**

2-32. A list of connectors on the front and rear panels of the Model 8501A is given in Table 2-2.

*Table 2-2. Model 8501A Mating Connectors*

Connector on Instrument	Mating Connector		
	Industry Identification	HP Part No.	Alternate Sources
J1 X J2 Y J3 Z	Type BNC, male connector UG-88/U	1250-0256	Amphenol Bendix Specialty Connector
J4 Labeling Interconnect	Series D, 25 contact, male connector	1251-0063	Cinch Cannon
J5 HP-IB	HP-IB Cable	10631A/B/C*	None
J6 Normalizer Interconnect	Series D, 24 contact male connector coax contact	1251-2204 1251-0179 (7 each)	Cinch Cannon

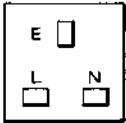
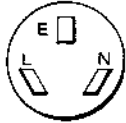
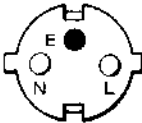
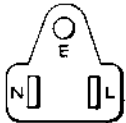
\*HP-IB cable 10631A is approximately 1 metre long; 10631B, 2 metres long; 10631C, 4 metres long.

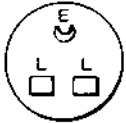
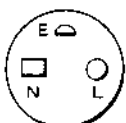
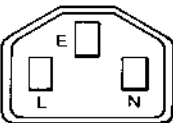
Plug Type	Cable HP Part Number	C D	Plug Description	Cable Length (inches)	Cable Color	For Use In Country
<b>250V</b> 	8120-1351 8120-1703	0 6	Straight*BS1363A 90°	90 90	Mint Gray Mint Gray	United Kingdom, Cyprus, Nigeria, Rhodesia, Singapore
<b>250V</b> 	8120-1369 8120-0696	0 4	Straight*NZSS198/ASC112 90°	79 87	Gray Gray	Australia, New Zealand
<b>250V</b> 	8120-1689 8120-1692	7 2	Straight*CEE7-Y11 90°	79 79	Mint Gray Mint Gray	East and West Europe, Saudi Arabia, Egypt So. Africa, India (unpolarized in many nations)
<b>125V</b> 	8120-1348 8120-1398 8120-1754 8120-1378 8120-1521 8120-1676	5 5 7 1 6 2	Straight*NEMA5-15P 90° Straight*NEMA5-15P Straight*NEMA5-15P 90° Straight*NEMA5-15P	80 80 36 80 80 36	Black Black Black Jade Gray Jade Gray Jade Gray	United States, Canada, Japan (100V or 200V), Mexico, Philippines, Taiwan
<b>250V</b> 	8120-2104	3	Straight*SEV1011 1959-24507 Type 12	79	Gray	Switzerland
<b>250V</b> 	8120-0698	6	Straight*NEMA6-15P			United States, Canada
<b>220V</b> 	8120-1957 8120-2956	2 3	Straight*DHCK 107 90°	79 79	Gray Gray	Denmark
<b>250 V</b> 	8120-1860	6	Straight*CEE22-V1 (Systems Cabinet use)			

\*Part number shown for plug is industry identifier for plug only. Number shown for cable is HP Part Number for complete cable including plug.  
E = Earth Ground; L = Line; N = Neutral

Figure 2-5. AC Power Cables Available

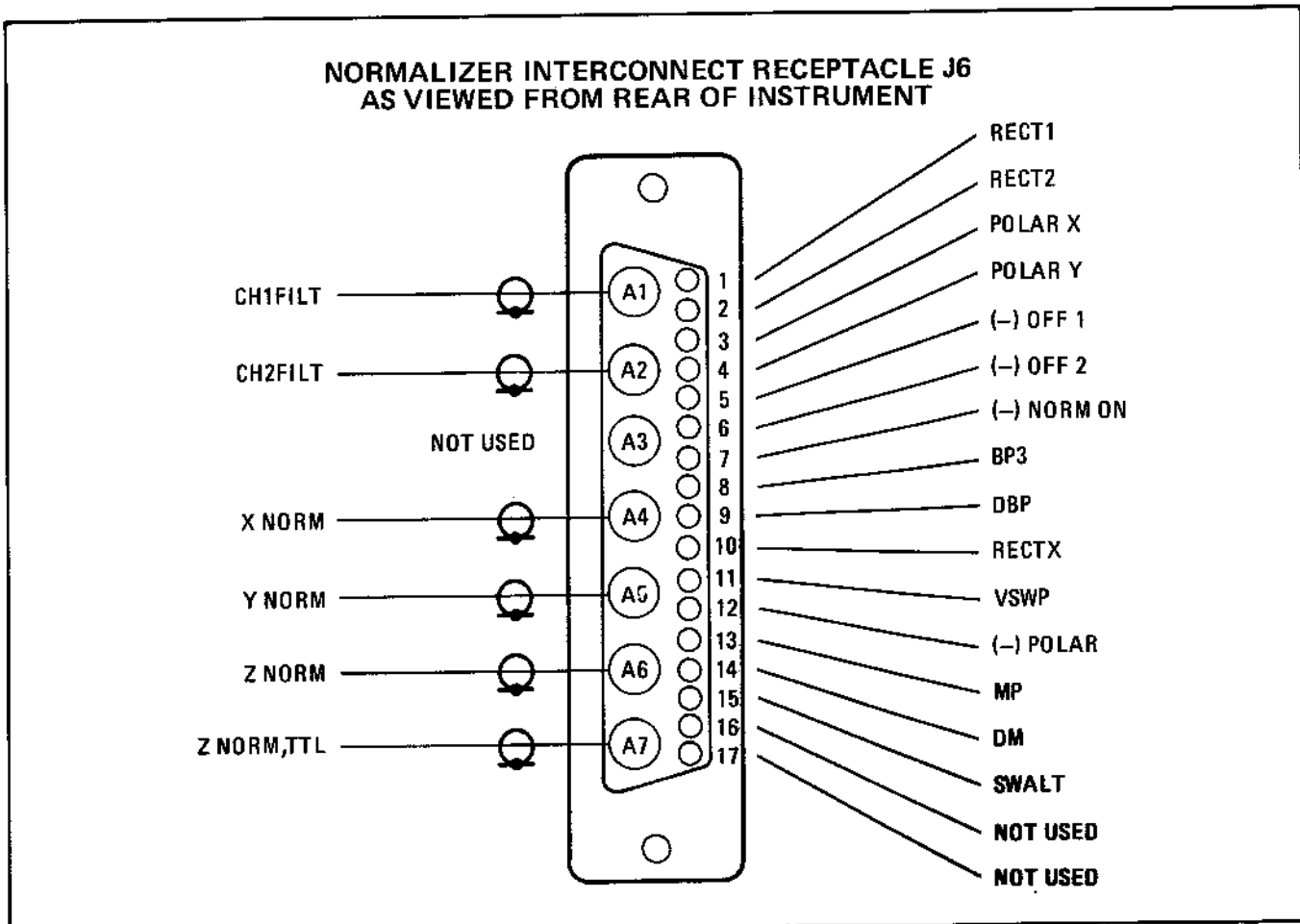

**MNEMONICS TABLE**

Mnemonic	Description
BP3	Blanking Pulse 3. High=retrace
CH1FILT	Channel 1 analog input
CH2FILT	Channel 2 analog input
DBP	Data Blanking Pulse. High=blank
DM	Data Marker. High=display marker and measure
MP	Marker Pulse. High=display marker
(-)NORMON	Normalizer input enable. Low=inputs enabled
(-)OFF1	Channel 1 blanking. Low=blank
(-)OFF2	Channel 2 blanking. Low=blank
(-)POLAR	Polar data select. Low=polar data
POLARX	Polar offset, X-axis
POLARY	Polar offset, Y-axis
RECT1	Channel 1 graph mode Y-axis offset
RECT2	Channel 2 graph mode Y-axis offset
RECTX	Graph mode X-axis offset
SWALT	Channel sweep alternate, High=Channel 1, Low=Channel 2
VSWP	Analog sweep ramp
XNORM	X-axis output
YNORM	Y-axis output
ZNORM	Z-axis output
ZNORM, TTL	Z-axis TTL blanking output. High=blank

*Figure 2-6. Normalizer Connector, Signals and Pin Configuration*



**LABELING INTERCONNECT RECEPTACLE J4  
AS VIEWED FROM REAR OF INSTRUMENT**

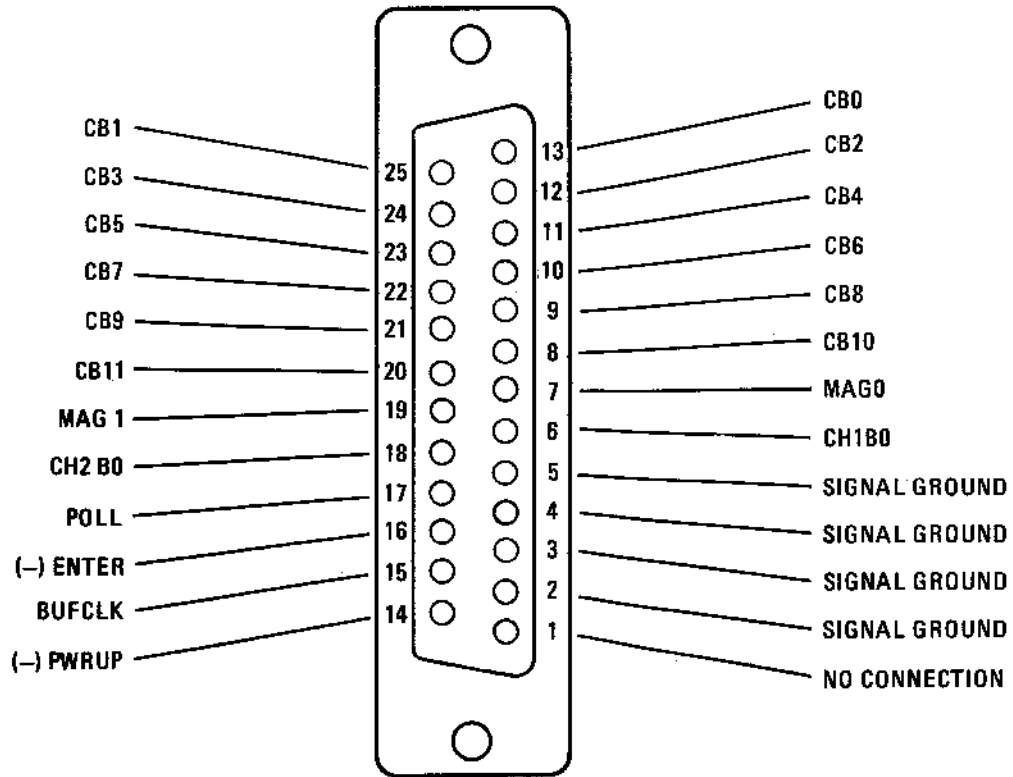

**MNEMONICS TABLE**

Mnemonic	Description
BUFCLK	Buffered 1 MHz clock for character I/O
CB 00 thru 11	Character Bus bit 00 thru 11
CH1B0	Channel 1 normalization select, High=normalization selected
CH2B0	Channel 2 normalization select, High=normalization selected
(-)ENTER	Low=Enter character bus into memory
MAG0	Magnifier bit 0
MAG1	Magnifier bit 1
POLL	I/O Poll enable
(-)PWRUP	Power-Up reset

Figure 2-7. Labeling Connector, Signals and Pin Configuration

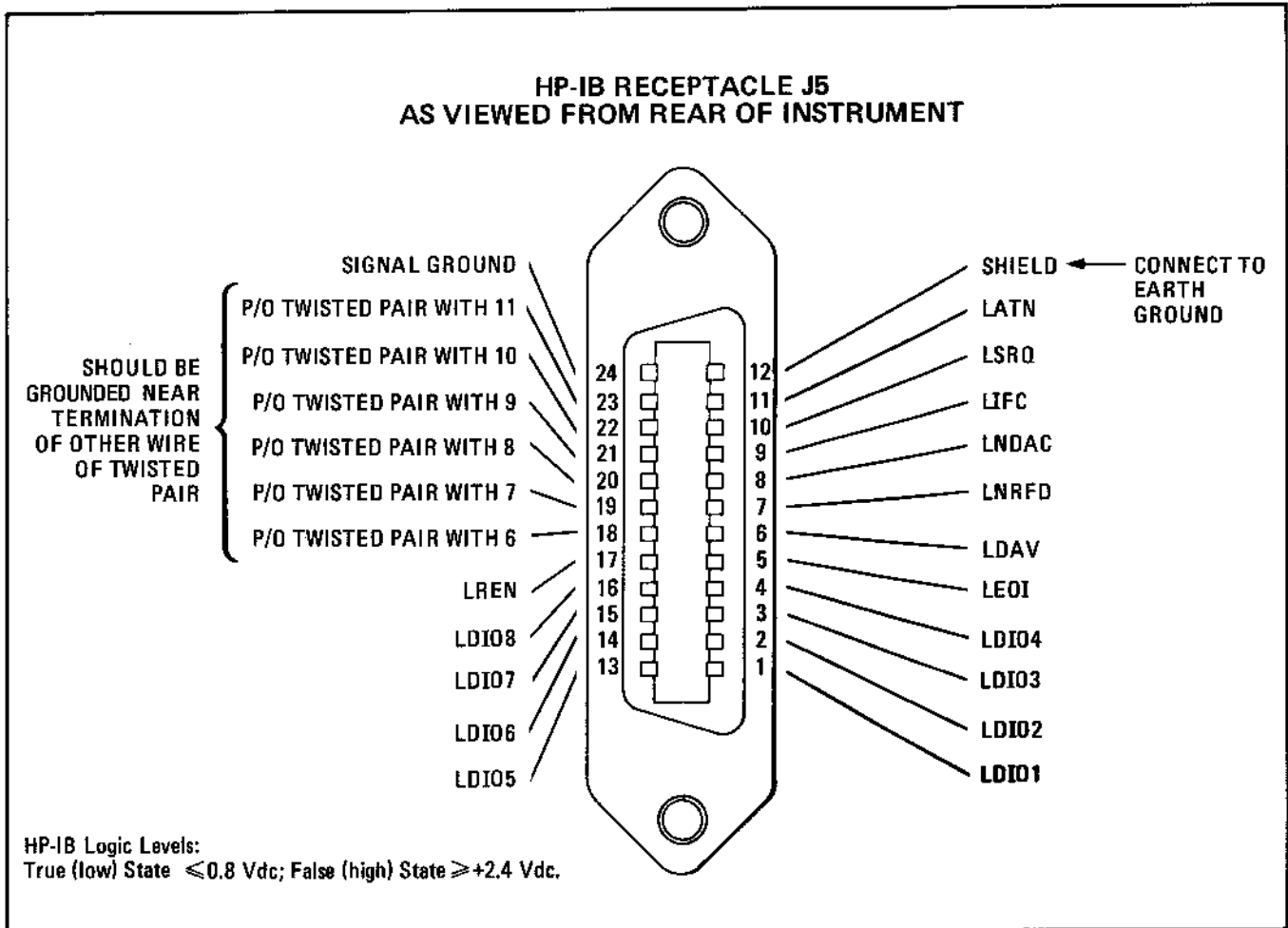

**MNEMONICS TABLE**

Mnemonic	Description
LATN	Attention control line
LDAV	Data Valid control line
LDIO1 thru 8	Data Input/Output lines
LEOI	End or Identify control line
LIFC	Interface Clear control line
LNDAC	Data Not Accepted control line
LNRFD	Not Ready For Data control line
LREN	Remote Enable control line
LSRQ	Service Request control line

*Figure 2-8. HP-IB Connector, Signals, and Pin Configuration*

**2-33. HP-IB ADDRESS SELECTION**

2-34. The 8501A Normalizer comes from the factory with an HP-IB "talk" address of "N" and a listen address of "." (period). The decimal value for this code is 14 and the five-bit binary value is 01110. The position of the address switches on A3S1 for this code is shown in Figure 2-9.

2-35. The selection of address codes are listed in Table 2-3. The talk and listen addresses are assigned in pairs. Each line across in Table 2-3 contains one talk and listen pair. In each pair, bits one through five are the same. The sixth and seventh bits are used to indicate whether the address is "listen" or "talk".

**2-36. STORAGE AND SHIPMENT**

**2-37. Environment**

2-38. The instrument should be stored in a clean, dry environment. The following environmental limits apply to both storage and shipment:

Temperature . . . . . -40°C to +75°C  
 Humidity . . . . . Up to 95% relative  
 Altitude . . . . . 15 240 metres (50 000 feet)

**2-39. Original Packaging**

2-40. Containers and materials identical with those used in factory packaging are available through

Hewlett-Packard offices. See Figure 2-10 for factory packaging. If the instrument is being returned to Hewlett-Packard for servicing, attach a tag indicating the type of service required, return address, model number, and full serial number. Also, mark the container FRAGILE to ensure careful handling. In any correspondence, refer to the instrument by model number and full serial number.

**2-41. Other Packaging**

2-42. The following general instructions apply for repackaging with commercially available materials.

- a. Wrap the instrument in heavy paper or plastic. (If shipping to a Hewlett-Packard office or service center, attach a tag indicating the type of service required, return address, model number, and full serial number.)
- b. Use a strong shipping container. A double-wall carton made of 275 pound bursting strength corrugated single-wall box is sufficient.
- c. Use enough shock-absorbing material (3-to-4-inch layer) around all sides of the instrument to provide a firm cushion and prevent movement inside the container. Protect the control panel with cardboard.
- d. Seal the shipping container.
- e. Mark the shipping container FRAGILE to ensure careful handling.

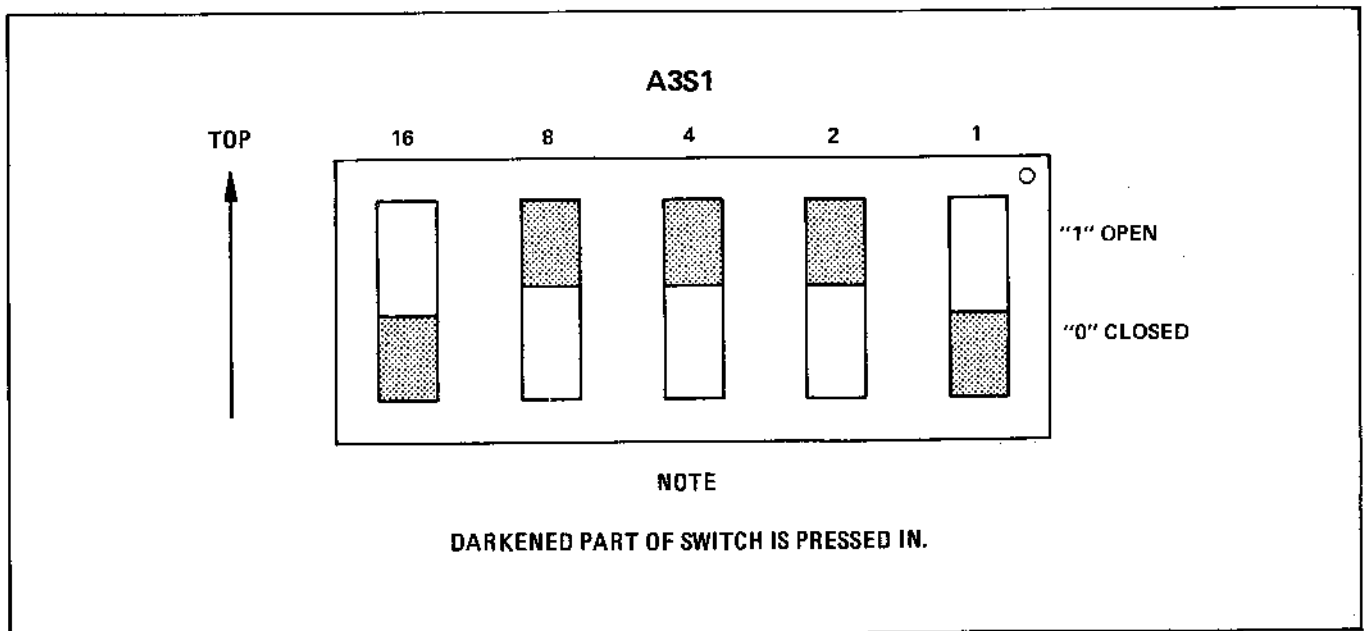

Figure 2-9. A3S1 Address Switch Showing Factory Set Position

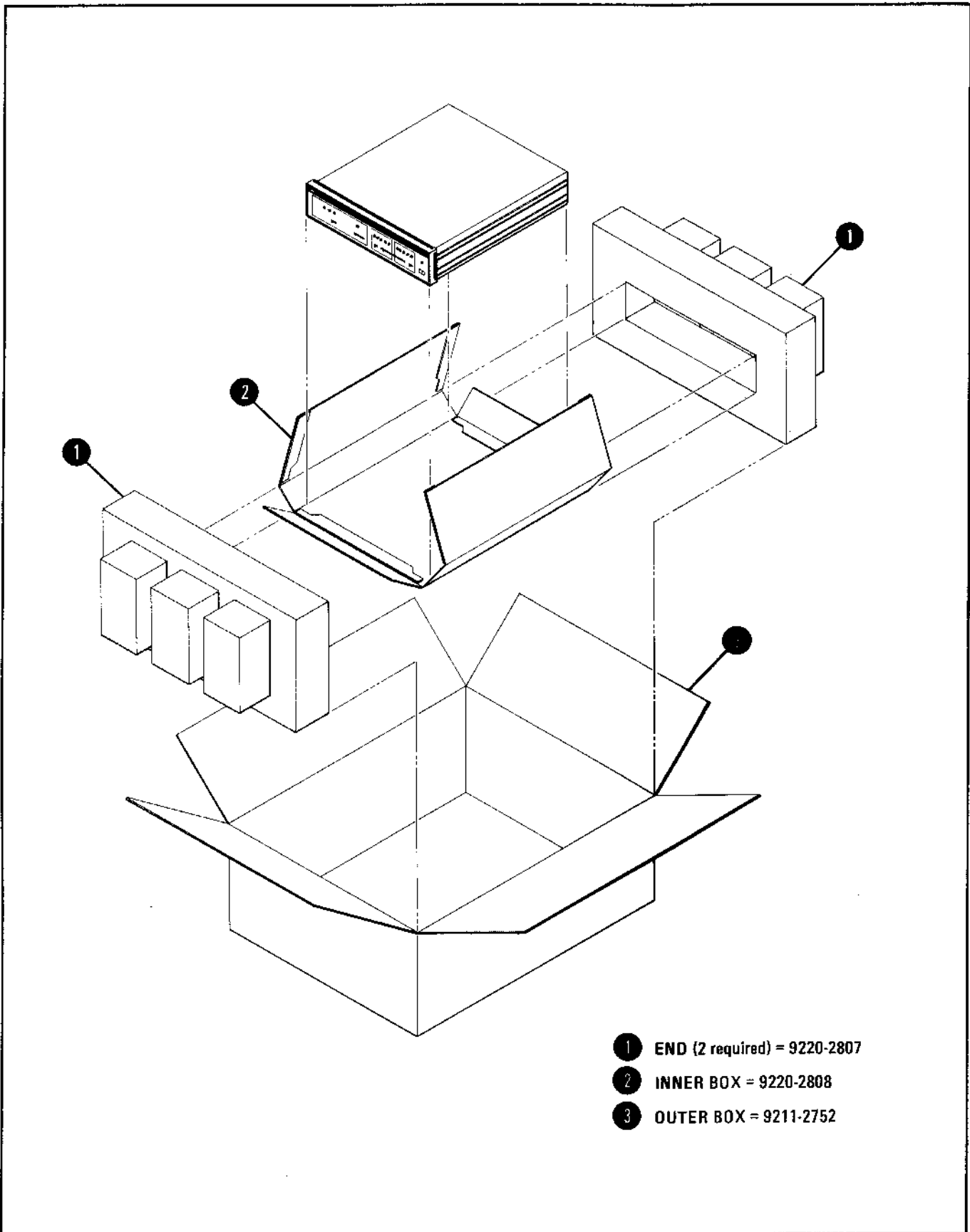

Figure 2-10. Factory Packaging

Table 2-3. Talk and Listen Address

Address Characters		Address Switch Settings					Address Codes	
Listen	Talk	(5)	(4)	(3)	(2)	(1)	decimal	octal
SP	@	0	0	0	0	0	0	0
!	A	0	0	0	0	1	1	1
"	B	0	0	0	1	0	1	1
#	C	0	0	0	1	1	3	3
\$	D	0	0	1	0	0	4	4
%	E	0	0	1	0	1	5	5
&	F	0	0	1	1	0	6	6
'	G	0	0	1	1	1	7	7
(	H	0	1	0	0	0	8	10
)	I	0	1	0	0	1	9	11
*	J	0	1	0	1	0	10	12
+	K	0	1	0	1	1	11	13
,	L	0	1	1	0	0	12	14
-	M	0	1	1	0	1	13	15
.	N	0	1	1	1	0	14	16 - Preset
/	O	0	1	1	1	1	15	17
0	P	1	0	0	0	0	16	20
1	Q	1	0	0	0	1	17	21
2	R	1	0	0	1	0	18	22
3	S	1	0	0	1	1	19	23
4	T	1	0	1	0	0	20	24
5	U	1	0	1	0	1	21	25
6	V	1	0	1	1	0	22	26
7	W	1	0	1	1	1	23	27
8	X	1	1	0	0	0	24	30
9	Y	1	1	0	0	0	25	31
:	Z	1	1	0	1	0	26	32
;	[	1	1	0	1	1	27	33
<	/	1	1	1	0	0	28	34
=	]	1	1	1	0	1	29	35
>	^	1	1	1	1	0	30	36

## SECTION III OPERATION AND PROGRAMMING

### 3-1. INTRODUCTION

3-2. This section explains the functions of the 8501A Storage-Normalizer controls, indicators, and connectors. Procedures in this section describe how to adjust the 8501A to adapt it to a network analyzer (Paragraph 3-19). Included in this section are instructions to program the 8501A with a desk-top computer. If a functional test procedure is desired, go to Section IV.

### 3-3. OPERATING FEATURES

3-4. The 8501A Storage-Normalizer adds several significant operating capabilities to the 8505A Network Analyzer and is fully programmable through the standard HP-IB interface.

3-5. With the Normalizer and labeling connections made to the 8505A, and with the 8501A STORAGE ON pushbutton pressed, the 8501A controls the 8505A CRT display to provide the following features:

- Digital Storage
- Normalization
- Magnification
- Averaging
- 8505A Operating Mode Labels

### 3-6. Digital Storage

3-7. With the 8501A INPUT ON switch pressed, the 8501A accepts measurement data from the 8505A at a rate selected by the 8505A SCAN TIME SEC sweep speed switch. This data is digitized and stored in memory. Simultaneously, the 8501A extracts the digital data from memory, converts it to an analog signal, and sends it back to the 8505A CRT display as a flicker-free trace. This produces a crisp continuous display of the measurement trace regardless of the 8505A scan time, permitting easy adjustment of the device-under-test.

### 3-8. Normalization

3-9. Normalization removes a reference response characteristic from the response characteristic of the device-under-test. Frequency response variations of the 8505A and the components in the test

setup are removed from the cartesian display by storing a reference trace (short, open, open/short, or through), then subtracting the stored reference trace from the device-under-test frequency response.

3-10. This is accomplished in the "Input-Memory" mode. Pressing the 8501A MEMORY STORE moves the displayed trace into reference memory. Selecting INPUT-MEMORY (-MEM) causes the reference trace to be subtracted from the current input measurement trace and the result is displayed on the 8505A CRT. This normalization process removes the need to draw calibration lines on the CRT.

### 3-11. Magnification

3-12. Selecting MAGNIFIER switch positions X2, X5, or X10, you can increase the CRT display resolution. In the X10 position, the resolution is 0.01 dB, 0.1 degree, and 0.1 nanosecond for the cartesian display and up to 0.001 linear coefficient full scale for the polar display. When the MAGNIFIER switch is set to other than X1, the actual scale/division selected is:

$$\frac{8505A}{SCALE/DIV} \times \frac{1}{\frac{8501A}{MAGNIFIER}} = \text{Actual SCALE/DIV}$$

The MAGNIFIER switch selects the magnification for both display channels.

### 3-13. Averaging

3-14. Setting the AVERAGING switch to ON causes the data for that channel to be averaged. Averaging is accomplished by an exponential running average technique where each trace has  $1/n$  weight, where  $n$  is the selected AVERAGING FACTOR. For example, if an averaging factor of 128 is selected, the new trace will have a weight of  $1/128$  to change the last trace.

3-15. The 8501A digital averaging functions similar to a video filter, eliminating random noise fluctuations from the displayed trace. This technique adds accuracy and resolution to network measurements by increasing the signal-to-noise ratio for the

measurements. This feature is useful in any measurement where noise is a problem.

**3-16. 8505A Operating Mode Labels**

3-17. Setting the LABELS switch to ON displays all major measurement mode settings directly on the 8505A CRT. At the top of the CRT are displayed the 8505A Channel 1 and Channel 2 INPUT, MODE, MKR value, SCALE/DIV, and if connected,

the 8503A S-Parameter Test Set switching state. Along the bottom of the CRT are displayed Start/Stop, CW±ΔF, or CW frequency settings, as well as the counted MKR frequency.

3-18. This labeling capability provides a simple way to document test results for photography and makes it possible to read magnitude, phase, and group delay measured values without looking away from the CRT.

**3-19. ADJUSTMENTS TO MATCH 8501A TO 8505A**

3-20. The following procedure describes the adjustment necessary to match the 8501A to the 8505A Network Analyzer being used. These adjustments should be made before the system is used to make measurements.

*Equipment Initial Setup*

1. Connect equipment as shown in Figure 3-1.

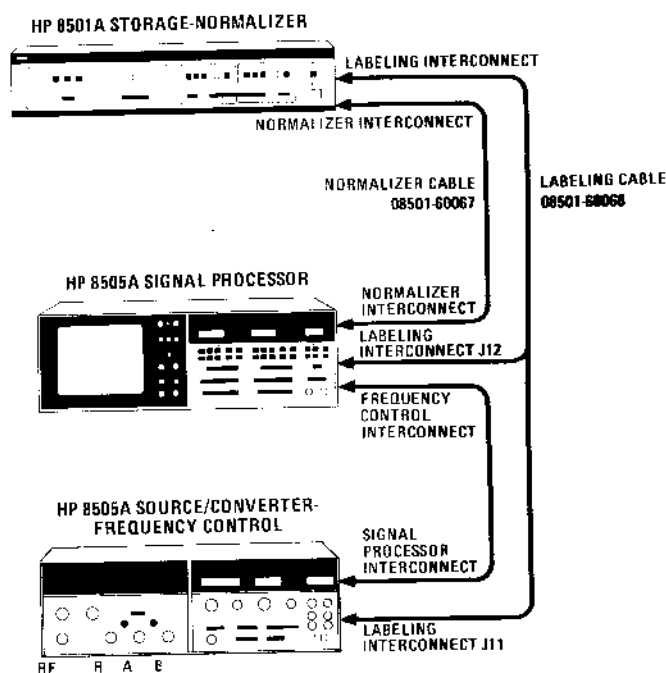

Figure 3-1. Test Setup to Make Initial Matching Adjustments

2. Set controls on the 8505A and 8501A as follows:

8501A

STORAGE ..... OFF (pressed)  
 MAGNIFIER ..... X1  
 CHANNEL 1 INPUT ..... ON (pressed)

CHANNEL 1 AVERAGING ..... OFF  
 CHANNEL 2 INPUT ..... ON (pressed)  
 CHANNEL 2 AVERAGING ..... OFF

8505A FREQUENCY CONTROL

MODE ..... LIN EXPAND  
 WIDTH ..... CW ± ΔF  
 SCAN TIME SEC ..... .1 — .01  
 TRIGGER ..... AUTO

8505A SIGNAL PROCESSOR

CHANNEL 1 INPUT ..... R  
 CHANNEL 1 MODE ..... MAG  
 CHANNEL 2 MODE ..... OFF  
 CRT Display REF LINE POSN ..... On (pressed in)  
 CRT Display CH 1 up-down control ..... Adjust reference line  
 trace to center line  
 CRT Display X POSN ..... Center trace end dots  
 over edge graticule lines  
 CRT Display TRACE ..... Adjust to align trace  
 to horizontal line



Any adjustment made to the instrument while its protective covers are removed must be performed **ONLY** by qualified maintenance service personnel who are aware of the hazards involved.

**NOTE**

**If the ends of the trace line do not fall directly on the edge lines of the graticule, adjustment of the X-deflection amplifier in the 8505A is necessary. (See 8505A Operating and Service Manual.)**

*Rear Panel Channel 1 Adjustment*

3. On 8501A, press STORAGE ON pushbutton. Adjust the rear panel X-OFFSET RECT control to center the reference line trace between the left and right edge of the graticule.
4. On 8501A, adjust the rear panel Y-OFFSET CH 1 control to place the reference line trace on the center graticule line.

*Rear Panel Channel 2 Adjustment*

5. On 8505A, set the following:

CHANNEL 1 MODE ..... OFF  
 CHANNEL 2 INPUT ..... R  
 CHANNEL 2 MODE ..... MAG

6. On 8501A, press front panel STORAGE OFF pushbutton. On the 8505A, adjust CRT Display CH 2 up-down control to place the reference line trace on the center graticule line.
7. On 8501A, press STORAGE ON pushbutton. Adjust the rear panel Y-OFFSET CH 2 control to place the reference line on the center graticule line.



*Rear Panel Polar Adjustments*

8. On 8501A, press STORAGE OFF pushbutton. On 8505A, set Channel 2 INPUT to A/R, MODE to POLAR MAG, and adjust the two CRT Display BEAM CENTER POL controls to place the dot on the trace in the center of the graticule.
9. On 8501A, press STORAGE ON pushbutton. Adjust rear panel X-OFFSET POL (polar) control to place the trace dot at the center of the graticule horizontally.
10. Adjust the rear panel Y-OFFSET POL (polar) control to place the trace dot at the center of the graticule vertically.

**NOTE**

**The 8501A is now adjusted to match the 8505A Network Analyzer and is ready to make measurements.**

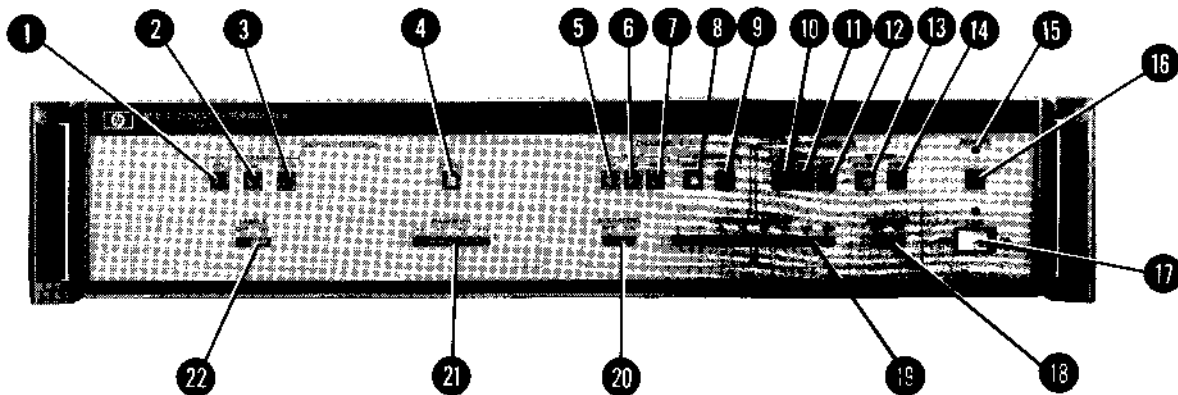
**FRONT PANEL**

- |   |  |
|---|--|
| <p><b>1 STORAGE OFF Pushbutton.</b> Pressing this pushbutton switches the 8501A out of the signal path, allowing a normal display without any effect from the Storage-Normalizer.</p> <p><b>2 STORAGE ON Pushbutton.</b> Pressing this pushbutton selects storage mode, switching the 8501A into the input signal path allowing flicker-free displays according to the mode selected by the Channel 1 and 2 INPUT switches.</p> <p><b>3 STORAGE HOLD Pushbutton.</b> Pressing this pushbutton holds on the CRT as a fixed trace whatever is being displayed when the pushbutton is pressed. This mode is used when photographing the CRT trace or when a stable trace is desired to inspect details of the CRT trace.</p> | <p><b>4 ERASE Pushbutton.</b> Pressing this pushbutton erases all memory, including references.</p> <p><b>5 CHANNEL 1 INPUT OFF Pushbutton.</b> Pressing this pushbutton turns off the Channel 1 signal trace. The labeling on the CRT is not affected.</p> <p><b>6 CHANNEL 1 INPUT ON Pushbutton.</b> Pressing this pushbutton turns on the Channel 1 signal trace.</p> <p><b>7 CHANNEL 1 INPUT — MEM (memory) Pushbutton.</b> Pressing this pushbutton subtracts the Channel 1 reference data stored in memory from the Channel 1 input signal, and displays the resultant on the CRT. This produces a display that is normalized to the reference memory. Note: Prior to using this function, a signal must be stored with Memory STORE button.</p> |
|---|--|

*Figure 3-2. Front Panel Controls (1 of 2)*

## FRONT PANEL (Cont'd)

- 8 CHANNEL 1 MEMORY STORE Pushbutton.** Pressing this pushbutton stores into P1 of memory the displayed trace at the time the pushbutton was pressed. This stored trace may be recalled by pressing Channel 1 memory VIEW pushbutton. The stored trace is also used to subtract from the input signal when Channel 1 INPUT--MEM pushbutton is pressed.
- 9 CHANNEL 1 MEMORY VIEW Pushbutton.** Pressing this pushbutton displays on the CRT, the trace stored in P1 of memory. This trace may be viewed simultaneously with the Channel 1 Input or input-memory trace.
- 10 CHANNEL 2 INPUT OFF Pushbutton.** Pressing this pushbutton turns off the Channel 2 data trace. The labeling on the CRT is not affected.
- 11 CHANNEL 2 INPUT ON Pushbutton.** Pressing this pushbutton turns on the Channel 2 data trace.
- 12 CHANNEL 2 INPUT — MEM (memory) Pushbutton.** Pressing this pushbutton subtracts the Channel 2 reference data stored in memory from the Channel 2 input signal, and displays the resultant on the CRT. This produces a display that is normalized to the reference memory. Note: Prior to using this function, a signal must be stored with Memory STORE button **13**.
- 13 CHANNEL 2 MEMORY STORE Pushbutton.** Pressing this pushbutton stores into P2 of memory the displayed trace at the time the pushbutton was pressed. This stored trace may be recalled by pressing Channel 2 memory VIEW pushbutton. The stored trace is also used to subtract from the input signal when Channel 2 INPUT—MEM pushbutton is pressed.
- 14 CHANNEL 2 MEMORY VIEW Pushbutton.** Pressing this pushbutton displays on the CRT, the trace stored in P2 of memory. This trace may be viewed simultaneously with the Channel 2 input or input-memory trace.
- 15 REMOTE Indicator.** When this lamp is lit, it indicates that the instrument is in remote mode and is being controlled by a computing controller on the HP-IB. To get from REMOTE to LOCAL mode, press LOCAL Pushbutton.
- 16 LOCAL Pushbutton.** In remote mode, pressing this pushbutton removes the 8501A from control of the computing controller on the HP-IB and gives control to the front panel. This may be inhibited by the controller with the LOCAL LOCKOUT command.
- 17 LINE OFF-ON Switch.** This switch sets the line power on or off.
- 18 CHANNEL 2 AVERAGING Switch.** Setting this switch to ON averages the Channel 2 signal trace as determined by the AVERAGING FACTOR switch.
- 19 AVERAGING FACTOR Switch.** This switch selects the weight of each new sweep to be applied to the displayed trace. For example, if an averaging factor of 128 is selected, the new trace will have a weight 1/128th of the displayed trace.
- 20 CHANNEL 1 AVERAGING Switch.** Setting this switch to ON averages the Channel 1 signal trace as determined by the AVERAGING FACTOR switch.
- 21 MAGNIFIER Switch.** This switch selects the degree of magnification in the vertical direction of the displayed trace. Selecting X1 gives a normal trace with no magnification.
- 22 LABELS Switch.** This switch turns on or off all alphanumeric labeling on the CRT display.

Figure 3-2. Front Panel Controls (2 of 2)

## REAR PANEL

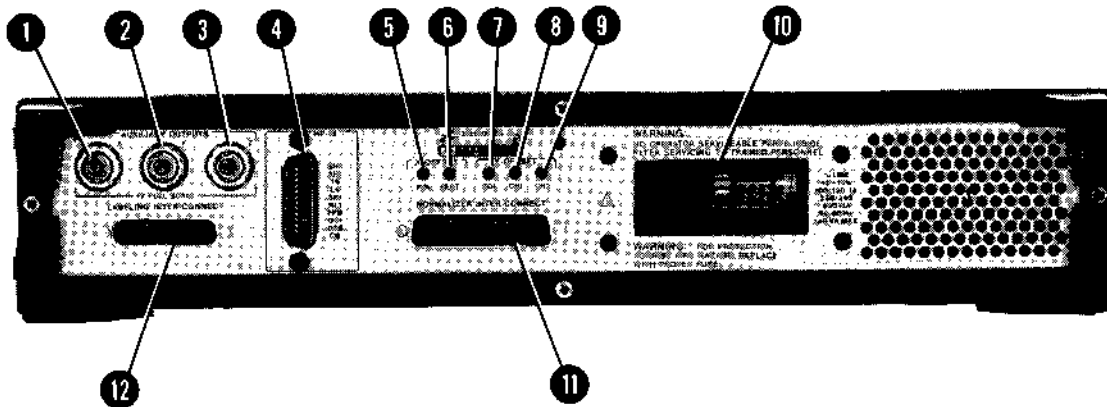

- 1 **X AUXILIARY OUTPUT Connector J1.** This is used for the X channel of an external CRT display. The output is 83 mV/Division. (1 Volt full screen = 12 divisions.)
- 2 **Y AUXILIARY OUTPUT Connector J2.** This is used for the Y channel of an external CRT display. The output is 100 mV/Division. (1 Volt full screen = 10 divisions.)
- 3 **Z AUXILIARY OUTPUT Connector J3.** This is used for the blanking signal of an external CRT display. (Plus 2 Volts unblanks the display and -1 Volt blanks it.)
- 4 **HP-IB Connector J5.** This is used when the instrument is connected in an HP-IB (Hewlett-Packard Interface Bus) configuration.
- 5 **X-OFFSET POL (polar) Adjustment.** This adjustment changes the 8501A stored polar trace position in the horizontal direction to match the input trace from the Network Analyzer.
- 6 **X-OFFSET RECT (rectangular) Adjustment.** This adjustment changes the 8501A stored rectangular trace position in the horizontal direction to match the input trace from the Network Analyzer.
- 7 **Y-OFFSET POL (polar) Adjustment.** This adjustment changes the 8501A stored polar trace position in the vertical direction to match the input trace from the Network Analyzer.
- 8 **Y-OFFSET CH 1 (Channel 1) Adjustment.** This adjustment changes the 8501A Channel 1 stored rectangular trace position in the vertical direction to match the input trace from the Network Analyzer.
- 9 **Y-OFFSET CH 2 (Channel 2) Adjustment.** This adjustment changes the 8501A Channel 2 stored rectangular trace position in the vertical direction to match the input trace from the Network Analyzer.
- 10 **AC Power Receptacle.** Input connector for line power. This power module also contains the voltage input selector and the line fuse. See Paragraph 2-12 for voltage and fuse selection.
- 11 **NORMALIZER INTERCONNECT Connector J6.** The interconnect cable for the Network Analyzer plugs into this connector.
- 12 **LABELING INTERCONNECT Connector J4.** The interconnect cable that carries labeling information and connects to the Network Analyzer plugs into this connector.

Figure 3-3. Rear Panel Adjustments and Connectors

**3-30. PROGRAMMING THE FRONT PANEL**

3-31. All instrument states, except power on/off, are programmable via the HP-IB using simple codes. In addition, the 8501A can output its current state using a 24 character string in the learn mode.

**3-32. Switch Codes**

3-33. Figure 3-4 shows the switch codes and examples of the data part of the program statements used to program specific instrument states. These codes consist of the boxed character adjacent to the switches and buttons followed by a number to indicate position. Sample 9825A and 9830A/B statements to program the front panel are:

9825A	9830A/B
0: "EXAMPLE 1":	10 REM EXAMPLE 1
1: wrt 714, "C2I1V0C1V0"	20 CMD "90.1" "C2I1V0C1V0"

3-34. When the 8501A is first placed in Remote mode, the instrument state is unchanged from the front panel switch settings. Switches not specifically programmed are not changed. With the exception that the channel prefix C1 or C2 must precede the INPUT, MEMORY, and AVERAGING switch codes, the switch codes can appear in any sequence and the switches are programmed in the order in which they appear from left to right in the statement.

3-35. In some applications, it may be desirable to preset the instrument to a convenient known state using the HP-IB Clear command. The Clear command selects STORAGE ON, LABELS ON, MAGNIFIER OFF, Channels 1 and 2 INPUT ON, AVERAGING OFF, MEMORY VIEW ON, and AVERAGING FACTOR 2, with memory erased and the 8501A accepting data from the 8505A. This is equivalent to programming:

S2L2M1C1I2A1V1C2I2A1V1F1EREX

Program the clear command as follows:

9825A	9830A/B
2: "EXAMPLE 2":	30 REM EXAMPLE 2
3: clr 714	40 CMD "90.1"
	50 FORMAT 3B
	60 OUTPUT (13,50)256,20,"5121"

**3-36. Learn Mode**

3-37. The current instrument state can be read into a 24 character string. A sequence used to learn the instrument state and store it as follows:

9825A	9830A/B
4: "EXAMPLE 3":	70 REM EXAMPLE 3
5: dim A\$(24)	80 DIM A\$(24)
6: wrt 714, "OL" ; read 714, A\$	90 CMD "90.1" "OL" ; "9NS"
	100 ENTER (13)A\$

The OL command programs the 8501A to output the learn string the next time it is addressed as a talker. In this example the learn string is stored in the A\$ string array. Figure 3-5 defines the switch code positions in the learn string. Even though the numeric values of the learned data will vary with instrument state, the position of each switch code is fixed and is therefore easily decoded.

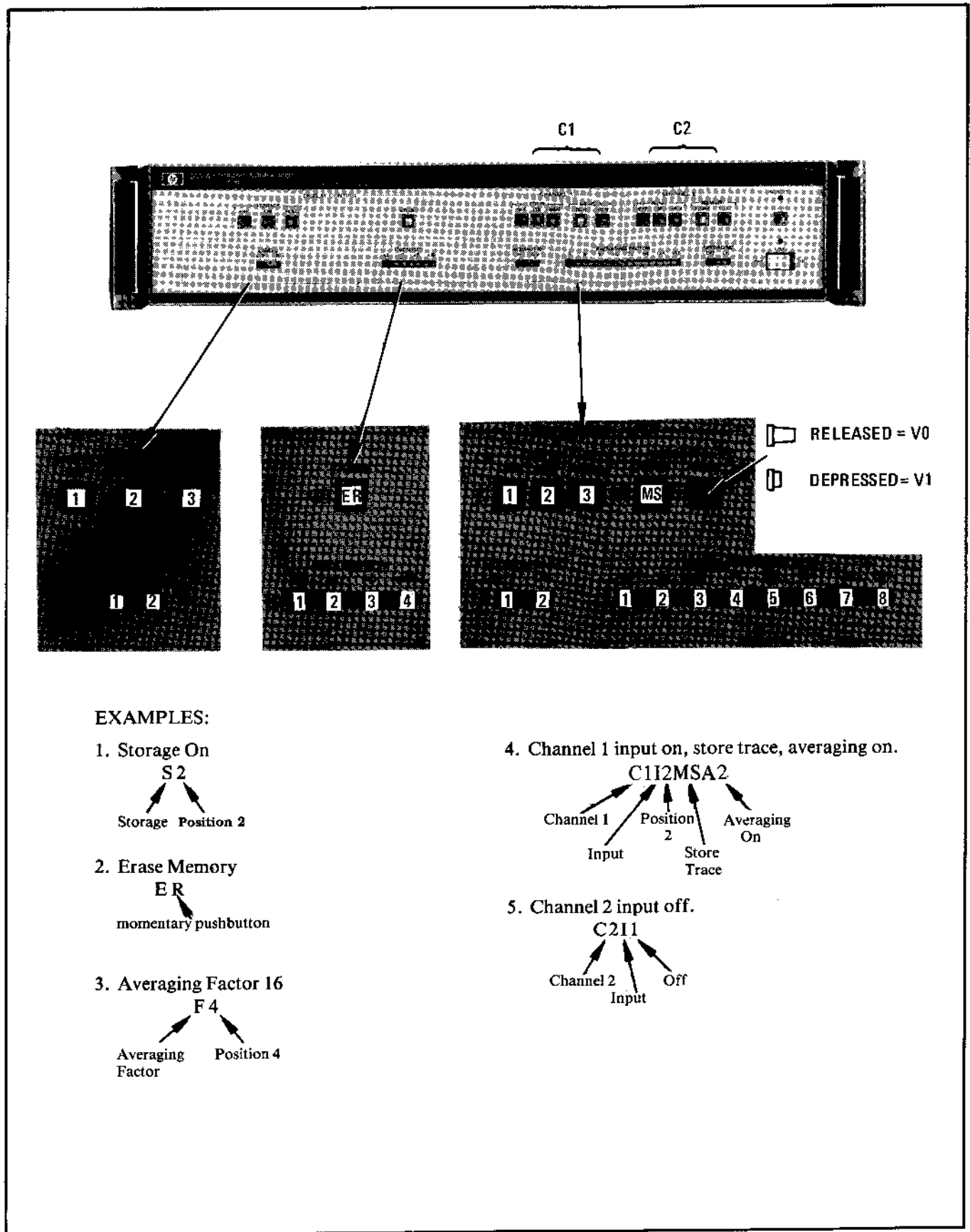

Figure 3-4. 8501A Switch Codes

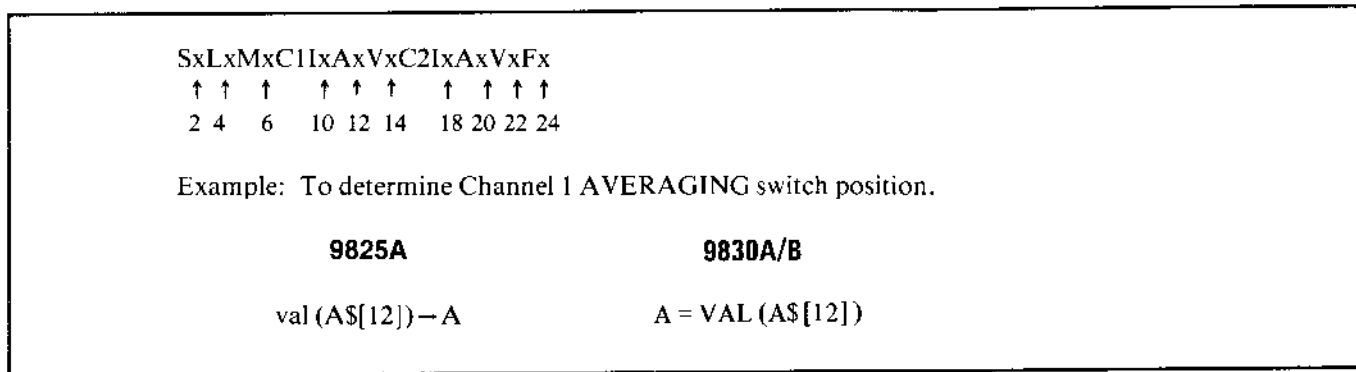

Figure 3-5. 8501A Learn String

3-38. The string can be output to the 8501A to restore it to a previous state as follows:

<b>9825A</b>	<b>9830A/B</b>
7: "EXAMPLE 4"	110 REM EXAMPLE 4
8: wrt 714;R#	120 CMD "?U.";R#

3-39. The learn mode can be used to advantage to reduce the amount of front panel programming required for an application as in this example.

<b>9825A</b>	<b>9830A/B</b>
9: "EXAMPLE 5"	130 REM EXAMPLE 5
10: dia T#[24];R#[24]	140 DIN T#[24];R#[24]
11: lcl 714;dsr	150 CMD "?U."
"SETUP FOR TEST 1"istp	160 FORMAT 3B
12: wrt 714;"OL";red 714;T#;lcl 714	170 OUTPUT (13;160)256;1;612)
13: dsr "SETUP FOR TEST 2"istp	180 DISP "SETUP FOR TEST 1"
14: wrt 714;"OL";red 714;R#	190 STOP
15: dsr "CONNECT TEST DEVICE"istp	200 CMD "?U."; "OL"; "9N5"
16: wrt 714;T#	210 ENTER (13;6)T#
17: dsr "ADJUST TEST 1 RESPONSE"istp	220 CMD "?U."
18: wrt 714;R#	230 OUTPUT (13;160)256;1;612)
19: dsr "ADJUST TEST 2 RESPONSE"istp	240 DISP "SETUP FOR TEST 2"
20: eto 15	250 STOP
	260 CMD "?U."; "OL"; "9N5"
	270 ENTER (13;6)R#
	280 DISP "CONNECT TEST DEVICE"
	290 STOP
	300 CMD "?U."; T#; ""; "EX"
	310 DISP "ADJUST TEST 1 RESPONSE"
	320 STOP
	330 CMD "?U."; R#; "EX"
	340 DISP "ADJUST TEST 2 RESPONSE"
	350 STOP
	360 GOTO 280

The operator makes manual switch settings for each measurement and stores the learn mode string. Thereafter, the program loops around the CONNECT TEST DEVICE message eliminating the need to make further manual control settings on the 8501A.

**3-40. CONTROLLING THE MEASUREMENT**

3-41. The Take Sweep command is a simple means to control the 8505A in normalization and averaging applications. The form is:

TSn,

where n = 1 to 255, 1 if unspecified. TSn, (the digits must be followed by a comma) initiates the specified number of sweeps, one per active 8505A channel, then halts after accepting data from the 8505A.

### 3-42. Normalization

3-43. Here is a normalization application in which the 8505A takes one sweep, stores the reference trace, then displays the normalized result.

#### 9825A

```

21: "EXAMPLE 6":
22: dsp "CONNECT STANDARD"istp
23: clr 714
24: wrt 714,"C211ABTS1,C1MSV0"
25: dsp "CONNECT TEST DEVICE"istp
26: wrt 714,"C1IBEX"
27: dsp "ADJUST FOR CORRECT RESPONSE"istp
28: ato 25

```

#### 9830A/B

```

370 REM EXAMPLE 6
380 DISP "CONNECT STANDARD"
390 STOP
400 CHD "9U."
410 FORMAT 38
420 OUTPUT (13,410)256,20,512f
430 CHD "9U.,"C211ABTS1,C1MSV0"
440 DISP "CONNECT TEST DEVICE"
450 STOP
460 CHD "9U.,"C1IBEX"
470 DISP "ADJUST FOR CORRECT RESPONSE"
480 STOP
490 GOTO 440

```

After the specified number of sweeps are complete, no further sweeps occur until the 8501A receives an EX command, another TSn, or the HP-IB Clear command.

3-44. The EX command restarts conversion and storage of data from the 8505A. The AB command halts the 8505A sweep in progress. Placing the AB in front of the TSn command as above assures that the specified number of complete sweeps are executed, not counting an incomplete sweep.

### 3-45. Averaging

3-46. For averaging applications, recall that the weighted running average method used converges to the final value exponentially. For f = selected averaging factor, the trace converges to 98% of final value in 4f sweeps; 95% in 3f sweeps, 87% in 2f sweeps, and 67% in 1f sweeps. Thus, to use the averaging capability to full advantage, use TSn to control the number of sweeps. For example, if the averaging factor selected is 16, use

TS64,

to specify the exact number of sweeps required to average one channel. Avoid unnecessary measurement delays by using the minimum averaging factor to reduce noise content to the desired value. In usual applications there is no practical value in using greater than 4f sweeps to produce the average.

### 3-47. GRAPHICS

3-48. Vector diagrams, lines of text, and rectilinear and polar plots can be displayed by transferring a sequence of display instructions and data from the controller to 8501A memory. The 8501A automatically transfers its memory contents to the CRT every 10 to 20 milliseconds to present a flicker-free display. 512 words (one page) of memory are available for graphics you generate without sacrificing any of the standard capabilities. Each memory word contains either a display instruction or data. The display instruction identifies how the 8501A processor is to interpret the data which follows. The data consists of a coordinate value or an ASCII character.

3-49. The first memory word to receive data is addressed using  
Pxn,

where x = the page number (1-8) and n designates the word to be written into next (0 to 511, 0 if unspecified). This instruction sets an internal pointer that specifies the next memory word to receive data from the HP-IB. It is not necessary to readdress memory with each operation if the objective is to write into consecutive memory words.

### 3-50. Vector Diagrams

3-51. A vector diagram consists of a PA display instruction followed by any number of x, y integer pairs. This example shows a sequence that draws a box on the CRT.

9825A

```
29: "EXAMPLE 7":
30: wrt 714, "ERP6PA144,120,144,240,288,240,288,120,144,120EX"
```

9830A/B

```
500 REN EXAMPLE 7
510 CMD "?B,"; "ERP6PA144,120,144,240,288,240,288,120,144,120EX"
```

ERP6 erases memory and addresses word 0 of page 6 to receive the following instructions and data. The PA instruction causes a blank vector (beam off) to be drawn to the following x,y pair, then the beam is turned on and the remaining x,y pairs are plotted. The position of the x = 0, y = 0 point is the lower left-hand corner of the CRT with the range of x from 0 to 432 and the range of y from 0 to 360. Figure 3-6 shows the scaling for PA vector diagrams.

3-52. Except for the P6 word address and the EX restart command, each display instruction or numeric value occupies one word. Thus, Example 7 uses eleven words of 8501A memory.

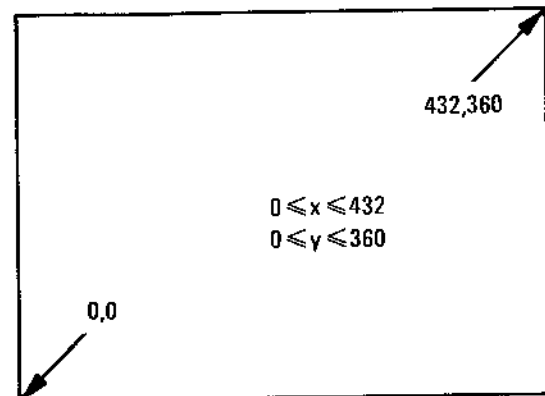

Figure 3-6. PA Vector Mode Scaling

This sequence draws a sine wave on the CRT.

9825A

```
31: "EXAMPLE 8":
32: fxd 0
33: wrt 714, "ERP6PA"
34: for X=0 to 432 by 2
35: 180sin(360X/432)+180+Y
36: wrt 714, X,Y
37: next X
38: wrt 714, "EX"
```



**9830A/B**

```

520 REM EXAMPLE 9
530 DEG
540 FIXED 0
550 CMD "ZUL";"ERP6PA"
560 FOR X=0 TO 432 STEP 2
570 Y=130*SIN(360*X/432)+100
580 OUTPUT (13,*)X;Y
590 NEXT X
600 CMD "ZUL";"EX"

```

Vector intensity depends on the length of the vector. To achieve a brighter trace, write the numeric values into memory more than once.

**9825A**

```

39: "EXAMPLE 9":
40: wrt 714;"ERP6PA;144;120;"
41: for I=1 to 4
42: wrt 714;"144;240;288;240;288;120;144;120;"
43: next I
44: wrt 714;"PS"

```

**9830A/B**

```

610 REM EXAMPLE 9
620 CMD "ZUL";"ERP6PA144;120;"
630 FOR I=1 TO 4
640 CMD "ZUL";"144;240;288;240;288;120;144;120;"
650 NEXT I
660 CMD "ZUL";"PS"

```

The PS, page skip, instruction minimizes CRT refresh time by causing the 8501A display processor to skip directly to word 0 of the next memory page.

**3-53. Scaling Vector Plots**

3-54. To plot data in user units, frequency vs. dB value for instance, the raw data must be scaled to the screen plotting units. For PA mode vector plots the scaling equations are:

$$432 \left( \frac{X_{\text{DATA}} - X_{\text{MIN}}}{X_{\text{MAX}} - X_{\text{MIN}}} \right) = X_{\text{PLOT}} \quad \text{and} \quad 360 \left( \frac{Y_{\text{DATA}} - Y_{\text{MIN}}}{Y_{\text{MAX}} - Y_{\text{MIN}}} \right) = Y_{\text{PLOT}}$$

where  $X_{\text{DATA}}$  and  $Y_{\text{DATA}}$  represent the raw data values to be rescaled and plotted,  $X_{\text{MIN}}$  and  $Y_{\text{MIN}}$  are the minimum values for the input data,  $X_{\text{MAX}}$  and  $Y_{\text{MAX}}$  are the maximum values for the input data, and  $X_{\text{PLOT}}$  and  $Y_{\text{PLOT}}$  represent x and y values scaled to the PA mode screen coordinates.

For example, if the range of x data to be plotted is 100 to 1000 and the range of y data is -20 to +10, then the scaling equations for a vector diagram using the PA plot mode can be programmed as follows:

**9825A**

```

45: "EXAMPLE 10":
46: wrt 714;"ERP6PA0;0;"
47: 432(A-100)/(1000-100)+X
48: 360(B--20)/(10--20)+Y
49: wrt 714;X;Y

```

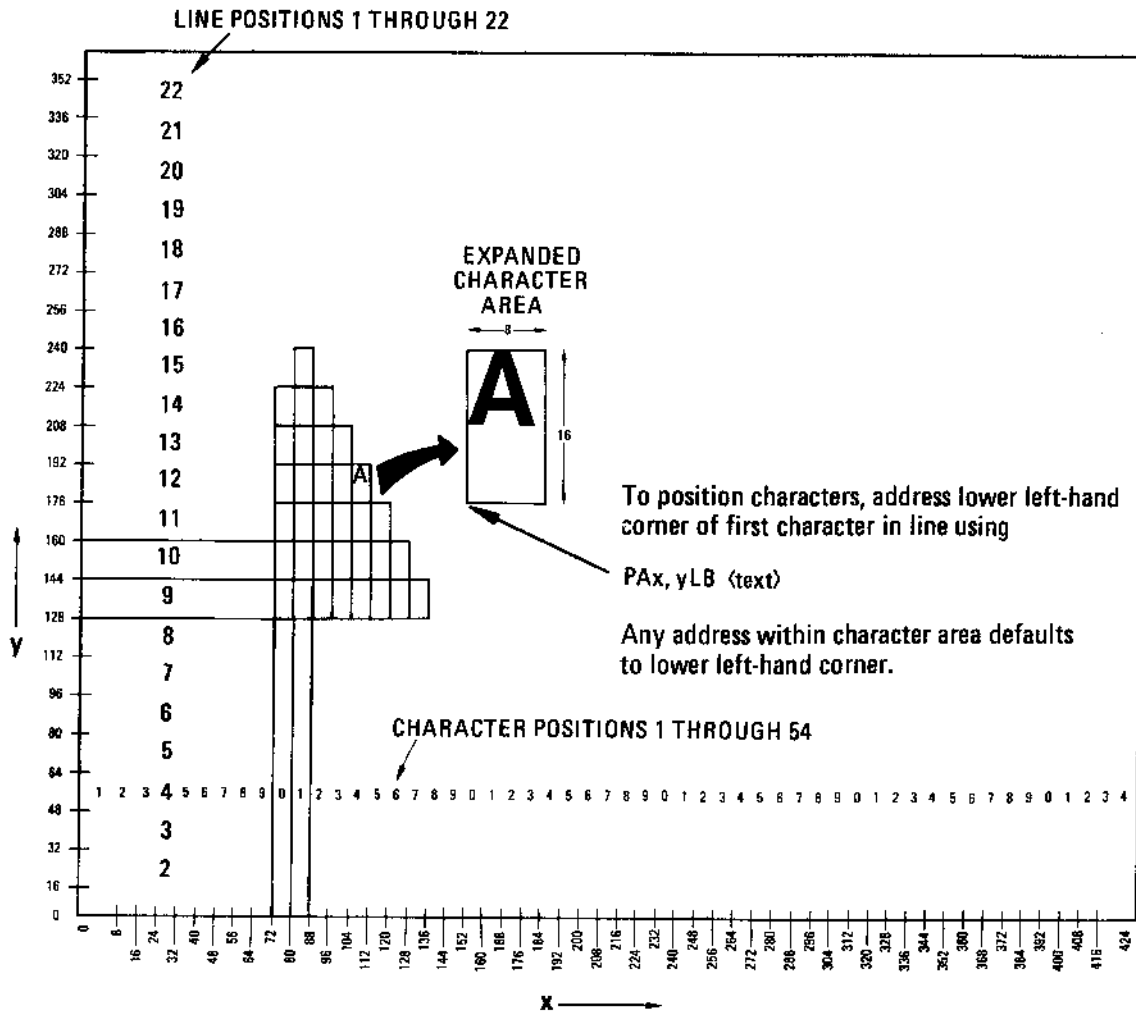

Figure 3-7. Text Mode Character Positions

9830A/B

```

790 REM EXAMPLE 12
800 CMD "?U.", "ERP6PA56,96LB"
810 FORMAT 10B
820 OUTPUT (13,810)83,177,178,61,66,177,47,65,178,3;
    
```

3-60. There are two ways to make text blink in order to attract the attention of the operator. Since display of text anywhere in memory is controlled by the LABELS switch, you can make all text blink by alternately switching between LABELS ON (L2) and LABELS OFF (L1). Portions of text can be made to blink as follows:

9825A

```

56: "EXAMPLE 13":
57: wrt 714, "ERP6PA96,176LBTEST COMPLETE. CONNECT NEXT DEVICE"
58: wtb 714,3;wait 500
59: for I=1 to 5
60: wrt 714, "P63B0";wait 500
61: wtb 714, "P63LB",3;wait 500
62: next I
    
```

CODE		CHAR.	
0	NULL	32	SP
1		33	!
2		34	"
3	ETX	35	#
4		36	\$
5		37	%
6		38	&
7		39	'
8	BS	40	(
9		41	)
10	LF	42	*
11		43	+
12		44	,
13	CR	45	-
14		46	.
15		47	/
16		48	0
17		49	1
18		50	2
19		51	3
20		52	4
21		53	5
22		54	6
23		55	7
24		56	8
25		57	9
26		58	:
27		59	;
28		60	<
29		61	=
30		62	>
31		63	? _
		64	@
		65	A
		66	B
		67	C
		68	D
		69	E
		70	F
		71	G
		72	H
		73	I
		74	J
		75	K
		76	L
		77	M
		78	N
		79	O
		80	P
		81	Q
		82	R
		83	S
		84	T
		85	U
		86	V
		87	W
		88	X
		89	Y
		90	Z
		91	[
		92	\
		93	]
		94	^
		95	' _
		96	`
		97	a
		98	b
		99	c
		100	d
		101	e
		102	f
		103	g
		104	h
		105	i
		106	j
		107	k
		108	l
		109	m
		110	n
		111	o
		112	p
		113	q
		114	r
		115	s
		116	t
		117	u
		118	v
		119	w
		120	x
		121	y
		122	z
		123	{
		124	
		125	}
		126	~
		127	' _
		128	^
		129	^
		130	^
		131	^
		132	^
		133	^
		134	^
		135	^
		136	^
		137	^
		138	^
		139	^
		140	^
		141	^
		142	^
		143	^
		144	^
		145	^
		146	^
		147	^
		148	^
		149	^
		150	^
		151	^
		152	^
		153	^
		154	^
		155	^
		156	^
		157	^
		158	^
		159	^
		160	^
		161	^
		162	^
		163	^
		164	^
		165	^
		166	^
		167	^
		168	^
		169	^
		170	^
		171	^
		172	^
		173	^
		174	^
		175	^
		176	^
		177	^
		178	^
		179	^
		180	^
		181	^
		182	^
		183	^
		184	^
		185	^
		186	^
		187	^
		188	^
		189	^
		190	^
		191	^
		192	^
		193	^
		194	^
		195	^
		196	^
		197	^
		198	^
		199	^
		200	^
		201	^
		202	^
		203	^
		204	^
		205	^
		206	^
		207	^
		208	^
		209	^
		210	^
		211	^
		212	^
		213	^
		214	^
		215	^
		216	^
		217	^
		218	^
		219	^
		220	^
		221	^
		222	^
		223	^
		224	^
		225	^
		226	^
		227	^
		228	^
		229	^
		230	^
		231	^
		232	^
		233	^
		234	^
		235	^
		236	^
		237	^
		238	^
		239	^
		240	^
		241	^
		242	^
		243	^
		244	^
		245	^
		246	^
		247	^
		248	^
		249	^
		250	^
		251	^
		252	^
		253	^
		254	^
		255	^

Figure 3-8. 8501A Character Set

## 9830A/B

```

830 REM EXAMPLE 13
840 CMD "?U.", "ERP6PA96,176LBTESTS COMPLETE. CONNECT NEXT DEVICE"
850 FORMAT B
860 OUTPUT (13,850)3;
870 WAIT 500
880 FOR I=1 TO 5
890 CMD "?U.", "P63BO"
900 WAIT 500
910 CMD "?U.", "P63LB"
920 OUTPUT (13,850)3;
930 WAIT 500
940 NEXT I

```

These examples make the text blink by alternately replacing the LB mnemonic with the BO (Block Off) instruction. For the 9825A, the switch between LB and BO is accomplished by lines 60 and 61; for the 9830A/B, by lines 890 and 910. Note the construction of 9825A line 61 which combines writing the LB mnemonic and clearing the Text Mode.

**3-61. Read Memory Address**

3-62. To output the presently addressed memory word, use the command

OA

in the sequence output to the 8501A. OA causes the next data output by the 8501A to be the last memory address written into or read from. The address is output in the form

3,	020	CR	LF
↑	↑	↑	↑
page	word	carriage return	line

where page and word are integer values representing the page number (1 through 8) and element number (0 through 511) respectively.

For example, the sequence

<b>9825A</b>	<b>9830A/B</b>
63: "EXAMPLE 14":	950 REM EXAMPLE 14
64: fmt 1,2f.0	960 CMD "?U.", "OA", "9N5"
65: wrt 714, "OA" red 714.1;A;B	970 ENTER (13,*)A;B
66: prt A;B	980 PRINT A;B

outputs the presently addressed memory word.

**3-63. Additional Memory for Graphics**

3-64. In the preceding examples P6 (Page 6 of 8501A memory) is used for all graphics. More 8501A memory than P6 can be made available for graphics by simply not using averaging or normalization for one or both channels, and all eight pages of memory can be used when the 8501A is not processing data from the 8505A.

Pages P1 through P8 all consist of 512 individually addressable words numbered 0 through 511. The function of each page during standard operation is as follows:

P1	Channel 1 reference trace	
P2	Channel 2 reference trace	(continued)

- P3 Channel 1 measurement trace
- P4 Channel 2 measurement trace
- P5 8505A and 8501A mode labels
- P6 Not used. (Available for graphics)
- P7 Channel 1 averaging data
- P8 Channel 2 averaging data

With INPUT ON, the Channel 1 and Channel 2 traces from the 8505A are digitized and stored into Pages P3 and P4, respectively. Pressing or programming C1MS or C2MS (Channel 1 or Channel 2 MEMORY STORE) copies the contents of P3 into P1, or P4 into P2. Selecting C1I3 or C2I3 (INPUT-MEMORY) subtracts the values stored in P1 or P2 from the digitized input trace, then stores the result in P3 or P4. With C1A2 or C2A2 (AVERAGING ON), the incoming trace is digitized. Then the averaging computations are performed using intermediate values stored in P7 (Channel 1), or P8 (Channel 2) prior to storing the averaged trace in P3 or P4. The 8505A and 8501A labels are automatically written into P5 at the end of the first and each subsequent sweep. Page P6 is not used for standard functions. However, P6 can be used for special purposes by loading display instructions and data into P6 under program control via the HP-IB interface as in the previous Graphics examples.

3-65. Table 3-2 shows the statements to increase memory availability for graphics by not using standard features.

*Table 3-2. Using more Memory for Graphics*

Available Words	Pages for Graphics	Command String
<b>No Averaging</b>		
512	P7	"C1A1C2A2P7<data>EFEX"
512	P8	"C1A2C2A1P71PSP8<data>EFEX"
1024	P7, P8	"C1A1C2A1P7<data>EFEX"
<b>No Input-Mem</b>		
512	P1	"C1V1P1<data>PSEX"
512	P2	"C2V1P2<data>PSEX"
1024	P1, P2	"C1V1C2V1<data>PSEX"
<b>Not Accepting 8505A Data</b>		
4096	P1-P8	8505A C1 and C2 MODE to other than OFF. 8501A HP-IB Clear Command and "ABER".

Either or both pages P7 or P8 are available for graphics if Channel 1 (P7) or Channel 2 (P8) AVERAGING OFF is selected. It is necessary to replace the EF instruction placed in word 1 of P7 by ERASE to allow display of data in P7 and P8. Either or both Pages P1 and P2 are available for graphics if Channel 1 (P1) or Channel 2 (P2) MEMORY STORE is not used. All eight pages can be used for graphics when the 8501A is in the AB state (not processing 8505A data). Page P5 is not under your control when data from the 8505A is being processed because the labels are automatically written into P5 at the end of each sweep. Likewise, since the 8505A MODE switches must be on in order for P3 and P4 to be displayed, data from the 8505A will replace any information in P3 and P4 when an EX is programmed.

**3-66. Rectilinear Plots**

3-67. Rectilinear graphs, scaled from the 8505A Channel 1 or Channel 2 reference line, can be plotted on the CRT by writing the GR display instruction followed by up to 500 values for y. Thus the sequence for

writing a rectilinear plot is:

`GRY0,y1,...y499PS`

3-68. When the 8501A processor encounters the GR instruction in memory, it draws a blank vector (beam off) to the following y value with x = 0, then plots the remaining y values automatically, incrementing the x value to provide the proper display. An example which draws a sine wave on the CRT follows.

```

9825A
67: "EXAMPLE 15":
68: fxd 0
69: wrt 714,"ERP6GR"
70: for X=1 to 500
71: 250*sin(360X/500)+Y
72: wrt 714,Y
73: next X

```

```

9830A/B
990 REM EXAMPLE 15
1000 DEG
1010 FIXED 0
1020 CMD "?U.,";"ERP6GR"
1030 FOR X=1 TO 500
1040 Y=250*SIN(360*X/500)
1050 OUTPUT (13,*)Y
1060 NEXT X

```

3-69. The position of the y = 0 point depends upon the Channel 1 reference line as set by the 8505A controls. (See Figure 3-9.) The y values are integer values ranging from -512 to +511 but if the reference line is at center screen, only values between -250 and +250 will be displayed. Moving the 8505A REF LINE POSN brings off-scale points onto the display. If the reference line is at the top graticule, values from 0 to -500 will be visible. GR plots can be magnified using the MAGNIFIER control.

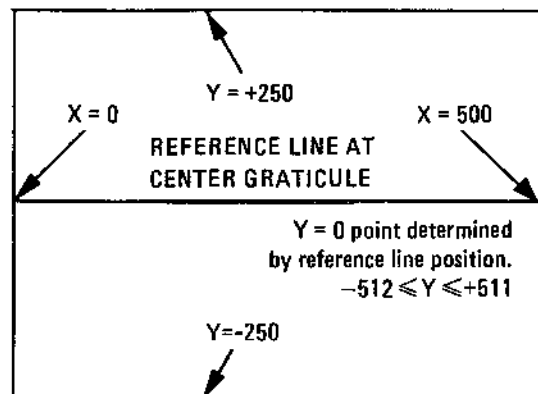

Figure 3-9. GR Cartesian Graph Scaling

3-70. To position the data relative to the 8505A Channel 2 reference line, use

`D3GRy,y...y`

The D3 mnemonic preceding GR alters the display mode causing the position of the y = 0 point to depend upon the position of the 8505A Channel 2 reference line, instead of the Channel 1 reference line.

### 3-71. Polar Plots

3-72. Polar graphs, scaled with respect to the 8505A polar beam center position, can be plotted on the CRT by writing the PR display instruction followed by any number of x,y pairs. Thus the sequence for writing a polar graph is

`PRx,y,x,y,...x,yPS`

When the 8501A processor encounters the PR instruction in memory it draws a blank vector (beam off) to the following x,y pair, then plots the following x,y pairs until another display instruction is encountered. An example of a polar plot which draws a circle on the CRT follows:

```

9825A
74: "EXAMPLE 16":
75: fxd 0
76: wrt 714,"ERP6PR"
77: for I=1 to 251 by 2
78: sin(360I/250)*125*X
79: cos(360I/250)*125*Y
80: wrt 714,X,Y
81: next I

```

```

9830A/B
1070 REM EXAMPLE 16
1080 DEG
1090 FIXED 0
1100 CMD "?U.,";"ERP6PR"
1110 FOR I=1 TO 251 STEP 2
1120 X=SIN(360*I/250)*125
1130 Y=COS(360*I/250)*125
1140 OUTPUT (13,*)X,Y
1150 NEXT I

```

3-73. The position of the  $x=0, y=0$  point depends upon the polar beam center position as set by the 8505A beam controls. The  $x,y$  pairs are integer values ranging from  $-512$  to  $+511$  but if the beam center position is set to the center of the display only values  $-300 \leq x \leq +300, -250 \leq y \leq +250$  will be displayed. Moving the beam center position brings off-scale points onto the display. PR plots can be magnified using the MAGNIFIER control.

**3-74. Scaling GR and PR Plots**

3-75. To scale data from user units to the plotting units for GR and PR modes, the following equations must be used:

$$500 \left( \frac{X_{\text{DATA}} - X_{\text{MIN}}}{X_{\text{MAX}} - X_{\text{MIN}}} \right) - 250 = X_{\text{PLOT}} \quad \text{and} \quad 500 \left( \frac{Y_{\text{DATA}} - Y_{\text{MIN}}}{Y_{\text{MAX}} - Y_{\text{MIN}}} \right) - 250 = Y_{\text{PLOT}}$$

Definitions are the same as in Paragraph 3-54, Scaling Vector Plots. For GR plots, only the equation for  $y$  is used. The equations assume that the rectilinear reference line and the polar beam center is at the center of the graticule.

**3-76. READ DATA FROM MEMORY**

3-77. You can easily read memory data from the 8501A memory which represents the Channel 1 or Channel 2 measurement trace or the Channel 1 or Channel 2 reference trace. For rectilinear trace, 8501A memory consists of a GR instruction followed by 500 ( $\pm 2$ ) integer  $y$  values ranging from  $-512$  to  $+511$  scaled from the Channel 1 or Channel 2 reference line and terminated by a PS instruction. For a polar trace from the 8505A, 8501A memory consists of a PR instruction followed by 250 ( $\pm 2$ ) integer  $x,y$  pairs ranging from  $-512$  to  $+511$  scaled from the polar beam center and terminated by a PS instruction.

**3-78. Standard ASCII Transfer**

3-79. To read and store ASCII values representing a measurement or reference trace:

- a. Address the first memory element to be output.
- b. Read the numeric data using a read statement for each element to be read. (Include the read statement in a loop to read consecutive words.)

It is not necessary to readdress memory with each read statement if the objective is to read consecutive memory words. The 8501A automatically increments its internal memory address each time a read statement is completed.

Thus, start at element 1 and read the next 500 elements.

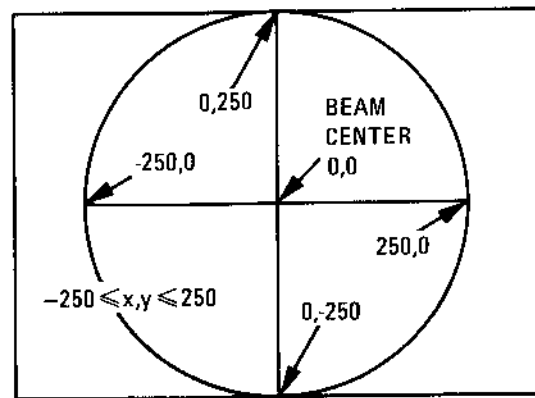

Figure 3-10. PR Polar Graph Scaling

**9830A/B**

```

9825A
82: "EXAMPLE 17":
83: dim Y[500]
84: wrt 714,"P3"
85: for I=1 to 500
86: red 714,Y[I]
87: next I
    
```

```

1160 REM EXAMPLE 17
1170 DIM X[250],Y[250]
1180 CMD"?U.", "P3", "?N5"
1190 FOR I=1 TO 500
1200 IF I>250 THEN 1230
1210 ENTER (13,*)X[I]
1220 GOTO 1240
1230 ENTER (13,*)Y[I-250]
1240 NEXT I
    
```

Two arrays are required for the 9830A/B example due to the maximum array size limitation. P3 addresses Page 3 (Channel 1 displayed trace). For the 9825A, the data in array y represents 500 y values for a rectilinear trace, or for a polar trace, the odd elements are values for x and even elements are values for y. For the 9830A/B, if a rectilinear plot were read, array X holds the values for odd words and array Y holds the even elements, or if for a polar plot, array X holds the x data and array Y holds the y values.

3-80. The red or ENTER statements having this form reject non-numeric characters. If a memory word containing a non-numeric character is addressed, the returned value is not accepted, the 8501A increments its memory address, and the next word is read. This sequence continues until a valid numeric character is output from the 8501A. In the above examples the memory instructions at the beginning of the page will be rejected and will not show up in the data stored in the arrays.

### 3-81. Rescaling, Memory Data to Measurement Units

3-82. Data representing a rectilinear trace can be read from 8501A memory and rescaled to units of dB, degrees, or seconds versus frequency. Reading 8501A memory in this way is the best available method to obtain normalized or averaged measurement data.

To rescale the frequency value, use:

$$\text{Scaled Frequency Value} = \left( \frac{\text{Frequency Span}}{500} \right) \left( \begin{array}{c} \text{data point} \\ \text{number} \end{array} \right) + \text{Start Frequency}$$

where scaled frequency value is the frequency of the data point, start frequency is the start frequency of the scan in the same units as frequency span, 500 is the total number of frequency points per sweep, and data point number represents the value being rescaled. The accuracy of this rescaling depends upon the accuracy to which the start and stop frequency values are known.

To obtain the scaled value for the y data in dB, degrees, or seconds, use:

$$\text{Scaled Measured Value} = \left( \frac{8505A \text{ Scale/Div}}{50} \right) (y \text{ data}) + 8505A \text{ Reference Offset}$$

where the number 50 represents the 8501A digitizer resolution per division, and y data is the digitized value for y read from 8501A memory.

3-83. For example, assume that the 8505A is measuring MAG with start and stop frequencies of 100 and 1000 MHz, that 8505A SCALE/DIV is set to 5 dB/division, and that -20 dB of REF OFFSET is applied to the measurement. With this information this example rescales the data read from page P3 in Example 17 and prints the frequency and magnitude values.

9825A	9830A/B
88: "EXAMPLE 18":	1250 REM EXAMPLE 18
89 for I=1 to 500	1260 FOR I=1 TO 500
90: 900/499*(I-1)+100)X	1270 X=(900/499)*(I-1)+100
91: 5/50*Y[I+20)Y	1280 IF I>250 THEN 1310
92: wrt 6,X,Y	1290 Y=5/50*X[I]+(-20)
93: next I	1300 GOTO 1320
	1310 Y=550*Y[I-250]+(-20)
	1320 OUTPUT (15,*)X,Y
	1330 NEXT I

The frequency, scale/division, and reference offset information can be obtained using the 8505A learn mode capability described in the 8503A or 85030B programmer's manual. Polar traces can be rescaled in a similar manner to obtain magnitude and phase angle information at 250 frequency points.



**3-84. High Speed Binary Transfer**

3-85. This technique is only available using the 9825A. The 9825A can use buffered I/O to perform high speed block data transfer both to and from 8501A memory. This capability is used in the 85010B Basic Measurements program to accomplish the SAVE and RECALL functions. It serves as a fast method to store a standard response characteristic. Following is an example that reads one page of memory and records the data on the tape cartridge.

**9825A**

```

94: "EXAMPLE 19":
95: dim B$(1024)
96: buf "1",B$,3
97: wrt 714,"P302"
98: buf "1"tfr 714,"1"
99: jmp rds("1")>-1
100: trk 1;rcf 1;B$;trk 0
    
```

Array B\$ is dimensioned to 1024 elements to read one 512 word memory page. Page 3 is addressed and the O2 selects the 8501A binary output mode in which data is transferred from memory in two byte binary form, most significant byte first. The fast transfer buffer is named "1" and the jmp statement checks its status to wait until the buffer is not busy to record the data on file 1 of the tape cartridge.

3-86. To retrieve the trace from tape and transfer it back into memory, use this sequence.

**9825A**

```

101: "EXAMPLE 20":
102: trk 1;ldr 1;B$;trk 0
103: wtb 714,"ABERP3IB"
104: tfr "1",714
105: jmp rds("1")>-1
106: wtb 714,128
    
```

File 1 is loaded into memory, then the 8501A is initialized using AB and ER and Page 3 is addressed to receive the data. The IB command selects the 8501A binary input mode in which data is received in two byte binary form, most significant byte first. The last statement transfers 128 in binary form which sets the most significant bit of the most significant byte true to return the 8501A to the ASCII input mode.

**3-87. ADVANCED PROGRAMMING**

**3-88. Alternate Graphics Modes**

3-89. The commands listed in Table 3-3 can immediately precede a GR, PA, PR, or an LB graphics mode selection to alter the display reference and resolution.

*Table 3-3. Alternate Graphics Display Mode Selections*

MNEMONIC	FUNCTION
D1	Selects PA reference and scaling.
D2	Selects GR reference and scaling; 8505A Channel 1 reference line defines Y = 0.
D3	Selects GR reference and scaling. 8505A Channel 2 reference line defines Y = 0.
D4	Selects PR reference and scaling.

3-90. For example, when the 8501A stores a cartesian Channel 1 input trace in P3, the memory mnemonic in word 2 is actually equivalent to a D2GR so that the Channel 1 reference line serves as the Y = 0 refer-

ence. For the Channel 2 cartesian trace in P4, the memory mnemonic in word 2 is actually equivalent to a D3GR so that the Channel 2 reference line serves as the Y = 0 reference.

3-91. These D commands serve only to change two bits of the word which contains the memory mnemonic. They are not stored as individual words. Thus, if the memory mnemonic is read into an ASCII string, the D command modifier is lost.

3-92. The two main uses for the D commands are to allow selection of the Channel 2 reference line as the Y = 0 reference for graphs you generate in the GR mode, and to allow text to be positioned relative to the Channel 1 or Channel 2 reference line, or the polar beam center position instead of the lower left-hand corner of the screen which is standard for the PA mode.

3-93. To position text relative to the reference line or beam center position, place the D2, D3, or D4 command immediately preceding the LB mnemonic. For example to place a character in the center of the screen use

```
" PA0,0D4LBCENTER"
```

This statement sets the lower left-hand corner of the first character position at 0,0 relative to polar beam center. Now if the beam center position changes the text position will also change.

3-94. In addition, placing D2, D3, or D4 preceding an LB makes the character size controllable by the MAGNIFIER. In the above example, if X2 magnification is selected the character will double in size.

**3-95. Data Formats**

3-96. All data and control information are stored in 8501A memory in binary form. (Table 3-3 shows the bit assignments.)

3-97. Data can be transferred to and from 8501A memory in either ASCII or binary form. The 8501A processor performs the conversion automatically, converting binary data to ASCII for output and converting ASCII data to binary for storage. All preceding examples have input and output data in ASCII form.

**3-98. ASCII Input Format.** The default input condition selects ASCII format. Data must be simple integers in the range of -512 to +511. Digits must be sent most significant first preceded by a minus or optionally a + sign. Numbers can be separated by a space, carriage return, line feed, comma, or any other non-numeric character including the + and -. Non-integer numbers will be truncated at the decimal.

**3-99. Binary Input Format.** The code "IB" selects Binary Input. Data is to be in 2 byte binary with the most significant byte being sent first. This mode must be terminated before any programming mnemonics can be executed or before data can be received in ASCII mode. Binary mode is terminated by the HP-IB Abort and Clear commands explained in Table 3-5, or by sending the instrument a binary number with the most significant bit of the most significant byte true. (See example below.) This number must be an odd numbered byte.

Example of Binary Input:

	Bit Position								
	7	6	5	4	3	2	1	0	
1st Byte	0	1	1	1	0	0	1	1	MSB
2nd Byte	1	0	0	1	0	1	0	0	LSB
⋮									
nth Byte	1	X	X	X	X	X	X	X	MSB

Clears Binary INPUT

**3-100. ASCII Output Format.** The code "O1" selects ASCII output format. Data is output in 3-digit signed integers sent most significant digit first and followed by CR LF (carriage return and line feed). Memory control words are output as two character ASCII programming mnemonics. ASCII is the default condition. When PS control word is read out of the 8501A memory in ASCII, the EOI message is sent concurrently true. EXAMPLE: "GR +234CRLF-348CRLF---+004CRLFPS". The EOI message will be sent true with the "S" at the end of the example.

**3-101. Binary Output Format.** The code "O2" selects binary output format. When data is taken from the instrument, it will be sent in 2 byte binary form with the most significant byte being sent first. This mode is cleared by selecting another output element, addressing another memory word using Pxn command, or by the HP-IB Abort and Clear commands.

3-102. The output format is the same as the input format except bit 16 has no significance and is always zero.

### 3-103. Additional Control Functions

3-104. By using the IB (input binary) command, elements of Table 3-4 can be used to create control functions not available through the programming mnemonics provided. The table represents the actual contents of a specific memory location.

3-105. This table shows bit positions zero through 14 that compose a single word in memory. This word may be either a control word or a data word. The first 14 lines in the table are control words; note that they have ones in bit positions 11 and 12. If both bit positions 11 and 12 do not have ones, the entry is a data word.

3-106. Combinations of several commands may be grouped together in a single word. When you combine commands, the following rules must be followed:

1. A "1" or "0" can overlay an X (don't care).
2. A "1" can overlay a "1" or a "0" on a "0".

3-107. An example of placing a non-standard control word in memory follows.

#### 9825A

wtb 714, "P1IB",122,16,128

#### 9830A/B

10 FORMAT 3B

20 WRITE (13, 10) 122,16,128

This puts a non-standard control word into memory. The 122, and 16 are decimal equivalents to the HIGH byte and LOW byte from the above table. The 122 selects Channel 2 RESOLUTION and REFERENCE, the 16 selects GRAPH mode and CLEAR X, and the 128 clears binary input mode. This example is equivalent to doing wrt 714, "PID3GR".

Table 3-4. Additional Control Function

INSTRUMENT FUNCTION	BIT POSITION														
	HIGH BYTE							LOW BYTE							
	14	13	12	11	10	9	8	7	6	5	4	3	2	1	0
CONTROL WORD .....	X	X	1	1	X	X	X	X	X	X	X	X	X	X	X
GRAPH MODE (GR) .....	X	X	1	1	X	X	X	X	X	X	X	X	0	0	0
VECTOR MODE (PA) .....	X	X	1	1	X	X	X	X	X	X	X	X	0	0	1
TEXT MODE (LB) .....	X	X	1	1	X	X	X	X	X	X	X	X	0	1	0
END OF DISPLAY MEMORY (EF) .....	X	X	1	1	X	X	X	X	X	X	X	X	0	1	1
POLAR MODE (PR) .....	X	X	1	1	X	X	X	X	X	X	X	X	1	0	1
BLOCK OFF (BO) .....	X	X	1	1	X	X	X	X	X	X	X	1	X	X	X
CLEAR X .....	X	X	1	1	X	X	X	X	X	X	1	X	X	X	X
CLEAR Y .....	X	X	1	1	X	X	X	X	X	1	X	X	X	X	X
PAGE SKIP (PS) .....	X	X	1	1	X	X	X	X	1	X	X	X	X	X	X
SELECT GRAPH 1 GAIN and OFFSET (D2) ..	X	X	1	1	X	0	1	X	X	X	X	X	X	X	X
SELECT GRAPH 2 GAIN and OFFSET (D3) ..	X	X	1	1	X	1	0	X	X	X	X	X	X	X	X
SELECT VECTOR GAIN and OFFSET (D1) ..	X	X	1	1	X	0	0	X	X	X	X	X	X	X	X
SELECT POLAR GAIN & OFFSET (D4) .....	X	X	1	1	X	1	1	X	X	X	X	X	X	X	X
BEAM OFF (PU) .....	X	X	0	1	X	X	X	X	X	X	X	X	X	X	X
BEAM ON (PD) .....	X	X	X	0	X	X	X	X	X	X	X	X	X	X	X
MARKER POINTING UP .....	0	0	X	0	X	X	X	X	X	X	X	X	X	X	X
MARKER POINTING DOWN .....	0	1	X	0	X	X	X	X	X	X	X	X	X	X	X
MARKER OFF .....	1	X	X	X	X	X	X	X	X	X	X	X	X	X	X
VALID DATA .....	X	X	0	X	1	1	X	X	X	X	X	X	X	X	X
VALID DATA .....	X	X	0	X	0	0	X	X	X	X	X	X	X	X	X
+ DATA OVERFLOW .....	X	X	0	X	0	1	X	X	X	X	X	X	X	X	X
- DATA OVERFLOW .....	X	X	0	X	1	0	X	X	X	X	X	X	X	X	X

1=TRUE; 0=FALSE; X=DON'T CARE.

Table 3-5. HP-IB Commands

Message Name	Function	Sample Statement Forms	
		9825A	9830A/B
Data	Write data to 8501A	wrt 714, ... wtb 714, ...	CMD "?U.", "<data>"
	Read data from 8501A	red 714, ... rdb 714, ...	CMD "?N5", <variable>
Clear	Set 8501A to S2L2M1C1 I2A1V1C2I2A1V1F1EREX	clr 714	10 CMD "?U." 20 FORMAT 3B 30 OUTPUT (13, 20) 256,20,512;
Remote	Set HP-IB to Remote: (required only after lcl 7)	rem 7	10 CMD "?U " 20 FORMAT B 30 OUTPUT (13,20) 768;
	Set 8501A to Remote: (required only after lcl 714)	wrt 714, ... wtb 714, ...	CMD "?U.", "<data>"
Local	Set HP-IB to Local	lcl 7	10 CMD "?U " 20 FORMAT B 30 OUTPUT (13,20) 1024;
	Set 8501A to Local	lcl 714	10 CMD "?U." 20 FORMAT 3B 30 OUTPUT (13,20) 256.1, 512;
Local Lockout	Disable Local Pushbutton	llo 7	10 CMD "?U " 20 FORMAT 3B 30 OUTPUT (13,20) 256,17,512;
Clear Local Lockout/ Set Local	Clear local lockout, Set 8501A to local, enable remote	lcl7, rem 7	10 CMD "?U " 20 FORMAT 2B 30 OUTPUT (13,20) 1024, 768;
Status Byte	Output status byte (140) for error; (000) for no error	rds (714) →A	A = STAT14
Abort	Clear interface, clear binary input mode, clear text mode	cli 7	Not available

Table 3-6. 8501A Mnemonics (1 of 2)

INPUT/OUTPUT					
Px, n	Address memory to specify source or destination of data and select ASCII output format. x = page = 1 – 8, n = word = 0 – 511 .				
OL	Output Learn String, 24 characters				
OA	Output current memory address. Data output as: page no. comma word no. carriage return-line feed				
IB	Input binary format data. (2 byte, high byte first). Place following memory address. Reset to default ASCII mode using HP-IB Clear command or sending most significant bit of high byte line.				
01	Output ASCII format data (default). Each data value is: sign integer carriage return-line feed				
02	Output binary format data 2 byte, high byte first Place following Memory address.				
FRONT PANEL					
S1 S2 S3	STORAGE OFF STORAGE ON STORAGE HOLD	C1 C2	CHANNEL 1 CHANNEL 2	A1 A2	AVERAGING OFF AVERAGING ON
L1 L2	LABELS OFF LABELS ON	I1 I2 I3	INPUT OFF INPUT ON INPUT-MEM	F1 F2 F3 F4 F5 F6 F7 F8	AVERAGING FACTOR 2 AVERAGING FACTOR 4 AVERAGING FACTOR 8 AVERAGING FACTOR 16 AVERAGING FACTOR 32 AVERAGING FACTOR 64 AVERAGING FACTOR 128 AVERAGING FACTOR 256
M1 M2 M3 M4	MAGNIFIER X1 MAGNIFIER X2 MAGNIFIER X5 MAGNIFIER X10	MS V0 V1	MEMORY STORE MEMORY VIEW OFF MEMORY VIEW ON		
ER	ERASE				
PROCESSOR COMMANDS					
AB	Stop processing data from 8505A.				
EX	Restart processing data from 8505A.				
TSn,	Take n 8505A sweeps, 1 sweep/channel.				

Table 3-6. 8501A Mnemonics (2 of 2)

<b>MEMORY MNEMONICS</b>	
<b>Mode Selection*</b>	
GR	Graph mode. 500 y values, $-500 \leq y \leq 500$ . y = 0 at Channel 1 reference line.
PA	Vector mode. X,y pairs, $0 \leq x \leq 432$ , $0 \leq y \leq 360$ . 0,0 at lower left-hand corner.
PR	Polar mode. 250 x,y pairs, $-500 \leq x,y \leq 500$ . 0, 0 at polar beam center.
LB	Label mode. Display ASCII and special characters. 22 lines, 50 characters/line. Clear text mode by End-of-Text character. (ASCII 3 character code).
<b>Beam Control</b>	
PU	Beam off. Blank vector to next point.
PD	Beam on.
<b>Memory Control*</b>	
BO	Block off. No data display until next memory mnemonic.
EF	End-of-file. Skip to word 1 of page 1.
PS	Page skip. Skip to word 1 of next page.
<b>Alternate Graphics Display (Place preceding Mode selection mnemonic)</b>	
D1	Select PA reference and scaling.
D2	Select GR reference and scaling. y = 0 at Channel 1 reference line.
D3	Select GR reference and scaling. y = 0 at Channel 2 reference line.
D4	Select PR reference and scaling.
* Mode selection and memory control mnemonics have the effect of AB processor command when input to 8501A.	

