

Errata

Title & Document Type: 8590A Operating Manual

Manual Part Number: 08590-90005

Revision Date: August 1986

HP References in this Manual

This manual may contain references to HP or Hewlett-Packard. Please note that Hewlett-Packard's former test and measurement, semiconductor products and chemical analysis businesses are now part of Agilent Technologies. We have made no changes to this manual copy. The HP XXXX referred to in this document is now the Agilent XXXX. For example, model number HP8648A is now model number Agilent 8648A.

About this Manual

We've added this manual to the Agilent website in an effort to help you support your product. This manual provides the best information we could find. It may be incomplete or contain dated information, and the scan quality may not be ideal. If we find a better copy in the future, we will add it to the Agilent website.

Support for Your Product

Agilent no longer sells or supports this product. You will find any other available product information on the Agilent Test & Measurement website:

www.tm.agilent.com

Search for the model number of this product, and the resulting product page will guide you to any available information. Our service centers may be able to perform calibration if no repair parts are needed, but no other support from Agilent is available.

HP 8590A Portable RF Spectrum Analyzer
Operating Manual



Manual Part Number: 08590-90005
Microfiche Part Number: 08590-90006
Printed in U.S.A. August 1986

Copyright © 1986 by Hewlett-Packard Company
1212 Valleyhouse Drive, Rohnert Park, CA 94928-4999

HP 8590A Documentation Description

Manuals shipped with your instrument:

Installation Manual

HP Part Number 08590-90003

- Tells you how to install the spectrum analyzer
- Tells you what to do in case of a failure



Operating Manual

HP Part Number 08590-90005

- Tells you how to make measurements with your spectrum analyzer
- Describes analyzer features



Options:

Support Manual (Option 915)

HP Part Number 08590-90008

- Describes troubleshooting and repair of the analyzer



Programming Manuals

HP Part Numbers:

HP-IB 08590-90011 (Option 021)

HP-IL 08590-90013 (Option 022)

RS-232 08590-90015 (Option 023)

- Describes analyzer operation via a remote controller (computer)

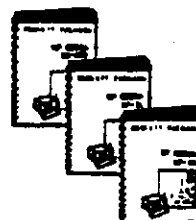

How to Use This Manual

Where to Start

If you are familiar with spectrum analyzers:

Skim Chapter 1, "Making Your First Measurement," for a brief introduction to the HP 8590A Spectrum Analyzer.

To find a description of a particular analyzer function, consult the index at the end of this manual. Page numbers that are bold reference control descriptions in Chapter 3, "Analyzer Functions." Non-bold page numbers refer you to reference material used during applications in Chapter 2, "Analyzer Measurements and Applications."

CAUTION

To prevent damage to your spectrum analyzer:

1. Do not exceed the maximum input power. The maximum input power is +30 dBm (1 Watt) continuous; 0 Volt dc.
2. Do not use the [CAL FLATNESS] softkeys unless you have access to the correct calibration data.

If you are not familiar with spectrum analyzers (and your spectrum analyzer has already been unpacked and installed):

Read Chapter 1, "Making Your First Measurement," which introduces you to the HP 8590A, leads you through a simple spectrum analyzer measurement, and shows how to make more accurate measurements.

After you've successfully made your first measurement, continue with Chapter 2, "Analyzer Measurements and Applications," to gain experience with spectrum analyzer measurements.

Manual Terms and Conventions

Words in this manual that appear in brackets [] refer to softkeys that appear on the screen. Keys that appear on the front panel of the instrument appear **boxed**.

Printing History

Each new edition of this manual incorporates all material updated since the previous edition. Manual change sheets may be issued between editions, allowing you to correct or insert information in the current edition.

The manual part number changes only when a new edition is published. Minor corrections or additions may be made as the manual is reprinted between editions.

Part Number 08590-90005
First Printing August 1986

Table of Contents

HP 8590 Documentation Description	2
How to Use This Manual	3
Where to Start	3
Manual Terms and Conventions	4
Printing History	4

1 Making Your First Measurement 1st Measurement

What You'll Learn in This Chapter	1-1
Making a Measurement	1-1
1. Relax!	1-2
2. Frequency	1-2
3. Span	1-3
4. Amplitude	1-3
5. Marker	1-5
Measurement Summary	1-6
Getting Acquainted With the Front Panel and Display	1-8
Front-Panel Overview	1-8
Menu and Softkey Overview	1-11
Screen Annotation	1-12
Improving Accuracy With Calibration Routines	1-14
Calibration Procedure	1-14
Warmup Time	1-15

2 Analyzer Measurements and Applications

Measurements

What You'll Learn in This Chapter	2-1
Comparing Signals With Delta Markers	2-2
Tracking Renegade Signals With Signal Track and Maximum Hold	2-8
Automatic Zooming With Auto Zoom	2-12
Resolving Signals of Equal Amplitude With Resolution Bandwidth	2-14
Comparing Small Signals and Large Signals With Resolution Bandwidth	2-18
Measuring Low-Level Signals With Attenuation, Bandwidth, and Video Averaging	2-20
Identifying Distortion Products Using the RF Attenuator and Traces	2-28
Distortion From the Analyzer	2-28
Third-Order Intermodulation Distortion	2-31
Using the Analyzer as a Receiver in Zero Span	2-35
Measuring Amplitude Modulation With the Fast Fourier Transform Function	2-38

3 Analyzer Functions

Functions

What You'll Learn in This Chapter	3-1
Data Controls	3-2
Knob	3-2
Step Keys	3-3
Number/Units Keyboard	3-3
Hold Key	3-4
Frequency and Span	3-4
Amplitude	3-6
Instrument State	3-9
Copy	3-18
Marker	3-20
Control Functions	3-25
Service Functions	3-28
Other Controls and Connectors	3-36
Intensity	3-36
Line Power	3-36
Front-Panel Connectors	3-37
Rear-Panel Connectors	3-38

Appendix

AM, FM, and Pulsed RF Reference Charts	A-1
--	-----

Index	Index-1
-------------	---------

HP 8590A Softkey Menus	Rear Inside Cover
------------------------------	-------------------

Chapter 1

Making Your First Measurement

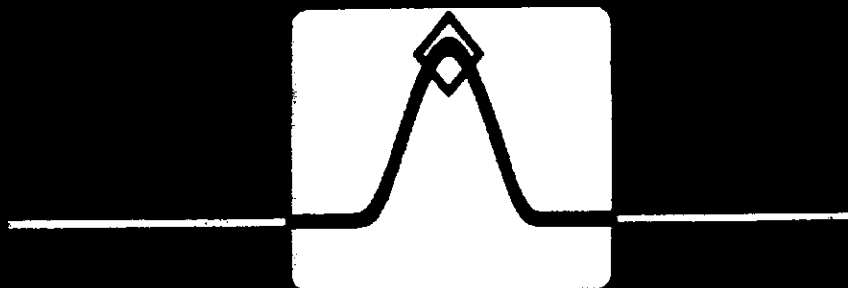

What You'll Learn in This Chapter

This chapter introduces the basic functions of the spectrum analyzer. In this chapter you will

- Measure a signal (the calibration signal)
- Get acquainted with the front panel and display
- Improve measurement accuracy using calibration routines

Note: Before using your analyzer, please read the HP 8590A Installation Manual, which describes how to install your analyzer and how to verify that it is installed correctly. The Installation Manual relates safety concerns.

Making a Measurement

Let's begin using the HP 8590A by measuring an input signal. Since the 299.9-MHz calibration signal (CAL OUTPUT) is readily available, we will use it as our input signal.

First, turn the instrument on (or, if it is already on, press **PRESET**). Connect the CAL OUTPUT to the RF INPUT on the front panel using the appropriate BNC cable, then follow the steps below.

1. Relax!

You cannot hurt the analyzer by using the calibration signal and pressing any of the keys described in this section. Don't be afraid to play with the knob, step keys, or number/units keyboard. (If you have experimented with other keys and wish to return to a known state, press the green **PRESET** key).

2. Frequency

Press the **FREQUENCY** key. "CENTER" appears on the left side of the screen, indicating that the center frequency function is active. (The space on the screen where "CENTER 750 MHz" appears is called the **active function block**. Functions appearing in this block are active: their values can be changed with the knob, step keys, or number/units keyboard.) Set the center frequency to 299.9 MHz with the DATA keys by pressing **2** **9** **9** **.** **9** **MHz**. The knob and step keys can also be used to set the center frequency.

3. Span

Press the **SPAN** key. "SPAN" is now displayed in the active function block. (Span refers to the frequency range on the screen.) Reduce the span to 200 MHz by using the down step key or pressing **2 0 0 MHz**.

4. Amplitude

When the peak of a signal does not appear on the screen, it may be necessary to adjust the amplitude level on the screen. Press the **AMPLITUDE** key and "REF LEVEL .0 dBm" appears in the active function block. The reference level is the top graticule line on the display and is set to 0.0 dBm. Changing the value of the reference level changes the amplitude level of the top graticule line.

If necessary, use the reference level function to place the signal peak on the screen using the knob, step keys, or number/units keyboard.

Figure 1-1 demonstrates the relationship between center frequency and reference level. The box in the figure represents the spectrum analyzer screen. Changing the center frequency changes the horizontal placement of the screen. Changing the reference level changes the vertical placement of the screen. Increasing the span increases the horizontal dimension of the screen.

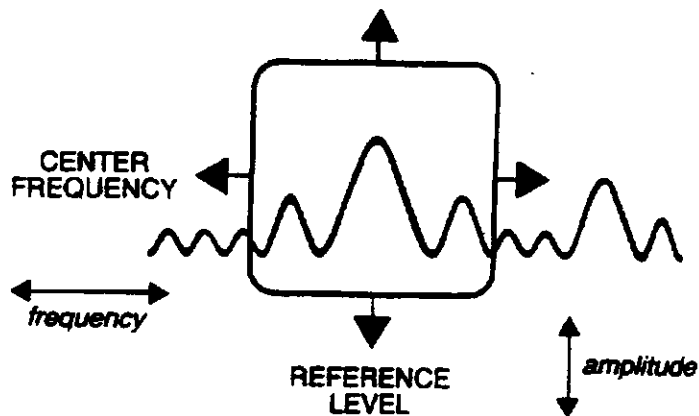

Figure 1-1

5. Marker

You can place a diamond-shaped marker on the signal peak to find the signal's frequency and amplitude.

To activate a marker, press the **MKR** key located in the **MARKER** section of the front panel. Then press the softkey next to **MARKER NORMAL**. Turn the knob to place the marker at the signal peak.

(The six keys along the right side of the display are called **softkeys**. Their labels are displayed on the screen. Pressing the labeled keys on the front panel changes the softkey labels or initiates functions. Softkeys are discussed in greater detail in the following section.)

You can also use the **PEAK SEARCH** key, which automatically places a marker at the highest peak on the trace.

Readouts of marker amplitude and frequency appear in the active function block and in the upper-right corner of the display. Look at the marker readout to determine the amplitude of the signal.

If another function is activated that affects the amplitude and frequency values of the signal, the frequency and amplitude can still be found from the marker readout in the upper-right corner.

Measurement Summary

1. Connect the CAL OUTPUT to the RF INPUT.
2. Set the center frequency:
FREQUENCY **3** **0** **0** **MHZ**.
3. Set the span: **SPAN** **2** **0** **0** **MHZ**.
4. If necessary, adjust the reference level: press **AMPLITUDE** to activate the reference level and use the knob or step keys to change the reference level.
5. Determine the amplitude and frequency of the signal. Press **PEAK SEARCH**. Or, press **MKR**, **[MARKER NORMAL]**, and move the marker to the signal peak. Read the amplitude and frequency.

The display screen should look like the one in Figure 1-2. Frequency is displayed horizontally and amplitude (power) is displayed vertically.

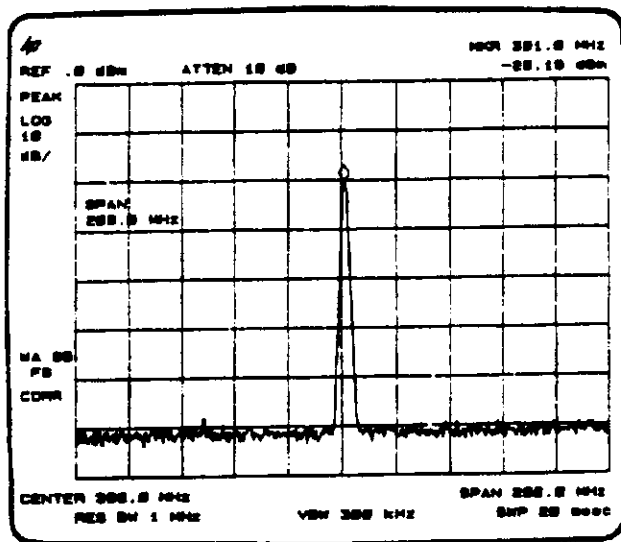

Figure 1-2

Getting Acquainted With the Front Panel and Display

Front-Panel Overview

Looking at the front panel of your HP 8590A Spectrum Analyzer, identify the features numbered in Figure 1-3.

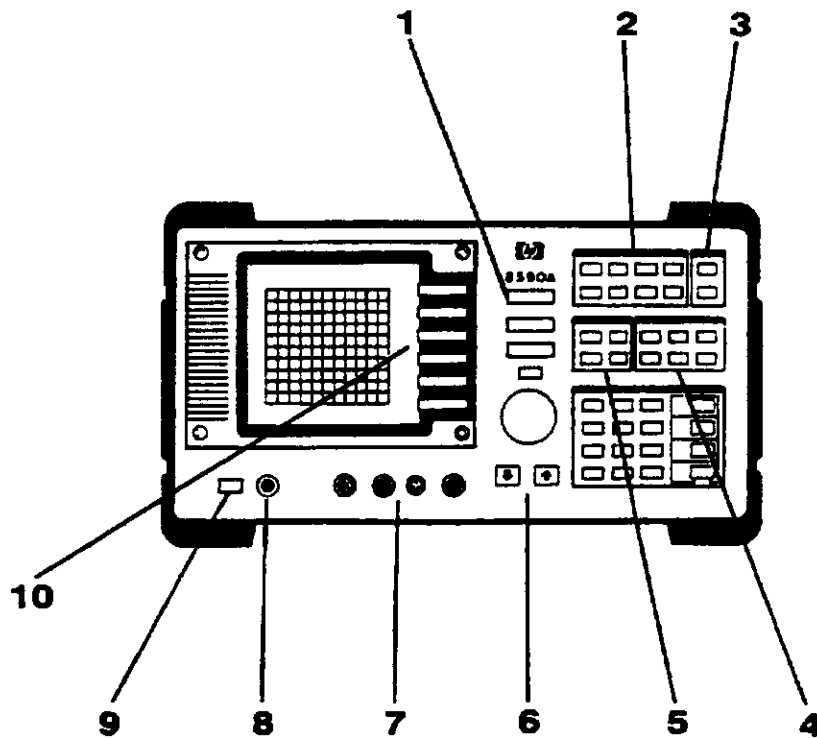

Figure 1-3

-
1. **FREQUENCY, SPAN, and AMPLITUDE** are three large dark keys that access fundamental spectrum analyzer functions. These keys activate the three primary analyzer functions and access menus that allow you to change related functions.
 2. **INSTRUMENT STATE** functions affect the status of the entire spectrum analyzer. Calibration functions and special function menus are accessed with these keys. The green **PRESET** key resets the entire analyzer state and is often used as a "panic" button when you wish to return to a known state.
 3. **COPY** functions allow you to control output to printers and plotters.
 4. **CONTROL** functions access menus to adjust the resolution bandwidth, to store and manipulate trace data, and to control the instrument display.
 5. **MARKER** functions read out frequencies and amplitudes along the spectrum analyzer trace, automatically locate the highest amplitude signal on a trace, and keep a signal in the center of the screen.
 6. **DATA** keys, **STEP** keys, and the **KNOB** allow you to change the numeric value of an active function. The **HOLD** key deactivates an active function.

-
7. **INPUTS/OUTPUTS** are connectors that allow you to apply a signal to the RF input of the spectrum analyzer, obtain the calibration signal, and power an accessory such as a probe. (See "Front-Panel Connectors" in Chapter 3.)
 8. **INTENSITY** adjusts the brightness of the display.
 9. **LINE** turns on the instrument, starts an instrument self-test, and leaves the analyzer in the **PRESET** state. (Also see "Warmup Time" at the end of this chapter.)
 10. **SOFTKEYS** and softkey menus are discussed in the following section.

Menu and Softkey Overview

While performing the measurement in the first part of this chapter, you may have noticed the menus along the right side of the display. These menus list functions other than those accessed directly by the keys that are labeled on the front panel of the instrument. (In this manual, front-panel keys that are labeled are **boxed**.)

When the instrument is first turned on, the frequency menu appears on the screen. To activate a function on the menu, press the unlabeled key immediately to the right of the annotation on the screen. The unlabeled keys next to the annotation on the display screen are called softkeys. (In this manual, softkeys are enclosed in **brackets**.)

Most front-panel keys access softkey menus which, in turn, list related functions. For example, press the **FREQUENCY** key. This calls up a menu containing frequency softkeys and activates the center frequency function. Press the **[START FREQ]** softkey. "START" appears in the active function block, indicating that start frequency is the active function. To activate a different frequency function, press another softkey. To select another menu, press another labeled front-panel key.

A summary of all HP 8590A softkeys can be found at the end of this manual.

Screen Annotation

Figure 1-4 shows annotation as it appears on the screen of the HP 8590A. Table 1-1 lists the features of the front panel alphabetically and references the numbers in Figure 1-4.

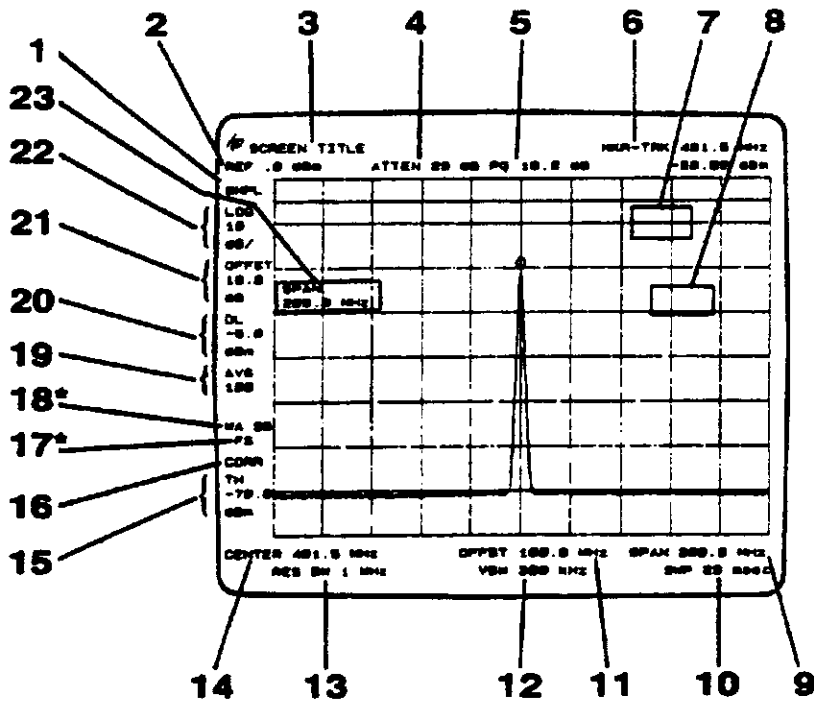

Figure 1-4

*Trace, sweep, and trigger modes appear on the display, indicating the active functions listed below:

<i>Trace</i>	<i>Sweep</i>	<i>Trigger</i>
W = clear write A/B	C = continuous	F = free
M = maximum hold A/B	S = single sweep	L = line
V = view A/B		V = video
S = store blank A/B		E = external.

Table 1-1 Screen Annotation

Feature	Index	Feature	Index
active function block	23	scale	22
amplitude scale	22	screen title	3
amplitude offset	21	service request	8
attenuation	4	signal track	6
corrected	16	span	9
center frequency	14	sweep mode	17
detector mode	1	sweep time	10
display line	20	start frequency	14
frequency offset	11	(or center frequency)	
frequency span	9	stop frequency (or span)	9
marker readout	6	threshold	15
measurement uncalibrated	7	trace mode	18
preamplifier gain	5	trigger	17
reference level	2	video average	19
resolution bandwidth	13	video bandwidth	12
RF attenuation	4		

Improving Accuracy With Calibration Routines

Calibration routines improve the analyzer's frequency and amplitude accuracy. Press the **[CAL]** key to view the calibration menus. The last function on this menu, labeled MORE, provides access to additional calibration functions. (For a summary of all calibration softkeys, see Chapter 3, "Analyzer Functions.")

The calibration routines should be used before calibrated measurements are made to ensure that the analyzer meets frequency and amplitude accuracy specifications. Allow the temperature of the instrument to stabilize before starting the calibration procedure.

Once the instrument has been calibrated, "CORR" (corrected) appears on the left side of the screen.

Calibration Procedure

1. Turn the instrument on or press **[PRESET]**. Connect the CAL OUTPUT to the RF INPUT using the appropriate BNC cable. (If the CAL signal is not connected, the CAL routines will not run correctly.)
2. Press the **[CAL]** key to reach the calibration softkey menu.
3. Press the **[CAL FREQ]** softkey to start the frequency calibration routine. This routine adjusts the sweep time and span accuracy in approximately one minute. When the frequency calibration routine has finished, the preset display (seen in step 1) returns.

-
4. Press the [CAL AMPTD] softkey to start the amplitude calibration routine. This routine takes approximately six minutes to adjust the bandwidths, log/linear switching, IF gains, RF attenuation, and log amplifier. When the amplitude calibration routine has finished, the preset display returns.
 5. Although the analyzer now uses this frequency and amplitude calibration data, the data will be lost if the analyzer is turned off.

To store the calibration data in the analyzer's nonvolatile memory, press the [CAL STORE] softkey. Once the calibration data has been stored, turning the instrument off and on automatically retrieves the stored calibration data.

6. "CORR" (corrected) now appears on the left side of the screen, indicating that the analyzer is using its frequency and amplitude correction factors. Correction factors can be turned off by pressing [CORRECT on OFF]. When ON is capitalized, the correction factors are used and CORR appears on the display. When OFF is capitalized, correction factors are not used.

Warmup Time

To meet spectrum analyzer specifications, allow two hours warmup time before attempting to make any calibrated measurements.

Chapter 2

Analyzer Measurements and Applications

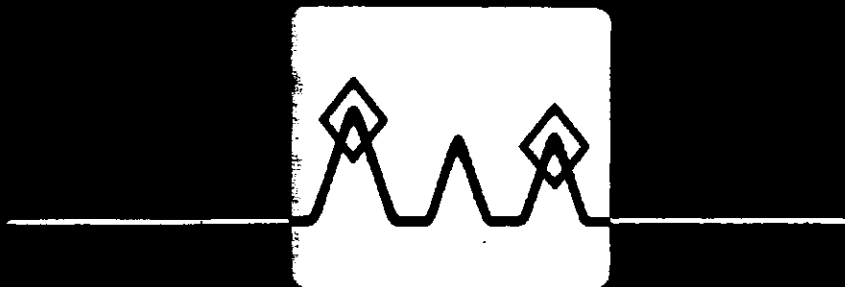

What You'll Learn in This Chapter

This chapter demonstrates spectrum analyzer measurement techniques with examples of typical applications. Each application focuses on different spectrum analyzer features. The measurement procedures covered in this chapter are listed below.

- Comparing signals with delta markers
- Tracking a renegade signal with signal track and maximum hold
- Automatic zooming with auto zoom
- Resolving signals of equal amplitude with resolution bandwidth
- Comparing small signals with large signals using the resolution bandwidth function
- Measuring low-level signals with attenuation, video bandwidth, and video averaging
- Identifying distortion using the RF attenuator and traces
- Using the analyzer as a receiver in zero frequency span
- Measuring amplitude modulation with the Fast Fourier Transform function

To find descriptions of specific analyzer functions, turn to Chapter 3, "Analyzer Functions," or look in the index.

Comparing Signals With Delta Markers

With the spectrum analyzer you can easily compare frequency and amplitude differences between signals, such as radio or television signal spectra. The spectrum analyzer's delta marker function lets you compare two signals when both appear on the screen at one time or when only one appears on the screen.

Example: Measure the differences between two signals on the same display screen.

1. Connect the CAL OUTPUT to the RF INPUT on the front panel. Turn the instrument on (or press **PRESET**). The calibration signal and its harmonics appear on the display.
2. Press **PEAK SEARCH** to place a marker at the highest peak on the display. The **[NEXT PK RIGHT]** and **[NEXT PK LEFT]** softkeys move the marker from peak to peak. Press **[NEXT PK RIGHT]** to move the marker to the 299.9-MHz calibration signal. See Figure 2-1.

The signal that appears at the left edge of the screen is the spectrum analyzer's local oscillator and represents 0 Hz.

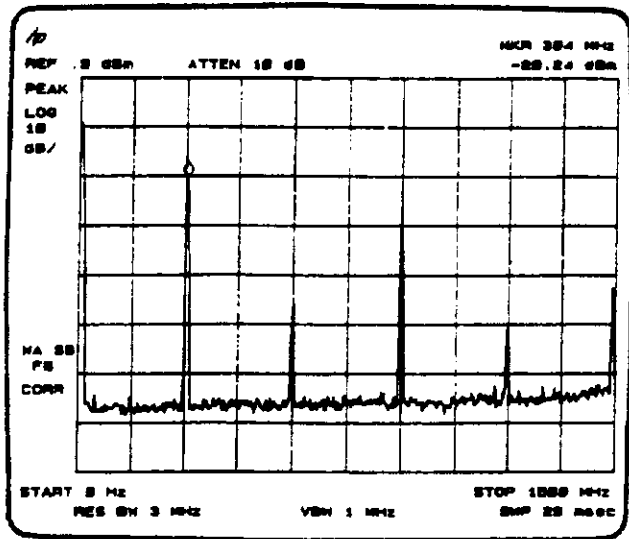

Figure 2-1

3. Press [MARKER DELTA] to activate a second marker at the position of the first marker. Move the second marker to another signal peak with the [NEXT PK RIGHT] or [NEXT PK LEFT] softkeys. You can also use the knob or step keys to move the second marker.
4. The amplitude and frequency difference between the markers is displayed in the active function block and in the upper-right corner of the screen. See Figure 2-2.

Press **[MKR]** and [MARKERS OFF] to turn the markers off.

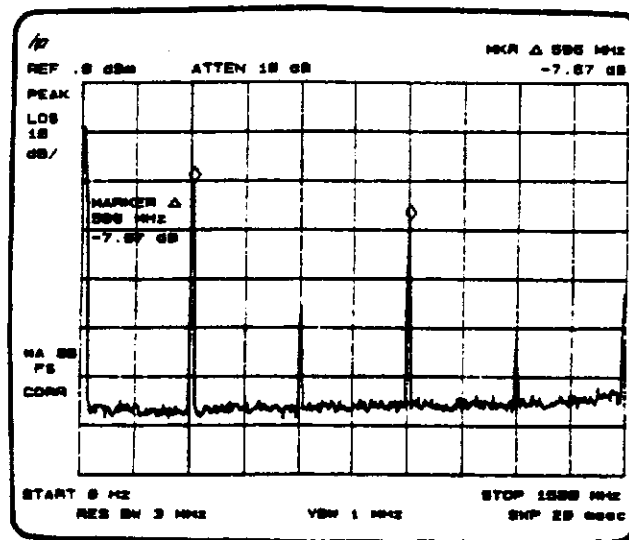

Figure 2-2

-
5. The [DELTA MEAS] softkey finds and displays the frequency and amplitude difference between the two highest amplitude signals. To use this automatic function, first decrease the span to 1200 MHz: press **SPAN**, **1**, **2**, **0**, **0**, **MHz**. Press **MENU 1** and [DELTA MEAS].

The frequency and amplitude differences between the signals appear in the active function block. In addition, the softkeys accessed by **PEAK SEARCH** appear on the screen.

Example: Measure the frequency and amplitude difference between two signals that do not appear on the screen at one time. (This technique is useful for harmonic distortion tests when narrow span and narrow bandwidth are necessary to measure the low-level harmonics.)

1. Connect the CAL OUTPUT to the RF INPUT connector on the front panel (if you have not already done so). Press **PRESET**, **SPAN**, and the down step key to narrow the frequency span until only one or two signals appear on the screen.
2. Press **PEAK SEARCH** to place a marker on the highest peak.
3. Press **MARKER DELTA** to identify the position of the first marker.
4. Press **FREQUENCY** to activate center frequency. Turn the knob counterclockwise to adjust the center frequency until a second signal peak is placed at the position of the second marker. The first marker remains on the screen at the amplitude of the first signal peak. See Figure 2-3.

The annotation in the upper-right corner of the screen indicates the amplitude and frequency difference between the two signals.

To turn the markers off, press **MKR** and **[MARKERS OFF]**.

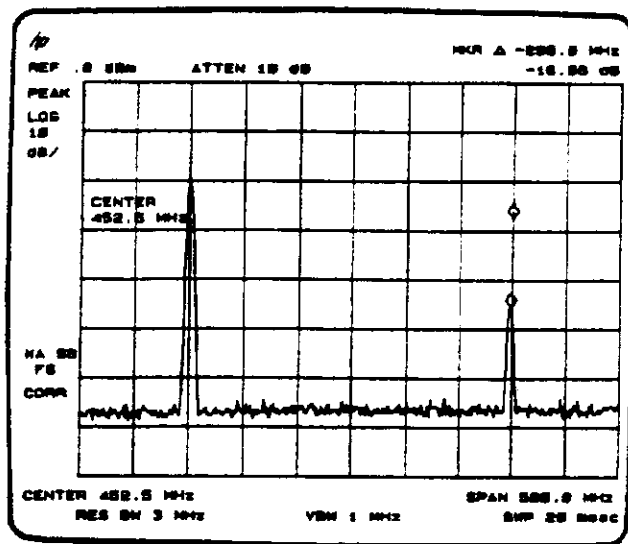

Figure 2-3

Tracking Renegade Signals With Signal Track and Maximum Hold

Two techniques can be used to follow and measure drifting and changing signals. One technique changes the center frequency value to center the signal on the screen, enabling the analyzer to track the signal. A second technique stores signal frequency data, using the maximum hold function to show peak-to-peak excursion. (The maximum hold function keeps the maximum responses of a signal on the display.) These techniques are described in the following examples.

Example: The analyzer automatically maintains drifting signals at the center of the screen with the **signal track** function. As the signal drifts, the center frequency automatically changes to bring the signal and marker to the center of the screen. Use **signal track** to keep a drifting signal at the center of the display and monitor its change in "real-time."

1. Press **[PRESET]**. Press **[PEAK SEARCH]** to place a marker on a signal peak. The marker readout appears in the upper-right corner of the screen. If you are using the **CAL OUTPUT** signal, press **[NEXT PK RIGHT]** to move the marker to the 299.9-MHz calibration signal. (The signal that appears at the left edge of the screen is the spectrum analyzer's local oscillator and represents 0 Hz.)
2. Press **[SIGNAL TRACK]**. "MKR-TRK" now appears on the screen, indicating that the marker and signal will be

maintained at the center of the screen. As the signal drifts, the marker finds the signal, and the spectrum analyzer's center frequency value is changed to move the signal back to the center of the screen. (If the signal moves off the screen in one sweep, return to step 1.) **Hint:** use a wider frequency span.)

3. The "real time" signal frequency drift can be read from the screen if both the signal track and marker delta functions are active. Press [MARKER DELTA] and **SIGNAL TRACK**. "MKR Δ -TRK" appears in the upper right corner of the screen, as in Figure 2-4.

The marker readout indicates the amount of frequency and amplitude change as the signal drifts.

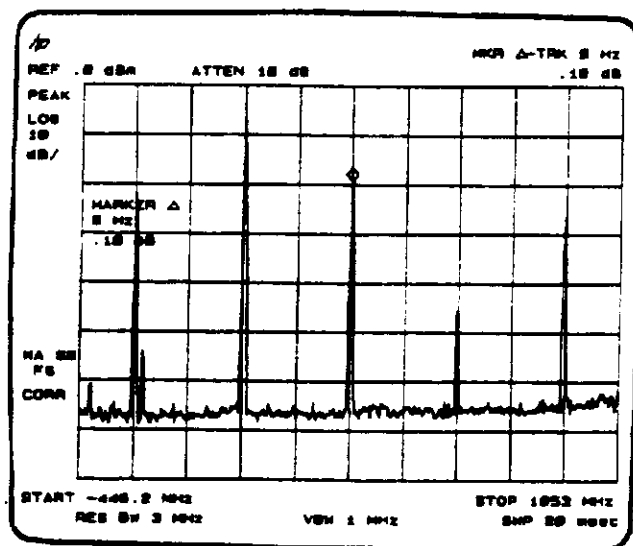

Figure 2-4

Example: A spectrum analyzer can measure the short- and long-term stability of a source. The maximum amplitude level and the frequency drift range of an input signal trace can be displayed and held with the **maximum hold** function.

You can use the maximum hold function if, for example, you want to determine how much of the frequency spectrum an FM signal occupies.

Using the maximum hold function, monitor the frequency drift of a signal.

1. Press **[PRESET]**. To center and view the signal in a narrow span, press **[FREQUENCY]**. This activates the center frequency and allows you to change the center frequency value. For example, if the CAL OUTPUT signal is connected, set the center frequency to 299.9 MHz.

Next, press **[SPAN]**. Reduce the span to 200 kHz. As the span is reduced, the center frequency value may be adjusted to keep the signal at the center of the screen.

(A more convenient technique for centering and zooming in on signals is shown in the following section, "Automatic Zooming.")

2. To measure the excursion of the signal, press **[TRACE A]** and **[MAX HOLD A]**. As the signal drifts, maximum hold maintains the maximum responses of the input signal, as shown in Figure 2-5. (To simulate this with the calibration signal, press **[FREQUENCY]** and turn the knob.)

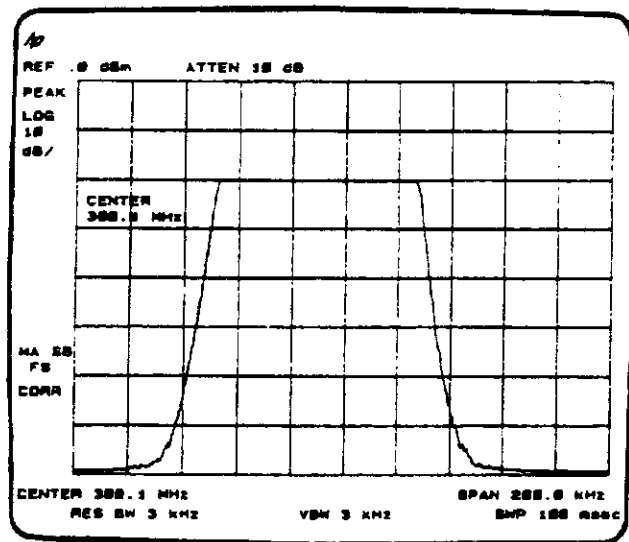

Figure 2-5

3. Annotation on the left side of the screen indicates the trace mode. For example, "MA SB" indicates trace A is in maximum-hold mode and trace B is in store-blank mode. (See "Screen Annotation" in Chapter 1.)

Press **TRACE B** and **[CLEAR WRITE B]** to place trace B in clear-write mode. The live signal is viewed in trace B as it moves. Trace A remains in maximum-hold mode, showing the frequency shift of the signal.

Automatic Zooming With Auto Zoom

Using the spectrum analyzer's automatic zoom function, you can quickly zoom in to see the sidebands of a signal.

Example: Examine a carrier in a 200-kHz span to see the sidebands.

1. Press **PEAK SEARCH** to place a marker on the carrier. (If you are using the CAL OUTPUT signal, place the marker on the 299.9-MHz calibration signal.)
2. Press **SIGNAL TRACK** and the signal will move to the center of the screen. Because the signal track function automatically maintains the signal on the center of the screen, you can zoom in automatically from a wide span to a narrow span for a closer look. (If the signal drifts, use a wider frequency span.)
3. Press **SPAN**, **2**, **0**, **0**, **kHz**. The span decreases in steps as automatic zoom is completed. You can also use the knob or step keys to decrease the span. See Figure 2-6.

Press **SIGNAL TRACK** again to turn off the tracking function. (Signal track must be off for zero span.)

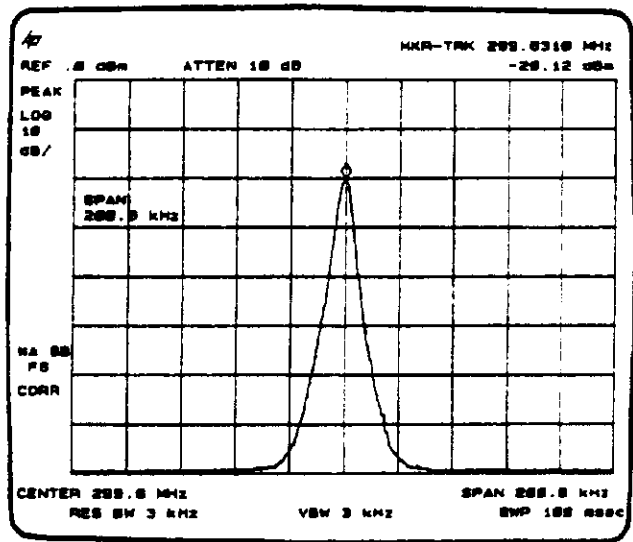

Figure 2-6

Resolving Signals of Equal Amplitude With Resolution Bandwidth

In responding to a continuous-wave signal, a swept-tuned spectrum analyzer traces out the shape of the spectrum analyzer's filter. As we change the filter bandwidth, we change the width of the displayed response. If a wide filter is used and two equal-amplitude input signals are close enough in frequency, then the two signals appear as one. Thus, signal resolution is determined by the IF filters inside the spectrum analyzer.

The resolution bandwidth function (RES BW) selects the appropriate IF filter for a measurement. Resolution bandwidth is defined as the 3-dB bandwidth of a filter. The 3-dB bandwidth tells us how close together equal amplitude signals can be and still be distinguished from each other.

Generally, to resolve two signals of equal amplitude, the resolution bandwidth must be less than or equal to the frequency separation of the two signals. Then a dip of at least 3 dB is seen between the peaks of the two signals, and it is clear that more than one signal is present.

Hint: In order to keep the analyzer calibrated, sweep time is inversely proportional to the square of the resolution bandwidth. So, if the resolution bandwidth is reduced by a factor of 10, the sweep time is increased by a factor of 100. ($ST = 1/[BW]^2$) For fastest measurement times, use the widest resolution bandwidth that still permits discrimination of all desired signals. The analyzer

allows you to select from 1-kHz to 3-MHz resolution bandwidth in a 1,3,10 sequence for maximum measurement flexibility.

Example: Resolve two signals of equal amplitude with a frequency separation of 100 kHz.

1. To obtain two signals with a 100-kHz separation, connect the calibration signal and a signal source to the spectrum analyzer RF INPUT as shown in Figure 2-7. (If available, two sources can be used.)

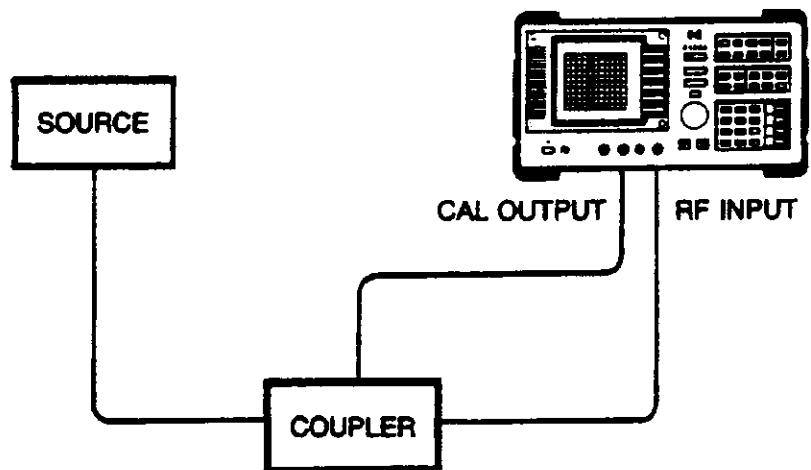

Figure 2-7

2. If you are using the 299.9-MHz calibration signal, set the frequency of the source 100 kHz greater than the calibration signal (for example, 300.0 MHz). The amplitude of both signals should be -20 dBm.
3. Since the resolution bandwidth must be less than or equal to the frequency separation of the two signals, a resolution bandwidth of 100 kHz must be used. Press **[SWP/BW]**, **[RES BW]**, and **[1]**, **[0]**, **[0]**, **[kHz]**. You can also use the knob and step keys to change the resolution bandwidth. See Figure 2-8.

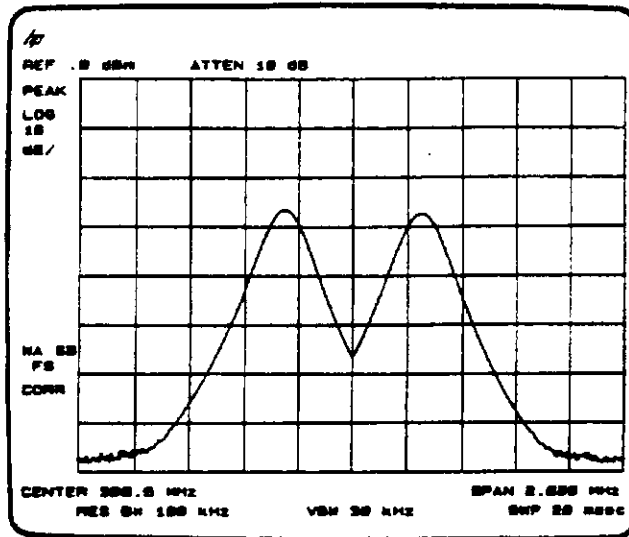

Figure 2-8

As the resolution bandwidth is decreased, resolution of the individual signal is improved and the sweep time is increased. For fastest measurement times, use the widest possible resolution bandwidth.

Under preset conditions, the resolution bandwidth is "coupled" (or linked) to other functions such as the sweep time.

Since the resolution bandwidth has been changed, a "#" mark appears next to RES BW in the lower corner of the screen, indicating it is uncoupled. (Also see **AUTO COUPLE** in Chapter 3.)

Note: To resolve two signals of equal amplitude with a frequency separation of 200 kHz, the resolution bandwidth must be less than the signal separation, and resolution of 100 kHz must be used. The next larger filter, 300 kHz, would exceed the 200-kHz separation and would not resolve the signals.

Comparing Small Signals and Large Signals With Resolution Bandwidth

When dealing with resolution of signals that are not equal in amplitude, you must consider the shape of the IF filter as well as its 3-dB bandwidth. The shape of the filter is defined by the **shape factor**, which is the ratio of the 60-dB bandwidth to the 3-dB bandwidth. (Generally, the IF filters in this spectrum analyzer have shape factors of 15:1 or less.)

If a small signal is too close to a larger signal, it can be hidden by the skirt of the larger signal. To view the smaller signal, you must select a resolution bandwidth such that $k < a$. See Figure 2-9.

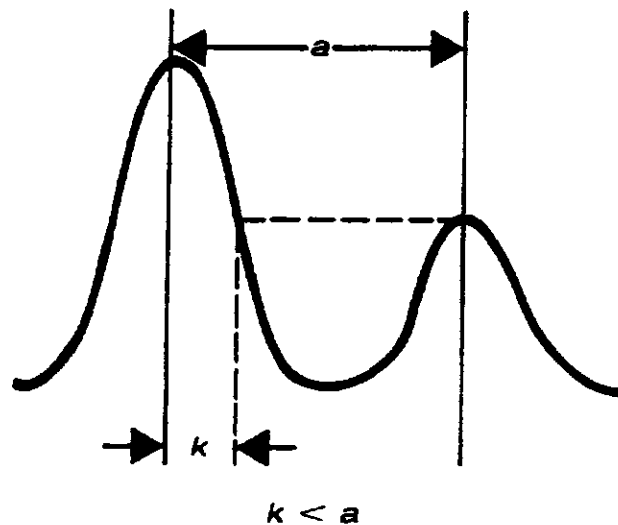

Figure 2-9

The separation between the two signals must be greater than half the filter width of the larger signal at the amplitude level of the smaller signal.

Example: Resolve two input signals with a frequency separation of 200 kHz and an amplitude separation of 50 dB.

1. To obtain two signals with a 200-kHz separation, connect the equipment as shown in the previous section, "Resolving Signals of Equal Amplitude."
2. Set the source so that the signal is 200 kHz higher than the calibration signal. Reduce the amplitude of the signal to -70 dBm (50 dB below the calibration signal).
3. If a 10-kHz filter with a typical shape factor of 15:1 is used, the filter will have a bandwidth of 150 kHz at 60 dB. The half-bandwidth (75 kHz) is narrower than the frequency separation, so the input signals will be resolved.

If a 30-kHz filter is used, the 60-dB bandwidth will be 450 kHz. Since the half-bandwidth (225 kHz) is wider than the frequency separation, the signals most likely will not be resolved. (To determine resolution capability for intermediate values of amplitude level differences, consider the filter skirts between the 3-dB and 60-dB points to be straight. In this case, we simply used the 60-dB value.)

Measuring Low-Level Signals With Attenuation, Bandwidth, and Video Averaging

Spectrum analyzer sensitivity is the ability to measure low-level signals and is limited by the noise generated inside the analyzer itself. The RF input attenuator and bandwidth settings affect the sensitivity by changing the signal-to-noise ratio. The attenuator affects the level of a continuous wave signal passing through the instrument, whereas the bandwidth affects the level of internal noise without affecting the signal. In the first two examples in this section, the attenuator and bandwidth settings are adjusted to view low-level signals.

If, after adjusting the attenuation and resolution bandwidth, a signal is still near the noise, visibility can be improved with the video bandwidth and video averaging functions, as demonstrated in the third and fourth examples.

Example: If a signal is very close to the noise floor, reducing input attenuation brings the signal out of the noise. Reducing the attenuation to 0 dB maximizes signal power in the analyzer. (The level of all input signals must not exceed the maximum power level for the analyzer.)

1. Connect the CAL OUTPUT signal to the RF INPUT. (The calibration signal does not exceed the maximum power level.) Press **[PRESET]**, then **[PEAK SEARCH]**. Press **[NEXT PK RIGHT]** until the marker is placed on the low signal peak at the right side of the screen. See Figure 2-10.

-
2. Press **SIGNAL TRACK** and the signal is moved to the center frequency. (Press **SIGNAL TRACK** again to turn off the tracking function.)

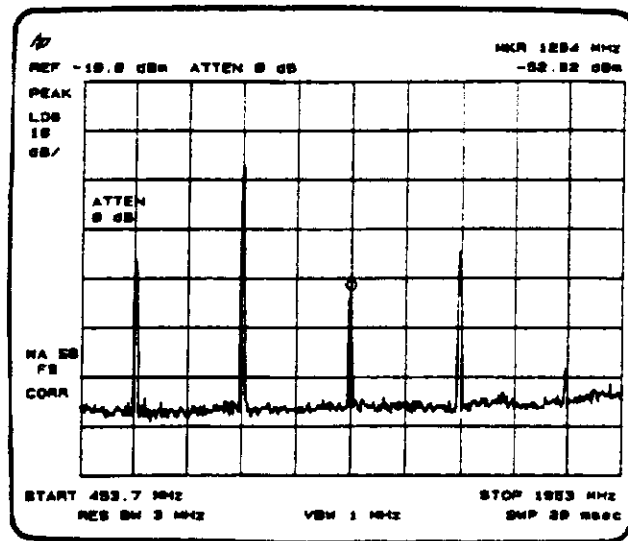

Figure 2-10

3. Press **AMPLITUDE** and **[ATTEN]**. Press the up step key once to select 20-dB attenuation. Increasing the attenuation moves the noise floor closer to the signal.

A “#” mark appears next to **ATTEN**, indicating the attenuation is no longer coupled.

-
4. To see the signal more clearly, press **0** **dB**. Zero attenuation makes the signal more visible. (As a precaution to protect the spectrum analyzer's input mixer, 0-dB RF attenuation can be selected only with the number/units keyboard.)

Before connecting other signals to the RF input, increase the RF attenuation to protect the analyzer's input mixer.

Example: The resolution bandwidth can be decreased to view low-level signals.

1. As in the previous example, connect the CAL OUTPUT signal to the RF INPUT connector. Press **PRESET**, then **PEAK SEARCH**. Press [NEXT PK RIGHT] until the marker is placed on the low signal peak at the right side of the screen.
2. Press **SIGNAL TRACK** and the signal moves to the center frequency. Press **SPAN** and select 500 MHz. (Press **SIGNAL TRACK** again to turn the function off.)
3. Press **SWP/BW**, [RES BW], and the down step key. The low-level signal appears more clearly because the noise level is reduced.

A "#" mark appears next to RES BW on the left corner of the screen, indicating that the resolution bandwidth is uncoupled.

As the resolution bandwidth is reduced, the sweep time is adjusted to maintain calibrated data.

Example: The video filter control is useful for noise measurements and observation of low-level signals close to the noise floor. The video filter is a post-detection low-pass filter that smooths the displayed trace by averaging random noise. (The normal detection mode is PEAK, so the displayed level of the noise drops from the peak value to the average value in the smoothing process.)

Thus, when signal responses near the noise level of the analyzer will be visually masked by the noise, the video filter can be narrowed to smooth this noise and improve the visibility of the signal. (Since video filtering requires slower sweep times to keep the analyzer calibrated, it is not used all the time.)

Using the video bandwidth function, measure the amplitude of a low-level signal.

1. Position a low-level signal on the analyzer screen as in the previous example. Press **[SWP/BW]** and **[VID BW]**. Press the down step key four times to narrow the video bandwidth, to clarify the signal, and to allow measurement of its amplitude. The sweep time will automatically increase to maintain calibration.

A “#” mark appears next to VBW on the screen, indicating that the video bandwidth is not coupled to the resolution bandwidth.

Instrument preset conditions couple the video bandwidth to the resolution bandwidth so that the video bandwidth is equal to or narrower than the resolution bandwidth. If the bandwidths are uncoupled when video bandwidth is the active function, pressing **[AUTO COUPLE]** will recouple the bandwidths.

Note: The video bandwidth must be set wider than the resolution bandwidth when measuring impulse noise levels.

2. Press **[PEAK SEARCH]**. See Figure 2-11. Move the marker to read the amplitude and frequency of the signal.

Example: If a signal level is very close to the noise floor, **video averaging** is another way to make the signal more visible. (Use this technique if your signals are subject to change. For example, you can use this technique to watch mobile radio transmissions since it shows you the "real time" responses.)

Video averaging is a digital process in which each trace point is averaged with the previous trace-point average. Selecting video averaging changes the detection mode from PEAK to SAMPLE. The sample mode displays the instantaneous value of the signal at the end of the time/frequency interval represented by each display point, rather than the value of the peak during the interval. The result is a sudden drop in the displayed noise level.

Video averaging clarifies low-level signals in wide bandwidths by averaging the signal and the noise. As the analyzer takes sweeps, you can observe video averaging smooth the trace.

-
1. Position a low-level signal on the analyzer screen.
 2. Press **TRACE A** and **[VIDEO AVERAGE]**. As the averaging routine smooths the trace, low-level signals become more visible. "VID AVG 100" appears in the active function block. The number represents the number of samples (or sweeps) taken to complete the averaging routine.

During averaging, the current sampling appears at the left side of the graticule. Changes to active functions, such as the center frequency or reference level, will restart the sampling. Or, press **[VIDEO AVERAGE]** to restart sampling.

To set the number of samples, use the number/units keyboard. The number of samples equals the number of sweeps in the averaging routine. Once the set number of sweeps has been completed, the analyzer continues to provide a running average based on this set number.

Identifying Distortion Products Using the RF Attenuator and Traces

Distortion From the Analyzer

High-level input signals may cause spectrum analyzer distortion products which could mask the real distortion on the input signal. Using trace B and the RF attenuator, you can determine which signals, if any, are internally generated distortion products.

Example: The signal shown in Figure 2-12 produces harmonic distortion products in the analyzer's input mixer. In the following steps, determine which signals are distortion products.

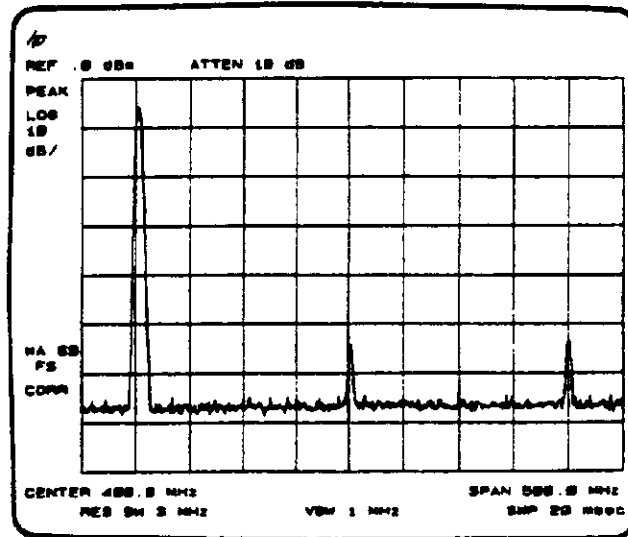

Figure 2-12

-
1. Connect a signal generator to the RF INPUT connector on the spectrum analyzer. Set the frequency of the signal to 200 MHz and set the amplitude to -5 dBm.

Set the center frequency of the spectrum analyzer to 300 MHz and set the span to 300 MHz.

2. To determine whether the intermodulation products are generated by the analyzer, first save the screen data in trace B. Press **TRACE B**, **[CLEAR WRITE B]**, and **[VIEW B]**.
3. To increase the RF attenuation by 10 dB, press **AMPLITUDE**, **[ATTEN]**, and the up step key once. See Figure 2-13. (If the reference level changes, return the reference level to its original position.)
4. Compare the response in trace A to the response in trace B. If the distortion product decreases as the attenuation increases, distortion products are caused by the analyzer's input mixer. The high-level signals causing the overload conditions must be attenuated to eliminate the interference caused by the internal distortion.

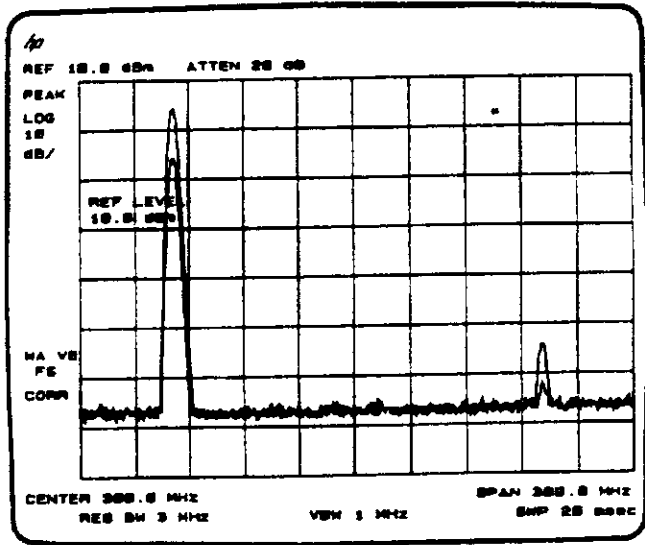

Figure 2-13

Third-Order Intermodulation Distortion

Two-tone, third-order intermodulation is a common problem in communication systems. When two signals are present in a system, they can mix with the second harmonics generated and create third-order intermodulation distortion products, which are located close to the original signals. These distortion products are generated by system components such as amplifiers and mixers.

Example: Test a device for third-order intermodulation. This example uses two sources set to 20 MHz and 21 MHz. (Other source frequencies may be substituted, but try to maintain a frequency separation of approximately 1 MHz.)

1. Connect the equipment as shown in Figure 2-14.

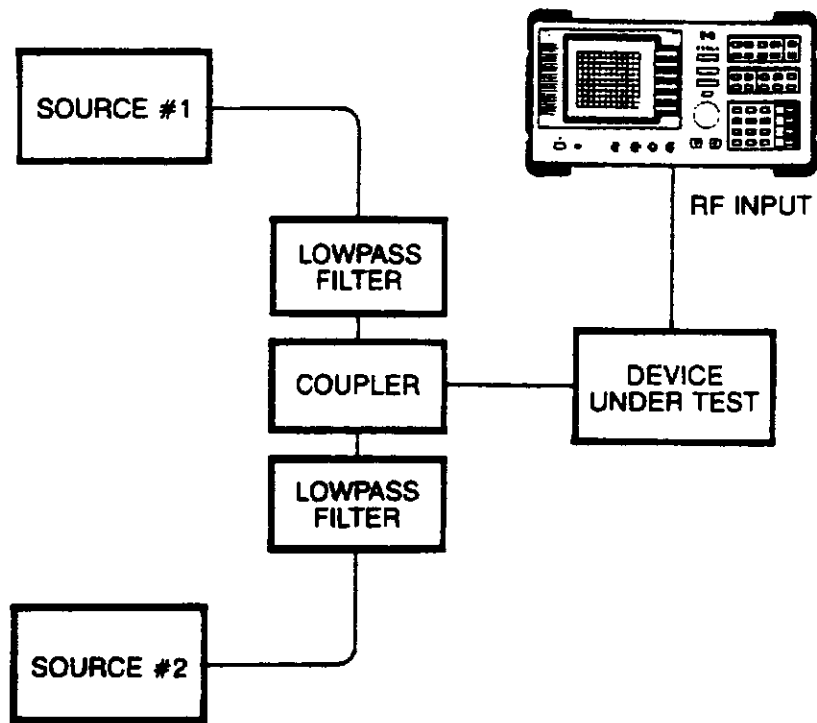

Figure 2-14

2. Set one source to 20 MHz and the other source to 21 MHz for a frequency separation of 1 MHz. Set the sources equal in amplitude (in this example, the sources are set to -20 dBm).
3. Tune both signals onto the screen by setting the center frequency to 20 MHz. Then, using the knob, center the two signals on the display. Reduce the frequency span to 5 MHz for a span wide enough to include the distortion products on the screen. To be sure the distortion products are resolved, reduce the resolution bandwidth until the distortion products are visible. Press **[SWP/BW]**, **[RES BW]**, and then use the step down key to reduce the resolution bandwidth.

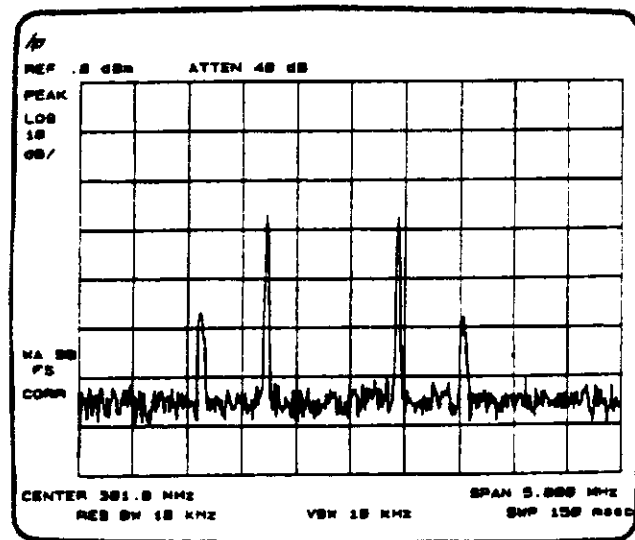

Figure 2-15

-
4. For best dynamic range, set the mixer input level to -40 dBm: press **AMPLITUDE** and **[MAX MXR LEVEL]**, and enter -40 dBm. The analyzer automatically sets the attenuation so that the maximum signal level seen at the input mixer is -40 dBm.
 5. To measure a distortion product, press **PEAK SEARCH** to place a marker on a source signal. To activate the second marker, press **[MARKER DELTA]**. Using the knob, adjust the second marker to the peak of the distortion product that is beside the test tone. The difference between the markers is displayed in the active function block.

To measure the other distortion product, press **PEAK SEARCH**, then **[NEXT PEAK]**. This places a marker on the next highest peak, which, in this case, is the other source signal. To measure the difference between this test tone and the second distortion product, press **[MARKER DELTA]**, and, using the knob, adjust the second marker to the peak of the second distortion product.

Using the Analyzer as a Receiver in Zero Span

The spectrum analyzer operates as a fix-tuned receiver in zero span. The zero span mode can be used to recover modulation on a carrier signal.

Center frequency in the swept-tuned mode becomes the tuned frequency in zero span. The horizontal axis of the screen becomes calibrated in time.

The following functions establish a clear display of the video waveform:

TRIGGER stabilizes the waveform trace on the display by triggering on the modulation envelope. If the signal's modulation is stable, VIDEO TRIGGER synchronizes the sweep with the demodulated waveform.

LINEAR mode is used in amplitude modulation (AM) measurements to remove distortion caused by the logarithmic amplifier when demodulating signals.

SWEEP TIME adjusts the full sweep time down to 15 milliseconds (ms) in zero span. In the time domain, sweep time range is 15 ms to 100 seconds. The sweep time readout refers to the full 10-division graticule. Divide this value by 10 to determine sweep time per division.

RESOLUTION and VIDEO BANDWIDTH are selected according to the signal bandwidth.

Each of the coupled function values remains at its current value when zero span is activated.

Example: View the modulation waveform of an AM signal in the time domain.

1. To obtain an AM signal, you can connect an antenna to the RF INPUT and tune to a commercial AM broadcast station, or you can connect a source to the RF INPUT and set the percent modulation of the source. (A headset can be used with the VIDEO OUT connector, and the spectrum analyzer will operate as a radio.)
2. First, center and zoom in on the signal in the frequency domain. (See "Automatic Zooming.") (Signal Track must be off for zero span.) See Figure 2-16.

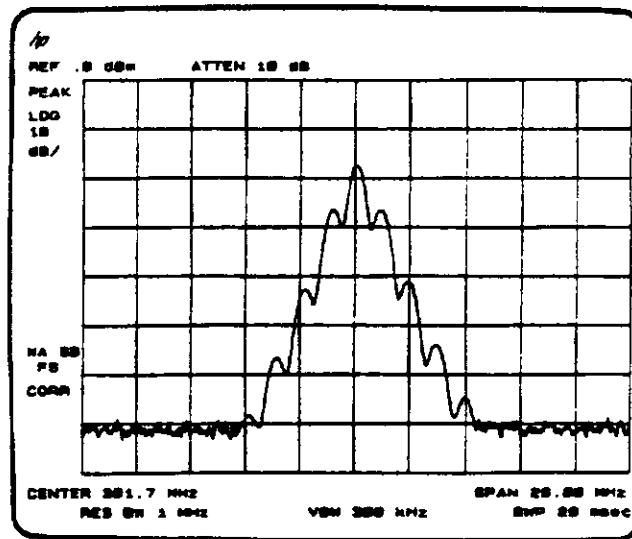

Figure 2-16

3. To demodulate the AM, increase the resolution bandwidth to include both sidebands of the signal within the passband of the spectrum analyzer. (Set the resolution bandwidth wide enough to account for spectrum analyzer drift. For an AM broadcast signal, set RES BW ≤ 20 kHz.) Press **[SWP/BW]** and **[RES BW]**, then use the step keys.
4. Position the signal at the reference level and select a linear voltage display. Press **[AMPLITUDE]** and change the reference level. Then press **[LINEAR]**.
5. To select zero span, press **[SPAN]**, **[0]**, **[Hz]**. See Figure 2-17. If the modulation is a steady tone (for example, from a signal generator), use video trigger to trigger on waveform and stabilize the display. Adjust the sweep-time to change the horizontal scale. Use markers and delta to measure time parameters of the waveform.

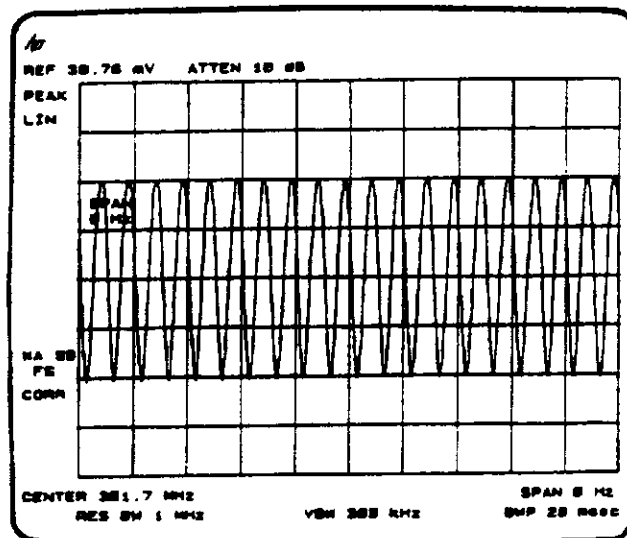

Figure 2-17

Measuring Amplitude Modulation With the Fast Fourier Transform Function

The Fast Fourier Transform (FFT) function of the spectrum analyzer allows measurements of amplitude modulation (AM). FFT transforms demodulated AM data from the time domain (zero span) to the frequency domain. The FFT function calculates the magnitude of each frequency component from a block of time-domain samples of the input signal. It is commonly used to measure AM at rates that cannot be measured in the normal frequency domain.

The FFT function requires a specific analyzer configuration. First, an AM signal is demodulated in the time domain. In order to do this, the resolution bandwidth is widened to include the signal sidebands within the passband of the spectrum analyzer. Then zero span is selected so that the spectrum analyzer operates as a fixed-tuned receiver. Tuning is centered about the AM carrier.

When [FFT MEAS] is pressed, the function sets sample-detection mode and takes a sweep to obtain a sample of the input signal. Then the spectrum analyzer executes a series of computations on the time data to produce the frequency-domain results.

Example: Measure the sidebands on a signal using the Fast Fourier Transform function.

1. Connect a signal generator to the RF INPUT on the front panel of the spectrum analyzer. Adjust the signal generator to produce an AM signal. (For example, set the modulation rate to 400 Hz, which cannot normally be measured in the frequency domain.)
2. Center the signal on the analyzer screen using the automatic zoom function described earlier in this chapter. Turn signal track off before proceeding.
3. Press **[SWP/BW]** and **[RES BW]**, and set the resolution bandwidth to 3 MHz. (The resolution bandwidth must be approximately 10 times greater than the modulation frequency.)
4. Press **[SPAN]** and select 0 Hz. The spectrum analyzer now operates as a fixed-tuned receiver.

Change the reference level to place the signal peak within the first two graticules of the screen by pressing **[AMPLITUDE]** and turning the knob. The signal must be below the reference level. For best results, select linear display mode with **[LINEAR]**.

5. See Figure 2-18, which shows maximum modulation frequency (f_m) in Hz versus sweep time (T_s) in seconds. Set the sweep time less than $T_s(\text{max})$ for that maximum modulation frequency (f_m) including the harmonics of the signal. The upper curve relates the sweep time to the maximum modulation frequency that can be observed (that is, the modulation frequency represented by the right edge of the graticule). The lower curve represents the modulation frequency one division from the left side of the graticule.

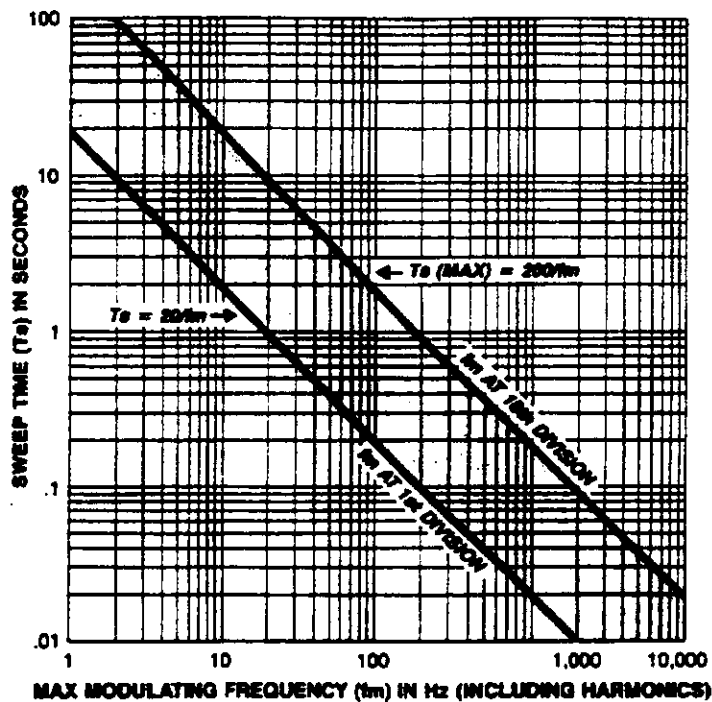

Figure 2-18

Set the sweep time to fall in the shaded area between the two lines and closer to the lower line. (Frequencies greater than the maximum modulation frequency for a specific sweep time will not be displayed accurately.) Press **[SWP/BW]** and **[SWEEP TIME]** to set the sweep time according to the figure.

6. Press **[SAVE]** **[2]** to save the current analyzer settings. If the measurement is repeated later, retrieve the analyzer settings with **[RECALL]** **[2]**.
7. Press **[MENU 2]** and **[FFT MEAS]**. The spectrum analyzer will perform a Fast Fourier Transform. The frequency-domain data appears on the screen.

8. A marker is automatically placed on the carrier at the 0-Hz reference (at the left edge of the graticule). Press **[MKR]** and **[MARKER DELTA]** to determine the frequency and amplitude difference between the signal and the modulation. See Figure 2-19.

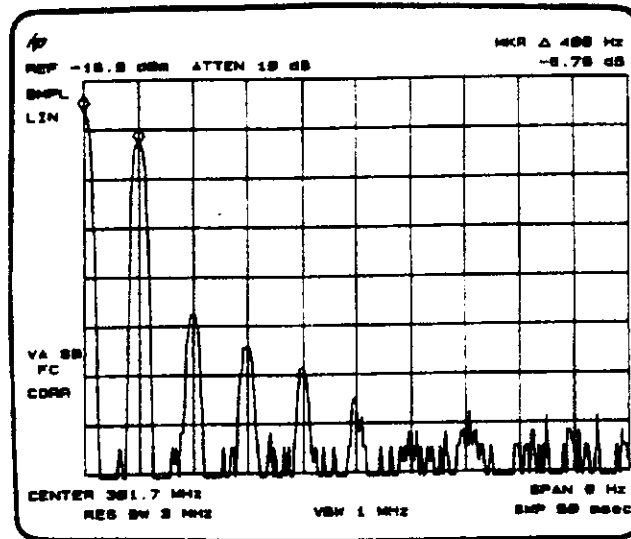

Figure 2-19

The results of the FFT function are displayed on the analyzer screen. The carrier appears at the left edge of the graticule with the modulation sidebands. Any modulation distortion appears along the horizontal graticule. The frequency calibration of the graticule is 20 Hz divided by the sweep time per division, and the left edge of the graticule represents 0 Hz relative to the carrier. The amplitude relationships among the carrier, sidebands, and distortion components are the same as they would be if the components were displayed with swept-tuned operation.

9. To repeat the test, you must first clear the screen data by pressing **TRACE A** and **[CLEAR WRITE A]**. Then repeat steps 7 and 8.

Chapter 3

Analyzer Functions

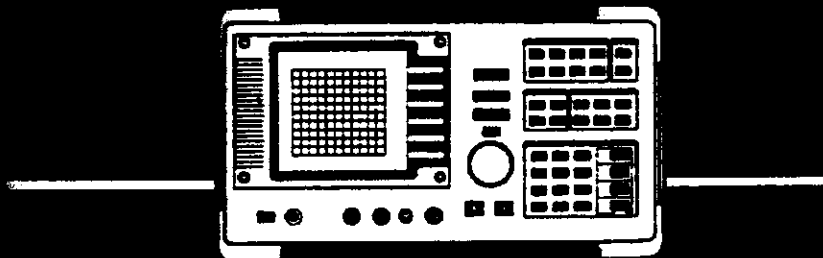

What You'll Learn in This Chapter

This chapter describes functions of the HP 8590A Spectrum Analyzer. The functions are divided into 11 sections, as follows:

- Data Controls
- Frequency and Span
- Amplitude
- Instrument State
- Copy
- Marker
- Control Functions
- Intensity
- Line Power
- Front-Panel Connectors
- Rear-Panel Connectors

Note: All analyzer functions are listed in the index at the end of this manual. The functions are followed by page numbers: the numbers in bold type refer to pages in this chapter. In addition, all softkeys are shown in the menu diagram inside the rear cover of this manual.

Data Controls

Data controls are used to change values for functions such as center frequency, start frequency, resolution bandwidth, and marker position.

The data controls will change the active function in a manner prescribed by that function. For example, you can change center frequency in fine steps with the knob, in steps proportional to the frequency span with the step keys, or to an exact value with the number/units keyboard. Resolution bandwidth, which can be set to discrete values only, is changed to predetermined values with any of the data controls.

Knob

The knob allows continuous change of functions such as center frequency, reference level, and marker position. It also changes the values of functions that change in increments only.

Clockwise rotation of the knob increases values. For continuous changes, the extent of alteration is determined by the measurement range and the speed at which the knob is turned.

Step Keys

The step keys allow rapid increase or decrease of the active function value. The step size depends upon the analyzer's measurement range or on a preset amount. Each press results in a single step change. For those parameters with fixed values, the next value in a sequence is selected each time a step key is pressed.

Number/Units Keyboard

The number/units keyboard allows entry of exact values for center frequency, reference level, log scale, marker positions, display line, threshold, and the coupled functions. The number portion may include a decimal point . If not, the decimal point is placed at the end of the number.

Numeric entries must be terminated with a unit key. The unit keys change the active function in a manner prescribed by that function. For example, the units keys for frequency span are GHz, MHz, kHz, and Hz (zero span), whereas the units for reference level are +dBm and -dBm.

If an entry from the number/units keyboard does not coincide with an allowed function value (for example, that of a bandwidth), the analyzer defaults to the nearest allowed value.

Hold Key

Deactivate functions with the **[HOLD]** key. The active function readout is blanked, indicating that no entry will be made inadvertently by using the knob, step keys, or keyboard. (Pressing a function key reenables the data controls.)

Frequency and Span

The softkeys accessed by **[FREQUENCY]** and **[SPAN]** let you set the center and width of the horizontal frequency window that the spectrum analyzer displays. Pressing **[FREQUENCY]** activates the center frequency function and accesses the frequency menu. Pressing **[SPAN]** activates the span function and accesses the frequency menu.

[CENTER FREQ] lets you select the frequency at the center graticule of the screen. The center frequency value will appear below the graticule line on the screen. Press **[FREQUENCY]** to activate the center frequency function and display the **[CENTER FREQ]** softkey.

[SPAN] lets you change the frequency range symmetrically about the center frequency. The frequency span readout describes the total displayed frequency range; to determine frequency span per horizontal graticule division, divide the frequency span by 10. Press **[SPAN]** to activate the span function and display the **[SPAN]** softkey.

[START FREQ] lets you set the frequency at the left side of the graticule. The left and right sides of the graticule sides correspond to the start and stop frequencies. When these frequencies are activated, their values are displayed below the graticule in place of center frequency and span.

[STOP FREQ] lets you set the frequency at the right side of the graticule.

[CF STEP SIZE] lets you change the step size for the center frequency function. Once a step size has been selected and the center frequency function is activated, the step keys change center frequency by the step-size value. The step size function is useful for finding harmonics and sidebands beyond the analyzer's current frequency span.

[FREQ OFFSET] lets you add an offset value to the frequency readout to account for pre-analyzer frequency conversions. Offset entries are added to all frequency readouts including marker, start frequency, and stop frequency. Entering an offset does not affect the trace. Offsets are not added to the span.

When a frequency offset is entered, its value is displayed on the **bottom** of the screen. (Amplitude offsets, obtained through **AMPLITUDE**, are displayed on the left side of the screen.) To eliminate an offset, press **[FREQ OFFSET]** and enter zero. **PRESET** also sets the offset to zero.

Amplitude

The softkeys accessed by **AMPLITUDE** change the input attenuation, vertical scale, mixer level, and amplitude offset. Pressing **AMPLITUDE** activates the reference level function and accesses the amplitude menu.

REF LEVEL is activated only when **AMPLITUDE** is pressed; it does not have a corresponding softkey. The reference level is the amplitude power or voltage represented by the top graticule line on the screen. Changing the value of the reference level changes the absolute-amplitude level (in dBm) of the top graticule line.

[ATTEN] lets you set the input attenuation from 0 to 60 dB, in 10-dB increments. The RF input attenuator, which is normally coupled (linked) to the reference level control, reduces the power level of the RF input signal at the input mixer.

The attenuator is recoupled with the **AUTO COUPLE** key.

CAUTION

To prevent damage to the input mixer, the power level at the input mixer must not exceed +30 dBm. To prevent signal compression, power at the input to the input mixer must be kept below -10 dBm.

Note: As a precaution for the input mixer's health, 0-dB RF attenuation (no input power reduction to the mixer) can be selected only from the number/units keyboard.

[LOG dB/DIV] lets you scale the vertical graticule divisions in logarithmic units. Values may range from 1 to 20 dB per division.

[LINEAR] translates the reference level units from dBm to volts. The reference level value is set to the top of the screen and the bottom graticule becomes zero volts. (Each division of the graticule is 1/10 the reference level in volts.)

[MAX MXR LEVEL] lets you change the maximum input mixer level in 10-dB steps from -10 dBm to -100 dBm. The mixer level is equal to the input signal level minus the attenuator setting. As the reference level changes, the input attenuator setting is changed to keep the power levels of displayed signals less than the selected level at the input mixer. **PRESET** resets the input mixer level to -10 dBm.

[REF LVL OFFSET] lets you add an offset value to the displayed reference level. Offsets are entered with the number/units key board. Entering an offset does not affect the trace. Reference level offsets are used when gain or loss occurs between a device under test and the spectrum analyzer input. For example, using an offset of -20 dB references the spectrum analyzer to the input of a 20-dB preamplifier. Thus, the signal level measured by the analyzer is the level at the input of an external amplitude conversion device.

When an amplitude offset is entered, its value is displayed on the left side of the screen.

Frequency offsets, obtained through **FREQUENCY**, are displayed at screen bottom. To eliminate an offset, press **[REF LVL OFFSET]** and enter zero. **PRESET** also sets the offset to zero.

Instrument State

PRESET provides a convenient starting point for making most measurements. Pressing **PRESET** places the **FREQUENCY** menu on the screen and establishes the following conditions:

Start/Stop Frequency	0 to 1500 MHz
Reference Level	0 dBm
Coupled Functions	All set to AUTO
Resolution Bandwidth	3 MHz
Video Bandwidth	1 MHz
Sweep Time	20 msec, full span
Attenuator	10 dB
CF Step Size	100 MHz
Trace A	Clear write
Trace B	Store blank
A-B ON OFF	OFF
Markers	OFF
Instrument States	Saved
Display Line	OFF
Threshold	OFF
Sweep	Continuous
Trigger	Free run

LOCAL enables front-panel control after the analyzer has been placed in the remote mode by an HP-IB controller. During remote operation, "RT" appears in the upper-right corner of the screen. When local is enabled, an "L" appears.

CONFIG accesses the following softkeys:

[ANALYZER ADDRESS] allows you to change the HP-IB or HP-IL address of the HP 8590A Spectrum Analyzer. The analyzer is commonly set to 18.

[PLOTTER ADDRESS] allows you to set the address for a plotter. It is used by analyzers that have an optional HP-IB or HP-IL connector. (Also see "Copy.")

[PRINTER ADDRESS] allows you to set the address for a printer. It is used by analyzers that have an optional HP-IB or HP-IL connector. (Also see "Copy.")

[BAUD RATE] allows you to set the data transmission speed. It is used by analyzers that have an RS-232 interface. (Also see "Copy.")

[PREAMP GAIN], similar to the amplitude offset function, allows you to add a positive or negative preamplifier gain value, which is subtracted from the displayed signal. Preamplifier gain offsets are used for measurements that require an external preamplifier or long cables. Offsets are subtracted from the amplitude readouts so that the displayed signal level represents the signal level at the input of the preamplifier. Preamplifier gain offsets are displayed at the top of the screen and are removed by entering zero.

[DISPOSE ALL] allows you to remove data from the spectrum analyzer's Random Access Memory (RAM). It frees all memory previously allocated for user-defined functions. The state registers, predefined traces, and Read Only Memory (ROM) are not affected.

[CAL] calls up the following softkeys:

[CAL FREQ] initiates a frequency calibration routine. (For more information, see "Improving Accuracy With Calibration Routines" in Chapter 1.)

[CAL AMPTD] initiates an amplitude calibration routine. (For more information, see "Improving Accuracy With Calibration Routines" in Chapter 1.)

[CORRECT ON off] controls use of the correction factors. When ON is capitalized, correction factors are used and "CORR" appears on the display. When OFF is capitalized, correction factors are not used. Turning the correction factors off degrades accuracy.

[CAL STORE] allows you to save calibration data in nonvolatile analyzer memory. Calibration data is stored in volatile memory until **[CAL STORE]** is pressed. If calibration data is stored and the instrument has been turned off and then on again, the stored calibration data is automatically retrieved. (Also see "Improving Accuracy With Calibration Routines" in Chapter 1.)

[CAL FETCH] allows you to retrieve stored calibration data. If you have run a second calibration routine but have not stored it, you can retrieve previously stored calibration data by pressing **[CAL FETCH]**.

[DISPLAY CAL DATA] places the stored calibration data on the screen. Press **[PRESET]** to retrieve a normal display. For more information, refer to the HP 8590A Support Manual (HP part number 08590-90008; not supplied with the instrument).

[CAL YTO DELAY] initiates a routine that calibrates the analyzer's timing delays.

[CONF TEST] initiates a test of the analyzer's resolution bandwidths, video bandwidths, and step gains. Failure messages appear if any of the above functions do not pass the test.

[HORIZ POSITION] allows you to change the horizontal position of the analyzer's screen. (The position is saved in nonvolatile memory when **[CAL STORE]** is pressed.)

[VERT POSITION] allows you to change the vertical position of the analyzer's screen. (The position is saved in nonvolatile memory when **[CAL STORE]** is pressed.)

[CAL FLATNESS] accesses the following service functions.

CAUTION

The following keys are designed for service usage only and may disrupt analyzer calibration data.

[SET 20dB ERR] and [ENTER FLT ERR], when pressed, let you remove the flatness and gain calibration data stored in the analyzer's nonvolatile memory.

CAUTION

Unless you have access to the correct calibration data, do not use either of these keys. If you have made a numeric entry but have not pressed a units key, press **PRESET** to deactivate these functions. For more information, refer to the HP 8590A Support Manual (HP part number 08590-90008; not supplied with the instrument).

[EXECUTE TITLE] tells the analyzer to execute the commands that appear in the screen title. (Also see [SCREEN TITLE].)

[STP GAIN ZERO] is primarily a service function that turns off the spectrum analyzer's step gains. Press **PRESET** to reactivate the step gains. Recalling a previously stored state with **RECALL** also reactivates the step gains.

[DACs] is a service function. For more information, refer to the HP 8590A Support Manual (HP part number 08590-90008; not supplied with the instrument).

[EEPROM INIT] resets the EEPROMs to their original state, removing frequency and amplitude calibration data stored in the analyzer's nonvolatile memory.

Note: If [EEPROM INIT] has been pressed, the frequency, YTO delay, and amplitude calibration routines must be run again. (See "Improving Accuracy With Calibration Routines" in Chapter 1.)

[SAVE] and [RECALL] allow you to store and retrieve nine spectrum analyzer states from the state registers. The analyzer's control settings can be saved in a state register and retrieved later at your convenience. States are saved even if the instrument is turned off. Trace data is not stored.

To save a state, press [SAVE] and enter a register number with the keyboard. States can be stored in registers 1 through 9. To recall a saved state, press [RECALL] and enter the register number.

MENU 1 and **MENU 2** access specialized softkeys.

[DELTA MEAS] finds and displays the frequency and amplitude differences between the two highest amplitude signals. **[DELTA MEAS]** performs the following key sequence: **PEAK SEARCH**, **[MARKER DELTA]**, **[NEXT PEAK]**.

[PK-PK MEAS] finds and displays the frequency and amplitude differences between the highest and lowest signals. **[PK-PK MEAS]** performs the following routine: **PEAK SEARCH**, **[MARKER DELTA]**, and then moves the second marker to the lowest detected signal.

[3rd ORD MEAS] finds the third-order product and measures the frequency and amplitude differences relative to the fundamental signal. **[3rd ORD MEAS]** performs the following routine: **PEAK SEARCH**, **[MARKER DELTA]**, **[NEXT PEAK]**, **[NEXT PEAK]**.

[3 dB POINTS] automatically places two markers at points 3 dB from the highest point on a signal and determines the frequency differences between the two markers. Thus, the 3-dB bandwidth of a signal is determined. The markers are placed on the highest signal on the screen. (This function is used with the HP 8444 Option 059 Tracking Generator.)

[6 db POINTS] automatically places two markers at points 6 dB from the highest point on a signal and determines the frequency differences between the two markers. Thus, the 6-dB bandwidth of a signal is determined. The markers are placed on the highest signal on the screen. (This function is used with the HP 8444 Option 059 Tracking Generator.)

[99% PWR BW] computes the power of all signal responses and returns the bandwidth under which 99% of total power is found.

[FFT MEAS] transforms zero span data into the frequency domain using a Fast Fourier Transform. The display is always in log mode.

[MODULATN MEAS] determines the percent of amplitude modulation. The function finds the amplitude difference between the two highest peaks on the screen and computes the percent modulation for the given dB difference. (See Appendix for AM percent charts.)

Copy

Note: Printing and plotting require one of the optional interfaces (HP-IB, HP-IL, or RS-232). Generally, spectrum analyzers with HP-IB set the plotter address to 5 and the printer address to 1. Unless there are additional instruments on the bus, analyzers with HP-IL set plotter and printer addresses to 1. Analyzers with RS-232 set the baud rate according to the printer or plotter being used.

PRNT initiates a print dump of the screen data, without an external controller, to the graphics printer specified under **CONFIG** and [PRINTER ADDRESS]. After you have obtained the spectrum analyzer screen you want to print, press **PRNT** and the process will begin. It can be halted by pressing **PRESET**. The screen remains frozen (no further sweeps taken) until the data transfer to the printer is complete. The HP 8590A works with the HP Thinkjet Printer and other graphics plotters.

PLOT initiates a plot dump over HP-IB, without an external controller, to the plotter specified under **CONFIG** and [PLOTTER ADDRESS]. The plotting process is similar to the printing process. Printing is usually faster than plotting, but plotting provides higher resolution output. The HP 8590A works with plotters such as the HP 7440A. Figure 3-1 shows the rear view of a typical plotter/spectrum analyzer configuration.

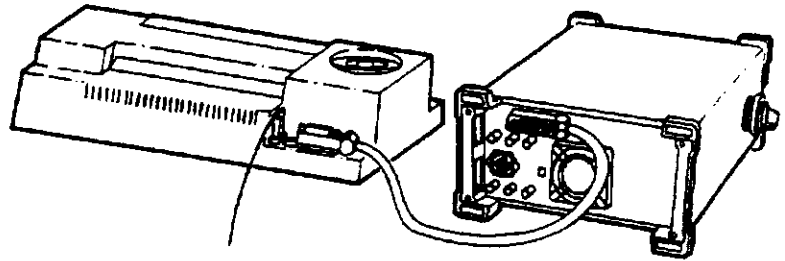

Figure 3-1

Marker

Markers are diamond-shaped characters lying directly on the trace that identify points of traces and allow the traces to be manipulated and controlled on the screen. During manual operation, two markers may appear on the display simultaneously; only one can be controlled at a time. The marker that is controlled is called the "active" marker.

MKR accesses the following softkeys:

[MARKER NORMAL] activates a single marker at the center of the screen on the active trace. Use the data controls to position the marker on a trace. Annotation in the active function block and in the upper-right corner indicate the frequency and amplitude of the marker.

[MARKER DELTA] activates a second marker at the position of the marker already on the trace. (If no marker is present, two markers appear at the center of the display.) The position of the first marker is fixed. The second marker is under your control. Annotation in the active function block and in the upper-right corner of the screen indicates the frequency and amplitude differences between the two markers.

[MARKER AMPTD] keeps the active marker at a desired amplitude on the screen once the marker has been positioned. Once activated, the marker remains at the same amplitude even as the signal frequency is changed. If the input signal is removed, the marker searches for the signal closest to the last amplitude value. For example, place a marker on a signal peak, press **[MARKER AMPTD]** and then **[FREQUENCY]**. Turn the knob and the marker will remain at the same amplitude on the screen. Press **[MARKERS OFF]** to turn off the amplitude marker.

[MKNOISE on OFF] reads out the average noise level referenced to a 1-Hz noise power bandwidth at the marker position. If no marker is present, a marker appears at the center of the screen. The root-mean-square noise level, normalized to a 1-Hz noise power bandwidth, is read out. Sample detection mode is automatically selected.

[MARKER PAUSE] stops the analyzer sweep at the marker position. You can set the pause time for a period of zero to 100 seconds. (If the trace distorts as a result of pause, lengthen the sweep time.) To turn the pause off, enter 0 seconds.

[MARKERS OFF] turns off all markers, including signal track. Marker annotation is removed.

[MKR →] (read “marker to”) calls up the following softkeys for the transfer of marker information directly into other functions:

[MARKER → CF] changes the analyzer settings so that the frequency at the marker becomes the center frequency.

[MARKER → RL] changes the analyzer settings so that the amplitude at the active marker becomes the reference level.

[MARKER → STEP] assigns the value of the active marker to the center frequency step size. Press **[FREQUENCY]** and **[CF STEP SIZE]** to view the step size. If marker delta is active, the step size will be set to the frequency difference between the markers.

[MKR Δ → SPAN] sets the start and stop frequencies to the values of the delta markers. The start and stop frequencies will not be set if the delta markers are off.

[MORE] accesses the softkeys under **[PEAK SEARCH]**. Pressing **[MORE]** instead of **[PEAK SEARCH]** lets you use those softkeys without initiating a new peak search.

PEAK SEARCH automatically places a marker on the highest amplitude of a trace, displays the marker's amplitude and frequency, and calls up the following softkeys:

[MARKER → CF] is described above.

[MARKER DELTA] activates a second marker at the position of the marker already on the trace. (If no marker is present, two markers appear at the center of the display.) The position of the first marker is fixed. The second marker is under your control. Annotation in the active function block and in the upper-right corner of the screen indicates the frequency and amplitude differences between the two markers.

[NEXT PEAK] places the marker on the next highest peak. (Also see **[PEAK EXCURSN]** and **[THRESHOLD]**.)

[NEXT PK RIGHT] moves the marker to the next peak to the right of the current marker. If there is no peak to the right, the marker will not move. The peaks found must be the peak excursion value above the threshold. (Also see **[PEAK EXCURSN]** and **[THRESHOLD]**.)

[NEXT PK LEFT] moves the marker to the next peak to the left of the current marker. If there is no peak to the left, the marker will not move. (Also see **[PEAK EXCURSN]**.)

[PEAK EXCURSN] allows you to set the minimum amplitude variation of signals that the marker can identify. If a value of 10 dB is selected, the marker moves only to peaks which rise and fall more than 10 dB from the threshold (or the noise floor of the display). Pushing [PRESET] or turning on power resets the excursion to 6 dB.

When the peak excursion rate is less than 6 dB, the marker-peaking functions may not recognize signals less than 6 dB above the noise floor. To correct this, when measuring signals near the noise floor, the excursion value can be reduced. To prevent the marker from identifying noise as signals, reduce the noise floor variance to a value less than the peak excursion by reducing the video bandwidth.

[SIGNAL TRACK] moves the signal with an active marker to the center of the screen and fixes the signal there. "MKR-TRK" appears in the upper-right corner of the display. Press [SIGNAL TRACK] again, [PRESET], [MARKER NORMAL], or [MARKER OFF] to turn this function off.

When signal track is on and the span is changed, an automatic zoom is performed: the span is reduced in steps so that the signal remains at the center of the screen. If the span is zero, signal track has no effect.

Control Functions

Six keys, located in the CONTROL section of the front panel, control the sweep, trigger, traces, and display.

[SWP/BW] calls up softkeys that control the sweep time, bandwidth, detectors, and service functions:

[RES BW] allows you to manually change the analyzer's IF bandwidth to 1 kHz, 3 kHz, 10 kHz, 30 kHz, 100 kHz, 300 kHz, 1 MHz, or 3 MHz. As the RES BW is decreased, the sweep time is increased to maintain amplitude calibration. To indicate that it is not coupled, a “#” mark appears next to RES BW on the screen. To recouple the RES BW, press **[RES BW]** and **[AUTO COUPLE]**.

[VID BW] allows you to manually change the analyzer's post-detection filter from 30 Hz to 3 MHz in a 1, 3, 10 sequence. As the VIDEO BW is decreased, the sweep time is increased to maintain amplitude calibration. To indicate that it is not coupled, a “#” mark appears next to VBW on the screen. To recouple the VID BW, press **[VID BW]** and **[AUTO COUPLE]**.

[VBW/RBW RATIO] allows you to select the ratio between the video and resolution bandwidths. If signal responses near the noise level are visually masked by the noise, the ratio can be set to less than 1 to smooth this noise. The knob and step keys change the ratio in a 1, 3, 10 sequence. **[PRESET]** sets the ratio to 0.300 X.

[SWEEP TIME] lets you manually select the length of time in which the analyzer sweeps the displayed frequency span. In all frequency spans, the sweep time varies continuously from 20 milliseconds (ms) to 100 seconds (sec). Reducing the sweep time increases the rate of sweeps.

From 20 ms to 1000 ms, the sweep time changes in 1-ms steps. From 1.0 sec to 10 sec, the sweep time changes in 0.1-sec steps. From 10 sec to 100 sec, the sweep time changes in 1-sec steps.

[DETECTOR] accesses the following softkeys that control the signal detection and service functions. The type of detection affects only the displayed noise and impulse signals.

[SAMPLE DETECTOR] selects sample detection and "SMPL" appears in the upper-left corner of the screen. (During a sweep, only a specified amount of time is available to write data for each of the available display points into each of the trace memory addresses. In sample mode, the instantaneous signal value of the final analog-to-digital conversion for the time period is placed in memory.) Sample detection is automatically activated for noise level markers and during video averaging.

[POS PK DETECTOR] selects peak detection and "PEAK" appears in the upper-left corner of the screen. (During a sweep, only a specified amount of time is available to write data for each of the available display points into each of the trace memory addresses. In each of these time periods, the positive peak detector obtains the maximum video signal and stores this value in the trace memory address.) Peak detection is selected by **PRESET** and power on.

Service Functions

The softkeys listed below are designed for troubleshooting and for diagnostic tests of the HP 8590A. They are described in the HP 8590A Support Manual (HP part number 08590-90008), which is not supplied with the instrument. The Support Manual is briefly described in the HP 8590A Documentation section at the front of this manual. Contact your HP Service Representative for more information.

These softkeys are accessed by **[SWP/BW]** and **[CAL FLATNESS]**:

[2v REF DETECTOR]	[COARSE TUNE DAC]
[GND REF DETECTOR]	[FINE TUNE DAC]
[DACS]	[X FINE TUNE DAC]
[ANALYZER TEST]	[+10V REF]
[MAIN COIL DR]	[-10V REF]
[FM COIL DRIVE]	[AUX A]
[FM SPAN]	[AUX B]
[MAIN SPAN]	[DROOP]
[BINARY SPAN]	[SWEEP RAMP]
[SWEEP TIME DAC]	[SET 20 dB ERR]
[ENTER FLT ERR]	[EXECUTE TITLE]

AUTO COUPLE is used to couple the operation of some spectrum analyzer functions after they have been uncoupled. (Coupled functions are functions that are linked: if one function is changed, the other function is changed.)

Note: If no function is active, **AUTO COUPLE** recouples all functions that can be coupled. The functions are listed below:

Resolution Bandwidth	Display Line Off
Video Bandwidth	Threshold Off
Sweep Time	Markers Off
RF Attenuation	Video Averaged Off
Step Size	MkPause Off
Video Bandwidth Ratio	

During normal operation, the sweep time, resolution bandwidth, and video bandwidth are coupled to yield optimum amplitude accuracy. If any of these functions becomes uncoupled (that is, is manually set), a “#” will appear next to it on the screen. Recouple a function by activating the function and pressing **AUTO COUPLE**.

AUTO COUPLE can also be used to deactivate functions including display line, threshold, video averaging, and markers.

If one or more function(s) is manually set so that the amplitude or frequency becomes uncalibrated, “MEAS UNCAL” appears on the right side of the graticule. Use **AUTO COUPLE** to recouple the functions.

[TRACE A] accesses the following trace softkeys that allow you to store and manipulate trace information. Each trace is comprised of a series of data points that form a register where frequency and amplitude information is stored. The analyzer updates the information for the active trace with each sweep. (Also see "Screen Annotation" in Chapter 1.)

[CLEAR WRITE A] erases any data previously stored in trace A and continuously displays any signals detected in the frequency range of the analyzer. This function is activated by **[PRESET]** and power on.

[MAX HOLD A] updates each trace point with the maximum level detected at each point during successive sweeps.

[VIEW A] holds the amplitude data in the trace A register. It disconnects the trace register from the signal-detection circuitry so that the trace A register will not be updated as the analyzer sweeps. If trace A is deactivated with **[STORE BLANK A]**, the stored data can be retrieved with **[VIEW A]**.

[CLEAR WRITE A] erases the stored data.

[STORE BLANK A] stores the amplitude data for trace A and removes it from the screen. It also disconnects the trace A register from the signal-detection circuitry so that the register will not be updated as the analyzer sweeps.

[VIDEO AVERAGE] initiates a digital averaging routine that averages displayed signals and noise. It does not affect the sweep time, bandwidth, or other analog characteristics of the analyzer. Annotation on the left side of the screen indicates the current number of sweeps averaged. The default number of sweeps is 100. Increasing the number of sweeps smooths the trace. Pressing **[VIDEO AVERAGE]** or the terminator keys restarts the averaging process. Deactivate video average with **AUTO COUPLE**.

[A-B on OFF], when ON, subtracts the data in trace B from the measured data. The resulting trace (trace A) is displayed, the input minus stored data. To deactivate this function, press the softkey so that OFF is capitalized. If trace B is in clear-write mode, it will be placed in view mode when A-B is turned on.

TRACE B accesses softkeys that manipulate trace B data.
(Also see "Screen Annotation" in Chapter 1.)

[CLEAR WRITE B] operates the same as **[CLEAR WRITE A]**. However, **PRESET** and power on do not activate trace B.

[MAX HOLD B] operates the same as **[MAX HOLD A]**.

[VIEW B] operates the same as **[VIEW A]**.

[STORE BLANK B] operates the same as **[STORE BLANK A]**.

[A EXCH B] exchanges the contents of the trace A register with the trace B register and puts trace A in view mode.

[B-DL → B] subtracts the value of the display line from all the points in trace B and stores the results in trace B. Trace B is placed in view mode. (Also see **[DISPLAY LINE]**.)

TRIG accesses softkeys that let you select the sweep mode and trigger mode. (Also see "Screen Annotation" in Chapter 1.)

[CONT SWEEP] enables continuous-sweep mode. If trigger conditions are met, one sweep follows another as soon as triggered. **PRESET** and power on select continuous sweep.

[SINGLE SWEEP] enables single-sweep mode. Each time **[SINGLE SWEEP]** is pressed and the trigger conditions are met, a sweep is initiated. A sweep in progress is terminated and restarted each time **[SINGLE SWEEP]** is pressed.

[FREE] activates the trigger condition that allows the next sweep to start as soon as possible after the last sweep.

[VIDEO] activates the trigger condition that allows the next sweep to start if the detected RF envelope voltage rises to a level set by the display line. When **[VIDEO]** is pressed, the display line appears on the screen. With the **CAL OUTPUT** signal, lower the display line to the noise floor for an example of video triggering.

[LINE] activates the trigger condition that allows the next sweep to start when the line voltage passes through zero, becoming positive.

[EXTERNAL] activates the trigger condition that allows the next sweep to start when an external voltage (connected to the EXT TRIG INPUT on the rear panel) passes through approximately 1.5 volts, becoming positive. The external trigger signal must be a 0 V to +5 V TTL signal.

[DISPLAY] accesses softkeys that activate the display line and threshold, allow title entry, control the graticule and annotation, and set display units.

[DISPLAY LINE] activates an adjustable horizontal line that is used as a visual reference line. The line, which is used for trace arithmetic, has amplitude values that correspond to its vertical position when compared to the reference level. The value of the display line appears in the active function block and on the left side of the screen. To deactivate the display line, press **[DISPLAY LINE]** **[AUTO COUPLE]**. (Also see **[VIDEO]** trigger.)

[THRESHOLD] sets a lower boundary to the active trace. The threshold line "clips" signals that appear below the line. The boundary is defined in amplitude units that correspond to its vertical position when compared to the reference level.

The value of the threshold appears in the active function block and on the lower-left side of the screen. The threshold level does not influence the trace memory. The peaks found by the markers must be the peak excursion value above the threshold level.

If a threshold is active, press [THRESHOLD] and **AUTO COUPLE** to turn the threshold off.

[SCREEN TITLE] allows you to write a 58-character message across the top of the screen. The marker readout may interfere with the last 24 characters. When [SCREEN TITLE] is pressed, a character table appears on the screen. To select a character, turn the knob to position the cursor under the desired character and press the **Hz** key. Numbers may be selected with the numeric key pad. The step keys move the cursor between rows. When all characters have been entered, press **HOLD**. A title will remain on the screen until the title function is activated again, or **PRESET** is pressed.

[GRAT ON off] lets you turn the screen graticule on and off. This is helpful when alternative graphics are drawn on the screen through a remote controller and during plotting, when a graticule is not required.

[ANOTATN ON off] lets you turn the screen annotation on and off. However, softkey annotation will remain on the screen. The annotation may not be required for prints or plots, or during remote operation.

[DISPLAY UNITS] accesses softkeys that let you choose the amplitude units. The choices are dBm, dBmV, dBuV, Volts, and Watts. The default amplitude units are dBm. (Once [Watts] is pressed, amplitude units are changed only with the step keys and knob.)

[INPUT IMPED] lets you set the input impedance for power-to-voltage conversions. The impedance you select is for computational purposes only, since the actual impedance is set by internal hardware (standard 50 ohms or optional 75 ohms). The preset value is 50 ohms. Select either 50 and 75 ohms with the number/units keyboard. Press **[DISPLAY UNITS]** to access the input impedance softkey.

Other Controls and Connectors

Intensity

The intensity knob allows you to change the brightness of the writing on the screen.

Line Power

The **[LINE]** key turns on the instrument and starts an instrument check. After applying power, allow the temperature of the instrument to stabilize for best measurement results.

Front-Panel Connectors

1ST LO OUTPUT allows the use of the HP 8444A Option 059 Tracking Generator. Terminate the connector with a 50-ohm load when not in use.

CAL OUTPUT provides the calibration signal of 299.9 MHz at -20 dBm. CAL OUTPUT has either a 50-ohm or 75-ohm (optional) impedance. It is connected to the RF INPUT during calibration.

PROBE POWER supplies power for high-impedance active probes or for preamplifiers, such as the HP 10855A Broadband Preamplifier.

RF INPUT 50 ohms is the signal input for the spectrum analyzer. It has either a 50-ohm or 75-ohm (optional) impedance. For calibration routines, the signal source is the CAL OUTPUT.

CAUTION

Excessive signal INPUT power will damage the RF input attenuator and the input mixer. Use extreme caution when using the HP 8590A around high-power RF sources and transmitters. The spectrum analyzer's maximum total input power rating (+30 dBm RF level and 0 Vdc) appears on the front panel of the analyzer near the RF INPUT connector.

Rear-Panel Connectors

The rear panel of your instrument may contain the following connectors, depending on the options ordered with the instrument. See the HP 8590A Installation Manual (HP part number 08590-90003) for more information on options.

SWEEP OUTPUT provides a voltage ramp proportional to the sweep and the spectrum analyzer span.

AUX VIDEO OUTPUT (standard) provides detected video output (before A/D conversion) proportional to vertical deflection of the CRT trace. Output increases 125 mV per division from 0 to 1V.

AUX IF OUTPUT is a 50-ohm, 21.4-MHz IF output that is related to the RF input of the analyzer. Output bandwidth is controlled by the spectrum analyzer resolution bandwidth setting. Output amplitude is controlled by input attenuation and reference level (-10 through -60 dBm with 0-dB input attenuation). Output level is approximately -10 dBm into 50 ohms with a signal displayed at the reference level.

HI SWEEP IN/OUT (TTL) provides an indication of sweep.

Input: provide input signal from open collector gate circuit. Use low input to stop sweep; otherwise leave open.

Output: high TTL indicates sweep; low TTL indicates retrace.

MONITOR OUTPUT allows the use of external CRT monitors, such as the HP 82913A.

EXT TRIG INPUT (TTL) allows the analyzer's internal sweep source to be triggered by an external voltage.

Interface Connectors: Optional interfaces for HP-IB, RS-232, and HP-IL allow remote instrument operation and direct plotting or printing of CRT screen data. (See the Installation Manual for more information.)



Appendix

This appendix contains charts and graphs that are helpful for amplitude modulation, frequency modulation, and pulsed RF measurements.

Amplitude Modulation

% Modulation	Sideband level below carrier (dB)
1	46
2	40
10	26
20	20
30	16.5
40	14
50	12
60	10.4
70	9.1
80	7.9
90	6.9
100	6.0

Sideband level below carrier (dB)	% Modulation
10	63
20	20
30	6.3
40	2.0
50	0.63
60	0.2
70	0.063
80	0.02

Percent Modulation

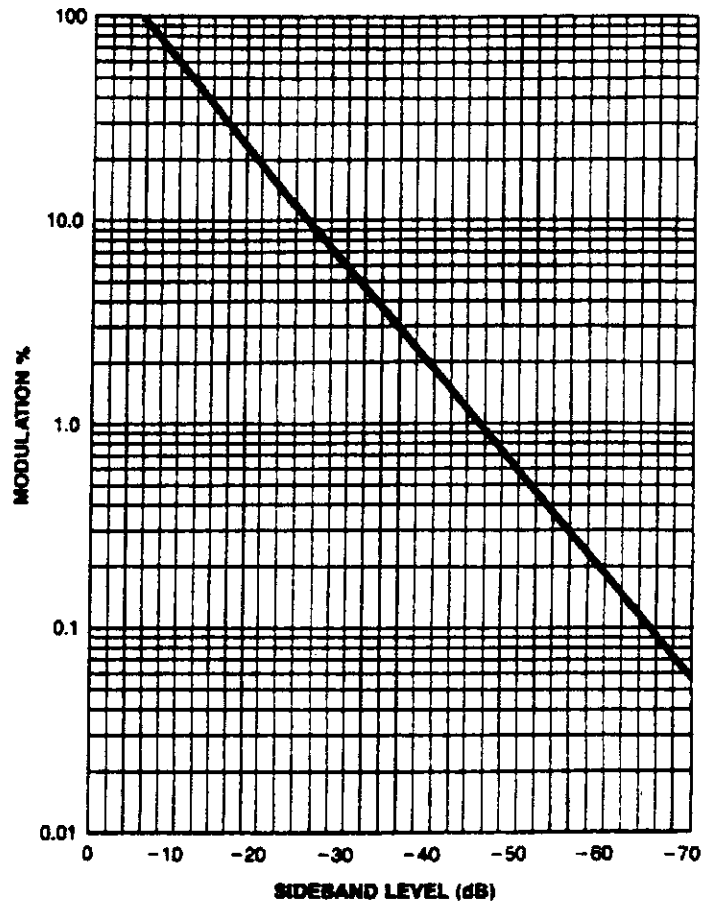

Frequency Modulation

Carrier and First Sideband Charts for Calibrating Deviation

Carrier Bessel NULL Number	$t = \frac{\Delta F}{f}$
1st	2.4048
2nd	5.5201
3rd	8.6531
4th	11.7915
5th	14.9309
6th	18.0711
7th	21.2116
8th	24.3525
9th	27.4935
10th	30.6346

$$J_0(t) = 0$$

First Sideband Bessel NULL Number	$t = \frac{\Delta F}{f}$
1st	3.83
2nd	7.02
3rd	10.17
4th	13.32
5th	16.47
6th	19.62
7th	22.76
8th	25.90
9th	29.05

$$J_1(t) = 0$$

Bessel Null Graph

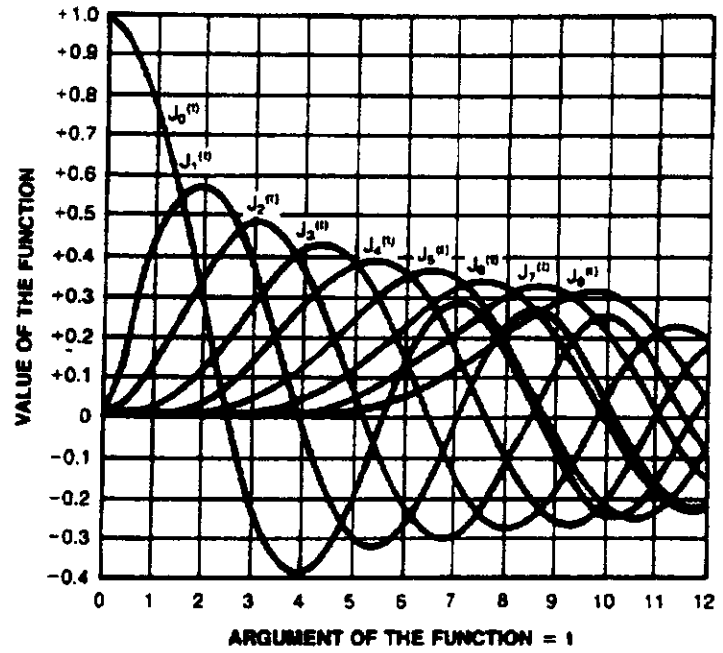

Bessel functions for the first eight orders

Pulsed RF

*Loss in Sensitivity
(Pulsed RF versus CW)*

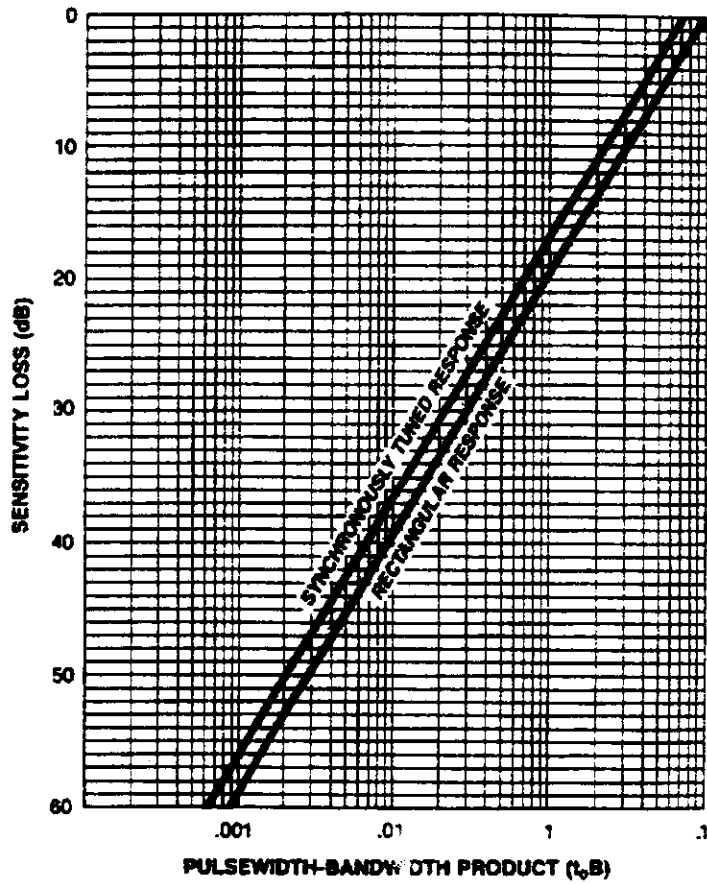

*Resolution Bandwidth Setting for Pulsed RF
Computed from $t_0B=0.1$*

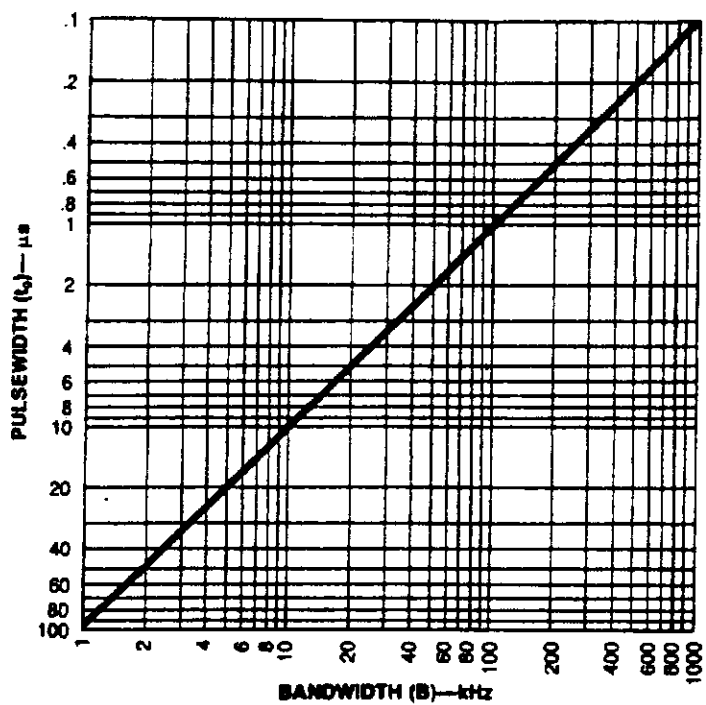

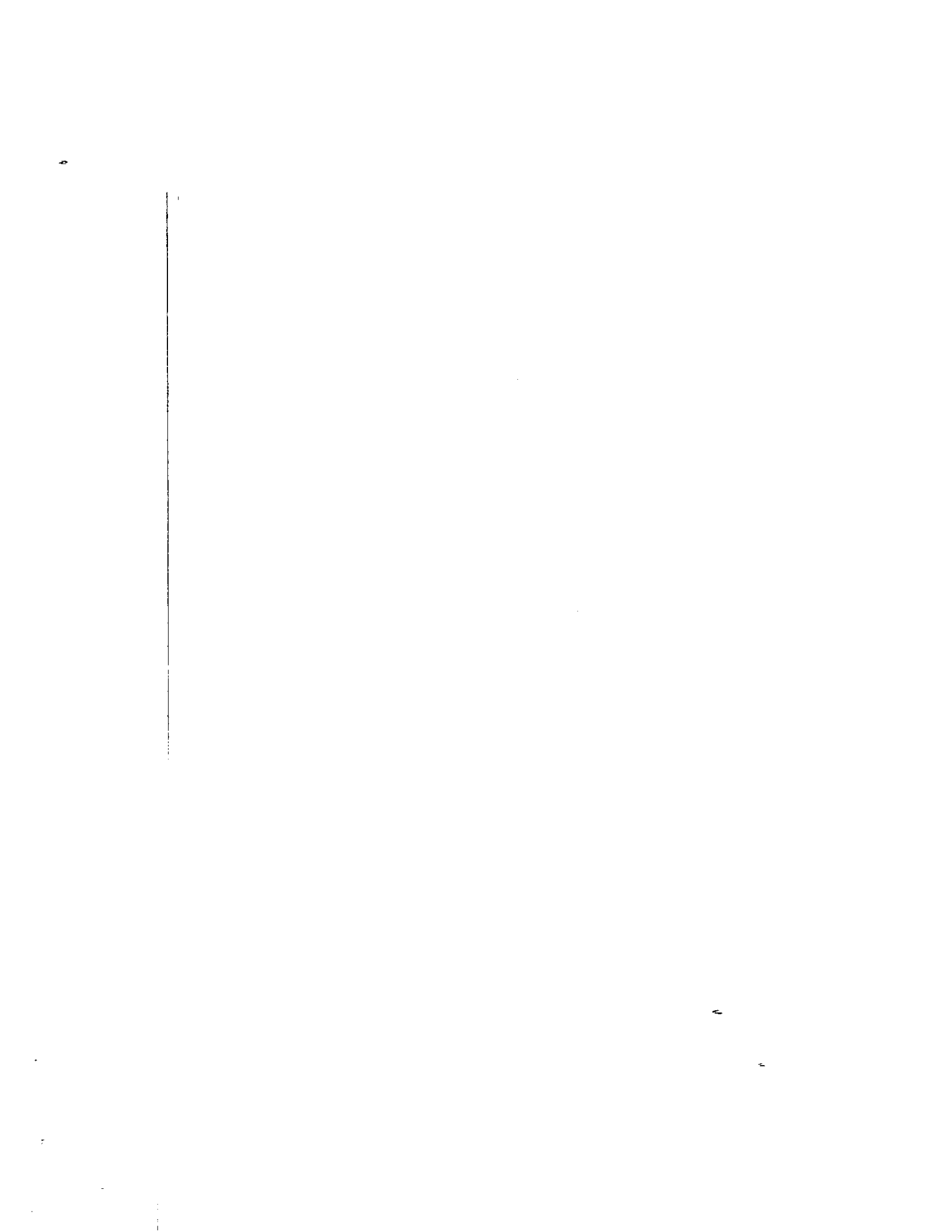

Index

1ST LO OUTPUT	3-37
[+10V REF]	3-28
[-10V REF]	3-28
[2v REF DETECTOR]	3-28
[3 db POINTS]	3-16
[3rd ORD MEAS]	3-16
[6 db POINTS]	3-17
[99% PWR BW]	3-17
[A - B on OFF]	3-31
Accuracy	1-14, 3-12
amplitude	1-14, 3-29
frequency	1-14
Address	
HP-IB	3-10
HP-IL	3-10
plotter	3-10, 3-18
printer	3-10, 3-18
trace memory	3-26, 3-27
[A EXCH B]	3-32
Amplitude Functions	3-6
AMPLITUDE	1-3, 1-6, 2-21, 2-29, 2-34, 2-37, 2-39, 3-5, 3-6
[ANALYZER ADDRESS]	3-10
[ANALYZER TEST]	3-28

Annotation	
marker	3-21
screen	1-11, 1-12, 1-13, 2-11, 3-20, 3-35
softkey	1-11, 3-35
[ANOTATN ON off]	3-35
[ATTEN]	2-21, 2-29, 3-6
Automatic Zooming With Auto Zoom	2-12
AUTO COUPLE	2-17, 2-24, 3-6, 3-25, 3-29, 3-31, 3-34, 3-35
[AUX A]	3-28
[AUX B]	3-28
[B - DL → B]	3-32
[BAUD RATE]	3-10
[BINARY SPAN]	3-28
CAL	1-14, 3-12
[CAL AMPTD]	1-15, 3-12
[CAL FETCH]	3-12
[CAL FLATNESS]	3-13, 3-28
[CAL FREQ]	1-14, 3-12
Calibration	3-12, 3-37
amplitude	1-14, 3-12, 3-25
frequency	1-15, 2-43, 3-12
data	1-15, 3-12, 3-13, 3-14, 3-15
functions	1-9, 1-14
routines	1-14, 3-12, 3-15, 3-37
signal	1-1, 1-10, 2-2, 2-8, 2-10, 2-12, 2-15, 2-16, 2-19, 2-20, 3-37
softkeys	1-14, 3-12

CAL OUTPUT	1-1, 1-6, 1-14, 2-2, 2-6, 2-8, 2-10, 2-12, 2-20, 2-22, 3-33, 3-37
[CAL STORE]	1-15, 3-12, 3-13
[CAL YTO DELAY]	3-13
Caution	
input power	3-6, 3-37
key usage	3, 3-14
[CENTER FREQ]	3-4
[CF STEP SIZE]	3-5, 3-22
[CLEAR WRITE A]	2-43, 3-30, 3-32
[CLEAR WRITE B]	2-11, 2-29, 3-32
[COARSE TUNE DAC]	3-28
Comparing Signals With Delta Markers	2-2
Comparing Small Signals and Large Signals	
With Resolution Bandwidth	2-18
CONFIG	3-10, 3-18, 3-19
[CONF TEST]	3-13
Connectors	3-36
front-panel	3-37
HP-IB	3-10, 3-39
HP-IL	3-10, 3-39
input/output	1-10
rear-panel	3-38
RF INPUT	2-6, 2-22, 2-29, 3-37
RS-232	3-39
VIDEO OUT	2-36, 2-38
Control functions	1-9, 3-25
[CONT SWEEP]	3-33
Copy functions	1-9, 3-18
[CORRECT on OFF]	1-15, 3-12

[DACS]	3-14, 3-28
Data Controls	1-2, 1-9, 3-2
[DELTA MEAS]	2-5, 3-16
[DETECTOR]	3-26
[DISPLAY]	3-34
[DISPLAY CAL DATA]	3-13
[DISPLAY LINE]	3-32, 3-34
[DISPLAY UNITS]	3-36
[DISPOSE ALL]	3-11
Distortion From the Analyzer	2-28
Documentation Description	2
Down step key	1-3, 2-6, 2-22, 2-24, 3-3
[DROOP]	3-28
[EEPROM INIT]	3-15
[ENTER FLT ERR]	3-14, 3-28
[EXECUTE TITLE]	3-14, 3-28
[EXTERNAL]	3-34
[FFT MEAS]	2-38, 3-17
[FINE TUNE DAC]	3-28
Fixed-tuned Receiver	2-25, 2-38, 2-39
[FM COIL DRIVE]	3-28
[FM SPAN]	3-28
[FREE]	3-33
[FREQ OFFSET]	3-5
[FREQUENCY]	1-2, 1-6, 1-11, 2-6, 2-10, 3-4, 3-8, 3-9, 3-21, 3-22
Frequency and Span Functions	3-4
Front-Panel Connectors	3-37
Front-Panel Overview	1-8

Gain	
calibration data	3-14
IF	1-15
preamplifier	1-13, 3-8, 3-11
step	3-14
Getting Acquainted With the Front Panel and Display	1-8
[GND REF DETECTOR]	3-28
[GRAT ON off]	3-35
HOLD	3-4
[HORIZ POSITION]	3-13
How to Use This Manual	3
Identifying Distortion Products	
Using the RF Attenuator and Traces	2-28
Impedance	
CAL OUTPUT	3-37
input	3-36, 3-37
Improving Accuracy With Calibration Routines	1-14
[INPUT IMPED]	3-36
Installation Manual	2, 1-1, 3-38, 3-39
Instrument State Functions	1-9, 3-9
Intensity	1-10, 3-36
Interface connectors	3-39
HP-IB	3-10, 3-18
HP-IL	3-10, 3-18
RS-232	3-10, 3-18
Intermodulation Distortion	2-31
Knob	3-2

[LINEAR]	2-37, 2-39, 3-7
[LINE] (Power)	3-33
[LINE] (Trigger)	3-36
[LOCAL]	3-9
[LOG dB/DIV]	3-7
[MAIN COIL DR]	3-28
[MAIN SPAN]	3-28
Making a Measurement	1-1
Manual Terms and Conventions	4
Marker Functions	1-5, 1-9, 3-20
[MARKER AMPTD]	3-21
[MARKER DELTA]	2-4, 2-6, 2-9, 2-34, 2-42, 3-16, 3-20, 3-23
[MARKER NORMAL]	1-6, 3-20, 3-24
[MARKER PAUSE]	3-21
[MARKER → CF]	3-22, 3-23
[MARKER → RL]	3-22
[MARKER → STEP]	3-22
[MARKERS OFF]	2-4, 2-7, 3-21, 3-24
[MAX HOLD A]	2-10, 3-30, 3-32
[MAX HOLD B]	3-32
[MAX MXR LEVEL]	2-34, 3-7
Meas Uncal Indicator	1-13, 3-29
Measurement Summary	1-6
Measuring Amplitude Modulation	
With the Fast Fourier Transform	2-38
Measuring Low-Level Signals With Attenuation, Bandwidth, and Video Average	2-20
Menu and Softkey Overview	1-11

MKR →	3-22
MKR	1-5, 1-6, 2-4, 2-7, 2-42, 3-20
[MKNOISE on OFF]	3-21
[MKR Δ → SPAN]	3-22
Modulation	2-35, 2-37, 2-42
amplitude	2-1, 2-35, 2-38, 3-17
frequency	2-40, 2-41
percent	3-17, Appendix
[MODULATN MEAS]	3-17
[MORE]	3-22
[NEXT PEAK]	2-34, 3-16, 3-23
[NEXT PK LEFT]	2-2, 2-4, 3-23
[NEXT PK RIGHT]	2-2, 2-4, 2-8, 2-20, 2-22, 3-23
Number/Units Keyboard	3-3
Options	3-38
documentation	2
75-ohm	3-36, 3-37
HP 8444 Tracking Generator	3-16, 3-17, 3-37
HP-IB	3-10, 3-18, 3-39
HP-IL	3-10, 3-18, 3-39
RS-232	3-18, 3-39
Other Controls and Connectors	3-36
[PEAK EXCURSN]	3-23, 3-24
PEAK SEARCH	1-5, 1-6, 2-2, 2-5, 2-6, 2-8, 2-12, 2-20, 2-22, 2-24, 2-34, 3-16, 3-22, 3-23
[PK-PK MEAS]	3-16
[PLOTTER ADDRESS]	3-10, 3-19

[PLOT]	3-19
[POS PK DETECTOR]	3-27
Power	3-6, 3-17
amplitude	3-6
bandwidth	3-17
input	3-7, 3-37
level	3-6, 3-7
line	3-36
noise power bandwidth	3-21
Power-to-voltage conversions	3-36
[PRESET]	1-1, 1-2, 1-9, 1-10, 1-14, 2-2, 2-6, 2-8, 2-10, 2-20, 2-22, 3-5, 3-7, 3-8, 3-9, 3-13, 3-14, 3-18, 3-24, 3-25, 3-27, 3-30, 3-32, 3-33, 3-35
[PREAMP GAIN]	3-11
[PRINTER ADDRESS]	3-10, 3-18
Printing History	4
[PRNT]	3-18
Probe Power	3-37
Rear-Panel Connectors	3-38
[RECALL]	2-41, 3-14, 3-15
Receiver (Fixed-Tuned)	2-35, 2-38
[REF LVL OFFSET]	3-8
[RES BW]	2-16, 2-22, 2-33, 2-39, 3-25
Resolving Signals of Equal Amplitude	
With Resolution Bandwidth	2-14
RF attenuation	1-13, 1-15, 2-1, 2-22, 2-28, 2-29, 3-7, 3-29
RF Input	1-1, 1-6, 1-10, 1-14, 2-2, 2-6, 2-15, 2-20, 2-22, 2-29, 2-36, 2-39, 3-6, 3-37, 3-38

[SAMPLE DETECTOR]	3-26
SAVE	2-41, 3-15
Screen Annotation	1-12
[SCREEN TITLE]	3-14, 3-35
Service Functions	3-28
[SET 20 dB ERR]	3-14, 3-28
SIGNAL TRACK	2-8, 2-9, 2-12, 2-21, 2-22, 3-24
[SINGLE SWEEP]	3-33
Softkeys	4, 1-10, 1-11
SPAN	1-3, 1-6, 2-5, 2-6, 2-10, 2-12, 2-22, 2-37, 2-39, 3-4
[SPA]	3-4
[START FRE]	1-11, 3-5
State	
instrument	1-9, 3-9
preset	1-10
registers	3-11, 3-15
Step Keys	1-9, 3-3
[STOP FREQ]	3-5
[STORE BLANK A]	3-30, 3-31, 3-32
[STORE BLANK B]	3-32
[STP GAIN ZERO]	3-14
[SWEEP RAMP]	3-28
[SWEEP TIME DAC]	3-28
[SWEEP TIME]	2-41, 3-26
SWP/BW	2-16, 2-22, 2-24, 2-33, 2-37, 2-39, 2-41, 3-25, 3-28

Temperature (Power On)	1-14, 3-36
Third-Order Intermodulation Distortion	2-31
[THRESHOLD]	3-23, 3-34
TRACE A	2-10, 2-27, 2-43, 3-30
TRACE B	2-11, 2-29, 3-32
Tracking Renegade Signals With	
Signal Track and Maximum Hold	2-8
TRIG	3-33
Uncalibrated Indicator	3-29
Units	
amplitude	3-36
display	3-34, 3-36
keyboard	1-2, 1-3, 2-22, 2-27,
3-2, 3-3, 3-7, 3-8, 3-36	
linear	3-7
logarithmic	3-7
Units keys	3-3, 3-14
Up step key	2-21, 2-29
Using the Analyzer as a Receiver in Zero Span	2-35
[VBW/RBW RATIO]	3-25
[VERT POSITION]	3-13
[VID BW]	2-24, 3-25
[VIDEO AVERAGE]	2-27, 3-31
[VIDEO]	3-33, 3-34
[VIEW A]	3-30, 3-32
[VIEW B]	2-29, 3-32

Warmup Time	1-15
[Watts]	3-36
[X FINE TUNE DAC]	3-28
Zero Span	2-35
Zoom (Auto Zoom)	2-12

HP 8590A Softkey Menus

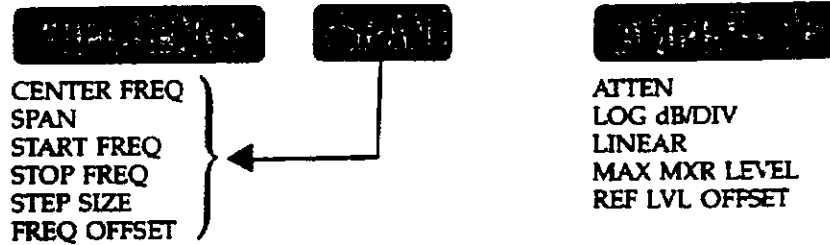

Marker

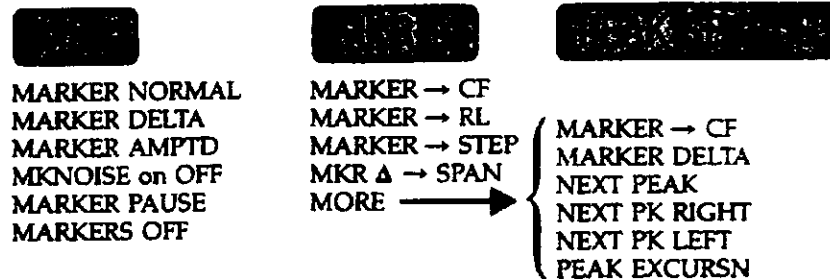

Instrument State

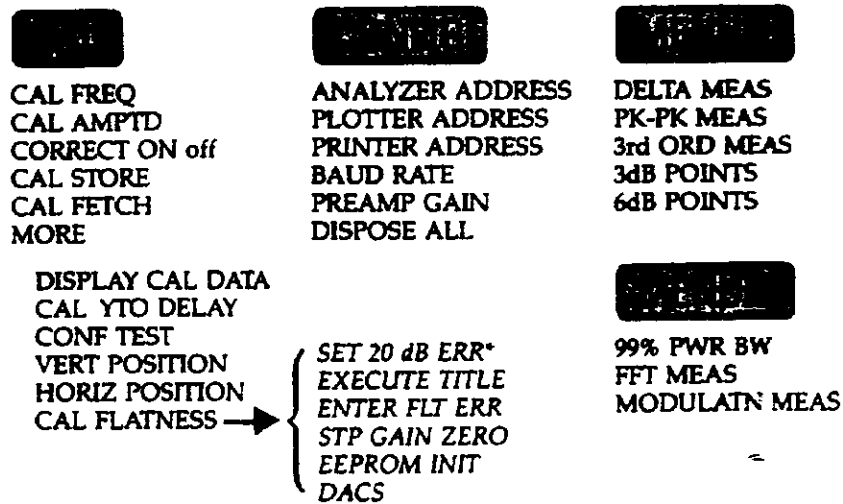

Control

CLEAR WRITE A
MAX HOLD A
VIEW A
STORE BLANK A
VIDEO AVERAGE
A-B on OFF

CLEAR WRITE B
MAX HOLD B
VIEW B
STORE BLANK B
A EXCH B
B-DL → B

CONT SWEEP
SINGLE SWEEP
FREE
VIDEO
LINE
EXTERNAL

RES BW
VID BW
VBW/RBW RATIO
SWEEP TIME
DETECTOR

DISPLAY LINE
THRESHOLD
SCREEN TITLE
GRAT ON off
ANOTATN ON off
DISPLAY UNITS
dBm
dBmV
dBuV
Volts
Watts
INPUT IMPED

SAMPLE DETECTOR
POS PK DETECTOR
2v REF DETECTOR
GND REF DETECTOR
ANALYZER TEST

MAIN COIL DR
FM COIL DRIVE
FM SPAN
MAIN SPAN
BINARY SPAN
MORE

SWEEP RAMP
SWEEP TIME DAC
COARSE TUNE DAC
FINE TUNE DAC
X FINE TUNE DAC
MORE

+10V REF DETECTOR
-10V REF DETECTOR

AUX A
AUX B
DROOP
MORE

**Italics indicate service function.*

1st Measurement

Measurements

Functions



HEWLETT
PACKARD

Hewlett-Packard Company
1212 Valleyhouse Drive, Rohnert Park, CA 94928-4999

Manual Part Number: 08590-90005
Microfiche Part Number: 08590-90006

August 1986
Printed in U.S.A.