

Errata

Title & Document Type: 8568A Spectrum Analyzer Operation Manual

Manual Part Number: 08568-90002

Revision Date: 1978-10-01

HP References in this Manual

This manual may contain references to HP or Hewlett-Packard. Please note that Hewlett-Packard's former test and measurement, semiconductor products and chemical analysis businesses are now part of Agilent Technologies. We have made no changes to this manual copy. The HP XXXX referred to in this document is now the Agilent XXXX. For example, model number HP8648A is now model number Agilent 8648A.

About this Manual

We've added this manual to the Agilent website in an effort to help you support your product. This manual provides the best information we could find. It may be incomplete or contain dated information, and the scan quality may not be ideal. If we find a better copy in the future, we will add it to the Agilent website.

Support for Your Product

Agilent no longer sells or supports this product. You will find any other available product information on the Agilent Test & Measurement website:

www.tm.agilent.com

Search for the model number of this product, and the resulting product page will guide you to any available information. Our service centers may be able to perform calibration if no repair parts are needed, but no other support from Agilent is available.

8568A Spectrum Analyzer Operation

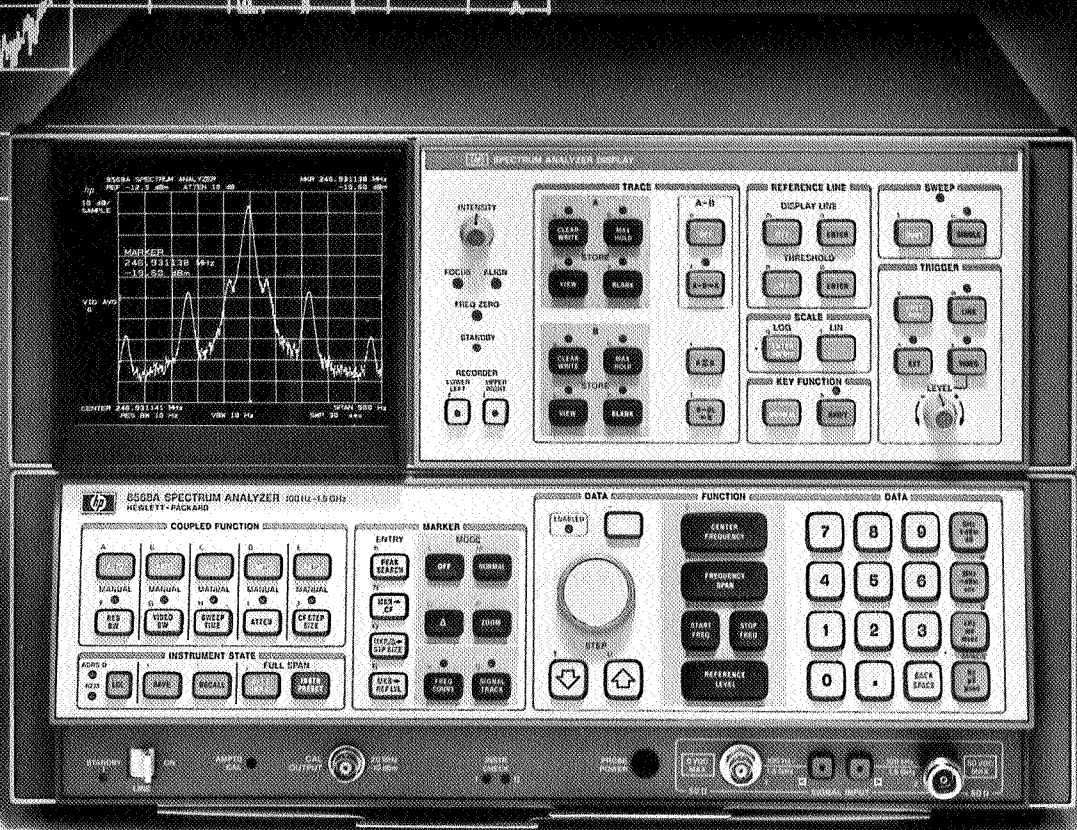
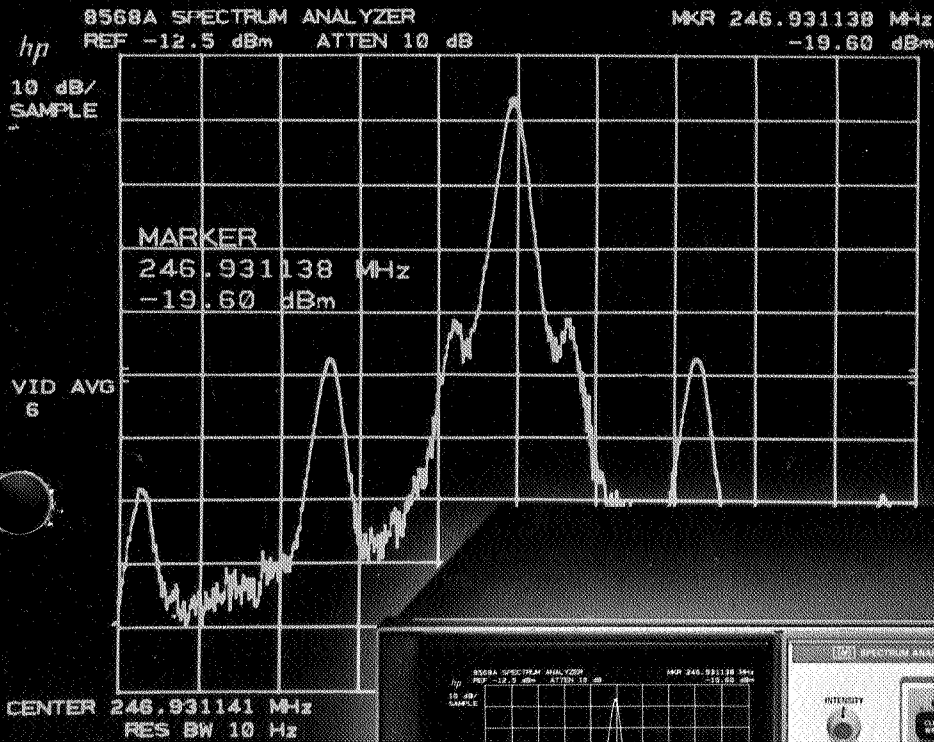

8568A Spectrum Analyzer Operation

OCTOBER 1978

HEWLETT  PACKARD

Copyright Hewlett Packard Co., 1977
1400 Fountain Grove Parkway
Santa Rosa, California, U.S.A.

Printed in U.S.A.

08568-90002

CHAPTERS

	Page
1. General Information	1.1
2. Getting Started	2.1
3. DATA	3.1
4. FUNCTION	4.1
5. CRT Display	5.1
6. TRACE	6.1
7. MARKER	7.1
8. SCALE and REFERENCE LINE	8.1
9. COUPLED FUNCTIONS	9.1
10. SWEEP and TRIGGER	10.1
11. INSTRUMENT STATE	11.1
12. Shift KEY FUNCTION	12.1
 Front Panel Outline	 Foldout Inside Back Cover

CONTENTS

Chapter	Page
1. General Information	1.1
Performance Summary	1.1
Description	1.1
Option Summary	1.2
Initial Power On and Calibration	1.2
Signal Inputs	1.4
Front Panel Overview	1.5
CRT Display	1.6
Rear Panel Outputs	1.7
2. Getting Started	2.1
Front Panel Concept	2.1
FUNCTION/DATA Controls	2.1
Starting From Full Span	2.2
Direct Signal Frequency and Amplitude Readout	2.3
Automatic Display Calibration	2.4
Automatic Measurements	2.5
3. DATA	3.1
DATA Entry Readout	3.2
Preventing DATA Entry	3.2
DATA Knob	3.2
DATA Step Keys	3.2
DATA Number/Units Keyboard	3.2
Multiple DATA Changes	3.3
4. FUNCTION	4.1
Display Calibration	4.2
Frequency Display Range	4.2
Center Frequency	4.2
Signal Tracking - Automatic Frequency Control	4.4
Frequency Span	4.4
Zero Frequency Span	4.5
Start and Stop Frequency	4.6
Reference Level	4.7
Frequency and Amplitude Offsets	4.10
5. CRT Display	5.1
Adjustment of the Display	5.1
Display Section Line Power	5.1
CRT Display Overview	5.1
6. TRACE	6.1
TRACE Identification	6.1
TRACE Modes	6.1
TRACE Exchange	6.4
TRACE C Modes	6.5
TRACE Arithmetic	6.5
TRACE Priority	6.7

CONTENTS

Chapter	Page
7. MARKER	7.1
MARKER Overview	7.2
MARKER On But Not Active	7.2
MARKER in the VIEW Mode	7.2
Single Marker - Normal	7.2
Differential Markers	7.3
MARKER Zoom	7.6
MARKER Off	7.9
Automatic Zoom	7.9
MARKER ENTRY	7.10
Peak Search	7.10
Signal Track - Automatic Frequency Control	7.13
Frequency and Noise Level Measurements	7.14
Frequency Count	7.14
Noise Level Measurement	7.16
8. SCALE and REFERENCE LINE	8.1
SCALE	8.1
REFERENCE LINE	8.4
Display Line	8.4
Threshold	8.5
9. COUPLED FUNCTION	9.1
DATA Entry for COUPLED FUNCTIONS	9.2
Resolution Bandwidth	9.2
Video Bandwidth	9.3
Video Averaging	9.4
Sweep Time	9.4
Input Attenuation	9.6
Center Frequency Step Size	9.8
10. SWEEP and TRIGGER	10.1
SWEEP	10.1
TRIGGER	10.2
11. INSTRUMENT STATE	11.1
Full Span Instrument Preset	11.1
Full Span 0-1.5 GHz	11.2
Saving and Recalling Instrument States	11.3
Local Operation	11.4
12. SHIFT KEY FUNCTION	12.1
General Description	12.1
Key Function Description	12.2
Index	12.15
Front Panel Outline	Foldout inside rear cover

Chapter 1

GENERAL INFORMATION

This chapter describes the 8568A Spectrum Analyzer's general performance characteristics, hardware, and the initial turn on procedure.

Performance Summary

Frequency

Range:	100 Hz to 1500 MHz
Resolution:	10 Hz to 3 MHz bandwidths in 1,3,10 sequence
Spectral Purity:	noise sidebands >80 dB below peak of CW signal 300 Hz offset in 10 Hz resolution bandwidth.
Accuracy:	internal frequency standard aging $< 1 \times 10^{-9}$ parts/day (2×10^{-7} /year) of calibration; center frequency \pm (2% of frequency span + frequency standard error x center frequency + 10 Hz)

Amplitude

Range:	-137 dBm to +30 dBm
Scaling:	dBm, dBmV, dB μ V with 10,5,2 or 1 dB per division; or linear voltage scale
Accuracy:	± 3.0 dB with 90 dB displayed range

Description

The 8568A Spectrum Analyzer consists of an 85662A Display Section and an 85680A RF Section.

Accessories supplied	Qty.	HP Part No.
Interconnection cable	1	85662-60071
Interconnection cable	1	85662-60069
Information card	1	7120-6781
Information card	1	7120-6782
Operating and Service Manual 8568A Spectrum	1	08568-90001
Analyzer Operation	1	08568-90002
8568A Spectrum Analyzer Remote Operation	1	08568-90003
Power cords	2	See Operating and Service Manual

**GENERAL
INFORMATION**

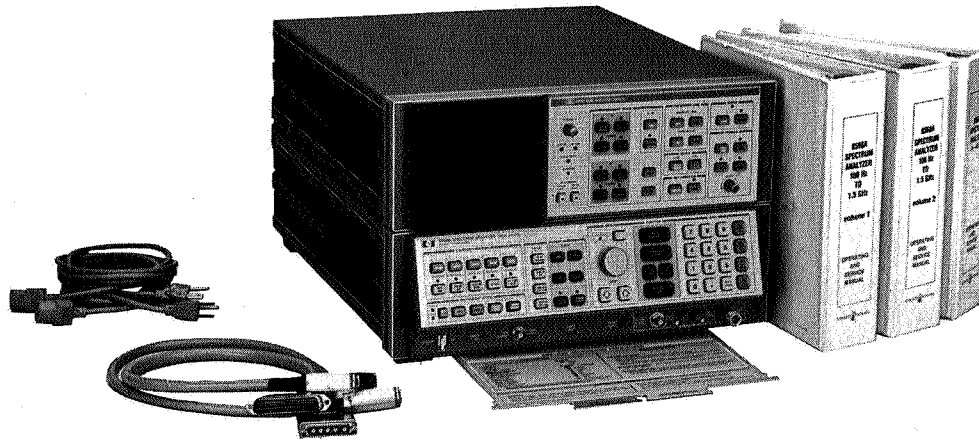

HP 8568A Spectrum Analyzer

Option Summary

The following options are available:

- 75Ω input impedance, 100 Hz to 1500 MHz, input 1
- 400 Hz power line frequency operation
- Front handle kits (one for each section)

- Option 001**
- Option 400**
- Option 907**

Initial Line Power On and Calibration

CAUTION

Prior to connecting the line power cords, make sure the proper line voltage and line fuse have been selected for both the RF and Display sections of the analyzer. For complete information on power cords, voltage and fuse selection, see 8568A Operating and Service Manual, section II.

Connect interconnection cables as shown:

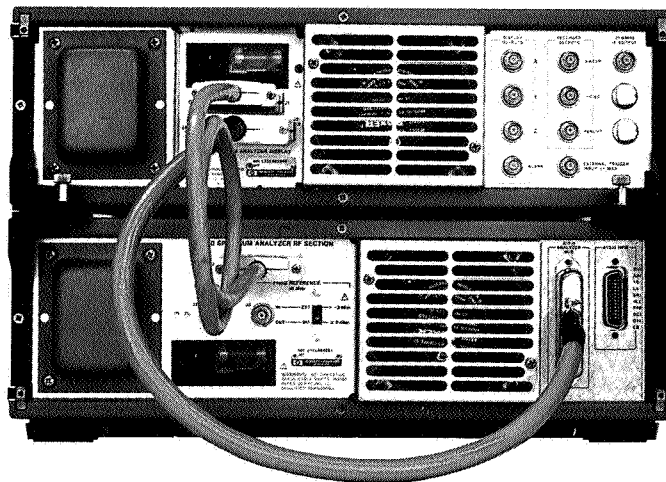

Rear Panel Connections

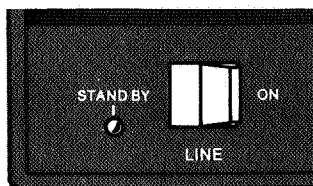

LINE ON and STANDBY

After making the AC power line connections the STANDBY lights of both Display and RF analyzer sections should be on. As long as the instrument is operating (LINE ON) or the STANDBY lights are on (LINE STANDBY), the accuracy specifications of the internal frequency standard will be met. After a cold start up, such as on-receipt operation, the analyzer requires 24 hours to stabilize.



Upon LINE ON, the instrument will perform an automatic internal instrument check, designated by the red INSTR CHECK lights. The HP-IB address will appear in the CRT display. If one or both lights remain on or the HP-IB address fails to appear after several seconds, refer to the Operating and Service Manual, section II.

Manual Calibrator Signal Adjustment

In order to meet specified frequency and amplitude accuracy, this calibration procedure should be used periodically along with the error correction routine below.

1. With LINE power ON, press **INSTR PRESET**.
2. Connect CAL OUTPUT to SIGNAL INPUT 2.
3. Press

CENTER FREQUENCY	2	0	MHz -dBm sec
FREQUENCY SPAN	2		MHz -dBm sec
RES BW	1		MHz -dBm sec
REFERENCE LEVEL	7		MHz -dBm sec
LOG	ENTER	1	GHz +dBm dB

 or press **RECALL 8**
4. Adjust AMPTD CAL for MKR amplitude of -10.00 dBm.
5. Press

FREQUENCY SPAN	0		Hz μV μsec
RES BW	3	0	Hz μV μsec
SWEEP TIME	1	0	MHz -dBm sec
SCALE LOG	ENTER	1	GHz +dBm dB

 or press **RECALL 9**
6. Maximize response with FREQ ZERO adjustment.

Error Correction Routine

A 1½ minute internal error correction routine minimizes errors due to changes in IF gain, resolution bandwidth, input attenuator or scale changes. To start the routine press KEY FUNCTION **SHIFT** **FREQUENCY SPAN**

A readout "CORR 'D'" will appear in the CRT display upon completion of this routine.

If the message "Adjust FREQ ZERO and AMPTD CAL" appears in the display, repeat the manual calibration before running the error correction routine again.

Chapter 12 KEY FUNCTION discusses the details of this error correction routine.

Signal Inputs

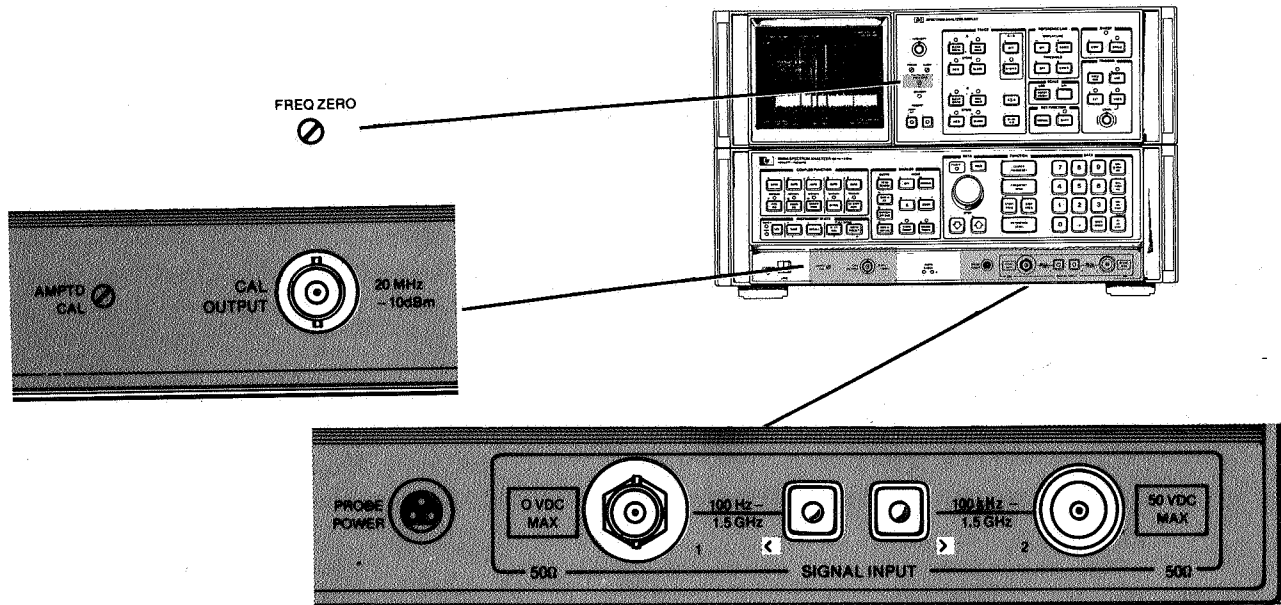

Signal Input and Calibration Controls

Either of the RF signal inputs can be selected:

INPUT 1: 100 Hz to 1500 MHz, dc coupled, BNC fused 50Ω.

INPUT 2: 100 kHz to 1500 MHz, ac coupled, Type N 50Ω

Isolation between inputs is > 90 dB.

CAUTION

Excessive signal INPUT power will damage the input RF attenuator and the input mixer. The spectrum analyzer total input power must not exceed the values listed:

INPUT	Maximum dc	Maximum RF
1	± 0 volts	+ 30 dBm (1 watt)
2	± 50 volts	+ 30 dBm (1 watt)

Probe Power

The probe power jack supplies power for high impedance 1:1 active probes, such as the HP 1121A 500 MHz AC Probe; and 50Ω preamplifiers such as the HP 10855A preamplifier. The voltage outputs are +15V, and -12.6V with a maximum current of 150 mA.

CAUTION

Active probes or amplifiers should not be used on RF Input 1, the dc coupled input, unless their output is specified ac only.

Front Panel Overview

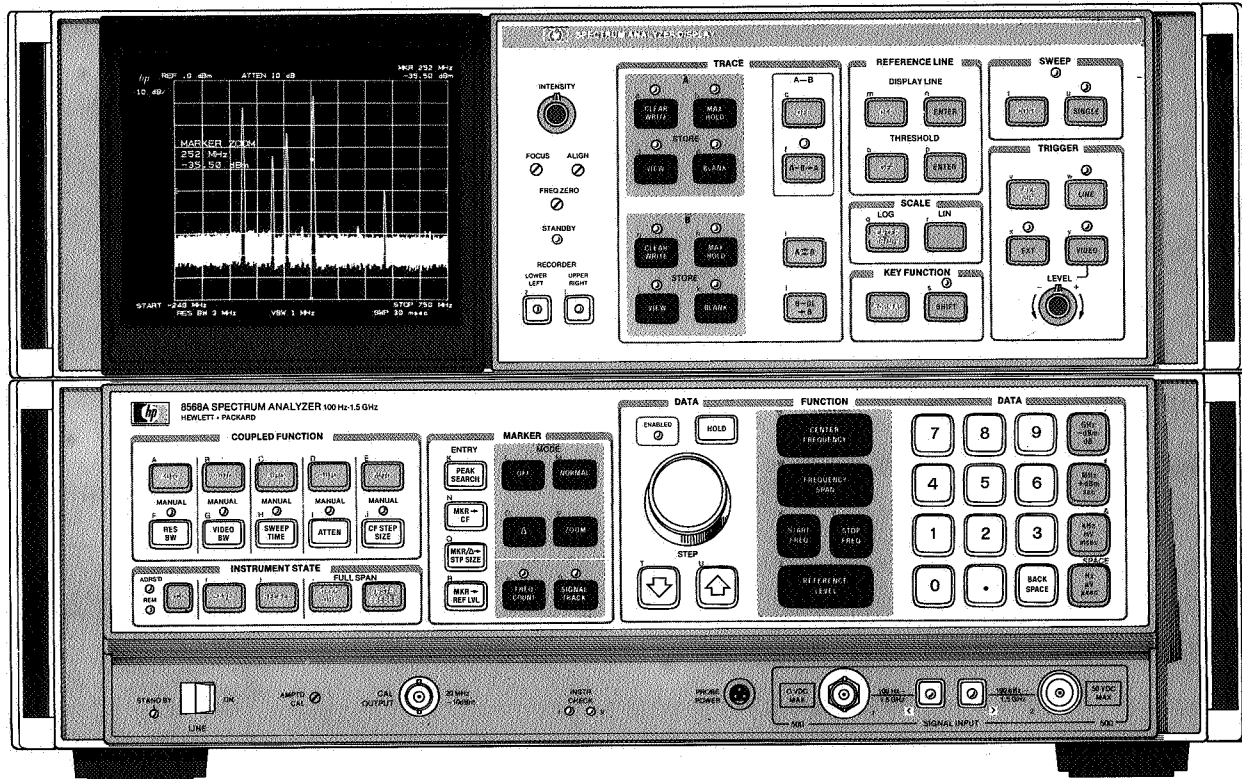

CONTROL GROUPS

SIGNAL INPUT:	100 Hz to 1500 MHz
DATA/FUNCTION:	Fundamental analyzer control
CAL OUTPUT:	Calibration signal
CRT DISPLAY:	Signal response and analyzer settings
TRACE:	Control of signal response display
MARKER:	Movable bright dot markers for direct frequency and amplitude readout
COUPLED FUNCTION:	Maintenance of absolute amplitude and frequency calibration by automatically selecting certain analyzer control settings
SWEEP and TRIGGER:	Selects amplitude scale and trace update trigger
SCALE:	Selects logarithmic or linear amplitude scale.
REFERENCE LINE:	Measurement and display aids
INSTRUMENT STATE:	Local, remote and preset control settings saving and recalling control settings
KEY FUNCTION:	Access to special functions
LINE ON/STANDBY	Powers instrument and performs instrument check
HP-IB CONNECTOR;	
AUXILIARY OUTPUTS	Rear panel output connectors for full HP-IB and xyz capability
INFORMATION CARDS:	Describes the function of each front panel control and  functions; indexes all the HP-IB programming codes; outlines the calibration procedure.

**GENERAL
INFORMATION**

CRT Display

The analyzer's CRT display presents the signal response trace and all pertinent measurement data. The active function area names the function under DATA control and shows the function values as they are changed. All the information necessary to scale and reference the graticule is provided.

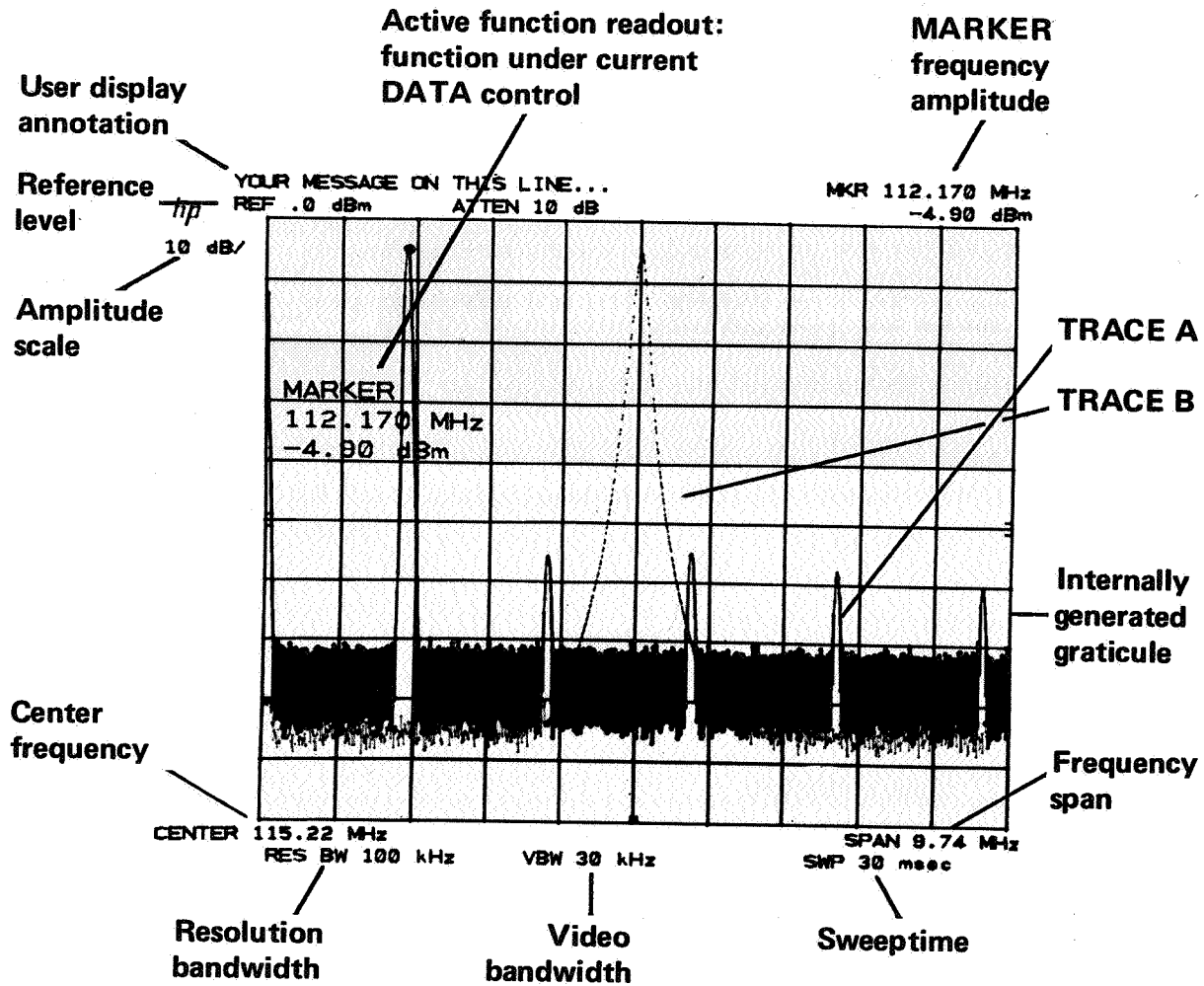

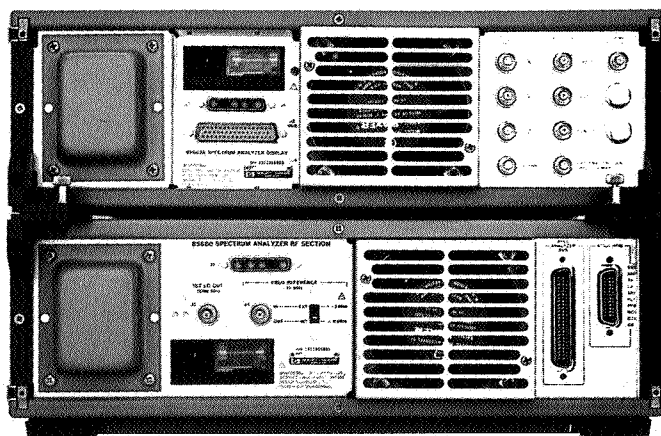

Rear Panel Outputs







Display Outputs

Display outputs allow all the CRT information to be displayed on an auxiliary CRT display such as the HP 1310A Large Screen Display.

Display Outputs	Output
 X  Y  Z	0 to +1 V Intensity: -1 V blank, 0 to 1 V intensity modulation

Recorder Outputs

The recorder outputs allow the x-y plot of trace data with x-y plotters using positive penlift coils or TTL penlift input. The front panel keys enable outputs for the calibration of x-y plotter reference points:

Recorder Outputs	RECORDER LOWER LEFT UPPER RIGHT  	RECORDER Outputs when keys or HP-IB commands are enabled	
		Lower Left	Upper Right
 SWEEP	A voltage proportional to the horizontal sweep of the CRT trace that ranges from 0 V for the left edge and to +10 V for the right edge.	0 V left	10 V right
 VIDEO		0 V lower	+1 V upper
 PENLIFT		+15 V	+15 V

HP-IB Input Output Connector

The Hewlett Packard Interface Bus allows remote operation of the analyzer as well as input and output of measurement data. See 8568A Spectrum Analyzer Remote Operation, HP part number 08568-90003.

Chapter 2



GETTING STARTED

This chapter is intended to provide you with an overview of the use and capability of the Hewlett Packard 8568A Spectrum Analyzer. The chapters following provide the details on each aspect of operation.

Front Panel Concept

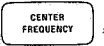
The front panel keys provide convenient control over functions such as center frequency, frequency span, reference level, resolution bandwidth, and sweep time. Any function can be selected by pressing its key and then changed by using the DATA control knob, step keys or number/units keyboard. For example, to specify center frequency

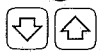
press , then change the value, as read out on the CRT, with *any* or *all* of the DATA controls:

-  Continuous coarse and fine tune
-  Change in steps
-  Set the value exactly

The analyzer's CRT display presents the signal response trace and all pertinent measurement data.

FUNCTION/DATA Controls

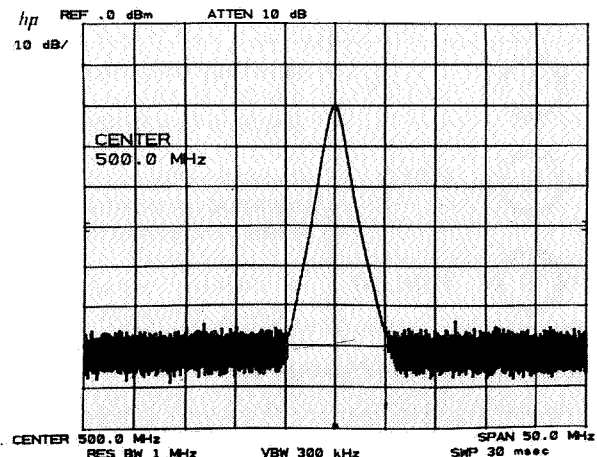
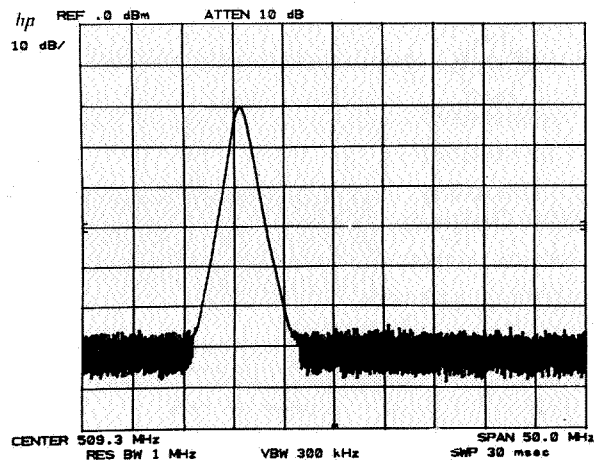

The front panel controls are divided into functional groups. Most measurements can be made from the FUNCTION/DATA control group. However, the other groups add to the measurement efficiency, convenience and capability.

The FUNCTION and DATA controls can be used to measure the frequency and amplitude of a signal such as the one shown.





First, move the signal to the center of the display with  .

The readout gives the signal frequency. (The DATA step keys or number/units keys could also have been used.)

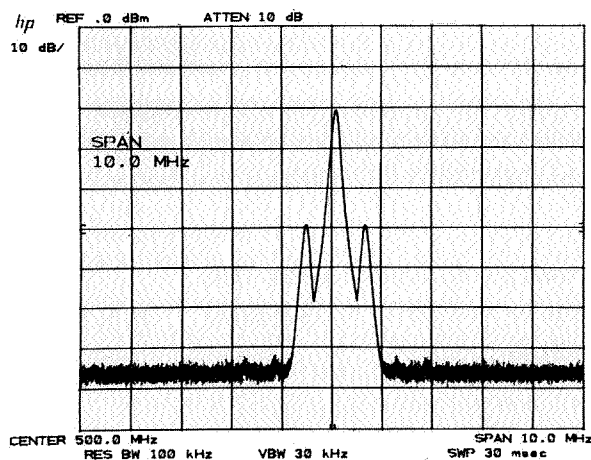
For better frequency resolution narrow the frequency span with   .



Now bring the signal peak to the reference level with   and . The reference level readout is the signal's power level.

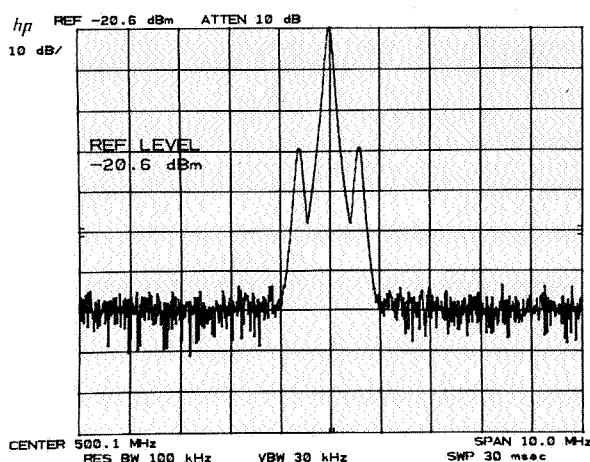

Starting From Full Span

A convenient place to start a new measurement is with a full 1500 MHz frequency span. A single key,  presets all the analyzer functions to give you a 0 Hz to 1500 MHz display with a 0 dBm reference level.

For example, after measurements in a narrow frequency span. . .

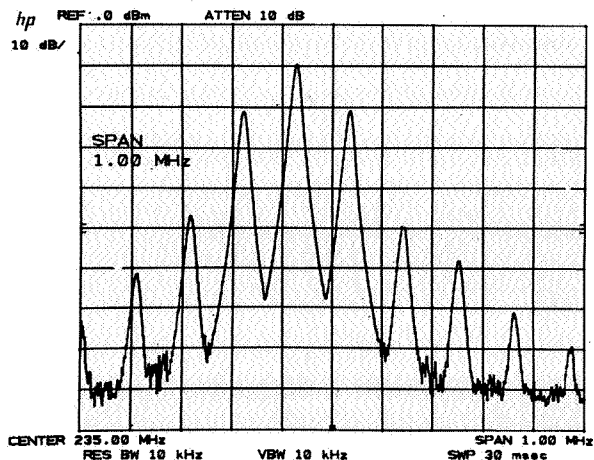

GETTING STARTED

INSTR PRESET allows you to view the entire 1500 MHz span for selection of the next signal to investigate.

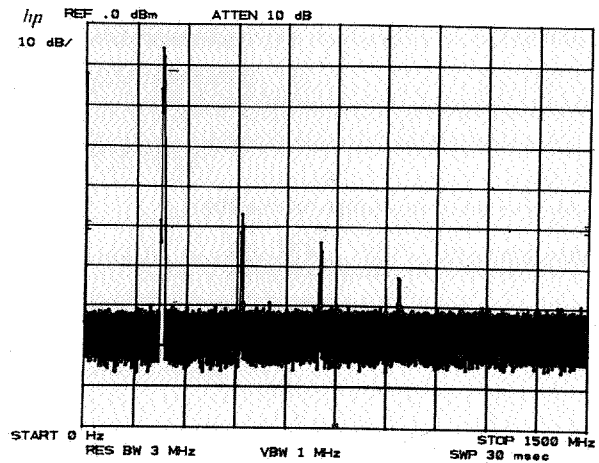

Direct Signal Frequency and Amplitude Readout

Signal frequencies and amplitudes, as well as differences, can be read out directly with the MARKER and DATA controls, without changing center frequency or reference level.

Activate the marker with **MARKER** **NORMAL**. Use the DATA knob  to position the marker. The amplitude and frequency are read out continuously.

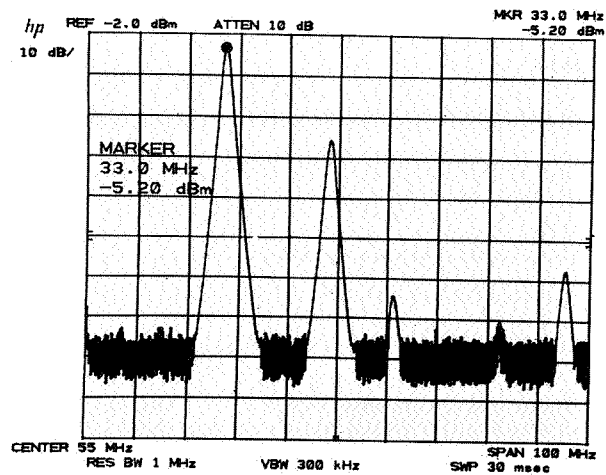

To measure the differences between this signal and any other on the display, press **A** and use  to move the second marker. The amplitude and frequency differences are read out continuously.

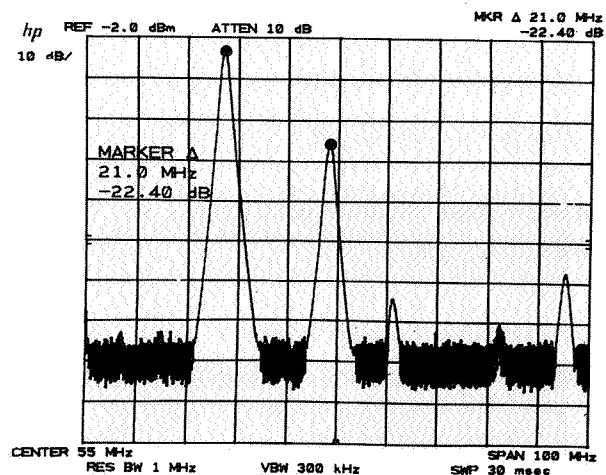





Automatic Display Calibration

Unless you specifically override the analyzer's COUPLED FUNCTION state, the analyzer will maintain absolute amplitude and frequency calibration during your measurements. Changes of frequency span automatically call for resolution bandwidths, video bandwidths and sweep times that keep the amplitude calibrated while maximizing the trace sweep rate. You can take manual control over any of these functions with the COUPLED FUNCTION and DATA controls.

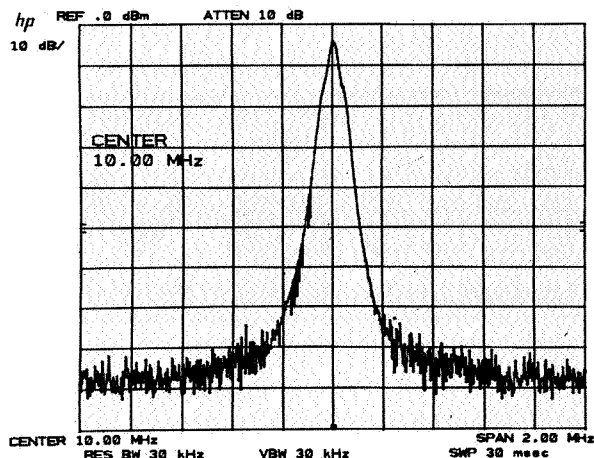
For example, for higher signal resolving capability the analyzer's resolution bandwidth can be narrowed using the COUPLED FUNCTION .



A signal with 40 kHz sidebands is viewed in a 2 MHz span. The sidebands are not visible, because of the 30 kHz resolution bandwidth.

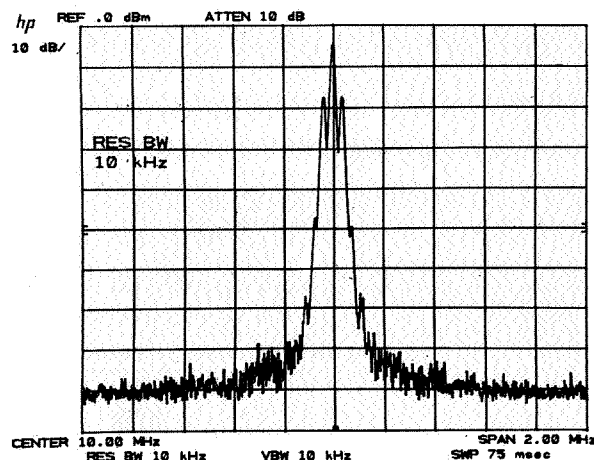

Reduce the resolution bandwidth without changing the span with  . (The DATA knob  or number/units keyboard could also have been used.)



The sweep time is increased automatically to compensate for the narrower resolution bandwidth. If the sweep time were in the manual mode, the display could become uncalibrated.

Press  . The display uncalibrated message appears in the display.

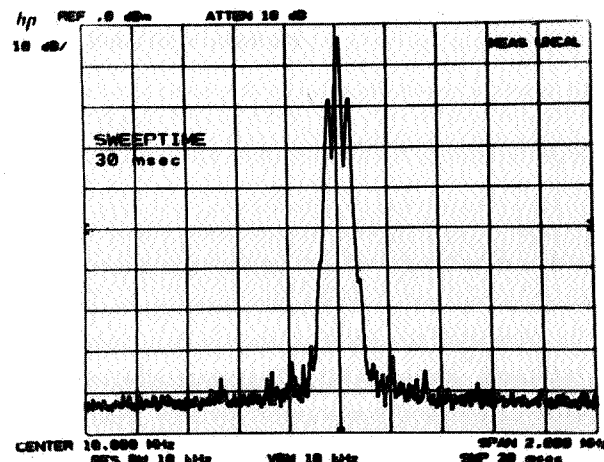

Automatic Measurements

Just as the front panel keys call functions and change their values, simple programming codes from a computing controller can control the spectrum analyzer for automatic measurement through the Hewlett-Packard Interface Bus (HP-IB). HP's implementation of IEEE Standard 488 and identical ANSI Standard MC1.1 "Digital interface for programmable instrumentation".

Detailed information on remote operation is the subject of 8568A Spectrum Analyzer Remote Operation, HP part number 08568-90003.

Chapter 3

DATA

DATA controls are used to change function values for functions such as center frequency, start frequency, resolution bandwidth or marker position.

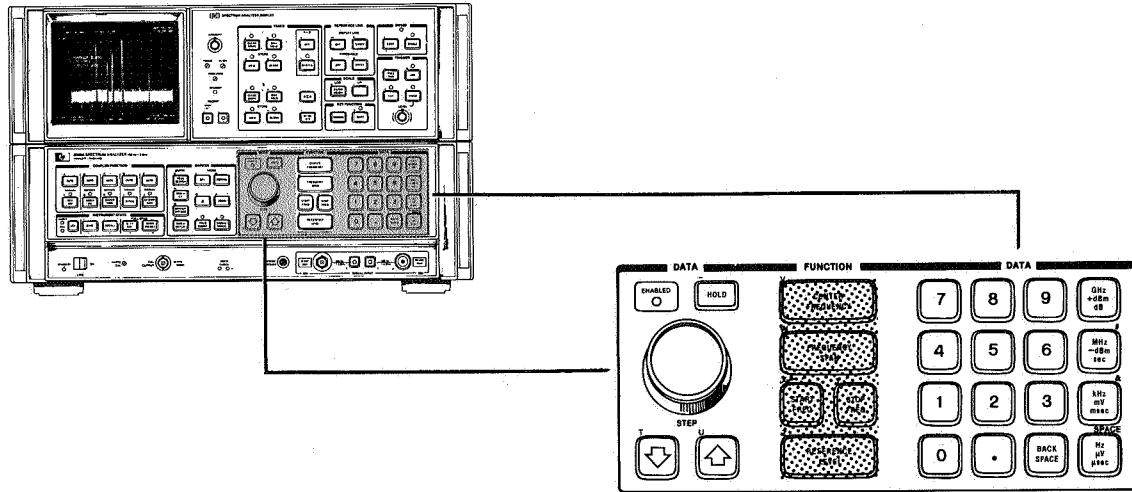

DATA Controls

The DATA controls are clustered about the FUNCTION keys which “call up” or activate the most frequently used spectrum analyzer control functions: center frequency, frequency span (or start/stop frequency) and reference level. The other functions that accept DATA control are shown below:

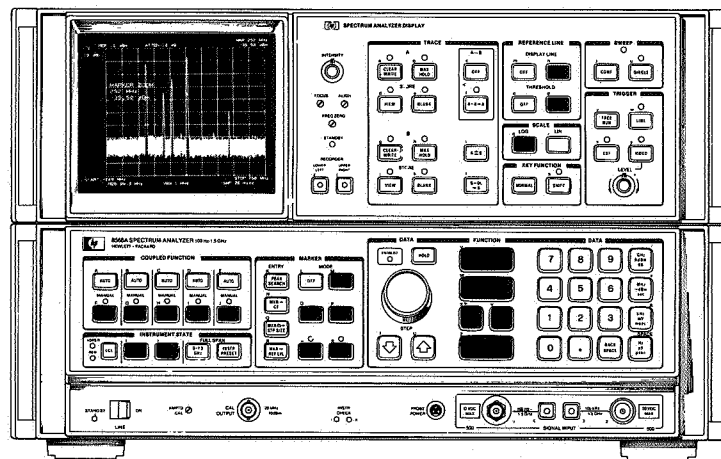

Front Panel Functions Using DATA Controls

To the left of the FUNCTION Keys are the DATA knob and the DATA STEP keys which are used to make incremental changes to the activated function. To the right of the FUNCTION keys is the DATA number/units keyboard which allows changes to an exact value.

The DATA controls will change the activated function in a manner prescribed by that function. For example, center frequency can be changed continuously with the DATA knob , or in steps proportional to the frequency span with the DATA STEP keys , or set exactly with the DATA number/units keyboard. Resolution bandwidth, which can be set only to discrete values, can still be changed with any of the DATA controls. The DATA knob and DATA STEP keys increment the setting from one bandwidth to the next. An entry from the number/units keyboard which may not coincide with an allowable bandwidth will select the nearest bandwidth.

DATA Entry Readout

DATA entries are read from the CRT display as they are changed.

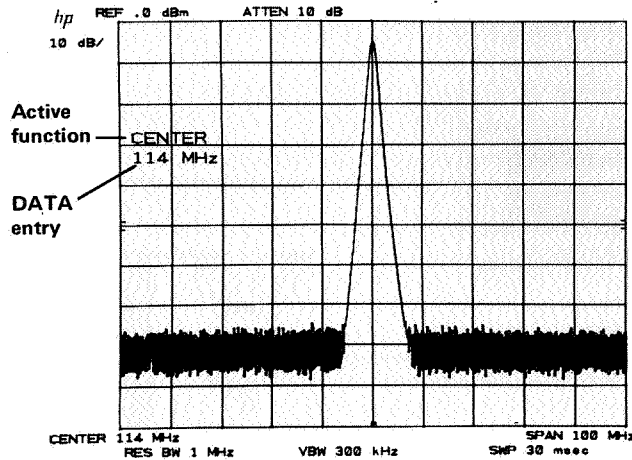

Preventing DATA Entry







A function can be deactivated by pressing **HOLD**. The active function readout is blanked and the ENABLED light goes out, indicating no DATA entry can be made. Pressing a function key re-enables the DATA controls.

DATA Knob

The DATA knob  allows the continuous change of center frequency, frequency span (or start/stop frequencies), reference level, and the positions of the marker, display line and threshold. It can also change the function values which are only incremented.

Clockwise rotation of the DATA knob will increase the function value. For continuous changes, the knob's sensitivity is determined by the measurement range and the speed at which the knob is turned. For example, when the center frequency is activated,  increases the value of the center frequency one horizontal division of span per one quarter turn.

DATA STEP Keys

The DATA STEP keys allow rapid increase  or decrease  of the active function value. The step size is dependent either upon the analyzer's measurements range, on a preset amount or, for those parameters with fixed values, the next value in a sequence. Examples: Activate center frequency and  will increase the center frequency value by an amount equal to one division of the frequency span (one tenth of the frequency span). If the center frequency step size **OFSTEP SIZE** has been preset,  will increase the center frequency by that preset amount. If frequency span were activated,  would change the span to the next lower value in predetermined sequence. Activate resolution bandwidth and  will select the next widest bandwidth.

Each press results in a single step.

DATA Number/Units Keyboard

The DATA number/units keyboard (or DATA keyboard) allows exact value entries to center frequency, frequency span (or start/stop frequency), reference level, log scale and the positions of the markers, display line, threshold and the COUPLED FUNCTIONS.

An activated parameter is changed by entering the number (with the CRT display providing a readout) then selecting the appropriate units key. The value is not changed (entered) until the units key is pressed.

The number portion of the entry may include a decimal, \cdot . If not, the decimal is understood at the end of the number. Corrections to number entries are made with \square which erases the last digit for each press.

Example: With center frequency activated



will set the center frequency to 1.250 GHz.

If the units key were pressed without a number entry, 1 is entered (except in zero frequency span).

Negative DATA Entry

Negative entries from the number units keyboard can be made for power and frequency but not time and voltage.

Negative power entries can be made using \square . The "-dBm" key will enter -dBm, -dBmV or -dB μ V. For example in reference level, with the dBmV units, an entry of \square \square \square will enter -50 dBmV.

Negative frequency entries can be made using

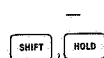

as a prefix to the frequency entry. For example, to enter a negative start frequency, press

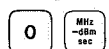

. This enters the frequency value as -100 MHz.

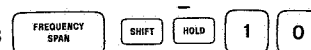

Not all functions will accept negative entries (the sign will be ignored).

Multiple DATA Changes

A function, once activated, may be changed as often as necessary without reactivating that function (see Chapter 4, FUNCTION). Any of the DATA controls can be used in any order.*

It is not always necessary to make a DATA entry. For example, start and stop frequency may be activated simply to allow readout of the left and right display reference frequencies as start/stop frequencies.

*Exceptions are the SHIFT KEY FUNCTIONS which use only DATA number/units keyboard. See Chapter 12.

Chapter 4

FUNCTION

This chapter describes the use of FUNCTION and DATA controls for establishing the desired amplitude and frequency display.

The FUNCTION group allows changes to the most used spectrum analyzer functions: center frequency, frequency span and reference level. An alternate method of setting the frequency scale is provided with the start and stop frequency functions.

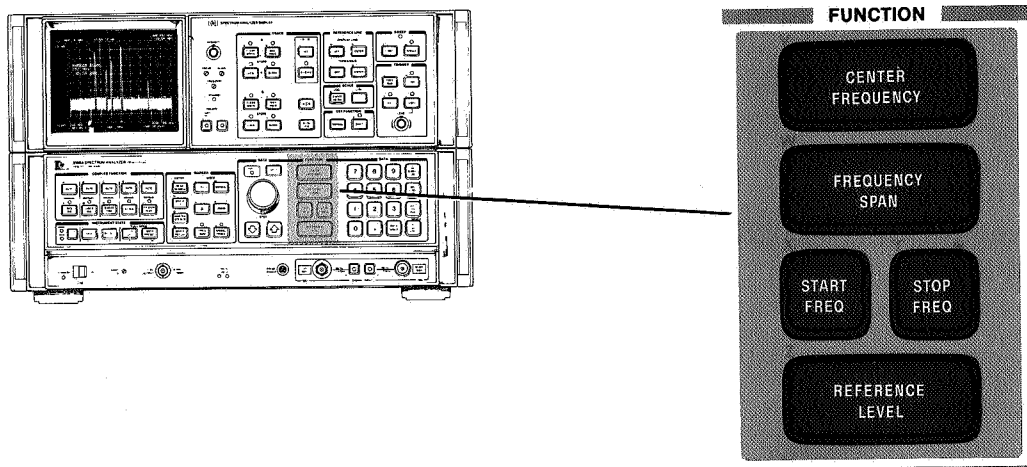

The changing value is read out from the display at the active function area and at the display position dedicated to that FUNCTION.

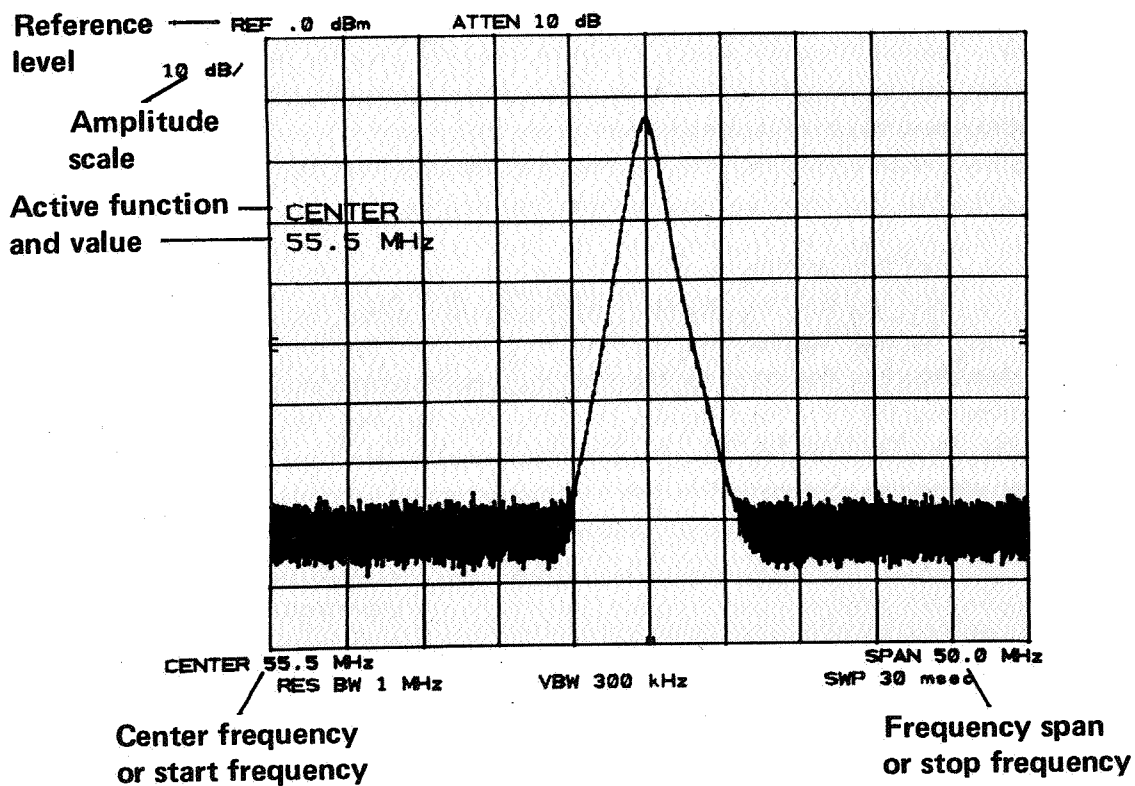

FUNCTION Value Readouts

CENTER
FREQUENCY

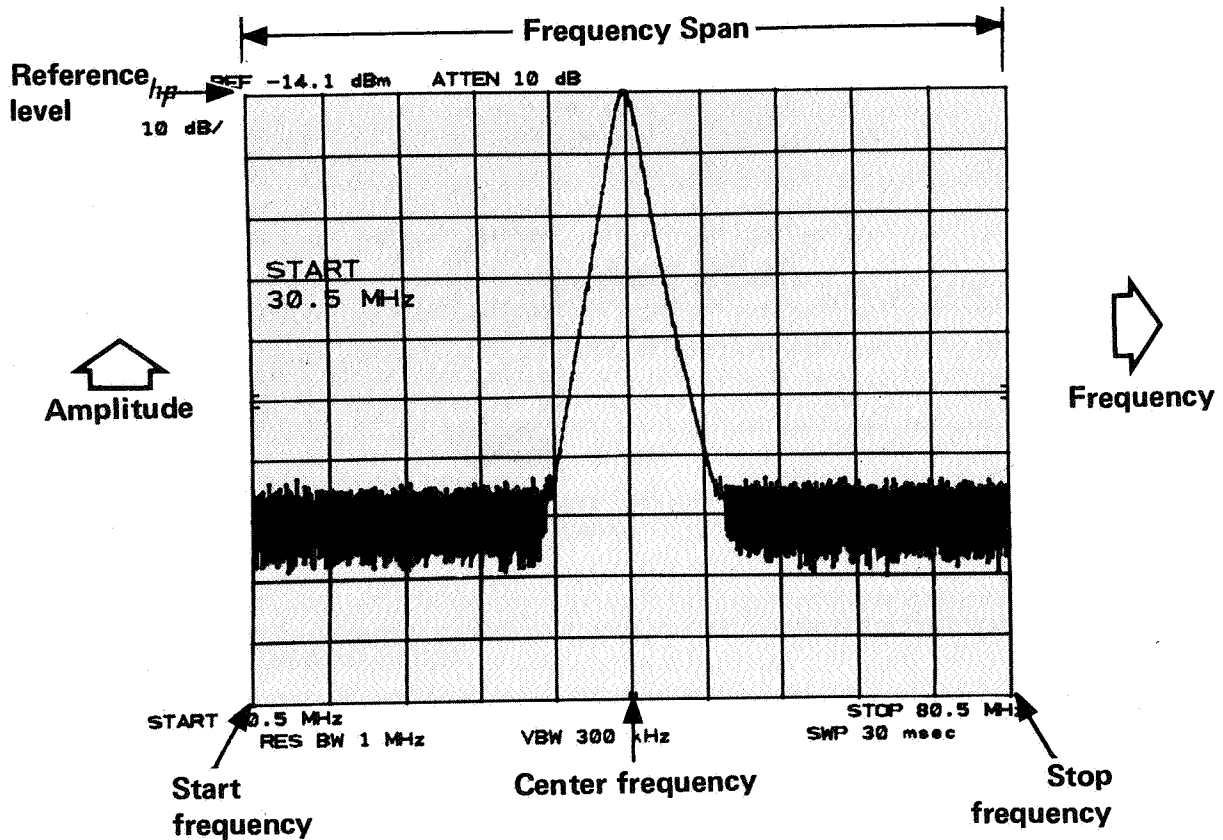

CRT Graticule Scaling With FUNCTION Readouts

Display Calibration

With changes to the displayed frequency range, the spectrum analyzer changes resolution bandwidth, video bandwidth and sweep time to maintain absolute amplitude and frequency calibration if the COUPLED FUNCTIONS are set to automatic. The examples in this chapter assume this condition. See Chapter 9, COUPLED FUNCTION for additional information on amplitude and frequency calibration.

NOTATION CONVENTION

The instructions explained throughout this manual use the following notation:
(DATA entry) - changing the value of an activated function with any of the appropriate DATA controls.

Frequency Display Range

The frequency range of the horizontal axis can be entered using either of two FUNCTION modes:

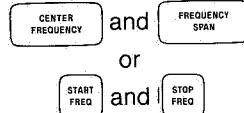

When a function from either mode is activated, only the function values of that mode will be displayed. Switching from one mode to the other with no DATA entry makes no change to the displayed frequency spectrum.

Center Frequency

CENTER FREQUENCY (DATA entry) changes the center frequency. Center frequency will remain activated (i.e., capable of being changed) until HOLD, INSTR PRESET or another function requiring DATA entry is activated.

FUNCTION

CENTER
FREQUENCY

Measurement and Readout Range

Center frequencies from 0 Hz to 1500 MHz can be entered.

62.7 MHz is the frequency at the center of the display graticule.

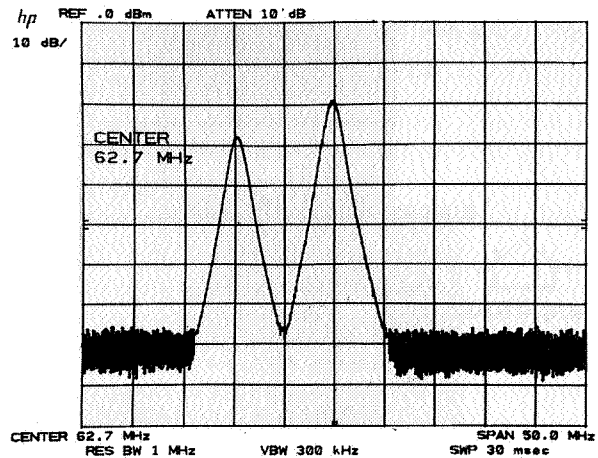

The number of significant digits in the readout depends upon the frequency span selected, the narrower the span the more significant digits.

The number of center frequency readout *digits to the right of the decimal* are as follows:

Center Frequency	Frequency Span						
	100 Hz to 999 Hz	1.00 kHz to 9.99 kHz	10.0 kHz to 99.9 kHz	100 kHz to 999 kHz	1.00 MHz to 9.99 MHz	10.0 MHz to 99.9 MHz	100 MHz to 1500 MHz
0 Hz to 999 Hz	0	0	0	0	0	0	0
1.000 kHz to 999.999 kHz or 1.000000 MHz to 1499.999999 MHz	3	2	1	0	0	0	0
	6	5	4	3	2	1	0

DATA Entry

	Changes the center frequency by about one half the total frequency span each full turn.
	Changes the center frequency by one tenth of the frequency span, i.e., by one division. COUPLED FUNCTION can be used to change this step size.
	Allows direct center frequency entry. The analyzer will accept a center frequency entry of up to 9 digits for frequencies less than 1000 MHz and 10 digits for frequencies of 1000 MHz to 1500 MHz. Even though the readout may show a fewer number of digits (due to wide frequency span), as the span is narrowed, the full entry will be read out. Abbreviated readouts are not rounded.

Only after a center frequency entry has been made will points along the trace reflect the spectrum change. For example, if the center frequency is changed when a slow sweep is in the middle of the graticule, signal responses on the left-hand side bear no relation to the new center frequency until the sweep passes through them.

Signal Track - Automatic Frequency Control

The center frequency can be locked to a specific signal using the **MARKER** function . Chapter 7, discusses the procedure and examples.

Frequency Span

 (DATA entry) changes the total display frequency range symmetrically about the center frequency. Frequency span is read out from the display.

NOTE



Frequency span readout refers to the total display frequency range. Divide by 10 to determine frequency span per division.

Measurement and Readout Range

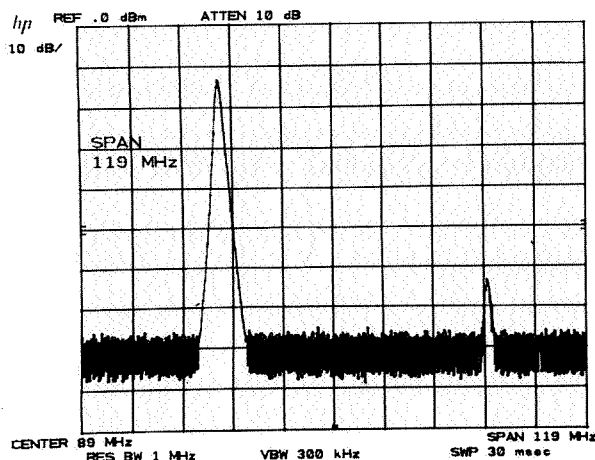
Frequency span can be varied from 100 Hz to 1500 MHz. Three significant digits are displayed for frequency spans up to 1000 MHz and four digits from spans of 1000 MHz to 1500 MHz.

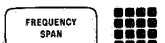

DATA Entry

	Changes the frequency span by about a factor of 2 for each half turn.
	Changes the frequency span to the next value in a 1, 2, 5, 10 sequence.
	Enters an exact value up to three or four digits, depending on span. Additional digits will be deleted without rounding.

Example of



Once a signal response is placed at the center of the display frequency range, the signal's frequency can be read out from center frequency. Reduction of the frequency span will increase the frequency readout resolution.

FUNCTION

FREQUENCY SPAN

A signal lower than the center frequency can be brought to the center with



CENTER FREQUENCY   

using  as a coarse tune,

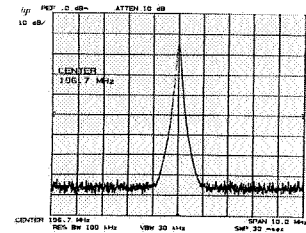
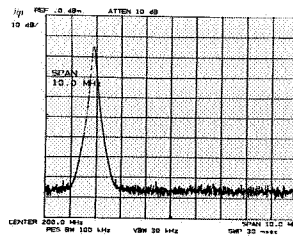
then fine tuning with .



Narrowing the frequency span will increase the center frequency resolution.

FREQUENCY SPAN    

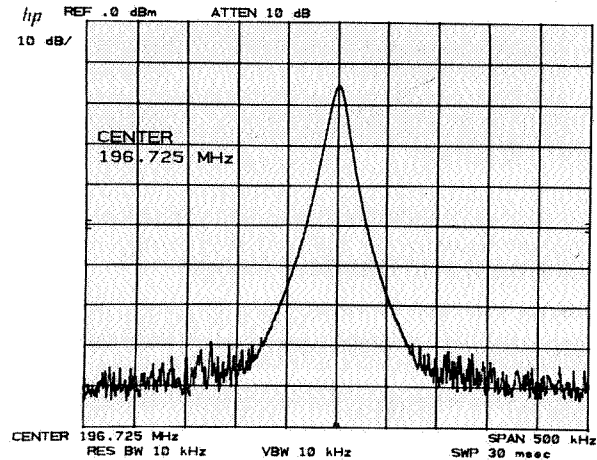

Zero Frequency Span - Fixed Tuned Receiver Operation

The spectrum analyzer can operate as a receiver fixed tuned to the center frequency. Modulation waveforms can be displayed in the time domain with calibrated sweep time.

To fix tune the spectrum analyzer press **FREQUENCY SPAN** **0** **MHz** and tune to the desired frequency with **CENTER FREQUENCY** (DATA entry).

The horizontal display axis becomes calibrated in time. The following functions establish a clear display of the video waveform:

<p>TRIGGER/LEVEL</p> <p>VIDEO </p>	<p>Stabilizes the waveform trace on the display by triggering on the modulation envelope.</p>
<p>SCALE</p> <p>LIN</p> <p><input type="checkbox"/></p>	<p>Voltage amplitude calibration.</p>

<p>COUPLED FUNCTIONS</p> <p>SWEEP TIME</p> <p>RES BW and VIDEO BW</p>	<p>Adjusts the full sweep time. Sweep times down to 1 μs full scale are available in zero span. Signal responses for sweep times < 20 msec are not digitally stored.</p> <p>Select according to signal bandwidth.</p>
--	---

Each of the COUPLED FUNCTION values remain at their current values when zero span is activated.

Measurement and Readout Range

An example shows the readout:

Press **FREQUENCY SPAN** **0** **Hz** **mV** **μsec** to activate zero span. Press **CENTER FREQUENCY** **1** **1** **0** **MHz** **-dBm** **sec**, then fine tune with  for optimum trace.

The analyzer is fixed tuned to 110 MHz. The time domain display shows a modulation waveform at 2 msec/division.

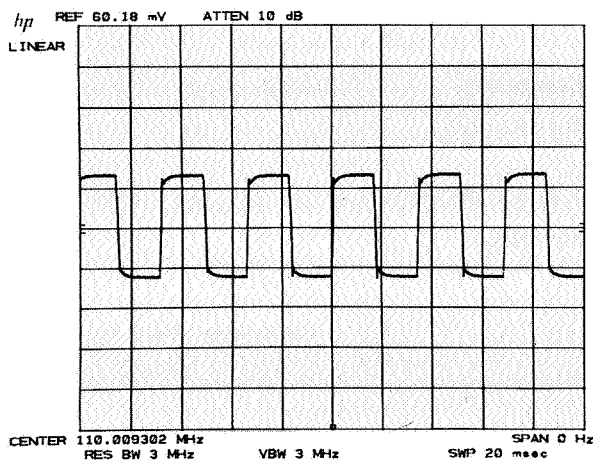



NOTE

The sweep time readout refers to the full 10 division display sweep time. Divide by 10 to determine sweep time per division.

In the time domain, sweep time range is 1 μsec to 10 msec in a 1, 2, 5, 10 sequence and 20 ms to 1500 sec in a 1, 1.5, 2, 3, 5, 7.5, 10 sequence.

The sensitivity of center frequency to the DATA  and   is dependent upon resolution bandwidth:

DATA ENTRY	CENTER FREQUENCY CHANGE
one revolution 	6 x (resolution bandwidth)
 or 	1 x (resolution bandwidth)

Start and Stop Frequency

A specified frequency range can be displayed by using

START FREQ (DATA entry) to set left graticule frequency.

STOP FREQ (DATA entry) to set right graticule frequency.

Start and stop are mutually exclusive with the center frequency and frequency span active functions. Activating either start or stop causes both to read out in place of center frequency and frequency span.

Measurement and Readout Range

START FREQ can be varied from -850 MHz to 1500 MHz, although entries less than 1700 MHz below stop frequency will effect the **START FREQ** readout.

STOP FREQ can be varied from 000 to 2500 MHz although entries 1700 MHz above the start frequency will effect the **STOP FREQ** readout.

The number of readout digits depends upon the frequency span. Narrower frequency ranges add digits to the readout.

FUNCTION



The key sequence

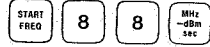

gives this readout.

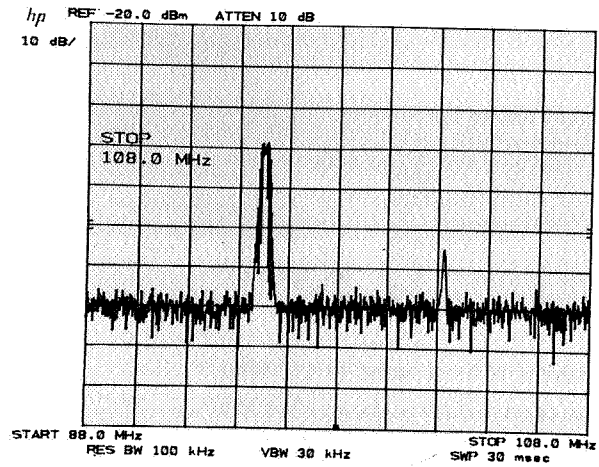

The rules governing the number of significant readout digits are the same as for



DATA Entry

Both start and stop frequencies can be entered from any of the DATA controls.

 OR 	<p>Changes the start or stop frequency. The amount of change per turn is a constant percentage of the frequency span.</p>
 OR 	<p>Changes the frequency by one tenth of the total frequency span.</p>
 OR 	<p>Exact start or stop frequencies can be entered. The number of digits readout depends upon the frequency span.</p>

Reference Level

(DATA entry) changes the absolute amplitude level of the top graticule line. The amplitude scale, that is, the number of amplitude units per division, is entered from the SCALE control group or .

Signal responses below the top graticule are measured by bringing the response to the reference level with (DATA entry).

NOTE

In logarithmic 10 dB per division scaling, the top 9 divisions are calibrated.

The maximum reference level value is dependent on the input attenuator setting. Levels to the input mixer, which could cause gain compression, will be displayed off the top of the reference level graticule. The maximum reference

level limit can be extended with KEY FUNCTION allowing a maximum reference level of +60.0 dBm. See Chapter 12 for details concerning reference level ranges.

CAUTION

Even with the reference level set to + 60 dBm the total input power should not exceed + 30 dBm.

Measurement and Readout Range

The reference level can be changed from + 30 dBm to -89.9 dBm in 0.1 dB steps. The readout shows one significant digit to the right of the decimal.

RF attenuator: 10 dB
Reference level: -11.2 dBm

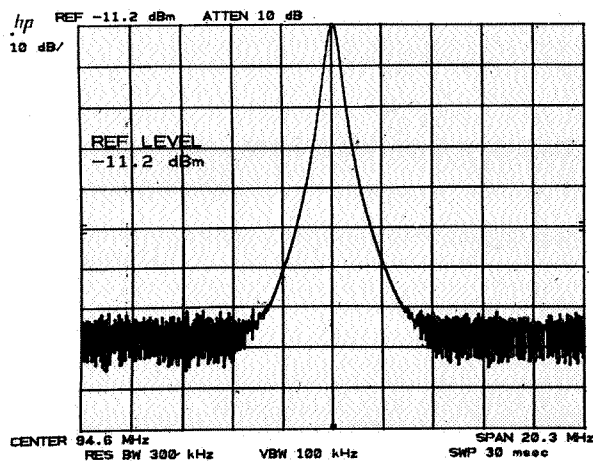

Reference level dBm units are selected with **INSTR PRESET**: dBmV, dBμV and volts referred to the analyzer's input impedance can be selected with **KEY SHIFT FUNCTIONS**. The absolute power of the reference level remains constant when units are changed.

Full amplitude readout units information can be found in Chapter 12, **KEY FUNCTIONS**, page 12.5.

DATA Entry

	<p>In logarithmic scale the changes are in 0.1 dB steps: in linear scale the changes are made to the least significant digit.</p>
	<p>In logarithmic scale, changes the reference level in steps according to dB/division scale. In linear scale, changes the reference level in 1 dB steps.</p>
	<p>Allows entry of exact reference levels. Digits entered beyond the displayed number of digits are deleted.</p>

Example

A signal's power level is measured by setting the reference level equal to the signal level.

FUNCTION

REFERENCE LEVEL

The signal level is roughly -35 dBm.

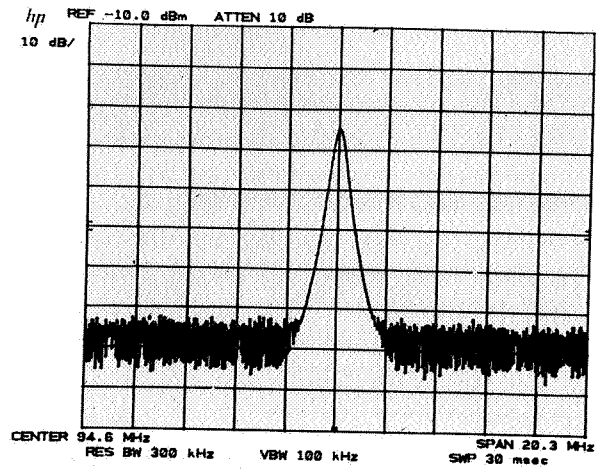

Change the reference level to the signal

with    

The signal level measured is -35.3 dBm.

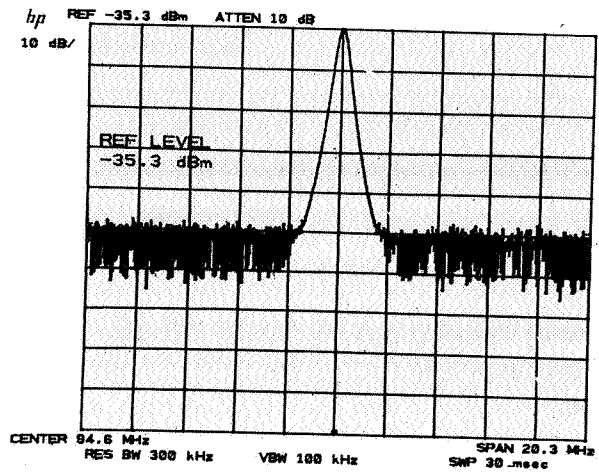

For voltage amplitude units press

D



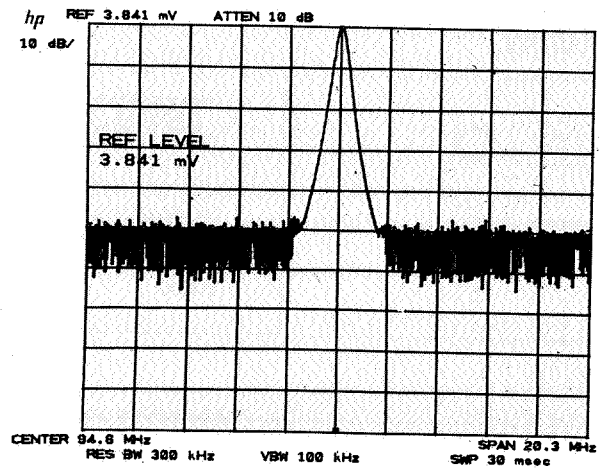

The corresponding level is 3.841 mV.





Frequency and Amplitude Offsets

The display readout and (HP-IB readout) of frequency and amplitude can be offset by values entered through  KEY FUNCTIONS. The offset values are read out on the display. Frequency offset is entered with

   (DATA entry).

Frequency offset may be used, for example, to provide a baseband frequency display scale for a signal which has been converted up or down.

Amplitude offset is entered with

   (DATA entry).

Amplitude offset can be used to take into effect external RF attenuation or gain in the reference level reading so that the signal level measured is the level at the input of the amplitude conversion device.

More details and examples are in Chapter 12, KEY FUNCTION, page 12.3.

Chapter 5

CRT DISPLAY

This chapter describes the CRT display adjustments, readouts and graphics.

Adjustment of the Display

The adjustments for intensity, focus and alignment simultaneously affect all the lines and characters on the display.

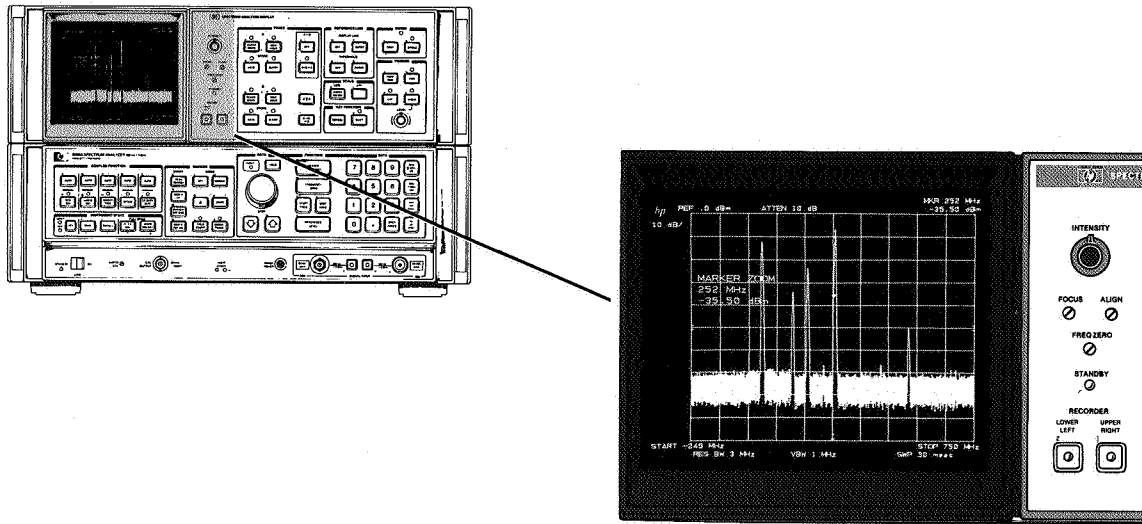

CRT Display and Adjustments

INTENSITY



Controls intensity for all the CRT writing.

FOCUS



A screwdriver adjustment which focuses all the CRT writing. Focusing any one element on the CRT focuses all the writing.

ALIGN



A screwdriver adjustment which tilts all the displayed CRT information.

Display Section Line Power

STANDBY



The light indicates power condition of the Spectrum Analyzer Display section as dictated by the LINE power switch on the 85680A RF section.

CRT Display Overview

The cathode ray tube of the Spectrum Analyzer Display section displays:

- active function name and value
- graticule
- traces of the signal response
- values that calibrate the frequency, time and amplitude axes.
- values for the spectrum analyzer receiver parameters, that is, COUPLED FUNCTIONS.
- operator originated labels and graphics

Active Function

The function which has been activated for DATA entry is read out in the graticule area shown.

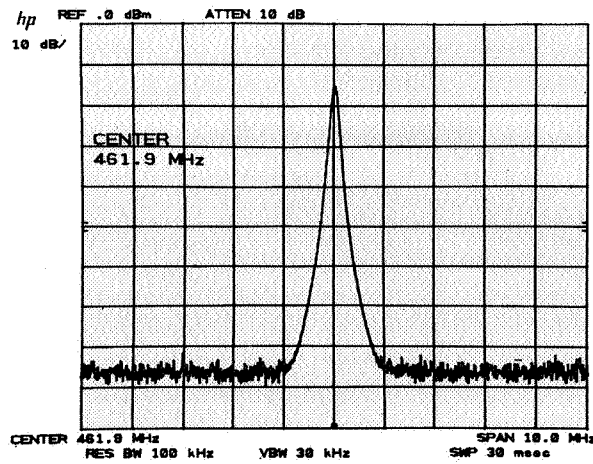

Activating a function immediately writes its name in the active function area along with its present value. The following summarizes the names and readout formats for the front panel designated active functions.

Function	Examples of Active Function Readout	Function	Examples of Active Function Readout
FUNCTION		COUPLED FUNCTION	
<input type="button" value="CENTER FREQ"/>	CENTER 750 MHz	<input type="button" value="RES BW"/>	RES BW 3 MHz
<input type="button" value="FREQ SPAN"/>	SPAN 1500 MHz	<input type="button" value="VIDEO BW"/>	VIDEO BW 3 MHz
<input type="button" value="START FREQ"/>	START 0 Hz	<input type="button" value="SWEEP TIME"/>	SWEEP TIME 20 msec
<input type="button" value="STOP FREQ"/>	STOP 1500 MHz	<input type="button" value="ATTEN"/>	RF ATTEN 10 dB
<input type="button" value="REFERENCE LEVEL"/>	REF LEVEL .0 dBm	<input type="button" value="CFSTEP SIZE"/>	CF STEP 150 MHz
MARKER		REFERENCE LINE	
<input type="button" value="NORMAL"/>	MARKER 550 kHz 19.8 dBm	<input type="button" value="ENTER"/>	DISPLAY LINE -45.0 dBm
<input type="button" value="Δ"/>	MARKER Δ 20.0 MHz -12.4 dB	<input type="button" value="ENTER"/>	THRESHOLD -90.0 dBm
<input type="button" value="ZOOM"/>	MARKER ZOOM 20.5 MHz -32.8 dBm	SCALE	
<input type="button" value="NORMAL"/> <input type="button" value="FREQ COUNT"/>	COUNTER 19.998 MHz -12.0 dBm	<input type="button" value="ENTER dB/DIV"/>	LOG 10 dB/
<input type="button" value="Δ"/> <input type="button" value="FREQ COUNT"/>	COUNTER Δ 20.000 MHz -.2 dB	KEY FUNCTION	
<input type="button" value="ZOOM"/> <input type="button" value="FREQ COUNT"/>	COUNTER ZOOM 20.000 MHz -.2 dBm	(See KEY FUNCTION, Chapter 12.)	
<input type="button" value="NORMAL"/> <input type="button" value="SHIFT"/> M	MARKER 16.3 MHz -140.4 dBm (1 Hz)	<input type="button" value="HOLD"/> deactivates any active function (except for <input type="button" value="SHIFT"/> E), blanking the active parameter readout.	

DISPLAY

Graticule

The display graticule is an internally generated 10 division by 10 division rectangle for referencing frequency, time and amplitude measurements. Double markings at the left, right and bottom designate the center axes.

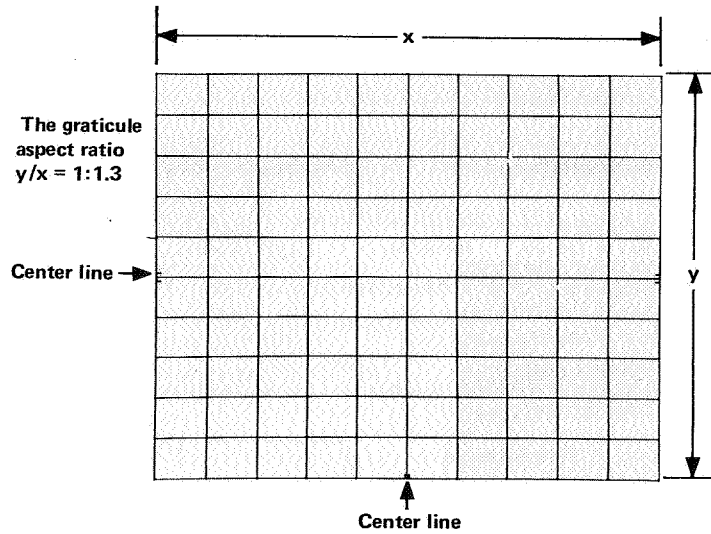

The graticule may be blanked from the display with KEY FUNCTION **SHIFT** m and restored with **SHIFT** n.

For CRT photography, the graticule may be intensified independent of the annotation and trace by pressing the following sequence:

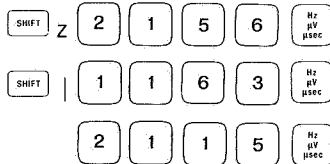

For more intensity, repeat the last two number entries, 1163 Hz and 2115 Hz. **INSTR PRESET** returns the graticule to normal.

Traces

Three separate traces, A, B and C, can be written onto the display. Each trace is generated from 1001 points across the graticule, connected by 1000 point-to-point straight line vectors. The location of each point is designated by an x and y location using the graticule as rectangular coordinates.

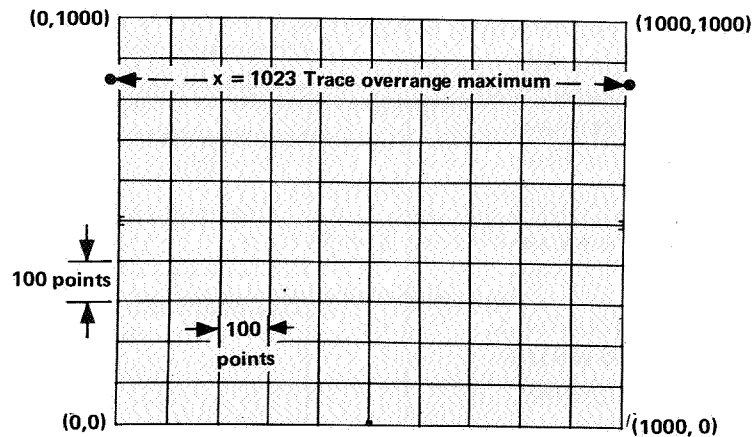

Graticule Referenced in Display Units

Display locations may be referenced in terms of these display units for HP-IB input and output. See Chapter 6 and 8568A Spectrum Analyzer Remote Operation, HP part number 08568-90003.

Trace overrange is an additional 23 display units above the top reference level graticule. This display area is not calibrated.

Locations of Permanent Readouts

The vertical and horizontal graticule axes are scaled by these readouts:

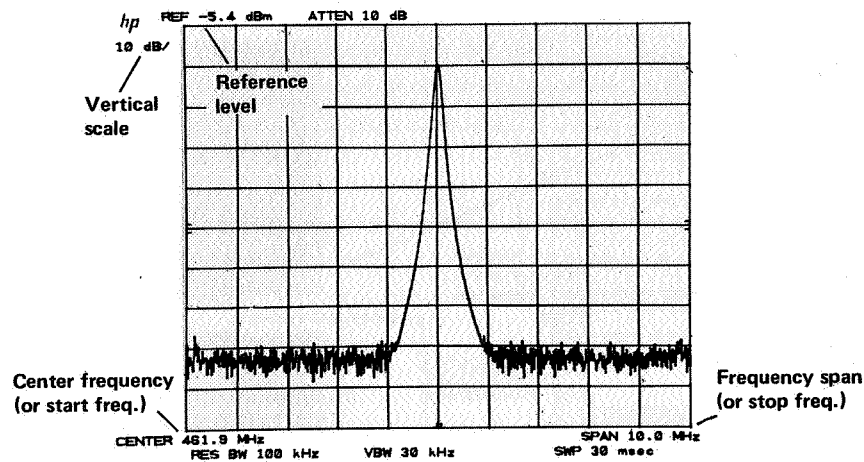

The COUPLED FUNCTIONS that describe the swept receiver characteristics of the spectrum analyzer are:

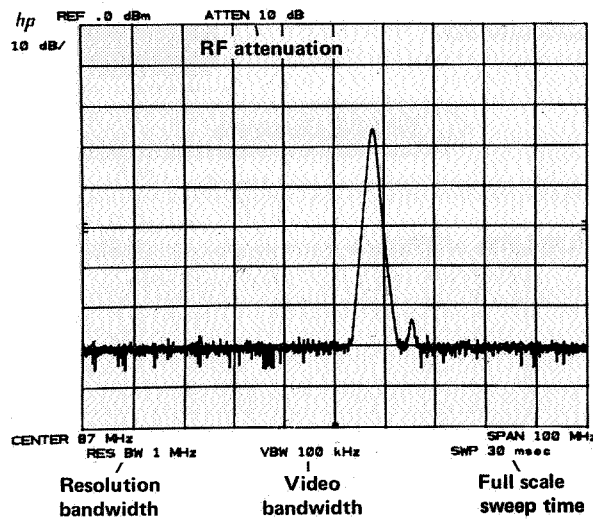

To blank all the character readouts, press KEY FUNCTION o. To restore, press p.

Other Readouts

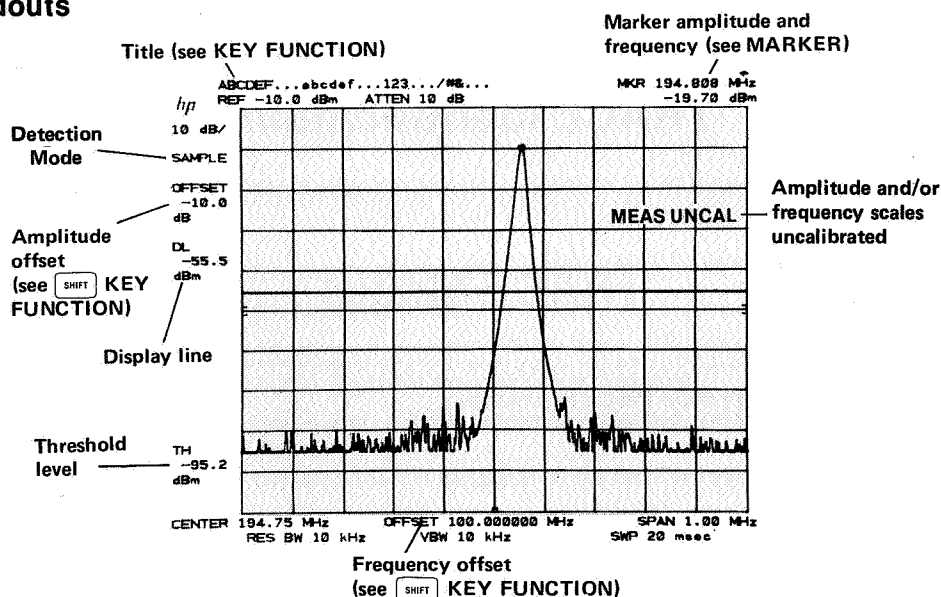

A number of other special function readouts can be activated. These are covered in chapter 12.

Chapter 6

TRACE

This chapter describes the use of the TRACE functions for writing, storing and manipulating trace data.

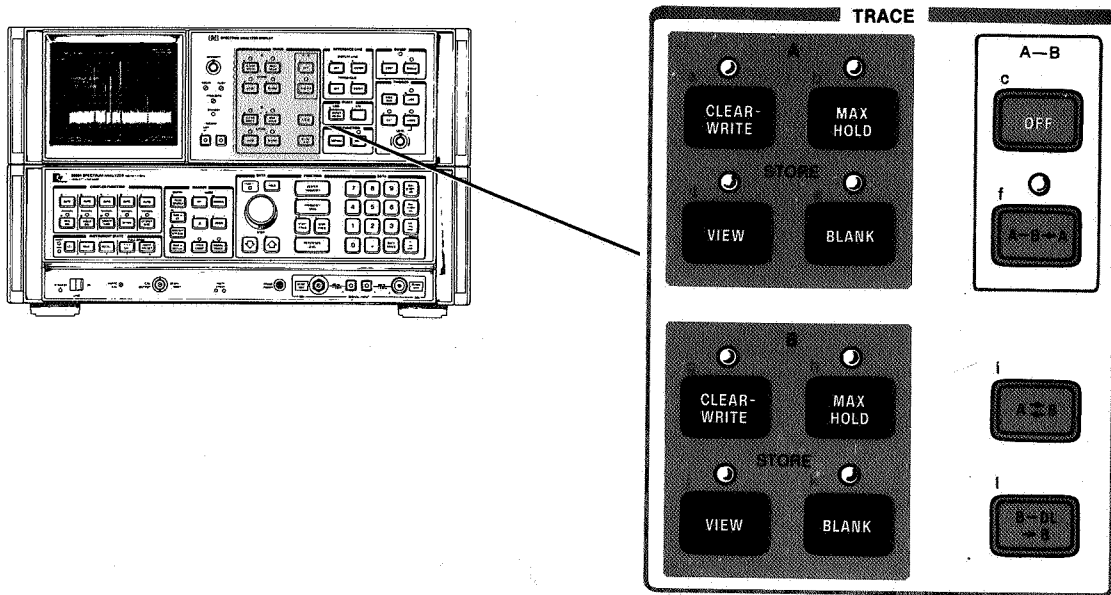

TRACE Controls

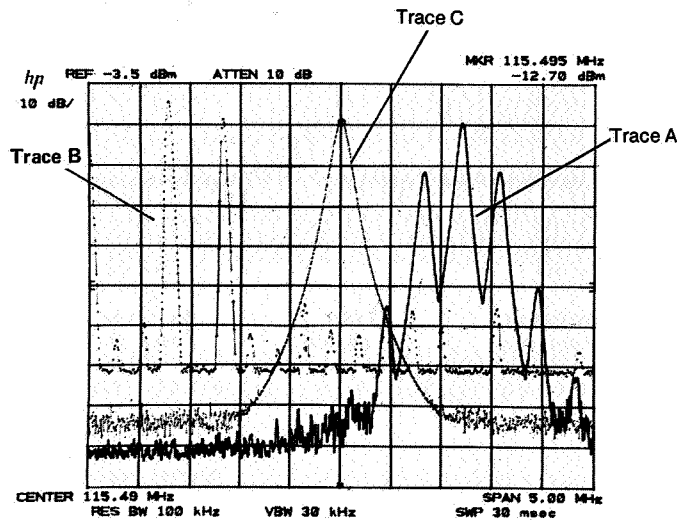

TRACE Identification

Traces are differentiated by intensity. Trace A is bright, trace B and trace C are dim. and allow positive identification.

TRACE Modes

Four mutually exclusive functions or modes for trace A and trace B determine the manner in which the traces are displayed. Indicator lights by the keys show the current modes.

WRITE MODES (sweeping):

Displays the input signal response in trace selected.

Displays and holds the maximum responses of the input signal in trace selected.

STORE MODES (not sweeping):

Stores the current trace and displays it on the CRT display.

Stores the current trace and blanks it from the CRT display.

Trace Memory

An understanding of the TRACE modes requires a description of the trace memory and trace data transfer within the analyzer.

Display traces are not written onto the CRT directly from the spectrum analyzer's IF section. Instead, the analog signal response is converted to digital information and stored in one trace memory which can then be transferred to the CRT display. The way in which the information is displayed depends upon the TRACE mode selected.

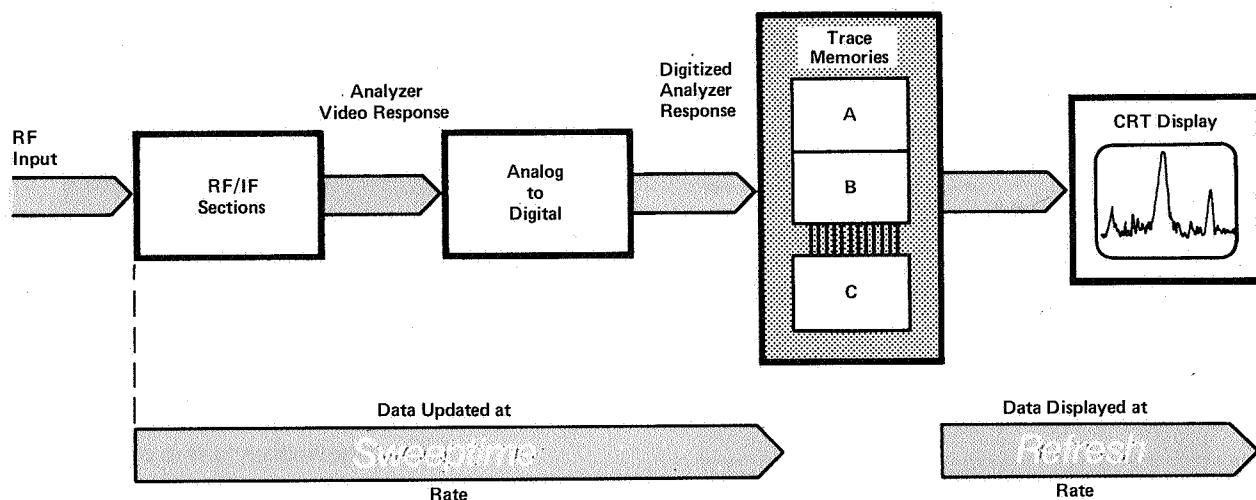

TRACE Modes determine how data is entered into and displayed from trace memories.

The analyzer's response is transferred into the trace memory at the sweep rate of the analyzer; that is, its sweep time. The trace memory is written onto the CRT display at a refresh rate of about 50 Hz, rapid enough to prevent flickering of the trace on the CRT. Trace intensities remain constant as analyzer sweep times are changed.

NOTE

It is important to understand the difference between sweep and refresh.

Sweep - refers to the spectrum analyzer sweeping from a start frequency to a stop frequency and storing measured amplitude data into a trace memory.

Refresh - refers to the transfer of display memory data to the CRT display.

Write Modes

For the write modes, the analyzer signal response is written into trace memory during the sweep and the memory contents are displayed on the CRT.

A(B) Sets all the values in the trace memory A(B) to zero when first activated (bottom line graticule), then displays the signal response.

A(B) Latest signal response is written into the trace A(B) memory only at the horizontal positions where the response is greater than the stored response.

When both A and B modes are selected, the analyzer writes into (*sweeps*) A and B alternately.

STORE Modes

In the STORE modes, no updating of the trace memory is made. The current memory data is saved.

A(B) The trace A(B) data are displayed on the CRT (that is, the refresh is enabled).

A(B) The trace A(B) data are not displayed on the CRT (that is, the refresh is disabled).

TRACE

Example

With TRACE modes, signals can be observed as the analyzer sweeps, can be stored for comparison, erased, or monitored for frequency drift.

Center and zoom in on a 20 MHz signal:

Press

Since has set A and B, only A is displayed.

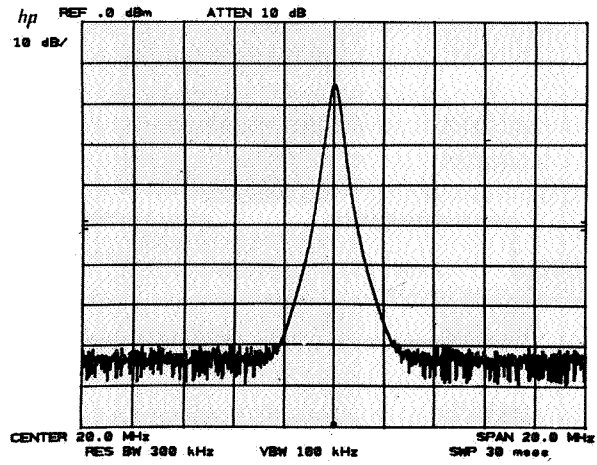

This response can be stored:

Press A.

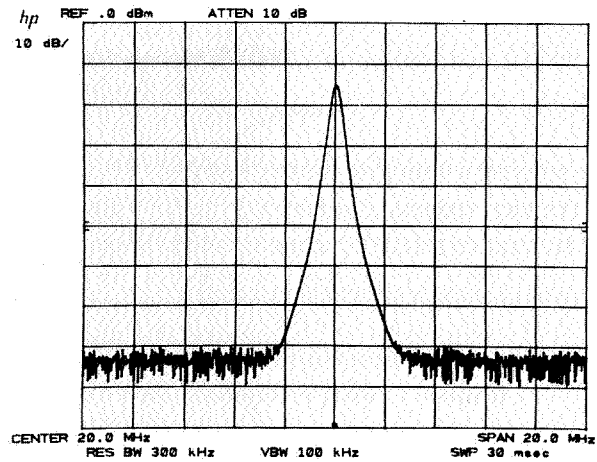

Write the same signal with B and change its position relative to trace A:

Press B

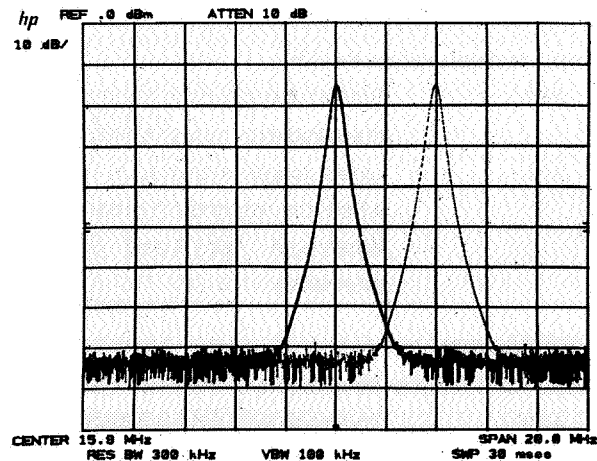

Blank trace A;

Press **BLANK** A.

This trace can be recalled with **VIEW** A as

long as **CLEAR-WRITE** A or **MAX HOLD** A is not used first.

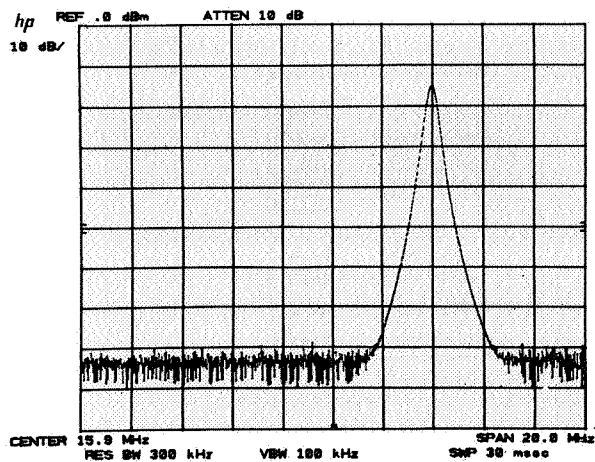

To display the drift of a signal press **MAX HOLD**

A.

(Simulate frequency drift with

CENTER FREQUENCY

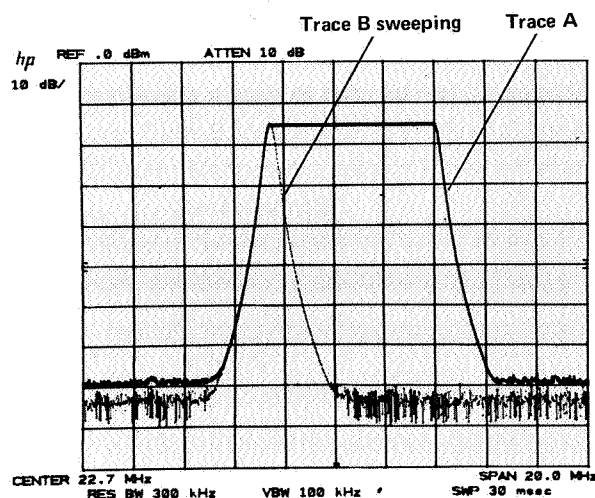

TRACE Exchange

A=B Exchanges trace A and B, changing their relative intensities and storage memory locations and enables A and B

VIEW. For example, in the trace display above, the modes and display appear.

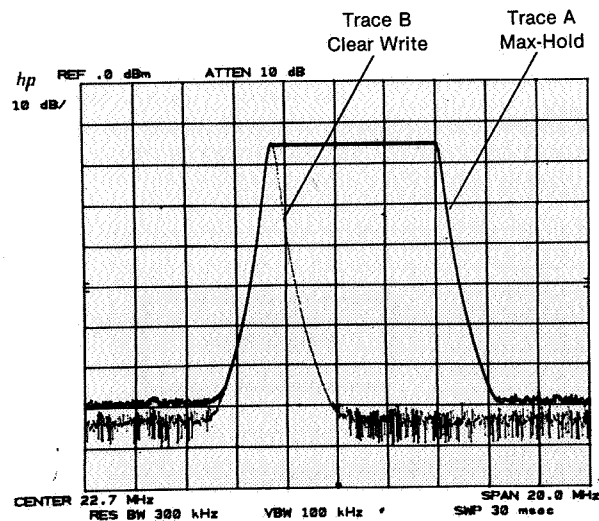
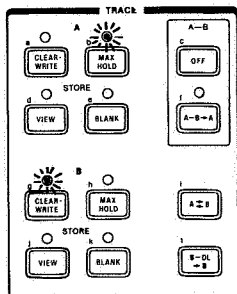

TRACE

Press **A⇌B**

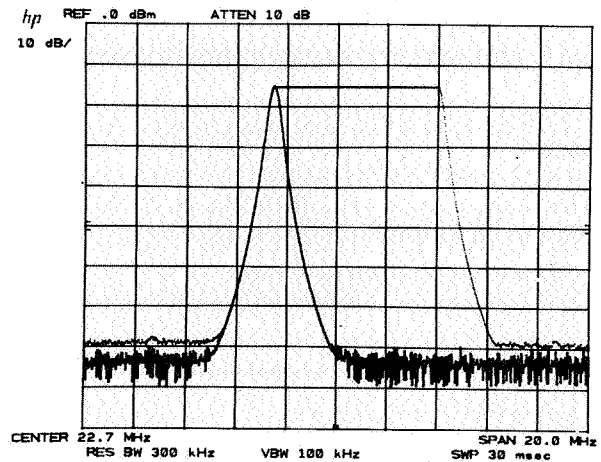
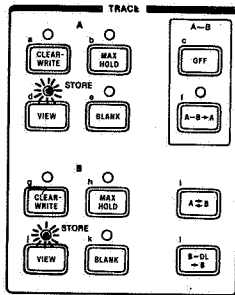

TRACE C Modes

A third trace, C, can be used to store a signal response. Trace C is not swept from the analyzer IF section as are traces A and B, but is input using a trace B into C function (B → C) or a B and C exchange function (B ⇌ C).

Access to the trace C modes is through KEY FUNCTION **SHIFT**. The modes are:

- View C: **SHIFT j** Displays trace C.
- Blank C: **SHIFT k** Blanks trace C from CRT display.
- B → C: **SHIFT l** Writes trace B into trace C. Trace A and B modes are not changed. If trace C was blanked it remains blanked.
- B ⇌ C: **SHIFT i** Exchanges traces B and C. If trace B is not blanked, trace C will not be blanked. If trace C is blanked trace B will be blanked.

TRACE Arithmetic

TRACE arithmetic allows one trace to be modified by another trace or a display line position.

- A-B **A-B→A** Trace B amplitude (measured in divisions from the bottom graticule) is subtracted from trace A and the result written into trace A from sweep to sweep. Trace B is placed or kept in a STORE mode.
- A-B **OFF** Turns **A-B→A** off.
- B-DL→B** Subtracts the amplitude of the display line from trace B and writes the result into trace B. Trace B is placed or kept in **VIEW**. Details on display line are in Chapter 8, REFERENCE LINE.

Example

Trace arithmetic with the display line can be used to correct for the frequency response characteristics (flatness) of a swept measurement system typified by this setup:

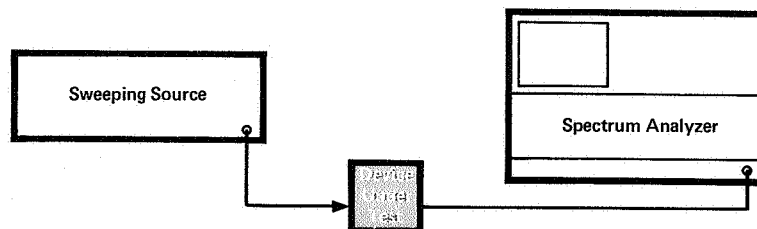

where the device under test is to be characterized for insertion loss over a specific frequency range.

The analyzer and source are set to the proper amplitude level and frequency span with the source output connected directly to the analyzer input.

- B, sweep source then
- B.

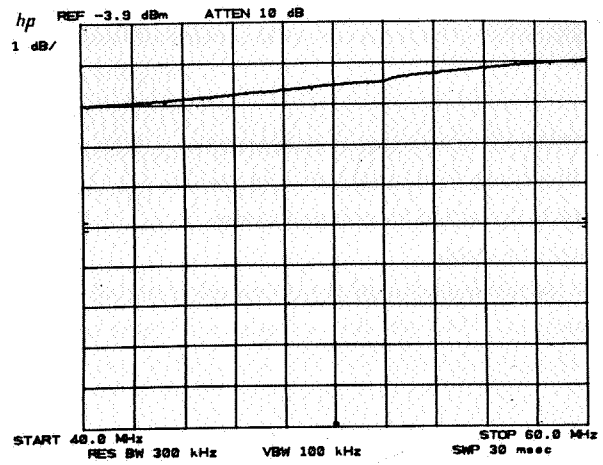

The display line is activated and set below the source/analyzer response.

- DL

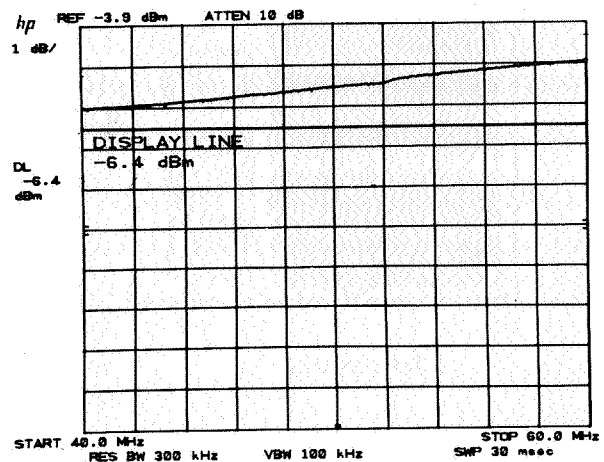

The difference between the display line (in display units) and the source/analyzer response is stored in trace B with

Negative values of the line would be stored even though not displayed.

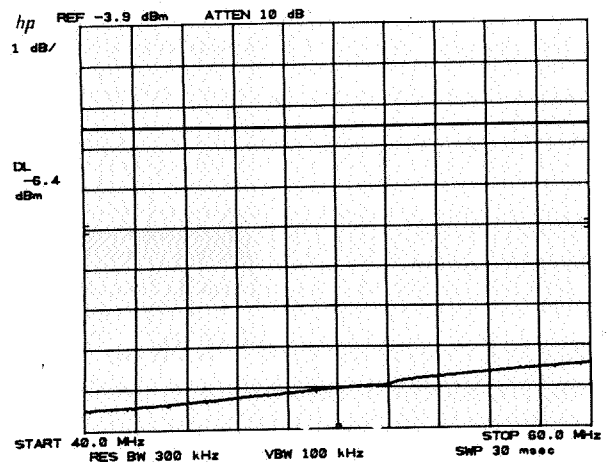

TRACE

Now the device under test is connected between source and analyzer and its response is corrected for source flatness uncertainty by using

A

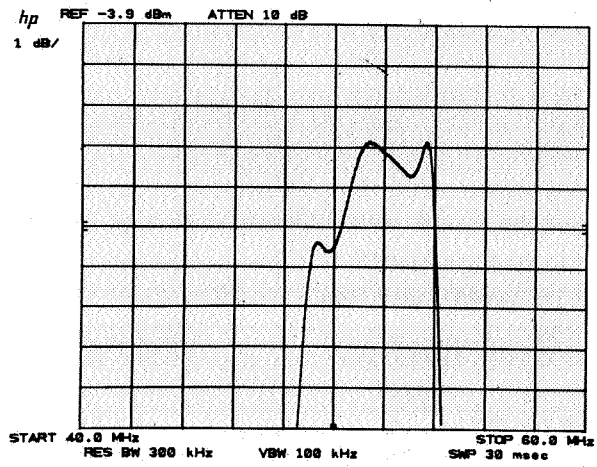

Trace Priority

Functions which act upon a trace always act upon the highest priority trace. Priority is defined by the trace modes as follows:

Highest priority



Lowest priority

A or A

B or B

A

B

view C

A

B

blank C

Marker functions, for example, use trace priority to decide which trace to mark. See chapter 7.

Chapter 7

MARKER

This chapter describes the use of the MARKER and DATA controls for making many measurements faster and with greater accuracy. Markers can be displayed only on TRACE A and TRACE B.

Two types of functions make up the MARKER group: MARKER MODEs, which enable or disable markers and their related functions; and MARKER ENTRY functions which allow the scaling of the display frequency and amplitude using marker information.

Markers are bright spots which lie directly on the display trace. The horizontal position of an activated marker is controlled by the DATA controls. The marker can be positioned at a specific frequency with the DATA number/units keyboard.

Readout of marker amplitude and frequency appears in the upper right of the display outside the graticule. When a MARKER MODE is active, its amplitude and frequency readout also appears in the active function area of the graticule.

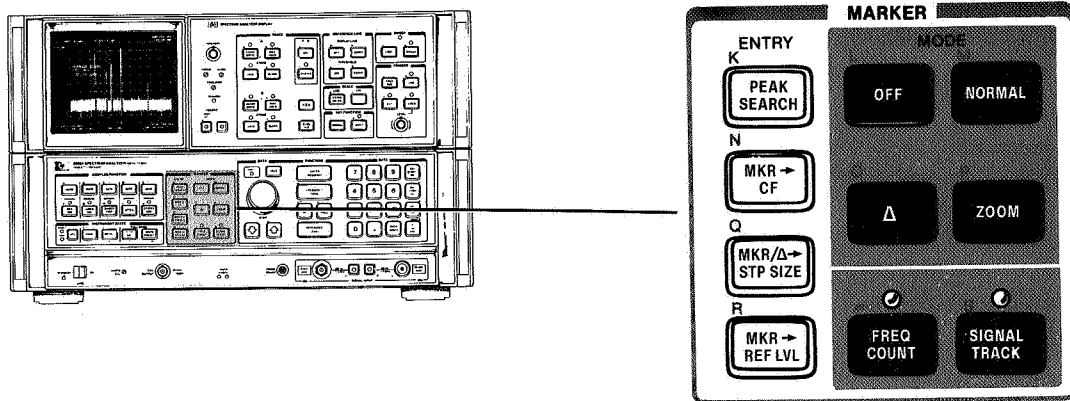

MARKER Controls

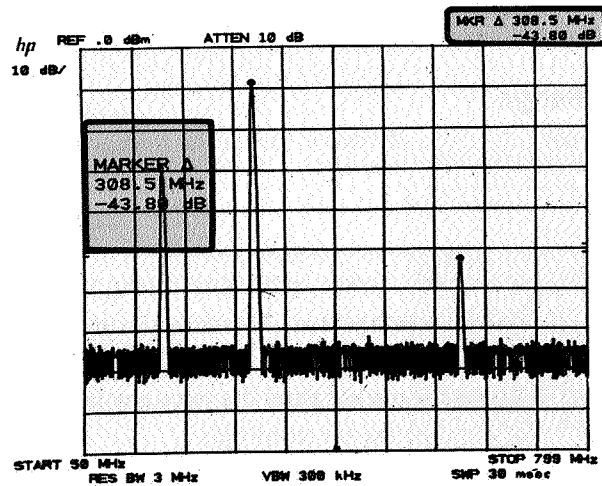

Marker Readout Locations

MARKER

NORMAL

MARKER Overview

- Direct readout of the amplitude and frequency of a point along the trace
- Direct readout of amplitude and frequency differences between points on the trace.
- Expansion of the span about a specific frequency.
- Placing a single marker at the highest response.
- Counter accuracy frequency measurements.
- Direct noise level readout.
- Analysis of stored traces.
- Amplitude and frequency display scaling.

FUNCTION

NORMAL

Δ

ZOOM

PEAK SEARCH

FREQ COUNT

SHIFT

M

MARKER with ENTRY

VIEW

MKR → CF

MKR/Δ → STP SIZE

MKR → REF LVL

MARKER On But Not Active

An activated marker mode can be deactivated by activating another function, such as display line, or by **DATA HOLD**. This does not erase the marker itself nor the upper right display readout. If the marker mode is reactivated, **DATA** control and active function readout will continue from its last position.

If a marker mode is deactivated by a function, other than **MARKER ENTRY**, where a value change of the new function results in a rescaling of the amplitude or frequency axes, the marker will not stay on the trace. Reactivating the marker will start it at the display center.

MARKER Off

OFF disables any marker mode, including **FREQ COUNT** and **SIGNAL TRACK**, and blanks the marker readout from the CRT display. **DATA** controls are disabled if the marker was active.

MARKER in VIEW

MARKER NORMAL and **Δ** may be used on traces A or B in the view mode. This allows detailed analysis of responses which are nonperiodic or unstable.

The markers will be placed on a viewed trace according to the priority defined in Chapter 6, TRACE PRIORITY.





Single Marker - NORMAL

NORMAL activates a single marker at the center of the display on the trace of highest priority. Trace priority is defined in Chapter 6. The marker will not activate on the TRACE modes **BLANK A**, **BLANK B**, view C or blank C.

Measurement and Readout Range

The number of significant digits to the right of the decimal in the marker frequency readout is the same as for center frequency readout.

DATA Entry

NORMAL 	Moves the marker continuously along the trace at about 5 horizontal divisions each full turn. The marker moves in display unit increments.
NORMAL  	Moves the marker along the trace one tenth of the total width per step.  moves marker to the right.
NORMAL 	Places the marker at the frequency entered. An out-of-range entry results in placement of the marker at a graticule edge.

Example

Reading frequencies and amplitudes of signals is greatly simplified using MARKER .

For a given display activate the single marker with then tune the marker with to position it at the signal peak. The frequency and amplitude is read out in two display areas.

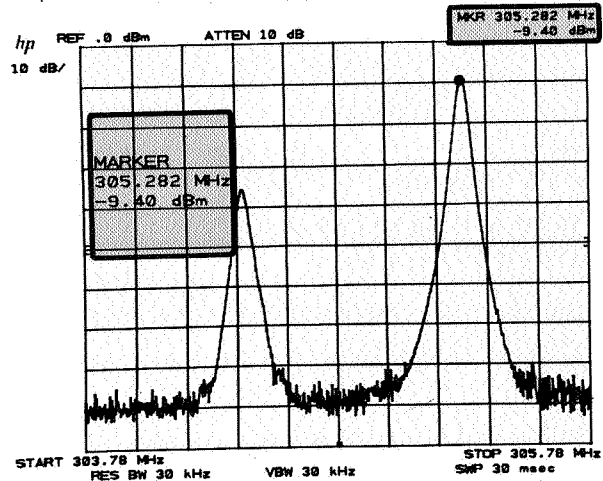

To read the left-hand signal's parameters move the marker to the signal peak with .

The signal's amplitude and frequency is read out directly.

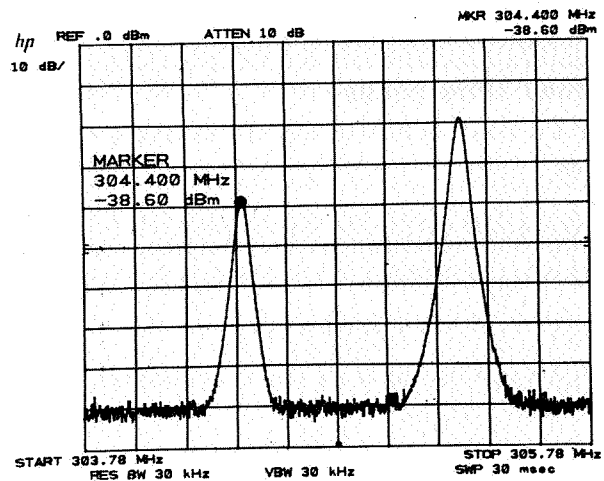

Differential Markers -

activates a second marker at the position of a single marker already on the trace. (If no single marker has been activated, places two markers at the center of the display.) The first marker's position is fixed. The second marker's position is under DATA control.

The display readout shows the difference in frequency and amplitude.

Example

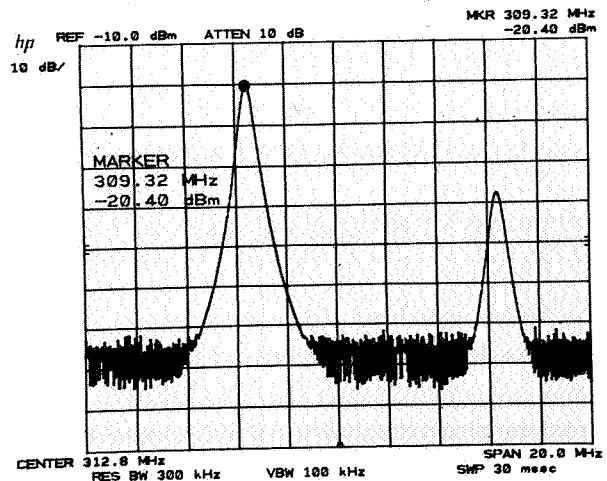

Measuring the differences between two signals on the same display.

First set the marker on one of the signal peaks with .



MARKER



Activate  and move the second marker to the other signal peak with  and read their differences directly.

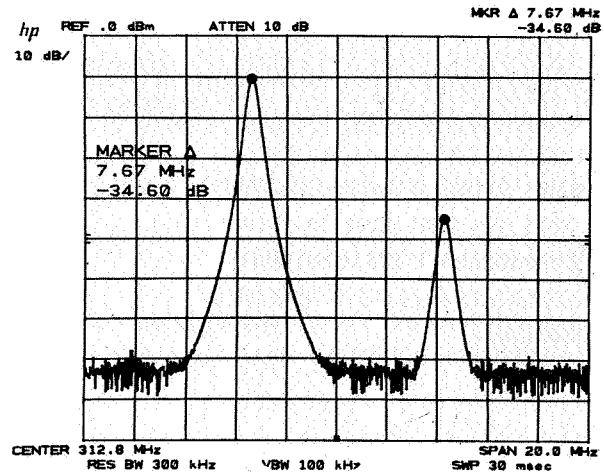

Fractional Differences

When the reference level is calibrated in voltage, marker  amplitudes are given as a fraction, the voltage ratio of two levels.

With *logarithmic* amplitude scale and the reference level in voltage, the fraction is based on the equation

$$\text{fraction} = 10^{-\left(\frac{\text{dB difference}}{20}\right)}$$

Since this equation yields the harmonic distortion due to a single harmonic, its distortion contribution can be read directly from the display.

Example

Set up  on the peaks of a fundamental (left) and its harmonic (right).

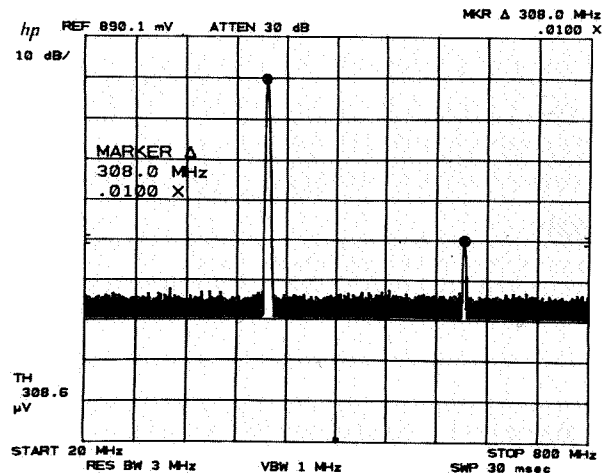

With the display referenced and scaled as shown, the readout ".0100X" designates the fractional harmonic content. Percent is calculated as $100X(.0100) = 1.0\%$.

With a *linear* amplitude scale and a reference level calibrated in voltage, the fractional amplitude readout is the simple linear ratio of the two markers.



Example

To measure % AM modulation from a spectral display, calibrate the display with the reference level in voltage and the amplitude scale in voltage.

Place the single marker on the carrier peak, **NORMAL** , and the second marker on one of the sideband peaks, **A** . The fractional amplitude readout gives one half the modulation index .283.
 $\%AM = 100 \times 2 \times .28 = 56\%$

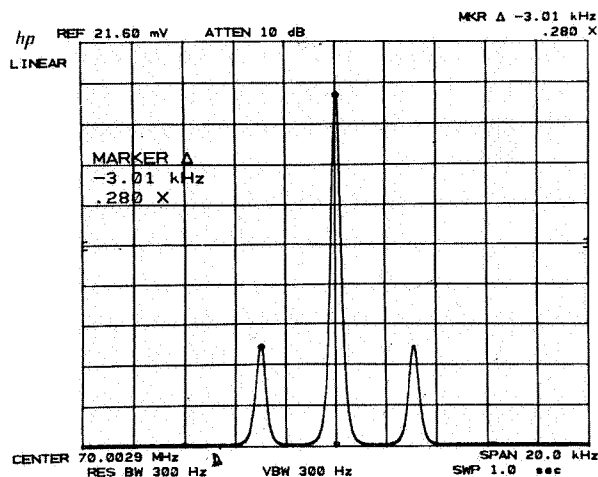

Measurement and Readout Range

The **A** function formats the amplitude readout according to reference level units and scale.

Reference Level Units	SCALE Logarithmic	SCALE Linear
dBm dBmV dB μ V	Amplitude in dB	Amplitude in dB
Voltage	Amplitude ratio $10^{-\left(\frac{\text{dB difference}}{20}\right)}$	Ratio of marker amplitudes

Amplitude Readout Format for MARKER **A**

The frequency readout for all MARKER **A** conditions has up to 4 significant digits, depending upon the portion of span measured.

The amplitude readout in dB has a resolution of $\pm .01$ dB for linear scale. The resolution for logarithmic scale depends upon the LOG **ENTER dB/DIV** value:

LOG SCALE dB PER DIV	RESOLUTION
10	± 0.1 dB
5	± 0.05 dB
2	± 0.02 dB
1	± 0.01 dB

MARKER



DATA Entry

The minimum incremental change for Δ frequency is 0.1% of the frequency span.

	<p>One full turn moves the active marker about one tenth of the horizontal span.</p>
	<p>One step moves the marker one tenth of the horizontal span.</p>
	<p>Positive entry places marker higher in frequency than the stationary marker, negative entry places marker lower in frequency. Larger entries than allowable will place the marker on the adjacent graticule border.</p> <p>Negative frequencies can be entered using a $\overline{\text{SHIFT}}$ $\overline{\text{HOLD}}$ prefix as the minus sign. For example, to set a Δ span of 10 MHz with the second marker positioned to the left of the first, press Δ $\overline{\text{SHIFT}}$ $\overline{\text{HOLD}}$ 1 0</p>

MARKER ZOOM

$\overline{\text{ZOOM}}$ activates a single marker on the trace of highest priority (see TRACE PRIORITY, Chapter 6). In $\overline{\text{ZOOM}}$ the DATA knob and STEP keys change the values of *different functions*.

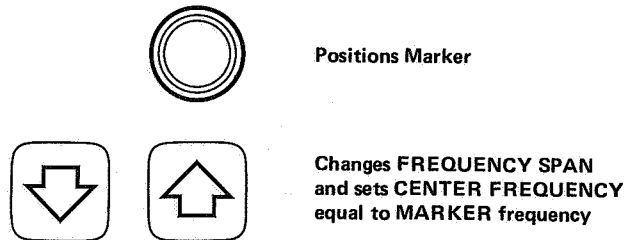

DATA Control Use for $\overline{\text{ZOOM}}$

The marker can be moved along the trace with the DATA knob , and the frequency span can be changed about the marker with DATA step and . Each step also sets center frequency equal to the marker frequency.

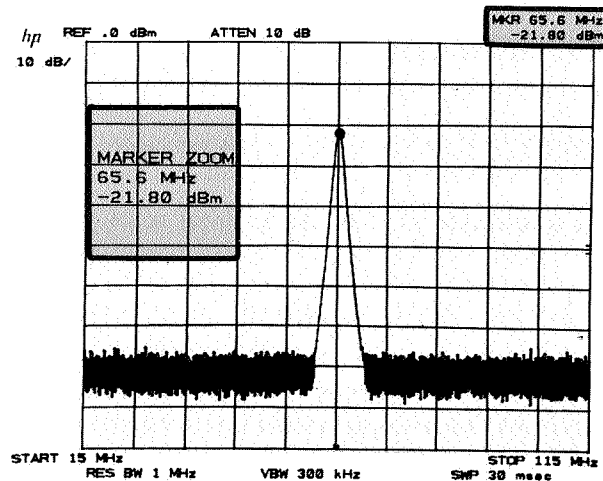



Measurement and Readout Range

The measurement and readout range for marker zoom is the same as marker **NORMAL**.

Better frequency count resolution and automatic recentering of a *signal* are additional zoom features when **FREQ COUNT** is activated.

DATA Entry

	Moves the marker continuously along the trace. Rate dependent on speed of rotation. The marker moves in display unit increments.
	Changes the frequency span to the next value in the sequence and sets the center frequency equal to the marker frequency.
	Places the marker at the frequency entered. An out-of-range entry places the marker at a graticule border.

Example

In wide frequency spans it is often necessary to expand a portion of the frequency span about a specific signal in order to resolve modulation sidebands or track frequency drift.

From an **INSTA PRESET** full span, select a signal using the marker with **ZOOM** .

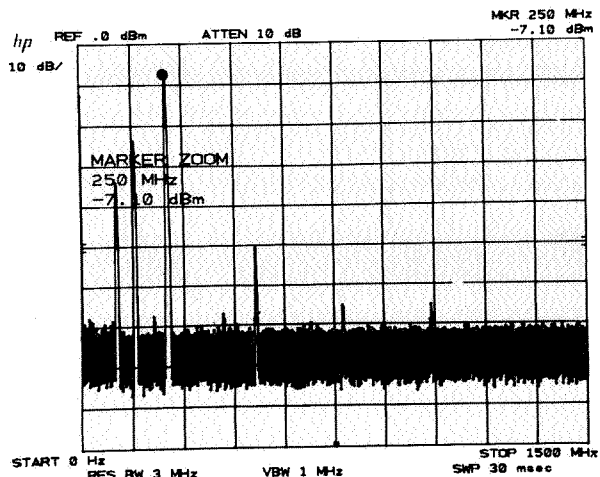

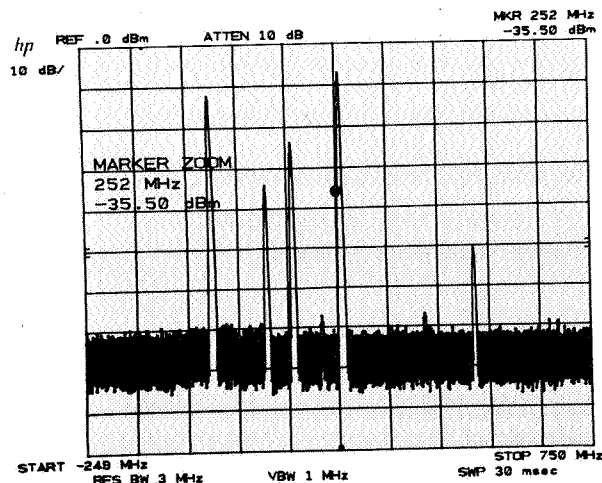

To center the marker and signal *and* expand the frequency span in one step, press .



MARKER

ZOOM

Expanding twice more with   shows the marker requires recentering on the signal.

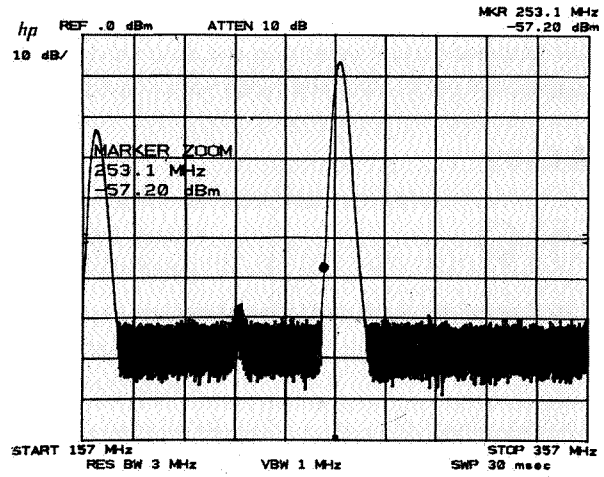

Recenter with 

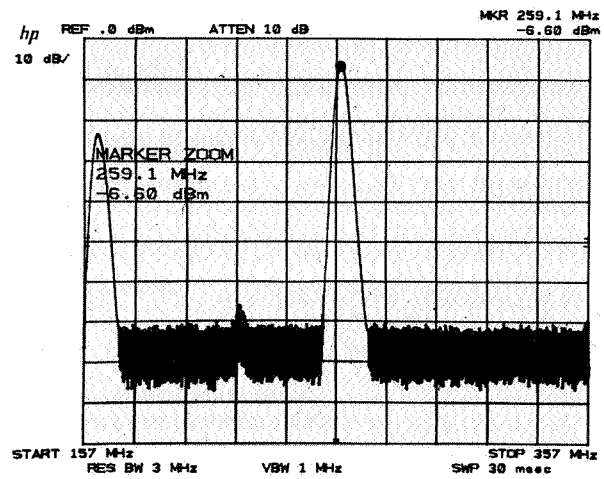

Continue using  (and recentering the marker on the signal when necessary) until the desired resolution is achieved.

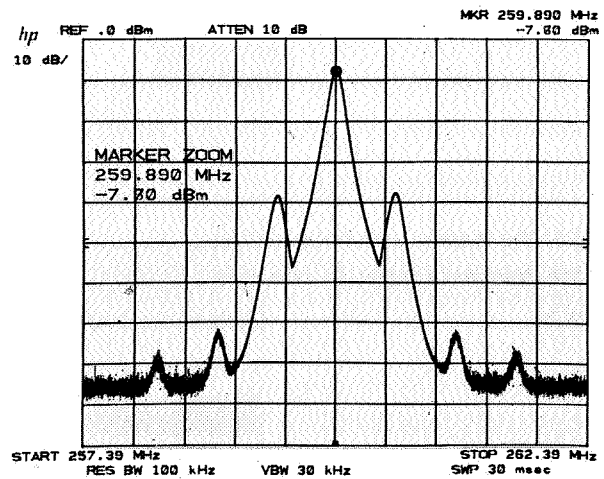

Automatic Zoom

The analyzer can automatically zoom in on a signal specified by a marker. The desired frequency span is input from the DATA number/units keyboard.

To use the automatic zoom function

Use to identify the signal to be zoomed in on.

Press and enter the desired span with the DATA number/units keyboard.

When the units key is pressed the zooming process will begin.

Example

A single carrier needs to be examined in a 200 kHz span to see the sidebands.

Place a marker on the carrier with

Press

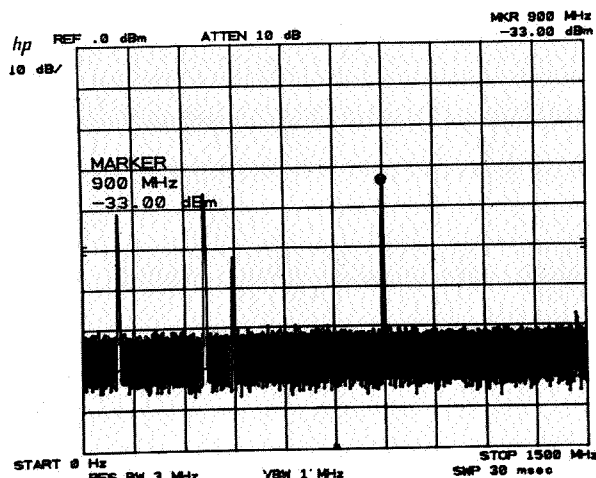

Enter the span,
Press and auto zoom
will be completed.

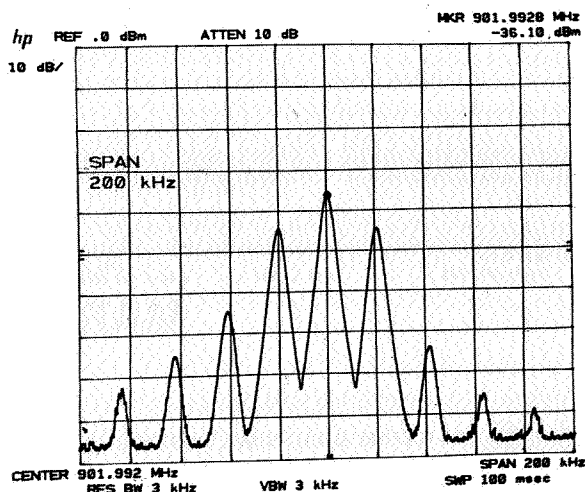

MARKER

PEAK SEARCH

PEAK SEARCH

Peak Search

Peak search places a single marker at the highest trace position of the highest priority trace. The active function is not changed.

Example

PEAK SEARCH is valuable to position the marker at the peak of the signal response.

In a narrow span the marker may be placed at the signal peak.

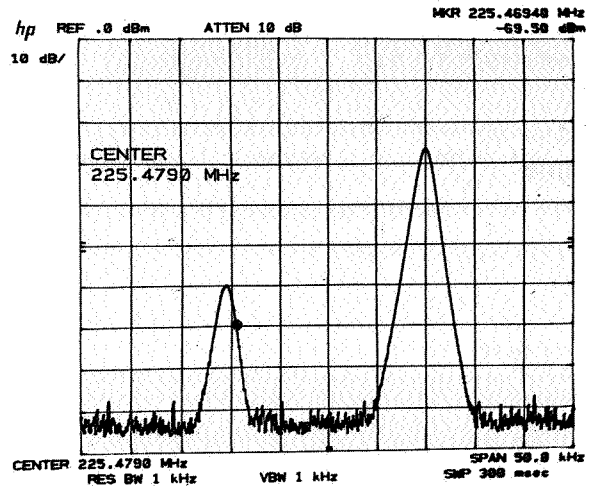

Press PEAK SEARCH

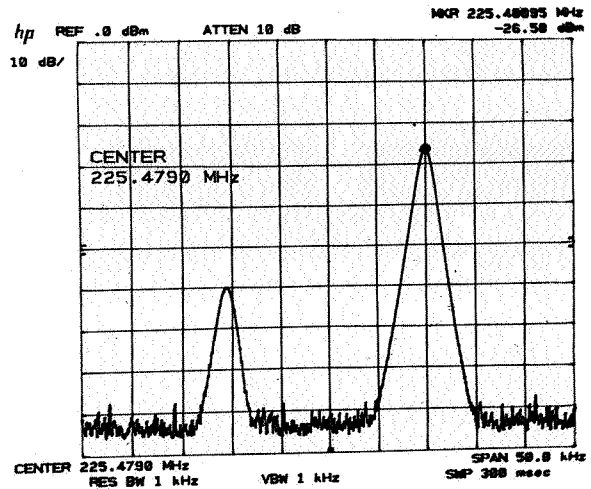

Note that the marker seeks the maximum trace response, no matter what the cause of the response. A larger signal, or the local oscillator feedthrough, would have attracted the marker.

MARKER ENTRY

MKR → CF, MKR → REF LVL and marker Δ into span. Immediately set the corresponding FUNCTION value equal to the readout of the active marker or markers:



ENTRY



marker frequency into

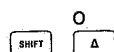

marker frequency into or /



marker amplitude into

immediately records the single or the differential marker frequency in COUPLED FUNCTION for use with DATA .

A marker entry can be made any time a marker is on the trace. (with only one marker displayed takes 0 Hz as the lower frequency.) The active function will not be changed.

Example

One of the fastest, most convenient ways to bring a signal to the center of the display is by using .

Activate a single marker and bring it to the desired signal:

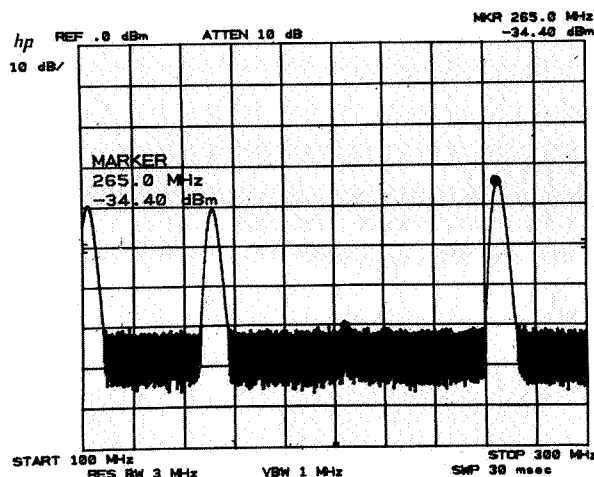

Change the center frequency to the marker frequency.

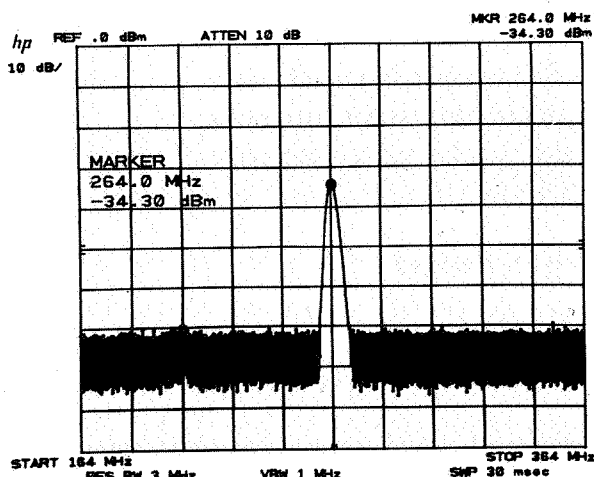

will also work if start/stop frequencies are read out.

MARKER

MKR/Δ-
STP SIZE

Example

One way to tune to a particular portion of a spectrum being displayed is to use the Δ→ span function.

Activate the single marker and place it at either end of the desired frequency span with NORMAL

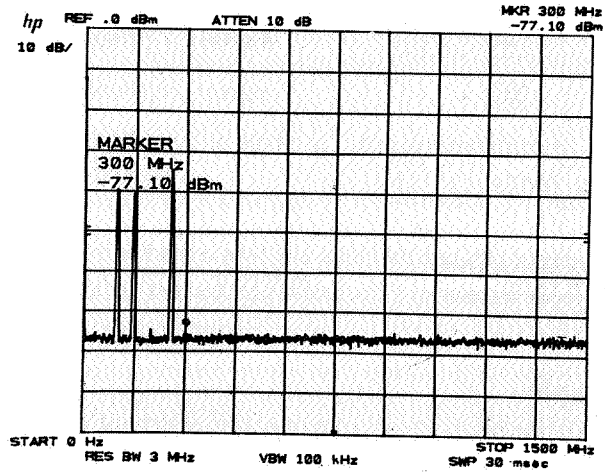

Activate the second marker and place it at the other end of the span with Δ

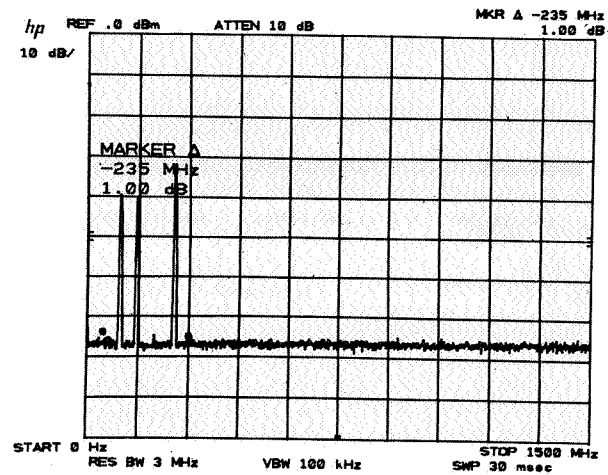

Set the start and stop frequencies equal to the left and right marker frequencies

with 0 SHIFT Δ

Marker NORMAL is activated.

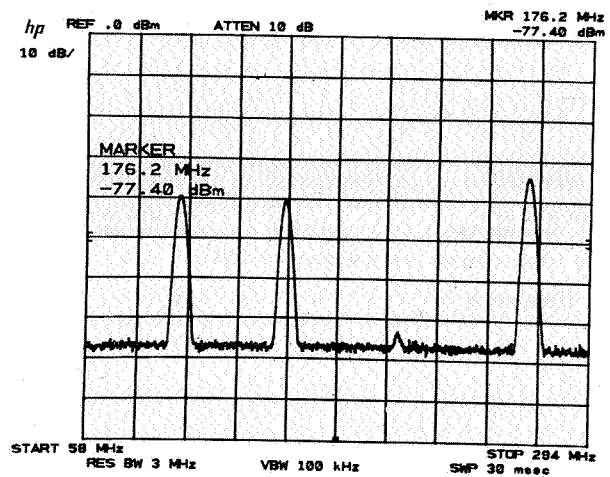

Δ→ span will work the same with start/stop frequency readout. Note that the markers can be placed at either end of the span.

Example

Here is a technique for viewing a fundamental and its harmonics (or any evenly spaced portions of the spectrum) with high resolution..

Narrow the span about the fundamental as necessary with **ZOOM**, centering the carrier.

Set the center frequency step size with **MOD/STF SIZE**.

Now enable center frequency. With each **↑**, successive harmonics will be displayed.

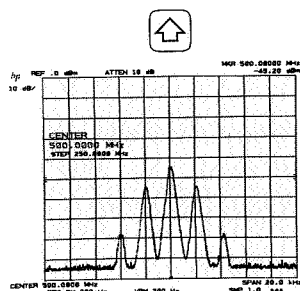
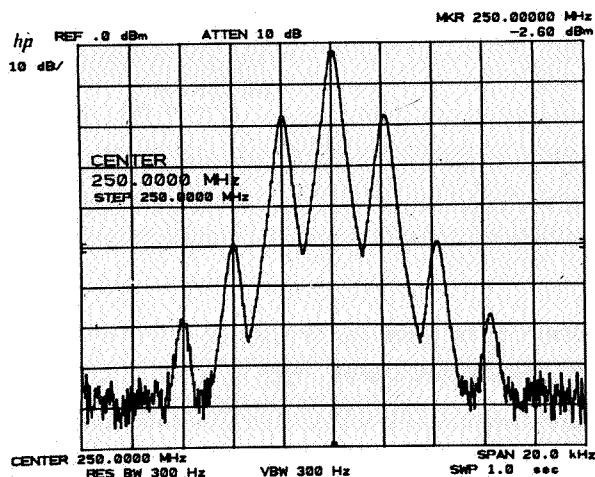

Second Harmonic

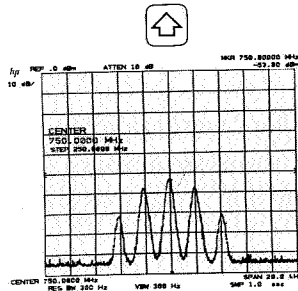

Third Harmonic

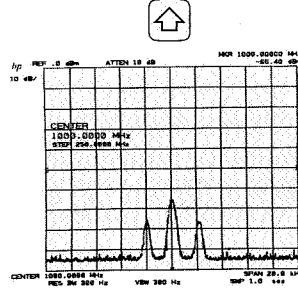

Fourth Harmonic

Similar stepping can be accomplished using marker **△** into step size for intermodulation products or other evenly spaced signals such as communication channels.

SIGNAL TRACK - Automatic Frequency Control

The analyzer is capable of automatically maintaining a drifting signal at the center of the display. To operate signal tracking

Press **NORMAL**, and place the marker on the signal to be tracked with **○**.

Press **SIGNAL TRACK** to initiate the tracking. The light above the key indicates tracking. (Press again to turn off.)

As the signal drifts, the center frequency will automatically change to bring the signal, and marker to the center of the display.

MARKER **OFF**, any other MARKER mode or the instrument preset turns the tracking function off.

MARKER

SIGNAL TRACK FREQ COUNT

The upper sideband of a transmitter is to be monitored as the carrier frequency is tuned.

Locate the sideband with .

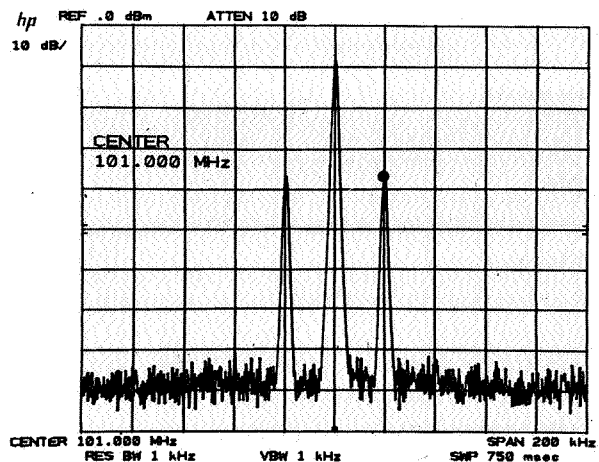

The upper carrier sideband is tracked

with then zoomed in with

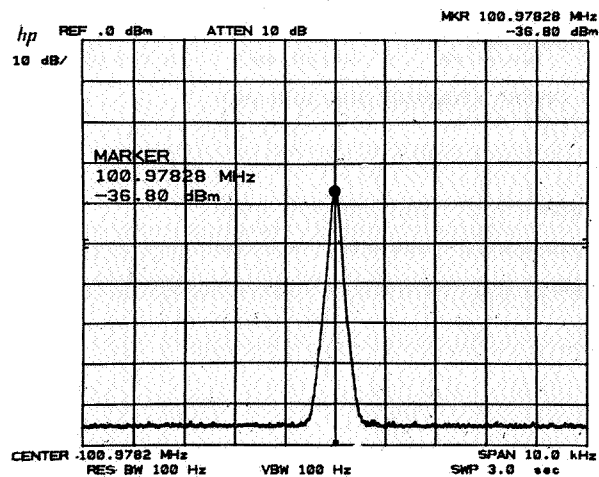

As the carrier frequency is changed, the sideband response will remain in the center of the display. Both the center frequency and marker frequency read out the sideband's frequency.

A combination of and allows the "real time" signal frequency drift to be read on the display.

FREQUENCY COUNT

Frequency count allows a number of measurements beyond the standard capability of the standard marker modes. Each is used in conjunction with one of the three active marker modes, , , or and utilize the DATA controls in the same manner.

counts the frequency of signals with great precision and accuracy even if the marker is not positioned at the signal peak.

When is on and the active marker placed on a signal response such that the marker is > 20 dB out of the noise or the intersections of two signal responses and in the top 6 divisions of the graticule, the signal's frequency will be read out directly. works only for frequency spans of 500 MHz and below.

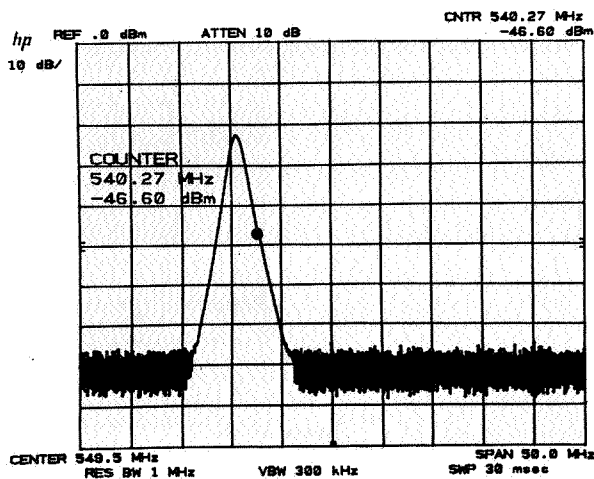

If the marker is not in the top 6 divisions, the display readout "CNTR" in the top right-hand marker area will blink, indicating the reading may be in error.

NOTE

The amplitude readout is for the absolute marker position and not the signal peak.

The marker mode combinations with **FREQ COUNT** are:

Readout	
FREQ COUNT + NORMAL	Signal frequency and marker amplitude.
FREQ COUNT + Δ	Frequency between the signal at the first marker, whose frequency has been <i>stored</i> , and the second marker's <i>counted</i> signal frequency. Amplitude between marker positions.
FREQ COUNT + ZOOM	Signal frequency and marker amplitude. Causes automatic recentering to exact signal frequency upon each successive reduction of span with  .

Measurement and Readout Range

The measurement and readout range for frequency count is the same as the associated marker modes, normal, differential and zoom. Counter resolution to 1 Hz is available using the KEY FUNCTION **SHIFT** **FREQ COUNT**. See Chapter 12, page 12.5.

DATA Entry

See MARKER **NORMAL**, **Δ** and **ZOOM**.

Example

Counted frequency differences between stable signals can be measured.



MARKER

FREQ
COUNT

Activate the frequency counter in a 400 MHz span and position the marker with



To count the difference between the signal and its neighbor place the marker on one signal with ; then activate marker differential and count the next signal.

Press  .

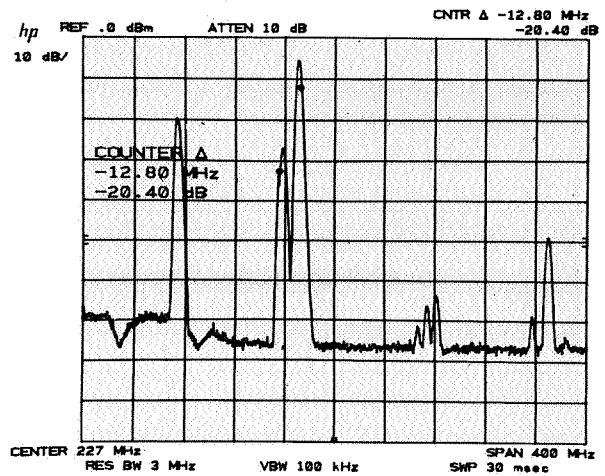
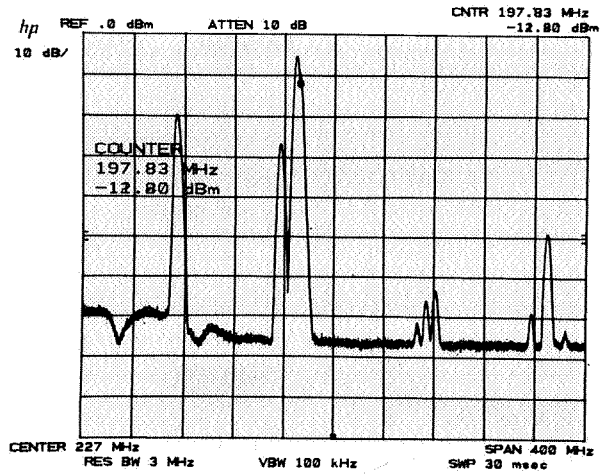

Note that the difference is not the difference of two current counter readings but of one stored counter reading and the current counter reading.

Noise Level Measurement

When noise level is activated and the marker is placed in the noise, the rms noise level is read out normalized to a 1 Hz noise power bandwidth.

M
Noise level enabled:

L
Noise level disabled:

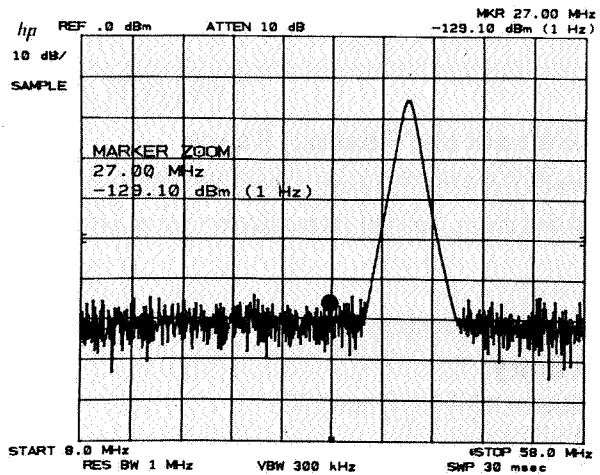

The noise level measurement readout is corrected for the analyzer's log amplifier response and detector response. The value is also normalized to a 1 Hz bandwidth.

Measurement and Readout Range

Noise level measures noise accurately down to 10 dB above the spectrum analyzer's noise level. The readout resolution is in steps of ± 0.1 dB.

DATA Entry

See MARKER , and .

Example

In a communication system the baseband noise level as well as signal to noise ratio measurements are required.

Select a frequency in the baseband spectrum clear of signals with a single marker.

Press .

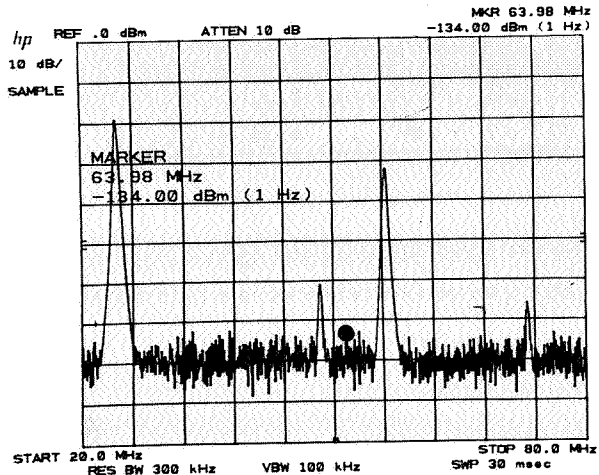

M

Read the noise at the marker by pressing .

The noise at 64 MHz is -134 dBm in a 1 Hz bandwidth. This corresponds to -134 dBm + 36 dB/4 kHz = -98 dBm in 4 kHz voice channel bandwidth.

Signal to noise measurements require the measurement of the noise level, as the example above, and the measurement of the absolute signal level. *

Measure the power level of the adjacent signal. To turn the noise level off, press

L

and read the power level.

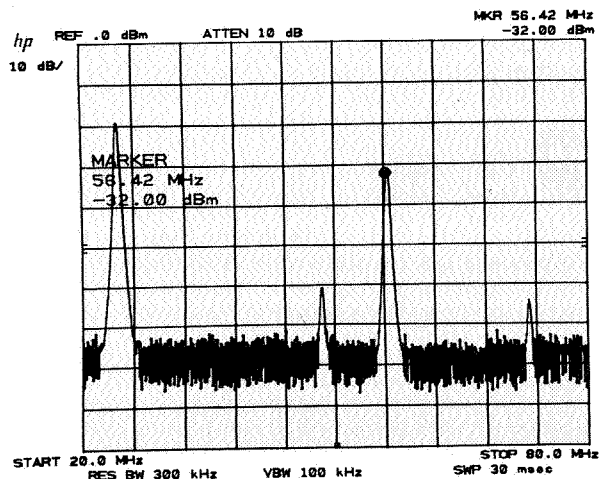

The signal to noise ratio referenced to 4 kHz bandwidth is -32 dBm - (-98 dBm) = 66 dB.

*Normalization to a desired bandwidth uses the equation $10 \log_{10} \left(\frac{\text{desired BW}}{1 \text{ Hz}} \right)$

Chapter 8

SCALE AND REFERENCE LINE

This chapter describes the use of SCALE and REFERENCE LINE control groups for setting the amplitude scale, and for making amplitude level measurements more conveniently.

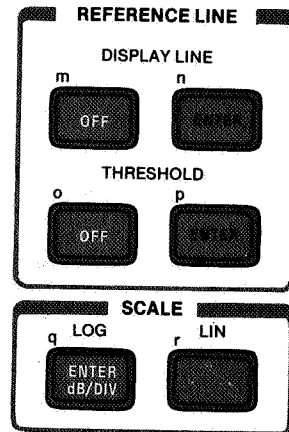
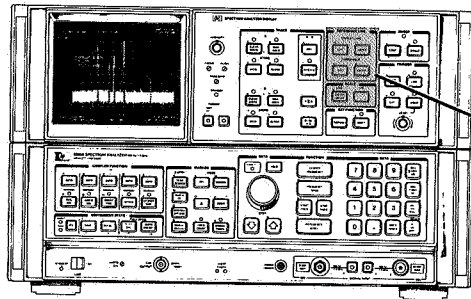

SCALE

SCALE keys allow the scaling of the vertical graticule divisions in logarithmic or linear units without changing the reference level value.

LOG

(DATA entry) scales the amplitude to 1 dB, 2 dB, 5 dB or 10 dB per division.

If is pressed when the scale is linear, 10 dB per division will be automatically entered. The subsequent (DATA), if any, will then replace the automatic 10 dB/div.

LOG
Press

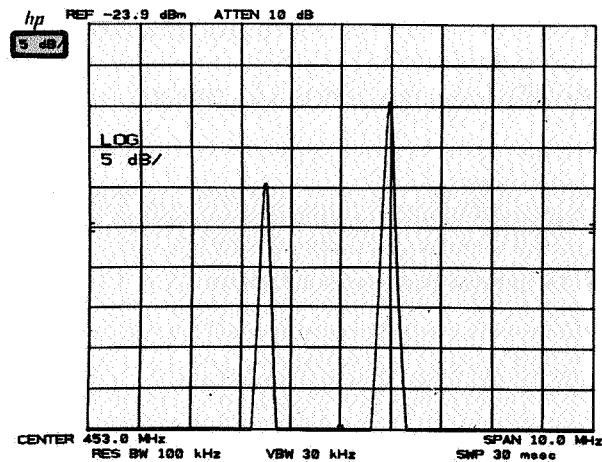

LIN

immediately scales the amplitude proportional to input voltage. The top graticule remains the reference level, the bottom graticule becomes zero voltage. Reference level, and all other amplitudes, are read out in voltage. However, other units may be selected. See Amplitude Units Selection, Chapter 12.





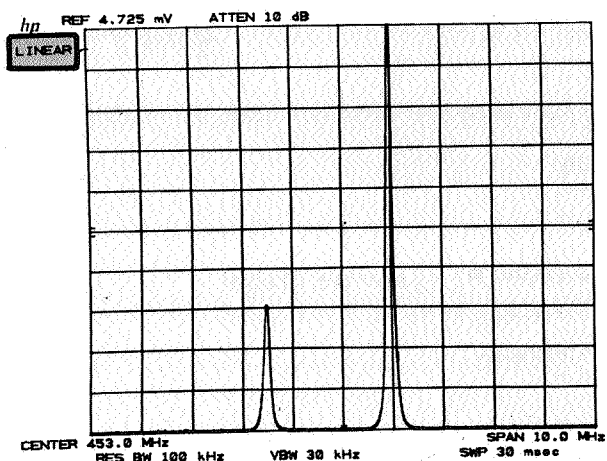

If is pressed when the scale is linear, 10 dB per division will be automatically entered.

LIN
Press



In LINEAR, a specific voltage per division scale can be set by entering a voltage reference level value. For example, to set the scale to 3 mV/division, key in 30 mV reference level. (Voltage entries are rounded to the nearest 0.1 dB, so the 30 mV entry becomes 30.16 mV, which equals -17.4 dBm.)

DATA Entry

   	Changes scale in allowable increments (1, 2, 5 or 10 dB per division).
 	Enables direct scale selection of allowed values. Other entries are rounded to an adjacent value.

LIN

No DATA entry will be accepted with the linear SCALE selection key, .

Example

It is convenient to observe AM sidebands in linear as well as logarithmic scales for analysis of both modulation percentages and distortion products.

Modulated AM signal displayed in the 10 dB/division scale shows the carrier, its sidebands and distortion products.

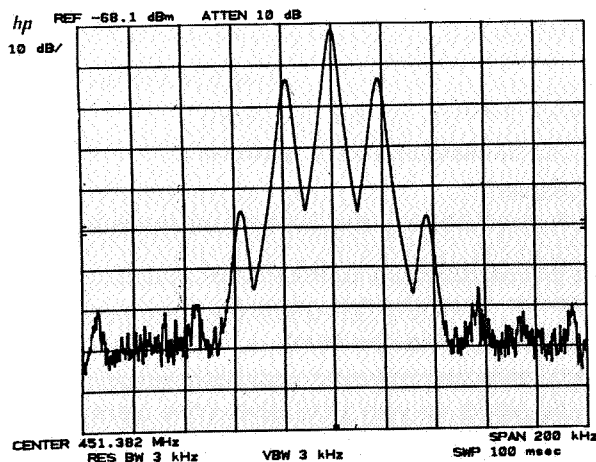

SCALE

Linear scaling enables the observation of the sidebands proportional to the carrier.

LIN
Press .

As in the MARKER example, Chapter 7, a direct readout of the percent modulation can be made.

The fractional readout is one half the modulation index (only one sideband is measured).

$$\% \text{ AM} = 2(.25) \times 100 = 50\%$$

Note that the carrier signal need not be placed at the reference level for an index ratio measurement.

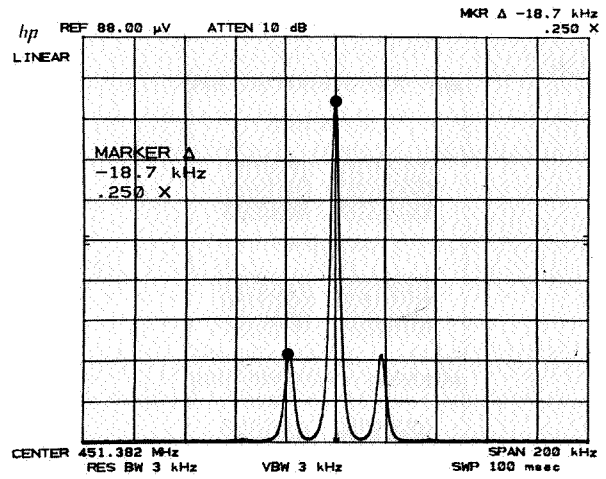

LOG
Change to a logarithmic scale with and change the dB/ with .

The sidebands are 12 dB down from the carrier, verifying the earlier measurement results.

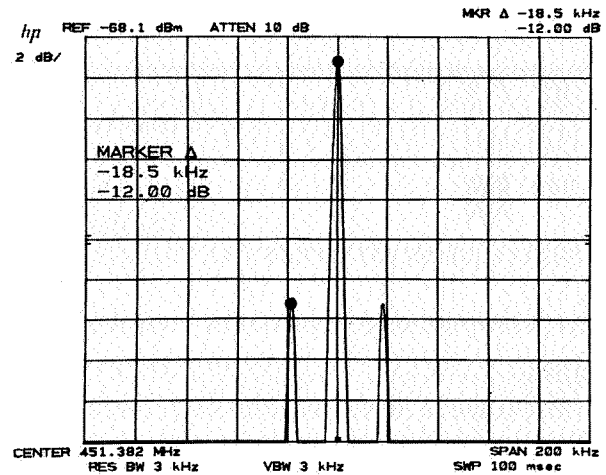

Harmonic distortion of the modulating signal can be measured as in MARKER , Chapter 7.

The modulation frequency is 18.8 kHz and the distortion caused by the second harmonic is 2.4%, (read out as .024X).

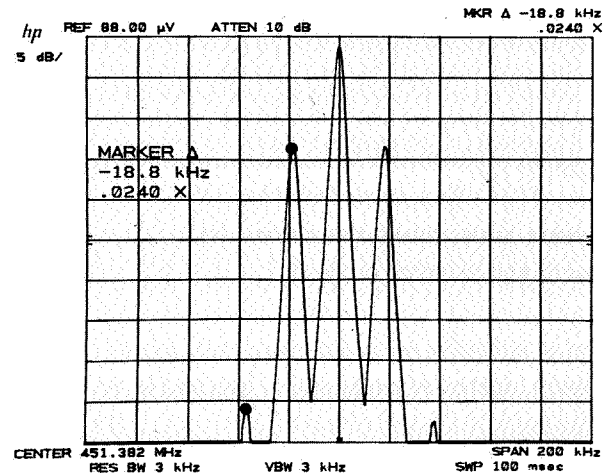

REFERENCE LINE

The reference line functions DISPLAY LINE (DL) and THRESHOLD (TH) place horizontal reference lines on the display. Their levels are read out.

DISPLAY LINE uses:

- measure signal levels with direct readout.
- establish a standard for go/no go test comparisons.
- eliminate or reduce amplitude errors due to system frequency response uncertainty in conjunction with TRACE arithmetic.

THRESHOLD provides:

- a base line clipper whose level is read out.

Display Line

Display line (DATA entry) places a horizontal reference line at any level on the graticule. The line's amplitude, in reference level units, is read out on the left-hand side of the CRT display.

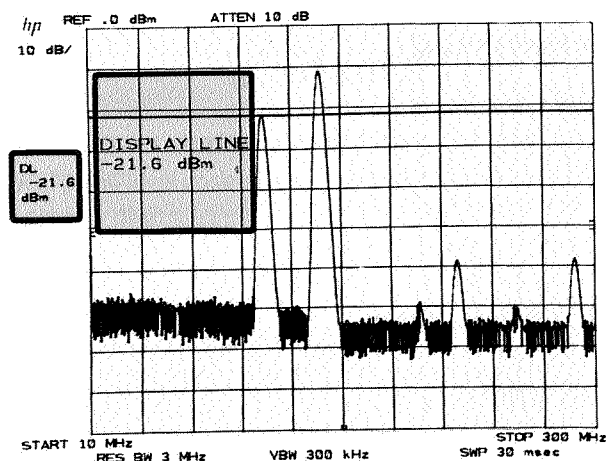

The display line can be positioned anywhere within the graticule. When activated after LINE power ON or the display line is placed 4.5 divisions down from the reference level.

Display line erases the line and readout from the CRT display but does not reset the last position. If the display line is activated again before LINE power ON or , it will return to its last position.

Display line position is always accessible for HP-IB and TRACE , even if never activated. See Chapter 6, TRACE arithmetic.

The display line readout has the same number of significant digits as reference level.

DATA Entry

<input type="button" value="ENTER"/>	Moves the line about two divisions for each full turn. The line moves in display unit increments.
<input type="button" value="ENTER"/> 	Moves the line one tenth of the total amplitude scale per step.
<input type="button" value="ENTER"/>	Positions the line to the exact entry level. Entry may be in mV, μ V, \pm dBm, \pm dBmV, or \pm dB μ V depending upon which units are selected.

REFERENCE LINE

Example

When the amplitude of a number of signals in the same span require a quick readout, the display line can be used.

Activate the display line with **ENTER**.
With **⊙** place the line through the peak of a signal and read out its absolute amplitude level.

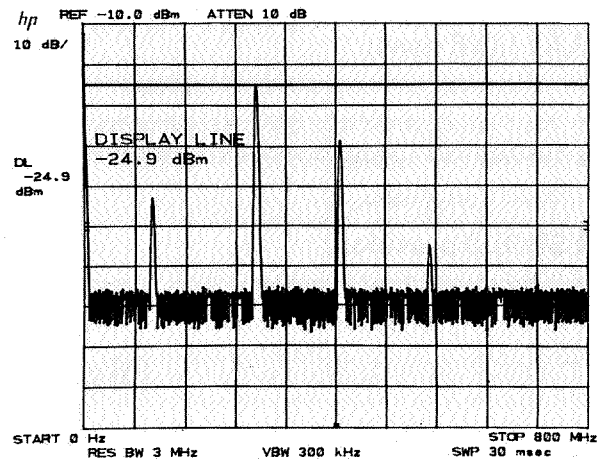

Moving the display line to each signal reads out its peak amplitude.

Threshold

Threshold **ENTER** (DATA entry) moves a lower boundary to the trace, similar to a base line clipper on direct writing CRT spectrum analyzers. The boundary's absolute amplitude level, in reference level units, is read out on the lower left-hand side of the CRT display.

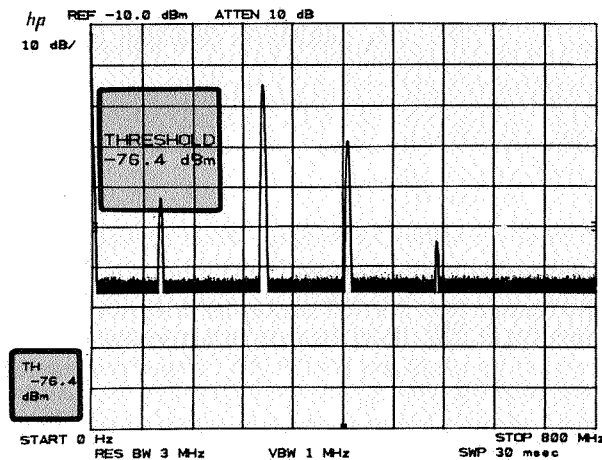



The threshold can be positioned anywhere within the graticule. It operates on TRACE **CLEAR-WRITE**, **MAX HOLD** or **VIEW** for TRACES A, B and C simultaneously. When activated after LINE power ON or **INSTR PRESET**, the threshold is placed 1 division from the bottom graticule.

The threshold level does not influence the trace memory, that is, the threshold level is not a lower boundary for trace information stored and output from the trace memories through the HP-IB. TH **OFF** removes the threshold boundary and readout from the CRT display but does not reset the position. If threshold is activated again before LINE power ON or **INSTR PRESET** it will resume at its last level.

The threshold readout has the same number of significant digits as reference level.

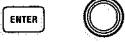
DATA Entry





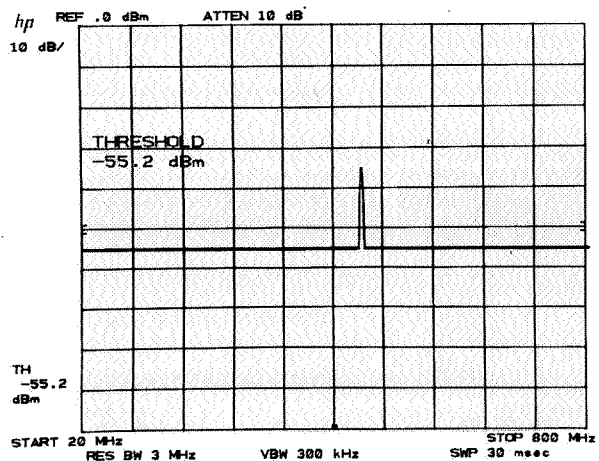
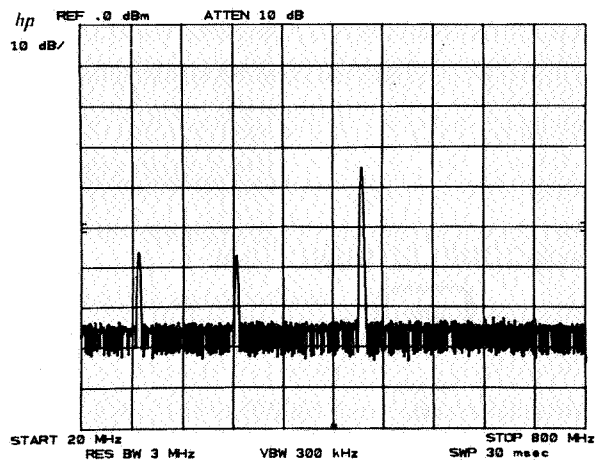

	<p>Moves the threshold about two divisions per rotation. The line moves in display unit increments.</p>
	<p>Moves the threshold one tenth of the total amplitude scale per step.</p>
	<p>Positions the threshold to the exact entry level. Entry may be in mV, μV, \pm dBm, \pm dBmV, or \pm dBμV depending upon units selected.</p>

Example

The threshold can be used as a go/no go test limit.

A series of signals can be tested for a specific threshold level by placing the threshold at the test level.



Press THRESHOLD    
 
 Only those signals > -55.2 dBm will be displayed

Chapter 9

COUPLED FUNCTION

This chapter describes the COUPLED FUNCTION group and its use in various measurements. The COUPLED FUNCTIONS control the receiver characteristics of the spectrum analyzer.

The values of the COUPLED FUNCTION are automatically selected by the analyzer to keep absolute amplitude and frequency calibration as frequency span and reference level are changed.* The functions are all coupled with LINE power ON, **INSTR PRESET** or when their individual **AUTO** is activated. **0-1.5 GHz** couples all functions but **ATTEN** and **CFSTEP SIZE**.

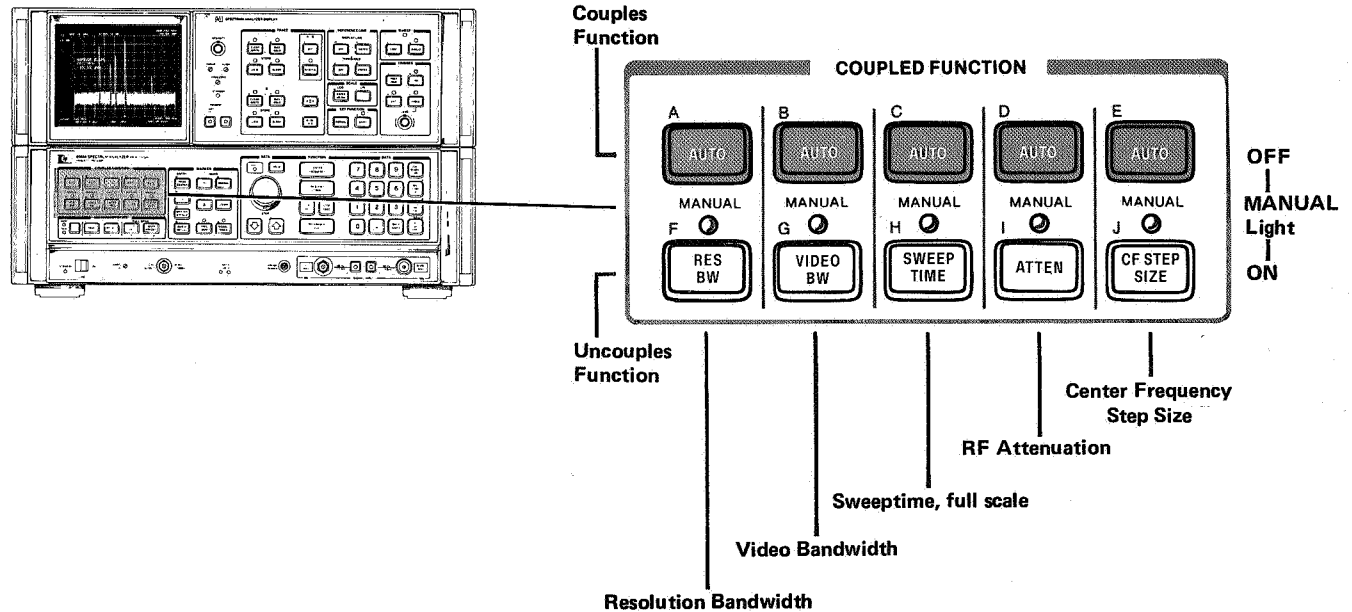

For each COUPLED FUNCTION:



Sets the function to the preset value dictated by the analyzer's current state. The function is coupled.

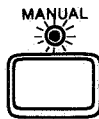

Function value will not change with instrument state. DATA entry changes value. The MANUAL light goes on and stays on until the function is placed in **AUTO** once again.

In most cases the **AUTO** coupled functions will change values to maintain amplitude calibration when one or more of the others are manually set. If the amplitude or frequency becomes uncalibrated, "MEAS UNCAL" appears in the right-hand side of the graticule.

Coupled Function



Selects
3 dB resolution bandwidth (IF filter) which largely determines the ability of the analyzer to resolve signals close together in frequency.



3 dB bandwidth of the post detection low pass filter that averages noise appearing on the trace.



The total time for the analyzer to sweep through the displayed frequency span or display a detected signal in zero frequency span.



The setting of the input RF attenuator which controls signal level at the input mixer.



Selects center frequency change for each DATA when **CENTER FREQUENCY** is activated.

*Center frequency step size does not affect amplitude or frequency calibration.

DATA Entry For COUPLED FUNCTIONS

Discrete values are entered for RES BW, VIDEO BW, SWEEP TIME and ATTEN. The DATA entry from DATA ○ and ↑ ↓ selects these values sequentially from the current value. A DATA entry from the keyboard which is not exactly equal to an allowable value will select an adjacent value. For example, RES BW 1 5 kHz will select 30 kHz bandwidth, the next higher IF bandwidth.

Resolution Bandwidth

RES BW (DATA entry) sets bandwidth selection to MANUAL and changes the analyzer's IF bandwidth. The bandwidths that can be selected are 10 Hz, 30 Hz, 100 Hz, 300 Hz, 1 kHz, 3 kHz, 10 kHz, 30 kHz, 100 kHz, 300 kHz, 1 MHz and 3 MHz.

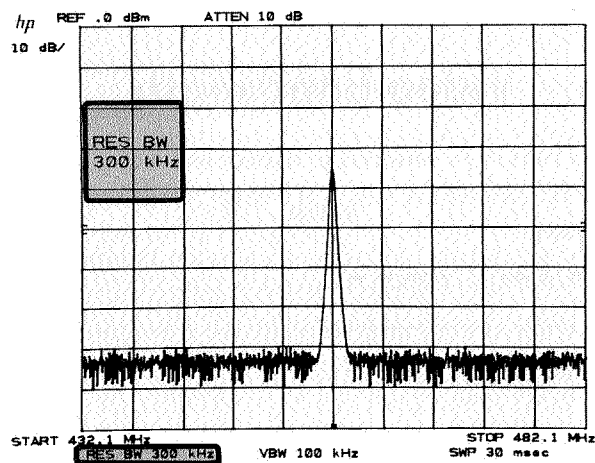

Example

A measurement requiring manual resolution bandwidth selection is the zero span (time domain) observation of modulation waveforms. An example can be found in Chapter 4, Zero Frequency Span - Fixed Tuned Receiver Operation.

Another use of manual resolution bandwidth is for better sensitivity over a given frequency span.

The low level intermodulation products of two signals spaced 100 MHz apart need to be measured. With the functions coupled the analyzer noise may mask these distortion products.

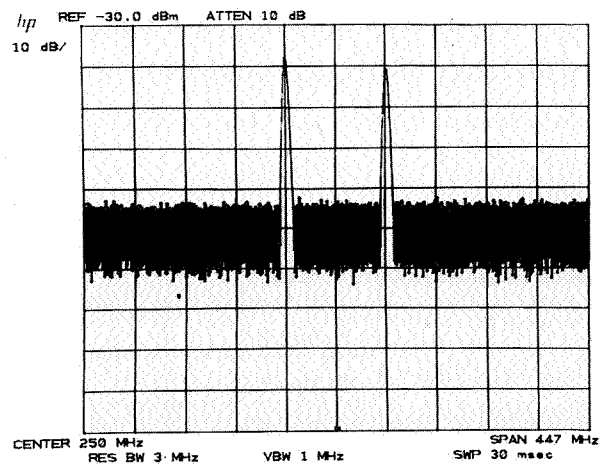

Reduction of the noise level by 10 dB (increased sensitivity) is achieved by decreasing the bandwidth by a factor of 10.



(THRESHOLD has been activated to clarify the display.)

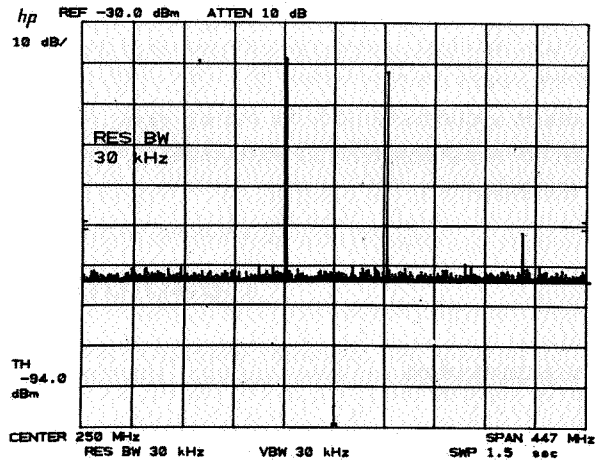

The sweep time automatically slows to maintain absolute amplitude calibration if SWEEP
TIME is coupled.

Video Bandwidth

VIDEO
BW (DATA Entry) sets the video bandwidth selection to manual and changes the analyzer's post detection filter bandwidth. The bandwidths that can be selected are 1 Hz, 3 Hz, 10 Hz, 30 Hz, 100 Hz, 300 Hz, 1 kHz, 3 kHz, 10 kHz, 30 kHz, 100 kHz, 300 kHz, 1 MHz and 3 MHz.

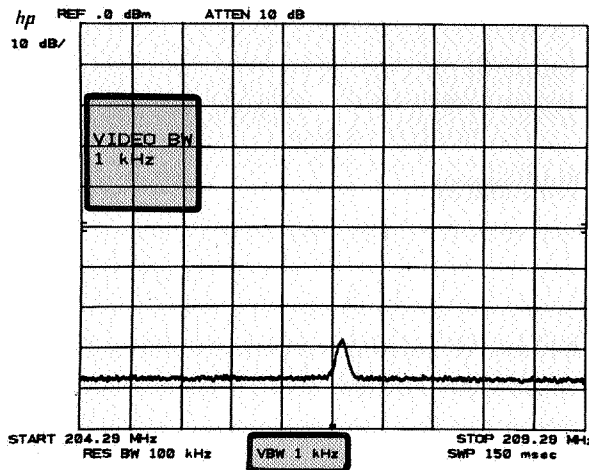

Example:

Signal responses near the noise level of the analyzer will be visually masked by the noise. The video filter can be narrowed to smooth this noise.

A low level signal at this center frequency can just be discerned from the noise.

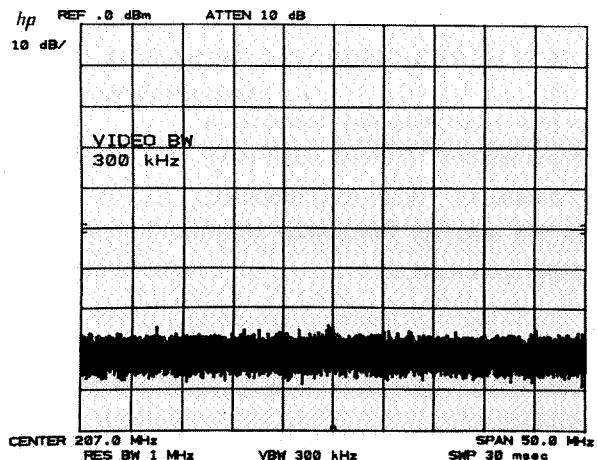

Narrowing the video bandwidth clarifies the signal and allows its amplitude measurement.

Press VIDEO BW ↓ ↓ ↓ ↓

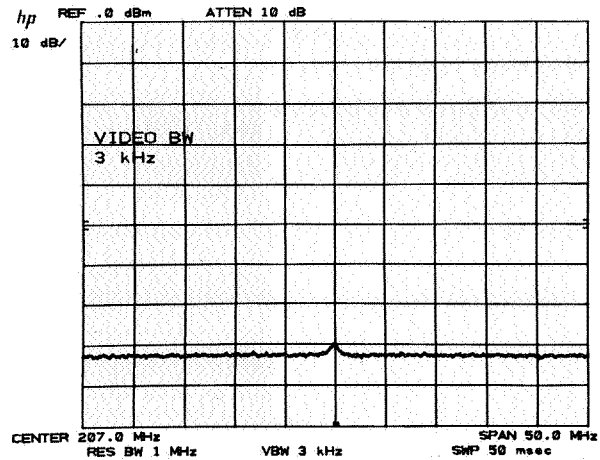

The sweep time will increase to maintain amplitude calibration.

NOTE
The video bandwidth must be set wider or equal to the resolution bandwidth when measuring impulse noise levels.

Video Averaging

Narrowing the video filter requires a slower sweep time to keep amplitude calibration since the narrower filter must have sufficient time to respond to each signal response. Video averaging is an internal routine which *digitally* averages a number of sweeps, allowing a more instantaneous display of spectral changes due to center frequency, frequency span or reference level changes. See Chapter 12, page 12.11.

Sweep Time

SWEEP TIME (DATA entry) sets the sweep time selection to manual and changes the rate at which the analyzer sweeps the displayed frequency or time span.

The sweep times that can be selected are:

	SWEEP TIME	SEQUENCE
FREQUENCY SPAN ≥ 100	20 ms to 1500 sec	1, 1.5, 2, 3, 5, 7.5 and 10
ZERO FREQUENCY SPAN	1 μs to 10 ms	1, 2, 5 and 10
	20 ms to 1500 sec	1, 1.5, 2, 3, 5, 7.5 and 10

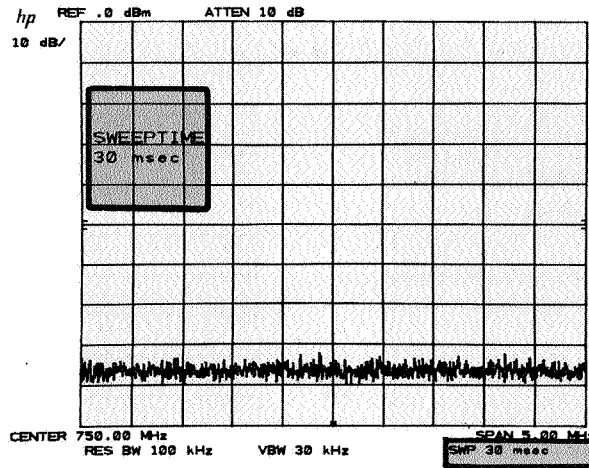

Example

To identify signals quickly in a very narrow frequency span (where the resolution bandwidth would be narrow) the sweep time can be temporarily reduced. (e.g. speed up sweep rate).

A frequency span of 10 kHz will have selected resolutions and video bandwidths of 100 Hz and a sweep time of 3 seconds.

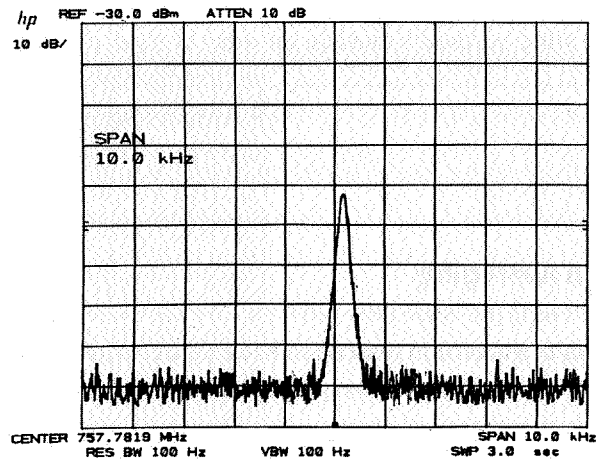

To quickly see signals present in the span press SWEEP
TIME and ↓ several times. When the sweep completes its span, couple sweep time again with AUTO.

Note the DISPL UNCAL message appears automatically, as the faster sweep time causes some distortion of the spectral response.

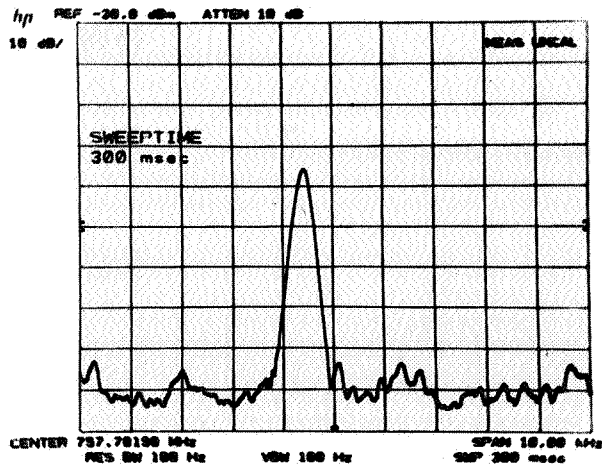

Input Attenuation

ATTEN (DATA entry) sets the attenuation function to MANUAL and changes the analyzer's RF input attenuation. The levels of attenuation that can be selected are 10 dB to 70 dB in 10 dB steps, or 0 dB under special conditions. Generally the reference level does not change with attenuator settings.

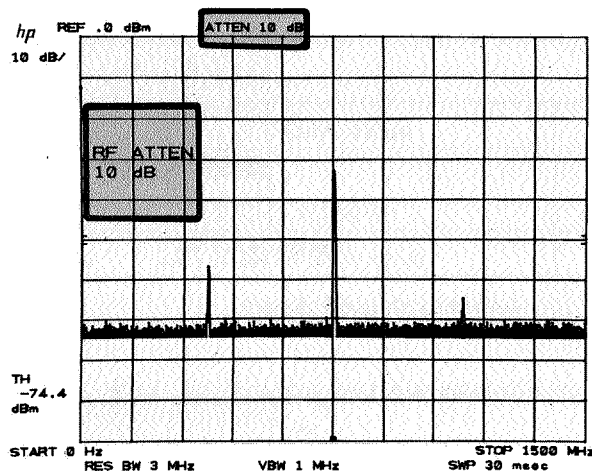

When the RF input attenuator function is coupled (AUTO), the value selected assures that the level at the input mixer is less than -10 dBm (the 1 dB compression point) for on-screen signals. For example, if the reference level is $+28$ dBm the input attenuator will be set to 40 dB: $+28$ dBm -40 dB = -12 dBm at the mixer.

The input mixer level can be changed to assure maximum dynamic range. See Input Mixer Level, Chapter 12.

CAUTION

Greater than $+30$ dBm total input power will damage the input attenuator. Input powers greater than $+13$ dBm at the input mixer will be reduced by an internal limiter.

Zero Attenuation

As a precaution to protect the spectrum analyzer's input mixer, 0 dB RF attenuation can only be selected from the number/units keyboard, press ATTEN 0 GHz +dBm dB.

Reference Levels ≤ -100 dBm and $> +30$ dBm

Reference levels ≤ -100 dBm or between $+30$ dBm and $+60$ dBm can be called when the reference level extended range is activated. Low reference level limits depend upon resolution bandwidth and scale.

Press SHIFT ATTEN to extend the reference level range.

See Chapter 4, FUNCTION REFERENCE LEVEL, and Chapter 12, KEY FUNCTION, page 12.5.

Determining Distortion Products

If the total power to the analyzer is overloading the input mixer, distortion products of input signals can be displayed as input signals. The RF attenuator is used to determine which signals, if any, are internally generated distortion products.

COUPLED FUNCTION ATTEN

Example

The two main signals shown are producing intermodulation products because the analyzer's input mixer is overloaded.

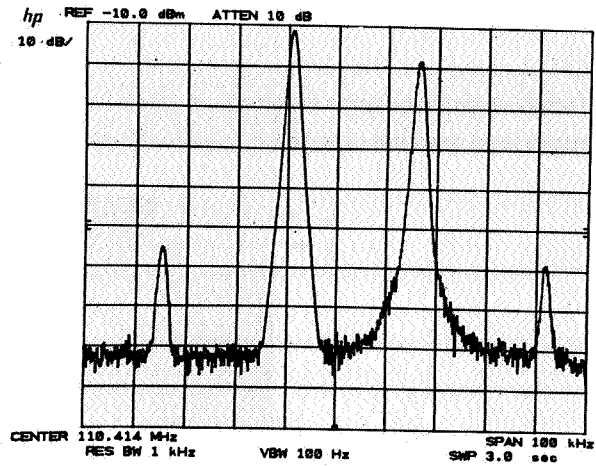

To determine whether these intermod products are generated by the analyzer, first save the spectrum displayed in B with CLEAR-WRITE B VIEW B

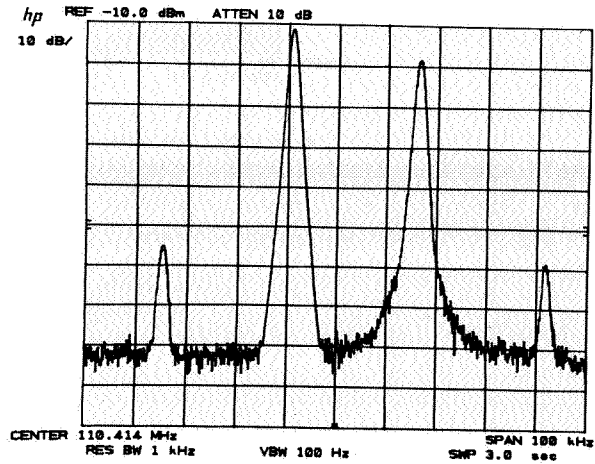

Increase the RF attenuation by 10 dB. Press ATTEN ↑. (If the reference level changes it will be necessary to return it back to its original value.)

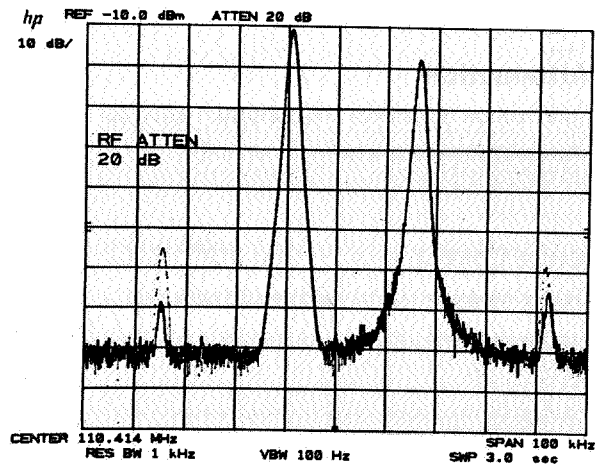

Since some of the signal responses decrease as the attenuation increases (by comparing the response in A with the stored trace in B), distortion products are caused by an overloaded input mixer. The high level signals causing the overload conditions must be attenuated to eliminate this condition.

Center Frequency Step Size

CFSTEP SIZE (DATA entry) sets step size to MANUAL, changes and stores the step size entered. While CFSTEP SIZE is in MANUAL, CENTER FREQUENCY ↑ and ↓ changes center frequency by the step size value stored in the register. Several functions can be used to enter step size value to the register. When a CF step size is AUTO, the center frequency steps will be 10% of the frequency span, even though the CF step size register contains another value.

	Entry Value	CFSTEP SIZE State
step size AUTO , INSTR PRESET or LINE power ON	100 MHz	coupled (AUTO)
CFSTEP SIZE (DATA entry)	DATA entry value	uncoupled (MANUAL)
MARKER MKB/STP SIZE	marker frequency readout	uncoupled (MANUAL)



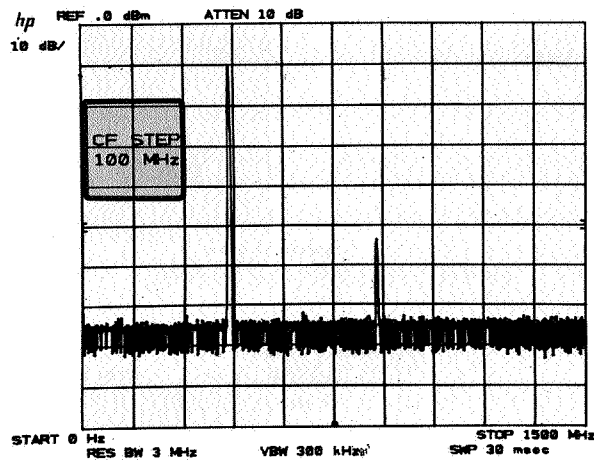

The step size can be varied from 0 Hz to 1500 MHz to a resolution equal of 1 Hz. It is displayed with the same resolution as center frequency.

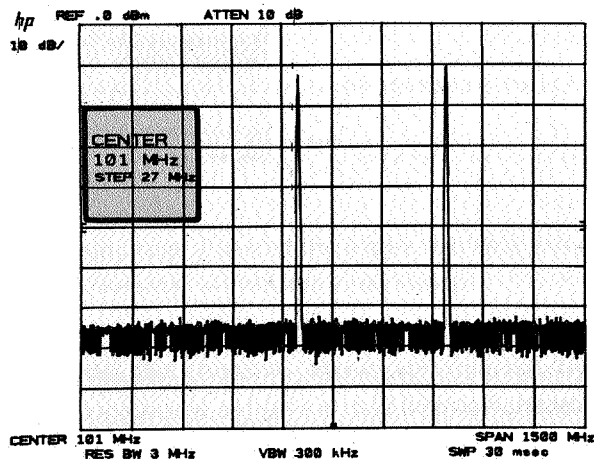

When the center frequency is activated with step size in MANUAL, the active function readout includes both the center frequency and the step size value.



DATA Entry

CFSTEP SIZE 	Changes the step size in display unit increments.
CFSTEP SIZE  	Changes the step size in steps equal to one tenth of the frequency span.
CFSTEP SIZE 	Selects a specific step size to a resolution equal to the current center frequency readout.

Example

Surveillance of a wide frequency span sometimes requires high resolution. One fast way to achieve this is to take the span in sequential pieces using a tailored center frequency step. This example looks from 0 Hz to 1500 MHz in 50 MHz spans.

First set a span and start frequency. For a

span of 50 MHz press FREQUENCY SPAN 5 0

MHz -dBm sec. Set the center frequency to 25 MHz

with CENTER FREQUENCY 2 5 MHz -dBm sec.

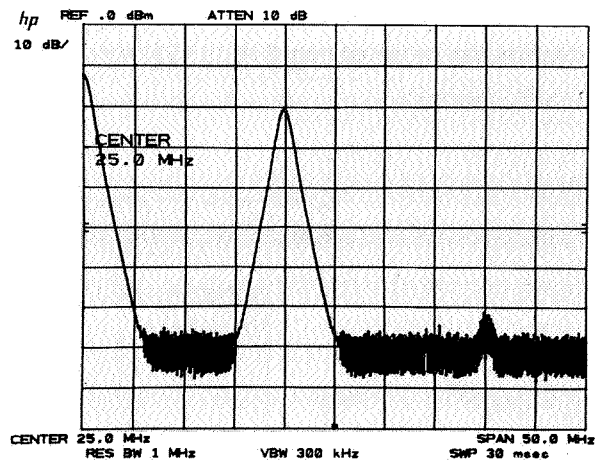

Set the step size to 50 MHz, CFSTEP SIZE 5

0 MHz -dBm sec, and reactivate center frequen-

cy with CENTER FREQUENCY.

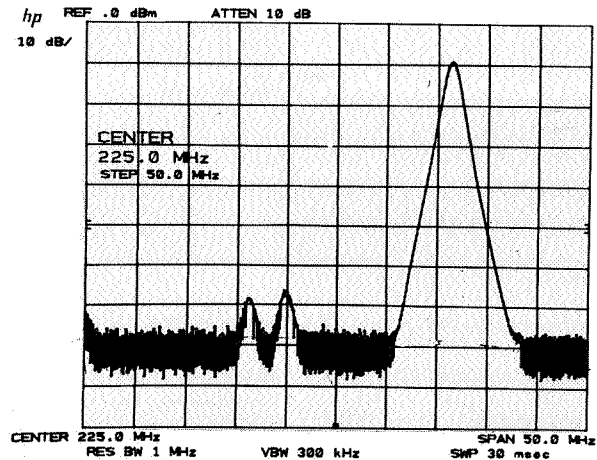

Now each  sets the center frequency to the next 50 MHz span for a span by span surveillance of the spectrum. (Center frequency = 25 MHz, 75 MHz, 125 MHz, etc.) Center frequency step size can also be defined by the marker, see the MARKER ENTRY portion of Chapter 7, page 7.13.

Chapter 10

SWEEP and TRIGGER

This chapter describes the use of SWEEP and TRIGGER control functions.

SWEEP controls enable:

- CONT continuous, or repetitive sweeping (sweep time ≥ 20 ms).
- SINGLE a single sweep which will repeat only on demand (sweep time ≥ 20 ms).

TRIGGER controls select the function which will begin a sweep:

- FREE RUN as soon as possible,
- LINE line voltage passes through zero on a positive swing,
- EXT an external signal voltage passes through ~ 1.5 volts on a positive swing.
- VIDEO the level of a detected RF envelope reaches up to the level on the CRT display determined by the LEVEL knob.

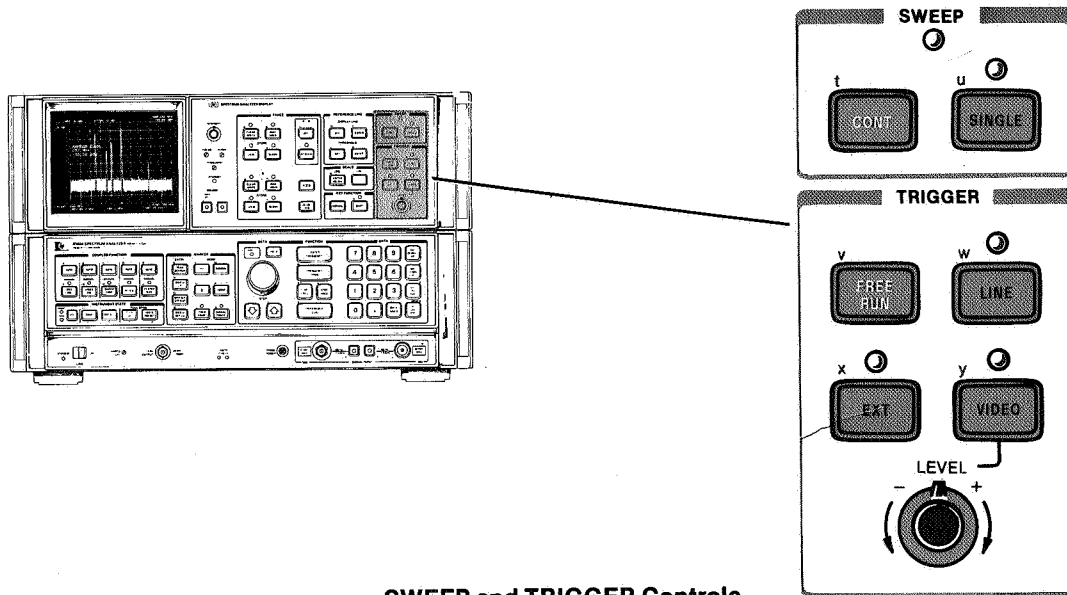

SWEEP and TRIGGER Controls

SWEEP

The spectrum analyzer frequency sweep (sweep times ≥ 20 ms), once triggered, continues at a uniform rate from the start frequency to the stop frequency unless new data entries are made to the analyzer from the front panel or the HP-IB. With faster sweeps, changes to center frequency, for example, appear continuous. With long sweep times, a change in center frequency noticeably suspends the sweep while the analyzer updates its state and readout, then the sweep continues from where it was, tracing out the new spectrum.

The SWEEP light indicates that a sweep is in progress. The light is out between sweeps, during data entry and during FREED COUNT gating. (The light is out for sweep times ≤ 10 ms.)

After a sweep, the next sweep will be initiated only if:

- continuous sweep mode is selected or a single sweep demand is made,
- the trigger conditions are met,
- data is not entered continuously from the front panel DATA controls or the HP-IB.

Continuous Sweep

CONT enables the continuous sweep mode. Provided the trigger and data entry conditions are met, one sweep will follow another as soon as triggered. Pressing CONT initiates a new sweep.

Single Sweep

SINGLE enables the single sweep mode. Each time SINGLE is pressed, including when the SWEEP mode is changed from continuous, one sweep is initiated provided the trigger and data entry conditions are met. A sweep in progress will be terminated and restarted upon SINGLE.

SWEEP TRIGGER

Zero Frequency Span Sweep

In zero frequency span, sweep times from 1 μ sec to 10 msec are also available. In these sweep times the SWEEP **CONT** and **SINGLE** are disabled. The video signal response is *not* digitally stored (trace modes also disabled), but multiplexed directly onto the display along with the graticule and readouts. The graticule and readouts are refreshed following each fast sweep.

To avoid flicker of the display when external or video triggers are less frequent than 25 msec, the analyzer will trigger internally. If triggers dependent *only* on external or video trigger are required press

- x
SHIFT **EXT** disables "auto" external trigger feature
- y
or **SHIFT** **VIDEO** disables "auto" video trigger feature

NOTE

For zero frequency span sweep times ≤ 10 msec and **SHIFT** x or **SHIFT** y the CRT display graticule and readout depend upon triggering. If no trigger is present the CRT display will be blank.

TRIGGER

The analyzer sweep is triggered by one of four modes selected.

- **FREE RUN** allows the next sweep to start as soon as possible after the last sweep.
- **LINE** allows the next sweep to start when the line voltage passes through zero, going positive.
- **EXT** allows the next sweep to start when an external voltage level passes through ≈ 1.5 volts, going positive.

The external trigger signal level must be between 0 V and +5 V.

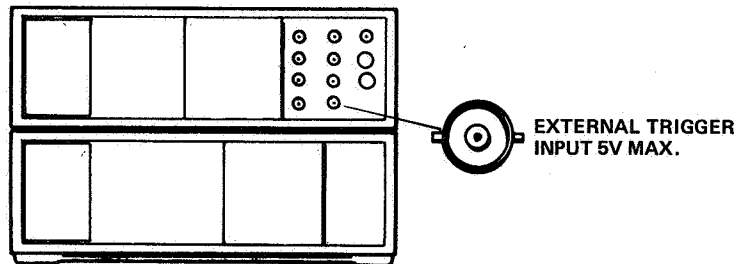

External TRIGGER Input

- **VIDEO** allows the next sweep to start if the detected RF envelope voltage rises to a level set by the LEVEL knob. The LEVEL corresponds to detected levels displayed on the CRT between the bottom graticule (full CCW) and the top graticule (full CW).

An RF envelope will trigger the sweep only if it is capable of being traced on the CRT display, that is, the resolution bandwidth and video bandwidth are wide enough to pass the modulation waveform of an input signal.

Example

A zero span display of this video waveform will trigger for all LEVEL knob settings..

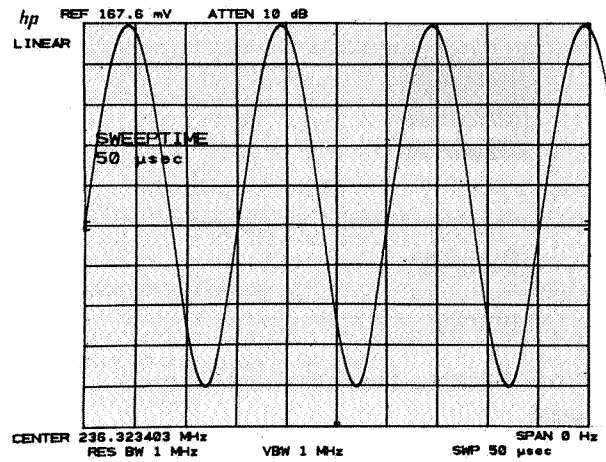
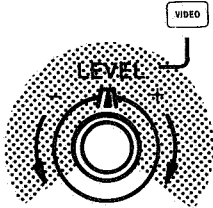

If the video signal lowers on the display, the LEVEL must be set towards the minus side.

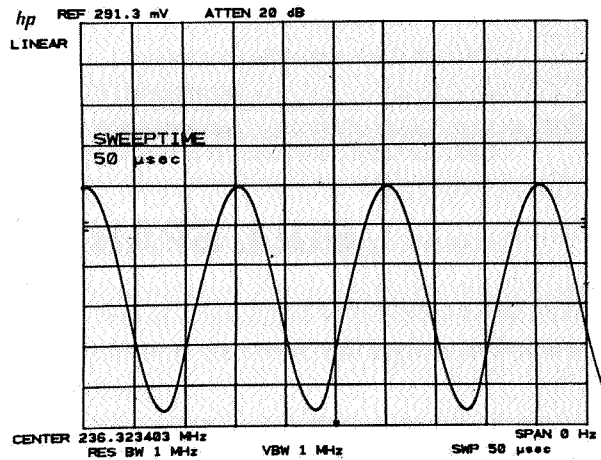
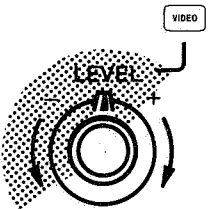

If the level does not cause a trigger within 25 msec, the sweep will be triggered anyway to insure a display. Note that this is true only for sweep times ≤ 10 msec.

Chapter 11

INSTRUMENT STATE

This chapter describes the INSTRUMENT STATE keys. Each key allows access to or activation of a specific set of functions and their values. Some of the sets are built in to the analyzer and some are user defined.

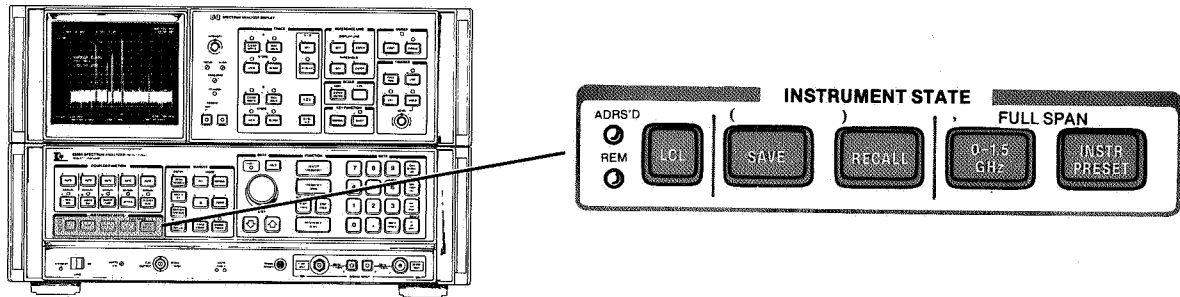

Instrument states that can be selected:

FULL SPAN



A full 0 Hz to 1500 MHz span with coupled operation and *all* the functions set to known states and values.

FULL SPAN



A full 0 Hz to 1500 MHz span with a minimum of other front panel functions changed.



1

Saves the complete set of current front panel function states and values for later recall. Registers 1 through 6 are available for storage.



1

Recalls the complete instrument state saved in the register called.



Calls for front panel control after the analyzer has been placed in a remote state by an HP-IB controller.

FULL SPAN Instrument Preset

provides a convenient starting point for making most measurements. That is, it calls for a full 1500 MHz span, coupled functions and a 0 dBm reference level, to name a few. LINE power ON automatically calls for an instrument preset.

The states that are set include all the functions and values of

- front panel functions,
- and ● KEY FUNCTIONS,
- and ● functions accessible only by the HP-IB.

Front Panel Preset

enables all the front panel functions designated by keys with white lettering. It will save a trace response in TRACE B, but not A or C.

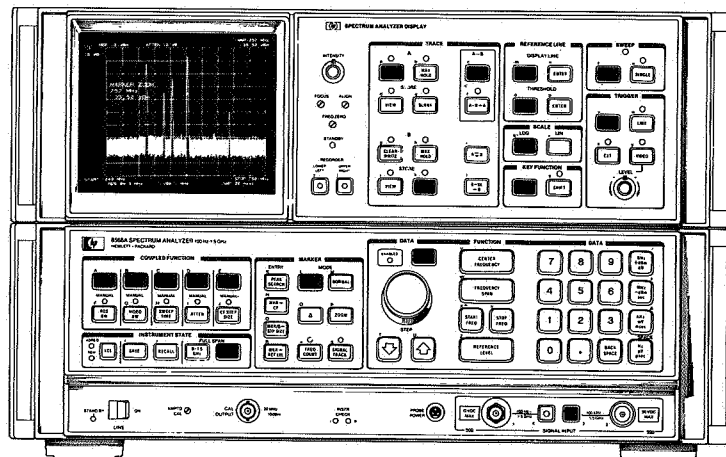

Functions Activated with

To be precise:

SIGNAL INPUT: Input 2 selected 100 kHz - 1.5 GHz
FUNCTION: Start Frequency 0 Hz
 Stop Frequency 1500 MHz
 Reference Level 0 dBm

DATA: Hold

COUPLED FUNCTION: All set to **AUTO** which corresponds to the following values:
 Resolution Bandwidth 3 MHz
 Video Bandwidth 1 MHz
 Sweep time 20 msec full scale
 Attenuator 10 dB, coupled to maintain <-10 dBm at input mixer
 Center Frequency Step Size 100 MHz entered in register

TRACE: A Clear-Write
 B Blanked but information in memory saved
 A — B Off
 Off

MARKER:

INSTRUMENT STATE

SAVE and **RECALL**: States are saved including the current state. See **RECALL** **7** below.

SCALE: Logarithmic, 10 dB/division

REFERENCE LINE: Display line off 5.5 divisions up
 Threshold off 1.0 divisions up

SWEEP: Continuous

TRIGGER: Free run

INSTR CHECK: An internal instrument check is made. If the check is false, lights will stay on.

KEY FUNCTION: Normal

FUNCTIONS: All **SHIFT** functions are disabled. For example, all titling is erased after an instrument preset. Chapter 12, **SHIFT** KEY FUNCTIONS, discusses the implications of activating instrument preset during **SHIFT** FUNCTION use.

If the key is activated (shift light on), **INSTR PRESET** unshifts the key. This is equivalent to pressing **NORMAL**.

HP-IB FUNCTIONS: "D1" Display size-normal
 "EM" Erase trace C memory
 "03" Output format ASCII absolute
 "PD" Pen down
 "DA" Display address set to 3072

Graphic information or control language written into the analyzer memory by HP-IB functions such as graph (GR), plot (PA), label (LB), or display write (DW) will be erased unless stored in trace memory B. Instrument preset also rewrites all the display graticule and character readouts into the appropriate section of the display memory.

See 8568A Spectrum Analyzer Remote Operation (HP part number 08568-90003) for further information.

FULL SPAN 0-1.5 GHz

0-1.5 GHz immediately sets the COUPLED FUNCTIONS **RES BW**, **VIDEO BW** and **SWEEP TIME** to automatic, the start frequency to 0 Hz and the stop frequency to 1500 MHz. The other front panel functions, **SHIFT** KEY FUNCTIONS or HP-IB only states are not changed.

Saving and Recalling Instrument States

(DATA keyboard entry) and (DATA keyboard entry) save and recall complete sets of user defined front panel function values. The DATA entry from the keyboard names the register which stores the instrument state. Six registers, through , can be saved and recalled. Only another will erase a saved register. The registers contain their last states even with a loss of line power (power failure). The registers are maintained with an internal battery supply for about a 30 day period after line power failure.

is a special recall function which recalls the instrument state prior to the *last* instrument preset or single function value change, which ever has most recently occurred. It aids in recovering from inadvertent entries.

The current instrument state, if the POWER switch is turned to STANDBY, (or a short term loss of ac line power) can be recovered at POWER ON if is activated previous to a power loss.

Some KEY FUNCTION values or states cannot be saved. Neither can information in the display memories, such as a title or trace.

The register is a buffer for instrument state transfer under remote operation and the and states are used for calibration signal adjustments.

Example

When a test sequence is used over and over, the instrument states can be set up in the registers prior to testing for recall during the procedure.

Keying in a specific state:

LIN SCALE

Then save with .

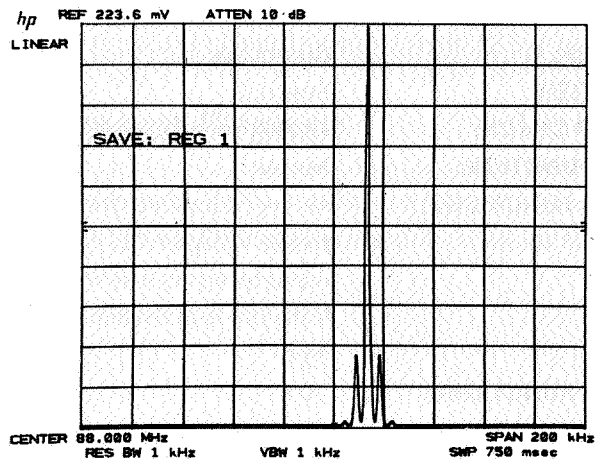

Press .

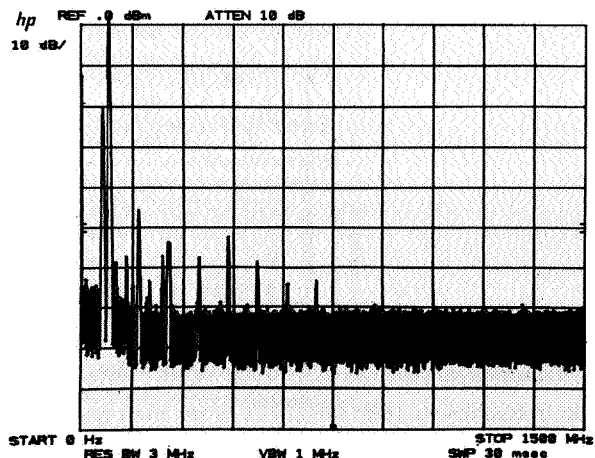

And recall the last state with .
 Once the state has been recalled, any function can be used for more detailed measurements.
 Note that in this case, the state could also have been recalled by .

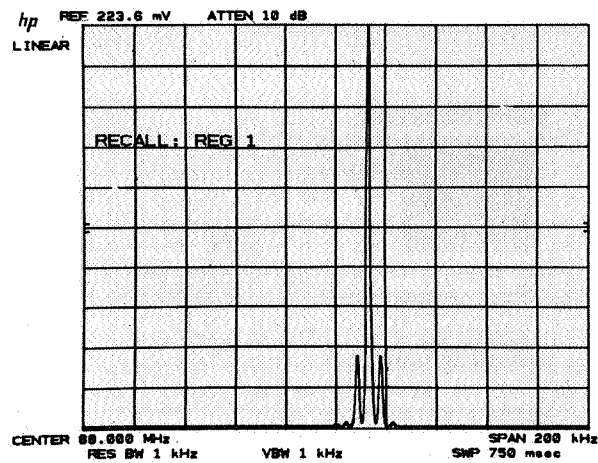

Local Operation

enables front panel control after an HP-IB remote LISTEN or TALK command has been executed. An HP-IB local lockout will disable until an HP-IB return to local command is executed or the LINE power is turned to STANDBY then ON again.

Indicates instrument has been addressed through HP-IB

Indicates instrument is in remote operation

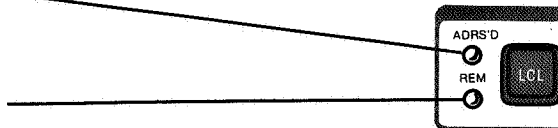

The addressed light remains on until an HP-IB device clear command or any unlisten command is executed. See 8568A Spectrum Analyzer Remote Operation, HP part number 08568-90003, for more detailed information.

Chapter 12

SHIFT KEY FUNCTIONS

This chapter describes access and use of the **SHIFT** KEY FUNCTIONS.

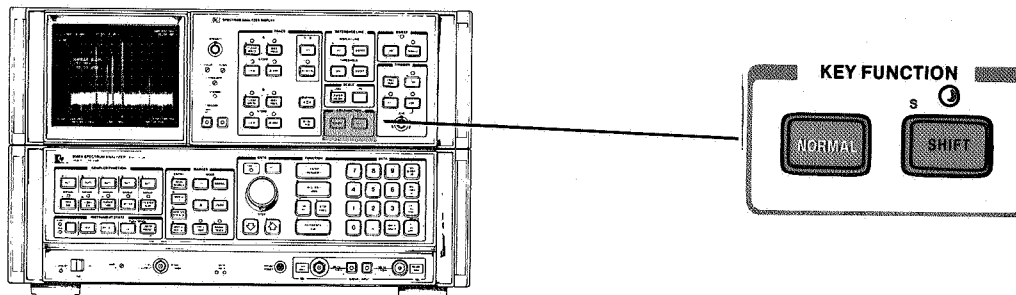

General Description

Shift functions supplement a front panel function or provide unique measurement capabilities. The **SHIFT** functions are not named on the front panel but are coded by the blue characters beside the keys. For example, the frequency offset function is designated by the code V. On the front panel the code V is found in the FUNCTION section:



The shift functions are activated by pressing **SHIFT** and then the front panel key with the appropriate blue code. A complete summary of shift FUNCTIONS is on the facing page. An index to all shift functions is on page 12.15.

Example

Activate the shift function V (frequency offset) with

press **SHIFT** shift light on

press **V**
CENTER
FREQUENCY shift light off and offset function activated

The shift light can always be turned off with **NORMAL**, which returns the front panel keys to their designated function. **NORMAL** does not disable the selected shift function (except for title).

DATA Entry

An active shift function value is readout and identified in the active function area of the display the same as any other function using DATA entry. Once the data has been entered, any other function can be activated. The shift function will retain its last value until **INSTR PRESET** or LINE power STANDBY.

DATA entries to shift functions are made only from the number/units keyboard. The ENABLED light remains off even though data may be entered.

Data is entered, that is, changes the instrument state, only when a units key is pressed. If the entry has no units (an address for example), use the **Hz** key as the terminator.

FUNCTION SUMMARY

General		Display		Instrument State	
HP-IB Service request	r	Annotation blanked	o	Save registers locked	(
Enter HP-IB address	P	Annotation on	p	Save registers unlocked)
Power on in last state	f	Display correction data	w		
Display Address	z	CRT beam off	g		
Display Write		CRT beam on	h		
Max mixer input level	,	Graticule blanked	m		
		Graticule on	n		
		Title	E		
Frequency		Trace		Error Correction	
Counter Resolution	=	A + B → A	c	Execute routine	W
Frequency offset	V	Detection:		Use correction data	X
Negative entry	-	normal	a	Do not use correction data	Y
		positive peak	b	Display data	w
		negative peak	d		
		sampling	e		
Amplitude		Trace C:			
Amplitude offset	Z	blank trace C	k		
Units: dBm	A	B = C	i	Diagnostics	
dBmV	B	B → C	l	Count pilot IF at marker	K
dB μ V	C	view trace C	j	Count signal IF at marker	Q
voltage	D			Count VTO at marker	N
Extended reference level		Video averaging on	G	Disable step gain	q
range	I	Video averaging off	H	Frequency diagnostic on	R
Negative entry	-			Inhibit phase lock flags	v
Preamp gain, input 1	<			Manual DACS control	J
Preamp gain, input 2	>			Measure sweep time	F
				Second LO auto	S
Marker				Second LO shift down	T
Counter resolution	=			Second LO shift up	U
Continue sweep from marker	t				
Enter Δ → span	O				
Noise level on	M	Trigger - Zero Span			
Noise level off	L	<input type="checkbox"/> Without 25 msec triggering	x		
Stop single sweep at marker	u	<input type="checkbox"/> Without 25 msec triggering	y		

ALPHABETICAL KEY CODE SUMMARY

A	Amplitude in dBm	U	Second LO shift up	o	Annotation blanked
B	Amplitude in dBmV	V	Frequency offset	p	Annotation on
C	Amplitude in dB μ V	W	Execute error correction routine	q	Disable step gain
D	Amplitude in voltage	X	Use correction data	r	HP-IB service request
E	Title	Y	Do not use correction data	t	Continue sweep from marker
F	Measure sweep time	Z	Amplitude offset	u	Stop single sweep at marker
G	Video averaging on	a	Normal detection	v	Inhibit phase lock flags
H	Video averaging off	b	Positive peak detection	w	Display correction data
I	Extended reference level range	c	A + B → A	x	<input type="checkbox"/> without 25 msec triggering
J	Manual DACS control	d	Negative peak detection	y	<input type="checkbox"/> without 25 msec triggering
K	Count pilot IF at marker	e	Sample detection	z	Display address
L	Noise level off	f	Power on in last state	-	Negative entry
M	Noise level on	g	CRT beam off	=	Counter resolution
N	Count VTO at marker	h	CRT beam on	(Save registers locked
O	Enter Δ → span	i	B = C)	Save registers, unlocked
P	Set HP-IB address	j	View trace C	<	Preamp gain, input 1
Q	Count signal IF at marker	k	Blank trace C	>	Preamp gain, input 2
R	Frequency diagnostic on	l	B → C		Display write
S	Second LO auto	m	Graticule blanked	,	Max mixer input level
T	Second LO shift down	n	Graticule on		

Negative DATA Keyboard Entry

Entering negative data from the DATA keyboard requires the use of a negative symbol prefix on the number entry.
negative entry:

For example to enter a negative 100 MHz offset frequency:

Press to activate frequency offset

Press to enter a negative frequency.

Not all values can be entered with a negative prefix, for example a negative entry to a voltage reference level will result in entering the positive value.

Negative entries in dB can be made with the -dBm units key or the negative prefix with the + dBm units key. If both negative prefix and are used, the value will be entered as positive.

Frequency and Amplitude Offset

The CRT display amplitude and frequency readout can be offset. Entering an offset does not affect the trace.

Frequency offset: (DATA keyboard entry)

Amplitude offset: (DATA keyboard entry)

Offset entries are added to all the frequency or amplitude readouts on the CRT display including marker, display line, threshold, start frequency and stop frequency.

FUNCTION

To eliminate an offset, activate the offset and enter zero. also sets the offsets to zero.

Offsets are stored with the functions for recall with .

When an offset is entered its value is displayed on the CRT.

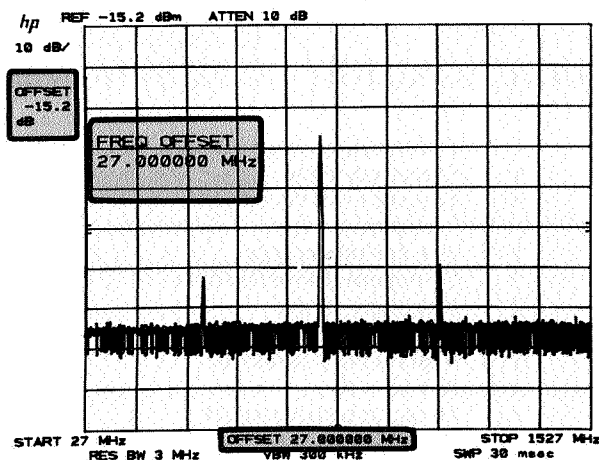

DATA entry from the keyboard can be in Hz, kHz, MHz or GHz for frequency and dB, -dB, mV and μ V for amplitude. The amplitude offset readout is always in dB. An entry in voltage can be made and will be converted to dB offset.

The offset range for frequency is -99.999999990 GHz to +99.999999999 GHz in 1 Hz steps. The amplitude offset range is greater than ± 100 dB in 0.1 dB steps. Least significant digits will be rounded for frequency and dropped for amplitude offset entries.

Example

An 102.6 MHz up converter with 12.7 dB attenuation is placed between a signal source and the spectrum analyzer. The offsets can be set so that the CRT display shows the trace referenced to the signal as input to the converter.

Amplitude offset is entered as a positive value to compensate (offset) the loss of the converter.

Press **Z**
 SHIFT REFERENCE LEVEL 1 2 . 7
 GHz +dBm dB

Note that the original REF LEVEL of 0 dBm is now changed to 12.7 dBm also.

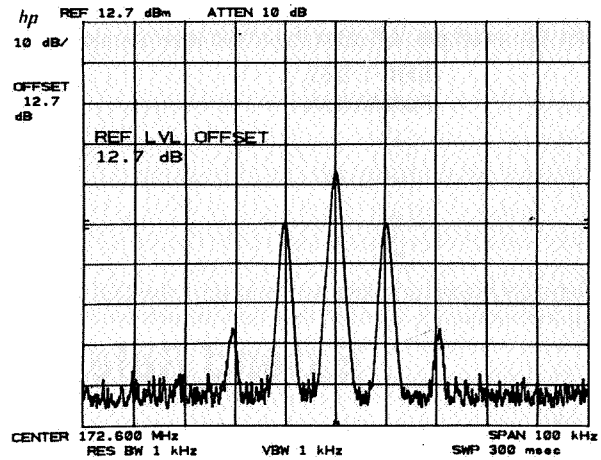

Frequency offset is entered as a negative value since the input frequency to the converter is lower than the output.

Press **V**
 SHIFT CENTER FREQUENCY SHIFT
 HOLD 1 0 2
 . 6 MHz -dBm sec

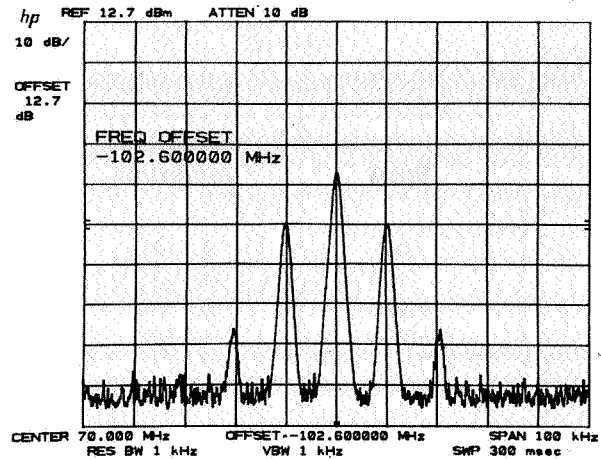

Input Mixer Level

As the reference level is changed, the coupled input attenuator is changed to keep the power levels of on-screen signals below -10 dBm at the input mixer. (The input mixer level is the input signal level minus the attenuator setting.) This input mixer level can be changed in 10 dB steps by pressing

SHIFT 0-15 GHz (DATA keyboard entry)

An input mixer level of -50 dBm ensures that the analyzer has best dynamic range as long as the input signal's total power level is below the analyzer's reference level. Also see Appendix C.

Instrument preset resets the input mixer level to -10 dBm.

Preamp Gain

Similar to the amplitude offset functions, the preamp gain function allows a positive or negative amplitude offset to all the amplitude readouts. The offsets are *subtracted* from the amplitude readouts so that the displayed amplitudes represent the power levels at the *input* of the preamp. Each signal input can be offset by different amounts.

Preamp gain, input 1: SHIFT < (DATA keyboard entry) } The < key is beside Input 1, and the
 Preamp gain, input 2: SHIFT > (DATA keyboard entry) } > key is beside the Input 2.

The offset is not read out on the CRT. Instrument preset resets the gains to 0 dB.

Amplitude Units Selection

The following shift key codes immediately select the corresponding units for all the amplitude readouts: reference level, marker, display line and threshold.

When a units change is made, all readouts are converted so as to preserve the absolute power levels of all the readouts. For example, a 0 dBm threshold level converts to 47.0 dBmV (50 ohm input) when dBmV units are called.

SHIFT KEY FUNCTION		AMPLITUDE UNITS
SHIFT A	or INSTR PRESET	dBm
SHIFT B		dBmV
SHIFT C		dB μ V
SHIFT D		voltage

The keys for these functions are located in the COUPLED FUNCTION group.

Extend Reference Level Range

Normally the reference level can be set to from -89.9 dBm to + 30.0 dBm in coupled operation. The limits of the range can be extended to a maximum of - 139.9 dBm and + 60.0 dBm.

Press SHIFT ALTEN

The lower limit of reference level depends upon resolution bandwidth, scale and attenuation.

Scale	Resolution Bandwidth	Minimum reference level with extended reference level	
		10 dB attenuation	0 dB attenuation
log	\leq 1 kHz	-129.9 dBm	-139.9 dBm
log	\geq 3 kHz	-109.9 dBm	-119.9 dBm
linear	\leq 1 kHz	-109.9 dBm	-119.9 dBm
linear	\geq 3 kHz	- 89.9 dBm	- 99.9 dBm

When the reference level is set at a minimum, the level may change if either scale or resolution bandwidth is changed. The extended range is disabled with instrument preset.

Counter Resolution

When FREQ COUNT is activated, the frequency of the signal marked by the active marker is counted. For more details see MARKER FREQ COUNT, Chapter 7, page 7.14. In this mode the resolution of the count is the same as the center frequency readout. To increase the resolution

=
press SHIFT FREQ COUNT (DATA keyboard entry).

For spans \leq 2 MHz, the data entry sets the least frequency digit to be counted. For example:

DATA entry	Readout for 100 MHz
100 kHz	100.0 MHz
10 kHz	100.00 MHz
1 kHz	100.000 MHz
100 Hz	100.0000 MHz
10 Hz	100.00000 MHz
1 Hz	100.000000 MHz

Counter resolution can be set between 1 Hz and 100 kHz. The resolution of the counter frequency will remain fixed until changed with a counter resolution data entry or until INSTR PRESET is used. The counter resolution cannot be stored with

SAVE

Values entered other than decade numbers, such as 25 Hz and 326 kHz, will be rounded to the next legal value. For example, a counter resolution data entry of 25 Hz will be entered as 10 Hz, and 326 kHz will become 100 kHz resolution.

Marker Sweeps

When a marker is displayed, the sweep can be made to stop at the active marker and to continue from the active marker. The front panel continuous sweep function is suspended but the sweep trigger and data conditions must still be met. See Chapter 10, SWEEP and TRIGGER.

Stop Sweep at Marker, TALK after Marker

To stop the sweep at the marker,

press MARKER and
press u.

A marker must be activated to enter this sweep function.

Each time a sweep is triggered, it will stop at the marker, even if the marker has been moved. A marker being moved when the sweep passes may not stop the sweep.

To disable the stop sweep at marker functions

press MARKER or .

In remote operation, the analyzer will not TALK until the trace sweep stops at the marker. TALK is suspended by keeping the HP-IB Data Valid line not true until the marker is placed.

Continue Sweep from Marker

To start the sweep at the active marker it is first necessary to activate the stop-sweep-at-marker function above. Then

press t.

Each time t is pressed the sweep will start at the active marker, continue through a full sweep back to the same marker and stop.

Graticule and Annotation On/Off

The graticule and character readouts can be selectively blanked with key functions. This is valuable when alternative graphics are drawn on the CRT through the HP-IB.

Graticule

Blank: press m

On: press n

Annotation

Blank: press o

On: press p

Display with annotation (characters) and graticule blanked.

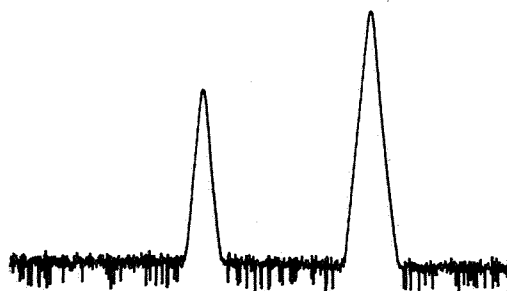

Display blanking does not affect HP-IB input/output of instrument function values or trace information.

CRT Beam On/Off

The CRT beam power supply can be turned off to avoid unnecessary wear of the CRT if the analyzer is operated unattended. Reducing intensity or blanking the traces does not reduce wear.

Beam off: press **SHIFT** g

Beam on: press **SHIFT** h

CRT beam power off does not affect HP-IB input/output of instrument function values or trace information.

Display Correction Data and Special Messages

The correction data generated from the error correction routine, can be displayed.

Display correction data: press **SHIFT** w (lower case)

Do not display correction data: press **INSTR PRESET**

The readout is detailed on page 12.13.

The instrument operating special messages can be displayed by disrupting the analyzers operation.

Display warning messages: press **SHIFT** v (by inhibiting phase lock flag)

Do not display special messages: press **INSTR PRESET**

More on the meaning of these messages can be found in the 8568A Operating and Service Manual, Section VIII.

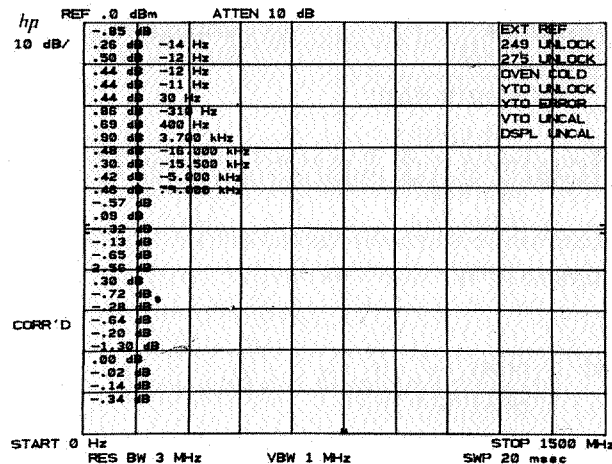

Both Correction Data and Special Messages Displayed

Title

The user can write a message in the top CRT display line. When the title is activated, the front panel blue characters, number keyboard numbers, decimal, backspace and space can be typed onto the top line starting at the left of the display. The full width of the display can be used, however, marker readout may interfere with the last 16 characters of the title.

Activate title: **SHIFT** E (shift light on)

Enter text: abcdefghijklmnopqrstuvwxyz

ABCDEFGHIJKLMNOPQRSTUVWXYZ

/#&= (.) > <

0123456789. [space]

To end a title: press **NORMAL** (shift light off)

A title will remain on the display until the title function is activated again, **INSTR PRESET** is pressed or an instrument state is recalled with **RECALL**.

To erase a title without changing the instrument state, end the title function if still active, then

press **SHIFT** E **NORMAL**

A + B → A

A + B → A enables the restoration of the original trace A after a **A←B→A** has been activated. A + B → A is executed with both Trace A and Trace B in **VIEW**:

press **SHIFT** c.

When executed, **A←B→A** is turned off and the amplitude in trace B is added to the amplitude in trace A (in display units) and the result is written into trace A.

Additional A + B → A executions will each add another trace B response to the cumulative trace A.

Trace Detection Modes

One of four detection techniques can be selected for displaying trace information.

Mode	Access	Use
normal	INSTR PRESET or SHIFT a	<ul style="list-style-type: none"> • Most measurements.
sample	SHIFT e	<ul style="list-style-type: none"> • Noise Level Measurements • Zero frequency span waveforms for sweeptimes ≥ 20 msec • Video averaging
positive peak negative peak	SHIFT b SHIFT d	<ul style="list-style-type: none"> • Diagnostic aids for servicing.

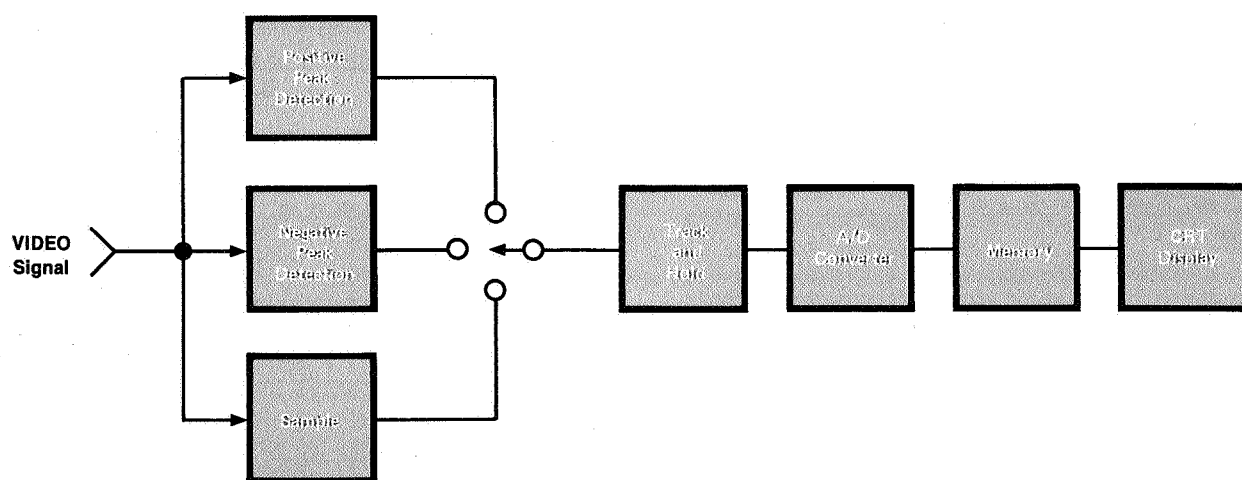

During a sweep, only a specified amount of time is available for writing data into each of the 1001 trace memory addresses. In two of these time periods, the positive and negative peak detectors obtain the maximum and minimum IF signal excursions, respectively, and store these values in *alternate* trace memory addresses. This technique allows a graphic presentation of noise on the CRT display.

Normal Mode

In normal mode a detection algorithm selectively chooses between the positive and negative peak values to be displayed. The choice is made dependent upon the type of VIDEO signal present.

Data from the positive peak detector (signal maximums) will always be displayed in the odd addressed trace memories (1,3, . . . 1001). If, within the time period following the storage of a value in an odd address memory, there is no change in VIDEO signal level, the positive peak detector value will also be stored in the even address. In other words, the even addressed memory will also contain positive peak detection data if the signal during that time period is monotonic. Negative peak detector data (VIDEO signal minimum) will be stored in the even addressed trace memory if the signal has a point of inflection during the time period.

Normal mode is selected with instrument preset.

Sample Mode

In the sample mode, the *instantaneous* signal value of the final analog-to-digital conversion for the time period is placed in memory. (As sweeptime increases, many analog-to-digital conversions occur in each time period but only the final, single value can be stored.)

Sample mode is selected automatically for video averaging and noise level.

Positive and Negative Peak Modes

Positive and negative peak modes store signal maximums and minimums respectively, in all trace memories.

Readout

Here, the same signal response is displayed with each trace detection mode.

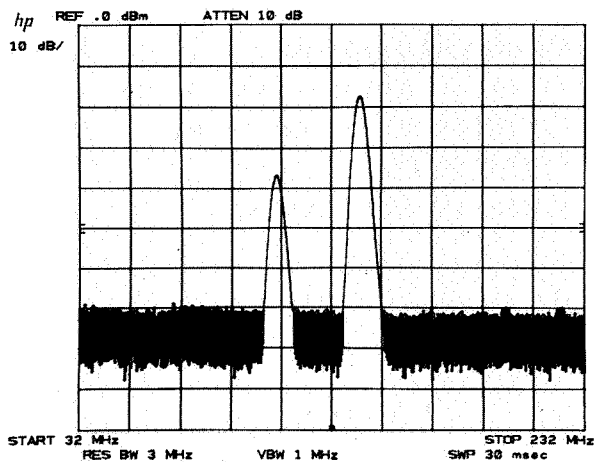

Normal

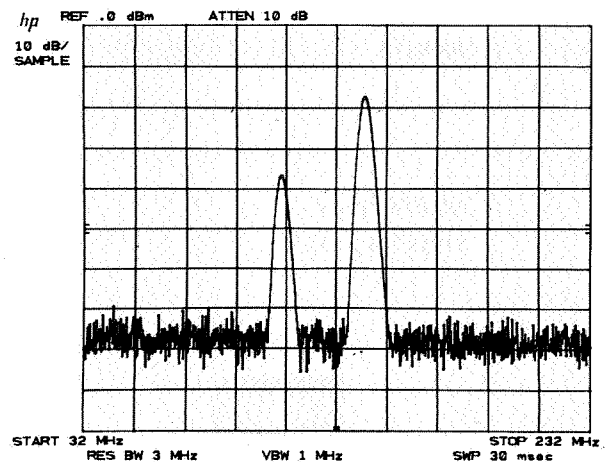

Sample

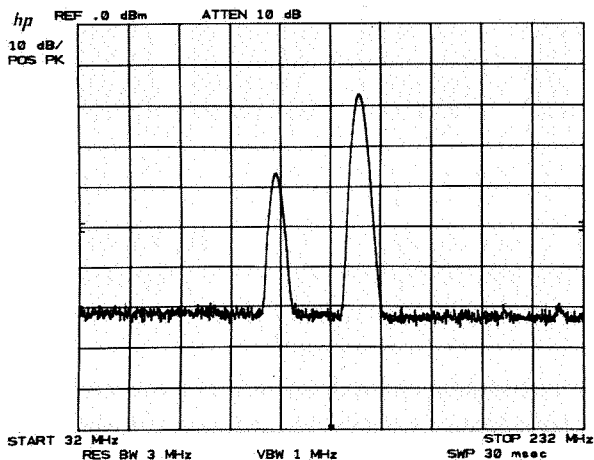

Positive Peak

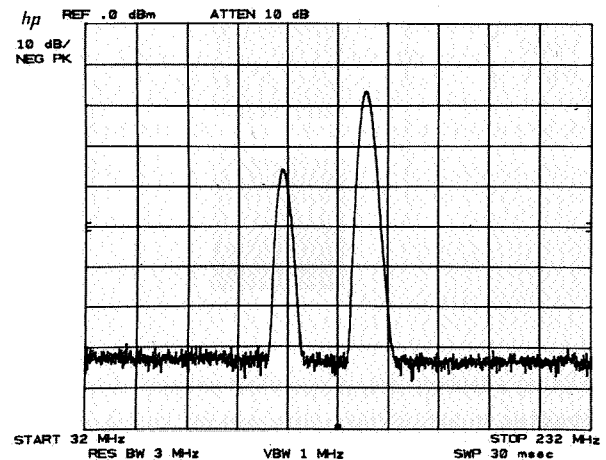

Negative Peak

Trace C

A third trace memory is available for the storage and display of trace information. Only the storage modes (view and blank) can be used.

View C: SHIFT j

Blank C: SHIFT k

These are analogous to the TRACE A and B modes discussed in Chapter 6.

Trace C cannot be written into directly from the analyzer except when video averaging is used.

Trace information from B can be transferred to C. To transfer from TRACE B to TRACE C, use

B → C: SHIFT B-DL → B

The sweep will be suspended, the trace in memory B will be read and written into trace C from left to right in about 20 msec. Trace C is viewed. Sweeping will then resume from where suspended. The trace information in B is not changed.

To exchange traces B and C

B ↔ C: SHIFT i

The trace information in B and C is interchanged point for point from left to right in about 20 msec. If TRACE B was blanked, it stays blanked. If trace C was blanked, it stays blanked.

To store TRACE A into trace C, the trace A data must first be transferred into trace B:

press A ↔ B SHIFT l (which also erases last trace C)

or press A ↔ B SHIFT i (which also saves last trace C in B)

Example

Comparisons of up to three different signal traces can be made simultaneously using traces A, B and C. In this example, the modulation level of a signal will be changed for each trace. To start, clear the display with

SHIFT k

The signal with the desired level of modulation will be stored in trace C:

Press CLEAR-WRITE B and allow one sweep.

Press SHIFT l which writes the trace from B into C.

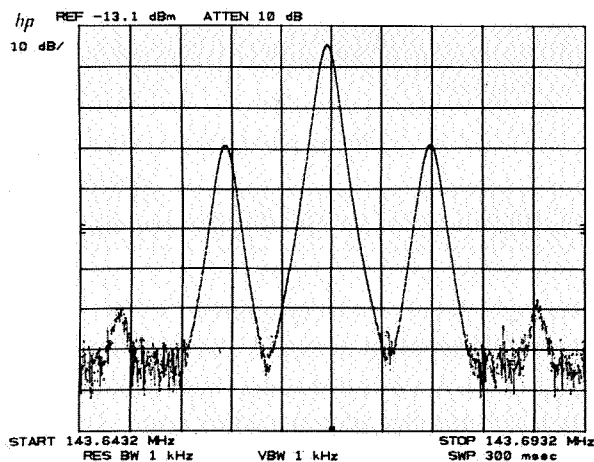

Change the modulation level, allow one sweep and store in B with VIEW B.

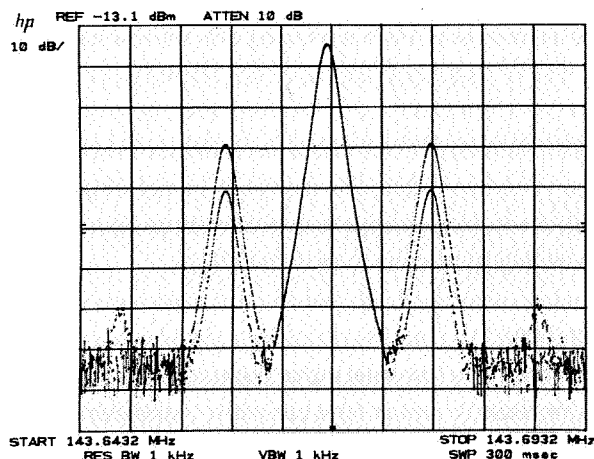

SHIFT

FUNCTION

Change the modulation level again and store in A, press **CLEAR-WRITE** A, allow one sweep and press **VIEW** A. The three traces are differentiated by intensity.

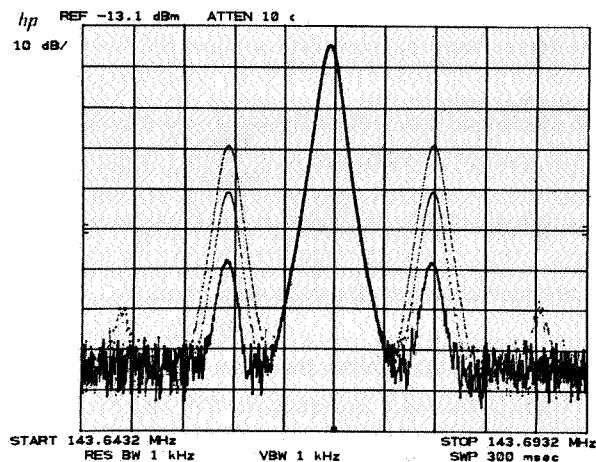

Video Averaging

Video averaging is a trace display routine that averages trace responses from sweep to sweep without requiring a narrow video bandwidth. (Averaging with the video bandwidth is discussed in Chapter 9, COUPLED FUNCTION **VIDEO BW**.) Both video averaging and reducing video bandwidth are primarily used to improve the analyzer's ability to measure low level signals by smoothing the noise response.

To activate video averaging (and sample detection mode)

press **SHIFT** **G** **VIDEO BW** (DATA keyboard entry).

To disable video averaging press **SHIFT** **H** **SWEEP TIME**

CAUTION

Video averaging may result in an uncalibrated amplitude display when

$$\frac{\text{frequency span}}{\text{resolution bandwidth}} > 1000$$

Readout in the active function display area is "VID AVG 100". The number represents the maximum number of samples (or sweeps) for complete averaging. The DATA entry can be used to change the maximum sample number in integers from 0 to 32767. A unity sample limit allows direct writing of analyzer response into Trace C (see Trace C below). A 100 sample limit is selected upon instrument preset. The higher the sample limit, the more smoothing possible. Averaging with high sample limits can provide more smoothing than the 1 Hz video bandwidth.

During video averaging the current sample being taken is read out at the left of the display.

The advantage of video averaging over narrowing the video filter is the ability of the user to see changes made to the amplitude or frequency scaling of the display while smoothing the noise response. For example, when a 100 Hz video bandwidth is used with a 200 kHz frequency span, the sweep time is 2 sec. Almost a full sweep time duration would have to pass before any center frequency change effect on the trace could be seen. If video averaging is used instead of the narrow video bandwidth, any change to center frequency will be seen immediately, even though full averaging will take roughly 6 sec. (Any change to control settings such as CENTER FREQUENCY, FREQUENCY SPAN, etc., will cause the video averaging process to be restarted.)

Example

To display very low level signal responses, very narrow resolution and video bandwidths are required. The accompanying increase in sweep time can make measurements cumbersome. Video averaging allows the display of low level signals without the long sweep time.

Viewing a low level signal with a video bandwidth of 1 Hz requires a 150 second sweep.

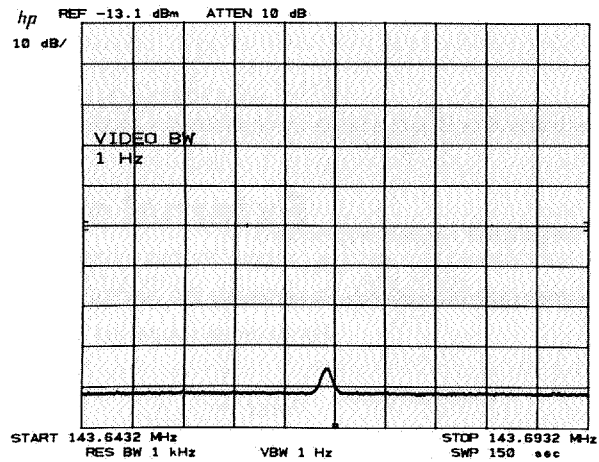

Take out the narrow resolution and video filters with video bandwidth and start video averaging, press .

Now the low level signals begin to show quickly. Changes to the frequency range or amplitude scale will restart the sampling to show the signals quickly, without having to wait 150 seconds. In fact, the video averaging shown took 42 x 300 ms = 12.6 sec., plus the internal computation time, 42 x 100 ms = 4.2 sec., for a total of 16.8 sec.

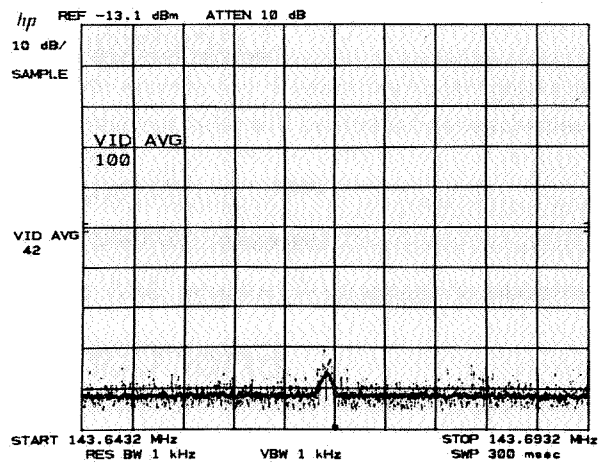

Video Averaging Algorithm

The averaging of each amplitude point depends upon the number of samples already taken and last average amplitude.

$$\bar{y}_n = \frac{n-1}{n} \bar{y}_{n-1} + \frac{1}{n} y_n$$

where \bar{y}_n latest average amplitude value in display units
 n current sample number

\bar{y}_{n-1} last average amplitude in trace memory (TRACE A or B)
 y_n new amplitude entry from analyzer (Trace C)

The new amplitude value, \bar{y}_n is weighted more heavily by the last average amplitude \bar{y}_{n-1} than the new amplitude entry, y_n .

When n equals the limit set (e.g. 100, the preset limit), the last average amplitude is gradually replaced with new data. Thus, the average will follow a slowly changing signal response, particularly if the sample limit is small.

Trace C

Video averaging requires the use of trace memory C. When video averaging is activated, the input signal response is written into trace C, the averaging algorithm is applied to these amplitudes and the results written into TRACE A. Thus two traces are displayed, the input signal in C and the averaged signal in A.

Trace C may be blanked without affecting the operation of video averaging.

Press k

SHIFT

FUNCTION

Trace C may be written into as traces A and B if a video average sample limit of one is selected.

G

Press

If either trace A or B is in a write trace mode the analyzer response will also be written into trace C.

External and Video Trigger

The front panel and trigger modes automatically keep the display refreshed in zero frequency spans for sweep times less than 20 ms. To eliminate the automatic refresh feature:

For external triggering

X

Press

For video triggering

Y

Press

Locking Save Registers

After saving instrument states in one or more of the six registers, 1 through 6, the registers can be secured from being written over and destroyed. The recall function is not affected.

Lock:
Unlocked: or

When locked, an attempt to will write "SAVE LOCKED" on the CRT and no DATA entry can be made.

Error Correction Routine

A built-in analyzer routine measures and records the amplitude and frequency error factors due to a number of parameters, then corrects the display for them. The routine takes about 1½ minutes to run. When complete, instrument preset will be called and the correction factors applied.

Connect CAL OUT to SIGNAL INPUT 2.

Execute the routine: W

Use Correction factors: X

Do not use correction factors: Y

Display correction factors: W

If "ADJUST FREQ ZERO" appears on the CRT, manual calibration adjustment is necessary before the routine can be successfully run. See Chapter 1 for the manual calibration procedure.

The correction factors are saved using an internal battery supply for about a 30 day period after line power failure. If the battery supply should be exhausted, all the values will be set to zero.

Indicates that the routine has been run and the display is corrected.

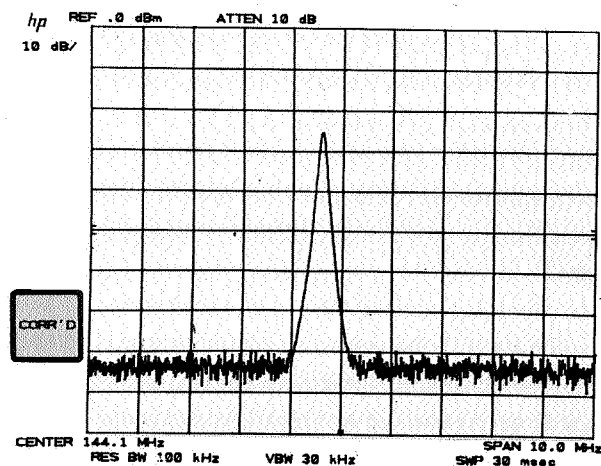

Correction can be turned on or off using **SHIFT** X and **SHIFT** Z after the routine has been successfully completed. Display of the correction factors is discussed on page 12.7.

For more information on accuracy, see the 8568A Spectrum Analyzer Data Sheet.

The readout of the correction factors is as follows:

Line (top to bottom)	Parameter	Correction Values Displayed
1	LOG and LIN scale, BW < 100 kHz	Amplitude
2	RES BW = 10 Hz	Both
3	30 Hz	
4	100 Hz	
5	300 Hz	
6	1 kHz	
7	3 kHz	
8	10 kHz	
9	30 kHz	
10	100 kHz	
11	300 kHz	
12	1 MHz	
13	3 MHz	
14	LOG and LIN scale, BW ≥ 100 kHz	
15	2nd local oscillator frequency shift	
16	30 dB gain	
17	20 dB gain	
18	10 dB gain	
} LIN operation only		
19	50 dB step gain errors	
20	40 dB	
21	30 dB	
22	20 dB	
23	10 dB	
24	0 dB	
25	- 10 dB	
26	- 20 dB	
27	offset error 2 dB/ LOG	
28	offset error 5 dB/ LOG	
29	offset error 10 dB/ LOG	

SHIFT **FUNCTION Index**

All the shift functions are listed below. (DATA) indicates the functions that use a number and unit entry.

	CODE	DISABLE CODE OR KEY	PAGE
GENERAL			
Display Address (DATA)	z		*
Display Write (DATA)			*
HP-IB service request	r		*
HP-IB address (DATA)	P		*
Power on in last state	f		11.3
Max. mixer input level	,		12.4

FREQUENCY AND AMPLITUDE

Amplitude offset	Z		12.3
Amplitude units selection			
dBm	A		12.5
dBmV	B		12.5
dB μ V	C		12.5
voltage	D		12.5
Extended reference level			
range (DATA)	I		12.5
Frequency offset (DATA)	V		12.3
Input mixer level	,		
Negative entry (DATA)	-		12.3
Preamp gain, Input 1 (DATA)	<		12.4
Preamp gain, Input 2 (DATA)	>		12.4

MARKER

Counter resolution (DATA)	=	= MARKER	12.5
Continue sweep from marker	t	OFF	12.6
Enter $\Delta \rightarrow$ Span	O		7.10
Noise Level on	M		7.16
Noise Level off	L		7.16
Stop single sweep at marker, TALK after marker	u	MARKER OFF	12.6

DISPLAY

Annotation blanked	o		12.6
Annotation on	p		12.6
CRT beam off	g		12.7
CRT beam on	h		12.7

	CODE	DISABLE CODE OR KEY	PAGE
Display correction data	w		12.7
Frequency diagnostic on	R		*
Graticule blanked	m		12.6
Graticule on	n		12.6
Title	E	NORMAL	12.7

TRACE

A + B - A	c		12.8
Detection Modes:			
normal	a		12.8
positive peak	b		12.8
negative peak	d		12.8
sample	e		12.8

Trace C

blank C	k		12.10
B \leftrightarrow C	i		12.10
B \rightarrow C	l		12.10
view C	j		12.10
Video averaging on	G		12.11
Video averaging off	H		12.11

TRIGGER, ZERO SPAN, SWEEP < 20 msec

EXT without 25 msec trigger	x	EXT	12.13
VIDEO without 25 msec trigger	y	VIDEO	12.13

INSTRUMENT STATE

Save Registers locked	(12.13
Save Registers unlocked)		12.13

ERROR CORRECTION

Execute Routine	W		12.13
Use data (display corrected)	X		12.13
Do not use data (display not corrected)	Y		12.13
Display correction data on CRT	w		12.13

DIAGNOSTIC AIDS

To aid in servicing the spectrum analyzer, there are a number of diagnostic shift functions. These functions are listed here, their operation and use is covered in the 8568A Operating and Service Manual, Section VIII.

	CODE		CODE		CODE
Count pilot IF at marker	K	Inhibit phase lock flags	v	Second LO auto	S
Count signal IF at marker	Q	Disable step gain	q	Second LO shift down	T
Count VTO at marker	N	Manual DACS control	J	Second LO shift up	U
Frequency diagnostic on	R	Scan time measure	F		

*See 8568A Spectrum Analyzer Remote Operation, HP part number 08568-90003.

Index

— A —			
Active Function	5.1, 1.6	ENABLED	3.2
ALIGN	5.1	Error Correction	1.3, 12.13, 12.14
Amplitude Calibration	4.2, 1.3		
Amplitude Modulation Index	7.5	— F —	
Amplitude Offset	12.3, 4.10	FOCUS	5.1
(Also see Preamp Gain)		FREQ ZERO	1.3
Amplitude Units Selection	12.5, 7.5	Frequency Calibration	4.2
Annotation on/off	12.6	FREQUENCY COUNT	7.14
Attenuation	9.6	Frequency Display Range	4.2
(See Preamp Gain)		Frequency Drift Compensation	
AUTO	9.1, 2.4	(see SIGNAL TRACK)	
(also see COUPLED FUNCTION)		Frequency Offset	12.3, 4.10
Automatic Spectrum Analyzer	2.5	Frequency Response Measurement	6.5
		(Example)	
— B —		FREQUENCY SPAN	4.4
BACK SPACE	3.3	Front Panel	1.5, 2.1
Baseline Clipper		(also see foldout)	
(see THRESHOLD)		FULL SPAN	11.2, 2.2
BLANK	6.2	FUNCTION	4.1
Blank		(also see individual functions)	
Annotation	12.6		
Display (CRT)	12.7	— G —	
Graticule	5.3, 12.6	Graticule	5.3
Blue Front Panel Characters	12.1	High Intensity	5.3
		On/Off	12.6
— C —			
CAL OUTPUT	1.3	— H —	
Calibration Procedures	1.3, 12.13	Harmonic Distortion	7.4
CENTER FREQUENCY	4.2	HOLD	3.2
CENTER FREQUENCY STEP SIZE	9.1, 9.8	HP-IB	2.5, 11.4
CLEAR-WRITE	6.1		
Counter Resolution	12.5	— I, J —	
COUPLED FUNCTION	9.1	INPUT	
ATTENUATION	9.6, 9.1	(see SIGNAL INPUT)	
AUTO	9.1	Input Attenuation	
CF STEP SIZE	9.8, 9.1	(see COUPLED FUNCTION ATTENUATION)	
RESOLUTION BW	9.2, 9.1	Input Mixer Limit	12.4
SWEEP TIME	9.4, 9.1, 4.5	INSTR CHECK	1.3
VIDEO BW	9.3, 9.1	INSTRUMENT PRESET	11.1
CRT Display	5.1, 1.6	INSTRUMENT STATE	11.1
Beam Off/On	12.7	FULL SPAN, 0-1.5 GHz	11.2
(also see Display)		INSTRUMENT PRESET	11.1
CRT Photography	5.3	LCL (Local Operation)	11.4
		SAVE and RECALL	11.3, 12.13
— D —		INTENSITY	5.1
DATA	3.1		
ENABLED	3.2	— K —	
HOLD	3.2	KEY FUNCTIONS	12.1
Knob	3.1	Index	12.15
Negative Entry	3.3, 12.3	NORMAL	12.1
Number/Units Keyboard	3.2	SHIFT	12.1
STEP Keys	3.2		
dBm	12.5	— L —	
dBmV	12.5	LINE Power	
dB μ V	12.5	ON	1.3
Detection Modes (see Trace Detection Modes)		STANDBY	1.3, 5.1
Diagnostic Aids	12.7	LINEAR	8.1
Display Line	8.4	LCL (Local)	11.4
Display	5.1	LOG	8.1
Readout	5.1		
Titling	12.7		
Units	12.5		

— M —	
MARKER	7.1, 2.3
Active	7.1
Differential, Δ	7.3
ENTRY	7.10
FREQ COUNT	7.14
Noise Level Measurement	7.16
NORMAL	7.2
OFF	7.2
ON	7.2
PEAK SEARCH	7.10
SIGNAL TRACK	7.13
Sweeps	12.6
ZOOM	7.6, 7.9
MAX HOLD	6.1

— N —	
Noise Level Measurement	7.16

— O —	
Operating Precautions	1.4
Outputs	1.7
HP-IB	1.7
Recorder	1.7
x, y and z	1.7

— P —	
Peak Detection Modes	12.8
Peak Search	7.10
Performance	1.1
Preamp Gain	12.4
PROBE POWER	1.4

— Q,R —	
Readouts	5.4, 12.7
RECALL	11.3, 12.13
RECORDER	
Lower Left Output	1.7
Upper Right Output	1.7
REFERENCE LEVEL	4.7
Extended Range	12.5
REFERENCE LINE	8.4
DISPLAY LINE	8.4
THRESHOLD	8.5, 8.4
Refresh	6.2
REM Light	11.4
Remote Operation	11.4
Resolution Bandwidth	9.2
RF Attenuation	9.6

— S —	
Sample Detection Mode	12.8
SAVE	11.3, 12.13
SCALE	8.1
Linear	8.1
Logarithmic	8.1

SIGNAL INPUT	1.4
SIGNAL TRACK	7.13, 4.4
SHIFT	12.1
Span	4.4
START FREQUENCY	4.6
STOP FREQUENCY	4.6
SWEEP	10.1, 6.2
Continuous	10.1
Single	10.1
Sweep Time	9.4
Swept Measurement (Example)	6.5

— T —	
THRESHOLD	8.5
Time Domain Measurement (see Zero Frequency Span)	
Title	12.7, 5.4
TRACE	6.1
A + B → A	12.8
A - B → A	6.5
A - B OFF	6.5
A → B	6.4
Arithmetic	6.5
B - DL → B	6.5
BLANK	6.1
C	6.5, 12.10, 12.12
CLEAR-WRITE	6.1, 6.2
Detection Modes	12.8
Identification	6.1
MAX HOLD	6.2
Priority	6.7
STORE Modes	6.2
VIEW	6.1, 6.2
Write Modes	6.2
TRIGGER	10.2
Automatic, Zero Span	10.2
EXTERNAL	10.2, 12.13
FREE RUN	10.1
LINE	10.1
VIDEO	10.2, 12.13
VIDEO Level	10.3

— U —	
Units (see Amplitude Units Selection)	12.5

— V —	
Video Averaging	12.12, 9.4
Video Bandwidth	9.3
VIEW	6.1, 6.2
Voltage (also see LINEAR)	12.5

— W,X,Y,Z —	
Zero Frequency Span	4.5, 10.2
Zoom	7.6
Automatic	7.9

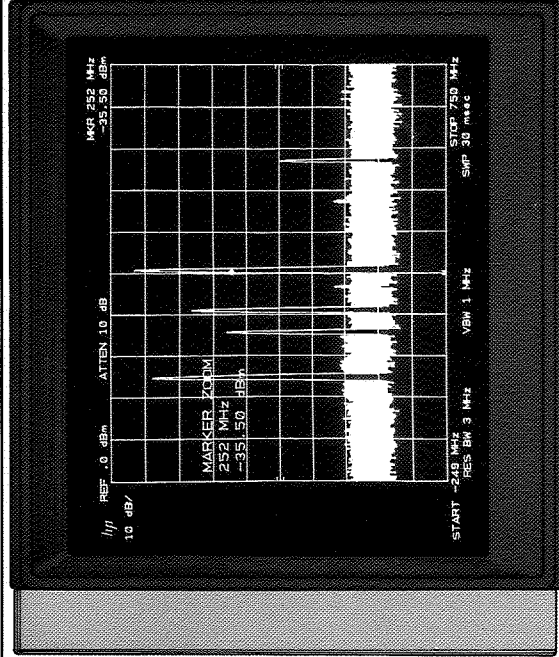

TRACE

A CLEAR WRITE STORE VIEW MAX HOLD BLANK

B CLEAR WRITE STORE VIEW MAX HOLD BLANK

INTENSITY **ALIGN** **FREQZERO** **STANDBY** **RECORDER** **UPPER** **RIGHT** **LOWER** **LEFT** **Z**

TRACE
 A-B
 C
 D
 E
 F
 G
 H
 I
 J
 K
 L
 M
 N
 O
 P
 Q
 R
 S
 T
 U
 V
 W
 X
 Y
 Z

REFERENCE LINE
 DISPLAY LINE
 THRESHOLD
 SCALE LINE
 LOG
 KEY FUNCTION

SWEEP
 SINGLE
 TRIGGER
 LINE
 VIDEO
 LEVEL

8568A SPECTRUM ANALYZER 100 Hz-1.5 GHz
 HEWLETT • PACKARD

COUPLED FUNCTION

A MANUAL RES BW **F** MANUAL 10 Hz
B MANUAL VIDEO BW **G** MANUAL SWEEP TIME
C MANUAL ATTEN **H** MANUAL FULL SPAN
D MANUAL OF STEP SIZE **I** MANUAL MARKER TRACK
E MANUAL MARKER COUNT

MARKER MODE
 OFF NORMAL ZOOM
 Δ

ENTRY
 K PEAK SEARCH
 L MARKER ON/OFF
 M MARKER STEP SIZE
 N MARKER REF. VAL.

FUNCTION
 CENTER FREQUENCY
 FREQUENCY SPAN
 START FREQ
 STOP FREQ
 REFERENCE LEVEL

DATA
 0 1 2 3 4 5 6 7 8 9

DATA
 100 Hz 1.5 GHz
 500 500

INSTRUMENT STATE
 ADRSD REM CAL
 INSTR CHECK

POWER
 PROBE POWER

LINE
 ON

CAL OUTPUT
 20 MHz 100 dBm

SIGNAL INPUT



For more information, call your local HP Sales Office or East (301) 948-6370 • Midwest (312) 255-9800 • South (404) 955-1500 • West (213) 877-1282. Or, write: Hewlett-Packard, 1501 Page Mill Road, Palo Alto, California 94304. In Europe, Post Office Box, CH-1217 Meyrin 2, Geneva, Switzerland. In Japan, Yokogawa-Hewlett-Packard, 1-59-1, Yoyogi, Shibuya-Ku, Tokyo, 151.

HP Part No. 08568-90002

OCTOBER 1978

Printed in U.S.A.