

Errata

Title & Document Type: 8657A Service Manual - July 1993

Manual Part Number: 08657-90157

Revision Date: July 1993

HP References in this Manual

This manual may contain references to HP or Hewlett-Packard. Please note that Hewlett-Packard's former test and measurement, semiconductor products and chemical analysis businesses are now part of Agilent Technologies. We have made no changes to this manual copy. The HP XXXX referred to in this document is now the Agilent XXXX. For example, model number HP8648A is now model number Agilent 8648A.

About this Manual

We've added this manual to the Agilent website in an effort to help you support your product. This manual provides the best information we could find. It may be incomplete or contain dated information, and the scan quality may not be ideal. If we find a better copy in the future, we will add it to the Agilent website.

Support for Your Product

Agilent no longer sells or supports this product. You will find any other available product information on the Agilent Test & Measurement website:

www.tm.agilent.com

Search for the model number of this product, and the resulting product page will guide you to any available information. Our service centers may be able to perform calibration if no repair parts are needed, but no other support from Agilent is available.

HP 8657A SYNTHESIZED SIGNAL GENERATOR (Including Options 001 and 002)

Service Manual

SERIAL NUMBERS

This manual provides complete information for instruments with serial-number prefixes:

3049A and above and all *MAJOR* changes that apply to your instrument/modules.

27464

First Edition

This material may be reproduced by or for the U.S. Government pursuant to the Copyright License under the clause at DFARS 52.227-7013 (APR 1988).

Copyright © HEWLETT-PACKARD COMPANY
EAST 24001 MISSION AVENUE, TAF-C 34, SPOKANE, WASHINGTON, U.S.A. 99220

Service Manual HP Part 08657-90157
Printed in U.S.A. : July 1993



SAFETY CONSIDERATIONS

GENERAL

This product and related documentation must be reviewed for familiarization with safety markings and instructions before operation.

This product is a Safety Class I instrument (provided with a protective earth terminal).

BEFORE APPLYING POWER

Verify that the product is set to match the available line voltage and the correct fuse is installed.

SAFETY EARTH GROUND

An uninterruptible safety earth ground must be provided from the main power source to the product input wiring terminals, power cord, or supplied power cord set.

SAFETY SYMBOLS



Instruction manual symbol: the product will be marked with this symbol when it is necessary for the user to refer to the instruction manual (refer to Table of Contents.)



Indicates hazardous voltages.



Indicates earth (ground) terminal.

WARNING

The WARNING sign denotes a hazard. It calls attention to a procedure, practice, or the like, which, if not correctly performed or adhered to, could result in personal injury. Do not proceed beyond a WARNING sign until the indicated conditions are fully understood and met.

CAUTION

The CAUTION sign denotes a hazard. It calls attention to an operating procedure, practice, or the like, which, if not correctly performed or adhered to, could result in damage to or destruction of part or all of the product. Do not proceed beyond a CAUTION sign until the indicated conditions are fully understood and met.

WARNING

Any interruption of the protective (grounding) conductor (inside or outside the instrument) or disconnecting the protective earth terminal will cause a potential shock hazard that could result in personal injury. (Grounding one conductor of a two conductor outlet is not sufficient protection).

Whenever it is likely that the protection has been impaired, the instrument must be made inoperative and be secured against any unintended operation.

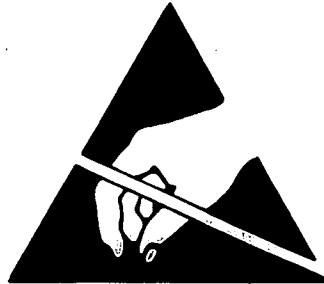
If this instrument is to be energized via an autotransformer (for voltage reduction) make sure the common terminal is connected to the earth terminal of the power source.

Servicing instructions are for use by service trained personnel only. To avoid dangerous electric shock, do not perform any servicing unless qualified to do so.

Adjustments described in the manual are performed with power supplied to the instrument while protective covers are removed. Energy available at many points may, if contacted, result in personal injury.

Capacitors inside the instrument may still be charged even if the instrument has been disconnected from its source of supply.

For continued protection against fire hazard, replace the line fuse(s) only with 250V fuse(s) of the same current rating and type (for example, normal blow, time delay, etc.) Do not use repaired fuses or short circuited fuseholders.



ATTENTION Static Sensitive Devices

This instrument was constructed in an ESD (electro-static discharge) protected environment. This is because most of the semi-conductor devices used in this instrument are susceptible to damage by static discharge.

Depending on the magnitude of the charge, device substrates can be punctured or destroyed by contact or mere proximity of a static charge. The results can cause degradation of device performance, early failure, or immediate destruction.

These charges are generated in numerous ways such as simple contact, separation of materials, and normal motions of persons working with static sensitive devices.

When handling or servicing equipment containing static sensitive devices, adequate precautions must be taken to prevent device damage or destruction.

Only those who are thoroughly familiar with industry accepted techniques for handling static sensitive devices should attempt to service circuitry with these devices.

In all instances, measures must be taken to prevent static charge build-up on work surfaces and persons handling the devices.

Section 6 REPLACEABLE PARTS

6-1. INTRODUCTION TO THIS SECTION

This section contains information for ordering parts. Table 6-1 lists reference designations, and Table 6-2 lists abbreviations that are used in the Replaceable Parts List. Table 6-3 lists all replaceable parts in the instrument. Table 6-4 contains the names and addresses that correspond to the manufacturer's code numbers listed in Table 6-3. Also included in this section are photographs and drawings to aid in identifying and ordering chassis mounted parts and mechanical parts.

6-2. REFERENCE DESIGNATIONS AND ABBREVIATIONS USED IN THIS MANUAL

Table 6-1 lists the reference designation letters for electrical parts in the instrument. The letter designations found in Table 6-1 are coupled with numeric designations to provide a unique reference designation for each part in the instrument. For example, A6R101 is the reference designation of a particular resistor R101 on assembly A6.

Table 6-2 lists abbreviations used in the parts list and on schematics.

6-3. REPLACEABLE PARTS LIST

Table 6-3 is a list of replaceable parts and is organized as follows:

- a. Electrical assemblies and their components with reference designations in alphanumeric order.
- b. Chassis-Mounted parts with reference designations in alphanumeric order.
- c. Mechanical parts with reference designations in alphanumeric order.

Ordering Parts.

Instrument Serial Numbers.

Attached to the rear of the instrument is a serial-number plate. The first four digits and the letter are the instrument serial-number prefix. The last five digits (serial-number suffix) are unique to each instrument. When parts in the instrument are changed, the serial-number prefix of the instrument may also change. This means that sometimes a part will be listed more than once in the the replaceable parts list along with a serial-number prefix or range of serial-number prefixes. Find the serial-number prefix on the serial plate of your instrument and order the part listed under the corresponding prefix in the table. If no serial prefix information is listed, the part is compatible in instruments of all serial numbers.

NOTE

It is possible that some assemblies in your instrument have been updated (through service or retrofitting) to reflect changes made to instruments with serial-number prefixes later than that shown on your instrument serial-number tag. Be sure to note the board number of the assembly being repaired or replaced when ordering parts for your instrument.

How to Order

To order a part in the Replaceable Parts List, call or write the nearest Hewlett-Packard Sales Office. Have the following information ready to speed the ordering process:

1. The Hewlett-Packard part number with the check digit. (The check digit will ensure accurate and timely processing of your order.)
2. The quantity required.
3. An approved purchase order number. (Sometimes required.)

NOTE

Within the USA, it is better to order directly from the HP Support Materials Organization, Roseville, California. Ask your nearest HP office for information and forms for the "Direct Order System".

Replaceable Parts List Updating (Manual Updates)

A "MANUAL UPDATES" packet is shipped with the manual, when necessary, to provide the most current information available at the time of shipment. These packets consist of replacement and addition pages which should be incorporated into the manual to bring it up to date.

Hewlett-Packard offers a Documentation Update Service that will provide you with further updates as they become available. If you operate or service instruments of different serial prefixes, we strongly recommend that you join this service immediately to ensure that your manual is kept current. For more information, refer to the Documentation Update Service reply card included in this manual.

6-4. MECHANICAL AND CHASSIS PART LOCATIONS AND REFERENCE DESIGNATIONS

Most mechanical parts are identified in Figures 6-1 to 6-9. These figures are located at the end of this section. Major mechanical parts have reference designations that begin with the letters MP. To find the part number and description of a mechanical part, find the part in one of the photographs or drawings, and then look up the reference designation in Table 6-3. Mechanical hardware, such as screws, are listed under the part which they attach. For example, the screws that attach the fan (B1) to the rear panel are listed under B1.

6-5. RECOMMENDED SPARES LIST

Stocking spare parts for an instrument is often done to ensure quick return to service after a malfunction occurs. Hewlett-Packard has prepared a "Recommended Spares" list for this instrument. The contents of the list are based on failure reports and repair data. Quantities given are for one year of parts support. You can request a complimentary copy of the "Recommended Spares" list from your nearest Hewlett-Packard office.

When stocking parts to support more than one instrument or to support a variety of Hewlett-Packard instruments, it may be more economical to work from one consolidated list rather than simply adding together stocking quantities from the individual instrument lists. Hewlett-Packard will prepare consolidated "Recommended Spares" lists for any number or combination of instruments. Contact your nearest Hewlett-Packard office for details.

Table 6-1. Reference Designations

REFERENCE DESIGNATIONS			
A assembly	E miscellaneous	P electrical connector	U integrated circuit.
AT attenuator, isolator, termination	F fuse	(movable portion).	V microcircuit
B fan, motor	FL filter	Q transistor, SCR, triode thyristor, FET	VR voltage regulator, breakdown diode
BT battery	H hardware	R resistor	W cable, transmission path, wire
C capacitor	HY circulator	RT thermistor	X socket
CP coupler	J electrical connector (stationary portion), jack	S switch	Y crystal unit (piezo-electric or quartz)
CR diode, thyristor, varactor	K relay	T transformer	Z tuned cavity, tuned circuit
DC directional coupler	L coil, inductor	TB terminal board	
DL delay line	M meter	TC thermocouple	
DS annunciator, signaling device (audible or visual), lamp: LED	MP miscellaneous mechanical part	TP test point	

Table 6-2. Abbreviations (1 of 2)

ABBREVIATIONS			
A ampere	COEF coefficient	EDP electronic data processing	INT internal
ac alternating current	COM common	ELECT electrolytic	kg kilogram
ACCESS accessory	COMP composition	ENCAP encapsulated	kHz kilohertz
ADJ adjustment	COMPL complete	EXT external	k kilohm
A/D analog-to-digital	CONN connector	F farad	kV kilovolt
AF audio frequency	CP cadmium plate	FET field-effect transistor	lb pound
AFC automatic frequency control	CRT cathode-ray tube	F/F flip-flop	LC inductance-capacitance
AGC automatic gain control	CTL complementary transistor logic	FH flat head	LED light-emitting diode
AL aluminum	CW continuous wave	FIL H fillister head	LF low frequency
ALC automatic level control	cw clockwise	FM frequency modulation	LG long
AM amplitude modulation	cm centimeter	FP front panel	LH left hand
AMPL amplifier	D/A digital-to-analog	FREQ frequency	LIM limit
APC automatic phase control	dB decibel	FXD fixed	LIN linear taper (used in parts list)
ASSY assembly	dBm decibel referred to 1 mW	g gram	LK WASH lock washer
AUX auxiliary	dc direct current	GE germanium	LO low, local oscillator
avg average	deg degree (temperature interval or difference)	GHz gigahertz	LOG logarithmic taper (used in parts list)
AWG American wire gauge	° degree (plane angle)	GL glass	log logarithm(ic)
BAL balance	°C degree Celsius (centigrade)	GRD grounded	LPF low pass filter
BCD binary coded decimal	°F degree Fahrenheit	H henry	LV low voltage
BD board	°K degree Kelvin	h hour	m meter (distance)
BECU beryllium copper	DEPC deposited carbon	HET heterodyne	mA milliampere
BFO beat frequency oscillator	DET detector	HD head	MAX maximum
BH binder head	diam diameter	HDW hardware	M megohm
BKDN breakdown	DIA diameter (used in parts list)	HF high frequency	MEG meg (10 ⁶) (used in parts list)
BP bandpass	DIFF AMPL differential amplifier	HG mercury	MET FLM metal film
BPF bandpass filter	div division	HI high	MET OX metallic oxide
BRS brass	DPDT double-pole, double-throw	HP Hewlett-Packard	MF medium frequency, microfarad (used in parts list)
BWO backward-wave oscillator	DR drive	HPF high pass filter	MFR manufacturer
CAL calibrate	DSB double sideband	HR hour (used in parts list)	mg milligram
ccw counter-clockwise	DTL diode transistor logic	HV high voltage	MHz megahertz
CER ceramic	DVM digital voltmeter	HZ Hertz	mH millihenry
CHAN channel	ECL emitter coupled logic	IC integrated circuit	mho mho
cm centimeter	EMF electromotive force	ID inside diameter	min minute (time)
CMO cabinet mount only		IF intermediate frequency	MINAT minute (plane angle)
COAX coaxial		IMP impregnated	mm millimeter
		IN incandescent	
		INCL include(s)	
		INP input	
		INS insulation	

NOTE

All abbreviations in the parts list will be in upper-case

Table 6-2. Abbreviations (2 of 2)

MOD modulator	OD outside diameter	PWV peak working voltage	TD time delay
MOM momentary	OH oval head	RC resistance-capacitance	TERM terminal
MOS metal-oxide semiconductor	OP AMPL operational amplifier	RECT rectifier	TFT thin-film transistor
ms millisecond	OPT option	REF reference	TGL toggle
MTG mounting	OSC oscillator	REG regulated	THD thread
MTR meter (indicating device)	OX oxide	REPL replaceable	THRU through
mV millivolt	oz ounce	RF radio frequency	TI titanium
mVac millivolt, ac	Ω ohm	RFI radio frequency interference	TOL tolerance
mVdc millivolt, dc	P peak (used in parts list)	RH round head; right hand	TRIM trimmer
mVpk millivolt, peak	PAM pulse-amplitude modulation	RLC resistance-inductance-capacitance	TSTR transistor logic
mVp-p millivolt, peak-to-peak	PC printed circuit	RMO rack mount only	TTL transistor-transistor logic
mVrms millivolt, rms	PCM pulse-code modulation; pulse-count modulation	rms root-mean-square	TV television
mW milliwatt	PDM pulse-duration modulation	RND round	TVI television interference
MUX multiplex	pF picofarad	ROM read-only memory	TWT traveling wave tube
MY mylar	PH BRZ phosphor bronze	R&P rack and panel	U micro (10^{-6}) (used in parts list)
μ A microampere	PHL Phillips	RWV reverse working voltage	UF microfarad (used in parts list)
μ F microfarad	PIN positive-intrinsic-negative	S scattering parameter	UHF ultrahigh frequency
μ H microhenry	PIV peak inverse voltage	s second (time)	UNDEF undefined
μ mho micromho	pk peak	s second (plane angle)	UNREG unregulated
μ s microsecond	PL phase lock	S-B slow-blow (fuse) (used in parts list)	V volt
μ V microvolt	PLO phase lock oscillator	SCR silicon controlled rectifier; screw	VA voltampere
μ Vac microvolt, ac	PM phase modulation	SE selenium	Vac volts, ac
μ Vdc microvolt, dc	PNP positive-negative-positive	SECT sections	VAR variable
μ Vpk microvolt, peak	P/O part of	SEMICON semiconductor	VCO voltage-controlled oscillator
μ Vp-p microvolt, peak-to-peak	POLY polystyrene	SHF superhigh frequency	Vdc volts, dc
μ Vrms microvolt, rms	PORC porcelain	SI silicon	VDCW volts, dc, working (used in parts list)
μ W microwatt	POS positive; position(s) (used in parts list)	SIL silver	V(F) volts, filtered
nA nanoampere	POSN position	SL slide	VFO variable-frequency oscillator
NC no connection	POT potentiometer	SNR signal-to-noise ratio	VHF very-high frequency
N/C normally closed	p-p peak-to-peak	SPDT single-pole, double-throw	Vpk volts, peak
NE neon	PP peak-to-peak (used in parts list)	SPG spring	Vp-p volts, peak-to-peak
NEG negative	PPM pulse-position modulation	SR split ring	Vrms volts, rms
nF nanofarad	PREAMPL preamplifier	SPST single-pole, single-throw	VSWR voltage standing wave ratio
NI PL nickel plate	PRF pulse-repetition frequency	SS Service Sheet	VTO voltage-tune oscillator
N/O normally open	PRR pulse repetition rate	SSB single sideband	VTVM vacuum-tube voltmeter
NOM nominal	ps picosecond	SST stainless steel	V(X) volts, switched
NORM normal	PT point	STL steel	W watt
NPN negative-positive-negative	PTM pulse-time modulation	SQ square	W/ with
NPO negative-positive zero (zero temperature coefficient)	PWM pulse-width modulation	SWR standing-wave ratio	WIV working inverse voltage
NRFR not recommended for field replacement		SYNC synchronize	WW wirewound
NSR not separately replaceable		T timed (slow-blow fuse)	W/O without
ns nanosecond		TA tantalum	YIG yttrium-iron-garnet
nW nanowatt		TC temperature compensating	Z ₀ characteristic impedance
OBD order by description			

NOTE

All abbreviations in the parts list will be in upper-case.

MULTIPLIERS

Abbreviation	Prefix	Multiple
T	tera	10^{12}
G	giga	10^9
M	mega	10^6
k	kilo	10^3
da	deka	10
d	deci	10^{-1}
c	centi	10^{-2}
m	milli	10^{-3}
μ	micro	10^{-6}
n	nano	10^{-9}
p	pico	10^{-12}
f	femto	10^{-15}
a	atto	10^{-18}

Table 6-3. Replaceable Parts

Reference Designation	HP Part Number	C D	Qty.	Description	Mfr. Code	Mfr. Part Number
A1						
A1	08657-60106	8	1	KEYBOARD ASSEMBLY	28480	08657-60106
A1DS1	1990-0835	9	21	LED-LAMP LUM-INT=6MCD IF=30MA-MAX BVR=5V	28480	HLMP-1523
A1DS2	1990-0835	9		LED-LAMP LUM-INT=6MCD IF=30MA-MAX BVR=5V	28480	HLMP-1523
A1DS3	1990-0835	9		LED-LAMP LUM-INT=6MCD IF=30MA-MAX BVR=5V	28480	HLMP-1523
A1DS4	1990-0835	9		LED-LAMP LUM-INT=6MCD IF=30MA-MAX BVR=5V	28480	HLMP-1523
A1DS5	1990-0486	6	2	LED-LAMP LUM-INT=2MCD IF=25MA-MAX BVR=5V	28480	HLMP-1301
A1DS6	1990-0486	6		LED-LAMP LUM-INT=2MCD IF=25MA-MAX BVR=5V	28480	HLMP-1301
A1DS7	1990-0835	9		LED-LAMP LUM-INT=6MCD IF=30MA-MAX BVR=5V	28480	HLMP-1523
A1DS8	1990-0835	9		LED-LAMP LUM-INT=6MCD IF=30MA-MAX BVR=5V	28480	HLMP-1523
A1DS9	1990-0835	9		LED-LAMP LUM-INT=6MCD IF=30MA-MAX BVR=5V	28480	HLMP-1523
A1DS10	1990-0835	9		LED-LAMP LUM-INT=6MCD IF=30MA-MAX BVR=5V	28480	HLMP-1523
A1DS11	1990-0835	9		LED-LAMP LUM-INT=6MCD IF=30MA-MAX BVR=5V	28480	HLMP-1523
A1DS12	1990-0835	9		LED-LAMP LUM-INT=6MCD IF=30MA-MAX BVR=5V	28480	HLMP-1523
A1DS13	1990-0835	9		LED-LAMP LUM-INT=6MCD IF=30MA-MAX BVR=5V	28480	HLMP-1523
A1DS14	1990-0835	9		LED-LAMP LUM-INT=6MCD IF=30MA-MAX BVR=5V	28480	HLMP-1523
A1DS15	1990-0835	9		LED-LAMP LUM-INT=6MCD IF=30MA-MAX BVR=5V	28480	HLMP-1523
A1DS16	1990-0835	9		LED-LAMP LUM-INT=6MCD IF=30MA-MAX BVR=5V	28480	HLMP-1523
A1DS17	1990-0835	9		LED-LAMP LUM-INT=6MCD IF=30MA-MAX BVR=5V	28480	HLMP-1523
A1DS18	1990-0835	9		LED-LAMP LUM-INT=6MCD IF=30MA-MAX BVR=5V	28480	HLMP-1523
A1DS19	1990-0835	9		LED-LAMP LUM-INT=6MCD IF=30MA-MAX BVR=5V	28480	HLMP-1523
A1DS20	1990-0835	9		LED-LAMP LUM-INT=6MCD IF=30MA-MAX BVR=5V	28480	HLMP-1523
A1J1	1252-2103	4	1	CONN-POST TYPE 100-PIN-SPCG 40-CONT	18873	68464-140

†Refer to Section 7 for update information.

*Factory Selected Component (Refer to Section 5).

Reference Designation	HP Part Number	C D	Qty.	Description	Mfr. Code	Mfr. Part Number
A2						
A2	08657-60135	3	1	DISPLAY ASSEMBLY	28480	08657-60135
A2C1	0180-4131		4	CAPACITOR-FXD 4.7UF + -10% 35VDC TA	28480	0180-4131
A2C2	0180-4832	4	21	CAPACITOR-FXD .01UF + -10% 100VDC CER	28480	0160-4832
A2C3	0180-4832	4		CAPACITOR-FXD .01UF + -10% 100VDC CER	28480	0160-4832
A2C4	0180-4832	4		CAPACITOR-FXD .01UF + -10% 100VDC CER	28480	0160-4832
A2C5	0180-4832	4		CAPACITOR-FXD .01UF + -10% 100VDC CER	28480	0160-4832
A2C6	0180-4832	4		CAPACITOR-FXD .01UF + -10% 100VDC CER	28480	0160-4832
A2C7	0180-4832	4		CAPACITOR-FXD .01UF + -10% 100VDC CER	28480	0160-4832
A2C8	0180-4832	4		CAPACITOR-FXD .01UF + -10% 100VDC CER	28480	0160-4832
A2C9	0180-4832	4		CAPACITOR-FXD .01UF + -10% 100VDC CER	28480	0160-4832
A2C10	0180-4832	4		CAPACITOR-FXD .01UF + -10% 100VDC CER	28480	0160-4832
A2C11	0180-4832	4		CAPACITOR-FXD .01UF + -10% 100VDC CER	28480	0160-4832
A2C12	0160-4831	3	1	CAPACITOR-FXD 4700PF + -10% 100VDC CER	28480	0160-4831
A2C13	0160-4822	2	2	CAPACITOR-FXD 1000PF + -5% 100VDC CER	28480	0160-4822
A2J1	1251-8671	1	1	CONN-POST TYPE .100-PIN-SPCG 10-CONT	28480	1251-8671
	1251-5595	2	9	POLARIZING KEY-POST CONN	28480	1251-5595
A2J2	1252-0223	5	1	CONN-POST TYPE .100-PIN-SPCG 40-CONT	28480	1252-0223
A2L1	9135-0095	9	1	INDUCTOR 143UH 5.245% 2.6D-MMX6.6LG-MM	28480	9135-0095
A2R1	1810-0398	9	1	NETWORK-RES 10-SIP 22.0K OHM X 9	11236	750-101-R22K
A2R2	1810-0371	8	1	NETWORK-RES 8-SIP 100.0K OHM X 7	11236	750-81-R100K
A2R3	0757-0442			RESISTOR 3.16K 1% .125W F TC = 0 + -100	28480	0757-0442
A2R4	0698-3161	9	3	RESISTOR 38.3K 1% .125W F TC = 0 + -100	24546	CT4-1/8-T0-3832-F
A2R5	0757-0443	0	1	RESISTOR 11K 1% .125W F TC = 0 + -100	24546	CT4-1/8-T0-1102-F
A2R6	1810-0402	6	13	NETWORK-RES 16-DIP 330.0 OHM X 8	01121	316B331
A2R7	1810-0402	6		NETWORK-RES 16-DIP 330.0 OHM X 8	01121	316B331
A2R8	1810-0402	6		NETWORK-RES 16-DIP 330.0 OHM X 8	01121	316B331
A2R9	1810-0402	6		NETWORK-RES 16-DIP 330.0 OHM X 8	01121	316B331
A2R10	1810-0402	6		NETWORK-RES 16-DIP 330.0 OHM X 8	01121	316B331
A2R11	1810-0402	6		NETWORK-RES 16-DIP 330.0 OHM X 8	01121	316B331
A2R12	1810-0402	6		NETWORK-RES 16-DIP 330.0 OHM X 8	01121	316B331
A2R13	1810-0402	6		NETWORK-RES 16-DIP 330.0 OHM X 8	01121	316B331
A2R14	1810-0402	6		NETWORK-RES 16-DIP 330.0 OHM X 8	01121	316B331
A2R15	1810-0330	9	3	NETWORK-RES 16-DIP 470.0 OHM X 8	11236	761-3-R470 OHMS
A2R16	1810-0402	6		NETWORK-RES 16-DIP 330.0 OHM X 8	01121	316B331
A2R17	1810-0402	6		NETWORK-RES 16-DIP 330.0 OHM X 8	01121	316B331
A2R18	1810-0402	6		NETWORK-RES 16-DIP 330.0 OHM X 8	01121	316B331
A2R19	0698-3446	3	1	RESISTOR 383 1% .125W F TC = 0 + -100	24546	CT4-1/8-T0-383R-F
A2R20	0698-3441	8		RESISTOR 215 1% .125W F TC = 0 + -100	24546	CT4-1/8-T0-215R-F
A2R21	0698-3441	8		RESISTOR 215 1% .125W F TC = 0 + -100	24546	CT4-1/8-T0-215R-F
A2R22	1810-0330	9		NETWORK-RES 16-DIP 470.0 OHM X 8	11236	761-3-R470 OHMS
A2R23	1810-0402	6		NETWORK-RES 16-DIP 330.0 OHM X 8	01121	316B331
A2R24	0698-3441	8		RESISTOR 215 1% .125W F TC = 0 + -100	24546	CT4-1/8-T0-215R-F
A2R25	0698-7235	6	1	RESISTOR 909 1% .05W F TC = 0 + -100	24546	C3-1/8-T0-909R-F
A2R26 ^Δ	0698-3132	4	1	RESISTOR 261 1% .125W F TC = 0 + -100	02995	SFR25H

[†]Refer to Section 7 for update information.

^{*}Factory Selected Component (Refer to Section 5).

^Δ Errata part change.

Reference Designation	HP Part Number	C D	Qty.	Description	Mfr. Code	Mfr. Part Number
A2R27	1810-0330	9		NETWORK-RES 16-DIP 470.0 OHM X 8	11236	761-3-R470 OHMS
A2R28	1810-0280	8	2	NETWORK-RES 10-SIP 10.0K OHM X 9	91637	CSC10A01-103G/MSP10A01-
A2R29	0698-7236	7	10	RESISTOR 1K 1% .05W F TC = 0 + -100	24546	C3-1/8-T0-1001-F
A2R30	0757-0442	9	56	RESISTOR 10K 1% .125W F TC = 0 + -100	24546	CT4-1/8-T0-1002-F
A2R31	0757-0442	9		RESISTOR 10K 1% .125W F TC = 0 + -100	24546	CT4-1/8-T0-1002-F
A2R32 ^Δ	0757-0280	3		RESISTOR 1K 1% .125W F TC = 0 + -100	02995	SFR25H
A2S1	3101-2692	9	1	SWITCH-PB SPST-NO MOM .125A 115 VAC	28480	3101-2692
A2SC1	5041-0944	4	1	KEY CAP "POWER"	28480	5041-0944
A2TP1	0360-2359	8	15	CONNECTOR SGL-CONT	28480	0360-2359
A2TP2	0360-2359	8		CONNECTOR SGL-CONT	28480	0360-2359
A2TP3	0360-2359	8		CONNECTOR SGL-CONT	28480	0360-2359
A2TP4	0360-2359	8		CONNECTOR SGL-CONT	28480	0360-2359
A2TP5	0360-2359	8		CONNECTOR SGL-CONT	28480	0360-2359
A2TP6	0360-2359	8		CONNECTOR SGL-CONT	28480	0360-2359
A2TP7	0360-2359	8		CONNECTOR SGL-CONT	28480	0360-2359
A2TP8	0360-2359	8		CONNECTOR SGL-CONT	28480	0360-2359
A2TP9	0360-2359	8		CONNECTOR SGL-CONT	28480	0360-2359
A2TP10	0360-2359	8		CONNECTOR SGL-CONT	28480	0360-2359
A2TP11	0360-2359	8		CONNECTOR SGL-CONT	28480	0360-2359
A2TP12	0360-2359	8		CONNECTOR SGL-CONT	28480	0360-2359
A2TP13	0360-2359	8		CONNECTOR SGL-CONT	28480	0360-2359
A2TP14	0360-2359	8		CONNECTOR SGL-CONT	28480	0360-2359
A2U1	1820-2056	1	4	IC FF TTL LS D-TYPE POS-EDGE-TRIG COM	01295	SN74LS378N
A2U2	1820-1858	9	3	IC FF TTL LS D-TYPE OCTL	01295	SN74LS377N
A2U3	1820-3181	5	2	IC SHF-RGTR CMOS/74HC SYNC/ASYNC	04713	MC74HC165N
A2U4	1990-1225	3	14	DISPLAY-DSPL-ST 14-CHAR .43-H GRN	28480	1990-1225
A2U5	1990-1225	3		DISPLAY-DSPL-ST 14-CHAR .43-H GRN	28480	1990-1225
A2U6	1990-1225	3		DISPLAY-DSPL-ST 14-CHAR .43-H GRN	28480	1990-1225
A2U7	1990-1225	3		DISPLAY-DSPL-ST 14-CHAR .43-H GRN	28480	1990-1225
A2U8	1990-1225	3		DISPLAY-DSPL-ST 14-CHAR .43-H GRN	28480	1990-1225
A2U9	1990-1225	3		DISPLAY-DSPL-ST 14-CHAR .43-H GRN	28480	1990-1225
A2U10	1990-1225	3		DISPLAY-DSPL-ST 14-CHAR .43-H GRN	28480	1990-1225
A2U11	1990-1225	3		DISPLAY-DSPL-ST 14-CHAR .43-H GRN	28480	1990-1225
A2U12	1990-1225	3		DISPLAY-DSPL-ST 14-CHAR .43-H GRN	28480	1990-1225
A2U13	1990-1225	3		DISPLAY-DSPL-ST 14-CHAR .43-H GRN	28480	1990-1225
A2U14	1990-1225	3		DISPLAY-DSPL-ST 14-CHAR .43-H GRN	28480	1990-1225
A2U15	1990-1225	3		DISPLAY-DSPL-ST 14-CHAR .43-H GRN	28480	1990-1225
A2U16	1990-1225	3		DISPLAY-DSPL-ST 14-CHAR .43-H GRN	28480	1990-1225
A2U17	1990-1225	3		DISPLAY-DSPL-ST 14-CHAR .43-H GRN	28480	1990-1225
A2U18	1820-3181	5		IC SHF-RGTR CMOS/74HC SYNC/ASYNC	04713	MC74HC165N
A2U19	1820-4053	2	1	IC INV CMOS/74HC HEX	01295	SN74HC05N
A2U20	1820-4053	2	1	IC INV CMOS/74HC HEX	01295	SN74HC05N
A2U21	1820-0471		2	IC DRVR TTL DSPL LED 7-INP	01295	SN75497N
A2U22	1820-0471			IC DRVR TTL DSPL LED 7-INP	01295	SN75497N
A2U23	1820-1433	6	2	IC SHF-RGTR TTL LS R-S SERIAL-IN PRL-OUT	01295	SN74LS164N
A2U24	1820-1433	6		IC SHF-RGTR TTL LS R-S SERIAL-IN PRL-OUT	01295	SN74LS164N
A2U25	1820-1216	3	4	IC DCDR TTL LS 3-TO-8-LINE 3-INP	01295	SN74LS138N

†Refer to Section 7 for update information.

*Factory Selected Component (Refer to Section 5).

Δ Errata part change.

Replaceable Parts

Reference Designation	HP Part Number	C D	Qty.	Description	Mfr. Code	Mfr. Part Number
A2U26	1820-1216	3	12	IC DCDR TTL LS 3-TO-8-LINE 3-INP	01295	SN74LS138N
A2U27	1820-1413	2		IC DCDR CMOS BCD-TO-7-SEG 4-TO-7-LINE	04713	MC14511BCP
A2U28	1820-1423	4	2	IC MV TTL LS MONOSTBL RETRIG DUAL	01295	SN74LS123N
A2U29	1820-1413	2		IC DCDR CMOS BCD-TO-7-SEG 4-TO-7-LINE	04713	MC14511BCP
A2U30	1820-2056	1		IC FF TTL LS D-TYPE POS-EDGE-TRIG COM	01295	SN74LS378N
A2U31	1820-1413	2		IC DCDR CMOS BCD-TO-7-SEG 4-TO-7-LINE	04713	MC14511BCP
A2U32	1820-1413	2		IC DCDR CMOS BCD-TO-7-SEG 4-TO-7-LINE	04713	MC14511BCP
A2U33	1820-1413	2		IC DCDR CMOS BCD-TO-7-SEG 4-TO-7-LINE	04713	MC14511BCP
A2U34	1820-1413	2		IC DCDR CMOS BCD-TO-7-SEG 4-TO-7-LINE	04713	MC14511BCP
A2U35	1820-1413	2		IC DCDR CMOS BCD-TO-7-SEG 4-TO-7-LINE	04713	MC14511BCP
A2U36	1820-1413	2		IC DCDR CMOS BCD-TO-7-SEG 4-TO-7-LINE	04713	MC14511BCP
A2U37	1820-1413	2		IC DCDR CMOS BCD-TO-7-SEG 4-TO-7-LINE	04713	MC14511BCP
A2U38	1820-1413	2		IC FF TTL LS D-TYPE POS-EDGE-TRIG COM	01295	SN74LS378N
A2U39	1820-2056	1		IC DCDR CMOS BCD-TO-7-SEG 4-TO-7-LINE	04713	MC14511BCP
A2U40	1820-1413	2		IC DCDR CMOS BCD-TO-7-SEG 4-TO-7-LINE	04713	MC14511BCP
A2U41	1820-1413	2		IC DCDR CMOS BCD-TO-7-SEG 4-TO-7-LINE	04713	MC14511BCP
A2U42	1820-1413	2		IC DCDR CMOS BCD-TO-7-SEG 4-TO-7-LINE	01295	SN74LS377N
A2U43	1820-1858	9		IC FF TTL LS D-TYPE OCTL	01295	SN74LS377N
A2SP1-SP5	1200-0915	3		SOCKET-DSPPL 14-CONT DIP DIP-SLDR	28480	1200-0915
A2SP6-A2SP11	1200-0915	3		SOCKET-DSPPL 14-CONT DIP DIP-SLDR	28480	1200-0915
A2SP12-A2SP14	1200-0915	3		SOCKET-DSPPL 14-CONT DIP DIP-SLDR	28480	1200-0915

†Refer to Section 7 for update information.

*Factory Selected Component (Refer to Section 5).

Δ Errata part change.

Reference Designation	HP Part Number	C D	Qty.	Description	Mfr. Code	Mfr. Part Number
A3						
A3	08657-80158		1	LOW FREQUENCY LOOP ASSEMBLY	28480	08657-60158
A3C1	0160-4835	7	46	CAPACITOR-FXD .1UF +-10% 50VDC CER	28480	0160-4835
A3C2	0160-4834	8	14	CAPACITOR-FXD .047UF +-10% 100VDC CER	28480	0160-4834
A3C3	0160-4834	8		CAPACITOR-FXD .047UF +-10% 100VDC CER	28480	0160-4834
A3C4	0160-4834	8		CAPACITOR-FXD .047UF +-10% 100VDC CER	28480	0160-4834
A3C5	0160-4835	7		CAPACITOR-FXD .1UF +-10% 50VDC CER	28480	0160-4835
A3C6	0160-4834	8		CAPACITOR-FXD .047UF +-10% 100VDC CER	28480	0160-4834
A3C7	0160-4835	7		CAPACITOR-FXD .1UF +-10% 50VDC CER	28480	0160-4835
A3C8	0180-4130	8	3	CAPACITOR-FXD 2.2UF +-10% 20VDC TA	28480	0180-4130
A3C9	0180-2929	8	2	CAPACITOR-FXD 68UF +-10% 10VDC TA	28480	0180-2929
A3C10	0160-4834	6		CAPACITOR-FXD .047UF +-10% 100VDC CER	28480	0160-4834
A3C11	0160-4789	0	1	CAPACITOR-FXD 15PF +-5% 100VDC CER 0 + -30	28480	0160-4789
A3C12	0160-4786	7	3	CAPACITOR-FXD 27PF +-5% 100VDC CER 0 + -30	28480	0160-4786
A3C13	0160-4814	2		CAPACITOR-FXD 150PF +-5% 100VDC CER	28480	0160-4814
A3C14	0160-4834	6		CAPACITOR-FXD .047UF +-10% 100VDC CER	28480	0160-4834
A3C15	0160-4834	6		CAPACITOR-FXD .047UF +-10% 100VDC CER	28480	0160-4834
A3C16	0160-4834	6		CAPACITOR-FXD .047UF +-10% 100VDC CER	28480	0160-4834
A3C17	0160-4535	4	2	CAPACITOR-FXD 1UF +-10% 50VDC CER	28480	0160-4535
A3C18	0160-4822	2		CAPACITOR-FXD 1000PF +-5% 100VDC CER	28480	0160-4822
A3C19	0180-0094	4	2	CAPACITOR-FXD 100UF +-75-10% 25VDC AL	56289	30D107G025DD2
A3C20	0160-4834	6		CAPACITOR-FXD .047UF +-10% 100VDC CER	28480	0160-4834
A3C21	0121-0061	1	1	CAPACITOR-V TRMR-CER 5.5-18PF 350V	73899	DV11PS18A
A3C22	0160-4833	5	3	CAPACITOR-FXD .022UF +-10% 100VDC CER	28480	0160-4833
A3C23*	0160-4807	3	3	CAPACITOR-FXD 33PF +-5% 100VDC CER 0 + -30	28480	0160-4807
A3C24	0160-4834	6		CAPACITOR-FXD .047UF +-10% 100VDC CER	28480	0160-4834
A3C25	0160-4834	6		CAPACITOR-FXD .047UF +-10% 100VDC CER	28480	0160-4834
A3C26	0180-0094	4		CAPACITOR-FXD 100UF +-75-10% 25VDC AL	56289	30D107G025DD2
A3C27	0160-4803	9	4	CAPACITOR-FXD 68PF +-5% 100VDC CER 0 + -30	28480	0160-4803
A3C28	0160-2436	0	2	CAPACITOR-FDTHRU 10PF 20% 200V CER	28480	0160-2436
A3C29	0160-4834	6		CAPACITOR-FXD .047UF +-10% 100VDC CER	28480	0160-4834
A3C30	0160-4834	6		CAPACITOR-FXD .047UF +-10% 100VDC CER	28480	0160-4834
A3C31-C99				NOT ASSIGNED		
A3C100	0180-2144	9	3	CAPACITOR-FXD 200UF +-75-10% 25VDC AL	56289	30D207G025DH9
A3C101	0180-2821	9	7	CAPACITOR-FXD 22UF +-20% 35VDC TA	28480	0180-2821
A3C102-C199				NOT ASSIGNED		
A3C200	0180-2208	6	5	CAPACITOR-FXD 220UF +-10% 10VDC TA	56289	150D227X9010S2
A3C201	0180-2208	8		CAPACITOR-FXD 220UF +-10% 10VDC TA	56289	150D227X9010S2
A3C202	0180-2144	9		CAPACITOR-FXD 200UF +-75-10% 25VDC AL	56289	30D207G025DH9
A3C203	0180-2144	9		CAPACITOR-FXD 200UF +-75-10% 25VDC AL	56289	30D207G025DH9
A3C204 ^Δ	0160-4801	8		CAPACITOR-FXD 22PF +-5% 100VDC CER -30	28480	0160-4801
A3C205 ^Δ	0160-4822	9		CAPACITOR-FXD 1000PF +-5% 100VDC CER	28480	0160-4822
A3C206	0160-4835	7		CAPACITOR-FXD .1UF +-10% 50VDC CER	28480	0160-4835
A3C207	0160-4801	7	5	CAPACITOR-FXD 100PF +-5% 100VDC CER	28480	0160-4801
A3C208	0160-4835	7		CAPACITOR-FXD .1UF +-10% 50VDC CER	28480	0160-4835
A3C209	0160-4835	7		CAPACITOR-FXD .1UF +-10% 50VDC CER	28480	0160-4835
A3C211	0160-4835	7		CAPACITOR-FXD .1UF +-10% 50VDC CER	28480	0160-4835
A3C212	0180-2929	8		CAPACITOR-FXD 68UF +-10% 10VDC TA	28480	0180-2929
A3C213	0160-5098	6	2	CAPACITOR-FXD .22UF +-10% 50VDC CER	16299	CAC05X7R224J050A
A3C214-C299				NOT ASSIGNED		
A3C300	0160-4835	7		CAPACITOR-FXD .1UF +-10% 50VDC CER	28480	0160-4835
A3C301	0160-4786	7	3	CAPACITOR-FXD 27PF +-5% 100VDC CER 0 + -30	28480	0160-4786

†Refer to Section 7 for update information.

*Factory Selected Component (Refer to Section 5).

Δ Errata part change.

Reference Designation	HP Part Number	C D	Qty.	Description	Mfr. Code	Mfr. Part Number
A3C302	0180-4132	3	5	CAPACITOR-FXD 1UF + -10% 35VDC TA	28480	0180-4132
A3C303	0160-4835	7		CAPACITOR-FXD .1UF + -10% 50VDC CER	28480	0160-4835
A3C304	0160-4835	7		CAPACITOR-FXD .1UF + -10% 50VDC CER	28480	0160-4835
A3C305	0160-4835	7		CAPACITOR-FXD .1UF + -10% 50VDC CER	28480	0160-4835
A3C306	0160-4835	7		CAPACITOR-FXD .1UF + -10% 50VDC CER	28480	0160-4835
A3C306	0160-4835	7		CAPACITOR-FXD .1UF + -10% 50VDC CER	28480	0160-4835
A3C308	0180-3888	3		CAPACITOR-FXD 15UF + -10% 20VDC TA	28480	0180-4835
A3C309	0160-4835	7		CAPACITOR-FXD .1UF + -10% 50VDC CER	28480	0160-4835
A3C310	0160-4835	7		CAPACITOR-FXD .1UF + -10% 50VDC CER	28480	0160-4835
A3C311	0160-4835	7		CAPACITOR-FXD .1UF + -10% 50VDC CER	28480	0160-4835
A3C312	0160-4803	9		CAPACITOR-FXD 68PF + -5% 100VDC CER 0 + -30	28480	0160-4803
A3C313	0160-4835	7		CAPACITOR-FXD .1UF + -10% 50VDC CER	28480	0160-4835
A3C314-C399				NOT ASSIGNED		
A3C400	0180-2821	9		CAPACITOR-FXD 22UF + -20% 35VDC TA	28480	0180-2821
A3C401	0180-2208	6		CAPACITOR-FXD 220UF + -10% 10VDC TA	56289	150D227X9010S2
A3C402	0160-4835	7		CAPACITOR-FXD .1UF + -10% 50VDC CER	28480	0160-4835
A3C403	0180-2821	9		CAPACITOR-FXD 22UF + -20% 35VDC TA	28480	0180-2821
A3C404	0160-4835	7		CAPACITOR-FXD .1UF + -10% 50VDC CER	28480	0160-4835
A3C405	0180-2821	9		CAPACITOR-FXD 22UF + -20% 35VDC TA	28480	0180-2821
A3C406	0160-4835	7		CAPACITOR-FXD .1UF + -10% 50VDC CER	28480	0160-4835
A3C407	0160-4835	7		CAPACITOR-FXD .1UF + -10% 50VDC CER	28480	0160-4835
A3C408	0180-2667	1	2	CAPACITOR-FXD 150UF + -10% 20VDC TA	56289	152D157X9020S2
A3C409	0160-5469	5	24	CAPACITOR-FXD 1UF 10% 50VDC	28480	0160-5469
A3C410	0160-4535	4		CAPACITOR-FXD 1UF + -10% 50VDC CER	28480	0160-4535
A3C411	0160-4835	7		CAPACITOR-FXD .1UF + -10% 50VDC CER	28480	0160-4835
A3C412	0180-0097	7	4	CAPACITOR-FXD 47UF + -10% 35VDC TA	56289	150D476X9035S2
A3C413	0180-2667	1		CAPACITOR-FXD 150UF + -10% 20VDC TA	56289	152D157X9020S2
A3C414	0160-5098	6	2	CAPACITOR-FXD .22UF + -10% 50VDC CER	16299	CAC05X7R224J050A
A3C415	0160-4835	7		CAPACITOR-FXD .1UF + -10% 50VDC CER	28480	0160-4835
A3C416	0160-4835	7		CAPACITOR-FXD .1UF + -10% 50VDC CER	28480	0160-4835
A3C417-C499				NOT ASSIGNED		
A3C500	0160-4803	9		CAPACITOR-FXD 68PF + -5% 100VDC CER 0 + -30	28480	0160-4803
A3C501	0160-4803	9		CAPACITOR-FXD 68PF + -5% 100VDC CER 0 + -30	28480	0160-4803
A3C502	0180-2208	6		CAPACITOR-FXD 220UF + -10% 10VDC TA	56289	150D227X9010S2
A3C503	0160-4835	7		CAPACITOR-FXD .1UF + -10% 50VDC CER	28480	0160-4835
A3C504	0160-4801	7		CAPACITOR-FXD 100PF + -5% 100VDC CER	28480	0160-4801
A3C505	0160-4835	7		CAPACITOR-FXD .1UF + -10% 50VDC CER	28480	0160-4835
A3C506	0160-4835	7		CAPACITOR-FXD .1UF + -10% 50VDC CER	28480	0160-4835
A3C507	0160-4801	7		CAPACITOR-FXD 100PF + -5% 100VDC CER	28480	0160-4801
A3C508	0160-4810	8	3	CAPACITOR-FXD 330PF + -5% 100VDC CER	28480	0160-4810
A3C509	0160-4810	8		CAPACITOR-FXD 330PF + -5% 100VDC CER	28480	0160-4810
A3C510	0160-4812	0	3	CAPACITOR-FXD 220PF + -5% 100VDC CER	28480	0160-4812
A3C511	0160-5558	3	1	CAPACITOR-FXD .68UF + -5% 100VDC	28480	0160-5558
A3C512	0160-4801	7		CAPACITOR-FXD 100PF + -5% 100VDC CER	28480	0160-4801
A3C513	0160-4789	4		CAPACITOR-FXD 15PF + -5% 100VDC CER 0 + 30	28480	0160-4789
A3C514	0160-4835	7		CAPACITOR-FXD .1UF + -10% 50VDC CER	28480	0160-4835
A3C515	0160-4835	7		CAPACITOR-FXD .1UF + -10% 50VDC CER	28480	0160-4835
A3C516	0160-4812	0		CAPACITOR-FXD 220PF + -5% 100VDC CER	28480	0160-4812
A3C517	0160-4799	2	1	CAPACITOR-FXD 2.2PF + -.25PF 100VDC CER	28480	0160-4799
A3C518	0160-4824	4	1	CAPACITOR-FXD 680PF + -5% 100VDC CER	28480	0160-4824

†Refer to Section 7 for update information.

*Factory Selected Component (Refer to Section 5).

Δ Errata part change.

Reference Designation	HP Part Number	C D	Qty.	Description	Mfr. Code	Mfr. Part Number
A3C518	0160-4808	4	1	CAPACITOR-FXD 470PF + -5% 100VDC CER	28480	0160-4808
A3C520	0160-4835	7		CAPACITOR-FXD .1UF + -10% 50VDC CER	28480	0160-4835
A3C521	0160-4835	7		CAPACITOR-FXD .1UF + -10% 50VDC CER	28480	0160-4835
A3C522	0160-4832				28280	0160-4832
A3C53-C589				NOT ASSIGNED		
A3C600	0160-4835	7		CAPACITOR-FXD .1UF + -10% 50VDC CER	28480	0160-4835
A3C601	0160-4787	8	7	CAPACITOR-FXD 22PF + -5% 100VDC CER 0 + -30	28480	0160-4787
A3C602	0160-4787	8		CAPACITOR-FXD 22PF + -5% 100VDC CER 0 + -30	28480	0160-4787
A3C603	0160-4835	7		CAPACITOR-FXD .1UF + -10% 50VDC CER	28480	0160-4835
A3C604	0160-7013	0	1	CAPACITOR-FXD .47UF + -5% 100VDC	28480	0160-7013
A3C605	0160-4835	7		CAPACITOR-FXD .1UF + -10% 50VDC CER	28480	0160-4835
A3C606	0160-4835	7		CAPACITOR-FXD .1UF + -10% 50VDC CER	28480	0160-4835
A3C607	0160-3661	5	1	CAPACITOR-FXD .1UF + -5% 50VDC MET-POLYC	28480	0160-3661
A3C608	0160-4787	8		CAPACITOR-FXD 22PF + -5% 100VDC CER 0 + -30	28480	0160-4787
A3C609	0160-4787	8		CAPACITOR-FXD 22PF + -5% 100VDC CER 0 + -30	28480	0160-4787
A3C610	0160-4835	7		CAPACITOR-FXD .1UF + -10% 50VDC CER	28480	0160-4835
A3C611	0160-0578	7	2	CAPACITOR-FXD .047UF + -1% 50VDC	28480	0160-0578
A3C612	0160-4835	7		CAPACITOR-FXD .1UF + -10% 50VDC CER	28480	0160-4835
A3C613	0160-2821	9		CAPACITOR-FXD 22UF + -20% 35VDC TA	28480	0160-2821
A3C614	0160-4787	8		CAPACITOR-FXD 22PF + -5% 100VDC CER 0 + -30	28480	0160-4787
A3C615	0160-4835	7		CAPACITOR-FXD .1UF + -10% 50VDC CER	28480	0160-4835
A3C616	0160-4787	8		CAPACITOR-FXD 22PF + -5% 100VDC CER 0 + -30	28480	0160-4787
A3C617	0160-4835	7		CAPACITOR-FXD .1UF + -10% 50VDC CER	28480	0160-4835
A3C618	0160-3888	5		CAPACITOR-FXD 15UF + -10% 20VDC TA	28480	0160-3888
A3C619	0160-4787	8		CAPACITOR-FXD 22PF + -5% 100VDC CER 0 + -30	28480	0160-4787
A3C620	0160-3531	8	1	CAPACITOR-FXD 2UF + -5% 50VDC MET-POLYC	28480	0160-3531
A3C621	0160-0578	7		CAPACITOR-FXD .047UF + -1% 50VDC	28480	0160-0578
A3C622-C699				NOT ASSIGNED		
A3C660	0160-3875				28480	0160-3875
A3C661	0160-4765				28480	0160-4765
A3C662	0160-3875				28480	0160-3875
A3C662	0160-5338				28480	0160-5338
A3C700	0160-4835	7		CAPACITOR-FXD .1UF + -10% 50VDC CER	28480	0160-4835
A3C701	0160-4835	7		CAPACITOR-FXD .1UF + -10% 50VDC CER	28480	0160-4835
A3C702	0160-4835	7		CAPACITOR-FXD .1UF + -10% 50VDC CER	28480	0160-4835
A3C703	0160-4835	7		CAPACITOR-FXD .1UF + -10% 50VDC CER	28480	0160-4835
A3C704	0160-4835	7		CAPACITOR-FXD .1UF + -10% 50VDC CER	28480	0160-4835
A3C705	0160-4835	7		CAPACITOR-FXD .1UF + -10% 50VDC CER	28480	0160-4835
A3C706	0160-4835	7		CAPACITOR-FXD .1UF + -10% 50VDC CER	28480	0160-4835
A3C707	0160-4801	7		CAPACITOR-FXD 100PF + -5% 100VDC CER	28480	0160-4801
A3C708	0160-4565	0	1	CAPACITOR-FXD 1000PF + -1% 100VDC CER	28480	0160-4565
A3C709	0160-4835	7		CAPACITOR-FXD .1UF + -10% 50VDC CER	28480	0160-4835
A3C710	0160-4835	7		CAPACITOR-FXD .1UF + -10% 50VDC CER	28480	0160-4835
A3C711	0160-4835	7		CAPACITOR-FXD .1UF + -10% 50VDC CER	28480	0160-4835
A3C712	0160-4791	4	3	CAPACITOR-FXD 10PF + -5% 100VDC CER 0 + -30	28480	0160-4791
A3C713	0160-4791	4	3	CAPACITOR-FXD 10PF + -5% 100VDC CER 0 + -30	28480	0160-4791
A3CR1	1901-0539	3	20	DIODE-SM SIG SCHOTTKY	28480	1901-0539
A3CR2	1901-0539	3		DIODE-SM SIG SCHOTTKY	28480	1901-0539
A3CR3	1901-0539	3		DIODE-SM SIG SCHOTTKY	28480	1901-0539
A3CR4	1901-0539	3		DIODE-SM SIG SCHOTTKY	28480	1901-0539
A3CR5	1901-0050	3	80	DIODE-SWITCHING 80V 200MA 2NS DO-35	9N171	1M4150
A3CR6	1901-0050	3		DIODE-SWITCHING 80V 200MA 2NS DO-35	9N171	1M4150
A3CR7	1901-0539	3		DIODE-SM SIG SCHOTTKY	28480	1901-0539
A3CR8	1901-0539	3		DIODE-SM SIG SCHOTTKY	28480	1901-0539
A3CR9	1901-0050	3		DIODE-SWITCHING 80V 200MA 2NS DO-35	9N171	1M4150
A3CR10	1901-0376	6	4	DIODE-GEN FRP 35V 50MA DO-35	28480	1901-0376

† Refer to Section 7 for update information.

* Factory Selected Component (Refer to Section 5).

Δ Errata part change.

Reference Designation	HP Part Number	C D	Qty.	Description	Mfr. Code	Mfr. Part Number
A3CR11	1901-0376	6	4	DIODE-GEN PRP 35V 50MA DO-35	28480	1901-0376
A3CR12	1901-0050	3		DIODE-SWITCHING 80V 200MA 2NS DO-35	9N171	1N4150
A3CR13-CR14				NOT ASSIGNED		
A3CR15	0122-0173	8	11	DIODE-VVC 13.5PF 7% C3/C25-MIN = 5 BVR = 30V	25403	BB809 SELECTED
A3CR16	1901-0050	3		DIODE-SWITCHING 80V 200MA 2NS DO-35	9N171	1N4150
A3CR17	1901-0050	3		DIODE-SWITCHING 80V 200MA 2NS DO-35	9N171	1N4150
A3CR18	1901-0050	3		DIODE-SWITCHING 80V 200MA 2NS DO-35	9N171	1N4150
A3CR19-CR189				NOT ASSIGNED		
A3CR200	1901-0050	3		DIODE-SWITCHING 80V 200MA 2NS DO-35	9N171	1N4150
A3CR201	1901-0050	3		DIODE-SWITCHING 80V 200MA 2NS DO-35	9N171	1N4150
A3CR202-CR399				NOT ASSIGNED		
A3CR400	1901-0539	3		DIODE-SM SIG SCHOTTKY	28480	1901-0539
A3CR401	1901-0539	3		DIODE-SM SIG SCHOTTKY	28480	1901-0539
A3CR402	1901-0539	3		DIODE-SM SIG SCHOTTKY	28480	1901-0539
A3CR403	1901-0539	3		DIODE-SM SIG SCHOTTKY	28480	1901-0539
A3CR404	1901-0050	3		DIODE-SWITCHING 80V 200MA 2NS DO-35	9N171	1N4150
A3CR405	1901-0539	3		DIODE-SM SIG SCHOTTKY	28480	1901-0539
A3CR406	1901-0050	3		DIODE-SWITCHING 80V 200MA 2NS DO-35	9N171	1N4150
A3CR407-CR499				NOT ASSIGNED		
A3CR500	1901-0050	3		DIODE-SWITCHING 80V 200MA 2NS DO-35	9N171	1N4150
A3CR501	1901-0050	3		DIODE-SWITCHING 80V 200MA 2NS DO-35	9N171	1N4150
A3CR502	1901-0539	3		DIODE-SM SIG SCHOTTKY	28480	1901-0539
A3CR503	1901-0539	3		DIODE-SM SIG SCHOTTKY	28480	1901-0539
A3CR504	1901-0539	3		DIODE-SM SIG SCHOTTKY	28480	1901-0539
A3CR505	1901-0539	3		DIODE-SM SIG SCHOTTKY	28480	1901-0539
A3CR506	1901-0539	3		DIODE-SM SIG SCHOTTKY	28480	1901-0539
A3CR507-CR599				NOT ASSIGNED		
A3CR600	1901-0050	3		DIODE-SWITCHING 80V 200MA 2NS DO-35	9N171	1N4150
A3CR601				NOT ASSIGNED		
A3CR602	1901-0376	6	4	DIODE-GEN PRP 35V 50MA DO-35	28480	1901-0376
A3CR603	1901-0050			DIODE-SWITCHING 80V 200MA 2NS DO-35		
A3CR700	1901-0050	3		DIODE-SWITCHING 80V 200MA 2NS DO-35	9N171	1N4150
A3CR701	1901-0050	3		DIODE-SWITCHING 80V 200MA 2NS DO-35	9N171	1N4150
A3CR702	1901-0050	3		DIODE-SWITCHING 80V 200MA 2NS DO-35	9N171	1N4150
A3CR703	1901-0050	3		DIODE-SWITCHING 80V 200MA 2NS DO-35	9N171	1N4150
A3CR704	1901-0539	3		DIODE-SM SIG SCHOTTKY	28480	1901-0539
A3CR705	1901-0539	3		DIODE-SM SIG SCHOTTKY	28480	1901-0539
A3CR706	1901-0539	3		DIODE-SM SIG SCHOTTKY	28480	1901-0539
A3CR707	1901-0539	3		DIODE-SM SIG SCHOTTKY	28480	1901-0539
A3DS1-DS489				NOT ASSIGNED		
A3DS500	1990-0517	4	1	LED-LAMP LUM-INT = 3MCD IF = 20MA-MAX BVR = 5V	28480	5082-4655
A3E1	9170-0847	3	1	CORE-SHIELDING BEAD	02114	56-590-65/3B PARYLENE COATED
A3FL1	9135-0002	8	4	FILTER-LOW PASS SOLDER-TERMS	33095	51-744-018
A3FL2	9135-0002	8		FILTER-LOW PASS SOLDER-TERMS	33095	51-744-018
A3FL3	9135-0002	8		FILTER-LOW PASS SOLDER-TERMS	33095	51-744-018
A3FL4	9135-0002	8		FILTER-LOW PASS SOLDER-TERMS	33095	51-744-018
A3J1	1251-5647	5	1	CONNECTOR 10-PIN M POST TYPE	28480	1251-5647
	1251-5595	2		POLARIZING KEY-POST CONN	28480	1251-5595
A3J2	1250-0835	1	3	CONNECTOR-RF SMC M PC 50-OHM	28480	1250-0835
A3CR603	1901-0050	3		DIODE-SWITCHING 80V 200MA 2NS DO-35	28480	1N4150

†Refer to Section 7 for update information.

*Factory Selected Component (Refer to Section 5).

Δ Errata part change.

Reference Designation	HP Part Number	C D	Qty.	Description	Mfr. Code	Mfr. Part Number
A3J3	1250-0835	1		CONNECTOR-RF SMC M PC 50-OHM	28480	1250-0835
A3J4	1250-0835	1		CONNECTOR-RF SMC M PC 50-OHM	28480	1250-0835
A3J5 ^Δ	1250-2305	4	4	CONNECTOR-RF SMC M SGL-HOLE-RR 50-OHM	06860	22SMC-50-0-X1865-111
A3J6 ^Δ	1250-2305	4		CONNECTOR-RF SMC M SGL-HOLE-RR 50-OHM	06860	22SMC-50-0-X1865-111
A3J7 ^Δ	1250-2305	4		CONNECTOR-RF SMC M SGL-HOLE-RR 50-OHM	06860	22SMC-50-0-X1865-111
A3J8 ^Δ	1250-2305	4		CONNECTOR-RF SMC M SGL-HOLE-RR 50-OHM	06860	22SMC-50-0-X1865-111
A3L1	9140-0394	2	3	INDUCTOR RF-CH-MLD 680NH 5%	28480	9140-0394
A3L2	9140-0394	2		INDUCTOR RF-CH-MLD 680NH 5%	28480	9140-0394
A3L3	9140-0394	2		INDUCTOR RF-CH-MLD 680NH 5%	28480	9140-0394
A3L4				NOT ASSIGNED		
A3L5	9140-0144	0	3	INDUCTOR RF-CH-MLD 4.7UH 10%	28480	9140-0144
A3L6*	9100-2255	4	3	INDUCTOR RF-CH-MLD 470NH 10% .105DX.26LG	28480	9100-2255
A3L7				PRINTED CIRCUIT TRACE INDUCTOR		
A3L8	9140-0141	7		INDUCTOR RF-CH-MLD 680NH 10%	28480	9140-0141
A3L9	9135-0072				28480	
A3L10	9135-0072				28480	
A3L11-L199				NOT ASSIGNED		
A3L200	9100-1788	6	2	CORE-FERRITE CHOKE-WIDEBAND;IMP:2680	28480	9100-1788
A3L201	9100-1788	6		CORE-FERRITE CHOKE-WIDEBAND;IMP:2680	28480	9100-1788
A3L202	9100-1618	1	2	INDUCTOR RF-CH-MLD 5.6UH 10%	28480	9100-1618
A3L203	9100-1618	1		INDUCTOR RF-CH-MLD 5.6UH 10%	28480	9100-1618
A3L204	9100-3922	4	8	INDUCTOR-FIXED 120-1300 HZ	28480	9100-3922
A3L205-L299				NOT ASSIGNED		
A3L300	9100-3922	4		INDUCTOR-FIXED 120-1300 HZ	28480	9100-3922
A3L301-L399				NOT ASSIGNED		
A3L400	9140-0129	1	3	INDUCTOR RF-CH-MLD 220UH 5%	28480	9140-0129
A3L401	9100-1620	5	3	INDUCTOR RF-CH-MLD 15UH 10%	28480	9100-1620
A3L402	9140-0129	1		INDUCTOR RF-CH-MLD 220UH 5%	28480	9140-0129
A3L403	9140-0129	1		INDUCTOR RF-CH-MLD 220UH 5%	28480	9140-0129
A3L404	9100-1620	5		INDUCTOR RF-CH-MLD 15UH 10%	28480	9100-1620
A3L405-L499				NOT ASSIGNED		
A3L500	9100-1620	5		INDUCTOR RF-CH-MLD 15UH 10%	28480	9100-1620
A3L501	9100-3922	4		INDUCTOR-FIXED 120-1300 HZ	28480	9100-3922
A3L502	9100-3922	4		INDUCTOR-FIXED 120-1300 HZ	28480	9100-3922
A3L503	9100-3922	4		INDUCTOR-FIXED 120-1300 HZ	28480	9100-3922
A3MP1	08656-00126	5	2	COVER TOP	28480	08656-00126
A3MP2	2360-0277	9	16	SCREW-MACH 6-32 .312-IN-LG HEX-HD-SLT	00000	ORDER BY DESCRIPTION
A3MP3	08656-00044	6	1	FENCE LFL SHLD	28480	08656-00044
A3MP4	08656-00128	7	2	COVER-FRAME	28480	08656-00128
A3MP5				NOT ASSIGNED		
A3MP6	2190-0124	4	9	WASHER-LK INTL T NO. 10 .195-IN-ID	28480	2190-0124
A3MP7	2190-0009	4	8	WASHER-LK INTL T NO. 8 .168-IN-ID	28480	2190-0009
A3MP8	2950-0078	9	5	NUT-HEX-DBL-CHAM 10-32-THD .067-IN-THK	28480	2950-0078
A3MP9	08656-00127	6	2	COVER BOTTOM	28480	08656-00127
A3MP10	1400-0966	8	17	CLIP-CMPNT .17-.185-DIA .195-WD STL	91506	6015-13AT
A3MP11	1205-0660	5	1	HEAT SINK DIP	98978	APIC050CB
A3MP12	0520-0128	7	2	SCREW-MACH 2-56 .25-IN-LG PAN-HD-POZI	00000	ORDER BY DESCRIPTION
A3MP13	0610-0001	6	2	NUT-HEX-DBL-CHAM 2-56-THD .062-IN-THK	00000	ORDER BY DESCRIPTION
A3MP14	2190-0654	5	2	WASHER-LK HLCL 2.0 MM 2.1-MM-ID	28480	2190-0654
MP11-14				NOT ASSIGNED		
A3MP15	3050-0063	5	5	WASHER-FL MTLCL NO. 8 .172-IN-ID	28480	3050-0063
A3MP16				NOT ASSIGNED		
A3MP17	0570-1189	7	4	STUD-PRS-IN 4-40 UNC-2A .312-IN-LG PH	28480	0570-1189
A3Q1	1853-0405	9	12	TRANSISTOR PNP SI PD = 300MW FT = 850MHZ	04713	2N4209
A3Q2	1853-0405	9		TRANSISTOR PNP SI PD = 300MW FT = 850MHZ	04713	2N4209
A3Q3	1854-0810	2	8	TRANSISTOR NPN SI PD = 625MW FT = 200MHZ	28480	1854-0810
A3Q4	1853-0405	9		TRANSISTOR PNP SI PD = 300MW FT = 850MHZ	04713	2N4209
A3Q5	1854-0809	9	8	TRANSISTOR NPN 2N2369A SI TO-18 PD = 360MW	28480	1854-0809

†Refer to Section 7 for update information.

*Factory Selected Component (Refer to Section 5).

Δ Errata part change.

Reference Designation	HP Part Number	C D	Qty.	Description	Mfr. Code	Mfr. Part Number
A3Q6	1853-0405	9		TRANSISTOR PNP SI PD = 300MW FT = 850MHZ	04713	2N4209
A3Q7	1855-0276	6	9	TRANSISTOR J-FET 2N4416A N-CHAN D-MODE	04713	2N4416A
A3Q8	1855-0276	6		TRANSISTOR J-FET 2N4416A N-CHAN D-MODE	04713	2N4416A
A3Q9	1855-0276	6		TRANSISTOR J-FET 2N4416A N-CHAN D-MODE	04713	2N4416A
A3Q10	1853-0281	9	11	TRANSISTOR PNP 2N2907A SI TO-18 PD = 400MW	04713	2N2907A
A3Q11	1853-0459	3	8	TRANSISTOR PNP SI PD = 625MW FT = 200MHZ	28480	1853-0459
A3Q12	1853-0405	9		TRANSISTOR PNP SI PD = 300MW FT = 850MHZ	04713	2N4209
A3Q13	1854-0810	2		TRANSISTOR NPN SI PD = 625MW FT = 200MHZ	28480	1854-0810
A3Q14	1854-0810	2		TRANSISTOR NPN SI PD = 625MW FT = 200MHZ	28480	1854-0810
A3Q15	1855-0276	6		TRANSISTOR J-FET 2N4416A N-CHAN D-MODE	04713	2N4416A
A3Q16	1855-0276	6		TRANSISTOR J-FET 2N4416A N-CHAN D-MODE	04713	2N4416A
A3Q17	1855-0276	6		TRANSISTOR J-FET 2N4416A N-CHAN D-MODE	04713	2N4416A
A3Q18	1853-0281	9		TRANSISTOR PNP 2N2907A SI TO-18 PD = 400MW	04713	2N2907A
A3Q19	1855-0276	6		TRANSISTOR J-FET 2N4416A N-CHAN D-MODE	04713	2N4416A
A3Q20	1853-0459	3		TRANSISTOR PNP SI PD = 625MW FT = 200MHZ	28480	1853-0459
A3Q21	1853-0594	7	1	TRANSISTOR-DUAL PNP 2N3808 TO-78	28480	1853-0594
A3Q22	1854-0809	9		TRANSISTOR NPN 2N2369A SI TO-18 PD = 360MW	28480	1854-0809
A3Q23	1854-0809	9		TRANSISTOR NPN 2N2369A SI TO-18 PD = 360MW	28480	1854-0809
A3Q24	1854-0809	9		TRANSISTOR NPN 2N2369A SI TO-18 PD = 360MW	28480	1854-0809
A3Q25	1853-0281	9		TRANSISTOR PNP 2N2907A SI TO-18 PD = 400MW	04713	2N2907A
A3Q26 ^Δ	1855-0824	0	1	TRANSISTOR J-FET P-CHAN D-MODE SI	02037	MFE5460
A3Q27	1853-0281	9		TRANSISTOR PNP 2N2907A SI TO-18 PD = 400MW	04713	2N2907A
A3Q28	1853-0281	9		TRANSISTOR PNP 2N2907A SI TO-18 PD = 400MW	04713	2N2907A
A3Q29	1854-0401	7	1	TRANSISTOR NPN SI TO-72 PD = 200MW	28480	1854-0401
A3Q30	1853-0430	0	2	TRANSISTOR PNP 2N4959 SI TO-72 PD = 200MW	04713	2N4959
A3Q31	1858-0087	3	1	TRANSISTOR ARRAY 14-PIN PLSTC TO-116	04713	MPO3904
A3Q32	1855-0418	8	1	TRANSISTOR-JFET DUAL N-CHAN D-MODE SI	28480	1855-0418
A3Q33	1853-0430	0		TRANSISTOR PNP 2N4959 SI TO-72 PD = 200MW	04713	2N4959
A3Q34	1855-0276	6		TRANSISTOR J-FET 2N4416A N-CHAN D-MODE	04713	2N4416A
A3Q35	1855-0420	2	7	TRANSISTOR J-FET 2N4391 N-CHAN D-MODE	01295	2N4391
A3Q36	1853-0405	9		TRANSISTOR PNP SI PD = 300MW FT = 850MHZ	04713	2N4209
A3Q37	1855-0276	6		TRANSISTOR J-FET 2N4416A N-CHAN D-MODE	04713	2N4416A
A3Q38	1854-0477	7	4	TRANSISTOR NPN 2N2222A SI TO-18 PD = 500MW	04713	2N2222A
A3Q39	1854-0809	9		TRANSISTOR NPN 2N2369A SI TO-18 PD = 360MW	28480	1854-0809
A3Q40	1854-0809	9		TRANSISTOR NPN 2N2369A SI TO-18 PD = 360MW	28480	1854-0809
A3Q41	1854-0809	9		TRANSISTOR NPN 2N2369A SI TO-18 PD = 360MW	28480	1854-0809
A3Q42	1854-0809	9		TRANSISTOR NPN 2N2369A SI TO-18 PD = 360MW	28480	1854-0809
A3Q43	1853-0281	9		TRANSISTOR PNP 2N2907A SI TO-18 PD = 400MW	04713	2N2907A
A3Q44	1853-0281	9		TRANSISTOR PNP 2N2907A SI TO-18 PD = 400MW	04713	2N2907A
A3Q45				NOT ASSIGNED		
A3Q46	1854-0810	2		TRANSISTOR NPN SI PD = 625MW FT = 200MHZ	28480	1854-0810
A3Q47	1854-0345	8	2	TRANSISTOR NPN 2N5179 SI TO-72 PD = 200MW	04713	2N5179
A3Q48	1853-0405	9		TRANSISTOR PNP SI PD = 300MW FT = 850MHZ	04713	2N4209
A3Q49	1853-0281	9		TRANSISTOR PNP 2N2907A SI TO-18 PD = 400MW	04713	2N2907A
A3Q50	1854-0247	9	1	TRANSISTOR NPN SI TO-39 PD = 1W FT = 800MHZ	28480	1854-0247
A3Q51	1853-0405	9		TRANSISTOR PNP SI PD = 300MW FT = 850MHZ	04713	2N4209
A3Q52	1853-0405	9		TRANSISTOR PNP SI PD = 300MW FT = 850MHZ	04713	2N4209
A3Q53	1853-0405	9		TRANSISTOR PNP SI PD = 300MW FT = 850MHZ	04713	2N4209
A3Q54	1853-0405	9		TRANSISTOR PNP SI PD = 300MW FT = 850MHZ	04713	2N4209
A3Q55	1854-0345	8		TRANSISTOR NPN 2N5179 SI TO-72 PD = 200MW	04713	2N5179

†Refer to Section 7 for update information.

*Factory Selected Component (Refer to Section 5).

Δ Errata part change.

Reference Designation	HP Part Number	C D	Qty.	Description	Mfr. Code	Mfr. Part Number
A3Q56	1853-0405	9		TRANSISTOR PNP SI PD = 300MW FT = 650MHZ	04713	2N4209
A3R1	0757-0398	4	4	RESISTOR 75 1% .125W F TC = 0 + -100	24546	CT4-1/8-T0-75R0-F
A3R2	0757-0402	1	3	RESISTOR 110 1% .125W F TC = 0 + -100	24546	CT4-1/8-T0-111-F
A3R3	0757-0402	1		RESISTOR 110 1% .125W F TC = 0 + -100	24546	CT4-1/8-T0-111-F
A3R4	0757-1094	9	7	RESISTOR 1.47K 1% .125W F TC = 0 + -100	24546	CT4-1/8-T0-1471-F
A3R5	0757-0402	1		RESISTOR 110 1% .125W F TC = 0 + -100	24546	CT4-1/8-T0-111-F
A3R6	0757-0397	3	2	RESISTOR 68.1 1% .125W F TC = 0 + -100	24546	CT4-1/8-T0-68R1-F
A3R7	0698-3429	2	2	RESISTOR 19.6 1% .125W F TC = 0 + -100	03888	PME55-1/8-T0-19R6-F
A3R8	1810-0203	5	1	NETWORK-RES 8-SIP 470.0 OHM X 7	11236	750-81-R470
A3R9	0698-7215	2		RESISTOR 133 1% .05W F TC = 0 + -100	24546	C3-1/8-T0-133R-F
A3R10	0698-3457	6	6	RESISTOR 316K 1% .125W F TC = 0 + -100	28480	0698-3457
A3R11	0698-3457	6		RESISTOR 316K 1% .125W F TC = 0 + -100	28480	0698-3457
A3R12	0698-3444	1	10	RESISTOR 316 1% .125W F TC = 0 + -100	24546	CT4-1/8-T0-316R-F
A3R13	0698-3155	1		RESISTOR 4.64K 1% .125W F TC = 0 + -100	24546	CT4-1/8-T0-4641-F
A3R14	0698-3457	6		RESISTOR 316K 1% .125W F TC = 0 + -100	28480	0698-3457
A3R15	0698-3444	1		RESISTOR 316 1% .125W F TC = 0 + -100	24546	CT4-1/8-T0-316R-F
A3R16	0698-3457	6		RESISTOR 316K 1% .125W F TC = 0 + -100	28480	0698-3457
A3R17	0698-3155	1		RESISTOR 4.64K 1% .125W F TC = 0 + -100	24546	CT4-1/8-T0-4641-F
A3R18	0757-0438	3	31	RESISTOR 5.11K 1% .125W F TC = 0 + -100	24546	CT4-1/8-T0-5111-F
A3R19	0698-3444	1		RESISTOR 316 1% .125W F TC = 0 + -100	24546	CT4-1/8-T0-316R-F
A3R20	0757-0280	3	43	RESISTOR 1K 1% .125W F TC = 0 + -100	24546	CT4-1/8-T0-1001-F
A3R21	0757-0465	6	9	RESISTOR 100K 1% .125W F TC = 0 + -100	24546	CT4-1/8-T0-1003-F
A3R22	2100-3659	7	1	RESISTOR-TRMR 20K 10% C TOP-ADJ 17-TRN	28480	2100-3659
A3R23	0698-0084	9	3	RESISTOR 2.15K 1% .125W F TC = 0 + -100	24546	CT4-1/8-T0-2151-F
A3R24	0698-7199	1	4	RESISTOR 28.7 1% .05W F TC = 0 + -100	24546	C3-1/8-T0-28R7-F
A3R25	0698-3445	2	1	RESISTOR 348 1% .125W F TC = 0 + -100	24546	CT4-1/8-T0-348R-F
A3R26	0757-0280	3		RESISTOR 1K 1% .125W F TC = 0 + -100	24546	CT4-1/8-T0-1001-F
A3R27	0757-0405	4	5	RESISTOR 162 1% .125W F TC = 0 + -100	24546	CT4-1/8-T0-162R-F
A3R28	0757-0438	3		RESISTOR 5.11K 1% .125W F TC = 0 + -100	24546	CT4-1/8-T0-5111-F
A3R29	0698-3432	7	3	RESISTOR 26.1 1% .125W F TC = 0 + -100	03888	PME55-1/8-T0-26R1-F
A3R30	0757-0442	9		RESISTOR 10K 1% .125W F TC = 0 + -100	24546	CT4-1/8-T0-1002-F
A3R31	0757-0416	7	11	RESISTOR 511 1% .125W F TC = 0 + -100	24546	CT4-1/8-T0-511R-F
A3R32	0698-4037	0	17	RESISTOR 46.4 1% .125W F TC = 0 + -100	28480	0698-4037
A3R33	0698-0082	7	12	RESISTOR 464 1% .125W F TC = 0 + -100	24546	CT4-1/8-T0-4640-F
A3R34-R99				NOT ASSIGNED		
A3R100	0757-0278	9	2	RESISTOR 1.78K 1% .125W F TC = 0 + -100	24546	CT4-1/8-T0-1781-F
A3R101	0757-0382	6	3	RESISTOR 16.2 1% .125W F TC = 0 + -100	19701	5033R-1/8-T0-16R2-F
A3R102				NOT ASSIGNED		
A3R103				NOT ASSIGNED		
A3R104	0698-3429	2		RESISTOR 19.6 1% .125W F TC = 0 + -100	03888	PME55-1/8-T0-19R6-F
A3R105-R189				NOT ASSIGNED		
A3R200	0757-0418	9	4	RESISTOR 619 1% .125W F TC = 0 + -100	24546	CT4-1/8-T0-619R-F
A3R201	0757-0400	9	1	RESISTOR 90.9 1% .125W F TC = 0 + -100	24546	CT4-1/8-T0-90R9-F
A3R202 ^Δ	8159-0005	0		RESISTOR 0 CWM	01339	L-2007-1
A3R203	0757-0280	3		RESISTOR 1K 1% .125W F TC = 0 + -100	24546	CT4-1/8-T0-1001-F
A3R204	0757-0280	3		RESISTOR 1K 1% .125W F TC = 0 + -100	24546	CT4-1/8-T0-1001-F
A3R205	0757-0401	0	14	RESISTOR 100 1% .125W F TC = 0 + -100	24546	CT4-1/8-T0-101-F
A3R206	0698-3444	1		RESISTOR 316 1% .125W F TC = 0 + -100	24546	CT4-1/8-T0-316R-F
A3R207	0698-3444	1		RESISTOR 316 1% .125W F TC = 0 + -100	24546	CT4-1/8-T0-316R-F
A3R208	0757-0438	3		RESISTOR 5.11K 1% .125W F TC = 0 + -100	24546	CT4-1/8-T0-5111-F
A3R209	0698-3444	1		RESISTOR 316 1% .125W F TC = 0 + -100	24546	CT4-1/8-T0-316R-F

†Refer to Section 7 for update information.

*Factory Selected Component (Refer to Section 5).

Δ Errata part change.

Reference Designation	HP Part Number	C D	Qty.	Description	Mfr. Code	Mfr. Part Number
A3R210	0698-0083	8	28	RESISTOR 1.96K 1% .125W F TC = 0 + -100	24546	CT4-1/8-TO-1961-F
A3R211	0698-0083	8		RESISTOR 1.96K 1% .125W F TC = 0 + -100	24546	CT4-1/8-TO-1961-F
A3R212-R297				NOT ASSIGNED		
A3R298	0757-0274			RESISTOR 1.21K 1% .12W	28480	0757-0274
A3R299	0698-3460			RESISTOR 422K 1% .12W	28480	0698-3460
A3R300	1810-0205	7	1	NETWORK-RES 8-SIP 4.7K OHM X 7	11236	750-81-R4.7K
A3R301	0698-0083	8		RESISTOR 1.96K 1% .125W F TC = 0 + -100	24546	CT4-1/8-TO-1961-F
A3R302	1810-0206	8	2	NETWORK-RES 8-SIP 10.0K OHM X 7	11236	750-81-R10K
A3R303	0698-3155	8	2	RESISTOR 3.48K 1% .125W F TC = 0 + -100	28480	0698-3155
A3R303*	0698-0083	8		RESISTOR 1.96K 1% .125W F TC = 0 + -100	24546	CT4-1/8-TO-1961-F
A3R304	0757-0444	1	7	RESISTOR 12.1K 1% .125W F TC = 0 + -100	24546	CT4-1/8-TO-1212-F
A3R305	0698-0083	8		RESISTOR 1.96K 1% .125W F TC = 0 + -100	24546	CT4-1/8-TO-1961-F
A3R306	0698-0083	8		RESISTOR 1.96K 1% .125W F TC = 0 + -100	24546	CT4-1/8-TO-1961-F
A3R307	0698-3432	7		RESISTOR 26.1 1% .125W F TC = 0 + -100	03888	PME55-1/8-TO-26R1-F
A3R308	0698-4037	0		RESISTOR 46.4 1% .125W F TC = 0 + -100	28480	0698-4037
A3R309-R399				NOT ASSIGNED		
A3R400	0698-0083	8		RESISTOR 1.96K 1% .125W F TC = 0 + -100	24546	CT4-1/8-TO-1961-F
A3R401	0698-0083	8		RESISTOR 1.96K 1% .125W F TC = 0 + -100	24546	CT4-1/8-TO-1961-F
A3R402	0757-0441	8	5	RESISTOR 8.25K 1% .125W F TC = 0 + -100	24546	CT4-1/8-TO-8251-F
A3R403	0698-0083	8		RESISTOR 1.96K 1% .125W F TC = 0 + -100	24546	CT4-1/8-TO-1961-F
A3R404	0757-0280	3		RESISTOR 1K 1% .125W F TC = 0 + -100	24546	CT4-1/8-TO-1001-F
A3R405	0757-0280	3		RESISTOR 1K 1% .125W F TC = 0 + -100	24546	CT4-1/8-TO-1001-F
A3R406	0698-0083	8		RESISTOR 1.96K 1% .125W F TC = 0 + -100	24546	CT4-1/8-TO-1961-F
A3R407	0757-0438	3		RESISTOR 5.11K 1% .125W F TC = 0 + -100	24546	CT4-1/8-TO-5111-F
A3R408	0698-4037	0		RESISTOR 46.4 1% .125W F TC = 0 + -100	28480	0698-4037
A3R409	0698-3153	9	4	RESISTOR 3.83K 1% .125W F TC = 0 + -100	24546	CT4-1/8-TO-3831-F
A3R410	0757-0200	7	2	RESISTOR 5.62K 1% .125W F TC = 0 + -100	24546	CT4-1/8-TO-5621-F
A3R411	0757-0419	0	5	RESISTOR 681 1% .125W F TC = 0 + -100	24546	CT4-1/8-TO-681R-F
A3R412	0757-0438	3		RESISTOR 5.11K 1% .125W F TC = 0 + -100	24546	CT4-1/8-TO-5111-F
A3R413	0757-1094	9		RESISTOR 1.47K 1% .125W F TC = 0 + -100	24546	CT4-1/8-TO-1471-F
A3R414	2100-2060	2	2	RESISTOR-TRMR 50 20% C TOP-ADJ 1-TRN	73138	82PR50
A3R415	1810-0294	4	1	NETWORK-RESISTOR 16 PIN DIP; RES	28480	1810-0294
A3R416	0757-0278	9		RESISTOR 1.78K 1% .125W F TC = 0 + -100	24546	CT4-1/8-TO-1781-F
A3R417	0757-0444	1		RESISTOR 12.1K 1% .125W F TC = 0 + -100	24546	CT4-1/8-TO-1212-F
A3R418	0698-3153	9		RESISTOR 3.83K 1% .125W F TC = 0 + -100	24546	CT4-1/8-TO-3831-F
A3R419	0698-0083	8		RESISTOR 1.96K 1% .125W F TC = 0 + -100	24546	CT4-1/8-TO-1961-F
A3R420	0757-0280	3		RESISTOR 1K 1% .125W F TC = 0 + -100	24546	CT4-1/8-TO-1001-F
A3R421	0698-3152	8	2	RESISTOR 3.48K 1% .125W F TC = 0 + -100	24546	CT4-1/8-TO-3481-F
A3R422	0757-0438	3		RESISTOR 5.11K 1% .125W F TC = 0 + -100	24546	CT4-1/8-TO-5111-F
A3R423	0757-0438	3		RESISTOR 5.11K 1% .125W F TC = 0 + -100	24546	CT4-1/8-TO-5111-F
A3R424	0757-0440	7	6	RESISTOR 7.5K 1% .125W F TC = 0 + -100	24546	CT4-1/8-TO-7501-F
A3R425	0698-0083	8		RESISTOR 1.96K 1% .125W F TC = 0 + -100	24546	CT4-1/8-TO-1961-F
A3R426	0757-0418	9		RESISTOR 619 1% .125W F TC = 0 + -100	24546	CT4-1/8-TO-619R-F
A3R427	0757-0280	3		RESISTOR 1K 1% .125W F TC = 0 + -100	24546	CT4-1/8-TO-1001-F
A3R428	0698-3153	9		RESISTOR 3.83K 1% .125W F TC = 0 + -100	24546	CT4-1/8-TO-3831-F
A3R429	0698-8961	7	1	RESISTOR 909K 1% .125W F TC = 0 + -100	28480	0698-8961
A3R430	0757-0442	9		RESISTOR 10K 1% .125W F TC = 0 + -100	24546	CT4-1/8-TO-1002-F
A3R431	0757-0444	1		RESISTOR 12.1K 1% .125W F TC = 0 + -100	24546	CT4-1/8-TO-1212-F
A3R432	2100-3296	8	1	RESISTOR-TRMR 1K 10% C TOP-ADJ 17-TRN	28480	2100-3296
A3R433	0698-3450	9	1	RESISTOR 42.2K 1% .125W F TC = 0 + -100	24546	CT4-1/8-TO-4222-F
A3R434	0698-4037	0		RESISTOR 46.4 1% .125W F TC = 0 + -100	28480	0698-4037
A3R435	0757-0442	9		RESISTOR 10K 1% .125W F TC = 0 + -100	24546	CT4-1/8-TO-1002-F
A3R436	0699-0073	8	2	RESISTOR 10M 1% .125W F TC = 0 + -150	28480	0699-0073
A3R437	0757-0274	5	1	RESISTOR 1.21K 1% .125W F TC = 0 + -100	24546	CT4-1/8-TO-1211-F
A3R438	0757-0442	9		RESISTOR 10K 1% .125W F TC = 0 + -100	24546	CT4-1/8-TO-1002-F
A3R439	2100-3096	6	1	RESISTOR-TRMR 50K 10% C TOP-ADJ 17-TRN	28480	2100-3096
A3R440	0757-0401	0		RESISTOR 100 1% .125W F TC = 0 + -100	24546	CT4-1/8-TO-101-F
A3R441	0757-0401	0		RESISTOR 100 1% .125W F TC = 0 + -100	24546	CT4-1/8-TO-101-F
A3R299	0698-3460					
A3R298	0757-0274					

†Refer to Section 7 for update information.

*Factory Selected Component (Refer to Section 5).

Δ Errata part change.

Reference Designation	HP Part Number	C D	Qty.	Description	Mfr. Code	Mfr. Part Number
A3R442	0757-0424	7	5	RESISTOR 1.1K 1% .125W F TC = 0 + -100	24546	CT4-1/8-T0-1101-F
A3R443	0698-8828	5	1	RESISTOR 25.6K 1% .125W F TC = 0 + -10	28480	0698-8828
A3R444	0698-4037	0		RESISTOR 46.4 1% .125W F TC = 0 + -100	28480	0698-4037
A3R445	0757-0401	0		RESISTOR 100 1% .125W F TC = 0 + -100	24546	CT4-1/8-T0-101-F
A3R446	0757-0441	8		RESISTOR 8.25K 1% .125W F TC = 0 + -100	24546	CT4-1/8-T0-8251-F
A3R447	0698-3159	5	1	RESISTOR 26.1K 1% .125W F TC = 0 + -100	24546	CT4-1/8-T0-2612-F
A3R448	0757-0441	8		RESISTOR 8.25K 1% .125W F TC = 0 + -100	24546	CT4-1/8-T0-8251-F
A3R449	0757-0441	8		RESISTOR 8.25K 1% .125W F TC = 0 + -100	24546	CT4-1/8-T0-8251-F
A3R450	0757-0442	9		RESISTOR 10K 1% .125W F TC = 0 + -100	24546	CT4-1/8-T0-1002-F
A3R451	0698-8812	7	1	RESISTOR 1 1% .125W F TC = 0 + -100	28480	0698-8812
A3R452	2100-2031	7	2	RESISTOR-TRMR 50K 10% C TOP-ADJ 1-TRN	73138	82PRS0K
A3R453	0698-8913					
A3R45-R499				NOT ASSIGNED		
A3R500	0757-0395	1	2	RESISTOR 56.2 1% .125W F TC = 0 + -100	24546	CT4-1/8-T0-56R2-F
A3R501	0757-0395	1		RESISTOR 56.2 1% .125W F TC = 0 + -100	24546	CT4-1/8-T0-56R2-F
A3R502	0757-0419	0		RESISTOR 681 1% .125W F TC = 0 + -100	24546	CT4-1/8-T0-681R-F
A3R503	0757-0419	0		RESISTOR 681 1% .125W F TC = 0 + -100	24546	CT4-1/8-T0-681R-F
A3R504	0757-0317	7	3	RESISTOR 1.33K 1% .125W F TC = 0 + -100	24546	CT4-1/8-T0-1331-F
A3R505	0757-0317	7		RESISTOR 1.33K 1% .125W F TC = 0 + -100	24546	CT4-1/8-T0-1331-F
A3R506	0698-4037	0		RESISTOR 46.4 1% .125W F TC = 0 + -100	28480	0698-4037
A3R507	0698-4037	0		RESISTOR 46.4 1% .125W F TC = 0 + -100	28480	0698-4037
A3R508	0698-0082	7		RESISTOR 464 1% .125W F TC = 0 + -100	24546	CT4-1/8-T0-4640-F
A3R509	0698-0082	7		RESISTOR 464 1% .125W F TC = 0 + -100	24546	CT4-1/8-T0-4640-F
A3R510	0698-0082	7		RESISTOR 464 1% .125W F TC = 0 + -100	24546	CT4-1/8-T0-4640-F
A3R511	0698-0082	7		RESISTOR 464 1% .125W F TC = 0 + -100	24546	CT4-1/8-T0-4640-F
A3R512	0698-4037	0		RESISTOR 46.4 1% .125W F TC = 0 + -100	28480	0698-4037
A3R513	0698-4037	0		RESISTOR 46.4 1% .125W F TC = 0 + -100	28480	0698-4037
A3R514	0698-4037	0		RESISTOR 46.4 1% .125W F TC = 0 + -100	28480	0698-4037
A3R515	0698-4037	0		RESISTOR 46.4 1% .125W F TC = 0 + -100	28480	0698-4037
A3R516	0757-0421	4	8	RESISTOR 825 1% .125W F TC = 0 + -100	24546	CT4-1/8-T0-825R-F
A3R517	0698-3440	7	16	RESISTOR 196 1% .125W F TC = 0 + -100	24546	CT4-1/8-T0-196R-F
A3R518	0757-0438	3		RESISTOR 5.11K 1% .125W F TC = 0 + -100	24546	CT4-1/8-T0-5111-F
A3R519	0757-0421	4		RESISTOR 825 1% .125W F TC = 0 + -100	24546	CT4-1/8-T0-825R-F
A3R520	0698-3150	6	3	RESISTOR 2.37K 1% .125W F TC = 0 + -100	24546	CT4-1/8-T0-2371-F
A3R521	0698-3162	0	9	RESISTOR 46.4K 1% .125W F TC = 0 + -100	24546	CT4-1/8-T0-4642-F
A3R522	0698-3430	5	2	RESISTOR 21.5 1% .125W F TC = 0 + -100	03888	PME55-1/8-T0-21R5-F
A3R523	0698-3162	0		RESISTOR 46.4K 1% .125W F TC = 0 + -100	24546	CT4-1/8-T0-4642-F
A3R524	0757-0200	7		RESISTOR 5.62K 1% .125W F TC = 0 + -100	24546	CT4-1/8-T0-5621-F
A3R525	0698-3161	9		RESISTOR 38.3K 1% .125W F TC = 0 + -100	24546	CT4-1/8-T0-3832-F
A3R526	0757-0280	3		RESISTOR 1K 1% .125W F TC = 0 + -100	24546	CT4-1/8-T0-1001-F
A3R527	0757-0422	5	2	RESISTOR 909 1% .125W F TC = 0 + -100	24546	CT4-1/8-T0-909R-F
A3R528	0698-3132	4	1	RESISTOR 261 1% .125W F TC = 0 + -100	24546	CT4-1/8-T0-2610-F
A3R529	0757-0444	2	6	RESISTOR 14.7K 1% .125W F TC = 0 + -100	24546	CT4-1/8-T0-1472-F
A3R530	0757-0382	6		RESISTOR 16.2 1% .125W F TC = 0 + -100	19701	5033R-1/8-T0-16R2-F
A3R531	0698-4037	0		RESISTOR 46.4 1% .125W F TC = 0 + -100	28480	0698-4037
A3R532	0757-0280	3		RESISTOR 1K 1% .125W F TC = 0 + -100	24546	CT4-1/8-T0-1001-F
A3R533	0757-0401	0		RESISTOR 100 1% .125W F TC = 0 + -100	24546	CT4-1/8-T0-101-F
A3R534	0757-0444	1		RESISTOR 12.1K 1% .125W F TC = 0 + -100	24546	CT4-1/8-T0-1212-F
A3R535	0698-4037	0		RESISTOR 46.4 1% .125W F TC = 0 + -100	28480	0698-4037
A3R536	0698-0083	8		RESISTOR 1.96K 1% .125W F TC = 0 + -100	24546	CT4-1/8-T0-1961-F
A3R537	0757-0401	0		RESISTOR 100 1% .125W F TC = 0 + -100	24546	CT4-1/8-T0-101-F

†Refer to Section 7 for update information.

*Factory Selected Component (Refer to Section 5).

Δ Errata part change.

Replaceable Parts

Model 8657A

Reference Designation	HP Part Number	C D	Qty.	Description	Mfr. Code	Mfr. Part Number
A3R538	0757-0280	3		RESISTOR 1K 1% .125W F TC = 0 + -100	24546	CT4-1/8-T0-1001-F
A3R539	0757-0416	7		RESISTOR 511 1% .125W F TC = 0 + -100	24546	CT4-1/8-T0-511R-F
A3R540	0698-3156	2		RESISTOR 14.7K 1% .125W F TC = 0 + -100	24546	CT4-1/8-T0-1472-F
A3R541	0698-0083	8		RESISTOR 1.96K 1% .125W F TC = 0 + -100	24546	CT4-1/8-T0-1961-F
A3R542	0757-0421	4		RESISTOR 825 1% .125W F TC = 0 + -100	24546	CT4-1/8-T0-825R-F
A3R543	0757-0418	9		RESISTOR 619 1% .125W F TC = 0 + -100	24546	CT4-1/8-T0-619R-F
A3R544	0757-0439	4	2	RESISTOR 6.81K 1% .125W F TC = 0 + -100	24546	CT4-1/8-T0-6811-F
A3R545	0757-0394	0		RESISTOR 51.1 1% .125W F TC = 0 + -100	24546	CT4-1/8-T0-51R1-F
A3R546	0757-0444	1		RESISTOR 12.1K 1% .125W F TC = 0 + -100	24546	CT4-1/8-T0-1212-F
A3R547	0698-0084	9		RESISTOR 2.15K 1% .125W F TC = 0 + -100	24546	CT4-1/8-T0-2151-F
A3R548	0698-4037	0		RESISTOR 46.4 1% .125W F TC = 0 + -100	28480	0698-4037
A3R549	0757-0416	7		RESISTOR 511 1% .125W F TC = 0 + -100	24546	CT4-1/8-T0-511R-F
A3R550	0757-0382	6		RESISTOR 16.2 1% .125W F TC = 0 + -100	19701	5033R-1/8-T0-16R2-F
A3R551	0698-3443	0	1	RESISTOR 287 1% .125W F TC = 0 + -100	24546	CT4-1/8-T0-287R-F
A3R552	0757-0419	0		RESISTOR 681 1% .125W F TC = 0 + -100	24546	CT4-1/8-T0-681R-F
A3R553	0698-4037	0		RESISTOR 46.4 1% .125W F TC = 0 + -100	28480	0698-4037
A3R554	0698-3136	8	1	RESISTOR 17.8K 1% .125W F TC = 0 + -100	24546	CT4-1/8-T0-1782-F
A3R555	0757-0401	0		RESISTOR 100 1% .125W F TC = 0 + -100	24546	CT4-1/8-T0-101-F
A3R556	0757-0280	3		RESISTOR 1K 1% .125W F TC = 0 + -100	24546	CT4-1/8-T0-1001-F
A3R557	0757-0394	0		RESISTOR 51.1 1% .125W F TC = 0 + -100	24546	CT4-1/8-T0-51R1-F
A3R558	0698-0083	8		RESISTOR 1.96K 1% .125W F TC = 0 + -100	24546	CT4-1/8-T0-1961-F
A3R559	0757-0438	3		RESISTOR 5.11K 1% .125W F TC = 0 + -100	24546	CT4-1/8-T0-5111-F
A3R560	0757-0421	4		RESISTOR 825 1% .125W F TC = 0 + -100	24546	CT4-1/8-T0-825R-F
A3R561	0757-0401	0		RESISTOR 100 1% .125W F TC = 0 + -100	24546	CT4-1/8-T0-101-F
A3R562	2100-2487	9	1	RESISTOR-TRMR 2K 10% C TOP-ADJ 1-TRN	73138	82PR2K
A3R563	0757-0280	3		RESISTOR 1K 1% .125W F TC = 0 + -100	24546	CT4-1/8-T0-1001-F
A3R564	0698-4037	0		RESISTOR 46.4 1% .125W F TC = 0 + -100	28480	0698-4037
A3R565	0757-0394	0		RESISTOR 51.1 1% .125W F TC = 0 + -100	24546	CT4-1/8-T0-51R1-F
A3R566	0698-3156	2		RESISTOR 14.7K 1% .125W F TC = 0 + -100	24546	CT4-1/8-T0-1472-F
A3R567	0698-4037	0		RESISTOR 46.4 1% .125W F TC = 0 + -100	28480	0698-4037
A3R568	0757-0442	9		RESISTOR 10K 1% .125W F TC = 0 + -100	24546	CT4-1/8-T0-1002-F
A3R569	0698-0082	7		RESISTOR 464 1% .125W F TC = 0 + -100	24546	CT4-1/8-T0-4640-F
A3R570	0757-0189	3	3	RESISTOR 21.5K 1% .125W F TC = 0 + -100	24546	CT4-1/8-T0-2152-F
A3R571	0698-0084			RF 2.1K 1% .125W	28480	0698-0084
A3R572	2100-3089			R-VITT 5K10%17T	28480	2100-3089
A3R573-R599				NOT ASSIGNED		
A3R600	0757-0462	3	4	RESISTOR 75K 1% .125W F TC = 0 + -100	24546	CT4-1/8-T0-7502-F
A3R601	0698-3162	0		RESISTOR 46.4K 1% .125W F TC = 0 + -100	24546	CT4-1/8-T0-4642-F
A3R602	0698-3157	3	5	RESISTOR 19.6K 1% .125W F TC = 0 + -100	24546	CT4-1/8-T0-1962-F
A3R603	0757-0467	8	2	RESISTOR 121K 1% .125W F TC = 0 + -100	24546	CT4-1/8-T0-1213-F
A3R604	0698-3162	0		RESISTOR 46.4K 1% .125W F TC = 0 + -100	24546	CT4-1/8-T0-4642-F
A3R605	0757-0279	0		RESISTOR 3.16K 1% .125W F TC = 0 + -100	24546	CT4-1/8-T0-3161-F
A3R606	0757-0444	1		RESISTOR 12.1K 1% .125W F TC = 0 + -100	24546	CT4-1/8-T0-1212-F
A3R607	0757-0424	7		RESISTOR 1.1K 1% .125W F TC = 0 + -100	24546	CT4-1/8-T0-1101-F
A3R608	0698-3444	1		RESISTOR 316 1% .125W F TC = 0 + -100	24546	CT4-1/8-T0-316R-F
A3R609	0698-3154	0	3	RESISTOR 4.22K 1% .125W F TC = 0 + -100	24546	CT4-1/8-T0-4221-F
A3R610	0757-0467	8		RESISTOR 121K 1% .125W F TC = 0 + -100	24546	CT4-1/8-T0-1213-F
A3R611	0757-0442	9		RESISTOR 10K 1% .125W F TC = 0 + -100	24546	CT4-1/8-T0-1002-F
A3R612	0757-0442	9		RESISTOR 10K 1% .125W F TC = 0 + -100	24546	CT4-1/8-T0-1002-F
A3R613	0757-0439	4		RESISTOR 6.81K 1% .125W F TC = 0 + -100	24546	CT4-1/8-T0-6811-F
A3R614	0757-0338	2	1	RESISTOR 1K 1% .25W F TC = 0 + -100	24546	NA5-1/4-T0-1001-F
A3R615	1810-0206	8		NETWORK-RES 8-SIP 10.0K OHM X 7	11236	750-81-R10K

†Refer to Section 7 for update information.

*Factory Selected Component (Refer to Section 5).

Δ Errata part change.

Reference Designation	HP Part Number	C D	Qty.	Description	Mfr. Code	Mfr. Part Number
A3R616	0757-0442	9		RESISTOR 10K 1% .125W F TC = 0 + -100	24546	CT4-1/8-T0-1002-F
A3R617	0757-0439	4		RESISTOR 6.81K 1% .125W F TC = 0 + -100	24546	CT4-1/8-T0-8811-F
A3R618	0698-3154	0	3	RESISTOR 4.22K 1% .125W F TC = 0 + -100	24546	CT4-1/8-T0-4221-F
A3R619	0757-0346	2	3	RESISTOR 10 1% .125W F TC = 0 + -100	28480	0757-0346
A3R620	2100-3210	6	2	RESISTOR-TRMR 10K 10% C TOP-ADJ 1-TRN	28480	2100-3210
A3R621	0757-0442	9		RESISTOR 10K 1% .125W F TC = 0 + -100	24546	CT4-1/8-T0-1002-F
A3R622	0757-0441	8		RESISTOR 8.25K 1% .125W F TC = 0 + -100	24546	CT4-1/8-T0-8251-F
A3R623	0698-0082			RF 464 1% .125W	28480	0698-0082
A3R624	0757-0418			RF 619 1% .125W	28480	0757-0418
A3R625	0698-0083			RF 1.96K 1% .125W	28480	0698-0083
A3R626	0698-4475			RESISTOR 9.76K 1% .12W	28480	0698-4475
A3R623-R699				NOT ASSIGNED		
A3R700	0698-0085	0	5	RESISTOR 2.61K 1% .125W F TC = 0 + -100	24546	CT4-1/8-T0-2611-F
A3R701	0698-0085	0		RESISTOR 2.61K 1% .125W F TC = 0 + -100	24546	CT4-1/8-T0-2611-F
A3R702	0698-0085	0		RESISTOR 2.61K 1% .125W F TC = 0 + -100	24546	CT4-1/8-T0-2611-F
A3R703	0698-0085	0		RESISTOR 2.61K 1% .125W F TC = 0 + -100	24546	CT4-1/8-T0-2611-F
A3R704	0757-0421	4		RESISTOR 825 1% .125W F TC = 0 + -100	24546	CT4-1/8-T0-825R-F
A3R705	0757-0438	3		RESISTOR 5.11K 1% .125W F TC = 0 + -100	24546	CT4-1/8-T0-5111-F
A3R706	0757-0438	3		RESISTOR 5.11K 1% .125W F TC = 0 + -100	24546	CT4-1/8-T0-5111-F
A3R707	0698-3435	0		RESISTOR 38.3 1% .125W F TC = 0 + -100	28480	CT4-1/8-T0-38R3-F
A3R708	0757-0280	3		RESISTOR 1K 1% .125W F TC = 0 + -100	24546	CT4-1/8-T0-1001-F
A3R709	0757-0280	3		RESISTOR 1K 1% .125W F TC = 0 + -100	24546	CT4-1/8-T0-1001-F
A3R710	0757-0438	3		RESISTOR 5.11K 1% .125W F TC = 0 + -100	24546	CT4-1/8-T0-5111-F
A3R711	1810-1514	4	1	NETWORK-RES 8-DIP 2.5K OHM X 2	28480	1810-0666
A3R712	2100-3296	8	1	RESISTOR-TRMR 1K 10% C TOP-ADJ 17-TRN	28480	2100-3296
A3R713	0757-0465	6	1	RESISTOR 100K 1% .125W F TC = 0 + -100	28480	0757-0465
A3R714	2100-3733	8	1	RESISTOR-TRMR 1M 20% C TOP-ADJ 17-TRN	28480	2100-3733
A3R715	0757-0440	7		RESISTOR 7.5K 1% .125W F TC = 0 + -100	24546	CT4-1/8-T0-7501-F
A3R716	0698-0083	8		RESISTOR 1.96K 1% .125W F TC = 0 + -100	24546	CT4-1/8-T0-1961-F
A3R717	0757-0438	3		RESISTOR 5.11K 1% .125W F TC = 0 + -100	24546	CT4-1/8-T0-5111-F
A3R718	0757-0440	7		RESISTOR 7.5K 1% .125W F TC = 0 + -100	24546	CT4-1/8-T0-7501-F
A3R719	0757-0424	7		RESISTOR 1.1K 1% .125W F TC = 0 + -100	24546	CT4-1/8-T0-1101-F
A3R720	0757-0424	7		RESISTOR 1.1K 1% .125W F TC = 0 + -100	24546	CT4-1/8-T0-1101-F
A3R721	0757-0438	3		RESISTOR 5.11K 1% .125W F TC = 0 + -100	24546	CT4-1/8-T0-5111-F
A3R722	0757-0465	6		RESISTOR 100K 1% .125W F TC = 0 + -100	24546	CT4-1/8-T0-1003-F
A3R723	2100-2030	6	1	RESISTOR-TRMR 20K 10% C TOP-ADJ 1-TRN	73138	82PR20K
A3R724	0757-1094	9		RESISTOR 1.47K 1% .125W F TC = 0 + -100	24546	CT4-1/8-T0-1471-F
A3R725	0698-3162	0		RESISTOR 46.4K 1% .125W F TC = 0 + -100	24546	CT4-1/8-T0-4642-F
A3R726	0698-3454	3	3	RESISTOR 215K 1% .125W F TC = 0 + -100	24546	CT4-1/8-T0-2153-F
A3R727	0757-0280	3		RESISTOR 1K 1% .125W F TC = 0 + -100	24546	CT4-1/8-T0-1001-F
A3R728	0757-0280	3		RESISTOR 1K 1% .125W F TC = 0 + -100	24546	CT4-1/8-T0-1001-F
A3R729	0757-0442	9		RESISTOR 10K 1% .125W F TC = 0 + -100	24546	CT4-1/8-T0-1002-F
A3R730				NOT ASSIGNED		
A3R731	0757-1094	9		RESISTOR 1.47K 1% .125W F TC = 0 + -100	24546	CT4-1/8-T0-1471-F
A3R732	0757-0280	3		RESISTOR 1K 1% .125W F TC = 0 + -100	24546	CT4-1/8-T0-1001-F
A3R733	0757-0280	3		RESISTOR 1K 1% .125W F TC = 0 + -100	24546	CT4-1/8-T0-1001-F
A3R734	0757-0401	0		RESISTOR 100 1% .125W F TC = 0 + -100	24546	CT4-1/8-T0-101-F
A3R735	0757-0458	7	6	RESISTOR 51.1K 1% .125W F TC = 0 + -100	24546	CT4-1/8-T0-5112-F
A3R736	0757-0458	7		RESISTOR 51.1K 1% .125W F TC = 0 + -100	24546	CT4-1/8-T0-5112-F
A3R737	0698-0083	8		RESISTOR 1.96K 1% .125W F TC = 0 + -100	24546	CT4-1/8-T0-1961-F
A3R738	0698-0083	8		RESISTOR 1.96K 1% .125W F TC = 0 + -100	24546	CT4-1/8-T0-1961-F
A3R739				NOT ASSIGNED		
A3R740	0757-0401	0		RESISTOR 100 1% .125W F TC = 0 + -100	24546	CT4-1/8-T0-101-F
A3R741	0757-0401	0		RESISTOR 100 1% .125W F TC = 0 + -100	24546	CT4-1/8-T0-101-F

†Refer to Section 7 for update information.

*Factory Selected Component (Refer to Section 5).

Δ Errata part change.

Reference Designation	HP Part Number	C D	Qty.	Description	Mfr. Code	Mfr. Part Number
A3TP1	1251-0600	0	38	CONNECTOR-SGL CONT PIN 1.14-MM-BSC-SZ SQ	28480	1251-0600
A3TP2	1251-0600	0		CONNECTOR-SGL CONT PIN 1.14-MM-BSC-SZ SQ	28480	1251-0600
A3TP3	1251-0600	0		CONNECTOR-SGL CONT PIN 1.14-MM-BSC-SZ SQ	28480	1251-0600
A3TP4	1251-0600	0		CONNECTOR-SGL CONT PIN 1.14-MM-BSC-SZ SQ	28480	1251-0600
A3TP5	1251-0600	0		CONNECTOR-SGL CONT PIN 1.14-MM-BSC-SZ SQ	28480	1251-0600
A3TP6	1251-0600	0		CONNECTOR-SGL CONT PIN 1.14-MM-BSC-SZ SQ	28480	1251-0600
A3TP7	1251-0600	0		CONNECTOR-SGL CONT PIN 1.14-MM-BSC-SZ SQ	28480	1251-0600
A3TP8	1251-0600	0		CONNECTOR-SGL CONT PIN 1.14-MM-BSC-SZ SQ	28480	1251-0600
A3TP9	1251-0600	0		CONNECTOR-SGL CONT PIN 1.14-MM-BSC-SZ SQ	28480	1251-0600
A3TP10	1251-0600	0		CONNECTOR-SGL CONT PIN 1.14-MM-BSC-SZ SQ	28480	1251-0600
A3TP11	1251-0600	0		CONNECTOR-SGL CONT PIN 1.14-MM-BSC-SZ SQ	28480	1251-0600
A3TP12	1251-0600	0		CONNECTOR-SGL CONT PIN 1.14-MM-BSC-SZ SQ	28480	1251-0600
A3TP13	1251-0600	0		CONNECTOR-SGL CONT PIN 1.14-MM-BSC-SZ SQ	28480	1251-0600
A3TP14	1251-0600	0		CONNECTOR-SGL CONT PIN 1.14-MM-BSC-SZ SQ	28480	1251-0600
A3TP15	1251-0600	0		CONNECTOR-SGL CONT PIN 1.14-MM-BSC-SZ SQ	28480	1251-0600
A3TP16	1251-4926	1	4	CONNECTOR 8-PIN M POST TYPE	28480	1251-4926
A3TP17	1251-4926	1		CONNECTOR 8-PIN M POST TYPE	28480	1251-4926
A3TP18	1251-4926	1		CONNECTOR 8-PIN M POST TYPE	28480	1251-4926
A3TP19	1251-4926	1		CONNECTOR 8-PIN M POST TYPE	28480	1251-4926
A3TP20	1251-0600	0		CONNECTOR-SGL CONT PIN 1.14-MM-BSC-SZ SQ	28480	1251-0600
A3TP21	1251-0600	0	CONNECTOR-SGL CONT PIN 1.14-MM-BSC-SZ SQ	28480	1251-0600	
A3TP22	1251-0600	0	CONNECTOR-SGL CONT PIN 1.14-MM-BSC-SZ SQ	28480	1251-0600	
A3TP23	1251-0600	0	CONNECTOR-SGL CONT PIN 1.14-MM-BSC-SZ SQ	28480	1251-0600	
A3TP24	1251-0600	0	CONNECTOR-SGL CONT PIN 1.14-MM-BSC-SZ SQ	28480	1251-0600	
A3TP25	1251-0600	0	CONNECTOR-SGL CONT PIN 1.14-MM-BSC-SZ SQ	28480	1251-0600	
A3TP26	1251-0600	0	CONNECTOR-SGL CONT PIN 1.14-MM-BSC-SZ SQ	28480	1251-0600	
A3TP27	1251-0600	0	CONNECTOR-SGL CONT PIN 1.14-MM-BSC-SZ SQ	28480	1251-0600	
A3TP28	1251-0600	0	CONNECTOR-SGL CONT PIN 1.14-MM-BSC-SZ SQ	28480	1251-0600	
A3TP29	1251-0600	0	CONNECTOR-SGL CONT PIN 1.14-MM-BSC-SZ SQ	28480	1251-0600	
A3TP30	1251-0600	0	CONNECTOR-SGL CONT PIN 1.14-MM-BSC-SZ SQ	28480	1251-0600	
A3TP31	1251-0600	0	CONNECTOR-SGL CONT PIN 1.14-MM-BSC-SZ SQ	28480	1251-0600	
A3TP32	1251-0600	0	CONNECTOR-SGL CONT PIN 1.14-MM-BSC-SZ SQ	28480	1251-0600	
A3TP33	1251-0600	0	CONNECTOR-SGL CONT PIN 1.14-MM-BSC-SZ SQ	28480	1251-0600	
A3U1	1820-1225	4	2	IC FF ECL D-M/S DUAL	04713	MC10231P
A3U2	1826-0371	1		IC OP AMP LOW-BIAS-HMPD TO-99 PKG	27014	LF256H
A3U3	1858-0032	8		TRANSISTOR ARRAY 14-PIN PLSTC DIP	3L585	CA3146E
A3U4	1826-1012	8		ANALOG SWITCH 4 SPST 16 -CERDIP	34371	HI1-0201-4
A3U5	1826-0371	1		IC OP AMP LOW-BIAS-HMPD TO-99 PKG	27014	LF256H
A3U6	1820-0693	8	4	IC FF TTL S D-TYPE POS-EDGE-TRIG	01295	SN74S74N
A3U7	1826-0932	0		IC OP AMP PRCN 8-DIP-C PKG	06665	OP-27FZ
A3U8	1820-1196	8		IC FF TTL LS D-TYPE POS-EDGE-TRIG COM	01295	SN74LS174N
A3U9	1826-0141	3		IC COMPARATOR GP DUAL 14-DIP-C PKG	27014	LM319J
A3U10	1826-0065	0		IC COMPARATOR PRCN 8-DIP-P PKG	S0545	UPC311C
A3U11	1826-0065	0		IC COMPARATOR PRCN 8-DIP-P PKG	S0545	UPC311C
A3U12	1826-0371	1		IC OP AMP LOW-BIAS-HMPD TO-99 PKG	27014	LF256H
A3U13	1826-1012	8		ANALOG SWITCH 4 SPST 16 -CERDIP	34371	HI1-0201-4
A3U14	1826-2190	4		IC OP AMP PRCN TO-99 PKG	06665	OP-07EJ
A3U15	1820-1144	6		IC GATE TTL LS NOR QUAD 2-INP	01295	SN74LS02N

†Refer to Section 7 for update information.

*Factory Selected Component (Refer to Section 5).

Δ Errata part change.

Reference Designation	HP Part Number	C D	Qty.	Description	Mfr. Code	Mfr. Part Number
A3U16	1826-0462	1	3	D/A 10-BIT 16-CBRZ/SDR BPLR	04713	MC3410CL
<i>2&38U AND ABOVE</i>						
A3U17	ISD6-0046	7	1	IC MISC HCMOS	28480	ISD6-0046
A3U18	1820-1201	6	2	IC GATE TTL LS AND QUAD 2-INP	01295	SN74LS08N
A3U19	1820-1112	8	6	IC FF TTL LS D-TYPE POS-EDGE-TRIG	01295	SN74LS74AN
A3U20	1820-1278	7	3	IC CNTR TTL LS BIN UP/DOWN SYNCHRO	01295	SN74LS191N
A3U21	1826-0021	8	1	IC OP AMP GP TO-99 PKG	27014	LM310H
A3U22	1826-1100	6	1	A/D 8-1/2-BIT 18-DIP-C BPLR	24355	AD570JD
A3U23	1820-1858	9		IC FF TTL LS D-TYPE OCTL	01295	SN74LS377N
A3U24	1820-1279	8	3	IC CNTR TTL LS DECD UP/DOWN SYNCHRO	01295	SN74LS190N
A3U25	1820-1112	8		IC FF TTL LS D-TYPE POS-EDGE-TRIG	01295	SN74LS74AN
A3U26	1820-1278	7		IC CNTR TTL LS BIN UP/DOWN SYNCHRO	01295	SN74LS191N
A3U27	1826-2190	6	2	IC OP AMP LOW-NOISE DUAL 14-DIP-C PKG	52063	XR5533AN(PER HP DWG)
A3U28	1820-4324	3	1	IC-8-BIT,6800 SERIES MCU(MASKED)	04713	MC6805P2CP(MASKED)
A3U29	1820-1195	7	1	IC FF TTL LS D-TYPE POS-EDGE-TRIG COM	01295	SN74LS175N
A3U30	1820-1279	8		IC CNTR TTL LS DECD UP/DOWN SYNCHRO	01295	SN74LS190N
A3U31	1820-0693	8		IC FF TTL S D-TYPE POS-EDGE-TRIG	01295	SN74S74N
A3U32	1820-1278	7		IC CNTR TTL LS BIN UP/DOWN SYNCHRO	01295	SN74LS191N
A3U33 ^Δ	1826-1319	4		IC OP AMP LOW-NOISE DUAL 14-DIP-C PKG	02910	NE5533AN
A3U34	1826-1202	9	2	D/A 10-BIT 16-CERDIP CMOS	24355	AD7533(SEL)
A3U35	1820-1144	6		IC GATE TTL LS NOR QUAD 2-INP	01295	SN74LS02N
A3U36	1820-1279	8		IC CNTR TTL LS DECD UP/DOWN SYNCHRO	01295	SN74LS190N
A3U37	1820-0693	8		IC FF TTL S D-TYPE POS-EDGE-TRIG	01295	SN74S74N
A3U38	1820-1112	8		IC FF TTL LS D-TYPE POS-EDGE-TRIG	01295	SN74LS74AN
A3U39	1820-1112	8		IC FF TTL LS D-TYPE POS-EDGE-TRIG	01295	SN74LS74AN
A3U40	1820-1882	9	1	IC GATE ECL EXCL-OR QUAD	04713	MC10113L
A3U41	1820-1206	1	1	IC GATE TTL LS NOR TPL 3-INP	01295	SN74LS27N
A3U42	1820-1446	1	1	IC SHF-RGTR TTL LS R-S PRL-IN PRL-OUT	01295	SN74LS395AN
A3U43	1820-1367	5	1	IC GATE TTL S AND QUAD 2-INP	01295	SN74S08N
A3U44	1820-1112	8		IC FF TTL LS D-TYPE POS-EDGE-TRIG	01295	SN74LS74AN
A3U45	1826-0547	1	1	IC OP AMP LOW-BIAS-H-IMPDP DUAL 8-DIP-C	01295	TL072ACJG
A3U46	1820-1225	4		IC FF ECL D-M/S DUAL	04713	MC10231P
A3U47	1820-0629	0	5	IC FF TTL S J-K NEG-EDGE-TRIG	01295	SN74S112N
A3U48	1820-1991	1	1	IC CNTR TTL LS DECD DUAL 4-BIT	07263	74LS390PC
A3U49	1820-0629	0		IC FF TTL S J-K NEG-EDGE-TRIG	01295	SN74S112N
A3U50	1820-0629	0		IC FF TTL S J-K NEG-EDGE-TRIG	01295	SN74S112N
A3U51	1820-1322	2	1	IC GATE TTL S NOR QUAD 2-INP	01295	SN74S02N
A3U52	1820-0693	8		IC FF TTL S D-TYPE POS-EDGE-TRIG	01295	SN74S74N
A3U53	1820-1383	5	1	IC CNTR ECL BCD POS-EDGE-TRIG	04713	MC10138L
A3U54	1820-0629	0		IC FF TTL S J-K NEG-EDGE-TRIG	01295	SN74S112N
A3U55	1820-0629	0		IC FF TTL S J-K NEG-EDGE-TRIG	01295	SN74S112N
A3U56	1826-0777					
A3U57	1826-0412					
A3VR200	1902-0945			DIODE-ZNR 3V 5% DO-35 PD = .4W TC = -.043%		1902-0945
A3VR1-VR299				NOT ASSIGNED		
A3VR300	1902-0945	7	1	DIODE-ZNR 3V 5% DO-35 PD = .4W TC = -.043%	28480	1902-0945
A3VR301-VR399				NOT ASSIGNED		
A3VR400	1902-0680	7	2	DIODE-ZNR 1N827 6.2V 5% DO-7 PD = .4W	04713	1N827
A3VR401	1902-0680	7		DIODE-ZNR 1N827 6.2V 5% DO-7 PD = .4W	04713	1N827
A3VR402-VR499				NOT ASSIGNED		
A3VR500	1902-0947	9	1	DIODE-ZNR 3.6V 5% DO-35 PD = .4W TC = -.036%	28480	1902-0947
A3VR501-VR600				NOT ASSIGNED		
A3VR601	1902-0962	8	1	DIODE-ZNR 15V 5% DO-35 PD = .4W TC = +.087%	28480	1902-0962

†Refer to Section 7 for update information.

*Factory Selected Component (Refer to Section 5).

Δ Errata part change.

Reference Designation	HP Part Number	C D	Qty.	Description	Mfr. Code	Mfr. Part Number
A3W1	1251-4670	2	6	CONNECTOR 3-PIN M POST TYPE	28480	1251-4670
A3W2	1251-8557	2	13	CONN-POST TYPE .100-PIN-SPCG 2-CONT	28480	1251-8557
A3W3	1251-4670	2		CONNECTOR 3-PIN M POST TYPE	28480	1251-4670
A3W4	1251-8557	2		CONN-POST TYPE .100-PIN-SPCG 2-CONT	28480	1251-8557
A3W5	1251-8557	2		CONN-POST TYPE .100-PIN-SPCG 2-CONT	28480	1251-8557
A3W6	1251-8557	2		CONN-POST TYPE .100-PIN-SPCG 2-CONT	28480	1251-8557
A3W7	1251-8557	2		CONN-POST TYPE .100-PIN-SPCG 2-CONT	28480	1251-8557
A3W8	1251-8557	2		CONN-POST TYPE .100-PIN-SPCG 2-CONT	28480	1251-8557
A3W9	1251-8557	2		CONN-POST TYPE .100-PIN-SPCG 2-CONT	28480	1251-8557
A3W10	1251-8557	2		CONN-POST TYPE .100-PIN-SPCG 2-CONT	28480	1251-8557
	1258-0209	8	8	JUMPER-REMOVABLE 2 POSITION; .200 IN	28480	1258-0209
A3W11	8159-0005	0		RESISTOR-ZERO OHMS 22AWG LEAD DIA	28480	8159-0005
A3W12	08656-20141	3	1	COAX CABLE F SMC-SMC (5) (A3J4 TO A3J2)	28480	08656-60141
A3W13	08656-60167	4	1	COAX F SMC-SMC (6)	28480	08656-60167
A3W14	8159-0005	0			28480	8159-0005
A3W20	5021-6437			(A3J5 TO A3J3)	28480	5021-6437
A3Y1	0410-1130	0	1	CRYSTAL-QUARTZ 50 MHZ HC-42/U-HLDR	28480	0410-1130
	1200-0758	2	1	SOCKET-XTAL 2-CONT HC-25/U DIP-SLDR	28480	1200-0758
A3Y2-Y299				NOT ASSIGNED		
A3Y300	0410-1180	0	2	CRYSTAL-QUARTZ 4.000 MHZ HC-18/U-HLDR	28480	0410-1180
	2580-0002	4	5	NUT-HEX-DBL-CHAM 8-32-THD .085-IN-THK	28480	2580-0002
	3050-0105	6	4	WASHER-FL MTLN NO. 4 .125-IN-ID	28480	3050-0105

†Refer to Section 7 for update information.

*Factory Selected Component (Refer to Section 5).

Δ Errata part change.

Reference Designation	HP Part Number	C D	Qty.	Description	Mfr. Code	Mfr. Part Number
A3A1						
A3A1	08657-60177	1	1	LOW FREQUENCY OSCILLATOR ASSY	28480	08657-60177
A3A1C1	0180-3879	7		CAPACITOR-FXD .01UF + .20% 100VDC CER	28480	0180-3879
A3A1C2	0180-0097	7		CAPACITOR-FXD 47UF + .10% 35VDC TA	56289	150D476X9035S2
A3A1C3	0180-3879	7		CAPACITOR-FXD .01UF + .20% 100VDC CER	28480	0180-3879
A3A1C4	0180-3879	7		CAPACITOR-FXD .01UF + .20% 100VDC CER	28480	0180-3879
A3A1C5	0180-4588	7	2	CAPACITOR-FXD 270PF + .5% 100VDC CER	28480	0180-4588
A3A1C6	0180-4040	6		CAPACITOR-FXD 1000PF + .5% 100VDC CER	28480	0180-4040
A3A1C7	0180-4040	6		CAPACITOR-FXD 1000PF + .5% 100VDC CER	28480	0180-4040
A3A1C8	0180-3879	7		CAPACITOR-FXD .01UF + .20% 100VDC CER	28480	0180-3879
A3A1C9	0180-3879	7		CAPACITOR-FXD .01UF + .20% 100VDC CER	28480	0180-3879
A3A1C10	0180-3879	7		CAPACITOR-FXD .01UF + .20% 100VDC CER	28480	0180-3879
A3A1C11				NOT ASSIGNED		
A3A1C12	0160-4493	3	1	CAPACITOR-FXD 27PF + .5% 200VDC CER 0 + -30	28480	0160-4493
A3A1C13	0160-4767	4	3	CAPACITOR-FXD 20PF + .5% 200VDC CER 0 + -30	28480	0160-4767
A3A1C14	0121-0445	5	1	CAPACITOR-V TRMR-CER 4.5-20PF 160V	28480	0121-0445
A3A1C15	0160-4588	7		CAPACITOR-FXD 270PF + .5% 100VDC CER	28480	0160-4588
A3A1C16	0160-2437	1	2	CAPACITOR-FDTHRU 5000PF + 80 -20% 200V	28480	0160-2437
A3A1C17	0160-2437	1		CAPACITOR-FDTHRU 5000PF + 80 -20% 200V	28480	0160-2437
A3A1C18	0160-4040	6		CAPACITOR-FXD 1000PF + .5% 100VDC CER	28480	0160-4040
A3A1C19	0160-0575	5	23	CAPACITOR-FXD .1UF + .20% 50VDC CER	28480	0160-0575
A3A1C20	0160-4385	2	1	CAPACITOR-FXD 15PF + .5% 200VDC CER 0 + -30	28480	0160-4385
A3A1C21-C119				NOT ASSIGNED		
A3A1C120	0160-2436	0		CAPACITOR-FDTHRU 10PF 20% 200V CER	28480	0160-2436
A3A1CR1	0122-0173	8		DIODE-VVC 13.5PF 7% C3/C25-MIN = 5 BVR = 30V	25403	BB809 SELECTED
A3A1CR2	0122-0173	8		DIODE-VVC 13.5PF 7% C3/C25-MIN = 5 BVR = 30V	25403	BB809 SELECTED
A3A1CR3	0122-0173	8		DIODE-VVC 13.5PF 7% C3/C25-MIN = 5 BVR = 30V	25403	BB809 SELECTED
A3A1CR4	0122-0173	8		DIODE-VVC 13.5PF 7% C3/C25-MIN = 5 BVR = 30V	25403	BB809 SELECTED
A3A1CR5	0122-0173	8		DIODE-VVC 13.5PF 7% C3/C25-MIN = 5 BVR = 30V	25403	BB809 SELECTED
A3A1CR6	0122-0173	8		DIODE-VVC 13.5PF 7% C3/C25-MIN = 5 BVR = 30V	25403	BB809 SELECTED
A3A1CR7	0122-0173	8		DIODE-VVC 13.5PF 7% C3/C25-MIN = 5 BVR = 30V	25403	BB809 SELECTED
A3A1CR8	0122-0173	8		DIODE-VVC 13.5PF 7% C3/C25-MIN = 5 BVR = 30V	25403	BB809 SELECTED
A3A1CR9	0122-0173	8		DIODE-VVC 13.5PF 7% C3/C25-MIN = 5 BVR = 30V	25403	BB809 SELECTED
A3A1CR10	0122-0173	8		DIODE-VVC 13.5PF 7% C3/C25-MIN = 5 BVR = 30V	25403	BB809 SELECTED
A3A1CR11	1901-0050	3		DIODE-SWITCHING 80V 200MA 2NS DO-35	9N171	1N4150
A3A1CR12	1901-0050	3		DIODE-SWITCHING 80V 200MA 2NS DO-35	9N171	1N4150
A3A1J1 ^Δ	1250-2305	4		CONNECTOR-RF SMC M SGL-HOLE-RR 50-OHM	06860	22SMC-50-0-X1865-111
A3A1L1	9100-3562	3	1	INDUCTOR RF-CH-MLD 2.7UH 5% .166DX.385LG	28480	9100-3562
A3A1L2	9100-2248	5	2	INDUCTOR RF-CH-MLD 120NH 10%	28480	9100-2248
A3A1L3				NOT ASSIGNED		
A3A1L4	9100-2250	9	1	INDUCTOR RF-CH-MLD 180NH 10%	28480	9100-2250
A3A1L5	9135-0073	3	10	INDUCTOR RF-CH-MLD 51NH 6% .102DX.26LG	28480	9135-0073
A3A1L6	9100-2249	6	3	INDUCTOR RF-CH-MLD 150NH 10%	28480	9100-2249
A3A1L7	9100-2252	1	1	INDUCTOR RF-CH-MLD 270NH 10%	28480	9100-2252
A3A1L8	9135-0081	3	1	INDUCTOR RF-CH-MLD 68NH 5%	28480	9135-0081
A3A1C22	0121-0445				28480	0121-0445
A3A1C23	0160-4804				28480	0160-4804
A3A1L9	9100-2250				28480	9100-2250
A3A1L10	9100-2247				28480	9100-2247
A3A1L11	9100-2247				28480	9100-2247

1 Refer to Section 7 for update information.

Δ Factory Selected Component (Refer to Section 5).

Δ Errata part change.

Reference Designation	HP Part Number	C D	Qty.	Description	Mfr. Code	Mfr. Part Number
A3A1MP1	08656-40016	5		COVER TOP	28480	08656-40016
A3A1MP2	08656-00128	7		COVER-FRAME	28480	08656-00128
A3A1MP3	08656-00127	6		COVER BOTTOM	28480	08656-00127
A3A1MP4	2380-0277	9		SCREW-MACH 6-32 .3124-IN-LG HEX-HD-SLT	00000	ORDER BY DESCRIPTION
A3A1MP5	2190-0124	4		WASHER-LK INTL T NO. 10 .105-IN-HD	28480	2190-0124
A3A1MP6	2950-0078	9		NUT-HEX-DBL-CHAM 10-32-THD .0674-IN-THK	28480	2950-0078
A3A1MP7	2190-0009	4		WASHER-LK INTL T NO. 8 .1684-IN-HD	28480	2190-0009
A3A1MP8	2580-0002	4		NUT-HEX-DBL-CHAM 8-32-THD .085-IN-THK	28480	2580-0002
A3A1MP9	2280-0001	5	12	NUT-HEX-DBL-CHAM 4-40-THD .084-IN-THK	28480	2280-0001
A3A1MP10	2190-0004	9	4	WASHER-LK INTL T NO. 4 .115-IN-HD	28480	2190-0004
A3A1MP11	4208-0277	9	1	FOAM-POLYU 8.53-MM-THK 110-MM-WD	28480	4208-0277
A3A1MP12	08657-00025	4	1	PAD-FOAM	28480	08657-00025
A3A1Q1 ^Δ	1854-1234	4		TRANSISTOR NPN SI PD = 180MW FT = 5GHZ	03334	BFR91A
A3A1Q2	1854-0832	6		TRANSISTOR NPN SI PD = 180MW FT = 4GHZ	25403	BFR91
A3A1Q3	1854-0378	7	1	TRANSISTOR NPN 2N5109 SI TC-39 PD = 800MW	3L585	2N5109
A3A1R1	0698-7197	6		RESISTOR 17.8 1% .05W F TC = 0 + -100	24546	C3-1/8-TO-17R8-F
A3A1R2	0698-7212	9		RESISTOR 100 1% .05W F TC = 0 + -100	24546	C3-1/8-TO-100R-F
A3A1R3	0757-0416	7		RESISTOR 511 1% .125W F TC = 0 + -100	24546	CT4-1/8-TO-511R-F
A3A1R4	0698-3440	4		RESISTOR 162 1% .125W F TC = 0 + -100	24546	CT4-1/8-TO-162R-F
A3A1R5	0698-1902	8		RESISTOR 10 1% .05W F TC = 0 + -100	24546	C3-1/8-TO-10R-F
A3A1R6	0698-7188	8		RESISTOR 10 1% .05W F TC = 0 + -100	24546	C3-1/8-TO-10R-F
A3A1R7	0757-0280	3		RESISTOR 1K 1% .125W F TC = 0 + -100	24546	CT4-1/8-TO-1001-F
A3A1R8	0698-3438	3		RESISTOR 147 1% .125W F TC = 0 + -100	24546	CT4-1/8-TO-147R-F
A3A1R9	0757-0438	3		RESISTOR 5.11K 1% .125W F TC = 0 + -100	24546	CT4-1/8-TO-5111-F
A3A1R10	0757-0280	3		RESISTOR 1K 1% .125W F TC = 0 + -100	24546	CT4-1/8-TO-1001-F
A3A1R11	0757-0416	7		RESISTOR 511 1% .125W F TC = 0 + -100	24546	CT4-1/8-TO-511R-F
A3A1R12	0757-0438	3		RESISTOR 5.11K 1% .125W F TC = 0 + -100	24546	CT4-1/8-TO-5111-F
A3A1R13	0757-0438	3		RESISTOR 5.11K 1% .125W F TC = 0 + -100	24546	CT4-1/8-TO-5111-F
A3A1R14	0698-7212	9		RESISTOR 100 1% .05W F TC = 0 + -100	24546	C3-1/8-TO-100R-F
A3A1R15	0698-7205	0		RESISTOR 51.1 1% .05W F TC = 0 + -100	24546	C3-1/8-TO-51R1-F
A3A1R16	0698-7224	3	1	RESISTOR 316 1% .05W F TC = 0 + -100	24546	C3-1/8-TO-316R-F
A3A1R17	0698-7209	9		RESISTOR 100 1% .05W F TC = 0 + -100	24546	C3-1/8-TO-100R-F
A3A1R18	0698-7223	2		RESISTOR 287 1% .05W F TC = 0 + -100	24546	C3-1/8-TO-287R-F
A3A1R19	0698-7194	6		RESISTOR 17.8 1% .05W F TC = 0 + -100	24546	C3-1/8-TO-17R8-F
A3A1R20	0698-7223	2		RESISTOR 287 1% .05W F TC = 0 + -100	24546	C3-1/8-TO-287R-F
A3A1R21	0698-7205	0		RESISTOR 51.1 1% .05W F TC = 0 + -100	24546	C3-1/8-TO-51R1-F
A3A1R22	0698-7219	6		RESISTOR 196 1% .05W F TC = 0 + -100	24546	C3-1/8-TO-196R-F
A3A1T1	08657-21022	1	1	CABLE SEMI-RIGID 2.18 NO CONN	28480	08657-21022
A3A1R202	0698-3624					

1 Refer to Section 7 for update information.

* Factory Selected Component (Refer to Section 5).

Δ Errata part change.

Reference Designation	HP Part Number	C D	Qty.	Description	Mfr. Code	Mfr. Part Number
A4						
EXCEPT OPTION 022						
A4	08657-60162	6	1	HIGH FREQUENCY LOOP ASSY	28480	08657-60162
A4C1	0180-3770	9	3	CAPACITOR-FXD 2.2UF + -10% 35VDC TA	28480	0180-3770
A4C2	0160-3879	7		CAPACITOR-FXD .01UF + -20% 100VDC CER	28480	0160-3879
A4C3	0180-3770	9		CAPACITOR-FXD 2.2UF + -10% 35VDC TA	28480	0180-3770
A4C4	0180-4389	6	28	CAPACITOR-FXD 100PF + -5PF 200VDC CER	28480	0180-4389
A4C5	0160-4082	6	2	CAPACITOR-FDTHRU 1000PF 20% 200V CER	28480	0160-4082
A4C6	0160-4040	6	34	CAPACITOR-FXD 1000PF + -5% 100VDC CER	28480	0160-4040
A4C7	0160-4040	6		CAPACITOR-FXD 1000PF + -5% 100VDC CER	28480	0160-4040
A4C8	0160-4040	6		CAPACITOR-FXD 1000PF + -5% 100VDC CER	28480	0160-4040
A4C9	0160-4619	5	3	CAPACITOR-FXD 2.7PF + -.25PF 200VDC CER	28480	0160-4619
A4C10	0160-4619	5		CAPACITOR-FXD 2.7PF + -.25PF 200VDC CER	28480	0160-4619
A4C11	0160-4619	5		CAPACITOR-FXD 2.7PF + -.25PF 200VDC CER	28480	0160-4619
A4C12	0160-4547	8	1	CAPACITOR-FXD 150PF + -5% 200VDC CER	28480	0160-4547
A4C13	0160-4040	6		CAPACITOR-FXD 1000PF + -5% 100VDC CER	28480	0160-4040
A4C14	0160-4382	6		CAPACITOR-FXD 1000PF + -5% 100VDC CER	28480	0160-4382
A4C15				NOT ASSIGNED		
A4C16	0160-4040	6		CAPACITOR-FXD 1000PF + -5% 100VDC CER	28480	0160-4040
A4C17	0160-3879	7		CAPACITOR-FXD .01UF + -20% 100VDC CER	28480	0160-3879
A4C18	0160-4389	6		CAPACITOR-FXD 100PF + -5PF 200VDC CER	28480	0160-4389
A4C19	0160-4389	6		CAPACITOR-FXD 100PF + -5PF 200VDC CER	28480	0160-4389
A4C20	0160-4511	6	2	CAPACITOR-FXD 220PF + -5% 200VDC CER	28480	0160-4511
A4C21	0160-4040	6		CAPACITOR-FXD 1000PF + -5% 100VDC CER	28480	0160-4040
A4C22				NOT ASSIGNED		
A4C23				NOT ASSIGNED		
A4C24	0160-4518	3	2	CAPACITOR-FXD 3.9PF + -.5PF 200VDC CER	28480	0160-4518
A4C25	0160-4389	6		CAPACITOR-FXD 100PF + -5PF 200VDC CER	28480	0160-4389
A4C26	0160-4389	6		CAPACITOR-FXD 100PF + -5PF 200VDC CER	28480	0160-4389
A4C27				NOT ASSIGNED		
A4C28	0160-3875	3	7	CAPACITOR-FXD 22PF + -5% 200VDC CER 0 + -30	28480	0160-3875
A4C29	0160-3873	1	2	CAPACITOR-FXD 4.7PF + -.5PF 200VDC CER	28480	0160-3873
<i>2746U TO 2907A</i>						
A4C30	0160-4491	1	7	CAPACITOR-FXD 8.2PF + -.5PF 200VDC CER	28480	0160-4491
<i>2913A AND ABOVE</i>						
A4C30	0160-4350	1	1	CAPACITOR-FXD 68PF + -.5PF 200VDC CER	06352	FD12COQ2D680J
A4C31	0160-4387	4	2	CAPACITOR-FXD 47PF + -5% 200VDC CER 0 + -30	28480	0160-4387
A4C32	0160-3879	7		CAPACITOR-FXD .01UF + -20% 100VDC CER	28480	0160-3879
A4C33	0160-4519	4	2	CAPACITOR-FXD 9.1PF + -.5PF 200VDC CER	28480	0160-4519
A4C34	0180-4130	8		CAPACITOR-FXD 2.2UF + -10% 20VDC TA	56289	150D225X9020A2
A4C35	0160-4498	8	16	CAPACITOR-FXD 5.6PF + -.5PF 200VDC CER	28480	0160-4498
A4C36	0160-4519	4		CAPACITOR-FXD 9.1PF + -.5PF 200VDC CER	28480	0160-4519
A4C37	0160-4383	0	4	CAPACITOR-FXD 6.8PF + -.5PF 200VDC CER	20932	5024E0200RD689D
A4C38	0160-4383	0		CAPACITOR-FXD 6.8PF + -.5PF 200VDC CER	20932	5024E0200RD689D
A4C39	0160-4588	2	5	CAPACITOR-FXD 10PF + -.5PF 200VDC CER	28480	0160-4588
A4C40				NOT ASSIGNED		
A4C41	0160-4383	0		CAPACITOR-FXD 6.8PF + -.5PF 200VDC CER	20932	5024E0200RD689D
A4C42 ^Δ	0160-4764	1		CAPACITOR-FXD 150PF + -5% 200VDC CER COG	02010	SR201A151JAAH
A4C43	0160-5980	0		CAPACITOR-FXD 6.8PF + -.5PF 200VDC CER	20932	5024E0200RD689D
A4C44	0160-3926	5	1	CAPACITOR-FDTHRU 100PF 20% 200V CER	28480	0160-3926
A4C45				Not Assigned		

† Refer to Section 7 for update information.

* Factory Selected Component (Refer to Section 5).

Δ Errata part change.

Reference Designation	HP Part Number	C D	Qty.	Description	Mfr. Code	Mfr. Part Number
A4						
EXCEPT OPTION 022						
A4C46				NOT ASSIGNED		
A4C47	0160-4511	6		CAPACITOR-FXD 220PF + .5% 200VDC CER	28480	0160-4511
A4C48				NOT ASSIGNED		
A4C49	0160-3873	1		CAPACITOR-FXD 4.7PF + .5PF 200VDC CER	28480	0160-3873
A4C50	0160-4381	8	1	CAPACITOR-FXD 1.5PF + .25PF 200VDC CER	28480	0160-4381
A4C51	0160-3879	7		CAPACITOR-FXD .01UF + .20% 100VDC CER	28480	0160-3879
A4C52				NOT ASSIGNED		
A4C53	0121-0449	9	3	CAPACITOR-V TRMR-CER 3.5-10PF 63V PC-MTG	28480	0121-0449
A4C54-C57				NOT ASSIGNED		
A4C58	0121-0461			CAPACITOR-V TRMR-CER 6.0-22 PF	28480	0121-0461
A4C59	0160-4040	6		CAPACITOR-FXD 1000PF + .5% 100VDC CER	28480	0160-4040
A4C60	0160-4040	6		CAPACITOR-FXD 1000PF + .5% 100VDC CER	28480	0160-4040
A4C61	0160-3875	3		CAPACITOR-FXD 22PF + .5% 200VDC CER 0 + .30	28480	0160-3875
A4C62	0160-4040	6		CAPACITOR-FXD 1000PF + .5% 100VDC CER	28480	0160-4040
A4C63	0160-4040	6		CAPACITOR-FXD 1000PF + .5% 100VDC CER	28480	0160-4040
A4C64	0160-4767	4		CAPACITOR-FXD 20PF + .5% 200VDC CER 0 + .30	28480	0160-4767
A4C65	0160-4040	6		CAPACITOR-FXD 1000PF + .5% 100VDC CER	28480	0160-4040
A4C66	0160-4040	6		CAPACITOR-FXD 1000PF + .5% 100VDC CER	28480	0160-4040
A4C67	0160-4497	6		CAPACITOR-FXD 100PF + .5PF 200VDC CER	28480	0160-4497
A4C68	0160-3879	7		CAPACITOR-FXD .01UF + .20% 100VDC CER	28480	0160-3879
A4C69	0160-4040	6		CAPACITOR-FXD 1000PF + .5% 100VDC CER	28480	0160-4040
A4C70	0160-4926	7	1	CAPACITOR-FXD 110PF + .5% 200VDC CER	28480	0160-4926
A4C71	0160-3879	7		CAPACITOR-FXD .01UF + .20% 100VDC CER	28480	0160-3879
A4C72	0160-4040	6		CAPACITOR-FXD 1000PF + .5% 100VDC CER	28480	0160-4040
A4C73	0160-4040	6		CAPACITOR-FXD 1000PF + .5% 100VDC CER	28480	0160-4040
A4C74	0160-4040	6		CAPACITOR-FXD 1000PF + .5% 100VDC CER	28480	0160-4040
A4C75	0121-0449	9		CAPACITOR-V TRMR-CER 3.5-10PF 63V PC-MTG	28480	0121-0449
A4C76	0160-3872	0	1	CAPACITOR-FXD 2.2PF + .25PF 200VDC CER	28480	0160-3872
A4C77	0160-4386	6		CAPACITOR-FXD 1000PF + .5% 100VDC CER	28480	0160-4386
A4C78	0160-4040	6		CAPACITOR-FXD 1000PF + .5% 100VDC CER	28480	0160-4040
A4C79	0160-4387	4		CAPACITOR-FXD 47PF + .5% 200VDC CER 0 + .30	28480	0160-4387
A4C80	0160-4498	8		CAPACITOR-FXD 5.6PF + .5PF 200VDC CER	28480	0160-4498
A4C81	0160-4498	8		CAPACITOR-FXD 5.6PF + .5PF 200VDC CER	28480	0160-4498
A4C82				NOT ASSIGNED		
A4C83	0160-3879	7		CAPACITOR-FXD .01UF + .20% 100VDC CER	28480	0160-3879
A4C84	0160-4521	8	1	CAPACITOR-FXD 12PF + .5% 200VDC CER 0 + .30	28480	0160-4521
A4C85	0121-0449	9		CAPACITOR-V TRMR-CER 3.5-10PF 63V PC-MTG	28480	0121-0449
A4C86	0160-4382	9	4	CAPACITOR-FXD 3.3PF + .25PF 200VDC CER	28480	0160-4382
A4C87	0160-4040	6		CAPACITOR-FXD 1000PF + .5% 100VDC CER	28480	0160-4040
A4C88	0160-3879	7		CAPACITOR-FXD .01UF + .20% 100VDC CER	28480	0160-3879
A4C89	0160-3879	7		CAPACITOR-FXD .01UF + .20% 100VDC CER	28480	0160-3879
A4C90	0160-0576	5		CAPACITOR-FXD .1UF + .20% 50VDC CER	28480	0160-0576
A4C91	0160-0576	5		CAPACITOR-FXD .1UF + .20% 50VDC CER	28480	0160-0576
A4C92	0160-0573	2	1	CAPACITOR-FXD 4700PF + .20% 100VDC CER	28480	0160-0573
A4C93	0160-3879	7		CAPACITOR-FXD .01UF + .20% 100VDC CER	28480	0160-3879
A4C94	0160-3879	7		CAPACITOR-FXD .01UF + .20% 100VDC CER	28480	0160-3879
A4C95	0160-0575	4	5	CAPACITOR-FXD .047UF + .20% 50VDC CER	28480	0160-0575
A4C96	0160-3879	7		CAPACITOR-FXD .01UF + .20% 100VDC CER	28480	0160-3879
A4C97	0160-3879	7		CAPACITOR-FXD .01UF + .20% 100VDC CER	28480	0160-3879

†Refer to Section 7 for update information.

*Factory Selected Component (Refer to Section 5).

Δ Errata part change.

Reference Designation	HP Part Number	C D	Qty.	Description	Mfr. Code	Mfr. Part Number
A4						
EXCEPT OPTION 022						
A4C98	0160-3879	7		CAPACITOR-FXD .01UF + -20% 100VDC CER	28480	0160-3879
A4C99	0160-3879	7		CAPACITOR-FXD .01UF + -20% 100VDC CER	28480	0160-3879
A4C100	0160-3879	7		CAPACITOR-FXD .01UF + -20% 100VDC CER	28480	0160-3879
A4C101	0160-3879	7		CAPACITOR-FXD .01UF + -20% 100VDC CER	28480	0160-3879
A4C102	0160-3879	7		CAPACITOR-FXD .01UF + -20% 100VDC CER	28480	0160-3879
A4C103	0160-4387	1	1	CAPACITOR-FXD 150PF + -5% 100VDC CER	28480	0160-4387
A4C104-C149				NOT ASSIGNED		
A4C150	0160-4527	4	1	CAPACITOR-FXD 56PF + -5% 200VDC CER 0 + -30	28480	0160-4527
A4C151	0160-4389	6	57	CAPACITOR-FXD 100PF + -5PF 200VDC CER	28480	0160-4389
A4C152	0160-4389	6		CAPACITOR-FXD 100PF + -5PF 200VDC CER	28480	0160-4389
A4C153	0160-4389	6		CAPACITOR-FXD 100PF + -5PF 200VDC CER	28480	0160-4389
A4C154	0160-5469	5		CAPACITOR-FXD 1UF 10% 50VDC	28480	0160-5469
A4C155*	0160-3875	3		CAPACITOR-FXD 22PF + -5% 200VDC CER 0 + -30	28480	0160-3875
A4C156	0160-4389	6		CAPACITOR-FXD 100PF + -5PF 200VDC CER	28480	0160-4389
A4C157	0160-5469	5		CAPACITOR-FXD 1UF 10% 50VDC	28480	0160-5469
A4C158	0160-4389	6		CAPACITOR-FXD 100PF + -5PF 200VDC CER	28480	0160-4389
A4C159 ^Δ	0160-4498	4		CAPACITOR-FXD 5.6PF + -8% 200VDC CER COG	06352	FD12COG2D5R6D
A4C160				PRINTED CIRCUIT TRACE CAPACITOR		
A4C161	0160-4766	3	3	CAPACITOR-FXD 30PF + -5% 200VDC CER 0 + -30	28480	0160-4766
A4C162	0160-4389	6		CAPACITOR-FXD 100PF + -5PF 200VDC CER	28480	0160-4389
A4C163	0160-4524	1	1	CAPACITOR-FXD 24PF + -5% 200VDC CER 0 + -30	51642	200-200-NP0-240J
A4C164	0160-4518	3		CAPACITOR-FXD 3.9PF + -.5PF 200VDC CER	28480	0160-4518
A4C165	0160-4389	6		CAPACITOR-FXD 100PF + -5PF 200VDC CER	28480	0160-4389
A4C166	0160-4389	6		CAPACITOR-FXD 100PF + -5PF 200VDC CER	28480	0160-4389
A4C167	0160-4766	3		CAPACITOR-FXD 30PF + -5% 200VDC CER 0 + -30	28480	0160-4766
A4C168	0160-4526	3	2	CAPACITOR-FXD 42PF + -5% 200VDC CER 0 + -30	28480	0160-4526
A4C169	0160-4526	3		CAPACITOR-FXD 42PF + -5% 200VDC CER 0 + -30	28480	0160-4526
A4C170	0160-4040	6		CAPACITOR-FXD 1000PF + -5% 100VDC CER	28480	0160-4040
A4C171	0160-4386	3	1	CAPACITOR-FXD 33PF + -5% 200VDC CER 0 + -30	28480	0160-4386
A4C172	0160-4766	3		CAPACITOR-FXD 30PF + -5% 200VDC CER 0 + -30	28480	0160-4766
A4C173	0160-3879			CAPACITOR-FXD .01F + -20% 100VDC CER		
A4C174	0160-3879	7		CAPACITOR-FXD .01UF + -20% 100VDC CER	28480	0160-3879
A4C175	0160-3879	7		CAPACITOR-FXD .01UF + -20% 100VDC CER	28480	0160-3879
A4C176	0160-3879	7		CAPACITOR-FXD .01UF + -20% 100VDC CER	28480	0160-3879
A4C177	0180-3770	9		CAPACITOR-FXD 2.2UF + -10% 35VDC TA	28480	0180-3770
A4C178	0160-4040	6		CAPACITOR-FXD 1000PF + -5% 100VDC CER	28480	0160-4040
A4C179	0160-5969			CAPACITRO-FXD 3.3PF	28480	0160-5969
A4C180	0160-5954			CAPACITOR-FXD 220PF	28480	0160-5954
A4CR1	1901-1098	3		DIODE-SWITCHING 80V 200MA 2NS DO-35	9N171	1N4150
A4CR2	1901-0189	9	1	DIODE-STEP RECOVERY	28480	1901-0189
A4CR3	1906-0098	9	4	DIODE-MATCHED 1V	28480	1906-0098
A4CR4	1906-0098	9		DIODE-MATCHED 1V	28480	1906-0098
A4CR5	1906-0098	9		DIODE-MATCHED 1V	28480	1906-0098
A4CR6	1906-0098	9		DIODE-MATCHED 1V	28480	1906-0098
A4CR7	1901-1098	3		DIODE-SWITCHING 80V 200MA 2NS DO-35	9N171	1N4150
A4CR8	1901-1098	3		DIODE-SWITCHING 80V 200MA 2NS DO-35	9N171	1N4150
A4CR9	1901-1098	3		DIODE-SWITCHING 80V 200MA 2NS DO-35	9N171	1N4150
A4CR10	1901-1098	3		DIODE-SWITCHING 80V 200MA 2NS DO-35	9N171	1N4150

†Refer to Section 7 for update information.

*Factory Selected Component (Refer to Section 5).

Δ Errata part change

Reference Designation	HP Part Number	C D	Qty.	Description	Mfr. Code	Mfr. Part Number
A4 EXCEPT OPTION 022						
A4CR11	1901-1098	3		DIODE-SWITCHING 80V 200MA 2NS DO-35	9N171	1N4150
A4CR12	1901-1098	3		DIODE-SWITCHING 80V 200MA 2NS DO-35	9N171	1N4150
A4CR13	1901-1098	3		DIODE-SWITCHING 80V 200MA 2NS DO-35	9N171	1N4150
A4CR14	1901-0518	8	2	DIODE-SM SIG SCHOTTKY	28480	1901-0518
A4CR15	1901-1098	3		DIODE-SWITCHING 80V 200MA 2NS DO-35	9N171	1N4150
A4CR16	1901-1098	3		DIODE-SWITCHING 80V 200MA 2NS DO-35	9N171	1N4150
A4CR17	1901-1098	3		DIODE-SWITCHING 80V 200MA 2NS DO-35	9N171	1N4150
A4CR18	1901-1098	3		DIODE-SWITCHING 80V 200MA 2NS DO-35	9N171	1N4150
A4CR19	1901-1098	3		DIODE-SWITCHING 80V 200MA 2NS DO-35	9N171	1N4150
A4CR20	1901-1098	3		DIODE-SWITCHING 80V 200MA 2NS DO-35	9N171	1N4150
A4CR21	1901-0050	3		DIODE-SWITCHING 80V 200MA 2NS DO-35	9N171	1N4150
A4CR22-CR100				NOT ASSIGNED		
A4CR101	0122-0161	4	6	DIODE-VVC 2.15PF 7% BVR = 30V	25403	BB405B
A4CR102	0122-0161	4		DIODE-VVC 2.15PF 7% BVR = 30V	25403	BB405B
A4J1	1251-8599	2	3	CONN-POST TYPE .100-PIN-SPCG 10-CONT	28480	1251-8599
A4L1	9100-1627	2	5	INDUCTOR RF-CH-MLD 39UH 5%	28480	9100-1627
A4L2	9100-1627	2		INDUCTOR RF-CH-MLD 39UH 5%	28480	9100-1627
A4L3	9100-1088	2		INDUCTOR RF-CH-MLD 39UH 5%	28480	9100-1088
A4L4	9100-1627	2		INDUCTOR RF-CH-MLD 39UH 5%	28480	9100-1627
A4L5	9100-2247	4	13	INDUCTOR RF-CH-MLD 100NH 10%	28480	9100-2247
A4L6-L9				PRINTED CIRCUIT TRACE INDUCTORS		
A4L10	9100-2247	4		INDUCTOR RF-CH-MLD 100NH 10%	28480	9100-2247
A4L11	9135-0071	1	1	INDUCTOR RF-CH-MLD 62NH 5.806%	28480	9135-0071
A4L12				NOT ASSIGNED		
A4L13	9100-2247	4		INDUCTOR RF-CH-MLD 100NH 10%	28480	9100-2247
A4L14				NOT ASSIGNED		
A4L15 ^Δ	9135-0072	6	1	INDUCTOR RF-CH-MLD 39NH 6%	28480	9135-0072
A4L16 ^Δ	9135-0072	6	1	INDUCTOR RF-CH-MLD 39NH 6%	28480	9135-0072
A4L17				NOT ASSIGNED		
A4L18				NOT ASSIGNED		
A4L19	9135-0068	6	5	INDUCTOR RF-CH-MLD 33NH 6.36%	28480	9135-0068
A4L20	9135-0068	6		INDUCTOR RF-CH-MLD 33NH 6.36%	28480	9135-0068
A4L21	9135-0076	6	1	INDUCTOR RF-CH-MLD 39NH 6%	28480	9135-0076
A4L22	9135-0073	3		INDUCTOR RF-CH-MLD 47NH 6.596%	28480	9135-0073
A4L23	9140-0158	6	37	INDUCTOR RF-CH-MLD 1UH 10%	28480	9140-0158
A4L24	9140-0141	6		INDUCTOR RF-CH-MLD 1UH 10%	28480	9140-0141
A4L25	9100-3514	0	4	INDUCTOR 30NH .285D-INX.4LG-IN	28480	9100-3514
A4L26	9135-0072	2	1	INDUCTOR 56NH 5.893% 2.6D-MMX6.6LG-MM	28480	9135-0072
A4L27	9135-0068	6		INDUCTOR RF-CH-MLD 33NH 6.36%	28480	9135-0068
A4L28	9100-3512	0		INDUCTOR 30NH .285D-INX.4LG-IN	28480	9100-3512
A4L29				NOT ASSIGNED		
A4L30	9100-2248	5		INDUCTOR RF-CH-MLD 120NH 10%	28480	9100-2248
A4L31	9140-0141	7		INDUCTOR RF-CH-MLD 680NH 10%	28480	9140-0141
A4L32				NOT ASSIGNED		
A4J2	1251-460			CONNECTOR POST TYPE	28480	1251-4670
A4J15	1251-8557			CONNECTOR POST TYPE	28480	1251-8557
A4J16	1251-8557			CONNECTOR POST TYPE	28480	1251-8557

†Refer to Section 7 for update information.

*Factory Selected Component (Refer to Section 5).

Δ Errata part change.

Reference Designation	HP Part Number	C D	Qty.	Description	Mfr. Code	Mfr. Part Number
A4						
EXCEPT OPTION 022						
A4L33	9100-2249	6		INDUCTOR RF-CH-MLD 150NH 10%	28480	9100-2249
A4L34				NOT ASSIGNED		
A4L35	9135-0068	6		INDUCTOR RF-CH-MLD 33NH 6.36%	28480	9135-0068
A4L36	9100-3514	0		INDUCTOR 30NH .285D-INX.4LG-IN	28480	9100-3514
A4L37	9100-3512	8	1	INDUCTOR 50NH .285D-INX.4LG-IN	28480	9100-3512
A4L38	9100-3514	0		INDUCTOR 30NH .285D-INX.4LG-IN	28480	9100-3514
A4L39	9100-3513	9	1	INDUCTOR 75NH .285D-INX.4LG-IN	28480	9100-3513
A4L40				NOT ASSIGNED		
A4L41	9100-2249	6		INDUCTOR RF-CH-MLD 150NH 10%	28480	9100-2249
A4L42	9135-0068	6		INDUCTOR RF-CH-MLD 33NH 6.36%	28480	9135-0068
A4L43	9100-2251	8		INDUCTOR RF-CH-MLD 1.5UH 10% .105DX.26LG	28480	9100-2251
A4L44	9100-2259					9100-2259
A4L45-L99				NOT ASSIGNED		
A4L100	9100-2247	4		INDUCTOR RF-CH-MLD 100NH 10%	28480	9100-2247
A4L101	9140-1088	3		INDUCTOR FIXED L:11.5UH TO 19.3UH	03273	51-254-1
A4L102	08901-00085	2	1	INDUCTOR	28480	08901-00085
A4L103	9100-2247	4		INDUCTOR RF-CH-MLD 100NH 10%	28480	9100-2247
A4L104				PRINTED CIRCUIT TRACE INDUCTOR		
A4L105	9100-2247	4		INDUCTOR RF-CH-MLD 100NH 10%	28480	9100-2247
A4L106	9100-2247	4		INDUCTOR RF-CH-MLD 100NH 10%	28480	9100-2247
A4L107				NOT ASSIGNED		
A4L108	9100-2247	4		INDUCTOR RF-CH-MLD 100NH 10%	28480	9100-2247
A4L109	9100-2247	4		INDUCTOR RF-CH-MLD 100NH 10%	28480	9100-2247
A4L110	9100-1627	2		INDUCTOR RF-CH-MLD 39UH 5%	28480	9100-1627
A4L111	9135-0074	3		INDUCTOR RF-CH-MLD 47NH 6.596%	28480	9135-0074
A4MP1	08656-60192	1	1	FEEDTHRU ASSEMBLY (INCLUDES C5 AND C44)	28480	08656-60192
	2190-0630	7	2	WASHER-LK HLCL NO. 6 .141-IN-ID	28480	2190-0630
	2420-0026	4	2	NUT-HEX-DBL-CHAM 6-32-THD .062-IN-THK	00000	ORDER BY DESCRIPTION
	08656-00089	9	1	FEEDTHRU BRACKET	28480	08656-00089
	08656-00074	2	1	BRACKET PLATE	28480	08656-00074
A4MP2	08656-00041	4		TAB-GROUNDING	28480	08656-00041
A4MP3	08656-00133	4	14	CLIP SEMI-R GRND	28480	08656-00133
A4Q1				NOT ASSIGNED		
A4Q2	1854-0632	6		TRANSISTOR NPN SI PD = 180MW FT = 4GHZ	25403	BFR91
A4Q3				NOT ASSIGNED		
A4Q4				NOT ASSIGNED		
A4Q5	1855-0423	5	1	TRANSISTOR MOSFET N-CHAN E-MODE TO-237	17856	VN10KM
A4Q6	1855-0235	7	1	TRANSISTOR J-FET N-CHAN D-MODE TO-52 SI	04713	U310(SELECTED)
A4Q7	1853-0007	7	1	TRANSISTOR PNP 2N3251 SI TO-18 PD = 360MW	04713	2N3251
A4Q8	1854-0810	2		TRANSISTOR NPN SI PD = 625MW FT = 200MHZ	28480	1854-0810
A4Q9	1854-0810	2		TRANSISTOR NPN SI PD = 625MW FT = 200MHZ	28480	1854-0810
A4Q10	1854-0810	2		TRANSISTOR NPN SI PD = 625MW FT = 200MHZ	28480	1854-0810
A4Q11-Q100				NOT ASSIGNED		
A4Q101	1854-1230	6		TRANSISTOR NPN SI PD = 180MW FT = 4GHZ	25403	BFR91
A4Q102	1853-0459	3		TRANSISTOR PNP SI PD = 625MW FT = 200MHZ	28480	1853-0459
A4Q103	1854-0810	2		TRANSISTOR NPN SI PD = 625MW FT = 200MHZ	28480	1854-0810
A4Q104	1854-1230	6		TRANSISTOR NPN SI PD = 180MW FT = 4GHZ	25403	BFR91

†Refer to Section 7 for update information.

*Factory Selected Component (Refer to Section 5).

Δ Errata part change.

Reference Designation	HP Part Number	C D	Qty.	Description	Mfr. Code	Mfr. Part Number
A4						
EXCEPT OPTION 022						
A4Q105	1853-0527	6	3	TRANSISTOR PNP SI PD = 500MW FT = 4GHZ	25403	BFQ-32
A4Q108	1854-1230	6		TRANSISTOR NPN SI PD = 180MW FT = 4GHZ	25403	BFR91
A4R1	0698-7227	6	10	RESISTOR 422 1% .05W F TC = 0 + -100	24546	CT3-1/8-TO-422R-F
A4R2	0698-7189	9	2	RESISTOR 11 1% .05W F TC = 0 + -100	24546	CT3-1/8-TO-11R0-F
A4R3	0698-7227	6		RESISTOR 422 1% .05W F TC = 0 + -100	24546	CT3-1/8-TO-422R-F
A4R4				NOT ASSIGNED		
A4R5	0698-7189	1		RESISTOR 28.7 1% .05W F TC = 0 + -100	24546	CT3-1/8-TO-28R7-F
A4R6	0698-7233	4	2	RESISTOR 750 1% .05W F TC = 0 + -100	02995	5063J
A4R7	0698-8821	8	1	RESISTOR 5.62 1% .125W F TC = 0 + -100	05524	CMF-55-1
A4R8	0698-3442	9	2	RESISTOR 237 1% .125W F TC = 0 + -100	24546	CT4-1/8-TO-237R-F
A4R9	0698-7252	7	4	RESISTOR 4.64K 1% .05W F TC = 0 + -100	24546	CT3-1/8-TO-4641-F
A4R10	0698-7233	4		RESISTOR 750 1% .05W F TC = 0 + -100	02995	5063J
A4R11	0698-3440	7		RESISTOR 196 1% .125W F TC = 0 + -100	24546	CT4-1/8-TO-196R-F
A4R12	0698-3440	7		RESISTOR 196 1% .125W F TC = 0 + -100	24546	CT4-1/8-TO-196R-F
A4R13	0757-0442	9		RESISTOR 10K 1% .125W F TC = 0 + -100	24546	CT4-1/8-TO-1002-F
A4R14	0757-0442	9		RESISTOR 10K 1% .125W F TC = 0 + -100	24546	CT4-1/8-TO-1002-F
A4R15	0698-3442	9		RESISTOR 237 1% .125W F TC = 0 + -100	24546	CT4-1/8-TO-237R-F
A4R16	0698-7227	9		RESISTOR 215 1% .05W F TC = 0 + -100	24546	CT3-1/8-TO-215R-F
A4R17				NOT ASSIGNED		
A4R18				NOT ASSIGNED		
A4R19	0698-7205	0		RESISTOR 51.1 1% .05W F TC = 0 + -100	24546	CT3-1/8-TO-51R1-F
A4R20	0698-7253	8	4	RESISTOR 5.11K 1% .05W F TC = 0 + -100	24546	CT3-1/8-TO-5111-F
A4R21	0698-7236	7		RESISTOR 1K 1% .05W F TC = 0 + -100	24546	CT3-1/8-TO-1001-F
A4R22	0698-3438	3		RESISTOR 147 1% .125W F TC = 0 + -100	24546	CT4-1/8-TO-147R-F
A4R23	0698-7205	0		RESISTOR 51.1 1% .05W F TC = 0 + -100	24546	CT3-1/8-TO-51R1-F
A4R24	0698-7205	0		RESISTOR 51.1 1% .05W F TC = 0 + -100	24546	CT3-1/8-TO-51R1-F
A4R25	0757-0346	2		RESISTOR 10 1% .125W F TC = 0 + -100	28480	0757-0346
A4R26	0698-3440	7		RESISTOR 196 1% .125W F TC = 0 + -100	24546	CT4-1/8-TO-196R-F
A4R27	0698-0083	9		RESISTOR 2.15K 1% .125W F TC = 0 + -100	24546	CT4-1/8-TO-2151-F
A4R28	0757-0394	0		RESISTOR 51.1 1% .125W F TC = 0 + -100	24546	CT4-1/8-TO-51R1-F
A4R29	0698-3447	4	14	RESISTOR 422 1% .125W F TC = 0 + -100	24546	CT4-1/8-TO-422R-F
A4R30	0757-0421	4		RESISTOR 825 1% .125W F TC = 0 + -100	24546	CT4-1/8-TO-825R-F
A4R31				NOT ASSIGNED		
A4R32	0757-0421	4		RESISTOR 825 1% .125W F TC = 0 + -100	24546	CT4-1/8-TO-825R-F
A4R33	0757-0280	3		RESISTOR 1K 1% .125W F TC = 0 + -100	24546	CT4-1/8-TO-1001-F
A4R34	0757-0398	4		RESISTOR 75 1% .125W F TC = 0 + -100	24546	CT4-1/8-TO-75R0-F
A4R35	0757-0401	4		RESISTOR 75 1% .125W F TC = 0 + -100	24546	CT4-1/8-TO-75R0-F
A4R36	0757-0401	4		RESISTOR 75 1% .125W F TC = 0 + -100	24546	CT4-1/8-TO-75R0-F
A4R37	0698-7227	6		RESISTOR 422 1% .05W F TC = 0 + -100	24546	CT3-1/8-TO-422R-F
A4R38	0698-7189	9		RESISTOR 11 1% .05W F TC = 0 + -100	24546	CT3-1/8-TO-11R0-F
A4R39	0698-7227	6		RESISTOR 422 1% .05W F TC = 0 + -100	24546	CT3-1/8-TO-422R-F
A4R40	0698-3447	4		RESISTOR 422 1% .125W F TC = 0 + -100	24546	CT4-1/8-TO-422R-F
A4R41	0698-3447	4		RESISTOR 422 1% .125W F TC = 0 + -100	24546	CT4-1/8-TO-422R-F
A4R42	0698-3447	4		RESISTOR 422 1% .125W F TC = 0 + -100	24546	CT4-1/8-TO-422R-F
A4R43	0698-3447	4		RESISTOR 422 1% .125W F TC = 0 + -100	24546	CT4-1/8-TO-422R-F
A4R44	0698-3447	4		RESISTOR 422 1% .125W F TC = 0 + -100	24546	CT4-1/8-TO-422R-F
A4R45	0698-3447	4		RESISTOR 422 1% .125W F TC = 0 + -100	24546	CT4-1/8-TO-422R-F

1 Refer to Section 7 for update information.

* Factory Selected Component (Refer to Section 5).

Δ Errata part change.

Reference Designation	HP Part Number	C D	Qty.	Description	Mfr. Code	Mfr. Part Number
A4						
EXCEPT OPTION 022						
A4R46	0698-3447		4	RESISTOR 422 1% .125W F TC = 0 + -100	24546	CT4-1/8-T0-422R-F
A4R47	0698-3447		4	RESISTOR 422 1% .125W F TC = 0 + -100	24546	CT4-1/8-T0-422R-F
A4R48	0698-3447		4	RESISTOR 422 1% .125W F TC = 0 + -100	24546	CT4-1/8-T0-422R-F
A4R49	0698-3447		4	RESISTOR 422 1% .125W F TC = 0 + -100	24546	CT4-1/8-T0-422R-F
A4R50	1810-0280		8	NETWORK-RES 10-SIP 10.0K OHM X 8	91637	CSC10A01-103G/MSP10A01-
A4R51	0698-0085		0	RESISTOR 2.61K 1% .125W F TC = 0 + -100	24546	CT4-1/8-T0-2611-F
A4R52	0757-0280		3	RESISTOR 1K 1% .125W F TC = 0 + -100	24546	CT4-1/8-T0-1001-F
A4R53	0757-0442		9	RESISTOR 10K 1% .125W F TC = 0 + -100	24546	CT4-1/8-T0-1002-F
A4R54	0757-0280		3	RESISTOR 1K 1% .125W F TC = 0 + -100	24546	CT4-1/8-T0-1001-F
A4R55	0757-0280		3	RESISTOR 1K 1% .125W F TC = 0 + -100	24546	CT4-1/8-T0-1001-F
A4R56	0757-0442		9	RESISTOR 10K 1% .125W F TC = 0 + -100	24546	CT4-1/8-T0-1002-F
A4R57	0757-0280		3	RESISTOR 1K 1% .125W F TC = 0 + -100	24546	CT4-1/8-T0-1001-F
A4R58	0698-3157		3	RESISTOR 19.6K 1% .125W F TC = 0 + -100	24546	CT4-1/8-T0-1962-F
A4R59 ^Δ	0757-0416		0	RESISTOR 100 1% .125W F TC = 0 + -100	02995	SFR25H
A4R60	0757-0465		6	RESISTOR 100K 1% .125W F TC = 0 + -100	24546	CT4-1/8-T0-1003-F
A4R61	0698-3452		1	3 RESISTOR 147K 1% .125W F TC = 0 + -100	24546	CT4-1/8-T0-1473-F
A4R62	0757-0416		7	RESISTOR 511 1% .125W F TC = 0 + -100	24546	CT4-1/8-T0-511R-F
A4R63	0757-0416		7	RESISTOR 511 1% .125W F TC = 0 + -100	24546	CT4-1/8-T0-511R-F
A4R64	0757-0416		7	RESISTOR 511 1% .125W F TC = 0 + -100	24546	CT4-1/8-T0-511R-F
A4R65	0757-0442		9	RESISTOR 10K 1% .125W F TC = 0 + -100	24546	CT4-1/8-T0-1002-F
A4R66	0757-0280		3	RESISTOR 1K 1% .125W F TC = 0 + -100	24546	CT4-1/8-T0-1001-F
A4R67	0757-0199		3	RESISTOR 21.5K 1% .125W F TC = 0 + -100	24546	CT4-1/8-T0-2152-F
A4R68	0698-0083		8	RESISTOR 1.96K 1% .125W F TC = 0 + -100	24546	CT4-1/8-T0-1961-F
A4R69	0757-0442		9	RESISTOR 10K 1% .125W F TC = 0 + -100	24546	CT4-1/8-T0-1002-F
A4R70 ^Δ	0757-0405		4	RESISTOR 75 1% .125W F TC = 0 + -100	05524	CMF-55-1,T-1
A4R71	0757-0442		9	RESISTOR 10K 1% .125W F TC = 0 + -100	24546	CT4-1/8-T0-1002-F
A4R72	0698-3441		8	RESISTOR 215 1% .125W F TC = 0 + -100	24546	CT4-1/8-T0-215R-F
A4R73				NOT ASSIGNED		
A4R74	0757-0123		3	1 RESISTOR 34.8K 1% .125W F TC = 0 + -100	28480	0757-0123
A4R75	0757-0461		4	RESISTOR 82.5K 1% .125W F TC = 0 + -100	24546	CT4-1/8-T0-8252-F
A4R76	0757-0438		3	RESISTOR 5.11K 1% .125W F TC = 0 + -100	24546	CT4-1/8-T0-5111-F
A4R77				NOT ASSIGNED		
A4R78	0698-3157		3	RESISTOR 19.6K 1% .125W F TC = 0 + -100	24546	CT4-1/8-T0-1962-F
A4R79	0698-3156		2	RESISTOR 14.7K 1% .125W F TC = 0 + -100	24546	CT4-1/8-T0-1472-F
A4R80	0698-3260		9	1 RESISTOR 464K 1% .125W F TC = 0 + -100	28480	0698-3260
A4R81	0757-0462		3	RESISTOR 75K 1% .125W F TC = 0 + -100	24546	CT4-1/8-T0-7502-F
A4R82	0699-0069		2	1 RESISTOR 2.15M 1% .125W F TC = 0 + -100	28480	0699-0069
A4R83	0698-0083		8	RESISTOR 1.96K 1% .125W F TC = 0 + -100	24546	CT4-1/8-T0-1961-F
A4R84	0698-3430		5	RESISTOR 21.5 1% .125W F TC = 0 + -100	03888	PME55-1/8-T0-21R5-F
A4R85	0698-7252		7	RESISTOR 4.64K 1% .05W F TC = 0 + -100	24546	CT3-1/8-T0-4641-F
A4R86	0698-7205		0	RESISTOR 51.1 1% .05W F TC = 0 + -100	24546	CT3-1/8-T0-51R1-F
A4R87	0757-0280		3	RESISTOR 1K 1% .125W F TC = 0 + -100	24546	CT4-1/8-T0-1001-F
A4R88	0757-0442		9	RESISTOR 10K 1% .125W F TC = 0 + -100	24546	CT4-1/8-T0-1002-F
A4R89	0698-3441		8	RESISTOR 215 1% .125W F TC = 0 + -100	24546	CT4-1/8-T0-215R-F
A4R90-R99				NOT ASSIGNED		

†Refer to Section 7 for update information.

*Factory Selected Component (Refer to Section 5).

Δ Errata part change.

Reference Designation	HP Part Number	C D	Qty.	Description	Mfr. Code	Mfr. Part Number
A4						
EXCEPT OPTION 022						
A4R100	0757-0401	0		RESISTOR 100 1% .125W F TC = 0 + -100	24546	CT4-1/8-TO-101-F
A4R101	0757-0442	9		RESISTOR 10K 1% .125W F TC = 0 + -100	24546	CT4-1/8-TO-1002-F
A4R102	0698-3447	4		RESISTOR 422 1% .125W F TC = 0 + -100	24546	CT4-1/8-TO-422R-F
A4R103	0698-0082	7		RESISTOR 464 1% .125W F TC = 0 + -100	24546	CT4-1/8-TO-4640-F
A4R104	0698-7243	8		RESISTOR 1.96K 1% .125W F TC = 0 + -100	24546	CT4-1/8-TO-1961-F
A4R105				NOT ASSIGNED		
A4R106	0757-0416	7		RESISTOR 511 1% .125W F TC = 0 + -100	24546	CT4-1/8-TO-511R-F
A4R107	0698-7236	7		RESISTOR 1K 1% .05W F TC = 0 + -100	24546	CT3-1/8-TO-1001-F
A4R108	0698-7253	8	4	RESISTOR 5.11K 1% .05W F TC = 0 + -100	24546	CT3-1/8-TO-5111-F
A4R109	0698-3438	3		RESISTOR 147 1% .125W F TC = 0 + -100	24546	CT4-1/8-TO-147R-F
A4R110	0698-3438	3		RESISTOR 147 1% .125W F TC = 0 + -100	24546	CT4-1/8-TO-147R-F
A4R111 ^Δ	0698-7195	7		RESISTOR 19.6 1% .05W F TC = 0 + -100	02995	5063J
A4R112 ^Δ	0698-7195	7		RESISTOR 19.6 1% .05W F TC = 0 + -100	02995	5063J
A4R113 ^Δ	0698-7195	7		RESISTOR 19.6 1% .05W F TC = 0 + -100	02995	5063J
A4R114				NOT ASSIGNED		
A4R115	0698-7252	7		RESISTOR 4.64K 1% .05W F TC = 0 + -100	24546	CT3-1/8-TO-4641-F
A4R116	0698-7227	6	10	RESISTOR 422 1% .05W F TC = 0 + -100	24546	CT3-1/8-TO-422R-F
A4R117	0698-3438	3		RESISTOR 147 1% .125W F TC = 0 + -100	24546	CT4-1/8-TO-147R-F
<i>2746U TO 2907A</i>						
A4R118	0698-3438	3		RESISTOR 147 1% .125W F TC = 0 + -100	24546	CT4-1/8-TO-147R-F
<i>2913A AND ABOVE</i>						
A4R118				NOT ASSIGNED		
A4R118	0698-7218	5		RESISTOR 178 1% .05W F TC = 0 + -100	24546	CT3-1/8-TO-178R-F
A4R120	0698-7200	5		RESISTOR 31.6 1% .05W F TC = 0 + -100	24546	CT3-1/8-TO-31R6-F
A4R121	0698-7218	5		RESISTOR 178 1% .05W F TC = 0 + -100	24546	CT3-1/8-TO-178R-F
A4R122	0698-7199	1		RESISTOR 28.7 1% .05W F TC = 0 + -100	24546	CT3-1/8-TO-28R7-F
A4R123	0698-7236	7		RESISTOR 1K 1% .05W F TC = 0 + -100	24546	CT3-1/8-TO-1001-F
A4R124	0698-7253	8		RESISTOR 5.11K 1% .05W F TC = 0 + -100	24546	CT3-1/8-TO-5111-F
A4R125	0757-0280	3		RESISTOR 1K 1% .125W F TC = 0 + -100	24546	CT4-1/8-TO-1001-F
A4R126	0698-7212	9		RESISTOR 100 1% .05W F TC = 0 + -100	24546	CT3-1/8-TO-100R-F
<i>2746U TO 2907A</i>						
A4R127				NOT ASSIGNED		
<i>2913A AND ABOVE</i>						
A4R127 ^Δ	0698-7270	9		RESISTOR 26.1K 1% .05W F TC = 0 + -100	02995	5063J
A4R128 ^Δ	0698-7270	9		RESISTOR 26.1K 1% .05W F TC = 0 + -100	02995	5063J
A4R129	0699-1432			RESISTOR-CHIP 511		
A4T1	11661-60087	7	1	XFMR TORD 6.0TRN	28480	11661-60087
A4TP1	1251-1556	7	18	CONNECTOR-SGL CONT SKT .018-IN-BSC-SZ	28480	1251-1556
A4TP2	1251-1556	7		CONNECTOR-SGL CONT SKT .018-IN-BSC-SZ	28480	1251-1556
A4TP3	1251-1556	7		CONNECTOR-SGL CONT SKT .018-IN-BSC-SZ	28480	1251-1556
A4TP4	1251-1556	7		CONNECTOR-SGL CONT SKT .018-IN-BSC-SZ	28480	1251-1556
A4TP5	1251-1556	7		CONNECTOR-SGL CONT SKT .018-IN-BSC-SZ	28480	1251-1556
A4TP6	1251-1556	7		CONNECTOR-SGL CONT SKT .018-IN-BSC-SZ	28480	1251-1556
A4TP7	1251-1556	7		CONNECTOR-SGL CONT SKT .018-IN-BSC-SZ	28480	1251-1556
A4TP8	1251-1556	7		CONNECTOR-SGL CONT SKT .018-IN-BSC-SZ	28480	1251-1556
A4TP9	1251-1556	7		CONNECTOR-SGL CONT SKT .018-IN-BSC-SZ	28480	1251-1556
A4TP10	1251-2359	0		CONNECTOR-SGL CONT PIN 1.14-MM-BSC-SZ SQ	28480	1251-2359
A4TP11	1251-2359	0		CONNECTOR-SGL CONT PIN 1.14-MM-BSC-SZ SQ	28480	1251-2359
A4TP12	1251-2359	0		CONNECTOR-SGL CONT PIN 1.14-MM-BSC-SZ SQ	28480	1251-2359
A4TP13-TP98				NOT ASSIGNED		
A4TP100	1251-1556	7		CONNECTOR-SGL CONT SKT .018-IN-BSC-SZ	28480	1251-1556
A4TP101	1251-1556	7		CONNECTOR-SGL CONT SKT .018-IN-BSC-SZ	28480	1251-1556
A4U1	0955-0146	0	1	U-WAVE MIXER 1 GHZ MAX	28480	0955-0146
A4U2	1826-1724	5	2	IC RF/IF AMPL IF 4-CUSTOM PKG	24539	MSA-0385
A4U3	1826-0982	0	1	IC OP AMP LOW-NOISE 8-DIP-C PKG	28480	1826-0982
A4U4	1826-1049	2	1	IC OP AMP PRCN 8-DIP-C PKG	06665	OP-27GZ
A4U5	1820-5490	3	1	IC DRVR 4810A P8	28480	1820-5490

†Refer to Section 7 for update information.

*Factory Selected Component (Refer to Section 5).

Δ Errata part change.

Reference Designation	HP Part Number	C D	Qty.	Description	Mfr. Code	Mfr. Part Number
A4						
EXCEPT OPTION 022						
A4U6	1820-1422	3	2	IC MV TTL LS MONOSTBL RETRIG	01295	SN74LS122N
A4U7	1826-0138	8	3	IC COMPARATOR GP QUAD 14-DIP-P PKG	01295	LM339N
A4U8	1820-1212	9	1	IC FF TTL LS J-K NEG-EDGE-TRIG	01295	SN74LS112AN
A4VR1	1902-0949	1	3	DIODE-ZNR 4.3V 5% DO-35 PD = .4W TC = +.017%	28480	1902-0949
A4VR2-VR101				NOT ASSIGNED		
A4VR102	1902-0949	1		DIODE-ZNR 4.3V 5% DO-35 PD = .4W TC = +.017%	28480	1902-0949
A4W1	1251-8557	2		CONN-POST TYPE .100-PIN-SPCG 2-CONT	28480	1251-8557
	1258-0209	9		JUMPER-REMOVABLE 2 POSITION; .200 IN	28480	1258-0209
A4W2	1251-4670	2		CONNECTOR 3-PIN M POST TYPE	28480	1251-4670
	1258-0209	9		JUMPER-REMOVABLE 2 POSITION; .200 IN	28480	1258-0209
A4W3	1251-8557	2		CONN-POST TYPE .100-PIN-SPCG 2-CONT	28480	1251-8557
	1258-0209	9		JUMPER-REMOVABLE 2 POSITION; .200 IN	28480	1258-0209
A4W4	1251-8557	2		CONN-POST TYPE .100-PIN-SPCG 2-CONT	28480	1251-8557
	1258-0209	9		JUMPER-REMOVABLE 2 POSITION; .200 IN	28480	1258-0209
	1251-5595	2		POLARIZING KEY-POST CONN	28480	1251-5595
A4W5 ^Δ				NOT ASSIGNED		
A4W6	8159-0005	0		RESISTOR-ZERO OHMS 22AWG LEAD DIA	28480	8159-0005
A4W7	8159-0005	0		RESISTOR-ZERO OHMS 22AWG LEAD DIA	28480	8159-0005
A4W8	8159-0005	0		RESISTOR-ZERO OHMS 22AWG LEAD DIA	28480	8159-0005

†Refer to Section 7 for update information.

*Factory Selected Component (Refer to Section 5).

Δ Errata part change.

Reference Designation	HP Part Number	C D	Qty.	Description	Mfr. Code	Mfr. Part Number
A4						
OPTION 022 ONLY						
A4	08657-60995	3	1	HIGH FREQUENCY LOOP ASSEMBLY	28480	08657-60995
A4C1	0180-3770	8	3	CAP-FXD 2.2UF 35 V TA	12344	T398C225K035AS
A4C2	0180-3879	7	23	CAP-FXD 0.01UF 100 V	09969	RPE121-105X7R103M100V
A4C3	0180-3770	8		CAP-FXD 2.2UF 35 V TA	12344	T398C225K035AS
A4C4	0160-4389	6	13	CAP-FXD 100PF 200 V	09969	RPE121-105C0G101J200V
A4C5	0180-4082	8	1	CAP-FXD 1000PF 200 V	09535	2430-004-X5F0-102M
A4C6	0160-4040	8	21	CAP-FXD 1000PF 100 V	09969	RPE121-105C0G102J100V
A4C7	0180-4040	8		CAP-FXD 1000PF 100 V	09969	RPE121-105C0G102J100V
A4C8	0160-4040	8		CAP-FXD 1000PF 100 V	09969	RPE121-105C0G102J100V
A4C9	0180-4619	5	3	CAP-FXD 2.7PF 200 V	09969	RPE121-105C0G2R7C200V
A4C10	0180-4619	5		CAP-FXD 2.7PF 200 V	09969	RPE121-105C0G2R7C200V
A4C11	0160-4619	5		CAP-FXD 2.7PF 200 V	09969	RPE121-105C0G2R7C200V
A4C12	0160-4547	8	2	CAP-FXD 150PF 200 V	09969	RPE121-105C0G151J200V
A4C13	0160-4040	8		CAP-FXD 1000PF 100 V	09969	RPE121-105C0G102J100V
A4C14	0160-4382	9	3	CAP-FXD 3.3PF 200 V	09969	RPE121-105C0G3R3C200V
A4C15	0160-3879	7		CAP-FXD 0.01UF 100 V	09969	RPE121-105X7R103M100V
A4C16	0160-4040	6		CAP-FXD 1000PF 100 V	09969	RPE121-105C0G102J100V
A4C17	0160-3879	7		CAP-FXD 0.01UF 100 V	09969	RPE121-105X7R103M100V
A4C18	0160-4389	6		CAP-FXD 100PF 200 V	09969	RPE121-105C0G101J200V
A4C19	0160-4389	6		CAP-FXD 100PF 200 V	09969	RPE121-105C0G101J200V
A4C20	0160-4511	6	2	CAP-FXD 220PF 200 V	09969	RPE121-105C0G221J200V
A4C21	0160-4040	6		CAP-FXD 1000PF 100 V	09969	RPE121-105C0G102J100V
A4C22				NOT ASSIGNED		
A4C23				NOT ASSIGNED		
A4C24	0160-4518	3	2	CAP-FXD 3.9PF 200 V	09969	RPE121-105C0G3R9D200V
A4C25	0160-4389	6		CAP-FXD 100PF 200 V	09969	RPE121-105C0G101J200V
A4C26	0160-4389	6		CAP-FXD 100PF 200 V	09969	RPE121-105C0G101J200V
A4C27				NOT ASSIGNED		
A4C28	0160-3875	3	3	CAP-FXD 22PF 200 V	09969	RPE121-105C0G220J200V
A4C29	0160-3873	1	2	CAP-FXD 4.7PF 200 V	09969	RPE121-105C0G4R7D200V
A4C30	0160-4491	1	1	CAP-FXD 8.2PF 200 V	09969	RPE121-105C0G8R2D200V
A4C31	0160-4387	4	3	CAP-FXD 47PF 200 V	09969	RPE121-105C0G470J200V
A4C32	0160-3879	7		CAP-FXD 0.01UF 100 V	09969	RPE121-105X7R103M100V
A4C33	0160-4519	4	2	CAP-FXD 9.1PF 200 V	09969	RPE121-105C0G9R1D200V
A4C34	0180-0197	8	1	CAP-FXD 2.2UF 20 V TA	56289	150D225X9020A2
A4C35	0160-4498	8	3	CAP-FXD 5.6PF 200 V	09969	RPE121-105C0G5R6D200V
A4C36	0160-4519	4		CAP-FXD 9.1PF 200 V	09969	RPE121-105C0G9R1D200V
A4C37	0160-4383	0	4	CAP-FXD 6.8PF 200 V	09969	RPE121-105C0G6R8D200V
A4C38	0160-4383	0		CAP-FXD 6.8PF 200 V	09969	RPE121-105C0G6R8D200V
A4C39	0160-4588	7	1	CAP-FXD 270PF 100 V	09969	RPE121-105C0G271J100V
A4C40				NOT ASSIGNED		
A4C41	0160-4383	0		CAP-FXD 6.8PF 200 V	09969	RPE121-105C0G6R8D200V
A4C42	0160-3879	7		CAP-FXD 0.01UF 100 V	09969	RPE121-105X7R103M100V
A4C43	0160-4383	0		CAP-FXD 6.8PF 200 V	09969	RPE121-105C0G6R8D200V
A4C44	0160-3926	5	1	CAP-FXD 100PF 0 V	33095	54-779-004-X5F-101M
A4C45	0160-3879	7		CAP-FXD 0.01UF 100 V	09969	RPE121-105X7R103M100V

†Refer to Section 7 for update information.

*Factory Selected Component (Refer to Section 5).

Δ Errata part change.

Reference Designation	HP Part Number	C D	Qty.	Description	Mfr. Code	Mfr. Part Number
A4						
OPTION 022 ONLY						
A4C48				NOT ASSIGNED		
A4C47	0160-4511	6		CAP-FXD 220PF 200 V	09969	RPE121-105C0G221J200V
A4C49	0160-3873	1		CAP-FXD 4.7PF 200 V	09969	RPE121-105C0G4R7D200V
A4C50	0160-4381	6	1	CAP-FXD 1.5PF 200 V	09969	RPE110-120C0G1R5C200V
A4C51	0160-3879	7		CAP-FXD 0.01UF 100 V	09969	RPE121-105X7R103M100V
A4C52				NOT ASSIGNED		
A4C53	0121-0449	9	3	CAP-VAR 3.5PF 1PF 63 V	09535	528-009 C3.5-10
A4C54-C56				NOT ASSIGNED		
A4C59	0160-4040	6		CAP-FXD 1000PF 100 V	09969	RPE121-105C0G102J100V
A4C60	0160-4040	6		CAP-FXD 1000PF 100 V	09969	RPE121-105C0G102J100V
A4C61	0160-3875	3		CAP-FXD 22PF 200 V	09969	RPE121-105C0G220J200V
A4C62	0160-4040	6		CAP-FXD 1000PF 100 V	09969	RPE121-105C0G102J100V
A4C63	0160-4040	6		CAP-FXD 1000PF 100 V	09969	RPE121-105C0G102J100V
A4C64	0160-4767	4	1	CAP-FXD 20PF 200 V	09969	RPE121-105C0G200J200V
A4C65	0160-4040	6		CAP-FXD 1000PF 100 V	09969	RPE121-105C0G102J100V
A4C66	0160-4040	6		CAP-FXD 1000PF 100 V	09969	RPE121-105C0G102J100V
A4C67	0160-4497	7	1	CAP-FXD 82PF 200 V	09969	RPE121-105C0G820J200V
A4C68	0160-3879	7		CAP-FXD 0.01UF 100 V	09969	RPE121-105X7R103M100V
A4C69	0160-4040	6		CAP-FXD 1000PF 100 V	09969	RPE121-105C0G102J100V
A4C70	0160-4826	7	1	CAP-FXD 110PF 200 V	09969	RPE121-105C0G111J200V
A4C71	0160-3879	7		CAP-FXD 0.01UF 100 V	09969	RPE121-105X7R103M100V
A4C72	0160-4040	6		CAP-FXD 1000PF 100 V	09969	RPE121-105C0G102J100V
A4C73	0160-4040	6		CAP-FXD 1000PF 100 V	09969	RPE121-105C0G102J100V
A4C74	0160-4040	6		CAP-FXD 1000PF 100 V	09969	RPE121-105C0G102J100V
A4C75	0121-0449	9		CAP-VAR 3.5PF 1PF 63 V	09535	528-009 C3.5-10
A4C76	0160-3872	0	2	CAP-FXD 2.2PF 200 V	09969	RPE121-105C0G2R2C200V
A4C77	0160-4040	6		CAP-FXD 1000PF 100 V	09969	RPE121-105C0G102J100V
A4C78	0160-4040	6		CAP-FXD 1000PF 100 V	09969	RPE121-105C0G102J100V
A4C79	0160-4387	4		CAP-FXD 47PF 200 V	09969	RPE121-105C0G470J200V
A4C80	0160-4498	8		CAP-FXD 5.6PF 200 V	09969	RPE121-105C0G5R6D200V
A4C81	0160-4498	8		CAP-FXD 5.6PF 200 V	09969	RPE121-105C0G5R6D200V
A4C82				NOT ASSIGNED		
A4C83	0160-3879	7		CAP-FXD 0.01UF 100 V	09969	RPE121-105X7R103M100V
A4C84	0160-4521	8	1	CAP-FXD 12PF 200 V	09969	RPE121-105C0G120J200V
A4C85	0121-0449	9		CAP-VAR 3.5PF 1PF 63 V	09535	528-009 C3.5-10
A4C86	0160-4382	9		CAP-FXD 3.3PF 200 V	09969	RPE121-105C0G3R3C200V
A4C87	0160-4040	6		CAP-FXD 1000PF 100 V	09969	RPE121-105C0G102J100V
A4C88	0160-3879	7		CAP-FXD 0.01UF 100 V	09969	RPE121-105X7R103M100V
A4C89	0160-3879	7		CAP-FXD 0.01UF 100 V	09969	RPE121-105X7R103M100V
A4C90	0160-0576	5	2	CAP-FXD 0.1UF 50 V	09969	RPE121-105X7R104M50V
A4C91	0160-0576	5		CAP-FXD 0.1UF 50 V	09969	RPE121-105X7R104M50V
A4C92	0160-0573	2	1	CAP-FXD 4700PF 100 V	06383	FD12X7R2A472M
A4C93	0160-3879	7		CAP-FXD 0.01UF 100 V	09969	RPE121-105X7R103M100V
A4C94	0160-3879	7		CAP-FXD 0.01UF 100 V	09969	RPE121-105X7R103M100V

†Refer to Section 7 for update information.

*Factory Selected Component (Refer to Section 5).

△ Errata part change.

Reference Designation	HP Part Number	C D	Qty.	Description	Mfr. Code	Mfr. Part Number
A4						
OPTION 022 ONLY						
A4C95	0160-0575	4	1	CAP-FXD 0.047UF 50 V	06132	B37987-M5473-M51
A4C96	0160-3879	7		CAP-FXD 0.01UF 100 V	09969	RPE121-105X7R103M100V
A4C97	0160-3872	0		CAP-FXD 2.2PF 200 V	09969	RPE121-105C0G2R2C200V
A4C98	0160-4547	8		CAP-FXD 150PF 200 V	09969	RPE121-105C0G151J200V
A4C99	0160-3879	7		CAP-FXD 0.01UF 100 V	09969	RPE121-105X7R103M100V
A4C100	0160-3879	7		CAP-FXD 0.01UF 100 V	09969	RPE121-105X7R103M100V
A4C101	0160-3879	7		CAP-FXD 0.01UF 100 V	09969	RPE121-105X7R103M100V
A4C102	0160-3879	7		CAP-FXD 0.01UF 100 V	09969	RPE121-105X7R103M100V
A4C103	0160-4387	4		CAP-FXD 47PF 200 V	09969	RPE121-105COG470J200V
A4C104-C149				NOT ASSIGNED		
A4C150	0160-4527	4	1	CAP-FXD 56PF 200 V	09969	RPE121-105C0G560J200V
A4C151	0160-4389	6		CAP-FXD 100PF 200 V	09969	RPE121-105C0G101J200V
A4C152	0160-4389	6		CAP-FXD 100PF 200 V	09969	RPE121-105C0G101J200V
A4C153	0160-4389	6		CAP-FXD 100PF 200 V	09969	RPE121-105C0G101J200V
A4C154	0160-5469	5	2	CAP-FXD 1UF 50 V POLYE-MET	50088	BF064D0105KDB
A4C155* ^Δ	0160-3875	3		CAP-FXD 22PF 200 V	09969	RPE121-105C0G220J200V
A4C156	0160-4389	6		CAP-FXD 100PF 200 V	09969	RPE121-105C0G101J200V
A4C157	0160-5469	5		CAP-FXD 1UF 50 V POLYE-MET	50088	BF064D0105KDB
A4C158	0160-4389	6		CAP-FXD 100PF 200 V	09969	RPE121-105C0G101J200V
A4C159 ^Δ	0160-4498	4	2	CAP-FXD 5.6PF 200 VDC CER COG	06352	FD12COG2D5R6D
A4C160				NOT ASSIGNED		
A4C161	0160-4766	3	3	CAP-FXD 30PF 200 V	09969	RPE121-105C0G300J200V
A4C162	0160-4389	6		CAP-FXD 100PF 200 V	09969	RPE121-105C0G101J200V
A4C163	0160-4524	1	1	CAP-FXD 24PF 200 V	09969	RPE121-105C0G240J200V
A4C164	0160-4518	3		CAP-FXD 3.9PF 200 V	09969	RPE121-105C0G3R9D200V
A4C165	0160-4389	6		CAP-FXD 100PF 200 V	09969	RPE121-105C0G101J200V
A4C166	0160-4389	6		CAP-FXD 100PF 200 V	09969	RPE121-105C0G101J200V
A4C167	0160-4766	3		CAP-FXD 30PF 200 V	09969	RPE121-105C0G300J200V
A4C168	0160-4526	3	2	CAP-FXD 42PF 200 V	09969	RPE121-105C0G420J200V
A4C169	0160-4526	3		CAP-FXD 42PF 200 V	09969	RPE121-105C0G420J200V
A4C170	0160-4040	6		CAP-FXD 1000PF 100 V	09969	RPE121-105C0G102J100V
A4C171	0160-4386	3	1	CAP-FXD 33PF 200 V	04222	SR152A330JAA
A4C172	0160-4766	3		CAP-FXD 30PF 200 V	09969	RPE121-105C0G300J200V
A4C173	0160-3879	7		CAP-FXD 0.01UF 100 V	09969	RPE121-105X7R103M100V
A4C174	0160-3879	7		CAP-FXD 0.01UF 100 V	09969	RPE121-105X7R103M100V
A4C175	0160-3879	7		CAP-FXD 0.01UF 100 V	09969	RPE121-105X7R103M100V
A4C176	0160-3879	7		CAP-FXD 0.01UF 100 V	09969	RPE121-105X7R103M100V
A4C177	0180-3770	9		CAP-FXD 2.2UF 35 V TA	12344	T398C225K035AS
A4C178	0160-4040	6		CAP-FXD 1000PF 100 V	09969	RPE121-105C0G102J100V
A4CR1	1901-1098	1	15	DIODE-SWITCHING 1N4150 50V 200MA 4NS	9N171	1N4150
A4CR2	1901-0189	9	1	DIODE-STEP RECOVERY	28480	QSRD-4653
A4CR3	1906-0098	9	1	DIODE-MATCHED 1V	28480	1906-0098
A4CR4-CR6				NOT ASSIGNED		
A4CR7	1901-1098	1		DIODE-SWITCHING 1N4150 50V 200MA 4NS	9N171	1N4150

†Refer to Section 7 for update information.

*Factory Selected Component (Refer to Section 5).

Δ Errata part change.

Reference Designation	HP Part Number	C D	Qty.	Description	Mfr. Code	Mfr. Part Number
A4						
OPTION 022 ONLY						
A4CR8	1901-1098	1		DIODE-SWITCHING 1N4150 50V 200MA 4NS	9N171	1N4150
A4CR9	1901-1098	1		DIODE-SWITCHING 1N4150 50V 200MA 4NS	9N171	1N4150
A4CR10	1901-1098	1		DIODE-SWITCHING 1N4150 50V 200MA 4NS	9N171	1N4150
A4CR11	1901-1098	1		DIODE-SWITCHING 1N4150 50V 200MA 4NS	9N171	1N4150
A4CR12	1901-1098	1		DIODE-SWITCHING 1N4150 50V 200MA 4NS	9N171	1N4150
A4CR13	1901-1098	1		DIODE-SWITCHING 1N4150 50V 200MA 4NS	9N171	1N4150
A4CR14	1901-0518	8	1	DIODE-SCHOTTKY SM SIG	12403	5082-2800
A4CR15	1901-1098	1		DIODE-SWITCHING 1N4150 50V 200MA 4NS	9N171	1N4150
A4CR16	1901-1098	1		DIODE-SWITCHING 1N4150 50V 200MA 4NS	9N171	1N4150
A4CR17	1901-1098	1		DIODE-SWITCHING 1N4150 50V 200MA 4NS	9N171	1N4150
A4CR18	1901-1098	1		DIODE-SWITCHING 1N4150 50V 200MA 4NS	9N171	1N4150
A4CR19	1901-1098	1		DIODE-SWITCHING 1N4150 50V 200MA 4NS	9N171	1N4150
A4CR20	1901-1098	1		DIODE-SWITCHING 1N4150 50V 200MA 4NS	9N171	1N4150
A4CR21	1901-1098	1		DIODE-SWITCHING 1N4150 50V 200MA 4NS	9N171	1N4150
A4CR22-CR100				NOT ASSIGNED		
A4CR101	0122-0161	4	2	DIODE-VVC 2.15PF 7% BVR = 30V	25403	BB405B
A4CR102	0122-0161	4		DIODE-VVC 2.15PF 7% BVR = 30V	25403	BB405B
A4J1	1251-8598	2	1	CONN-POST TYPE .100-PIN-SPCG 10-CONT	28480	1251-8598
A4J2	1251-4670	2	1	CONN-POST TYPE .100-PIN-SPCG 3-CONT	28480	1251-4670
A4J15	1251-8557	2	3	CONN-POST TYPE .100-PIN-SPCG 2-CONT	28480	1251-8557
A4J16	1251-8557	2		CONN-POST TYPE .100-PIN-SPCG 2-CONT	28480	1251-8557
A4J17	1251-8557	2		CONN-POST TYPE .100-PIN-SPCG 2-CONT	28480	1251-8557
A4L1	9100-1627	2	4	INDUCTOR RF-CH-MLD 39UH + -5%	91637	IM-4 39UH 5%
A4L2	9100-1627	2		INDUCTOR RF-CH-MLD 39UH + -5%	91637	IM-4 39UH 5%
A4L3	9140-1088	3	2	INDUCTOR-FIXED L:11.5 UH TO 19.3 UH @ 4	24226	51-254-1
A4L4	9100-1627	2		INDUCTOR RF-CH-MLD 39UH + -5%	91637	IM-4 39UH 5%
A4L5	9100-2247	4	10	INDUCTOR RF-CH-MLD 100NH + -10%	91637	IM-2 .1UH 10%
A4L6-L8				NOT ASSIGNED		
A4L10	9100-2247	4		INDUCTOR RF-CH-MLD 100NH + -10%	91637	IM-2 .1UH 10%
A4L11	9135-0071	1	1	INDUCTOR RF-CH-MLD 62NH + -5.806%	24226	10M062X-1
A4L12				NOT ASSIGNED		
A4L13	9100-2247	4		INDUCTOR RF-CH-MLD 100NH + -10%	91637	IM-2 .1UH 10%
A4L14				NOT ASSIGNED		
A4L15 ^Δ	9135-0072	2	3	INDUCTOR RF-CH-MLD 56NH + -6%	03273	10M056X-1
A4L16 ^Δ	9135-0072	2		INDUCTOR RF-CH-MLD 56NH + -6%	03273	10M056X-1
A4L17				NOT ASSIGNED		
A4L18				NOT ASSIGNED		
A4L19	9135-0068	6	5	INDUCTOR RF-CH-MLD 33NH + -6.36%	24226	10M033X-1
A4L20	9135-0068	6		INDUCTOR RF-CH-MLD 33NH + -6.36%	24226	10M033X-1
A4L21	9135-0076	6		INDUCTOR RF-CH-MLD 39NH + -6%	06560	010150-054J
A4L22	9135-0073	3	1	INDUCTOR RF-CH-MLD 51NH + -6.596%	24226	10M051X-1
A4L23	9140-0158	6	1	INDUCTOR RF-CH-MLD 1UH + -10%	91637	IM-2 1UH 10%

†Refer to Section 7 for update information.

*Factory Selected Component (Refer to Section 5).

Δ Errata part change

Reference Designation	HP Part Number	C D	Qty.	Description	Mfr. Code	Mfr. Part Number
A4						
OPTION 022 ONLY						
A4L24	9140-0141	7	2	INDUCTOR RF-CH-MLD 680NH + -10%	91637	IM-2 .68UH 10%
A4L25	9100-3514	0	4	INDUCTOR 30NH .285D-INX.4LG-IN	28480	9100-3514
A4L26	9135-0072	2	1	INDUCTOR 56NH + -5.893% 2.6D-MMX6.8LG-MM	24226	10M056X-1
A4L27	9135-0068	6		INDUCTOR RF-CH-MLD 33NH + -6.36%	24226	10M033X-1
A4L28	9100-3514	0		INDUCTOR 30NH .285D-INX.4LG-IN	28480	9100-3514
A4L29				NOT ASSIGNED		
A4L30	9100-2248	5	1	INDUCTOR RF-CH-MLD 120NH + -10%	91637	IM-2 .12UH 10%
A4L31	9140-0141	7		INDUCTOR RF-CH-MLD 680NH + -10%	91637	IM-2 .68UH 10%
A4L32				NOT ASSIGNED		
A4L33	9100-2249	8	2	INDUCTOR RF-CH-MLD 150NH + -10%	91637	IM-2 .15UH 10%
A4L34				NOT ASSIGNED		
A4L35	9135-0068	6		INDUCTOR RF-CH-MLD 33NH + -6.36%	24226	10M033X-1
A4L36	9100-3514	0		INDUCTOR 30NH .285D-INX.4LG-IN	28480	9100-3514
A4L37	9100-3512	8	1	INDUCTOR 50NH .285D-INX.4LG-IN	28480	9100-3512
A4L38	9100-3514	0		INDUCTOR 30NH .285D-INX.4LG-IN	28480	9100-3514
A4L39	9100-3513	9	1	INDUCTOR 75NH .285D-INX.4LG-IN	28480	9100-3513
A4L41	9100-2249	6		INDUCTOR RF-CH-MLD 150NH + -10%	91637	IM-2 .15UH 10%
A4L42	9135-0068	6		INDUCTOR RF-CH-MLD 33NH + -6.36%	24226	10M033X-1
A4L43	9100-2251	0	1	INDUCTOR RF-CH-MLD 220NH + -10%	91637	IM-2 .22UH 10%
A4L44-L99				NOT ASSIGNED		
A4L100	9100-2247	4		INDUCTOR RF-CH-MLD 100NH + -10%	91637	IM-2 .1UH 10%
A4L101	9140-1088	3		INDUCTOR-FIXED L:11.5 UH TO 19.3 UH @ 4	24226	51-254-1
A4L102	08901-00068	2	1	INDUCTOR	28480	08901-00068
A4L103	9100-2247	4		INDUCTOR RF-CH-MLD 100NH + -10%	91637	IM-2 .1UH 10%
A4L104				NOT ASSIGNED		
A4L105	9100-2247	4		INDUCTOR RF-CH-MLD 100NH + -10%	91637	IM-2 .1UH 10%
A4L106	9100-2247	4		INDUCTOR RF-CH-MLD 100NH + -10%	91637	IM-2 .1UH 10%
A4L107	9100-2247	4		INDUCTOR RF-CH-MLD 100NH + -10%	91637	IM-2 .1UH 10%
A4L108	9100-2247	4		INDUCTOR RF-CH-MLD 100NH + -10%	91637	IM-2 .1UH 10%
A4L109	9100-2247	4		INDUCTOR RF-CH-MLD 100NH + -10%	91637	IM-2 .1UH 10%
A4L110	9100-1627	2		INDUCTOR RF-CH-MLD 39UH + -5%	91637	IM-4 39UH 5%
A4L111	9135-0074	4	1	INDUCTOR RF-CH-MLD 47NH + -6.17%	24226	10M047X-1
A4MP1				NOT ASSIGNED		
A4MP2	5021-3273	6	1	CABLE HOLDER	28480	5021-3273
A4MP3	08656-00074	2	1	PLATE-HFL BRKT	28480	08656-00074
A4MP4	08656-00089	9	1	BRKT HFL FDTHRU	28480	08656-00089
<i>2746U TO 2944A</i>						
<i>A4MP5</i>	08656-00090	2	1	TAB-GROUNDING	28480	08656-00090
<i>3012A AND ABOVE</i>						
<i>A4MP5</i>	08656-00041	4		TAB-GROUNDING	28480	08656-00041
A4MP6	2420-0026	4	2	NUT-HEX-DBL-CHAM 6-32-THD .062-IN-THK	00000	ORDER BY DESCRIPTION
A4MP7				NOT ASSIGNED		
A4MP8	8150-0449	8	1	WIRE 24AWG R 300V PVC 7X32 80C	28480	8150-0449
A4MP9	8150-0460	3	1	WIRE 24AWG W/O 300V PVC 7X32 80C	28480	8150-0460
A4MP10	1251-5595	2	1	POLARIZING KEY-POST CONN	76381	3518

†Refer to Section 7 for update information.

*Factory Selected Component (Refer to Section 5).

Δ Errata part change.

Reference Designation	HP Part Number	C D	Qty.	Description	Mfr. Code	Mfr. Part Number
A4						
OPTION 022 ONLY						
A4Q1				NOT ASSIGNED		
A4Q2	1854-0632	6	1	TRANSISTOR NPN SI PD = 180MW FT = 4GHZ	25403	BFR91
A4Q3	1855-0423	5	3	TRANSISTOR MOSFET N-CHAN E-MODE TO-237	17856	VN10KM
A4Q4	1855-0423	5		TRANSISTOR MOSFET N-CHAN E-MODE TO-237	17856	VN10KM
A4Q5	1855-0423	5		TRANSISTOR MOSFET N-CHAN E-MODE TO-237	17856	VN10KM
A4Q6						
A4Q8	1855-0235	7	1	TRANSISTOR J-FET N-CHAN D-MODE TO-52 SI	04713	U310(SELECTED)
A4Q7	1853-0007	7	1	TRANSISTOR PNP 2N3251 SI TO-18 PD = 360MW	04713	2N3251
A4Q8	1854-0810	2	4	TRANSISTOR NPN SI PD = 625MW FT = 200MHZ	56289	CT-1058
A4Q9	1854-0810	2		TRANSISTOR NPN SI PD = 625MW FT = 200MHZ	56289	CT-1058
A4Q10	1854-0810	2		TRANSISTOR NPN SI PD = 625MW FT = 200MHZ	56289	CT-1058
A4Q11-Q100				NOT ASSIGNED		
A4Q101	1854-1230	2	3	TRANSISTOR NPN SI PD = 180MW FT = 4MHZ	28480	1854-1230
A4Q102	1853-0459	3	1	TRANSISTOR PNP SI PD = 625MW FT = 200MHZ	28480	1853-0459
A4Q103	1854-0810	2		TRANSISTOR NPN SI PD = 625MW FT = 200MHZ	56289	CT-1058
A4Q104	1854-1230	2		TRANSISTOR NPN SI PD = 180MW FT = 4MHZ	28480	1854-1230
A4Q105	1853-0527	6	1	TRANSISTOR PNP SI PD = 500MW FT = 4GHZ	25403	BFQ-32
A4Q106	1854-1230	2		TRANSISTOR NPN SI PD = 180MW FT = 4MHZ	28480	1854-1230
A4R1	0698-7227	6	6	RESISTOR 422 + -1% .05W TF TC = 0 + -100	12498	C3-1/8-TO-422R-F
A4R2	0698-7189	9	3	RESISTOR 11 + -1% .05W TF TC = 0 + -100	12498	C3-1/8-TO-11R0-F
A4R3	0698-7227	6		RESISTOR 422 + -1% .05W TF TC = 0 + -100	12498	C3-1/8-TO-422R-F
A4R4 ^Δ	0757-0420	3	1	RESISTOR 750 + -1% .125W TF TC = 0 + -100	02995	SFR25H
A4R5	0698-7189	9		RESISTOR 11 + -1% .05W TF TC = 0 + -100	12498	C3-1/8-TO-11R0-F
A4R6	0698-7218	5	4	RESISTOR 178 + -1% .05W TF TC = 0 + -100	12498	C3-1/8-TO-178R-F
A4R7	0757-0180	2	1	RESISTOR 31.6 + -1% .125W TF TC = 0 + -100	D8439	MK2
A4R8	0698-3442	9	5	RESISTOR 237 + -1% .125W TF TC = 0 + -100	12498	CT4-1/8-TO-237R-F
A4R9	0698-7252	7	3	RESISTOR 4.64K + -1% .05W TF TC = 0 + -100	12498	C3-1/8-TO-4641-F
A4R10	0698-7218	5		RESISTOR 178 + -1% .05W TF TC = 0 + -100	12498	C3-1/8-TO-178R-F
A4R11	0698-3440	7	3	RESISTOR 196 + -1% .125W TF TC = 0 + -100	12498	CT4-1/8-TO-196R-F
A4R12	0698-3440	7		RESISTOR 196 + -1% .125W TF TC = 0 + -100	12498	CT4-1/8-TO-196R-F
A4R13	0757-0442	9	9	RESISTOR 10K + -1% .125W TF TC = 0 + -100	12498	CT4-1/8-TO-1002-F
A4R14	0757-0442	9		RESISTOR 10K + -1% .125W TF TC = 0 + -100	12498	CT4-1/8-TO-1002-F
A4R15	0698-3442	9		RESISTOR 237 + -1% .125W TF TC = 0 + -100	12498	CT4-1/8-TO-237R-F
A4R16	0698-7227	6		RESISTOR 422 + -1% .05W TF TC = 0 + -100	12498	C3-1/8-TO-422R-F
A4R17				NOT ASSIGNED		
A4R18				NOT ASSIGNED		
A4R19	0698-7205	0	7	RESISTOR 51.1 + -1% .05W TF TC = 0 + -100	12498	C3-1/8-TO-51R1-F
A4R20	0698-7253	8	3	RESISTOR 5.11K + -1% .05W TF TC = 0 + -100	12498	C3-1/8-TO-5111-F
A4R21	0698-7236	7	3	RESISTOR 1K + -1% .05W TF TC = 0 + -100	12498	C3-1/8-TO-1001-F
A4R22	0698-3438	3	5	RESISTOR 147 + -1% .125W TF TC = 0 + -100	12498	CT4-1/8-TO-147R-F
A4R23	0698-7205	0		RESISTOR 51.1 + -1% .05W TF TC = 0 + -100	12498	C3-1/8-TO-51R1-F
A4R24	0698-7205	0		RESISTOR 51.1 + -1% .05W TF TC = 0 + -100	12498	C3-1/8-TO-51R1-F
A4R25	0757-0346	2	1	RESISTOR 10 + -1% .125W TF TC = 0 + -100	D8439	MK2

†Refer to Section 7 for update information.

*Factory Selected Component (Refer to Section 5).

Δ Errata part change.

Reference Designation	HP Part Number	C D	Qty.	Description	Mfr. Code	Mfr. Part Number
A4						
OPTION 022 ONLY						
A4R26	0698-3440	7		RESISTOR 196 +-1% .125W TF TC = 0+-100	12498	CT4-1/8-TO-196R-F
A4R27	0698-0083	8	3	RESISTOR 1.96K +-1% .125W TF TC = 0+-100	12498	CT4-1/8-TO-1961-F
A4R28	0757-0394	0	1	RESISTOR 51.1 +-1% .125W TF TC = 0+-100	12498	CT4-1/8-TO-51R1-F
A4R29	0698-3447	4	12	RESISTOR 422 +-1% .125W TF TC = 0+-100	12498	CT4-1/8-TO-422R-F
A4R30	0757-0421	4	2	RESISTOR 825 +-1% .125W TF TC = 0+-100	12498	CT4-1/8-TO-825R-F
A4L31				NOT ASSIGNED		
A4R32	0757-0421	4		RESISTOR 825 +-1% .125W TF TC = 0+-100	12498	CT4-1/8-TO-825R-F
A4R33	0757-0280	3	10	RESISTOR 1K +-1% .125W TF TC = 0+-100	12498	CT4-1/8-TO-1001-F
A4R34	0757-0398	4	1	RESISTOR 75 +-1% .125W TF TC = 0+-100	D8439	MK2
A4R35	0757-0401	0	3	RESISTOR 100 +-1% .125W TF TC = 0+-100	12498	CT4-1/8-TO-101-F
A4R36	0757-0401	0		RESISTOR 100 +-1% .125W TF TC = 0+-100	12498	CT4-1/8-TO-101-F
A4R37	0698-7227	8		RESISTOR 422 +-1% .05W TF TC = 0+-100	12498	C3-1/8-TO-422R-F
A4R38	0698-7189	9		RESISTOR 11 +-1% .05W TF TC = 0+-100	12498	C3-1/8-TO-11R0-F
A4R39	0698-7227	6		RESISTOR 422 +-1% .05W TF TC = 0+-100	12498	C3-1/8-TO-422R-F
A4R40	0698-3447	4		RESISTOR 422 +-1% .125W TF TC = 0+-100	12498	CT4-1/8-TO-422R-F
A4R41	0698-3447	4		RESISTOR 422 +-1% .125W TF TC = 0+-100	12498	CT4-1/8-TO-422R-F
A4R42	0698-3447	4		RESISTOR 422 +-1% .125W TF TC = 0+-100	12498	CT4-1/8-TO-422R-F
A4R43	0698-3447	4		RESISTOR 422 +-1% .125W TF TC = 0+-100	12498	CT4-1/8-TO-422R-F
A4R44	0698-3447	4		RESISTOR 422 +-1% .125W TF TC = 0+-100	12498	CT4-1/8-TO-422R-F
A4R45	0698-3447	4		RESISTOR 422 +-1% .125W TF TC = 0+-100	12498	CT4-1/8-TO-422R-F
A4R46	0698-3447	4		RESISTOR 422 +-1% .125W TF TC = 0+-100	12498	CT4-1/8-TO-422R-F
A4R47	0698-3447	4		RESISTOR 422 +-1% .125W TF TC = 0+-100	12498	CT4-1/8-TO-422R-F
A4R48	0698-3447	4		RESISTOR 422 +-1% .125W TF TC = 0+-100	12498	CT4-1/8-TO-422R-F
A4R49	0698-3447	4		RESISTOR 422 +-1% .125W TF TC = 0+-100	12498	CT4-1/8-TO-422R-F
A4R50	1810-0280	8	1	NETWORK-RES 10-SIP 10.0K OHM X 9	C1433	750-101
A4R51	0698-0085	0	1	RESISTOR 2.61K +-1% .125W TF TC = 0+-100	12498	CT4-1/8-TO-2611-F
A4R52	0757-0280	3		RESISTOR 1K +-1% .125W TF TC = 0+-100	12498	CT4-1/8-TO-1001-F
A4R53	0757-0442	9		RESISTOR 10K +-1% .125W TF TC = 0+-100	12498	CT4-1/8-TO-1002-F
A4R54	0757-0280	3		RESISTOR 1K +-1% .125W TF TC = 0+-100	12498	CT4-1/8-TO-1001-F
A4R55	0757-0280	3		RESISTOR 1K +-1% .125W TF TC = 0+-100	12498	CT4-1/8-TO-1001-F
A4R56	0757-0442	9		RESISTOR 10K +-1% .125W TF TC = 0+-100	12498	CT4-1/8-TO-1002-F
A4R57	0757-0280	3		RESISTOR 1K +-1% .125W TF TC = 0+-100	12498	CT4-1/8-TO-1001-F
A4R58 ^Δ	0698-3157	3	1	RESISTOR 19.6K +-1% .125W TF TC = 0+-100	02995	SFR25H
A4R59	0757-0401	0	3	RESISTOR 100 +-1% .125W TF TC = 0+-100	12498	CT4-1/8-TO-101-F
A4R60	0757-0465	6	1	RESISTOR 100K +-1% .125W TF TC = 0+-100	12498	CT4-1/8-TO-1003-F
A4R61	0698-3452	1	1	RESISTOR 147K +-1% .125W TF TC = 0+-100	12498	CT4-1/8-TO-1473-F
A4R62	0698-3442	9		RESISTOR 237 +-1% .125W TF TC = 0+-100	12498	CT4-1/8-TO-237R-F
A4R63	0698-3442	9		RESISTOR 237 +-1% .125W TF TC = 0+-100	12498	CT4-1/8-TO-237R-F
A4R64	0698-3442	9		RESISTOR 237 +-1% .125W TF TC = 0+-100	12498	CT4-1/8-TO-237R-F
A4R65	0757-0442	9		RESISTOR 10K +-1% .125W TF TC = 0+-100	12498	CT4-1/8-TO-1002-F
A4R66	0757-0280	3		RESISTOR 1K +-1% .125W TF TC = 0+-100	12498	CT4-1/8-TO-1001-F
A4R67	0757-0199	3	1	RESISTOR 21.5K +-1% .125W TF TC = 0+-100	12498	CT4-1/8-TO-2152-F
A4R68	0698-0083	8		RESISTOR 1.96K +-1% .125W TF TC = 0+-100	12498	CT4-1/8-TO-1961-F
A4R69	0757-0442	9		RESISTOR 10K +-1% .125W TF TC = 0+-100	12498	CT4-1/8-TO-1002-F
A4R70 ^Δ	0757-0398	4	1	RESISTOR 75 +-1% .125W TF TC = 0+-100	05524	CMF-55-1, T-1

†Refer to Section 7 for update information.

*Factory Selected Component (Refer to Section 5).

Δ Errata part change.

Reference Designation	HP Part Number	C D	Qty.	Description	Mfr. Code	Mfr. Part Number
A4						
OPTION 022 ONLY						
A4R71	0757-0442	9		RESISTOR 10K +-1% .125W TF TC=0+-100	12498	CT4-1/8-T0-1002-F
A4R72 ^Δ	0698-3441	8		RESISTOR 215 +-1% .125W TF TC=0+-100	02095	SFR25H
A4R73	0698-3445	2	1	RESISTOR 348 +-1% .125W TF TC=0+-100	12498	CT4-1/8-T0-348R-F
A4R74	0757-0123	3	1	RESISTOR 34.8K +-1% .125W TF TC=0+-100	12498	CT4
A4R75	0757-0461	2	1	RESISTOR 68.1K +-1% .125W TF TC=0+-100	12498	CT4-1/8-T0-6812-F
A4R76	0757-0438	3	1	RESISTOR 5.11K +-1% .125W TF TC=0+-100	12498	CT4-1/8-T0-5111-F
A4R77	0757-0280	3		RESISTOR 1K +-1% .125W TF TC=0+-100	12498	CT4-1/8-T0-1001-F
A4R78	0698-3157	3	1	RESISTOR 19.6K +-1% .125W TF TC=0+-100	12498	CT4-1/8-T0-1962-F
A4R79	0698-3156	2	1	RESISTOR 14.7K +-1% .125W TF TC=0+-100	12498	CT4-1/8-T0-1472-F
A4R80	0698-3260	9	1	RESISTOR 464K +-1% .125W TF TC=0+-100	12498	CT4
A4R81	0757-0462	3	1	RESISTOR 75K +-1% .125W TF TC=0+-100	12498	CT4-1/8-T0-7502-F
A4R82	0698-3456	5	1	RESISTOR 287K +-1% .125W TF TC=0+-100	12498	CT4-1/8-T0-2873-F
A4R83	0698-0083	8		RESISTOR 1.96K +-1% .125W TF TC=0+-100	12498	CT4-1/8-T0-1961-F
A4R84	0698-3430	5	1	RESISTOR 21.5 +-1% .125W TF TC=0+-100	D8439	MK2
A4R85	0698-7252	7		RESISTOR 4.64K +-1% .05W TF TC=0+-100	12498	C3-1/8-T0-4641-F
A4R86	0698-7205	0		RESISTOR 51.1 +-1% .05W TF TC=0+-100	12498	C3-1/8-T0-51R1-F
A4R87	0757-0280	3		RESISTOR 1K +-1% .125W TF TC=0+-100	12498	CT4-1/8-T0-1001-F
A4R88	0757-0442	9		RESISTOR 10K +-1% .125W TF TC=0+-100	12498	CT4-1/8-T0-1002-F
A4R89	0698-3441	8		RESISTOR 215 +-1% .125W TF TC=0+-100	12498	CT4-1/8-T0-215R-F
A4R90-R99				NOT ASSIGNED		
A4R100	0757-0401	0		RESISTOR 100 +-1% .125W TF TC=0+-100	12498	CT4-1/8-T0-101-F
A4R101	0757-0442	9		RESISTOR 10K +-1% .125W TF TC=0+-100	12498	CT4-1/8-T0-1002-F
A4R102	0698-3447	4		RESISTOR 422 +-1% .125W TF TC=0+-100	12498	CT4-1/8-T0-422R-F
A4R103	0698-0082	7	1	RESISTOR 464 +-1% .125W TF TC=0+-100	12498	CT4-1/8-T0-4640-F
A4R104	0698-7243	6	1	RESISTOR 1.96K +-1% .05W TF TC=0+-100	12498	C3-1/8-T0-1961-F
A4R105				NOT ASSIGNED		
A4R106	0757-0416	7		RESISTOR 511 +-1% .125W TF TC=0+-100	12498	CT4-1/8-T0-511R-F
A4R107	0698-7236	7		RESISTOR 1K +-1% .05W TF TC=0+-100	12498	C3-1/8-T0-1001-F
A4R108	0698-7253	8		RESISTOR 5.11K +-1% .05W TF TC=0+-100	12498	C3-1/8-T0-5111-F
A4R109	0698-3438	3		RESISTOR 147 +-1% .125W TF TC=0+-100	12498	CT4-1/8-T0-147R-F
A4R110	0698-3438	3		RESISTOR 147 +-1% .125W TF TC=0+-100	12498	CT4-1/8-T0-147R-F
A4R111	0698-7205	0	4	RESISTOR 51.1 +-1% .05W TF TC=0+-100	12498	C3-1/8-T0-51R1-F
A4R112	0698-7205	0	4	RESISTOR 51.1 +-1% .05W TF TC=0+-100	12498	C3-1/8-T0-51R1-F
A4R113	0698-7205	0	4	RESISTOR 51.1 +-1% .05W TF TC=0+-100	12498	C3-1/8-T0-51R1-F
A4R114				NOT ASSIGNED		
A4R115	0698-7252	7		RESISTOR 4.64K +-1% .05W TF TC=0+-100	12498	C3-1/8-T0-4641-F
A4R116	0698-7227	6		RESISTOR 422 +-1% .05W TF TC=0+-100	12498	C3-1/8-T0-422R-F
A4R117	0698-3438	3		RESISTOR 147 +-1% .125W TF TC=0+-100	12498	CT4-1/8-T0-147R-F
A4R118	0698-3438	3		RESISTOR 147 +-1% .125W TF TC=0+-100	12498	CT4-1/8-T0-147R-F
A4R119	0698-7218	5		RESISTOR 178 +-1% .05W TF TC=0+-100	12498	C3-1/8-T0-178R-F
A4R120	0698-7200	5	1	RESISTOR 31.6 +-1% .05W TF TC=0+-100	12498	C3-1/8-T0-31R6-F
A4R121	0698-7218	5		RESISTOR 178 +-1% .05W TF TC=0+-100	12498	C3-1/8-T0-178R-F
A4R122	0698-7199	1	1	RESISTOR 28.7 +-1% .05W TF TC=0+-100	12498	C3-1/8-T0-28R7-F
A4R123	0698-7236	7		RESISTOR 1K +-1% .05W TF TC=0+-100	12498	C3-1/8-T0-1001-F
A4R124	0698-7253	8		RESISTOR 5.11K +-1% .05W TF TC=0+-100	12498	C3-1/8-T0-5111-F

†Refer to Section 7 for update information.

*Factory Selected Component (Refer to Section 5).

Δ Errata part change.

Reference Designation	HP Part Number	C D	Qty.	Description	Mfr. Code	Mfr. Part Number
A4						
OPTION 022 ONLY						
A4R125	0757-0280	3		RESISTOR 1K +-1% .125W TF TC = 0 +-100	12498	CT4-1/8-T0-1001-F
A4R128	0898-7212	9	1	RESISTOR 100 +-1% .05W TF TC = 0 +-100	12498	C3-1/8-TC-100R-F
A4R127 ^Δ	0898-7270	9	2	RESISTOR 26.1K +-1% .05W TF TC = 0 +-100	02985	5083J
A4R128 ^Δ	0898-7270	9		RESISTOR 26.1K +-1% .05W TF TC = 0 +-100	02985	5083J
A4T1	11661-60087	7	1	XFMR TORQ 6.0 TRN	28480	11661-60087
A: TG1	1251-1558	7	22	CONNECTOR-SGL CONT SKT .024IN-BSC-SZ RND	98291	006-4844-00-0-990
A4TG2	1251-1558	7		CONNECTOR-SGL CONT SKT .024IN-BSC-SZ RND	98291	006-4844-00-0-990
A4TG3	1251-1558	7		CONNECTOR-SGL CONT SKT .024IN-BSC-SZ RND	98291	006-4844-00-0-990
A4TG4	1251-1556	7		CONNECTOR-SGL CONT SKT .024IN-BSC-SZ RND	98291	006-4844-00-0-990
A4TG5	1251-1558	7		CONNECTOR-SGL CONT SKT .024IN-BSC-SZ RND	98291	006-4844-00-0-990
A4TG6	1251-1556	7		CONNECTOR-SGL CONT SKT .024IN-BSC-SZ RND	98291	006-4844-00-0-990
A4TG7	1251-1558	7		CONNECTOR-SGL CONT SKT .024IN-BSC-SZ RND	98291	006-4844-00-0-990
A4TG8	1251-1556	7		CONNECTOR-SGL CONT SKT .024IN-BSC-SZ RND	98291	006-4844-00-0-990
A4TG9	1251-1558	7		CONNECTOR-SGL CONT SKT .024IN-BSC-SZ RND	98291	006-4844-00-0-990
A4TG10-TG99				NOT ASSIGNED		
A4TG100	1251-1556	7		CONNECTOR-SGL CONT SKT .024IN-BSC-SZ RND	98291	006-4844-00-0-990
A4TG101	1251-1556	7		CONNECTOR-SGL CONT SKT .024IN-BSC-SZ RND	98291	006-4844-00-0-990
A4TP1	1251-1556	7		CONNECTOR-SGL CONT SKT .024IN-BSC-SZ RND	98291	006-4844-00-0-990
A4TP2	1251-1556	7		CONNECTOR-SGL CONT SKT .024IN-BSC-SZ RND	98291	006-4844-00-0-990
A4TP3	1251-1556	7		CONNECTOR-SGL CONT SKT .024IN-BSC-SZ RND	98291	006-4844-00-0-990
A4TP4	1251-1556	7		CONNECTOR-SGL CONT SKT .024IN-BSC-SZ RND	98291	006-4844-00-0-990
A4TP5	1251-1556	7		CONNECTOR-SGL CONT SKT .024IN-BSC-SZ RND	98291	006-4844-00-0-990
A4TP6	1251-1556	7		CONNECTOR-SGL CONT SKT .024IN-BSC-SZ RND	98291	006-4844-00-0-990
A4TP7	1251-1556	7		CONNECTOR-SGL CONT SKT .024IN-BSC-SZ RND	98291	006-4844-00-0-990
A4TP8	1251-1556	7		CONNECTOR-SGL CONT SKT .024IN-BSC-SZ RND	98291	006-4844-00-0-990
A4TP9	1251-1556	7		CONNECTOR-SGL CONT SKT .024IN-BSC-SZ RND	98291	006-4844-00-0-990
A4TP10	0360-2359	0	3	TERMINAL-TEST POINT .230IN ABOVE	4G810	230.100
A4TP11	0360-2359	0		TERMINAL-TEST POINT .230IN ABOVE	4G810	230.100
A4TP12	0360-2359	0		TERMINAL-TEST POINT .230IN ABOVE	4G810	230.100
A4TP13-TP99				NOT ASSIGNED		
A4TP100	1251-1556	7		CONNECTOR-SGL CONT SKT .024IN-BSC-SZ RND	98291	006-4844-00-0-990
A4TP101	1251-1556	7		CONNECTOR-SGL CONT SKT .024IN-BSC-SZ RND	98291	006-4844-00-0-990
A4U1				NOT ASSIGNED		
A4U2	1826-1724	0	1	IC RF/IF AMPL 4-CUSTOM PKG	24539	MSA-0785
A4U3	1826-0982	0	1	IC OP AMP LOW-NOISE 8-DIP-C PKG	06665	OP-37GZ
A4U4	1826-1049	2	1	IC OP AMP PRCN 8-DIP-C PKG	06665	OP-27GZ
A4U5	1820-5490	3	1	IC-INTERFACE DRVR BIMOS DISPLAY	56289	UCN-5810A
A4U6	1820-1422	3	1	IC MV TTL LS MONOSTBL RETRIG	01295	SN74LS122N
A4U7	1826-0138	8	1	IC COMPARATOR GP QUAD 14-DIP-P PKG	27014	LM339N
A4U8	1820-1212	9	1	IC FF TTL LS J-K NEG-EDGE-TRIG	01295	SN74LS112AN
A4VR1	1902-0949	1	2	DIODE-ZNR 4.3V 5% DO-35 PD = .4W TC = +.017%	28480	1902-0949
A4VR102	1902-0949	1		DIODE-ZNR 4.3V 5% DO-35 PD = .4W TC = +.017%	28480	1902-0949
A4W1	1258-0209	9	4	JUMPER-REMOVABLE 2 POSITION; .250 IN	18873	68786-202
A4W2	1258-0209	9		JUMPER-REMOVABLE 2 POSITION; .250 IN	18873	68786-202
A4W3	1258-0209	9		JUMPER-REMOVABLE 2 POSITION; .250 IN	18873	68786-202
A4W4	1258-0209	9		JUMPER-REMOVABLE 2 POSITION; .250 IN	18873	68786-202
A4W5 ^Δ				NOT ASSIGNED		
A4W6 ^Δ	8159-0005	0	1	RESISTOR-ZERO OHMS 22 AWG LEAD DIA	11502	YZO 1/4
A4Z1	0955-0146	0	1	U-WAVE MIXER 1 GHZ MAX	15542	TFM2-9

†Refer to Section 7 for update information.

*Factory Selected Component (Refer to Section 5).

Δ Errata part change.

Reference Designation	HP Part Number	C D	Qty.	Description	Mfr. Code	Mfr. Part Number
A5				NOT ASSIGNED		

†Refer to Section 7 for update information.

*Factory Selected Component (Refer to Section 5).

Δ Errata part change.

Reference Designation	HP Part Number	C D	Qty.	Description	Mfr. Code	Mfr. Part Number
A6						
A6	08657-60197	5	1	OUTPUT ASSY	28480	08657-60197
A6C1-C100				NOT ASSIGNED		
A6C101	0160-4040	6		CAPACITOR-FXD 1000PF + -5% 100VDC CER	28480	0160-4040
A6C102	0160-4040	6		CAPACITOR-FXD 1000PF + -5% 100VDC CER	28480	0160-4040
A6C103	0160-4389	6		CAPACITOR-FXD 100PF + -5PF 200VDC CER	28480	0160-4389
A6C104	0160-4389	6		CAPACITOR-FXD 100PF + -5PF 200VDC CER	28480	0160-4389
A6C105	0160-4040	6		CAPACITOR-FXD 1000PF + -5% 100VDC CER	28480	0160-4040
A6C106	0160-4040	6		CAPACITOR-FXD 1000PF + -5% 100VDC CER	28480	0160-4040
A6C107	0160-0575	4		CAPACITOR-FXD .047UF + -20% 50VDC CER	28480	0160-0575
A6C108	0160-4040	4		CAPACITOR-FXD 1000PF + -5% 100VDC CER	28480	0160-4040
A6C109	0160-0575	4		CAPACITOR-FXD .047UF + -20% 50VDC CER	28480	0160-0575
A6C110	0160-4040	6		CAPACITOR-FXD 1000PF + -5% 100VDC CER	28480	0160-4040
A6C111	0160-4040	6		CAPACITOR-FXD 1000PF + -5% 100VDC CER	28480	0160-4040
A6C112	0160-4389	6		CAPACITOR-FXD 100PF + -5PF 200VDC CER	28480	0160-4389
A6C113	0160-4389	6		CAPACITOR-FXD 100PF + -5PF 200VDC CER	28480	0160-4389
A6C114	0160-4040	6		CAPACITOR-FXD 1000PF + -5% 100VDC CER	28480	0160-4040
A6C115	0160-4768	5		CAPACITOR-FXD 470PF + -5% 100VDC CER	28480	0160-4768
A6C116	0160-3879	7		CAPACITOR-FXD .01UF + -20% 100VDC CER	28480	0160-3879
A6C117	0160-4040	6		CAPACITOR-FXD 1000PF + -5% 100VDC CER	28480	0160-4040
A6C118	0160-3879	7		CAPACITOR-FXD .01UF + -20% 100VDC CER	28480	0160-3879
A6C119	0160-4389	6		CAPACITOR-FXD 100PF + -5PF 200VDC CER	28480	0160-4389
A6C120	0160-4389	6		CAPACITOR-FXD 100PF + -5PF 200VDC CER	28480	0160-4389
A6C121	0160-4040	6		CAPACITOR-FXD 1000PF + -5% 100VDC CER	28480	0160-4040
A6C122				NOT ASSIGNED		
A6C123	0160-3879	7		CAPACITOR-FXD .01UF + -20% 100VDC CER	28480	0160-3879
A6C124	0160-0576	5		CAPACITOR-FXD .1UF + -20% 50VDC CER	28480	0160-0576
A6C125	0160-0576	5		CAPACITOR-FXD .1UF + -20% 50VDC CER	28480	0160-0576
A6C126	0160-0576	5		CAPACITOR-FXD .1UF + -20% 50VDC CER	28480	0160-0576
A6C127	0160-0576	5		CAPACITOR-FXD .1UF + -20% 50VDC CER	28480	0160-0576
A6C128				NOT ASSIGNED		
A6C129	0160-4040	6		CAPACITOR-FXD 1000PF + -5% 100VDC CER	28480	0160-4040
A6C130	0180-2667	1	1	CAPACITOR-FXD 150UF + -10% 20VDC TA	56289	150D157X9020S2
A6C131	0160-3879	7		CAPACITOR-FXD .01UF + -20% 100VDC CER	28480	0160-3879
A6C132	0160-3879	7		CAPACITOR-FXD .01UF + -20% 100VDC CER	28480	0160-3879
A6C133	0160-3879	7		CAPACITOR-FXD .01UF + -20% 100VDC CER	28480	0160-3879
A6C134	0160-3879	7		CAPACITOR-FXD .01UF + -20% 100VDC CER	28480	0160-3879
A6C135	0160-3879	7		CAPACITOR-FXD .01UF + -20% 100VDC CER	28480	0160-3879
A6C136	0160-3879	7		CAPACITOR-FXD .01UF + -20% 100VDC CER	28480	0160-3879
A6C137	0160-4382	2	2	CAPACITOR-FXD 1.2PF + -.25PF 200VDC CER	28480	0160-4382
A6C138	0160-4382	2		CAPACITOR-FXD 1.2PF + -.25PF 200VDC CER	28480	0160-4382
A6C139				NOT ASSIGNED		
A6C140	0160-3879	7		CAPACITOR-FXD .01UF + -20% 100VDC CER	28480	0160-3879
A6C141	0160-3879	7		CAPACITOR-FXD .01UF + -20% 100VDC CER	28480	0160-3879
A6C142	0160-3879	7		CAPACITOR-FXD .01UF + -20% 100VDC CER	28480	0160-3879
A6C143	0160-3879	7		CAPACITOR-FXD .01UF + -20% 100VDC CER	28480	0160-3879

† Refer to Section 7 for update information.

* Factory Selected Component (Refer to Section 5).

Δ Errata part change.

Reference Designation	HP Part Number	C D	Qty.	Description	Mfr. Code	Mfr. Part Number
A6C144	0160-4040	6		CAPACITOR-FXD 1000PF + -5% 100VDC CER		
A6C145	0180-3874	2		CAPACITOR-FXD 10PF + -.5PF 200VDC CER	28480	0160-4040
A6C146	0160-3874	2		CAPACITOR-FXD 10PF + -.5PF 200VDC CER	28480	0160-3874
A6C147	0160-3873	1	2	CAPACITOR-FXD 4.7PF + -.5PF 500VDC CER	28480	0160-3873
A6C148-C200				NOT ASSIGNED		
A6C201	0160-6216	2	7	CAPACITOR-FXD 1000PF + -5% 50VDC CER	28480	0160-6216
A6C202	0160-6216	2		CAPACITOR-FXD 1000PF + -5% 50VDC CER	28480	0160-6216
A6C203				NOT ASSIGNED		
A6C204	0160-6216	2		CAPACITOR-FXD 1000PF + -5% 50VDC CER	28480	0160-6216
A6C205				NOT ASSIGNED		
A6C206	0160-3879	7		CAPACITOR-FXD .01UF + -20% 100VDC CER	28480	0160-3879
A6C207	0160-5945	2	3	CAPACITOR-FXD .01UF + -10% 50VDC CER	28480	0160-5945
A6C208	0160-3879	7		CAPACITOR-FXD .01UF + -20% 100VDC CER	28480	0160-3879
A6C209	0160-3879	7		CAPACITOR-FXD .01UF + -20% 100VDC CER	28480	0160-3879
A6C210	0160-6216	2		CAPACITOR-FXD 1000PF + -5% 50VDC CER	28480	0160-6216
A6C211	0160-5945	2		CAPACITOR-FXD .01UF + -10% 50VDC CER	28480	0160-5945
A6C212	0160-5980	5	3	CAPACITOR-FXD 1.8PF + -.25PF 50VDC CER	28480	0160-5980
A6C213				NOT ASSIGNED		
A6C214	0160-6216	2		CAPACITOR-FXD 1000PF + -5% 50VDC CER	28480	0160-6216
A6C215	0160-3879	7		CAPACITOR-FXD .01UF + -20% 100VDC CER	28480	0160-3879
A6C216	0160-6216	2		CAPACITOR-FXD 1000PF + -5% 50VDC CER	28480	0160-6216
A6C217	0160-5945	2		CAPACITOR-FXD .01UF + -10% 50VDC CER	28480	0160-5945
A6C218	0160-5980	5		CAPACITOR-FXD 1.8PF + -.25PF 50VDC CER	28480	0160-5980
A6C219	0160-3879	7		CAPACITOR-FXD .01UF + -20% 100VDC CER	28480	0160-3879
A6C220	0160-6216	2		CAPACITOR-FXD 1000PF + -5% 50VDC CER	28480	0160-6216
A6C221	0160-5961	6	1	CAPACITOR-FXD 47PF + -5% 50VDC CER 0 + -30	28480	0160-5957
A6C222	0160-3875	3		CAPACITOR-FXD 22PF + -5% 200VDC CER 0 + -30	28480	0160-3875
A6C223	0160-0576	5		CAPACITOR-FXD .1UF + -20% 50VDC CER	28480	0160-0576
A6C224	0160-0576	5		CAPACITOR-FXD .1UF + -20% 50VDC CER	28480	0160-0576
A6C225	0160-4741	4	14	CAPACITOR-FXD .22UF + -10% 50VDC CER	28480	0160-4741
A6C226	0160-0576	5		CAPACITOR-FXD .1UF + -20% 50VDC CER	28480	0160-0576
A6C227	0160-4741	4		CAPACITOR-FXD .22UF + -10% 50VDC CER	28480	0160-4741
A6C228	0160-4824	2	1	CAPACITOR-FXD 1000PF + -5% 100VDC CER	28480	0160-4824
A6C229				NOT ASSIGNED		
A6C230	0180-4132	1	3	CAPACITOR-FXD 6.8UF + -10% 35VDC TA	56289	150D685X9035B2
A6C231	0180-4132	1		CAPACITOR-FXD 6.8UF + -10% 35VDC TA	56289	150D685X9035B2
A6C232*	0160-5980	5		CAPACITOR-FXD 1.8PF + -.25PF 50VDC CER	28480	0160-5980
A6C233	0160-3879	7		CAPACITOR-FXD .01UF + -20% 100VDC CER	28480	0160-3879
A6C234	0160-4389	6		CAPACITOR-FXD 100PF + -5PF 200VDC CER	28480	0160-4389
A6C235	0160-0576	5		CAPACITOR-FXD .1UF + -20% 50VDC CER	28480	0160-0576
A6C236-C239				NOT ASSIGNED		
A6C240	0160-6216			CAPACITOR-FXD 1000P 50V	28480	0160-6216
A6C241	0160-6216			CAPACITOR-FXD 1000P 50V	28480	0160-6216
A6C242	0160-3879			CAPACITOR-FXD .01UF + -20% 100VDC CER		0160-3879
A6C243	0160-3879			CAPACITOR-FXD .01UF + -20% 100VDC CER		0160-3879
A6C244	0160-5945				28480	0160-5945
A6C245-C300				NOT ASSIGNED		
A6C301	0160-4389	6		CAPACITOR-FXD 100PF + -5PF 200VDC CER	28480	0160-4389
A6C302	0160-4494	4	3	CAPACITOR-FXD 39PF + -5% 200VDC CER 0 + -30	28480	0160-4494
A6C303	0160-4741	4		CAPACITOR-FXD .22UF + -10% 50VDC CER	28480	0160-4741
A6C304	0160-4383	0		CAPACITOR-FXD 6.8PF + -.5PF 200VDC CER	20932	5024E0200RD689D
A6C305	0160-4524	4		CAPACITOR-FXD 20PF + -5% 200VDC CER 0 + -30	28480	0160-4524
A6C306	0160-4494	4		CAPACITOR-FXD 39PF + -5% 200VDC CER 0 + -30	28480	0160-4494
A6C307	0160-0576	5		CAPACITOR-FXD .1UF + -20% 50VDC CER	28480	0160-0576
A6C308	0160-4741	4		CAPACITOR-FXD .22UF + -10% 50VDC CER	28480	0160-4741

†Refer to Section 7 for update information.

*Factory Selected Component (Refer to Section 5).

△ Errata part change.

Reference Designation	HP Part Number	C D	Qty.	Description	Mfr. Code	Mfr. Part Number
A6C309	0160-4741	4		CAPACITOR-FXD .22UF + .10% 50VDC CER	28480	0160-4741
A6C310	0160-4741	4		CAPACITOR-FXD .22UF + .10% 50VDC CER	28480	0160-4741
A6C311	0160-0576	5		CAPACITOR-FXD .1UF + .20% 50VDC CER	28480	0160-0576
A6C312	0160-3879	7		CAPACITOR-FXD .01UF + .20% 100VDC CER	28480	0160-3879
A6C313				NOT ASSIGNED		
A6C314	0160-4741	4		CAPACITOR-FXD .22UF + .10% 50VDC CER	28480	0160-4741
A6C315	0160-4741	4		CAPACITOR-FXD .22UF + .10% 50VDC CER	28480	0160-4741
A6C316				NOT ASSIGNED		
A6C317	0160-0576	5		CAPACITOR-FXD .1UF + .20% 50VDC CER	28480	0160-0576
A6C318	0160-4491	1	2	CAPACITOR-FXD 8.2PF + .5% 200VDC CER	28480	0160-4491
A6C319	0160-4491	1	2	CAPACITOR-FXD 8.2PF + .5% 200VDC CER	28480	0160-4491
A6C320	0160-0576	5		CAPACITOR-FXD .1UF + .20% 50VDC CER	28480	0160-0576
A6C321	0160-0576	5		CAPACITOR-FXD .1UF + .20% 50VDC CER	28480	0160-0576
A6C322	0160-3879			CAPACITOR-FXD .01UF + .20% 100VDC CER	28480	0160-3879
A6C323	0160-5958			NOT ASSIGNED	28480	0160-5958
A6C324	0160-3879	5		CAPACITOR-FXD .1UF + .20% 50VDC CER	28480	0160-3879
A6C325	0160-3873	1	2	CAPACITOR-FXD 4.7PF + .5PF 500VDC CER	28480	0160-3873
A6C326	0160-5958	8	1	CAPACITOR-FXD 12PF + .5% 200VDC CER 0 + .30	28480	0160-5958
A6C327				NOT ASSIGNED		
A6C328	0160-0576	5		CAPACITOR-FXD .1UF + .20% 50VDC CER	28480	0160-0576
A6C329	0160-0576	5		CAPACITOR-FXD .1UF + .20% 50VDC CER	28480	0160-0576
A6C330	0160-4741	4		CAPACITOR-FXD .22UF + .10% 50VDC CER	28480	0160-4741
A6C331	0160-0576	5		CAPACITOR-FXD .1UF + .20% 50VDC CER	28480	0160-0576
A6C332	0160-4741	4		CAPACITOR-FXD .22UF + .10% 50VDC CER	28480	0160-4741
A6C333	0160-4741	4		CAPACITOR-FXD .22UF + .10% 50VDC CER	28480	0160-4741
A6C334	0160-4389	6		CAPACITOR-FXD 100PF + .5PF 200VDC CER	28480	0160-4389
A6C335						
A6C336	0160-0576	5		CAPACITOR-FXD .1UF + .20% 50VDC CER	28480	0160-0576
A6C337	0160-4741	4		CAPACITOR-FXD .22UF + .10% 50VDC CER	28480	0160-4741
A6C338	0160-4741	4		CAPACITOR-FXD .22UF + .10% 50VDC CER	28480	0160-4741
A6C339	0160-0576	5		CAPACITOR-FXD .1UF + .20% 50VDC CER	28480	0160-0576
A6C340	0160-4741	4		CAPACITOR-FXD .22UF + .10% 50VDC CER	28480	0160-4741
A6C341				NOT ASSIGNED		
A6C342	0160-0576	5		CAPACITOR-FXD .1UF + .20% 50VDC CER	28480	0160-0576
A6C343-A6C349				NOT ASSIGNED		
A6C350	0160-5977				28480	0160-5977
A6C351-A6C400				NOT ASSIGNED		
A6C401	0160-0576	5		CAPACITOR-FXD .1UF + .20% 50VDC CER	28480	0160-0576
A6C402	0160-4741	4		CAPACITOR-FXD .22UF + .10% 50VDC CER	28480	0160-4741
A6C403	0160-4031	5		CAPACITOR-FXD 330PF + .5% 100VDC CER	28480	0160-4031
A6C404	0160-4741	4		CAPACITOR-FXD .22UF + .10% 50VDC CER	28480	0160-4741
A6C405	0160-3879	7		CAPACITOR-FXD .01UF + .20% 100VDC CER	28480	0160-3879
A6C406	0160-4741	4		CAPACITOR-FXD .22UF + .10% 50VDC CER	28480	0160-4741
A6C407	0180-0183	2	1	CAPACITOR-FXD 10UF + 75-10% 50VDC AL	56289	30D106G050CB2
A6C408				NOT ASSIGNED		
A6C409				NOT ASSIGNED		
A6C410	0160-0576	5		CAPACITOR-FXD .1UF + .20% 50VDC CER	28480	0160-0576
A6C411	0160-0576	5		CAPACITOR-FXD .1UF + .20% 50VDC CER	28480	0160-0576
A6C412	0160-0576	5		CAPACITOR-FXD .1UF + .20% 50VDC CER	28480	0160-0576
A6C413				NOT ASSIGNED		
A6C414	0180-0087	7	1	CAPACITOR-FXD 47UF + .10% 35VDC TA	56289	150D476X9035S2
A6C415	0180-1974	1	2	CAPACITOR-FXD 10UF + .10% 35VDC TA	56289	150D106X9035R2
A6C416	0180-1974	1		CAPACITOR-FXD 10UF + .10% 35VDC TA	56289	150D106X9035R2
A6C417	0180-4132	1		CAPACITOR-FXD 6.8UF + .10% 35VDC TA	56289	150D685X9035B2
A6C418	0160-3879	7		CAPACITOR-FXD .01UF + .20% 100VDC CER	28480	0160-3879
A6C419	0160-3879	7		CAPACITOR-FXD .01UF + .20% 100VDC CER	28480	0160-3879
A6C420				NOT ASSIGNED		

†Refer to Section 7 for update information.

*Factory Selected Component (Refer to Section 5).

Δ Errata part change.



Reference Designation	HP Part Number	C D	Qty.	Description	Mfr. Code	Mfr. Part Number
A6C421	0160-4389	6		CAPACITOR-FXD 100PF + .5PF 200VDC CER	28480	0160-4389
A6C422	0160-3879	7		CAPACITOR-FXD .01UF + .20% 100VDC CER	28480	0160-3879
A6C423	0160-3879	7		CAPACITOR-FXD .01UF + .20% 100VDC CER	28480	0160-3879
A6C424	0160-3879	7		CAPACITOR-FXD .01UF + .20% 100VDC CER	28480	0160-3879
A6C425	0160-3879	7		CAPACITOR-FXD .01UF + .20% 100VDC CER	28480	0160-3879
A6C426	0160-3879	7		CAPACITOR-FXD .01UF + .20% 100VDC CER	28480	0160-3879
A6C427	0180-4129			C TA 1U 35V	28480	0180-4129
A6C480	0160-4389			CAPACITOR-FXD 100PF + .5PF 200VDC CER	28480	0160-4389
A6CR1-CR100				NOT ASSIGNED		
A6CR101	1901-1096	9	13	DIODE-PIN	28480	1901-1096
A6CR102	1901-1096	9		DIODE-PIN	28480	1901-1096
A6CR103	1901-1096	9		DIODE-PIN	28480	1901-1096
A6CR104	0122-0161	4		DIODE-VVC 2.15PF 7% BVR = 30V	25403	BB405B
A6CR105	0122-0161	4		DIODE-VVC 2.15PF 7% BVR = 30V	25403	BB405B
A6CR106	1901-0050	3		DIODE-SWITCHING 80V 200MA 2NS DO-35	9N171	1N4150
A6CR107	1901-0050	3		DIODE-SWITCHING 80V 200MA 2NS DO-35	9N171	1N4150
A6CR108	1901-0050	3		DIODE-SWITCHING 80V 200MA 2NS DO-35	9N171	1N4150
A6CR109	1901-1096	9		DIODE-PIN	28480	1901-1096
A6CR110	1901-1096	9		DIODE-PIN	28480	1901-1096
A6CR111	1901-1096	9		DIODE-PIN	28480	1901-1096
A6CR112	0122-0162	5	10	DIODE-VVC 29PF 10% BVR = 30V	25403	BB809
A6CR113	0122-0162	5		DIODE-VVC 29PF 10% BVR = 30V	25403	BB809
A6CR114	0122-0162	5		DIODE-VVC 29PF 10% BVR = 30V	25403	BB809
A6CR115	0122-0162	5		DIODE-VVC 29PF 10% BVR = 30V	25403	BB809
A6CR116	1901-0050	3		DIODE-SWITCHING 80V 200MA 2NS DO-35	9N171	1N4150
A6CR117	1901-1096	9		DIODE-PIN	28480	1901-1096
A6CR118	1901-1096	9		DIODE-PIN	28480	1901-1096
A6CR119	1901-1096	9		DIODE-PIN	28480	1901-1096
A6CR120	0122-0162	5		DIODE-VVC 29PF 10% BVR = 30V	25403	BB809
A6CR121	0122-0162	5		DIODE-VVC 29PF 10% BVR = 30V	25403	BB809
A6CR122	0122-0162	5		DIODE-VVC 29PF 10% BVR = 30V	25403	BB809
A6CR123	0122-0162	5		DIODE-VVC 29PF 10% BVR = 30V	25403	BB809
A6CR124	1901-1096	9		DIODE-PIN	28480	1901-1096
A6CR125	1901-1096	9		DIODE-PIN	28480	1901-1096
A6CR126	1901-1096	9		DIODE-PIN	28480	1901-1096
A6CR127	1902-0627	2	1	DIODE-CUR RGLTR 1N5312 100V DO-7	04713	1N5312
A6CR128	1901-0050	3		DIODE-SWITCHING 80V 200MA 2NS DO-35	9N171	1N4150
A6CR129	1901-0050	3		DIODE-SWITCHING 80V 200MA 2NS DO-35	9N171	1N4150
A6CR130	1901-0050	3		DIODE-SWITCHING 80V 200MA 2NS DO-35	9N171	1N4150
A6CR131	1901-0050	3		DIODE-SWITCHING 80V 200MA 2NS DO-35	9N171	1N4150
A6CR132	1901-0050	3		DIODE-SWITCHING 80V 200MA 2NS DO-35	9N171	1N4150
A6CR133	1901-0050	3		DIODE-SWITCHING 80V 200MA 2NS DO-35	9N171	1N4150
A6CR134	1901-0050	3		DIODE-SWITCHING 80V 200MA 2NS DO-35	9N171	1N4150
A6CR135	1901-0050	3		DIODE-SWITCHING 80V 200MA 2NS DO-35	9N171	1N4150
A6CR136	1901-0050	3		DIODE-SWITCHING 80V 200MA 2NS DO-35	9N171	1N4150
A6CR137	1901-0050	3		DIODE-SWITCHING 80V 200MA 2NS DO-35	9N171	1N4150
A6CR138	1901-0050	3		DIODE-SWITCHING 80V 200MA 2NS DO-35	9N171	1N4150
A6CR139	1901-0050	3		DIODE-SWITCHING 80V 200MA 2NS DO-35	9N171	1N4150
A6CR140	1901-0050	3		DIODE-SWITCHING 80V 200MA 2NS DO-35	9N171	1N4150
A6CR141	1901-0050	3		DIODE-SWITCHING 80V 200MA 2NS DO-35	9N171	1N4150
A6CR142	1901-1134	6	1	DIODE-PIN	25403	BA483
A6CR143	0122-0161	4		DIODE-VVC 2.15PF 7% BVR = 30V	25403	BB405B
A6CR144	0122-0161	4		DIODE-VVC 2.15PF 7% BVR = 30V	25403	BB405B



†Refer to Section 7 for update information.

*Factory Selected Component (Refer to Section 5).

Δ Errata part change.



Reference Designation	HP Part Number	C D	Qty.	Description	Mfr. Code	Mfr. Part Number
A6CR145	0122-0162	5		DIODE-VVC 29PF 10% BVR = 30V	25403	BB809
A6CR146	0122-0162	5		DIODE-VVC 29PF 10% BVR = 30V	25403	BB809
A6CR147-CR200				NOT ASSIGNED		
A6CR201	1906-0245	8	4	DIODE-MATCHED VF DIFF = 5MV	28480	1906-0245
A6CR202	1906-0245	8		DIODE-MATCHED VF DIFF = 5MV	28480	1906-0245
A6CR203	1901-0050	3		DIODE-SWITCHING 80V 200MA 2NS DO-35	9N171	1N4150
A6CR204	1901-0050	3		DIODE-SWITCHING 80V 200MA 2NS DO-35	9N171	1N4150
A6CR205	1901-0050	3		DIODE-SWITCHING 80V 200MA 2NS DO-35	9N171	1N4150
A6CR206	1901-0050	3		DIODE-SWITCHING 80V 200MA 2NS DO-35	9N171	1N4150
A6CR207	1901-0050	3		DIODE-SWITCHING 80V 200MA 2NS DO-35	9N171	1N4150
A6CR208	1901-0050	3		DIODE-SWITCHING 80V 200MA 2NS DO-35	9N171	1N4150
A6CR209	1901-0050	3		DIODE-SWITCHING 80V 200MA 2NS DO-35	9N171	1N4150
A6CR210	1901-0050	3		DIODE-SWITCHING 80V 200MA 2NS DO-35	9N171	1N4150
A6CR211	1901-0050	3		DIODE-SWITCHING 80V 200MA 2NS DO-35	9N171	1N4150
A6CR212-CR300				NOT ASSIGNED		
A6CR301	1906-0245	8		DIODE-MATCHED VF DIFF = 5MV	28480	1906-0245
A6CR302	1901-1096	8		DIODE-PIN	28480	1901-1096
A6CR303	1906-0245	8		DIODE-MATCHED VF DIFF = 5MV	28480	1906-0245
A6CR304	1902-0943	3		DIODE-SCHOTTKY SM SIG	02062	50825510
A6CR305	1901-0050	3		DIODE-SWITCHING 80V 200MA 2NS DO-35	9N171	1N4150
A6CR306	1901-0518			D SCH 70V 35		
A6CR307-CR400				NOT ASSIGNED		
A6CR401	1901-1128	3		DIODE-SWITCHING 80V 200MA 2NS DO-35	9N171	1N4150
A6CR402	1901-0050	3		DIODE-SWITCHING 80V 200MA 2NS DO-35	9N171	1N4150
A6CR403-CR410				NOT ASSIGNED		
A6CR411	1901-0050	3		DIODE-SWITCHING 80V 200MA 2NS DO-35	9N171	1N4150
A6CR412 ^Δ	1990-0486	6	1	LED-LAMP LUM-INT = 1MCD IF = 25MA-MAX	01542	HLMP-1301
A6J1-J202				NOT ASSIGNED		
A6J203	5021-2826	3	3	RF FTING 2.2 DIA	28480	5021-2826
	1251-2194	1	3	CONNECTOR-SGL CONT SKT .021-IN-BSC-SZ	28480	1251-2194
A6J204-J300				NOT ASSIGNED		
A6J301	1251-2194	1		CONNECTOR-SGL CONT SKT .021-IN-BSC-SZ	28480	1251-2194
A6J302	5021-2826	3		RF FTING 2.2 DIA	28480	5021-2826
	1251-2194	1		CONNECTOR-SGL CONT SKT .021-IN-BSC-SZ	28480	1251-2194
A6J303	5021-2826	3		RF FTING 2.2 DIA	28480	5021-2826
	1251-2194	1		CONNECTOR-SGL CONT SKT .021-IN-BSC-SZ	28480	1251-2194
A6J304-J400				NOT ASSIGNED		
A6J401	1251-8599	2		CONN-POST TYPE .100-PIN-SPCG 10-CONT	28480	1251-8599
	1251-5595	2		POLARIZING KEY-POST CONN	28480	1251-5595
A6J402	1251-8599	2		CONN-POST TYPE .100-PIN-SPCG 10-CONT	28480	1251-8599
	1251-5595	2		POLARIZING KEY-POST CONN	28480	1251-5595
A6L1-L100				NOT ASSIGNED		
A6L101	9140-0158	6		INDUCTOR RF-CH-MLD 1UH 10%	28480	9140-0158
A6L102	9140-0158	6		INDUCTOR RF-CH-MLD 1UH 10%	28480	9140-0158
A6L103	9140-0158	6		INDUCTOR RF-CH-MLD 1UH 10%	28480	9140-0158
A6L104	9140-0158	6		INDUCTOR RF-CH-MLD 1UH 10%	28480	9140-0158
A6L105	9140-0158	6		INDUCTOR RF-CH-MLD 1UH 10%	28480	9140-0158
A6L106	9100-2247	4		INDUCTOR RF-CH-MLD 100NH 10%	28480	9100-2247
A6L107	9140-0158	6		INDUCTOR RF-CH-MLD 1UH 10%	28480	9140-0158
A6L108	9135-0073	3		INDUCTOR RF-CH-MLD 47NH 6.596%	28480	9135-0073
A6L109	9135-0073	3		INDUCTOR RF-CH-MLD 47NH 6.596%	28480	9135-0073

{Refer to Section 7 for update information.

*Factory Selected Component (Refer to Section 5).

Δ Errata part change.

Reference Designation	HP Part Number	C D	Qty.	Description	Mfr. Code	Mfr. Part Number
A6L110	9135-0073	3		INDUCTOR RF-CH-MLD 47NH 6.596%	28480	9135-0073
A6L111	9140-0158	6		INDUCTOR RF-CH-MLD 1UH 10%	28480	9140-0158
A6L112	9140-0158	6		INDUCTOR RF-CH-MLD 1UH 10%	28480	9140-0158
A6L113	9140-0158	6		INDUCTOR RF-CH-MLD 1UH 10%	28480	9140-0158
A6L114-L117				NOT ASSIGNED		
A6L118	9100-1630	7		INDUCTOR RF-CH-MLD 51UH 5% .166DX.385LG	28480	9100-1630
A6L119	9140-0158	6		INDUCTOR RF-CH-MLD 1UH 10%	28480	9140-0158
A6L120	9140-0158	6		INDUCTOR RF-CH-MLD 1UH 10%	28480	9140-0158
A6L121	9140-0158	6		INDUCTOR RF-CH-MLD 1UH 10%	28480	9140-0158
A6L122	9140-0158	6		INDUCTOR RF-CH-MLD 1UH 10%	28480	9140-0158
A6L123	9140-0158	6		INDUCTOR RF-CH-MLD 1UH 10%	28480	9140-0158
A6L124	9140-0158	6		INDUCTOR RF-CH-MLD 1UH 10%	28480	9140-0158
A6L125-L126				NOT ASSIGNED		
A6L127	9140-0158	6		INDUCTOR RF-CH-MLD 1UH 10%	28480	9140-0158
A6L128	9140-0158	6		INDUCTOR RF-CH-MLD 1UH 10%	28480	9140-0158
A6L129-L200				NOT ASSIGNED		
A6L201	9100-2247	4		INDUCTOR RF-CH-MLD 100NH 10%	28480	9100-2247
A6L202	9100-2247	4		INDUCTOR RF-CH-MLD 100NH 10%	28480	9100-2247
A6L203	9100-3922	4		INDUCTOR-FIXED 120-1300 HZ	28480	9100-3922
A6L204	9100-3922	4		INDUCTOR-FIXED 120-1300 HZ	28480	9100-3922
A6L205	9100-3922	4		INDUCTOR-FIXED 120-1300 HZ	28480	9100-3922
A6L206				NOT ASSIGNED		
A6L207	9100-3560	6		INDUCTOR RF-CH-MLD 5.6UH 5%	28480	9100-3560
A6L208	9100-3560	6		INDUCTOR RF-CH-MLD 5.6UH 5%	28480	9100-3560
A6L209	9140-0158	6		INDUCTOR RF-CH-MLD 1UH 10%	28480	9140-0158
A6L210	9100-3299	4		INDUCTOR-FIXED 120-1300 Hz	28480	9100-3299
A6L211-L299				NOT ASSIGNED		
A6L300	9100-3560	6		INDUCTOR RF-CH-MLD 5.6UH 5%	28480	9100-3560
A6L301	9135-0071	3		INDUCTOR RF-CH-MLD 47NH 6.596%	28480	9135-0071
A6L302	9100-2817	8	1	INDUCTOR RF-CH-MLD 82NH 5.61%	28480	9100-2817
A6L303	9135-0071	3		INDUCTOR RF-CH-MLD 47NH 6.596%	28480	9135-0071
A6L304	9135-0073	3		INDUCTOR RF-CH-MLD 47NH 6.596%	28480	9135-0073
A6L305	9100-2247	4		INDUCTOR RF-CH-MLD 100NH 10%	28480	9100-2247
A6L306	8159-0005	0		RESISTOR-ZERO OHMS 22AWG LEAD DIA	28480	8159-0005
A6L307	9100-2247	4		INDUCTOR RF-CH-MLD 100NH 10%	28480	9100-2247
A6L308-L400				NOT ASSIGNED		
A6L401	9100-1665	8	2	INDUCTOR RF-CH-MLD 3.3MH 5%	28480	9100-1665
A6L402	9100-1665	8		INDUCTOR RF-CH-MLD 3.3MH 5%	28480	9100-1665
A6L403	9100-3560	6		INDUCTOR RF-CH-MLD 5.6UH 5%	28480	9100-3560
A6L404-L409				NOT ASSIGNED		
A6L410	9100-3551	5	1	INDUCTOR RF-CH-MLD 1UH 5%	28480	9100-3551
A6L411	9100-3560	6		INDUCTOR RF-CH-MLD 5.6UH 5%	28480	9100-3560
A6L412	9100-3560	6		INDUCTOR RF-CH-MLD 5.6UH 5%	28480	9100-3560
A6L413	9100-3560	6		INDUCTOR RF-CH-MLD 5.6UH 5%	28480	9100-3560
A6L414	9140-0158	6		INDUCTOR RF-CH-MLD 1UH 10%	28480	9140-0158
A6L415	9140-0158	6		INDUCTOR RF-CH-MLD 1UH 10%	28480	9140-0158
A6L416	9140-0158	6		INDUCTOR RF-CH-MLD 1UH 10%	28480	9140-0158
A6L417	9140-0158	6		INDUCTOR RF-CH-MLD 1UH 10%	28480	9140-0158
A6L418	9140-0158	6		INDUCTOR RF-CH-MLD 1UH 10%	28480	9140-0158
A6L419	9140-0158	6		INDUCTOR RF-CH-MLD 1UH 10%	28480	9140-0158
A6L420	9140-0142	6		INDUCTOR RF-CH-MLD 2.2UH 10%	28480	9140-0142
A6L421	9140-0158	6		INDUCTOR RF-CH-MLD 1UH 10%	28480	9140-0158
A6L422	9140-0158	6		INDUCTOR RF-CH-MLD 1UH 10%	28480	9140-0158

†Refer to Section 7 for update information.

*Factory Selected Component (Refer to Section 5).

Δ Errata part change.

Reference Designation	HP Part Number	C D	Qty.	Description	Mfr. Code	Mfr. Part Number
A6L423	9140-0158	6		INDUCTOR RF-CH-MLD 1UH 10%	28480	9140-0158
A6L424	9140-0158	6		INDUCTOR RF-CH-MLD 1UH 10%	28480	9140-0158
A6L425	9140-0158	6		INDUCTOR RF-CH-MLD 1UH 10%	28480	9140-0158
A6L426	9140-0158	6		INDUCTOR RF-CH-MLD 1UH 10%	28480	9140-0158
<i>2748U TO 2944A</i>						
A6MP1,2,3,4,5,9	08656-00090	2		TAB-GROUNDING	28480	08656-00090
A6MP8	08656-00133	4		CLIP SEMI-R GRND	28480	08656-00133
A6Q1-Q100				NOT ASSIGNED		
A6Q101	1854-0477	7		TRANSISTOR NPN 2N2222A SI TO-18 PD = 500MW	04713	2N2222A
A6Q102	1854-0477	7		TRANSISTOR NPN 2N2222A SI TO-18 PD = 500MW	04713	2N2222A
A6Q103	1854-1050	8		TRANSISTOR NPN SI PD = 180MW FT = 4GHZ	25403	BFR91
A6Q104	1854-0477	7		TRANSISTOR NPN 2N2222A SI TO-18 PD = 500MW	04713	2N2222A
A6Q105	1854-0632					
A6Q106-Q200				NOT ASSIGNED		
A6Q201	1854-1032	2	3	TRANSISTOR NPN SI PD = 2.5W	04713	MRF581
A6Q202	1853-0459	3		TRANSISTOR PNP SI PD = 625MW FT = 200MHZ	28480	1853-0459
A6Q203	1854-1032	2		TRANSISTOR NPN SI PD = 2.5W	04713	MRF581
A6Q204	1853-0459	3		TRANSISTOR PNP SI PD = 625MW FT = 200MHZ	28480	1853-0459
A6Q205	1854-1032	2		TRANSISTOR NPN SI PD = 2.5W	04713	MRF581
A6Q206	1853-0459	3		TRANSISTOR PNP SI PD = 625MW FT = 200MHZ	28480	1853-0459
A6Q207	1858-0032	8		TRANSISTOR ARRAY 14-PIN PLSTC DIP	3L585	CA3146E
A6Q208	1853-0459	3		TRANSISTOR PNP SI PD = 625MW FT = 200MHZ	28480	1853-0459
A6Q209	1853-0459	3		TRANSISTOR PNP SI PD = 625MW FT = 200MHZ	28480	1853-0459
A6Q210	1853-0459	3		TRANSISTOR PNP SI PD = 625MW FT = 200MHZ	28480	1853-0459
A6Q211	1854-1032	2		TRANSISTOR NPN SI PD = 2.5W	04713	MRF581
A6Q212	1854-0477	7		TRANSISTOR NPN 2N2222A SI TO-18 PD = 500MW	04713	2N2222A
A6Q213	1855-0877			XSTR FET J174	28480	1855-0877
A6Q214	1855-0877			XSTR FET J174	28480	1855-0877
A6Q215-Q300				NOT ASSIGNED		
A6Q301	1853-0527	6		TRANSISTOR PNP SI PD = 500MW FT = 4GHZ	25403	BFQ-32
A6Q302	1853-0527	6		TRANSISTOR PNP SI PD = 500MW FT = 4GHZ	25403	BFQ-32
A6Q303	1854-0720	3	3	TRANSISTOR NPN SI PD = 500MW FT = 4GHZ	28480	1854-0720
A6Q304	1854-0720	3		TRANSISTOR NPN SI PD = 500MW FT = 4GHZ	28480	1854-0720
A6Q305	1855-0877			YSTR FET J174	28480	1855-0877
A6Q306	1855-0877			YSTR FET J174	28480	1855-0877
A6Q307-Q409				NOT ASSIGNED		
A6Q410	1853-0281	9		TRANSISTOR PNP 2N2907A SI TO-18 PD = 400MW	04713	2N2907A
A6Q411	1853-0281	9		TRANSISTOR PNP 2N2907A SI TO-18 PD = 400MW	04713	2N2907A
A6Q412	1854-0477	7		TRANSISTOR NPN 2N2222A SI TO-18 PD = 500MW	04713	2N2222A
A6R1-R100				NOT ASSIGNED		
A6R101	0698-3150	6		RESISTOR 2.37K 1% .125W F TC = 0 + -100	24546	CT4-1/8-T0-2371-F
A6R102	0757-0416	7		RESISTOR 511 1% .125W F TC = 0 + -100	24546	CT4-1/8-T0-511R-F
A6R103	0698-3440	7		RESISTOR 196 1% .125W F TC = 0 + -100	24546	CT4-1/8-T0-196R-F
A6R104	0698-3153	7		RESISTOR 196 1% .125W F TC = 0 + -100	24546	CT4-1/8-T0-196R-F
A6R105	0698-7227	6		RESISTOR 422 1% .05W F TC = 0 + -100	24546	CT3-1/8-T0-422R-F
A6R106	0699-1902	8		RESISTOR 10 1% .05W F TC = 0 + -100	24546	CT3-1/8-T0-10R-F
A6R107	0698-7227	6		RESISTOR 422 1% .05W F TC = 0 + -100	24546	CT3-1/8-T0-422R-F
A6R108	0757-0438	3		RESISTOR 5.11K 1% .125W F TC = 0 + -100	24546	CT4-1/8-T0-5111-F
A6R109	0757-0438	3		RESISTOR 5.11K 1% .125W F TC = 0 + -100	24546	CT4-1/8-T0-5111-F
A6R110	0757-0438	3		RESISTOR 5.11K 1% .125W F TC = 0 + -100	24546	CT4-1/8-T0-5111-F
A6R111	0757-0438	3		RESISTOR 5.11K 1% .125W F TC = 0 + -100	24546	CT4-1/8-T0-5111-F
A6R112	0698-3440	7		RESISTOR 464 1% .125W F TC = 0 + -100	24546	CT4-1/8-T0-4640-F
A6R113	0698-3440	7		RESISTOR 464 1% .125W F TC = 0 + -100	24546	CT4-1/8-T0-4640-F
A6R114	0698-0082	7		RESISTOR 464 1% .125W F TC = 0 + -100	24546	CT4-1/8-T0-4640-F

†Refer to Section 7 for update information.

*Factory Selected Component (Refer to Section 5).

Δ Errata part change.

Reference Designation	HP Part Number	C D	Qty.	Description	Mfr. Code	Mfr. Part Number
A6R115	0698-3440	7		RESISTOR 196 1% .125W F TC = 0 + -100	24546	CT4-1/8-TO-196R-F
A6R116	0698-3430	7		RESISTOR 196 1% .125W F TC = 0 + -100	24546	CT4-1/8-TO-196R-F
A6R117	0698-3440	7		RESISTOR 196 1% .125W F TC = 0 + -100	24546	CT4-1/8-TO-196R-F
A6R118	0698-3150	7		RESISTOR 2.37K 1% .125W F TC = 0 + -100	24546	CT4-1/8-TO-2371-F
A6R119	0698-7227	6		RESISTOR 422 1% .05W F TC = 0 + -100	24546	CT3-1/8-TO-422R-F
A6R120	0699-1902	8		RESISTOR 10 1% .05W F TC = 0 + -100	24546	CT3-1/8-TO-10R-F
A6R121	0698-7227	6		RESISTOR 422 1% .05W F TC = 0 + -100	24546	CT3-1/8-TO-422R-F
A6R122	0757-0438	3		RESISTOR 5.11K 1% .125W F TC = 0 + -100	24546	CT4-1/8-TO-5111-F
2913A AND ABOVE						
A6R123				NOT ASSIGNED		
A6R124	0698-0082	7		RESISTOR 464 1% .125W F TC = 0 + -100	24546	CT4-1/8-TO-4640-F
A6R125	0698-0082	7		RESISTOR 464 1% .125W F TC = 0 + -100	24546	CT4-1/8-TO-4640-F
A6R126	0698-7219	6	1	RESISTOR 196 1% .05W F TC = 0 + -100	24546	CT4-1/8-TO-196R-F
A6R127-R127				NOT ASSIGNED		
A6R128	0698-3440	7		RESISTOR 196 1% .125W F TC = 0 + -100	24546	CT4-1/8-TO-196R-F
A6R129	0698-0084	7		RESISTOR 196 1% .125W F TC = 0 + -100	24546	CT4-1/8-TO-196R-F
A6R130	0698-7227	6		RESISTOR 422 1% .05W F TC = 0 + -100	24546	CT3-1/8-TO-422R-F
A6R131	0699-1902	8		RESISTOR 10 1% .05W F TC = 0 + -100	24546	CT3-1/8-TO-10R-F
A6R132	0698-7227	6		RESISTOR 422 1% .05W F TC = 0 + -100	24546	CT3-1/8-TO-422R-F
A6R133	0698-0083	8		RESISTOR 1.96K 1% .125W F TC = 0 + -100	24546	CT4-1/8-TO-1961-F
A6R134	0757-0288	1	15	RESISTOR 9.09K 1% .125W F TC = 0 + -100	19701	5033R-1/8-TO-9091-F
A6R135	0698-3157	3		RESISTOR 19.6K 1% .125W F TC = 0 + -100	24546	CT4-1/8-TO-1962-F
A6R136	0698-3161	9		RESISTOR 38.3K 1% .125W F TC = 0 + -100	24546	CT4-1/8-TO-3832-F
A6R137	0757-0463	4	1	RESISTOR 82.5K 1% .125W F TC = 0 + -100	24546	CT4-1/8-TO-8252-F
A6R138	0757-0470	3	1	RESISTOR 162K 1% .125W F TC = 0 + -100	24546	CT4-1/8-TO-1623-F
A6R139	0698-3457	6		RESISTOR 316K 1% .125W F TC = 0 + -100	28480	0698-3457
A6R140	0757-0442	9		RESISTOR 10K 1% .125W F TC = 0 + -100	24546	CT4-1/8-TO-1002-F
A6R141	0757-0288	1		RESISTOR 9.09K 1% .125W F TC = 0 + -100	19701	5033R-1/8-TO-9091-F
A6R142	0757-0442	9		RESISTOR 10K 1% .125W F TC = 0 + -100	24546	CT4-1/8-TO-1002-F
A6R143	0757-0442	9		RESISTOR 10K 1% .125W F TC = 0 + -100	24546	CT4-1/8-TO-1002-F
A6R144	0757-0280	3		RESISTOR 1K 1% .125W F TC = 0 + -100	24546	CT4-1/8-TO-1001-F
A6R145	0757-0442	9		RESISTOR 10K 1% .125W F TC = 0 + -100	24546	CT4-1/8-TO-1002-F
A6R146	0757-0444	9		RESISTOR 10K 1% .125W F TC = 0 + -100	24546	CT4-1/8-TO-1002-F
A6R147	0757-0280	3		RESISTOR 1K 1% .125W F TC = 0 + -100	24546	CT4-1/8-TO-1001-F
A6R148	0757-0442	9		RESISTOR 10K 1% .125W F TC = 0 + -100	24546	CT4-1/8-TO-1002-F
A6R149	0757-0442	9		RESISTOR 10K 1% .125W F TC = 0 + -100	24546	CT4-1/8-TO-1002-F
A6R150	0757-0280	3		RESISTOR 1K 1% .125W F TC = 0 + -100	24546	CT4-1/8-TO-1001-F
A6R151	0698-3160	8	4	RESISTOR 31.6K 1% .125W F TC = 0 + -100	24546	CT4-1/8-TO-3162-F
A6R152	0698-3160	8		RESISTOR 31.6K 1% .125W F TC = 0 + -100	24546	CT4-1/8-TO-3162-F
A6R153	0698-3160	8		RESISTOR 31.6K 1% .125W F TC = 0 + -100	24546	CT4-1/8-TO-3162-F
A6R154	0698-3440	7		RESISTOR 196 1% .125W F TC = 0 + -100	24546	CT4-1/8-TO-196R-F
A6R155	0698-3440	7		RESISTOR 196 1% .125W F TC = 0 + -100	24546	CT4-1/8-TO-196R-F
A6R156	0698-3440	7		RESISTOR 196 1% .125W F TC = 0 + -100	24546	CT4-1/8-TO-196R-F
A6R157	0698-3440	7		RESISTOR 196 1% .125W F TC = 0 + -100	24546	CT4-1/8-TO-196R-F
A6R158	0698-7219	6	1	RESISTOR 196 1% .05W F TC = 0 + -100	24546	CT4-1/8-TO-196R-F
A6R159	0698-7205	0		RESISTOR 51.1 1% .05W F TC = 0 + -100	24546	CT3-1/8-TO-51R1-F
A6R160	0698-7223	6		RESISTOR 422 1% .05W F TC = 0 + -100	24546	CT3-1/8-TO-422R-F
A6R161	0698-7194	6		RESISTOR 17.8 1% .05W F TC = 0 + -100	02995	5063J
A6R162	0698-7223	6		RESISTOR 422 1% .05W F TC = 0 + -100	24546	CT3-1/8-TO-422R-F
A6R163	0698-7204	9	1	RESISTOR 46.4 1% .05W F TC = 0 + -100	24546	CT3-1/8-TO-46R4-F
A6R164	0698-7212	9		RESISTOR 100 1% .05W F TC = 0 + -100	24546	CT3-1/8-TO-100R-F

†Refer to Section 7 for update information.

*Factory Selected Component (Refer to Section 5).

△ Errata part change.

Reference Designation	HP Part Number	C D	Qty.	Description	Mfr. Code	Mfr. Part Number
A6R165-R200				NOT ASSIGNED		
A6R201	0698-3334	8	1	RESISTOR 178 1% .5W F TC = 0 + -100	28480	0757-3334
A6R202	0698-3334	8	1	RESISTOR 178 1% .5W F TC = 0 + -100	28480	0698-3334
A6R203	0698-7243	8	3	RESISTOR 1.96K 1% .05W F TC = 0 + -100	24546	CT3-1/8-T0-1961-F
A6R204	0699-1421	2	3	RESISTOR 178 1% .125W F TC = 0 + -100	28480	0699-1421
A6R205	0698-3618	1	3	RESISTOR 82 5% 2W MO TC = 0 + -200	27167	FP42-2-T00-82R0-J
A6R206	0699-1360	8	12	RESISTOR 46.4 1% .125W F TC = 0 + -100	28480	0699-1360
A6R207	0699-1360	8		RESISTOR 46.4 1% .125W F TC = 0 + -100	28480	0699-1360
A6R208	0699-1360	8		RESISTOR 46.4 1% .125W F TC = 0 + -100	28480	0699-1360
A6R209	0699-1360	8		RESISTOR 46.4 1% .125W F TC = 0 + -100	28480	0699-1360
A6R210	0698-3618	1		RESISTOR 82 5% 2W MO TC = 0 + -200	27167	FP42-2-T00-82R0-J
A6R211	0698-7243	6		RESISTOR 1.96K 1% .05W F TC = 0 + -100	24546	CT3-1/8-T0-1961-F
A6R212	0699-1356	2	2	RESISTOR 31.6 1% .125W F TC = 0 + -100	28480	0699-1356
A6R213	0699-1421	2		RESISTOR 178 1% .125W F TC = 0 + -100	28480	0699-1421
A6R214	0699-1360	8		RESISTOR 46.4 1% .125W F TC = 0 + -100	28480	0699-1360
A6R215	0699-1360	8		RESISTOR 46.4 1% .125W F TC = 0 + -100	28480	0699-1360
A6R216	0699-1360	8		RESISTOR 46.4 1% .125W F TC = 0 + -100	28480	0699-1360
A6R217	0699-1360	8		RESISTOR 46.4 1% .125W F TC = 0 + -100	28480	0699-1360
A6R218	0757-0440	9		RF 7.5K 1% .125W	24546	CT4-1/8-T0-1002-F
A6R219	0757-0442	9	15	RESISTOR 10K 1% .125W F TC = 0 + -100	19701	5033R-1/8-T0-9091-F
A6R220	0698-7243	6		RESISTOR 1.96K 1% .05W F TC = 0 + -100	24546	CT3-1/8-T0-1961-F
A6R221	0699-1356	2		RESISTOR 31.6 1% .125W F TC = 0 + -100	28480	0699-1356
A6R222	0698-3618	1		RESISTOR 82 5% 2W MO TC = 0 + -200	27167	FP42-2-T00-82R0-J
A6R223	0699-1360	8		RESISTOR 46.4 1% .125W F TC = 0 + -100	28480	0699-1360
A6R224	0699-1360	8		RESISTOR 46.4 1% .125W F TC = 0 + -100	28480	0699-1360
A6R225	0699-1360	8		RESISTOR 46.4 1% .125W F TC = 0 + -100	28480	0699-1360
A6R226	0699-1360	8		RESISTOR 46.4 1% .125W F TC = 0 + -100	28480	0699-1360
A6R227	0699-1364	2	1	RESISTOR 68.1 1% .125W F TC = 0 + -100	28480	0699-1364
A6R228 ^Δ	0699-1365	3	1	RESISTOR 75 1% .125W F TC = 0 + -100	05524	CROW1206F
A6R229	0698-7236	7		RESISTOR 1K 1% .05W F TC = 0 + -100	24546	CT3-1/8-T0-1001-F
A6R230	0698-3452	1		RESISTOR 147K 1% .125W F TC = 0 + -100	24546	CT4-1/8-T0-1473-F
A6R231	0698-3452	1		RESISTOR 147K 1% .125W F TC = 0 + -100	24546	CT4-1/8-T0-1473-F
A6R232	0757-0442	9		RESISTOR 10K 1% .125W F TC = 0 + -100	24546	CT4-1/8-T0-1002-F
A6R233	0698-0083	8		RESISTOR 1.96K 1% .125W F TC = 0 + -100	24546	CT4-1/8-T0-1961-F
A6R234	0757-0442	9		RESISTOR 10K 1% .125W F TC = 0 + -100	24546	CT4-1/8-T0-1002-F
A6R235	0698-7244	7	1	RESISTOR 2.15K 1% .05W F TC = 0 + -100	24546	CT3-1/8-T0-2151-F
A6R236	2100-1986	9	1	RESISTOR-TRMR 1K 10% C TOP-ADJ 1-TRN	73138	82PR1K
A6R237	0698-7284	5		RESISTOR 100K 1% .05W FTC = 0 + -100	25456	0698-7284
A6R238	0698-7284	5		RESISTOR 100K 1% .05W FTC = 0 + -100	25456	0698-7284
A6R239	0698-7219	6		RESISTOR 100K 1% .05W FTC = 0 + -100	28480	CT4-1/8-T0-196R-F
A6R240	0698-0083	8		RESISTOR 1.96K 1% .125W F TC = 0 + -100	24546	CT4-1/8-T0-1961-F
A6R241	0757-0442	9		RESISTOR 10K 1% .125W F TC = 0 + -100	24546	CT4-1/8-T0-1002-F
A6R242	0757-0280	3		RESISTOR 1K 1% .125W F TC = 0 + -100	24546	CT4-1/8-T0-1001-F
A6R243	0757-0442	9		RESISTOR 10K 1% .125W F TC = 0 + -100	24546	CT4-1/8-T0-1002-F
A6R244	0757-0442	9		RESISTOR 10K 1% .125W F TC = 0 + -100	24546	CT4-1/8-T0-1002-F
A6R245	0757-0442	9		RESISTOR 10K 1% .125W F TC = 0 + -100	24546	CT4-1/8-T0-1002-F
A6R246	0757-0438	3		RESISTOR 5.11K 1% .125W F TC = 0 + -100	24546	CT4-1/8-T0-5111-F
A6R247	0698-0082	7		RESISTOR 464 1% .125W F TC = 0 + -100	24546	CT4-1/8-T0-4640-F
A6R248	2100-2031	7		RESISTOR-TRMR 50K 10% C TOP-ADJ 1-TRN	73138	82PRS0K
A6R249	0757-0442	9		RESISTOR 10K 1% .125W F TC = 0 + -100	24546	CT4-1/8-T0-1002-F
A6R250	0698-3432	7		RESISTOR 26.1 1% .125W F TC = 0 + -100	03888	PME55-1/8-T0-26R1-F
A6R251	0757-0438	3		RESISTOR 5.11K 1% .125W F TC = 0 + -100	24546	CT4-1/8-T0-5111-F
A6R252	0757-0442	9		RESISTOR 10K 1% .125W F TC = 0 + -100	24546	CT4-1/8-T0-1002-F

†Refer to Section 7 for update information.

*Factory Selected Component (Refer to Section 5).

Δ Errata part change.

Reference Designation	HP Part Number	C D	Qty.	Description	Mfr. Code	Mfr. Part Number
A6R253	0757-0401	0		RESISTOR 100 1% .125W F TC = 0 + -100	24546	CT4-1/8-T0-101-F
A6R254	0757-0438	3		RESISTOR 5.11K 1% .125W F TC = 0 + -100	24546	CT4-1/8-T0-5111-F
A6R255	0757-0438	3		RESISTOR 5.11K 1% .125W F TC = 0 + -100	24546	CT4-1/8-T0-5111-F
A6R256	0699-1421	2		RESISTOR 178 1% .125W F TC = 0 + -100	28480	0699-1421
A6R257	0757-0280	3		RESISTOR 1K 1% .125W F TC = 0 + -100	24546	CT4-1/8-T0-1001-F
A6R258	0757-0442	9		RESISTOR 10K 1% .125W F TC = 0 + -100	24546	CT4-1/8-T0-1002-F
A6R259	0698-7219	6	1	RESISTOR 196 1% .05W F TC = 0 + -100	24546	CT4-1/8-T0-196R-F
A6R260	0757-0458	7		RESISTOR 51.1K 1% .125W F TC = 0 + -100	24546	CT4-1/8-T0-5112-F
A6R261	0757-0458	7		RESISTOR 51.1K 1% .125W F TC = 0 + -100	24546	CT4-1/8-T0-5112-F
A6R262	0698-3157	3		RESISTOR 19.6K 1% .125W F TC = 0 + -100	24546	CT4-1/8-T0-1962-F
A6R263	0698-7205	0		RESISTOR 51.1 1% .05W F TC = 0 + -100	24546	CT3-1/8-T0-51R1-F
A6R264				NOT ASSIGNED		
A6R265	0699-1430				28480	0699-1430
A6R266	0699-1344				28480	0699-1344
A6R267	0699-1344				28480	0699-1344
A6R268	0698-3618	1	3	RESISTOR 82 5% 2W MO TC = 0 + -200	27167	FP42-2-T00-82R0-J
A6R269	0699-1421	2	3	RESISTOR 178 1% .125W F TC = 0 + -100	28480	0699-1421
A6R270	0698-7243	6	3	RESISTOR 1.96K 1% .05W F TC = 0 + -100	24546	CT3-1/8-T0-1961-F
A6R271	0699-1360	8		RESISTOR 46.4 1% .125W F TC = 0 + -100	28480	0699-1360
A6R272	0699-1360	8		RESISTOR 46.4 1% .125W F TC = 0 + -100	28480	0699-1360
A6R273	0699-1360	8		RESISTOR 46.4 1% .125W F TC = 0 + -100	28480	0699-1360
A6R274	0699-1360	8		RESISTOR 46.4 1% .125W F TC = 0 + -100	28480	0699-1360
A6R301	0699-1968	3	2	RESISTOR 68.1 1% .05W F TC = 0 + -100	24546	CT3-1/8-T0-68R1-F
A6R302	0698-7217	4	1	RESISTOR 162 1% .05W F TC = 0 + -100	24546	CT3-1/8-T0-162R-F
A6R303	0699-1968	3		RESISTOR 68.1 1% .05W F TC = 0 + -100	24546	CT3-1/8-T0-68R1-F
A6R304	0698-7207	2		RESISTOR 61.9 1% .05W F TC = 0 + -100	24546	CT3-1/8-T0-61R9-F
A6R305	0699-2079	8	2	RESISTOR 82.5 1% .05W F TC = 0 + -100	28480	0699-2079
A6R306 ^Δ	0698-7260	7	2	RESISTOR 10K 1% .05W F TC = 0 + -100	24546	CT3-1/8-T0-1002-F
A6R307	0698-7205	0		RESISTOR 51.1 1% .05W F TC = 0 + -100	24546	CT3-1/8-T0-51R1-F
A6R308	0698-7236	7		RESISTOR 1K 1% .05W F TC = 0 + -100	24546	CT3-1/8-T0-1001-F
A6R309	0698-7244	7	1	RESISTOR 2.15K 1% .05W F TC = 0 + -100	24546	CT3-1/8-T0-2151-F
A6R310	0698-7253	8		RESISTOR 5.11K 1% .05W F TC = 0 + -100	24546	CT3-1/8-T0-5111-F
A6R311	0698-3439	4	4	RESISTOR 178 1% .125W F TC = 0 + -100	24546	CT4-1/8-T0-178R-F
A6R312	0698-3439	4		RESISTOR 178 1% .125W F TC = 0 + -100	24546	CT4-1/8-T0-178R-F
A6R313	0699-1356	2	2	RESISTOR 31.6 1% .125W F TC = 0 + -100	28480	0699-1356
A6R314	0699-1356	2	2	RESISTOR 31.6 1% .125W F TC = 0 + -100	28480	0699-1356
A6R315	0699-1356	2	2	RESISTOR 31.6 1% .125W F TC = 0 + -100	28480	0699-1356
A6R316	0757-0465	7	3	RESISTOR 10K 1% .05W F TC = 0 + -100	02995	5063J
A6R317	0698-7199	1	1	RESISTOR 28.7 1% .05W F TC = 0 + -100	24546	CT3-1/8-T0-28R7-F
A6R318	0698-7205	0		RESISTOR 51.1 1% .05W F TC = 0 + -100	24546	CT3-1/8-T0-51R1-F
A6R319	0698-7220	9	1	RESISTOR 215 1% .05W F TC = 0 + -100	24546	CT3-1/8-T0-215R-F
A6R320	0699-2079	8	2	RESISTOR 82.5 1% .05W F TC = 0 + -100	28480	0699-2079
A6R321	0698-7260	7	3	RESISTOR 10K 1% .05W F TC = 0 + -100	02995	5063J
A6R322	0698-3437	2		RESISTOR 133 1% .125W F TC = 0 + -100	24546	CT4-1/8-T0-133R-F
A6R323	0757-0280	3		RESISTOR 1K 1% .125W F TC = 0 + -100	24546	CT4-1/8-T0-1001-F
A6R324	0757-0280	3		RESISTOR 1K 1% .125W F TC = 0 + -100	24546	CT4-1/8-T0-1001-F
A6R325	0698-7203	8	4	RESISTOR 422 1% .05W F TC = 0 + -100	24546	CT3-1/8-T0-422R-F
A6R326	0698-7203	8	4	RESISTOR 422 1% .05W F TC = 0 + -100	24546	CT3-1/8-T0-422R-F
A6R327	0757-0394	0		RESISTOR 51.1 1% .125W F TC = 0 + -100	24546	CT4-1/8-T0-51R1-F
A6R328	0698-7236	7		RESISTOR 1K 1% .05W F TC = 0 + -100	24546	CT3-1/8-T0-1001-F
A6R329	0698-7229	8	1	RESISTOR 511 1% .05W F TC = 0 + -100	24546	CT3-1/8-T0-511R-F
A6R330	0698-7236	7		RESISTOR 1K 1% .05W F TC = 0 + -100	24546	CT3-1/8-T0-1001-F
A6R331	0698-7203	8	4	RESISTOR 422 1% .05W F TC = 0 + -100	24546	CT3-1/8-T0-422R-F
A6R332	0698-7203	8	4	RESISTOR 422 1% .05W F TC = 0 + -100	24546	CT3-1/8-T0-422R-F
A6R333	0757-0394	0		RESISTOR 51.1 1% .125W F TC = 0 + -100	24546	CT4-1/8-T0-51R1-F
A6R334				NOT ASSIGNED		

†Refer to Section 7 for update information.

*Factory Selected Component (Refer to Section 5).

Δ Errata part change.

Reference Designation	HP Part Number	C D	Qty.	Description	Mfr. Code	Mfr. Part Number
A6R335				NOT ASSIGNED		
A6R336	0698-3437	2		RESISTOR 133 1% .125W F TC = 0 + -100	24546	CT4-1/8-T0-133R-F
A6R337				NOT ASSIGNED		
A6R338				NOT ASSIGNED		
A6R339	0757-0399	5	2	RESISTOR 82.5 1% .125W F TC = 0 + -100	24546	CT4-1/8-T0-82R5-F
A6R340	0757-0401	5	2	RESISTOR 82.5 1% .125W F TC = 0 + -100	24546	CT4-1/8-T0-82R5-F
A6R341	0698-7209	3		RESISTOR 147 1% .05W F TC = 0 + -100	24546	CT3-1/8-T0-147R-F
A6R342	0698-0403	7		RESISTOR 38.3 1% .05W F TC = 0 + -100	24546	CT3-1/8-T0-38R3-F
A6R343	0698-7209	3		RESISTOR 147 1% .05W F TC = 0 + -100	24546	CT3-1/8-T0-147R-F
A6R344				NOT ASSIGNED		
A6R345				NOT ASSIGNED		
A6R346	0698-3456	5	2	RESISTOR 287K 1% .125W F TC = 0 + -100	24546	CT4-1/8-T0-2873-F
A6R347	0698-3456	5		RESISTOR 287K 1% .125W F TC = 0 + -100	24546	CT4-1/8-T0-2873-F
A6R348				NOT ASSIGNED		
A6R349	0698-7205	0		RESISTOR 51.1 1% .05W F TC = 0 + -100	24546	CT3-1/8-T0-51R1-F
A6R350				NOT ASSIGNED		
A6R351	0698-7205	0		RESISTOR 51.1 1% .05W F TC = 0 + -100	24546	CT3-1/8-T0-51R1-F
A6R352	0757-0401	0		RESISTOR 100 1% .125W F TC = 0 + -100	24546	CT4-1/8-T0-101-F
A6R353	0698-7203	8	4	RESISTOR 42.2 1% .05W F TC = 0 + -100	24546	CT3-1/8-T0-42R2-F
A6R354	0698-7203	8	4	RESISTOR 42.2 1% .05W F TC = 0 + -100	24546	CT3-1/8-T0-42R2-F
A6R355	2100-2031	7		RESISTOR-TRMR 50K 10% C TOP-ADJ1-TRN	73138	82PR50K
A6R356	0698-7284	5		RESISTOR 100K 1% .05W F TC = 0 + -100	24546	CT3-1/8-T0-1003-F
A6R357	0698-7284	5		RESISTOR 100K 1% .05W F TC = 0 + -100	24546	CT3-1/8-T0-1003-F
A6R358	0699-1364	2	1	RESISTOR 68.1 1% .125W F TC = 0 + -100	28480	0699-1364
A6R359	0698-1364	2	1	RESISTOR 68.1 1% .125W F TC = 0 + -100	28480	0698-1364
A6R360	0699-1364	2	1	RESISTOR 68.1 1% .125W F TC = 0 + -100	28480	0699-1364
A6R361	0699-1364	2	1	RESISTOR 68.1 1% .125W F TC = 0 + -100	28480	0699-1364
A6R362	0698-7223	6		RESISTOR 422 1% .05W F TC = 0 + -100	24546	CT3-1/8-T0-422R-F
A6R363-R369				NOT ASSIGNED		
A6R370	0757-0401			NOT ASSIGNED		
A6R371-R400				NOT ASSIGNED		
A6R401	0757-0438	3		RESISTOR 5.11K 1% .125W F TC = 0 + -100	24546	CT4-1/8-T0-5111-F
A6R402	0757-0447	4	1	RESISTOR 16.2K 1% .125W F TC = 0 + -100	24546	CT4-1/8-T0-1622-F
A6R403-R409						
A6R410	1810-0206	8	1	NETWORK-RES 8-SIP 10.0KOHM X7	01121	208A103
A6R411				NOT ASSIGNED		
A6R412	0757-0280	3		RESISTOR 1K 1% .125W F TC = 0 + -100	24546	CT4-1/8-T0-1001-F
A6R413				NOT ASSIGNED		
A6R414	0757-0442	9		RESISTOR 10K 1% .125W F TC = 0 + -100	24546	CT4-1/8-T0-1002-F
A6R415	0698-0083	8		RESISTOR 1.96K 1% .125W F TC = 0 + -100	24546	CT4-1/8-T0-1961-F
A6R416	0698-3155	1		RESISTOR 4.64K 1% .125W F TC = 0 + -100	02995	SFR25H
A6R417	0698-0083	8		RESISTOR 1.96K 1% .125W F TC = 0 + -100	24546	CT4-1/8-T0-1961-F
A6R418	0698-7228	7		RESISTOR 464 1% .05W F TC = 0 + -100	05524	CMF-50-2
A6R419	0698-7239	0		RESISTOR 1.33K 1% .05W F TC = 0 + -100	02995	5063J
A6R420	0757-0442	9		RESISTOR 10K 1% .125W F TC = 0 + -100	24546	CT4-1/8-T0-1002-F
A6R421	0698-6362			RESISTOR 1K.1% .12W	28480	0698-6362
A6R422	0757-0464			RF 90.9K1% .125W		

†Refer to Section 7 for update information.

*Factory Selected Component (Refer to Section 5).

Δ Errata part change.

Reference Designation	HP Part Number	C D	Qty.	Description	Mfr. Code	Mfr. Part Number
A6R423	0757-0442	8		RESISTOR 10K 1% .125W F TC = 0 + -100	24546	CT4-1/8-T0-1002-F
A6TP1-TP100				NOT ASSIGNED		
A6TP101	1251-1556	7		CONNECTOR-SGL CONT SKT .018-IN-BSC-SZ	28480	1251-1556
A6TP102-TP200				NOT ASSIGNED		
A6TP201	1251-1556	7		CONNECTOR-SGL CONT SKT .018-IN-BSC-SZ	28480	1251-1556
A6TP202	1251-1556	7		CONNECTOR-SGL CONT SKT .018-IN-BSC-SZ	28480	1251-1556
A6TP203	1251-1556	7		CONNECTOR-SGL CONT SKT .018-IN-BSC-SZ	28480	1251-1556
A6TP204	1251-1556	7		CONNECTOR-SGL CONT SKT .018-IN-BSC-SZ	28480	1251-1556
A6TP205	1251-1556	7		CONNECTOR-SGL CONT SKT .018-IN-BSC-SZ	28480	1251-1556
A6TP206	1251-0600	0		CONNECTOR-SGL CONT PIN 1.14-MM-BSC-SZ SQ	28480	1251-0600
A6TP207-TP300				NOT ASSIGNED		
A6TP301	1251-1556	7		CONNECTOR-SGL CONT SKT .018-IN-BSC-SZ	28480	1251-1556
A6TP302	1251-1556	7		CONNECTOR-SGL CONT SKT .018-IN-BSC-SZ	28480	1251-1556
A6TP303	1251-1556	7		CONNECTOR-SGL CONT SKT .018-IN-BSC-SZ	28480	1251-1556
A6TP304-TP400				NOT ASSIGNED		
A6TP401	1251-0600	0		CONNECTOR-SGL CONT PIN 1.14-MM-BSC-SZ SQ	28480	1251-0600
A6U1-U100				NOT ASSIGNED		
A6U101	1820-7278	3	1	IC PRESCR ECL	52648	SP8606B
A6U102	1820-3485	2	1	IC PRESCR ECL	04713	MC12090L
A6U103	1826-0557	5	4	IC OP AMP GP QUAD 14-DIP-C PKG	27014	LM348J
A6U104-U200				NOT ASSIGNED		
A6U201	1826-2168	5		IC RF/IF AMPL IF 4-CUSTOM PKG	24539	MSA-0385
A6U202	1826-2168	6	1	IC RF/IF AMPL IF 4-CUSTOM PKG	24539	MSA-0485
A6U203-U206				NOT ASSIGNED		
A6U207	1826-0753	3	2	IC OP AMP LOW-BIAS-H-IMPQ QUAD 14-DIP-C	04713	MC34004BL
A6U208-U300				NOT ASSIGNED		
A6U301	0955-0145	8	1	U-WAVE MIXER 1 GHZ MAX	28480	0955-0145
A6U302	1826-0371	1		IC OP AMP LOW-BIAS-H-IMPQ TO-99 PKG	27014	LF256H
A6U303	1826-2175	5		IC RF/IF AMPL IF 4-CUSTOM PKG	24539	MSA-0385
A6U304	1826-2168	8		IC RF/IF AMPL IF 4-CUSTOM PKG	24539	MSA-0385
A6U305-U400				NOT ASSIGNED		
A6U401	1826-0180	0	1	IC TIMER TTL MONO/ASTBL	18324	NE555N
A6U402-U409				NOT ASSIGNED		
A6U410	1820-5490	8	1	IC DRVR 5810AP10	28480	1820-5490
A6U411	1820-1422	3		IC MV TTL LS MONOSTBL RETRIG	01295	SN74LS122N
A6W1-W201				NOT ASSIGNED		
A6W202	1251-4670	2		CONNECTOR 3-PIN M POST TYPE	28480	1251-4670
	1258-0209	8		JUMPER-REMOVABLE 2 POSITION; .200 IN	28480	1258-0209

†Refer to Section 7 for update information.

*Factory Selected Component (Refer to Section 5).

Δ Errata part change.

Reference Designation	HP Part Number	C D	Qty.	Description	Mfr. Code	Mfr. Part Number
A7						
A7	08657-60111	5	1	200MHZ LOW-PASS FILTER ASSEMBLY	28480	08657-60111
A7C1	0160-4498	8		CAPACITOR-FXD 5.6PF +-.5PF 200VDC CER	28480	0160-4498
A7C2	0160-4498	8		CAPACITOR-FXD 5.6PF +-.5PF 200VDC CER	28480	0160-4498
A7C3	0160-4498	8		CAPACITOR-FXD 5.6PF +-.5PF 200VDC CER	28480	0160-4498
A7C4	0160-4498	8		CAPACITOR-FXD 5.6PF +-.5PF 200VDC CER	28480	0160-4498
A7C5	0160-4498	8		CAPACITOR-FXD 5.6PF +-.5PF 200VDC CER	28480	0160-4498
A7C6	0160-4498	8		CAPACITOR-FXD 5.6PF +-.5PF 200VDC CER	28480	0160-4498
A7C7	0160-4491	1		CAPACITOR-FXD 8.2PF +-.5PF 200VDC CER	28480	0160-4491
A7C8	0160-4491	1		CAPACITOR-FXD 8.2PF +-.5PF 200VDC CER	28480	0160-4491
A7C9	0160-4491	1		CAPACITOR-FXD 8.2PF +-.5PF 200VDC CER	28480	0160-4491
A7C10	0160-4491	1		CAPACITOR-FXD 8.2PF +-.5PF 200VDC CER	28480	0160-4491
A7C11	0160-4491	1		CAPACITOR-FXD 8.2PF +-.5PF 200VDC CER	28480	0160-4491
A7C12	0160-4491	1		CAPACITOR-FXD 8.2PF +-.5PF 200VDC CER	28480	0160-4491
A7C13	0160-4498	8		CAPACITOR-FXD 5.6PF +-.5PF 200VDC CER	28480	0160-4498
A7C14	0160-4498	8		CAPACITOR-FXD 5.6PF +-.5PF 200VDC CER	28480	0160-4498
A7C15	0160-4498	8		CAPACITOR-FXD 5.6PF +-.5PF 200VDC CER	28480	0160-4498
A7C16	0160-4498	8		CAPACITOR-FXD 5.6PF +-.5PF 200VDC CER	28480	0160-4498
A7C17	0160-4498	8		CAPACITOR-FXD 5.6PF +-.5PF 200VDC CER	28480	0160-4498
A7C18	0160-4498	8		CAPACITOR-FXD 5.6PF +-.5PF 200VDC CER	28480	0160-4498
A7MP1	08656-00133	4		CLIP SEMI-R GRND	28480	08656-00133
A7MP2	08656-00133	4		CLIP SEMI-R GRND	28480	08656-00133
A7MP3	0380-1680	0	12	SPACER-PRESS-IN 0.188 IN LG; 0.143 IN ID	00000	ORDER BY DESCRIPTION
A7MP4	0380-1680	0		SPACER-PRESS-IN 0.188 IN LG; 0.143 IN ID	00000	ORDER BY DESCRIPTION
A7MP5	0380-1680	0		SPACER-PRESS-IN 0.188 IN LG; 0.143 IN ID	00000	ORDER BY DESCRIPTION

†Refer to Section 7 for update information.

*Factory Selected Component (Refer to Section 5).

Δ Errata part change.

Reference Designation	HP Part Number	C D	Qty.	Description	Mfr. Code	Mfr. Part Number
A8						
EXCEPT OPTION 022						
A8	08657-60163	7	1	FREQUENCY MULTIPLIER ASSEMBLY	28480	08657-60163
A8C1	0180-2207	5		CAPACITOR-FXD 100UF + -10% 10VDC TA	56289	150D107X9010R2
A8C2	0180-4040	6		CAPACITOR-FXD 1000PF + -5% 100VDC CER	28480	0180-4040
A8C3	0180-4040	6		CAPACITOR-FXD 1000PF + -5% 100VDC CER	28480	0180-4040
A8C4	0180-4040	6		CAPACITOR-FXD 1000PF + -5% 100VDC CER	28480	0180-4040
A8C5*	0180-4527	4	4	CAPACITOR-FXD 56PF + -5% 200VDC CER 0 + -30	28480	0180-4527
A8C6	0180-4040	6		CAPACITOR-FXD 1000PF + -5% 100VDC CER	28480	0180-4040
A8C7	0180-4793	6	1	CAP-FXD 6.8PF 100 V	09969	RPA10C0G6R8D100
A8C8	0180-4527	4		CAPACITOR-FXD 56PF + -5% 200VDC CER 0 + -30	28480	0180-4527
A8C9	0180-4527	4		CAPACITOR-FXD 56PF + -5% 200VDC CER 0 + -30	28480	0180-4527
A8C10	0180-4040	6		CAPACITOR-FXD 1000PF + -5% 100VDC CER	28480	0180-4040
A8C11	0180-4040	6		CAPACITOR-FXD 1000PF + -5% 100VDC CER	28480	0180-4040
A8C12	0180-4040	6		CAPACITOR-FXD 1000PF + -5% 100VDC CER	28480	0180-4040
A8C13	0180-4618	4	1	CAP-FXD 3.9PF 200 V	09969	RPE121-105C0G3R9C200V
A8C14	0180-4040	6		CAPACITOR-FXD 1000PF + -5% 100VDC CER	28480	0180-4040
A8C15	0180-4040	6		CAPACITOR-FXD 1000PF + -5% 100VDC CER	28480	0180-4040
A8C16	0180-4040	6		CAPACITOR-FXD 1000PF + -5% 100VDC CER	28480	0180-4040
A8C17	0160-3879	7	1	CAP-FXD 0.01UF 100 V	09969	RPE121-105X7R103M100V
A8C18	0180-2243	7	1	CAPACITOR-FXD 2.7PF + -.25PF 500VDC CER	28480	0180-2243
A8C19	0160-4524	1		CAP-FXD 24PF 200 V	09969	RPE121-105C0G240J200V
A8C20	0160-3878	6		CAPACITOR-FXD 1000PF + -20% 100VDC CER	28480	0160-3878
A8C21	0160-3878	6		CAPACITOR-FXD 1000PF + -20% 100VDC CER	28480	0160-3878
A8C22	0180-4040	6		CAPACITOR-FXD 1000PF + -5% 100VDC CER	28480	0180-4040
A8C23	0160-6705	4		CAPACITOR-FXD 27PF + -5% 200VDC CER 0 + -30	28480	0160-6705
A8C24	0160-4040	6		CAPACITOR-FXD 1000PF + -5% 100VDC CER	28480	0160-4040
A8C25	0160-4040	6		CAPACITOR-FXD 1000PF + -5% 100VDC CER	28480	0160-4040
A8C26	0160-4040	6		CAPACITOR-FXD 1000PF + -5% 100VDC CER	28480	0160-4040
A8C27	0160-4040	6		CAPACITOR-FXD 1000PF + -5% 100VDC CER	28480	0160-4040
A8C28	0160-3873	1		CAPACITOR-FXD 4.7PF + -.5PF 200VDC CER	28480	0160-3873
A8C29	0160-3873	1		CAPACITOR-FXD 4.7PF + -.5PF 200VDC CER	28480	0160-3873
A8C30	0160-5254	6	1	CAP-FXD 1.5PF 100 V	09969	RPA10COG1R5C100
A8C31	0121-0448	8		CAPACITOR-V TRMR-CER 2.5-5PF 63V PC-MTG	28480	0121-0448
A8C32	0160-3029	9		CAPACITOR-FXD 7.5PF + -.5PF 100VDC CER	28480	0160-3029
A8C33	0160-4518	3		CAPACITOR-FXD 3.9PF + -.5PF 200VDC CER	28480	0160-4518
A8C34	0160-4527	4		CAPACITOR-FXD 56PF + -5% 200VDC CER 0 + -30	28480	0160-4527
A8C35	0160-4382	9		CAPACITOR-FXD 3.3PF + -.25PF 200VDC CER	28480	0160-4382
A8C36	0160-4498	6	4	CAP-FXD 5.6PF 200 V	09969	RPE121-105C0G5R6D200V
A8C37	0160-4498	6		CAP-FXD 5.6PF 200 V	09969	RPE121-105C0G5R6D200V
A8C38	0160-3878	6		CAPACITOR-FXD 1000PF + -20% 100VDC CER	28480	0160-3878
A8C39	0160-3878	6		CAPACITOR-FXD 1000PF + -20% 100VDC CER	28480	0160-3878
A8C40*	0160-3878	6	27	CAPACITOR-FXD 1000PF + -20% 100VDC CER	28480	0160-3878
A8C41	0160-4383	0		CAPACITOR-FXD 6.8PF + -.5PF 200VDC CER	20932	5024E0200RD689D
A8C42	0160-4040	6		CAPACITOR-FXD 1000PF + -5% 100VDC CER	28480	0160-4040
A8C43	0160-3878	6		CAPACITOR-FXD 1000PF + -20% 100VDC CER	28480	0160-3878
A8C44	0160-3878	6		CAPACITOR-FXD 1000PF + -20% 100VDC CER	28480	0160-3878
A8C45	0160-4040	6		CAPACITOR-FXD 1000PF + -5% 100VDC CER	28480	0160-4040

*Refer to Section 7 for update information.

*Factory Selected Component (Refer to Section 5).

Δ Errata part change.

Reference Designation	HP Part Number	C D	Qty.	Description	Mfr. Code	Mfr. Part Number
A8 EXCEPT OPTION 022						
A8C46	0160-2234	6	1	CAPACITOR-FXD .51PF + .25PF 500VDC CER	28480	0160-2234
A8C47	0160-4521	8	1	CAP-FXD 12PF 200 V	09969	RPE121-105C0G120J200V
A8C48	0160-4040	6		CAPACITOR-FXD 1000PF + .5% 100VDC CER PART IS ETCHED TRACE ON CIRCUIT BOARD	28480	0160-4040
A8C49						
A8C50	0160-4518	3		CAPACITOR-FXD 3.9PF + .5PF 200VDC CER	28480	0160-4518
A8C51				PART IS ETCHED TRACE ON CIRCUIT BOARD		
A8C52	0160-4040	6		CAPACITOR-FXD 1000PF + .5% 100VDC CER	28480	0160-4040
A8C53				PART IS ETCHED TRACE ON CIRCUIT BOARD		
A8C54	0160-3878	6		CAPACITOR-FXD 1000PF + .20% 100VDC CER	28480	0160-3878
A8C55	0160-3875	8		CAPACITOR 22P 200 V	28480	0160-40440
A8C56	0160-4382	9		CAPACITOR-FXD 3.3PF + .25PF 200VDC CER	28480	0160-4382
A8C57	0160-4490	0	1	CAPACITOR-FXD 1.8PF + .25PF 200VDC CER	28480	0160-4490
A8C58	0160-3878	6		CAPACITOR-FXD 1000PF + .20% 100VDC CER	28480	0160-3878
A8C60	0121-0448	8		CAP-VAR 5PF 2.5PF 63 V	09535	528-001 A 2.5-5
A8C61	0121-0443	3	1	CAP-VAR 9PF 3PF 160 V	52763	300-427-204
A8C62	0160-4517	2	1	CAP-FXD 1.2F 200 V	28480	0160-4517
A8C63	0160-4522	9	1	CAP-FXD 13PF 200 V	09969	RPE121-105C0G130J200V
A8J1	1200-0507	9		SOCKET-IC 16-CONT DIP-SLDR	28480	1200-0507
A8J2	1200-0507	9		SOCKET-IC 16-CONT DIP-SLDR	28480	1200-0507
A8J3	1250-1626	0	2	CONNECTOR-RF SMC M PC 50-OHM	28480	1250-1626
	2190-0124	4	7	WASHER-LK INTL T NO. 10 .195-IN-ID	28480	2190-0124
	2950-0078	9	7	NUT-HEX-DBL-CHAM 10-32-THD .067-IN-THK	28480	2950-0078
A8J4	1250-1626	0		CONNECTOR-RF SMC M PC 50-OHM	28480	1250-1626
	2190-0124	4		WASHER-LK INTL T NO. 10 .195-IN-ID	28480	2190-0124
	2950-0078	9		NUT-HEX-DBL-CHAM 10-32-THD .067-IN-THK	28480	2950-0078
A8L1	9100-3560	6	1	INDUCTOR RF-CH-MLD 5.6UH + .5%	91637	IM-4 5.6UH 5%
A8L2	9140-0141	7		INDUCTOR RF-CH-MLD 680NH 10% .105DX.26LG	28480	9140-0141
A8L3				PART IS ETCHED TRACE ON CIRCUIT BOARD		
A8L4				PART IS ETCHED TRACE ON CIRCUIT BOARD		
A8L5				PART IS ETCHED TRACE ON CIRCUIT BOARD		
A8L6				PART IS ETCHED TRACE ON CIRCUIT BOARD		
A8L7	9100-3922	4		INDUCTOR-FIXED 120-1300 HZ	28480	9100-3922
A8L8				PART IS ETCHED TRACE ON CIRCUIT BOARD		
A8L9				PART IS ETCHED TRACE ON CIRCUIT BOARD		
A8L10				PART IS ETCHED TRACE ON CIRCUIT BOARD		
A8L11	9100-2251	0	3	INDUCTOR RF-CH-MLD 220NH 10% .105DX.26LG	28480	9100-2251
A8L12				PART IS ETCHED TRACE ON CIRCUIT BOARD		
A8L13				PART IS ETCHED TRACE ON CIRCUIT BOARD		
A8L14				PART IS ETCHED TRACE ON CIRCUIT BOARD		
A8L15				PART IS ETCHED TRACE ON CIRCUIT BOARD		
A8L16	9100-3922	4		INDUCTOR-FIXED 120-1300 HZ	28480	9100-3922
A8L17				PART IS ETCHED TRACE ON CIRCUIT BOARD		
A8L18				PART IS ETCHED TRACE ON CIRCUIT BOARD		
A8L19				PART IS ETCHED TRACE ON CIRCUIT BOARD		
A8L20				PART IS ETCHED TRACE ON CIRCUIT BOARD		
A8L21				PART IS ETCHED TRACE ON CIRCUIT BOARD		
A8L22				PART IS ETCHED TRACE ON CIRCUIT BOARD		
A8L23				PART IS ETCHED TRACE ON CIRCUIT BOARD		
A8L24	9100-2251	0		INDUCTOR RF-CH-MLD 220NH 10% .105DX.26LG	28480	9100-2251
A8L25				PART IS ETCHED TRACE ON CIRCUIT BOARD		
A8L26				PART IS ETCHED TRACE ON CIRCUIT BOARD		
A8L27	9100-3922	4		INDUCTOR-FIXED 120-1300 HZ	28480	9100-3922
A8L28				PART IS ETCHED TRACE ON CIRCUIT BOARD		
A8L29	9100-2251	0		INDUCTOR RF-CH-MLD 220NH + .10%	91637	IM-2 .22UH 10%
A8L30				PART IS ETCHED TRACE ON CIRCUIT BOARD		

† Refer to Section 7 for update information.

* Factory Selected Component (Refer to Section 5).

Δ Errata part change.

Reference Designation	HP Part Number	C D	Qty.	Description	Mfr. Code	Mfr. Part Number
A8						
EXCEPT OPTION 022						
A8L31				PART IS ETCHED TRACE ON CIRCUIT BOARD		
A8L32				PART IS ETCHED TRACE ON CIRCUIT BOARD		
A8L33	9135-0081	1	2	INDUCTOR RF-CH-MLD 62NH + .5.806%	24226	10M062X-1
A8L34				PART IS ETCHED TRACE ON CIRCUIT BOARD		
A8L35				PART IS ETCHED TRACE ON CIRCUIT BOARD		
A8L36				PART IS ETCHED TRACE ON CIRCUIT BOARD		
A8L37				PART IS ETCHED TRACE ON CIRCUIT BOARD		
A8L38				PART IS ETCHED TRACE ON CIRCUIT BOARD		
A8L39	9135-0071	1		INDUCTOR RF-CH-MLD 62NH + .5.806%	24226	10M062X-1
A8L40	9100-2251	0		INDUCTOR RF-CH-MLD 220NH 10% .105DX.26LG	28480	9100-2251
A8L41	9135-0071	1		INDUCTOR RF-CH-MLD 62NH + .5.806%	24226	10M062X-1
A8L42				PART IS ETCHED TRACE ON CIRCUIT BOARD		
A8L43				PART IS ETCHED TRACE ON CIRCUIT BOARD		
A8L44	9135-0069			IDCTR 3 ONH 5%	28480	9135-0069
A8L45	9100-2247			COIL-MLD .1UH	28480	9100-2247
A8L46	9100-2251	0		INDUCTOR RF-CH-MLD 220NH 10% .105DX.26LG	28480	9100-2251
A8L47-A8L56				NOT ASSIGNED		
A8L57	9100-3922	4		INDUCTOR-FIXED 120-1300 HZ	28480	9100-3922
A8MP1	08656-00099	1	1	MULTI GROUND TAB	28480	08656-00099
A8MP2	08656-00133	4		CLIP SEMI-R GRND	28480	08656-00133
A8MP3	1251-2194	1	1	CONNECTOR-SGL CONT SKT .021-IN-BSC-SZ	28480	1251-2194
A8Q1	1854-1050	4		TRANSISTOR NPN SI PD = 180MW FT = 5GHZ	25403	BFR91A
A8Q2	1854-1050	4		TRANSISTOR NPN SI PD = 180MW FT = 5GHZ	25403	BFR91A
A8Q3	1854-0632	6		TRANSISTOR NPN SI PD = 180MW FT = 4GHZ	25403	BFR-91
A8Q4	1853-0020	4		TRANSISTOR PNP SI PD = 300MW FT = 150MHZ	28480	1853-0020
A8Q5	1854-0632	6		TRANSISTOR NPN SI PD = 180MW FT = 4GHZ	25403	BFR-91
A8Q6	1854-0696	2		TRANSISTOR NPN SI TO-72 PD = 200MW	28480	1854-0696
A8Q7	1854-0247	9		TRANSISTOR NPN SI TO-39 PD = 1W FT = 800MHZ	28480	1854-0247
	1200-0173	5		INSULATOR-XSTR DAP-GL	28480	1200-0173
A8Q8	1854-0247	9		TRANSISTOR NPN SI TO-39 PD = 1W FT = 800MHZ	28480	1854-0247
	1200-0173	5		INSULATOR-XSTR DAP-GL	28480	1200-0173
A8R1	0757-0294	9		RESISTOR 17.8 1% .125W F TC = 0 + .100	19701	MF4C1/8-T0-17R8-F
A8R2	0698-3439	4		RESISTOR 178 1% .125W F TC = 0 + .100	28480	0698-3439
A8R3	0698-0398	4		RESISTOR 178 1% .125W F TC = 0 + .100	24546	C4-1/8-T0-178R-F
A8R4	0698-3443	0		RESISTOR 287 1% .125W F TC = 0 + .100	24546	C4-1/8-T0-287R-F
A8R5	0757-0424	7		RESISTOR 1.1K 1% .125W F TC = 0 + .100	24546	C4-1/8-T0-1101-F
A8R6	0698-3153	9		RESISTOR 3.83K 1% .125W F TC = 0 + .100	24546	C4-1/8-T0-3831-F
A8R7	0757-0398	4		RESISTOR 75 1% .125W F TC = 0 + .100	24546	C4-1/8-T0-75R0-F
A8R8	0757-0140	2		RESISTOR 10 1% .125W F TC = 0 + .100	24546	C4-1/8-T0-10R0-F
A8R9	0757-0424	7		RESISTOR 1.1K 1% .125W F TC = 0 + .100	24546	C4-1/8-T0-1101-F
A8R10	0698-3153	9		RESISTOR 3.83K 1% .125W F TC = 0 + .100	24546	C4-1/8-T0-3831-F
A8R11	2100-2030	9		RESISTOR 237 1% .125W F TC = 0 + .100	28480	2100-2030
A8R12	0757-0424	7		RESISTOR 1.1K 1% .125W F TC = 0 + .100	24546	C4-1/8-T0-1101-F
A8R13	0757-0398	4		RESISTOR 75 1% .125W F TC = 0 + .100	24546	C4-1/8-T0-75R0-F
A8R14	0757-0278	9		RESISTOR 1.78K 1% .125W F TC = 0 + .100	24546	C4-1/8-T0-1781-F
A8R15	0698-3153	9		RESISTOR 3.83K 1% .125W F TC = 0 + .100	24546	C4-1/8-T0-3831-F
A8R16	0757-0346	2		RESISTOR 10 1% .125W F TC = 0 + .100	24546	C4-1/8-T0-10R0-F
A8R17	0757-0424	7		RESISTOR 1.1K 1% .125W F TC = 0 + .100	24546	C4-1/8-T0-1101-F
A8R18	0698-4037	0		RESISTOR 46.4 1% .125W F TC = 0 + .100	24546	C4-1/8-T0-46R4-F
A8R19	0757-0346	2		RESISTOR 10 1% .125W F TC = 0 + .100	24546	C4-1/8-T0-10R0-F
A8R20	0757-0424	7		RESISTOR 1.1K 1% .125W F TC = 0 + .100	24546	C4-1/8-T0-1101-F

†Refer to Section 7 for update information.

*Factory Selected Component (Refer to Section 5).

Δ Errata part change.

Reference Designation	HP Part Number	C D	Qty.	Description	Mfr. Code	Mfr. Part Number
A8						
EXCEPT OPTION 022						
A8R21	0698-3153	9		RESISTOR 3.83K 1% .125W F TC = 0 + -100	24546	C4-1/8-T0-3831-F
A8R22	0698-3153	9		RESISTOR 3.83K 1% .125W F TC = 0 + -100	24546	C4-1/8-T0-3831-F
A8R23	0757-0398	4		RESISTOR 75 1% .125W F TC = 0 + -100	24546	C4-1/8-T0-75R0-F
A8R24	0757-0698	0		RESISTOR 100 1% .125W F TC = 0 + -100	28480	0757-0698
A8R25	0698-3439	4		RESISTOR 825 1% .125W F TC = 0 + -100	28480	0698-3439
A8R26	0698-3151	7		RESISTOR 1.1K 1% .125W F TC = 0 + -100	28480	0698-3151
A8R27	0757-0276	0		RESISTOR 100 1% .125W F TC = 0 + -100	28480	0757-0276
A8R28	0757-0424	7		RESISTOR 1.1K 1% .125W F TC = 0 + -100	24546	C4-1/8-T0-1101-F
A8R29	0757-0346	2		RESISTOR 10 1% .125W F TC = 0 + -100	24546	C4-1/8-T0-10R0-F
A8R30	0698-3153	9		RESISTOR 3.83K 1% .125W F TC = 0 + -100	24546	C4-1/8-T0-3831-F
A8R31	0757-0180	0		RESISTOR 100 1% .125W F TC = 0 + -100	28480	0757-0180
A8R32	0757-0398	4		RESISTOR 75 1% .125W F TC = 0 + -100	24546	C4-1/8-T0-75R0-F
A8R33	0698-3444	2		RESISTOR 31.6 1% .125W F TC = 0 + -100	28480	0698-3444
A8R34	0698-4037	0		RESISTOR 46.4 1% .125W F TC = 0 + -100	24546	C4-1/8-T0-46R4-F
A8R35	0757-0421	4		RESISTOR 825 1% .125W F TC = 0 + -100	24546	C4-1/8-T0-825R-F
A8R36	0698-4037	0		RESISTOR 46.4 1% .125W F TC = 0 + -100	24546	C4-1/8-T0-46R4-F
A8R37	0757-0398	4		RESISTOR 75 1% .125W F TC = 0 + -100	24546	C4-1/8-T0-75R0-F
A8R38	0757-0401	0		RESISTOR 100 1% .125W F TC = 0 + -100	24546	C4-1/8-T0-101-F
A8R39	0757-0278	9		RESISTOR 1.78K 1% .125W F TC = 0 + -100	24546	C4-1/8-T0-1781-F
A8R40	8190-0005			0 OHM RESISTOR	28480	8190-0005
A8R41	0699-1361				28480	0699-1361
A8TP1				NOT SEPARATELY REPLACEABLE		
A8TP2				NOT SEPARATELY REPLACEABLE		
A8TP3				NOT SEPARATELY REPLACEABLE		
A8U1	0955-0145	9		MIXER-DBL BALANCED FREQ = 1 TO 1000 MHZ	28480	0955-0145
A8W1	08656-20018	6		CABLE SEMI-RIGID	28480	08656-20018
A8W2	8150-4927			WIRE JMP 24 .100	28480	8150-4927
A8W3	8150-0459			HL5 WIRE AWB/R	28480	8150-0459
A8W4 ^Δ	8151-0013	4		BARE WIRE 22G	28480	8151-0013
A8Z1						

† Refer to Section 7 for update information.

* Factory Selected Component (Refer to Section 5).

Δ Errata part change.

Reference Designation	HP Part Number	C D	Qty.	Description	Mfr. Code	Mfr. Part Number
A8						
OPTION 022 ONLY						
A8	08657-60998	6	1	FREQUENCY MULTIPLIER	28480	08657-60998
A8C1	0180-2207	5	1	CAP-FXD 100UF 10 V TA	56289	150D107X9010R2
A8C2	0160-4040	6	26	CAP-FXD 1000PF 100 V	09969	RPE121-105C0G102J100V
A8C3	0160-4040	6		CAP-FXD 1000PF 100 V	09969	RPE121-105C0G102J100V
A8C4	0160-4040	6		CAP-FXD 1000PF 100 V	09969	RPE121-105C0G102J100V
A8C5	0160-4527	4	4	CAP-FXD 56PF 200 V	09969	RPE121-105C0G560J200V
A8C6	0160-4040	6		CAP-FXD 1000PF 100 V	09969	RPE121-105C0G102J100V
A8C7	0160-4793	6	1	CAP-FXD 6.8PF 100 V	09969	RPA10C0G6R8D100
A8C8	0160-4527	4		CAP-FXD 56PF 200 V	09969	RPE121-105C0G560J200V
A8C9	0160-4527	4		CAP-FXD 56PF 200 V	09969	RPE121-105C0G560J200V
A8C10	0160-4040	6		CAP-FXD 1000PF 100 V	09969	RPE121-105C0G102J100V
A8C11	0160-4040	6		CAP-FXD 1000PF 100 V	09969	RPE121-105C0G102J100V
A8C12	0160-4040	6		CAP-FXD 1000PF 100 V	09969	RPE121-105C0G102J100V
A8C13	0160-4618	4	1	CAP-FXD 3.9PF 200 V	09969	RPE121-105C0G3R9C200V
A8C14	0160-4040	6		CAP-FXD 1000PF 100 V	09969	RPE121-105C0G102J100V
A8C15	0160-4040	6		CAP-FXD 1000PF 100 V	09969	RPE121-105C0G102J100V
A8C16	0160-4524	1	2	CAP-FXD 24PF 200 V	09969	RPE121-105C0G240J200V
A8C17	0160-3879	7	1	CAP-FXD 0.01UF 100 V	09969	RPE121-105X7R103M100V
A8C18	0160-4799	2	1	CAP-FXD 2.2PF 100 V	09969	RPA10C0G2R2C100
A8C19	0160-4524	1		CAP-FXD 24PF 200 V	09969	RPE121-105C0G240J200V
A8C20	0160-4040	6		CAP-FXD 1000PF 100 V	09969	RPE121-105C0G102J100V
A8C21	0160-4040	6		CAP-FXD 1000PF 100 V	09969	RPE121-105C0G102J100V
A8C22	0160-4040	6		CAP-FXD 1000PF 100 V	09969	RPE121-105C0G102J100V
A8C23	0160-4493	3	1	CAP-FXD 27PF 200 V	09969	RPE121105C0G270J200V
A8C24	0160-4040	6		CAP-FXD 1000PF 100 V	09969	RPE121-105C0G102J100V
A8C25	0160-4040	6		CAP-FXD 1000PF 100 V	09969	RPE121-105C0G102J100V
A8C26	0160-4040	6		CAP-FXD 1000PF 100 V	09969	RPE121-105C0G102J100V
A8C27	0160-4040	6		CAP-FXD 1000PF 100 V	09969	RPE121-105C0G102J100V
A8C28	0160-3873	1	2	CAP-FXD 4.7PF 200 V	09969	RPE121-105C0G4R7D200V
A8C29	0160-3873	1		CAP-FXD 4.7PF 200 V	09969	RPE121-105C0G4R7D200V
A8C30	0160-5254	6	1	CAP-FXD 1.5PF 100 V	09969	RPA10COG1R5C100
A8C31	0121-0448	8	2	CAP-VAR 5PF 2.5PF 63 V	09535	528-001 A 2.5-5
A8C32	0160-3029	9	1	CAP-FXD 7.5PF 100 V	28480	0160-3029
A8C33	0160-4386	3	5	CAP-FXD 33PF 200 V	04222	SR152A330JAA
A8C34	0160-4527	4		CAP-FXD 56PF 200 V	09969	RPE121-105C0G560J200V
A8C35	0160-4382	9	1	CAP-FXD 3.3PF 200 V	09969	RPE121-105C0G3R3C200V
A8C36	0160-4498	8	4	CAP-FXD 5.6PF 200 V	09969	RPE121-105C0G5R6D200V
A8C37	0160-4498	8		CAP-FXD 5.6PF 200 V	09969	RPE121-105C0G5R6D200V
A8C38	0160-4040	6		CAP-FXD 1000PF 100 V	09969	RPE121-105C0G102J100V
A8C39	0160-4386	3		CAP-FXD 33PF 200 V	04222	SR152A330JAA
A8C40	0160-4040	6		CAP-FXD 1000PF 100 V	09969	RPE121-105C0G102J100V
A8C41	0160-4040	6		CAP-FXD 1000PF 100 V	09969	RPE121-105C0G102J100V
A8C42	0160-4040	6		CAP-FXD 1000PF 100 V	09969	RPE121-105C0G102J100V
A8C43	0160-4040	6		CAP-FXD 1000PF 100 V	09969	RPE121-105C0G102J100V
A8C44	0160-4040	6		CAP-FXD 1000PF 100 V	09969	RPE121-105C0G102J100V
A8C45	0160-4040	6		CAP-FXD 1000PF 100 V	09969	RPE121-105C0G102J100V

† Refer to Section 7 for update information.

* Factory Selected Component (Refer to Section 5).

Δ Errata part change.

Reference Designation	HP Part Number	C D	Qty.	Description	Mfr. Code	Mfr. Part Number
A8						
OPTION 022 ONLY						
A8C46	0160-4386	3		CAP-FXD 33PF 200 V	04222	SR152A330JAA
A8C47	0160-4521	8	1	CAP-FXD 12PF 200 V	09969	RPE121-105C0G120J200V
A8C48	0160-4040	6		CAP-FXD 1000PF 100 V	09969	RPE121-105C0G102J100V
A8C49				NOT ASSIGNED		
A8C50	0160-4386	3		CAP-FXD 33PF 200 V	04222	SR152A330JAA
A8C51				NOT ASSIGNED		
A8C52	0160-4386	3		CAP-FXD 33PF 200 V	04222	SR152A330JAA
A8C53				NOT ASSIGNED		
A8C54	0160-4040	6		CAP-FXD 1000PF 100 V	09969	RPE121-105C0G102J100V
A8C55	0160-3875	8		CAOICTOR 22P 200 V	28480	0160-40440
A8C56	0160-4381	8	1	CAP-FXD 1.5PF 200 V	09969	RPE110-120C0G1R5C200V
A8C57	0160-4490	0	1	CAP-FXD 1.8PF 200 V	09969	RPE121-105C0G1R8C200V
A8C58	0160-4040	6		CAP-FXD 1000PF 100 V	09969	RPE121-105C0G102J100V
A8C59	0160-4498	8		CAP-FXD 5.6PF 200 V	09969	RPE121-105C0G5R6D200V
A8C60	0121-0448	8		CAP-VAR 5PF 2.5PF 63 V	09535	528-001 A 2.5-5
A8C61	0121-0443	3	1	CAP-VAR 9PF 3PF 160 V	52763	300-427-204
A8C62	0160-4517	2	1	CAP-FXD 1.2F 200 V	28480	0160-4517
A8C63	0160-4522	9	1	CAP-FXD 13PF 200 V	09969	RPE121-105C0G130J200V
A8C64	0160-4387	4	1	CAP-FXD 47PF 200 V	09969	RPE121-105COG470J200V
A8CR1	1901-1096	9	1	DIODE-PIN	28480	1901-1096
A8J1	1250-0835	1	2	CONNECTOR-RF SMC M PC 50-OHM	24931	37JR104-2
A8J2	1250-0835	1		CONNECTOR-RF SMC M PC 50-OHM	24931	37JR104-2
A8J3	1250-1626	0	2	CONNECTOR-RF SMC M PC 50-OHM	98291	50-053-0279
	2190-0124	4	2	WASHER-LK INTL T NO. 10 .195-IN-ID	16179	500222
	2950-0078	9	2	NUT-HEX-DBL-CHAM 10-32-THD .067-IN-THK	28480	2950-0078
A8J4	1250-1626	0		CONNECTOR-RF SMC M PC 50-OHM	98291	50-053-0279
	2190-0124	4		WASHER-LK INTL T NO. 10 .195-IN-ID	16179	500222
	2950-0078	9		NUT-HEX-DBL-CHAM 10-32-THD .067-IN-THK	28480	2950-0078
A8J5	1251-2194	1	4	CONNECTOR-SGL CONT SKT .021-IN-BSC-SZ	00779	3-331272-0
A8J6	1251-2194	1		CONNECTOR-SGL CONT SKT .021-IN-BSC-SZ	00779	3-331272-0
A8J7	1251-2194	1		CONNECTOR-SGL CONT SKT .021-IN-BSC-SZ	00779	3-331272-0
A8J8	1251-2194	1		CONNECTOR-SGL CONT SKT .021-IN-BSC-SZ	00779	3-331272-0
A8J9	1251-1556	7	7	CONNECTOR-SGL CONT SKT .02-IN-BSC-SZ RND	98291	006-4844-00-0-990
A8J10	1251-1556	7		CONNECTOR-SGL CONT SKT .02-IN-BSC-SZ RND	98291	006-4844-00-0-990
A8L1	9100-3560	6	1	INDUCTOR RF-CH-MLD 5.6UH +.5%	91637	IM-4 5.6UH 5%
A8L2	9140-0141	7	1	INDUCTOR RF-CH-MLD 680NH +.10%	91637	IM-2 .68UH 10%
A8L3-L6				NOT ASSIGNED		
A8L7	9100-3922	4	4	INDUCTOR-FIXED 120-1300 HZ	28480	9100-3922
A8L9				NOT ASSIGNED		
A8L10				NOT ASSIGNED		
A8L11	9100-2251	0	6	INDUCTOR RF-CH-MLD 220NH +.10%	91637	IM-2 .22UH 10%
A8L12-L15				NOT ASSIGNED		
A8L16	9100-3922	4		INDUCTOR-FIXED 120-1300 HZ	28480	9100-3922
A8L18-L23				NOT ASSIGNED		

†Refer to Section 7 for update information.

*Factory Selected Component (Refer to Section 5).

Δ Errata part change.

Reference Designation	HP Part Number	C D	Qty.	Description	Mfr. Code	Mfr. Part Number
A8						
OPTION 022 ONLY						
A8L24	9100-2251	0		INDUCTOR RF-CH-MLD 220NH +.10%	91637	IM-2 .22UH 10%
A8L25	9100-3922	4		INDUCTOR-FIXED 120-1300 HZ	28480	9100-3922
A8L26				NOT ASSIGNED		
A8L27	9100-3922	4		INDUCTOR-FIXED 120-1300 HZ	28480	9100-3922
A8L28				NOT ASSIGNED		
A8L29	9100-2251	0		INDUCTOR RF-CH-MLD 220NH +.10%	91637	IM-2 .22UH 10%
A8L30-L32				NOT ASSIGNED		
A8L33	9135-0081	1	2	INDUCTOR RF-CH-MLD 62NH +.5.806%	24226	10M062X-1
A8L34-L38				NOT ASSIGNED		
A8L39	9135-0071	1		INDUCTOR RF-CH-MLD 62NH +.5.806%	24226	10M062X-1
A8L40	9100-2251	0		INDUCTOR RF-CH-MLD 220NH +.10%	91637	IM-2 .22UH 10%
A8L41	9100-2251	0		INDUCTOR RF-CH-MLD 220NH +.10%	91637	IM-2 .22UH 10%
A8L42				NOT ASSIGNED		
A8L43				NOT ASSIGNED		
A8L44	9135-0069	7	1	INDUCTOR 30NH +.5% 2.6D-MMX6.6LG-MM Q=60	24226	10M030X-1
A8L45	9100-2247	4	1	INDUCTOR RF-CH-MLD 100NH +.10%	91637	IM-2 .1UH 10%
A8L46	9100-2251	0		INDUCTOR RF-CH-MLD 220NH +.10%	91637	IM-2 .22UH 10%
A8MP1				NOT ASSIGNED		
A8MP2	7121-4611			LABEL INFO	28480	7121-4611
A8MP3-14	5021-3273			CABLE HOLDER	28480	5021-3273
A8MP15-18	2950-0078			NUT-HEX 10-32	28480	2950-0078
A8MP19-22	2190-0124			WASHER-LK IN T 10	28480	2190-0124
A8MP23-24	1200-0173	5		INSULATOR-XSTR DAP-GL	13103	7717-86 DAP
A8MP25	08656-00099			MULTI GROUND TAB	28480	08656-00099
A8Q1				NOT ASSIGNED		
A8Q2				NOT ASSIGNED		
A8Q3	1854-0632	6	2	TRANSISTOR NPN SI PD = 180MW FT = 4GHZ	25403	BFR91
A8Q4	1853-0020	4	1	TRANSISTOR PNP SI PD = 300MW FT = 150MHZ	2M627	XA22BCP20-1
A8Q5	1854-0632	6		TRANSISTOR NPN SI PD = 180MW FT = 4GHZ	25403	BFR91
A8Q6	1854-0696	2	1	TRANSISTOR NPN SI TO-72 PD = 200MW	28480	1854-0696
A8Q7	1854-0247	9	2	TRANSISTOR NPN SI TO-39 PD = 1W FT = 800MHZ	28480	1854-0247
	1200-0173	5	2	INSULATOR-XSTR DAP-GL	13103	7717-86 DAP
A8Q8	1854-0247	9		TRANSISTOR NPN SI TO-39 PD = 1W FT = 800MHZ	28480	1854-0247
	1200-0173	5		INSULATOR-XSTR DAP-GL	13103	7717-86 DAP
A8R1	0757-0294	9	1	RESISTOR 17.8 +.1% .125W TF TC = 0 +.100	19701	5033R-1/8-T0-17R8-F
A8R2	0698-3439	4	2	RESISTOR 178 +.1% .125W TF TC = 0 +.100	12498	CT4-1/8-T0-178R-F
A8R3	0757-0398	4	5	RESISTOR 75 +.1% .125W TF TC = 0 +.100	D8439	MK2
A8R4	0698-3443	0	1	RESISTOR 287 +.1% .125W TF TC = 0 +.100	12498	CT4-1/8-T0-287R-F
A8R5	0757-0424	7	6	RESISTOR 1.1K +.1% .125W TF TC = 0 +.100	12498	CT4-1/8-T0-1101-F
A8R6	0698-3153	9	5	RESISTOR 3.83K +.1% .125W TF TC = 0 +.100	12498	CT4-1/8-T0-3831-F
A8R7	0757-0398	4		RESISTOR 75 +.1% .125W TF TC = 0 +.100	D8439	MK2
A8R8	0757-0180	2	4	RESISTOR 31.6 +.1% .125W TF TC = 0 +.100	D8439	MK2
A8R9	0757-0424	7		RESISTOR 1.1K +.1% .125W TF TC = 0 +.100	12498	CT4-1/8-T0-1101-F
A8R10	0698-3153	9		RESISTOR 3.83K +.1% .125W TF TC = 0 +.100	12498	CT4-1/8-T0-3831-F

*Factory Selected Component (Refer to component selection procedure at the end of this parts list.)

Δ Errata part change

Reference Designation	HP Part Number	C D	Qty.	Description	Mfr. Code	Mfr. Part Number
A8						
OPTION 022 ONLY						
A8R11	2100-2030	6	1	RESISTOR-TRMR 20K 10% TKF TOP-ADJ 1-TRN	73138	82PR20K
A8R12	0757-0424	7		RESISTOR 1.1K +-1% .125W TF TC = 0 +-100	12498	CT4-1/8-T0-1101-F
A8R13	0757-0398	4		RESISTOR 75 +-1% .125W TF TC = 0 +-100	D8439	MK2
A8R14	0757-0278	9	1	RESISTOR 1.78K +-1% .125W TF TC = 0 +-100	12498	CT4-1/8-T0-1781-F
A8R15	0698-3153	9		RESISTOR 3.83K +-1% .125W TF TC = 0 +-100	12498	CT4-1/8-T0-3831-F
A8R16	0757-0346	2	3	RESISTOR 10 +-1% .125W TF TC = 0 +-100	D8439	MK2
A8R17	0757-0424	7		RESISTOR 1.1K +-1% .125W TF TC = 0 +-100	12498	CT4-1/8-T0-1101-F
A8R18	0698-4037	0	2	RESISTOR 46.4 +-1% .125W TF TC = 0 +-100	D8439	MK2
A8R19	0757-0346	2		RESISTOR 10 +-1% .125W TF TC = 0 +-100	D8439	MK2
A8R20	0757-0424	7		RESISTOR 1.1K +-1% .125W TF TC = 0 +-100	12498	CT4-1/8-T0-1101-F
A8R21	0698-3153	9		RESISTOR 3.83K +-1% .125W TF TC = 0 +-100	12498	CT4-1/8-T0-3831-F
A8R22				NOT ASSIGNED		
A8R23	0757-0398	4		RESISTOR 75 +-1% .125W TF TC = 0 +-100	D8439	MK2
A8R24	0757-0180	2		RESISTOR 31.6 +-1% .125W TF TC = 0 +-100	D8439	MK2
A8R25	0698-3439	4		RESISTOR 178 +-1% .125W TF TC = 0 +-100	12498	CT4-1/8-T0-178R-F
A8R26	0698-3151	7	1	RESISTOR 2.87K +-1% .125W TF TC = 0 +-100	12498	CT4-1/8-T0-2871-F
A8R27	0757-0276	7	1	RESISTOR 61.9 +-1% .125W TF TC = 0 +-100	12498	CT4-1/8-T0-6192-F
A8R28	0757-0424	7		RESISTOR 1.1K +-1% .125W TF TC = 0 +-100	12498	CT4-1/8-T0-1101-F
A8R29	0757-0346	2		RESISTOR 10 +-1% .125W TF TC = 0 +-100	D8439	MK2
A8R30	0698-3153	9		RESISTOR 3.83K +-1% .125W TF TC = 0 +-100	12498	CT4-1/8-T0-3831-F
A8R31	0757-0180	2		RESISTOR 31.6 +-1% .125W TF TC = 0 +-100	D8439	MK2
A8R32	0757-0398	4		RESISTOR 75 +-1% .125W TF TC = 0 +-100	D8439	MK2
A8R33	0698-3444	1	1	RESISTOR 316 +-1% .125W TF TC = 0 +-100	12498	CT4-1/8-T0-316R-F
A8R34	0698-4037	0		RESISTOR 46.4 +-1% .125W TF TC = 0 +-100	D8439	MK2
A8R35	0757-0180	2		RESISTOR 31.6 +-1% .125W TF TC = 0 +-100	D8439	MK2
A8R36	0698-4037	0		RESISTOR 46.4 +-1% .125W TF TC = 0 +-100	D8439	MK2
A8R37-R40				NOT ASSIGNED		
A8R41	0699-1361			RCHIP 51.1 1%	28480	0699-1361
A8TG1	1251-1556	7		CONNECTOR-SGL CONT SKT .02-IN-BSC-SZ RND	98291	006-4844-00-0-990
A8TG2				NOT ASSIGNED		
A8TG3	1251-1556	7		CONNECTOR-SGL CONT SKT .02-IN-BSC-SZ RND	98291	006-4844-00-0-990
A8TP1	1251-1556	7		CONNECTOR-SGL CONT SKT .02-IN-BSC-SZ RND	98291	006-4844-00-0-990
A8TP2	1251-1556	7		CONNECTOR-SGL CONT SKT .02-IN-BSC-SZ RND	98291	006-4844-00-0-990
A8TP3	1251-1556	7		CONNECTOR-SGL CONT SKT .02-IN-BSC-SZ RND	98291	006-4844-00-0-990
A8U1				NOT ASSIGNED		
A8U2	1826-1724	0	3	IC RF/IF AMPL 4-CUSTOM PKG	24539	MSA-0785
A8U3	1826-1724	0		IC RF/IF AMPL 4-CUSTOM PKG	24539	MSA-0785
A8U4	1826-1724	0		IC RF/IF AMPL 4-CUSTOM PKG	24539	MSA-0785
A8W1	08656-20018	6	1	SR 2.18 NO CONN	28480	08656-20018
A8W2	8150-4927	5	1	WIRE 24AWG 1X24 105C	01634	J0.100X0.125B24
A8W3 ^Δ	8150-0459	0		WIRE 24 AWG W/R	28480	8150-0459
A8W4 ^Δ	8151-0013	4		BARE WIRE 22G	28480	8151-0013
A8Z1	0955-0145	9	1	U-WAVE MIXER 1 GHZ MAX	15542	TFM2-10

Table 6-3. Replaceable Parts

Reference Designation	HP Part Number	C D	Qty.	Description	Mfr. Code	Mfr. Part Number
A9						
A9				ATTENUATOR ASSEMBLY		
A9AT1	5061-4820	5	2	HET ASSEMBLY	28480	5061-4820
A9AT2	5061-4822	7	2	60 DB ASSEMBLY	28480	5061-4822
A9AT3	5061-4823	8	2	80 DB ASSEMBLY	28480	5061-4823
A9AT4	5061-4819	2	2	REVERSE POWER ASSEMBLY	28480	5061-4819
A9J1				NOT ASSIGNED		
A9J2-J11				NOT SEPARATELY REPLACEABLE		
A9MP1	2200-0111	2	25	SCREW-MACH 4-40 .5-IN-LG PAN-HD-POZI	00000	ORDER BY DESCRIPTION
A9MP2	0535-0109	5		NUTM DBLHX M5	28480	0535-0109
A9W1	08657-21017	8	1	CABLE SEMI-RIGID A9J5 "RF OUT" TO A9J6 "IN" (60 DB)	28480	08657-21017
A9W2	08657-21018	9	1	CABLE SEMI-RIGID A9J7 "OUT" (60 DB) TO A9J8 "IN" (80 DB)	28480	08657-21018
A9W3	08657-21023	6		CABLE SEMI-RIGID A9J9 "OUT" (80 DB) TO A9J10 "IN" (REV POW)	28480	08657-21023

†Refer to Section 7 for update information.

*Factory Selected Component (Refer to Section 5).

Table 6-3. Replaceable Parts

Reference Designation	HP Part Number	C D	Qty.	Description	Mfr. Code	Mfr. Part Number
A9A1						
A9A1	08657-60101	3	1	ATTENUATOR MOUNTING ASSEMBLY	28480	08657-60101
A9A1C1	0160-5469	5		CAPACITOR-FXD 1UF 10% 50VDC	28480	0160-5469
A9A1C2	0160-5469	5		CAPACITOR-FXD 1UF 10% 50VDC	28480	0160-5469
A9A1C3	0160-5469	5		CAPACITOR-FXD 1UF 10% 50VDC	28480	0160-5469
A9A1C4	0160-5469	5		CAPACITOR-FXD 1UF 10% 50VDC	28480	0160-5469
A9A1C5	0160-5469	5		CAPACITOR-FXD 1UF 10% 50VDC	28480	0160-5469
A9A1C6	0160-5469	5		CAPACITOR-FXD 1UF 10% 50VDC	28480	0160-5469
A9A1C7	0160-5469	5		CAPACITOR-FXD 1UF 10% 50VDC	28480	0160-5469
A9A1C8	0160-5469	5		CAPACITOR-FXD 1UF 10% 50VDC	28480	0160-5469
A9A1C9	0160-5469	5		CAPACITOR-FXD 1UF 10% 50VDC	28480	0160-5469
A9A1C10	0160-5469	5		CAPACITOR-FXD 1UF 10% 50VDC	28480	0160-5469
A9A1C11	0160-5469	5		CAPACITOR-FXD 1UF 10% 50VDC	28480	0160-5469
A9A1C12	0160-5469	5		CAPACITOR-FXD 1UF 10% 50VDC	28480	0160-5469
A9A1C13	0160-5469	5		CAPACITOR-FXD 1UF 10% 50VDC	28480	0160-5469
A9A1C14	0160-5469	5		CAPACITOR-FXD 1UF 10% 50VDC	28480	0160-5469
A9A1J1	1252-0277	9	4	CONN-POST TYPE .100-PIN-SPCG 20-CONT	28480	1252-0277
A9A1J2-J11	1251-5595	2		POLARIZING KEY-POST CONN NOT SEPARATELY REPLACEABLE	28480	1251-5595
A9A1L1	9140-0137	1	12	INDUCTOR RF-CH-MLD 1MH 5%	28480	9140-0137
A9A1L2	9140-0137	1		INDUCTOR RF-CH-MLD 1MH 5%	2848C	9140-0137
A9A1L3	9140-0137	1		INDUCTOR RF-CH-MLD 1MH 5%	28480	9140-0137
A9A1L4	9140-0137	1		INDUCTOR RF-CH-MLD 1MH 5%	28480	9140-0137
A9A1L5	9140-0137	1		INDUCTOR RF-CH-MLD 1MH 5%	28480	9140-0137
A9A1L6	9140-0137	1		INDUCTOR RF-CH-MLD 1MH 5%	28480	9140-0137
A9A1L7	9140-0137	1		INDUCTOR RF-CH-MLD 1MH 5%	28480	9140-0137
A9A1L8	9140-0137	1		INDUCTOR RF-CH-MLD 1MH 5%	28480	9140-0137
A9A1L9	9140-0137	1		INDUCTOR RF-CH-MLD 1MH 5%	28480	9140-0137
A9A1L10	9140-0137	1		INDUCTOR RF-CH-MLD 1MH 5%	28480	9140-0137
A9A1L11	9140-0137	1		INDUCTOR RF-CH-MLD 1MH 5%	28480	9140-0137
A9A1L12	9140-0137	1		INDUCTOR RF-CH-MLD 1MH 5%	28480	9140-0137
A9A1MP1	0380-1680	0		SPACER-PRESS-IN 0.188 IN LG; 0.143 IN ID	00000	ORDER BY DESCRIPTION
A9A1R1	0757-0441	8		RESISTOR 8.25K 1% .125W F TC=0+-100	24546	CT4-1/8-T0-8251-F
A9A1R2	0757-0441	8		RESISTOR 8.25K 1% .125W F TC=0+-100	24546	CT4-1/8-T0-8251-F

†Refer to Section 7 for update information.

*Factory Selected Component (Refer to Section 5).

Table 6-3. Replaceable Parts

Reference Designation	HP Part Number	C D	Qty.	Description	Mfr. Code	Mfr. Part Number
A10						
A10	08657-60105	7	1	AUDIO/POWER SUPPLY ASSY	28480	08657-60105
A10C1				NOT ASSIGNED		
A10C2				NOT ASSIGNED		
A10C3	0160-5469	5		CAPACITOR-FXD 1UF 10% 50VDC	28480	0160-5469
A10C4	0180-2821	9		CAPACITOR-FXD 22UF+-20% 35VDC TA	28480	0180-2821
A10C5	0180-2821	9		CAPACITOR-FXD 22UF+-20% 35VDC TA	28480	0180-2821
A10C6	0160-4791	4		CAPACITOR-FXD 10PF +-5% 100VDC CER 0+-30	28480	0160-4791
A10C7	0180-2815	1	2	CAPACITOR-FXD 100UF+-20% 10VDC TA	28480	0180-2815
A10C8	0160-5035	1	1	CAPACITOR-FXD .051UF +-2% 100VDC	28480	0160-5035
A10C9	0160-5036	2	1	CAPACITOR-FXD .27UF +-2% 100VDC	28480	0160-5036
A10C10	0180-2815	1		CAPACITOR-FXD 100UF+-20% 10VDC TA	28480	0180-2815
A10C11	0180-0375	4	1	CAPACITOR-FXD 68UF+-10% 20VDC TA	56289	150D686X9020B2
A10C12	0160-2225	5	1	CAPACITOR-FXD 2000PF +-5% 300VDC MICA	28480	0160-2225
A10C13	0160-0336	5	1	CAPACITOR-FXD 100PF +-1% 300VDC MICA	28480	0160-0336
A10C14	0160-4835	7		CAPACITOR-FXD .1UF +-10% 50VDC CER	28480	0160-4835
A10C15	0160-4835	7		CAPACITOR-FXD .1UF +-10% 50VDC CER	28480	0160-4835
A10C16	0160-5469	5		CAPACITOR-FXD 1UF 10% 50VDC	28480	0160-5469
A10C17	0160-4795	8	1	CAPACITOR-FXD 4.7PF +-.5PF 100VDC CER	28480	0160-4795
A10C18	0160-4807	3		CAPACITOR-FXD 33PF +-5% 100VDC CER 0+-30	28480	0160-4807
A10C19	0180-0100	3		CAPACITOR-FXD 4.7UF+-10% 35VDC TA	56289	150D475X9035B2
A10C20	0180-0100	3		CAPACITOR-FXD 4.7UF+-10% 35VDC TA	56289	150D475X9035B2
A10C21	0160-4807	3		CAPACITOR-FXD 33PF +-5% 100VDC CER 0+-30	28480	0160-4807
A10C22	0160-4835	7		CAPACITOR-FXD .1UF +-10% 50VDC CER	28480	0160-4835
A10C23	0160-4812	0		CAPACITOR-FXD 220PF +-5% 100VDC CER	28480	0160-4812
A10C24	0160-5469	5		CAPACITOR-FXD 1UF 10% 50VDC	28480	0160-5469
A10C25	0160-5469	5		CAPACITOR-FXD 1UF 10% 50VDC	28480	0160-5469
A10C26	0180-4029	3	1	CAPACITOR-FXD 6800U 50V AL	28480	0180-4029
A10C27	0180-2141	6	1	CAPACITOR-FXD 3.3UF+-10% 50VDC TA	56289	150D335X9050B2
A10C28	0180-4028	2	1	CAPACITOR-FXD 3900U 50V AL	28480	0180-4028
A10C29				NOT ASSIGNED		
A10C30	0180-3209	9	1	CAPACITOR-FXD .024F + 75-10% 20VDC AL	28480	0180-3209
A10C31-C34				NOT ASSIGNED		
A10C35	0180-0097	7		CAPACITOR-FXD 47UF+-10% 35VDC TA	56289	150D476X9035S2
A10C36	0180-2208	6		CAPACITOR-FXD 220UF+-10% 10VDC TA	56289	150D227X9010S2
A10C37	0180-0097	7		CAPACITOR-FXD 47UF+-10% 35VDC TA	56289	150D476X9035S2
A10C38	0180-0291	3		CAPACITOR-FXD 1UF+-10% 35VDC TA	56289	150D105X9035A2
A10C39	0180-0291	3		CAPACITOR-FXD 1UF+-10% 35VDC TA	56289	150D105X9035A2
A10C40	0180-0291	3		CAPACITOR-FXD 1UF+-10% 35VDC TA	56289	150D105X9035A2
A10C41-C43				NOT ASSIGNED		
A10C44	0160-0574	3	12	CAPACITOR-FXD .022UF +-20% 100VDC CER	28480	0160-0574
A10C45	0160-0574	3		CAPACITOR-FXD .022UF +-20% 100VDC CER	28480	0160-0574
A10C46	0160-0574	3		CAPACITOR-FXD .022UF +-20% 100VDC CER	28480	0160-0574
A10C47	0160-0574	3		CAPACITOR-FXD .022UF +-20% 100VDC CER	28480	0160-0574

†Refer to Section 7 for update information.

*Factory Selected Component (Refer to Section 5).

Table 6-3. Replaceable Parts

Reference Designation	HP Part Number	C D	Qty.	Description	Mfr. Code	Mfr. Part Number
A10C48	0160-0574	3		CAPACITOR-FXD .022UF ±20% 100VDC CER	28480	0160-0574
A10C49	0160-0574	3		CAPACITOR-FXD .022UF ±20% 100VDC CER	28480	0160-0574
A10C50	0160-0574	3		CAPACITOR-FXD .022UF ±20% 100VDC CER	28480	0160-0574
A10C51	0160-0574	3		CAPACITOR-FXD .022UF ±20% 100VDC CER	28480	0160-0574
A10C52	0160-0574	3		CAPACITOR-FXD .022UF ±20% 100VDC CER	28480	0160-0574
A10C53	0160-0574	3		CAPACITOR-FXD .022UF ±20% 100VDC CER	28480	0160-0574
A10C54	0160-0574	3		CAPACITOR-FXD .022UF ±20% 100VDC CER	28480	0160-0574
A10C55	0160-0574	3		CAPACITOR-FXD .022UF ±20% 100VDC CER	28480	0160-0574
A10C56	0160-4835	7		CAPACITOR-FXD .1UF ±10% 50VDC CER	28480	0160-4835
A10C57	0160-4835	7		CAPACITOR-FXD .1UF ±10% 50VDC CER	28480	0160-4835
A10C58	0160-4835	7		CAPACITOR-FXD .1UF ±10% 50VDC CER	28480	0160-4835
A10C59	0160-4835	7		CAPACITOR-FXD .1UF ±10% 50VDC CER	28480	0160-4835
A10C60	0160-4835	7		CAPACITOR-FXD .1UF ±10% 50VDC CER	28480	0160-4835
A10CR1	1901-0880	7		DIODE-GEN PRP 125MA DO-35	28480	1901-0880
A10CR2	1901-0040	1	4	DIODE-SWITCHING 30V 50MA 2NS DO-35	9N171	1N4148
A10CR3	1901-0040	1		DIODE-SWITCHING 30V 50MA 2NS DO-35	9N171	1N4148
A10CR4	1901-0040	1		DIODE-SWITCHING 30V 50MA 2NS DO-35	9N171	1N4148
A10CR5	1901-0376	6	2	DIODE-SWITCHING 35V 50MA 2NS DO-35	28480	1901-0376
A10CR6	1901-0376	6		DIODE-SWITCHING 35V 50MA 2NS DO-35	28480	1901-0376
A10CR7	1901-0040	1		DIODE-SWITCHING 30V 50MA 2NS DO-35	9N171	1N4148
A10CR8				NOT ASSIGNED		
A10CR9				NOT ASSIGNED		
A10CR10	1901-0418	7	4	DIODE-PWR RECT 400V 1.5A	28480	1901-0418
A10CR11	1901-0418	7		DIODE-PWR RECT 400V 1.5A	28480	1901-0418
A10CR12	1901-0418	7		DIODE-PWR RECT 400V 1.5A	28480	1901-0418
A10CR13	1901-0418	7		DIODE-PWR RECT 400V 1.5A	28480	1901-0418
A10CR14	1901-0028	5	6	DIODE-PWR RECT 400V 750MA DO-29	28480	1901-0028
A10CR15	1901-0028	5		DIODE-PWR RECT 400V 750MA DO-29	28480	1901-0028
A10CR16	1901-0028	5		DIODE-PWR RECT 400V 750MA DO-29	28480	1901-0028
A10CR17	1901-0050	3		DIODE-SWITCHING 80V 200MA 2NS DO-35	9N171	1N4150
A10CR18				NOT ASSIGNED		
A10CR19	1901-0028	5		DIODE-PWR RECT 400V 750MA DO-29	28480	1901-0028
A10CR20	1901-0028	5		DIODE-PWR RECT 400V 750MA DO-29	28480	1901-0028
A10CR21	1901-0028	5		DIODE-PWR RECT 400V 750MA DO-29	28480	1901-0028
A10CR22				NOT ASSIGNED		
A10CR23	1901-0050	3		DIODE-SWITCHING 80V 200MA 2NS DO-35	9N171	1N4150
A10CR24	1901-0050	3		DIODE-SWITCHING 80V 200MA 2NS DO-35	9N171	1N4150
A10CR25	1901-0050	3		DIODE-SWITCHING 80V 200MA 2NS DO-35	9N171	1N4150
A10CR26	1901-0050	3		DIODE-SWITCHING 80V 200MA 2NS DO-35	9N171	1N4150
A10CR27	1901-0050	3		DIODE-SWITCHING 80V 200MA 2NS DO-35	9N171	1N4150
A10CR28	1901-0050	3		DIODE-SWITCHING 80V 200MA 2NS DO-35	9N171	1N4150
A10CR29	1901-0050	3		DIODE-SWITCHING 80V 200MA 2NS DO-35	9N171	1N4150
A10CR30	1901-0050	3		DIODE-SWITCHING 80V 200MA 2NS DO-35	9N171	1N4150
A10CR31	1901-0050	3		DIODE-SWITCHING 80V 200MA 2NS DO-35	9N171	1N4150
A10CR32	1901-0050	3		DIODE-SWITCHING 80V 200MA 2NS DO-35	9N171	1N4150
A10CR33	1901-0050	3		DIODE-SWITCHING 80V 200MA 2NS DO-35	9N171	1N4150

†Refer to Section 7 for update information.

*Factory Selected Component (Refer to Section 5).

Table 4-3. Replaceable Parts

A10DS1				NOT ASSIGNED		
A10DS2	1990-0835	9		LED-LAMP LUM-INT = 8MCD IF = 30MA-MAX BVR = 5V	28480	HLMP-1523
A10DS3	1990-0835	9		LED-LAMP LUM-INT = 8MCD IF = 30MA-MAX BVR = 5V	28480	HLMP-1523
A10DS4	1990-0835	9		LED-LAMP LUM-INT = 8MCD IF = 30MA-MAX BVR = 5V	28480	HLMP-1523
A10F1 ^Δ	2110-0001	8	4	FUSE 1A 250V NTD 1.25X.25 UL	75915	312001
	2110-0726	4		FUSEHOLDER-VERT-PC	02803	1115-0597T
A10F2	2110-0043	8		FUSE 1.5A 250V NTD 1.25X.25 UL	28480	2110-0043
	2110-0269	0		FUSEHOLDER-CLIP TYPE-25D-FUSE	28480	2110-0269
A10F3	2110-0043	8		FUSE 1.5A 250V NTD 1.25X.25 UL	28480	2110-0043
	2110-0269	0		FUSEHOLDER-CLIP TYPE-25D-FUSE	28480	2110-0269
A10F4	2110-0010	9	1	FUSE 5A 250V NTD 1.25X.25 UL	75915	312005
	2110-0269	0		FUSEHOLDER-CLIP TYPE-25D-FUSE	28480	2110-0269
A10J1	1252-0277	9		CONN-POST TYPE .100-PIN-SPCG 20-CONT	28480	1252-0277
	1251-5595	2		POLARIZING KEY-POST CONN	28480	1251-5595
A10J2	1251-5810	4	1	CONNECTOR 10-PIN M POST TYPE	28480	1251-5810
A10J3	1252-0277	9		CONN-POST TYPE .100-PIN-SPCG 20-CONT	28480	1252-0277
	1251-5595	2		POLARIZING KEY-POST CONN	28480	1251-5595
A10J4	1251-8041	9	1	CONN-POST TYPE .156-PIN-SPCG 8-CONT	28480	1251-8041
A10J5	1251-5169	6	1	CONNECTOR 6-PIN M POST TYPE	28480	1251-5169
A10K1	0490-1407	2	1	RELAY 4C 24VDC-COIL 7.5A 115VAC	28480	0490-1407
A10L1	9140-0144	0		INDUCTOR RF-CH-MLD 4.7UH 10%	28480	9140-0144
A10L2	9140-0142	8	1	INDUCTOR RF-CH-MLD 2.2UH 10%	28480	9140-0142
A10L3	9140-0144	0		INDUCTOR RF-CH-MLD 4.7UH 10%	28480	9140-0144
A10MP1	1400-0482	3	6	CABLE TIE .062-3-DIA .14-WD NYL	28480	1400-0482
A10MP2	1400-0966	8		CLIP-CMPNT .17-.185-DIA .195-WD STL	91506	8015-13AT
A10Q1	1884-0244	9	1	THYRISTOR-SCR VRRM = 400	3L585	52600D2A
A10Q2	1855-0292	6	2	TRANSISTOR J-FET 2N5432 N-CHAN D-MODE	17856	2N5432
A10Q3	1884-0316	6	1	THYRISTOR-SCR 2N6402 TO-220AB VRRM = 200	04713	2N6402
A10Q4				NOT ASSIGNED		
A10Q5	1855-0420	2		TRANSISTOR J-FET 2N4391 N-CHAN D-MODE	01295	2N4391
A10Q6	1855-0420	2		TRANSISTOR J-FET 2N4391 N-CHAN D-MODE	01295	2N4391
A10Q7	1855-0292	6		TRANSISTOR J-FET 2N5432 N-CHAN D-MODE	17856	2N5432
A10Q8	1855-0420	2		TRANSISTOR J-FET 2N4391 N-CHAN D-MODE	01295	2N4391
A10Q9	1855-0420	2		TRANSISTOR J-FET 2N4391 N-CHAN D-MODE	01295	2N4391
A10Q10	1855-0420	2		TRANSISTOR J-FET 2N4391 N-CHAN D-MODE	01295	2N4391
A10Q11	1855-0420	2		TRANSISTOR J-FET 2N4391 N-CHAN D-MODE	01295	2N4391
A10Q12	1855-0253	9	1	TRANSISTOR J-FET N-CHAN D-MODE TO-92 SI	28480	1855-0253
A10Q13				NOT ASSIGNED		
A10Q14	1853-0281	9		TRANSISTOR PNP 2N2907A SI TO-18 PD = 400MW	04713	2N2907A
A10R1	0757-0814	9	1	RESISTOR 511 1% .5W F TC = 0+/-100	28480	0757-0814
A10R2	2100-0568	1	2	RESISTOR-TRMR 100 10% C TOP-ADJ 1-TRN	28480	2100-0568
A10R3	0698-3440	7		RESISTOR 196 1% .125W F TC = 0+/-100	24546	CT4-1/8-TO-196R-F
A10R4	0698-3447	4		RESISTOR 422 1% .125W F TC = 0+/-100	24546	CT4-1/8-TO-422R-F

Table 4-3. Replaceable Parts

A10R5-F7				NOT ASSIGNED		
A10R8	0698-6295	8	2	RESISTOR 300 .1% .125W F TC = 0+ -50	28480	0698-6295
A10R9	0698-6295	8		RESISTOR 300 .1% .125W F TC = 0+ -50	28480	0698-6295
A10R10	0698-3180	8		RESISTOR 31.8K 1% .125W F TC = 0+ -100	24548	CT4-1/B-T0-3182-F
A10R11	0698-4016	4	2	RESISTOR 600 .5% .125W F TC = 0+ -100	28480	0698-4016
A10R12	0698-0073	8		RESISTOR 10M 1% .125W F TC = 0+ -150	28480	0698-0073
A10R13	0757-0465	6		RESISTOR 100K 1% .125W F TC = 0+ -100	24548	CT4-1/B-T0-1003-F
A10R14	0698-4016	4		RESISTOR 600 .5% .125W F TC = 0+ -100	28480	0698-4016
A10R15	0757-0442	9		RESISTOR 10K 1% .125W F TC = 0+ -100	24548	CT4-1/B-T0-1002-F
A10R16	0757-0442	9		RESISTOR 10K 1% .125W F TC = 0+ -100	24548	CT4-1/B-T0-1002-F
A10R17	0757-0465	6		RESISTOR 100K 1% .125W F TC = 0+ -100	24548	CT4-1/B-T0-1003-F
A10R18	0757-0438	3		RESISTOR 5.11K 1% .125W F TC = 0+ -100	24548	CT4-1/B-T0-5111-F
A10R19	0698-3441	8		RESISTOR 215 1% .125W F TC = 0+ -100	24548	CT4-1/B-T0-216R-F
A10R20	0757-0482	3		RESISTOR 78K 1% .125W F TC = 0+ -100	24548	CT4-1/B-T0-7802-F
A10R21	0757-0461	2	1	RESISTOR 68.1K 1% .125W F TC = 0+ -100	24548	CT4-1/B-T0-6812-F
A10R22	0698-3457	8		RESISTOR 318K 1% .125W F TC = 0+ -100	28480	0698-3457
A10R23	0757-0280	3		RESISTOR 1K 1% .125W F TC = 0+ -100	24548	CT4-1/B-T0-1001-F
A10R24-A	0698-3498	6		RESISTOR 8.68K 1% .125W F TC = 0+ -100	02995	8FR25H
A10R25	0698-6983	9	6	RESISTOR 20.4K .1% .125W F TC = 0+ -25	19701	8033R-1/B-T9-2042-B
A10R26	0698-6983	9		RESISTOR 20.4K .1% .125W F TC = 0+ -25	19701	8033R-1/B-T9-2042-B
A10R27	0757-0420	3		RESISTOR 750 1% .125W F TC = 0+ -100	24548	CT4-1/B-T0-751-F
A10R28	2100-0568	1		RESISTOR-TRMR 100 10% C TOP-ADJ 1-TRN	28480	2100-0568
A10R29	0757-0394	0		RESISTOR 51.1 1% .125W F TC = 0+ -100	24548	CT4-1/B-T0-51R1-F
A10R30	0757-0465	6		RESISTOR 100K 1% .125W F TC = 0+ -100	24548	CT4-1/B-T0-1003-F
A10R31	0757-0465	6		RESISTOR 100K 1% .125W F TC = 0+ -100	24548	CT4-1/B-T0-1003-F
A10R32	0757-0465	6		RESISTOR 100K 1% .125W F TC = 0+ -100	24548	CT4-1/B-T0-1003-F
A10R33	0698-6983	9		RESISTOR 20.4K .1% .125W F TC = 0+ -25	19701	8033R-1/B-T9-2042-B
A10R34				NOT ASSIGNED		
A10R35	0757-0463	4	1	RESISTOR 82.5K 1% .125W F TC = 0+ -100	24548	CT4-1/B-T0-8252-F
A10R36	0698-6320	8	2	RESISTOR 5K .1% .125W F TC = 0+ -25	03888	PME55-1/B-T9-5001-B
A10R37	0698-8863	8	2	RESISTOR 5.2K .1% .125W F TC = 0+ -25	28480	0698-8863
A10R38	2100-0558	9	2	RESISTOR-TRMR 20K 10% C TOP-ADJ 1-TRN	28480	2100-0558
A10R39	2100-0558	9	2	RESISTOR-TRMR 20K 10% C TOP-ADJ 1-TRN	28480	2100-0558
A10R40	0698-8863	8		RESISTOR 5.2K .1% .125W F TC = 0+ -25	28480	0698-8863
A10R41	0698-6320	8		RESISTOR 5K .1% .125W F TC = 0+ -25	03888	PME55-1/B-T9-5001-B
A10R42	0698-3151	7	2	RESISTOR 2.87K 1% .125W F TC = 0+ -100	24548	CT4-1/B-T0-2871-F
A10R43	0698-3151	7		RESISTOR 2.87K 1% .125W F TC = 0+ -100	24548	CT4-1/B-T0-2871-F
A10R44	0698-8827	4		RESISTOR 1M 1% .125W F TC = 0+ -100	28480	0698-8827
A10R45	0757-0280	3		RESISTOR 1K 1% .125W F TC = 0+ -100	24548	CT4-1/B-T0-1001-F
A10R46	0757-0280	3		RESISTOR 1K 1% .125W F TC = 0+ -100	24548	CT4-1/B-T0-1001-F
A10R47	0698-3454	3		RESISTOR 215K 1% .125W F TC = 0+ -100	24548	CT4-1/B-T0-2153-F
A10R48	0698-3454	3		RESISTOR 215K 1% .125W F TC = 0+ -100	24548	CT4-1/B-T0-2153-F
A10R49	0757-0280	3		RESISTOR 1K 1% .125W F TC = 0+ -100	24548	CT4-1/B-T0-1001-F
A10R50	0698-4475	0	1	RESISTOR 9.76K 1% .125W F TC = 0+ -100	24548	CT4-1/B-T0-9761-F
A10R51	0698-3266	5	2	RESISTOR 237K 1% .125W F TC = 0+ -100	24548	CT4-1/B-T0-2373-F
A10R52	2100-3286	6	1	RESISTOR-TRMR 10K 10% C TOP-ADJ 17-TRN	28480	2100-3286
A10R53	0698-3266	6		RESISTOR 237K 1% .125W F TC = 0+ -100	24548	CT4-1/B-T0-2373-F
A10R54	0757-0442	9		RESISTOR 10K 1% .125W F TC = 0+ -100	24548	CT4-1/B-T0-1002-F
A10R55	0698-3154	0		RESISTOR 4.22K 1% .125W F TC = 0+ -100	24548	CT4-1/B-T0-4221-F
A10R56	0757-0394	0		RESISTOR 51.1 1% .125W F TC = 0+ -100	24548	CT4-1/B-T0-51R1-F

Table 6-3. Replaceable Parts

Reference Designation	HP Part Number	C D	Qty.	Description	Mfr. Code	Mfr. Part Number
A10R57	0698-6983	9		RESISTOR 20.4K .1% .125W F TC=0+-25	19701	5033R-1/8-T9-2042-B
A10R58	0698-6983	9		RESISTOR 20.4K .1% .125W F TC=0+-25	19701	5033R-1/8-T9-2042-B
A10R59	0698-8827	4		RESISTOR 1M 1% .125W F TC=0+-100	28480	0698-8827
A10R60	0757-0465	6		RESISTOR 100K 1% .125W F TC=0+-100	24546	CT4-1/8-T0-1003-F
A10R61	0757-0465	6		RESISTOR 100K 1% .125W F TC=0+-100	24546	CT4-1/8-T0-1003-F
A10R62	0757-0440	7		RESISTOR 7.5K 1% .125W F TC=0+-100	24546	CT4-1/8-T0-7501-F
A10R63	2100-3212	8	1	RESISTOR-TRMR 200 10% C TOP-ADJ 1-TRN	28480	2100-3212
A10R64	0698-3157	3		RESISTOR 19.6K 1% .125W F TC=0+-100	24546	CT4-1/8-T0-1962-F
A10R65	0757-0278	9	1	RESISTOR 1.78K 1% .125W F TC=0+-100	24546	CT4-1/8-T0-1781-F
A10R66	2100-0567	0	1	RESISTOR-TRMR 2K 10% C TOP-ADJ 1-TRN	28480	2100-0567
A10R67	0757-0401	0		RESISTOR 100 1% .125W F TC=0+-100	24546	CT4-1/8-T0-101-F
A10R68	0757-0422	5		RESISTOR 909 1% .125W F TC=0+-100	24546	CT4-1/8-T0-909R-F
A10R69	0757-1094	9		RESISTOR 1.47K 1% .125W F TC=0+-100	24546	CT4-1/8-T0-1471-F
A10R70	0757-0280	3		RESISTOR 1K 1% .125W F TC=0+-100	24546	CT4-1/8-T0-1001-F
A10R71	0698-3459	8	1	RESISTOR 383K 1% .125W F TC=0+-100	28480	0698-3459
A10R72	0757-0421	4		RESISTOR 825 1% .125W F TC=0+-100	24546	CT4-1/8-T0-825R-F
A10R73	2100-0558	9		RESISTOR-TRMR 20K 10% C TOP-ADJ 1-TRN	28480	2100-0558
A10R74	0698-7394	8	1	RESISTOR 698 .1% .125W F TC=0+-25	19701	5033R-1/8-T9-698R-R
A10R75	0698-6347	9	1	RESISTOR 1.5K .1% .125W F TC=0+-25	28480	0698-6347
A10R76	0698-3444	1		RESISTOR 316 1% .125W F TC=0+-100	24546	CT4-1/8-T0-316R-F
A10R77	0757-0394	0		RESISTOR 51.1 1% .125W F TC=0+-100	24546	CT4-1/8-T0-51R1-F
A10R78-R82				NOT ASSIGNED		
A10R83	0698-3405	4	1	RESISTOR 422 1% .5W F TC=0+-100	28480	0698-3405
A10R84	0757-0280	3		RESISTOR 1K 1% .125W F TC=0+-100	24546	CT4-1/8-T0-1001-F
A10R85	0698-3407	6	2	RESISTOR 1.96K 1% .5W F TC=0+-100	28480	0698-3407
A10R86	0698-3407	6		RESISTOR 1.96K 1% .5W F TC=0+-100	28480	0698-3407
A10R87-R89				NOT ASSIGNED		
A10R90	0757-0816	1	1	RESISTOR 681 1% .5W F TC=0+-100	28480	0757-0816
A10R91-R99				NOT ASSIGNED		
A10R100	0698-3441	8		RESISTOR 215 1% .125W F TC=0+-100	24546	CT4-1/8-T0-215R-F
A10R101	0757-0397	3		RESISTOR 68.1 1% .125W F TC=0+-100	24546	CT4-1/8-T0-68R1-F
A10R102	2100-2060	2		RESISTOR-TRMR 50 20% C TOP-ADJ 1-TRN	73138	82PR50
A10R103	0757-0440	7		RESISTOR 7.5K 1% .125W F TC=0+-100	24546	CT4-1/8-T0-7501-F
A10R104	0698-3439	4		RESISTOR 178 1% .125W F TC=0+-100	24546	CT4-1/8-T0-178R-F
A10R105	0757-0158	4	2	RESISTOR 619 1% .5W F TC=0+-100	28480	0757-0158
A10R106	0698-3439	4		RESISTOR 178 1% .125W F TC=0+-100	24546	CT4-1/8-T0-178R-F
A10R107	0757-0158	4		RESISTOR 619 1% .5W F TC=0+-100	28480	0757-0158
A10R108-R110				NOT ASSIGNED		
A10R111	0757-0442	9		RESISTOR 10K 1% .125W F TC=0+-100	24546	CT4-1/8-T0-1002-F
A10R112	0757-0442	9		RESISTOR 10K 1% .125W F TC=0+-100	24546	CT4-1/8-T0-1002-F
A10R113	0757-0442	9		RESISTOR 10K 1% .125W F TC=0+-100	24546	CT4-1/8-T0-1002-F
A10R114	0757-0442	9		RESISTOR 10K 1% .125W F TC=0+-100	24546	CT4-1/8-T0-1002-F

†Refer to Section 7 for update information.

*Factory Selected Component (Refer to Section 5).

Table 4-3. Replaceable Parts

A10R115	0757-0442	9		RESISTOR 10K 1% .125W F TC = 0+ -100	24548	CT4-1/8-T0-1002-F	
A10R116	0757-0442	9		RESISTOR 10K 1% .125W F TC = 0+ -100	24548	CT4-1/8-T0-1002-F	
A10R117	0757-0442	9		RESISTOR 10K 1% .125W F TC = 0+ -100	24548	CT4-1/8-T0-1002-F	
A10R118	0757-0442	9		RESISTOR 10K 1% .125W F TC = 0+ -100	24548	CT4-1/8-T0-1002-F	
A10R119	0757-0442	9		RESISTOR 10K 1% .125W F TC = 0+ -100	24548	CT4-1/8-T0-1002-F	
A10R120	0757-0442	9		RESISTOR 10K 1% .125W F TC = 0+ -100	24548	CT4-1/8-T0-1002-F	
A10R121	0757-0442	9		RESISTOR 10K 1% .125W F TC = 0+ -100	24548	CT4-1/8-T0-1002-F	
A10R122	0757-0442	9		RESISTOR 10K 1% .125W F TC = 0+ -100	24548	CT4-1/8-T0-1002-F	
A10R123	0757-0268	1		RESISTOR 9.09K 1% .125W F TC = 0+ -100	19701	6033R-1/8-T0-9091-F	
A10R124	0757-0268	1		RESISTOR 9.09K 1% .125W F TC = 0+ -100	19701	6033R-1/8-T0-9091-F	
A10R125	0757-0268	1		RESISTOR 9.09K 1% .125W F TC = 0+ -100	19701	6033R-1/8-T0-9091-F	
A10R126	0757-0268	1		RESISTOR 9.09K 1% .125W F TC = 0+ -100	19701	6033R-1/8-T0-9091-F	
A10R127	0757-0268	1		RESISTOR 9.09K 1% .125W F TC = 0+ -100	19701	6033R-1/8-T0-9091-F	
A10R128	0757-0268	1		RESISTOR 9.09K 1% .125W F TC = 0+ -100	19701	6033R-1/8-T0-9091-F	
A10R129	0757-0268	1		RESISTOR 9.09K 1% .125W F TC = 0+ -100	19701	6033R-1/8-T0-9091-F	
A10R130	0757-0268	1		RESISTOR 9.09K 1% .125W F TC = 0+ -100	19701	6033R-1/8-T0-9091-F	
A10R131	0757-0268	1		RESISTOR 9.09K 1% .125W F TC = 0+ -100	19701	6033R-1/8-T0-9091-F	
A10R132	0757-0268	1		RESISTOR 9.09K 1% .125W F TC = 0+ -100	19701	6033R-1/8-T0-9091-F	
A10R133	0757-0268	1		RESISTOR 9.09K 1% .125W F TC = 0+ -100	19701	6033R-1/8-T0-9091-F	
A10R134	0757-0268	1		RESISTOR 9.09K 1% .125W F TC = 0+ -100	19701	6033R-1/8-T0-9091-F	
A10R135	0698-3399	5	8	RESISTOR 133 1% .5W F TC = 0+ -100	26480	0698-3399	
A10R136	0698-3399	5		RESISTOR 133 1% .5W F TC = 0+ -100	26480	0698-3399	
A10R137	0698-3399	5		RESISTOR 133 1% .5W F TC = 0+ -100	26480	0698-3399	
A10R138	0698-3399	5		RESISTOR 133 1% .5W F TC = 0+ -100	26480	0698-3399	
A10R139	0698-3399	5		RESISTOR 133 1% .5W F TC = 0+ -100	26480	0698-3399	
A10R140	0698-3399	5		RESISTOR 133 1% .5W F TC = 0+ -100	26480	0698-3399	
A10R141	0698-3399	5		RESISTOR 133 1% .5W F TC = 0+ -100	26480	0698-3399	
A10R142	0698-3399	5		RESISTOR 133 1% .5W F TC = 0+ -100	26480	0698-3399	
A10R143	0757-1060	9	2	RESISTOR 198 1% .5W F TC = 0+ -100	26480	0757-1060	
A10R144	0757-1060	9		RESISTOR 198 1% .5W F TC = 0+ -100	26480	0757-1060	
<i>3746U TO 3012A</i>							
A10R145	0698-3398	2	2	RESISTOR 38.3 1% .5W F TC = 0+ -100	26480	0698-3398	
A10R146	0698-3398	2	2	RESISTOR 38.3 1% .5W F TC = 0+ -100	26480	0698-3398	
<i>3023A AND ABOVE</i>							
A10R146	8159-0005	0	2	JUMPER WIRE 22W	26480	8159-0005	
A10R146	8159-0005	0	2	JUMPER WIRE 22W	26480	8159-0005	
A10R147	0698-3152	8		RESISTOR 3.48K 1% .125W F TC = 0+ -100	24548	CT4-1/8-T0-3481-F	
A10R148	0757-1094	9		RESISTOR 1.47K 1% .125W F TC = 0+ -100	24546	CT4-1/8-T0-1471-F	
A10R149	0757-0438	3		RESISTOR 5.11K 1% .125W F TC = 0+ -100	24546	CT4-1/8-T0-5111-F	
A10R150 ^A	0757-0416	7		RESISTOR 511 1% .125W F TC = 0+ -100	02995	SFR25H	
A10R151	0698-3153	9		RESISTOR 3.83K 1% .125W F TC = 0+ -100	24546	CT4-1/8-T0-3831-F	
A10R152	0698-0083	8		RESISTOR 1.98K 1% .125W F TC = 0+ -100	24546	CT4-1/8-T0-1981-F	
A10R153	0698-0083	8		RESISTOR 1.98K 1% .125W F TC = 0+ -100	24546	CT4-1/8-T0-1981-F	
A10R154	0757-0198	2	2	RESISTOR 100 1% .5W F TC = 0+ -100	26480	0757-0198	
A10R155	0757-0198	2		RESISTOR 100 1% .5W F TC = 0+ -100	26480	0757-0198	
A10R156	0757-0465	8		RESISTOR 100K 1% .125W F TC = 0+ -100	24546	CT4-1/8-T0-1003-F	
A10TP1	1251-0600	0		CONNECTOR-SGL CONT PIN 1.14-MM-BSC-SZ SQ	26480	1251-0600	
A10TP2	1251-0600	0		CONNECTOR-SGL CONT PIN 1.14-MM-BSC-SZ SQ	26480	1251-0600	
A10TP3	1251-0600	0		CONNECTOR-SGL CONT PIN 1.14-MM-BSC-SZ SQ	26480	1251-0600	
A10TP4	1251-0600	0		CONNECTOR-SGL CONT PIN 1.14-MM-BSC-SZ SQ	26480	1251-0600	
A10TP5	1251-0600	0		CONNECTOR-SGL CONT PIN 1.14-MM-BSC-SZ SQ	26480	1251-0600	
A10TP6	0360-2050	8		CONNECTOR-SGL CONT	26480	0360-2050	
A10TP7				NOT ASSIGNED			
A10TP8				NOT ASSIGNED			
A10TP9	1251-0600	0		CONNECTOR-SGL CONT PIN 1.14-MM-BSC-SZ SQ	26480	1251-0600	
A10TP10	1251-0600	0		CONNECTOR-SGL CONT PIN 1.14-MM-BSC-SZ SQ	26480	1251-0600	

Table 4-3. Replaceable Parts

A10TP11	0360-2050	8		CONNECTOR-SGL CONT	28480	0360-2050
A10TP12	0360-2050	8		CONNECTOR-SGL CONT	28480	0360-2050
A10U1	1820-1423	4		IC MV TTL LS MONOSTBL RETRIG DUAL	01295	SN74LS123N
A10U2-UM				NOT ASSIGNED		
A10U5	1820-0471	0	1	IC INV TTL HEX 1-INP	01295	SN7406N
A10U6	1826-0482	1		D/A 10-BIT 18-CBRZ/SDR BPLR	04713	MC3410CL
A10U7	1820-1730	8	7	IC FF TTL LS D-TYPE POS-EDGE-TRIG COM	01295	SN74LS273N
A10U8				NOT ASSIGNED		
A10U9	1820-1730	8		IC FF TTL LS D-TYPE POS-EDGE-TRIG COM	01295	SN74LS273N
A10U10	1820-1730	8		IC FF TTL LS D-TYPE POS-EDGE-TRIG COM	01295	SN74LS273N
A10U11	1826-0482	1		D/A 10-BIT 18-CBRZ/SDR BPLR	04713	MC3410CL
A10U12	1820-1730	8		IC FF TTL LS D-TYPE POS-EDGE-TRIG COM	01295	SN74LS273N
A10U13	1826-1202	8		D/A 10-BIT 18-CERDIP CMOS	24355	AD7533(SEL)
A10U14	1826-0371	1		IC OP AMP LOW-BIAS-HMPD TO-99 PKG	27014	LF256H
A10U15	1820-1730	8		IC FF TTL LS D-TYPE POS-EDGE-TRIG COM	01295	SN74LS273N
A10U16	1826-0371	1		IC OP AMP LOW-BIAS-HMPD TO-99 PKG	27014	LF256H
A10U17	1820-1144	8		IC GATE TTL LS NOR QUAD 2-INP	01295	SN74LS02N
A10U18	1820-1730	8		IC FF TTL LS D-TYPE POS-EDGE-TRIG COM	01295	SN74LS273N
A10U19 ^Δ	1826-2313	5	1	IC OP AMP PRCN QUAD 14 PIN DIP-P	10858	LT1058CN
A10U20	1826-0753	3		IC OP AMP LOW-BIAS-HMPD QUAD 14-DIP-C	04713	MC34004BL
A10U21	1826-0785	1	1	IC OP AMP LOW-BIAS-HMPD DUAL 8-DIP-C	01295	TL072ACJG
A10U22	1826-0138	8		IC COMPARATOR GP QUAD 14-DIP-P PKG	01295	LM339N
A10U23	1826-0138	8		IC COMPARATOR GP QUAD 14-DIP-P PKG	01295	LM339N
A10U24	1826-0932	0		IC OP AMP PRCN 8-DIP-C PKG	06665	OP-27FZ
A10U25	1820-1730	8		IC FF TTL LS D-TYPE POS-EDGE-TRIG COM	01295	SN74LS273N
A10U26 ^Δ	1826-0161	7		IC OP AMP GP QUAD 14-DIP-C PKG	03408	LM324N
A10U27 ^Δ	1826-0161	7		IC OP AMP GP QUAD 14-DIP-C PKG	03408	LM324N
A10U28 ^Δ	1826-0161	7		IC OP AMP GP QUAD 14-DIP-C PKG	03408	LM324N
A10U29	1858-0086	2	8	TRANSISTOR ARRAY 14-PIN PLSTC TO-118	04713	MPO6700
A10U30	1858-0086	2		TRANSISTOR ARRAY 14-PIN PLSTC TO-118	04713	MPO6700
A10U31	1858-0086	2		TRANSISTOR ARRAY 14-PIN PLSTC TO-118	04713	MPO6700
A10U32	1858-0086	2		TRANSISTOR ARRAY 14-PIN PLSTC TO-118	04713	MPO6700
A10U33	1858-0086	2		TRANSISTOR ARRAY 14-PIN PLSTC TO-118	04713	MPO6700
A10U34	1858-0086	2		TRANSISTOR ARRAY 14-PIN PLSTC TO-118	04713	MPO6700
A10U35	1826-0371	1		IC OP AMP LOW-BIAS-HMPD TO-99 PKG	27014	LF256H
A10U36	1820-0304	8	1	IC FF TTL J-K M/S PULSE PRESET/CLEAR	01295	SN7472N
A10VR1	1902-0957	1	2	DIODE-ZNR 9.1V 5% DO-35 PD = .4W TC = +.069%	28480	1902-0957
A10VR2	1902-0957	1		DIODE-ZNR 9.1V 5% DO-35 PD = .4W TC = +.069%	28480	1902-0957
A10VR3	1902-0064	1	1	DIODE-ZNR 7.5V 5% DO-35 PD = .4W TC = +.05%	28480	1902-0064
A10VR4	1902-3381	1	1	DIODE-ZNR 68.1V 5% DO-7 PD = .4W TC = +.079%	28480	1902-3381
A10VR5	1902-0970	8	1	DIODE-ZNR 33V 5% DO-35 PD = .4W TC = +.097%	28480	1902-0970
A10VR6	1902-0953	7	1	DIODE-ZNR 6.2V 5% DO-35 PD = .4W TC = +.053%	28480	1902-0953
A10VR7	1902-0777	3	1	DIODE-ZNR 1N825 6.2V 5% DO-7 PD = .4W	04713	1N825
A10W1	1251-4670	2		CONNECTOR 3-PIN M POST TYPE	28480	1251-4670
	1258-0209	9		JUMPER-REMOVABLE 2 POSITION; .200 IN	28480	1258-0209
A10W2	1251-4670	2		CONNECTOR 3-PIN M POST TYPE	28480	1251-4670
	1258-0209	9		JUMPER-REMOVABLE 2 POSITION; .200 IN	28480	1258-0209
A10W3	1251-4670	2		CONNECTOR 3-PIN M POST TYPE	28480	1251-4670
	1258-0209	9		JUMPER-REMOVABLE 2 POSITION; .200 IN	28480	1258-0209
A10W4	1251-4670	2		CONNECTOR 3-PIN M POST TYPE	28480	1251-4670
	1258-0209	9		JUMPER-REMOVABLE 2 POSITION; .200 IN	28480	1258-0209

Reference Designation	HP Part Number	C D	Qty.	Description	Mfr. Code	Mfr. Part Number
A11						
A11	08657-60200	6	1	MICROPROCESSOR ASSY	28480	08657-60200
A11BT1	1420-0281	2	1	BATTERY 2.8V .35A-HR L/M PIN	28480	1420-0281
A11C1	0180-2207	5	1	CAPACITOR-FXD 100UF + -10% 10VDC TA	56289	150D107X9010R2
A11C2	0180-4135	3				
A11C3	0180-4832	4		CAPACITOR-FXD .01UF + -10% 100VDC CER	28480	0160-4832
A11C4	0180-4135	7				
A11C5	0160-4832	4		CAPACITOR-FXD .01UF + -10% 100VDC CER	28480	0160-4832
A11C6	0160-4832	4		CAPACITOR-FXD .01UF + -10% 100VDC CER	28480	0160-4832
A11C7	0160-4832	4		CAPACITOR-FXD .01UF + -10% 100VDC CER	28480	0160-4832
A11C8	0180-4130					
A11C9	0160-4832	4		CAPACITOR-FXD .01UF + -10% 100VDC CER	28480	0160-4832
A11C10	0180-3888					
A11C11	0160-4832	4		CAPACITOR-FXD .01UF + -10% 100VDC CER	28480	0160-4832
A11C12				NOT ASSIGNED		
A11C13	0160-4832	4		CAPACITOR-FXD .01UF + -10% 100VDC CER	28480	0160-4832
A11C14	0160-4832	4		CAPACITOR-FXD .01UF + -10% 100VDC CER	28480	0160-4832
A11C15	0160-4832	4		CAPACITOR-FXD .01UF + -10% 100VDC CER	28480	0160-4832
A11C16	0160-4786	7		CAPACITOR-FXD 27PF + -5% 100VDC CER 0 + -30	28480	0160-4786
A11C17	0160-4832	4		CAPACITOR-FXD .01UF + -10% 100VDC CER	28480	0160-4832
A11C18	0160-4835	7		CAPACITOR-FXD .1UF + -10% 50VDC CER	28480	0160-4835
A11C19	0160-4832	4		CAPACITOR-FXD .01UF + -10% 100VDC CER	28480	0160-4832
A11C20	0160-4833	5		CAPACITOR-FXD .022UF + -10% 100VDC CER	28480	0160-4833
A11C21	0160-4833	5		CAPACITOR-FXD .022UF + -10% 100VDC CER	28480	0160-4833
A11C22	0160-4786	7		CAPACITOR-FXD 27PF + -5% 100VDC CER 0 + -30	28480	0160-4786
A11C23				NOT ASSIGNED		
A11C24	0180-0229	7				
A11C25	0160-5098	6		CAPACITOR-FXD .22UF + -10% 50VDC CER	16299	CAC05X7R224J050A
A11C27	0160-4832	4		CAPACITOR-FXD .01UF + -10% 100VDC CER	28480	0160-4832
A11C28						
A11CR1	1901-0050	3		DIODE-SWITCHING 80V 200MA 2NS DO-35	9N171	1N4150
A11CR2	1901-0518	8		DIODE-SM SIG SCHOTTKY	28480	1901-0518
A11J1	1252-0277	9		CONN-POST TYPE .100-PIN-SPCG 20-CONT	28480	1252-0277
A11J2	1200-0507	9	2	SOCKET-IC 16-CONT DIP-SLDR	28480	1200-0507
A11J3	1200-0507	9		SOCKET-IC 16-CONT DIP-SLDR	28480	1200-0507
A11J4	1252-0597	6	1	CONN-POST TYPE .100-PIN-SPCG 16-CONT	28480	1252-0597
A11J5	1251-8472	0	1	CONN-POST TYPE .100-PIN-SPCG 26-CONT	28480	1251-8472
A11J6	1251-5595	2		POLARIZING KEY-POST CONN	28480	1251-5595
A11MP1	1400-0966	8		CLIP-CMPNT .17-.185-DIA .195-WD STL	91506	6015-13AT
A11MP2	1400-0966	8		CLIP-CMPNT .17-.185-DIA .195-WD STL	91506	6015-13AT
A11MP3	1400-0966	8		CLIP-CMPNT .17-.185-DIA .195-WD STL	91506	6015-13AT
A11MP4	1400-0966	8		CLIP-CMPNT .17-.185-DIA .195-WD STL	91506	6015-13AT
A11MP5	1400-0966	8		CLIP-CMPNT .17-.185-DIA .195-WD STL	91506	6015-13AT
A11Q1	1854-0810	2		TRANSISTOR NPN SI PD = 625MW FT = 200MHZ	28480	1854-0810
A11Q2	1858-0008	8	1	TRANSISTOR ARRAY 14-PIN PLSTC DIP	28480	1858-0008
A11R1	0698-3162	0				
A11R2	0757-0280	3		RESISTOR 46.4K 1% .125W F TC = 0 + -100	24546	CT4-1/8-T0-4642-F
A11R3	0757-0280	3		RESISTOR 1K 1% .125W F TC = 0 + -100	24546	CT4-1/8-T0-1001-F
A11R4	0757-0442	9		RESISTOR 10K 1% .125W F TC = 0 + -100	24546	CT4-1/8-T0-1002-F
A11R5	0698-3162	0				

†Refer to Section 7 for update information.

*Factory Selected Component (Refer to Section 5).

Δ Errata part change.

Reference Designation	HP Part Number	C D	Qty.	Description	Mfr. Code	Mfr. Part Number
A11R6	0757-0401	0		RESISTOR 100 1% .125W F TC = 0 + -100	24546	CT4-1/8-T0-101-F
A11R7	0698-3437	2		RESISTOR 133 1% .125W F TC = 0 + -100	24546	CT4-1/8-T0-133R-F
A11R8	0698-3162	0		RESISTOR 46.4K 1% .125W F TC = 0 + -100	24546	CT4-1/8-T0-4642-F
A11R9				NOT ASSIGNED		
A11R10	0757-0279	0		RESISTOR 3.16K 1% .125W F TC = 0 + -100	24546	CT4-1/8-T0-3161-F
A11R11	0757-0279	0		RESISTOR 3.16K 1% .125W F TC = 0 + -100	24546	CT4-1/8-T0-3161-F
A11R12	0757-0317	7		RESISTOR 1.33K 1% .125W F TC = 0 + -100	24546	CT4-1/8-T0-1331-F
A11R13	0757-1094	9		RESISTOR 1.47K 1% .125W F TC = 0 + -100	24546	CT4-1/8-T0-1471-F
A11R14	0698-3162	0		RESISTOR 46.4K 1% .125W F TC = 0 + -100	24546	CT4-1/8-T0-4642-F
A11R15	0698-3444	1		RESISTOR 316 1% .125W F TC = 0 + -100	24546	CT4-1/8-T0-316R-F
A11R16	0698-3444	1		RESISTOR 316 1% .125W F TC = 0 + -100	24546	CT4-1/8-T0-316R-F
A11R17	0698-3154	0		RESISTOR 4.22K 1% .125W F TC = 0 + -100	24546	CT4-1/8-T0-4221-F
A11R18	0757-0417	8	1	RESISTOR 562 1% .125W F TC = 0 + -100	24546	CT4-1/8-T0-562R-F
A11R19	0757-0290	5	1	RESISTOR 6.19K 1% .125W F TC = 0 + -100	19701	5033R-1/8-T0-6191-F
A11R20	0757-0442	9		RESISTOR 10K 1% .125W F TC = 0 + -100	24546	CT4-1/8-T0-1002-F
A11R21	0757-0419	0		RESISTOR 681 1% .125W F TC = 0 + -100	24546	CT4-1/8-T0-681R-F
A11R22	0757-0279	0		RESISTOR 3.16K 1% .125W F TC = 0 + -100	24546	CT4-1/8-T0-3161-F
A11R23	0757-0442	9		RESISTOR 10K 1% .125W F TC = 0 + -100	24546	CT4-1/8-T0-1002-F
A11S1	3101-2482	5	2	SWITCH-RKR DIP-RKR-ASSY 3PDT .05A 30VDC	28480	3101-2482
A11S2	3101-2482	5		SWITCH-RKR DIP-RKR-ASSY 3PDT .05A 30VDC	28480	3101-2482
A11S3	3101-2135	5	1	SWITCH-RKR DIP-RKR-ASSY DPDT .05A 30VDC	28480	3101-2135
A11TP1	0360-2359	8		CONNECTOR-SGL CONT	28480	0360-2359
A11TP2	0360-2359	8		CONNECTOR-SGL CONT	28480	0360-2359
A11TP3	0360-2359	8		CONNECTOR-SGL CONT	28480	0360-2359
A11TP4	0360-2359	8		CONNECTOR-SGL CONT	28480	0360-2359
A11TP5	0360-2359	8		CONNECTOR-SGL CONT	28480	0360-2359
A11TP6	0360-2359	8		CONNECTOR-SGL CONT	28480	0360-2359
A11TP7	0360-2359	8		CONNECTOR-SGL CONT	28480	0360-2359
A11TP8	0360-2359	8		CONNECTOR-SGL CONT	28480	0360-2359
A11TP9	0360-2359	8		CONNECTOR-SGL CONT	28480	0360-2359
A11TP10	0360-2359	8		CONNECTOR-SGL CONT	28480	0360-2359
A11TP11	0360-2359	8		CONNECTOR-SGL CONT	28480	0360-2359
A11TP12	0360-2359	8		CONNECTOR-SGL CONT	28480	0360-2359
A11TP13	0360-2359	8		CONNECTOR-SGL CONT	28480	0360-2359
A11TP14	0360-2359	8		CONNECTOR-SGL CONT	28480	0360-2359
A11U1	1820-2024	3	1	IC DRVR TTL LS LINE DRVR OCTL	01295	SN74LS244N
A11U2	1820-3100		2	IC DCDR TTL S 3-TO-8-LINE 3-INP	28480	1820-3100
A11U3	1818-3185		1	IC CMOS 16384 (16K) STAT RAM 250-NS 3-S	28480	1818-3185
A11U4	1826-1338	2	1	IC MISC 8-DIP-P PKG	01717	TL7705A
A11U5				IF U5 FAILS, CONTACT HEWLETT-PACKARD SERVICE CENTER		
A11U6	1820-2102	8	1	IC LCH TTL LS D-TYPE OCTL	01295	SN74LS373N
A11U7				NOT ASSIGNED		
A11U8	1820-1759	9	4	IC BFR TTL LS NON-INV OCTL	27014	DM81LS97N
A11U9	1820-2099	2	1	IC MICPROC NMOS 8-BIT	04713	MC6802P
A11U10	1820-2075	4	2	IC TRANSCEIVER TTL LS BUS OCTL	01295	SN74LS245N
A11U11	1820-1416	5	1	IC SCHMITT-TRIG TTL LS INV HEX 1-INP	01295	SN74LS14N
A11U12	1820-2075	4		IC TRANSCEIVER TTL LS BUS OCTL	01295	SN74LS245N
A11U13	1820-1491	6	1	IC BFR TTL LS NON-INV HEX 1-INP	01295	SN74LS367AN
A11U14	1820-1759	9		IC BFR TTL LS NON-INV OCTL	27014	DM81LS97N

†Refer to Section 7 for update information.

*Factory Selected Component (Refer to Section 5).

Δ Errata part change.

Reference Designation	HP Part Number	C D	Qty.	Description	Mfr. Code	Mfr. Part Number
A11U15	1820-1759	9		IC BFR TTL LS NON-INV OCTL	27014	DM81LS97N
A11U16	1820-2219	8	1	IC MICPROC-ACCESS NMOS 8-BIT	04713	MC68488P
A11U17	1820-1759	9		IC BFR TTL LS NON-INV OCTL	27014	DM81LS97N
A11U18	1820-1199	1	1	IC INV TTL LS HEX 1-INP	01295	SN74LS04N
A11U19	1820-3100	3		IC DCDR TTL LS 3-TO-8-LINE 3-INP	28480	1820-3100
A11U20	1820-3513	4	4	IC TRANSCEIVER TTL INSTR-BUS IEEE-488	28480	1820-3513
A11U21	1820-1208	3	1	IC GATE TTL LS OR QUAD 2-INP	01295	SN74LS32N
A11U22	1820-3100			IC DCDR TTL S 3-TO-8-LINE 3-INP	28480	1820-3100
A11U23	1820-1201	6		IC GATE TTL LS AND QUAD 2-INP	01295	SN74LS08N
A11U24	1820-3431			IC TRANSCEIVER TTL INSTR-BUS IEEE-488	04713	1820-3431
A11U25	1820-1689	4		IC TRANSCEIVER TTL INSTR-BUS IEEE-488	04713	MC3446AP
A11U27	1820-1112	8		IC FF TTL LS D-TYPE POS-EDGE-TRIG	01295	SN74LS74AN
A11U28	1820-1689	4		IC TRANSCEIVER TTL INSTR-BUS IEEE-488	04713	MC3446AP
A11U29	1820-1568	8	1	IC BFR TTL LS BUS QUAD	01295	SN74LS125AN
A11U30	1820-2056	1		IC FF TTL LS D-TYPE POS-EDGE-TRIG COM	01295	SN74LS378N
A11U31	1820-1216	3		IC DCDR TTL LS 3-TO-8-LINE 3-INP	01295	SN74LS138N
A11VR1	1902-0946	8	1	DIODE-ZNR 3.3V 5% DO-35 PD = .4W TC = -.039%	28480	1902-0946
A11XU1-XU4				NOT ASSIGNED		
XU5	1200-0567	1	1	SOCKET-IC 28-CONT DIP DIP-SLDR	28480	1200-0567
A11XU6-XU8				NOT ASSIGNED		
A11XU10-XU15				NOT ASSIGNED		
XU32	1200-0567	1	1	SOCKET-IC 28-CONT DIP DIP-SLDR	28480	1200-0567
A11Y1	0410-1180	0		CRYSTAL-QUARTZ 4.000 MHZ HC-18/U-HLDR	28480	0410-1180

†Refer to Section 7 for update information.

*Factory Selected Component (Refer to Section 5).

Δ Errata part change.

Table 6-3. Replaceable Parts

Reference Designation	HP Part Number	C D	Qty.	Description	Mfr. Code	Mfr. Part Number
A12-A14				NOT ASSIGNED		
A15						
A15	0960-0679	5	1	LINE MODULE-FILTERED	28480	0960-0679
A16						
A16	0950-0411	2	1	10MHZ REFERENCE OSCILLATOR ASSEMBLY (OPTION 001 ONLY)		0950-0411
A16W1	08656-60166	9	1	CABLE ASSEMBLY-COAXIAL A16 REFERENCE OSCILLATOR TO REAR PANEL J6 "HIGH STABILITY TIMEBASE OUTPUT"	28480 28480	08656-60166 08656-60166

† Refer to Section 7 for update information.

* Factory Selected Component (Refer to Section 5).

Table 6-3. Replaceable Parts

Reference Designation	HP Part Number	C D	Qty.	Description	Mfr. Code	Mfr. Part Number
B1	3160-0512	2	1	FAN-TBAX 38.8-CFM 24VDC	28480	3160-0512
C1-C9				NOT ASSIGNED		
C10	0160-4082	6		CAPACITOR-FDTHRU 1000PF 20% 200V CER	28480	0160-4082
F1	2110-0002	9		FUSE 2A 250V NTD 1.25X.25 UL (FOR 100/120V OPERATION)	75915	312002
F1	2110-0043	8	1	FUSE 1.5A 250V NTD 1.25X.25 UL (FOR 220/240V OPERATION)	28480	2110-0043
FL1	08656-60005	5	1	PCA BP FILTER	28480	08656-60005
J1	1250-0118	3	2	CONNECTOR-RF BNC FEM SGL-HOLE-FR 50-OHM (*MOD INPUT/OUTPUT*, INCLUDES ATTACHING HARDWARE)	28480	1250-0118
J2	5061-5386	0	1	CONN ASSY TYPE N (*RF OUTPUT*, EXCEPT OPTION 002 INCLUDES ATTACHING HARDWARE)	28480	5061-5386
J2	1250-1811	5	1	RF CONNECTOR ASSEMBLY (OPTION 002 ONLY, REAR PANEL *RF OUTPUT*, INCLUDES ATTACHING HARDWARE)	28480	5061-5386
J3	1250-0102	5	2	CONNECTOR-RF BNC FEM SGL-HOLE-FR 50-OHM (*TIMEBASE INPUT*, P/O W22)	28480	1250-0102
J3MP1	2190-0068	5	2	WASHER-LK INTL T 1/2 IN .505-IN-ID	28480	2190-0068
J3MP2	2950-0054	1	2	NUT-HEX-DBL-CHAM 1/2-28-THD .125-IN-THK	00000	ORDER BY DESCRIPTION
J4	1250-0102	5	2	CONNECTOR-RF BNC FEM SGL-HOLE-FR 50-OHM (*TIMEBASE OUTPUT*, P/O W24)	28480	1250-0102
J4MP1	2190-0068	5		WASHER-LK INTL T 1/2 IN .505-IN-ID	28480	2190-0068
J4MP2	2950-0054	1		NUT-HEX-DBL-CHAM 1/2-28-THD .125-IN-THK	00000	ORDER BY DESCRIPTION
J5	1250-0118	3		CONNECTOR-RF BNC FEM SGL-HOLE-FR 50-OHM (*SEQ*)	28480	1250-0118
J5MP1	2190-0016	3	2	WASHER-LK INTL T 3/8 IN .377-IN-ID	28480	2190-0016
J5MP2	2950-0001	8	2	NUT-HEX-DBL-CHAM 3/8-32-THD .094-IN-THK	00000	ORDER BY DESCRIPTION
J6				NOT SEPARATELY REPLACEABLE, P/O A16W1 (*HIGH STABILITY TIME BASE OUTPUT*, ADDED FOR OPTION 001 ONLY)		
J7	1251-6835	5	1	CONN-RECT MICRORBN 24-CKT 24-CONT	28480	1251-6835
J8-J2199				NOT ASSIGNED		
J2200	1250-1251	7	2	ADAPTER-COAX STR F-SMA F-SMA (*800 MHZ INPUT*, ADDED FOR OPTION 022 ONLY)	28480	1250-1251
J2201	1250-1251	7	2	ADAPTER-COAX STR F-SMA F-SMA (*800 MHZ OUTPUT*, ADDED FOR OPTION 022 ONLY)	28480	1250-1251
MP1	08657-21005	4	1	CASTING MACHINED (EXCEPT OPTION 022)	28480	08657-21005
MP1	08657-61035	4	1	CASTING MACHINED (OPTION 022 ONLY)	28480	08657-61035
MP2	5040-7202	9	1	TRIM TOP	28480	5040-7202
MP3	5001-0439	8	2	TRIM SIDE FRT F	28480	5001-0439
MP4	08656-00156	1	1	EXTERNAL CVR TOP	28480	08656-00156
MP5	0340-1119	6	4	INS COV TO-66	28480	0340-1119
MP6	08656-00034	4	1	HINGE TOP	28480	08656-00034
MP7	1460-1761	9	4	SPRING-CPRSN .36-IN-OD 1.5-IN-OA-LG MUW	28480	1460-1761
MP8	2740-0003	5	5	NUT-HEX-W/LKWR 10-32-THD .125-IN-THK	00000	ORDER BY DESCRIPTION
MP9	3050-0002	2	4	WASHER-FL MTLC NO. 10 .203-IN-ID	28480	3050-0002
MP10	0363-0159	0	2	RFI STRIP-FINGERS BE-CU ZINC PLATED	28480	0363-0159

†Refer to Section 7 for update information.

*Factory Selected Component (Refer to Section 5)

Δ Errata part change

Table 6-3. Replaceable Parts

Reference Designation	HP Part Number	C D	Qty.	Description	Mfr. Code	Mfr. Part Number
MP11	2360-0113	2	20	SCREW-MACH 6-32 .25-IN-LG PAN-HD-POZI	00000	ORDER BY DESCRIPTION
MP12	08657-61014	9	1	COVER-TOP RF	28480	08657-61014
MP13	5021-6839	6	2	STANDOFF-HEX 1-IN-LG .25-IN-AVF STNLS-STEEL	28480	5021-6839
MP14	5060-9803	2	2	STRAP HNDL AY 15	28480	5060-9803
MP15	5041-6834	3	4	STRP HOLE & CAP	28480	5041-6834
MP16				NOT ASSIGNED		
MP17	0515-1239	2	4	SCREW-MACH M5 X 0.8 12MM-LG	28480	0515-1239
MP18				NOT ASSIGNED		
MP19	08656-20112	1	2	RTNR RF GASKET	28480	08656-20112
MP20	08656-00100	5	2	RETAINER HINGE	28480	08656-00100
MP21	8160-0350	1	1	RFI GASKET MNL/NPRN 3.2-MM-OD 25-MM-LG	28480	8160-0350
MP22	08657-61011	6	1	CVR BOTTOM RF	28480	08657-61011
MP23	08656-00059	3	1	HINGE BOTTOM	28480	08656-00059
MP24	08656-00157	2	1	EXTERNAL CVR BOT	28480	08656-00157
MP25	08656-20101	8	2	FOOT FRONT	28480	08656-20101
MP26	1460-1345	5	2	TILT STAND SST	28480	1460-1345
MP27	5040-7201	8	2	FOOT FULL-1/2 MOD	28480	5040-7201
MP28				NOT ASSIGNED		
MP29	7120-8130	6	2	CAUTION LABEL	28480	7120-8130
MP30				NOT ASSIGNED		
MP31	08656-00079	7	4	INTERNAL RF COVER #1	28480	08656-00079
MP32	08656-00080	0	2	INTERNAL RF COVER #2	28480	08656-00080
MP33	08657-00027	6	2	INTERNAL RF COVER #3	28480	08656-00081
MP34	08656-00082	2	2	INTERNAL RF COVER #4	28480	08656-00082
MP35	08656-00083	3	2	INTERNAL RF COVER #5	28480	08656-00083
MP36	08657-00013	0	2	CVR INTRL RF #6	28480	08657-00013
MP37	08656-00086	6	4	INTERNAL RF COVER #8	28480	08656-00086
MP38	08656-00087	7	2	INTERNAL RF COVER #9	28480	08656-00087
MP39				NOT ASSIGNED		
MP40				NOT ASSIGNED		
MP41	0520-0131	2	1	SCREW-MACH 2-56 .438-IN-LG PAN-HD-POZI	00000	ORDER BY DESCRIPTION
MP42	3030-0189	4	4	SCREW-SKT HD CAP 4-40 .25-IN-LG SST	00000	ORDER BY DESCRIPTION
MP43				NOT ASSIGNED		
MP44	3050-0890	6	1	WASHER-FL MTLC 2.5MM 2.78MM-ID	28480	3050-0890
MP45				NOT ASSIGNED		
MP46	08657-00006	1	1	RFI CLIP-OUTPUT	28480	08657-00006
MP47	08657-00005	0	1	RFI CLIP-OUTPUT	28480	08657-00005
MP48	08656-00037	7	1	WALL CLIP SEMI-R	28480	08656-00037
MP49	08656-00039	9	1	FEEDTHRU BRACKET	28480	08656-00039
MP50	2360-0123	4	8	SCREW-MACH 6-32 .625-IN-LG PAN-HD-POZI	00000	ORDER BY DESCRIPTION
MP51	8150-4815	0	3	WIRE 22AWG 1X22 105C	28480	8150-4815
MP52	7100-1305	1	1	TRANSFORMER COVER .8-IN-DIP	28480	7100-1305
MP53	1400-0031	8	1	CLMP-CA .375-DIA .5-WD NYL	28480	1400-0031
MP54	08657-00028	7	1	REAR PANEL	28480	08657-00028
MP55	2360-0191	6	1	SCREW-MACH 6-32 .188-IN-LG PAN-HD-POZI	00000	ORDER BY DESCRIPTION

Refer to Section 7 for update information.

*Factory Selected Component (Refer to Section 5).

Δ Errata part change.

Table 6-3. Replaceable Parts

Reference Designation	HP Part Number	C D	Qty.	Description	Mfr. Code	Mfr. Part Number
MP58	0380-0001	5	1	TERMINAL-SLDR LUG LK-MTG FOR #6-SCR	28480	0380-0001
MP57	2420-0003	7	5	NUT-HEX-DBL-CHAM 6-32-THD .094-IN-THK	28480	2420-0003
MP58	2190-0008	1	4	WASHER-LX HLCL NO. 8 .141-IN-ID	28480	2190-0008
MP59	3050-0227	3	4	WASHER-FL MTLCL NO. 8 .148-IN-ID	28480	3050-0227
<i>283U AND ABOVE</i>						
<i>MP57-59</i>				NOT ASSIGNED		
MP60	0860-0088	4	1	HOLE PLUG FOR .375-D-HOLE NYL	28480	0860-0088
MP61	0380-0844	4	2	STANDOFF-HEX .327-IN-LG 6-32-THD	28480	0380-0844
MP62	0624-0208	2	2	SCREW-TPG 6-32 .25-IN-LG PAN-HD-POZI STL	00000	ORDER BY DESCRIPTION
MP63	1400-0054	5	2	CLAMP-CABLE .078-DIA .375-WD STL	28480	1400-0054
MP64	08656-20188	5	1	HP B SHIELD	28480	08656-20188
MP65	7120-8348	6	2	LABEL, FRONT	28480	7120-8348
MP66	08657-40001	0	1	KEY PAD #1	28480	08657-40001
MP67	08657-40002	1	1	KEY PAD #2	28480	08657-40002
<i>2746U TO 2852A</i>						
<i>MP68</i>	08657-21004	3	14	STAND OFF	28480	08657-21004
<i>MP69</i>	08657-00007	2	1	FRONT PANEL SUPPORT	28480	08657-00007
<i>2919A AND ABOVE</i>						
<i>MP68</i>	08657-21014	5	14	STAND OFF	28480	08657-21014
<i>MP69</i>	08657-00018	5	1	FRONT PANEL SUPPORT	28480	08657-00018
MP70	2950-0132	6	1	NUT-HEX-DBL-CHAM 7/16-26-THD .094-IN-THK	00000	ORDER BY DESCRIPTION
MP71	2190-0104	0	1	WASHER-LX INTL T 7/16 IN .438-IN-ID	28480	2190-0104
MP72	2190-0018	3		WASHER-LX INTL T 3/8 IN .377-IN-ID	28480	2190-0018
MP73	2950-0001	8		NUT-HEX-DBL-CHAM 3/8-32-THD .094-IN-THK	00000	ORDER BY DESCRIPTION
MP74	3050-0225	1	4	WASHER-FL MTLCL 1/4 IN .265-IN-ID	28480	3050-0225
MP75				WIRE 22AWG 1X22		ORDER BY DESCRIPTION
MP76	1400-0249	0	17	CABLE TIE .062-.025-DIA .091-WD NYL	28480	1400-0249
MP77	0535-0109	5	13	NUTM-DBL-HX M5	28480	0535-0109
MP78	0380-0920	9	4	STANDOFF-HEX .875-IN-LG 6-32-THD	28480	0380-0920
MP79	0380-1817	3	4	STANDOFF-HEX .64-IN-LG 6-32-THD	00000	ORDER BY DESCRIPTION
MP80	2190-0008	3	8	WASHER-LX EXT T NO. 8 .141-IN-ID	28480	2190-0008
MP81-MP99				NOT ASSIGNED		
MP100	08657-61008	1	1	FRONT PANEL (EXCEPT OPTION 002)	28480	08657-61008
MP100	08657-61050	3	1	FRONT PANEL (OPTION 002 ONLY)	28480	08657-61050
MP101				NOT ASSIGNED		
MP102	2420-0003	7		NUT-HEX-DBL-CHAM 6-32-THD .094-IN-THK	28480	2420-0003
MP103	2190-0918	4	1	WASHER-LX HLCL NO. 8 .141-IN-ID	28480	2190-0918
MP104-MP108				NOT ASSIGNED		
<i>2746U TO 2852A</i>						
<i>MP107</i>	2360-0184	7	6	SCREW-MACH 6-32 .438-IN-LG 82 DEG	00000	ORDER BY DESCRIPTION
<i>2919A AND ABOVE</i>						
<i>MP107</i>	0515-0896	5	4	SCREW-MACH 6-32 .438-IN-LG 82 DEG	00000	ORDER BY DESCRIPTION
MP108				NOT ASSIGNED		
MP109	08656-00147	0	1	BRKT OUTPUT CONN	28480	08656-00147
MP110	0380-1088	2	8	STANDOFF-HEX .438-IN-LG 4-40THD	00000	ORDER BY DESCRIPTION
MP111	2200-0111	2		SCREW-MACH 4-40 .64-IN-LG PAN-HD-POZI	00000	ORDER BY DESCRIPTION
MP112	1400-0510	8	9	CLAMP-CABLE .15-DIA .62-WD NYL	28480	1400-0510
MP113-MP124				NOT ASSIGNED		
MP125	5001-6501	5	4	TRANS SPACER TO 3	28480	5001-6501
MP126				NOT ASSIGNED		
MP127	2200-0105	4	4	SCREW-MACH 4-40 .312-IN-LG PAN-HD-POZI	00000	ORDER BY DESCRIPTION
MP128	0380-0533	0	2	STANDOFF-HEX 1-IN-LG 4-40THD .25-IN-A/F	00000	ORDER BY DESCRIPTION
MP129	7120-4298	7	1	LABEL-WARNING .688-IN-WD 1.6-IN-LG AL	28480	7120-4298
MP130				NOT ASSIGNED		

†Refer to Section 7 for update information.

*Factory Selected Component (Refer to Section 5)

Δ Errata part change

Table 6-3. Replaceable Parts

Reference Designation	HP Part Number	C D	Qty.	Description	Mfr. Code	Mfr. Part Number
<i>8746U TO 8852A</i>						
MP131	2200-0103	2	18	SCREW-MACH 4-40 .26-IN-LG PAN-HD-POZI	00000	ORDER BY DESCRIPTION
<i>8918A AND ABOVE</i>						
MP131	0616-1079	8	14	SCREW-MACH 4-40 .26-IN-LG PAN-HD-POZI	00000	ORDER BY DESCRIPTION
MP132				NOT ASSIGNED		
MP133	2680-0073	1	4	SCREW-MACH 10-32 2-IN-LG PAN-HD-POZI	00000	ORDER BY DESCRIPTION
MP134	2380-0201	9	4	SCREW-MACH 6-32 .5-IN-LG PAN-HD-POZI	00000	ORDER BY DESCRIPTION
MP135	2180-0008	3		WASHER-LX EXT T NO. 6 .141-IN-HD	00000	ORDER BY DESCRIPTION
MP136	2180-0918	4	1	WASHER-LX HLCL NO. 6 .141-IN-HD	28480	2180-0918
MP137-MP139				NOT ASSIGNED		
MP140	3180-0309	6	1	FINGER GUARD	48833	12801-43 UL VERSION
MP141	2380-0201	9	4	SCREW-MACH 6-32 .5-IN-LG PAN-HD-POZI	00000	ORDER BY DESCRIPTION
MP142	2380-0219	9	4	SCREW-MACH 6-32 1.375-IN-LG PAN-HD-POZI	00000	ORDER BY DESCRIPTION
<i>8833U AND ABOVE</i>						
MP142	0616-1903	7	4	SCREW-MACH 6-32 .625-IN-LG PAN-HD-POZI	28480	0616-1903
MP143	2200-0111	2		SCREW-MACH 4-40 .5-IN-LG PAN-HD-POZI	00000	ORDER BY DESCRIPTION
MP144	8960-0041	1	1	PLUG-HOLE FL-HD FOR .5-D-HOLE NYL	28480	8960-0041
MP145	08657-00026	5	1	RFI CUP	28480	08657-00026
MP148	2510-0045	8	58	SCREW-MACH 6-32 .375-IN-LG PAN-HD-POZI	00000	ORDER BY DESCRIPTION
MP147	3050-0176	1	3	WASHER-FL MTLCL NO. 6 .188-IN-HD	28480	3050-0176
MP148	3050-0002	2	4	WASHER-FL MTLCL NO. 10 .203-IN-HD	28480	3050-0002
MP149	2510-0045	8	58	SCREW-MACH 6-32 .375-IN-LG PAN-HD-POZI	00000	ORDER BY DESCRIPTION
MP150	7121-4983	7	1	NAMEPLATE 9.23-MM-WVD 13.7-MM-LG CU	28480	7121-4983
MP151	2380-0116	4	16	SCREW-MACH 6-32 .312-IN-LG PAN-HD-POZI	00000	ORDER BY DESCRIPTION
MP152	08657-00053	8	1	CONNECTOR PLATE (OPTION 022 ONLY)	28480	08657-00053
MP153	2380-0116	4	1	SCREW-MACH 6-32 .312-IN-LG PAN-HD-POZI (IF ONLY OPTION 022 IS INSTALLED)	00000	ORDER BY DESCRIPTION
MP153	2200-0105	4	1	SCREW-MACH 4-40 .312-IN-LG PAN-HD-POZI (IF OPTION 022 AND 001 ARE INSTALLED)	00000	ORDER BY DESCRIPTION
MP154	2420-0003	7	5	NUT-HEX-DBL-CHAM 6-32-THD .094-IN-THK	28480	2420-0003
MP155	2380-0201	9	4	SCREW-MACH 6-32 .5-IN-LG PAN-HD-POZI	00000	ORDER BY DESCRIPTION
MP156	2180-0918	4	1	WASHER-LX HLCL NO. 6 .141-IN-HD	28480	2180-0918
P1	1251-7045	1	1	CONNECT D-SUBMIN 15-CKT	28480	1251-7045
	1252-0653	5	7	CONTACT-CONN UWW-SUBMIN-D FEM CRP	28480	1252-0653
	1252-1045	1	6	CONTACT-CONN UWW-SUBMIN-D FEM CRP	00779	745230-2
R1	0757-0346	2	1	RESISTOR 10 1% .125W F TC = 0 + .100	24546	CT4-1/8-TO-10R0-F
T1	9100-4412	9	1	TRANSFORMER-POWER 100/120/220/240V	28480	9100-4412
U1	1826-1181	3	1	IC V RGLTR-FXD-POS 14.7/15.3V TO-3 PKG	27014	LM340AK-15
U2 ^Δ	1826-0677	0		ICR 338 M03	28480	1826-0677
U3	1826-C169	5	1	IC V RGLTR TO-3	27014	LM320K-15
U4	1906-C231	2	1	DIODE-CT-RECT 200V 15A	1B548	F712
W1				24 AWG WIRE (Ø7) NOT SEPARATELY REPLACEABLE		
W2	08657-61012	7	1	FRONT PANEL HARNESS W16P4 TO A2J1	28480	08657-61012
W3	08657-61039	8	1	COAX CABLE ASSEMBLY A3A1J1 TO A7	28480	08657-61039
W4	08656-60169	2	1	RIBBON CABLE CNDCT28AWG W16P3 TO C10, A3J1	28480	08656-60169
W5	08656-60019	1	1	COAX CABLE ASSEMBLY (smc-smc 0 A3J8 TO A6J3)	28480	08656-60019
W6	08657-61053	2	1	RIBBON CABLE ASSEMBLY A6J402 TO A4J1	28480	08657-61053

†Refer to Section 7 for update information.

*Factory Selected Component (Refer to Section 5).

Δ Errata part change

Table 6-3. Replaceable Parts

Reference Designation	HP Part Number	C D	Qty.	Description	Mfr. Code	Mfr. Part Number
W7	08656-60171	6	1	RIBBON CABLE CNDCT28AWG W16P2 TO A6J401	28480	08656-60171
W8	08656-20022	2	1	SEMI-RIGID CABLE 2.18 NO CONN FL1 TO A4	28480	08656-20022
W9	08656-20019	7	1	SEMI-RIGID CABLE 2.18 NO CONN A8 TO A4	28480	08656-20019
W10	08656-20023	3	1	SEMI-RIGID CABLE 2.18 NO CONN A8 TO A6J301	28480	08656-20023
W11	08657-61016	1	1	ATTENUATOR DRIVER CABLE A10J3 TO A9A1J1	28480	08657-61016
W12	08657-21019	0	1	SEMI-RIGID CABLE A6J303 TO A9J4	28480	08657-21019
W13	08657-21021	4	1	SEMI-RIGID CABLE A9J3 TO A6J302	28480	08657-21021
W14	08657-21020	3	1	SEMI-RIGID CABLE A6J203 TO A9J2	28480	08657-21020
W15	08656-60172	7	1	RIBBON CABLE 20CNDCT28AWG A11J1 TO A10J1	28480	08656-60172
W16	08657-61009	2	1	MAIN WIRING HARNESS	28480	08657-61009
	0360-0037	7		TERMINAL-SLDR LUG PL-MTG FOR-#6-SCR	28480	0360-0037
	0362-0227	1	4	CONNECTOR-SGL CONT SKT 1.14-MM-BSC-SZ	28480	0362-0227
W16P1	1251-7044	0		CONNECTOR 15-PIN M D TYPE	28480	1251-7044
	1252-0311	2	14	CONTACT-CONN UW-POST-TYPE M CRP	28480	1252-0311
W16P2	1252-0461	3	1	CONNECTOR 9-PIN M	28480	1252-0461
W16P3	1252-0004	0		CONNECTOR 9-PIN M	28480	1252-0004
W16P4	1252-0004	0		CONNECTOR 9-PIN M	28480	1252-0004
W16P5	1251-5207	3		CONNECTOR 16-PIN F POST TYPE	28480	1251-5207
	1251-4182	1	14	CONNECTOR-SGL CONT SKT .025-IN-BSC-SZ SQ	28480	1251-4182
W16P6	1251-4968	1		CONNECTOR 7-PIN F POST TYPE	28480	1251-4968
	1251-3411	7	6	CONTACT-CONN UW-POST-TYPE FEM CRP	28480	1251-3411
	1251-3966	7	18	CONTACT-CONN UW-POST-TYPE FEM CRP	28480	1251-3966
W16P7	1251-4968	1		CONNECTOR 7-PIN F POST TYPE	28480	1251-4968
	1251-3411	7		CONTACT-CONN UW-POST-TYPE FEM CRP	28480	1251-3411
	1251-3966	7		CONTACT-CONN UW-POST-TYPE FEM CRP	28480	1251-3966
W16P8	1251-3537	8		CONNECTOR 10-PIN F POST TYPE	28480	1251-3537
W17	08657-61006	9	1	SEMI-RIGID CABLE 2.18 SMA-NONE A9J11 TO FRONT PANEL J2 "RF OUTPUT"	28480	08657-61006
W18	08656-60173	8	1	RIBBON CABLE 26CNDCT28AWG A11J5 TO REAR PANEL "HP-IB"	28480	08656-60173

† Refer to Section 7 for update information

* Factory Selected Component (Refer to Section 5).

Δ Errata part change

Table 6-3. Replaceable Parts

Reference Designation	HP Part Number	C D	Qty.	Description	Mfr. Code	Mfr. Part Number
W19 ^A	08656-60362	4		REGULATOR WIRE HARNESS	28480	08656-60362
W19C1	0180-2620	6	1	CAPACITOR-FXD 2.2UF + -10% 50VDC TA	25088	D2P2GS1B50K
W19C2	0180-0291	3		CAPACITOR-FXD 1UF + -10% 35VDC TA	66289	160D106X8035A2
W19C3	0180-1735	2	1	CAPACITOR-FXD .22UF + -10% 35VDC TA	66289	160D224X8035A2
W19C4	0180-0100	3		CAPACITOR-FXD 4.7UF + -10% 35VDC TA	66289	160D476X8035B2
W19C5	0180-0228	6	1	CAPACITOR-FXD 22UF + -10% 15VDC TA	66289	160D226X8015B2
W19C6	0180-0374	3	1	CAPACITOR-FXD 10UF + -10% 20VDC TA	66289	160D106X9020B2
W19C7	0180-3631	8	1	CAPACITOR-FXD 2UF + -5% 50VDC MET-POLYC	28480	0180-3631
W19MP1	0360-0009	3	1	TERMINAL-SLDR LUG PLMTG FOR-#6-SCR	28480	0360-0009
W19MP2	1200-0830	8	1	SOCKET-XSTR 2-CONT TO-3 SLDR-EYE	28480	1200-0830
W19MP3	1200-1323	8	1	SOCKET-XSTR 2-CONT TO-3 DIP-SLDR	72825	8T3H-X3A-X2-43
W19P1	1252-0321	4	1	CONNECT D-SUBMIN 16-CKT 16-CONT	28480	1252-0321
W19P2	1251-7044	0	1	CONNECTOR 16-PIN M D TYPE	28480	1251-7044
W20	8120-1378	1	1	CABLE ASSY 18AWG 3-CONDCT JGK-JKT LINE POWER CABLE	28480	8120-1378
W21	08657-61010	5	1	SEMI-RIGID CABLE ASSEMBLY A8J11 TO W23 ADDED IN PLACE OF W17 FOR OPTION 002	28480	08657-61010
W22	08656-60183	0	1	COAX CABLE ASSEMBLY F BNC-SMC 5 REAR PANEL J3 "TIMEBASE INPUT" TO A3J6	28480	08656-60183
W23	08657-60187	4	1	SEMI-RIGID CABLE ASSEMBLY W21 TO REAR PANEL J2 "RF OUTPUT" ADDED IN PLACE OF W17 FOR OPTION 002	28480	08657-60187
W24	08656-60184	1	1	COAX CABLE ASSEMBLY (3) A3J7 TO REAR PANEL "TIMEBASE OUTPUT"	28480	08656-60184
W25	08657-61039	8	1	COAX CABLE ASSEMBLY A7 TO A8J4	28480	08657-61039
W26	8120-2628	2	1	CABLE ASSY-COAX 50-OHM 30PF/FT J8 "HIGH STABILITY TIMEBASE OUTPUT" TO J3 "TIMEBASE INPUT", OPTION 001 ONLY	28480	8120-2628
W27	08657-61039	8	1	COAX CABLE ASSEMBLY A8J1 TO A8J2	28480	08657-61039
W28-W2199				NOT ASSIGNED		
W2200	08657-61077	4	2	CABLE ASSEMBLY (GRAY, OPTION 022 ONLY) J2200 (800 MHZ REF INPUT) TO W2203	28480	08657-61077
W2201 ^A	08657-61083	2		CABLE ASSEMBLY (GRAY, OPTION 022 ONLY) J2201 (800 MHZ REF OUTPUT) TO W2202	28480	08657-61083
W2202 ^A	5061-4808	9	2	CABLE ASSEMBLY (WHITE/RED/YELLOW, OPTION 022 ONLY) W2201 TO A8J1	28480	5061-4808
W2203 ^A	5061-4808	9	2	CABLE ASSEMBLY (WHITE/RED/YELLOW, OPTION 022 ONLY) W2200 TO A8J2	28480	5061-4808
W2204	08642-20046	4	1	CABLE ASSEMBLY (SEMI-RIGID, OPTION 022 ONLY) J2201 TO J2202 (REMOVE WHEN ASSEMBLING OPT 022)	28480	08642-20046

Table 6-4. Code List of Manufacturers

Mfr. Code	Manufacturer Name	Location	Zip Code
00000	ANY SATISFACTORY SUPPLIER		
00779	AMP INC	HARRISBURG, PA	17111
01121	ALLEN-BRADLEY CO INC	EL PASO, TX	79935
01295	TEXAS INSTR INC	DALLAS, TX	75265
01717	AKRO-MILLS	AKRON, OH	44309
02114	FERROXCUBE CORP	SAUGERTIES, NY	12477
03888	K D I PYROFILM CORP	WHIPPANY, NJ	07981
04713	MOTOROLA INC SEMICONDUCTOR PRODUCTS	PHOENIX, AZ	85008
06665	PRECISION MONOLITHICS INC	SANTA CLARA, CA	95050
07263	FAIRCHILD CORP	MOUNTAIN VIEW, CA	94042
1B546	VARO SEMICONDUCTOR INC	GARLAND, TX	75046
11236	CTS CORP BERNE DIV	BERNE, IN	46711
16299	CORNING ELECTRONICS	RALEIGH, NC	27604
17856	SILICONIX INC	SANTA CLARA, CA	95054
18324	SIGNETICS CORP	SUNNYVALE, CA	94086
18873	DUPONT E I DE NEMOUTS & CO	WILMINGTON, DE	19801
19701	MEPCO/CENTRALAB INC	WEST PALM BEACH, FL	33407
20932	EMCON DIV ITW	SAN DIEGO, CA	92129
24355	ANALOG DEVICES INC	NORWOOD, MA	02062
24539	AVANTEK INC	SANTA CLARA, CA	95061
24546	CORNING GLASS ELECTRONICS	SANTA CLARA, CA	95050
25088	SIEMENS CORP	ISELIN, NJ	08830
25403	N.V. PHILIPS-ELCOMA DEPARTMENT	EINDHOVEN, HL	02876
26654	VARADYNE INC	SANTA MONICA, CA	90404
27014	NATIONAL SEMICONDUCTOR CORP	SANTA CLARA, CA	95052
27167	CORNING GLASS WORKS (WILMINGTON)	WILMINGTON, NC	28401
28480	HEWLETT-PACKARD CO CORPORATE HQ	PALO ALTO, CA	94304
3L585	RCA CORP SOLID STATE DIV	SOMERVILLE, NJ	
33095	SPECTRUM CONTROL INC	FAIRVIEW, PA	16415
34371	HARRIS CORP	MELBOURNE, FL	32901
34649	INTEL CORP	SANTA CLARA, CA	95054
4N833	ETRI INC	MONROE, NC	28110
51642	CENTRE ENGINEERING INC	STATE COLLEGE, PA	16801
52063	EXAR INTEGRATED SYSTEMS INC	SUNNYVALE, CA	94086
52648	PLESSEY SEMICONDUCTORS	SANTA ANA, CA	92705
56289	SPRAGUE ELECTRIC CO	NORTH ADAMS, MA	01247
72825	EBY HUGH H INC	PHILADELPHIA, PA	19144
73138	BECKMAN INDUSTRIAL CORP	FULLERTON, CA	92632
73899	J F D ELECTRONICS CORP	BROOKLYN, NY	11219
75915	LITTELFUSE INC	DES PLAINES, IL	60016
9D949	ALLIED AMPHENOL PRODUCTS	LISLE, IL	60532
9N171	UNITRODE CORP	LEXINGTON, MA	02173
91506	AUGAT INC	MANSFIELD, MA	02048
91637	DALE ELECTRONICS INC	EL PASO, TX	79936
98978	INTL ELECTRONIC INC	BURBANK, CA	91502

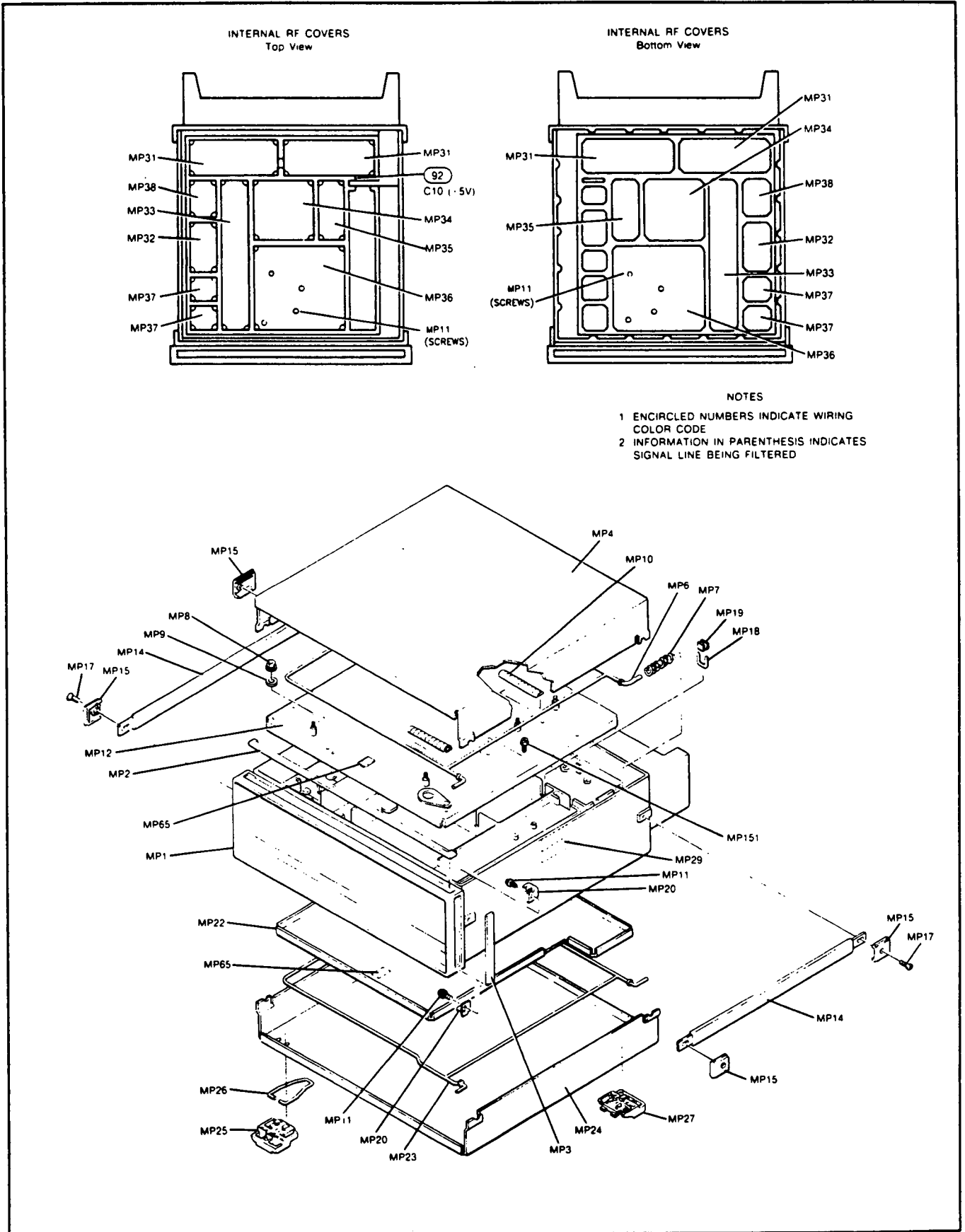


Figure 6-1. Cabinet Parts and Internal RF Covers

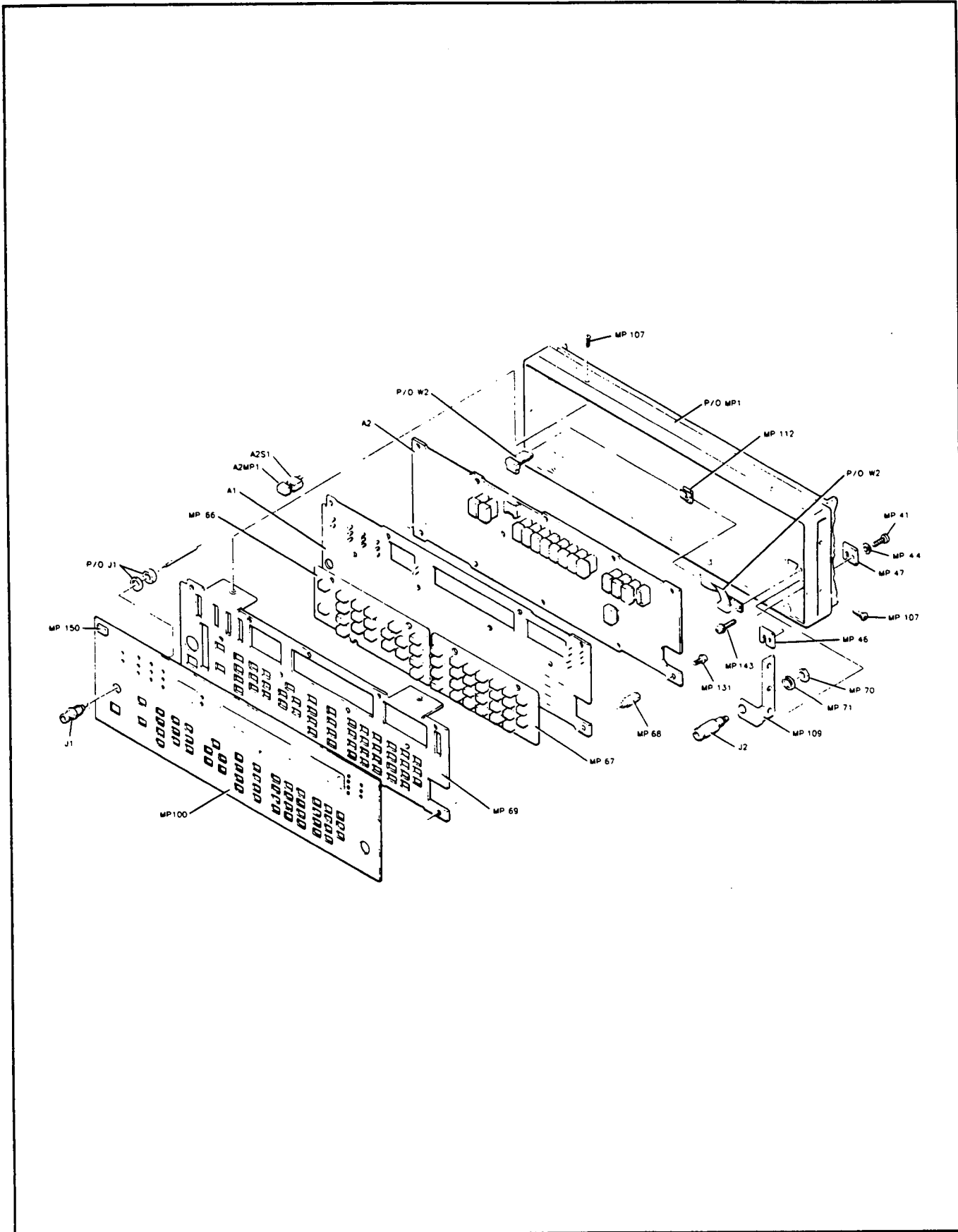


Figure 6-2. Exploded View of the Front Panel

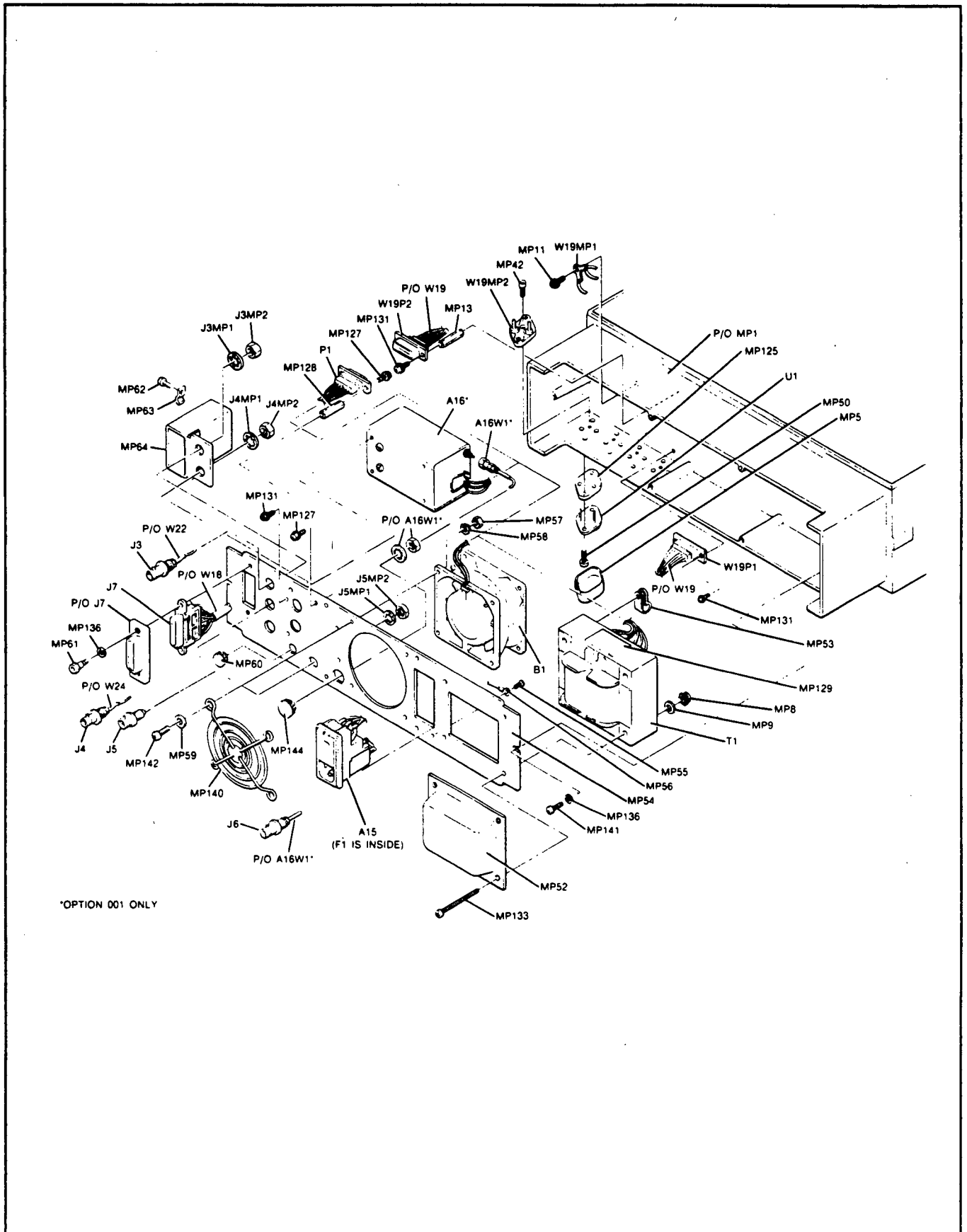


Figure 6-3. Exploded View of the Rear Panel

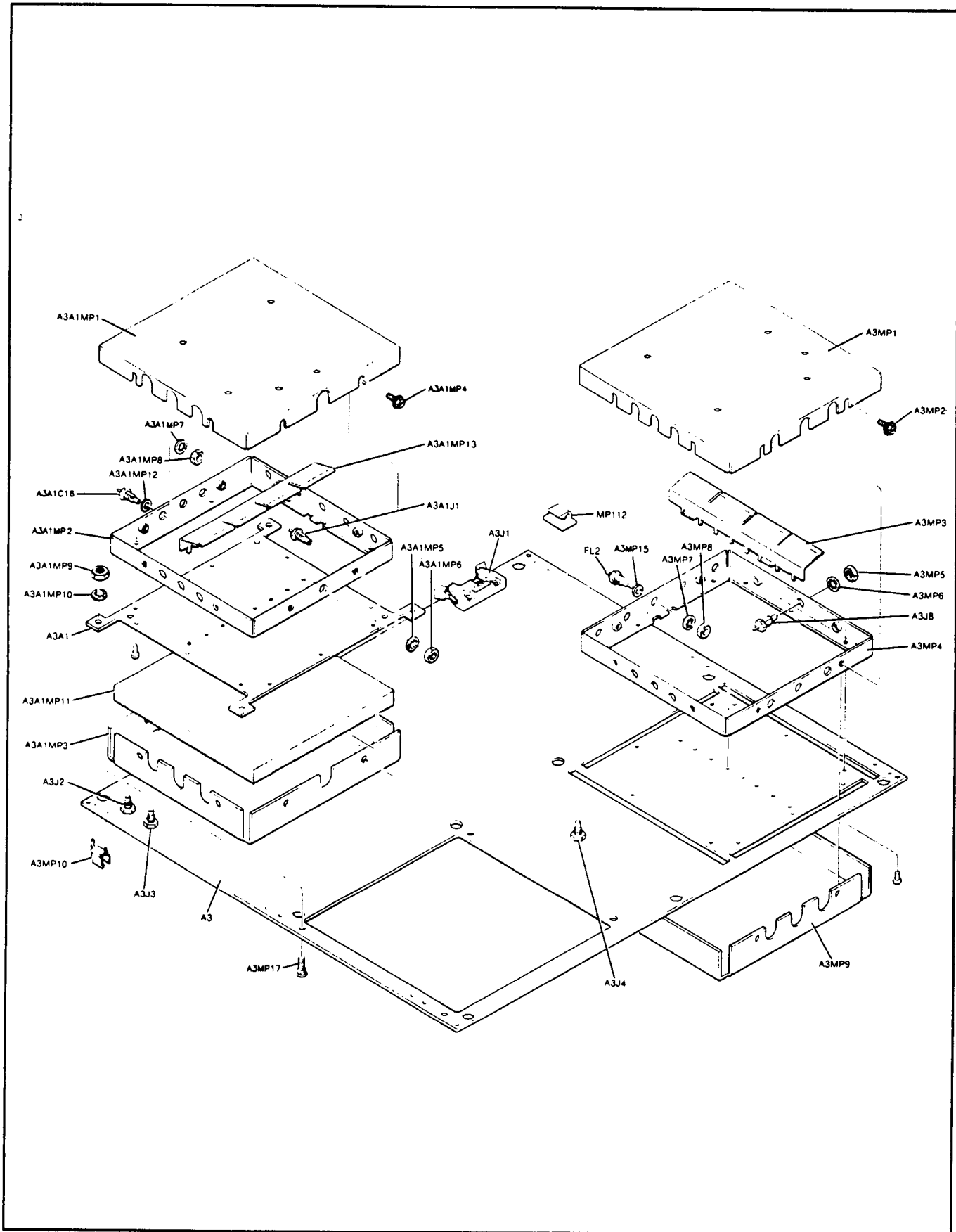


Figure 6-4. Exploded View of the A3A1 Assembly

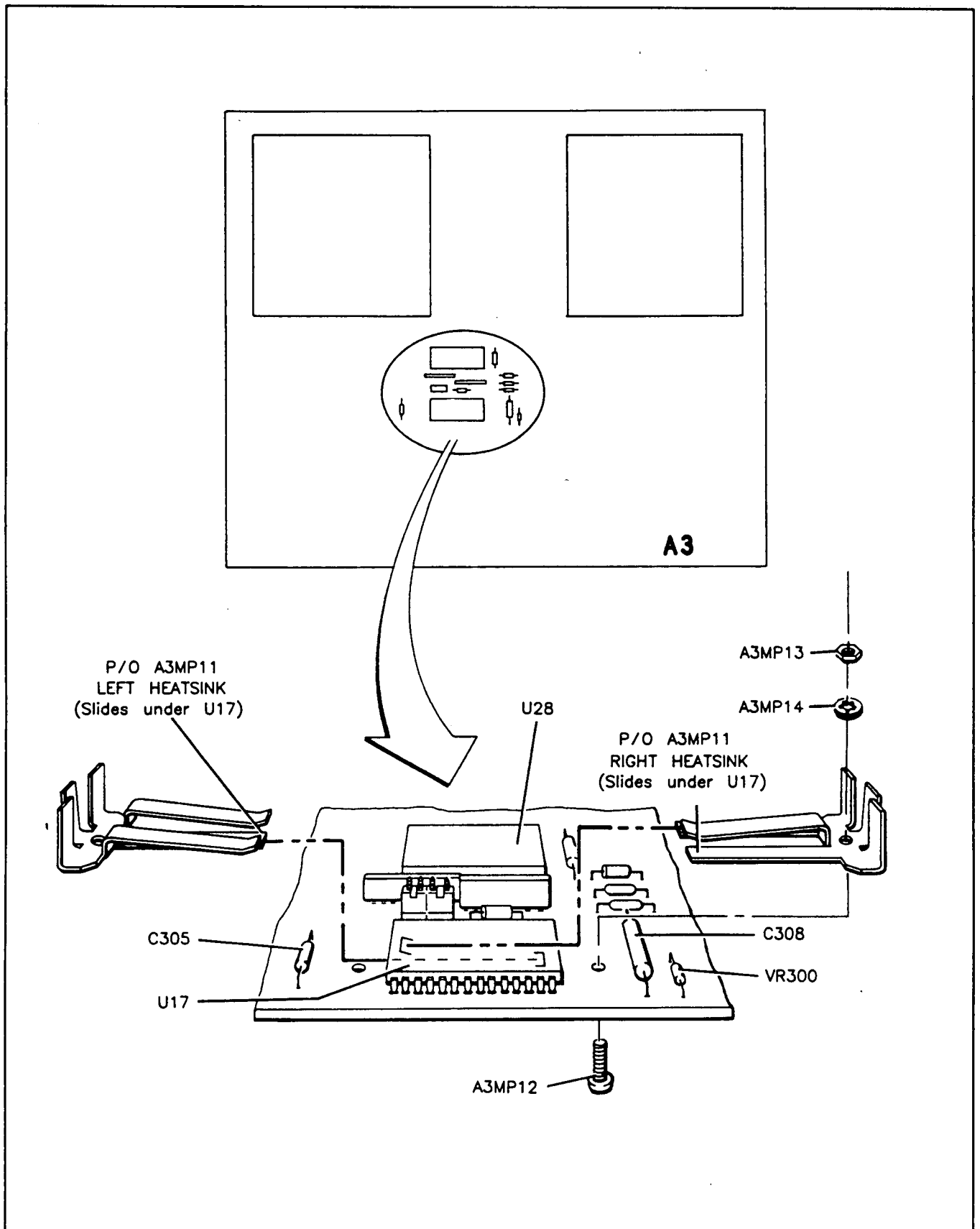


Figure 6-5. A3U17 (Serial Prefixes 2747U to 2823U)

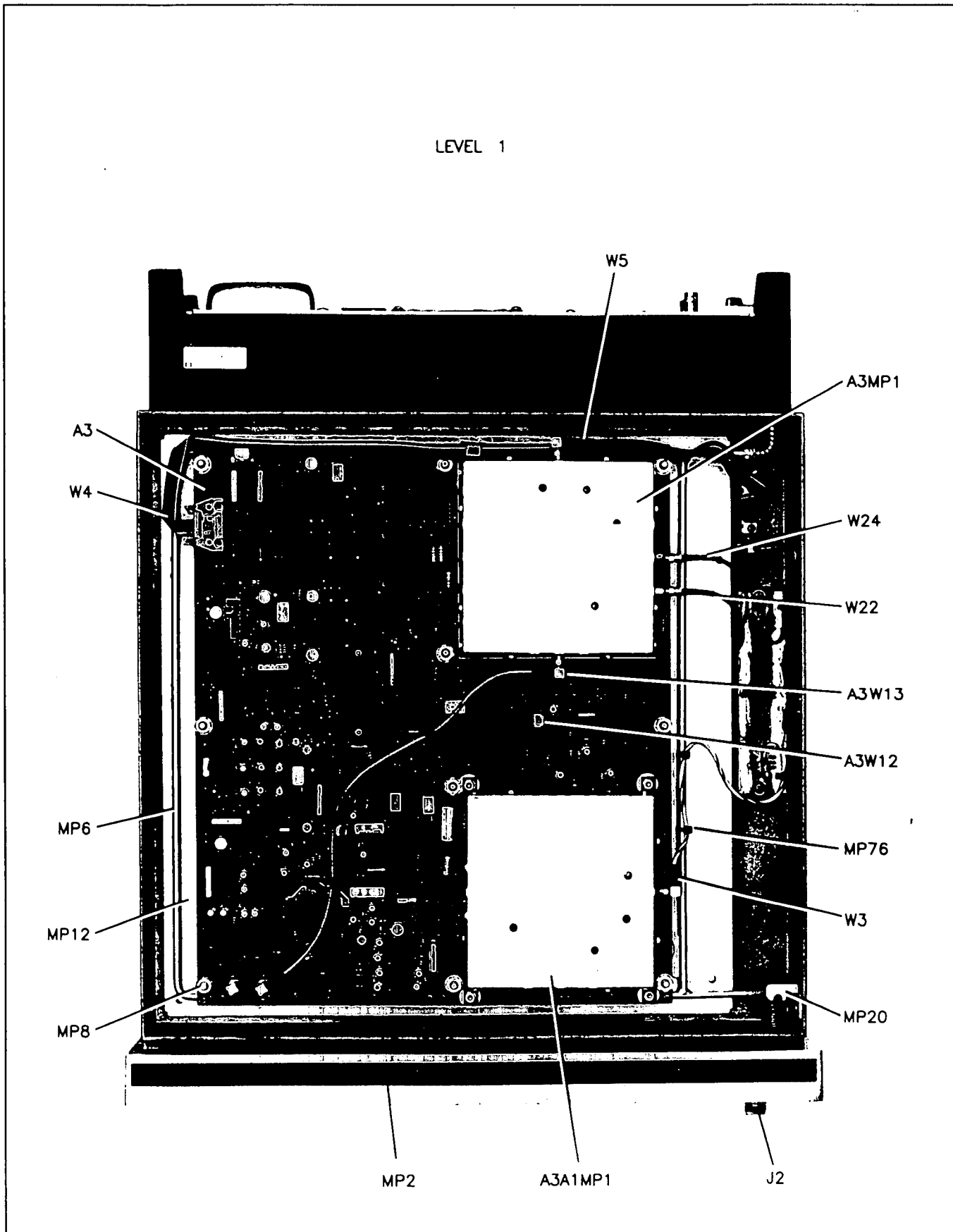


Figure 6-6. Top Internal View Level 1

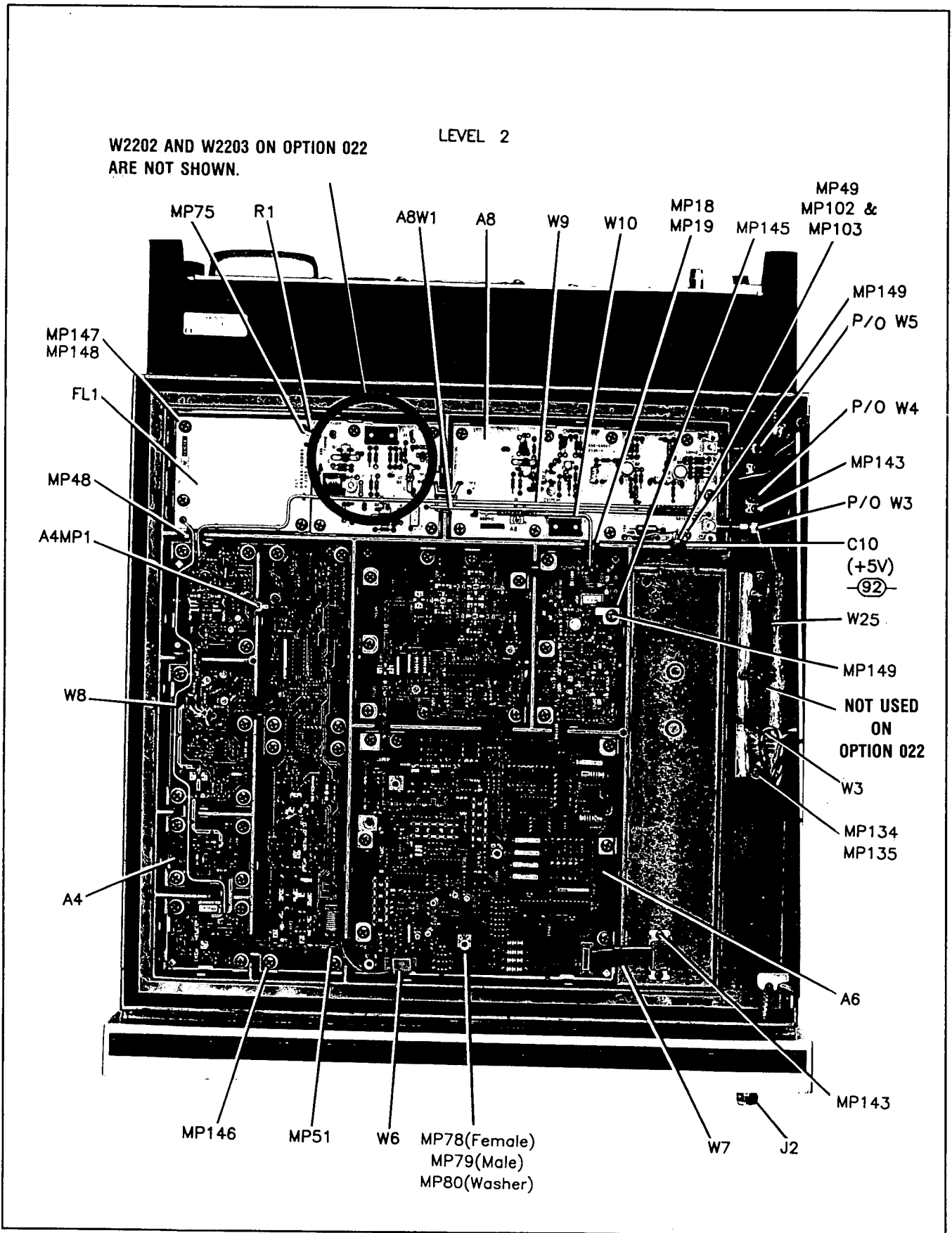


Figure 6-7. Top Internal View Level 2

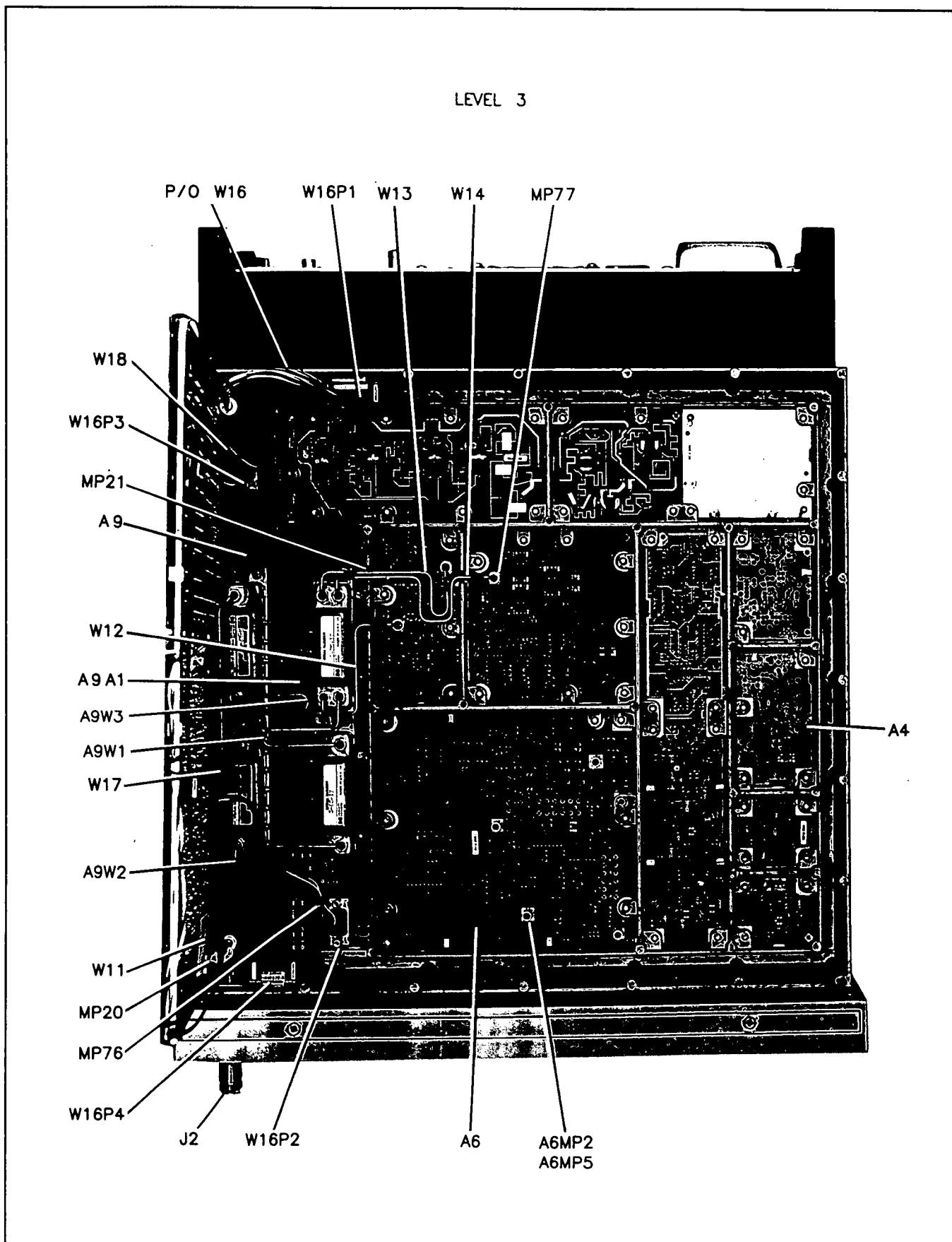


Figure 6-8. Bottom Internal View Level 3

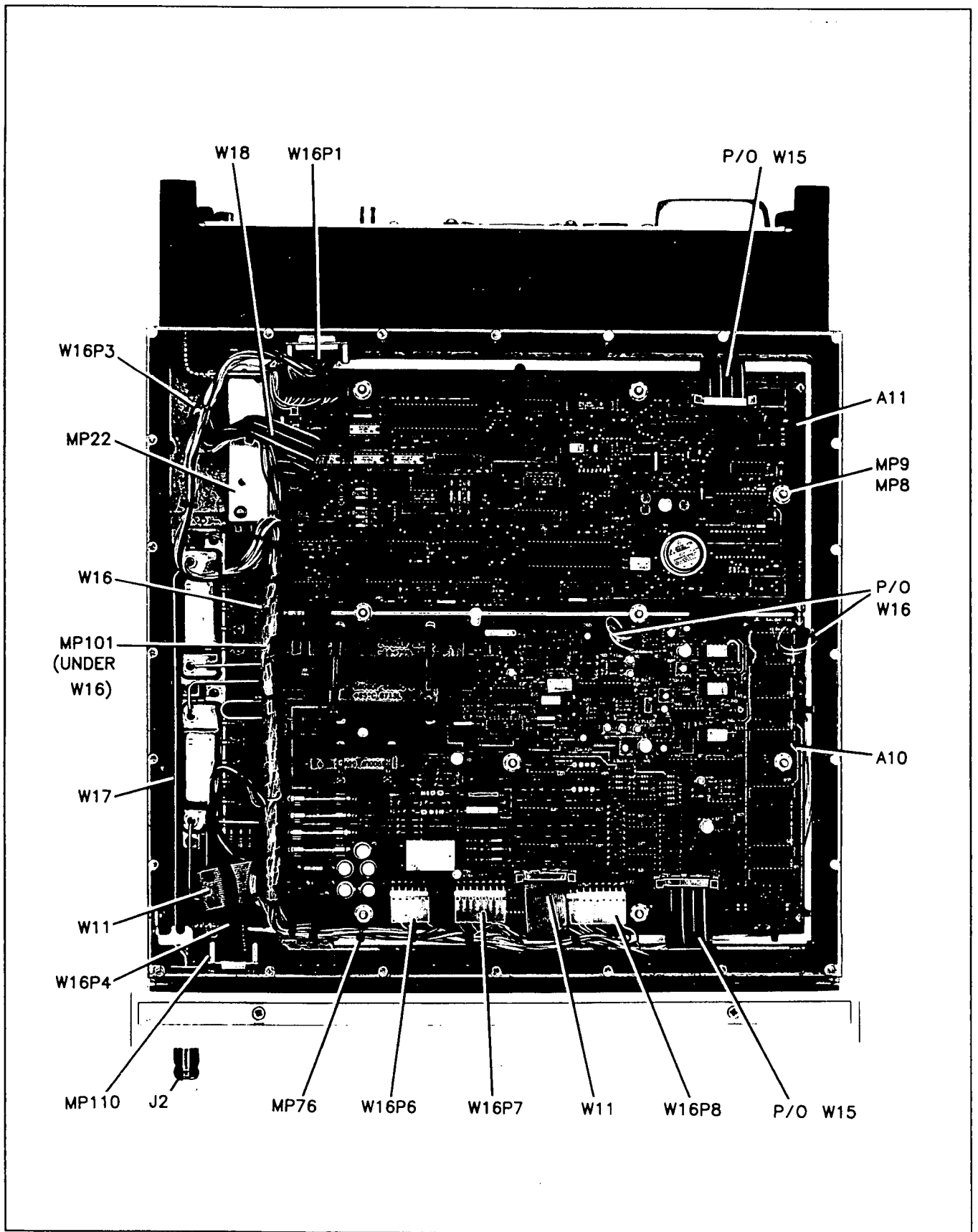


Figure 6-9. Bottom Internal View Level 4

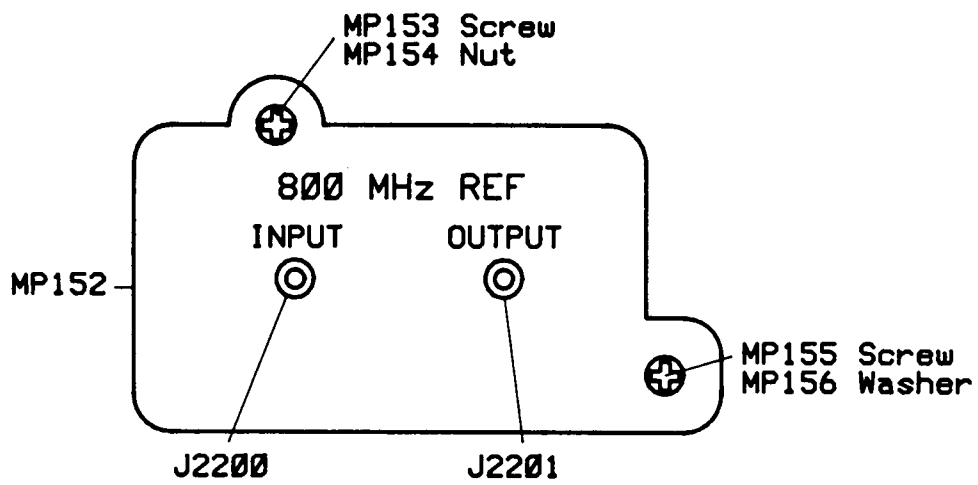


Figure 6-10. Option 022 Rear Panel Parts Identification

Section 7 INSTRUMENT CHANGES

7-1. INTRODUCTION TO THIS SECTION

This section contains instrument modification recommendations and procedures that could improve the performance and reliability of your instrument. Refer to *Instruments Covered by This Manual* in Section 1 of the HP 8657A *Operation and Calibration Manual* for important information about serial number coverage.

7-2. INSTRUMENT MODIFICATIONS

2750U AND ABOVE. A resistor (R156) is added to the A10 Audio assembly. This prevents the reverse power protection from tripping intermittently.

2823U AND ABOVE. The four screws used to hold the cooling fan to the rear panel are changed to self tapping screws.

2838U AND ABOVE. The Fractional N Controller (U17) on the A3 low frequency loop assembly is changed to a new part number.

2849U AND ABOVE. The A6 output assembly is replaced by a new A6 assembly (08657-60121). This new assembly adds additional gain stages in the output amplifier.

Section 8 SERVICE

8-1. INTRODUCTION

This section contains information for troubleshooting and repairing the Signal Generator. Included are principles of operation, troubleshooting tests, repair procedures, and block and circuit diagrams.

8-2. SERVICE SHEETS

Circuit principles of operation and troubleshooting information is found in the pages directly preceding the block and circuit schematic diagram foldouts. The foldout pages are found in the last part of this section. They consist of component locator diagrams, block diagrams, notes, supplemental diagrams, associated information, and circuit schematic diagrams.

Principles of Operation

The principles of operation and related tables and diagrams are part of Block Diagrams 1 through 4, and Service Sheets 1 through 25. A general statement followed by more specific information is included to aid in understanding the operation of circuitry in the Signal Generator.

Troubleshooting

The troubleshooting tests and checks are part of Block Diagrams 1 through 4, and Service Sheets 1 through 25. These tests and checks are used to aid in the service and repair of the Signal Generator. Troubleshooting using signature analysis is found where verifying the operation of digital circuitry is necessary. See paragraph 8-7, *Troubleshooting* for further troubleshooting information.

Block Diagrams

The block diagrams are found on Block Diagram 1 through Block Diagram 4. Block Diagram 1 is the overall block diagram that shows the major functional sections. Block Diagram 1 serves as an index to the troubleshooting blocks, and as a starting point for troubleshooting.

The troubleshooting block diagrams are found on Block Diagram 2 through Block Diagram 4. Each troubleshooting block diagram shows the major circuits in their functional groupings. These blocks serve as indexes to the circuit schematic diagrams. The High Frequency Loop and Output Section is shown on Block Diagram 2, the Low Frequency Loop on Block Diagram 3, and the digital (control) circuits are on Block Diagram 4.

Circuit Schematic Diagrams

The circuit schematic diagrams are found on Service Sheets 1 through 25. These diagrams, in functional groupings, are aids for understanding operation and for troubleshooting the Signal Generator. Refer to the paragraphs entitled Principles of Operation, and Troubleshooting for more information.

8-3. SAFETY CONSIDERATIONS

Before Applying Power

Verify that the instrument is set to match the available AC line voltage and that the correct fuse is installed (refer to paragraph 2-4 in Section 2). An uninterrupted safety earth ground must be provided from the main power source to the instrument input wiring terminals, power cord, or supplied power cord set.

Warnings and Cautions

Pay attention to WARNINGS and CAUTIONS. They must be followed for your protection and to avoid damage to the equipment.

WARNING

Maintenance described herein is performed with power supplied to the instrument and with the protective covers removed. Such maintenance should be performed only by service-trained personnel who are aware of the hazards involved (for example, fire and electrical shock). Where maintenance can be performed without power supplied, the power should be removed.

Any interruption of the protective (grounding) conductor (inside or outside the instrument) or disconnection of the protective earth terminal will create a potential shock hazard that could result in personal injury. Grounding one conductor of a two conductor outlet is not sufficient. Whenever it is likely that the protection has been impaired, the instrument must be made inoperative (that is, secured against unintended operation).

If this instrument is to be energized via an autotransformer, make sure that the autotransformer's common terminal is connected to the earth terminal of the power source.

Capacitors inside the instrument can still be charged even if the instrument is disconnected from its source of supply.

Make sure that only 250 volt fuses with the required rated current and of the specified type (normal blow, time delay, etc.) are used for replacement. Do not use repaired fuses or short-circuited fuseholders. To do so could create a shock or fire hazard.

CAUTION

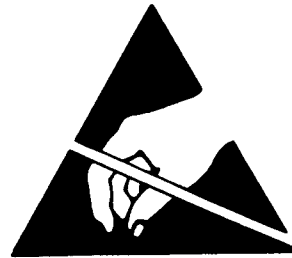
Do not disconnect or remove any boards in the Signal Generator unless the instrument is unplugged from the AC line. Some boards contain devices which can be damaged if the board is removed when the power is on. Use conductive foam when removing MOS devices from sockets. Use care when unplugging ICs from high-grip sockets.

8-4. SPECIAL HANDLING CONSIDERATIONS FOR STATIC SENSITIVE DEVICES

General

This information is provided to familiarize users of Hewlett-Packard instruments with special handling precautions for static sensitive devices. These precautions should be observed when servicing printed circuit boards or components that are static sensitive.

All schematics with circuit assemblies containing static sensitive components are designated with the international awareness symbol. This symbol indicates that special precautions apply when servicing these circuits. Following the precautions described in the following paragraphs could prevent damage to the circuit and its components.



ATTENTION
Static Sensitive
Devices

Description

Static Sensitive Devices are electronic components that are susceptible to damage or complete destruction in the presence of a static discharge. While all electronic components are static sensitive to some degree, the possibility of damage due to electro-static discharge (ESD) becomes greater as the insulating materials in the components become thinner and as component densities increase. Depending on the magnitude of the charge, device substrates can be punctured or destroyed by contact or mere proximity of a static charge.

Static charges accumulate harmlessly in a person's body, therefore the charges can be passed on in numerous ways such as simple contact with the device, during separation of materials, or during normal motions of persons with static sensitive devices. In many cases, destructive static discharges (< 4000V) cannot be seen or felt. The results of this damage can cause degradation of device performance, early failure, or complete destruction of the device.

Component Handling Precautions

- a. Those persons servicing the instrument should use metal or conductive plastic wriststraps with a 1 Megohm series resistor connected to ground.
- b. Packages should not be removed from their conductive or antistatic carriers until required and should only be removed by an operator that is grounded through a 1 Megohm series resistor. Devices that are removed should be placed in a conductive tray.
- c. Metal parts of fixtures, tools, soldering irons, and table tops should be grounded to a common point.
- d. Handling equipment, trays, table tops, and transport carts should be electrically conductive.
- f. The circuit board should have a conductive strip placed on the board edge-connectors to short all the connections together.

Device Classes

The following is a classification of the ESD sensitivity of components used in most Hewlett-Packard instruments:

CLASS I devices have a sensitivity range from 0 to 1,000V. Devices in this range include microwave diodes (especially Schottky), BIFET and precision OP AMP ($I_{os} < 50 \text{ nA}$, $V_{os} < 1 \text{ mV}$), unprotected MOS (especially VLSI), MOS capacitors, advanced Schottky logic, junction FETs and low current SCRs ($< 0.15\text{A}$), microwave and VHF transistors and ICs, precision IC voltage regulators and resistors, low power resistors ($< 0.05\text{W}$), VLSICs with dual-level metallization, and Surface Acoustic Wave (SAW) devices.

CLASS II devices have a sensitivity range from 1,000 to 4,000V. Devices in this range include MOS ICs with internal protection (CMOS, NMOS, PMOS) and LSI ICs, Schottky rectifier diodes, linear ICs (bipolar), precision resistor networks, high speed bipolar logic (ECL, LS-TTL, S-TTL), varactor diodes, monolithic ceramic capacitors, RF Mixers and other RF devices utilizing diodes.

CLASS III devices have a sensitivity range from 4,000 to 15,000V. Devices in this range include small signal diodes, and transistors, low-speed bipolar logic (TTL, DTL), quartz and piezoelectric crystals, and thin and thick film resistors ($< 1/8\text{W}$, $\geq 500\text{k ohms}$).

Component Replacement Procedures

The A2, A3, A3A1, A6, A10, and A11 printed circuit board assemblies are manufactured using a Hot Air Leveled (HAL) process. The printed circuit board traces, pads and plated-through holes (PTH) are copper. While the process has several advantages over conventional processes, the printed circuit boards are more susceptible to broken traces, lifted pads, and damage to the plated-through holes. Therefore, additional care must be taken when replacing components on HAL printed circuit boards.

Listed below are soldering considerations that apply to all printed circuit boards:

- The temperature of the soldering iron tip and time the tip is in contact with the printed circuit board.
- The size and shape of the soldering iron tip.
- The pressure of the soldering iron tip on the pad.
- The operator's skill.

When replacing components on HAL printed circuit boards the following steps should also be taken.

1. Use a temperature controlled soldering iron set at a temperature of 600°F (315°C).

Extensive tests were made by Hewlett-Packard using commercial brands of soldering irons. As a result of these tests, the recommended soldering iron was the HEXACON THERM-O-TRAC STATION #1000 with the FINGER GRIP SLEEVE 21 A-5 and solder tip #J 301X. During soldering, the tip temperature of the HEXACON THERM-O-TRAC STATION remained very stable.

2. Cut out the body of the component to be removed. (Leave leads as long as possible for easier removal.)

3. Apply heat to the lead only, add solder as required, slide tip down to the pad and remove solder with solder sucker.

CAUTION

Tip pressure on the pad is most critical and is totally operator dependent. Excessive tip pressure will damage or destroy the board. Do not use tin desoldering braid or solder wicking techniques on Hot Air Leveled boards.

The melting point of solder in the plated through hole (PTH) is reached in 2.5 seconds at tip temperature of 600° to 750° F (315° to 400° C). The recommended time for heat to be applied is 3 seconds.

Keep the solder sucker clean and do not let the tip of the solder sucker hit the pad when removing solder. Breaking the lead loose can damage the PTH. If the lead is attached to the PTH after the solder has been removed, reheat the lead to remove it.

4. When soldering or desoldering multilead components, do not consecutively apply heat to adjacent leads. Distribute heat by skipping leads or crossing to opposite side of device.

8-5. RECOMMENDED TEST EQUIPMENT AND ACCESSORIES

Test equipment and test accessories required to maintain the Signal Generator are listed in the table of Recommended Test Equipment in Section 1. Equipment other than that listed may be used if it meets the listed critical specifications.

8-6. SERVICE TOOLS, AIDS AND INFORMATION

Service Tools

There are unique tools available that will make servicing of this instrument easier. Service aids are provided in the instrument. Service information is provided in this manual. Information provided in the paragraph entitled Repair (found in this section) shows how the instrument is accessed for repair purposes. See Figure 8-1 for the recommended position for maintenance and servicing.

Pozidriv Screwdrivers. Many screws in the Signal Generator appear to be Phillips type, but are not. To avoid damage to the screw slots, Pozidriv screwdrivers should be used. HP 8710-0899 is the No. 1 Pozidriv. HP 8710-0900 is the No. 2 Pozidriv.

Tuning Tools. For adjustments requiring non-metallic tuning tools, use the HP 8710-0033 blade tuning tool or the HP 8710-1010 (JFD Model No. 5284) hex tuning tool. For other adjustments an ordinary small screwdriver or suitable tool is sufficient. No matter which tool is used, never force any adjustment control. This is especially critical when adjusting variable inductors or capacitors.

Torque Wrench. A torque wrench is needed whenever semi-rigid cables on the A6 Output Assembly or A9 Attenuator Assembly are installed. Use an 8 mm open end torque wrench capable of 4.5 in/lbs (± 0.5 in/lbs) of torque. Overtightening the connectors that hold these cables will change the cables dielectric constant. Undertightening can cause RF leakage.

Parts and Cable Locations

The locations of individual components mounted on printed circuit boards or other assemblies are shown adjacent to the schematic diagram on the back of the preceding Service Sheet. The part reference designator is the assembly designator plus the part designator. For example, A6R9 is R9 on the A6 assembly. For specific component descriptions and ordering information, refer to Table 6-3, Replaceable Parts, in Section 6. Illustrated parts breakdowns of chassis and frame parts, as well as assemblies and mechanical parts and cables, are shown in Section 6.

Mechanical parts have reference designations that begin with the letters MP. Some mechanical parts, such as screws, are listed in the replaceable parts list below the part to which they fasten. To find the part number and description of mechanical part, find the part in one of the figures in Section 6 or Section 8. The part in the figure is labeled with its reference designator. Look up that reference designator in the table of Replaceable Parts. If the part is a fastener, such as a screw, nut, or washer and does not have an assigned reference designator, look to the figure for the part to which it fastens. Then, look up the fastened part in the parts list. Just below the fastened part, you will see the part numbers and descriptions of the desired fastener.

Test Points and Adjustment Locations

Most test points and adjustments are indicated on individual circuit board assemblies. Test points and adjustments can also be found on the component locator diagram adjacent to the assembly's schematic diagram.

Service Aids on Printed Circuit Boards

Service aids on printed circuit boards include test points, indicator lights, transistor and integrated circuit and relay designations, adjustment names, and assembly part numbers.

Other Service Documents

Service Notes, Manual Changes supplements, and other service literature are available through Hewlett-Packard. For further information, contact your nearest Hewlett-Packard office.

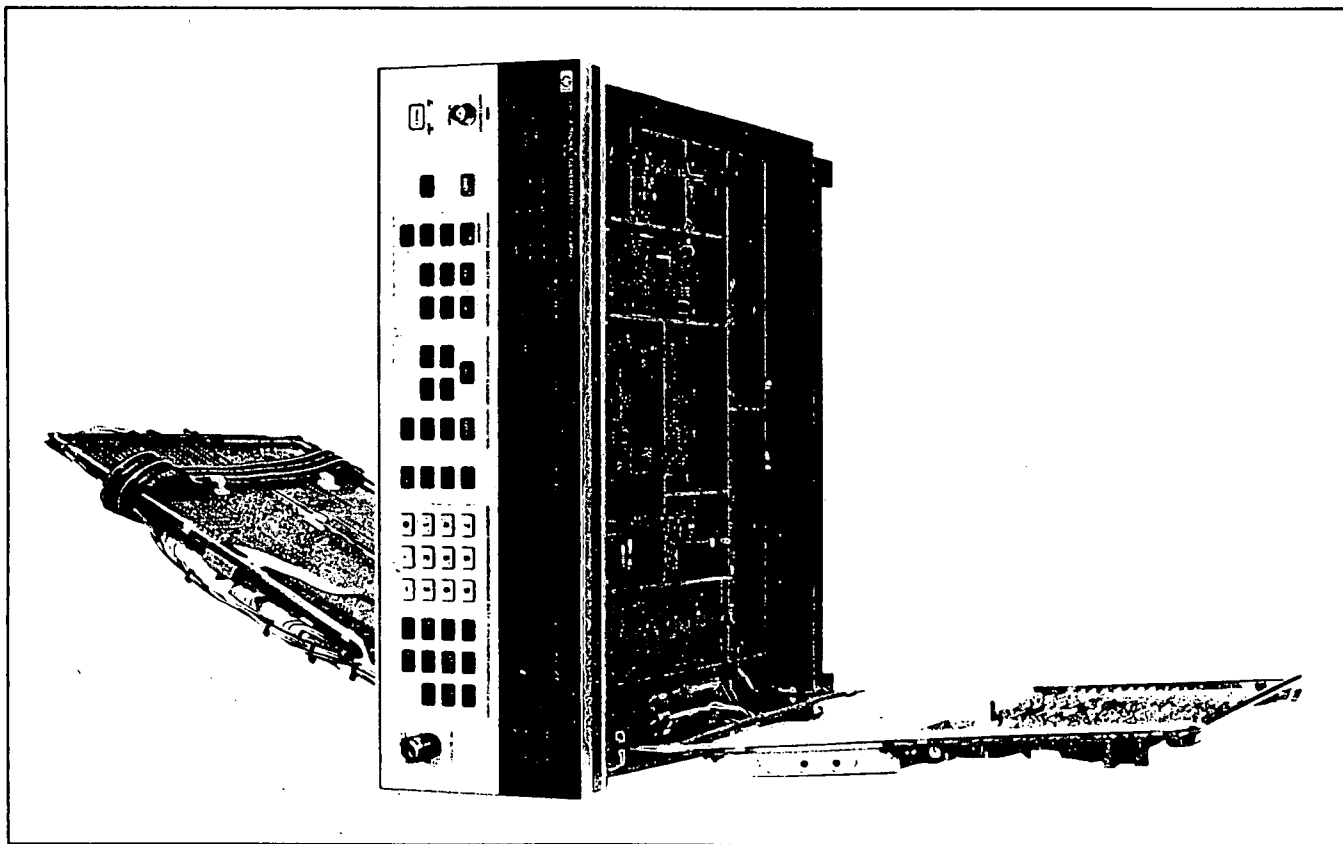


Figure 8-1. Recommended Position for Maintenance and Servicing.

8-7. TROUBLESHOOTING

General

Instrument problems usually fall into three general categories: operator errors, instrument out of specification, and catastrophic failures. The troubleshooting strategy is different for each category. For more information refer to the table of Specifications in Section 1 and the detailed operating instructions found in Section 3.

Operator Error. Apparent failures sometimes result from operator errors. These may take one of several forms. The operator may allow external influences which affect instrument operation. At times he may attempt to operate the instrument in an "out of specification" mode. Under certain circumstances the Signal Generator allows for out of specification operation. Under other conditions it does not.

A reverse power level greater than 1.0 watt (7.07V) coupled to the front-panel RF OUTPUT connector switches the output signal off and causes the Amplitude display to flash. This, however, is normal operation under the circumstances. The Signal Generator has temporarily disconnected itself from the high power level that could do damage to internal circuits. To bring the Signal Generator back to its normal operating mode, remove the high reverse power at the RF OUTPUT connector and enter a new output power level at the front-panel.

NOTE

The Reverse Power Protection provided by this circuit is adequate up to 50 watts (25V dc).

The Signal Generator does allow out of specification operation at frequencies below 0.1 MHz. The frequency is accurate but other specifications, such as RF output power level may be incorrect.

Not-allowed operation is generally indicated by displays that flash or default to the last valid entry. An example of the former is a flashing FM display that occurs when a frequency is changed to a range that will not allow wide deviation. To stop the flashing display, press the FM mode select button. This changes the FM deviation to a level that is acceptable.

Examples of not-allowed operation where the Signal Generator defaults to the last valid entry are: selecting an RF output level that is too high or selecting an AM depth that causes the maximum total RF output power level to be too high.

Instrument Out of Specification. If it is suspected that the instrument's operating parameters are out of tolerance, the abbreviated Performance Tests table in Section 4 tells which test may be performed to verify proper operation. This table may also be used to determine which assembly requires adjusting and on what service sheet the adjustable components are located. The Post-Repair Adjustments table in Section 5 tells which adjustments are related and may also require adjustment. After adjustments are complete, perform the performance test(s) in Section 4. If the performance is still out of tolerance, refer to troubleshooting information. Although the problem may be solved very quickly by going to the service sheet where the adjustment is located, it is good practice to begin with the overall troubleshooting information found on Block Diagram 1.

Catastrophic Failures. When a catastrophic failure occurs, begin troubleshooting on Block Diagram 1. The information there is used to quickly isolate the problem to one of three major sections in instrument.

Strategy

Troubleshooting for the Signal Generator is organized into three levels. The overall troubleshooting level is where problems are isolated to the power supply or one of the functional sections. The functional section level of troubleshooting isolates the malfunction to the circuit level. At the circuit level, the problem is isolated to a stage within the circuits shown on the schematic. It is expected that further troubleshooting, to the component level, depends on the skill and experience of the troubleshooter.

Overall Troubleshooting (Block Diagram 1)

Overall troubleshooting begins with verifying that the power-on sequence occurs properly. At this point, power supply problems become evident. The effect of inputs from the keyboard and an external computer are compared. It is possible to separate a digital or analog problem at this level. Digital problems are usually referred to Block Diagram 4. Further troubleshooting determines which analog (phase lock) loop is defective. Problems here are referred to Block Diagrams 2 or 3. If none of the sections or circuits above are defective, further troubleshooting isolates a malfunction in the special circuits.

Functional Section Troubleshooting (Block Diagrams 2-4)

Troubleshooting of the loop sections (Block Diagrams 2 and 3) is done primarily from an analog viewpoint with the intent of isolating a malfunction to the circuit level. The digital section (Block Diagram 4) continues with troubleshooting from Block Diagram 1 but with the intent of isolating the problem to the circuit level.

Circuit Troubleshooting (Service Sheets 1-25)

The goal of troubleshooting at the previous service sheet level is to be confident that the problem is within the circuits shown by the schematic. Because of the interaction of the circuits in the Signal Generator, it may be necessary to refer to other service sheets to completely isolate a problem. Some of the circuits that are mostly analog have digital control circuits. In these cases, troubleshooting the digital circuits first is offered as an alternative. When a problem is isolated to a stage, the ability of the one doing the troubleshooting is utilized to isolate the defective component.

Signature Analysis

Signature analysis is a simple method of verifying the operation of digital circuitry. When properly used, signature analysis can detect extremely subtle hardware faults. Signatures must identically match those given in the signature tables located with the Troubleshooting for that schematic. If everything is working correctly, signatures will all match exactly. If they do not match, by even one digit, something is wrong. With the Generator's internal signature analysis routine, the signature analyzer's test probe is used to check nodes in the circuit under test. The signature analyzer converts the signals at the node into a four digit "signature", which it displays. The signature is then compared to the signature in the Troubleshooting table appropriate for that schematic. These two signatures must be identical.

Signature analysis can be sped up if the following considerations are kept in mind:

1. Make sure that every step is performed as described in the set-up procedure. That is, make sure that the clock, start, and stop connections and triggering are correct.
2. Double-check that the signatures are being taken at the correct node.
3. Make sure that the signature analyzer probe is making good contact with the pin being checked. Oxidation on pins can cause invalid signatures due to poor contacts.
4. When you think that you have found a bad signature, double check to make sure.
5. When checking a node, check that the unstable signature indicator is not blinking.

Additional Information

Additional troubleshooting information may be found in various locations in the manual. Reference is made to the information in the appropriate troubleshooting procedure. Examples of this information are the Power-On Sequence, the Basic Functional Checks, and the HP-IB Functional Checks which are all found in Section 3.

8-8. REPAIR

Disassembly Procedures

For the most part, disassembling the Signal Generator is quite straightforward. Most of the procedures simply indicate the size, number, type, and general location of the mounting hardware. Where it is necessary, the procedures are more detailed. Table 8-1 indicates which procedure will give access to a particular assembly and which figure shows the location of a particular assembly. Reference to the appropriate exploded view in Section 6 is included. If a circuit board within the main casting is to be removed from the Signal Generator, seek access to its component (top) side. To reassemble the Signal Generator, follow the procedures in the reverse order.

WARNING

Before beginning any disassembly procedure be sure that the AC line voltage is disconnected.

Table 8-1. Assembly Access Information.

To Gain Access to an Assembly or Module	Perform Procedure(s)	For Part Locations Refer to Figure(s)
A1 and A2	Front Panel Removal and if required, A1 Keyboard and A2 Display Assembly Removal	6-2
A3 (top)	Cover Removal, Top (Level 1 Access)	6-1, 6-4, 6-5
A3 (top and bottom)	Cover Removal, Top (Level 1 Access) and A3 Assembly Service Position (Level 2 Access)	6-1, 6-5, 6-6, 8-1
A4, A6, and A8 (top)	Cover Removal, Top (Level 1 Access) and A3 Assembly Service Position (Level 2 Access)	6-1, 6-5, 6-6, 8-1
A4, A6, A8 (bottom), and A9	Cover Removal, Bottom (Level 4 Access) and A10/A11 Assemblies Service Position (Level 3 Access)	6-1, 6-7, 6-8, 8-1
A10 and A11 (top and bottom)	Cover Removal, Bottom (Level 4 Access) and A10/A11 Assemblies Service Position	6-1, 6-8, 8-1
A15, A16, B1 and T1	Rear Panel Removal	6-3, 8-2

Front-Panel Removal. Remove the knurled nut P/O J2 from the RF Output connector (not included in Option 002) with a pair of soft jawed pliers (HP part number 8710-0986). Remove the top trim MP2 and four No. 2 Pozidriv screws MP107 from the top and bottom edge of the front-panel casting. Pull the front-panel forward until it is free of the casting. Disconnect W2 from A2J1.

A1 Keyboard and A2 Display Assembly Removal. The front panel has been removed. Place the front panel face down. To separate the A2 Assembly from the A1 Assembly, remove the fourteen No. 2 Pozidriv screws MP131 from the back of the circuit board. If the instrument does not have the Option 002 rear panel RF output, unsolder wire W20 from the front panel MOD INPUT/OUTPUT BNC connector. The A2 Assembly can now be separated from the A1 Assembly.

Cover Removal, Top and Bottom (Levels 1 and 4 Access) Set the Signal Generator in its normal operating position. Free the handles by removing four No. 2 Pozidriv screws MP17.

Remove the front and rear handle caps (MP15) and the handles MP14. The top cover may now be lifted off for Level 1 access or the instrument may be turned over and the bottom cover lifted off for Level 4 access.

A3 Assembly Service Position. The top cover has been removed. Remove ten 10-32 inch nuts and washers (MP8 and MP9) from the top of the circuit board. Rotate the circuit board on the hinged carrier MP6 up and to the right. To lock the carrier in place, press the spring loaded hinge toward the rear of the instrument until it slides around the hinge lock MP20.

Level 2 Access. Remove two No. 2 Pozidriv screws MP11 from the top internal cover MP12. Lift the top internal cover up and out by the cover handles. Remove the four No. 2 Pozidriv screws MP11 from the top internal RF cover MP36. Use a small standard blade screwdriver to pry under each internal RF cover at the corners. Lift the cover from the casting.

NOTE

Insert all shield braid removed during disassembly into the appropriate space(s) in the casting wall before the internal RF covers are reinstalled.

DO NOT PRESS the internal RF covers all the way into the casting during reassembly. Make sure the top of the cover is the same level as the top of the casting.

A10/A11 Assemblies Service Position. The bottom cover has been removed. Remove eleven 10-32 hex nuts and associated washers (MP8 and MP9) from the top of the circuit board.

Refer to Figure 8-2 to remove two standoffs (MP110) from the stationary screws (MP111) attached to W2, and then pull off W16P4.

Raise the circuit board and hinged carrier MP23. To lock the carrier in place, press the spring loaded hinge toward the rear of the Signal Generator until it slides around the hinge lock MP20. Plug W16P4 back in. The two standoffs which were removed, do not have to be put back on until reassembling A10/A11.

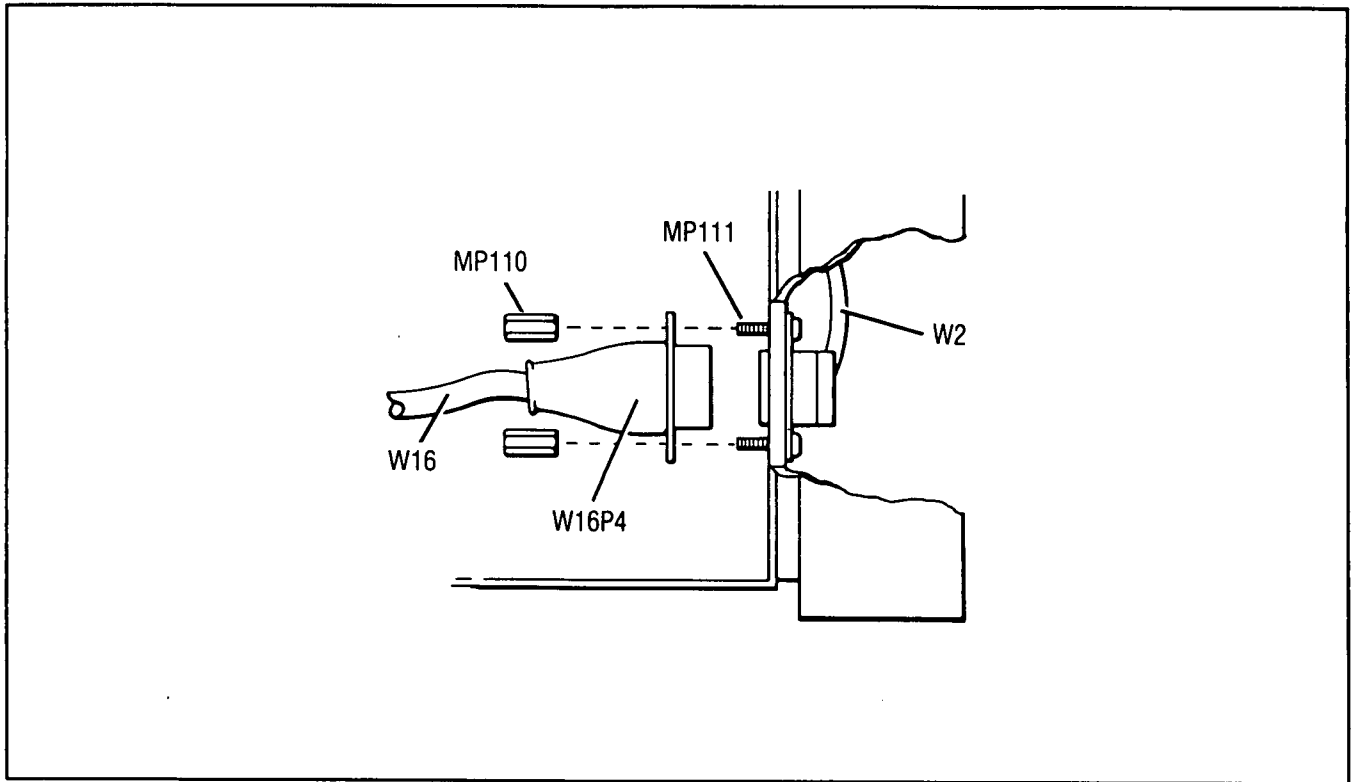


Figure 8-2. P/O A10/A11 Assembly Service Positioning.

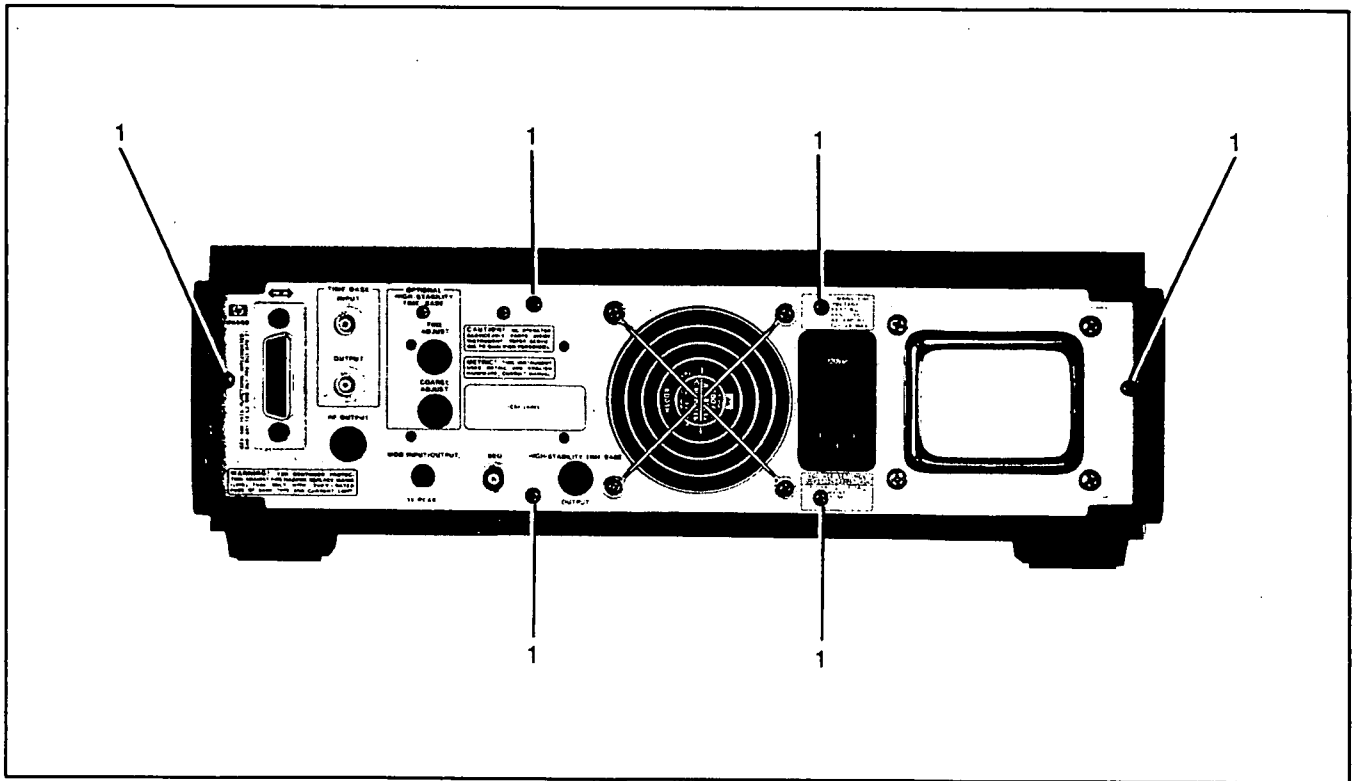


Figure 8-3. Rear Panel Removal.

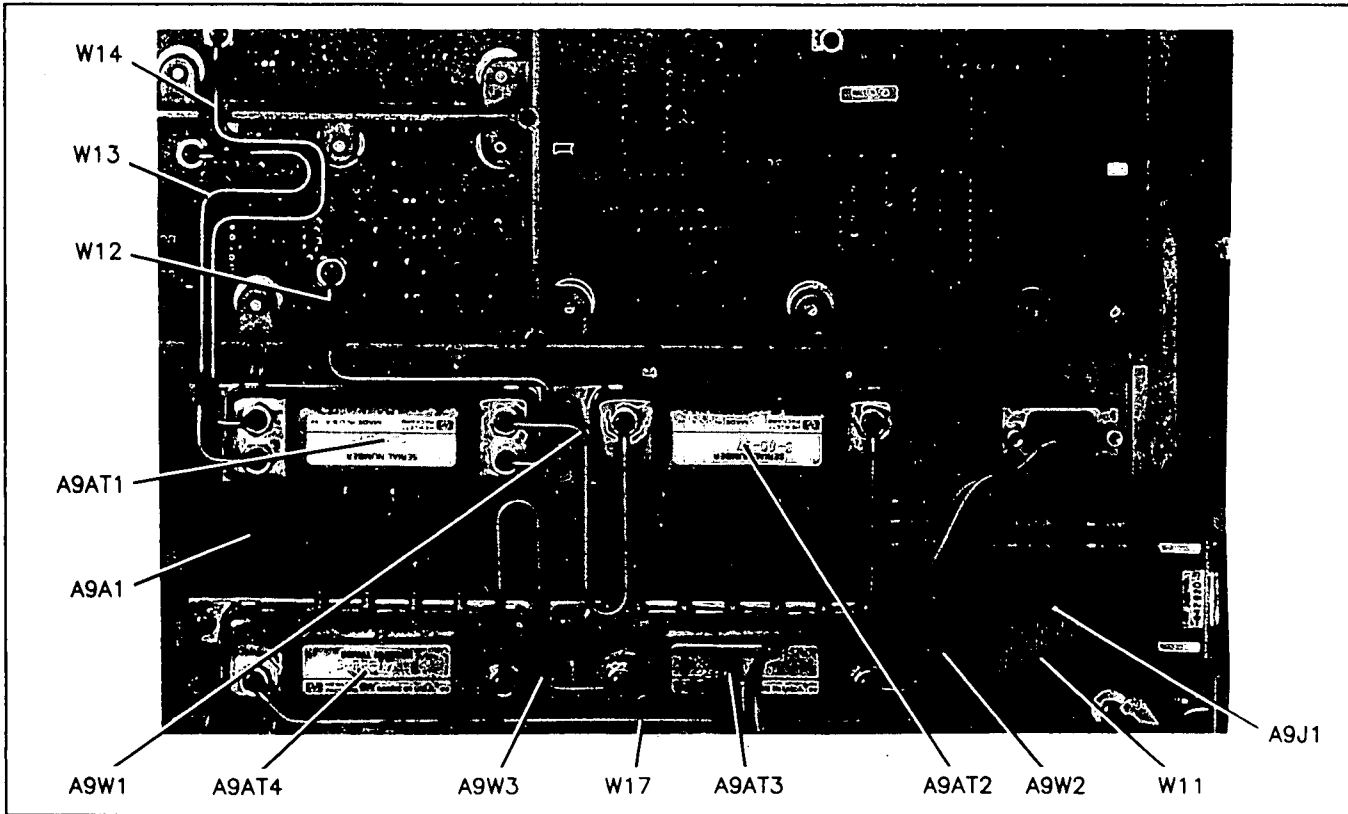


Figure 8-4. Attenuator Assembly A9.

Level 3 Access. A10/A11 Assemblies have been locked into the service position. Remove ten No. 2 Pozidriv screws MP11 from the bottom internal cover MP22. Lift the bottom internal cover up and out by the cover handles. Remove the four No. 2 Pozidriv screws MP11 from the bottom internal RF cover MP36. Access to individual boards is achieved by using a small standard blade screwdriver to pry under each internal RF cover at the corners.

NOTE

DO NOT PRESS the internal RF covers all the way in. Make sure the top of the cover is the same level as the top of the casting.

Rear-Panel Removal. Position the Signal Generator so you are facing the rear-panel as shown in Figure 8-3.

1. Remove six No.2 Pozidriv screws and lockwashers (items 1).
2. Pull the rear-panel away from the casting.
3. If the rear-panel is to be completely removed from the instrument, disconnect the TB IN (W22) and TB OUT (W24) coax cable assemblies from the A3 assembly. Also, remove the HP-IB ribbon cable (W18) from the A11 assembly. The connectors for these three cables will pass through the instrument's casting.
4. When reinstalling the rear-panel, reverse the preceding procedure.

Attenuator Removal. Position the Signal Generator so you are facing the instrument's front-panel.

1. Follow the Level 3 Access Procedure and remove the two internal RF covers, MP35 and MP38.
2. Use an 8 mm wrench to loosen hex nuts securing W12 to connectors A6J303 and A9J4.
3. Use a pair of needle-nose pliers and carefully remove W12 from the instrument.
4. Use an 8 mm wrench to loosen hex nuts securing W13 to connectors A6J302 and A9J3.
5. Use a pair of needle-nose pliers and carefully remove W13 from the instrument.
6. Use an 8 mm wrench to loosen hex nuts securing W14 to A6J203 and A9J2. Use a pair of needle-nose pliers and carefully remove W14 from the instrument.
7. Loosen hex nut securing W17 (W21 for Option 002) to connector A9J11. Remove the cable from the connector.
8. Disconnect ribbon cable W11 from A9J1.
9. Free the A9 Assembly from the frame by removing the 9 No. 1 Pozidriv screws (MP152).
10. Remove the A9 Assembly from the instrument.

Individual Attenuator Section Removal. Follow the attenuator removal procedure and remove the A9A1 Assembly from the instrument. Lay the A9A1 Assembly with the A9 attenuator section facing up; then use one of the following procedures to remove the particular attenuator section.

A9AT1 (HET) Removal.

11. Loosen hex nuts securing A9W1 to A9J5 and A9J6.
12. Carefully remove A9W1 from the A9 Assembly.
13. Turn the A9 Assembly over and unsolder the two A9AT1 feedthrough capacitors from the printed circuit board.
14. Turn the A9 Assembly back over and remove A9AT1.

A9AT2 (60 dB) Removal.

15. Loosen hex nuts securing A9W1 to A9J5 and A9J6.
16. Carefully remove A9W1 from the A9 Assembly.
17. Loosen hexnuts securing A9W2 to A9J7 and A9J8.
18. Carefully remove A9W2 from the A9 Assembly.
19. Turn the A9 Assembly over and unsolder the five AT2 feedthrough capacitors from the printed circuit board.
20. Turn the A9 Assembly back over and remove AT2.

A9AT3 (80 dB) Removal.

21. Loosen hex nuts securing A9W2 to A9J7 and A9J8.
22. Carefully remove A9W2 from the A9 Assembly.
23. Loosen hex nuts securing A9W3 to A9J9 and A9J10.
24. Carefully remove A9W3 from the A9 Assembly.
25. Turn the A9 Assembly over and unsolder the five AT3 feedthrough capacitors from the printed circuit board.
26. Turn the A9 Assembly back over and remove AT3.

A9AT4 (REV POW) Removal.

27. Loosen hex nuts securing A9W3 to A9J9 and A9J10.
28. Carefully remove A9W3 from the A9 Assembly.
29. Turn the A9 Assembly over and unsolder the four AT4 feedthrough capacitors from the printed circuit board.
30. Turn the A9 Assembly back over and remove AT4.

CAUTION

Over tightening the hex nuts on the A6 Assembly and the A9 Assembly RF connectors (in step 3) will change the dielectric constant of the semi-rigid cable. (Under tightening may cause RF leakage.)

Attenuator Installation. When re-installing a new individual attenuator section into the A9A1 Assembly, or when re-installing the A9A1 Assembly into the instrument, reverse the procedure used for removal. When re-installing any associated semi-rigid cables, use the following procedure:

1. Tighten the hex nut on the connectors until they are just finger tight.
2. Simultaneously insert both cable ends into their connectors. Make sure the cables are firmly seated in the connectors.
3. Use an 8mm torque wrench and tighten the hex nut on the connectors to **4.5 in/lbs ±0.5 in/lbs**.

Factory-Selected Components (*)

Some component values are selected at the time of final checkout at the factory (see Table 5-1). These values are selected to provide optimum compatibility with associated components. These components are identified on individual schematics and the parts list by an asterisk (*).

Etched Circuits (Printed Circuit Boards)

The etched circuit boards in the Signal Generator have plated-through holes which make a solderable path through to both sides of the insulating material. Soldering can be done from either side of the board with equally good results. When soldering to any circuit board, keep in mind the following recommendations:

4. Avoid unnecessary component substitution. Substitution can result in damage to the circuit board and/or adjacent components.
5. Do not use a high power soldering iron on etched circuit boards. Excessive heat may lift a conductor or damage the board.
6. Use a suction device or wooden toothpick to remove solder from component mounting holes. **DO NOT USE A SHARP METAL OBJECT SUCH AS AN AWL OR TWIST DRILL FOR THIS PURPOSE. SHARP OBJECTS MAY DAMAGE THE PLATED-THROUGH CONDUCTOR.** Refer to Table 8-2 for information on available tools for working on etched circuit boards.

Table 8-2. Etched Circuit Soldering Equipment.

Item	Use	Specification	Item Recommended	HP Part No.
Soldering Tool	Soldering	Wattage: 35W Tip Temp.:390-440° C (735-825° F)	Ungar No. 135 Ungar Division Eldon Ind. Corp. Compton, CA 90220	8690-0167
Soldering Tip	Soldering, Unsoldering	Shape: Chisel*	Ungar PL113*	8690-0007
De-Soldering Aid	To remove molten solder from connection	Suction Device	Soldapullit by Edsyn Co., Van Nuys, CA 91406	8690-0060
Solder	Component replacement; Circuit Board repair wiring	Rosin (flux) core, high tin content (63/37 tin/lead), 18 gauge (SWG) 0.048 in. diameter preferred.		8090-0607
<p>* For working on circuit boards; for general purpose work, use No. 555 Handle (8690-0261) and No. 4037 Heating Unit 47 1/2-56 1/2 W (HP 8690-0006); tip temperature of 850-900° F, and Ungar No. PL113 1/8" chisel tip.</p>				

MOS and CMOS Integrated Circuit Replacement

MOS and CMOS integrated circuits are used in this instrument. They are prone to damage from both static and transients and must be handled carefully. Refer to paragraph 8-4 Special Handling Considerations for Static Sensitive Devices for further information. When working on the Signal Generator, keep in mind the following recommendations to avoid damaging these sensitive components.

1. Do not remove any board unless the Signal Generator has been unplugged.
2. When removing a socketed MOS and CMOS device from an assembly, be careful not to damage it. Avoid removing devices from these sockets with pullers. Instead, use a small screwdriver to pry the device up from one end, slowly pulling it up one pair of pins at a time.
3. Once a MOS or CMOS device has been removed from an assembly, immediately stick it into a pad of conductive foam or other suitable holding medium.
4. When replacing a MOS or CMOS device, ground the foam on which it resides to the instrument before removing it. If a device requires soldering, make sure that the assembly is lying on a sheet of conductive foam, and that the foam and soldering iron tip are grounded to the assembly. Apply as little heat as possible.
5. Before turning the instrument off, remove any large ac sources which may be driving MOS switches.

8-9. RETROFITTING OPTION 001

Option 001 may be retrofitted to the Signal Generator after taking delivery. Refer to Section 1 for the description and part numbers under the paragraphs entitled Options.

8-10. SCHEMATIC SYMBOLOGY AND SCHEMATIC DIAGRAM NOTES

Table 8-3 summarizes the symbology used in presenting many devices found in the instrument. The logic symbols used in this manual are based on the Institute of Electrical and Electronic Engineers (IEEE) in IEEE-STD 91-1984, *Graphic Symbols for Logic Functions*. This publication may be purchased from:

Institute of Electrical and Electronic Engineers
 345 East 47th Street
 New York, NY 10017

Table 8-3. Schematic Diagram Notes (1 of 11)

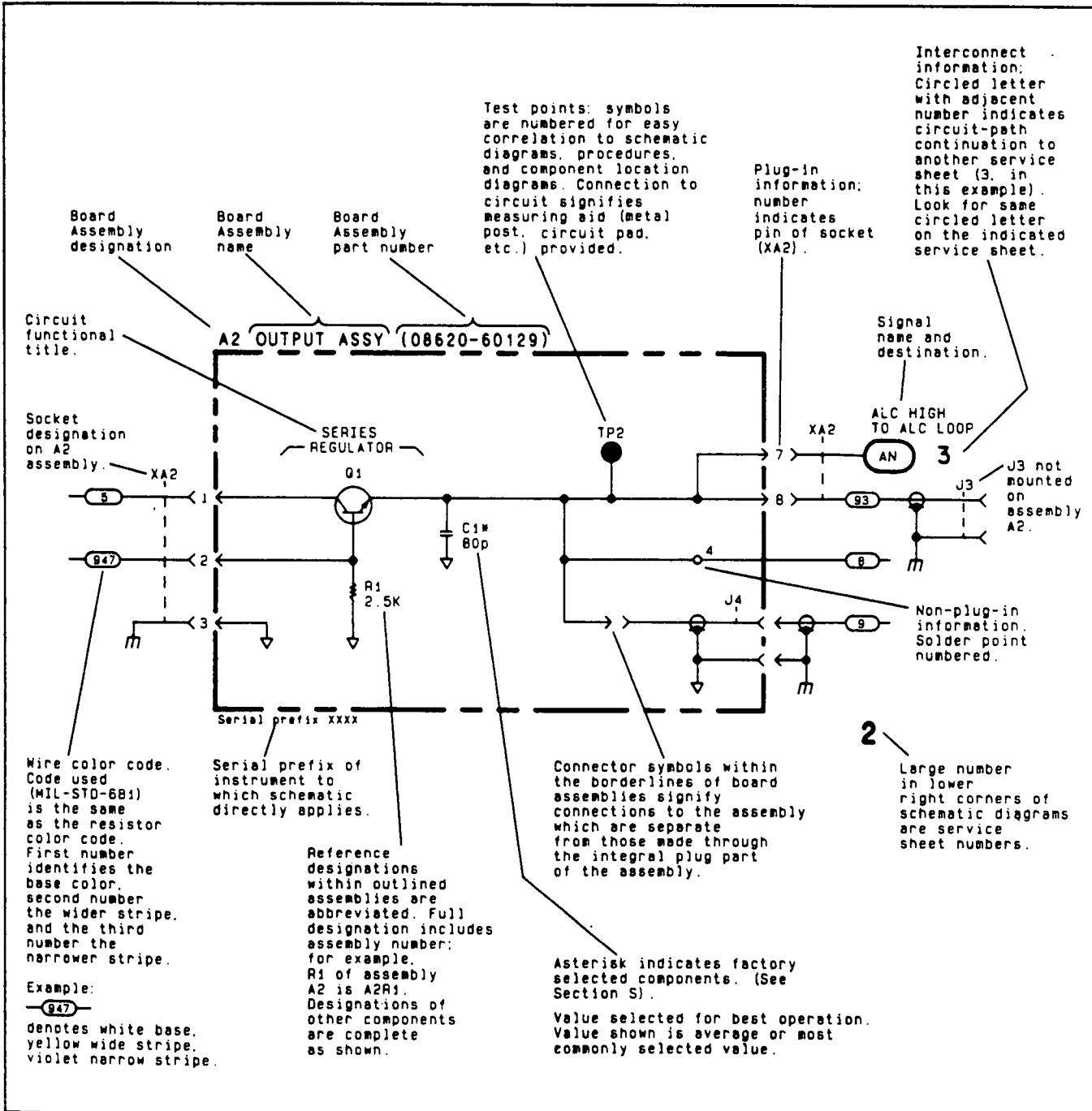


Table 8-3. Schematic Diagram Notes (2 of 11)

Values for all components are marked in units of farads, henries, and ohms unless otherwise specified.





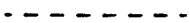











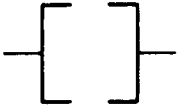
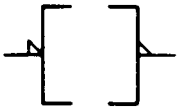
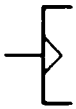
*	Asterisk denotes a factory-selected value. Value shown is typical. See Section V.
	Tool-aided adjustment.
	Encloses front-panel designation.
	Encloses rear-panel designation
	Circuit assembly borderline.
	Other assembly borderline.
	Heavy line with arrows indicates path and direction of main signal.
	Heavy dashed line with arrows indicates path and direction of main feedback.
	Indicates stripline (i.e., RF transmission line above ground).
	Wiper moves toward cw with clockwise rotation of control (as viewed from shaft or knob).
	Numbered Test Point measurement aid provided.
	Encloses wire or cable color code. Code used is the same as the resistor color code. First number identifies the base color, second number identifies the wider stripe, and the third number identifies the narrower stripe, e.g., 647 denotes white base, yellow wide stripe, violet narrow stripe.
	A direct conducting connection to earth, or a conducting connection to a structure that has a similar function (e.g., the frame of an air, sea, or land vehicle).
	A conducting connection to a chassis or frame.
	Common connections. All like-designation points are connected.
	Letter = off-page connection. Number = Service Sheet number for off-page connection. In the example, signal flow is continued on Service Sheet 12, at the point marked.
	Number (only) = on-page connection.

Table 8-3. Schematic Diagram Notes (3 of 11)**DIGITAL SYMBOLOGY REFERENCE INFORMATION****Input and Output Indicators**

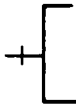
Implied Indicator—Absence of polarity indicator (see below) implies that the active state is a relative high voltage level. Absence of negation indicator (see below) implies that the active state is a relative high voltage level at the input or output.



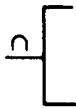
Polarity Indicator—The active state is a relatively low voltage level.



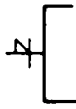
Dynamic Indicator—The active state is a transition from a relative low to a relative high voltage level.



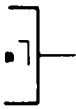
Inhibit Input—Input that, when active, inhibits (blocks) the active state outputs of a digital device.



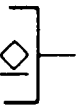
Analog Input—Input that is a continuous signal function (e.g., a sine wave).



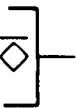
Polarity Indicator used with Inhibit Indicator—Indicates that the relatively low level signal inhibits (blocks) the active state outputs of a digital device.



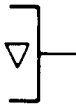
Output Delay—Binary output changes state only after the referenced input (m) returns to its inactive state (m should be replaced by appropriate dependency or function symbols).



Open Collector Output.



Open Emitter Output.



Three-state Output—Indicates outputs can have a high impedance (disconnect) state in addition to the normal binary logic states.

Table 8-3. Schematic Diagram Notes (4 of 11)



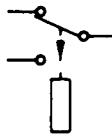
Indicates multiple paths represented by only one line. Letters or names identify individual paths. Numbers indicate number of paths represented by the line.



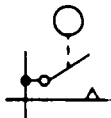
Coaxial or shielded cable.



Ferrite bead. (Increases the self-inductance of the conductor passing through the bead.)



Relay. Contact moves in direction of arrow when energized.



Indicates a pushbutton switch with a momentary (ON) position.



Feedthrough capacitor. (Acts as a feedthrough terminal when mounted on a chassis or a frame.)



Indicates a PIN diode.



Indicates a current regulation diode.



Indicates a voltage regulation diode.



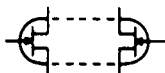
Indicates a capacitive (varactor) diode.



Indicates a Schottky (hot-carrier) diode.



Light-emitting diode.



Multiple transistors in a single package—physical location of the pins is shown in package outline on schematic.



Identification of logic families as shown (in this case, ECL).

Table 8-3. Schematic Diagram Notes (5 of 11)**DIGITAL SYMBOLOGY REFERENCE INFORMATION****Combinational Logic Symbols and Functions**



Σ	Summing Junction—Outputs added together at a common point.
&	AND—All inputs must be active for the output to be active.
≥ 1	OR—One or more inputs being active will cause the output to be active.
$\geq m$	Logic Threshold—m or more inputs being active will cause the output to be active (replace m with a number).
=1	EXCLUSIVE OR—Output will be active when one (and only one) input is active.
=m	m and only m—Output will be active when m (and only m) inputs are active (replace m with a number).
=	Logic Identity—Output will be active only when all or none of the inputs are active (i.e., when all inputs are identical, output will be active).
	Amplifier—The output will be active only when the input is active (can be used with polarity or logic indicator at input or output to signify inversion).
X/Y	Signal Level Converter—Input level(s) are different than output level(s).
	Bilateral Switch—Binary controlled switch which acts as an on/off switch to analog or binary signals flowing in both directions. Dependency notation should be used to indicate affecting/affected inputs and outputs. Note: amplifier symbol (with dependency notation) should be read to indicate unilateral switching.
X→Y	Coder—Input code (X) is converted to output code (Y) per weighted values or a table.
(Functional Labels)	The following labels are to be used as necessary to ensure rapid identification of device function.
MUX	Multiplexer—The output is dependent only on the selected input.
DEMUX	Demultiplexer—Only the selected output is a function of the input.
CPU	Central Processing Unit

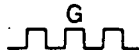
Table 8-3. Schematic Diagram Notes (6 of 11)

DIGITAL SYMBOLOGY REFERENCE INFORMATION

Sequential Logic Functions



Monostable—Single shot multivibrator. Output becomes active when the input becomes active. Output remains active (even if the input becomes inactive) for a period of time that is characteristic of the device and/or circuit.



Oscillator—The output is a uniform repetitive signal which alternates between the high and low state values. If an input is shown, then the output will be active if and only if the input is in the active state.

FF

Flip-Flop—Binary element with two stable states, set and reset. When the flip-flop is set, its outputs will be in their active states. When the flip-flop is reset, its outputs will be in their inactive states.

T

Toggle Input—When active, causes the flip-flop to change states.

S

Set Input—When active, causes the flip-flop to set.

R

Reset Input—When active, causes the flip-flop to reset.

J

J Input—Analogous to set input.

K

K Input—Analogous to reset input.

D

Data Input—Always enabled by another input (generally a C input—see Dependency Notation). When the D input is dependency-enabled, a high level at D will set the flip-flop; a low level will reset the flip-flop. Note: strictly speaking, D inputs have no active or inactive states—they are just enabled or disabled.

+m

Count-Up Input—When active, increments the contents (count) of a counter by "m" counts (m is replaced with a number).

-m

Count-Down Input—When active, decrements the contents (count) of a counter by "m" counts (m is replaced with a number).

→m

Shift Right (Down) Input—When active, causes the contents of a shift register to shift to the right or down "m" places (m is replaced with a number).

←m

Shift Left (Up) Input—When active, causes the contents of a shift register to shift to the left or up "m" places (m is replaced with a number).

NOTE

For the four functions shown above, if m is one, it is omitted.

(Functional Labels)

The following functional labels are to be used as necessary in symbol build-ups to ensure rapid identification of device function.

mCNTR

Counter—Array of flip-flops connected to form a counter with modules m (m is replaced with a number that indicates the number of states: 5 CNTR, 10 CNTR, etc.).

Table 8-3. Schematic Diagram Notes (7 of 11)**DIGITAL SYMBOLOGY REFERENCE INFORMATION****Sequential Logic Functions (Cont'd)**

REG	Register—Array of unconnected flip-flops that form a simple register or latch.
SREG	Shift Register—Array of flip-flops that form a register with internal connections that permit shifting the contents from flip-flop to flip-flop.
ROM	Read Only Memory—Addressable memory with read-out capability only.
RAM	Random Access Memory—Addressable memory with read-in and read-out capability.

Dependency Notation

Cm	Control Dependency—Binary affecting input used where more than a simple AND relationship exists between the C input and the affected inputs and outputs (used only with D-type flip-flops).
Gm	Gate (AND) Dependency—Binary affecting input with an AND relationship to those inputs or outputs labeled with the same identifier. The m is replaced with a number or letter (the identifier).
Vm	OR Dependency—Binary affecting input with an OR relationship to those inputs or outputs labeled with the same identifier. The m is replaced with a number or the letter (the identifier).
mAm	Address Dependency—Binary affecting inputs of affected outputs. The m prefix is replaced with a number that differentiates between several address inputs, indicates dependency, or indicates demultiplexing of address inputs and outputs. The m suffix indicates the number of cells that can be addressed.
ENm	Enable Dependency—Binary affecting input which, when active enables all outputs. When inactive open-collector and open-emitter outputs are off, and three-state outputs are at an external high impedance state. When the enable input affects only certain inputs and outputs, they will be numbered to indicate the logic connection.
Xm	Transmission Dependency—Binary affecting input which bidirectionally connects dependent inputs and outputs.
Mm	Mode Dependency—Binary affecting input used to indicate that the effects of particular inputs and outputs of an element depend on the mode in which the element is operating. The m is replaced with a number or letter (the identifier).
Zm	Interconnection Dependency—Indicates the existence of internal logic connections between inputs, outputs, internal inputs, and/or internal outputs. The m is replaced with a number (the identifier).
,	Comma—AND Function.
/	Slant—OR Function.

NOTE

The identifier (m) is omitted if it is one—that is, when there is only one dependency relationship of that kind in a particular device. When this is done, the dependency indicator itself (G, C, EN, or V) is used to prefix or suffix the affected (dependent) input or output.

Table 8-3. Schematic Diagram Notes (8 of 11)

DIGITAL SYMBOLOGY REFERENCE INFORMATION

Miscellaneous



Schmitt Trigger—Input characterized by hysteresis; one threshold for positive going signals and a second threshold for negative going signals.

Active

Active State—A binary physical or logical state that corresponds to the true state of an input, an output, or a function. The opposite of the inactive state.

Table 8-3. Schematic Diagram Notes (9 of 11)

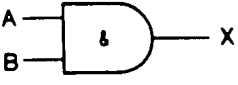
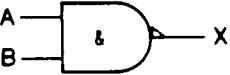


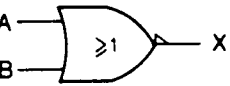
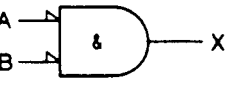
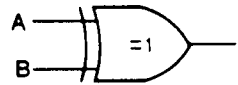
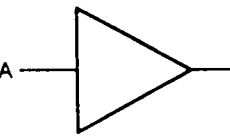
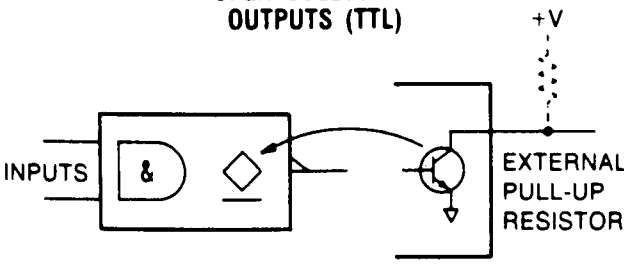
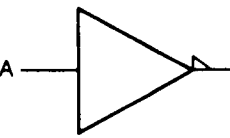
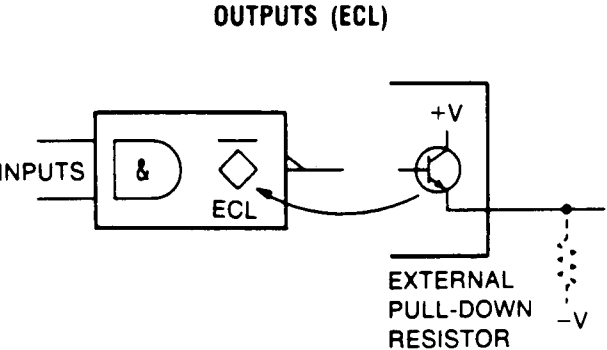
<p>AND GATE</p>  <table border="1" data-bbox="399 340 690 520"> <thead> <tr> <th>A</th> <th>B</th> <th>X</th> </tr> </thead> <tbody> <tr> <td>H</td> <td>H</td> <td>H</td> </tr> <tr> <td>H</td> <td>L</td> <td>L</td> </tr> <tr> <td>L</td> <td>H</td> <td>L</td> </tr> <tr> <td>L</td> <td>L</td> <td>L</td> </tr> </tbody> </table>	A	B	X	H	H	H	H	L	L	L	H	L	L	L	L	<p>NAND GATE</p>  <table border="1" data-bbox="1077 310 1367 499"> <thead> <tr> <th>A</th> <th>B</th> <th>X</th> </tr> </thead> <tbody> <tr> <td>H</td> <td>H</td> <td>L</td> </tr> <tr> <td>H</td> <td>L</td> <td>H</td> </tr> <tr> <td>L</td> <td>H</td> <td>H</td> </tr> <tr> <td>L</td> <td>L</td> <td>H</td> </tr> </tbody> </table> <p>OR GATE WITH INVERTED INPUTS</p> 	A	B	X	H	H	L	H	L	H	L	H	H	L	L	H
A	B	X																													
H	H	H																													
H	L	L																													
L	H	L																													
L	L	L																													
A	B	X																													
H	H	L																													
H	L	H																													
L	H	H																													
L	L	H																													
<p>OR GATE</p>  <table border="1" data-bbox="399 772 690 953"> <thead> <tr> <th>A</th> <th>B</th> <th>X</th> </tr> </thead> <tbody> <tr> <td>H</td> <td>H</td> <td>H</td> </tr> <tr> <td>H</td> <td>L</td> <td>H</td> </tr> <tr> <td>L</td> <td>H</td> <td>H</td> </tr> <tr> <td>L</td> <td>L</td> <td>L</td> </tr> </tbody> </table>	A	B	X	H	H	H	H	L	H	L	H	H	L	L	L	<p>NOR GATE</p>  <table border="1" data-bbox="1077 699 1367 888"> <thead> <tr> <th>A</th> <th>B</th> <th>X</th> </tr> </thead> <tbody> <tr> <td>H</td> <td>H</td> <td>L</td> </tr> <tr> <td>H</td> <td>L</td> <td>L</td> </tr> <tr> <td>L</td> <td>H</td> <td>L</td> </tr> <tr> <td>L</td> <td>L</td> <td>H</td> </tr> </tbody> </table> <p>AND GATE WITH INVERTED INPUTS</p> 	A	B	X	H	H	L	H	L	L	L	H	L	L	L	H
A	B	X																													
H	H	H																													
H	L	H																													
L	H	H																													
L	L	L																													
A	B	X																													
H	H	L																													
H	L	L																													
L	H	L																													
L	L	H																													
<p>EXCLUSIVE-OR GATE</p>  <table border="1" data-bbox="399 1203 690 1383"> <thead> <tr> <th>A</th> <th>B</th> <th>X</th> </tr> </thead> <tbody> <tr> <td>H</td> <td>H</td> <td>L</td> </tr> <tr> <td>H</td> <td>L</td> <td>H</td> </tr> <tr> <td>L</td> <td>H</td> <td>H</td> </tr> <tr> <td>L</td> <td>L</td> <td>L</td> </tr> </tbody> </table>	A	B	X	H	H	L	H	L	H	L	H	H	L	L	L	<p>BUFFER</p>  <table border="1" data-bbox="1110 1039 1308 1165"> <thead> <tr> <th>A</th> <th>X</th> </tr> </thead> <tbody> <tr> <td>H</td> <td>H</td> </tr> <tr> <td>L</td> <td>L</td> </tr> </tbody> </table>	A	X	H	H	L	L									
A	B	X																													
H	H	L																													
H	L	H																													
L	H	H																													
L	L	L																													
A	X																														
H	H																														
L	L																														
<p>OPEN COLLECTOR OUTPUTS (TTL)</p> 	<p>INVERTER</p>  <table border="1" data-bbox="1110 1302 1308 1428"> <thead> <tr> <th>A</th> <th>X</th> </tr> </thead> <tbody> <tr> <td>H</td> <td>L</td> </tr> <tr> <td>L</td> <td>H</td> </tr> </tbody> </table>	A	X	H	L	L	H																								
A	X																														
H	L																														
L	H																														
<p>OPEN EMITTER OUTPUTS (ECL)</p> 																															

Table 8-3. Schematic Diagram Notes (10 of 11)

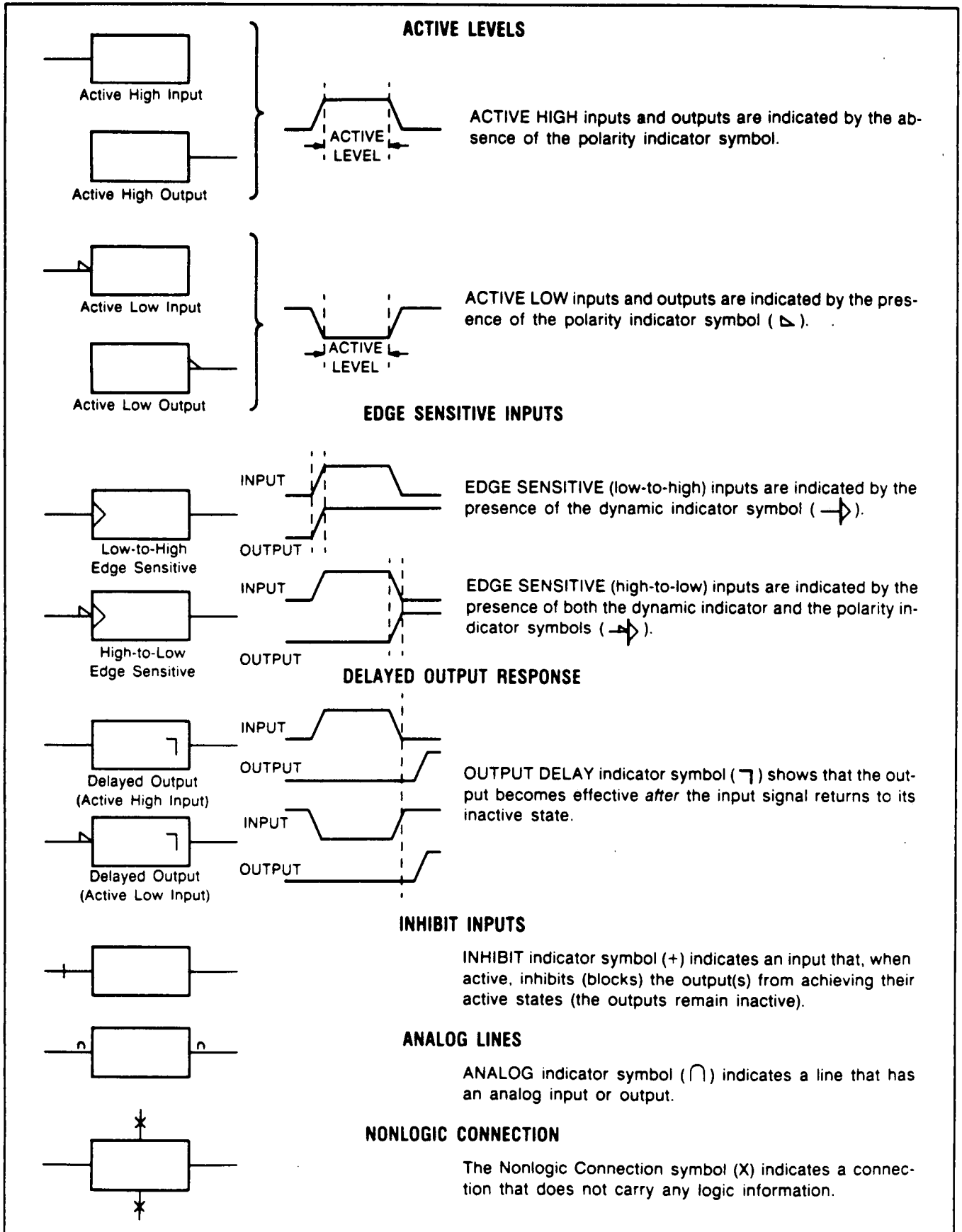
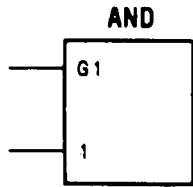
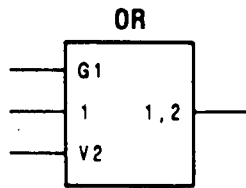


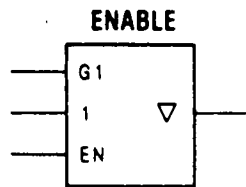
Table 8-3. Schematic Diagram Notes (11 of 11)



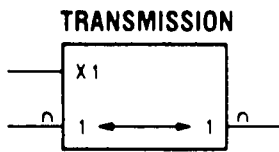
The input that controls or gates other inputs is labeled with a C or a G, followed by an identifying number. The controlled or gated input or output is labeled with the same number. In this example, 1 is controlled by G1.



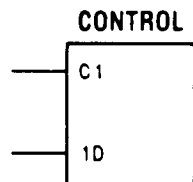
When a V input is active, the output will be in its active state. With the V input inactive, the device functions as if the V input doesn't exist.



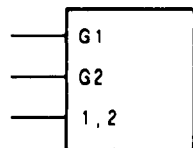
When the EN input is active, the output is enabled to function normally. When the EN input is inactive, the three-state output (▽), in this case, becomes a high impedance, effectively removing that device from the circuit.



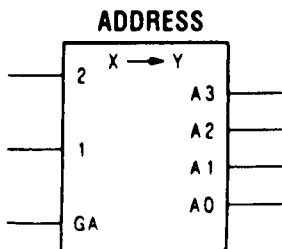
When the X1 input is active, the associated input-output pair are bi-directionally connected together. When X1 is inactive, the connection is broken.



When the controlled or gated input or output already has a functional label (D is used here), that label will be prefixed by the identifying number.



If the input or output is affected by more than one gate or control input, then the identifying numbers of each gate or control input will appear separated by commas.



When GA is active, the active address line (0 through 3) is the decoded value of the 1 and 2 binary inputs. When the controlled address lines have a functional value, that value will be prefixed by the identifying letter.

Block Diagram 1

OVERALL BLOCK DIAGRAM

PRINCIPLES OF OPERATION

General

The Signal Generator can be conceptually broken down into three subsections. The individual subsections are illustrated on the following Block Diagrams.

Block Diagram 2- High Frequency and Output Section

Block Diagram 3 - Low Frequency and FM Section

Block Diagram 4 - Microprocessor, Keyboard, and Display Section

The Signal Generator uses frequency synthesis to generate a carrier frequency range of 100 kHz to 1040 MHz. Its output amplitude is leveled and calibrated from +13 to -143.5 dBm. AM and/or FM functions can be individually selected. The carrier frequency, output amplitude, and modulation functions can be remotely programmed via the HP-IB.

Frequency synthesis translates a stable, accurate reference into an output signal of a different frequency. The output frequency can have a finite number of values within a frequency range. The resolution of the synthesizer determines the spacing between the discrete values that the output frequency can assume. All output frequencies retain the same accuracy and stability as the reference signal.

When using the indirect synthesis method of generating output frequencies, phase lock loops are locked to a signal from a crystal controlled reference oscillator. The two phase lock loops used in the Signal Generator generate signals which are combined to produce the instrument's frequency range (100 kHz to 1040 MHz). Every output frequency starts as a signal in the basic oscillator frequency band (520 to 1040 MHz) and is divided or heterodyned in the output section if required. The broad frequency range is generated in the following four bands:

1. 100 kHz to 129.99999 MHz (Heterodyned)
2. 130 to 259.99999 MHz (Divide by 4)
3. 260 to 519.99999 MHz (Divide by 2)
4. 520 to 1040 MHz (Divide by 1 or Basic Band)

High Frequency and Output Section

The Frequency Multiplier multiplies the 50 MHz reference signal by 16 to obtain an 800 MHz signal. It also mixes the 800 MHz with the 60 to 110 MHz output of the low frequency loop to provide a frequency between 690 and 740 MHz in steps of 10 Hz and to phase lock the high frequency loop. The 800 MHz is also sent to the Output Section and mixed with specific frequencies in the basic band (800.1 to 929.99999 MHz) to obtain the heterodyne band of frequencies (100 kHz to 129.99999 MHz).

The high frequency feedback loop phase locks the 520 to 1040 MHz basic band VCO. A signal from the oscillator is mixed with a 690 to 740 MHz signal from the Frequency Multiplier. Both the upper and lower sidebands from the Mixer are used to obtain one of six possible Intermediate Frequencies (IF) every 50 MHz from 0 to 300 MHz. Any frequency in the 520 to 1040 MHz range can be selected by adding or subtracting the appropriate IF frequency (for example, 690 to 740 + 300 = 990 to 1040 MHz, 690 to 740 - 150 = 540 to 590 MHz). The IF frequency is sampled by the output of the Pulse Generator that is driven by the 50 MHz Reference Oscillator signal. Correction voltage from the sampler tunes the high frequency VCO to correct for frequency error. The VCO is phase locked to an oscillator in the low frequency loop with only a 50 MHz tuning range (60 to 110 MHz) which in turn is phase

locked to the 50 MHz reference through a programmable divider. Noise from the high frequency VCO is corrected for in the wideband phase lock loop. Therefore, the main contributor of noise and residual FM is the 60 to 110 MHz low frequency VCO.

The Output Section translates the 520 to 1040 MHz basic band frequencies to all other frequencies by dividing (130 MHz to 1040 MHz) or heterodyning (100 kHz to 129.99999 MHz). It controls the RF output amplitude, and provides harmonic filtering and AM.

Each of the divide-by-1, 2, and 4 bands is one octave (for example, 520 to 1040 MHz for the divide-by-1 band, 260 to 519.99999 MHz for the divide-by-2 band, and 129.99999 to 259.99999 MHz for the divide-by-4 band). Each Voltage Tuned Filter's bandwidth is also one octave and tuned by the microprocessor. The filters therefore track the oscillator's frequency and are biased on only when that band is selected. This selection of filters provides filtering of the out-of-band spurious and harmonic frequencies.

Output level is stepped in 10 dB steps by an electronic step attenuator. Output level changes less than 10 dB are controlled by the ALC Amplifier from the Level DAC. The ALC Amplifier has two inputs. One is the detected output voltage. The other is the sum of the amplitude modulation voltage and the level voltage (for level changes less than 10 dB and level correction for frequency response). The output of the ALC Amplifier controls the current through the PIN Modulator which controls the fine level attenuation and amplitude modulation of the output.

When triggered, the reverse power protection circuit opens a relay in series with the output. Limiting diodes protect the attenuator and level circuits during high power transients. A detector senses reverse power and provides the voltage to open the relay and protect the output circuits until the reverse power circuit is reset.

Internal modulation signals of 400 Hz or 1 kHz for amplitude and frequency modulation from the Audio Oscillator can be used, or external amplitude and frequency modulation can be selected at the front-panel. The internal and external modulation signals are converted by the AM% DAC and the FM Dev DAC. The Signal Generator's output can be simultaneously amplitude and frequency modulated by either one of the 400 Hz or 1 kHz internal signals and an external signal or any combination thereof. The carrier frequency modulation is generated in the low frequency loop which allows for RF output FM deviation up to 99 kHz for all output frequencies that are not divided by four. FM deviation in the divide-by-4 band (130 to 259.99999 MHz) is limited to 50 kHz. The amplitude modulation signal is applied to the ALC Amplifier.

Low Frequency and FM Section

The 50 MHz Reference Oscillator is a crystal oscillator. Its output phase locks the VCOs, and is also divided down to provide the 1 MHz time base. The rear-panel TIME BASE OUTPUT is a jumper-selectable frequency of 1, 5, or 10 MHz that is divided from the 50 MHz Reference Oscillator and can be used as a stable reference for other instruments.

For Option 001, a 10 MHz temperature-stabilized crystal oscillator is used. A phase lock loop is established between the crystal oscillator and the internal reference for greater accuracy and stability. An external reference of 1, 5, or 10 MHz may also be used to phase lock the 50 MHz Reference Oscillator. However, the jumper-selected frequency of 1, 5, or 10 MHz must be the same as the external frequency. The 50 MHz reference signal is distributed and translated by frequency doublers and mixers to provide reference signals at other frequencies.

The 60 to 110 MHz low frequency VCO is tracked by the high frequency basic band oscillator's frequency. The low frequency VCO is tuned to the correct frequency by the Microprocessor and is locked to the 50 MHz Reference Oscillator. Depending upon the frequency, the Reference Oscillator and the low frequency VCO signals are both divided down to 100 kHz. This output is used to phase lock the VCO. Any phase difference between the two signals is converted to a voltage, sampled, and applied to the VCO to correct its frequency. The low frequency loop's VCO is frequency modulated outside the loop bandwidth and phase modulated inside the loop bandwidth. The VCO is tuned over its 50 MHz range in 10 Hz steps. It therefore steps the 690 to 740 MHz signal, generated by mixing the 60 to 110 MHz with the 800 MHz in the Frequency Multiplier Mixer, in 10 Hz steps.

Microprocessor, Keyboard, and Display Section.

The Microprocessor controls the information on the address and data bus, thereby controlling all digital data throughout the instrument. The Microprocessor with its associated read only memory (ROM), random access memory (RAM), input/output (I/O), and decoder circuits processes the front-panel keyboard inputs, the HP-IB inputs, and all displayed information.

Digital data sent to the High Frequency and Output Section performs the following functions:

- a. Controls the Voltage-Controlled Oscillator (VCO) lock point.
- b. Turns off the correct IF notch filter to pass the specified IF frequency and lock the VCO at the correct frequency.
- c. Corrects the output level for frequency response.
- d. Changes output amplitude in less than 10 dB increments.
- e. Controls the amplitude modulation of the carrier.
- f. Selects the heterodyne frequencies, and the divide-by-one, two, or four band as required.
- g. Sets attenuation in 10 dB steps.
- h. Resets the Reverse Power Relay.
- i. Tunes the Voltage Tuned Filters.
- j. Turns switched +15V and RF on or off.
- k. Sets the bandwidth of the ALC amplifier.

Digital data sent to the Low Frequency and FM Section determines the frequency modulation of the carrier and the frequency resolution of the output (10 Hz).

Two high and low frequency data words are serially sent to the High Frequency and Output Sections, and the Low Frequency and FM Section. The serial data is strobed into the correct registers by decoding the address bus bits. Parallel data is also sent to the High Frequency and Output Section to select AM, FM, and level control, to select the frequency bands, and to select the amount of attenuation in the step attenuator.

TROUBLESHOOTING

The troubleshooting checks on this service sheet are used to isolate a malfunction to one of the three major functional assemblies. The checks are easy to perform and provide much key information. In most instances the checks isolate a failure to either a hardware or a software (controller) problem. The comments associated with each procedure summarize the information known as a result of passing or failing the check. The checks should be done in order.

Troubleshooting Help

Section 2, Line Voltage and Fuse Selection
Section 3, Operator's Checks, and Power-On Sequence

√1 Line Check

Procedure.

Remove the Signal Generator's bottom cover. Refer to Disassembly Procedures under Repair in Section 8. After the bottom cover is removed, connect the line voltage.

Normal Indications.

1. Set the POWER switch to the ON position. The three light emitting diodes (LEDs) on the A10 Audio Power Supply Assembly are lighted indicating that the regulated supplies are operating. This does not mean that the supply voltages are within the required tolerance.

Abnormal Indications. If an abnormal indication occurs:

1. Check rear-panel line fuse and line voltage selector.
2. Measure individual regulated supplies and the unregulated supply. If necessary, go to Service Sheet 25 Troubleshooting.

√2 Power-Up Check

Procedure.

Switch the POWER switch to STBY and back to ON. Check the front-panel annunciators (LEDs) and display segments.

Normal Indications.

All front-panel indicators are lighted for approximately 1.5 seconds to provide a visual inspection of each front-panel annunciator and display segment.

1. All the display segments will display the number eight, and the most significant AMPLITUDE digit will be a one.
2. When the power-on subroutine is completed, the signal generator will display the same modulation, frequency, and amplitude settings as when it was last ON.

Abnormal Indications.

If an abnormal indication occurs, that is:

1. The LEDs stay lighted and display segments remain eights, and one, go to Block Diagram 4.
2. The LEDs stay lighted and the numerical displays are all zeros.
 - a. Check for a noisy +5 Vdc power supply. If necessary, go to Service Sheet 25 Troubleshooting.
 - b. Check the Microprocessor clock. Go to Service Sheet 17 Troubleshooting.
3. An LED or display segment does not show the correct output. Check the display's associated components and drive circuits. Go to Service Sheets 22 or 23 Troubleshooting (FREQUENCY Display problem) or Service Sheet 22 or 24 Troubleshooting (MODULATION or AMPLITUDE Display problem).
4. A RAM or ROM error code is displayed in the FREQUENCY Display. Refer to Table 3-1 Power-On Error Codes to identify where the problem is.

√3 Frequency and Amplitude

Procedure.

1. Set the Signal Generator as follows:

Frequency	100 MHz
Amplitude	0 dBm
Modulation	Off
2. Check the RF Output frequency and output amplitude.

Normal Indications.

1. The RF output frequency is phase locked at 100 MHz; the output amplitude is 0 dBm ±1.0 dB.
2. The FREQUENCY Display is 100 MHz; the AMPLITUDE Display is 0 dBm.

Abnormal Indications.

If an abnormal indication occurs, that is:

1. The RF output frequency is not phase locked, go to Block Diagram 2 or Block Diagram 3 Troubleshooting.
2. The RF output frequency is incorrect, go to Block Diagram 2 Troubleshooting.
3. The output amplitude is incorrect, go to Block Diagram 2 Troubleshooting.

√4 Modulation

Procedure.

1. Set the Signal Generator as follows:

Frequency	100 MHz
Amplitude	0 dBm
Modulation	AM 50%, and FM 50 kHz
Source	1 kHz (Int.)
2. Check AM and FM at the RF OUTPUT connector J2.

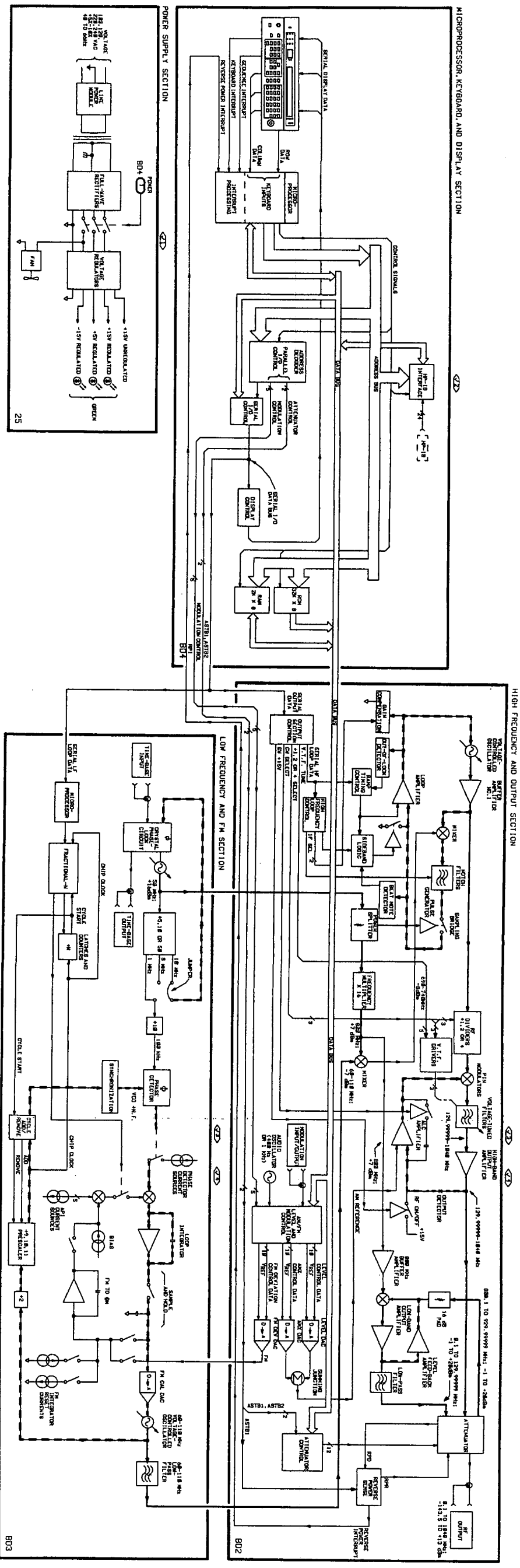
Normal Indications.

1. The MODULATION Display shows 50% or 50 kHz, and the MODULATION LEDs 1 kHz, INT AM, INT FM will be lighted (depending on last input).
2. Modulation at the RF OUTPUT connector, J2, should be 50% AM and 50 kHz FM deviation at a 1 kHz rate.

Abnormal Indications.

If abnormal indications occur, that is:

1. The MODULATION Display is incorrect, go to Block Diagram 4 Troubleshooting.
2. The AM level is incorrect, go to Block Diagram 2 Troubleshooting.
3. The FM level is incorrect, go to Block Diagram 2 or Block Diagram 3 Troubleshooting.
4. The 1 kHz modulation rate is incorrect, go to Service Sheets 6 and 7 Troubleshooting.



Block Diagram 1
Figure 1
7

Overall Troubleshooting BD1
SEE REVERSE SIDE

Block Diagram 2

HIGH FREQUENCY AND OUTPUT SECTION

PRINCIPLES OF OPERATION

A8 Frequency Multiplier Assembly

The Frequency Multiplier Assembly multiplies the 50 MHz reference signal by 16 to obtain an 800 MHz signal. The reference signal is doubled four times for frequencies of 100, 200, 400, and 800 MHz. The output of each multiplier is passed through a bandpass filter for the output frequency of that stage to filter out the harmonics and subharmonics generated by the multiplier.

The 800 MHz signal is applied to the A6 Output Assembly and mixed with specific basic band frequencies (800.1 to 929.99999 MHz) when output frequencies in the heterodyne band (100 kHz to 129.99999 MHz) are selected. It is also applied to the Frequency Multiplier Buffer Amplifier No. 1. The signal is amplified and then mixed with the 60 to 110 MHz output from the A3 Low Frequency Loop Assembly (see BD3). The output from the mixer is a frequency between 690 and 740 MHz that is used to phase lock the high frequency loop. Before a frequency between 690 and 740 MHz is sent to the A4 High Frequency Loop Assembly, it is amplified by two buffer amplifiers and filtered by a bandpass filter. The 690 to 740 MHz Bandpass Filter filters out the 800 MHz and the mixer products of 860 to 910 MHz. The Compensation Network is adjusted for a flat frequency response of ± 1.5 dB at the input of the A4 High Frequency Loop Assembly.

A4 High Frequency Loop Assembly

The High Frequency Loop Assembly phase locks the High Frequency VCO to the A3 50 MHz Reference Oscillator. The High Frequency VCO generates the instrument's 520 to 1040 MHz basic band frequencies. The output from the VCO is amplified by Buffer Amplifier No. 1 and then split by the Power Splitter. One output of the Power Splitter is amplified by Buffer Amplifier No. 2 and sent to the A6 Output Assembly. The other output of the Power Splitter is amplified by Buffer Amplifier No. 3, filtered by the 1100 MHz Low-Pass Filter, amplified by Buffer Amplifier No. 4, and attenuated 2 dB before being applied to the mixer and mixed with a frequency between 690 and 740 MHz from the A8 Frequency Multiplier Assembly. Both upper and lower sidebands from the Mixer are used to obtain Intermediate Frequencies (IF) phase lock signals in 50 MHz steps from DC to 300 MHz. The IF phase lock signal is filtered by the 320 MHz Low-Pass IF Input Filter, and then the 300 and 400 MHz Notch Filters. The IF signal is then amplified by the IF Buffer Amplifier and is applied to the Notch Filters. The notch filter for the specific IF is not selected and allows that IF signal to pass through the Notch Filters. The IF signal is filtered by the 320 MHz Low-Pass IF Output Filter, and then sampled at a 50 MHz rate by a pulse from the Pulse Generator that is driven by the A3 50 MHz Reference Oscillator signal. The output of the Sampling Bridge is a correction voltage proportional to the phase difference of the IF frequency and the 50 MHz reference. The correction voltage is amplified by the Sampler Amplifier, filtered by the 13 MHz Low-Pass Filter and applied to the Loop Amplifier. It is then fed back to correct the frequency of the VCO.

The dc notch is not selected, and the IF Buffer Amplifier is not biased on when the high frequency VCO output is 690 to 740 MHz. The Mixer then functions as a phase detector with both inputs at the same frequency. The Mixer's output is now a voltage proportional to the phase difference of the two inputs. All other circuits function as previously described in the high frequency loop.

The ten bit data word used to control the high frequency loop is clocked serially into the HF Loop Data Shift Register and then latched to the shift register's parallel output by the data strobe. Seven bits are used to select either the DC, 50, 100, 150, 200, 250, or 300 MHz IF. Two bits control the Gain Compensation to compensate for the nonlinearity of the VCO frequency change with respect to voltage. One bit controls whether the loop will lock on the upper IF frequency or on the lower IF frequency.

This is necessary because both the upper and lower sidebands from the Mixer are used for IF frequencies of 50, 100, 150, and 200 MHz to phase lock VCO frequencies between 520 and 940 MHz. Also, only the upper sidebands are used and the lower sidebands must be rejected for IF frequencies of 250 and 300 MHz in order to phase lock VCO frequencies between 940 and 1040 MHz. The data strobe is also applied to the Ramp Timing Control circuits, and starts the Loop Amplifier ramping downwards in voltage from its positive rail. This sweeps the VCO from its highest frequency towards its lowest frequency. When the proper IF beatnote is detected by the Beatnote Detector, the Sideband Switch will open and the loop will lock.

A6 Output Assembly

The Output Assembly translates the 520 to 1040 MHz baseband frequencies by dividing (130 to 1040 MHz) or heterodyning (100 kHz to 129.99999 MHz) the basic band frequencies. Each of the divide-by-1, 2, and 4 bands is one octave. The output of the dividers passes through the PIN diode Modulators to the Voltage-Tuned Filters. Each filter's bandwidth is also one octave and tuned by the Microprocessor. The filters track the VCO frequency and are biased on only when that band is selected. This selection of filters provides better isolation and filtering of the out-of-band spurious and harmonic frequencies.

A ten-bit data word is clocked serially into the Output Section Data Storage/Drivers circuit. Three bits control the dividers and five bits control the Voltage-Tuned Filters. One bit selects CW, and one bit turns the switched +15V on and off, which turns RF on and off.

The output from the Voltage-Tuned Filters is amplified by the High-Band Output Amplifier and applied to the Output Detector and the A9 Attenuator Assembly. Output level changes (when the accumulated change is less than 10 dB referenced from +7 dBm) are controlled by the input to the ALC Amplifier from the digital-to-analog converter (DAC) on the A10 Audio/Power Supply Assembly. The ALC amplifier has two inputs. One is the detected output voltage to level the output. The other is the sum of the amplitude modulation voltage and the level voltage (for level changes less than 10 dB and level correction for frequency response). The output of the ALC amplifier controls the current through the PIN diodes of the PIN Modulator which controls amplitude modulation and level into the output attenuator (-8 to +20 dBm).

When output frequencies from 100 kHz to 129.99999 MHz are selected, the A9 Attenuator Assembly switches to the A6 Output Assembly where the output frequencies of 800.1 to 923.5 MHz are mixed (heterodyned) with the 800 MHz from the A8 Frequency Multiplier Assembly. The difference frequency of 100 kHz to 129.99999 MHz is filtered by a low-pass Diplex Filter, amplified by the Low-Band Output Amplifier, and returned to the A9 Attenuator Assembly.

A9 Attenuator Assembly

The Attenuator is a solid state electronic step attenuator (excluding the reverse power relay) providing attenuation settings from 0 dB to 140 dB in 10 dB steps. The output circuits are reverse power protected for inputs up to 50 watts and 25 Vdc. A power level of 1 watt will trigger the circuit and open the reverse power relay within the attenuator assembly. When a reverse power condition is detected by the Reverse Power Sense circuit, the RPI bit is generated to interrupt the Microprocessor. The AMPLITUDE Display will flash to indicate that a reverse power condition has been detected. The reverse power relay remains open until the source of reverse power is removed and the AMPTD key is pressed. At that time, ASTB1 from the Microprocessor will reset the relay.

Two 8-bit data words are clocked into the Attenuator Control Latches by ASTB1 and ASTB2. The output of the latches are applied to the Attenuator Drivers circuit to turn on or off the appropriate switching networks within the attenuator.

A10 Audio/Power Supply Assembly

The amplitude modulation, frequency modulation and level circuits portion of the Audio/Power Supply Assembly are shown on Block Diagram 2. The external modulation signal level must be set at the source and, the output of the External Modulation Buffer is monitored by the Over and Under Modulation Comparators which control the HI EXT and LOW EXT LEDs (not shown) on the front-panel to indicate when the input is too high or low.

The modulation signals are applied to the FM Deviation Summing Amplifier and to the AM% Summing Amplifier. On the A10 Audio/Power Supply Assembly, the internal and external frequency modulation signals are applied to the FM Deviation Summing Amplifier, converted by the FM Deviation DAC (programmed by the FM Deviation Control Data from the Microprocessor), and amplified by the FM Deviation Amplifier. The output of the AM% Summing Amplifier is used as a reference voltage by the AM% DAC. The digitally controlled output of the AM% DAC is summed with the dc level voltage from the Level DAC and applied to the input of the AM Reference Summing Amplifier. The AM reference is applied to the ALC Amplifier on A6.

Five 8-bit data words are strobed into the Modulation Control Latches each time a front-panel or HP-IB modulation entry is made. These data words are used to control all modulation functions, the level of the modulation signals, and the reference level voltage applied to the ALC loop.

TROUBLESHOOTING

General

Procedures for checking the High Frequency and Output Section of the instrument are given below. The blocks or points to check are marked on the block diagram by a hexagon with a check mark and a number inside, for example, $\sqrt{2}$.

Troubleshooting Help

Block Diagram 1

Table 4-1. Abbreviated Performance Tests

Table 5-2. Post-Repair Adjustments

Test Equipment

Measuring Receiver	HP 8902A
Sensor Module	HP 11722A
Adapter Probe	HP 1250-1598
Adapter N(f) to BNC(m)	HP 1250-0077
Adapter BNC(f) to BNC(f)	HP 1250-0080
Cable BNC(m) to SMC(f)	HP 08662-60075

$\sqrt{1}$ RF Output and Attenuator Check

1. Set the Signal Generator as follows:

Frequency	520 MHz
Amplitude	0 dBm
Modulation	Off

2. Set the measuring receiver with the sensor module precalibrated as follows:

Measurement	RF POWER
Display	LOG

3. Zero the measuring receiver and wait for the zero LED to go out.
4. Connect the sensor module to the Signal Generator's RF OUTPUT connector.
5. Verify that the RF output frequency is locked at 520 MHz with an output amplitude of 0 dBm.
 - a. If the signal is unlocked perform $\sqrt{3}$.
 - b. If there is no output, perform $\sqrt{2}$.
 - c. If the output amplitude is not 0 dBm ± 3.0 dB, continue with $\sqrt{1}$ step 6.
6. Reduce the Signal Generator's output amplitude in 10 dB steps to -50 dBm. The output amplitude should change 10 dB for each step.
 - a. If the output amplitude does not change in 10 dB steps, go to Service Sheet 8 Troubleshooting.
 - b. If the output amplitude changes in 10 dB steps, perform $\sqrt{2}$.
7. Set the Signal Generator's frequency to 100 MHz. If there is no RF output frequency or if it's low, go to Service Sheet 5 Troubleshooting.

√2 Output Assembly Check

1. Set the Signal Generator as follows:

Frequency 520 MHz
 Amplitude 0 dBm
 Modulation Off

2. Set the measuring receiver with the sensor module precalibrated as follows:

- a. For amplitude measurements...

Measurement RF POWER
 Display LOG

- b. For frequency measurements...

Measurement FREQ

3. When making amplitude measurements, zero the measuring receiver and wait for the zero LED to go out.
4. Measure amplitude and frequency at the assembly input A6TP1 and output A6J5 with the measuring receiver (see Service Sheet 4).
 - a. If the input is correct (520 MHz and -3 to +4 dBm), but the output level is low (less than -1.5 dBm measured by disconnecting coax cable W14 from A6J5), or if the frequency is incorrect, go to Service Sheet 4 Troubleshooting.
 - b. If the input amplitude or frequency is wrong, go to Service Sheet 1 Troubleshooting.
5. Set the Signal Generator's frequency to 300 MHz and then 150 MHz. Measure the output of the assembly with the measuring receiver. If the output level is low or the frequency is not 300 or 150 MHz, check the Output Control Section (see Service Sheet 5 Troubleshooting).

√3 Frequency Multiplier

1. Set the Signal Generator as follows:

Frequency 500 MHz
 Amplitude 0 dBm
 Modulation Off

2. Set the measuring receiver with the sensor module precalibrated as follows:

Measurement RF POWER
 Display LOG

3. Zero the measuring receiver and wait for the zero LED to go out.
4. Measure the 50 MHz input directly from W5 with the measuring receiver (see Service Sheet 3). If either the level (+16 to +19 dBm) or the frequency (50 MHz) is incorrect, go to Service Sheet 16 Troubleshooting.
5. Measure the 60 to 110 MHz input (100 MHz) directly from W3 with the measuring receiver. If either the level (-9 to -7 dBm) or the frequency (100 MHz) is incorrect or unlocked, go to Block Diagram 3 Troubleshooting.
6. Measure the output (690 to 740 MHz) of the FL1 Bandpass Filter. If either the level (<-5.0 dBm) or the frequency (700 MHz) is incorrect, go to Service Sheet 3 Troubleshooting. If both level and frequency are correct, go to Service Sheet 1 or Service Sheet 2 Troubleshooting.

√4 Audio/Power Supply

- 1. Set the Signal Generator as follows:

Frequency 500 MHz
Amplitude 0 dBm
Modulation AM 50%
Source 1 kHz (Int.)

- 2. Set the measuring receiver as follows:

Measurement AM

- 3. Connect the measuring receiver to the Signal Generator's RF OUTPUT connector.

- 4. Measure the amplitude modulation. It should be 50% ±5%. If the modulation level is incorrect, go to Service Sheet 7 Troubleshooting (control circuits) or Service Sheet 4 Troubleshooting (ALC PIN modulator).

- 5. Set the Signal Generator as follows:

Frequency 500 MHz
Amplitude 0 dBm
Modulation FM 50 kHz
Source 1 kHz (Int.)

- 6. Set the measuring receiver as follows:

Measurement FM

- 7. Measure the frequency modulation. It should be 50 kHz ±2.5 kHz. If the modulation level is incorrect, go to Service Sheet 7 Troubleshooting (control circuits) or Block Diagram 3 Troubleshooting.

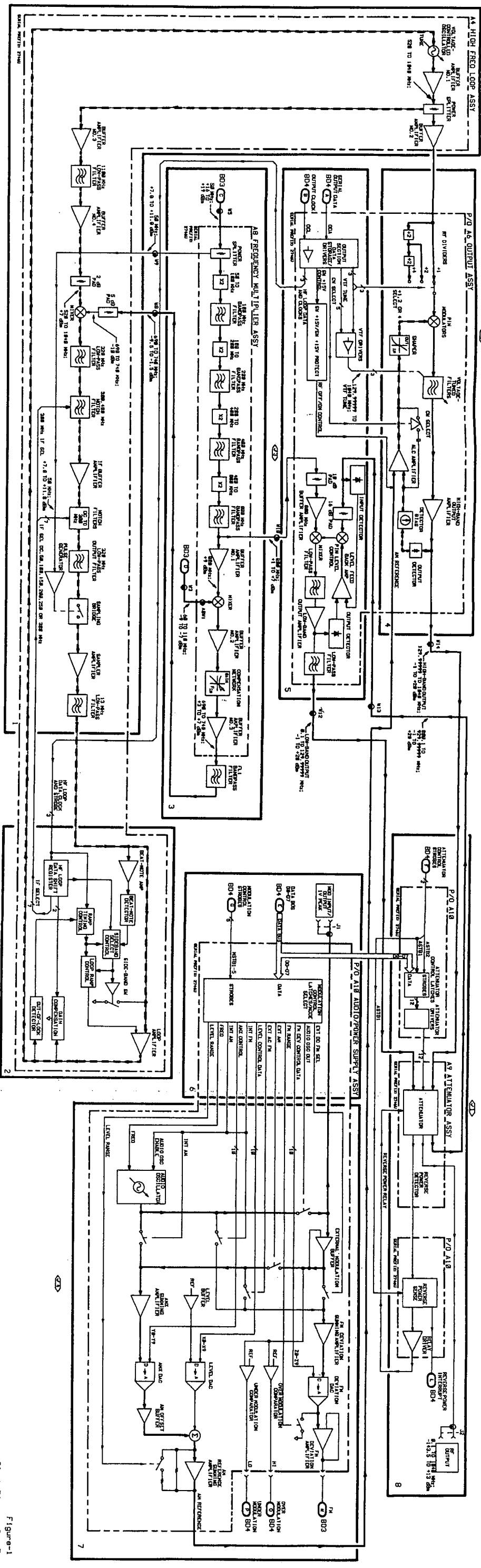


Figure-1
Block Diagram 2 7

(2) OF 17

2 1

x:]

High Frequency and
Output Section **BD2**
SEE REVERSE SIDE

Block Diagram 3

LOW FREQUENCY LOOP AND FM SECTION

PRINCIPLES OF OPERATION

Fractional-N Phase Lock Loop Overview.

The Low Frequency Loop is a Fractional-N phase lock loop. The Low Frequency Loop VCO can be locked at fractional frequencies of the 100 kHz Reference. A VCO fractional frequency is any frequency that is not a whole number, integer, multiple of the reference. The VCO's frequency range is 60 to 110 MHz. When the VCO frequency is 100 MHz, its frequency is an integer multiple of the 100 kHz reference ($100 \text{ kHz} \times 1000$) = 100 MHz. When the VCO frequency is 100.01 MHz, its frequency is not an integer multiple of the 100 kHz reference ($100 \text{ kHz} \times 1000.1$) = 100.01 MHz, a fractional frequency.

The hardware needed to build a divider that can divide by a fractional number is more complex than the hardware needed to build an integer only divider. The method used is to have a integer divider that can be switched between two divide numbers (N and N-1) so the average divide number has a fractional part. From the example, $N = 1000.1$, the divider would divide-by-1000 for 9 times and 1001 for 1 time.

Figure 1 illustrates the basic Phase Lock Loop. The Phase Detector compares the Voltage Controlled Oscillator (VCO) output signal to the Reference signal. A Tune Voltage proportional to the phase difference between the two signals is produced. The Tune Voltage is filtered by the Low Pass Filter to suppress noise and high frequency components. The Tune Voltage corrects the VCO's frequency so it phase-tracks the Reference. For this loop to lock the VCO and the Reference must be at the same frequency. For the loop to lock at multiple integer frequencies of the VCO a Divide-By-N circuit must be added as shown in Figure 2. The VCO can now produce a discrete range of frequencies all phase locked to the Reference.

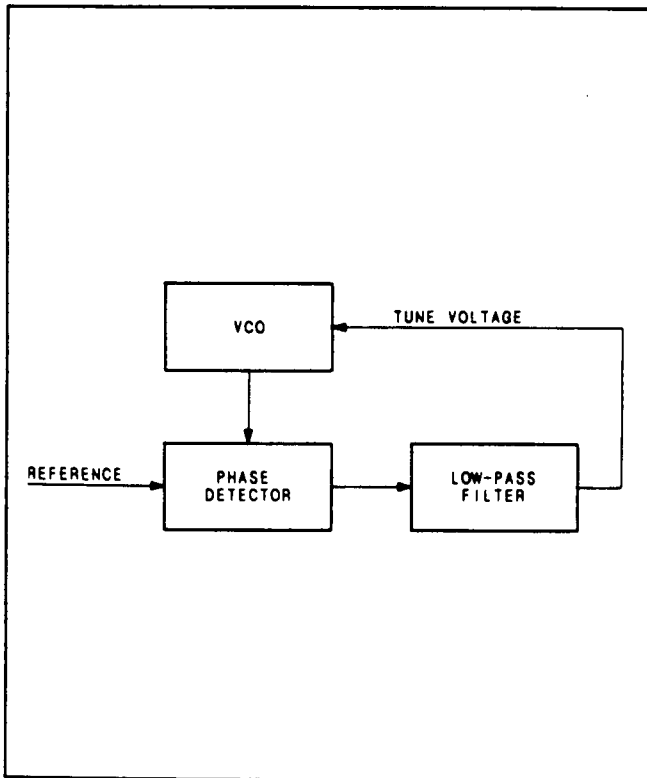


Figure 1. Basic Single Frequency Phase Lock Loop.

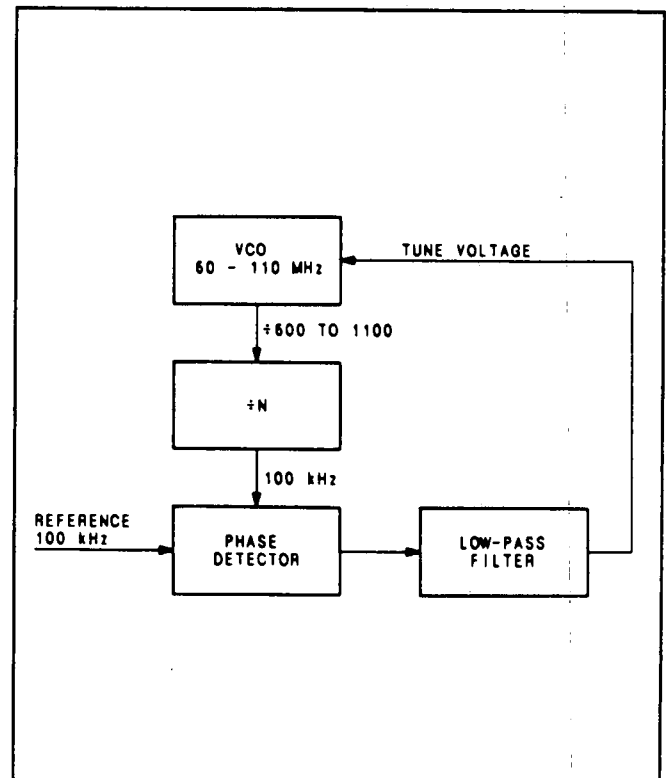


Figure 2. Basic 100 kHz Step Phase Lock Loop.

A Fractional-N loop is a modified Divide-By-N loop and can lock at frequencies that are not integers of the Reference. It can lock at fractional multiples of the Reference. For Fractional-N loops the N in N.F. represents the integral multiple, the Divide-By-N number. The F represents the fractional part of the VCO's offset frequency with respect to the integral frequency. With our fixed Reference frequency of 100 kHz, the VCO's frequency can be changed in 100 kHz steps, $(100 \text{ kHz} \times N) = \text{VCO frequency}$, the VCO's integral part. When the VCO's frequency is a fractional frequency, the VCO is continually advancing in phase with respect to the Divide-By-N number N times the Reference. When the phase of the VCO has advanced one cycle the loop divides by N-1 to remove a VCO cycle. In the following example, a VCO cycle is removed every 10 reference cycles.

The Reference frequency is 100 kHz, the divide number is 1000.1, and the VCO frequency is 100.01 MHz, a fractional multiple (1000.1) of the reference. Without the removal of a VCO cycle every 10 reference cycles the VCO will advance one cycle (refer to Table 1), and the output voltage of the Phase Detector would continue to increase. The loop would not lock. The continual removal of a VCO cycle means that the output of the Phase Detector is a sawtooth waveform. The waveform increases linearly because of the advancing phase of the VCO. When a cycle is removed it drops to a fixed voltage, canceling the phase advancement of one cycle. With one cycle (360°) removed, the Phase Detector returns to 0° phase output (refer to Figure 3).

Since one cycle must be removed from the VCO each time its phase advances one cycle on the VCO's integral part ($100 \text{ kHz} \times N$), a Remove Cycle circuit is added in Figure 4. If a VCO cycle is removed each time its output advances one cycle of phase, the average frequency applied to the Divide-By-N block is $100 \text{ kHz} \times N$, and the average frequency applied to the Phase Detector is 100 kHz.

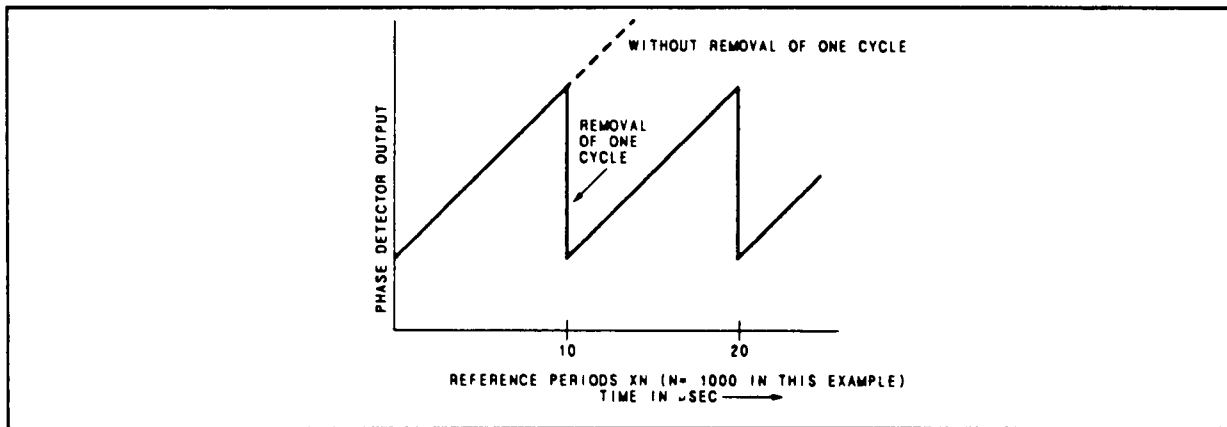


Figure 3. The Output of the Phase Detector Shown Here is a Sawtooth Riding on a dc Voltage.

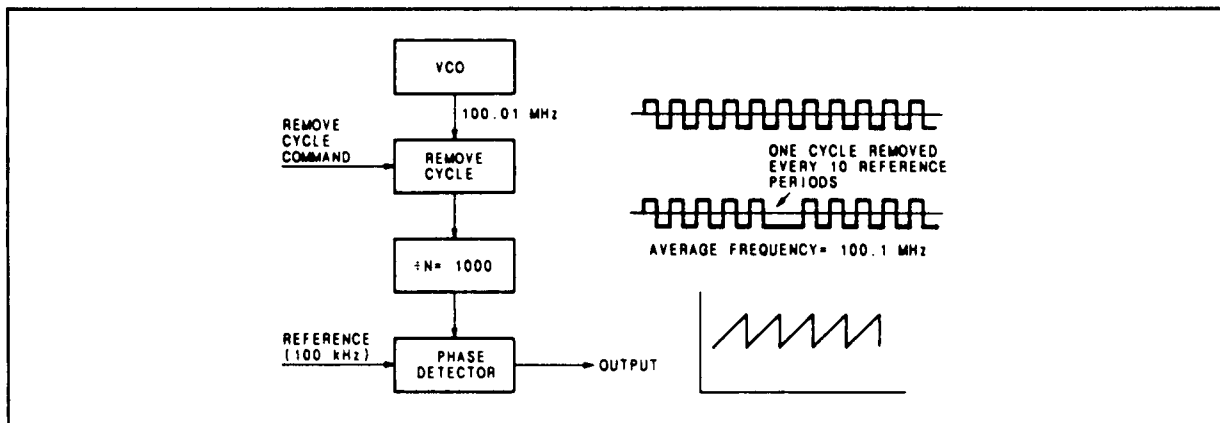


Figure 4. The Basic Block Diagram of a Modified Divide-by-N Loop with a Pulse Remover Added to Allow the VCO to Operate at a Fractional Frequency.

A method of determining when the VCO has advanced one cycle of phase is needed. The Remove Cycle circuit can then be triggered to remove a cycle. The fractional part of the VCO frequency determines the time required for the oscillator's frequency to advance one cycle of phase in reference to $100 \text{ kHz} \times N$. The time required is the period of F and corresponds to a number of reference periods. In the example, the Signal Generator's frequency is 100.01 MHz . The divide number is 1000.1 , $N = 1000$ and $F = 0.1$.

Table 1. Phase Relationship of the Integral Part of the VCO Frequency Times N Relative to its Fractional Part as Expressed in Phase Advancement.

No. of Ref. Periods ($F_{ref} = 100 \text{ kHz} = 0.1 \text{ MHz}$)	No. of Completed Cycles of		Phase Advancement on N.F on $N \times F_{ref}$
	$N \times F_{ref}^* = 100 \text{ MHz}$ ($N = 1000$)	$N.F^{**} = 100.01 \text{ MHz}$	
1	1000	1000.1	0.1 cycle of phase
2	2000	2000.2	0.2 cycle of phase
3	3000	3000.3	0.3 cycle of phase
4	4000	4000.4	0.4 cycle of phase
⋮	⋮	⋮	⋮
9	9000	9000.9	0.9 cycle of phase
10	10000	10001.0	1 full cycle of phase (360°)
11	1000	1000.1	0.1 cycle of phase

* $N \times F_{ref}$ = Integer part of the VCO frequency.
 **N.F = Integer and fractional part of the VCO frequency.

The fractional part of the frequency is stored in the Fractional Register, and then added to a second register each reference cycle. The second register, the Phase Accumulator, contains the total number of degrees the phase of the VCO has advanced at any point in time. The Fractional Register, Phase Accumulator, and Add Circuit are added as shown in Figure 5.

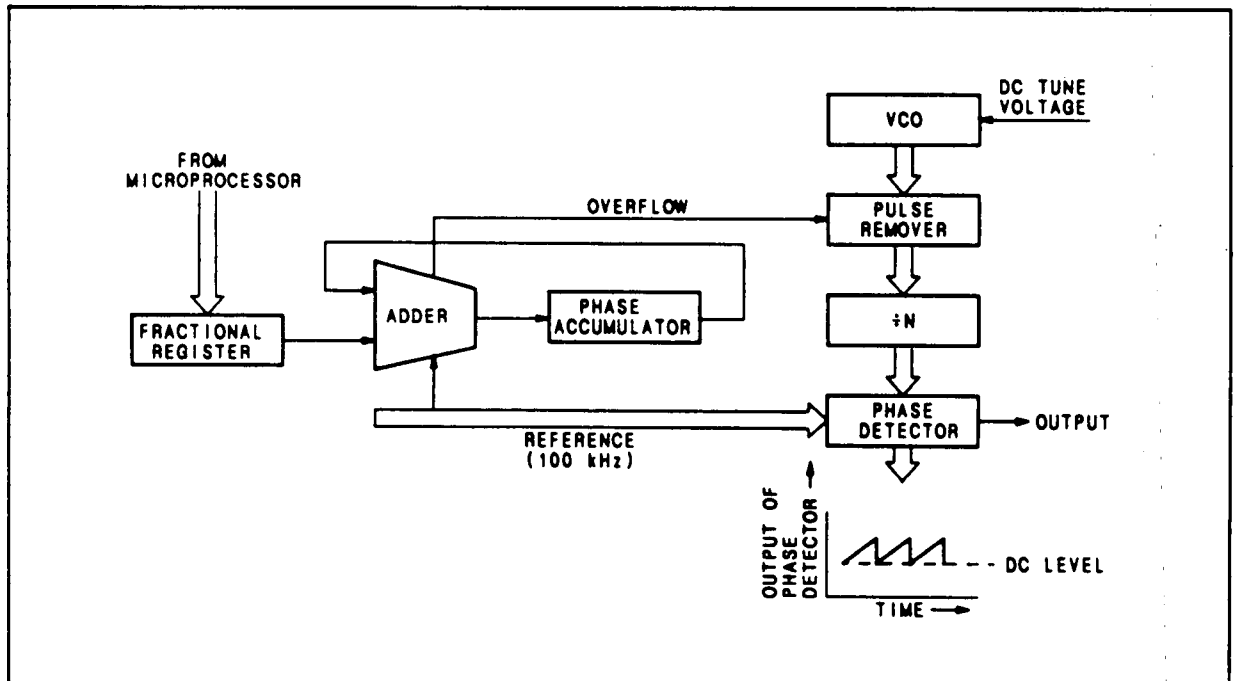


Figure 5. Fractional-N Loop Showing a Phase Register Used to Trigger the Removal of One VCO Cycle (or Pulse).

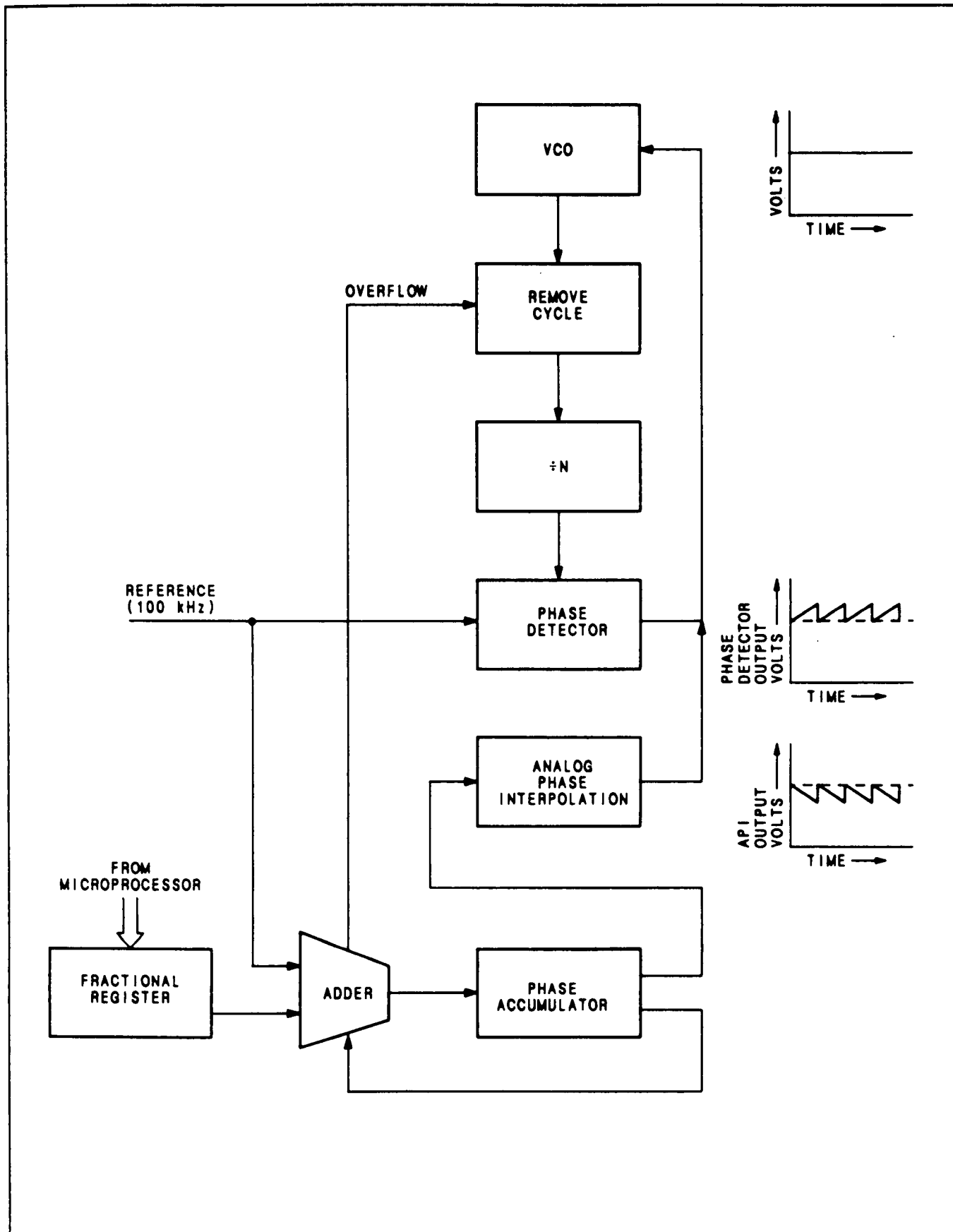


Figure 6. Simplified Diagram of A Fractional-N Phase Lock Loop.

During the reference cycle that the VCO advances one full cycle of phase, the Phase Accumulator reaches unity. For example, the oscillator has gone 1000.1 cycles in one reference cycle, 10 μ s, 2000.2 cycles in two reference cycles, and so on. The Phase Accumulator contains 0.1 after one reference cycle, 0.2 after the second, and so on. When unity is reached, the register overflows. The VCO has advanced one cycle of phase and the overflow bit instructs the Remove Cycle circuits to remove a cycle from the VCO.

The open-loop Phase Detector output is sawtooth on some dc voltage level as tuning voltage for a stable output signal. A sawtooth signal on the dc tuning voltage will cause frequency modulation of the VCO's output. The sawtooth signal must be removed from the tuning voltage. The output of the Phase Detector is a voltage that at some value, rises to an increased value, and returns to the value started with when the cycle repeats. Figure 7 shows the waveform generated by the Phase Detector.

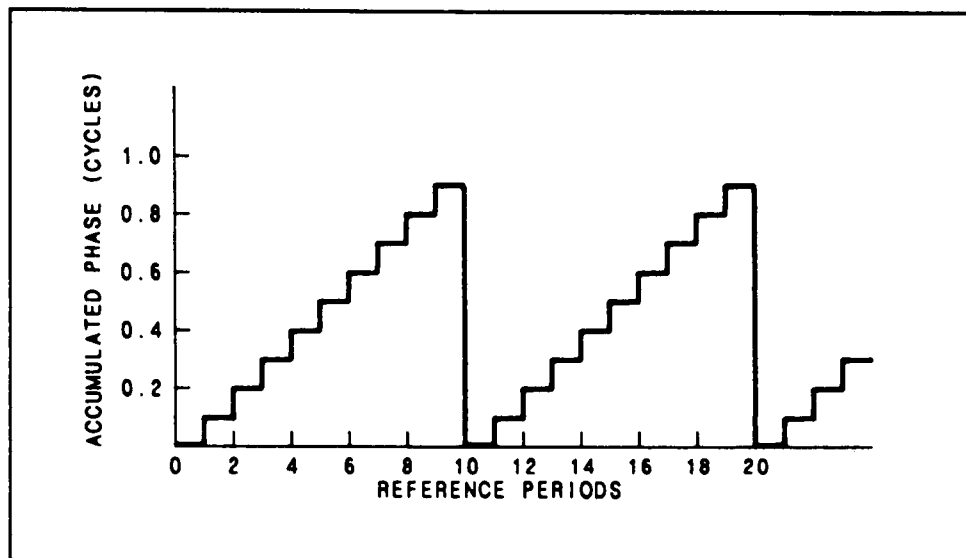


Figure 7. Phase Detector Waveform.

The technique used to eliminate this unwanted sawtooth waveform is to generate a waveform with the same shape but opposite in polarity, and sum it with the Phase Detector output. This cancels the unwanted waveform leaving only the dc voltage to tune the VCO. It is possible to generate a waveform of the opposite polarity because the shape of the unwanted waveform can be predicted exactly. The Analog Phase Interpolation (API) circuit in Figure 6 is added to determine the voltage on each reference cycle to sum with the output of the Phase Detector.

A3 Low Frequency Loop Assembly.

The 50 MHz Reference Oscillator (Service Sheet 16) is a crystal oscillator that is used to phase lock the Voltage Controlled Oscillators. Its output is divided down to provide the 100 kHz Reference to the Phase Detector. The rear-panel TIME BASE OUTPUT signal is a jumper-selectable frequency of 1, 5, or 10 MHz divided from the 50 MHz Reference Oscillator and coupled through the Crystal Phase Lock Circuit. For Option 001, a 10 MHz temperature-stabilized crystal oscillator is installed in the Signal Generator. The Option 001 oscillator output is available at the rear-panel TIME BASE HIGH STABILITY OPTION connector (not shown). When connected to the TIME BASE INPUT connector, a phase lock is established between the high stability oscillator and the 50 MHz Reference Oscillator. The switched 5 MHz is the clock that generates the 400 ns pulses required for DCFM and ACFM (in-band) Reset Timing.

Digital data is written from the main Microprocessor to the Low Frequency Loop Microprocessor (Service Sheet 11) when its frequency is changed, when frequency modulation (AC or DC) is selected, turned off, changed or calibrated. The digital data consists of instructions and data. Instructions select frequency modulation and controls when a frequency modulation calibration is performed. Instructions and data are sent from the Low Frequency Loop Microprocessor to the Fractional-N Controller which handles all instructions and data to lock the Low Frequency Loop at fractional frequencies (refer to the Low Frequency Loop Timing Diagram Figure 8). The Fractional-N Controller converts the data to its nine's compliment and transfers the data to the Divide-By-N Latches. The nine's compliment data is used by the Divide-By-N Counters, clocked by the Chip Clock output of the Prescaler, to generate the VCO Divide-By-N.F. 100 kHz pulse input to the Phase Detector. The output pulse of the Phase Detector (Service Sheet 13) determines the length of time Phase Detector current is active and the voltage output of the Loop Integrator is changed. The output of the Loop Integrator is stored on the Sample and Hold Capacitor and corrects the output frequency of the VCO.

After the correction voltage is stored on the Sample and Hold Capacitor, the Fractional-N Controller sets the Bias Control active to reset the Loop Integrator. The Loop Integrator is reset by the Bias Current that supplies current to the Loop Integrator. If the frequency of the VCO is a fractional frequency (not an integer multiple of 100 kHz), the Analog Phase Interpolation (API) (Service Sheet 12) outputs from the Fractional-N Controller are active for a varying amount of time when Bias is active. The API Currents are summed with the Bias Current to determine the voltage reset point of the Loop Integrator (Figure 9 shows how the API currents are shared). The voltage is dependent on the phase difference between the 100 kHz reference and the VCO Divided-By-N.F. that is the result of the VCO's frequency being a fractional frequency.

A cycle is added or removed at the Prescaler (Service Sheet 10) to change its modulus from 10 to 9 or 11. A remove cycle is latched into the Cycle Add/Remove Latches and gated to the Prescaler by the Fractional-N Controller to generate fractional frequencies, and by the FM Digital circuits to control Frequency Modulation. An add cycle is latched into the Cycle Add/Remove Latches by the FM Calibration circuits, and by the FM Digital Control circuits to control Frequency Modulation. FM calibration is necessary to ensure that the FM deviation does not vary with oscillator frequency. Calibration is performed by offsetting the frequency of the VCO by 200 kHz, and then removing the offset. Any difference in voltage is detected by the Tune Voltage Sampler, and then converted by the A/D to set the bits of the FM Cal DAC.

To have continuous Frequency Modulation both in the bandwidth and out of the bandwidth of the Low Frequency Loop, the Low Frequency Loop VCO is Phase Modulated in the loop bandwidth. The modulation signal is converted to phase by the FM to Φ M Integrator and summed with the current to the Loop Integrator. When the output of the FM to Φ M Integrator crosses the high threshold, the High Threshold Comparator is set and a Remove Cycle control pulse is generated. When the output of the Integrator crosses the low threshold, the Low Threshold comparator is set and an Add Cycle control pulse is generated. The Remove or Add Cycle pulse is gated to the Prescaler and a cycle is removed or added to the VCO Divide-By-N.F. signal. When a cycle is removed or added, a precise API 2 or API 3 current is directed to the FM to Φ M Integrator. Just enough charge is removed from or added to the Integrator to offset the 360° of phase caused by removing or adding a cycle by the Prescaler. (Figure 9 shows how the API currents are shared.)

The FM Reset Timing and currents reset the Integrator (Service Sheet 15). The Up/Down Counters and Phase Deviation DAC keep track of the number of times, and the direction the Integrator is reset. The Up/Down Counters and Phase Deviation DAC reconstruct a staircase voltage approximation of the total VCO phase offset caused by the modulation Remove or Add Cycle control inputs to the Prescaler.

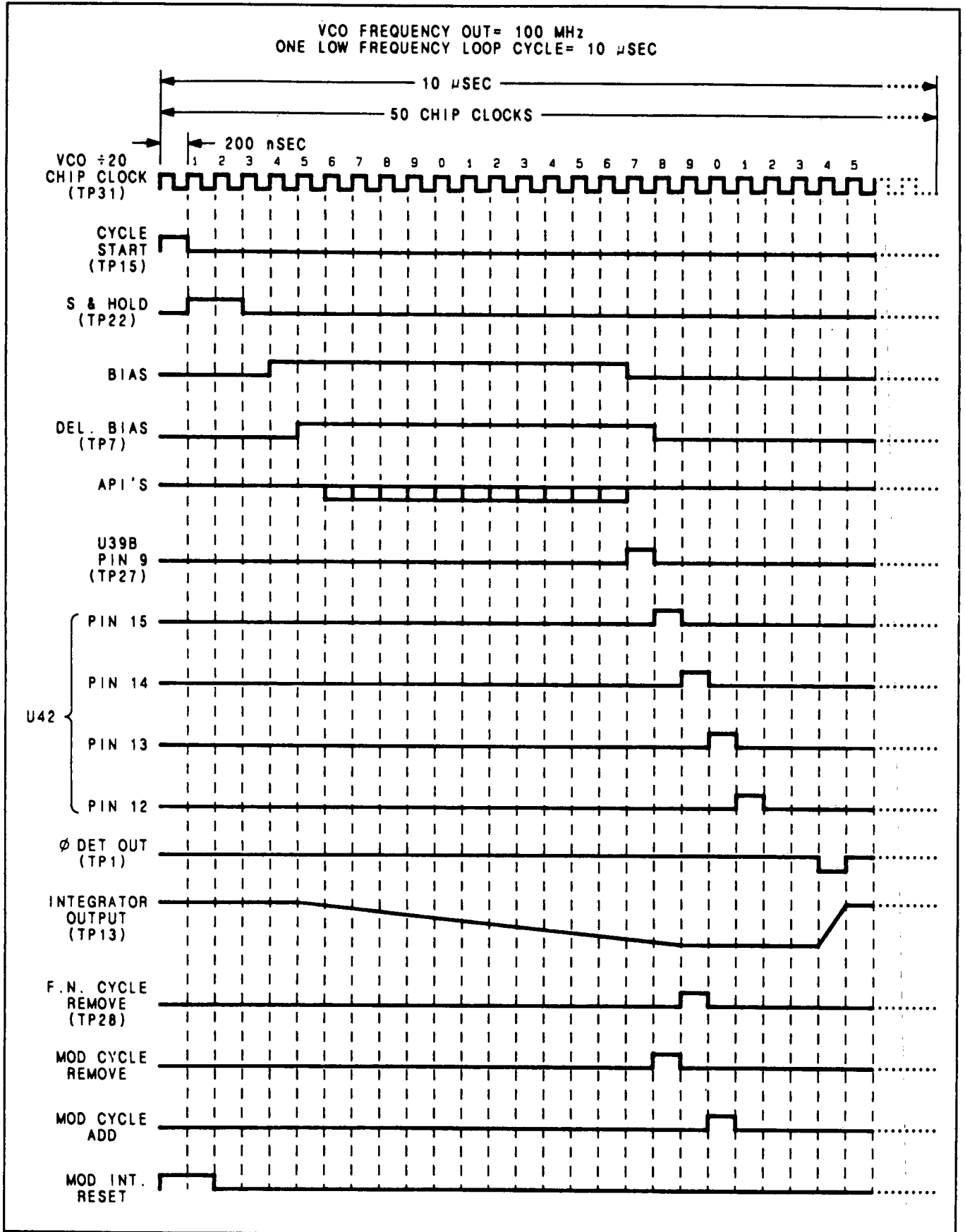


Figure 8. Low Frequency Loop Timing Diagram.

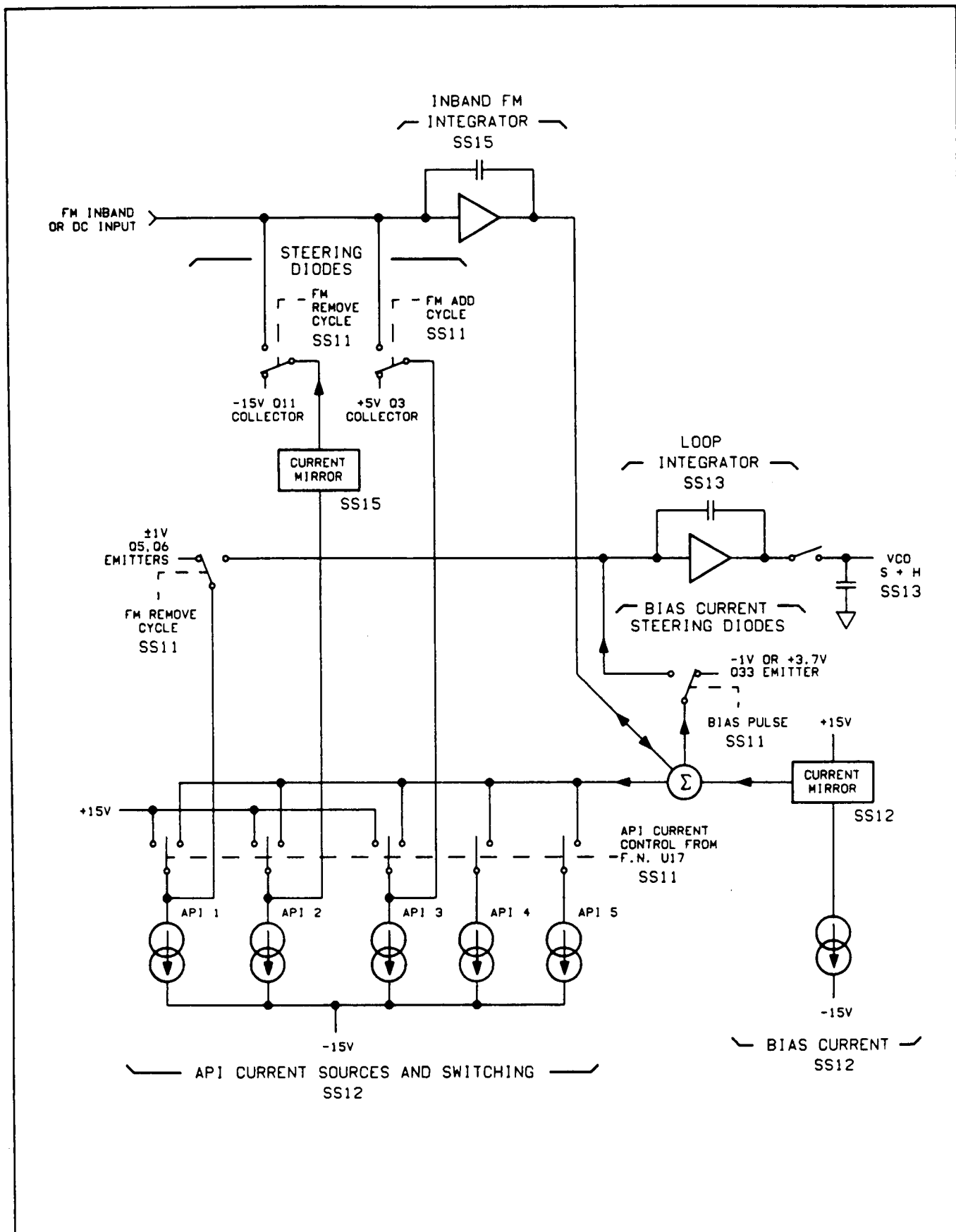


Figure 9. Low Frequency Loop API and Bias Currents.

TROUBLESHOOTING

Procedures for checking the Low Frequency Loop and FM Sections of the instrument are given below. The blocks or points to check are marked on the block diagram by a hexagon with a check mark and a number inside, for example, $\sqrt{2}$.

Troubleshooting Help

- Block Diagram 1
- Table 4-1. Abbreviated Performance Tests
- Table 5-2. Post-Repair Adjustments

Test Equipment

Digital Multimeter	HP 3466A
Measuring Receiver	HP 8902A
Sensor Module	HP 11722A
Oscilloscope	HP 54100A
Oscilloscope Active Probe	HP 54001A
Function Generator	HP 3312A

Low Frequency Loop Lock Check

The Low Frequency Loop can be checked from the front panel to determine if the loop is locked or unlocked. Enter the Keyboard-Invoked Tests and run Test 6 to determine the loop's condition. When the loop is locked a "1" is shown in the FREQUENCY Display window, and when it's unlocked a "0" is shown.

- Enter the Keyboard-Invoked Tests by first pressing the "SHIFT" key, and then pressing the "INCR SET" key. A "1" should be shown in the MODULATION Display window.
- Press the "AMPTD" up-arrow key until a "6" is shown in the MODULATION Display window. Test 6, the Low Frequency Loop Lock Test, is ready to run.
- Press the "INCR SET" key to start the test. A "1" is shown in the FREQUENCY Display when the loop is locked. A "0" is shown in the FREQUENCY Display when the loop is unlocked.
- To exit Test 6, press the "AMPTD" up-arrow key once. A "00" should be shown in the AMPLITUDE Display window.
- To exit the Keyboard-Invoked Tests, press the "AMPTD" up-arrow key until a "7" is shown in the MODULATION Display window. Then press the "INCR SET" key.

The red LED, A3DS500 on the Low Frequency Loop Assembly (refer to Service Sheet 13), is lit when the loop is unlocked.

$\sqrt{1}$ 50 MHz Reference Oscillator Checks

1. Set the Signal Generator as follows:

Frequency	500 MHz
Amplitude	0.0dBm
Modulation	Off
2. Connect the Signal Generator's TIME BASE OUTPUT (J4) on the rear panel to the measuring receiver's INPUT. With the Signal Generator's Time Base jumper in the 10 MHz position check that the frequency at J4 is 10 MHz. If the frequency is not correct, go to step 3.
3. Connect the measuring receiver to the 50 MHz Reference output by removing W5 from A3J8. The frequency at A3J8 should be 50 MHz and the power level +16 to +19 dBm. If the frequency or level is not correct, go to Service Sheet 16.

4. Select Frequency Modulation at the front panel, press the FM key. Check the switched 5 MHz at feedthrough capacitor A3C28 with an oscilloscope. If the 5 MHz square wave is not correct go to Service Sheet 16.
5. Check the 100 kHz Reference pulse to the Phase Detector at connector A3J5 with the oscilloscope. The pulse is approximately +2V, 0.1 μ s pulse (including ringing) and occurs every 10 μ s. Adjust the Timebase Sec/Div to view more than one pulse. If the pulses are not present go to Service Sheet 16.

√2 VCO Tune Voltage and FM Checks

1. Remove jumper A3W6 (refer to Service Sheet 14). The VCO Tune Voltage goes to approximately 0.0V.
2. Connect the measuring receiver to A3A1J1 (VCO output). The frequency should be 96 MHz \pm 7 MHz and the power level -9 to -7 dBm. If it is not correct go to Service Sheet 9.
3. Connect the digital multimeter to feedthrough capacitor A3A1C101 (the +11 Vdc power supply for the Low Frequency Loop VCO). The voltage should be +11 \pm 2 Vdc with the noise less than 0.05 Vpp. (Measure the + 11V noise with an Analog Oscilloscope, such as the HP 1740A). If the voltage or noise is not correct, go to Service Sheet 9 or Service Sheet 25 (+15 Vdc power supply).

√3 Divider and Prescaler Checks

1. Check the Low Frequency Loop VCO's frequency at A3TP29. The frequency should be 100 MHz (Signal Generator's frequency 500 MHz). If the frequency is not correct go to Service Sheet 10.
2. Check the Low Frequency Loop VCO's frequency Divided-By-2 at A3TP30 and divided-by-20 at A3TP31. If either frequency is not correct go to Service Sheet 10. If loop is still unlocked go to **√4**, below.
3. Set the Signal Generator's frequency to 500.0011 MHz. Check the Remove Cycle pulse input at A3W8. If the pulse is not present go to Service Sheet 11.
4. Set the Signal Generator as follows:

Frequency	500 MHz
Amplitude	Any
Modulation	ACFM, 99 kHz
Source	EXT

5. Connect a function generator to the MOD INPUT connector on the Signal Generator.
 6. Set the function generator as follows:
- | | |
|--------------------|-----------------------------|
| Function | Square Wave |
| Frequency | 100 Hz |
| Output Level | 1 V/P (HI and LO LED's out) |
7. Check the Add Cycle pulse at A3W7. If the pulse is not present go to Service Sheet 11.

√4 Digital Control, Remove and Add Cycle, and Divide-By-N Counters Checks

1. Check the Cycle Start pulse at A3TP15. Refer to Figure 8 Low Frequency Loop Timing Diagram. If the pulse is not present go to Service Sheet 11.
2. Check the VCO Divided-By-N.F., 100 kHz pulses, at A3J4. It should be a narrow approximately +2V pulse every 10 μ s. Adjust the Timebase Sec/Div to view more than one pulse. If the pulse is not present go to Service Sheet 11.

√5 Integrator Set and Reset Checks

1. Check the +1 to -1V waveform at A3TP1 every 10 μs. If it is not correct go to Service Sheet 13.
2. Check the voltage waveform output of the Integrator at A3TP13. Refer to Figure 8. If the waveform is not correct go to Service Sheet 12.
3. Check the Bias Control pulse at A3TP10. Refer to Figure 8 (Bias Pulse). If the pulse is not correct go to Service Sheet 11.
4. Check the API Control Delayed Bias at A3TP7. TP7 should be approximately -7 to +1 volt pulse, one Chip Clock less than the Bias Pulse. Refer to Figure 8. If the pulse is not correct go to Service Sheet 11.

√6 Frequency Modulation (In-Band) Checks

1. In-band frequency modulation is checked with the Low Frequency Loop locked.
2. Set the Signal Generator as follows:

Frequency 950 MHz
 Amplitude Any
 Modulation ACFM, 5 kHz
 Source EXT

3. Set the oscilloscope as follows:

Chan 1

Chan 1 Display On
 VOLTS/DIV 500 mV
 OFFSET 850 mV

Timebase

SEC/DIV 2 ms

Trigger

Trigger Mode Edge
 Trig Src Chan 1
 TRIG LEVEL 1.5V
 Slope Positive

4. Set the function generator as follows:

Function Square Wave
 Frequency 100 Hz
 Output Level 1 V/P (HI and LO LED's out)

5. Connect the oscilloscope to A3TP3. If the waveform at TP3 is not the same as shown in Figure 10 go to Service Sheet 15.

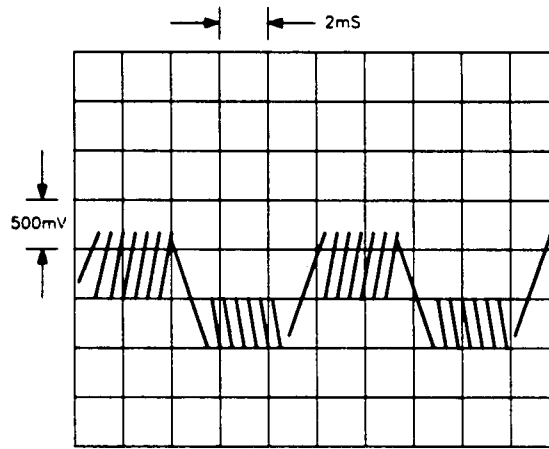


Figure 10. Oscilloscope Display of TP3 (dc Coupled), Signal Generator's Frequency 950 MHz, Modulation EXT FM, 5 kHz Deviation (100 Hz Square Wave).

√7 Frequency Modulation Calibration Checks

1. Connect the oscilloscope to feedthrough Capacitor A3A1C100 or A3W6 and set the Signal Generator's modulation to 1 kHz INT, FM, 99 kHz deviation. The modulation signal should be approximately 0.1 Vpp. If it is not correct, go to Service Sheet 14 and perform the FM checks.
2. Connect the oscilloscope to A3TP14. Verify that the voltage changes when the Signal Generator's frequency is incremented 10 MHz. If the voltage does not change, go to Service Sheet 14.

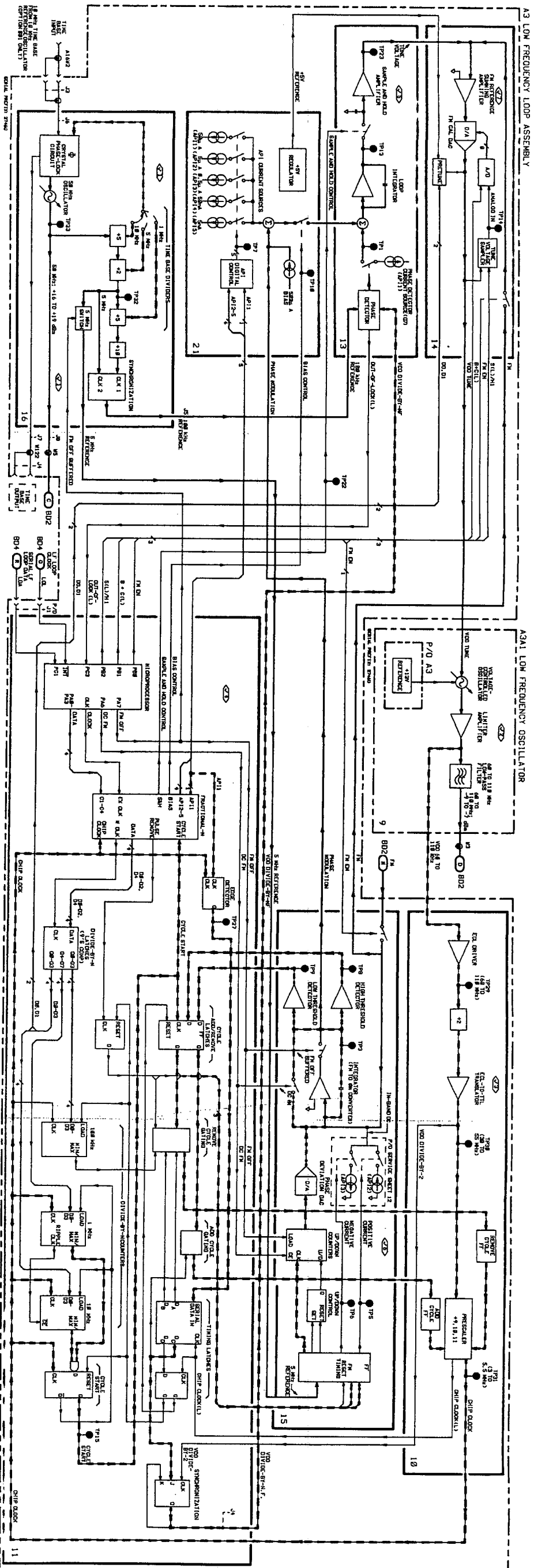


Figure 11
Block Diagram 3 13

Low Frequency and
FM Section

BD3

SEE REVERSE SIDE

Block Diagram 4

MICROPROCESSOR, KEYBOARD, AND DISPLAY SECTION

PRINCIPLES OF OPERATION

A1 Keyboard Assembly

The Keyboard Assembly consists of 48 pushbuttons or keys hardwired in an 8-row by 6-column matrix. Whenever a key is pressed, a row line is connected to a column line. This causes a keyboard interrupt to be issued to the Microprocessor. When the Microprocessor is interrupted, the row and column data is strobed into the Keyboard Data Latch/Shift Register and then serially shifted over the data bus to the Microprocessor.

A11 Microprocessor, Memory, and HP-IB Assembly.

The data bus (D0 through D7) consists of eight bidirectional lines which are used to transfer 8-bit, positive-true data to and from the Microprocessor. The Microprocessor reads data from memory, the keyboard, and the HP-IB interface. Information on the data bus is buffered as it enters or leaves the Microprocessor. The Read/Write signal (R/W) from the Microprocessor is used to control the direction of data transfer on the data bus. This signal is buffered by one of the Microprocessor Control Line Buffers.

The address bus (A0 through A15) consists of sixteen unidirectional lines which are used to transfer the 16-bit, positive-true address from the Microprocessor. These address bits are buffered and then used to enable the Interface Bus Select Decoder and to address the ROM and RAM locations. In addition, the buffered address bits are decoded to produce control strobes for modulation, attenuation, and serial I/O. The Serial I/O Control changes six bits of parallel data into serial data and clocks this data to the high frequency loop and output section (see BD2), the low frequency loop (see BD3), and the display. It also clocks serial input data from the keyboard to the Microprocessor.

The Reset input starts the Microprocessor from a power-down condition and is used during initial power-up of the instrument, after a power failure has occurred, or after TP12 RESET is momentarily touched to ground (see Service Sheet 17). When the Microprocessor is reset, it enters its power-up subroutine to initialize the instrument.

The Maskable Interrupt Request (IRQ) input to the Microprocessor is used to interrupt program execution. Maskable interrupts occur whenever a key on the keyboard is pressed, a reverse power condition is detected, or an active low is on the rear-panel connector J5 (SEQ). The three maskable interrupts plus the four status conditions (i.e., Over Modulation, Under Modulation, HP-IB Interrupt, and LF Loop Ready) all provide status inputs to the Interrupt Processing circuit which puts the instrument status information on the data bus. The Signal Generator memory consists of 2k bytes of RAM and 32k bytes of ROM. The program used to control the operation of the Signal Generator is stored in the ROM.


All HP-IB data input/output, control, and handshake signals are buffered before being applied to the HP-IB General Purpose Interface Adapter.

A2 Display Assembly

Sixteen bits of serial display data (DDA) are sent from the Microprocessor to the Display Address and Data Shift Registers. Six of the bits are decoded to produce the twelve display strobes and two keyboard strobes. The keyboard strobes are used to strobe column and row data from the keyboard while the display strobes are used to strobe modulation, frequency, and amplitude display data into their respective control drivers and latches. The display data is decoded and latched to drive the applicable 7-segment display or LED annunciator.

TROUBLESHOOTING

General

Procedures for checking the Microprocessor, Keyboard, and Display sections of the instrument are given below. The blocks or points to check are marked on the block diagram by a hexagon with a check mark and a number inside, for example, .

Troubleshooting Help

- Block Diagram 1
- Table 4-1. Abbreviated Performance Tests
- Table 5-2. Post-Repair Adjustments

Test Equipment

- HP-IB Controller Any
- HB-IB Interface Any
- Measuring Receiver HP 8902A

Power-On Sequence

1. Press the POWER switch from STBY to ON to initiate an internal memory check. This check tests for a failure in ROM (Read Only Memory) and in RAM (Random Access Memory). During this check, all front-panel indicators light for approximately 1.5 seconds to provide a quick visual inspection of each front-panel annunciator and display segment. All the display segments will display the number eight except the most significant AMPLITUDE digit which will be a number one. If a memory failure is detected, a RAM or ROM error code will be displayed in the FREQUENCY Display window. The error code remains displayed until any front-panel key is pressed. Refer to Table 1 for a listing of the Power-On Error Codes. If the memory check was successful, the front-panel indicators will display the frequency, amplitude and modulation settings as when the instrument was last ON.

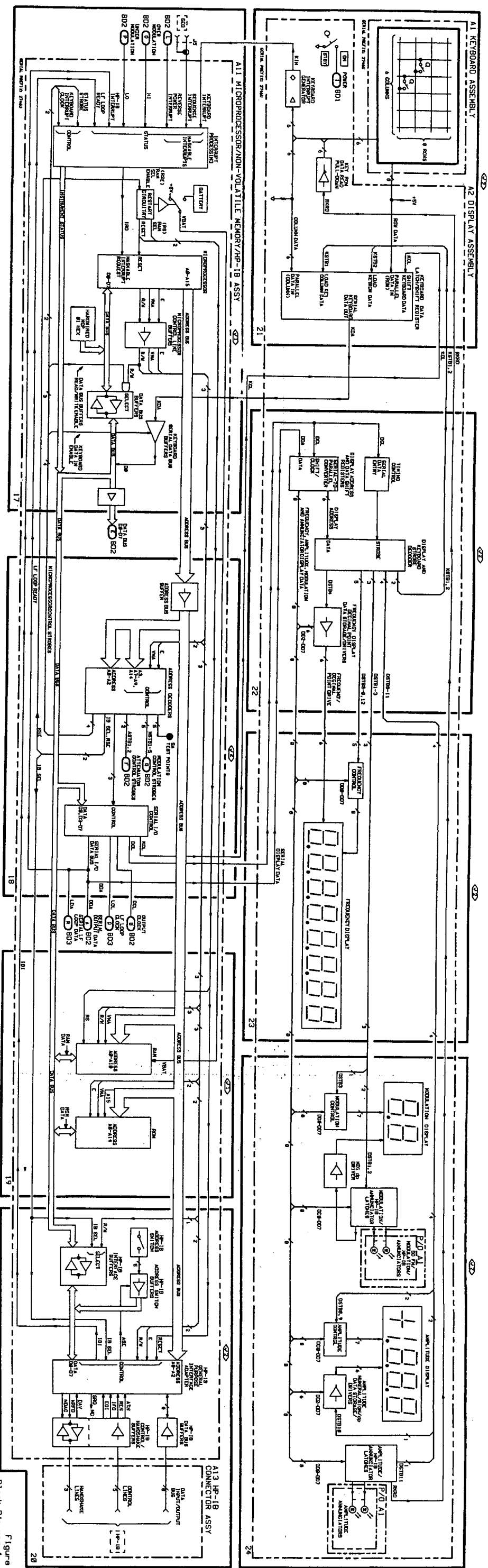
Table 1. Power-On Error Codes.

Error Code	Fault	Address
10	RAM Error	0000-07FF
20	ROM Error	8000-FFFF
30	RAM and ROM Error	

If the power-on sequence was not completed successfully, see Troubleshooting for Service Sheets 17 and 19. Perform signature checks for both Service Sheets.

√2 Keyboard and HP-IB Checks

1. Connect the measuring receiver to the Signal Generator's RF OUTPUT connector.
2. Connect the HP-IB controller to the Signal Generator's HP-IB connector.
3. Enter modulation, frequency and amplitude data from the Signal Generator's keyboard and from the controller.
 - a. If the RF output modes follow the data entered, but one or more of the displays do not, go to Service Sheets 22 and 23 or 24. Troubleshoot the appropriate strobes, latches, drivers and displays.
 - b. If the displays follow the data entered but one or more of the RF output modes do not, go to the Troubleshooting sections for Block Diagram 2, Block Diagram 3, or Service Sheet 18.
 - c. If the output modes and displays follow data entered from the keyboard but not the HP-IB controller, go to Service Sheet 20 Troubleshooting .
 - d. If the output and displays follow data entered from the HP-IB controller but not the keyboard, go to Service Sheet 21 Troubleshooting.



Block Diagram 4 5
Figure 1

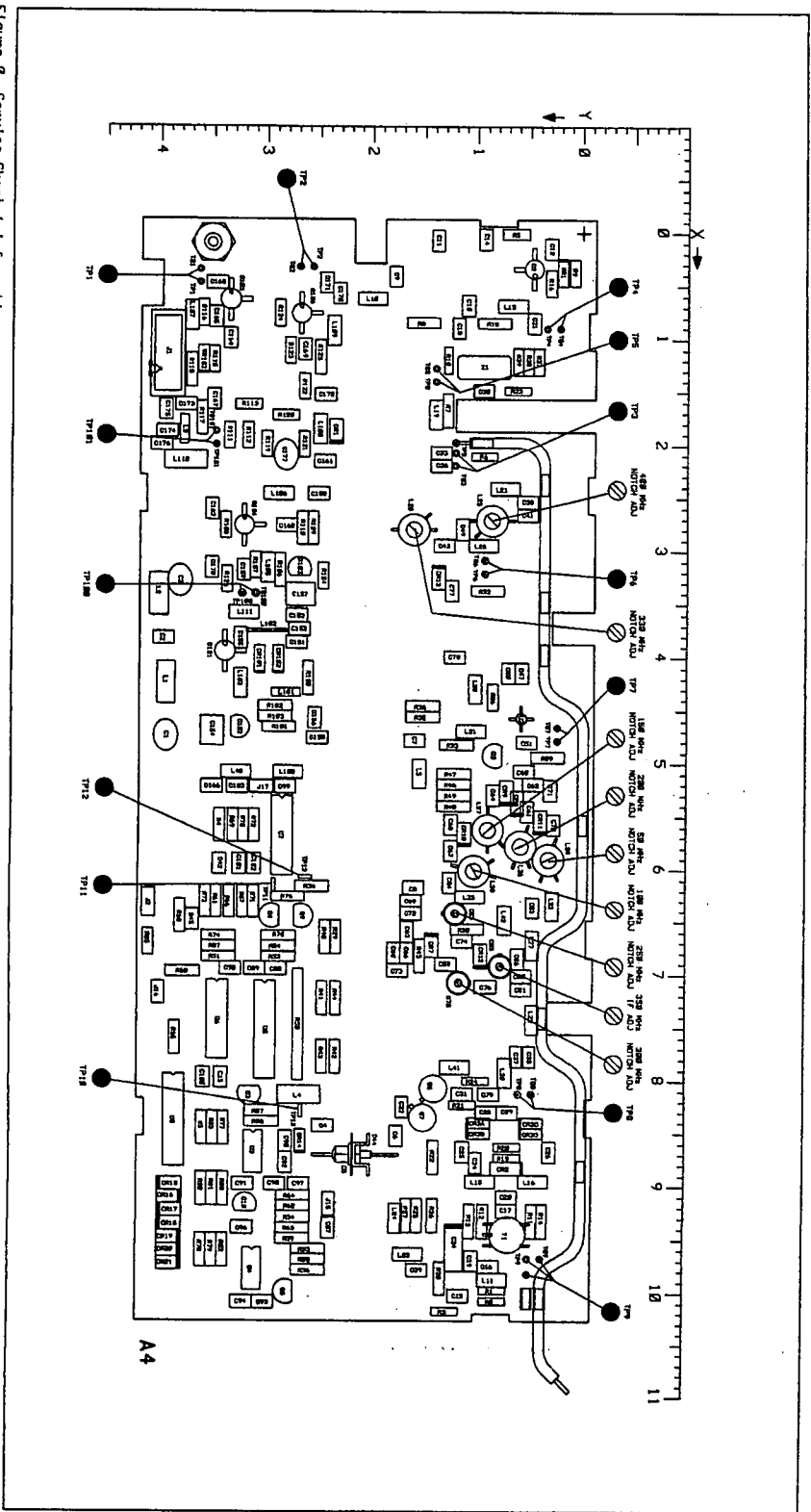
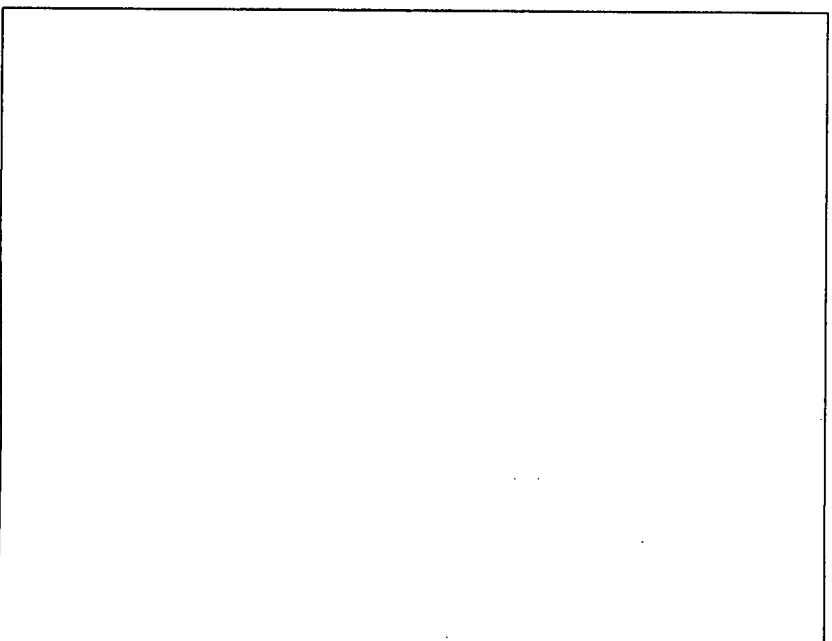
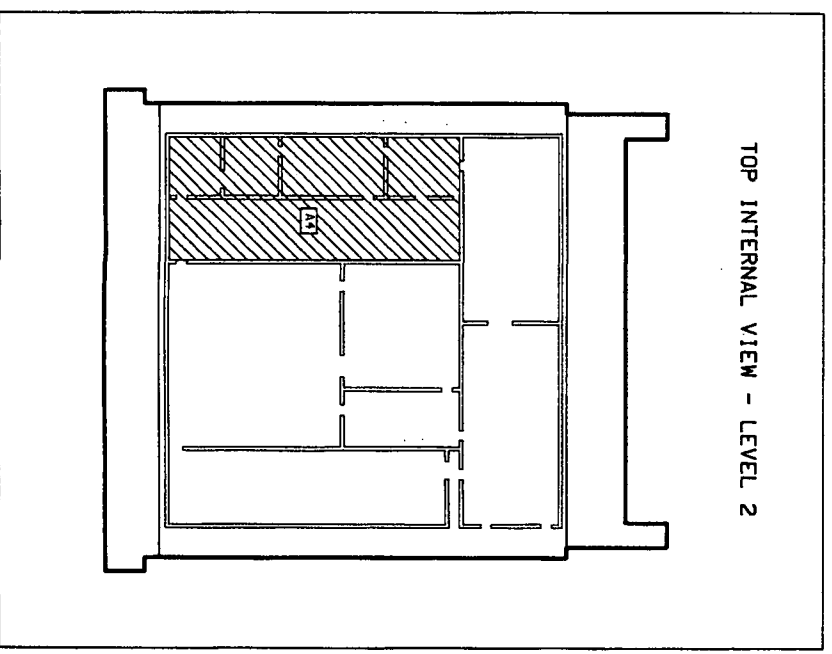


Figure 8. Service Sheet 1 Information.

Component Locator



MICROPROCESSOR KITBOARD
AND DISPLAY SECTION
SEE NETWORK FILE
BD4



Service

Model 8657A

Service Sheet 1

HIGH FREQUENCY OSCILLATOR AND IF

PRINCIPLES OF OPERATION

General

The Voltage Controlled Oscillator (VCO) oscillates over a range of 520 to 1040 MHz. It is tuned over this range by a -7.5V to $+12\text{V}$ signal. The output signal passes through a resistor power splitter and is coupled to Buffer Amplifier No. 3 to lock the High Frequency Loop and Buffer Amplifier No. 2 to the Output Assembly's RF Dividers. When the RF is turned OFF at the front panel or over HP-IB, the switched $+15\text{V}$, $+15\text{V(SW)}$ is switched OFF. The HF Loop VCO Buffer Amplifiers No. 1, No. 2 and No. 3 are disabled.

Within the High Frequency Loop, the VCO signal is mixed with the phase locked signal (690 to 740 MHz). As the VCO is searching for its lock point, the mixer generated sidebands pass through a bank of selectable notch filters. The appropriate filter is turned off thus allowing the selected Intermediate Frequency (IF) to pass. The sampling bridge phase-compares the IF Frequency (a multiple of 50 MHz) with a 50 MHz reference signal. When the correct IF Frequency appears at the sampling bridge, the output from the Loop Amplifier (which up to now has been a continuously changing voltage) becomes a fixed voltage. This voltage sets the High Frequency Loop phase lock point. For more information, refer to Service Sheet 2.

Voltage Controlled Oscillator

The tune voltage ramp and the phase lock voltage are supplied to varicaps CR101 and CR102 by the Loop Amplifier in conjunction with the Sideband Select and Loop Amplifier Ramp controls. This voltage is coupled into the VCO by the low-pass filter composed of L100, L101 and C150. The low-pass filter also isolates the VCO. Varicaps CR101 and CR102 tune the tank circuit which includes inductor L102. Capacitors C151, C152 and C153 provide RF ground for the tank circuit. Varicap bias voltage of approximately -7.5 Vdc is obtained from voltage divider R102, R103 and the -15V (F5) supply. The output of the tank circuit is coupled into the VCO transistor Q101 by capacitor C155. Transistor Q101 is dc biased by R102, R103, and L103. Power Supply variations are filtered by Q102 and capacitor C154 for the -15V supply and Q103 and capacitor C157 for the $+15\text{V}$ supply. Series inductor L104, Inductor L111, capacitor C178, and resistor R126, provide the necessary load for the oscillator over its frequency range 520 MHz to 1040 MHz to prevent spurious oscillations. Capacitors C156 and C158 bypass RF frequencies and power supply noise to ground. Power supply noise or other noise will frequency modulate the oscillator output.

Buffer Amplifier No. 1

Output of the VCO is coupled to the base of Buffer Amplifier No. 1, Q104, by capacitor C159. High frequency transistor Q104 is dc biased by resistor R107 and R108. The base of Q104 is biased at 0.7V . The output of Q104 is voltage limited. Inductor L106 is an RF choke and capacitors C161 and C162 are RF bypass capacitors.

Power Splitter

Output of Q104 is coupled to the resistive Power Splitter R111, R112 and R113 by capacitor C163. There is a 6 dB loss through the Power splitter. One output of the Power Splitter is coupled to Buffer Amplifier No. 2 by C164 and R114. The other output goes through the 4 dB pad R119, R120, R121, and is then coupled to Buffer Amplifier No. 3 by C169 and R122. This output is used to phase lock the VCO.

Buffer Amplifier No. 2 and Buffer Amplifier No. 3

Output of the Power Splitter is coupled to the base of Buffer Amplifier No. 1 Q105 by capacitor C164 and resistor R114. High frequency transistor Q105 is dc biased by zener diode VR102 and resistor R115. Capacitor C165 provides collector to base feedback. The base of Q105 is biased at 0.7V and the zener diode sets the collector voltage at +5V. The output of Q105 is voltage limited. Inductor L107 is an RF choke and capacitors C160 and C167 RF by-pass capacitors. Output of the Power Splitter is ac coupled to the base of Buffer Amplifier No. 3, Q106, by capacitor C169 and resistor R122. Q106 is dc biased by resistors R123 and R124. Output is current limited.

Buffer Amplifier No. 4 / Mixer

Output from Buffer Amplifier No. 3 is ac coupled to the base of Q2, Buffer Amplifier No. 4, through the 1100 MHz Low-Pass Filter composed of L6 through L9, C9 through C11, and C14. Buffer Amplifier No. 4 operates the same as Buffer Amplifier No. 2 but is not a limiter.

The signal, 520 MHz to 1040 MHz, is then ac coupled by C21 to the 2 dB pad and the pad's output is one input of the Mixer U1. The other input of Mixer U1 is a 690 to 740 MHz signal from the Frequency Multiplier Assembly A8. The factory selected pad of resistors R6*, R7*, and R10* is selected to adjust this input to -10 dBm controlling the gain of the loop. The difference frequencies from the Mixer are passed through a 320 MHz Low-Pass Filter which consists of inductors L19, L21, L26 and capacitors C33, C36, C38 and C41. The output of mixer, U1, is terminated by C30 and R23. C43 and L28 form a notch filter tuned to 300 MHz, and C49 and L25 form a notch filter tuned to 400 MHz. The 400 MHz notch filter is adjusted to remove spurious signals. The 300 MHz notch filter adjustment L28 is adjusted with 300 MHz notch filter adjustment C75 to remove 300 MHz signals.

IF Buffer Amplifier / Notch Filters

Mixer U1 mixes the 520 to 1040 MHz input from the VCO with the 690 to 740 MHz input from the Multiplier Assembly. The 690 to 740 MHz input is tuned so the Mixer's output is a multiple of 50 MHz from 0 MHz (dc voltage) to 300 MHz when the VCO is locked. The Mixer's output functions as a phase detector when both of the inputs are in the 690 to 740 MHz frequency range. The Mixer's output is filtered by the 320 MHz Low Pass Filter and applied to the IF Buffer Amplifier. The Notch Filters select the IF from the Mixer to lock the High Frequency Loop VCO at the correct frequency. Refer to Table 1 for a listing of frequencies. Table 1 can be used to find the IF frequency for any VCO frequency.

For all High Frequency Loop frequencies other than 690 to 740 MHz, the Mixer outputs an IF Frequency that is the frequency difference of the two inputs. The IF Amplifier is biased on to amplify the IF Frequency, frequency difference, by approximately 12 dB. The DC Notch Filter is on to remove dc offset voltages from the Mixer. One of the Notch Filters, 50, 100, 150, 200, 250 or 300 MHz is not selected (turned off). The IF Frequency is selected to lock the VCO at the correct frequency. The DC Notch Select bit, pin 10 of U5 (refer to Service Sheet 2) is a positive voltage (+15V) and biases on Q9. Q9 switches +15V to the gate of Q5 and to U2 to turn them on. When a notch filter control line is set high by the output of Shift Register, U5, (refer Service Sheet 2), the Notch Filter is turned off by biasing on one of the diodes CR7, CR8, CR9, CR10, CR11 or CR15 which shorts out the series capacitor of the Notch Filter C53, C61, C64, C67, C70 or C76. The Notch Filter that is turned off and the Notch Filters that are turned on form a bandpass filter to pass the selected IF frequency. The amplified and filtered IF signal is then compared to the 50 MHz reference by the Sampler to lock the VCO or to correct the VCO's frequency.

At High Frequency Loop VCO frequencies of 690 to 740 MHz, the Mixer acts as a phase detector. The Mixer's output voltage is proportional to the phase difference between the two input signals. The IF Buffer Amplifier, U2, is biased off. The dc Notch Select bit biases off Q9 and the +15V is removed from Q5 and U2 turning them off. The gate of Q5 is grounded through resistors in U2. The dc Notch Filter, Q5, is biased off, and the Notch Filters are not selected (turned off). The dc voltage from the mixer passes through L30 and L33 and is then compared to the 50 MHz reference by the Sampler to lock the VCO or to correct the VCO's frequency.

Table 1. HF Loop and IF Sideband Frequencies.

High Frequency VCO Output (MHz)	Difference Frequencies from Mixing LF Loop Output and 800 MHz (MHz)	'Not Selected' IF Sideband (MHz)
520 to 540	720 to 740	-200
540 to 590	690 to 740	-150
590 to 640	690 to 740	-100
640 to 690	690 to 740	-50
690 to 740	690 to 740	dc
740 to 790	690 to 740	+50
790 to 840	690 to 740	+100
840 to 890	690 to 740	+150
890 to 940	690 to 740	+200
940 to 990	690 to 740	+250
990 to 1040	690 to 740	+300

The 350 MHz Notch Filter C85, C86 and C40 filter any 350 MHz spurious signals. The bias supply voltage to U2 and Q5 is filtered by low pass filter C8, L5 and C7 to remove any high frequency signals on the supply. Diplexer C50 and R86 is a high frequency match for U2's input. Inductors L 30 and L 33 are RF chokes and block high frequency signals from passing through the DC path.

Sampling Bridge and Pulse Generator

The output of the IF Buffer Amplifier and Notch Filters or the DC Notch Filter is the input to be sampled by the Sampling Bridge. The 50, 100, 150, 200, 250 or 300 MHz IF frequency is filtered by the IF Output Filter (L20, L22, L27, C35, C37, C80, and C81). Resistor R24 and capacitors C79 and C31 provide a 50 ohm impedance looking into the Sampling Bridge. Capacitor C29 and inductor L41 decreases the input level to the sampling bridge when the IF frequency is 50 MHz.

The 50 MHz Reference Oscillator drives the Sampling Bridge. The 50 MHz, +7.8 to +11.8 dBm reference signal is applied to transformer T1. Resistors R1, R2 and R3 form a 2 dB pad and inductor L11 and capacitor C12 are used for impedance matching. T1 is the input to the Pulse Generator where 50 MHz pulses are generated by biasing the step recovery diode CR2 on and off. When CR2 is biased off, inductors L15 and L16 turn the Sampling Bridge on for 1.5 ns. The IF input to the Sampling Bridge is sampled every 20 ns for 1.5 ns.

The sampled output is stored in capacitors C28 and C29, and the dc voltage is applied to the 13 MHz Low-Pass Filter through R27. When the level of the voltage from the sampler is changing at a rate greater than 80 Hz, the voltage is coupled through C29 and C34 to the 13 MHz Low-Pass Filter. FET Q6 provides a high impedance for the sampling bridge to drive, and transistor Q7 provides a low impedance output to drive the 13 MHz Low-Pass Filter. The Sampler Amplifier, which consists of Q6 and Q7, is a voltage follower feedback amplifier which functions to increase the bandwidth of the sampler. Transistor Q7 and FET Q6 are always turned on. Approximately 5 mA flows through R22 and Q6 providing 0.6 Vdc between the base and emitter to bias Q7 on. The sampled voltage is stored in capacitor C29 and C28 which is connected to the gate of Q6. For a small voltage change on the gate of Q6 more current must go through R26 to produce the voltage change at the collector-source junction of Q6 and Q7. A portion of the current is supplied by Q6 and the remainder is collector current from Q7. This voltage change is also coupled through C16 to increase the sampler bandwidth.

TROUBLESHOOTING

Procedures for checking circuits of the A5 High Frequency Oscillator Assembly and P/O A4 High Frequency Loop Assembly are given below. The areas or points to check are marked on the schematic by a hexagon with a checkmark and a number inside, for example, $\checkmark 1$. Fixed voltages are shown on the schematic inside a hexagon, for example, $\langle 2V \pm 0.2V \rangle$. Transistor bias voltages are shown without tolerances.

Troubleshooting Help

Block Diagram 2

Table 4-1. Abbreviated Performance Tests

Table 5-2. Post-Repair Adjustments

Test Equipment

Measuring Receiver	HP 8902A
Sensor Module	HP 11722A
Digital Multimeter	HP 3466A
Frequency Counter	HP 5328A
Adapter Probe	HP 1250-1598
Adapter N(f) to BNC(m)	HP 1250-0077
Adapter BNC(f) to BNC(f)	HP 1250-0080
Cable BNC(m) to SMC (f)	HP 08662-60075

$\checkmark 1$ Voltage Tuned Oscillator Check

1. Check the bias voltages on A4Q101.
2. Connect the frequency counter to A4TP100 using the appropriate cables and adapters.
3. Connect the frequency counter's time base to the Signal Generator's TIME BASE INPUT.
4. Set the Signal Generator as follows:

Frequency	520 MHz
Amplitude	-10 dBm
Modulation	Off
5. Verify that the oscillator frequency is within ± 1000 Hz, and that the VCO tune voltage is within tolerance for each frequency shown in Table 2.

NOTE

If the signal generator does not lock up, or locks to the wrong frequency, a variable dc power supply (HP 6200B or equivalent) can be used to tune the VCO. This allow you to continue with the troubleshooting checks.

Disconnect A4W4 (VCO Tune) and connect the power supply to A4L100. VCO frequency versus tune voltage must be within the range specified in Table 2. In addition, to check the A4 IF section, the front panel setting must correspond to the tuned VCO frequency ± 1 MHz (for example, if the front panel setting is 520 MHz, VCO frequency must be 520 MHz ± 1 MHz).

Table 2. VCO Frequency versus Tune Voltage.

Oscillator Frequency (MHz)	Typical Tune* Voltage (Vdc)	Tune Voltage* Tolerance (Vdc)
520.0000	-6.127	-6.5 to -5.6
530.0000	-5.912	-6.3 to -5.4
540.0000	-5.688	-6.1 to -5.6
550.0000	-5.450	-5.9 to -5.0
715.0000	-0.905	-3.0 to +2.5
990.0000	+6.945	+2.5 to +12
1040.000	+9.580	+5.5 to +14

* Voltage measured at TUNE signal location (A4W4).

√2 Buffer Amplifier No. 1, No. 2, and No. 3

1. Check the bias voltages on transistors A4Q104, A4Q105, and A4Q106.
2. Set the Signal Generator as follows:

Frequency 520 MHz
 Amplitude -10 dBm
 Modulation Off

3. Set the measuring receiver with the sensor module precalibrated as follows:

Measurement RF POWER
 Display LOG

4. Zero the measuring receiver and wait for the zero LED to go out.

NOTE

The mismatch caused by insertion of the 50 ohm input impedance Adapter Probe into the 50 ohm transmission line (at the RF Test Points), decreases power level readings. At some frequencies the decrease is 3 dB, and at others it can be less or greater than than 3 dB.

5. Connect the sensor module to the test points indicated in Table 3 by using the appropriate cables and adapters. Verify that the power levels are correct.

Table 3. Buffer Amplifier No. 1, No. 2, and No. 3 Power Levels.

Test Point	Power Level (dBm)		Circuit Opened By*
	Closed Circuit	Open Circuit	
A4TP101	+9.2 to +1.5	+13.0 to +5.0	Remove A4R111 and A4R112
A4TP1	+9.0 to +2.0	+14.5 to +8.5	Remove jumper to A6
A4TP2	+5.0 to -3.0	+6.0 to -1.0	Remove A4C9, C10, C11 and C14

* The circuit is opened by unsoldering one end of the component(s) or jumpers and lifting the unsoldered end from the printed circuit board.

√3 Buffer Amplifier No. 4 and IF Mixer Input

1. Check the bias voltages on A4Q2
2. Set the Signal Generator as follows:
 - Frequency 520 MHz
 - Amplitude -10 dBm
 - Modulation Off
3. Set the measuring receiver with the sensor module precalibrated as follows:
 - Measurement RF POWER
 - Display LOG
4. Zero the measuring receiver and wait for the zero LED to go out.
5. Connect the sensor module to the test points indicated in Table 4 by using the appropriate cables and adapters. Verify that the power levels are correct.

Table 4. Buffer Amplifier No. 4 and IF Mixer Input Power Levels.

Test Point	Power Level (dBm)		Circuit Opened By*
	Closed Circuit	Open Circuit	
A4TP3	-2.0 to -10.0	+1.0 to -7.5	Remove A4R6 and R7
A4TP4	+9.5 to +2.5	+14.0 to +8.2	Remove A4R37 and R38

* The circuit is opened by unsoldering one end of the component(s) or jumpers and lifting the unsoldered end from the printed circuit board.

√4 320 MHz Low-Pass IF Input Filter

1. Set the Signal Generator as follows:
 - Frequency 520 MHz
 - Amplitude -10 dBm
 - Modulation Off
2. Set the measuring receiver with the sensor module precalibrated as follows:
 - Measurement RF POWER
 - Display LOG
3. Zero the measuring receiver and wait for the zero LED to go out.
4. Connect the sensor module to the test points indicated in Table 5 by using the appropriate cables and adapters. Verify that the power levels are correct.

NOTE

When power levels at TP5 and TP6 are measured using a spectrum analyzer, the levels will be approximately 7 dB below the power level shown in Table 5. The HP 11722A Sensor Module is a wideband detector and measures all the outputs from the mixer U1.

Table 5. IF Input Filter Power Levels.

Test Point	Power Level (dBm)		Circuit Opened By*
	Closed Circuit	Open Circuit	
A4TP5	-14.0 to -20.0	-12.0 to -17.5	Disconnect A4C30, L19
A4TP6	-20.0 to -24.0	-17.5 to -22.5	Disconnect A4C47, C50, L30
* The circuit is opened by unsoldering one end of the component(s) or jumpers and lifting the unsoldered end from the printed circuit board.			

√5 IF Buffer Amplifier

1. Set the Signal Generator as follows:

Frequency 520 MHz
 Amplitude -10 dBm
 Modulation Off

2. Measure and verify the voltages shown at A4U2 for the frequencies indicated in Table 6.

Table 6. IF Buffer Amplifiers Bias Voltages.

Signal Generator Frequency	Bias Voltages A4U2 (Vdc)	
	Pin 1	Pin 3
520 MHz	+1.6V	+4.7V
700 MHz	0.0V	0.0V

3. Set the measuring receiver with the sensor module precalibrated as follows:

Measurement RF Power
 Display Log

4. Connect the sensor module to the test point indicated in Table 7 by using the appropriate cables and adapters. Verify that the power levels are correct for the frequencies indicated.
5. Disconnect the TUNE voltage to the VCO at A4W4. Verify the the voltage at TP8 is 0.000 ±0.005 Vdc.

Table 7. IF Buffer Amplifier Output Power Levels.

Signal Generator Frequency	Power Levels at TP7 (dBm)
520 MHz	-10.0 to -16.0

√6 Notch Filters

1. Set the Signal Generator as follows:

Frequency 700 MHz
 Amplitude -10 dBm
 Modulation Off

2. Connect the frequency counter to A4TP8 by using the appropriate cables and adapters.
3. Measure and verify the Notch Filter select voltages and IF frequencies as indicated in Table 8.

Table 8. Notch Filter Select Voltages.

Signal Generator Frequency (MHz)	Voltage (Vdc) At IF SEL Input							Frequency at A4TP8 (MHz)
	300	250	200	150	100	50	AC	
700	0.0	0.0	0.0	0.0	0.0	0.0	0.0	DC
750	0.0	0.0	0.0	0.0	0.0	12.5	12.5	50
800	0.0	0.0	0.0	0.0	12.5	0.0	12.5	100
850	0.0	0.0	0.0	12.5	0.0	0.0	12.5	150
900	0.0	0.0	12.5	0.0	0.0	0.0	12.5	200
950	0.0	12.5	0.0	0.0	0.0	0.0	12.5	250
1000	12.5	0.0	0.0	0.0	0.0	0.0	12.5	300

√7 Pulse Generator, Sampling Bridge

1. Set the Signal Generator as follows:

Frequency 520 MHz
 Amplitude -10 dBm
 Modulation Off

2. Set the measuring receiver with the sensor module precalibrated as follows:

Measurement RF POWER
 Display LOG

3. Zero the measuring receiver and wait for the zero LED to go out.
4. Connect the sensor module to the test points indicated in Table 9 by using the appropriate cables and adapters. Verify that the power levels are correct.
5. Disconnect the VCO Tune voltage at A4W4. Disconnect W1 from the A4 Assembly (refer to Service Sheet 2). Verify that the voltage at the feedthrough A4C44 is 0.000 ±0.010 Vdc.

Table 9. Pulse Generator and Sampling Bridge Power Levels.

Test Point	Power Level (dBm)		Circuit Opened By*
	Closed Circuit	Open Circuit	
A4TP8	-9.0 to -15.0	-	-
A4TP9	+10.0 to +5.0	+15.0 to +11.0	Disconnect A4R1, R2

* The circuit is opened by unsoldering one end of the component(s) and lifting the unsoldered end from the printed circuit board.

A4 Component Coordinates

COMP	X	Y	COMP	X	Y	COMP	X	Y
C1	4.8	3.9	C64	5.3	0.8	C162	2.8	2.8
C2	3.8	4.0	C65	5.1	0.5	C163	2.6	3.5
C3	3.3	3.8	C66	6.8	1.6	C164	1.0	3.3
C4	8.4	2.4	C67	5.8	1.2	C165	0.8	3.5
C6	8.5	1.7	C68	5.6	1.2	C166	5.2	3.5
C7	4.8	1.6	C69	6.3	1.6	C167	1.6	3.5
C8	6.2	1.6	C70	5.6	0.3	C168	0.5	3.5
C9	0.4	1.8	C71	5.3	0.3	C169	1.1	2.6
C10	0.7	1.1	C72	6.4	1.6	C170	0.6	2.3
C11	0.1	1.4	C73	7.0	1.7	C171	0.5	2.4
C12	10.0	1.1	C74	6.7	1.1	C172	1.5	2.4
C13	0.9	1.2	C75	7.1	1.1	C173	1.6	3.8
C14	0.1	0.9	C76	7.1	0.9	C174	1.9	3.9
C15	8.0	3.4	C77	3.4	1.2	C175	1.7	3.9
C16	9.8	0.8	C78	4.0	1.2	C176	2.0	4.0
C17	9.2	0.7	C79	8.1	0.9	C177	2.1	2.8
C18	0.1	0.3	C80	7.0	0.6	C178	3.2	3.5
C19	9.7	1.0	C81	7.1	0.6			
C20	9.1	0.7	C83	6.4	0.5	CR1	2.0	2.3
C21	0.9	0.5	C84	6.1	1.2	CR2	8.8	0.5
C24	8.8	1.0	C85	6.9	0.8	CR3A	8.4	1.1
C25	8.7	1.1	C86	6.9	0.6	CR3B	8.5	1.1
C26	8.7	0.3	C87	9.4	2.4	CR3C	8.4	0.6
C28	8.3	0.9	C88	7.0	2.9	CR3D	8.5	0.6
C29	8.3	0.7	C89	7.0	3.1	CR7	6.6	1.4
C30	1.5	0.9	C90	8.6	2.8	CR8	5.6	0.6
C31	8.1	1.1	C91	9.0	3.2	CR9	5.5	0.7
C32	8.3	1.7	C92	8.8	2.8	CR10	5.8	1.1
C33	2.1	1.3	C93	10.1	3.0	CR11	5.7	0.4
C34	9.3	1.2	C94	10.1	3.2	CR12	7.0	0.9
C35	7.8	0.5	C95	7.0	3.3	CR13	3.1	1.4
C36	2.2	1.3	C96	9.4	3.2	CR14	8.7	2.6
C37	7.8	0.6	C97	9.0	2.7	CR15	9.0	4.0
C38	2.5	0.5	C98	9.0	2.9	CR16	9.1	3.7
C39	9.8	1.5	C99	5.2	2.8	CR17	9.2	4.0
C41	2.7	0.5	C100	8.0	3.6	CR18	9.4	4.0
C42	6.0	3.4	C101	6.0	3.2	CR19	9.5	3.7
C43	3.0	1.3	C102	6.0	3.1	CR20	9.6	3.7
C44	8.7	1.7	C103	5.2	3.3	CR21	9.7	3.7
C45	6.5	3.7	C150	4.8	2.5	CR101	4.2	3.1
C47	4.2	0.6	C151	3.9	2.7	CR102	4.2	2.9
C49	2.8	1.1	C152	3.7	2.7			
C50	4.2	0.7	C153	3.6	2.7	J1	1.0	4.0
C51	4.8	0.5	C154	4.7	3.5	J2	6.2	4.1
C53	6.4	1.2	C155	3.8	3.2	J15	9.1	2.4
C59	6.9	1.3	C156	4.6	2.5	J16	7.2	4.0
C60	6.8	1.8	C157	3.4	2.7	J17	5.2	3.0
C61	5.5	0.5	C158	2.5	2.5			
C62	5.2	0.5	C159	3.2	3.2	L1	4.0	3.9
C63	6.6	1.6	C161	2.2	2.4			

A4 Component Coordinates

COMP	X	Y	COMP	X	Y	COMP	X	Y
L2	3.1	4.0	Q10	9.2	3.2	R46	5.2	1.4
L3	1.9	3.8	Q101	4.0	3.4	R47	5.1	1.4
L4	8.1	2.4	Q102	4.7	3.2	R48	5.4	1.4
L5	4.9	1.5	Q103	3.2	2.7	R49	5.3	1.4
L10	0.6	2.2	Q104	2.8	3.2	R50	7.0	2.7
L11	9.9	1.0	Q105	0.6	3.3	R51	6.8	3.2
L13	0.7	0.9	Q106	0.8	2.7	R52	6.8	2.6
L15	9.0	1.1				R53	9.6	2.3
L16	9.0	0.6	R1	10.0	1.0	R54	9.3	2.9
L19	1.5	1.4	R2	10.1	1.0	R55	9.7	2.3
L20	7.7	0.7	R3	10.2	1.4	R56	9.8	2.3
L21	2.4	0.9	R4	5.8	3.4	R57	8.3	2.8
L22	7.2	0.5	R5	0.0	0.5	R58	8.4	2.8
L23	9.6	1.8	R6	2.1	1.1	R59	9.5	2.5
L24	9.5	1.7	R7	1.4	1.3	R60	7.0	3.5
L25	2.7	0.9	R8	0.9	1.7	R61	6.1	3.4
L26	3.0	1.1	R9	0.6	0.1	R62	9.2	2.5
L27	6.5	0.5	R10	1.4	1.3	R63	9.4	2.5
L28	2.8	1.6	R11	9.1	0.4	R64	9.1	2.5
L30	4.1	1.0	R12	9.1	0.9	R65	7.4	3.8
L31	4.7	1.2	R13	9.1	1.0	R66	6.1	3.3
L33	6.2	0.3	R14	9.1	0.3	R67	6.1	3.2
L35	6.3	1.2	R15	0.9	1.1	R68	6.7	3.8
L36	5.8	0.6	R16	0.3	0.3	R69	5.8	3.3
L37	5.6	0.9	R19	8.7	0.9	R70	5.8	3.2
L38	6.0	1.0	R20	8.6	0.9	R71	6.5	3.1
L39	5.9	0.3	R21	8.2	1.3	R72	5.8	3.1
L41	7.9	1.4	R22	8.5	1.4	R73	6.1	3.5
L42	6.3	0.7	R23	1.5	0.8	R74	6.6	3.6
L43	5.1	3.5	R24	8.0	0.8	R75	6.6	3.1
L100	5.1	3.0	R25	9.1	1.5	R76	6.3	3.0
L101	4.3	2.8	R26	9.1	1.4	R77	8.2	3.4
L102	3.8	3.1	R27	9.1	1.6	R78	9.4	3.6
L103	4.1	3.2	R28	9.6	1.3	R79	9.8	3.5
L105	3.0	3.0	R29	6.4	2.3	R80	9.3	3.6
L106	2.5	3.1	R30	6.6	1.3	R81	9.3	3.5
L107	0.6	3.7	R32	3.4	0.7	R82	9.8	3.4
L108	1.7	2.5	R33	4.8	1.4	R83	8.7	3.5
L109	0.7	2.4	R34	6.2	2.3	R84	6.7	2.6
L110	2.1	4.0	R35	4.6	1.3	R85	6.9	4.1
L111	3.6	3.4	R36	4.5	1.3	R86	4.2	0.8
			R37	1.0	0.4	R87	6.7	3.6
Q2	0.3	0.5	R38	1.0	0.5	R88	8.8	3.4
Q3	8.1	3.1	R39	1.0	0.6	R89	4.9	0.5
Q4	6.5	2.9	R40	6.4	2.4	R100	4.0	2.6
Q5	4.9	0.8	R41	7.0	2.4	R101	4.7	3.1
Q6	8.1	1.4	R42	7.6	2.3	R102	4.5	3.1
Q7	8.3	1.5	R43	7.6	2.4	R103	4.6	3.1
Q8	10.0	2.8	R44	7.0	2.3	R104	3.1	2.5
Q9	6.5	2.6	R45	6.6	1.5	R106	3.4	2.9

A4 Component Coordinates

COMP	X	Y	COMP	X	Y	COMP	X	Y
R107	3.0	3.1	Z1	1.3	1.1			
R108	2.9	3.4						
R109	3.0	2.6						
R110	3.0	2.7						
R111	1.7	3.3						
R112	1.7	3.2						
R113	1.6	3.3						
R115	1.0	3.5						
R116	0.9	3.6						
R117	2.0	3.6						
R118	1.1	3.7						
R119	1.8	3.0						
R120	1.7	2.6						
R121	2.2	2.6						
R122	1.6	2.6						
R123	0.9	2.8						
R124	0.6	2.9						
R125	1.0	2.5						
R126	3.1	3.4						
T1	9.6	0.6						
TP1	0.5	3.6						
TP2	0.3	2.6						
TP3	2.1	1.2						
TP4	0.9	0.3						
TP5	1.4	1.4						
TP6	3.2	0.9						
TP7	4.8	0.2						
TP8	8.1	0.6						
TP9	9.7	0.5						
TP10	8.3	2.6						
TP11	6.2	2.9						
TP12	6.1	2.6						
TP100	3.4	3.2						
TP101	2.0	3.5						
U2	4.6	0.6						
U3	8.5	3.2						
U4	9.6	3.2						
U5	7.1	3.1						
U6	7.1	3.6						
U7	5.4	3.0						
U8	8.0	4.0						
VR1	0.2	0.2						
VR102	1.4	3.6						
W5	8.2	3.6						



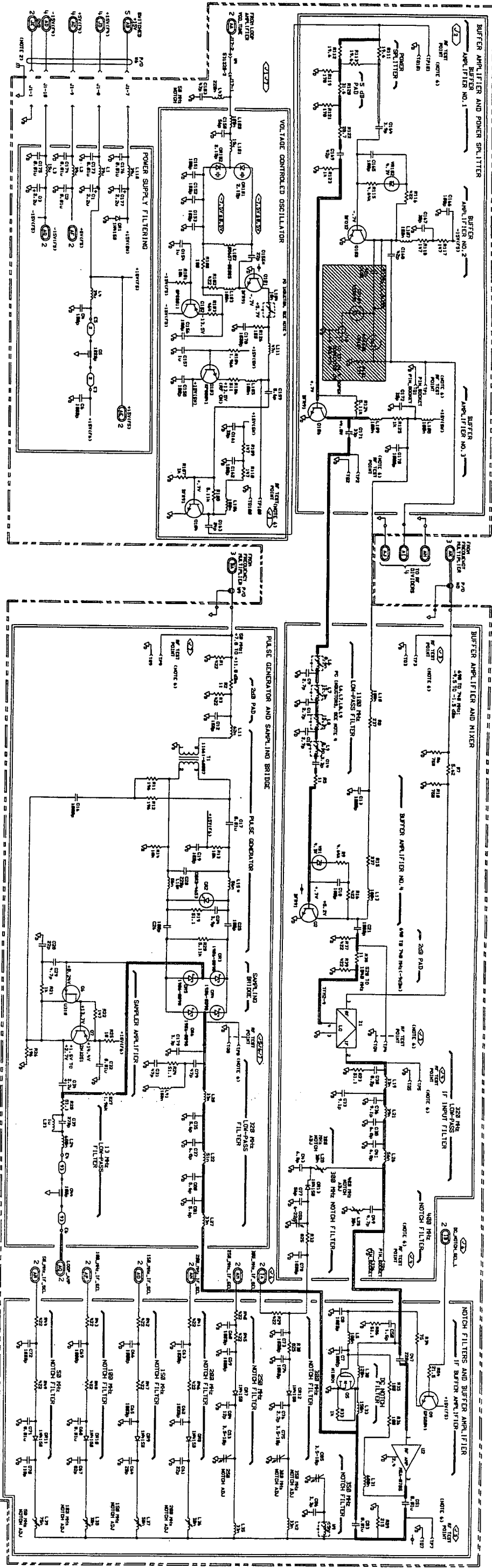


Figure 1
SERVICE SHEET 1

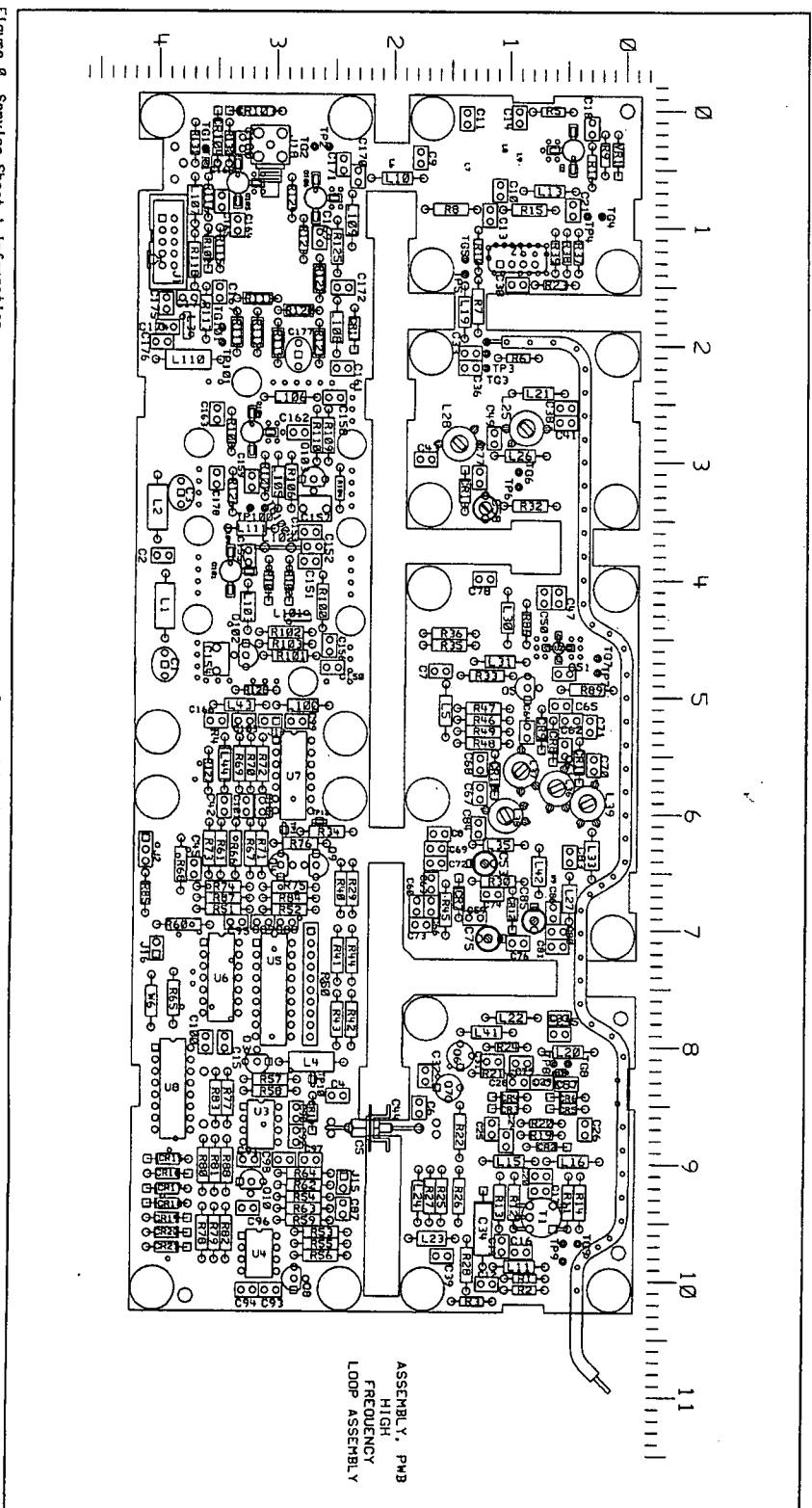
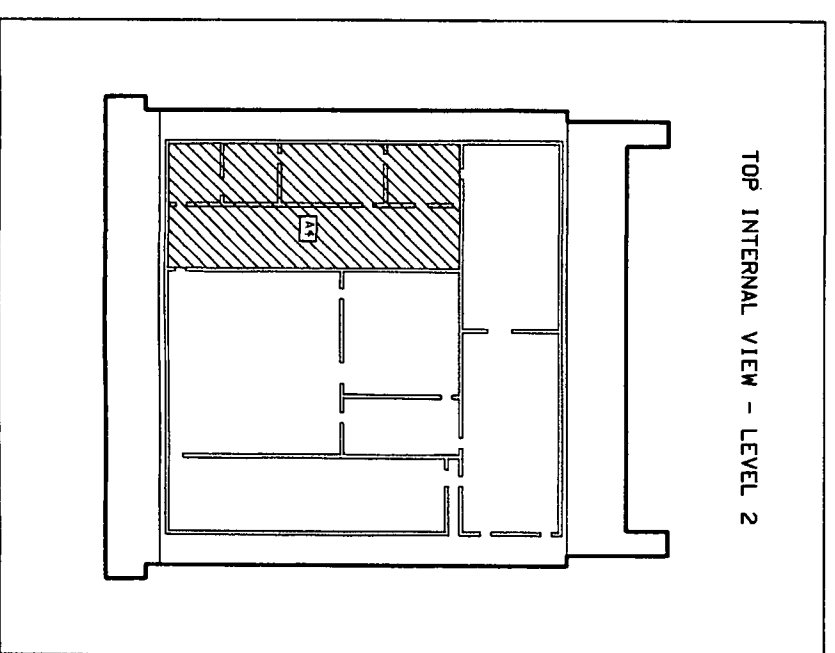
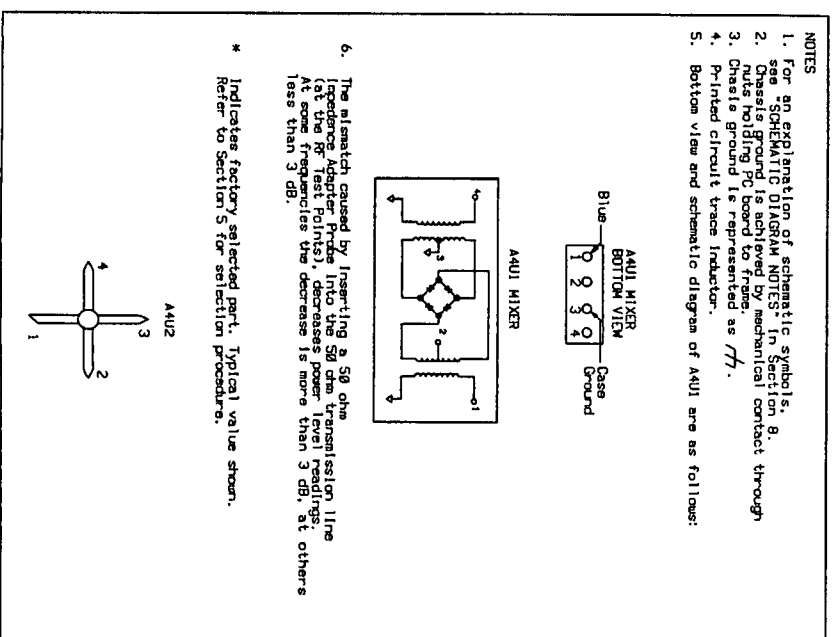


Figure 8. Service Sheet 1 Information.

Component Locator



Service Sheet 2

HIGH FREQUENCY LOOP AMPLIFIER AND CONTROL

PRINCIPLES OF OPERATION

General

Latched data in the High Frequency Loop Data Shift Register will select the Notch Filters (refer to Service Sheet 1), the Gain Compensation, and the Sideband that the High Frequency Loop will lock on.

A High Frequency Loop Lock cycle is started by the SDA input from the Microprocessor Assembly or the Out-Of-Lock Detector by triggering the High Frequency Loop One-Shot. The High Frequency Loop One-Shot output pulse causes the Side Band Select Control and Loop Amplifier Ramp Control to ramp the Loop Amplifier to its Maximum voltage. When the High Frequency Loop One-Shot times out, the Loop Amplifier voltage will ramp down. As the voltage ramps down, the High Frequency Loop VCO's frequency will sweep from high, 1040 MHz, to low, 520 MHz. During this sweep, the VCO's frequency will pass through a valid High Frequency Loop lock point. At the lock point, the Sampler will output a beatnote. The beatnote is amplified and detected by the Beatnote Detector. The Beatnote Detector outputs a clock pulse to the Side Band Select Control to terminate the Loop Amplifier's voltage ramp at the lock point. See Figure 1.

Beatnote Amplifier

When the VCO frequency is swept over its frequency range and a lock point is encountered, a beatnote will be generated by the Sampler. The beatnote starts out as a high frequency sine wave that decreases in frequency and increases in amplitude. See Figure 1, High Frequency Loop Control Timing Diagram. The beatnote from the sampler is amplified by the Beatnote Amplifier, U3, and is applied to the Beatnote Detector, U7C.

Capacitor C87 and resistor R53 are a high pass filter to couple the beatnote into the amplifier. The amplifier voltage gain is set by R57 and R58. C90 and C91 are power supply bypass capacitors.

Beatnote Detector

The Beatnote Detector senses the presence of a valid beatnote and generates a negative going pulse to clock the sideband select control flip-flops U8A and U8B.

Diode CR14 and capacitor C92 detect the positive peak of the beatnote sine wave from the amplifier and converts it to a positive voltage. The voltage is applied through resistor R66 to the negative input of comparator U7C. When the voltage at the negative input becomes greater than the threshold level set at the positive input, the comparator output goes low (0V). The comparator's threshold voltage is set by R67, R68, R87, and the comparator's output. When the comparator output is high (no beatnote), the threshold level at U7C pin 9 is set to approximately 0.2V by resistors R67, R68, and R87. When the comparator output is low (beatnote detected), the threshold level is set to approximately 0V because no current flows through R67 and R87. This hysteresis in the threshold level prevents the comparator from going back high until the voltage level from the detector has returned to 0V. (The low-going output pulse from the comparator is referred to as the birdie pulse.) This birdie pulse clocks the Side Band Select Logic Control, U8A pin 1 and U8B pin 13.

Ramp Timing Control

When the instrument's frequency is changed, a 1 ms SDA strobe pulse from the microprocessor, is applied to the High Frequency Loop One-Shot U6 pin 2. This strobe pulse starts the lock-up procedure for the loop.

The strobe pulse triggers the High Frequency Loop One-Shot, a high to low 1.5 ms pulse is generated. The pulse is applied to the Loop Amplifier Ramp Control ramp-up circuitry and the Reset inputs of the Sideband Select Control flip-flops U8A and U8B. R60 and C95 set the one-shot pulse width. R65 is a pull-up for the one-shot not Q output.

The negative pulse turns off diodes CR15, CR16, and CR17. When these diodes are turned off, CR18 turns on and applies a negative voltage -15V through R78 to the negative input of Loop Amplifier U4. This negative voltage causes the output voltage of the Loop Amplifier (integrator) to ramp up. The negative pulse from the one-shot applied to the Reset inputs of flip-flops U8A and U8B causes the Sideband Select Control's Q outputs goes Low and not Q outputs goes high.

The high not Q output at U8B pin 7 does three things. It turns on transistor Q8 sideband switch which grounds the positive input to the Loop Amplifier U4. This removes the Sampler signal from the loop amplifier. Transistor Q10 is also turned on and provides a path to ground for capacitors C98 and C34 (refer to Service Sheet 1) to prevent any charge from being developed on the capacitors when the tune voltage is changing. Also, the output not Q high turns on CR19 forming a voltage divider between R79 and R81 which turns off CR20. When CR20 is off, CR21 turns on and applies $+15\text{V}$ through R80 to the negative input of the Loop Amplifier U4. Normally a positive voltage would cause the amplifier to ramp downward. However, when CR21 first turns on, CR18 is also turned on. Since the resistance of R78 is less than that of R80, the net effect is that the Loop Amplifier's output continues to ramp up. The amplifier will continue to ramp up until the positive rail of the op-amp is reached, $+14\text{V}$. The amplifier will remain railed to the high side until the one-shot U6 times-out and its output goes high. At this time CR15, CR16, and CR17 turn on and CR18 turns off. CR21 is still on which causes the loop amplifier's output voltage to ramp down. At this time, the Side Band Select Control is active and determines the proper sideband to lock the High Frequency Loop.

Sideband Select Control/Loop Amplifier Ramp Control

The Side Band Select Control determines if the High Frequency VCO locks at a frequency above or below 715 MHz. When the VCO's frequency is greater than 940 MHz, the 250 MHz or 300 MHz IFs are used to lock the loop. The loop can only lock on the upper sideband in these two IFs. When the VCO's frequency is 940 MHz or less, the 50, 100, 150 or 200 MHz IFs are used to lock the loop, and the loop can lock on the upper or lower sideband. Therefore, in the lower four IFs there are two lock points, one above the VCO frequency of 715 MHz and one below the VCO frequency of 715 MHz. When an IF frequency is passed by the Notch Filters, the correct sideband is selected by the data bit at pin 1 of Shift Register U5. If the data bit is low, the loop is to lock on the upper sideband. If data bit is high, the loop is to lock on the lower sideband. R51 and R52 convert the voltage at U5 pin 1 to TTL levels which drives the set input of U8A at pin 4.

When the Ramp Timing Control High Frequency One-Shot U6 times-out (pulse goes from low to high), the Side Band Control logic flip-flops, U8A and U8B, have been Reset by the Low pulse and the Loop Amplifier, U4, output voltage is approximately $+14\text{V}$. When the Reset inputs at U8A pin 15 and at U8B pin 14 are high, the Side Band Select Control becomes active to select the correct sideband for the loop to lock. The high not Q output of U6 also turns diodes CR15, CR16 and CR17 on which turns CR18 off. U8B's not Q output at pin 7 is high. Diode CR19 is on, CR20 is off, and CR21 is on. With CR21 turned on, the Loop Amplifier's output voltage (VCO's tune voltage) starts ramping down. The VCO's frequency is tuned from high, 1040 MHz, to low, 520 MHz. As the VCO frequency goes through a valid lock point, a birdie is generated by the Beatnote Detector U7C from the sampler input and applied to the CLK inputs of the flip-flops U8A and U8B.

When the Sideband Control bit at U8A's set input (pin 4) is low, Sideband Select Control's U8A is not clocked. U8A's Q output is set high. U8B's Q output is low and not Q output is high. The J input of U8B is High and the K input remains Low. The set input of U8B is tied High and U8B will clock on each clock received. With U8B's J input High and K input Low the first birdie clock received clocks its Q output High and not Q output Low. The High Frequency Loop's VCO locks on the upper sideband. The first beatnote received from the Sampler.

A high Sideband Control input to the set input of U8A allows it to clock on each clock received. U8A's Q output is set low, and U8B's Q output is low and not Q output is high. The first birdie clock received clocks both U8A and U8B. The first birdie clocks U8A's Q output High and not Q output Low, since its J input is High and K input is Low. The outputs of U8B will not change on the first clock with its J input Low and K input Low. The first Sampler beatnote is skipped and the VCO's tune voltage and frequency continues to ramp down. The next Sampler beatnote and Beatnote Detector birdie clock clocks the not Q output of U8B low. The High Frequency Loop VCO locks on the lower sideband.

When the not Q output of U8B goes Low, diode CR19 turns off and no current flows through R79 thus the cathode of CR20 is pulled low through R81 and CR20 is turned on. CR21 now turns off and the Loop Amplifier output voltage stops ramping downward. At this point, transistor Q8 and Q10 turns off, the Sampler output is applied to the Loop Amplifier, and the High Frequency Loop locks-up.

Example

Let's take an example.

1. Enter Keyboard Invoked Test No. 3 by pressing the SHIFT key, and then the INCR SET key.
2. Press the AMPT up-arrow key three times until the number "3" appears in the MODULATION Display.
3. Press INCR SET and "00" should appear in the AMPLITUDE Display.

Keyboard Invoked Test No. 3 allows you to enter data to the Signal Generator while the test is running.

1. Press the AMPT up-arrow key four times until a "7" is displayed in the AMPLITUDE Display.
2. Press INCR SET. The Signal Generator will go through its power-up routine and will be ready to accept data. The test will continue until the Signal Generator is reset.
3. Set the Signal Generator's Frequency to 550 MHz. See Figure 1, High Frequency Loop Control Timing Diagram.

NOTE

With the Signal Generator tuned to 550 MHz, and Service Function 3 initiated, the High Frequency Loop is unlocked by the SDA signal from the Microprocessor. The VCO tune Voltage is reset to +14V and then ramps downward to -5V while the HF Loop VCO locks at 550 MHz. At time T5, the SDA signal unlocks the loop again. The cycle repeats itself again.

The High Frequency Loop VCO is to lock at a frequency of 550 MHz. The sideband select data bit at pin 1 of Shift Register U5 is high. The loop is to lock on the lower sideband. The 150 MHz Notch Filter is not selected, and the 150 MHz IF is passed to the Sampler. The other IFs are filtered out by the Notch Filters selected. The input frequency to Mixer A4U1 is 700 MHz. See Figure 1. At time T1, the SDA data bit triggers the High Frequency One-Shot U6. The Loop Amplifier's output voltage at W4 is ramped high and remains high until U6 times out at time T2. The VCO's frequency has been swept high, 1040 MHz. At time T2, the VCO tune voltage and frequency starts to ramp down. At time T3, the VCO's frequency is 850 MHz. The IF is 150 MHz, $850 - 700 = 150$, and a beatnote is received from the Sampler. The beatnote is amplified and detected by the Beatnote Amplifier and Beatnote Detector. The Beatnote Amplifier a birdie pulse to clock the Side Band Select Control. The loop would lock but the high sideband select data at U5 pin 1 will cause the Side Band Select Control to skip the first birdie pulse, the upper beatnote at time T3. The loop is prevented from locking at 850 MHz.

The VCO tune voltage and frequency continue to sweep down. At time T4 the VCO's frequency has swept down to 550 MHz and the IF is 150 MHz, $550 - 700 = -150$. A beatnote is received from the Sampler. The beatnote is amplified and detected by the Beatnote Amplifier and Beatnote Detector. A birdie pulse is output to the Side Band Select Control. The side Band select Control stops the Loop Amplifier from ramping down and the High Frequency Loop VCO locks on the lower sideband, at time T4. The loop is locked at 550 MHz. The High Frequency Loop VCO remains locked until time T5 when a SDA is received and the High frequency Loop One-Shot is triggered. The process is repeated.

Out-of-Lock Detector

When the frequency of the instrument is changed, the loop will go through its lock-up procedure to change to the new frequency. During the lock-up procedure, the Loop Amplifier's output voltage is ramped to its highest value and then ramped downward. During normal operation the loop will lock during this downward voltage ramp. However, if for some reason the loop has not properly settled, it may not lock during the downward ramp. If this is the case, once the ramp voltage gets below $-7V$ (VCO frequency < 520 MHz), then the voltage at the positive input of the comparator U7D drops lower than the negative input and the Out-Of-Lock Detector's, U7D, output goes low. The low transition from the comparator triggers the Ramp Timing Control's High Frequency Loop One-Shot which restarts the loop lock-up procedure.

R75 and R74 set the $-7V$ threshold on the Loop Amplifier output voltage. R76 is a pull-up resistor for the U7D comparator.

Gain Compensation

The VCO gain is not constant over its frequency range; therefore, the gain of the loop changes with frequency. To compensate for this non-linear condition, lead-lag network C101 and R70 and lead-lag network C102 and R72 are switched in. U7A and U7B are open collector comparators which act as switches to turn on and off the switchable lead-lag networks. R69 and R71 are protection resistors for the comparator inputs. A logic High from the High Frequency Loop Data Shift Register U5 pin 2 will make the voltage at the negative input of U7A higher than the positive input. This causes the output transistor in the comparator to turn on thus switching in the lead-lag network C101 and R70. A logic High from U5 pin 12 switches the output of comparator U7B Low and lead-lag network C102 and R72 is switched in.

Loop Amplifier

The loop amplifier U4 serves as an integrator for frequencies less than 15 kHz and a non-inverting unity gain amplifier for frequencies greater than 15 kHz. Resistor R59 and capacitor C96 serve as the ac feedback network for the integrator portion of the amplifier. The lowpass filter created by R63 and C97 rolls off the integrator portion of the amplifier as the non-inverting portion of the amplifier starts occurring. The non-inverting unity gain portion of the amplifier is achieved through the feed-forward network R62, C98, and R64.

Resistor R82 creates a constant positive offset voltage on the negative input to the amplifier. This forces the amplifier output voltage to slew down if the loop is unlocked. Capacitors C93 and C94 are power supply bypass capacitors for the amplifier.

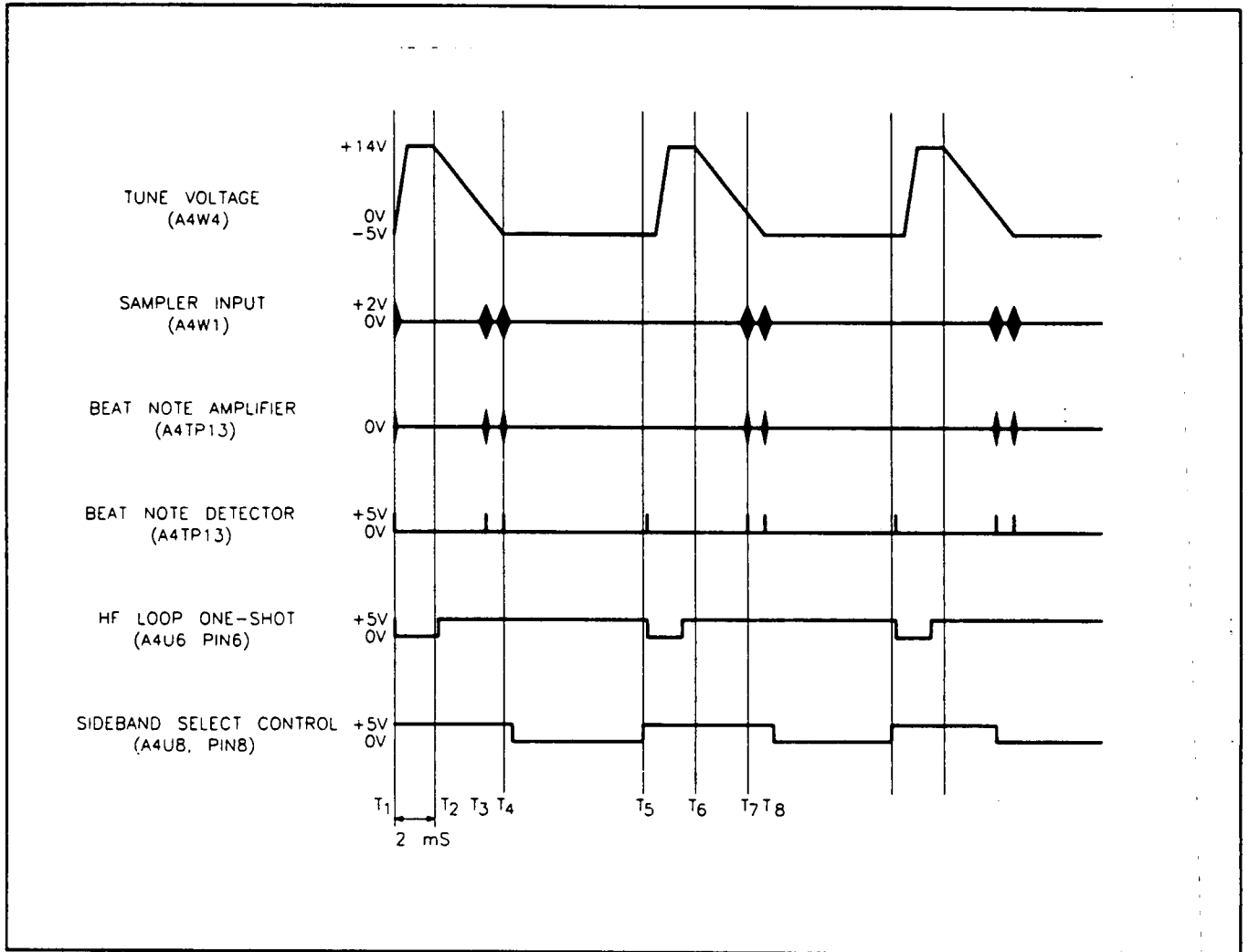


Figure 1. High Frequency Loop Control Timing Diagram.

TROUBLESHOOTING

Procedures for checking part of the A4 High Frequency Loop Assembly circuits are given below. The area or points to check are marked on the schematic by a hexagon with a check mark and a number inside, for example, (√1). Fixed voltages are shown on the schematic inside a hexagon, for example, (2V ±0.2V). Transistor bias voltages are shown without tolerances.

Troubleshooting Help

- Block Diagram 2
- Table 4-1. Abbreviated Performance Tests
- Table 5-2. Post-Repair Adjustments

Test Equipment

- Digital Multimeter HP 3466A
- Oscilloscope HP 54100A
- Oscilloscope, Analog HP 1740A
- Oscilloscope 1 Megohm Probe Pod, Chan 2 HP 54003A
- Oscilloscope Active Probe, Chan 1 HP 54001A
- Oscilloscope Probe HP 54003-61617

(√1) HF Loop Data Shift Register

4. Set the Signal Generator as follows:

- Frequency 650 MHz
- Amplitude -10 dBm
- Modulation Off

5. Verify A4U5 output levels for the frequencies indicated in Table 1.

Table 1. High Frequency Loop Control Logic.

Signal Generator Frequency (MHz)	A4U5 Digital Logic Levels*									
	IF SEL (L) Notch Filters**							Side-Band Select	Gain Compensation	
	300 Pin 18	250 Pin 11	200 Pin 10	150 Pin 9	100 Pin 8	50 Pin 3	DC Pin 17		Pin 1	Pin 12
650	L	L	L	L	L	H	H	H	H	H
700	L	L	L	L	L	L	L	L	H	L
750	L	L	L	L	L	H	H	L	H	L
800	L	L	L	L	H	L	H	L	H	L
850	L	L	L	H	L	L	H	L	H	L
900	L	L	H	L	L	L	H	L	H	L
950	L	H	L	L	L	L	H	L	H	L
1000	H	L	L	L	L	L	H	L	L	L

* Digital Levels: H ≥ 12 Vdc, L < 0.5 Vdc.
 ** A notch filter that is selected filters out that IF sideband. Therefore, the required IF sideband filter is not selected in order to pass the required frequency.

√2 Loop Amplifier, Out of Lock Detector, Beatnote Detector

The High Frequency Loop is unlocked and placed in a continuous sweep mode by placing A4W2 into the W2A position and then clocking the High Frequency Loop one-shot. Sideband Select Control is disabled and will not detect the lock point and the Loop Amplifier will continue to sweep through the tune voltage range of -7V to +14V as seen at A4W4. The Out of Lock Detector and High Frequency Loop One-Shot will continue to reset the Loop Amplifier as seen at U6 pin 6.

1. Set the Signal Generator as follows:

FREQUENCY 800 MHz
 AMPLITUDE -10 dBm

2. Switch the Signal Generator to STBY.

3. Place A4W2 in the W2A position.

4. Set the oscilloscope as follows:

Chan 1

Ch 1 Mode Normal
 Ch 1 Display On
 VOLTS/DIV 10.0V
 OFFSET 0.0V

Chan 2

Ch 2 Mode Normal
 Ch 2 Display On
 VOLTS/DIV 4.0V
 OFFSET 360 mV

Timebase

SEC/DIV 2 ms
 DELAY 0.0s
 Delay Ref at Left
 Sweep Trg'd

Trigger

Trigger Mode Edge
 Trig Src Chan 1
 TRIG LEVEL 0.0 mV
 Slope Pos
 Holdoff Time

Display

Display Mode Normal
 DISPLAY TIME 200 ms
 Split Screen ON
 Graticle Grid

5. Connect Channel 1 to VCO Tune at A4W4.
6. Connect Channel 2 to A4U6 pin 6.
7. Switch the Signal Generator back ON. Verify that the oscilloscope display shown in Figure 2 is correct.
8. Connect Chan 2 to A4W2, open pin. Verify that the oscilloscope display shown in Figure 3 is correct.

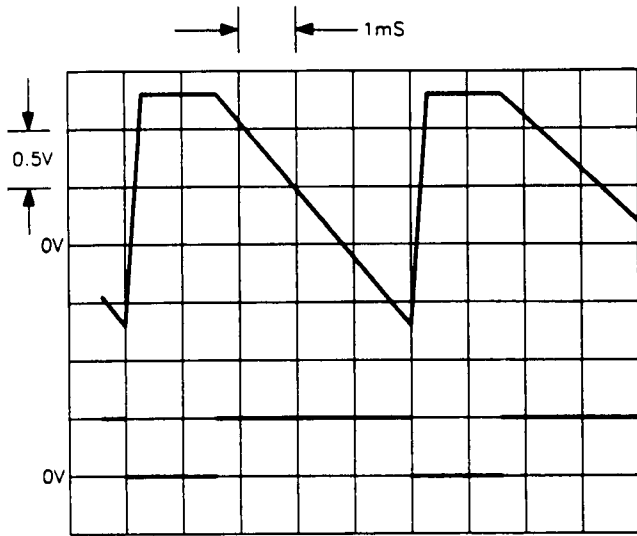


Figure 2. VCO Tune and High Frequency Loop One-Shoot.

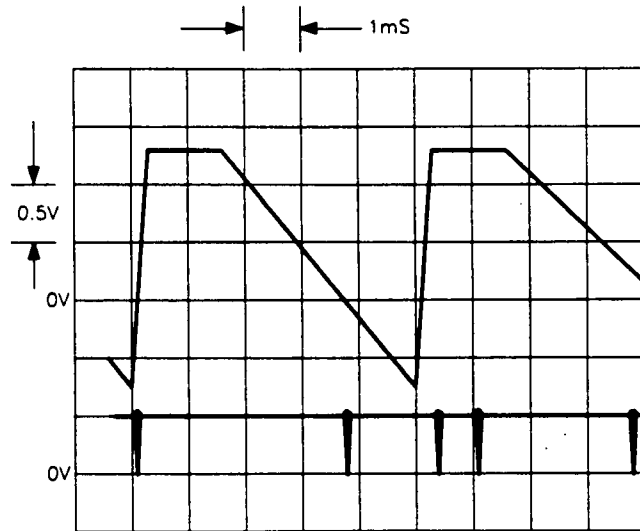


Figure 3. VCO Tune and Beatnote Detector.

√3 Beatnote Detector

Beatnotes from the 13 MHz Low Pass Filter at W1 (refer to Service Sheet 1) are compared to the amplified beatnotes at A4TP10 and the detected beatnotes at A4W2 (open pin). If no beatnotes are present out of the 13 MHz Low Pass Filter, check the circuits associated with Service Sheet 1.

1. Set the Signal Generator as follows:

Frequency 750 MHz
 Amplitude -10 dBm

2. Switch the Signal Generator to STBY.
3. Place A4W2 in the W2A position.

NOTE

The beatnotes in Figures 4 and 5 can not be checked with the digital oscilloscope. The HP 1740A analog oscilloscope (obsolete) or equivalent can be used.

4. Set the oscilloscope as follows:

TRIGGER Channel A
 TIME/DIV 2 ms
 Channel A VOLTS/DIV 0.005V
 Channel B VOLTS/DIV 0.1V

5. Connect Channel A to A4W1.
6. Connect Channel B to A4TP10.
7. Switch the Signal Generator back ON and verify that the oscilloscope display shown in Figure 4 is correct.
8. Connect Channel B to A4W2, open pin, and verify that the oscilloscope display shown in Figure 5 is correct. Place A4W2 back to the W2 position.

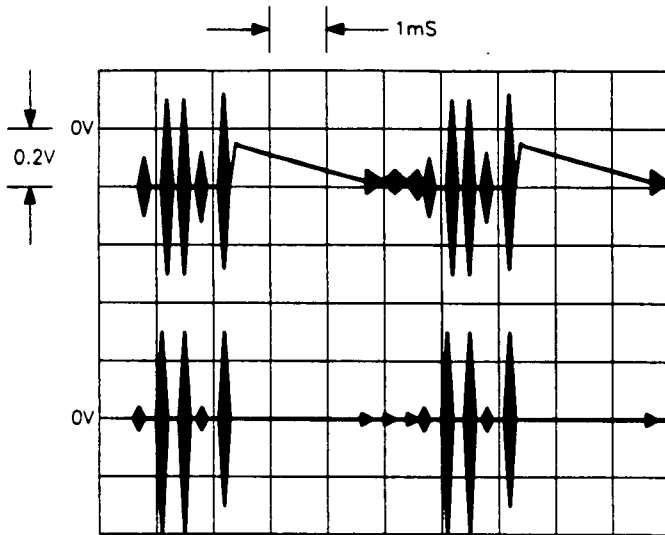


Figure 4. Beatnote Amplifier.

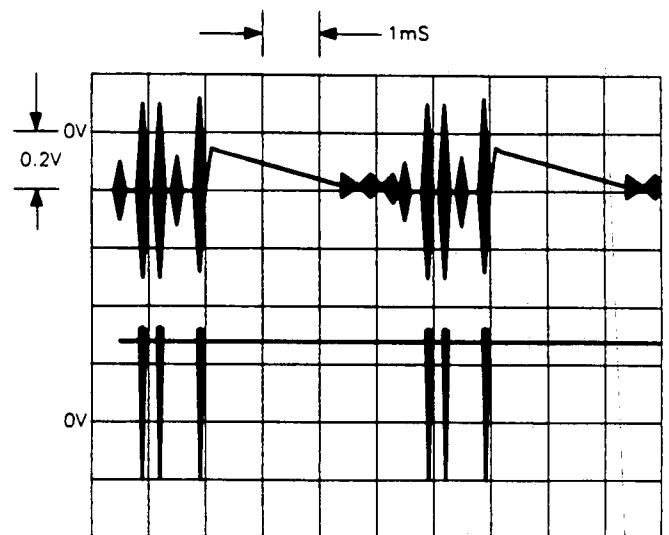


Figure 5. Beatnote Detector.

√4 High Frequency Loop Keyboard Invoked Test.

The Signal Generator has a special Keyboard Invoked Test for troubleshooting the A4 High Frequency Loop. During the test, data from the Microprocessor starts a new lock-up cycle every 10 ms. During every lock-up cycle, the Loop Amplifier's output voltage ramps up to approximately +14 Vdc and then ramps downward until the proper beatnote is detected, at which point the loop should lock. The loop stays locked until the Microprocessor begins the next lock-up cycle. Full front panel control is maintained while the test is running. This allows loop lock-up to be checked at any frequency setting.

1. Set the Signal Generator as follows:

Frequency 550 MHz
 Amplitude -10 dBm

2. Set the oscilloscope as follows:

Channel 1

Ch 1 Mode Normal
 Ch 1 Display On
 VOLTS/DIV 10.0V
 OFFSET 0.0V

Channel 2

Ch 2 Mode Normal
 Ch 2 Display On
 VOLTS/DIV 2.0V
 OFFSET 2.0V

Timebase

SEC/DIV 2 ms
 DELAY 0.0s
 Delay Ref at Left
 Sweep Trg'd

Trigger

Trigger Mode Edge
 Trig Src Chan 1
 TRIG LEVEL 7.0V
 Slope Pos
 Holdoff Time

Display

Display Mode Normal
 DISPLAY TIME 200 ms
 Split Screen ON
 Graticle Grid

3. Connect Chan 1 to the VCO Tune at A4W4.
4. Connect Chan 2 to A4W2.
5. The test routine is "entered" to start the test and then "exited" to regain control of the front panel. The test continues to run until the instrument is reset.
 - Enter the Keyboard-Invoked Tests by first pressing the **SHIFT** key and then pressing the **INCR SET** key. A "1" should be shown in the MODULATION display window.
 - Enter the High Frequency Loop Test by pressing the **AMPTD** \uparrow until a "3" is shown in the MODULATION display window.
 - Start the test routine by pressing the **INCR SET** key. "00" should be shown in the AMPLITUDE Display window.
 - Exit the Keyboard-Invoked Tests by pressing the **AMPTD** \uparrow until a "7" is shown in the MODULATION display window, then press the **INCR SET** key. The Signal Generator should go through it's power-up routine and then display a front panel setting of 550 MHz and -10 dBm.
6. Verify that the oscilloscope display shown in Figure 6 is correct. Note the lock-up point of approximately -5.0 Vdc on the Channel A display and that lock-up occurs on the second beatnote detected during ramp down of the Loop Amplifier.
7. Change the frequency of the Signal Generator to 850 MHz. Verify that the oscilloscope display shown in Figure 7 is correct. Note the lock-up point of approximately +0.4 Vdc on the Channel A display and that lock-up occurs on the first beatnote detected during ramp down of the Loop Amplifier.
8. Reset the Signal Generator by pressing the **SHIFT** key and then pressing the **0** key, PRESET.

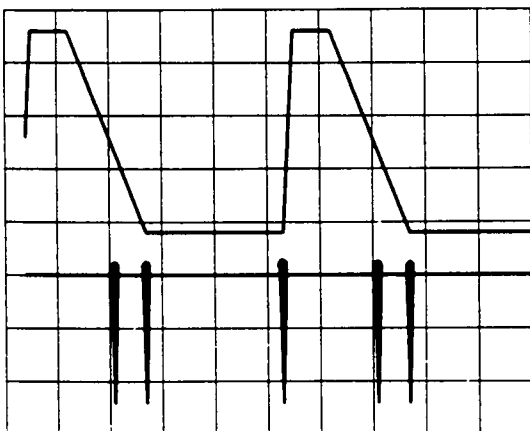


Figure 6. Loop Amplifier -5.0 Vdc Lock-Up.

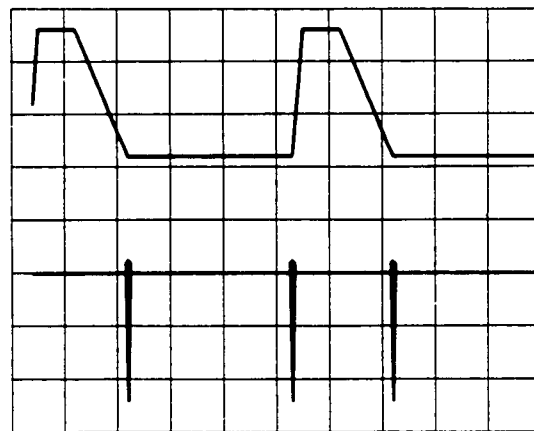


Figure 7. Loop Amplifier +0.4 Vdc Lock-Up.

A4 Component Coordinates

COMP	X	Y	COMP	X	Y	COMP	X	Y
C1	4.8	3.9	C64	5.3	0.8	C162	2.8	2.8
C2	3.8	4.0	C65	5.1	0.5	C163	2.6	3.5
C3	3.3	3.8	C66	6.8	1.6	C164	1.0	3.3
C4	8.4	2.4	C67	5.8	1.2	C165	0.8	3.5
C6	8.5	1.7	C68	5.6	1.2	C166	5.2	3.5
C7	4.8	1.6	C69	6.3	1.6	C167	1.6	3.5
C8	6.2	1.6	C70	5.6	0.3	C168	0.5	3.5
C9	0.4	1.8	C71	5.3	0.3	C169	1.1	2.6
C10	0.7	1.1	C72	6.4	1.6	C170	0.6	2.3
C11	0.1	1.4	C73	7.0	1.7	C171	0.5	2.4
C12	10.0	1.1	C74	6.7	1.1	C172	1.5	2.4
C13	0.9	1.2	C75	7.1	1.1	C173	1.6	3.8
C14	0.1	0.9	C76	7.1	0.9	C174	1.9	3.9
C15	8.0	3.4	C77	3.4	1.2	C175	1.7	3.9
C16	9.8	0.8	C78	4.0	1.2	C176	2.0	4.0
C17	9.2	0.7	C79	8.1	0.9	C177	2.1	2.8
C18	0.1	0.3	C80	7.0	0.6	C178	3.2	3.5
C19	9.7	1.0	C81	7.1	0.6			
C20	9.1	0.7	C83	6.4	0.5	CR1	2.0	2.3
C21	0.9	0.5	C84	6.1	1.2	CR2	8.8	0.5
C24	8.8	1.0	C85	6.9	0.8	CR3A	8.4	1.1
C25	8.7	1.1	C86	6.9	0.6	CR3B	8.5	1.1
C26	8.7	0.3	C87	9.4	2.4	CR3C	8.4	0.6
C28	8.3	0.9	C88	7.0	2.9	CR3D	8.5	0.6
C29	8.3	0.7	C89	7.0	3.1	CR7	6.6	1.4
C30	1.5	0.9	C90	8.6	2.8	CR8	5.6	0.6
C31	8.1	1.1	C91	9.0	3.2	CR9	5.5	0.7
C32	8.3	1.7	C92	8.8	2.8	CR10	5.8	1.1
C33	2.1	1.3	C93	10.1	3.0	CR11	5.7	0.4
C34	9.3	1.2	C94	10.1	3.2	CR12	7.0	0.9
C35	7.8	0.5	C95	7.0	3.3	CR13	3.1	1.4
C36	2.2	1.3	C96	9.4	3.2	CR14	8.7	2.6
C37	7.8	0.6	C97	9.0	2.7	CR15	9.0	4.0
C38	2.5	0.5	C98	9.0	2.9	CR16	9.1	3.7
C39	9.8	1.5	C99	5.2	2.8	CR17	9.2	4.0
C41	2.7	0.5	C100	8.0	3.6	CR18	9.4	4.0
C42	6.0	3.4	C101	6.0	3.2	CR19	9.5	3.7
C43	3.0	1.3	C102	6.0	3.1	CR20	9.6	3.7
C44	8.7	1.7	C103	5.2	3.3	CR21	9.7	3.7
C45	6.5	3.7	C150	4.8	2.5	CR101	4.2	3.1
C47	4.2	0.6	C151	3.9	2.7	CR102	4.2	2.9
C49	2.8	1.1	C152	3.7	2.7			
C50	4.2	0.7	C153	3.6	2.7	J1	1.0	4.0
C51	4.8	0.5	C154	4.7	3.5	J2	6.2	4.1
C53	6.4	1.2	C155	3.8	3.2	J15	9.1	2.4
C59	6.9	1.3	C156	4.6	2.5	J16	7.2	4.0
C60	6.8	1.8	C157	3.4	2.7	J17	5.2	3.0
C61	5.5	0.5	C158	2.5	2.5			
C62	5.2	0.5	C159	3.2	3.2	L1	4.0	3.9
C63	6.6	1.6	C161	2.2	2.4			

A4 Component Coordinates

COMP	X	Y	COMP	X	Y	COMP	X	Y
L2	3.1	4.0	Q10	9.2	3.2	R46	5.2	1.4
L3	1.9	3.8	Q101	4.0	3.4	R47	5.1	1.4
L4	8.1	2.4	Q102	4.7	3.2	R48	5.4	1.4
L5	4.9	1.5	Q103	3.2	2.7	R49	5.3	1.4
L10	0.6	2.2	Q104	2.8	3.2	R50	7.0	2.7
L11	9.9	1.0	Q105	0.6	3.3	R51	6.8	3.2
L13	0.7	0.9	Q106	0.8	2.7	R52	6.8	2.6
L15	9.0	1.1				R53	9.6	2.3
L16	9.0	0.6	R1	10.0	1.0	R54	9.3	2.9
L19	1.5	1.4	R2	10.1	1.0	R55	9.7	2.3
L20	7.7	0.7	R3	10.2	1.4	R56	9.8	2.3
L21	2.4	0.9	R4	5.8	3.4	R57	8.3	2.8
L22	7.2	0.5	R5	0.0	0.5	R58	8.4	2.8
L23	9.6	1.8	R6	2.1	1.1	R59	9.5	2.5
L24	9.5	1.7	R7	1.4	1.3	R60	7.0	3.5
L25	2.7	0.9	R8	0.9	1.7	R61	6.1	3.4
L26	3.0	1.1	R9	0.6	0.1	R62	9.2	2.5
L27	6.5	0.5	R10	1.4	1.3	R63	9.4	2.5
L28	2.8	1.6	R11	9.1	0.4	R64	9.1	2.5
L30	4.1	1.0	R12	9.1	0.9	R65	7.4	3.8
L31	4.7	1.2	R13	9.1	1.0	R66	6.1	3.3
L33	6.2	0.3	R14	9.1	0.3	R67	6.1	3.2
L35	6.3	1.2	R15	0.9	1.1	R68	6.7	3.8
L36	5.8	0.6	R16	0.3	0.3	R69	5.8	3.3
L37	5.6	0.9	R19	8.7	0.9	R70	5.8	3.2
L38	6.0	1.0	R20	8.6	0.9	R71	6.5	3.1
L39	5.9	0.3	R21	8.2	1.3	R72	5.8	3.1
L41	7.9	1.4	R22	8.5	1.4	R73	6.1	3.5
L42	6.3	0.7	R23	1.5	0.8	R74	6.6	3.6
L43	5.1	3.5	R24	8.0	0.8	R75	6.6	3.1
L100	5.1	3.0	R25	9.1	1.5	R76	6.3	3.0
L101	4.3	2.8	R26	9.1	1.4	R77	8.2	3.4
L102	3.8	3.1	R27	9.1	1.6	R78	9.4	3.6
L103	4.1	3.2	R28	9.6	1.3	R79	9.8	3.5
L105	3.0	3.0	R29	6.4	2.3	R80	9.3	3.6
L106	2.5	3.1	R30	6.6	1.3	R81	9.3	3.5
L107	0.6	3.7	R32	3.4	0.7	R82	9.8	3.4
L108	1.7	2.5	R33	4.8	1.4	R83	8.7	3.5
L109	0.7	2.4	R34	6.2	2.3	R84	6.7	2.6
L110	2.1	4.0	R35	4.6	1.3	R85	6.9	4.1
L111	3.6	3.4	R36	4.5	1.3	R86	4.2	0.8
			R37	1.0	0.4	R87	6.7	3.6
Q2	0.3	0.5	R38	1.0	0.5	R88	8.8	3.4
Q3	8.1	3.1	R39	1.0	0.6	R89	4.9	0.5
Q4	6.5	2.9	R40	6.4	2.4	R100	4.0	2.6
Q5	4.9	0.8	R41	7.0	2.4	R101	4.7	3.1
Q6	8.1	1.4	R42	7.6	2.3	R102	4.5	3.1
Q7	8.3	1.5	R43	7.6	2.4	R103	4.6	3.1
Q8	10.0	2.8	R44	7.0	2.3	R104	3.1	2.5
Q9	6.5	2.6	R45	6.6	1.5	R106	3.4	2.9

A4 Component Coordinates

COMP	X	Y	COMP	X	Y	COMP	X	Y
R107	3.0	3.1	Z1	1.3	1.1			
R108	2.9	3.4						
R109	3.0	2.6						
R110	3.0	2.7						
R111	1.7	3.3						
R112	1.7	3.2						
R113	1.6	3.3						
R115	1.0	3.5						
R116	0.9	3.6						
R117	2.0	3.6						
R118	1.1	3.7						
R119	1.8	3.0						
R120	1.7	2.6						
R121	2.2	2.6						
R122	1.6	2.6						
R123	0.9	2.8						
R124	0.6	2.9						
R125	1.0	2.5						
R126	3.1	3.4						
T1	9.6	0.6						
TP1	0.5	3.6						
TP2	0.3	2.6						
TP3	2.1	1.2						
TP4	0.9	0.3						
TP5	1.4	1.4						
TP6	3.2	0.9						
TP7	4.8	0.2						
TP8	8.1	0.6						
TP9	9.7	0.5						
TP10	8.3	2.6						
TP11	6.2	2.9						
TP12	6.1	2.6						
TP100	3.4	3.2						
TP101	2.0	3.5						
U2	4.6	0.6						
U3	8.5	3.2						
U4	9.6	3.2						
U5	7.1	3.1						
U6	7.1	3.6						
U7	5.4	3.0						
U8	8.0	4.0						
VR1	0.2	0.2						
VR102	1.4	3.6						
W5	8.2	3.6						

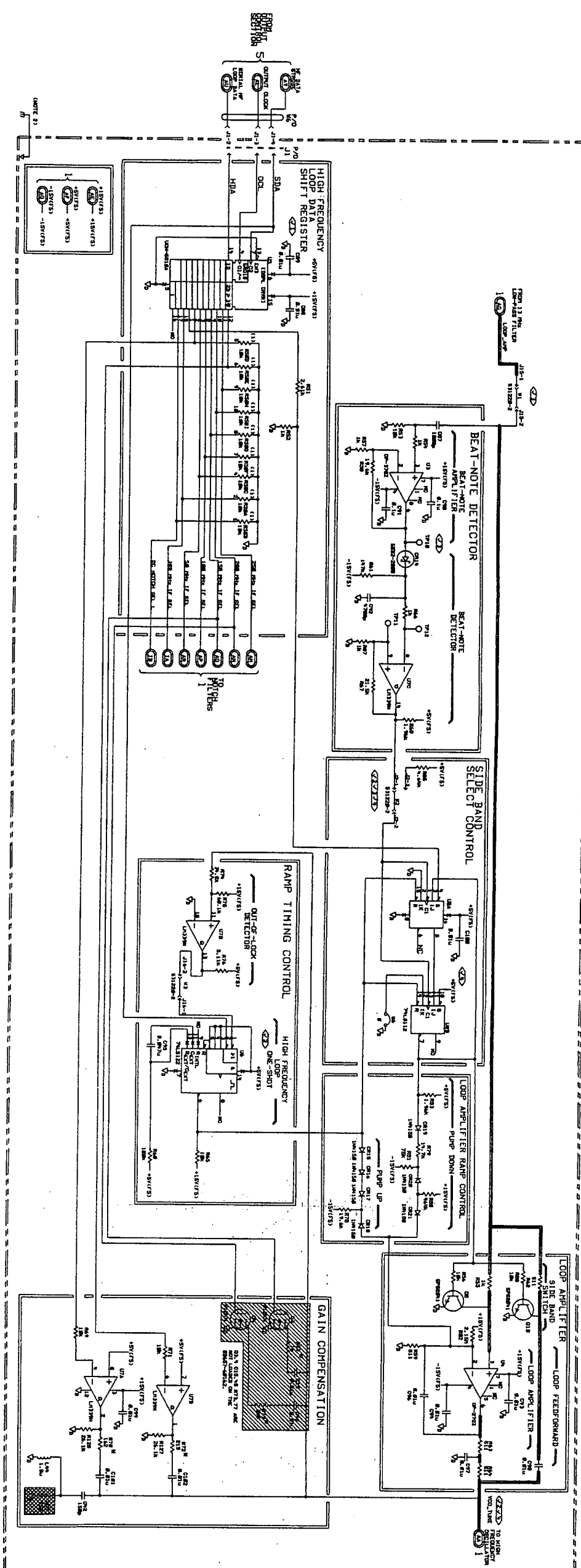


Figure 8
SERVICE SHEET 2

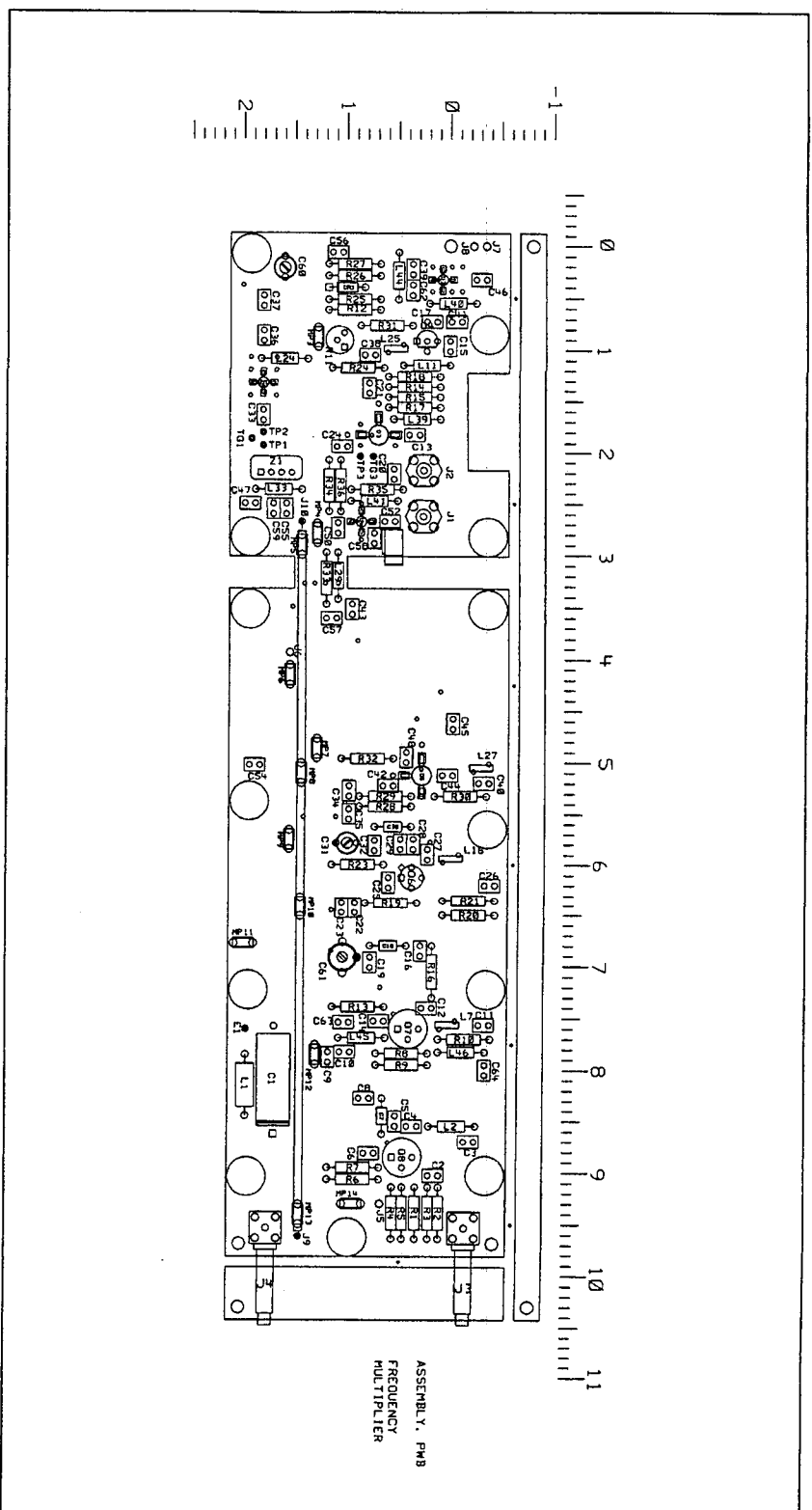
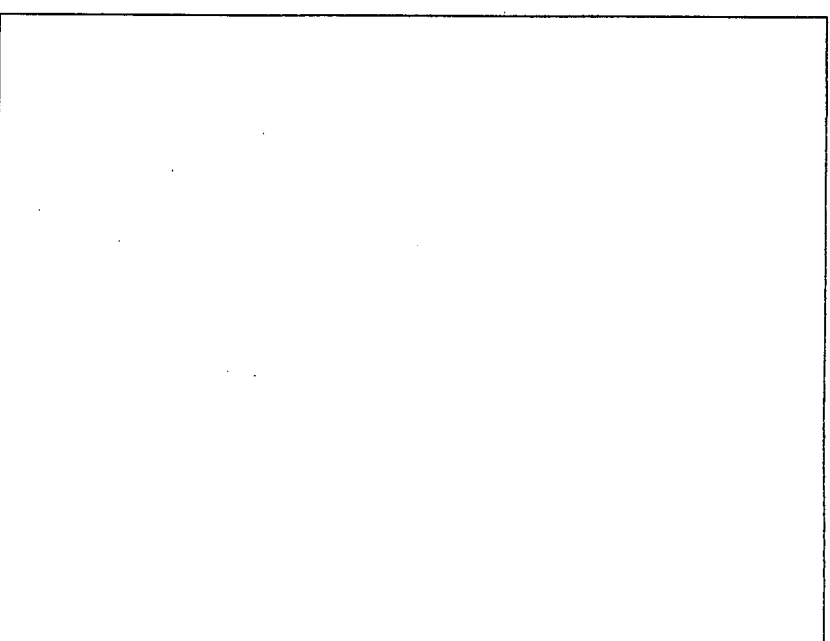
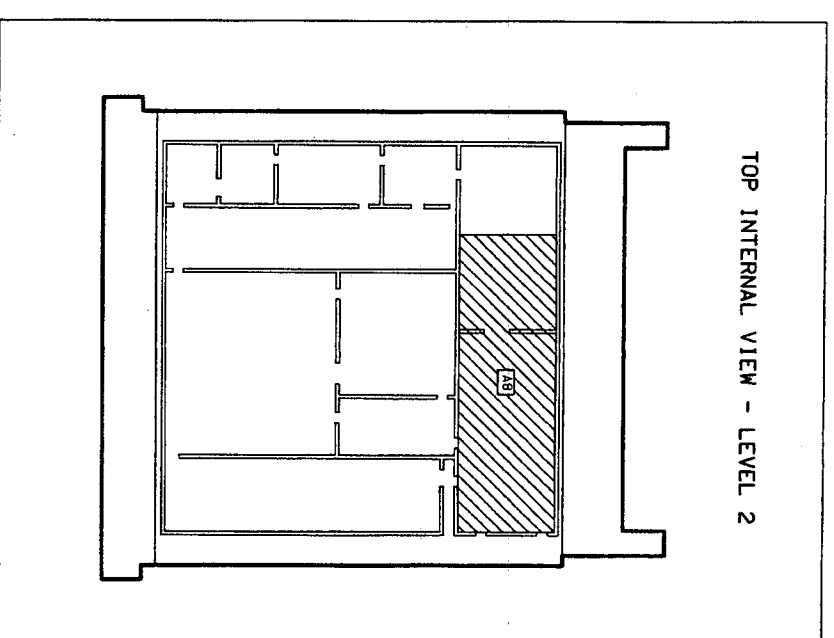


Figure 8. Service Sheet 3 Information

Component Locator



P/O A4 HIGH FREQUENCY LOOP
AMPLIFIER AND CONTROL
SS2
SEE SERVICE SHEET



SRV1CB

Model 8657A

8 Service Sheet 2

Service Sheet 3

FREQUENCY MULTIPLIER

PRINCIPLES OF OPERATION

General

The 50 MHz reference is multiplied by 16 to 800 MHz. It is mixed with the phase locked 60 to 110 MHz signal from the Low Frequency Loop Assembly. The Mixer's output is amplified and applied to a Bandpass Filter that passes the difference frequency 690 to 740 MHz. The input frequencies to the Mixer are phase locked to the 50 MHz reference. Therefore, the Mixer's output serves as a reference to lock the High Frequency Loop. The 800 MHz output is also applied to the Output Assembly (refer to Service Sheet 5).

Frequency Multiplier

The 50 MHz +16 to +19 dBm input from the Reference Oscillator is applied to the Power Splitter consisting of R1, R2, R3, and R4. One output of the Power Splitter goes to the Sampling Bridge of the High Frequency Loop (shown on Service Sheet 1). The other output is ac coupled by C2 to Q8, the first multiplier stage. Subsequently, the 50 MHz is doubled four times to a frequency of 800 MHz.

Each of the four multiplier stages (Q8, 7, 6, and 5) is dc biased so the transistor operates in its non-linear region thus generating harmonics. The output of each stage is filtered by a bandpass filter at 100, 200, 400, or 800 MHz. This passes the doubled frequency and filters out the input frequency and other harmonics. Since the stages are electrically equivalent, only the first stage will be discussed in detail. Note, however, that the 800 MHz filter utilizes printed circuit trace capacitors and inductors instead of discrete capacitors and inductors.

Resistors R5 and R6 divide the +5 Vdc supply voltage to dc bias the base of Q8 at approximately +1.0 Vdc without the 50 MHz signal connected. Resistor R7 is the emitter bias resistor. Capacitor C6 bypasses the ac emitter signal to ground. Inductor L2 is an RF choke. Capacitor C3 is an RF bypass. Capacitor C4 ac couples the output to the 100 MHz Bandpass Filter. The 800 MHz output of the last multiplier stage Q5 is applied to the 800 MHz Bandpass Filter on the output Assembly A6 (shown on Service Sheet 5) and to Buffer Amplifier No. 1.

Buffer Amplifier No. 1/Mixer U1

The 800 MHz signal is coupled to the base of Q3 through resistor R11, the circuit board transmission line, and capacitor C13. The transmission line serves to isolate Q3 from the input. DC current flows through resistors R14 and R15 to dc bias the base of Q4. Since the emitter of Q4 is also connected to the +5V(F) supply by resistor R18, the emitter voltage will be approximately 0.6 Vdc more positive than the base. The current through resistor R18 is determined by the voltage difference between the +5 Vdc supply and the voltage at the emitter of Q4. The current through R18 takes two paths. One path is into the emitter of Q4 and out at its collector. This current minus the base current of Q4 is the base current of Q3. The other path for the current from R18 flows through L12 and into the collector of Q3. The base to collector current ratio depends on the dc current gain of Q3. Therefore, the total current from R18 is equal to the emitter current of Q3. Inductor L11 is an RF choke while L12 serves as a matching element. Capacitors C15, C20, C21, and C58 are RF bypass capacitors. Capacitor C24 ac couples the output of Buffer Amplifier No.1 to Mixer U1. The other input to Mixer U1 is the 60 to 110 MHz from the Voltage Controlled Oscillator (refer to Service Sheet 9). The difference output of 690 to 740 MHz is ac coupled to Buffer Amplifier No. 2.

Buffer Amplifiers No. 2 and 3

The dc current flowing through resistors R25 and R26 dc biases the base of Q2 at approximately 2.0 Vdc. Resistor R27 is the emitter bias resistor and capacitors C36 and C37 are the emitter resistor bypass to ground. Inductor L24 is an RF choke while capacitors C38 and C39 are RF bypass capacitors. L23, L25 and C41 all serve as matching elements. The output of Buffer Amplifier No. 2 is ac coupled to the Compensation Network by capacitor C41. The Compensation Network is adjusted to keep the 690 to 740 MHz flatness within ± 1.5 dB. The signal is ac coupled to Buffer Amplifier No. 3 which functions the same as Buffer Amplifier No. 2. The output of the buffer amplifier passes through Bandpass Filter FL1 which passes the difference frequencies (between 690 and 740 MHz) from the Mixer, and filters and eliminates all the other frequencies. A frequency between 690 and 740 MHz goes to the Mixer in the High Frequency Loop (refer to Service Sheet 1) to serve as a phase locked reference for the A5 Voltage Controlled Oscillator.

TROUBLESHOOTING

Procedures for checking circuits of the A8 Frequency Multiplier Assembly are given below. The areas or points to check are marked on the schematic by a hexagon with a check mark and a number inside, for example, $\checkmark 3$. Fixed voltages are shown on the schematic inside a hexagon, for example, $\checkmark 2V \pm 0.2V$. Transistor bias voltages are shown without tolerances.

Troubleshooting Help

- Block Diagram 2
- Table 4-1. Abbreviated Performance Tests
- Table 5-2. Post-Repair Adjustments

Test Equipment

Measuring Receiver	HP 8902A
Sensor Module	HP 11722A
Digital Multimeter	HP 3466A
Adapter Probe	HP 1250-1598
Adapter N(f) to BNC(m)	HP 1250-0077
Adapter BNC(f) to BNC(f)	HP 1250-0080
Cable BNC(m) to SMC(f)	HP 08662-60075

$\checkmark 1$ Multiplier Stages Bias Voltages

1. Set the Signal Generator to any frequency.
2. Measure and verify the bias voltages as indicated in Table 1 with and without the 50 MHz Reference Oscillator input signal connected at A8J3.

Table 1. Multiplier Stages Bias Voltages.

Transistor	50 MHz Input Signal (Vdc)	
	Connected	Not Connected
Q8-E (J2-Pin 2)	+0.8	+0.23 to 0.47
Q8-B	+1.0	+1.0
Q8-C	+5.0	+5.0
Q7-E (J2-Pin 4)	+0.8	+0.23 to 0.47
Q7-B	+1.0	+1.0
Q7-C	+5.0	+5.0
Q6-E (J2-Pin 6)	+0.8	+0.23 to 0.47
Q6B	+1.0	+1.0
Q5-E (J2-Pin 8)	+0.8	+0.23 to 0.47
Q5-B	+1.0	+1.0
Q5-C	+5.0	+5.0

√2 RF Levels

1. Set the Signal Generator as follows:

Frequency Any
 Amplitude Any
 Modulation Off

2. Set the measuring receiver with the sensor module precalibrated as follows:

Measurement RF POWER
 Display Log

3. Zero the measuring receiver and wait for the zero LED to go out.

4. Check the 50 MHz Reference Oscillator input to the Frequency Multiplier Assembly.

5. Disconnect coax cable W5 from A8J3, and connect the sensor module to W5 using the appropriate cables and adapters. The level should be +16 to +19 dBm and the frequency should be 50 MHz ±100 Hz.

6. Reconnect W5 to the A8 Assembly.

7. Check the 60 to 110 MHz Low Frequency Loop input to the Frequency Multiplier Assembly.

8. Disconnect coax cable W3 from A8J4, and connect the sensor module to W3 using the appropriate cables and adapters. The level should be -9 to -7 dBm.

9. Reconnect W3 to the A8 assembly.

10. Table 2 shows power levels at various points and the conditions for measurement. Verify that each level is within the required range by connecting the sensor module to each point using the appropriate cables and adapters.

NOTE

The mismatch caused by insertion of the 50 ohm input impedance adapter probe into the 50 ohm transmission line (at the RF Test Points), decreases power level readings. At some frequencies the decrease is 3 dB, and at others it is less than 3 dB.

Table 2. RF Power Levels.

Conditions	RF Power Levels (dBm) at Measurement Locations				
	W10	TP3	TP2	TP1	A8 Output to FL1
All Cables Connected	+1 to +7	+2 to +8	+2 to +8	-20 to -14	0 to +6
W10 Not Connected	+5 to +9	+5 to +9	+5 to +9	—	—
Jumper Removed	—	—	—	-14 to -10	—
FL1 Not Connected	—	—	—	—	+2 to +7

A8 Component Coordinates

COMP	X	Y	COMP	X	Y	COMP	X	Y
C1	8.6	1.7	C54	5.0	1.9	R1	9.1	0.3
C2	9.0	0.1	C55	2.5	1.4	R2	9.1	0.1
C3	8.7	-0.2	C56	0.1	1.1	R3	9.1	0.2
C4	8.6	0.3	C57	3.6	1.2	R4	9.1	0.5
C5	8.5	0.5	C58	2.8	0.7	R5	9.1	0.4
C6	8.8	0.8	C59	2.5	1.6	R6	9.1	0.7
C7	8.3	0.6	C60	0.2	1.6	R7	9.0	0.7
C8	8.3	0.8	C61	6.9	1.0	R8	7.8	0.2
C9	7.9	1.2	C62	0.4	0.4	R9	8.0	0.2
C10	7.8	1.0	C63	7.5	1.0	R10	7.7	0.1
C11	7.6	-0.4	C64	8.0	-0.4	R11	0.8	1.1
C12	7.4	0.2				R12	0.6	1.2
C13	1.8	0.3	CR1	0.4	1.2	R13	7.4	0.6
C14	7.5	0.7				R14	1.4	0.6
C15	1.0	0.0	J1	2.6	0.3	R15	1.5	0.6
C16	6.9	0.3	J2	2.2	0.3	R16	7.3	0.1
C17	0.7	0.2	J3	9.5	-0.2	R17	1.6	0.6
C18	6.8	0.4	J4	9.5	1.7	R18	1.3	0.6
C19	7.0	0.8	J5	9.3	0.6	R19	6.4	0.8
C20	2.2	0.5	J6	3.9	1.5	R20	6.5	0.1
C21	1.4	0.8	J7	0.0	-0.4	R21	6.4	0.1
C22	6.4	0.9	J8	0.0	-0.2	R23	6.1	0.7
C23	6.4	1.0	J9	9.6	1.4	R24	1.2	0.6
C24	1.9	1.0	J10	2.7	1.4	R25	0.5	1.2
C25	6.2	0.6				R26	0.3	1.2
C26	6.2	-0.4	L1	7.9	2.0	R27	0.2	1.2
C27	5.9	0.2	L2	8.6	-0.3	R28	5.4	0.4
C28	5.8	0.3	L7	7.6	0.0	R29	5.3	0.4
C29	5.8	0.5	L11	1.2	0.5	R30	5.3	0.1
C30	5.6	0.7	L16	5.9	-0.0	R31	0.8	0.4
C31	5.8	1.0	L24	1.1	1.8	R32	5.0	0.5
C32	5.8	0.7	L25	1.0	0.5	R33	3.5	1.2
C33	1.6	1.8	L27	5.1	-0.3	R34	2.6	1.2
C34	5.3	1.0	L29	3.0	1.1	R35	2.4	1.0
C35	5.5	1.0	L33	2.4	1.9			
C36	0.9	1.8	L39	1.7	0.1	TP1	1.9	1.8
C37	0.5	1.8	L40	0.6	-0.3	TP2	1.8	1.8
C38	1.1	0.8	L41	2.5	0.5	TP3	2.1	1.1
C39	0.2	0.4	L44	0.1	0.5			
C40	5.2	-0.3	L45	7.7	1.1	U2	1.3	1.8
C41	0.7	-0.1	L46	7.8	0.1	U3	0.3	0.1
C42	5.2	0.6				U4	2.7	0.9
C43	3.5	0.9	Q3	1.8	0.7			
C44	5.1	0.0	Q4	0.9	0.2	Z1	2.2	1.8
C45	4.6	-0.0	Q5	5.1	0.3			
C46	0.3	-0.3	Q6	6.1	0.4			
C47	2.5	1.8	Q7	7.6	0.4			
C48	5.0	0.4	Q8	8.9	0.4			
C50	2.7	1.1						
C52	2.7	0.6						

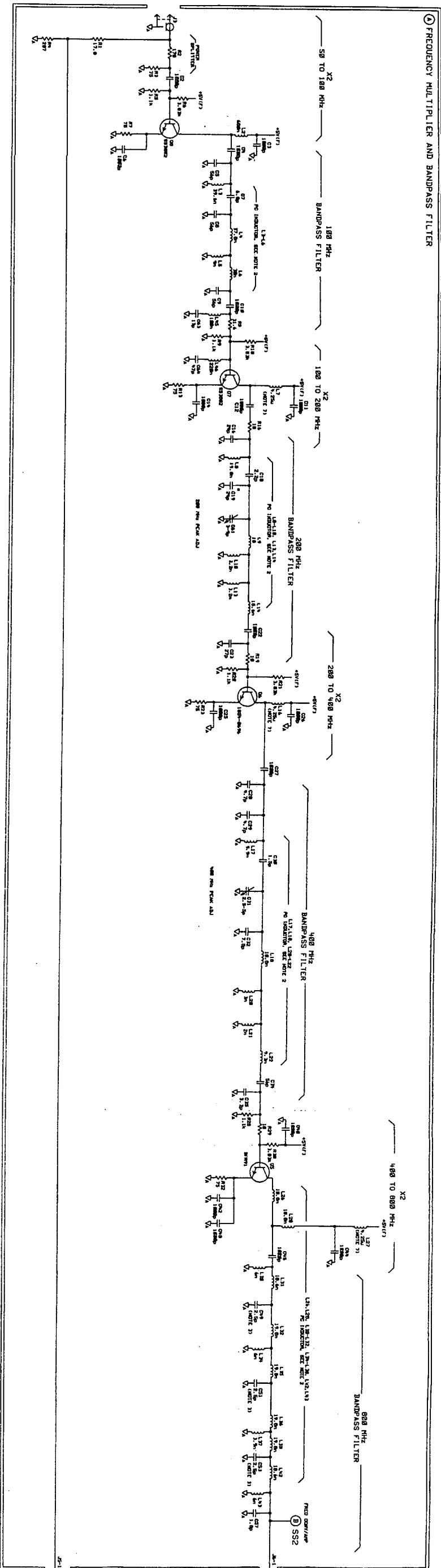


Figure 1
SERVICE SHEET 3a 6

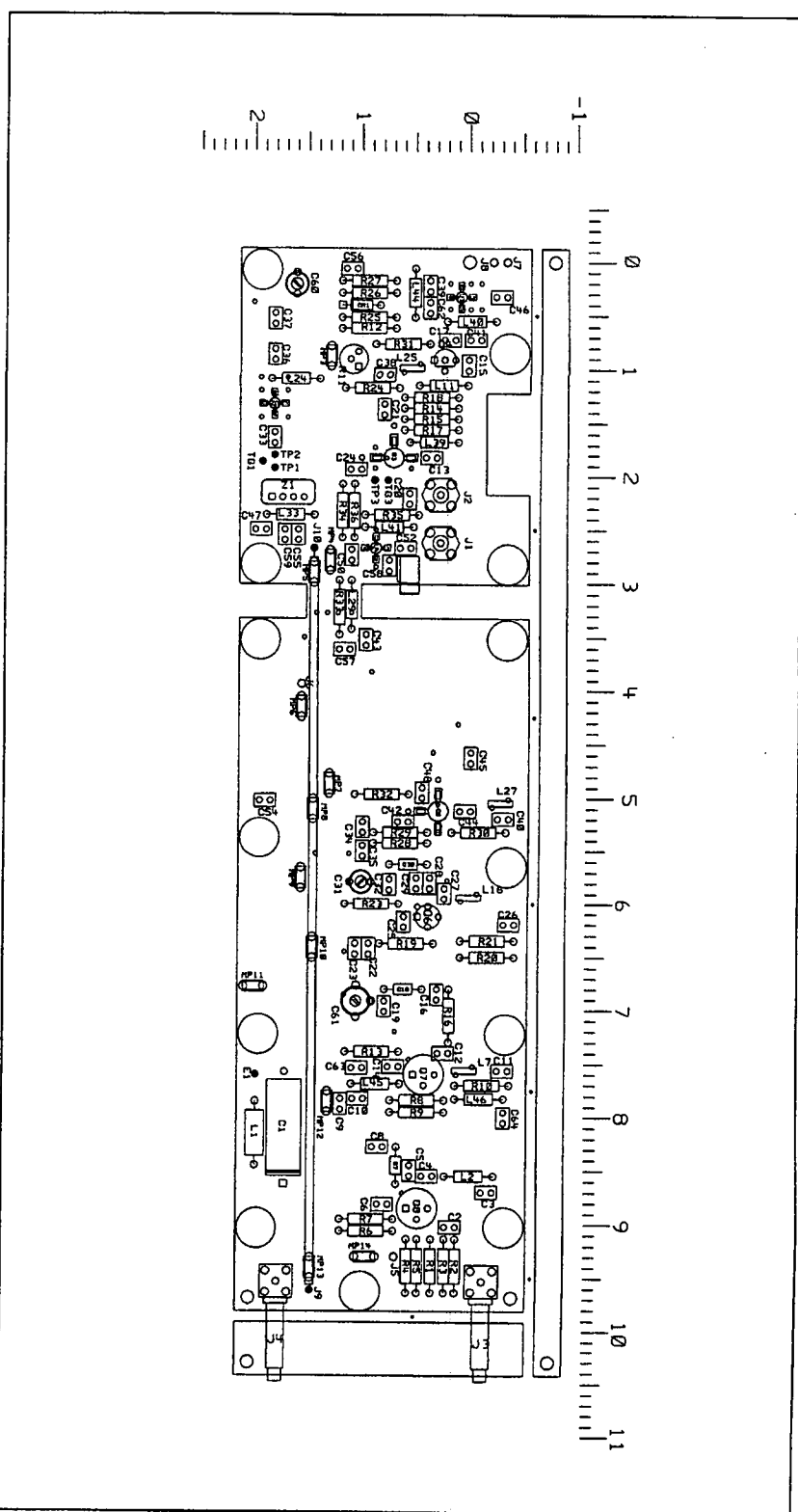
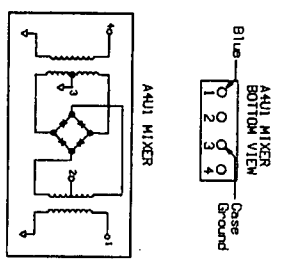


Figure 8. Service Sheet 3 Information

Component Location

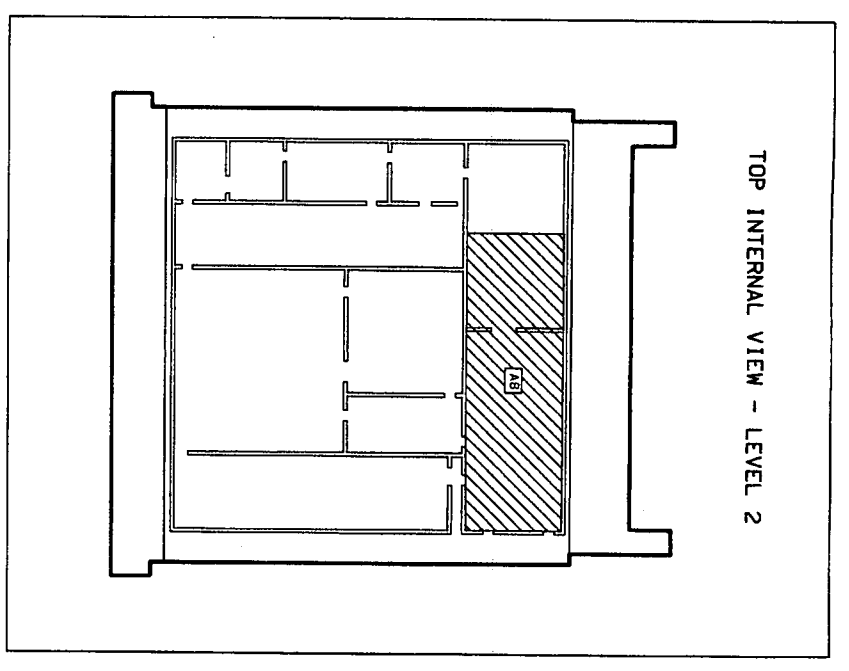
- NOTES
1. For an explanation of schematic symbols, see "SCHEMATIC DIAGRAM NOTES" in Section 8.
 2. Printed circuit trace inductor.
 3. Pin of dual-in-line test socket J1 or J2.
 4. Service test point. Pin of dual-in-line test socket through.
 5. Chassis ground is achieved by mechanical contact through.
 6. Note holding PC board to frame.
 7. Board shipped with jumper installed. In normal operation.
 8. L7, 16, 27 and 57 present an impedance 1200 ohms at 120 MHz to 650 MHz and 900 ohms at 650 MHz to 1300 MHz.
 9. Bottom view and schematic diagram of A4U are as follows:



9. The mismatch caused by inserting a 50 ohm impedance (at the RF test points) decreases power gain. At some frequencies the decrease is more than 3 dB, at others less than 3 dB.

* Indicates factory selected part. Typical value shown. Refer to Section 5 for selection procedure.

SEE EXACT SIZE
A8 FREQUENCY MULTIPLIER
SS3



0 Service Sheet 3

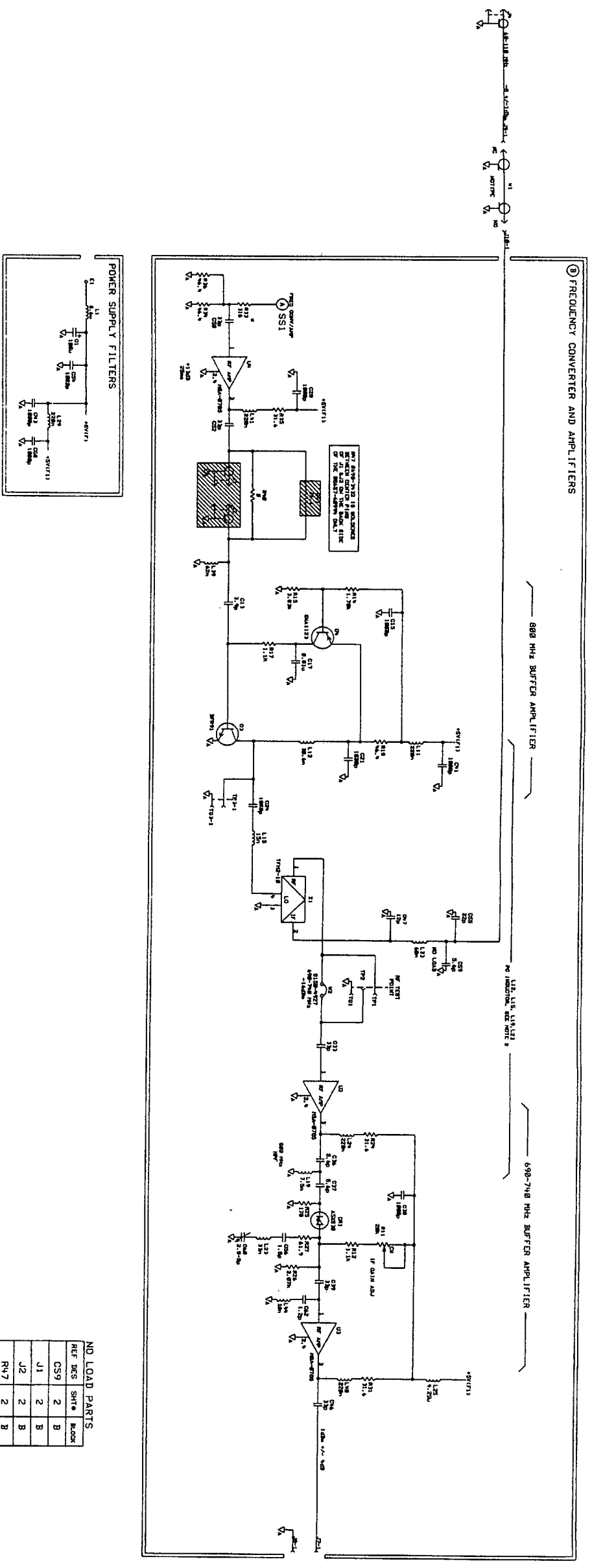


Figure 1
SERVICE SHEET

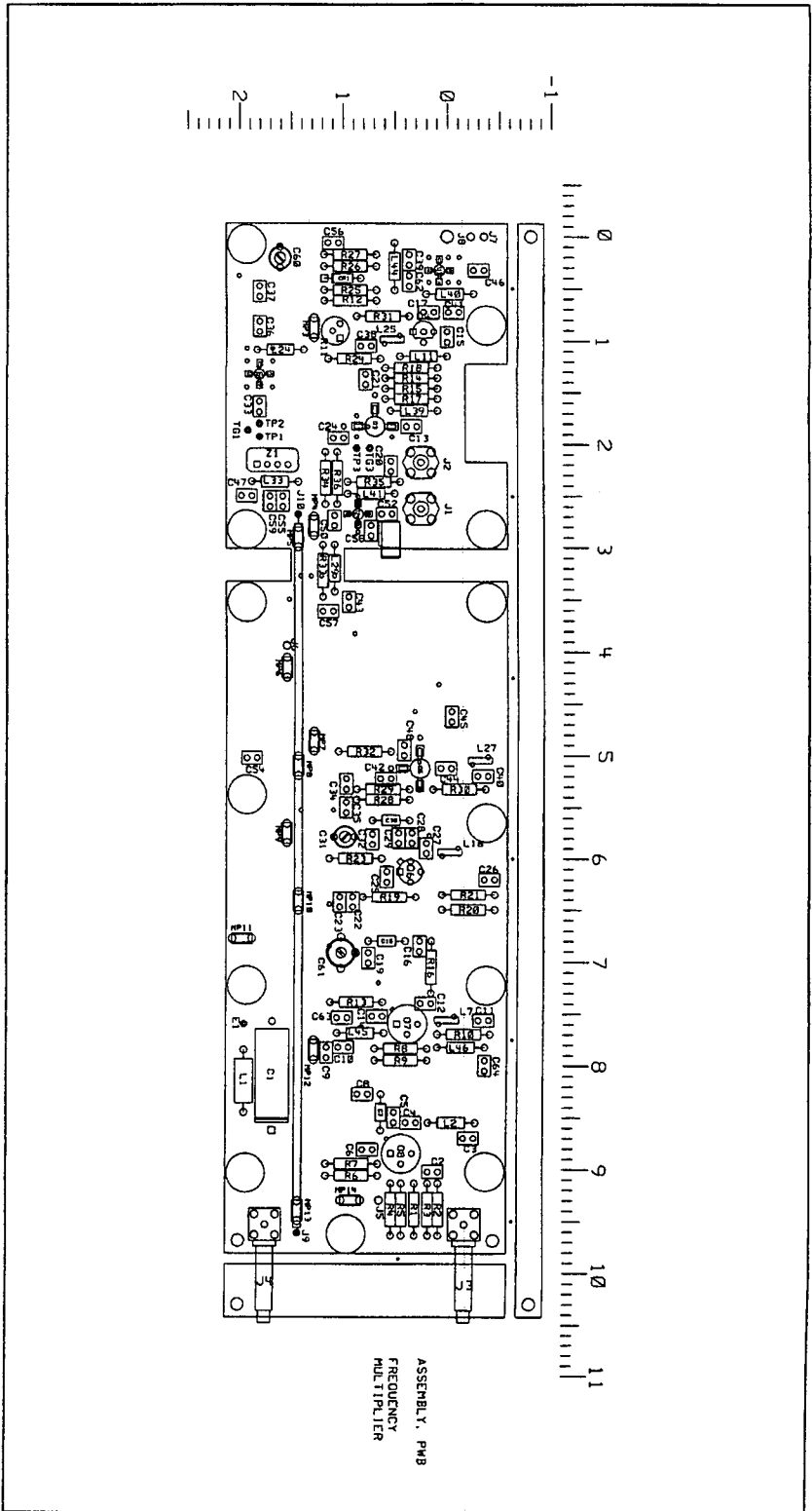
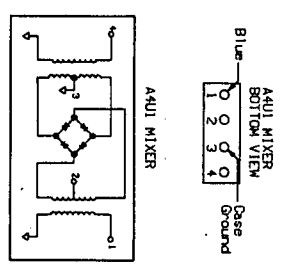


Figure 8. Service Sheet 3 Information

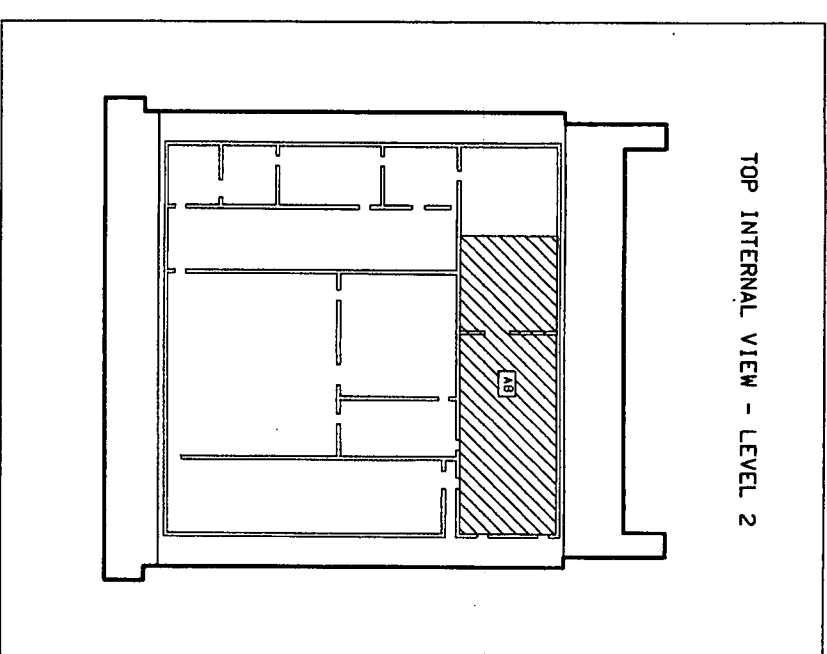
Component Locator

- NOTES
1. for an explanation of schematic symbols, see SCHEMATIC DIAGRAM NOTES in Section 8.
 2. Printed circuit trace capacitor.
 3. Printed circuit trace capacitor.
 4. Service test point. Pin of dual-in-line test socket J1 or J2.
 5. Chassis ground is achieved by mechanical contact through plate holding PC board to frame.
 6. Out board shipped with jumper installed. In for normal operation.
 7. L7, L6, 27 and 57 present an impedance 1200 ohms at 120 MHz to 650 MHz and 900 ohms at 650 MHz to 1300 MHz.
 8. Bottom view and schematic diagram of AKU1 are as follows:



9. The mismatch caused by inserting a 50 ohm Impedance Adapter Probe into the 50 ohm (at the RF Test Points), decreases power level readings. At some frequencies the decrease is more than 3 dB, at others less than 3 dB.
- * Indicates factory selected part. Typical value shown. Refer to Section 5 for selection procedure.

A8 FREQUENCY MULTIPLIER **SS3**
SEE SERVICE SIX



Service Sheet 3

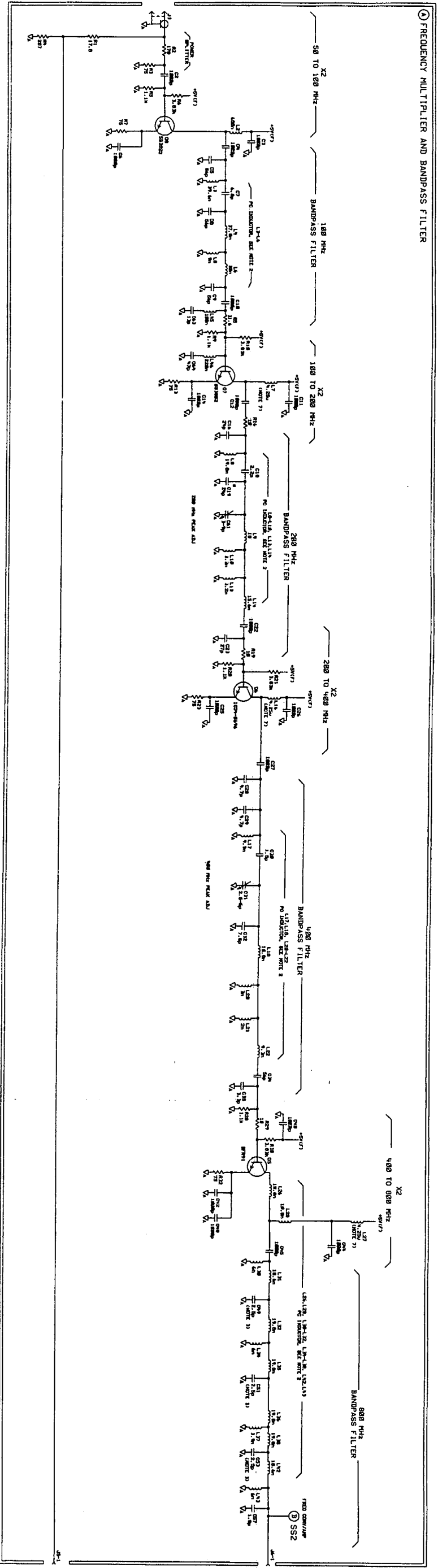


Figure 1
SERVICE SHEET 3A 8

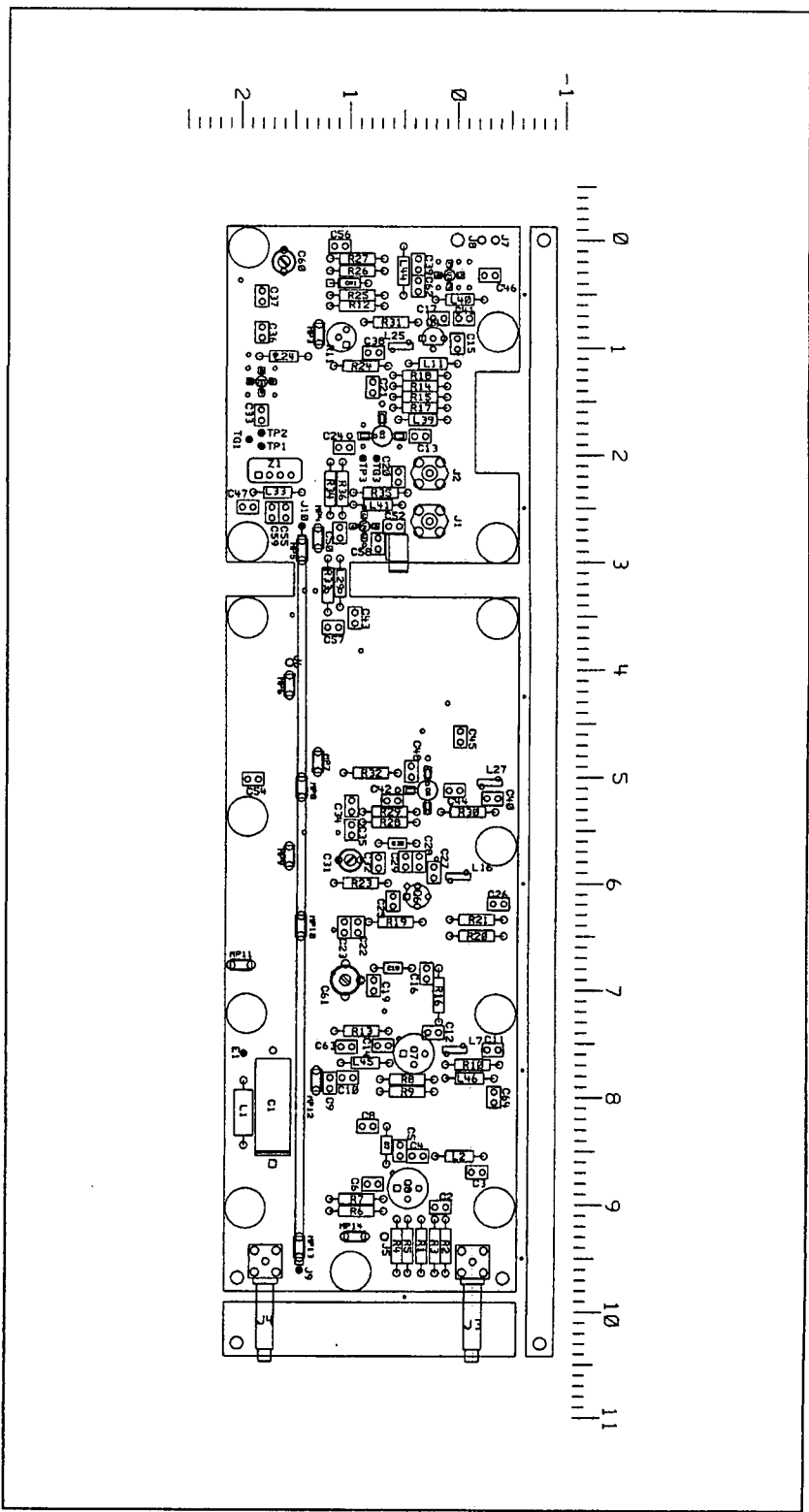
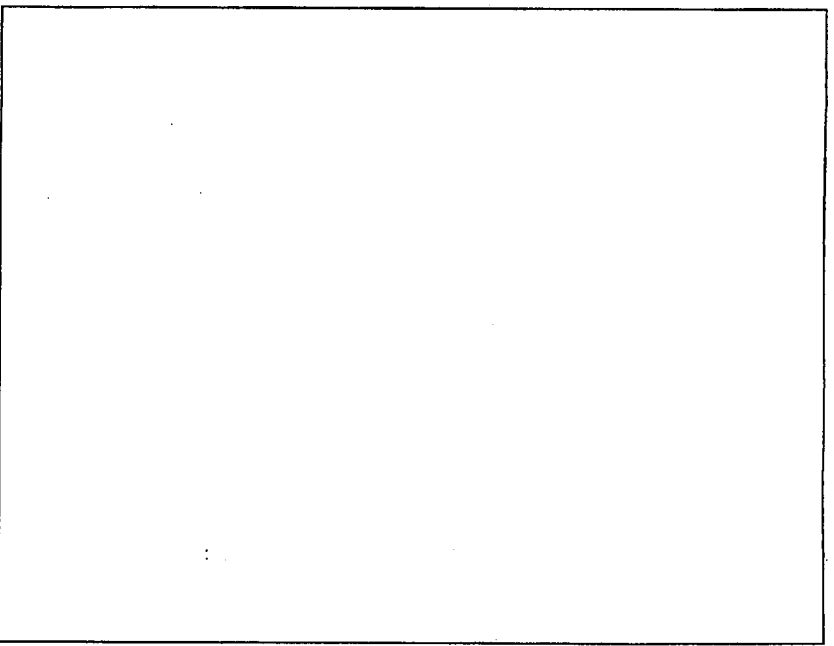
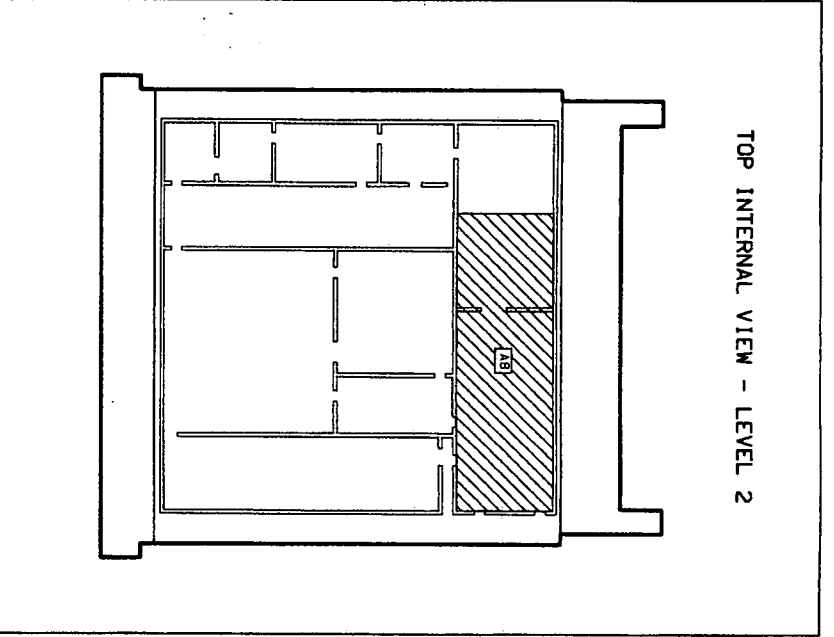


Figure 8. Service Sheet 3 Information

Component Location



SEE SCHEMATIC PAGE
A8 FREQUENCY MULTIPLIER
SS3



Service

Model 8657A

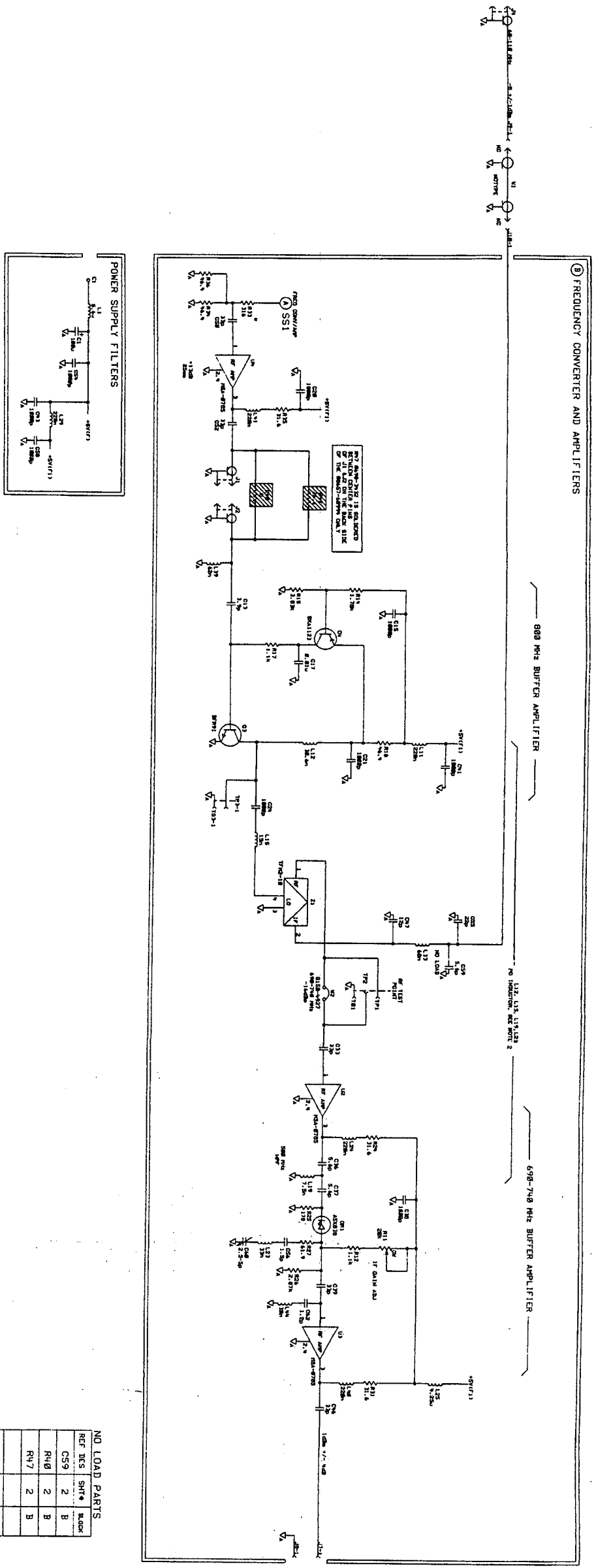
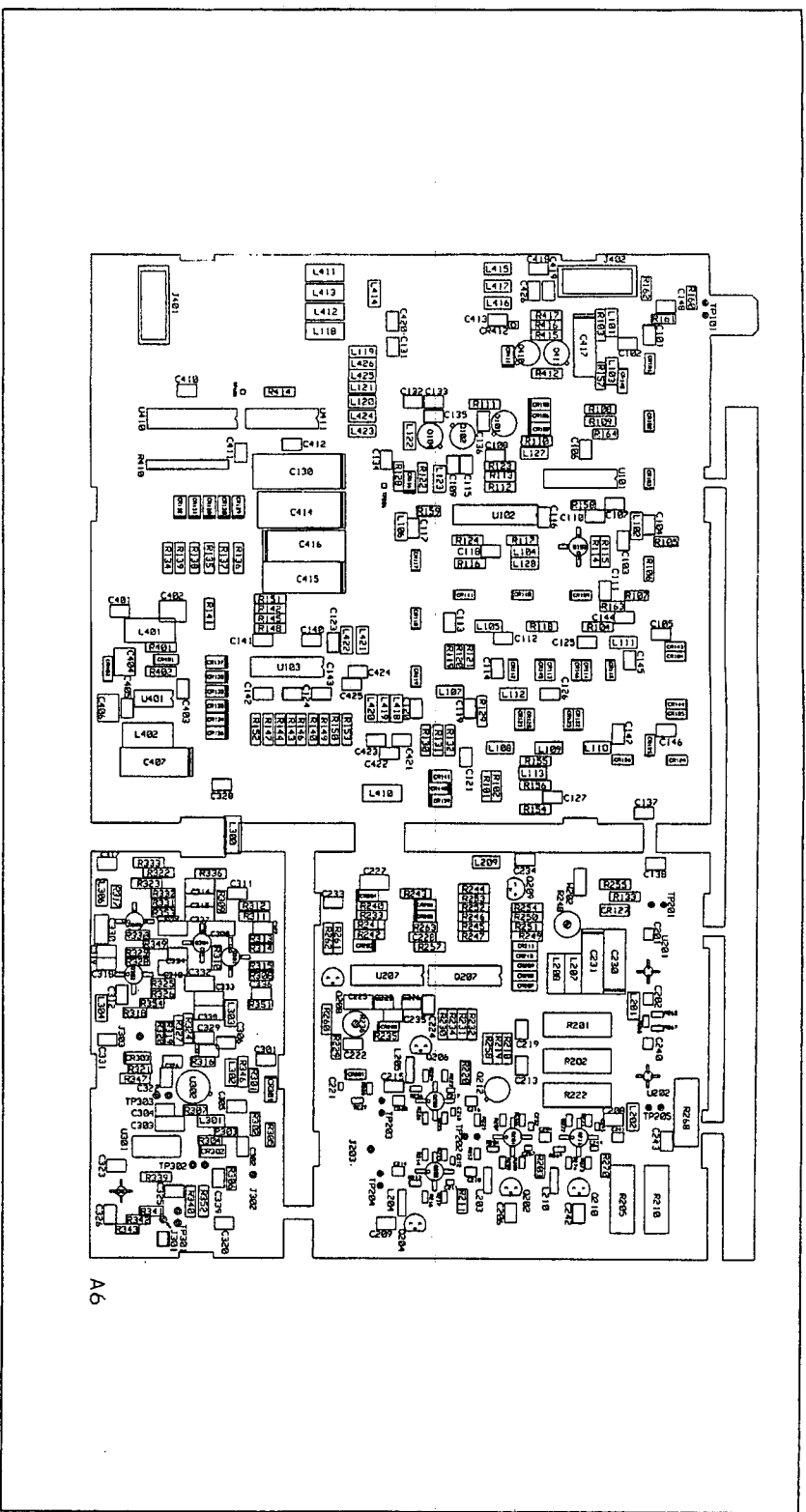
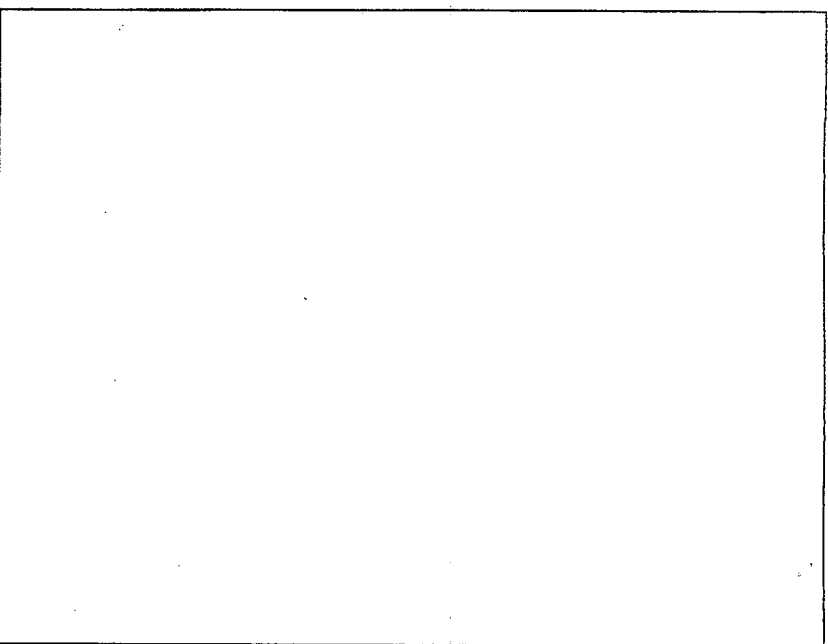


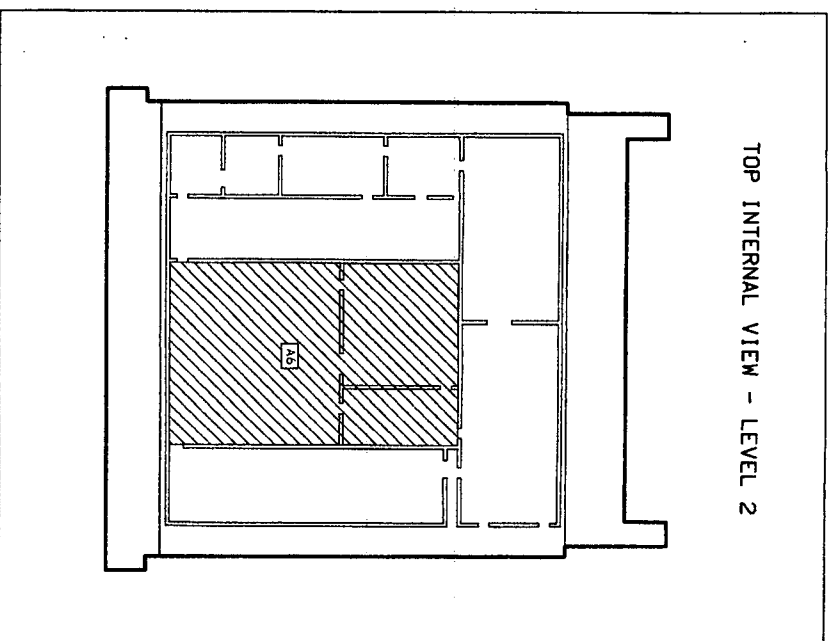
Figure 1
SERVICE SHEET 3b 9



A6



SEE REVERSE SIDE
A8 FREQUENCY MULTIPLIER
SS3



Service

Model 8657A

Figure 8. Service Sheet 4 Information
(SERIAL PREFIX 2849U AND ABOVE)

Component Locator

Service Sheet 4

OUTPUT

PRINCIPLES OF OPERATION

General

The 520 to 1040 MHz signal from the High Frequency Oscillator is input to the Output Assembly. The signal takes one of three paths determined by the frequency selected at the front panel. The signal is divided-by-1, 2 or 4. The signal is then passed through the Pin Diode Modulators and the Voltage Tuned Filter for the divider path selected. The harmonic filtered output is then amplified by the Output Amplifiers.

The Output Amplifier's output is applied to the Peak Detector and to the output Attenuator. The Peak Detector measures the signal's level and with the Automatic Level Control (ALC) Loop keeps the output level constant. In the ALC loop, the Peak Detector's voltage is compared to the AM/Reference input voltage. The difference is amplified and coupled back to the PIN Modulator which acts as a current controlled attenuator. The Attenuator provides amplitude control beyond the range of the ALC Loop.

Divider, PIN Modulator, And Voltage Tuned Filter Path Selection

The Divide-by-1, Divide-by-2, or Divide-by-4 data control inputs from the VTF/Band Select Shift Register And Driver, U410 (refer to Service Sheet 5), select the divide-by-1, divide-by-2, or divide-by-4 path. The active divider's control input is at a logic High (+12V), and the other two dividers control inputs are at a logic Low (0V). The active divider control input turns on the divider's power supply, activates the PIN modulator, and selects the voltage tuned filter for that path. PIN Modulator selection is accomplished by allowing current to flow through the diodes. The Voltage Tuned Filters are controlled by the voltage output of U103B, C, or D (refer to Service Sheet 5). The 520 to 1040 MHz oscillator output signal from the High Frequency Loop Buffer Amplifier (+2 to +8 dBm) is applied to the Output Assembly. The signal is ac coupled by C101 into the RF Dividers where it is divided by one, two, or four depending on the output frequency selected at the front-panel. The divider selected determines the signal path. The divide-by-1 path is selected when an output frequency from 520 to 1040 MHz, or less than 130 MHz is selected. The divide-by-2 path is selected when an output frequency from 260 to 520 MHz is selected. The divide-by-4 path is selected when an output frequency from 130 to 260 MHz is selected.

Divide-By-1 Path

When the divide-by-1 path is selected, the divide-by-1 control output of the VTF/Band Select Shift Register And Drivers is set high (+12V), (refer to Service Sheet 5). With the divide-by-1 control line high, diode CR142 is turned off and PIN Modulator diodes CR101, CR102, and CR103 are selected. The signal is ac coupled from the PIN Modulator through a 2 db impedance matching pad to the divide-by-1 band Voltage-Tuned Filter. Diode CR124 is turned on and the signal is routed to the High Band Output Amplifier.

Divide-By-2 Path

In the divide-by-2 configuration, the divide-by-2 control input is set high (+12V) and diodes CR107, CR108, and CR142 are turned on. With diode CR142 turned on, C106 couples the input signal to U101 where it is divided-by-two. Divider U101 and Buffer Amplifier Q103 are turned on by the positive voltage at the base of Q101 and Q102. Q101 switches the +5V to the divider's Vcc input at pin 14 turning the divider on. Q102 switches the +5V to Q103 biasing Q103 on. The output at pin 10 of U1 is dc coupled to Q103. The output of Q103 is coupled to the PIN Modulator by C11. The positive divide-by-2 voltage also selects the divide-by-2 Pin Modulator diodes CR109, CR110, and CR111. The signal is ac coupled from the PIN Modulator through a 2 db impedance matching pad to the divide-by-2 band Voltage-Tuned Filter. Diode CR125 is turned on and the signal is routed to the High Band Output Amplifier.

Divide-By-4 Path

In the divide-by-4 configuration, the divide-by-4 control input is set high (+12V) and diodes CR106, CR116, and CR142 are turned on. With diode CR142 turned on, C106 couples the input signal to U101 where it is divided by two. Divider U101 is turned on by the positive voltage at the base of Q101. Q101 switches the +5V to the divider's Vcc input at pin 14 turning the divider on, the same as in the Divide-By-2 mode.

The output at pin 11 of U101 is applied to the input at pin 7 of the second divider, U102. Divider U102 is activated when CR116 is turned on and Q104 switches +5V to pins 1 and 16. The positive divide-by-4 voltage also selects the divide-by-4 Pin Modulator diodes CR117, CR118, and CR119. The signal is ac coupled from the PIN Modulator through a 2 db impedance matching pad to the divide-by-4 band Voltage-Tuned Filter. Diode CR126 is turned on and the signal is routed to the High Band Output Amplifier.

PIN Modulator

The divide-by-1, 2, 4 PIN Modulators are identical. The PIN Modulators consist of three series PIN diodes. The RF resistance of the PIN diodes decreases as the current through the diodes increase. The diodes function as current controlled RF resistors where the RF resistance is inversely proportional to the current through the diodes. Output level and amplitude modulation are controlled by varying the current through the PIN diodes.

Voltage-Tuned Filters

Three voltage-tuned low-pass filters pass the 130 to 1040 MHz output of the PIN Modulators and remove the harmonics generated by the dividers and oscillator. Each filter covers one octave of the frequency range; therefore, the harmonics are not passed to the Output Amplifier. Each Voltage Tuned Filter's (VTF) tune voltage is derived from data bits 6 through 10 of RF Word 2, (refer to Service Sheet 5). The 5 VTF data bits to the binary weighted resistor network R135 through R139 (discrete DAC) are summed for the correct current input to U103A. The divide-by-1, 2, 4 control data bits also select the correct VTF.

The power supply voltages of U103 are 0 and +27V which allows the tune voltage to vary from +2V to +25V. U103B, C, or D amplifies the output of U103A. The amplifier that is not turned off by the divide-by-1, 2, or 4 controls the inputs.

When the divide-by-1 band is selected diodes CR135 and CR137 are turned on and amplifiers U103C and D are turned off. The output voltage of U103B tunes the divide-by-1 VTF to pass the correct frequency and turns on diode CR124 to pass the output to the first Output Amplifier U201. Divide-by-2 and 4 function the same.

The VTF TUNE voltage of +2 to +25V will vary the capacitance of the varactors approximately 8 to 32 pF in the 260 To 526 MHz Voltage-Tuned Filter and the 130 to 260 MHz Voltage-Tuned Filter, and approximately 2 to 8 pF in the 520 To 1048 MHz Voltage-Tuned Filter.

Output Amplifier

The output of the Voltage-Tuned Filters is ac coupled to the Output Amplifier by capacitor C201. The High-Band Output Amplifier functions as a four stage amplifier with 26 dB of gain from 130 MHz to 1040 MHz. U201 and U202 are monolithic amplifiers with 12 dB and 8 dB of gain respectively. The third stage consisting of Q202 and Q201 has 6 dB of gain. Q201 is a power amplifier with approximately 6 dB of gain and a maximum output power level of approximately +20 dBm. The output of Q201 is applied to broadband resistor power splitter R212 and R221. The power splitter couples the output to the final output amplifier Q203 and to the ALC Loop Amplifier Q205. Both amplifiers are identical and have 6 dB of gain. The total gain of the Output section is approximately 26 dB. Amplifiers Q201, Q203 and Q205 are identical, each with 6 dB of gain.

The base of Q202 is dc biased by the +7.5V reference voltage divided from the +15V (F3) power supply voltage by resistors R218 and R219. Since the emitter of Q202 is connected to the +15V supply by R205, the emitter voltage is approximately 0.6V more positive than the base. The current in resistor R205 is determined by the voltage difference of the emitter voltage and the +15V supply. The current through R205 takes two paths. One path for the current is into the emitter of Q202 and out the collector. This current is multiplied by the common-base current gain of Q202 which is approximately one. This is the base current for amplifier Q201. The other current path is the collector current for Q201. The total current from R205 is the sum of the base current and collector current of Q201. The result is that the bias current for amplifier Q201 is stable. Resistor R204 and capacitor C207 are for collector-to-base feedback. Resistors R206, R207, R208 and R209 in the emitter of Q201 provide series feedback. Amplifiers Q203 and Q205 function same as amplifier Q201.

The output of Q203 is ac coupled by capacitor C214 to the Heterodyne section of the Attenuator and is the main output. The output of Q205 is applied to the load and Peak Detector formed by R227, R228, CR301 and C221. The gain of Q203 and Q205 is matched in every respect so their outputs track over temperature and aging. The level measured by the peak detector at the output of Q205 should be the same as the main output at J203.

ALC Loop

The Automatic Level Control Loop (ALC Loop) Peak Detector detects the output of amplifier Q205. The Peak Detector's output is compared to the AM/ Reference input (refer to Service Sheet 7) in the loop to keep the level constant and to provide Amplitude Modulation.

Peak Detector

Transistors Q207B and Q207C are two tracking temperature compensated 50 μ A current sources that bias diodes CR201 and CR302. The correct sources are temperature compensated by transistors Q207A and Q207D. The Detector Adjustment (DET ADJ) R236 is adjusted to compensate offsets in the detector circuits. The transistors are biased-on by the resistor divider network of R232, R234. Diodes CR201 and CR202 are matched diodes. CR202 provides temperature compensation for the detector CR201.

ALC Amplifier

The ALC Amplifier has two modes of operation, narrow and wide bandwidth. Narrow bandwidth is used when the Signal Generator's output is CW, no modulation, and wide bandwidth is used when its output is modulated, AM, FM, or both.

The voltage at the positive input of U207B and U207C is the peak voltage of the RF output. The voltage at their negative inputs is the AM/Reference voltage from the Audio Power Supply Assembly, A10. This input voltage at U207B pin 6 and U207C pin 9 is shaped by resistors R207, R248, R249, R250, R251 and diodes CR207, CR208, CR209, and CR210 and CR211. For very low levels, the input voltage characteristic should approximate the square law region of the detector. (The square law region is the non-linear portion of the detector's current-versus-voltage curve. In this region the change in current is proportional to the square of the change in voltage.) If the voltages to the inputs are the same, there is very little distortion.

When CW is selected, (AM and FM Modulation off) Continuous Wave Select (refer to Service Sheet 5) to Bandwidth Select comparator U207A selects summing amplifier U207C and narrow bandwidth. The High CW Select +15V input to voltage divider R246, R245 sets the positive input to approximately +10V and switches the output of U207A to +15V. The +15V output turns on Diode CR203, and the high input voltage sets the output of U207B high. Diode CR205 is turned off and U207B is disconnected from the circuit. Amplifier U207C is active (the narrow bandwidth amplifier).

When Amplitude Modulation, Frequency Modulation, or both are selected, the CW Select input to the Bandwidth Select Comparator, U207A, is low. U207A's output is switched to approximately -15V. Diode CR204 is turned on and the low input voltage to U207C sets its output low. Diode CR206 is turned off and narrow bandwidth amplifier U207C is disconnected from the circuit. Wide bandwidth amplifier U207B is active. The output of the ALC Amplifier controls the current of the selected PIN Modulator and therefore controls its resistance (jumper W201 in position W201A). The Modulation Shaper circuit (R101, R102, and diodes CR139, CR140, and CR141) compensates for the non-linearity of the PIN Modulator diodes. When jumper W201 is in the W201B position, the PIN Modulator current is fixed and the ALC Loop is open for service.

TROUBLESHOOTING

Procedures for checking part of the A6 Output Assembly circuits are given below. The area or points to check are marked on the schematic by a hexagon with a checkmark and a number inside, for example, $\checkmark 3$. Fixed voltages are shown on the schematic inside a hexagon, for example, $2V \pm 0.2V$. Transistor bias voltages are shown without tolerances.

Troubleshooting Help

- Block Diagram 2
- Table 4-1. Abbreviated Performance Tests
- Table 5-2. Post-Repair Adjustment Procedures

Test Equipment

Digital Multimeter	HP 3466A
Measuring Receiver	HP 8902A
Sensor Module	HP 11722A
Adapter Probe	HP 1250-1598
Adapter N(f) to BNC(m)	HP 1250-0077
Adapter BNC(f) to BNC(f)	HP 1250-0080
Cable BNC(m) to SMC(f)	HP 08662-60075

$\checkmark 1$ RF Dividers

1. Set the Signal Generator as follows:

Frequency	520 MHz
Amplitude	-20 dBm
Modulation	Off

2. Set the measuring receiver with the sensor module precalibrated as follows:

Measurement	RF POWER
Display	LOG

NOTE

The mismatch caused by insertion of the 50 ohm input impedance Adapter Probe into the 50 ohm transmission line (at the RF Test Points), decreases power level readings. At some frequencies the decrease is 3 dB, and at others it is less than 3 dB.

3. Zero the measuring receiver and wait for the zero LED to go out.
4. Measure the voltages, power levels, and signals as shown in Tables 1, 2, and 3 for each front-panel frequency setting.

Table 1. RF Divider Voltages.

Signal Generator Frequency (MHz)	Divider Voltages (Vdc), U410			Signal at TP101	
	÷1 SEL Pin 10	÷2 SEL Pin 11	÷4 SEL Pin 12	Level (dBm)	Frequency (MHz)
520	+12.5	+0.04	+0.04	+8.0 to +2.0	520
260	+0.04	+12.5	+3.5	+8.0 to +2.0	520
130	+0.04	+3.5	+12.5	+8.0 to +2.0	520

Table 2. RF Divider Vcc Voltage.

Signal Generator Frequency (MHz)	Voltages (Vdc) on	
	U101 Pin 14	U102 Pin 1,16
520	+0.4	+0.4
260	+5.0	+2.1
130	+5.0	+5.0

Table 3. Bias Voltages.

Signal Generator Frequency (MHz)	Bias Voltages (Vdc)											
	Q101			Q102			Q103			Q104		
	E	B	C	E	B	C	E	B	C	E	B	C
520	0.0	0.0	+5.2	0.0	0.0	+5.2	0.0	0.0	0.0	0.0	0.0	+5.2
260	+5.0	+5.7	+5.2	+5.0	+5.7	+5.2	0.0	+0.7	+2.3	+2.2	+2.8	+5.2
130	+5.0	+5.7	+5.2	+2.6	+3.2	+5.2	0.0	+0.6	+1.7	+5.0	+5.7	+5.2

√2 Voltage Tuned Filters.

The tune voltage for each Voltage Tuned Filters is checked at its highest tuned frequency in each of the three RF divider bands. The input power to the Dividers and the output power of the Voltage Tuned filters are checked.

1. Set the Signal Generator as follows:

Frequency 1040 MHz
 Amplitude -10 dBm

2. Measure the voltages shown in Table 4 for each Signal Generator frequency.

Table 4. Voltage Tuned Filter (VTF) Control Voltages.

Signal Generator Frequency (MHz)	VTF Tune Voltages (Vdc) (Maximum Tune Frequency)		
	130 to 259.99999 MHz VTF	260 to 519.99999 MHz VTF	520 to 1040 MHz VTF
1040	+2.1	+2.1	+22.0
519	+2.1	+22.0	+2.1
259	+22.0	+2.1	+2.1

- Set the Signal Generator as follows:

Frequency 520 MHz
 Amplitude -20 dBm

- Set the Measuring Receiver with the sensor precalibrated as follows:

Measurement RF POWER
 Display LOG

- Zero the Measuring Receiver and wait for the zero LED to go out.
- Measure the power levels and frequencies shown in Table 5 and change the front-panel frequency as indicated.

Table 5. RF Divider Signal Measurements.

Signal Generator Frequency (MHz)	Signal at TP101		Signal at TP201	
	Level (dBm)	Frequency (MHz)	Level (dBm)	Frequency (MHz)
520	+8.0 to +1.0	520	-23.0 to -30.0	520
260	+8.0 to +1.0	520	-23.0 to -30.0	260
130	+8.0 to +1.0	520	-23.0 to -30.0	130

√3 High-Band Output Amplifier.

- Check the bias voltages on A6U201, U202, Q201, Q203, and Q205.
- Set the Signal Generator as follows:

Frequency 520 MHz
 Amplitude -20 dBm
 Modulation Off

- Set the Measuring Receiver with the sensor module precalibrated as follows:

Measurement RF Power
 Display Log

- Zero the measuring receiver and wait for the zero LED to go out.
- Measure the power levels at the test points indicated in Table 6.

Table 6. High-Band Output Amplifier Levels (ALC Loop Closed).

Test Point	Power Levels (dBm)
TP201	-23.0 to -30.0
TP205	-10.0 to -16.0
TP202	+1.0 to -5.0
TP203	+4.0 to -2.0
TP204	+4.0 to -2.0

- Open the ALC loop by placing jumper W202 in the W202B position.
- Measure the power levels at the test points indicated in Table 7.

Table 7. High-Band Output Amplifier Levels (ALC Loop Open).

Test Point	Power Levels (dBm)
TP201	-2.0 to -9.0
TP205	+8.0 to +1.0
TP202	+16.0 to +9.0
TP203	+19.0 to +12.0
TP204	+19.0 to +12.0

- Place W202 back in the W202A position.

√4 ALC Amplifier

- Set the Signal Generator as follows:
 Frequency 520 MHz
 Amplitude -20 dBm
 Modulation Off
- Check the ALC Bandwidth Control voltage as indicated in Table 8 for both modulation off and 1% AM (Internal 1 kHz source).

Table 8. ALC Bandwidth Control Voltages.

Signal Generator AM	U207					
	Pin 3	Pin 1	Pin 5	Pin 7	Pin 9	Pin 8
Off	+8.5V	+13.0V	+4.5V	+13.3V	+0.5V	+10.1V
AM 1% (1k Int)	0.0V	-13.0V	+0.5V	+10.2V	-10.6V	+13.4V

- Set the Signal Generator as follows:
 Frequency 520 MHz
 Amplitude +13 dBm
 Modulation Off

4. Check the ALC amplifier voltages as indicated in Table 9. Change the front-panel amplitude as indicated.

NOTE

Voltages may differ from the voltages shown in Table 9 because of level correction. The voltage change for each step from +13 dBm to -3 dBm is consistent.

Table 9. ALC Amplifier Voltages (Vdc).

Signal Generator Amplitude	A6TP206	A6U207				A6Q209	
		Pin 12	Pin 13	Pin 14	Pin 8	B	E
+13 dBm	+2.24	+1.85	+1.85	+2.25	+9.64	+10.17	+10.77
+7 dBm	+1.15	+0.76	+0.76	+1.16	+9.96	+10.48	+11.09
+5 dBm	+0.89	+0.5	+0.5	+0.89	+10.03	+10.55	+11.15
+2 dBm	+0.64	+0.25	+0.25	+0.64	+10.08	+10.60	+11.23
0 dBm	+0.51	+0.12	+0.12	+0.52	+10.14	+10.66	+11.27
-3 dBm	+0.37	+0.02	+0.02	+0.37	+10.19	+10.71	+11.32

5. Set the Signal Generator as follows:

Frequency 520 MHz
 Amplitude -10 dBm
 Modulation AM 50%
 Source 1 kHz (Int.)

6. Using the oscilloscope, check the waveforms as indicated in Figure 1.

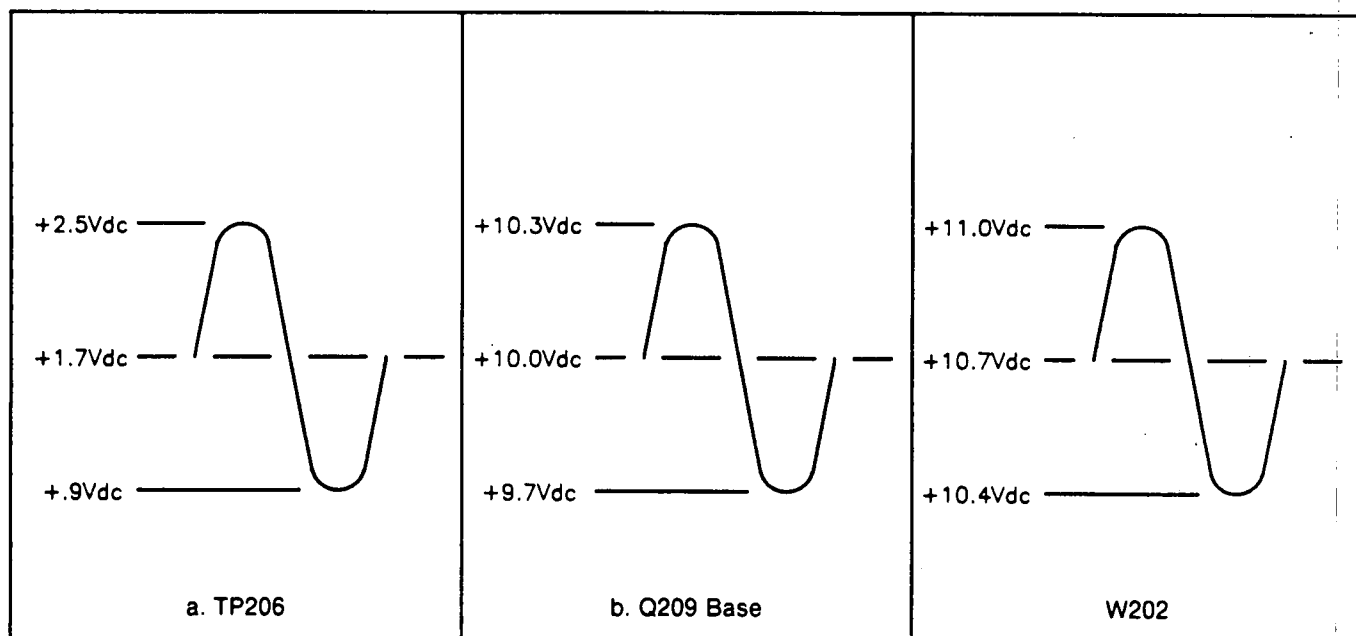


Figure 1. ALC Amplifier Waveforms and Logic Level.

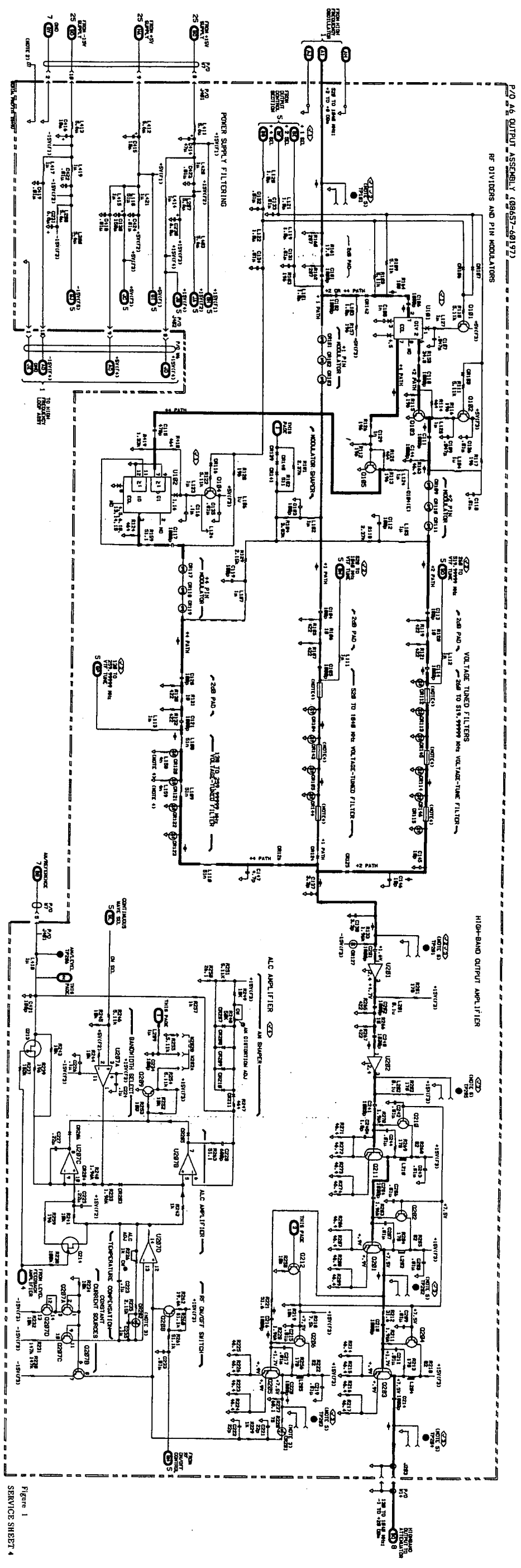


Figure 1
SERVICE SHEET 4 11

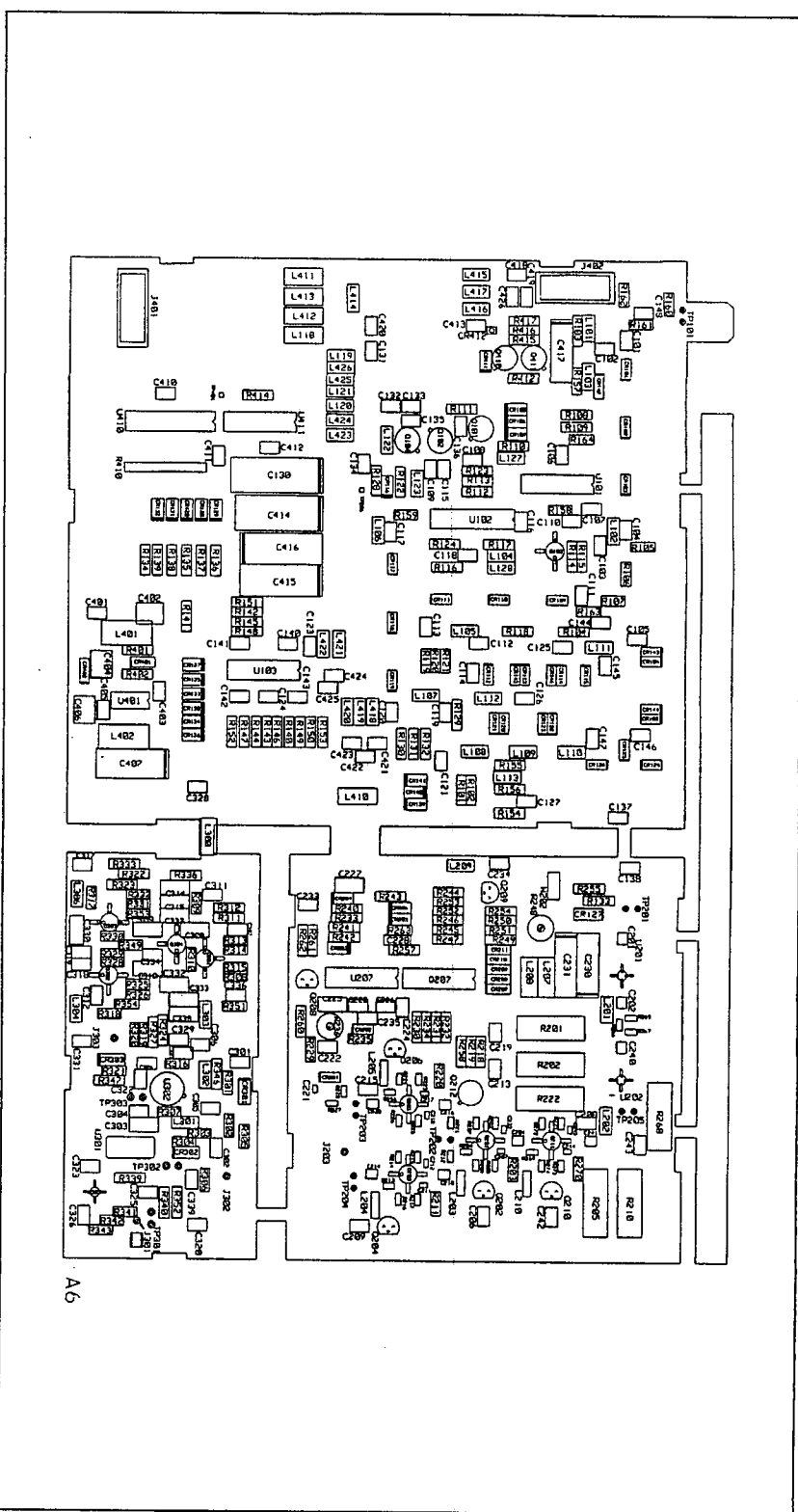


Figure 8. Service Sheet 5 Information
(SERIAL PREFIX 2849U AND ABOVE)

Component Location

A6

NOTES

1. For an explanation of schematic symbols, see "SCHEMATIC DIAGRAM NOTES" in Section 8.
2. Chassis ground is achieved by mechanical contact through nuts holding PC board to frame.
3. Bottom view and schematic diagram of U301 are as follows:

U301 MIXER

U301 MIXER
BOTTOM VIEW

4. Printed circuit trace inductor.
5. The mismatch caused by inserting a 50 ohm Impedance Adapter Probe into the 50 ohm transmission line at the RF Test Point(s), decreases power level readings. others less than 3 dB.

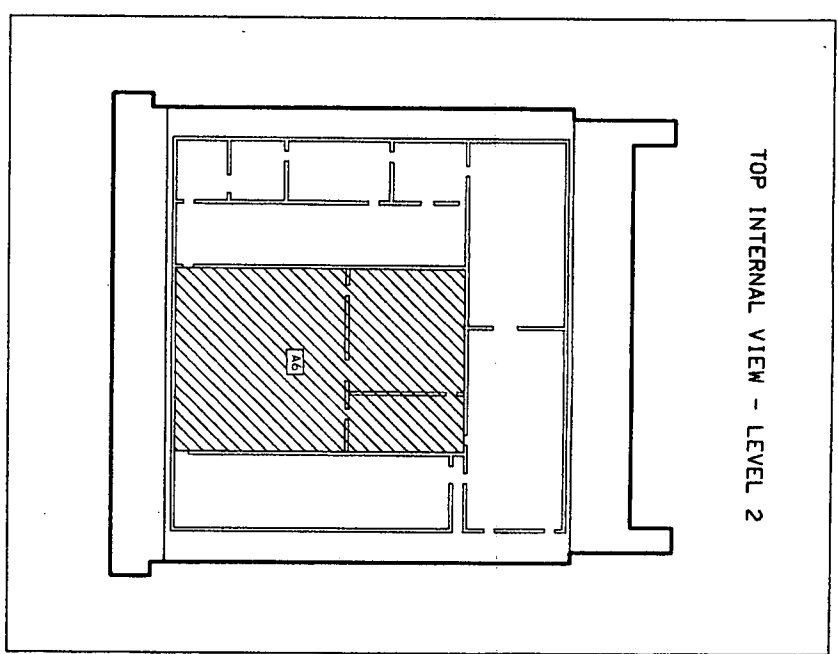
ADD8
TCP VIEW

LOGIC LEVELS

LEVEL	TIME	STATE
HIGH	27	3.5V
LOW	27	1.5V
OPEN	15	MORE THAN 1500
UNKNOWN	HIGH	UNKNOWN
UNKNOWN	LOW	UNKNOWN

P/O A6 OUTPUT SS4

SEE REVERSE SIDE



Service Sheet 5

HETERODYNE AND OUTPUT CONTROL

PRINCIPLES OF OPERATION

General

When the RF Output frequency is between 0.1 and 129.99999 MHz, the Divide-By-1/Heterodyne mode is selected. The High Frequency Loop VCO's frequency is between 800.1 and 929.99999 MHz. These frequencies are mixed with 800 MHz and the difference frequencies, 0.1 to 129.99999 MHz, are the heterodyne band frequencies.

The Output Clock (OCL) clocks twenty Serial Output Data (ODA) bits into the VTF/Band Select Shift Register And Driver, U410, and by way of the HDA line, into the High Frequency Loop Data Shift Register, U5, (refer to Service Sheet 2).

The ten bits of Serial Output Data latched into U410 are the RF Divider Control Data, VTF Voltage Control Data, and CW Select Data. The RF Divider Control data selects the RF Divider, PIN Modulator, and the VTF Driver.

Heterodyne Section

When an RF Output frequency between 0.1 and 129.99999 MHz is selected, the Heterodyne mode is entered. An RF signal (between 800.1 and 929.99999 MHz) from the High Band Output Amplifier Q203 (refer to Service Sheet 4) goes to the Attenuator Assembly, A9. The Attenuator Assembly's Heterodyne Switch switches the RF signal into the Heterodyne Section.

A frequency from 800.1 MHz to 929.99999 MHz at a level from -1 to $+20$ dBm, vernier level dependent, is switched to the Heterodyne Section and applied to the Mixer, U301, through J302, 16 dB pad (R301, 302 and 303), and PIN diode CR302. The 16 dB pad and PIN diode control the signal level into the Mixer, U301. The PIN diode's attenuation is controlled by Integrator U302. The Integrator's output is controlled by the Input Peak Detector (CR301) and the Output Peak Detector (CR303). The Peak Detector outputs are the inputs to the Integrator, controlling the output. The output level of the Heterodyne Section is controlled by the input level.

The other input to the Mixer is the 800 MHz from the Multiplier Assembly (refer to Service Sheet 3). The 800 MHz at $+1$ to $+7$ dBm enters the Output Assembly, A6, through J301, 10 dB pad (R341, 342, and 343), and Buffer Amplifier U303. The Buffer Amplifier is tuned for maximum gain at 800 MHz. The difference output frequencies (0.1 to 129.99999 MHz) are passed by the 200 MHz Low-Pass Filter (LPF) to Low-Band Amplifier Q301. The input of the filter is diplexed by C304 and R307 to give a good match at all frequencies and to reduce spurious signals, primarily from the other mixing products. The output of the Mixer is coupled to the Low-Pass Filter and Amplifier, Q301.

Resistors R308, R310, R311 and R312 form a voltage divider to dc bias Q301. Resistors R313, R314, and R315 in the emitter provide series feedback, and collector to base resistor R310 provides shunt feedback. By using three emitter resistors, the inductance in the emitter current path is reduced. The Amplifier's gain is approximately 15 dB.

The output of Q301 is ac coupled to the base of emitter follower Q304. The emitter follower functions as an impedance matching transformer and drives the push-pull Low-Band Output Amplifier stage of Q302 and Q303.

Resistors R323, R324, R328 and R330 form a voltage divider to dc bias Q302 and Q303. Their collector voltage is set to approximately -7.5V by the voltage divider. The -7.5V is divided by resistors R309 and R329 to bias the emitter-follower Q304. Resistors R325, R326, and R354 in the emitter of Q302 provide series feedback. By using three resistors and three by-pass capacitors, the inductance in the emitter path is reduced. The resistors and capacitors in the emitter of Q303 have the same function. The Low-Band Output Push-Pull Amplifier drives the Output Peak Detector and the load. The output is filtered by the Low-Pass Filter.

The Low-Band Amplifier is coupled back to the Attenuator Assembly's Heterodyne Section. Resistor R317 approximates a 50 ohm output impedance. The Low-Band Output Amplifier's gain is approximately 15 dB for a total Heterodyne Section gain of 30 dB to restore the RF Signal to the same level as the input but at the lower frequency.

Output Control Section

The 10 bit High Frequency Word 2 is received by the VTF/Band Select Shift Register and Driver from the Microprocessor by way of the Serial Output Data line (ODA). The five most significant data bits (VTF1, 2, 4, 16) set the five bit discrete resistor DAC of R134, 135, 136, 137, 138, and 139. The output voltage of the DAC tunes the selected VTF. The VTF and RF Dividers are selected by the three least significant bits, divide-by-1, divide-by-2, or divide-by-4. The VTF and RF Divider are selected when output frequencies in their frequency band are selected. Divide-by-1 band is 520-1040 MHz, Divide-by-2 band is 260-520 MHz and Divide-by-4 band is 130-260 MHz.

High Frequency Word 2 data bit 4 is the CW Select Control for the ALC Loop (refer to Service Sheet 4), and data bit 5 controls the switched +15V supply. Transistor Q410 is turned off when the RF Output is turned off by the RF ON/OFF front-panel key or over the HP-IB.

When the RF Output is turned OFF, the Microprocessor sets data bit 5 at pin 8 of U410 Low (0V). Diode CR411 is turned on and resistors R415 and R416 form a voltage divider to dc bias Q411 on. Q411 is turned on and Q410 is dc biased off. The switched +15V to the RF ON/OFF switch (refer to Service Sheet 4) and to the A4 Assembly (refer to Service Sheets 1 and 2) is switched off. LED CR412 is turned on indicating the +15V is off. With the RF Output ON, the data bit is +15V. CR411 is turned OFF, Q411 is biased OFF and Q410 is turned ON.

Q410 and Q411 also function as a circuit breaker if the switched +15V is shorted to ground. The circuit functions the same when the switched +15V is shorted as when the Microprocessor sets data bit 5 low. LED CR412 is turned on, when the RF OUTPUT is off or when the switched +15V is shorted.

VTF Drivers

The DC To DC Converter U401 translates the +15V (F1) power supply voltage to +27V. U401 is a timer configured to operate as an astable multivibrator. Its output at pin 3 is a square wave 0 to approximately +15V at a frequency of approximately 100 kHz. The output frequency of the square wave is determined by R401, R402 and C403. CR401, CR402, C404 and C406 form a voltage doubler circuit. The output voltage is filtered by capacitor C406 and inductor L402. The output of the filter is approximately +27V and is the power supply voltage for U103. With its power supply voltages of 0 and +27V, U103 can produce a VTF tune voltage from +2V to +25V. The output of U103A is amplified by U103B, U103C or U103D. The amplifier that is not turned off by the divide-by-1, 2, or 4 controls input.

The VTF tune voltage is derived from VTF1, VTF2, VTF4, VTF8, and VTF16 (data bits 6 through 10 latched into U410). The five VTF input voltages to binary weighted resistors R135 through R139 (discrete DAC) are summed to provide the input to U103A.

TROUBLESHOOTING

Procedures for checking part of the A6 Output Assembly circuits are given below. The area or points to check are marked on the schematic by a hexagon with a checkmark and a number inside, for example, $\checkmark 3$. Fixed voltages are shown on the schematic inside a hexagon, for example, $2V \pm 0.2V$. Transistor bias voltages are shown without tolerances.

TROUBLESHOOTING HELP

- Block Diagram 2
- Table 4-1. Abbreviated Performance Tests
- Table 5-2. Post-Repair Adjustment Procedures

Test Equipment

Digital Multimeter	HP 3466A
Measuring Receiver	HP 8902A
Sensor Module	HP 11722A
Adapter Probe	HP 1250-1598
Adapter N(f) to BNC(m)	HP 1250-0077
Adapter BNC(f) to BNC(f)	HP 1250-0080
Cable, BNC(m) to SMC(f)	HP 08662-60075
Test Cable	HP 5061-4827

$\checkmark 1$ Heterodyne Section

1. Check biasing on transistors Q305, Q301, Q309, and Q310.
2. Set the Signal Generator as follows:

Frequency	100 MHz
Amplitude	-20 dBm
Modulation	Off

3. Set the measuring receiver with the sensor module precalibrated as follows:

Measurement	RF POWER
Display	LOG

NOTE

The mismatch caused by insertion of the 50 ohm input impedance Adapter Probe into the 50 ohm transmission line (at the RF Test Points), decreases power level readings. At some frequencies the decrease is 3 dB, and at others it is less than 3 dB.

4. Zero the measuring receiver and wait for the zero LED to go out.
5. Connect the sensor module to the test points indicated in Table 1 by using the appropriate cables and adapters. Verify that the power levels and frequencies are correct.

NOTE

Measure power levels for J302, input from Attenuator Assembly, at A9AT1J3 using the Test Cable.

Table 1. Heterodyne Section Power Levels.

Test Point	Power Level (dBm)	Frequency (MHz)
TP301	+7.0 to +3.5	800.00
TP302	-3.5 to -6.5	900.00
J303	-3.5 to -6.5	100.00

√2 Divider Control, CW SEL, and SW +15V

1. Set the Signal Generator as follows:

Frequency 520 MHz
 Amplitude -20 dBm
 Modulation Off

2. Measure the voltage at U410 pin 9 (CW SEL). It should be +13.0 Vdc.

3. Set the Signal Generator as follows:

Modulation AM 50%
 Source Internal 1 kHz

4. Measure the voltage at U410 pin 9 (CW SEL). It should measure 0.0 Vdc.

5. Set the Signal Generator as follows:

Modulation Off
 RF ON/OFF Control RF ON

6. Measure the voltages and verify LED function as indicated in Table 2 for both RF ON and RF OFF.

Table 2. Switched +15V, Switched +15V Protection.

RF ON/OFF Control	U410 Pin 8	Q411 Base	Q410 Base	Q410 Collector	CR412 (LED)
RF ON	+13.0 Vdc	+14.0 Vdc	+13.4 Vdc	+14.0 Vdc	Off
RF OFF	+2.1 Vdc	+13.0 Vdc	+14.2 Vdc	+0.3 Vdc	On

7. Set the Signal Generator as follows:

Frequency 520 MHz
 Amplitude -20 dBm
 Modulation Off

8. Measure the voltages for U410 Divider Selects as shown in Table 3 and change the front panel frequencies as indicated.

Table 3. RF Divider Selects.

Signal Generator Frequency	Divider Select Voltages (Vdc)		
	÷1 Select U410 Pin 10	÷2 Select U410 Pin 11	÷4 Select U410 Pin 12
520	12.5	+0.04	+0.04
260	+0.04	+12.5	+3.5
130	+0.04	+3.5	+12.5

√3 Voltage Tuned Filter (VTF) Drivers.

The Voltage Tuned Filter's tune voltage is tuned manually to set different tune voltage. The data entered manually by a series of front Panel key strokes overrides data sent to the Voltage Tuned Filters from the Microprocessor in normal operation. The data and tune voltages are checked in the 520 MHz to 1040 MHz frequency band. The VTF's data and tune voltage are checked at the maximum voltage level for the divide-by-2 and divide-by-4 bands.

1. Set the Signal Generator as follows:

Frequency 1040 MHz
 Amplitude -10 dBm

2. Measure the supply voltage at U103 pin 4. It should be between +23 Vdc and +27 Vdc.
3. Set the Voltage Tuned Filters to their maximum frequency setting by pressing the **FREQ** key, the **0** key, the **SHIFT** key, and then the **←** key. The **0** key entry determines the data sent to U410 which determines the tune voltage.

NOTE

The key sequence described in step 3 must be repeated for each number key or keys entered to change tune data from the Microprocessor.

4. Measure the data bits at U410 and the VTF tune voltages as indicated in Table 4 for each front-panel entry as indicated. The VTF tune voltage may vary depending on the +27 Vdc supply voltage. Repeat step 3 after each number key change.

Table 4. Voltage Tuned Filter (VTF) Data and Tune Voltage.

Number Key	VTF Data U410 (Vdc)					VTF Tune Voltage (Vdc)
	Pin 3	Pin 2	Pin 1	Pin 18	Pin 17	U103, Pin 7
0	+0.3	+0.3	+0.3	+0.3	+0.3	+23.8
5	+13.5	+0.3	+13.5	+0.3	+0.3	+23.2
10	+0.3	+13.5	+0.3	+13.5	+0.3	+18.5
15	+13.5	+13.5	+13.5	+13.5	+0.3	+14.0
20	+0.3	+0.3	+13.5	+0.3	+13.5	+9.5
25	+13.5	+0.3	+0.3	+13.5	+13.5	+4.7
31	+13.5	+13.5	+13.5	+13.5	+13.5	+2.0

- Set the Signal Generator as follows:

Frequency 520 MHz
 Amplitude -10 dBm

- Tune the Voltage Tuned Filters to their maximum frequency setting by pressing the **FREQ** key, the **0** key, the **SHIFT**, and then the **←**.

NOTE

The key sequence described in step 6 must be repeated after each frequency change in order to override tune data from the Microprocessor.

- Measure the voltages for U410 and VTF tune voltages as indicated in Table 5. The VTF tune voltages may vary slightly depending on the +27 Vdc supply voltage. Change the front-panel frequency as indicated. Repeat step 6 after each frequency change.

Table 5. Voltage Tuned Filter (VTF) Drivers (Maximum Frequency Setting).

Signal Generator Frequency (MHz)	VTF Data U410 (Vdc)					VTF Tune Voltage (Vdc), U103		
	Pin 3	Pin 2	Pin 1	Pin 18	Pin 17	Divide-By-4 Band Pin 14	Divide-By-2 Band Pin 8	Divide-By-1 Band Pin 7
520	+0.3	+0.3	+0.3	+0.3	+0.3	+0.3	+2.0	+23.8
260	+0.3	+0.3	+0.3	+0.3	+0.3	+2.0	+23.8	+2.0
130	+0.3	+0.3	+0.3	+0.3	+0.3	+23.8	+2.0	+2.0

TROUBLESHOOTING USING SIGNATURE ANALYSIS

This is an alternate method of troubleshooting the Service Sheet 5 circuits. If the signatures for these circuits are correct, the problem may be in the controlled (analog) circuits. In this case, use the preceding troubleshooting information. Remember that a malfunction could be on the control (digital) circuits of Service Sheet 2. If the problem is definitely in the Output or High Frequency Loop circuits, you may wish to refer to Block Diagram 2.

Test Equipment

Signature Analyzer HP 5005A

Data Transfer Test

The Data Transfer Test verifies the correct data transfer from the Microprocessor to the Output Assembly.

- Connect the signature analyzer as follows:

GND GND (A11TP3, refer to Service Sheet 17)
 CLK SA4 (A11TP10, refer to Service Sheet 18)
 START SA5 (A11TP13, refer to Service Sheet 18)
 STOP SA5 (A11TP13, refer to Service Sheet 18)

2. Set the signature analyzer controls as follows:

FUNCTION	SIGNATURE (NORM)
CLK	Negative Edge
START	Negative Edge
STOP	Positive Edge

3. Set up the Signal Generator as follows:

- a. On the A6 Output Assembly board, short TP401 to ground.
- b. Set switch A11S1C to the L/K position (refer to Service Sheet 17).
- c. Set switch A11S1B to the DSA position (refer to Service Sheet 17).

4. Briefly connect A11TP4 (NMI) to A11TP3 (GND) (refer to Service Sheet 17).

NOTE

With careless probing it is possible to get the Microprocessor into a program sequence other than that portion intended for signature analysis. If the +5V signature in Table 6 is incorrect, this has probably happened. Restart the test by briefly connecting A11TP12 (RESET) to A11TP3 (GND). Then briefly connect A11TP4 (NMI) to A11TP3 (GND).

5. Connect the signature analyzer probe to each node indicated in Table 6. Verify that each signature is correct and stable.

Table 6. V.T.F. Band Select Shift Register Signatures.

Node	Correct Signature	Comments
+5V	F84P	
A6U410 #4*	F84P	OCL
A6U410 #14	6UPP	ODA
A6U410 #16	PH25	HDA
A6U410 #12	OPU3	÷4 SEL
A6U410 #11	6C80	÷2 SEL
A6U410 #10	7H6P	÷1 SEL
A6U410 #9	7002	CW SEL
A6U410 #8	F84P	SW +15V

* This signature is the same as the +5V signature but the signature analyzer's probe should blink.

6. If troubleshooting is complete and signatures have been taken, disconnect the jumper between A6TP401 and ground.

Reset switch A11S1C back to the R/R position and switch A11S1B back to the DIAG position.

Reset the Signal Generator by pressing the **SHIFT** key and then pressing the **0** key.

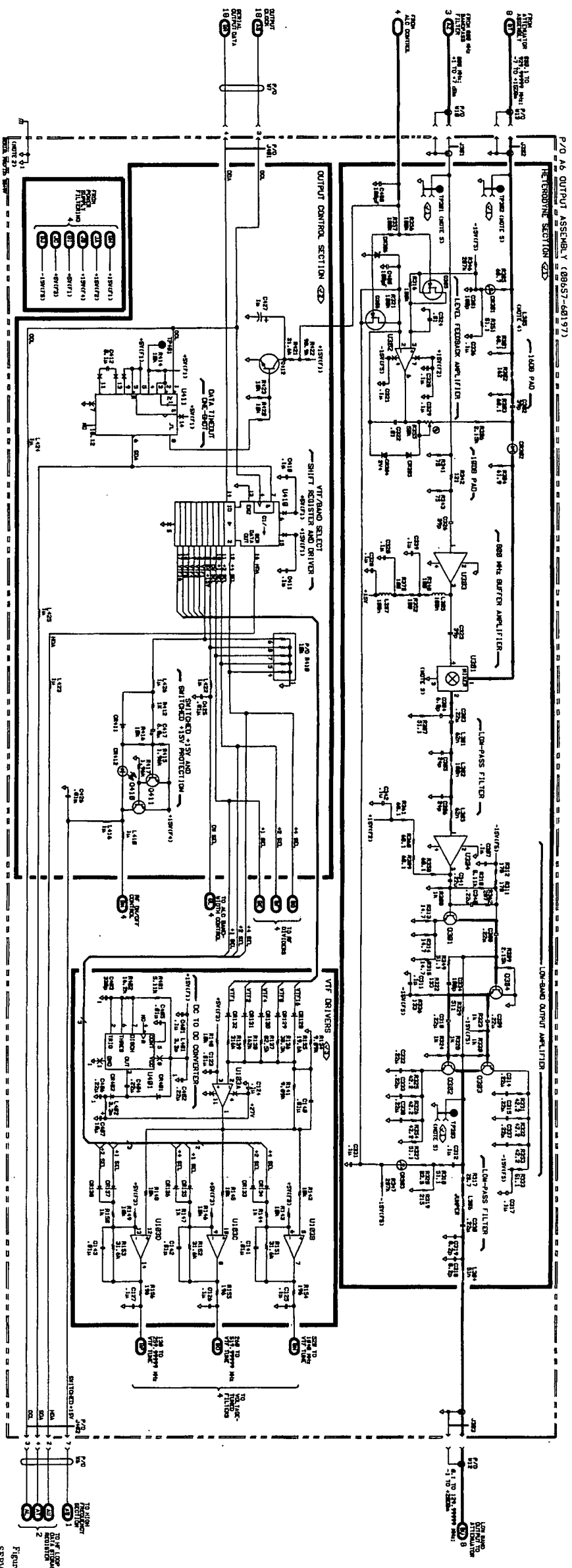


Figure 1
SERVICE SHEET 5

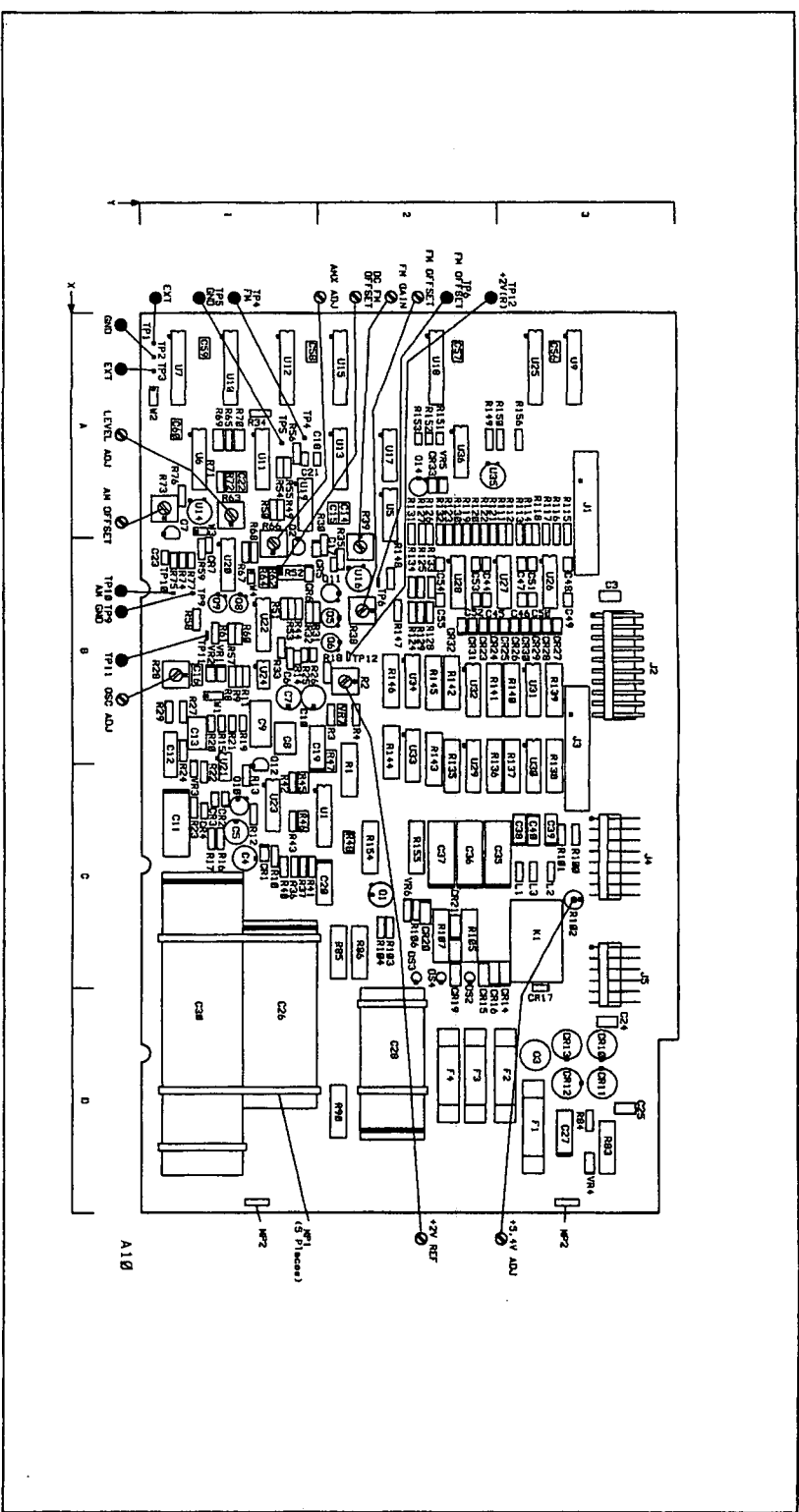
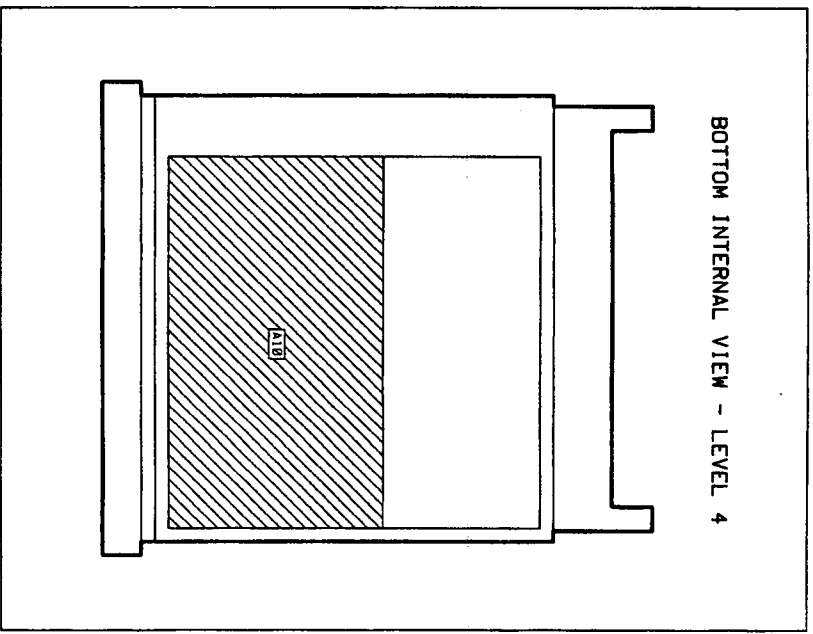


Figure B. Service Sheet 6 Information

Component Locator

- NOTES
1. For an explanation of schematic symbols, see SCHEMATIC DIAGRAM NOTES - In Section 8.
 2. Chassis ground is achieved by AIGS-1 and S connections and mechanical contact through nuts holding P.C. board to frame.
 3. Chassis ground is represented by 77.
 4. Resistor capacitor is part of Mfg. 802 M191, is not separately specified in Opt. 802 M191.

P/O A6 NETEODIVE AND OUTPUT CONTROL SSS
SEE REVERSE SIDE



Service Sheet 6

Service

Model 9657A

Service Sheet 6

MODULATION CONTROL AND LEVEL LATCHES AND MODE SELECT

PRINCIPLES OF OPERATION

General

Encoded data output from the Microprocessor is input to the Level and Modulation Control Latches. This data is used to control the RF output amplitude level versus the output frequency. The data also controls the amplitude and frequency modulation signals.

Amplitude Control/Level Latches

Data from the Microprocessor is used to control output level vernier adjustments, and to perform output level correction. The level vernier adjusts the output level in increments as small as 0.1 dB. Typical vernier range is from -3 dB to +7 dB of attenuator setting for output levels less than 0.0 dBm and from 0.0 dB to $\approx +17$ dB for output levels greater than 0.0 dBm. The level vernier's dB adjustment varies from one instrument to another because of different level correction data stored in ROM. A vernier overrange is selected by the Microprocessor to add 10 dB to the vernier range for output levels above +7 dBm or whenever a vernier setting greater than +7 dB is necessary for level correction. Using the vernier overrange permits level correction without changing attenuator settings. For example, if a front panel setting of 100 MHz and an output level of -63.6 dBm is selected, with no level correction, the Microprocessor would switch in 70 dB of attenuation and set the vernier to +6.4 dB ($-70+6.4 = -63.6$). If +1.0 dB of level correction (stored in ROM) is necessary to achieve the proper output level at that frequency and attenuator setting, the Microprocessor would select the vernier overrange and then increase the vernier setting to +8.9 dBm ($6.4+2.5$).

When a new output amplitude level is selected, the Microprocessor controls the change so that the final level is always approached from a lower level. For example, if the vernier level is at its minimum and the output level is decreased by 4 dB, the Attenuator will increase attenuation by 10 dB. The vernier level then increases the level input to the attenuator by 6 dB to complete the change. The 6 dB increase will never occur first. For the same reason, a 4 dB increase with the vernier set to maximum causes a 6 dB decrease in level followed by a 10 dB decrease in attenuation in the Attenuator. After the output amplitude is changed, the level correction for frequency is made. The vernier's level is also turned off every time a frequency change is made.

Ten bits of Microprocessor data are strobed into Modulation Control Level Latches U7 and U10 by strobes MSTB1 and MSTB2 from Address Decoder U2 (refer to Service Sheet 18). The data bits, X0-X9, are then applied to the Level Digital-To-Analog Converter (DAC) U6 (refer to Service Sheet 7).

Modulation Control

Data from the Microprocessor selects AM, FM or both AM and FM, internal modulation sources of 400 or 1000 Hz, and/or external modulation. External AC FM and external DC FM can not be selected at the same time. Data from the Microprocessor also controls AM depth and FM deviation levels.

AM % Latches

Ten bits of Microprocessor data are clocked into Modulation Control Latches U10 and U12 by strobes MSTB2 and MSTB3 from the Address Decoder U2 (refer to Service Sheet 18). The data bits, Y0-Y9, are then applied to the AM% DAC U11 (refer to Service Sheet 7).

FM Latches

Ten bits of Microprocessor data are clocked into Modulation Control Latches U12 and U15 by strobes MSTB3 and MSTB4 from the Address Decoder U2 (refer to Service Sheet 18). The data bits, Z0-Z9, are then applied to the FM Deviation DAC U13 (refer to Service Sheet 7).

Level range select bit is latched into U15. It controls the gain of the AM-Reference Summing Amplifier U20A (refer to Service Sheet 7). The Level range bit is set high when the vernier output level is greater than +7.0 dBm.

Modulation Function Latch

Eight bits of Microprocessor data are clocked into the Modulation Function Latch U18 by strobe MSTB5 from the Address Decoder U2 (refer to Service Sheet 18). The data bits are then applied to the appropriate comparator for the modulation function selected (refer to Service Sheet 7).

Audio Oscillator Control Buffer

The Audio Oscillator is enabled by a high from either the INT AM or INT FM data bits. Both bits are applied to U5. The output of U5 enables the Audio Oscillator U21A (refer to Service Sheet 7).

Ext FM Mode Select

Data bits AC FM and EXT FM are gated through NOR gates U17A, B, C and D. The two bits are gated together so that external AC FM is turned off when external DC FM is selected. The EXT FM data bit is high when external FM is selected. The AC FM data bit is high when external AC FM is selected and low when external DC FM is selected. Both data bits are low when external FM is off. The output at pin 13 of U17D is high when external DC FM is selected, and the output at pin 4 of U17B is high when external AC FM is selected.

TROUBLESHOOTING

Procedures for checking part of the A10 Audio/Power Supply Assembly circuits are given below. The areas or points to check are marked on the schematic by a hexagon with a checkmark and a number inside, for example, $\checkmark 1$. Fixed voltages are shown on the schematic inside a hexagon, for example, $2V \pm 0.2V$. Transistor bias voltages are shown without tolerances.

Troubleshooting Help

- Block Diagram 2
- Table 4-1. Abbreviated Performance Tests
- Table 5-2. Post-Repair Adjustments

Test Equipment

Digital Multimeter HP 3466A

$\checkmark 1$ P/O Modulation Control Latches, Level

1. Data bits latched into the Level Latches A10U7 and U10, can vary for each instrument. This is because the level correction data can be different for each instrument. The Level Latches are checked using Keyboard-Invoked Test 2. Data bits latched into U7 and U10 are all Low.
2. The test routine is "entered" to start the test and the "exited" to regain control of the front panel.
 - Enter the Keyboard-Invoked Tests by first pressing the **SHIFT** key and then pressing the **INCR SET** key. A "1" should be shown in the MODULATION display window.
 - Enter the High Frequency Loop Test by pressing the **AMPTD** \uparrow until a "2" is shown in the AMPLITUDE Display window.
 - Start the test routine by pressing the **INCR SET** key. "00" should be shown in the AMPLITUDE Display window.
 - Exit the Keyboard-Invoked Tests by pressing the **AMPTD** \uparrow until a "7" is shown in the MODULATION display window, then press the **INCR SET** key. The Signal Generator should go through it's power-up routine.
3. Check that data bits X0 through X9, U7 and U10, are all Low.
4. Exit Keyboard-Invoked Tests.
5. Set Signal Generator as follows:

Amplitude	-10 dBm
Amplitude Increment Set	1 dB
Frequency	100 MHz
Modulation	OFF
6. Increment the amplitude up and down in 1.0 dB steps.
7. Check that all data bits X0 through X9 change from Low to High.

√2 P/O Modulation Control Latches, AM%

1. Data bits latched in the Am% Latches, A10U10 and U12, will vary for each instrument. The data bits are different because the level correction data which is used to determine the data sent to the AM% DAC is different for each instrument. The AM% Latches are checked using Keyboard-Invoked Test 2. Data bits latched into U0 and U12 are all Low.
2. The test routine is "entered" to start the test and the "exited" to regain control of the front panel.
 - Enter the Keyboard-Invoked Tests by first pressing the **SHIFT** key and then pressing the **INCR SET** key. A "1" should be shown in the MODULATION display window.
 - Enter the High Frequency Loop Test by pressing the **AMPTD** ↑ until a "2" is shown in the AMPLITUDE Display window.
 - Start the test routine by pressing the **INCR SET** key. "00" should be shown in the AMPLITUDE Display window.
 - Exit the Keyboard-Invoked Tests by pressing the **AMPTD** ↑ until a "7" is shown in the MODULATION display window, then press the **INCR SET** key. The Signal Generator should go through it's power-up routine.
3. Check that data bits Y0 through Y9 are all Low.
4. Exit Keyboard-Invoked Tests.
5. Set Signal Generator as follows:
 - Amplitude -7 dBm
 - Frequency Any
 - Modulation AM, 80%
 - Source 1 kHz (Int.)
 - AM Increment Set 1%
6. Increment the modulation up and down in 1% steps.
7. Check that all data bits Y0 through Y9 change from Low to High.

√3 P/O Modulation Control Latches, FM Deviation

1. Set the Signal Generator as follows:
 - Frequency 520 MHz
 - Amplitude -10 dBm
 - Modulation FM 1 kHz
 - Source 1 kHz (Int.)
2. Measure the voltage levels as indicated in Table 1 for each of the front-panel FM settings.

Table 1. FM Deviation Control Voltage Levels.

Front-Panel FM (kHz)	Measure the Voltage* as Indicated at									
	A10U12				A10U15					
	12	15	16	19	2	5	6	9	12	15
1	L	L	L	L	H	H	L	L	H	H
5	L	H	L	L	L	L	L	L	L	L
10	H	L	L	L	L	L	L	L	L	L
20	H	H	H	H	H	H	H	H	H	H
50	L	H	L	L	L	L	L	L	L	L
80	L	H	H	L	L	H	H	L	L	H
99	L	H	H	H	H	H	H	L	H	L

*Low is ≤0.8 Vdc; High is ≥2.0 Vdc.

√4 P/O Modulation Control Latches, Function

1. Set the Signal Generator as follows:

Frequency 520 MHz
 Amplitude -10 dBm

2. Measure the voltage levels as indicated in Table 2 for each of the front-panel Modulation Source settings. The AM depth or FM deviation for each front-panel Modulation Source setting can be between 0-99% or 0-99 kHz respectively.

Table 2. Function Control Voltage Levels.

Front-Panel FM kHz	Measure the Voltage* as Indicated at										
	A10U18								A10U17		A10U15
	2	5	6	9	12***	15	16	19	4	13	19
Int 1 kHz AM (Int AM Off)	H	H	L	H	L	L	L	L	L	L	L
Int 400 Hz FM (Int FM Off)	H	L	H	H	L	H	L	L	L	L	L
Ext AM (Ext AM Off)	L	L	L	H***	L	J	H	L	L	L	L
Ext AC FM	L	L	L	H	L	H	L	H	H	L	L
Ext DC FM	L	L	L	H	L	L	L	H	H	L	L
Amp + 10 dBm	L	L	L	H	L	H	L	L	L	L	H

* Low is ≤ 0.8 Vdc; High is ≥ 2.0 Vdc.
 ** Internal 40 Hz bit. Frequency Pin 9 remains high until 1 kHz source is select with Modulation Function.
 *** Low for FM Deviation 20 kHz and below.

A10 Component Coordinates (1 of 2)

COMP	X,Y	COMP	X,Y	COMP	X,Y	COMP	X,Y	COMP	X,Y	COMP	X,Y
C3	B,3	C56	A,3	J1	A,3	R21	B,1	R66	B,1	R131	A,2
C4	C,1	C57	A,2	J2	B,3	R22	C,1	R67	B,1	R132	A,2
C5	C,1	C58	A,1	J3	B,3	R23	C,1	R68	B,1	R133	B,2
C6	B,1	C59	A,1	J4	C,3	R24	B,1	R69	A,1	R134	B,2
C7	B,1	C60	A,1	J5	C,3	R25	B,1	R70	A,1	R135	C,2
C8	B,1					R26	B,1	R71	A,1	R136	C,2
C9	B,1	CR1	C,1	K1	C,3	R27	B,1	R72	A,1	R137	C,3
C10	B,1	CR2	C,1			R28	B,1	R73	A,1	R138	C,3
C11	C,1	CR3	C,1	L1	C,3	R29	B,1	R74	B,1	R139	B,3
C12	B,1	CR4	C,1	L2	C,3	R30	B,2	R75	B,1	R140	B,3
C13	B,1	CR5	B,1	L3	C,3	R31	B,1	R76	A,1	R141	B,2
C14	A,2	CR6	B,1			R32	B,1	R77	B,1	R142	B,2
C15	A,2	CR7	B,1	MP1	D,1	R33	B,1	R83	D,3	R143	B,2
C16	B,1	CR10	D,3	MP2	D,1	R34	A,1	R84	D,3	R144	B,2
C17	B,2	CR11	D,3			R35	B,2	R85	C,2	R145	B,2
C18	A,1	CR12	D,3	Q1	C,2	R36	C,1	R86	C,2	R146	B,2
C19	B,1	CR13	D,3	Q2	B,1	R37	C,1	R90	D,2	R147	B,2
C20	C,2	CR14	C,3	Q3	D,3	R38	B,2	R100	C,3	R148	B,2
C21	A,1	CR15	C,2	Q5	B,2	R39	B,2	R101	C,3	R149	A,2
C22	A,1	CR16	C,2	Q6	B,2	R40	C,1	R102	C,3	R150	A,3
C23	B,1	CR17	D,3	Q7	A,1	R41	C,1	R103	C,2	R151	A,2
C24	D,3	CR19	C,2	Q8	B,1	R42	C,1	R104	C,2	R152	A,2
C25	D,3	CR20	C,2	Q9	B,1	R43	C,1	R105	C,2	R153	A,2
C26	D,1	CR21	C,2	Q10	C,1	R44	B,1	R106	C,2	R154	C,2
C27	D,3	CR23	B,2	Q11	B,2	R45	C,1	R107	C,2	R155	C,2
C28	D,2	CR24	B,2	Q12	C,1	R46	C,1	R111	A,3	R156	A,3
C30	D,1	CR25	B,3	Q14	A,2	R47	B,2	R112	A,3		
C35	C,2	CR26	B,3			R48	C,2	R113	A,3	TP1	A,1
C36	C,2	CR27	B,3	R1	C,2	R49	A,1	R114	A,3	TP2	A,1
C37	C,2	CR28	B,3	R2	B,2	R50	A,1	R115	A,3	TP3	A,1
C38	C,3	CR29	B,3	R3	B,2	R51	B,1	R116	A,3	TP4	A,1
C39	C,3	CR30	B,3	R4	B,2	R52	B,1	R117	A,3	TP5	A,1
C40	C,3	CR31	B,2	R8	B,1	R53	B,1	R118	A,3	TP6	B,2
C44	B,2	CR32	B,2	R9	B,1	R54	A,1	R119	A,2	TP9	B,1
C45	B,2	CR33	A,2	R10	C,1	R55	A,1	R120	A,2	TP10	B,1
C46	B,3			R11	B,1	R56	A,1	R121	A,2	TP11	B,1
C47	B,3	DS2	C,2	R12	C,1	R57	B,1	R122	A,2	TP12	B,2
C48	B,3	DS3	C,2	R13	C,1	R58	B,1	R123	A,2		
C49	B,3	DS4	C,2	R14	B,1	R59	B,1	R124	B,2	U1	C,2
C50	B,3			R15	B,1	R60	B,1	R125	B,2	U5	A,2
C51	B,3			R16	C,1	R61	B,1	R126	A,2	U6	A,1
C52	B,2	F1	D,3	R17	C,1	R62	B,1	R127	A,2	U7	A,1
C53	B,2	F2	D,3	R18	B,2	R63	A,1	R128	B,2	U9	A,3
C54	B,2	F3	D,2	R19	B,1	R64	B,1	R129	B,2	U10	A,1
C55	B,2	F4	D,2	R20	B,1	R65	A,1	R130	A,2	U11	A,1

A10 Component Coordinates (2 of 2)

COMP	X,Y	COMP	X,Y	COMP	X,Y	COMP	X,Y	COMP	X,Y	COMP	X,Y
U12	A.1										
U13	A.2										
U14	A.1										
U15	A.2										
U16	B.2										
U17	A.2										
U18	A.2										
U19	A.1										
U20	B.1										
U21	C.1										
U22	B.1										
U23	C.1										
U24	B.1										
U25	A.3										
U26	B.3										
U27	B.3										
U28	B.2										
U29	C.2										
U30	C.3										
U31	B.3										
U32	B.2										
U33	B.2										
U34	B.2										
U35	A.2										
U36	A.2										
VR1	B.1										
VR2	B.1										
VR3	C.1										
VR4	D.3										
VR5	A.2										
VR6	C.2										
VR7	B.2										
W1	B.1										
W2	A.1										
W3	A.1										
W4	B.1										

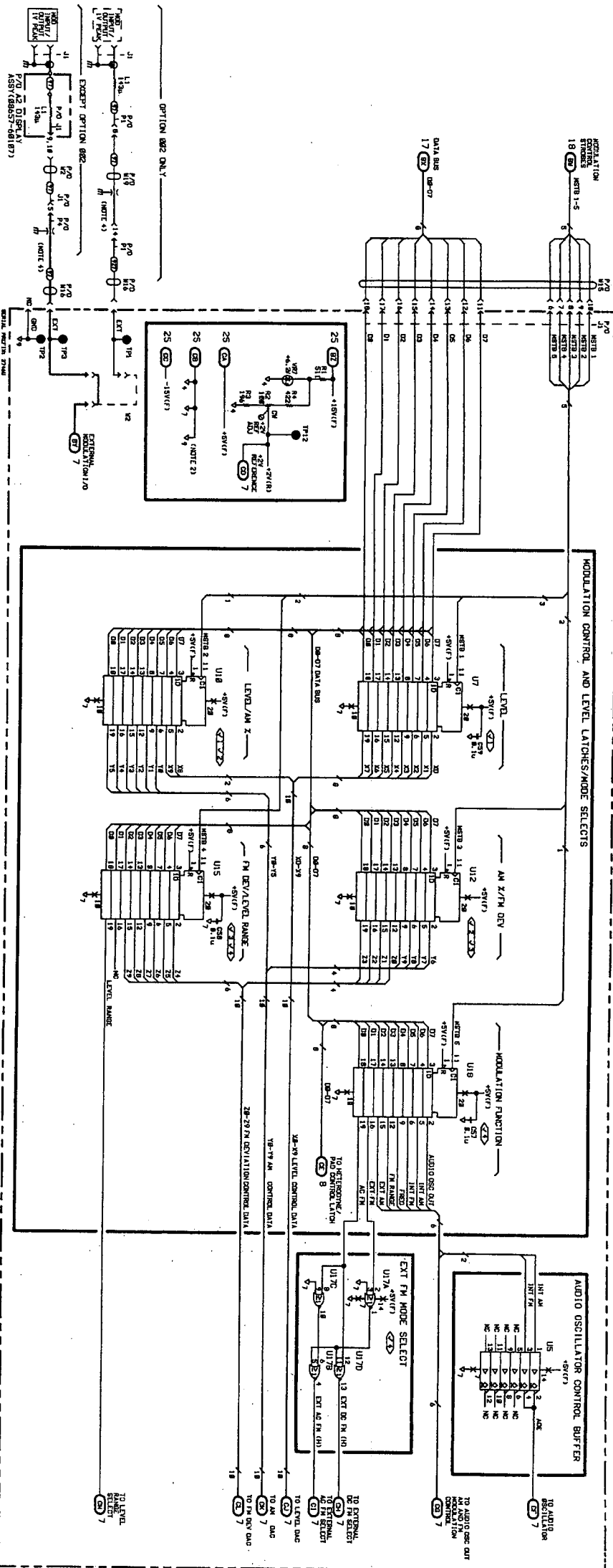


Figure 1
Service Sheet 6 9

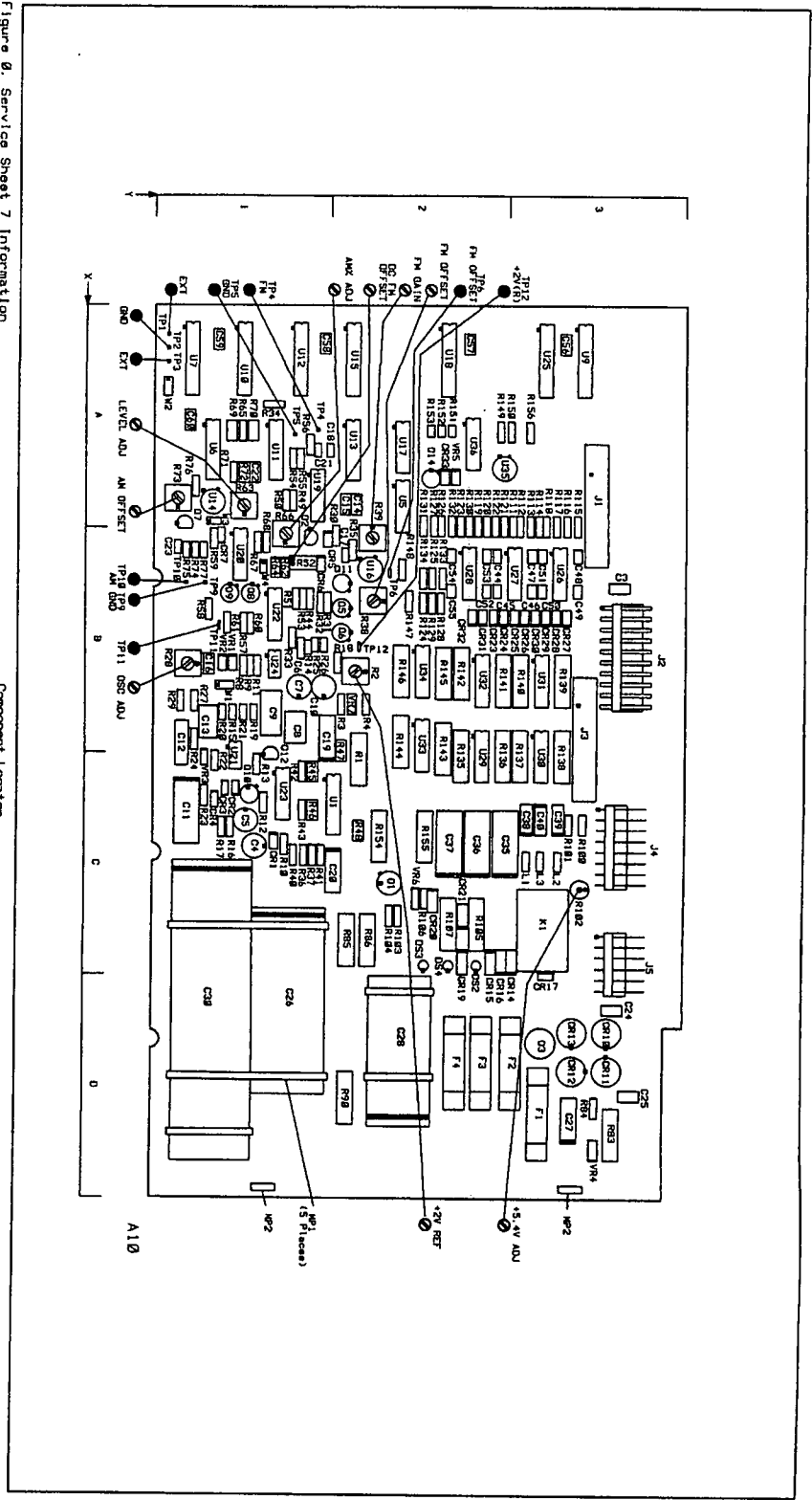


Figure 8. Service Sheet 7 Information

Component Locator

NOTES

1. For an explanation of schematic symbols, see SCHEMATIC DIAGRAM NOTES in Section 8.
2. Chassis ground is defined by A102-1 and 5 connections and by mechanical contact through pins holding TP board to frame.
3. Feedback capacitor is part of M162 or M163 and is not separately specified.
4. Chassis ground is achieved through mechanical contact with M162.

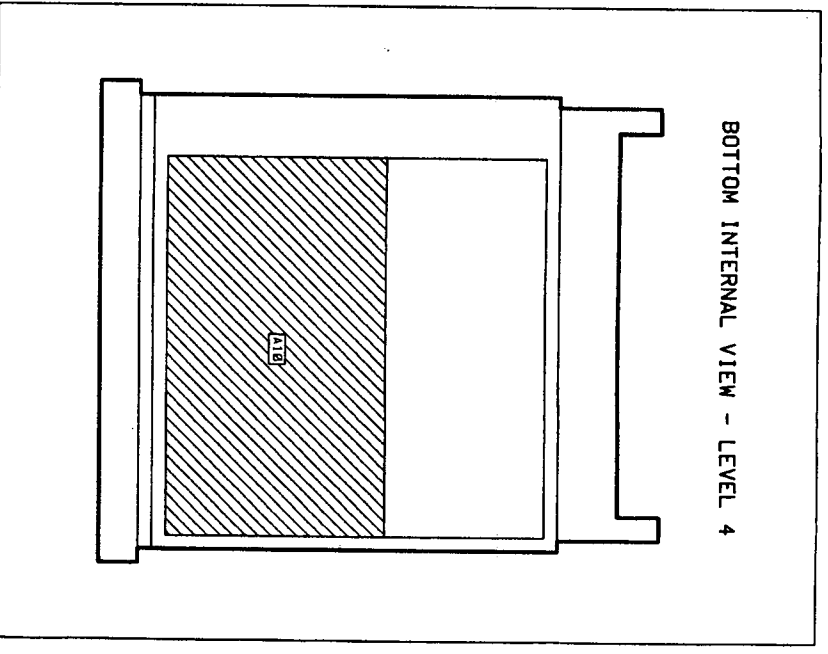
LOGIC LEVELS

HIGH	LOW
1	0
2	1
3	0
4	1
5	0
6	1
7	0
8	1
9	0
10	1
11	0
12	1
13	0
14	1
15	0
16	1
17	0
18	1
19	0
20	1
21	0
22	1
23	0
24	1
25	0
26	1
27	0
28	1
29	0
30	1
31	0
32	1
33	0
34	1
35	0
36	1
37	0
38	1
39	0
40	1
41	0
42	1
43	0
44	1
45	0
46	1
47	0
48	1
49	0
50	1
51	0
52	1
53	0
54	1
55	0
56	1
57	0
58	1
59	0
60	1
61	0
62	1
63	0
64	1
65	0
66	1
67	0
68	1
69	0
70	1
71	0
72	1
73	0
74	1
75	0
76	1
77	0
78	1
79	0
80	1
81	0
82	1
83	0
84	1
85	0
86	1
87	0
88	1
89	0
90	1
91	0
92	1
93	0
94	1
95	0
96	1
97	0
98	1
99	0
100	1

A102-1,16
TOP VIEW

A102-5-12
TOP VIEW

P/O A10 MODULATION CONTROL LATCHES AND MODE SELECT SS6
SEE REVERSE SIDE



Service Sheet 7

FM AND AM MODULATION CONTROL, AND RF AMPLITUDE CONTROL

PRINCIPLES OF OPERATION

General

Data from the Level Control Latches is used to control the RF output amplitude level in fine steps, and the RF output amplitude level versus frequency correction. The Modulation Control Latches also control the amplitude and frequency modulation signals.

RF Output Amplitude Control

Ten data bits latched into Modulation Control Latches U7 and U10 (refer to Service Sheet 6) are applied to the Level Digital-to-Analog Converter (DAC) U6. The digitally controlled output of the Level DAC adjusts the reference voltage input from the unity-gain Level Buffer U20C. This dc voltage controls the vernier output level. The output voltage is applied to the AM Reference Summing Amplifier U20A.

When amplitude modulation is selected, the Level DAC voltage is summed with the AM% DAC voltage, and applied to A6U6 of the Automatic Level Control (ALC) Amplifier (refer to Service Sheet 4).

The Microprocessor determines when the vernier output level is greater than +7.0 dBm. At this time the Level Range select bit is set high, and the output of U20B goes to approximately -15V. FET switch Q7 opens increasing the gain of AM-Reference Summing Amplifier U20A. This allows for the higher output levels and for level correction.

AM Modulation Control

Ten data bits latched into Modulation Control Latches U10 and U12 (refer to Service Sheet 6) are applied to the AM% DAC U11. The digitally controlled output level of the AM% DAC adjusts the input modulation signal from the AM% Summing Amplifier U20D to the level that modulates the RF signal to the depth selected. The output signal is ac coupled by C22 to the unity-gain AM Offset Buffer U14. The AM Offset Adjustment at R73 nulls any dc offset of the modulation signal. The amplitude modulation signal is then summed with the level voltage at U20A as discussed above.

Internal AM Select

Internal AM is selected when the data bit latched into pin 5 of U18 is high (refer to Service Sheet 6). The high output (INT AM) to the positive input of the Internal AM Select comparator U22B, being more positive than +2V(R) at the negative input, switches its output to approximately 0.0V. FET switch Q9 is turned on. When Q9 is on, the output of the Audio Oscillator U21A is then ac coupled by C16 through resistor R58 to the AM% Summing Amplifier U20D.

External AM Select

External AM is selected when the data bit latched into pin 15 of U18 is high (refer to Service Sheet 6). The high output (EXT AM) switches the output of the External AM Select comparator U22A to approximately 0.0V. FET switch Q8 is turned on. When Q8 is on, the external modulation signal from the External Modulation Buffer U24 is then applied to the AM% Summing Amplifier U20D through resistor R57.

FM Modulation Control

Ten data bits latched into the Modulation Control Latches U12 and U15 (refer to Service Sheet 6), are applied to the FM Deviation DAC U13. The digitally controlled output level of the FM deviation DAC adjusts the modulation signal from the FM Deviation Summing Amplifier U16 to the FM Deviation Amplifier U19A. The DAC and FM Deviation Amplifier output the signal level required to frequency modulate the RF output at the selected FM deviation.

Internal FM Select

Internal FM is selected when the data bit latched into pin 6 of U18 is high (refer to Service Sheet 6). The high output (INT FM) switches the output of the Internal FM Select comparator U22D to approximately 0.0V. FET switch Q6 is turned on. When Q6 is on, the output of the Audio Oscillator U21A is ac coupled by C16 through resistor R33 to the FM Deviation Summing Amplifier U16.

External FM Select

External AC FM or DC FM is selected by the data bits latched into pin 19 (AC FM) and pin 16 (EXT FM) of U18, and gated through NOR gates U17 (refer to Service Sheet 6). The high output at pin 4 of U17B switches the output of the External AC FM Select comparator U22C to approximately 0.0V. FET switch Q5 is turned on. When Q5 is on, the external ac modulation signal from the External Modulation Buffer U24 is ac coupled by C7 and C10 through resistor R26 to the FM Deviation Summing Amplifier U16. The high output at pin 13 of U17D switches the output of the External DC FM Select comparator U19C to approximately 0.0V. FET switch Q11 is turned on. When Q11 is on, the external dc modulation signal from the External Modulation Buffer U24 is dc coupled by resistor R25 to the FM Deviation Summing Amplifier U16. External AC FM and external DC FM can not be selected at the same time.

Audio Oscillator Section

When only internal modulation is selected, the data bit latched into pin 2 of U18 is high (refer to Service Sheet 6). The high output (AUDIO OSC OUT) switches the output of Audio Oscillator Out comparator U23B to approximately 0.0V. FET switch Q10 is turned on. When Q10 is on, the 400 Hz or 1 kHz internal Audio Oscillator output through buffer amplifier U21B and C4 and C5 is applied to the MOD INPUT/OUTPUT connector on the front-panel.

The internal Audio Oscillator's frequency is enabled by a high latched into pins 5 or 6 of U18. These two bits (INT AM and INT FM) are each applied to Audio Oscillator Buffer U5 (refer to Service Sheet 6). The low output (AOE) of U5 enables the internal Audio Oscillator U21A.

The internal Audio Oscillator's frequency of 400 Hz or 1 kHz is selected by the data bit latched into pin 9 of U18. For 1 kHz the FREQ line is low; for 400 Hz it is high. The high output switches the output of Audio Frequency Select comparator U23A to approximately 0.0V. FET switch Q12 is turned on and capacitor C8 is bypassed. This increased capacitance switches the Audio Oscillator's frequency to 400 hz. If 1 kHz is selected, Q12 is turned off by a low on the FREQ line to U23A, and C8 is left in the oscillator's circuit. The peak output of the Audio Oscillator is approximately +7.5V as determined by VR3, CR3, and CR4. These components form the feedback path for the positive input of U21A.

Modulation Calibration

Internal and external modulation is calibrated only if the modulation signal from the internal Audio Oscillator or the external MOD INPUT/OUTPUT connector is equal to +1.00 Vpk \pm 0.05 Vpk. The amplitude from the internal Audio oscillator is adjusted by R28 (OSC ADJ).

Over/Under Modulation Comparators

The input amplitude level at the MOD INPUT/OUTPUT connector must be set by the external source. The input amplitude level is monitored by the Over/Under Modulation comparators U23C and D. When the modulation input signal is high, comparator U23C switches its output from -15V to 0.0V . The monostable multivibrator U1A is enabled. The output at pin 13 goes high for approximately 0.45 seconds. As long as the input is enabled by the high modulation signal, the multivibrator continues to output the pulse.

The HI(H) pulse from the multivibrator is applied to the Service Request Register A11U6 (refer to Service Sheet 17). The Microprocessor receives this status bit over the data bus when the inputs to the Service Request Register are clocked in by the status strobe. The HI EXT LED is turned on.

When the modulation input signal is low, the output of comparator U23C and D are both approximately -15V . The monostable multivibrators are not enabled. The active high output of U1A is low and the active low output of U1B is high. The high output of U1B is applied to the Service Request Register, and the LO EXT LED is turned on.

When the modulation input signal is 1 Vpk , the output of comparator U23D is switched high which enables the monostable multivibrator U1B. The high output at pin 12 is set low, and the LO EXT LED is turned off.

TROUBLESHOOTING

Procedures for checking part of the A10 Audio/Power Supply Assembly circuits are given below. The areas or points to check are marked on the schematic by a hexagon with a checkmark and a number inside, for example, $\sqrt{1}$.

Troubleshooting Help

- Block Diagram 4
- Table 4-1. Abbreviated Performance Tests
- Table 5-2. Post-Repair Adjustments

Test Equipment

Digital Multimeter HP 3466A

$\sqrt{1}$ Level DAC, AM Reference Summing Amplifier

1. Set the Signal Generator as follows:

Frequency 520 MHz
 Amplitude -3 dBm
 Modulation Off

2. Measure and verify the voltages shown in Table 1 at test point A10TP10 (AM). Change the RF output amplitude level from the front-panel as indicated.

NOTE

Voltages measured may differ from the voltages shown in Table 1 because of level correction. The voltage change for each step from -3 to +13.0 dBm is consistent.

Table 1. Level Control Voltages versus Front-Panel Amplitude.

Front-Panel Amplitude (dBm)	A10TP10 (Vdc)
-3.0	+0.4
0.0	+0.6
+5.0	+1.1
+10.0	+1.9
+13.0	+2.8

√2 AM% DAC, AM Offset Buffer

1. Set the Signal Generator as follows:

Frequency 520 MHz
 Amplitude -10 dBm
 Modulation AM 1%
 Source 1 kHz (Int.)

2. Measure and verify the voltages shown in Table 2 at test point A10TP10 (AM). Change the AM% depth from the front panel as indicated.

NOTE

Absolute voltage levels measured may differ from the voltages shown in Table 2 depending on the adjustment of A10R66 (AM%). The relative change for each AM% change should be consistent, however.

Table 2. AM% Control Voltage Levels.

Front-Panel AM%	A10TP10 (Vrms)
1	0.0045
5	0.023
10	0.046
20	0.092
50	0.229
70	0.321
99	0.453

√3 FM Deviation DAC, FM Deviation Amplifier

1. Set the Signal Generator as follows:

Frequency 520 MHz
 Amplitude -10 dBm
 Modulation FM 1 kHz
 Source 1 kHz (Int.)

2. Measure and verify the voltages shown in Table 3 at test point A10TP4 (FM). Change the FM deviation from the front panel as indicated.

NOTE

Absolute voltage levels measured may differ from the voltages shown in Table 3 depending on the adjustment of A10R39 (FM GAIN). The relative change for each FM kHz change should be consistent, however.

Table 3. FM Deviation Control Voltage Levels.

Front-Panel FM (kHz)	A10TP4 (Vrms)
1	0.0022
5	0.110
10	0.221
20	0.440
50	1.099
70	1.536
99	2.171

√4 Comparators, FET Switches

1. Set the Signal Generator as follows:

Frequency 520 MHz
 Amplitude -10 dBm
 Modulation Off

2. Select the front-panel Modulation Source functions as indicated in Table 4. Measure and verify the voltages shown for the associated comparator.

Table 4. Voltage Checks.

Function Selected	Comparator	Comparator Output (Vdc)	FET Switch	Open/ Closed
Int 1 kHz, AM	U22B	0.0	Q9	closed
Int 400 Hz	U23A	0.0	Q12	closed
Audio Osc Out	U23B	+5.0	Q10	closed
Int FM	U22D	0.0	Q6	closed
Ext AC FM	U22C	0.0	Q5	closed
Ext DC FM	U19C	+14.0	Q11	closed
Ext AM	U22A	0.0	Q8	closed
Amplitude +10 dBm	U20B	-13.0	Q7	open
FM Range (< 21 kHz)	U19B	+14.0	Q2	open
Ext AM No Input	U23D	-13.0	J1 pin 5 J1 pin 4	L H
Ext AM 1 Vpk Input	U23D	-13.0	J1 pin 5 J1 pin 4	H L

A10 Component Coordinates (1 of 2)

COMP	X,Y	COMP	X,Y	COMP	X,Y	COMP	X,Y	COMP	X,Y	COMP	X,Y
C3	B,3	C56	A,3	J1	A,3	R21	B,1	R66	B,1	R131	A,2
C4	C,1	C57	A,2	J2	B,3	R22	C,1	R67	B,1	R132	A,2
C5	C,1	C58	A,1	J3	B,3	R23	C,1	R68	B,1	R133	B,2
C6	B,1	C59	A,1	J4	C,3	R24	B,1	R69	A,1	R134	B,2
C7	B,1	C60	A,1	J5	C,3	R25	B,1	R70	A,1	R135	C,2
C8	B,1					R26	B,1	R71	A,1	R136	C,2
C9	B,1	CR1	C,1	K1	C,3	R27	B,1	R72	A,1	R137	C,3
C10	B,1	CR2	C,1			R28	B,1	R73	A,1	R138	C,3
C11	C,1	CR3	C,1	L1	C,3	R29	B,1	R74	B,1	R139	B,3
C12	B,1	CR4	C,1	L2	C,3	R30	B,2	R75	B,1	R140	B,3
C13	B,1	CR5	B,1	L3	C,3	R31	B,1	R76	A,1	R141	B,2
C14	A,2	CR6	B,1			R32	B,1	R77	B,1	R142	B,2
C15	A,2	CR7	B,1	MP1	D,1	R33	B,1	R83	D,3	R143	B,2
C16	B,1	CR10	D,3	MP2	D,1	R34	A,1	R84	D,3	R144	B,2
C17	B,2	CR11	D,3			R35	B,2	R85	C,2	R145	B,2
C18	A,1	CR12	D,3	Q1	C,2	R36	C,1	R86	C,2	R146	B,2
C19	B,1	CR13	D,3	Q2	B,1	R37	C,1	R90	D,2	R147	B,2
C20	C,2	CR14	C,3	Q3	D,3	R38	B,2	R100	C,3	R148	B,2
C21	A,1	CR15	C,2	Q5	B,2	R39	B,2	R101	C,3	R149	A,2
C22	A,1	CR16	C,2	Q6	B,2	R40	C,1	R102	C,3	R150	A,3
C23	B,1	CR17	D,3	Q7	A,1	R41	C,1	R103	C,2	R151	A,2
C24	D,3	CR19	C,2	Q8	B,1	R42	C,1	R104	C,2	R152	A,2
C25	D,3	CR20	C,2	Q9	B,1	R43	C,1	R105	C,2	R153	A,2
C26	D,1	CR21	C,2	Q10	C,1	R44	B,1	R106	C,2	R154	C,2
C27	D,3	CR23	B,2	Q11	B,2	R45	C,1	R107	C,2	R155	C,2
C28	D,2	CR24	B,2	Q12	C,1	R46	C,1	R111	A,3	R156	A,3
C30	D,1	CR25	B,3	Q14	A,2	R47	B,2	R112	A,3		
C35	C,2	CR26	B,3			R48	C,2	R113	A,3	TP1	A,1
C36	C,2	CR27	B,3	R1	C,2	R49	A,1	R114	A,3	TP2	A,1
C37	C,2	CR28	B,3	R2	B,2	R50	A,1	R115	A,3	TP3	A,1
C38	C,3	CR29	B,3	R3	B,2	R51	B,1	R116	A,3	TP4	A,1
C39	C,3	CR30	B,3	R4	B,2	R52	B,1	R117	A,3	TP5	A,1
C40	C,3	CR31	B,2	R8	B,1	R53	B,1	R118	A,3	TP6	B,2
C44	B,2	CR32	B,2	R9	B,1	R54	A,1	R119	A,2	TP9	B,1
C45	B,2	CR33	A,2	R10	C,1	R55	A,1	R120	A,2	TP10	B,1
C46	B,3			R11	B,1	R56	A,1	R121	A,2	TP11	B,1
C47	B,3	DS2	C,2	R12	C,1	R57	B,1	R122	A,2	TP12	B,2
C48	B,3	DS3	C,2	R13	C,1	R58	B,1	R123	A,2		
C49	B,3	DS4	C,2	R14	B,1	R59	B,1	R124	B,2	U1	C,2
C50	B,3			R15	B,1	R60	B,1	R125	B,2	U5	A,2
C51	B,3			R16	C,1	R61	B,1	R126	A,2	U6	A,1
C52	B,2	F1	D,3	R17	C,1	R62	B,1	R127	A,2	U7	A,1
C53	B,2	F2	D,3	R18	B,2	R63	A,1	R128	B,2	U9	A,3
C54	B,2	F3	D,2	R19	B,1	R64	B,1	R129	B,2	U10	A,1
C55	B,2	F4	D,2	R20	B,1	R65	A,1	R130	A,2	U11	A,1

A10 Component Coordinates (2 of 2)

COMP	X,Y	COMP	X,Y	COMP	X,Y	COMP	X,Y	COMP	X,Y	COMP	X,Y
U12	A,1										
U13	A,2										
U14	A,1										
U15	A,2										
U16	B,2										
U17	A,2										
U18	A,2										
U19	A,1										
U20	B,1										
U21	C,1										
U22	B,1										
U23	C,1										
U24	B,1										
U25	A,3										
U26	B,3										
U27	B,3										
U28	B,2										
U29	C,2										
U30	C,3										
U31	B,3										
U32	B,2										
U33	B,2										
U34	B,2										
U35	A,2										
U36	A,2										
VR1	B,1										
VR2	B,1										
VR3	C,1										
VR4	D,3										
VR5	A,2										
VR6	C,2										
VR7	B,2										
W1	B,1										
W2	A,1										
W3	A,1										
W4	B,1										

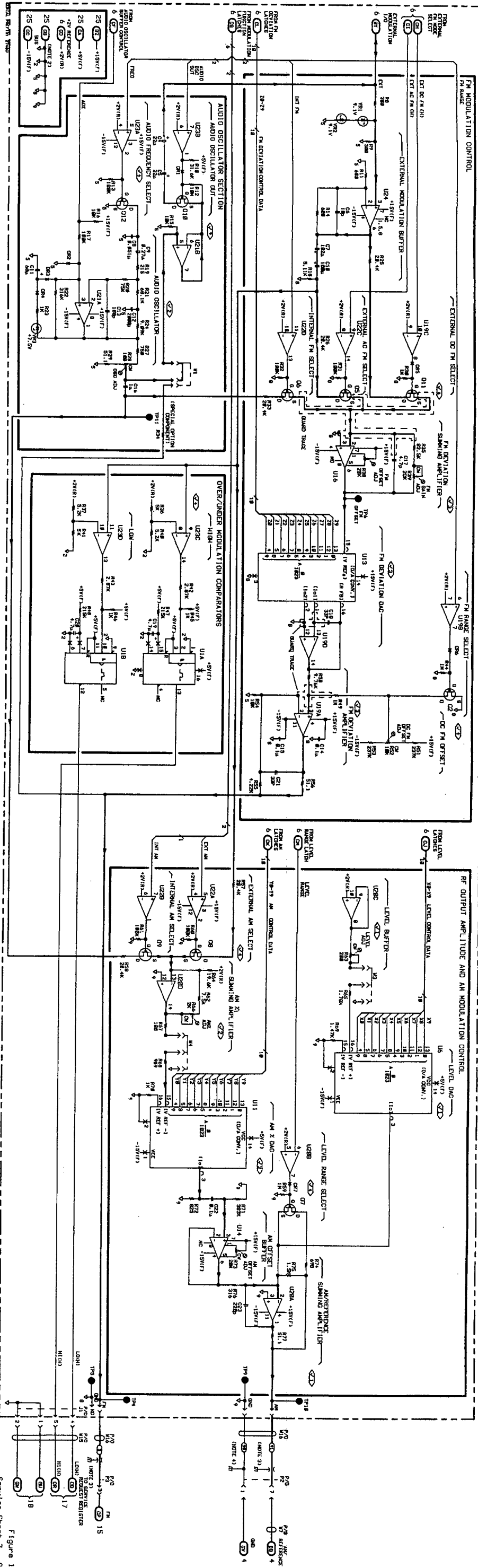


Figure 1
Service Sheet 7 9

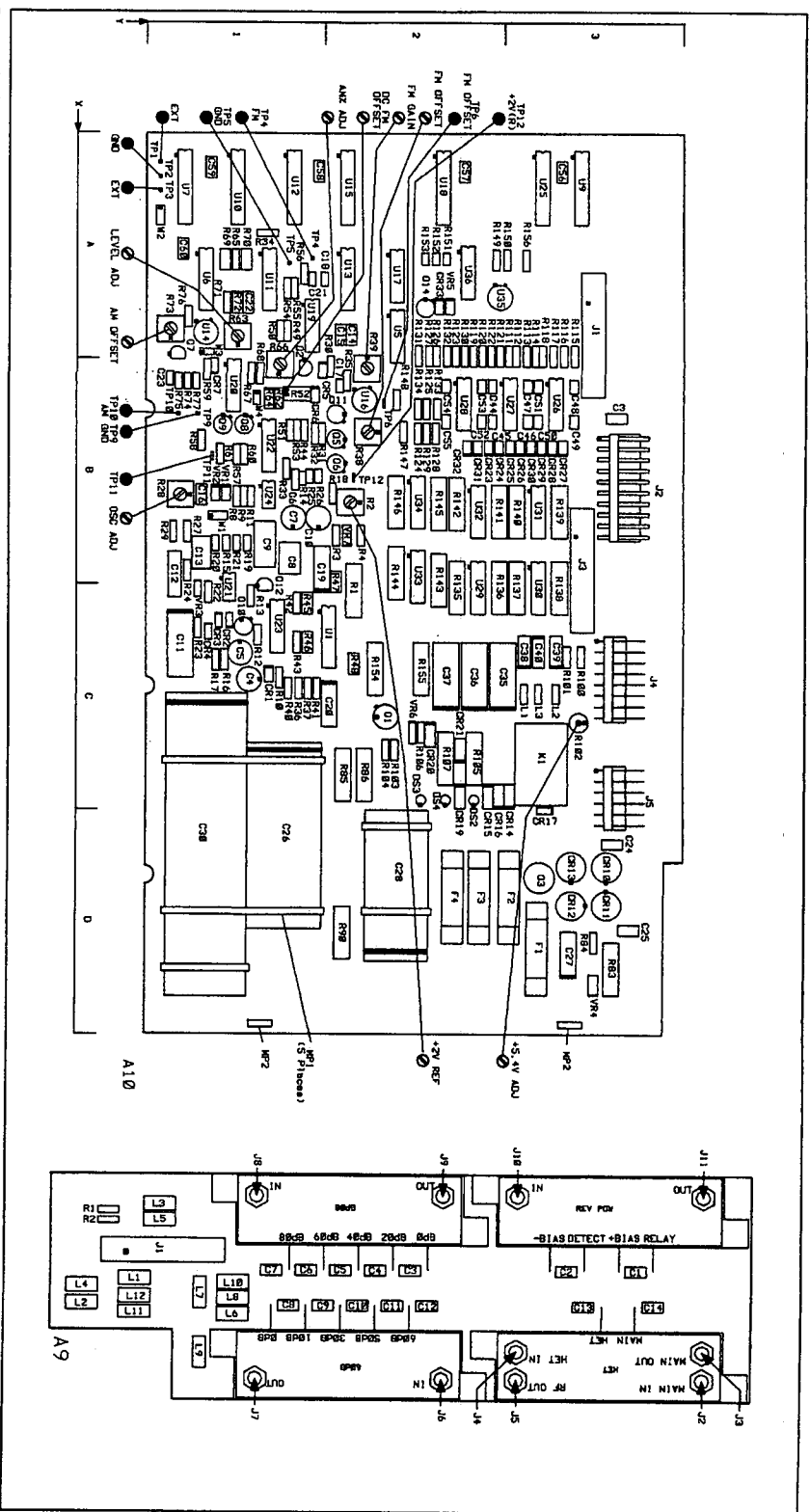
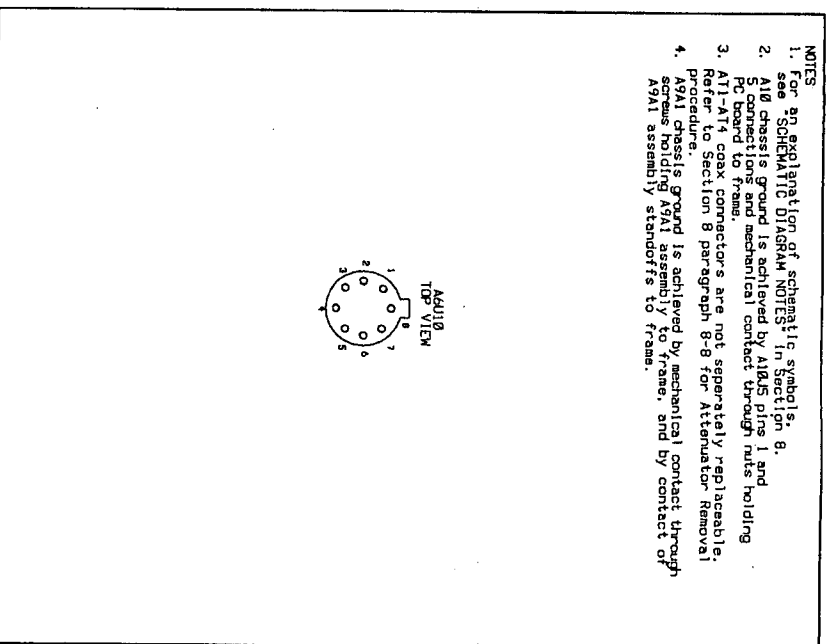
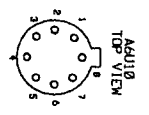


Figure 8. Service Sheet 8 Information

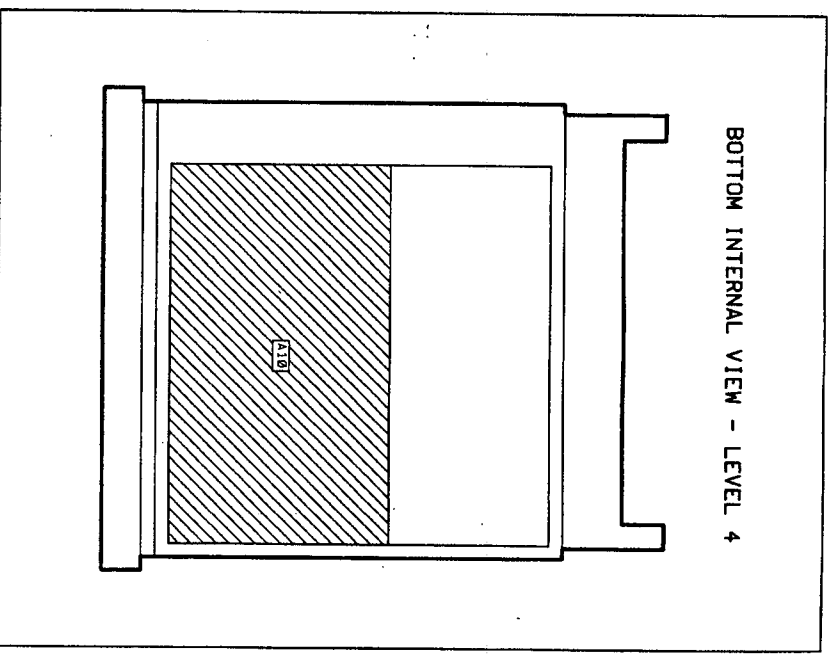
Component Locator



- NOTES
1. For an explanation of schematic symbols, see SCHEMATIC DIAGRAM NOTES in Section 8.
 2. A10 chassis ground is achieved by A10S pins 1 and 2. A10S pins 3 and 4 are connected to the PC board to frame mechanical contact through pins holding A11-A14 coax connectors, are not separately replaceable. Refer to Section 8 paragraph 8-8 for Attenuator Removal procedure.
 3. A11 chassis ground is achieved by mechanical contact through A11S pins 1 and 2 to frame, and by contact of A11 assembly standoff to frame.



P/O A10 FM AND AM MODULATION CONTROL AND AMPLITUDE CONTROL S57 SEE REVERSE SIDE



Service

Model 8657A

Service Sheet 8

ATTENUATOR, ATTENUATOR CONTROL, AND REVERSE POWER PROTECTION

PRINCIPLES OF OPERATION

General

Encoded data from the Microprocessor is clocked into the Attenuator Control Latches, and is applied to the Attenuator Drivers. Control signals select the heterodyne mode for frequencies below 130 MHz, and add or remove attenuation from the RF output signal path depending upon the output amplitude selected.

If excessive power from an external source is connected to the RF OUTPUT connector. The Reverse Power Protection circuits cause a relay in series with the output to open.

Attenuator Control

Data from the Microprocessor is clocked into the Attenuator Control Latches U9 and U25 by Attenuator Strobes ASTB1 and ASTB2. The data is applied to the negative inputs of comparators U26, U27, and U28 and is compared to the +1.5V reference at the comparator's positive input. With a logic high applied to the comparator's negative input, its output is +14V. A 0.022 μ F feedback capacitor is used to decrease the slew rate of the comparator. This prevents high frequency switching transients which could couple into the attenuator. If the comparator output is +14V, the voltage is applied through a diode to the base of the positive source transistor, turning it on, and to the base of the negative source transistor, turning it off. The source transistors provide the necessary current to drive the diode switching networks within the attenuator assemblies. The collector of the positive source transistor is tied to +15V. When the transistor is turned on, +15V is applied to the switching circuits within the attenuator, and the attenuator function is turned on. Resistors are used to limit current from the positive source transistors for HET (HET), HET (MAIN), AT2 (0), and AT1 (0).

A logic low from the Attenuator Control Latch applied to the comparator's negative input will cause the output to go to -14V. A -14V output from the comparator turns off the positive source transistor and turns on the negative source transistor. The collector of the negative source transistor is tied to -15V. When the transistor is turned on, -15V is applied through a current limiting resistor to the switching circuits within the attenuator, and the attenuator function is turned off. The diode in the base circuit of the positive source transistor prevents emitter/base junction reverse bias limits from being exceeded when the comparator output switches from +14V to -14V.

The A9 Attenuator Assembly consists of four separate sub-assemblies, the HET section (AT1), the 60 dB section (AT2), the 80 dB section (AT3), and the Reverse Power section (AT4). For output frequencies of 130 MHz to 1040 MHz, HET(MAIN) is selected by the Microprocessor and frequencies from 130 MHz to 1040 MHz from the A6 Assembly High-Band Output Amplifier are applied to AT1. These frequencies are passed through AT1 and then to AT2, AT3, and AT4. For output frequencies from 0.1 MHz to 129.99999 MHz, HET(HET) is selected by the Microprocessor and High-Band frequencies from 800.1 MHz to 929.99999 MHz are switched from AT1 to the RF input of the A6 Assembly Heterodyne Section. The 0.1 MHz to 129.99999 MHz Low-Band output from the A6 Assembly Heterodyne Section output is applied to AT1 and then passed on to AT2, AT3, and AT4. AT2 can be selected for 0 dB, 10 dB, 30 dB, 50 dB, or 60 dB of attenuation. AT3 can be selected for 0 dB, 20 dB, 40 dB, 60 dB, or 80 dB of attenuation. Together, AT2 and AT3 provide from 0 to 140 dB of attenuation in 10 dB steps (refer to Table 1). Data from the Microprocessor selects the proper attenuator combination for the output amplitude selected.

Reverse Power Protection

The AT4 reverse power limiter/detector circuits in the attenuator prevent reverse power levels from damaging the Attenuator or Output Amplifiers. The limiter limits the maximum voltage on the transmission line to ± 5 Vpk. The power in the attenuator is detected and a proportional dc voltage is applied to the negative input of A10U35A in the Reverse Power Sense circuits. U35A functions as a voltage comparator where the positive input reference voltage is approximately +2.5 Vdc by resistors A10R149 and R150 divided from the +5V(F1) supply voltage. When the negative input to comparator A10U35A becomes more positive than the +2.5V reference, the output of A10U35A switches to approximately -15 Vdc.

The current through A10R151 fixes the voltage at J-K Flip-Flop A10U36 at approximately 0.0V which resets the flip-flop. The active low output at pin 6 of A10U36 is high and biases transistor A10Q14 off and removes the current through the reverse power relay within the attenuator. This opens the relay in the transmission line removing the external input. The active high output at pin 5 of A10U36 is low and provides a reverse power interrupt, RPI, to the Microprocessor. The Microprocessor services the interrupt causing the AMPLITUDE Display to flash. The keyboard is locked up except for the Amplitude controls alerting the operator of a reverse power condition. The relay remains open until a new output level is entered. Attenuator Strobe 1 (ASTB1) clocks A10U36 (refer to Table 2). The active low not Q output turns on A10Q14 energizing the relay. If the reverse power condition was not removed, the detector detects the condition as before, re-opening the relay.

Table 1. Attenuation Selected Versus Instrument Attenuation.

Instrument Attenuation (dB)	A9AT2 (60 dB) Attenuation Selected					A9AT3 (80 dB) Attenuation Selected				
	0 dB	10 dB	30 dB	50 dB	60 dB	0 dB	20 dB	40 dB	60 dB	80 dB
0	S*					S				
10		S								
20	S						S			
30		S					S			
40	S							S		
50			S				S			
60	S								S	
70			S					S		
80					S		S			
90				S				S		
100					S			S		
110				S					S	
120					S				S	
130				S						S
140					S					S

* S = Pad Selected

Table 2. A10U36 Operation.

Set	Reset	J	K	CLK (ASTB1) to J-K	Outputs	
					Active High	Active Low
H	L	X	X	X	L	H
H	H	H	L	↑	H	L

Low is $\leq +0.8$ Vdc; High is $\geq +2.0$ Vdc.

TROUBLESHOOTING

Procedures for checking the A9 Attenuator, and part of the A10 Audio/Power Supply Assembly circuits are given below. The areas or points to check are marked on the schematic by a hexagon with a checkmark and a number inside, for example, $\checkmark 1$. Fixed voltages are shown on the schematic inside a hexagon, for example, $2V \pm 0.2V$. Transistor bias voltages are shown without tolerances.

Troubleshooting Help

Block Diagram 2

Table 4-1. Abbreviated Performance Tests

Table 5-2. Post-Repair Adjustments

Test Equipment

Digital Multimeter	HP 3466A
DC Power Supply	HP 6215A
Measuring Receiver	HP 8902A
Sensor Module	HP 11722A
Signature Analyzer	HP 5005A
Test Cable	HP 5061-4827

CAUTION

Over-tightening the hex nuts on the A6 Assembly and the A9 Assembly RF connectors (to > 5 in/lbs) will change the dielectric constant of the semi-rigid cable. (Under-tightening may cause RF leakage.)

NOTE

The Attenuator Assembly, A9, is repaired by replacing the failed section (AT1, Heterodyne), (AT2, 60 dB), (AT3, 80 dB), (AT4, Reverse Power) or cable. The complete assembly is not a replaceable part.

√1 Attenuator Control

Two data words are latched into the Attenuator Control Latches U9 and U25 by Attenuator Strobes ASTB1 and ASTB2. The output of the latches are applied to the Attenuator Driver comparators U26, U27, and U28. The comparators turn on the appropriate current source transistors to drive the switching networks within the attenuator. A positive voltage enables the attenuator function and a negative voltage disables the attenuator function.

1. Set the Signal Generator as follows:

Frequency 100 MHz
 Amplitude 0 dBm

2. Verify the Attenuator Control Latch output logic and the attenuator drive voltages shown in Table 3 and change the front-panel frequency as indicated.

3. Set the Signal Generator as follows:

Frequency 520 MHz
 Amplitude 0 dBm

4. Verify the Attenuator Control Latch logic levels shown in Table 4 and change the front-panel amplitude as indicated.

5. Set the Signal Generator as follows:

Frequency 520 MHz
 Amplitude 0dBm

6. Verify the Attenuator Driver voltages as shown in Table 5 and change the front-panel amplitude as indicated.

Table 3. Main Band/HET Band Attenuator Drivers.

Signal Generator Frequency	A10U25 Logic*		A10U34 (Vdc)	
	Pin 16	Pin 19	Pin 3	Pin 12
100	L	H	-12.0	+13.1
520	H	L	+13.1	-12.0

* Low is ≤ 0.8 Vdc; High is ≥ 2.0 Vdc.

Table 4. Attenuator Control Output Logic.*

Signal Generator Amplitude (dBm)	A10U9								A10U25	
	Pin 2	Pin 5	Pin 6	Pin 9	Pin 12	Pin 15	Pin 16	Pin 19	Pin 2	Pin 5
0	H	L	H	H	H	H	H	H	L	L
-10	H	L	H	H	L	H	H	H	L	H
-20	H	L	H	H	H	H	H	H	H	L
-30	H	L	H	H	L	H	H	H	H	H
-40	H	H	H	H	H	H	H	H	H	L
-50	H	H	H	H	H	L	H	H	H	H
-60	H	H	L	H	H	H	H	H	H	L
-70	H	H	H	H	H	L	H	H	H	H
-80	H	H	H	H	H	H	H	L	H	H
-90	H	H	H	H	H	H	L	H	H	H
-100	H	H	H	H	H	H	H	L	H	H
-110	H	H	L	H	H	H	L	H	H	H
-120	H	H	L	H	H	H	H	L	H	H
-130	H	H	H	L	H	H	L	H	H	H
-140	L	L	H	L	H	H	H	L	H	H

* Low is ≤ 0.8 Vdc; High is ≥ 2.0 Vdc.

Table 5. Attenuator Driver Voltage Levels (Vdc).

Signal Generator Amplitude (dBm)	A10U29		A10U30		A10U32		A10U31		A10U33	
	Pin 3	Pin 12	Pin 3	Pin 12	Pin 3	Pin 12	Pin 3	Pin 12	Pin 3	Pin 12
0	-8.3	-8.3	-8.3	-8.3	-8.3	-8.3	-8.3	-8.3	+12.6	+12.6
-10	-8.3	-8.3	-8.3	+12.6	-8.3	-8.3	-8.3	-8.3	+12.6	-6.3
-20	-8.3	-8.3	-8.3	-8.3	+12.6	-8.3	-8.3	-8.3	-6.3	+12.6
-30	-8.3	-8.3	-8.3	+12.6	+12.6	-8.3	-8.3	-8.3	-6.3	-6.3
-40	-8.3	-8.3	-8.3	-8.3	-8.3	+12.6	-8.3	-8.3	-6.3	+12.6
-50	-8.3	-8.3	+12.6	-8.3	+12.6	-8.3	-8.3	-8.3	-6.3	-6.3
-60	-8.3	-8.3	-8.3	-8.3	-8.3	-8.3	+12.6	-8.3	-6.3	+12.6
-70	-8.3	-8.3	+12.6	-8.3	-8.3	+12.6	-8.3	-8.3	-6.3	-6.3
-80	+12.6	-8.3	-8.3	-8.3	+12.6	-8.3	-8.3	-8.3	-6.3	-6.3
-90	-8.3	+12.6	-8.3	-8.3	-8.3	+12.6	-8.3	-8.3	-6.3	-6.3
-100	+12.6	-8.3	-8.3	-8.3	-8.3	+12.6	-8.3	-8.3	-6.3	-6.3
-110	-8.3	+12.6	-8.3	-8.3	-8.3	-8.3	+12.6	-8.3	-6.3	-6.3
-120	+12.6	-8.3	-8.3	-8.3	-8.3	-8.3	+12.6	-8.3	-6.3	-6.3
-130	-8.3	+12.6	-8.3	-8.3	-8.3	-8.3	-8.3	+12.6	-6.3	-6.3
-140	+12.6	-8.3	-8.3	-8.3	-8.3	-8.3	-8.3	+12.6	-6.3	-6.3

√2 Reverse Power Protection

1. Set the Signal Generator as follows:

Frequency 520 MHz
 Amplitude -10 dBm
 Modulation Off

2. Set the dc power supply to +20 Vdc, turn the power supply OFF, and connect it to the RF OUTPUT connector. Then turn the power supply ON.

The Reverse Power Protection circuitry should be activated and the front-panels AMPLITUDE Display should be flashing. (Dependent upon the rise time of the power supply output voltage.)

3. Measure and verify the voltages shown in Table 6.

Table 6. Reverse Power Protection Operating Voltages (Vdc).

Reverse Power Relay	A10U35	A10U36		A10Q14		
	Pin 6	Pin 2	Pin 6	E	B	C
Closed	+4.5	+4.5	+0.2	+5.0	+4.3	+5.0
Open	+4.5	+4.5*	+5.0	+5.0	+5.0	0.0

* The output of the comparator (A10U35 pin 6) will be low only for the time required to open the reverse power relay.

4. Disconnect the dc power supply from the Signal Generator and press the front-panel AMPTD key. Check for a high TTL ASTB1 pulse at A10U36 pin 12. The ASTB1 pulse clocks the J-K Flip-Flop, biasing A10Q14 on, and closes the reverse power relay in the attenuator.

√3 AT2, and AT3 Check

AT2 (60 dB Section) and AT3 (80 dB Section) are checked by selecting Keyboard-Invoked Test Number 1.

Keyboard-Invoked Test Number 1

The test routine is “entered” to start the test and then “exited” to regain control of the front panel.

5. Enter the Keyboard-Invoked Tests by first pressing the **SHIFT** key and then pressing the **INCR SET** key. A “1” should be shown in the **MODULATION** display window.
6. Start the test routine by pressing the **INCR SET** key. A “0” should be shown in the **FREQUENCY** display window.
7. Select keyboard numbers 0 through 8 to select the attenuation levels shown in Table 7 for the 60 dB and 80 dB sections. Each number selected appears in the Frequency Display.
8. Exit the Keyboard-Invoked Tests by pressing the **AMPTD H** key until a “7” is shown in the **MODULATION** display window, then press the **INCR SET** key. The Signal Generator should go through its power-up routine.

Table 7. Attenuation Selected Versus Keyboard Entry.

Keyboard Number	A9AT2 (60 dB) Attenuation Selected					A9AT3 (80 dB) Attenuation Selected				
	0 dB	10 dB	30 dB	50 dB	60 dB	0 dB	20 dB	40 dB	60 dB	80 dB
0	S					S				
1							S			
2								S		
3									S	
4										S
5		S								
6			S							
7				S						
8					S					

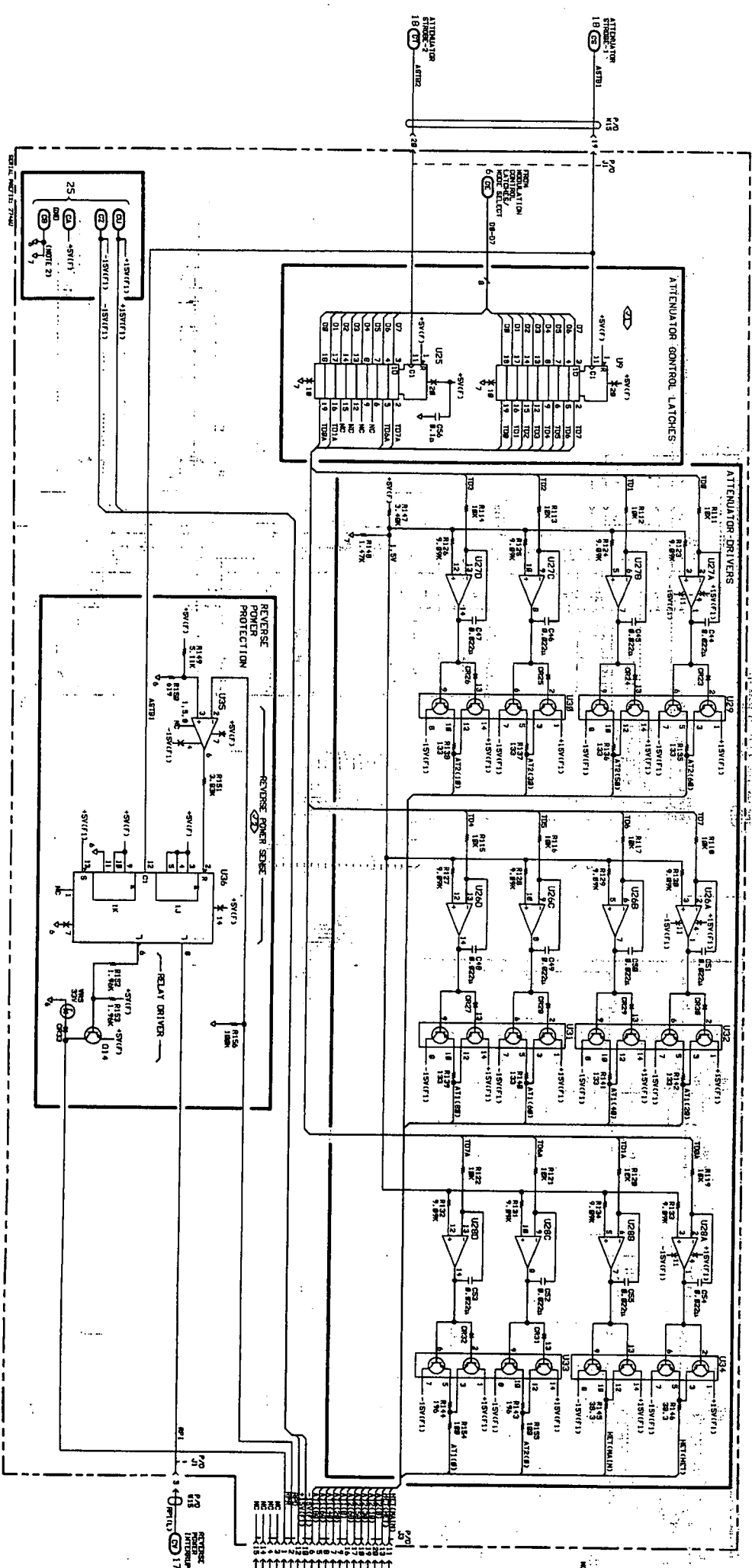
A10 Component Coordinates (1 of 2)

COMP	X,Y	COMP	X,Y	COMP	X,Y	COMP	X,Y	COMP	X,Y	COMP	X,Y
C3	B,3	C56	A,3	J1	A,3	R21	B,1	R66	B,1	R131	A,2
C4	C,1	C57	A,2	J2	B,3	R22	C,1	R67	B,1	R132	A,2
C5	C,1	C58	A,1	J3	B,3	R23	C,1	R68	B,1	R133	B,2
C6	B,1	C59	A,1	J4	C,3	R24	B,1	R69	A,1	R134	B,2
C7	B,1	C60	A,1	J5	C,3	R25	B,1	R70	A,1	R135	C,2
C8	B,1					R26	B,1	R71	A,1	R136	C,2
C9	B,1	CR1	C,1	K1	C,3	R27	B,1	R72	A,1	R137	C,3
C10	B,1	CR2	C,1			R28	B,1	R73	A,1	R138	C,3
C11	C,1	CR3	C,1	L1	C,3	R29	B,1	R74	B,1	R139	B,3
C12	B,1	CR4	C,1	L2	C,3	R30	B,2	R75	B,1	R140	B,3
C13	B,1	CR5	B,1	L3	C,3	R31	B,1	R76	A,1	R141	B,2
C14	A,2	CR6	B,1			R32	B,1	R77	B,1	R142	B,2
C15	A,2	CR7	B,1	MP1	D,1	R33	B,1	R83	D,3	R143	B,2
C16	B,1	CR10	D,3	MP2	D,1	R34	A,1	R84	D,3	R144	B,2
C17	B,2	CR11	D,3			R35	B,2	R85	C,2	R145	B,2
C18	A,1	CR12	D,3	Q1	C,2	R36	C,1	R86	C,2	R146	B,2
C19	B,1	CR13	D,3	Q2	B,1	R37	C,1	R90	D,2	R147	B,2
C20	C,2	CR14	C,3	Q3	D,3	R38	B,2	R100	C,3	R148	B,2
C21	A,1	CR15	C,2	Q5	B,2	R39	B,2	R101	C,3	R149	A,2
C22	A,1	CR16	C,2	Q6	B,2	R40	C,1	R102	C,3	R150	A,3
C23	B,1	CR17	D,3	Q7	A,1	R41	C,1	R103	C,2	R151	A,2
C24	D,3	CR19	C,2	Q8	B,1	R42	C,1	R104	C,2	R152	A,2
C25	D,3	CR20	C,2	Q9	B,1	R43	C,1	R105	C,2	R153	A,2
C26	D,1	CR21	C,2	Q10	C,1	R44	B,1	R106	C,2	R154	C,2
C27	D,3	CR23	B,2	Q11	B,2	R45	C,1	R107	C,2	R155	C,2
C28	D,2	CR24	B,2	Q12	C,1	R46	C,1	R111	A,3	R156	A,3
C30	D,1	CR25	B,3	Q14	A,2	R47	B,2	R112	A,3		
C35	C,2	CR26	B,3			R48	C,2	R113	A,3	TP1	A,1
C36	C,2	CR27	B,3	R1	C,2	R49	A,1	R114	A,3	TP2	A,1
C37	C,2	CR28	B,3	R2	B,2	R50	A,1	R115	A,3	TP3	A,1
C38	C,3	CR29	B,3	R3	B,2	R51	B,1	R116	A,3	TP4	A,1
C39	C,3	CR30	B,3	R4	B,2	R52	B,1	R117	A,3	TP5	A,1
C40	C,3	CR31	B,2	R8	B,1	R53	B,1	R118	A,3	TP6	B,2
C44	B,2	CR32	B,2	R9	B,1	R54	A,1	R119	A,2	TP9	B,1
C45	B,2	CR33	A,2	R10	C,1	R55	A,1	R120	A,2	TP10	B,1
C46	B,3			R11	B,1	R56	A,1	R121	A,2	TP11	B,1
C47	B,3	DS2	C,2	R12	C,1	R57	B,1	R122	A,2	TP12	B,2
C48	B,3	DS3	C,2	R13	C,1	R58	B,1	R123	A,2		
C49	B,3	DS4	C,2	R14	B,1	R59	B,1	R124	B,2	U1	C,2
C50	B,3			R15	B,1	R60	B,1	R125	B,2	U5	A,2
C51	B,3			R16	C,1	R61	B,1	R126	A,2	U6	A,1
C52	B,2	F1	D,3	R17	C,1	R62	B,1	R127	A,2	U7	A,1
C53	B,2	F2	D,3	R18	B,2	R63	A,1	R128	B,2	U9	A,3
C54	B,2	F3	D,2	R19	B,1	R64	B,1	R129	B,2	U10	A,1
C55	B,2	F4	D,2	R20	B,1	R65	A,1	R130	A,2	U11	A,1

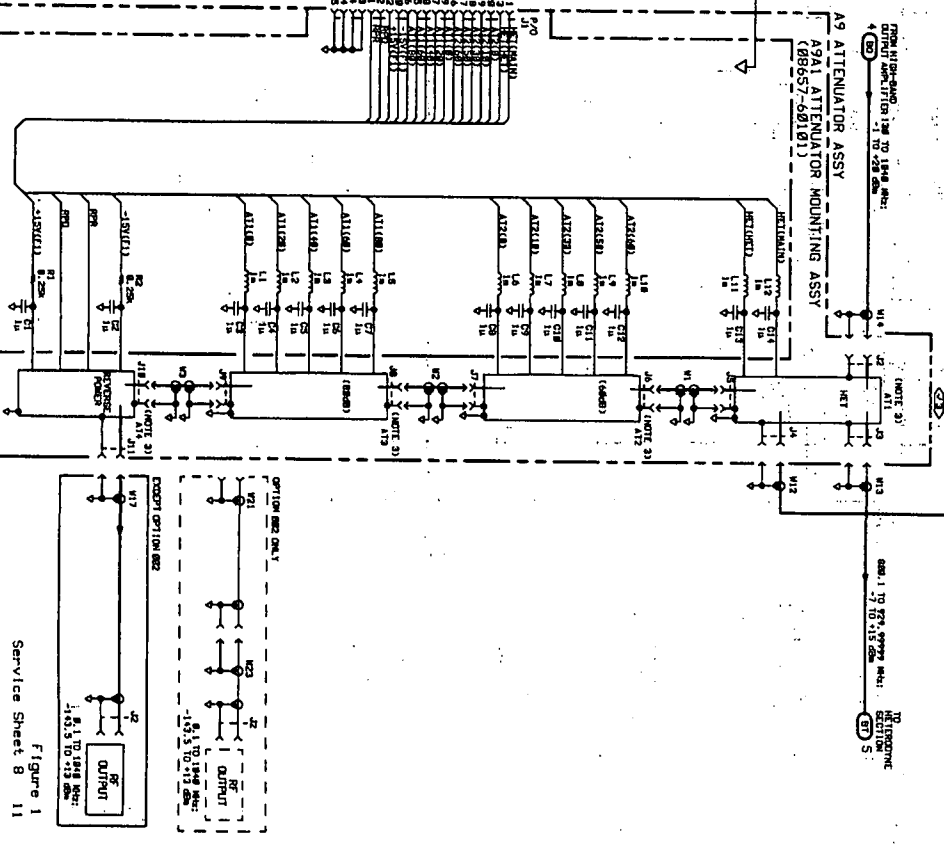
A10 Component Coordinates (2 of 2)

COMP	X,Y	COMP	X,Y	COMP	X,Y	COMP	X,Y	COMP	X,Y	COMP	X,Y
U12	A,1										
U13	A,2										
U14	A,1										
U15	A,2										
U16	B,2										
U17	A,2										
U18	A,2										
U19	A,1										
U20	B,1										
U21	C,1										
U22	B,1										
U23	C,1										
U24	B,1										
U25	A,3										
U26	B,3										
U27	B,3										
U28	B,2										
U29	C,2										
U30	C,3										
U31	B,3										
U32	B,2										
U33	B,2										
U34	B,2										
U35	A,2										
U36	A,2										
VR1	B,1										
VR2	B,1										
VR3	C,1										
VR4	D,3										
VR5	A,2										
VR6	C,2										
VR7	B,2										
W1	B,1										
W2	A,1										
W3	A,1										
W4	B,1										

A10 AUDIO/POWER SUPPLY ASSEMBLY (88657-60105)



A9 ATTENUATOR ASSY (88657-60101)



Service Sheet 8 Figure 11

A9, A9A1 ATTENUATOR, ATTENUATOR
P/O A10 CONTROL AND REVERSE
POWER PROTECTION

SEE REVERSE SIDE

SS8

Errata

Title & Document Type: 8657A Service Manual Volume 2

Manual Part Number: 08657-90157

Revision Date: July 1993

HP References in this Manual

This manual may contain references to HP or Hewlett-Packard. Please note that Hewlett-Packard's former test and measurement, semiconductor products and chemical analysis businesses are now part of Agilent Technologies. We have made no changes to this manual copy. The HP XXXX referred to in this document is now the Agilent XXXX. For example, model number HP8648A is now model number Agilent 8648A.

About this Manual

We've added this manual to the Agilent website in an effort to help you support your product. This manual provides the best information we could find. It may be incomplete or contain dated information, and the scan quality may not be ideal. If we find a better copy in the future, we will add it to the Agilent website.

Support for Your Product

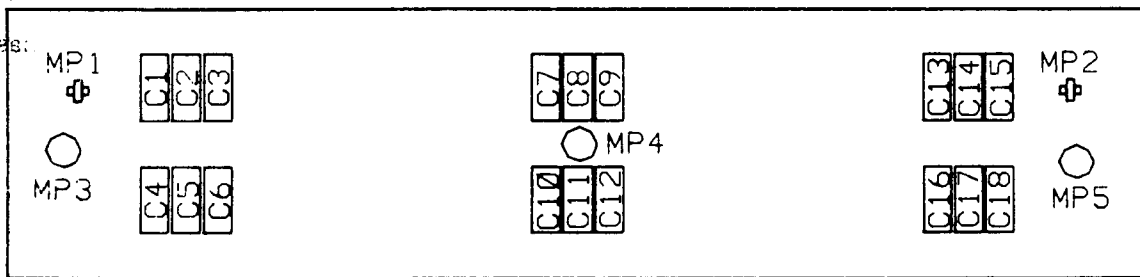
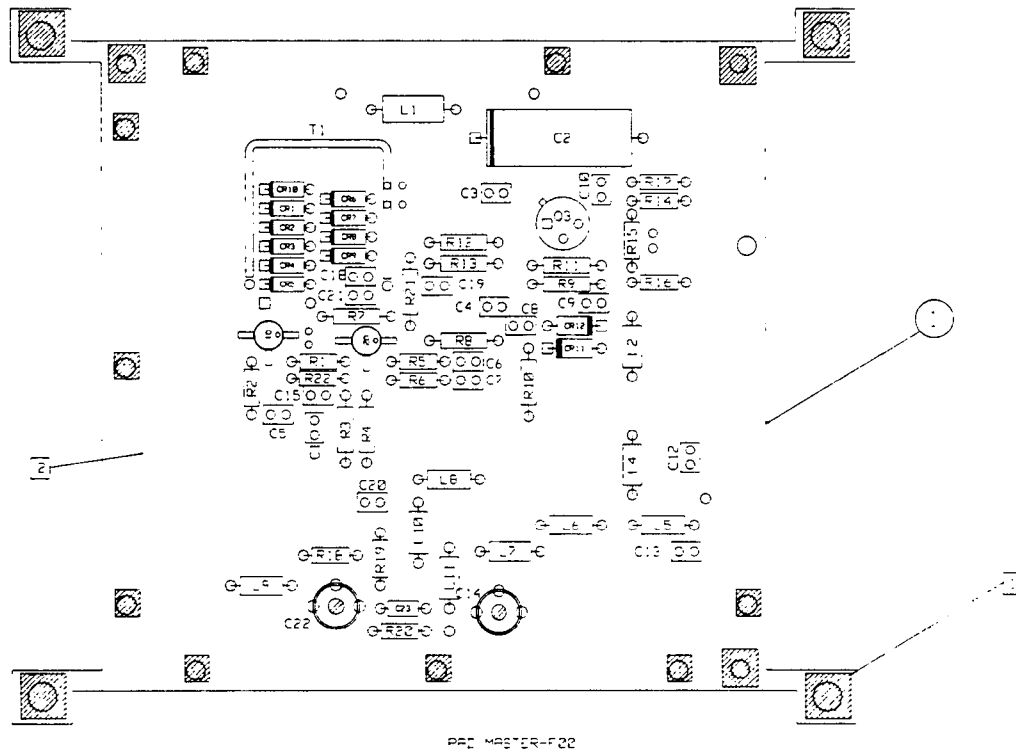
Agilent no longer sells or supports this product. You will find any other available product information on the Agilent Test & Measurement website:

www.tm.agilent.com

Search for the model number of this product, and the resulting product page will guide you to any available information. Our service centers may be able to perform calibration if no repair parts are needed, but no other support from Agilent is available.

NOTES

1. For an explanation of schematic symbols, see "SCHEMATIC DIAGRAM NOTES" in Section 8.
2. Chassis ground is achieved by mechanical contact through nuts holding PC board to frame.
3. Printed circuit trace inductor.
4. T₁ is realized with semi-rigid coax cable. Inner conductor acts as transformer primary, outer ground shield acts as transformer secondary.
5. +11V is located on AC ground plane.



Component Locators

Figure 0. Service Sheet 9 Information

Service Sheet 9

LOW FREQUENCY LOOP VOLTAGE CONTROLLED OSCILLATOR

PRINCIPLES OF OPERATION

General

The Low Frequency Voltage Controlled Oscillator (VCO) and Limiter Amplifier generate the 60 to 110 MHz signal that is mixed with 800 MHz on the Multiplier Assembly to lock the High Frequency Loop. The VCO is phase locked to the instrument's 50 MHz frequency reference by the Fractional-N phase lock loop. The Fractional-N phase lock loop and the VCO's frequency are controlled by data from the Microprocessor.

60 to 110 MHz VCO

The VCO is a tuned collector oscillator with transformer feedback. The transformer T1 is a piece of semi-rigid coax cable. The outer jacket is the primary and the center conductor is the secondary. The outer jacket primary is a 25 nH inductor and together with varactors CR1 through CR10 forms the tuned resonant circuit for the oscillator. Ten varactors are needed to achieve the tuning capacitance of 75 to 300 pF. Transistors Q1, Q2, and their associated components form an inverting amplifier with approximately 20 dB of gain. Positive feedback for oscillation is provided by feeding the amplifier output to the resonator by way of R11, while the input is connected to the secondary.

The VCO's frequency from 60-110 MHz is controlled by the tune voltage from the Fractional-N phase lock loop. The tune voltage is applied to the resonant circuit varactors through inductor L1. The frequency is approximately 60 MHz with the tune voltage at +9V and approximately 110 MHz with the tune voltage at -6V.

The +11V supply is the internal virtual ground for RF signals and is a stable dc voltage for the oscillator. Biasing for Q2 is provided through the primary (outer jacket) of T1 and resistors R3 and R7. Biasing for the base of Q1 is provided by resistors R12 and R13 through the center conductor (secondary) of T1.

Resistors R2 and R21 with their respective capacitors C5 and C15 are for oscillator stability. C18, C6, and C7 are dc-blocking capacitors.

Limiter Amplifier

The VCO's output is ac coupled to limiter amplifier Q3. The bias voltages of Q3 are set by resistors R9, R10 and R11. Collector to base diodes CR11 and CR12 limit the collector swing to \pm one diode drop.

The output of the Limiter Amplifier is ac coupled by capacitor C10 to the Fractional-N phase lock loop Buffer Amplifier Q47 shown on Service Sheet 10 and to the 110 MHz Low-pass filter.

110 MHz Low-Pass Filter and Attenuator Pads

The input Attenuator of R14, R15 and R16 sets the input signal level to the Low-Pass Filter and provides impedance matching. The filter passes the 60 to 110 MHz VCO signal and rejects its harmonics. Capacitor C14 and inductor L7 form a series resonant circuit for adjusting the filters frequency response. The adjustment optimizes the filters rejection at 120 MHz. The output of the filter is fed to J1 through the level-setting attenuator formed by R18, R19, and R20.

TROUBLESHOOTING

Procedures for checking the A3A1 Low Frequency Loop Oscillator circuits are given below. The areas or points to check are marked on the schematic by a hexagon with a checkmark and a number inside, for example, $\checkmark 1$. Fixed voltages are shown on the schematic inside a hexagon, for example, $2V \pm 0.2V$. Transistor bias voltages are shown without tolerances.

Troubleshooting Help

- Block Diagram 3
- Table 4-1. Abbreviated Performance Tests
- Table 5-2. Post-Repair Adjustments

Test Equipment

Digital Multimeter	HP 3466A
Measuring Receiver	HP 8902A
Sensor Module	HP 11722A
Adapter Probe	HP 1250-1598
Adapter N(f) to BNC(m)	HP 1250-0077
Adapter BNC(f) to BNC(f)	HP 1250-0080
Cable BNC(m) to SMC(f)	HP 08662-60075

$\checkmark 1$ Voltage Controlled Oscillator, Limiter Amplifier and 110 MHz Low-Pass Filter

1. Set the Signal Generator as follows:

Frequency	80 MHz
Amplitude	-10 dBm
Modulation	Off

2. Set the measuring receiver with the sensor module precalibrated as follows:

Measurement	RF POWER
Display	LOG

3. Zero the measuring receiver and wait for the zero LED to go out.
4. Change the Signal Generator's frequency to 90 MHz. This ensures the frequency of the Low Frequency Loop VCO to be 60 MHz.

5. Measure frequency, tune voltage and power levels at each point indicated in Table 1.

NOTE

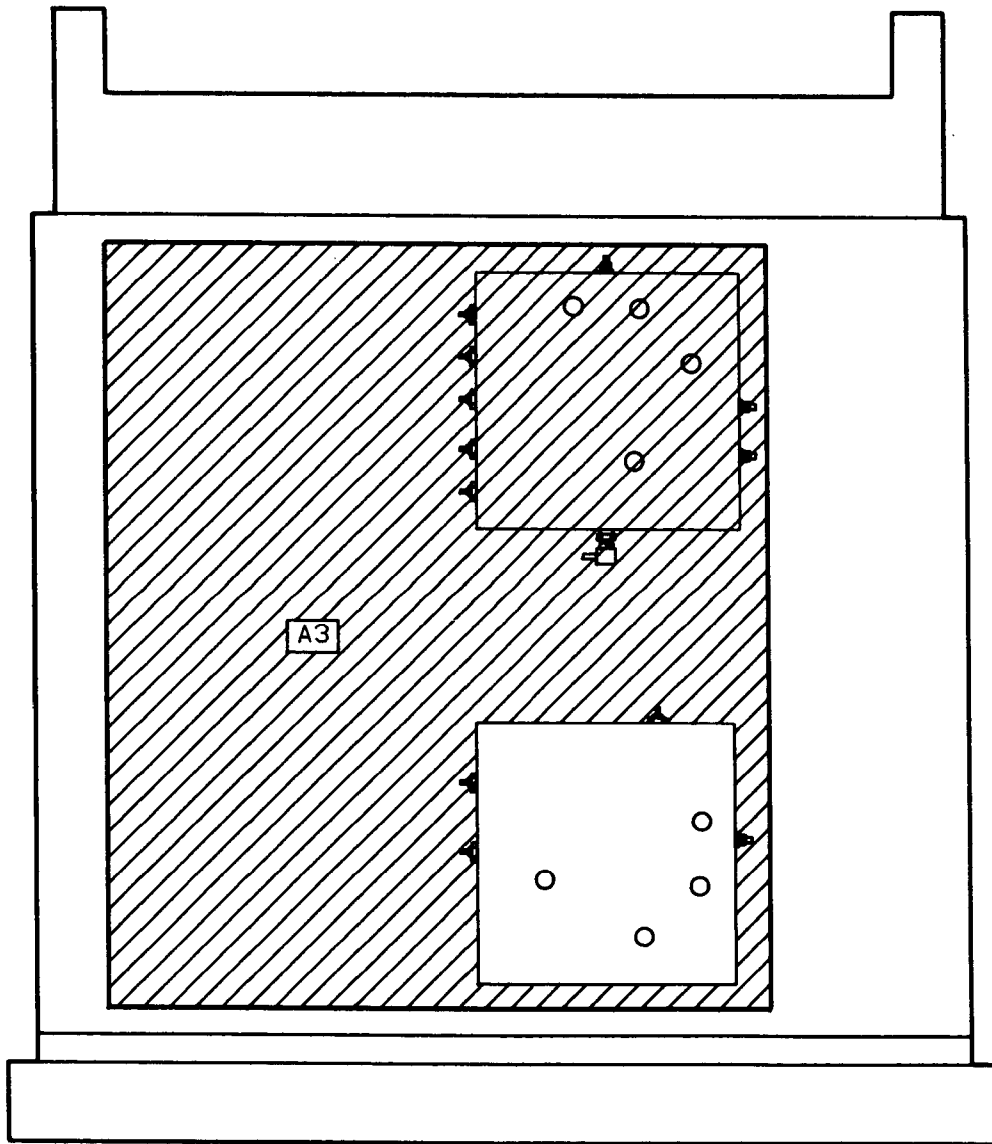
When probing the VCO with the covers removed, a frequency shift may be introduced.

6. Measure Residual FM using the measuring receivers 300 Hz and 3 kHz high-pass and low-pass filters, and RMS Detector. The Residual FM should be less than 3 Hz for all frequencies.
7. Measure Residual FM using the measuring receivers 50 Hz and 15 kHz high-pass and low-pass filters and RMS Detector. The Residual FM should be less than 5 Hz for all frequencies.

Table 1. VCO Frequency, Power Output and Tune Voltage.

Frequency (MHz)		VCO Tune Voltage at C16 (Vdc)	Power Level at J1 (dBm)
Front-Panel Setting	VCO Output (at J1)		
90	60	+9 to +7	-4.5 to -6.5
85	65	+8 to +6	-4.5 to -6.5
80	70	+6 to +4	-4.5 to -6.5
75	75	+5 to +3	-4.5 to -6.5
70	80	+3.5 to 1.5	-5.0 to -7.0
65	85	+2.0 to 0.0	-5.0 to -7.0
60	90	+1.0 to -1.0	-5.5 to -7.5
55	95	-0.5 to -2.5	-5.5 to -7.5
50	100	-1.5 to -3.5	-5.5 to -7.5
45	105	-3.0 to -5.0	-5.5 to -7.5
40	110	-5.0 to -7.0	-5.5 to -7.5

TOP INTERNAL VIEW - LEVEL 1



NOTES

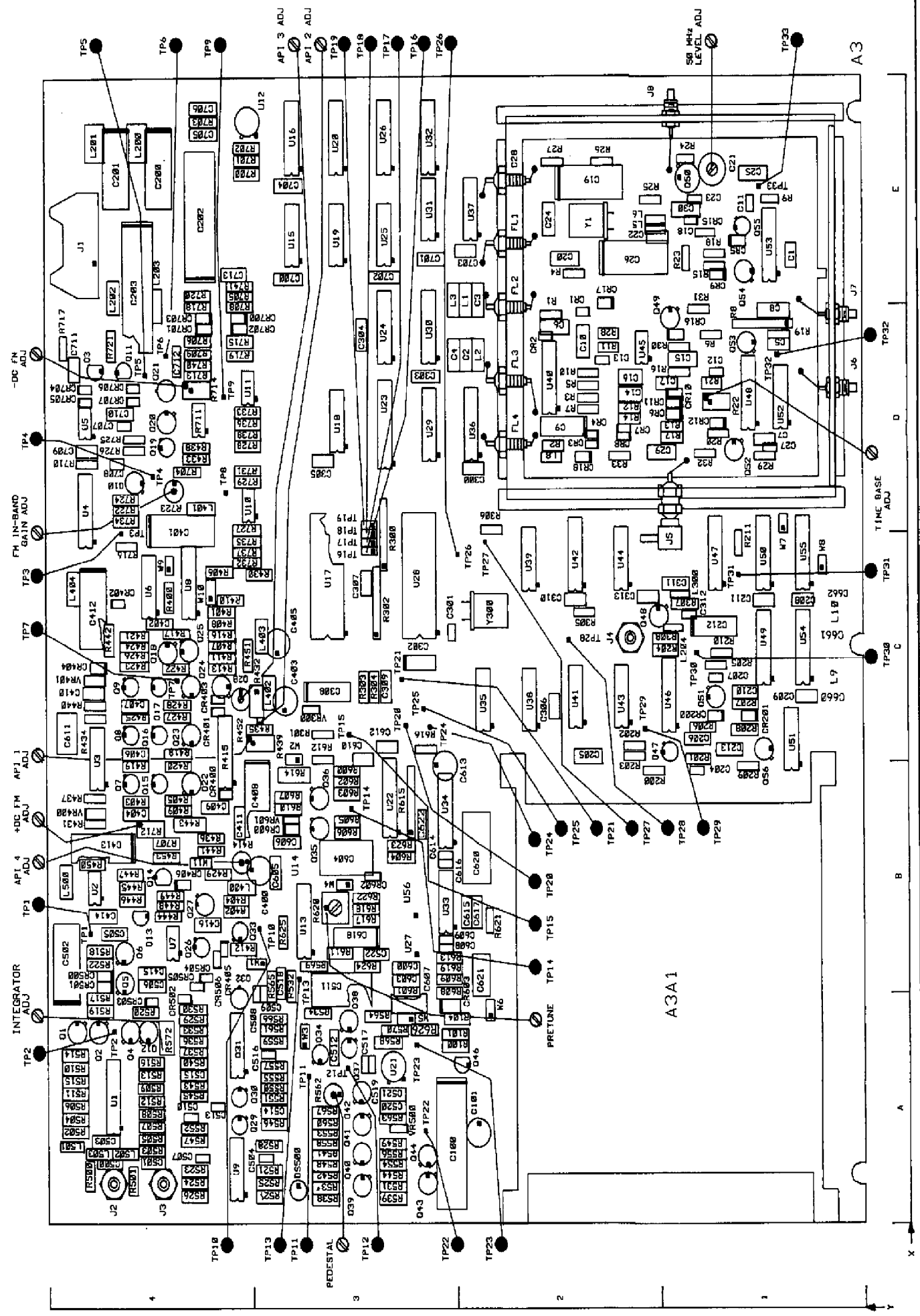
1. For an explanation of schematic symbols, see "SCHEMATIC DIAGRAM NOTES" in Section 8.
2. Nominal value of RF choke is 2.5-6uH.
3. Chassis ground is achieved by mechanical contact through nuts holding PC board to cover and W4.
4. Reference designations on this service sheet C, CR, L and R have numbers ranging from 200 to 299 only.
5. Wide-band RF choke approximately 6uH.

LOGIC LEVELS

	TTL	ECL
HIGH	2V	+4.2V
LOW	0.8V	+3.3V
IS MORE NEG. THAN IS MORE POS. THAN		
OPEN	HIGH	LOW
GROUND	LOW	HIGH

P/O A3, LOW FREQUENCY LOOP
A3A1, A7 VOLTAGE CONTROLLED
SEE REVERSE SIDE OSCILLATOR

SS9



Component Locator

Figure 0. Service Sheet 10 Information

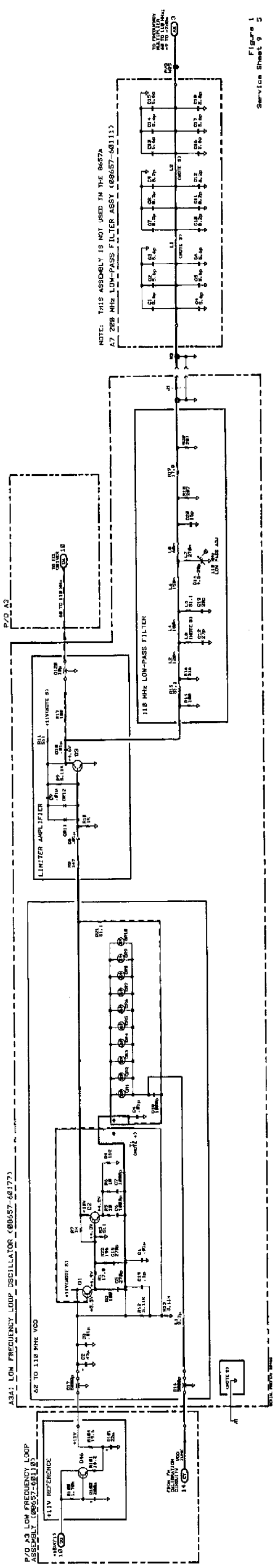


Figure 1
Service Sheet 9 5

Service Sheet 10

LOW FREQUENCY LOOP DIVIDE-BY-2, AND PRESCALER

PRINCIPLES OF OPERATION

General

The VCO's output, 60 to 110 MHz, passes through Buffer Amplifier Q47, and is divided-by-2 at U46A. The output frequency of the Divide-By-2 circuit is 30 to 55 MHz, and is the clock for the Prescaler. The Prescaler divides the 30 to 55 MHz frequencies by 9, 10 or 11. The Prescaler is a variable 4-to-6-bit ring-counter followed by a divide-by-2 circuit. In the divide-by-10 mode, the ring-counter is set to modulus 5, and the Divide-By-2 circuit makes the total divisor equal to 10. In the divide-by-11 mode, the ring-counter is set to modulus 6 for one cycle, and to modulus 5 for another cycle of the Prescaler. After 2 cycles, the result is a divide-by-11. In the divide-by-9 mode, the ring-counter is set to modulus 4 for one cycle, and to modulus 5 for another cycle of the Prescaler. After 2 cycles, the result is a divide-by-9.

The modulus of the ring-counter is controlled by the Remove Cycle, and the Add Cycle control inputs. A high on the Remove Cycle control input changes the modulus of the Prescaler to 6, by controlling the K input of U54A. As long as the Remove Cycle control input is high, the modulus of the Prescaler is 6 for one cycle, and 5 for another cycle; the Prescaler divides-by-11. A high on the Add Cycle control input changes the modulus to 4, by controlling the K input of U54B. As long the Add Cycle control input is high, the modulus of the Prescaler is 4 for one cycle, and 5 for another cycle; the Prescaler divides-by-9. If both inputs are high, the Prescaler modulus is 4 (an unwanted state).

The Remove and Add Cycle inputs are used for the following purposes:

- The Remove Cycle, Divide-By-11, is set high by the Fractional-N IC to generate fractional frequencies, and by the FM Digital circuits to control frequency modulation.
- The Add Cycle, Divide-By-9, is set high by the FM Calibration circuits and by the FM Digital circuits to control frequency modulation.

Buffer Amplifier and Divide-By-2

The VCO's output, 60 to 110 MHz, is ac coupled by C204 to the base of Buffer Amplifier Q47. Q47 is dc biased at the collector for approximately +3.5 Vdc. The VCO's input voltage causes the collector voltage to cross valid ECL logic levels $< +3.3\text{V}$ and $> +4.2\text{V}$. The ECL high and low output clocks the divide-by-2 master-slave D flip-flop U46A on each low to high transition. Thus, the output of U46A toggles dividing the input frequency by 2, and making the output frequency 30 to 55 MHz. Transistor Q51 translates the ECL logic levels to TTL logic levels. The output of U46A toggles Q51 on and off changing its collector voltage from approximately 0 Vdc (TTL low), to approximately +3.5 Vdc (TTL high). Buffer Driver Q56 buffers the output of Q51, and with U51D provides the drive required for the Prescaler.

Prescaler

The 30 to 55 MHz output clocks the Prescaler. U49, U50, and U54 have their set and reset inputs disabled; thus, their output state is dependent upon the J, K, and clock inputs.

Divide-By-10

The Prescaler divides-by-10 when the Add Cycle control input, and the Remove Cycle control input are both low. The ring-counter modulus is 5 for all cycles of the Prescaler. The timing diagram for this mode is shown in Figure 1.

The J inputs to U55A and U55B are low, and the K, set, and reset inputs are hard-wired high. U55A and U55B are clocked on the high to low transition of U50A's Q output, the output of the ring-counter. The high K and low J inputs of U55A and U55B sets their Q outputs low and not Q outputs high, but only after the ring-counter has completed a cycle and is reset. After the first Prescaler cycle the output state of U55A and U55B does not change when clocked. The inputs to U51B are both high, its output and the K input of U54A is low. With the J input of U54A connected to +5 Vdc, its Q output is clocked high on the next VCO divide-by-2 clock at time T1. The inputs to U51C are high at pin 9 and low at pin 8, its output and the K input of U54B is low. Since the J input to U54B was just clocked high, the next clock pulse at time T2 sets its output high. The output of U54A remains high until the Remove Cycle control input is set high. The high Q output of U54B is clocked through the ring-counter to the Q output of U50A at time T3. The low output of U50A sets the input of U51C at pin 9 low, its output and the K input of U54B is set high. The K inputs of U49A, U49B and U50A are set high by the Q output of U50A, on the next VCO divide-by-2 clock their Q outputs are all toggled low at time T4. The output of the ring-counter sets the J and K inputs of the divide-by-2 flip-flop U50B high. U50B is toggled at the end of each ring-counter cycle when both J and K inputs are high at time T4. The Q output of U54A remains high, and on the next clock the Q output of U54B is clocked high at time T5 and the high is clocked through to U50A. The cycle is repeated until a high is received at the Remove or at the Add Cycle control input instructing the Prescaler to remove or add a cycle.

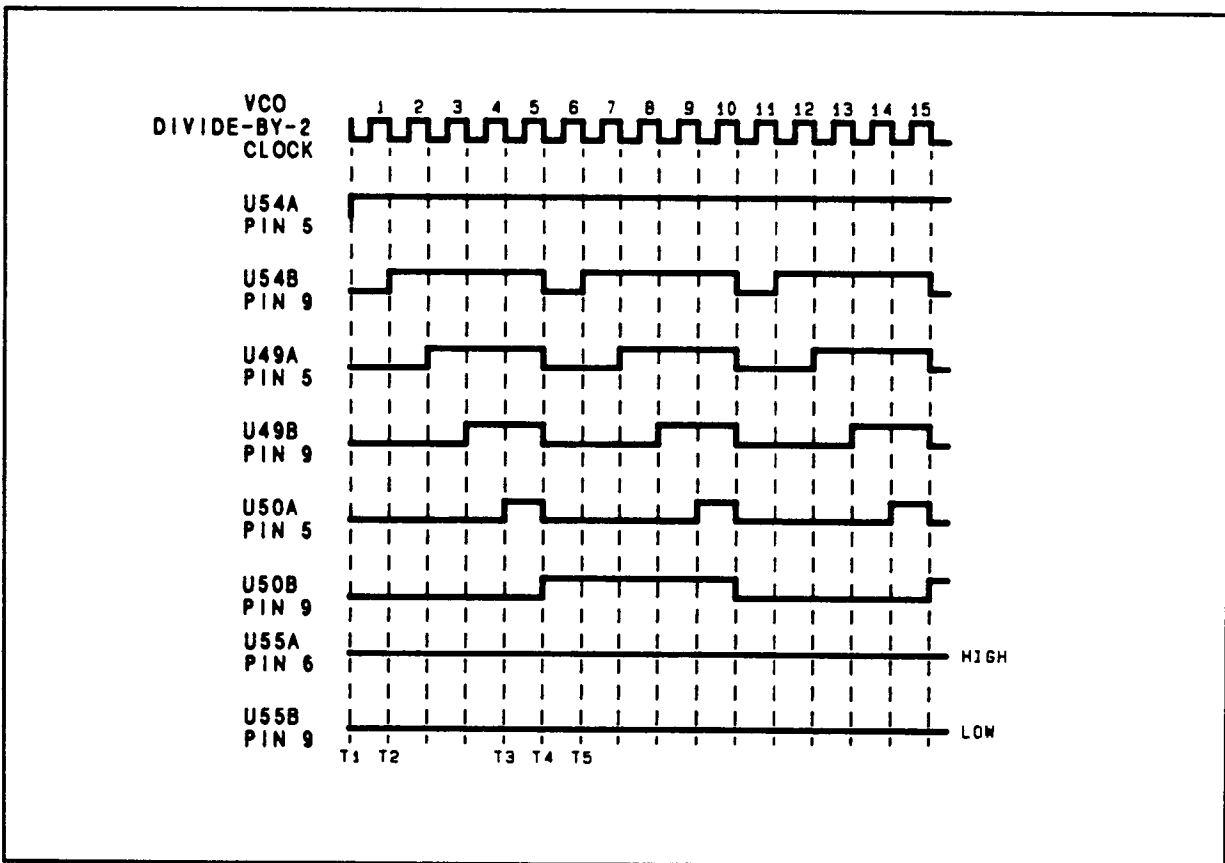


Figure 1. Divide-by-10 Timing Diagram.

Divide-By-11

The Prescaler divides-by-11 when the Remove Cycle control input is high, and the Add Cycle control input is low. The ring-counter's modulus is changed to 6 for one cycle, and to 5 for the next cycle of the Prescaler. The timing diagram for the divide-by-11 mode is shown in Figure 2.

With the J and K inputs to U55A high, when clocked the outputs toggle for each Prescaler cycle. The ring-counter's modulus also toggles from 6 to 5 each Prescaler cycle, and the Prescaler divides-by-11. This cycle is repeated until the Remove Cycle control input is set low. U55A is clocked on the high to low transition of U50A's Q output; at T2, the end of the Prescaler cycle. At time T1 the input at pin 5 of U51B is high, and the input at pin 6 is low. The K input to U54A is low and remains low until the not Q output of U55A is clocked low at time T2. The ring-counter remains in modulus 5 for the next cycle of the Prescaler. The K input to U54A is still low and at time T2 its Q output remains high. The Q output of U54B is toggled low, the not Q output of U55A is toggled low, and the Q output of U50B is toggled high. The VCO frequency is divided-by-5. At time T3, the Q output of U50A is high, and the not Q output is low. Both inputs to U51B are low, its output and the K input of U54A is high. The J and K inputs to U54A are both high and, its Q output is toggled low by the next clock at time T4. The K inputs of U49A, U49B, and U50A are set high by the high Q output of U50A. The next VCO divide-by-2 clock at time T4 toggles their Q outputs low. The Q output of U50A also sets the J and K inputs of the divide-by-2 J/K flip-flop U50B high at time T3. Its output is toggled low at time T4. The Q output of U54A remains low for one clock cycle, and is clocked high at time T5. The J and K inputs of U54B, U49A, U49B and U50A remain low. Their output does not change states when they are clocked. On the next clock, U54A's Q output is toggled high and is clocked through the ring-counter to the output of U50A. The modulus was changed to 6 for this Prescaler cycle with the added clock to toggle U54A. Figure 2 shows the 6 clock cycles between time T4 and T6. The high Remove Cycle control input is set low and the J input of U55A is low. The Q output of U50A clocks the not Q output of U55A high at time T4. The K input of U54A is low, and its output remains high. The ring-counter's modulus is changed to 5 at time T6, and remains in modulus 5 until an active Remove or Add Cycle control input is received.

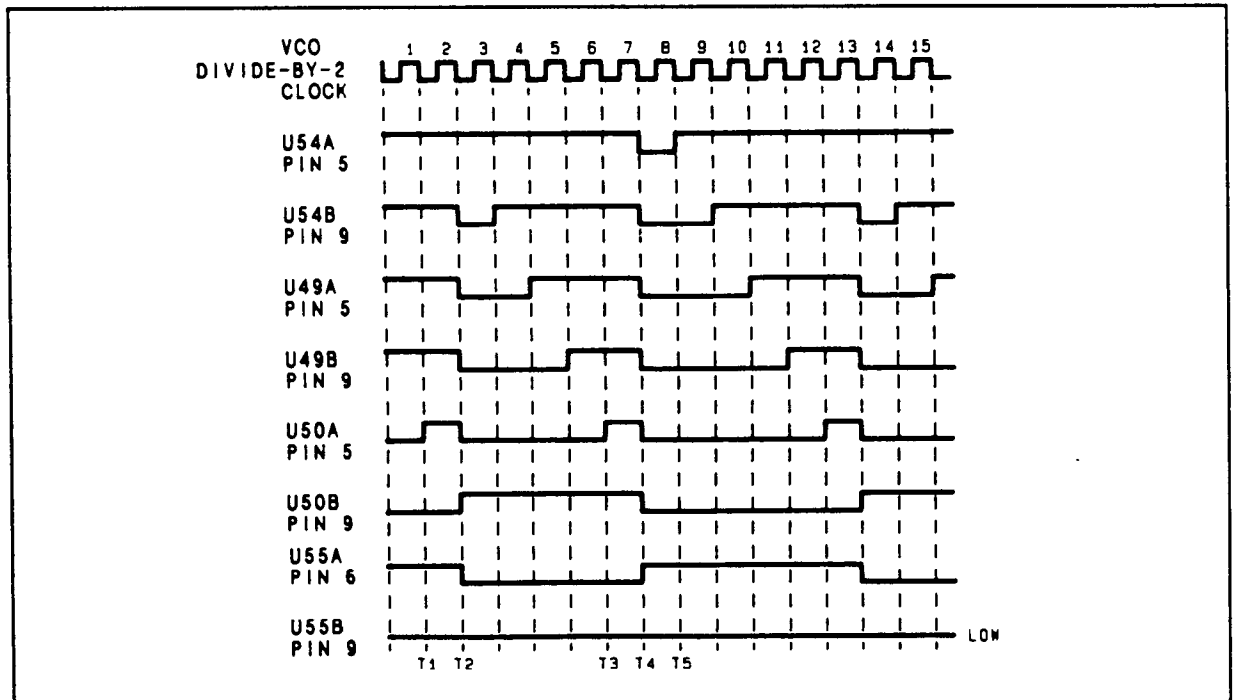


Figure 2. Divide-by-11 Timing Diagram.

Divide-by-9

The Prescaler divides-by-9 when the Add Cycle control input is high, and the Remove Cycle control input is low. The ring-counter's modulus is changed to 4 for one cycle, and to 5 for the next cycle of the Prescaler. The timing diagram for the divide-by-9 mode is shown in Figure 3.

With the J and K inputs to U55B high, when clocked, the outputs toggle for each Prescaler cycle. The ring-counter's modulus also toggles from 4 to 5, and the Prescaler divides-by-9. This cycle is repeated until the Add Cycle control input is set low. At time T1, both inputs to U51C are low and its output is high. The K input to U54B is still high at time T2. At time T2 the Q output of U55B is toggled high, and the Q output of U50A is toggled low. The ring-counter's modulus is still 5. The K input to U54A remains low, and its output remains high. The Q output of U54B is toggled low. The Q output of U55B is toggled high, and the Q output of U50B is toggled high. At time T3, the Q output of U50A is high, and the not Q output is low. The input of U51C at pin 9 is low. The input at pin 8 is high, set high by the Add Cycle input latched into U55B at time T2. The output of U51C (the K input of U54B) goes low. The Q output of U54B will not change when clocked at time T4. The K inputs of U49A, U49B and U50A are set high by the high Q output U50A at time T3. The VCO divide-by-2 clock at time T4 toggles their Q outputs low, and toggles the Q output of U50B low. The ring-counter's modulus is 4. The Q output of U54B is not reset low at time T4. The Q output of U49A is toggled low for one cycle at time T4, and high at time T5. The high Q output of U49A is clocked through to the Q output of U50A at time T6. The high Add Cycle input is removed, and the Q output of U55B is clocked low at time T4. Both inputs to U51C are low at time T6. U51C's output, the K input to U54B is high. Therefore, on the same clock that toggled the Q outputs of U49A, U49B, and U50A low, the output of U54B is toggled low at time T7. On the next clock the Q output of U54B is clocked high, and the high is clocked through to U50A. The ring-counter's modulus is changed to 5 at time T7, and remains in modulus 5 until an active Remove or Add Cycle control input is received.

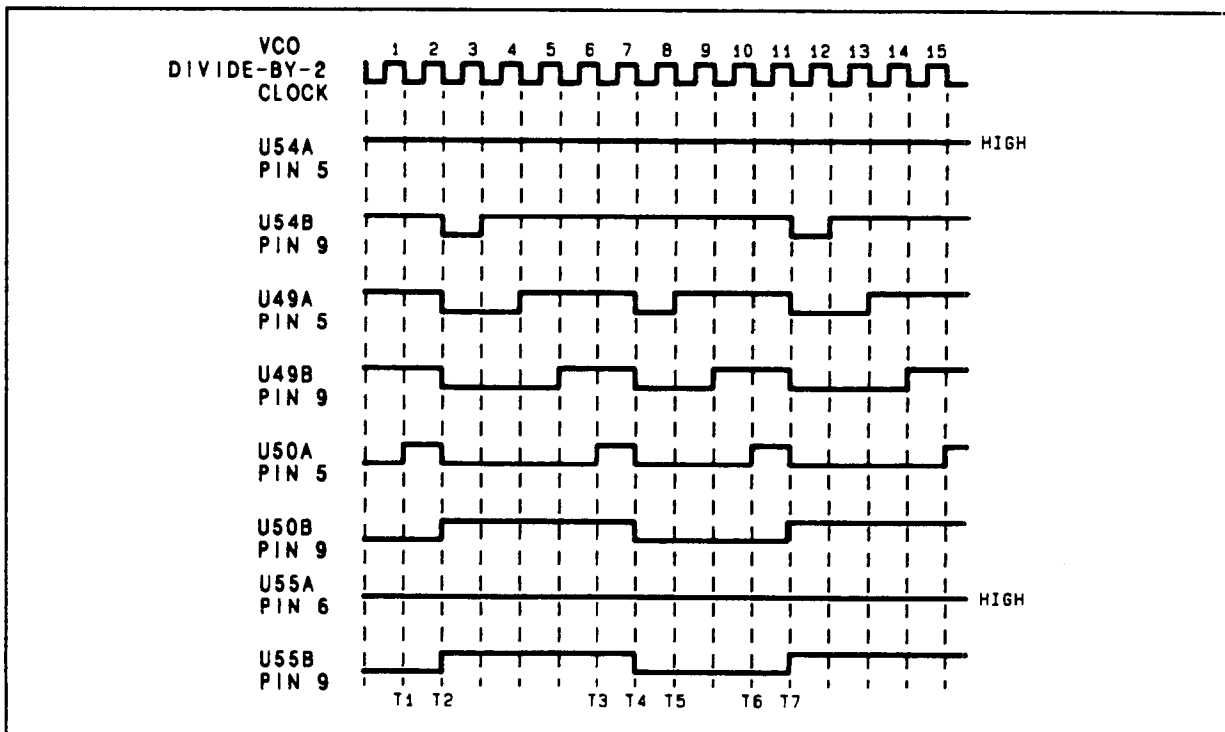


Figure 3. Divide-by-9 Timing Diagram.

TROUBLESHOOTING

Procedures for checking part of the A3 Low Frequency Loop Assembly circuits are given below. Areas or points to check are marked on the schematic by a hexagon with a checkmark and a number inside, for example, $\sqrt{1}$. The frequencies shown on the schematic for Test Points 29, 30, and 31 are present when the Low Frequency Loop is locked.

Troubleshooting Help

Block Diagram 3

Table 4-1. Abbreviated Performance Tests

Table 5-2. Post-Repair Adjustments

Test Equipment

Frequency Counter	HP 5328A
Oscilloscope	HP 54100A
Oscilloscope Active Probe	HP 54001A

$\sqrt{1}$ Buffer Amplifier

1. Remove jumper A3W6 (refer to Service Sheet 14). The VCO TUNE voltage goes to approximately 0.0V.
2. Connect the frequency counter to A3TP29 and measure the VCO frequency. The VCO frequency should be 96 MHz \pm 7 MHz.

NOTE

The ground connection to the counter probe must be as short as possible. If the counter does not count the 100 MHz, check the signal with the oscilloscope. Signal level is approximately 0.6 Vpp at A3TP29, and at ECL levels (low < +3.3V, high > +4.2V).

$\sqrt{2}$ Divide-BY-2 and ECL to TTL

1. Connect the frequency counter to A3TP30 and measure the VCO frequency divided-by-2.
2. If the frequency is not correct, the outputs of Q51, and U51D should be checked.
 - a. Q51's base VCO frequency is divided-by-2 and is at approximately 2.2 to 3.4 Vpp.
 - b. Q51's collector voltage is at approximately 0.0 to 2.4 Vpp.
 - c. U51D at pin 13 is approximately 1.0 to 3.4 Vpp.

$\sqrt{3}$ Prescaler

1. Connect the frequency counter to A3TP31, and measure the VCO frequency divided-by-20.
2. If the frequency is not correct, check the frequencies shown in Tables 1, 2, and 3. (The frequencies shown in the tables are approximate, and are dependent upon the frequency of the Low Frequency Loop VCO when the VCO TUNE voltage input is approximately 0.0V.)

NOTE

Jumper A3W6 must be removed. The VCO TUNE voltage is approximately 0.0V. The VCO frequency should be 96 MHz \pm 7 MHz (refer to check 1). In the active state, the outputs of the J/K flip-flops are changing and not fixed at a TTL high or a TTL low.

Table 1. Prescaler J/K Flip-Flop Output Add and Remove Cycle Controls Inactive Low.

J/K Flip-Flops	J/K Flip-Flops Output	
	State	Frequency
U55A Pin 6	Inactive	—
U55B Pin 9	Inactive	—
U54A Pin 5	Inactive	—
U54B Pin 9	Active	10 MHz
U49A Pin 5	Active	10 MHz
U49B Pin 9	Active	10 MHz
U50A Pin 5	Active	10 MHz
U50B Pin 9	Active	5 MHz

3. Remove A3W8, and connect U55A pin 3 to +5 Vdc. (The frequencies in Table 2 are approximate, and are dependent upon the Low Frequency Loop VCO frequency when the VCO TUNE voltage input is approximately 0.0V.)

Table 2. Prescaler J/K Flip-Flop Output Add Cycle Control (Inactive Low) and Remove Cycle Control (Active High).

J/K Flip-Flops	J/K Flip-Flops Output	
	State	Frequency
U55A Pin 6	Active	4.5 MHz
U55B Pin 9	Inactive	—
U54A Pin 5	Active	4.5 MHz
U54B Pin 9	Active	9 MHz
U49A Pin 5	Active	9 MHz
U49B Pin 9	Active	9 MHz
U50A Pin 5	Active	9 MHz
U50B Pin 9	Active	4.5 MHz

4. Remove A3W7, and connect U55B pin 11 to +5 Vdc. (The frequencies in Table 3 are approximate, and are dependent upon the Low Frequency Loop VCO frequency when the VCO TUNE voltage input is approximately 0.0V.)

Table 3. Prescaler J/K Flip-Flop Output Add Cycle Control (Active High) and Remove Cycle Control (Inactive Low).

J/K Flip-Flops	J/K Flip-Flops Output	
	State	Frequency
U55A Pin 6	Inactive	—
U55B Pin 9	Active	5.5 MHz
U54A Pin 5	Inactive	—
U54B Pin 9	Active	5.5 MHz
U49A Pin 5	Active	11 MHz
U49B Pin 9	Active	11 MHz
U50A Pin 5	Active	11 MHz
U50B Pin 9	Active	5.5 MHz

A3 Component Coordinates (1 of 3)

COMP	X,Y	COMP	X,Y	COMP	X,Y	COMP	X,Y	COMP	X,Y	COMP	X,Y
C1	E,1	C213	C,1	C513	A,4	CR1	D,2	FL1	E,2	Q10	D,4
C2	D,2	C300	D,2	C514	A,3	CR2	D,2	FL2	E,2	Q11	D,4
C3	E,2	C301	C,3	C515	A,4	CR3	D,2	FL3	D,2	Q12	A,4
C4	D,2	C302	C,3	C516	A,3	CR4	D,2	FL4	D,2	Q13	B,4
C5	D,1	C303	D,3	C517	A,3	CR5	E,1			Q14	B,4
C6	D,2	C304	D,3	C518	B,3	CR6	D,1	J1	E,4	Q15	B,4
C7	D,1	C305	D,3	C519	A,3	CR7	D,2	J2	A,4	Q16	C,4
C8	D,1	C306	C,2	C520	A,3	CR8	D,2	J3	A,4	Q17	C,4
C9	D,2	C307	C,3	C521	A,3	CR9	E,1	J4	C,2	Q18	C,4
C10	D,2	C308	C,3	C600	B,3	CR10	D,1	J5	C,1	Q19	D,4
C11	E,1	C309	C,3	C601	B,3	CR11	D,1	J6	D,1	Q20	D,4
C12	D,1	C310	C,2	C602	B,3	CR12	D,1	J7	E,1	Q21	D,4
C13	D,2	C311	C,1	C603	B,3	CR15	E,1	J8	E,2	Q22	B,4
C14	D,2	C312	C,1	C604	B,3	CR16	D,1			Q23	C,4
C15	D,1	C313	C,2	C605	B,3	CR17	E,2	L1	E,2	Q24	C,4
C16	D,2	C400	B,3	C606	B,3	CR18	D,2	L2	D,2	Q25	C,4
C17	D,1	C401	D,4	C607	B,3	CR200	C,1	L3	E,2	Q26	B,4
C18	E,1	C402	C,4	C608	B,3	CR201	C,1	L5	E,2	Q27	B,4
C19	E,2	C403	C,3	C609	B,3	CR400	B,4	L6	E,2	Q28	C,4
C20	E,2	C404	B,4	C610	C,3	CR401	C,4	L8	D,2	Q29	A,4
C21	E,1	C405	C,3	C611	C,4	CR402	C,4	L200	E,4	Q30	A,4
C22	E,2	C406	C,4	C612	C,3	CR403	C,4	L201	E,4	Q31	A,4
C23	E,1	C407	C,4	C613	B,3	CR404	C,4	L202	E,4	Q32	A,4
C24	E,2	C408	B,3	C614	B,3	CR405	B,4	L203	E,4	Q33	B,4
C25	E,1	C409	B,4	C615	B,2	CR406	B,4	L204	C,1	Q34	A,3
C26	E,2	C410	C,4	C616	B,3	CR500	B,4	L300	C,1	Q35	B,3
C27	D,1	C411	B,4	C617	B,2	CR501	B,4	L400	B,4	Q36	B,3
C28	E,2	C412	C,4	C618	B,3	CR502	A,4	L401	D,4	Q37	A,3
C29	D,1	C413	B,4	C619	B,3	CR503	A,4	L402	C,3	Q38	A,3
C30	E,1	C414	B,4	C620	B,2	CR504	B,4	L403	C,3	Q39	A,3
C100	A,3	C415	B,4	C621	B,2	CR505	B,4	L404	C,4	Q40	A,3
C101	A,2	C416	B,4	C700	E,3	CR506	B,4	L500	B,4	Q41	A,3
C200	E,4	C500	A,4	C701	E,3	CR600	B,3	L501	A,4	Q42	A,3
C201	E,4	C501	A,4	C702	E,3	CR602	B,3	L502	A,4	Q43	A,3
C202	E,4	C502	B,4	C703	E,2	CR700	D,4	L503	A,4	Q44	A,3
C203	E,4	C503	A,4	C704	E,3	CR701	D,4			Q46	A,2
C204	B,1	C504	A,3	C705	E,4	CR702	D,4	Q1	A,4	Q47	C,1
C205	C,2	C505	B,4	C706	E,4	CR703	D,4	Q2	A,4	Q48	C,2
C206	C,1	C506	B,4	C707	D,4	CR704	D,4	Q3	D,4	Q49	D,1
C207	C,1	C507	A,4	C708	D,4	CR705	D,4	Q4	A,4	Q50	E,1
C208	C,1	C508	B,3	C709	D,4	CR706	D,4	Q5	B,4	Q51	C,1
C209	C,1	C509	B,3	C710	D,4	CR707	D,4	Q6	B,4	Q52	D,1
C210	C,1	C510	A,4	C711	D,4			Q7	B,4	Q53	D,1
C211	C,1	C511	B,3	C712	D,4			Q8	C,4	Q54	E,1
C212	C,1	C512	A,3	C713	E,4	DS500	A,3	Q9	C,4	Q55	E,1

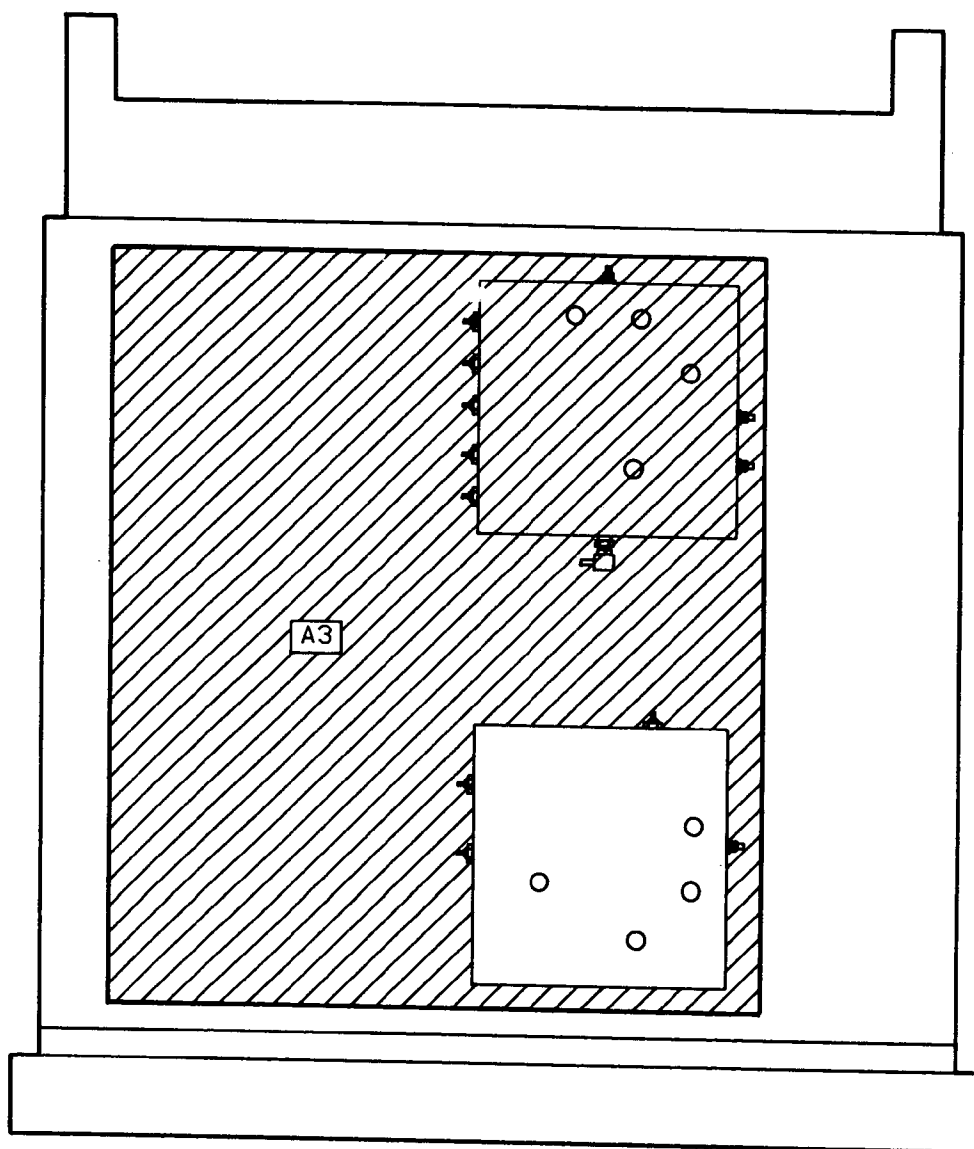
A3 Component Coordinates (2 of 3)

COMP	X,Y	COMP	X,Y	COMP	X,Y	COMP	X,Y	COMP	X,Y	COMP	X,Y
Q56	C,1	R207	C,1	R431	B,4	R523	A,4	R568	A,3	R719	D,4
		R208	C,1	R432	C,3	R524	A,4	R569	B,3	R720	E,4
R1	D,2	R209	B,1	R433	D,4	R525	A,3	R570	A,3	R721	D,4
R2	D,2	R210	C,1	R434	C,4	R526	A,4	R600	B,3	R722	D,4
R3	D,2	R211	C,1	R435	C,3	R527	A,3	R601	B,3	R723	D,4
R4	E,2	R300	C,3	R436	B,4	R528	A,3	R602	B,3	R724	D,4
R5	D,2	R301	C,3	R437	B,4	R529	A,4	R603	B,3	R725	D,4
R6	D,1	R302	C,3	R438	D,4	R530	A,4	R604	B,3	R726	D,4
R7	D,2	R303	C,3	R439	C,3	R531	A,3	R605	B,3	R727	D,4
R8	D,1	R304	C,3	R440	C,4	R532	B,3	R606	B,3	R728	D,4
R9	E,1	R305	C,2	R441	B,4	R533	A,4	R607	B,3	R729	D,4
R10	D,2	R306	D,2	R442	C,4	R534	A,3	R608	A,3	R731	D,4
R11	D,2	R307	C,1	R443	B,4	R535	A,3	R609	B,3	R732	C,4
R12	D,2	R308	C,1	R444	B,4	R536	A,4	R610	B,3	R733	D,4
R13	D,1	R400	C,4	R445	B,4	R537	A,4	R611	B,3	R734	D,4
R14	D,2	R401	C,4	R446	B,4	R538	A,3	R612	C,3	R735	C,4
R15	E,1	R402	B,4	R447	B,4	R539	A,3	R613	B,3	R736	D,4
R16	D,1	R403	B,4	R448	B,4	R540	A,4	R614	B,3	R737	C,4
R17	D,1	R404	B,4	R449	B,4	R541	A,3	R615	B,3	R738	D,4
R18	E,1	R405	B,4	R450	B,4	R542	A,3	R616	C,3	R740	D,4
R19	D,1	R406	C,4	R451	C,4	R543	A,4	R617	B,3	R741	E,4
R20	D,1	R407	C,4	R452	C,4	R544	A,3	R618	B,3		
R21	D,1	R408	C,4	R500	A,4	R545	A,4	R619	B,3	TP1	B,4
R22	D,1	R409	B,4	R501	A,4	R546	A,3	R620	B,3	TP2	A,4
R23	E,1	R410	C,4	R502	A,4	R547	A,4	R621	B,2	TP3	D,4
R24	E,1	R411	C,4	R503	A,4	R548	A,3	R622	B,3	TP4	D,4
R25	E,2	R412	B,4	R504	A,4	R549	A,3	R700	E,4	TP5	D,4
R26	E,2	R413	C,4	R505	A,4	R550	A,3	R701	E,4	TP6	D,4
R27	E,2	R414	B,4	R506	A,4	R551	A,3	R702	E,4	TP7	C,4
R28	D,2	R415	C,4	R507	A,4	R552	A,4	R703	E,4	TP8	D,4
R29	D,1	R416	C,4	R508	A,4	R553	A,3	R704	D,4	TP9	D,4
R30	D,1	R417	C,4	R509	A,4	R554	A,3	R705	E,4	TP10	B,3
R31	D,1	R418	C,4	R510	A,4	R555	A,3	R706	D,4	TP11	A,3
R32	D,1	R419	B,4	R511	A,4	R556	A,3	R707	B,4	TP12	A,3
R33	D,2	R420	B,4	R512	A,4	R557	A,3	R708	E,4	TP13	B,3
R100	A,2	R421	C,4	R513	A,4	R558	A,3	R709	D,4	TP14	B,3
R101	A,2	R422	C,4	R514	A,4	R559	A,3	R710	D,4	TP15	C,3
R104	A,2	R423	C,4	R515	A,4	R560	A,3	R711	D,4	TP16	C,3
R200	B,2	R424	C,4	R516	A,4	R561	A,3	R712	B,4	TP17	C,3
R201	C,1	R425	C,4	R517	A,4	R562	A,3	R713	D,4	TP18	D,3
R202	C,2	R426	C,4	R518	B,4	R563	A,3	R714	D,4	TP19	D,3
R203	C,2	R427	C,4	R519	A,4	R564	A,3	R715	D,4	TP20	C,3
R204	C,1	R428	C,4	R520	A,4	R565	B,3	R716	C,4	TP21	C,3
R205	C,1	R429	B,4	R521	A,3	R566	A,3	R717	D,4	TP22	A,3
R206	C,1	R430	C,3	R522	B,4	R567	A,3	R718	E,4	TP23	A,3

A3 Component Coordinates (3 of 3)

COMP	X,Y	COMP	X,Y	COMP	X,Y	COMP	X,Y	COMP	X,Y
TP24	C,3	U35	C,2						
TP25	C,3	U36	D,2						
TP26	C,2	U37	E,2						
TP27	C,2	U38	C,2						
TP28	C,2	U39	C,2						
TP29	C,2	U40	D,2						
TP30	C,1	U41	C,2						
TP31	C,1	U42	C,2						
TP32	D,1	U43	C,2						
TP33	E,1	U44	C,2						
		U45	D,2						
U1	A,4	U46	C,1						
U2	B,4	U47	C,1						
U3	C,4	U48	D,1						
U4	D,4	U49	C,1						
U5	D,4	U50	C,1						
U6	C,4	U51	C,1						
U7	B,4	U52	D,1						
U8	C,4	U53	E,1						
U9	A,4	U54	C,1						
U10	D,4	U55	C,1						
U11	D,4								
U12	E,3	VR300	C,3						
U13	B,3	VR400	B,4						
U14	B,3	VR401	C,4						
U15	E,3	VR500	A,3						
U16	E,3	VR601	B,3						
U17	C,3								
U18	D,3	W1	B,3						
U19	E,3	W2	C,3						
U20	E,3	W3	A,3						
U21	A,3	W4	B,3						
U22	B,3	W5	A,3						
U23	D,3	W6	A,2						
U24	D,3	W7	D,1						
U25	E,3	W8	C,1						
U26	E,3	W9	C,4						
U27	B,3	W10	C,4						
U28	C,3	W11	B,4						
U29	D,3								
U30	D,3	Y1	E,2						
U31	E,3	Y300	C,2						
U32	E,3								
U33	B,3								
U34	B,3								

TOP INTERNAL VIEW - LEVEL 1



NOTES

1. For an explanation of schematic symbols, see "SCHEMATIC DIAGRAM NOTES" in Section 8.
2. Nominal value of RF choke is 2.5-6uH.
3. Chassis ground is achieved by mechanical contact through nuts holding PC board to cover and W4.
4. Reference designations on this service sheet C, CR, L and R have numbers ranging from 200 to 299 only.
5. Wide-band RF choke approximately 6uH.

LOGIC LEVELS

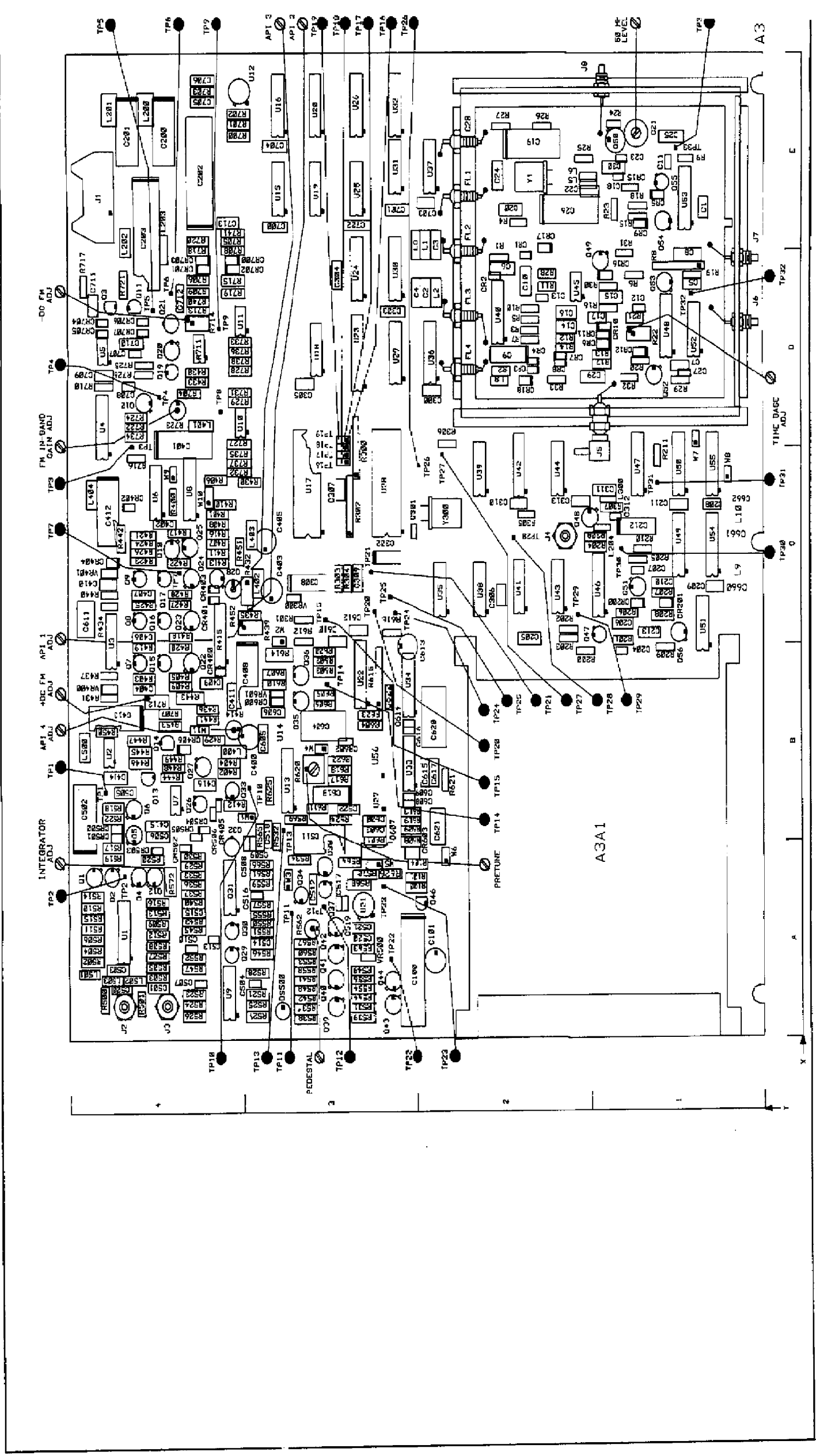
	TTL	ECL
HIGH	2V	+4.2V
LOW	0.8V	+3.3V
	IS MORE NEG. THAN IS MORE POS. THAN	
OPEN	HIGH	LOW
GROUND	LOW	HIGH

P/O A3

SEE REVERSE SIDE

LOW FREQUENCY LOOP
DIVIDE-BY-2
AND PRESCALER

SS10



Component Locator

Figure 4. Service Sheet 11 Information

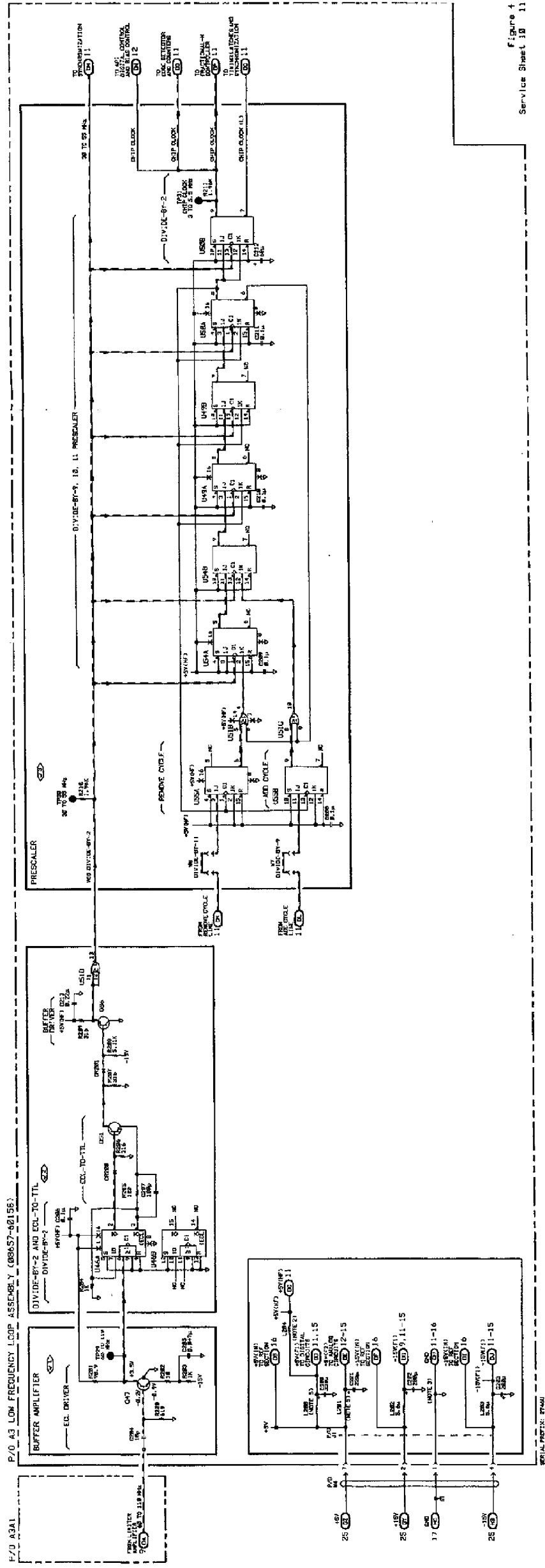


Figure 4
Service Sheet 10 11

Service Sheet 11

LOW FREQUENCY LOOP FRACTIONAL-N, DIVIDE-BY-N, AND DIGITAL TIMING LOGIC

PRINCIPLES OF OPERATION

General

Serial data is generated by the main Microprocessor A11U9 (refer to Service Sheet 17) it writes data to the Serial I/O Control Register A11U30 (refer to Service Sheet 18). Pin 2 of the Serial I/O Control Register is the data bit for the Serial I/O Data Bus. Serial Low Frequency Loop data is passed through the LF Loop Serial Data Bus Buffer A11U29A (refer to Service Sheet 18) when it is enabled. Serial Data is transferred to the Low Frequency Loop when its frequency is changed, when frequency modulation (AC or DC) is selected, turned off, changed or calibrated, or when phase is incremented or decremented. An Out-Of-Lock status bit is transferred from the Low Frequency Loop to the Microprocessor Assembly during diagnostic tests. An automatic indication that the Low Frequency Loop is out-of-lock is displayed on the A3 assembly by a lit LED. Serial LF Loop Data (LDA) is clocked into the LF Loop Microprocessor A3U28 by the LF Loop Clock (LCL). Serial LF Loop Data is clocked into the LF Loop Microprocessor by active low LCL pulses. At the completion of the data transfer, the LF Loop Serial Data Bus Buffer is disabled and the LF Loop Clock is discontinued. Timing for data transfer and clock generation is firmware controlled.

Microprocessor

Serial LF Loop Data written to the LF Loop Microprocessor, U28 at pin 9, consists of instructions and data. The LF Loop Microprocessor uses a firmware routine to input the serial data, and to handle all timing constraints. Instructions and data transferred to the LF Loop Microprocessor tell the LF Loop what operations to perform. For example, some instructions select frequency modulation and calibration. Instructions and data sent to the Fractional-N Controller tell it what operation to perform. The LF Loop Microprocessor stores the data sent over the serial data bus and very quickly transfers it to the Fractional-N Controller as a series of four-bit words. The first word transferred is always an instruction followed by a 70 μ s wait to assure that Fractional-N Controller has received a Cycle Start Pulse. Sixteen data words are then sent followed by an instruction word to define the data, and an instruction to terminate the data transfer.

The Microprocessor has three I/O Ports. Two eight-bit ports PA, PB and one four-bit port PC. The eight-bits of I/O port PA and four-bits of I/O port PB function as outputs. PA0 (pin 20) through PA3 (pin 23) transfer instructions and data words to the Fractional-N Controller, U17. PA4 (pin 24) is the external clock (EXT CLK) that clocks the data words into the Fractional-N Controller, and PA5 (pin 25) is the instruction valid (INST VLD) input that clocks the instructions into the Fractional-N Controller. Outputs PA6 (pin 26), PA7 (pin 27) and PB0 through PB3 (pins 12 through 15) enable frequency modulation, turn frequency modulation off, select DC FM and activate B+C(L) and S(L)/H1 control lines for frequency modulation calibration. The other four PB I/O Ports function as inputs. TP18 (PB5) and TP17 (PB6) are connected to ground to initiate microprocessor controlled service routines. The LF Loop Microprocessor mode input TP26 must also be grounded. TP16 (PB7) is not used. See Table 1 for further information.

With TP19 (PB4) connected to ground and TP26 not grounded the frequency switching speed is increased by eliminating the FM calibration cycle. Jumper W2 connecting the B+C(L) to U22 (refer to Service Sheet 14), must be removed also. The FM Calibration DAC (U34) is then set to 75% of its range. To exit the service routines, the instrument's POWER switch is set to STBY and then to ON.

An external 4 MHz crystal Y300 is directly connected to the LF Loop Microprocessor (pins 4 and 5). Capacitor C301 is used to keep the frequency stable. The Microprocessor converts the 4 MHz crystal to a 1 MHz clock.

Table 1. LF Loop Microprocessor Initiated Tests.

Test Point Grounded	TP26 Grounded	LF Loop Microprocessor Test Initiated
	Yes	Increment Signal Generator's frequency by 10 MHz. An FM calibration is performed every 100 mSec until ground is removed.
TP17	Yes	Signature Analysis
TP18	Yes	Low Frequency Loop VCO's frequency is set to 66.80001 MHz
TP19	No	No FM calibration with VCO's frequency changed, switching speed is increased.

The LF Loop Microprocessor can be RESET by briefly shorting TP21 (Reset) to TP20 (ground). The mode input for the LF Loop Microprocessor is the PC2 input (pin 10). The mode input is high for normal Low Frequency Loop operation. The special Low Frequency Loop service mode is entered when the instrument is powered up with the mode input TP26 grounded. Then, the LF Loop Microprocessor will not receive data or clock inputs from the main Microprocessor (A11U9). TP26 is grounded when TP17 or 18 are grounded to access the Low Frequency Loop service routines.

Fractional-N Controller

Six of the eight inputs to the Fractional-N Controller (U17) are the four data inputs (C1-C4), the instruction valid input (INST VLD), and the external clock input (EXT CLK). The other two inputs are the chip clock input (CHIP CLK), and the cycle start input (CYCLE START). CHIP CLK is the LF Loop VCO frequency divided-by-20, and is the output of the Prescaler at pin 9 of U50B. The Chip Clock frequency varies from 3.0 to 5.5 MHz and is the clock for the Fractional-N Controller. Cycle Start is the LF Loop VCO frequency divided-by-N.F. (refer to Block Diagram 3). Cycle Start is synchronized with the Chip Clock by the Cycle Start Synchronization flip-flop U19A. The Cycle Start input initiates a Fractional-N Controller cycle. The Cycle Start pulse is one Chip Clock long (refer to the Low Frequency Loop Timing Diagram, Figure 1). At the termination of the Cycle Start pulse, the Sample and Hold pulse at pin 11 is active for two Chip Clocks. The Low Frequency Loop VCO control voltage from the integrator is stored on the Sample and Hold Capacitor C519 (refer to Service Sheet 13). One Chip Clock after the Sample and Hold Pulse is terminated, the Bias Pulse at pin 10 is active for thirteen Chip Clocks. The Bias pulse is synchronized with the Chip Clock at flip-flop U6B (refer to Service Sheet 12), initiating the Delayed Bias Pulse. During the Bias Pulse, a current resets the LF Loop Integrator. The Integrator is readied for the next output from the Phase Detector. The Fractional-N Controller Analog Phase Interpolation (API) outputs, at pins 2 through 6, are active during the Bias Pulse. Each of the five API outputs is pulse width modulated to sum the correct current into the Integrator to compensate for Fractional-N (F.N.) variations in phase differences. F.N. phase difference variations occur when the LF Loop VCO frequency is not an even multiple of the 100 kHz reference. The Fractional-N Controller keeps track of the F.N. phase difference between the VCO divided-by-N.F. and the 100 kHz reference. When the phase difference changes by $360/N$ degrees, the Prescaler is instructed to remove a cycle. A cycle is removed by the Prescaler to compensate for fractional frequencies. A cycle is removed or added by the Prescaler when frequency modulating at large modulation indexes (m). The LF Loop Integrator is reset during the Bias Pulse by the Bias Current. Therefore, all Chip Clocks must be of equal length when Bias Current is on, and the Prescaler does not remove or add cycles. The Bias Pulse directs the Bias Current to the Integrator and closes the API FET switches (refer to Service Sheet 12). When the FET switches are open, the API currents are directed to the Phase Detector and FM Current Switches (refer to Service Sheets 13 and 14). Otherwise the API currents are directed to the API switches. The Integrator is reset before the next input from the Phase Detector is received. The Fractional-N Controller determines the pulse width of the API Pulses, and terminates the API Pulses one Chip Clock before the end of the Bias Pulse (refer to the Low Frequency

Loop Timing Diagram, Figure 1). The pulse width of the negative API Pulses varies when a fractional frequency is selected. A fractional frequency is any LF Loop frequency that is not an even multiple of the 100 kHz reference. The timing of the Remove Cycle input to the Prescaler is initiated when the API 1 pulse goes high. The data sent to the Fractional-N Controller includes the divide number for the Divide-By-N-Counters, U24, U30, and U36. The data is received as a four bit BCD number, changed to its nine's complement and sent serially least significant digit first to the nine's complement latches U23 and U29. The data is clocked into the latches by the Fractional-N Controller's divide-by-N clock output. The nine's complement data is then loaded into the Divide-By-N-Counters each 100 kHz cycle of the Low Frequency Loop, every 10 μ s. U24, U30, and U36 function as up counters, their faster mode of operation.

Divide-By-N

The Divide-By-N-Counters use "Prescaler Counting" to divide the Low Frequency Loop VCO's frequency to 100 kHz pulses. The VCO frequencies of 60 MHz to 110 MHz are divided-by-N.F. (N.F. refers to the possible fractional division ratios using Fractional-N technology) to output a pulse every 10 μ s. Prescaler counting does not require the use of high-speed counters for direct counting. The VCO's frequency is divided-by-2 and the Prescaler divides this frequency by 11 when the 100 kHz counter is counted, and by 10 otherwise.

Remove Cycle

Figure 2 shows the output of the counters when the Signal Generator's RF output is 800.2 MHz. The frequency of the Low Frequency Loop VCO is 99.80 MHz; 49 Chip Clocks are required for the 10 μ s Low Frequency Loop cycle. The VCO frequency of 99.80 MHz divided-by-2 is 49.90 MHz. Less two 1 MHz counts for Cycle Start Synchronization, and reloading data into the Counters will give a divide number of 479 to the 100 kHz VCO Divided-By-N.F. input to the Phase Detector. The nine's complement of 479 is 520. At the completion of the Cycle Start Pulse (U19A), the first seven Chip Clocks count the 1 MHz counter from 2 to 9. This counter is then repeatedly counted from 0 to 9, ten Chip Clocks, for the remaining Chip Clocks in a 10 μ s cycle. Four clocks from the 1 MHz counter count the 10 MHz counter from 5 to 9, and nine Chip Clocks count the 100 kHz counter from 0 to 9 once each Low frequency Loop cycle.

The Chip Clock is the Low Frequency Loop VCO frequency divided-by-20 or divided-by-22. The VCO frequency is divided-by-22 when the 100 kHz counter is counting and the Prescaler's modulus is 11. The frequency of the Chip Clock is 4.990 MHz for 40 Chip Clocks and each clock is 0.2004 μ s. The frequency of the Chip Clock is 4.536 MHz for 9 Chip clocks and each clock is 0.22044 μ s.

$$(0.2004 \mu s \times 40) + (0.22044 \mu s \times 9) = 10 \mu s$$

The nine's complement data held in the Latches (nine's Complement) is loaded into the 100 kHz, 1 MHz, and 10 MHz up Counters when their load input at pin 11 is set low. When the counters are loaded their carry output at pin 12 is set low. The enable input at pin 4 of the 100 kHz counter is active low and is controlled by its carry output at pin 12. The enable input at pin 4 of the 1 MHz counter is tied low and is therefore active. The enable input, at pin 4, of the 10 MHz counter is controlled by the Ripple Count output of the 1 MHz counter at pin 13. The Chip Clock input to the counters will begin to count the 100 kHz and 1 MHz counters up as soon as the data is loaded. At this time, the 10 MHz Counter is not enabled to count. Refer to the Counter Timing diagram, Figure 2. The 100 kHz Counter is enabled when its carry output is low. The carry output is set low on each cycle when the data is reloaded. The low carry output at pin 12 is connected to the enable input at pin 4. The low carry output that enables the 100 kHz Counter is also gated through the remove cycle gates of U41A, U41B, and U51A to set the Remove Cycle input to the Prescaler high. Each cycle of the Prescaler that the Remove Cycle input is high, the VCO Divided-By-2 input is divided-by-11. The Chip Clock counts the 100 kHz counter up to nine. The carry output and enable input are set high, and the counter is disabled until the next Low Frequency Loop cycle. The high carry output sets the output of U41A low, and the low is gated through the remove cycle gates to set the Remove Cycle input to the Prescaler low.

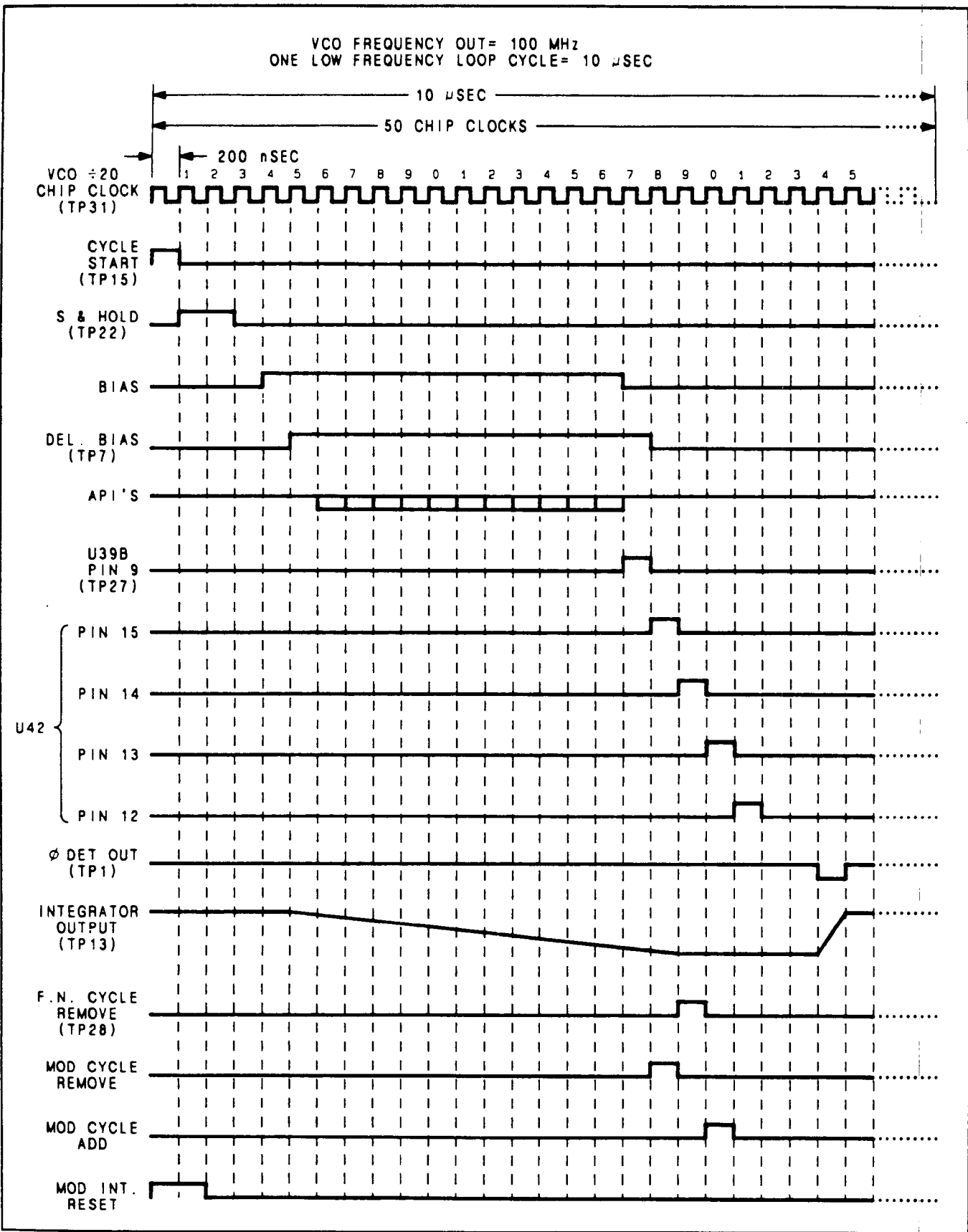


Figure 1. Low Frequency Loop Timing Diagram.

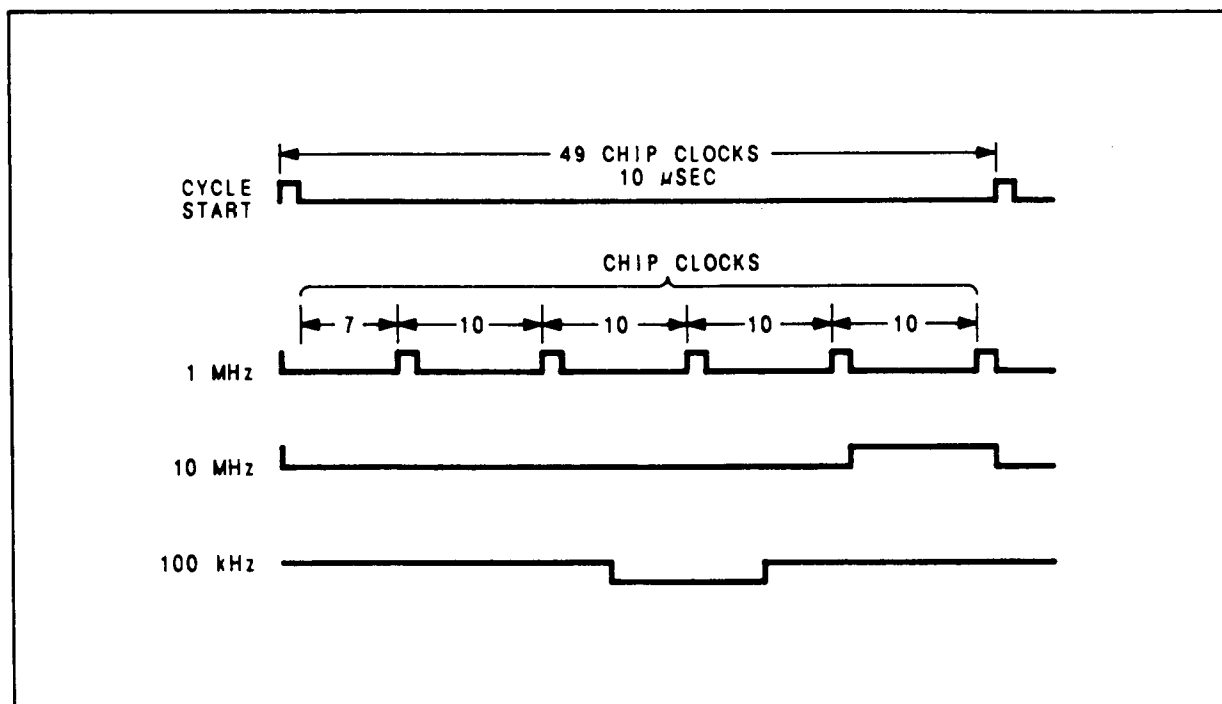


Figure 2. Counter Timing.

When the 1 MHz counter, U30, is counted up to nine, its ripple count output at pin 13 goes low, and the 10 MHz counter is enabled for one count. Each time the 1 MHz counter is counted up to nine, the 10 MHz counter is counted up one count. The carry output of U30, the 1 MHz counter, at pin 12 goes high for one count. The high output is one input to the AND gate U18C. The 1 MHz counter continues to count, and the 10 MHz counter is counted up to nine. The carry output at pin 12 is high. Both inputs to AND gate U18C are high at this time and its output is high. The D input to U19A is set high, and on the next Chip Clock the Q output is set high initiating the Cycle Start Pulse. The not Q output of U19A is low and the load enable input at pin 11 for the 1 MHz and the 10 MHz counters is low. The data in Latch, U23, is loaded in the 1 MHz and 10 MHz counters. The two counters are ready for the next Low Frequency Loop cycle. The carry output of the counters is set low when they are reloaded. The inputs to AND gate U18C are low and the output of U18C is returned to the low state. On the next Chip Clock, the outputs of U19A are set pin 5 low and pin 6 high terminating the Cycle Start pulse and disabling the 1 MHz and 10 MHz counters load input. The Cycle Start Synchronization circuit, U18C and U19A synchronize the Cycle Start pulse with the Chip Clock which is required for high speed operation of the counters. The synchronization takes two Chip Clocks, and the number loaded into the 1 MHz counter is two less. When the RF output frequency of the Signal Generator is 733.2 MHz, the frequency of the Low Frequency Loop VCO's frequency is 66.8 MHz. The nine's complement loaded into the latches is 685. The Low Frequency Loop VCO frequency is divided-by-2 (refer to Service Sheet 10), for a frequency of 33.4 MHz. Then 2 MHz is subtracted for Cycle Start Synchronization, $33.4 \text{ MHz} - 2.0 \text{ MHz} = 31.4 \text{ MHz}$. The nine's complement of 314 is 685.

Digital Timing Logic

The Cycle Start pulse is received by the Fractional-N Controller, and a Low Frequency Loop cycle is started. The Fractional-N Controller sends out the Sample and Hold, Bias, and API outputs as previously described. When the negative API 1 pulse is terminated, the low to high transition clocks the Edge Detector's U39A output at pin 5 high. The high output is applied to the D input of U39B. U39B's output at pin 9 is clocked high, and its output at pin 8 low by the next Chip Clock. The low output at pin 8 is applied to the Reset input of U39A at pin 1, and the output at pin 5 of U39A is reset low. The D input of U39B then goes low. On the next Chip Clock, the output at pin 9 of U39B is set low

and the output at pin 8 high. The positive pulse which was generated from pin 9 of U39B is applied to the Timing Latches shift register U42 at pin 2. The pulse is clocked through the shift register, by the Chip Clock(L), to the outputs at pins 15, 14, 13, and 12. The output at pin 15 sets U43B's input pin 5 high and, enables a frequency modulation remove cycle high input at pin 4 to be gated to the Prescaler. The output at pin 14 sets U43D's input at pin 12 high, and enables a Fractional-N remove cycle high input at pin 13 to be gated to the Prescaler. The output at pin 13 sets U43C's input at pin 9 high, and enables a frequency modulation add cycle high input at pin 10 to be gated to the Prescaler. The output at pin 13 is also applied to the J input of Synchronization J/K flip-flop U47A to resynchronize the Low Frequency Loop VCO Divide-By-N.F. input to the Phase Detector. The output at pin 12 is applied to the D input of U44B. On the next Chip Clock, the high D input is clocked to the output at pin 9, and the output at pin 8 is clocked low. The output's of U44B are at this state for one cycle of the Chip Clock(L). The high output pulse from pin 9 of U44B is applied to the NOR gates U41A, and U35D to set their outputs low. The low output of U35D resets Cycle Remove Latch U38B. The low output pulse of U44B at pin 8 resets Cycle Add/Remove Latches U38A, and U44A. It also resets the Cycle Start Synchronization flip-flop U19A, and enables the load input at pin 11 of the 100 kHz counter.

The instructions to add or remove a cycle are latched into the Cycle Add/Remove Latches U38A, U38B and U44A. Cycles are added or removed during frequency modulation. Cycles are also removed when the Low Frequency Loop VCO is operating at a fractional frequency. The Fractional-N Controller U17 determines when a cycle is removed for fractional frequencies. The active Cycle Remove output at pin 12 clocks the Remove Cycle Latch U44A. The D input at pin 1 of U44A is tied high and is clocked to the output at pin 5. This is one input to AND gate U43D. As described above the output at pin 14 of the Shift Register U42 gates the output of U43D high which gates the output of NOR gate U41B low. The low output of U41B gates the output of U51A high and the Prescaler removes a cycle.

The High Threshold and Low Threshold inputs are activated during frequency modulation (refer to Service Sheet 15). The High Threshold cycle remove control is the D input at pin 12 of the Cycle Remove Latch U38B. The high D input is clocked to its output at pin 9 by the Cycle Start pulse. The output at pin 9 is one input to AND gate U43B, and is the Remove Cycle input to the FM Digital Circuits. As described above the output at pin 15 of the Shift Register U42 gates the output of U43B high which gates the output of NOR gate U41B low. The low output of U41B gates the output of U51A high and the Prescaler removes a cycle. Refer to the Timing Diagram, Figure 1. The Low Threshold cycle add control is the D input at pin 2 of Cycle Add Latch U38A. The high D input is clocked to its output at pin 5 by the Cycle Start pulse. The output at pin 5 is one input to AND gate U43C, and is the Add Cycle input to the FM Digital Circuits. As described above the output at pin 13 of the Shift Register U42 gates the output of U43C high, and the Prescaler adds a cycle.

Synchronization

The Synchronization J/K flip-flop's U47A and U47B resynchronize the Low Frequency VCO Divided-By-N.F. output pulse to the Phase Detector (refer to Service Sheet 13). As described above, the output at pin 13 of Shift Register U42 is applied to the J input of J/K flip-flop U47A at pin 3. The K input is then low. The next high to low transition of Chip Clock(L) clocks the output at pin 5 high and the output at pin 6 low. The high output at pin 5 is applied to the J input of J/K flip-flop U47B at pin 11. The K input at pin 12 is then low. The high to low transition of the VCO Divide-By-2 input at pin 13 clocks the output at pin 9 high. The output at pin 5 of U47A is also its K input at pin 2. The J input was set low when the high pulse of the Shift Register U42 was clocked through the register. The next high to low transition of Chip Clock(L) clocks the output at pin 5 low and the output at pin 6 high. The next high to low transition of the VCO Divide-By-2 input clocks the output at pin 9 of U47B low. When the output at pin 9 of U47B is high, transistor Q48 is turned off. The collector is connected to ground through resistor R308 and R500 (refer to Service Sheet 13). The output of Q48 is approximately 0.0 Vdc. On the high to low transition of U47B's pin 9 output, Q48 is turned on and its output is pulsed to approximately +4V. The Phase Detector is clocked on the low to high transition of the output of Q48. Capacitor C312 turns transistor Q48 on and off very quickly.

TROUBLESHOOTING USING SIGNATURE ANALYSIS

Procedures for checking part of the A3 Low Frequency Loop Assembly circuits are given below. The areas or points to check are marked on the schematic by a hexagon with a checkmark and a number inside, for example, (✓1). Troubleshooting is done on the LF Loop Microprocessor using Signature Analysis. The LF Loop's Microprocessor troubleshooting routines are used to check the Fractional-N Controller and the Divide-By-N-Counters.

Troubleshooting Help

- Block Diagram 3
- Table 4-1. Abbreviated Performance Tests
- Table 5-2. Post-Repair Adjustments

Test Equipment

Signature Analyzer	HP 5005A
Audio Source	HP 8903B
Frequency Counter	HP 5328A
Oscilloscope	HP 54100A
Oscilloscope Probe	HP 54003-61617
Oscilloscope Active Probe, Chan 1	HP 54001A
Oscilloscope 1 Megohm Probe Pod, Chan 2	HP 54003A

(✓1) Low Frequency Loop Microprocessor

1. Connect the signature analyzer as follows:

GND	GND (See Note below)
CLK	DSA CLK A3TP24
START	DSA S/S A3TP25
STOP	DSA S/S A3TP25

NOTE

Connect to ground as close to the circuitry being probed as possible. Bad grounding can cause unstable signatures.

2. Set the signature analyzer's controls as follows:

CLK	Positive Edge
START	Positive Edge
STOP	Negative Edge

CAUTION

The LF Loop Clock input (LCL) at pin 2 and the LF Loop Data input (LDA) at pin 9 from the A11 Assembly must be opened before A3TP17 and A3TP26 are connected to ground. Open LCL and LDA inputs by removing W16 from A11J4. The LF Loop Microprocessor U28 does not require data from the main Microprocessor to run the signature analysis checks.

3. Set up the Signal Generator as follows:
 - a. Connect A3TP26 to A3TP20 (ground).
 - b. Connect A3TP17 to ground. Use the jumper provided.
 - c. Turn the Signal Generator's POWER switch to STANDBY and then back to ON.
4. Connect the signature analyzer probe to each node indicated in Table 2 and verify that each signature is correct and stable.

The alternate Microprocessor signatures at pins 14 and 20 to 27 check the input at pins 2, 8 to 11 and 16 to 19. When the input is low, the signature at the related pin is the alternate signature.

Table 2. Low Frequency Loop Microprocessor Signatures.

Node A3U28 Pin	Normal Signature	Alternate Signature	Alternate Signature Determining Factor
#1	0000	---	
#2	7U39	0000	Pin tied low
#3	7U39	---	
#6	0000	---	
#7	7U39	---	
#8	0000	---	
#9	0000	7U39	Pin pulled high
#10	7U39	0000	Pin tied low
#11	7U39	0000	Out-of-lock LED on
#14	0021	0020	Pin 2 low
#15	0010	40C5	RAM error
#16	7U39	0000	Pin tied low
#17	7U39	0000	Pin tied low
#18	7U39	0000	Pin tied low
#19	7U39	0000	Pin tied low
#20	2050	2052	Pin 8 low
#21	102C	1029	Pin 9 low
#22	0816	0814	Pin 10 low
#23	0408	040A	Out-of-lock LED on
#24	0201	0205	Pin 16 low
#25	0106	0102	Pin 17 low
#26	0085	0081	Pin 18 low
#27	0044	0040	Pin 19 low
#28	7U39	---	

5. After the signatures are taken, remove A3TP26 and A3TP17 from ground. Store the jumper between the ground pins of A3TP16-19.

Turn the Signal Generator's POWER switch to STBY and then back to ON.

√2 Fractional-N and Latches

1. Set the Signal Generator's POWER switch to STBY.
2. Connect A3TP26 to ground. Connect A3TP18 to ground using the jumper provided.
3. Set the Signal Generator's POWER switch to ON.
4. The LF Loop's Microprocessor troubleshooting routine is now entered as a result of completing step 2. The nine's complement data loaded into the Divide-By-N-Counters is 685, and the LF Loop VCO's frequency is set to 66.8 MHz.

If the LF Loop VCO's frequency is not 66.8 MHz, check the nine's complement data loaded into the nine's Complement Latches. The nine's compliment data should be as follows:

- a. 100 kHz DIGIT: U29 pin 2 (H), pin 7 (L), pin 10 (H), pin 15 (L)
 - b. 1 MHz DIGIT: U23 pin 12 (L), pin 15 (L), pin 16 (L), pin 19 (H)
 - c. 10 MHz DIGIT: U23 pin 2 (L), pin 5 (H), pin 6 (H), pin 9 (L)
5. Use the oscilloscope to check that the API outputs of U17 at pins 2 to 6 pulse low every 10 μs.
 6. Use the oscilloscope to check that the Bias output of U17 at pin 10 pulses high for 13 Chip Clocks every 10 μs.
 7. Disconnect A3TP20 from A3TP26. Disconnect A3TP18 from ground.

√3 Counters and Cycle Start Synchronization

1. Remove jumper A3W6 (refer to Service Sheet 14). The VCO TUNE voltage goes to approximately 0.0V.
2. Connect the frequency counter to A3TP29 (60 to 110 MHz) (refer to Service Sheet 10) and measure the VCO frequency. The VCO frequency should be 96 MHz ±7 MHz.
3. Subtract the VCO frequency from 1050 MHz and select the difference frequency as the RF output frequency of the Signal Generator to 5 significant digits, for example, 950.73 MHz.
 - a. RF Output Frequency = (800 - VCO) + Notch Filter Frequency
 - b. The Notch Filter Frequency is 250 MHz
 - c. RF output Frequency = 800 - VCO + 250 = 1050 - VCO
 - d. The nine's complement data in the nine's Complement Latches is the data required to lock the Low Frequency Loop VCO.
4. Set the Oscilloscope as follows:

Chan 1

Ch 1 Mode Normal
 Ch 1 Display On
 VOLTS/DIV 1.0V
 OFFSET 0.0V

Chan 2

Ch 2 Mode Normal
 Ch 2 Display On
 VOLTS/DIV 2.0V
 OFFSET 1.0V

Timebase

SEC/DIV 1.0 μ s
 DELAY 0.0s
 Delay Ref at Left
 Sweep Trg'd

Trigger

Trigger Mode Edge
 Trig Src Chan 1
 TRIG LEVEL 1.5V
 Slope Pos

Display

Display Mode Normal
 DISPLAY TIME 200 ms
 Split Screen ON
 Graticle ON

5. Connect Chan 1 to A3TP15 (CYCLE START), and Chan 2 to pin 12 of each Counter A3U24, U30, and U36.

Figure 2 shows the oscilloscope display for the 1 MHz, 10 MHz, and 100 kHz Counters for a VCO frequency of 99.8 MHz. With a VCO frequency of 96 MHz \pm 7 MHz the oscilloscope display of the Counter output is the same except for timing.

√4 Edge Detector, Timing Latches, and Synchronization

1. Remove jumper A3W6 (refer to Service Sheet 14). The VCO TUNE voltage goes to approximately 0.0V.
2. Timing pulse generation and clocking is checked.
3. Set the Oscilloscope as follows:

Chan 1

Ch 1 Mode Normal
 Ch 1 Display On
 VOLTS/DIV 2.0V
 OFFSET 0.0V

Chan 2

Ch 2 Mode Normal
 Ch 2 Display On
 VOLTS/DIV 2.0V
 OFFSET 1.0V

Timebase

SEC/DIV 200 ns
 DELAY 0.0s
 Delay Ref at Left
 Sweep Trg'd

Trigger

Trigger Mode Edge
 Trig Src Chan 2
 TRIG LEVEL 200 mV
 Slope Pos

Display

Display Mode Normal
 DISPLAY TIME 200 ms
 Split Screen ON
 Graticle ON

4. Connect Chan 1 to A3TP31 (CHIP CLOCK) (refer to Service Sheet 10), and Chan 2 to A3TP27 (START SHIFT). The Start Shift pulse should be present and have a pulse width of one Chip Clock.
5. With the Chan 1 probe, check that the pulse is clocked through the Timing Latches, U42, U44B and Synchronization flip/flop U47. The VCO divide-by-N.F. output of Q48 is a narrow pulse.

√5 Cycle Add/Remove Latches and Add/Remove Cycle Gates

1. Remove jumper A3W6 (refer to Service Sheet 14). The VCO TUNE voltage goes to approximately 0.0V.
2. The 100 kHz Counter remove cycle pulse is checked.
3. Set the Oscilloscope as follows:

Chan 1

Ch 1 Mode Normal
 Ch 1 Display On
 VOLTS/DIV 2.0V
 OFFSET 0.0V

Chan 2

Ch 2 Mode Normal
 Ch 2 Display On
 VOLTS/DIV 2.0V
 OFFSET 1.0V

Timebase

SEC/DIV 1.0 μ s
 DELAY 0.0s
 Delay Ref at Center
 Sweep Trg'd

Trigger

Trigger Mode Edge
 Trig Src Chan 2
 TRIG LEVEL 1.5V
 Slope Pos

Display

Display Mode Normal
 DISPLAY TIME 200 ms
 Split Screen ON
 Graticle ON

4. Connect Chan 1 to A3TP27 (START SHIFT), and check that the 100 kHz Counter remove cycle pulse is gated through U41A, U41B and U51A.

5. Replace jumper W6.
6. Set the function generator as follows:
Frequency 20 Hz
Level 1.41V
7. Connect the function generator to the Signal Generator's MOD INPUT/ OUTPUT connector.
8. Set the Signal Generator as follows:
Frequency Any
Amplitude Any
Modulation FM, 5 kHz
Source External
9. Connect Chan 2 to U38A, U38B, U43C, U43B, U51A, and A3TP15, and check that the Add and Remove Cycle pulses are gated through them.

A3 Component Coordinates (1 of 3)

COMP	X,Y	COMP	X,Y	COMP	X,Y	COMP	X,Y	COMP	X,Y	COMP	X,Y
C1	E,1	C213	C,1	C513	A,4	CR1	D,2	FL1	E,2	Q10	D,4
C2	D,2	C300	D,2	C514	A,3	CR2	D,2	FL2	E,2	Q11	D,4
C3	E,2	C301	C,3	C515	A,4	CR3	D,2	FL3	D,2	Q12	A,4
C4	D,2	C302	C,3	C516	A,3	CR4	D,2	FL4	D,2	Q13	B,4
C5	D,1	C303	D,3	C517	A,3	CR5	E,1			Q14	B,4
C6	D,2	C304	D,3	C518	B,3	CR6	D,1	J1	E,4	Q15	B,4
C7	D,1	C305	D,3	C519	A,3	CR7	D,2	J2	A,4	Q16	C,4
C8	D,1	C306	C,2	C520	A,3	CR8	D,2	J3	A,4	Q17	C,4
C9	D,2	C307	C,3	C521	A,3	CR9	E,1	J4	C,2	Q18	C,4
C10	D,2	C308	C,3	C600	B,3	CR10	D,1	J5	C,1	Q19	D,4
C11	E,1	C309	C,3	C601	B,3	CR11	D,1	J6	D,1	Q20	D,4
C12	D,1	C310	C,2	C602	B,3	CR12	D,1	J7	E,1	Q21	D,4
C13	D,2	C311	C,1	C603	B,3	CR15	E,1	J8	E,2	Q22	B,4
C14	D,2	C312	C,1	C604	B,3	CR16	D,1			Q23	C,4
C15	D,1	C313	C,2	C605	B,3	CR17	E,2	L1	E,2	Q24	C,4
C16	D,2	C400	B,3	C606	B,3	CR18	D,2	L2	D,2	Q25	C,4
C17	D,1	C401	D,4	C607	B,3	CR200	C,1	L3	E,2	Q26	B,4
C18	E,1	C402	C,4	C608	B,3	CR201	C,1	L5	E,2	Q27	B,4
C19	E,2	C403	C,3	C609	B,3	CR400	B,4	L6	E,2	Q28	C,4
C20	E,2	C404	B,4	C610	C,3	CR401	C,4	L8	D,2	Q29	A,4
C21	E,1	C405	C,3	C611	C,4	CR402	C,4	L200	E,4	Q30	A,4
C22	E,2	C406	C,4	C612	C,3	CR403	C,4	L201	E,4	Q31	A,4
C23	E,1	C407	C,4	C613	B,3	CR404	C,4	L202	E,4	Q32	A,4
C24	E,2	C408	B,3	C614	B,3	CR405	B,4	L203	E,4	Q33	B,4
C25	E,1	C409	B,4	C615	B,2	CR406	B,4	L204	C,1	Q34	A,3
C26	E,2	C410	C,4	C616	B,3	CR500	B,4	L300	C,1	Q35	B,3
C27	D,1	C411	B,4	C617	B,2	CR501	B,4	L400	B,4	Q36	B,3
C28	E,2	C412	C,4	C618	B,3	CR502	A,4	L401	D,4	Q37	A,3
C29	D,1	C413	B,4	C619	B,3	CR503	A,4	L402	C,3	Q38	A,3
C30	E,1	C414	B,4	C620	B,2	CR504	B,4	L403	C,3	Q39	A,3
C100	A,3	C415	B,4	C621	B,2	CR505	B,4	L404	C,4	Q40	A,3
C101	A,2	C416	B,4	C700	E,3	CR506	B,4	L500	B,4	Q41	A,3
C200	E,4	C500	A,4	C701	E,3	CR600	B,3	L501	A,4	Q42	A,3
C201	E,4	C501	A,4	C702	E,3	CR602	B,3	L502	A,4	Q43	A,3
C202	E,4	C502	B,4	C703	E,2	CR700	D,4	L503	A,4	Q44	A,3
C203	E,4	C503	A,4	C704	E,3	CR701	D,4			Q46	A,2
C204	B,1	C504	A,3	C705	E,4	CR702	D,4	Q1	A,4	Q47	C,1
C205	C,2	C505	B,4	C706	E,4	CR703	D,4	Q2	A,4	Q48	C,2
C206	C,1	C506	B,4	C707	D,4	CR704	D,4	Q3	D,4	Q49	D,1
C207	C,1	C507	A,4	C708	D,4	CR705	D,4	Q4	A,4	Q50	E,1
C208	C,1	C508	B,3	C709	D,4	CR706	D,4	Q5	B,4	Q51	C,1
C209	C,1	C509	B,3	C710	D,4	CR707	D,4	Q6	B,4	Q52	D,1
C210	C,1	C510	A,4	C711	D,4			Q7	B,4	Q53	D,1
C211	C,1	C511	B,3	C712	D,4			Q8	C,4	Q54	E,1
C212	C,1	C512	A,3	C713	E,4	DS500	A,3	Q9	C,4	Q55	E,1

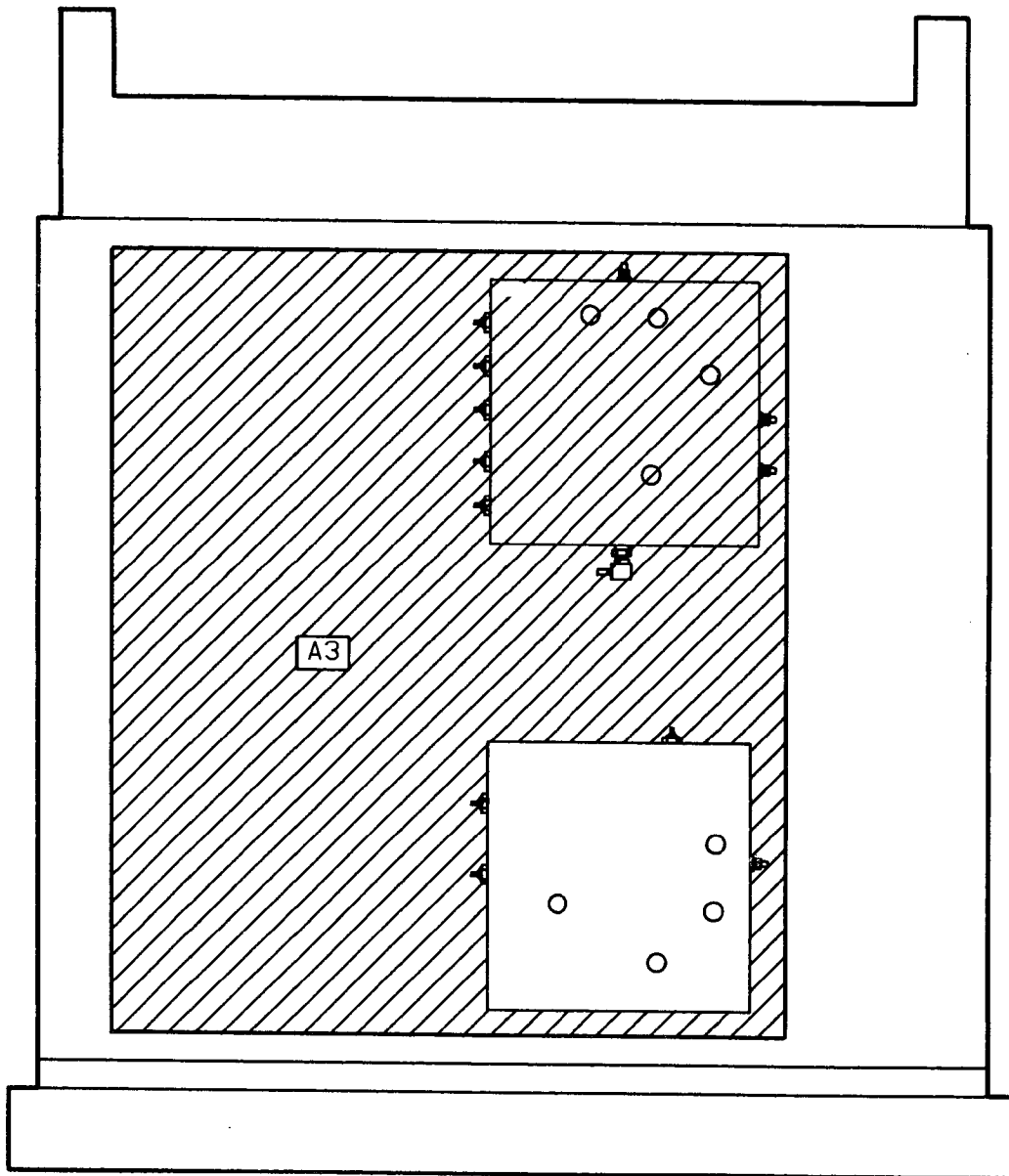
A3 Component Coordinates (2 of 3)

COMP	X,Y	COMP	X,Y	COMP	X,Y	COMP	X,Y	COMP	X,Y	COMP	X,Y
Q56	C,1	R207	C,1	R431	B,4	R523	A,4	R568	A,3	R719	D,4
		R208	C,1	R432	C,3	R524	A,4	R569	B,3	R720	E,4
R1	D,2	R209	B,1	R433	D,4	R525	A,3	R570	A,3	R721	D,4
R2	D,2	R210	C,1	R434	C,4	R526	A,4	R600	B,3	R722	D,4
R3	D,2	R211	C,1	R435	C,3	R527	A,3	R601	B,3	R723	D,4
R4	E,2	R300	C,3	R436	B,4	R528	A,3	R602	B,3	R724	D,4
R5	D,2	R301	C,3	R437	B,4	R529	A,4	R603	B,3	R725	D,4
R6	D,1	R302	C,3	R438	D,4	R530	A,4	R604	B,3	R726	D,4
R7	D,2	R303	C,3	R439	C,3	R531	A,3	R605	B,3	R727	D,4
R8	D,1	R304	C,3	R440	C,4	R532	B,3	R606	B,3	R728	D,4
R9	E,1	R305	C,2	R441	B,4	R533	A,4	R607	B,3	R729	D,4
R10	D,2	R306	D,2	R442	C,4	R534	A,3	R608	A,3	R731	D,4
R11	D,2	R307	C,1	R443	B,4	R535	A,3	R609	B,3	R732	C,4
R12	D,2	R308	C,1	R444	B,4	R536	A,4	R610	B,3	R733	D,4
R13	D,1	R400	C,4	R445	B,4	R537	A,4	R611	B,3	R734	D,4
R14	D,2	R401	C,4	R446	B,4	R538	A,3	R612	C,3	R735	C,4
R15	E,1	R402	B,4	R447	B,4	R539	A,3	R613	B,3	R736	D,4
R16	D,1	R403	B,4	R448	B,4	R540	A,4	R614	B,3	R737	C,4
R17	D,1	R404	B,4	R449	B,4	R541	A,3	R615	B,3	R738	D,4
R18	E,1	R405	B,4	R450	B,4	R542	A,3	R616	C,3	R740	D,4
R19	D,1	R406	C,4	R451	C,4	R543	A,4	R617	B,3	R741	E,4
R20	D,1	R407	C,4	R452	C,4	R544	A,3	R618	B,3		
R21	D,1	R408	C,4	R500	A,4	R545	A,4	R619	B,3	TP1	B,4
R22	D,1	R409	B,4	R501	A,4	R546	A,3	R620	B,3	TP2	A,4
R23	E,1	R410	C,4	R502	A,4	R547	A,4	R621	B,2	TP3	D,4
R24	E,1	R411	C,4	R503	A,4	R548	A,3	R622	B,3	TP4	D,4
R25	E,2	R412	B,4	R504	A,4	R549	A,3	R700	E,4	TP5	D,4
R26	E,2	R413	C,4	R505	A,4	R550	A,3	R701	E,4	TP6	D,4
R27	E,2	R414	B,4	R506	A,4	R551	A,3	R702	E,4	TP7	C,4
R28	D,2	R415	C,4	R507	A,4	R552	A,4	R703	E,4	TP8	D,4
R29	D,1	R416	C,4	R508	A,4	R553	A,3	R704	D,4	TP9	D,4
R30	D,1	R417	C,4	R509	A,4	R554	A,3	R705	E,4	TP10	B,3
R31	D,1	R418	C,4	R510	A,4	R555	A,3	R706	D,4	TP11	A,3
R32	D,1	R419	B,4	R511	A,4	R556	A,3	R707	B,4	TP12	A,3
R33	D,2	R420	B,4	R512	A,4	R557	A,3	R708	E,4	TP13	B,3
R100	A,2	R421	C,4	R513	A,4	R558	A,3	R709	D,4	TP14	B,3
R101	A,2	R422	C,4	R514	A,4	R559	A,3	R710	D,4	TP15	C,3
R104	A,2	R423	C,4	R515	A,4	R560	A,3	R711	D,4	TP16	C,3
R200	B,2	R424	C,4	R516	A,4	R561	A,3	R712	B,4	TP17	C,3
R201	C,1	R425	C,4	R517	A,4	R562	A,3	R713	D,4	TP18	D,3
R202	C,2	R426	C,4	R518	B,4	R563	A,3	R714	D,4	TP19	D,3
R203	C,2	R427	C,4	R519	A,4	R564	A,3	R715	D,4	TP20	C,3
R204	C,1	R428	C,4	R520	A,4	R565	B,3	R716	C,4	TP21	C,3
R205	C,1	R429	B,4	R521	A,3	R566	A,3	R717	D,4	TP22	A,3
R206	C,1	R430	C,3	R522	B,4	R567	A,3	R718	E,4	TP23	A,3

A3 Component Coordinates (3 of 3)

COMP	X,Y	COMP	X,Y	COMP	X,Y	COMP	X,Y	COMP	X,Y
TP24	C,3	U35	C,2						
TP25	C,3	U36	D,2						
TP26	C,2	U37	E,2						
TP27	C,2	U38	C,2						
TP28	C,2	U39	C,2						
TP29	C,2	U40	D,2						
TP30	C,1	U41	C,2						
TP31	C,1	U42	C,2						
TP32	D,1	U43	C,2						
TP33	E,1	U44	C,2						
		U45	D,2						
U1	A,4	U46	C,1						
U2	B,4	U47	C,1						
U3	C,4	U48	D,1						
U4	D,4	U49	C,1						
U5	D,4	U50	C,1						
U6	C,4	U51	C,1						
U7	B,4	U52	D,1						
U8	C,4	U53	E,1						
U9	A,4	U54	C,1						
U10	D,4	U55	C,1						
U11	D,4								
U12	E,3	VR300	C,3						
U13	B,3	VR400	B,4						
U14	B,3	VR401	C,4						
U15	E,3	VR500	A,3						
U16	E,3	VR601	B,3						
U17	C,3								
U18	D,3	W1	B,3						
U19	E,3	W2	C,3						
U20	E,3	W3	A,3						
U21	A,3	W4	B,3						
U22	B,3	W5	A,3						
U23	D,3	W6	A,2						
U24	D,3	W7	D,1						
U25	E,3	W8	C,1						
U26	E,3	W9	C,4						
U27	B,3	W10	C,4						
U28	C,3	W11	B,4						
U29	D,3								
U30	D,3	Y1	E,2						
U31	E,3	Y300	C,2						
U32	E,3								
U33	B,3								
U34	B,3								

TOP INTERNAL VIEW - LEVEL 1

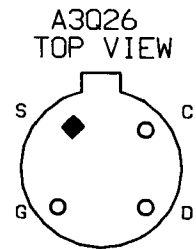
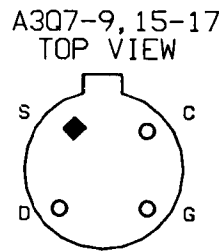
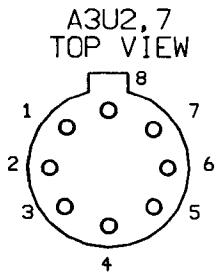


NOTES

1. For an explanation of schematic symbols, see "SCHEMATIC DIAGRAM NOTES" in Section 8.
2. Chassis ground is achieved by mechanical contact through nuts holding PC board to cover and W4.
3. Isolation (guard) trace.
4. Reference designations on this service sheet C, CR, L, R and VR have numbers ranging from 400 to 499 only.

LOGIC LEVELS

	TTL
HIGH	2V
LOW	0.8V
*S MORE NEG. THAN IS MORE POS. THAN	
OPEN	HIGH
GROUND	LOW



P/O A3 LOW FREQUENCY LOOP
FRACTIONAL-N,
DIVIDE-BY-N AND
DIGITAL TIMING LOGIC
SEE REVERSE SIDE

SS11

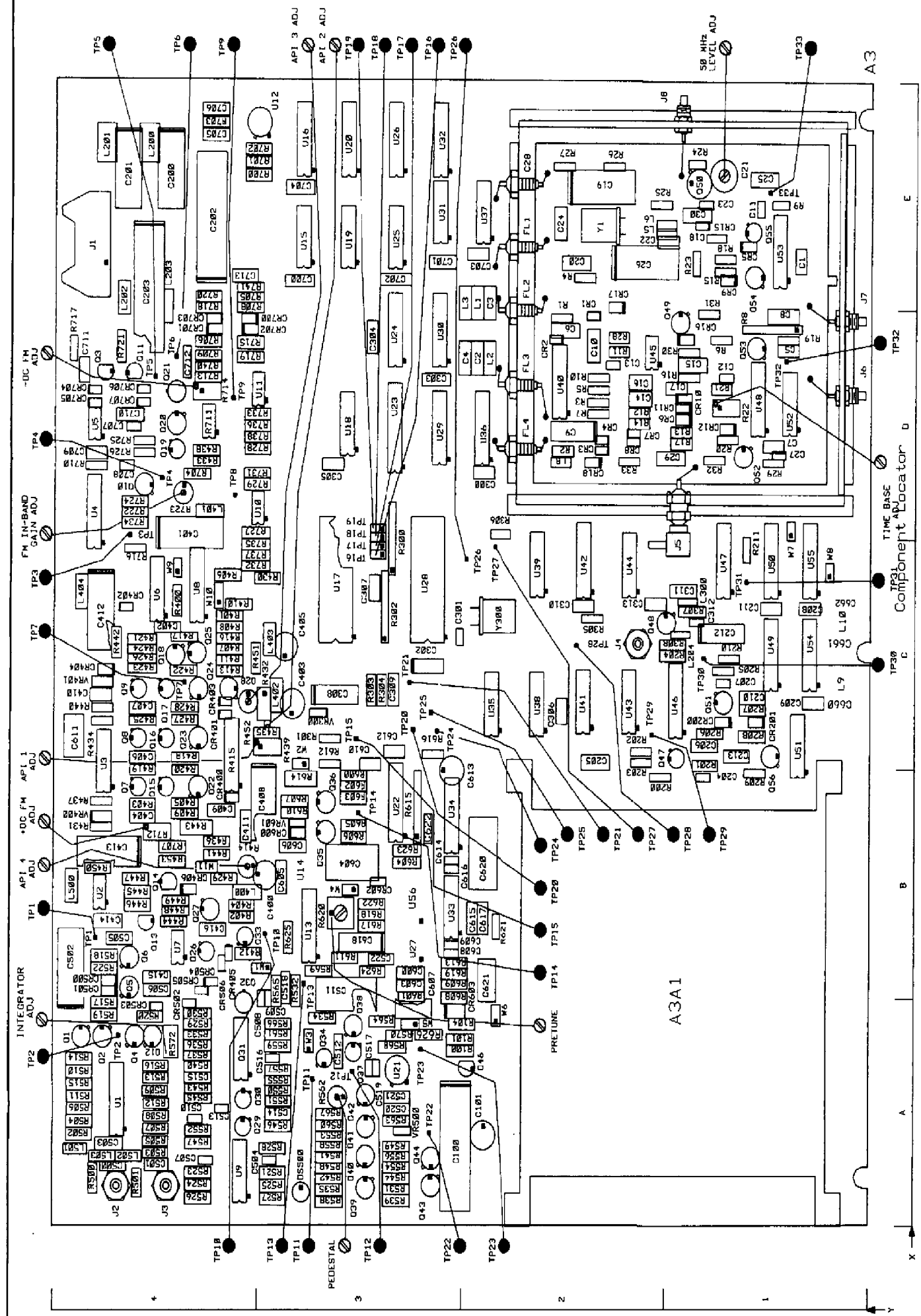


Figure 0. Service Sheet 12 Information

Component Locator

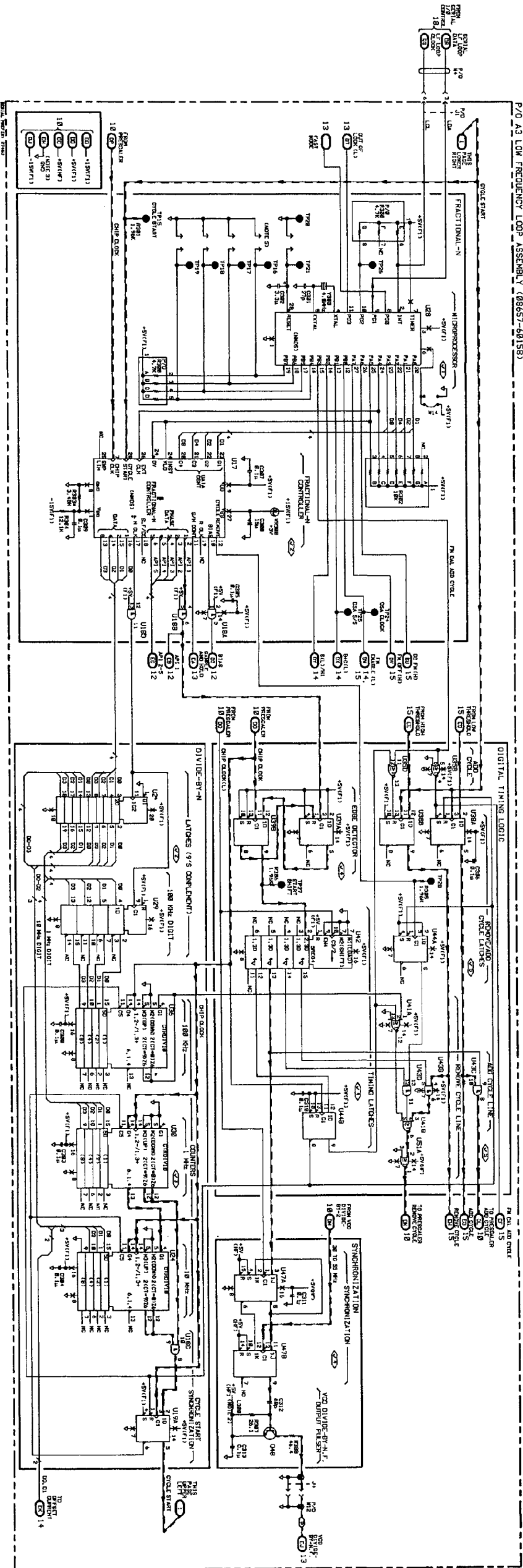


Figure 3
Service Sheet 11 17

Service Sheet 12

LOW FREQUENCY LOOP ANALOG PHASE INTERPOLATION (API), CURRENT SOURCES, CURRENT SUMMING, AND BIAS

PRINCIPLES OF OPERATION

General

The Bias pulse from the Fractional-N Controller U17 is the D input at pin 12 of D flip-flop U6B. CHIP CLOCK at pin 11 clocks the high D input of U6B to the output at pin 9, Delayed Bias. The Bias and Delayed Bias pulses remain high for 13 CHIP CLOCK pulses. The Fractional-N Controller sets its BIAS output high one Chip Clock after its Sample and Hold output was set inactive (low). The Integrator's correction voltage has been stored on the Sample and Hold capacitor. See Figure 1, the Low Frequency Loop Timing Diagram. The Integrator is reset before the next phase correction input is received from the Phase Detector. The Delayed Bias Pulse resets the Integrator by directing Bias Current to the Integrator. Figure 2 shows the API and Bias Currents.

Bias Control

Bias Pulse Off

The Bias pulse from the Fractional-N Controller is off, low. The low Delayed Bias output at pin 9 of U6B sets the base of emitter follower Q33 to approximately -1.6V . The emitter voltage is approximately -1.0V . Bias current-steering diode CR405 is turned on, and CR506 is turned off (refer to Service Sheet 13). The Bias Current is directed to the Bias Control transistor Q33.

Bias Pulse On

The Bias pulse from the Fractional-N Controller is on, high. The high Delayed Bias output at pin 9 of U6B sets the base of Q33 to approximately $+3.0\text{V}$. The emitter voltage increases to approximately $+3.7\text{V}$. Q33's increased positive emitter voltage turns Bias Current steering diodes CR405 off and CR506 on. The Bias Current is directed to the Integrator.

Current Routing Control

The base of Q28 is biased at approximately $+5\text{ Vdc}$ from the $+5\text{ Vdc}$ (F2) supply voltage through resistor R408. The collector of Q25 is connected to -15 Vdc (F1). The base voltage of Q18 is biased at approximately $+1.2\text{ Vdc}$ divided from the $+15\text{ Vdc}$ by resistors R424 and R426 to ground.

Bias Pulse Off

The Bias pulse from the Fractional-N Controller is off, low. The low Delayed Bias pulse output at pin 9 of U6B turns off Q28. The emitter voltage of Q28 is approximately $+5\text{V}$, divided from the $+15\text{ Vdc}$ supply voltage by resistors R411 and R413. The dc bias for Q25 is divided from the -15 Vdc (F1) supply voltage by resistors R416 and R417 to ground. The base voltage of Q25 is approximately -1.9V . Q25 is turned on since its emitter is connected to $+15\text{ Vdc}$ by R421. The voltage on the emitter is approximately -1.2V . The emitter voltage of Q25 is also the emitter voltage of Q18, and the negative emitter voltage turns Q18 off. Its collector voltage is -7.5V , divided from the -15 Vdc (F1) supply voltage by resistors R422 and R423 to ground. The -7.5V is connected to the gates of FET switches, Q15, Q16, and Q17 turning them off. With the FET switches turned off the current for the current sources of U3 is directed to Q3 and Q21 (refer to Service Sheet 15), and Q5 (refer to Service Sheet 13).

Bias Pulse On

The Bias pulse from the Fractional-N Controller is on, high. The high Delayed Bias pulse output at pin 9 of U6B turns on Q28. When the Delayed Bias pulse goes high, the emitter voltage of Q28 increases to approximately +5.7V. Transistor Q28 is turned on and the collector voltage increases to approximately +5.7V. The collector voltage of Q28 is the base voltage for Q25, and is used to turn Q25 off. Q25 is turned off during the Bias pulse. With Q25 turned off its emitter voltage goes positive. The emitter voltage of Q25 is also the emitter voltage of Q18, and is used to turn Q18 on. When Q18 is turned on, its collector increases from approximately -7.5V to approximately +2V. The three FET switches, Q15, Q16, and Q17 are turned on. The current for the current sources from U3 is directed from the three API transistors, Q22, Q23, and Q24. The API transistors Q22 (API 1), Q23 (API 2), and Q24 (API 3) are turned on. When the the API transistors are turned on API current steering diodes CR400, CR401 and CR403 are turned off.

During the Bias pulse from the Fractional-N Controller the Analog Phase Interpolation (API) pulses are also active. The API pulses are controlled by the Fractional-N Controller. The API pulses control the amount of phase correction current subtracted from the Bias Current during the Bias pulse. The Bias Current resets the Integrator after the Integrator voltage has been stored on the Sample and Hold capacitor (refer to Service Sheet 13). The Integrator's voltage is dependent on the phase difference between the VCO and the reference signals. The Fractional-N Controller controls the pulse duration for each of the 5 API signals. When the Low Frequency Loop VCO is tuned to a whole number, multiple of 100 kHz, the API pulses are active for a fixed length of time during each Bias pulse. The phase of the Low Frequency Loop VCO is not changing in relation to the 100 kHz reference. The length of the API pulses change when the Phase Increment mode is selected, and the phase of the RF output is incremented.

When the Low Frequency VCO is operating at a fractional frequency, the length of time each API pulse is active varies from one cycle to the next cycle. The Low Frequency Loop VCO is not tuned to a whole number multiple of 100 kHz. The API pulses when viewed with an oscilloscope are not nice and steady but are changing each cycle. The phase between the Low Frequency Loop VCO divided-by-N.F. and the 100 kHz reference is continually changing. When the phase difference between the 100 kHz reference, and the VCO divided-by-N.F. signals changes by 360 degrees, a cycle is removed by the Prescaler. The Fractional-N Controller measures the phase difference between the VCO divided-by-N.F. and the reference signals, and it controls the Prescaler. Each time a cycle is removed by the Prescaler, the phase difference between the VCO and reference returns to the same nominal offset.

The API pulses compensate for the Fractional-N phase changes between the Low Frequency Loop VCO and the reference. When the Bias pulse is high, the Integrator is reset. API current is subtracted from the Bias Current. The API pulses are active low and the Integrator's output voltage is offset. The Integrator's output voltage is offset to compensate for the Phase Detector's output that results from the fractional frequency phase difference between the VCO Divided-By-N.F., and the 100 kHz reference.

When transistor Q22 is turned off by the API 1 pulse, the API 1 current steering diode CR400 is turned on. API 1 current to Current Buffer Q7 and part of Current Source U3 is summed with the Bias Current at Current Summing Amplifier U7. The two currents are summed together for the length of time the API 1 pulse is active. Q22 is turned on, turning off CR400 and steering the API 1 current through Q22.

The API pulses are active low and are controlled by the Fractional-N Controller. The D input to U6A, part of the API Digital Control circuits, is high when API 1 is not active. The high D input is clocked to the output at pin 5 by the Chip Clock. The +15 Vdc is divided by R405 and R409 to the +5V at U6A pin 5. The base of Q22 is approximately +6V. Its emitter voltage is approximately +5.4V. Q22 is turned on, and CR400 is turned off since the anode of CR400 is connected to the virtual +5 Vdc summing node through resistor network of R435, R439, and R415A and B. A low API 1 pulsed input at pin 2 of U6A is clocked to the output at pin 5. The +15 Vdc is divided to approximately 0V at pin 5 by R405 and R409. The base of Q22 is approximately +3V, and the emitter voltage wants to decrease to turn on Q22. But when its voltage gets to approximately +4.4V CR400 is turned on. Q22 is turned off until the API 1 pulse returns high. Transistors Q23 and Q24 operate the same for API 2 and 3 currents. The amount of the API currents is precisely controlled by the current sources, by the adjustments, and by resistor R415.

The four Current Sources of U3, and the three Current Buffers Q7, Q8 and Q9 are always turned on. The base of all transistors in U3 are biased at -8.2 Vdc, and are controlled by the 6.2V Zener diode VR401, and the diode voltage drop of CR404. Their emitter voltages are then -8.8 Vdc. Each Current Source produces a precise amount of current determined by the voltage drop of each emitter resistor (1.15k for 5.4 mA, 2.3k for 2.7 mA, and 12.1k for 0.5 mA). When API 1 is active, the 5.4 mA of the Current Source is divided by resistors R435, R439, and R415A and B. The current summed with the Bias Current is approximately $54 \mu\text{A}$. The actual value of the current is adjusted by R439 for minimum API 1 spurs. When API 2 is active, the 2.7 mA of the Current Source is divided by resistors R432, and R415C and F. The current summed with the Bias Current is approximately $5.4 \mu\text{A}$. The actual value of the current is adjusted by R432 for minimum API 2 spurs. When API 3 is active the 2.7 mA of the Current Source is divided by resistors R452, R51, and R415D and R415E. The current summed with the Bias Current is approximately $0.54 \mu\text{A}$. The actual value of the current is adjusted by R452 for minimum API 3 spurs. When API 4 is active, the low output of U8 at pin 7 causes a current to flow from the +5 Vdc to the low at pin 7. The current is divided by resistors R429, R414, and R406. The current summed with the Bias Current is approximately 50 nA. The actual value of the API 4 current is adjusted by R414 for minimum API 4 spurs. When API 5 is active, the low output of U8 at pin 10 causes a current to flow from the +5 Vdc to the low at pin 10. The current is divided by resistors R436, and R441. The current summed with the Bias Current is approximately 5.0 nA. The API 5 current is not adjustable.

The API currents are summed with the Bias Current at the Current Summing Amplifier U7. The currents are summed into the virtual +5 Vdc node at pin 2 of U7, and all of the current flows through FET Q26 to the Integrator. This all occurs during the Bias pulse. The length of time that the Bias pulse is active varies depending upon the Low Frequency Loop's VCO's frequency, 60 to 110 MHz. After 12 Chip Clocks the API pulses are all turned off, and at the completion of the 13th Chip Clock the Bias pulse is turned off. The Integrator is reset and ready for the next input from the Phase Detector. When the Bias pulse is turned off, the Delayed Bias pulse at pin 9 of U6B also goes low. Q33 is turned on, CR405 is turned on, and CR506 is turned off. The Bias Current flows through Q33. The FET switches Q15, Q16, and Q17 are turned off by the -7.5V at the collector of Q18.

A Bias Current of 0.5 mA is continually provided by Q27, and is controlled by the 0.5 mA from the Current Source U3 and Q14. Transistor Q14 senses variations in the +5 Vdc summing node and compensates for the variations. The +5 Vdc of the summing node must be kept constant to prevent spurs on the RF output of the Signal Generator.

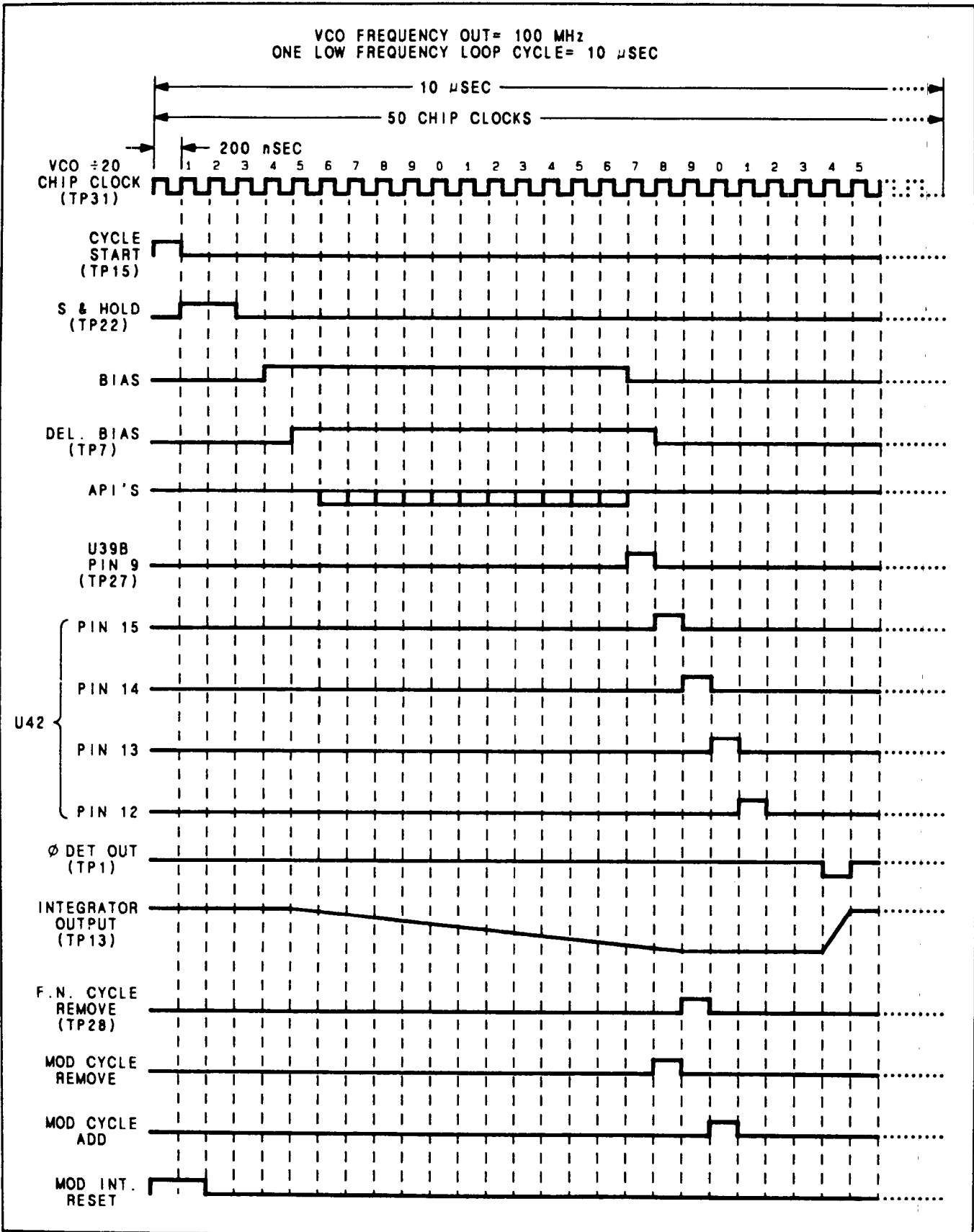


Figure 1. Low Frequency Loop Timing Diagram.

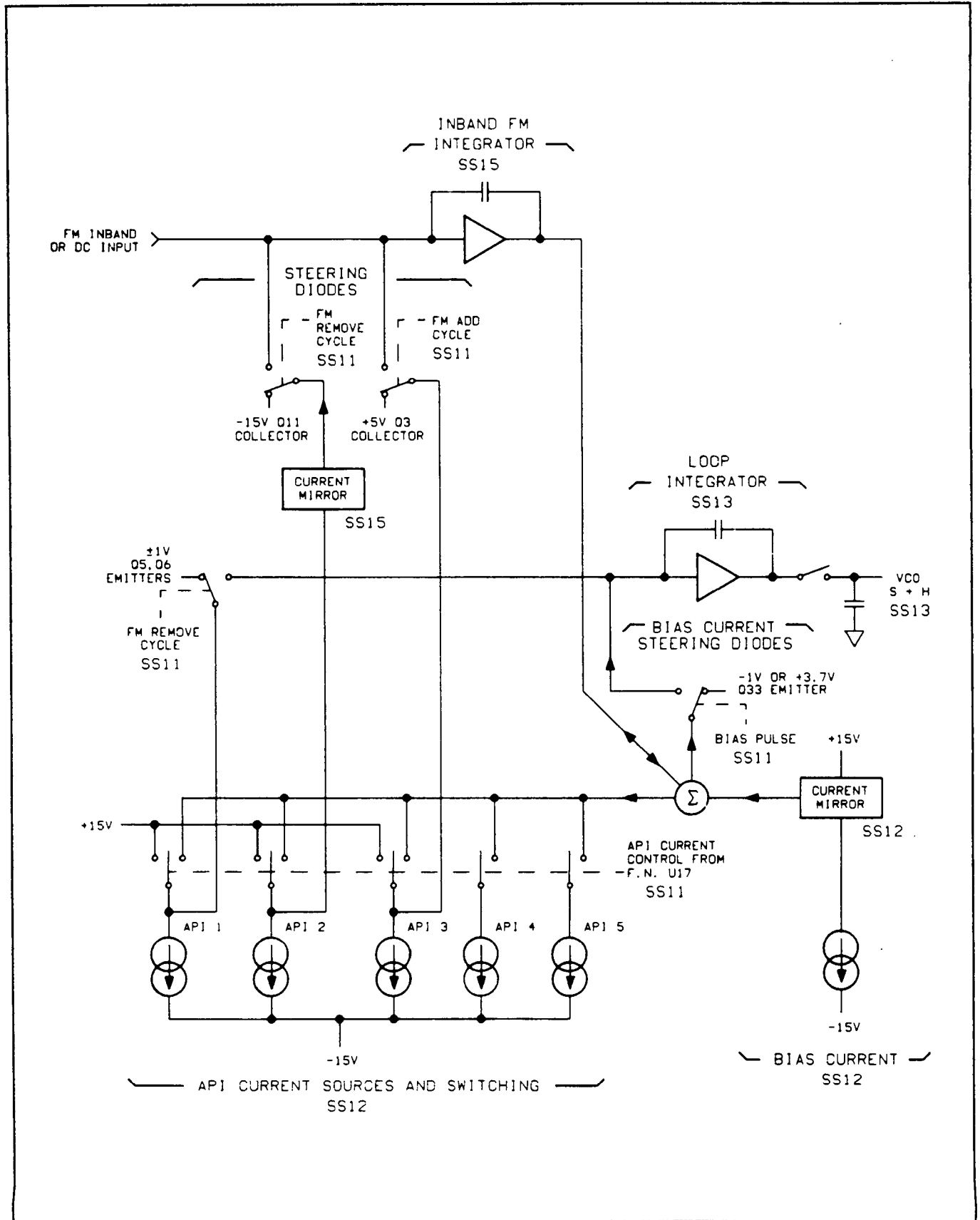


Figure 2. Low Frequency Loop API and Bias Currents.

TROUBLESHOOTING

Procedures for checking part of the A3 Low Frequency Loop Assembly circuits are given below. The areas or points to check are marked on the schematic by a hexagon with a checkmark and a number inside, for example, $\checkmark 1$. Transistor bias voltages are shown without tolerances. If the Low Frequency Loop does not lock, circuit problems could be in the Bias Control, in the Current Routing Control, in the Current Sources, in the API 1 current or in the Bias Current. If spurious signals (spurs) are high, the problem could be in the Current Routing of API Currents or in the API Current Sources.

Troubleshooting Help

Block Diagram 3

Table 4-1. Abbreviated Performance Tests

Table 5-2. Post-Repair Adjustments

Test Equipment

Digital Multimeter	HP 3466A
Oscilloscope	HP 54100A
Oscilloscope Active Probe Chan 1	HP 54001A
Oscilloscope 1 Megohm Probe Pod Chan 2	HP 54003A
Oscilloscope Probe	HP 54003-61617

$\checkmark 1$ Bias Control and P/O Current Routing Control

1. Check the Bias pulse at pin 12 of U6B, and the Delayed Bias pulse at pin 9. The pulses are at TTL levels and 13 Chip Clocks long. If the Low Frequency Loop is not locked, and the pulses are still 13 Chip Clocks long, but the pulse width changes as the frequency of the Chip Clock changes, refer to Figure 1 and continue with check 1.
2. The pulse at TP10 (BIAS SW) is a TTL high during the Bias pulse, and should be the same pulse width as the Bias pulse. Bias Current steering diode CR405 is turned off.
3. The pulse at TP7 (DELAYED BIAS) is approximately 0V during the Bias pulse, and approximately -7.5V when the Bias pulse is off.
4. Transistor Q28 is on, Q25 is off, and Q18 is on during the Bias pulse.

$\checkmark 2$ API Digital Control and P/O Current Routing Control

1. Enter a frequency of 100 MHz from the keyboard. The Low Frequency Loop does not have to be locked.
2. Check the low API pulses at the outputs of U6A and U8. The pulses are at TTL levels and 12 Chip Clocks long. If the loop is not locked, the pulses are still 12 Chip Clocks long but vary as the frequency of the Chip Clock changes.
3. Check that transistors Q22, Q23, and Q24 are turned off and API current steering diodes CR400, CR401, and CR403 are turned on when their API pulses are active low.

√3 Current Sources and Current Dividers

1. Enter a frequency of 100 MHz from the keyboard.
2. Measure the dc voltages for the Current Sources and the Current Buffers.
3. Measure the voltage drop across the Current Source's emitter resistors and calculate the current through the resistors.
4. Measure for a voltage drop across resistors R415A, B, C, D, E, F, when the API pulses are active low.

√4 Current Summing and Bias

1. Measure the dc voltages of Q14, Q27, and Q26.
2. Measure the reference voltage +5V (Ref).

A3 Component Coordinates (1 of 3)

COMP	X,Y	COMP	X,Y	COMP	X,Y	COMP	X,Y	COMP	X,Y	COMP	X,Y
C1	E,1	C213	C,1	C513	A,4	CR1	D,2	FL1	E,2	Q10	D,4
C2	D,2	C300	D,2	C514	A,3	CR2	D,2	FL2	E,2	Q11	D,4
C3	E,2	C301	C,3	C515	A,4	CR3	D,2	FL3	D,2	Q12	A,4
C4	D,2	C302	C,3	C516	A,3	CR4	D,2	FL4	D,2	Q13	B,4
C5	D,1	C303	D,3	C517	A,3	CR5	E,1			Q14	B,4
C6	D,2	C304	D,3	C518	B,3	CR6	D,1	J1	E,4	Q15	B,4
C7	D,1	C305	D,3	C519	A,3	CR7	D,2	J2	A,4	Q16	C,4
C8	D,1	C306	C,2	C520	A,3	CR8	D,2	J3	A,4	Q17	C,4
C9	D,2	C307	C,3	C521	A,3	CR9	E,1	J4	C,2	Q18	C,4
C10	D,2	C308	C,3	C600	B,3	CR10	D,1	J5	C,1	Q19	D,4
C11	E,1	C309	C,3	C601	B,3	CR11	D,1	J6	D,1	Q20	D,4
C12	D,1	C310	C,2	C602	B,3	CR12	D,1	J7	E,1	Q21	D,4
C13	D,2	C311	C,1	C603	B,3	CR15	E,1	J8	E,2	Q22	B,4
C14	D,2	C312	C,1	C604	B,3	CR16	D,1			Q23	C,4
C15	D,1	C313	C,2	C605	B,3	CR17	E,2	L1	E,2	Q24	C,4
C16	D,2	C400	B,3	C606	B,3	CR18	D,2	L2	D,2	Q25	C,4
C17	D,1	C401	D,4	C607	B,3	CR200	C,1	L3	E,2	Q26	B,4
C18	E,1	C402	C,4	C608	B,3	CR201	C,1	L5	E,2	Q27	B,4
C19	E,2	C403	C,3	C609	B,3	CR400	B,4	L6	E,2	Q28	C,4
C20	E,2	C404	B,4	C610	C,3	CR401	C,4	L8	D,2	Q29	A,4
C21	E,1	C405	C,3	C611	C,4	CR402	C,4	L200	E,4	Q30	A,4
C22	E,2	C406	C,4	C612	C,3	CR403	C,4	L201	E,4	Q31	A,4
C23	E,1	C407	C,4	C613	B,3	CR404	C,4	L202	E,4	Q32	A,4
C24	E,2	C408	B,3	C614	B,3	CR405	B,4	L203	E,4	Q33	B,4
C25	E,1	C409	B,4	C615	B,2	CR406	B,4	L204	C,1	Q34	A,3
C26	E,2	C410	C,4	C616	B,3	CR500	B,4	L300	C,1	Q35	B,3
C27	D,1	C411	B,4	C617	B,2	CR501	B,4	L400	B,4	Q36	B,3
C28	E,2	C412	C,4	C618	B,3	CR502	A,4	L401	D,4	Q37	A,3
C29	D,1	C413	B,4	C619	B,3	CR503	A,4	L402	C,3	Q38	A,3
C30	E,1	C414	B,4	C620	B,2	CR504	B,4	L403	C,3	Q39	A,3
C100	A,3	C415	B,4	C621	B,2	CR505	B,4	L404	C,4	Q40	A,3
C101	A,2	C416	B,4	C700	E,3	CR506	B,4	L500	B,4	Q41	A,3
C200	E,4	C500	A,4	C701	E,3	CR600	B,3	L501	A,4	Q42	A,3
C201	E,4	C501	A,4	C702	E,3	CR602	B,3	L502	A,4	Q43	A,3
C202	E,4	C502	B,4	C703	E,2	CR700	D,4	L503	A,4	Q44	A,3
C203	E,4	C503	A,4	C704	E,3	CR701	D,4			Q46	A,2
C204	B,1	C504	A,3	C705	E,4	CR702	D,4	Q1	A,4	Q47	C,1
C205	C,2	C505	B,4	C706	E,4	CR703	D,4	Q2	A,4	Q48	C,2
C206	C,1	C506	B,4	C707	D,4	CR704	D,4	Q3	D,4	Q49	D,1
C207	C,1	C507	A,4	C708	D,4	CR705	D,4	Q4	A,4	Q50	E,1
C208	C,1	C508	B,3	C709	D,4	CR706	D,4	Q5	B,4	Q51	C,1
C209	C,1	C509	B,3	C710	D,4	CR707	D,4	Q6	B,4	Q52	D,1
C210	C,1	C510	A,4	C711	D,4			Q7	B,4	Q53	D,1
C211	C,1	C511	B,3	C712	D,4			Q8	C,4	Q54	E,1
C212	C,1	C512	A,3	C713	E,4	DS500	A,3	Q9	C,4	Q55	E,1

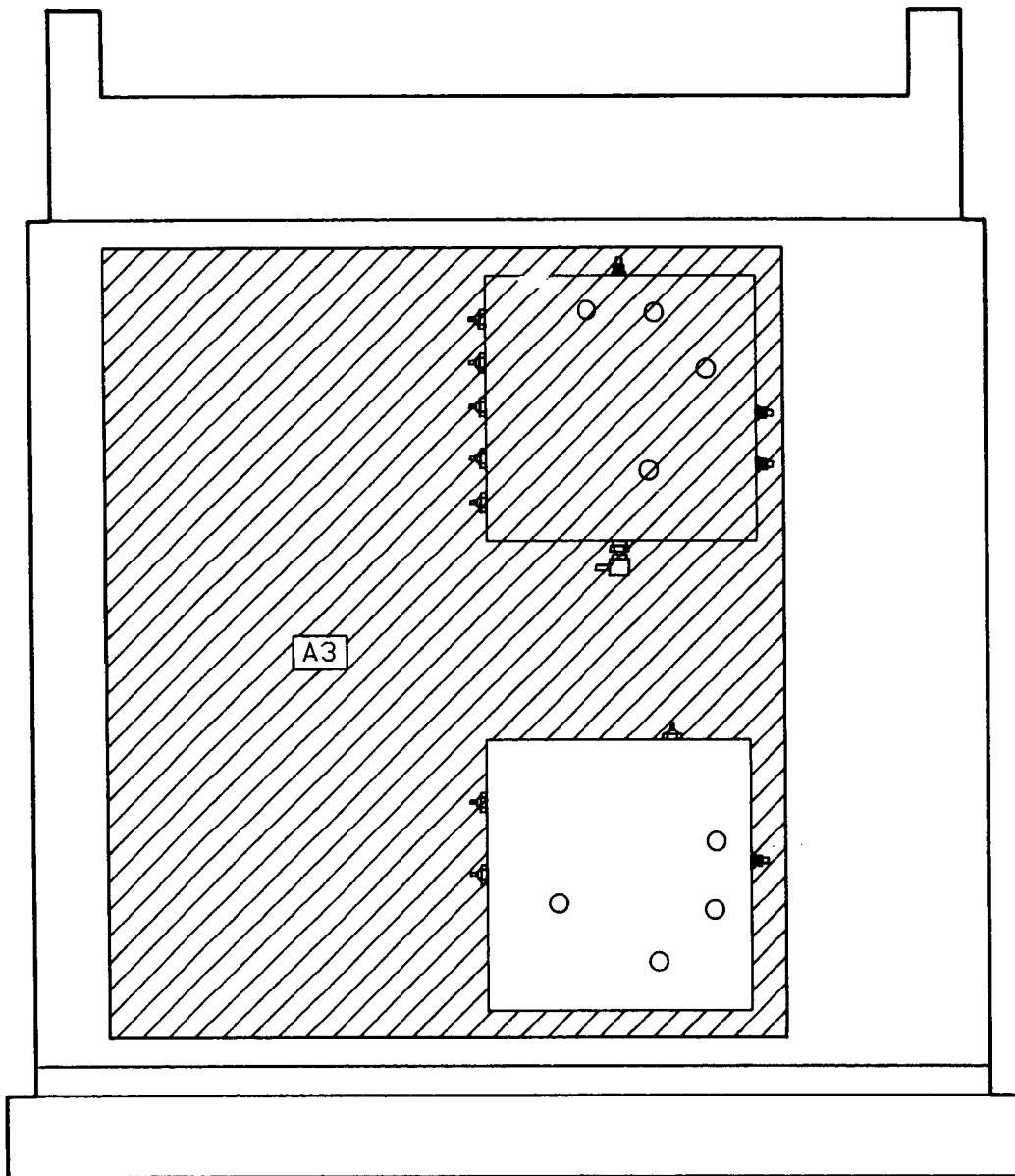
A3 Component Coordinates (2 of 3)

COMP	X,Y	COMP	X,Y	COMP	X,Y	COMP	X,Y	COMP	X,Y	COMP	X,Y
Q56	C,1	R207	C,1	R431	B,4	R523	A,4	R568	A,3	R719	D,4
		R208	C,1	R432	C,3	R524	A,4	R569	B,3	R720	E,4
R1	D,2	R209	B,1	R433	D,4	R525	A,3	R570	A,3	R721	D,4
R2	D,2	R210	C,1	R434	C,4	R526	A,4	R600	B,3	R722	D,4
R3	D,2	R211	C,1	R435	C,3	R527	A,3	R601	B,3	R723	D,4
R4	E,2	R300	C,3	R436	B,4	R528	A,3	R602	B,3	R724	D,4
R5	D,2	R301	C,3	R437	B,4	R529	A,4	R603	B,3	R725	D,4
R6	D,1	R302	C,3	R438	D,4	R530	A,4	R604	B,3	R726	D,4
R7	D,2	R303	C,3	R439	C,3	R531	A,3	R605	B,3	R727	D,4
R8	D,1	R304	C,3	R440	C,4	R532	B,3	R606	B,3	R728	D,4
R9	E,1	R305	C,2	R441	B,4	R533	A,4	R607	B,3	R729	D,4
R10	D,2	R306	D,2	R442	C,4	R534	A,3	R608	A,3	R731	D,4
R11	D,2	R307	C,1	R443	B,4	R535	A,3	R609	B,3	R732	C,4
R12	D,2	R308	C,1	R444	B,4	R536	A,4	R610	B,3	R733	D,4
R13	D,1	R400	C,4	R445	B,4	R537	A,4	R611	B,3	R734	D,4
R14	D,2	R401	C,4	R446	B,4	R538	A,3	R612	C,3	R735	C,4
R15	E,1	R402	B,4	R447	B,4	R539	A,3	R613	B,3	R736	D,4
R16	D,1	R403	B,4	R448	B,4	R540	A,4	R614	B,3	R737	C,4
R17	D,1	R404	B,4	R449	B,4	R541	A,3	R615	B,3	R738	D,4
R18	E,1	R405	B,4	R450	B,4	R542	A,3	R616	C,3	R740	D,4
R19	D,1	R406	C,4	R451	C,4	R543	A,4	R617	B,3	R741	E,4
R20	D,1	R407	C,4	R452	C,4	R544	A,3	R618	B,3		
R21	D,1	R408	C,4	R500	A,4	R545	A,4	R619	B,3	TP1	B,4
R22	D,1	R409	B,4	R501	A,4	R546	A,3	R620	B,3	TP2	A,4
R23	E,1	R410	C,4	R502	A,4	R547	A,4	R621	B,2	TP3	D,4
R24	E,1	R411	C,4	R503	A,4	R548	A,3	R622	B,3	TP4	D,4
R25	E,2	R412	B,4	R504	A,4	R549	A,3	R700	E,4	TP5	D,4
R26	E,2	R413	C,4	R505	A,4	R550	A,3	R701	E,4	TP6	D,4
R27	E,2	R414	B,4	R506	A,4	R551	A,3	R702	E,4	TP7	C,4
R28	D,2	R415	C,4	R507	A,4	R552	A,4	R703	E,4	TP8	D,4
R29	D,1	R416	C,4	R508	A,4	R553	A,3	R704	D,4	TP9	D,4
R30	D,1	R417	C,4	R509	A,4	R554	A,3	R705	E,4	TP10	B,3
R31	D,1	R418	C,4	R510	A,4	R555	A,3	R706	D,4	TP11	A,3
R32	D,1	R419	B,4	R511	A,4	R556	A,3	R707	B,4	TP12	A,3
R33	D,2	R420	B,4	R512	A,4	R557	A,3	R708	E,4	TP13	B,3
R100	A,2	R421	C,4	R513	A,4	R558	A,3	R709	D,4	TP14	B,3
R101	A,2	R422	C,4	R514	A,4	R559	A,3	R710	D,4	TP15	C,3
R104	A,2	R423	C,4	R515	A,4	R560	A,3	R711	D,4	TP16	C,3
R200	B,2	R424	C,4	R516	A,4	R561	A,3	R712	B,4	TP17	C,3
R201	C,1	R425	C,4	R517	A,4	R562	A,3	R713	D,4	TP18	D,3
R202	C,2	R426	C,4	R518	B,4	R563	A,3	R714	D,4	TP19	D,3
R203	C,2	R427	C,4	R519	A,4	R564	A,3	R715	D,4	TP20	C,3
R204	C,1	R428	C,4	R520	A,4	R565	B,3	R716	C,4	TP21	C,3
R205	C,1	R429	B,4	R521	A,3	R566	A,3	R717	D,4	TP22	A,3
R206	C,1	R430	C,3	R522	B,4	R567	A,3	R718	E,4	TP23	A,3

A3 Component Coordinates (3 of 3)

COMP	X,Y	COMP	X,Y	COMP	X,Y	COMP	X,Y	COMP	X,Y
TP24	C,3	U35	C,2						
TP25	C,3	U36	D,2						
TP26	C,2	U37	E,2						
TP27	C,2	U38	C,2						
TP28	C,2	U39	C,2						
TP29	C,2	U40	D,2						
TP30	C,1	U41	C,2						
TP31	C,1	U42	C,2						
TP32	D,1	U43	C,2						
TP33	E,1	U44	C,2						
		U45	D,2						
U1	A,4	U46	C,1						
U2	B,4	U47	C,1						
U3	C,4	U48	D,1						
U4	D,4	U49	C,1						
U5	D,4	U50	C,1						
U6	C,4	U51	C,1						
U7	B,4	U52	D,1						
U8	C,4	U53	E,1						
U9	A,4	U54	C,1						
U10	D,4	U55	C,1						
U11	D,4								
U12	E,3	VR300	C,3						
U13	B,3	VR400	B,4						
U14	B,3	VR401	C,4						
U15	E,3	VR500	A,3						
U16	E,3	VR601	B,3						
U17	C,3								
U18	D,3	W1	B,3						
U19	E,3	W2	C,3						
U20	E,3	W3	A,3						
U21	A,3	W4	B,3						
U22	B,3	W5	A,3						
U23	D,3	W6	A,2						
U24	D,3	W7	D,1						
U25	E,3	W8	C,1						
U26	E,3	W9	C,4						
U27	B,3	W10	C,4						
U28	C,3	W11	B,4						
U29	D,3								
U30	D,3	Y1	E,2						
U31	E,3	Y300	C,2						
U32	E,3								
U33	B,3								
U34	B,3								

TOP INTERNAL VIEW - LEVEL 1

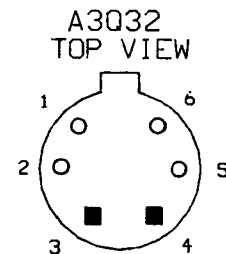
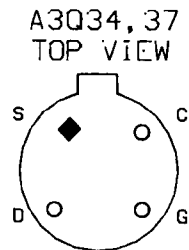
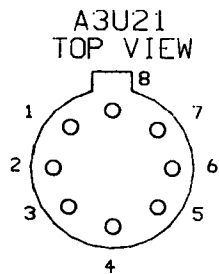


NOTES

1. For an explanation of schematic symbols, see "SCHEMATIC DIAGRAM NOTES" in Section 8.
2. Nominal value of RF choke is 2.5-6uH.
3. Chassis ground is achieved by mechanical contact through nuts holding PC board to cover and W14.
4. Isolation (guard) trace.
5. Reference designations on this service sheet C, CR, L, R and VR have numbers ranging from 500 to 599 only.
6. Inverting input of U21 is internally connected to the output pin 6.

LOGIC LEVELS

	TTL
HIGH	2V
LOW	0.8V
	IS MORE NEG. THAN IS MORE POS. THAN
OPEN	HIGH
GROUND	LOW



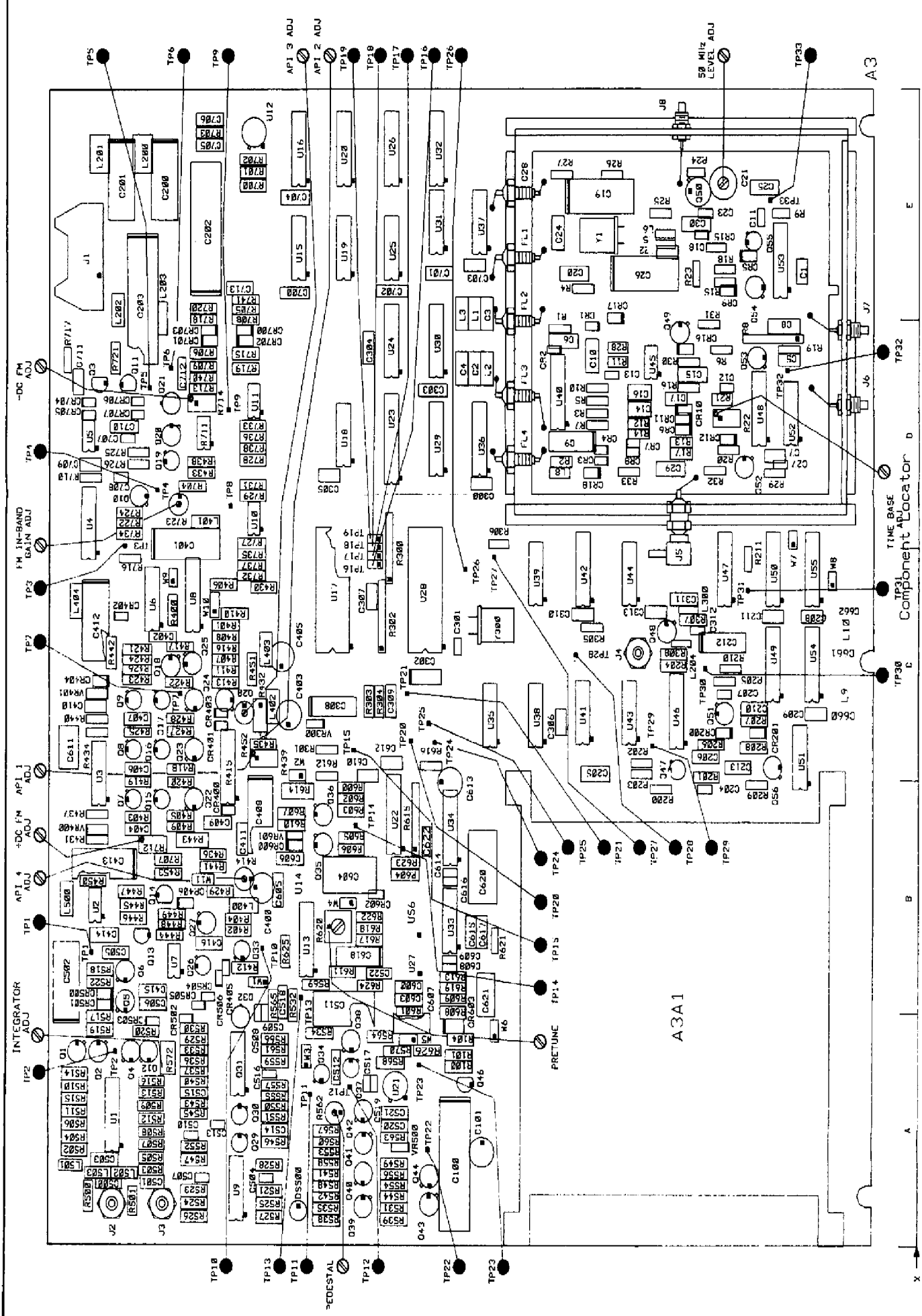


Figure 0. Service Sheet 13 Information
Component Locator

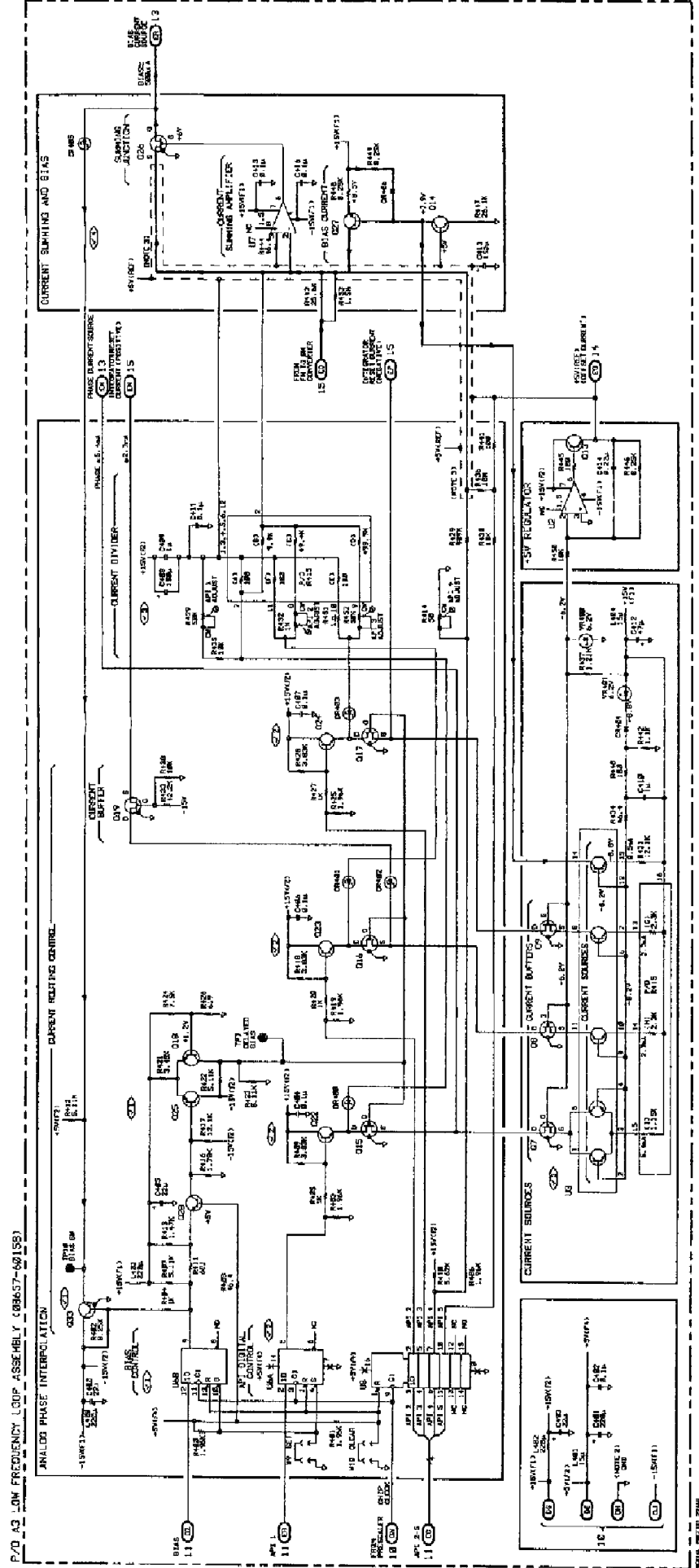


Figure 3
Service Sheet 12 13

Service Sheet 13

LOW FREQUENCY LOOP PHASE DETECTOR, INTEGRATOR, AND SAMPLE AND HOLD

PRINCIPLES OF OPERATION

General

The Phase Detector determines the phase difference between the VCO Divide-By-N.F., and reference inputs. The VCO Divide-By-N.F. input pulse is the Low Frequency Loop VCO's frequency divided by an integer (N.), and a fractional part (F.) for fractional frequencies (refer to Block Diagram 3). The Phase Detector's output pulse width is proportional to the phase difference between the VCO Divide-By-N.F., and the reference inputs. The pulse width determines the length of time current is supplied by the Integrator to ramp its output voltage up. The Sample and Hold circuits stores the Integrator's output voltage on the Sample and Hold Capacitor. The voltage stored on the Sample and Hold Capacitor is the tune voltage for the Low Frequency Loop VCO.

Phase Comparator

The Phase Comparator determines the phase difference between the VCO Divide-By-N.F. input and the Reference input. The pulse width of the Phase Detector output represents the phase difference between the two input signals. The phase of the VCO Divide-By-N.F. leads the phase of the reference when the loop is locked. The clock enable inputs at pins 6 and 11 of ECL Master-Slave Dual D flip-flop U1A and U1B are dc biased just below the ECL low threshold, <3.3V, by dividing the +5 Vdc. The +5 Vdc is divided by resistors R502 and R504 for U1A, and resistors R503 and R505 for U1B. The common clock input at pin 4 of U1A and pin 9 of U1B are both held low by internal pull-down resistors. With the common clock inputs low, U1A and U1B are clocked on the low to high transition of the clock enable inputs at pin 6 of U1A and pin 11 of U1B. The logic levels at each D input is clocked to the Q open emitter outputs. The Low Frequency Loop VCO's output frequency is divided to narrow pulses at a 100 kHz rate. Resistor R500 is an approximate 50 ohm termination for the VCO Divide-By-N.F. input pulses, and capacitor C500 ac couples the pulses to the clock enable input at pin 6 of U1A. U1A is clocked on the low to high transition, and when high resets U1B. The set input at pin 12 of U1B, and the reset input at pin 4 of U1A are held low by internal pull-down resistors. Resistor R501 is an approximate 50 ohm termination for the 100 kHz Reference input, and capacitor C501 ac couples the Reference to the clock enable input at pin 11. The Reference input clocks U1B on the low to high transition, and when high it sets U1A.

VCO Divide-By-N.F. Leads Reference

The VCO Divided-By-N.F. input pulses at a 100 kHz rate leads the 100 kHz Reference input in normal operation. When the Low Frequency Loop is locked and the VCO's frequency is 100 MHz, the 100 kHz pulses lead the Reference pulses by approximately 8 degrees, 0.22 μ s. When the VCO's frequency is 60 MHz, the VCO Divide-By-N.F. pulses leads the Reference pulses by approximately 13 degrees, 0.37 μ s.

When the VCO Divide-By-N.F. input leads the Reference input, normal operation, the VCO Divide-By-N.F. input at pin 6 clocks U1A on the low to high transition. When high, the VCO Divide-By-N.F. pulse resets U1B. When U1B is reset the output at pin 15 is low, and the output at pin 14 is high. The low D input at pin 7 of U1A is then clocked to the output at pin 2 and is applied to the D input at pin 10 of U1B. The Reference pulse at pin 11 of U1B clocks the low D input of U1B to the output at pin 15 and sets U1A. The output at pin 2 of U1A is set high and the output at pin 3 is set low. The next VCO Divide-By-N.F. input pulse clocks the low D input of U1A to the output at pin 2, and resets the output at pin 15 of U1B low. Therefore, the output at pin 15 of U1B is always low when the VCO Divide-By-N.F. input leads the Reference input. Refer to the Timing VCO Divide-By-N.F. Leads Reference, Figure 1.

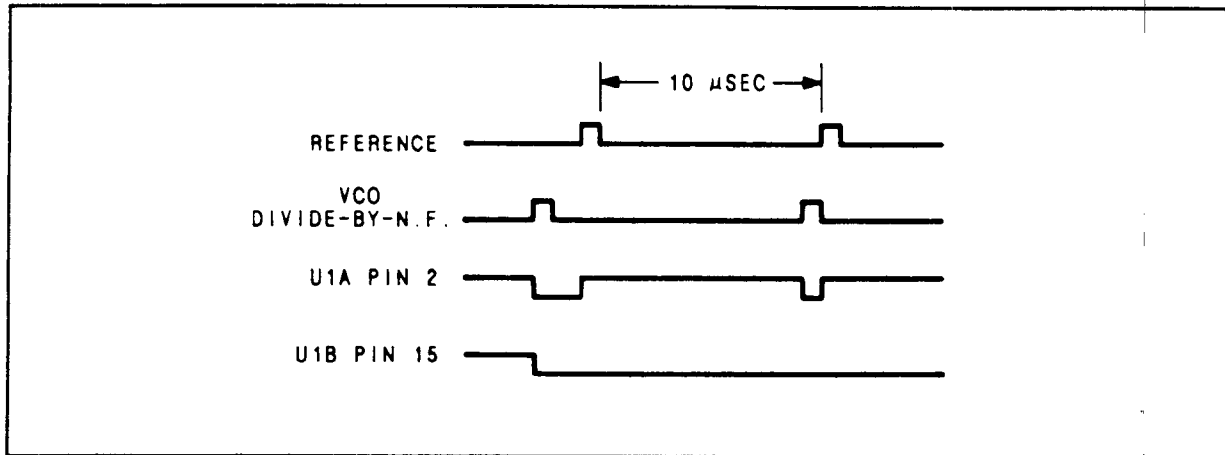


Figure 1. Timing VCO Divide-By-N.F. Leads Reference.

The low output at pin 15, and the high output at pin 14 of U1B is the bias voltage for differential switch transistors Q1 and Q2. The low output at pin 15 turns Q1 on, and the high output at pin 14 turns Q2 off. CR503 is turned on, and CR505 is turned off. The diodes remain in this condition unless the Reference input pulse leads the VCO Divide-By-N.F. pulse.

The VCO Divide-By-N.F. pulse clocks the low D input to the output at pin 2 of U1A, and the output at pin 3 of U1A high. The low output at pin 2, and the high output at pin 3 of U1A is the base voltage for differential switch Q12 and Q4. The low output at pin 12 turns Q12 on, and the high output at pin 3 turns Q4 off. With no current through Q4, the bias voltage on the base of Q5 is approximately $-0.4V$ and the emitter voltage is then approximately $-1.0V$. The $-1.0V$ turns CR502 off, and turns CR504 on. The anode voltage of CR504 is approximately $0.0V$. When the Bias pulse and API pulses are inactive (refer to Service Sheet 12), the 5.4 mA 's of API 1 current is directed from the node between diodes CR502 and CR504. With CR504 on, the Integrator supplies current for the API 1 current source. The Integrator's output voltage is ramped to a voltage dependent upon the phase error between the VCO Divide-By-N.F. input and the Reference input. The Reference pulse sets U1A's output at pin 2 high and the output at pin 3 low. Transistor Q12 is turned off, and Q4 is turned on. The current through Q4 biases the base of Q5 at approximately $+1.6V$, and the emitter voltage is approximately $+1.0V$. The $+1.0V$ turns on CR502, and API 1 current is then supplied by Q5. When CR502 is turned on, CR504 can not be turned on. Refer to the Low Frequency Loop Timing Diagram, Figure 7.

Reference Leads VCO Divide-By-N.F.

The VCO Divided-By-N.F. input pulses at a 100 kHz rate leads the 100 kHz Reference input pulses in normal operation. If the Reference pulses leads the VCO Divide-By-N.F. pulses, the speed-up circuit of Q1 and Q2 will tune the VCO until the VCO Divide-By-N.F. input leads the Reference input. When the Reference input leads the VCO Divide-By-N.F. input, the Reference clocks U1B on the low to high transition and when high it sets U1A. The high D input at pin 10 of U1B is clocked to the output at pin 15, and the output at pin 2 of U1A is set high. The VCO Divide-By-N.F. input will clock the high D input of U1A to the output at pin 2, and will reset U1B. The output at pin 15 of U1B is then reset low. The next Reference input clocks the high D input of U1B to the output at pin 15, and set the output at pin 2 of U1A high. Therefore, the output at pin 2 of U1A remains high as long as the Reference input leads the VCO Divide-By-N.F. input. Refer to Figure 2.

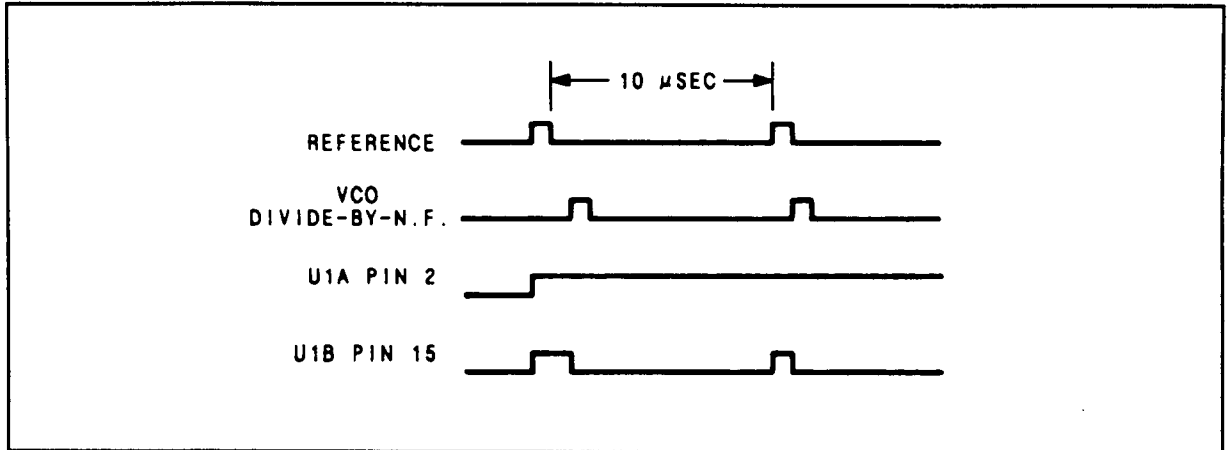


Figure 2. Timing Reference Leads VCO Divide-By-N.F.

The speed-up circuit consists of differential switch Q1 and Q2, and diodes CR503 and CR505. The speed-up circuit tunes the frequency of the VCO quickly until the VCO Divide-By-N.F. input to the Phase Comparator leads the Reference. The high output at pin 15, and low output at pin 14 of U1B is the base voltage for the differential switch. The Reference input clocks the output at pin 15 high, and the output at pin 14 low. The high output at pin 15 turns Q1 off, and the low output at pin 14 turns Q2 on. The collector voltage of Q2 rises above 0.0V. CR503 is turned off, and CR505 is turned on. Current is directed through CR505 to the Integrator and the VCO's frequency is increased. The VCO Divide-By-N.F. input resets the output at pin 15 of U1B low, and the output at pin 14 high. Q1 is turned on and Q2 is turned off. With no current through Q2, CR503 is turned on and CR505 is reverse biased at approximately 0.5V. The speed-up circuit is active (on) until the VCO Divide-By-N.F. input leads the Reference input.

The high output at pin 2, and low output at pin 3 of U1A is the base voltage for the differential switch, transistors Q12 and Q4. The output at pin 2 remains high, and Q12 is off and Q4 is on. The current through Q4 biases the base of Q5 at approximately +2.0V, and the emitter is biased at approximately +1.0V. The +1.0V turns CR502 on to supply current to the API 1 current source. When CR502 is turned on, CR504 can not be turned on. All current going to the Integrator is from the speed-up circuit.

This condition exists until the VCO Divide-By-N.F. input leads the Reference input, and lasts for a number of milliseconds. The number of milliseconds is dependent upon the amount the VCO frequency is changed.

Unlock Detection Comparators

The Low Frequency Loop Unlock Detection Comparators, U9A and U9B, detect when the loop is unlocked, light the unlock LED, and send an Out-Of-Lock (L) input to the Low Frequency Loop Microprocessor. The positive input at pin 4 of U9A is fixed at approximately -0.3 Vdc divided from -15 Vdc by resistors R525 and R527. The negative input at pin 10 of U9B is fixed at approximately +0.87 Vdc divided from +5 Vdc by resistors R524 and R526. Resistor R521 and capacitor C504 average the voltage at the collector of Q2 to detect an out-of-lock condition. Resistor R523 and capacitor C507 average the voltage at the emitter of Q5 to detect an out-of-lock condition. When the loop is unlocked, either the negative input at pin 5 of U9A can go positive or the positive input of U9B can go negative switching their output low, detecting an out-of-lock condition. The comparator's output that is switched low is dependent upon which input is leading. If the Reference input pulse is leading the VCO Divide-By-N.F. input pulse, comparator U9A is switched. If the VCO Divide-By-N.F. pulse is leading, the Reference pulse U9B is switched. The negative input of U9A is approximately -0.5V when the loop is locked and changes to approximately +0.6 when the loop is unlocked. The Reference leads the VCO Divide-By-N.F.. The positive input at pin 9 of U9B is approximately +1.0V when the loop is locked and changes to approximately -1.0V when the loop is unlocked. The VCO Divide-By-N.F. leads the Reference. In either case, the LED is turned on, and the Out-Of-Lock (L) input to the Microprocessor is low.

Integrator

The Integrator is a wide bandwidth fast settling Operational Amplifier and consists of dual FET U32, transistors Q29, Q30, and Q31. The Integrator's output voltage is determined by parallel capacitors C508 and C509, and the input current. There are two current inputs to the Integrator, Bias Current and Phase Detector controlled API 1 Current. After the Integrator's output voltage has been sampled by the Sample and Hold Circuits, Bias Current ramps the Integrator's output voltage down to reset the Integrator. The Phase Detector's output pulse controls the length of time API 1 Current is supplied by the Integrator. The Integrator's output voltage is ramped up to a voltage dependent on the pulse width of the Phase Detector's output. The pulse width is determined by the phase difference between the VCO Divide-By-N.F. and the input pulses.

FET Q32, is a common source, unity gain, high input impedance Buffer Amplifier for the Differential Pair Q31C and Q31D. The gate at pin 3 of the dual FET Q32, is connected to ground, and the gate at pin 6 is fixed at approximately 0.0V by feedback around the operational amplifier. The sources at pins 4 and 1 are biased slightly above ground by approximately 1 mA of current through resistors R529, R540, and the FET's. The bias voltage for the dual FET sources is also the base voltage for the Differential Pair Q31C and Q31D, and sets their bias conditions. Current through Q31C and Q31D is approximately 4 mA each. The input at pin 6 of Q32 appears amplified and inverted at the collector of Q31C and drives the emitter of Q30 like a common base amplifier. The input also appears amplified but not inverted at the collector of Q31D, and drives the base of Q30 like a common emitter amplifier. Driving both the emitter and the base increases the dc gain of the stage. Bias for Q30 is set by the collector currents of Q31C and Q31D. Transistor Q29, is an active load and current source for Q30. Q29 has a high output impedance so the load that Q30 sees is primarily the input impedance of the Darlington dual emitter follower output stage Q31A and Q31B. Transistor Q30 supplies most of the voltage gain of the amplifier. At higher frequencies the gain is reduced by capacitor C513 shunting part of the signal to ground. Additional compensation is provided by capacitor C510 which shunts high frequency signals on the collector of Q31D (base of Q30) to ac ground. Although Q30 is driven as a common emitter and common base amplifier, at higher frequencies Q30 functions only as a common base amplifier with all of its input at the emitter. Emitter follower Q31A is biased by approximately 3 mA of current through resistor R559. Emitter follower Q31B is biased by approximately 6 mA of current 1 mA through resistor R556 and 5 mA to the Sample and Hold Circuit. The output impedance of an emitter follower can look inductive and cause ringing when driving capacitive loads. To correct for this condition, RC networks of R557, C516 and R565, C518, connected to the output of the emitter followers Q31A and Q31B, makes their output impedance look resistive at high frequencies.

Frequency Compensation RC Circuit of resistor R534 and capacitor C511 add Integrator gain at low frequencies and improves the stability of the phase lock loop.

Sample and Hold

The Sample and Hold Circuit is activated by the Sample and Hold pulse, active high for two Chip Clocks, from the Low Frequency Loop Fractional-N Controller. (Refer to Service Sheet 11, and the Timing Diagram Figure 7.) At the termination of the Phase Detector pulse, the Integrator's output voltage is representative of the phase difference between the VCO Divide-By-N.F., and the Reference input pulses to the Phase Detector. The first two Chip Clocks of each cycle, activates the Sample and Hold Circuit, and the Integrator's voltage is stored on the Sample and Hold capacitor C519. The VCO is then phase locked to the correct frequency.

The TTL high (>+2.0V) Sample and Hold Pulse from the Fractional N Controller, turns Q44 off. Its base voltage is changed from approximately -0.6V to approximately +1.5V. When transistor Q44 is turned off, transistors Q40 and Q41 are also turned off. When transistors Q40 and Q41 are off, the two FET switches Q34 and Q37 are closed (turned on). The Integrator's output voltage is then applied to capacitor C512 and to the Sample and Hold Capacitor C519. The capacitors then charge to the output voltage of the Integrator. Transistor Q43 is turned on when transistor Q44 is turned off. Q43's base voltage changes from 0.0V to approximately +0.3V. When transistor Q43 is on, transistor Q39 and Q42 are also turned on.

When the Sample and Hold pulse is terminated, the base of transistor Q44 changes from approximately +1.5V to approximately -0.6V. Q44 is turned on. The base voltage of transistors Q40 and Q41 is less negative, and they are turned on. When Q40 and Q41 are turned on, the gate of FET switches Q34 and Q37 is 8V to 10V below their source voltage. The FET switches are opened (turned off). The Integrator's output voltage at this time is not sampled. Transistor Q43 is turned off when transistor Q44 is turned on. Q43's base voltage changes from approximately +0.3V to 0.0V. When transistor Q43 is off, transistors Q39 and Q42 are also turned off. One transistor of each differential pair, Q39 and Q40, Q41 and Q42, Q43 and Q44, is on while the other transistor is off. With one transistor of the differential pairs always on, there is a constant current through their emitter resistors R542, R560, R544, and a constant voltage on their emitters.

Capacitor C517 reduces a spur caused by the gate to drain capacitance of FET switch Q37. The gate to drain capacitance of Q37 provides an ac path to the Sample and Hold Capacitor C519 each time FET switch Q37 is closed.

The gate voltage is changed at the start of each Sample and Hold pulse, and FET switch Q37 is closed. Differential pair Q41 and Q42 are always in opposite states of on and off. Capacitor C517 provides an ac path to the Sample and Hold Capacitor and an equal but opposite polarity pulse is applied to C519. Resistor R562 is adjusted so that the pulses are equal, and since they are opposite in polarity the pulses cancel. The adjustment of R562 determines the voltage at the collector of Q42 and the amplitude of the pulse.

FET switches Q34 and Q37 must be biased when they are switched on during the Sample and Hold cycle. They are biased where V_{gs} is just below 0.0V. The output voltage of the Integrator is at the correct level to bias Q34, and the Sample and Hold voltage on C519 is at the correct level to bias Q37. When the Low Frequency Loop is locked, the two voltages are equal. The Integrator's voltage is connected to the gate of Q34 by resistor R541, and the Integrator's cycle is shown by the waveform at TP11. Figures 3 and 4 show the waveform at TP11 and TP12 with the Low Frequency Loop locked and a Signal Generator RF output frequency of 950 MHz. In Figures 5 and 6, the Signal Generator's RF output is 990 MHz. The voltage level shifts as the VCO's TUNE VOLTAGE is changed to tune its frequency 100 MHz to 60 MHz.

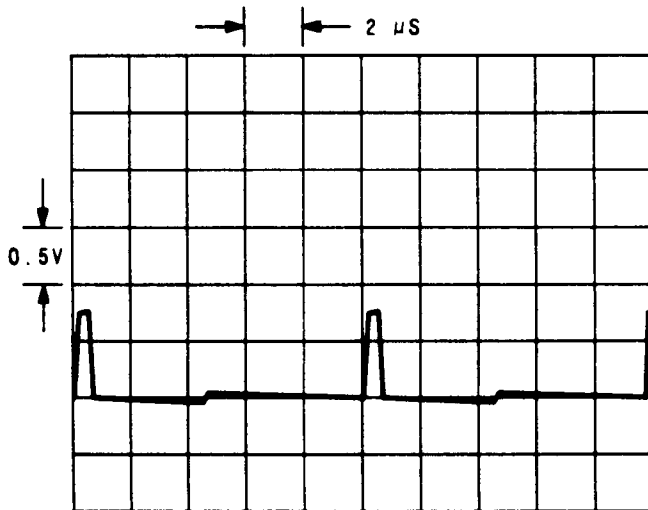


Figure 3. Oscilloscope Display of TP11 (dc coupled), W3 in W3A position, Low Frequency Loop locked, Signal Generator's frequency 950 MHz.

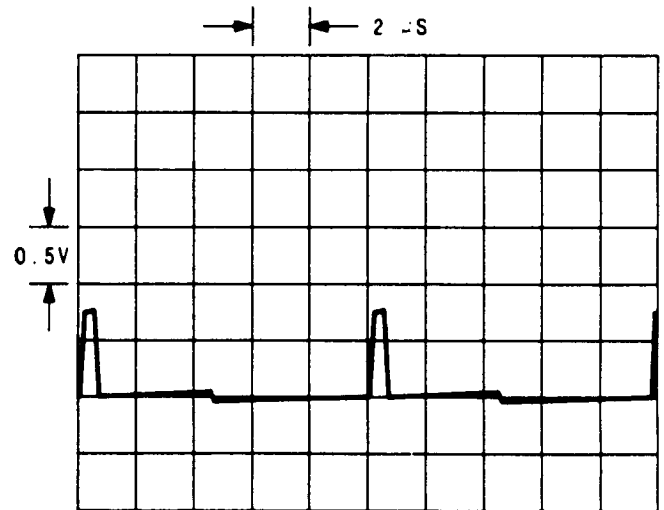


Figure 4. Oscilloscope Display of TP12 (decoupled), W3 in W3A position, Low Frequency Loop locked, Signal Generator's frequency 950 MHz.

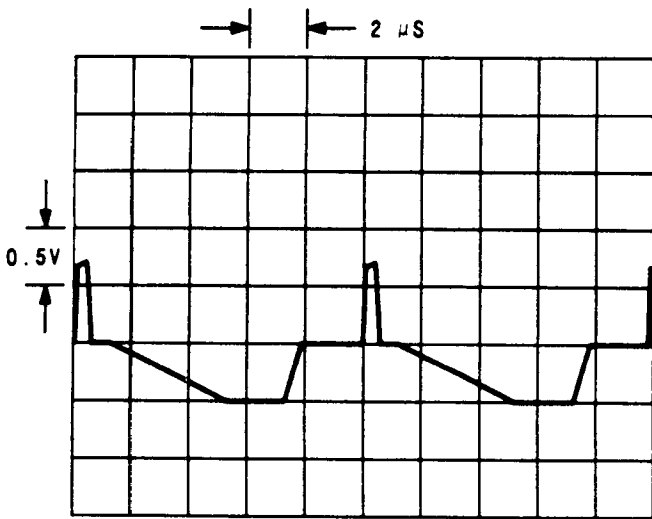


Figure 5. Oscilloscope display of TP11 (dc coupled) W3 in W3A position, Low Frequency Loop locked, Signal Generator's frequency 990 MHz.

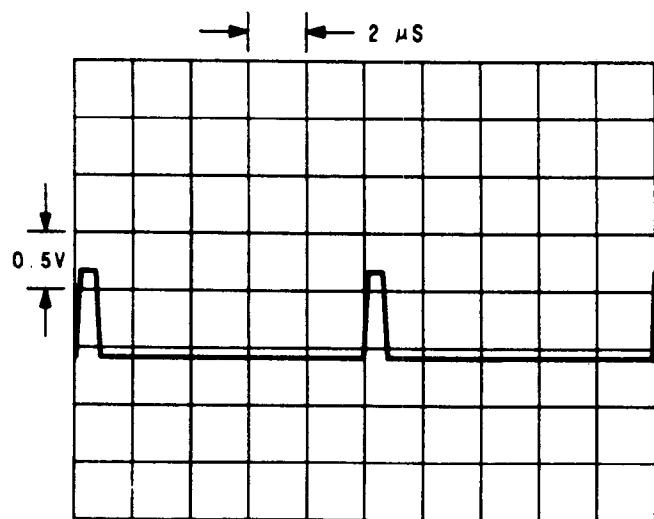


Figure 6. Oscilloscope Display of TP12 W3 to W3A position, Low Frequency Loop locked, Signal Generator's frequency 990 MHz.

To apply the Sample and Hold voltage to the gate of Q37 is more difficult. By connecting the source of Q37 to the collector resistors of Q41 and Q42 the Sample and Hold voltage would be connected to the gate of Q37. However, one transistor of the differential pair Q41 and Q42 is always on and the Sample and Hold Capacitor C519 would be quickly discharged through either Q41 or Q42. The voltage on the Sample and Hold Capacitor must be constant between samples so that the VCO frequency does not change. To prevent the voltage on C519 from changing, C519 is connected to a unity gain high input impedance Buffer Amplifier U21. The output of the Buffer Amplifier is connected through transistor Q38 back to the collector resistors of Q41 and Q42. The Sample and Hold voltage biases the gate of Q37 during the Sample and Hold pulse, and will not discharge the Sample and Hold Capacitor C519. Transistor Q38 reduces the amount of current U21 must supply. The output of U21 is also the TUNE VOLTAGE for the Low Frequency Loop VCO, and the Pedestal adjustment is adjusted for a continuous Sample and Hold voltage.

Two FET switches Q34 and Q37 are used to reduce feedthrough of the Integrator's voltage when the FET switches are off. With the FETs turned off there is still approximately 1 to 2 pF of source-to-drain capacitance. The FET's source-to-drain capacitance forms an ac voltage divider with capacitors C512 and C519 isolating the Integrator's changing voltage during the time of each cycle that the Sample and Hold operation is turned off. If the feedthrough was not reduced, there would be high 100 kHz and API spurs.

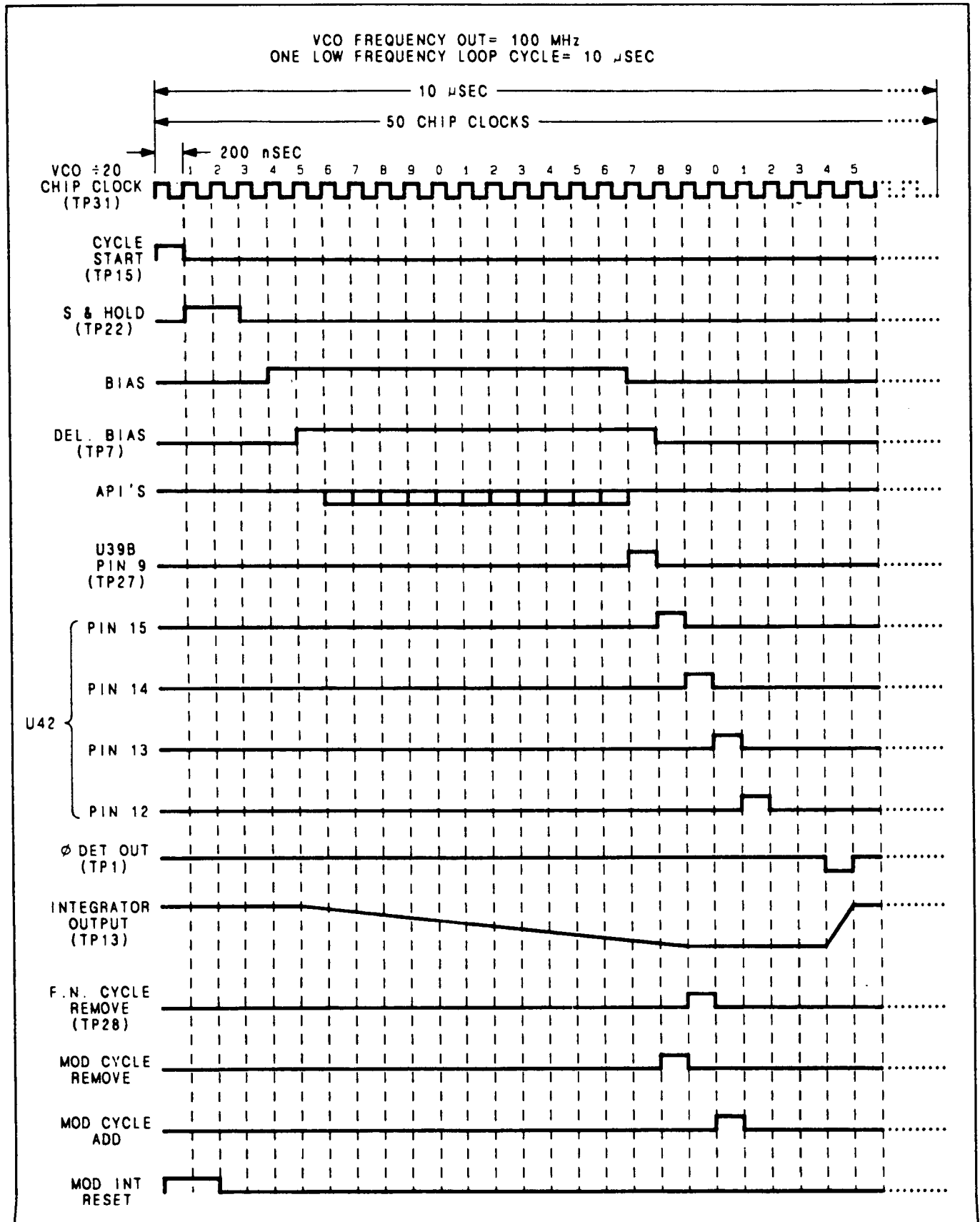


Figure 7. Low Frequency Loop Timing Diagram.

TROUBLESHOOTING

Procedures for checking part of the A3 Low Frequency Loop Assembly circuits are given below. The areas or points to check are marked on the schematic by a hexagon with a checkmark and a number inside, for example, $\sqrt{1}$. Transistor bias voltages are shown without tolerances.

Troubleshooting Help

- Block Diagram 3
- Table 4-1. Abbreviated Performance Tests
- Table 5-2. Post-Repair Adjustments

Test Equipment

Digital Multimeter	HP 3466A
Oscilloscope	HP 54100A
Frequency Counter	HP 5328A
Audio Source	HP 8903B
Oscilloscope 1 Megohm Probe Pod Chan 2	HP 54003A
Oscilloscope Probe	HP 54003-61617

$\sqrt{1}$ Phase Detector, Integrator, Sample and Hold

1. The Phase Detector, Integrator, and Sample and Hold circuits are checked for proper operation with the Low Frequency Loop unlocked.
2. Remove jumper A3W6 (refer to Service Sheet 14). The TUNE VOLTAGE input to the Low Frequency Loop VCO at feedthrough capacitor C100 goes to approximately 0.0V (refer to Service Sheet 9).
3. Set the RF output frequency of the Signal Generator to 990 MHz.
4. Set the Oscilloscope as follows:

Chan 1

Ch 1 Display Off

Chan 2

Ch 2 Mode Normal
 Ch 2 Display On
 VOLTS/DIV 500 mV
 OFFSET 3.0V

Timebase

SEC/DIV 20 ns
 DELAY 0.0s
 Delay Ref at Center
 Sweep Trg'd

Trigger

Trigger Mode Edge
 Trig Src Chan 2
 TRIG LEVEL 3.5V
 Slope Pos

Display

Display Mode Normal
 DISPLAY TIME 400 ms
 Split Screen Off
 Graticle On

5. Check for the VCO Divide-By-N.F., and the 100 kHz Reference pulses at pin 6 and pin 11 of U1. The pulses are ECL logic, appear every 10 μ s, and are narrow. They must be present for the Phase Detector to work.
6. Set the Signal Generator's frequency increment to 10 MHz.
7. Connect Chan 2 to W5. If the voltage displayed on the oscilloscope is +10V, increment the Signal Generator's frequency DOWN 10 MHz. The voltage on the oscilloscope should change to -10V. If the voltage displayed is -10V increment the frequency up and voltage should change to +10V.
8. The voltage on the oscilloscope should change from +10 to -10V as the frequency is incremented UP and DOWN 10 MHz. The Phase Detector, Integrator and Sample and Hold circuits are all working correctly. The +10V to -10V is the maximum swing of the Integrator.

√2 Phase Detector

1. With the Low Frequency Loop VCO and Signal Generator set-up the same as for steps 2 through 3 of **√1**, the Phase Detector is checked.
2. Increment the frequency UP 10 MHz. The VCO Divide-By-N.F. input is leading the Reference input.
3. Set the Oscilloscope as follows:

Chan 1

Ch 1 Display Off

Chan 2

Ch 2 Mode Normal
 Ch 2 Display On
 VOLTS/DIV 500 mV
 OFFSET OV

Timebase

SEC/DIV 10 μ s
 DELAY 0.0s
 Delay Ref at Left
 Sweep Auto

Trigger

Trigger Mode Edge
 Trig Src Chan 2
 TRIG LEVEL 500 mV
 Slope Pos

Display

Display Mode Normal
 DISPLAY TIME 200 ms
 Split Screen Off
 Graticle On

4. Connect Chan 2 to TP1 (PHASE DET). The pulses at TP1 should be from +1V to -1V and are unstable since the loop is not locked.
5. If the pulses are not present at TP1, check that the output of U1A is changing between ECL high and low.
6. Check that the base of Q4, and Q12 is being pulsed from approximately +3V to approximately +4V. Check that the base of Q5 is being pulsed from approximately -0.6V to approximately +2V. Check that the base of Q6 is being pulsed from approximately -2V to approximately +0.6V.
7. Pin 9 of U9B is also pulsed, and the out-of-lock LED (DS500) is on.
8. Connect Chan 2 to TP2 (SPEEDUP). The pulses at TP2 should be approximately 0V to +5V and unstable since the loop is not locked.
9. If the pulses are not present at TP2, check that the output of U1B is changing between ECL high and low.
10. Check that the base of Q1 and Q2 is being pulsed from approximately +3V to approximately +4V.
11. Pin 5 of U9A is also pulsed and the out-of-lock LED (DS500) is on.
12. Reinstall jumper A3W6.

√3 Integrator

1. Remove jumper A3W1 from position W1A and install A3W1 in position W1B. Remove A3W3 from the W3A position.
2. Connect a 1 kHz 0.1V signal from the audio source to A3W1.

Table 1. Integrator Voltages with W1 in W1B Position.

Transistor	Emitter (Vdc)	Base (Vdc)	Collector (Vdc)
Q31C	Pin 10, -0.75	Pin 9, -0.025	Pin 8, +12.5
Q31D	Pin 12, -0.75	Pin 13, -0.025	Pin 14, -12.0
Q30	— -12.5	— -11.9	— -1.3
Q29	— -13.2	— -12.5	— +1.3
Q31A	Pin 3, -0.5	Pin 2, -1.2	Pin 1, +14.0
Q31B	Pin 5, -0.007	Pin 6, -0.6	Pin 7, +14.0

3. Connect Chan 2 of the oscilloscope to TP13. The output at TP13 should be a 500 mVpp, 1 kHz signal.
4. Measure the transistor voltages according to Table 1.
5. Reinstall A3W1 to position W1A (normal operation).

√4 Sample and Hold

1. Install A3W3 in the W3B position. +5V(F2) is thus connected to the input of the Sample and Hold circuit.
2. Connect Chan 2 of the oscilloscope to TP23. The output at TP23 should be +5V (+5V at W5).
3. If +5V is not present at TP23, check the Sample and Hold pulse at TP22 (SAMPLE). Verify that the waveform in Figure 8 is correct. (The VCO frequency with W6 removed and the Signal Generator's frequency will affect the time between pulses.)

4. Verify that the waveform in Figure 9 is correct.
5. Verify that the waveform in Figure 10 is correct.
6. Reinstall A3W3 in the W3A position.

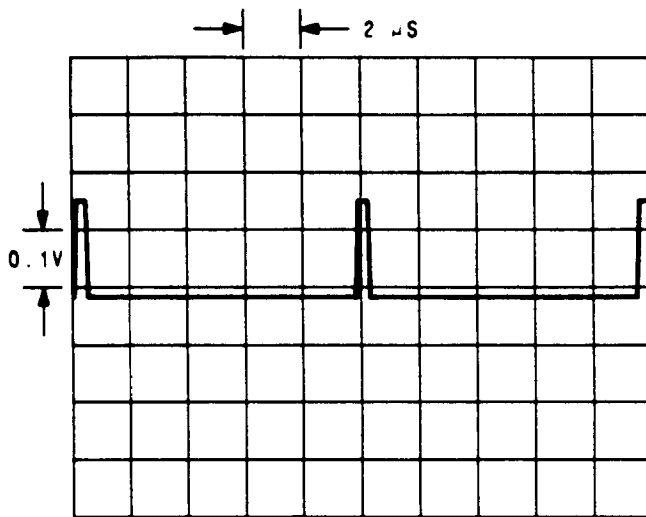


Figure 8. Oscilloscope Display of TP22, Sample and Hold Pulse, W6 removed, Signal Generator's frequency is 960 MHz, Low Frequency Loop is unlocked.

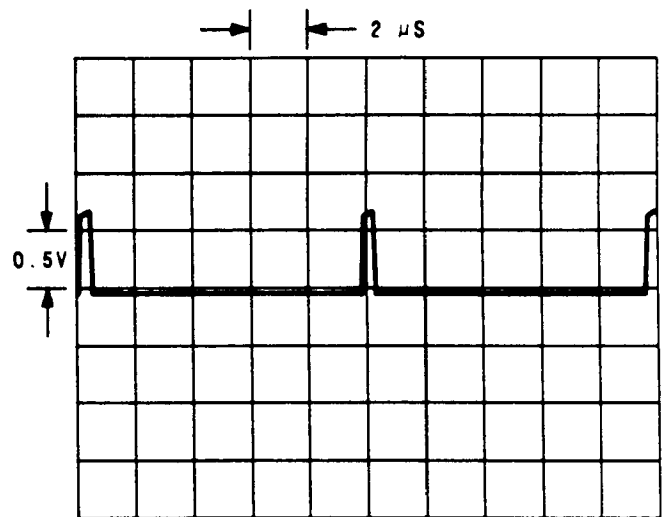


Figure 9. Oscilloscope Display of TP11, W3 in position W3B (service position), Signal Generator's frequency 960 MHz.

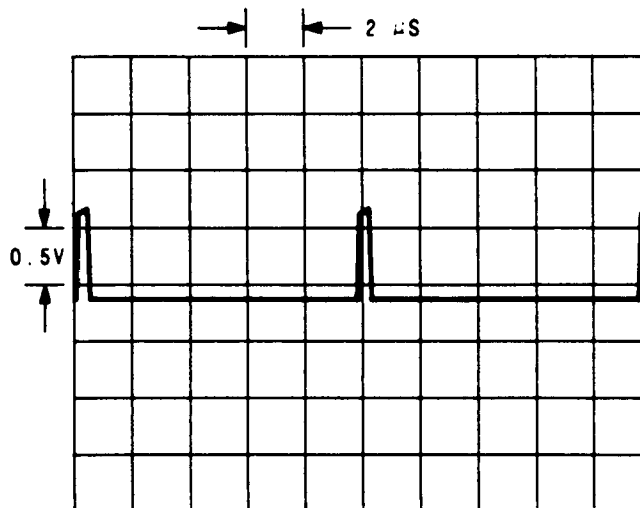


Figure 10. Oscilloscope Display of TP12, W3 in position W3B (service position), Signal Generator's frequency 960 MHz.

A3 Component Coordinates (1 of 3)

COMP	X,Y	COMP	X,Y	COMP	X,Y	COMP	X,Y	COMP	X,Y	COMP	X,Y
C1	E,1	C213	C,1	C513	A,4	CR1	D,2	FL1	E,2	Q10	D,4
C2	D,2	C300	D,2	C514	A,3	CR2	D,2	FL2	E,2	Q11	D,4
C3	E,2	C301	C,3	C515	A,4	CR3	D,2	FL3	D,2	Q12	A,4
C4	D,2	C302	C,3	C516	A,3	CR4	D,2	FL4	D,2	Q13	B,4
C5	D,1	C303	D,3	C517	A,3	CR5	E,1			Q14	B,4
C6	D,2	C304	D,3	C518	B,3	CR6	D,1	J1	E,4	Q15	B,4
C7	D,1	C305	D,3	C519	A,3	CR7	D,2	J2	A,4	Q16	C,4
C8	D,1	C306	C,2	C520	A,3	CR8	D,2	J3	A,4	Q17	C,4
C9	D,2	C307	C,3	C521	A,3	CR9	E,1	J4	C,2	Q18	C,4
C10	D,2	C308	C,3	C600	B,3	CR10	D,1	J5	C,1	Q19	D,4
C11	E,1	C309	C,3	C601	B,3	CR11	D,1	J6	D,1	Q20	D,4
C12	D,1	C310	C,2	C602	B,3	CR12	D,1	J7	E,1	Q21	D,4
C13	D,2	C311	C,1	C603	B,3	CR15	E,1	J8	E,2	Q22	B,4
C14	D,2	C312	C,1	C604	B,3	CR16	D,1			Q23	C,4
C15	D,1	C313	C,2	C605	B,3	CR17	E,2	L1	E,2	Q24	C,4
C16	D,2	C400	B,3	C606	B,3	CR18	D,2	L2	D,2	Q25	C,4
C17	D,1	C401	D,4	C607	B,3	CR200	C,1	L3	E,2	Q26	B,4
C18	E,1	C402	C,4	C608	B,3	CR201	C,1	L5	E,2	Q27	B,4
C19	E,2	C403	C,3	C609	B,3	CR400	B,4	L6	E,2	Q28	C,4
C20	E,2	C404	B,4	C610	C,3	CR401	C,4	L8	D,2	Q29	A,4
C21	E,1	C405	C,3	C611	C,4	CR402	C,4	L200	E,4	Q30	A,4
C22	E,2	C406	C,4	C612	C,3	CR403	C,4	L201	E,4	Q31	A,4
C23	E,1	C407	C,4	C613	B,3	CR404	C,4	L202	E,4	Q32	A,4
C24	E,2	C408	B,3	C614	B,3	CR405	B,4	L203	E,4	Q33	B,4
C25	E,1	C409	B,4	C615	B,2	CR406	B,4	L204	C,1	Q34	A,3
C26	E,2	C410	C,4	C616	B,3	CR500	B,4	L300	C,1	Q35	B,3
C27	D,1	C411	B,4	C617	B,2	CR501	B,4	L400	B,4	Q36	B,3
C28	E,2	C412	C,4	C618	B,3	CR502	A,4	L401	D,4	Q37	A,3
C29	D,1	C413	B,4	C619	B,3	CR503	A,4	L402	C,3	Q38	A,3
C30	E,1	C414	B,4	C620	B,2	CR504	B,4	L403	C,3	Q39	A,3
C100	A,3	C415	B,4	C621	B,2	CR505	B,4	L404	C,4	Q40	A,3
C101	A,2	C416	B,4	C700	E,3	CR506	B,4	L500	B,4	Q41	A,3
C200	E,4	C500	A,4	C701	E,3	CR600	B,3	L501	A,4	Q42	A,3
C201	E,4	C501	A,4	C702	E,3	CR602	B,3	L502	A,4	Q43	A,3
C202	E,4	C502	B,4	C703	E,2	CR700	D,4	L503	A,4	Q44	A,3
C203	E,4	C503	A,4	C704	E,3	CR701	D,4			Q46	A,2
C204	B,1	C504	A,3	C705	E,4	CR702	D,4	Q1	A,4	Q47	C,1
C205	C,2	C505	B,4	C706	E,4	CR703	D,4	Q2	A,4	Q48	C,2
C206	C,1	C506	B,4	C707	D,4	CR704	D,4	Q3	D,4	Q49	D,1
C207	C,1	C507	A,4	C708	D,4	CR705	D,4	Q4	A,4	Q50	E,1
C208	C,1	C508	B,3	C709	D,4	CR706	D,4	Q5	B,4	Q51	C,1
C209	C,1	C509	B,3	C710	D,4	CR707	D,4	Q6	B,4	Q52	D,1
C210	C,1	C510	A,4	C711	D,4			Q7	B,4	Q53	D,1
C211	C,1	C511	B,3	C712	D,4			Q8	C,4	Q54	E,1
C212	C,1	C512	A,3	C713	E,4	DS500	A,3	Q9	C,4	Q55	E,1

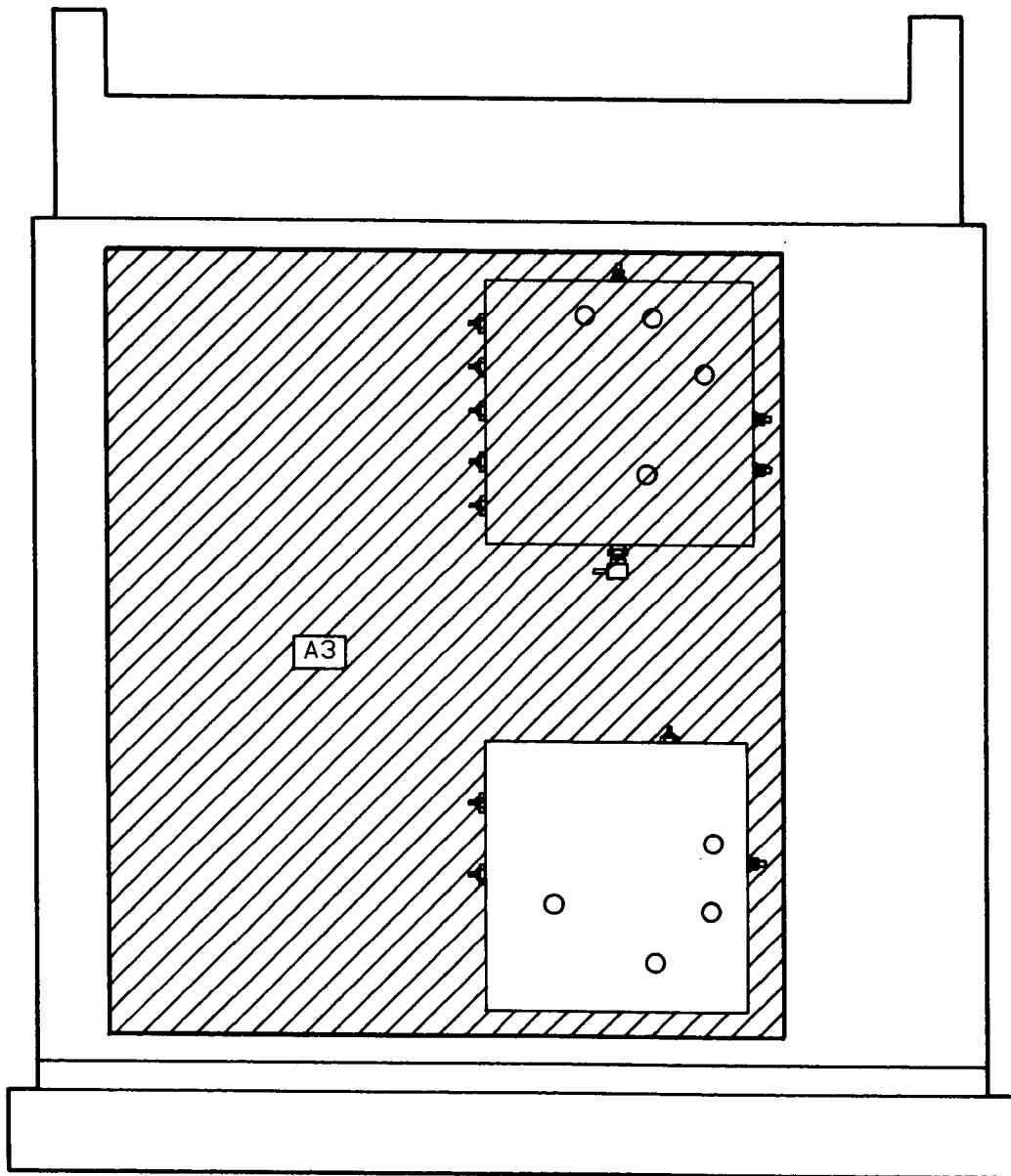
A3 Component Coordinates (2 of 3)

COMP	X,Y	COMP	X,Y	COMP	X,Y	COMP	X,Y	COMP	X,Y	COMP	X,Y
Q56	C,1	R207	C,1	R431	B,4	R523	A,4	R568	A,3	R719	D,4
		R208	C,1	R432	C,3	R524	A,4	R569	B,3	R720	E,4
R1	D,2	R209	B,1	R433	D,4	R525	A,3	R570	A,3	R721	D,4
R2	D,2	R210	C,1	R434	C,4	R526	A,4	R600	B,3	R722	D,4
R3	D,2	R211	C,1	R435	C,3	R527	A,3	R601	B,3	R723	D,4
R4	E,2	R300	C,3	R436	B,4	R528	A,3	R602	B,3	R724	D,4
R5	D,2	R301	C,3	R437	B,4	R529	A,4	R603	B,3	R725	D,4
R6	D,1	R302	C,3	R438	D,4	R530	A,4	R604	B,3	R726	D,4
R7	D,2	R303	C,3	R439	C,3	R531	A,3	R605	B,3	R727	D,4
R8	D,1	R304	C,3	R440	C,4	R532	B,3	R606	B,3	R728	D,4
R9	E,1	R305	C,2	R441	B,4	R533	A,4	R607	B,3	R729	D,4
R10	D,2	R306	D,2	R442	C,4	R534	A,3	R608	A,3	R731	D,4
R11	D,2	R307	C,1	R443	B,4	R535	A,3	R609	B,3	R732	C,4
R12	D,2	R308	C,1	R444	B,4	R536	A,4	R610	B,3	R733	D,4
R13	D,1	R400	C,4	R445	B,4	R537	A,4	R611	B,3	R734	D,4
R14	D,2	R401	C,4	R446	B,4	R538	A,3	R612	C,3	R735	C,4
R15	E,1	R402	B,4	R447	B,4	R539	A,3	R613	B,3	R736	D,4
R16	D,1	R403	B,4	R448	B,4	R540	A,4	R614	B,3	R737	C,4
R17	D,1	R404	B,4	R449	B,4	R541	A,3	R615	B,3	R738	D,4
R18	E,1	R405	B,4	R450	B,4	R542	A,3	R616	C,3	R740	D,4
R19	D,1	R406	C,4	R451	C,4	R543	A,4	R617	B,3	R741	E,4
R20	D,1	R407	C,4	R452	C,4	R544	A,3	R618	B,3		
R21	D,1	R408	C,4	R500	A,4	R545	A,4	R619	B,3	TP1	B,4
R22	D,1	R409	B,4	R501	A,4	R546	A,3	R620	B,3	TP2	A,4
R23	E,1	R410	C,4	R502	A,4	R547	A,4	R621	B,2	TP3	D,4
R24	E,1	R411	C,4	R503	A,4	R548	A,3	R622	B,3	TP4	D,4
R25	E,2	R412	B,4	R504	A,4	R549	A,3	R700	E,4	TP5	D,4
R26	E,2	R413	C,4	R505	A,4	R550	A,3	R701	E,4	TP6	D,4
R27	E,2	R414	B,4	R506	A,4	R551	A,3	R702	E,4	TP7	C,4
R28	D,2	R415	C,4	R507	A,4	R552	A,4	R703	E,4	TP8	D,4
R29	D,1	R416	C,4	R508	A,4	R553	A,3	R704	D,4	TP9	D,4
R30	D,1	R417	C,4	R509	A,4	R554	A,3	R705	E,4	TP10	B,3
R31	D,1	R418	C,4	R510	A,4	R555	A,3	R706	D,4	TP11	A,3
R32	D,1	R419	B,4	R511	A,4	R556	A,3	R707	B,4	TP12	A,3
R33	D,2	R420	B,4	R512	A,4	R557	A,3	R708	E,4	TP13	B,3
R100	A,2	R421	C,4	R513	A,4	R558	A,3	R709	D,4	TP14	B,3
R101	A,2	R422	C,4	R514	A,4	R559	A,3	R710	D,4	TP15	C,3
R104	A,2	R423	C,4	R515	A,4	R560	A,3	R711	D,4	TP16	C,3
R200	B,2	R424	C,4	R516	A,4	R561	A,3	R712	B,4	TP17	C,3
R201	C,1	R425	C,4	R517	A,4	R562	A,3	R713	D,4	TP18	D,3
R202	C,2	R426	C,4	R518	B,4	R563	A,3	R714	D,4	TP19	D,3
R203	C,2	R427	C,4	R519	A,4	R564	A,3	R715	D,4	TP20	C,3
R204	C,1	R428	C,4	R520	A,4	R565	B,3	R716	C,4	TP21	C,3
R205	C,1	R429	B,4	R521	A,3	R566	A,3	R717	D,4	TP22	A,3
R206	C,1	R430	C,3	R522	B,4	R567	A,3	R718	E,4	TP23	A,3

A3 Component Coordinates (3 of 3)

COMP	X,Y	COMP	X,Y	COMP	X,Y	COMP	X,Y	COMP	X,Y
TP24	C,3	U35	C,2						
TP25	C,3	U36	D,2						
TP26	C,2	U37	E,2						
TP27	C,2	U38	C,2						
TP28	C,2	U39	C,2						
TP29	C,2	U40	D,2						
TP30	C,1	U41	C,2						
TP31	C,1	U42	C,2						
TP32	D,1	U43	C,2						
TP33	E,1	U44	C,2						
		U45	D,2						
U1	A,4	U46	C,1						
U2	B,4	U47	C,1						
U3	C,4	U48	D,1						
U4	D,4	U49	C,1						
U5	D,4	U50	C,1						
U6	C,4	U51	C,1						
U7	B,4	U52	D,1						
U8	C,4	U53	E,1						
U9	A,4	U54	C,1						
U10	D,4	U55	C,1						
U11	D,4								
U12	E,3	VR300	C,3						
U13	B,3	VR400	B,4						
U14	B,3	VR401	C,4						
U15	E,3	VR500	A,3						
U16	E,3	VR601	B,3						
U17	C,3								
U18	D,3	W1	B,3						
U19	E,3	W2	C,3						
U20	E,3	W3	A,3						
U21	A,3	W4	B,3						
U22	B,3	W5	A,3						
U23	D,3	W6	A,2						
U24	D,3	W7	D,1						
U25	E,3	W8	C,1						
U26	E,3	W9	C,4						
U27	B,3	W10	C,4						
U28	C,3	W11	B,4						
U29	D,3								
U30	D,3	Y1	E,2						
U31	E,3	Y300	C,2						
U32	E,3								
U33	B,3								
U34	B,3								

TOP INTERNAL VIEW - LEVEL 1

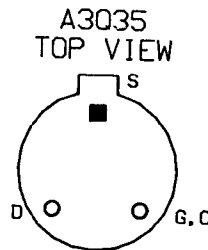
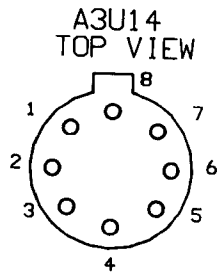


NOTES

1. For an explanation of schematic symbols, see "SCHEMATIC DIAGRAM NOTES" in Section 8.
2. Chassis ground is achieved by mechanical contact through nuts holding PC board to cover and W4.
3. Isolation (guard) trace.
4. Reference designations on this service sheet C, CR, L, R and VR have numbers ranging from 600 to 699 only.

LOGIC LEVELS

	TTL	CMOS
HIGH	2V	3.5V
LOW	0.8V	1.5V
IS MORE NEG. THAN IS MORE POS. THAN		
OPEN	HIGH	UNDEF.
GROUND	LOW	LOW

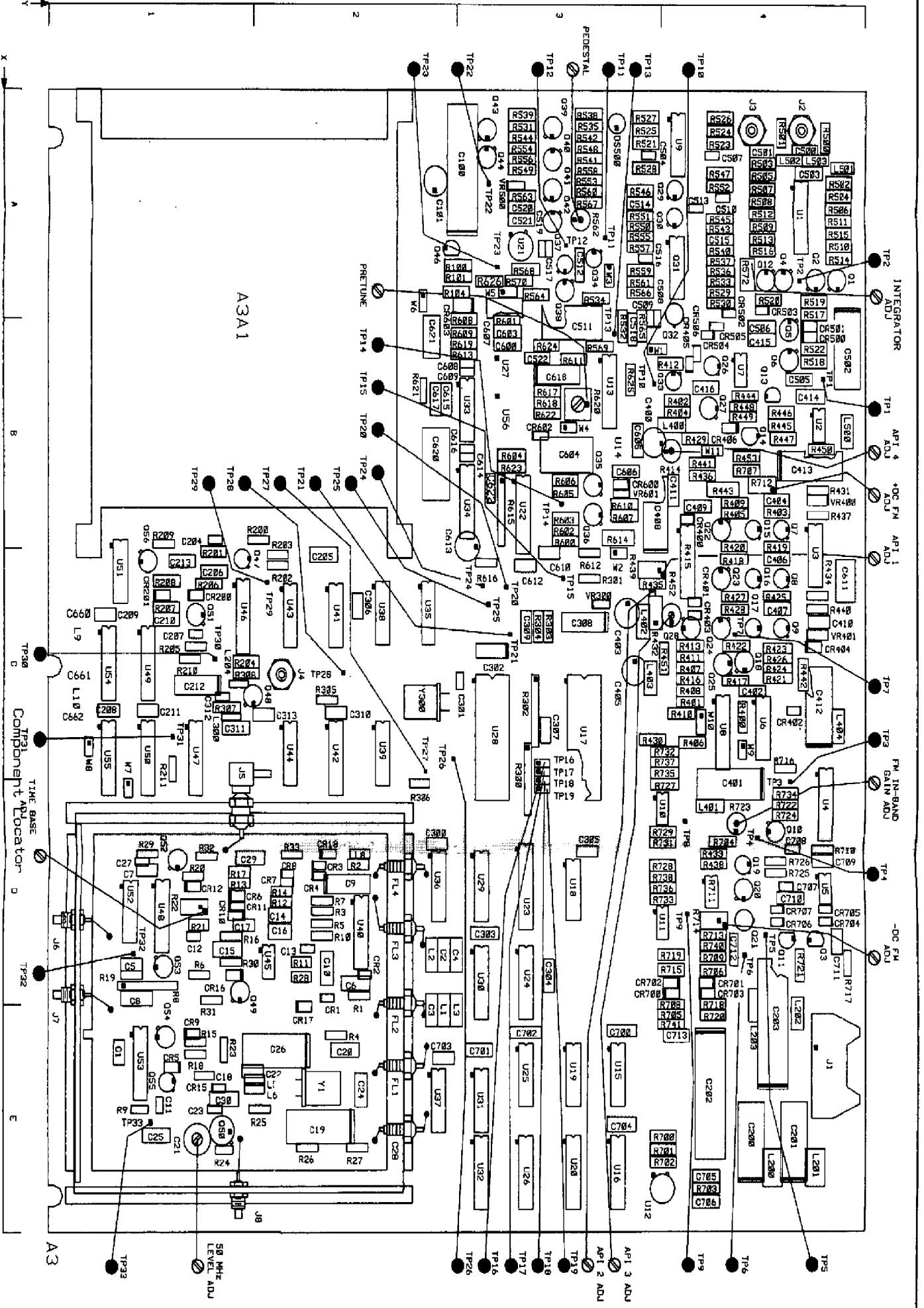


P/O A3
SEE REVERSE SIDE

LOW FREQUENCY LOOP
PHASE DETECTOR,
INTEGRATOR, AND
SAMPLE AND HOLD

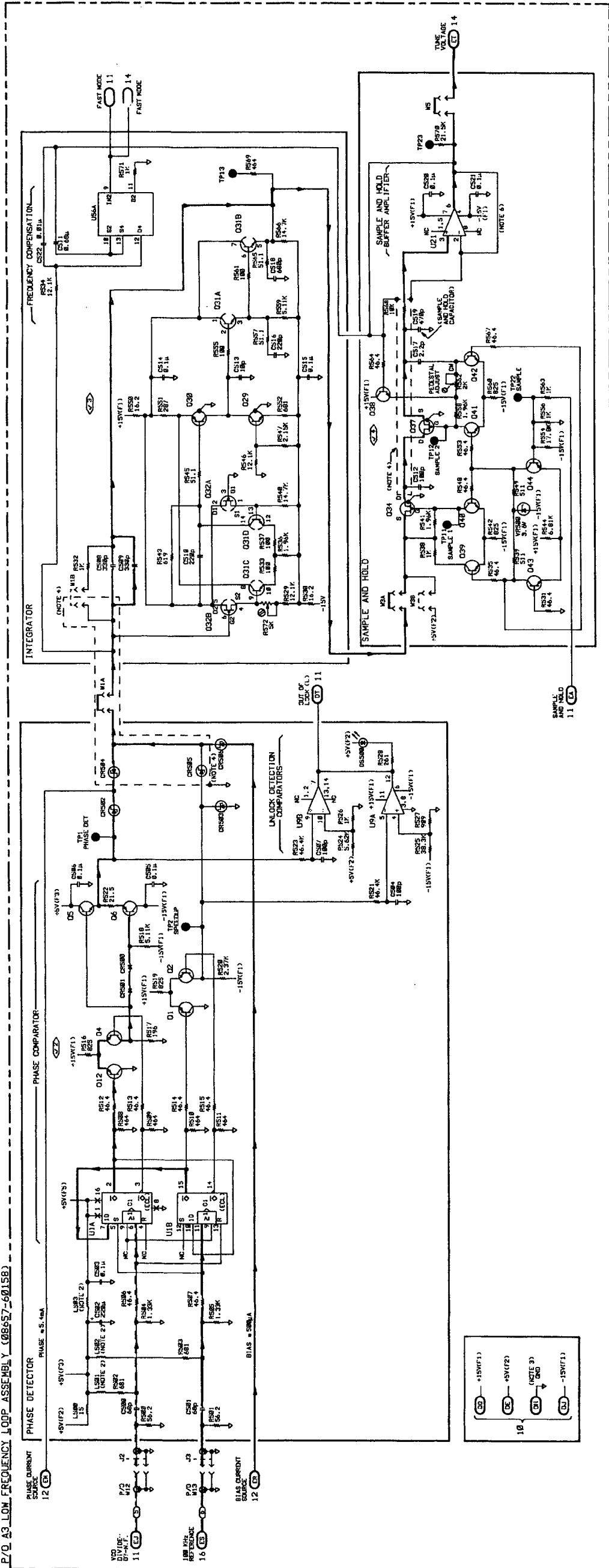
SS13

Figure 0. Service Sheet 14 Information



Component Locator

P/O A3 LOW FREQUENCY LOOP ASSEMBLY (08657-6015B)



Service Sheet 14

LOW FREQUENCY LOOP FREQUENCY MODULATION CALIBRATION

PRINCIPLES OF OPERATION

General

The voltage-to-frequency conversion of the Low Frequency Loop's VCO is dependent upon its output frequency. The purpose of FM Calibration is to make the VCO gain seen by the Low Frequency Loop appear constant. To guarantee calibrated frequency modulation at all frequencies, the loop must compensate for the VCO's nonlinear gain. The VCO Tune Voltage, and the Frequency Modulation signal are summed together at the FM Summing Amplifier U33A. The Low Frequency Loop adjusts the level of the inputs to the VCO by setting the bits of the FM Calibration DAC. The adjusted level at the output of the Current-To-Voltage Converter is the level required to lock the VCO at the correct frequency, and to have calibrated frequency modulation. An FM calibration is performed and the FM Calibration DAC is set each time the Low Frequency Loop VCO's frequency crosses a predetermined boundary, every 200 kHz.

When the Signal Generator's RF output frequency is changed, and the VCO's frequency crosses a 200 kHz boundary, the Low Frequency Loop data is latched into the Latches (refer to Service Sheet 11). The Low Frequency Loop's Microprocessor sets the Add Cycle input to the Prescaler high, divide-by-9. The loop adds two cycles and the frequency of the VCO is offset 200 kHz, F-200 kHz. The FM Calibration circuits store the Tune Voltage on capacitor C604. Immediately after the Tune Voltage is sampled, the Add Cycle input to the Prescaler is set low and the VCO returns to the frequency it was set to before the 200 kHz offset. The Tune Voltage difference between the 200 kHz offset, and the correct VCO frequency is detected by capacitor C604. The difference of the two tune voltages is input to the Analog-To-Digital Converter U22. The analog input voltage and the internal reference voltage determines the digital data, and stores the data in its DAC. The digital output sets the gain of the FM Calibration DAC U34 from 0.46 to 0.97.

The Offset Current circuits sums in an offset voltage at the output of the FM Calibration DAC U34. The Offset Voltage reduces the voltage required at the input of the DAC to tune the Low Frequency Loop VCO over its frequency range of 60 MHz to 110 MHz.

FM Summing, D to A Conversion

The Low Frequency Loop VCO's Tune Voltage is filtered by the 5 kHz Low Pass Filter, R608 and C607, and is connected through input resistor R609 to the input of the FM Summing Amplifier U33A at pin 1. The 5 kHz Low Pass Filter filters digital noise. The frequency modulation signal is summed at the input of U33A with the VCO's dc Tune Voltage. When frequency modulation is selected at the front-panel or over the HP-IB, the two inputs are summed together. When FM is not selected, the FM Enable input from the microprocessor is set high and switches U13A and U13D are both off. When Frequency Modulation is selected the FM Enable input at pin 1 of U13A and pin 16 of U13D is low. The two switches are closed and the frequency modulation input is summed with the VCO Tune Voltage. Tune Voltage gain of the FM Summing Amplifier is approximately 1.5, and FM signal gain is approximately 0.68. The VCO Tune Voltage is applied to the Vref input at pin 15 of the FM Calibration DAC U34. The bits of the DAC are set during the FM Calibration cycle. The Tune Voltage input is attenuated by the DAC and is dependent on the DAC bits set. The output current of the DAC at pin 1 is converted to a voltage by the Current-To-Voltage Converter U33B. The Tune Voltage output of U33B at pin 10 is applied to the Lag-Lead circuit of R619, R621, C620 and C621 to attenuate the DAC and amplifier noise by 33 dB. The output tunes the Low Frequency Loop VCO to the correct frequency, corrects for phase errors, and frequency modulates the VCO when FM is enabled. The VCO Tune Voltage is also applied to Inverting Amplifier U27B for FM Calibration.

FM Calibration

FM Calibration compensates for the non-linearity of the VCO's varactor diode. The varactor diode changes the frequency of the VCO a different amount for a fixed change in tune voltage as the VCO is tuned over its frequency range. The FM Calibration cycle sets the VCO's gain by setting the bits of the FM Calibration DAC. The VCO gain seen by the Low Frequency Loop appears constant over its frequency range of 60 MHz to 110 MHz. The FM Calibration Cycle is initiated each time the frequency of the Low Frequency Loop VCO crosses a predetermined boundary of 200 kHz.

During the FM Calibration cycle, the following sequence of events occur controlled by the Low Frequency Loop Microprocessor. Figure 1 shows the timing diagram of the FM Calibration cycle.

At time T1, the Low Frequency Loop Microprocessor U28 (shown on Service Sheet 11), sets the DCFM bit high. DCFM is enabled.

At time T2, the FM Enable bit is set high. If frequency modulation was enabled, it is disabled. The output of the Current-To-Voltage Converter U33B is always connected through resistor R601 to the input of the Inverting Amplifier U27B at pin 7. The FM Calibration bit from the Microprocessor sets the add cycle bit high. The Low Frequency Loop VCO's frequency is offset by 200 kHz. The S(L)/H1 is set low and the base voltage of Q36 is changed to approximately $-0.7V$ divided from the $-15 Vdc$ supply voltage to the low input by resistors R602 and R603. Q36 is biased on and FET switch Q35's gate voltage is approximately $0.0V$ turning Q35 on. The offset VCO Tune Voltage is stored on capacitor C604. The B+C(L) bit is set high. The high input at pin 11 of the Analog-To-Digital Converter blanks and opens its outputs, and readies U22 for the next analog to digital conversion. With the digital output of U22 tri-stated (open), the data input to the FM Calibration DAC is determined by the pull up resistors of R615 to $+5 Vdc$ and pull down resistor R616 to ground. The FM Calibration DAC bits 0 through 6 and 8 are high and bit 7 is low. The FM Calibration DAC U34 is set at 0.75 of its maximum value of 1.0 or 191/256.

By time T3, the frequency of the Low Frequency Loop's VCO has settled to a frequency of $F-200 kHz$. The 200 kHz offset is the result of the active Add Cycle high input to the Prescaler to divide its input by nine. The S(L)/H1 bit is set high by the Low Frequency Loop Microprocessor and the voltage at the base of Q36 changes to approximately $+1.4V$. Q36 is biased off and the gate voltage of FET switch Q35 changes to approximately $-12.0 Vdc$ divided from $-15 Vdc$ to ground by resistors R605 and R606. Q35 is turned off, opened. The tune voltage for the VCO frequency of $F-200 kHz$ is stored on capacitor C604.

At time T4, the FM Calibration add cycle bit is reset low, and the Prescaler divides-by-10. The frequency of the VCO moves to and settles at frequency F . The VCO Tune Voltage has changed by the amount that was required to offset the VCO's frequency by 200 kHz. The change in the Tune Voltage is detected by capacitor C604 and applied through the Tune Voltage Step Amplifier U14 to the analog input at pin 13 of Analog-To-Digital Converter U22. With the FET switch Q35 open, the output of capacitor C604 is connected to a high impedance, and any change at the input is a change at the output. The voltage across the capacitor must remain constant. There is not a current path for C604 with Q35 open.

At time T5, the voltage at the output of capacitor C604 is amplified by the Tune Voltage Step Amplifier U14 and applied to the analog input at pin 13 of the Analog-To-Digital Converter.

Diode CR600 and Zener Diode VR601 prevent the analog input at pin 13 of the Analog-To-Digital Converter from going below approximately $+3V$. If the input was allowed to go to $0V$, the bits to the the FM Calibration DAC could all be set to 0. The DAC would be set for maximum attenuation and the loop would not lock.

At time T6, the B+C(L) bit is reset low. On the high to low transition, the Analog-To-Digital Converter U22 starts a new conversion. The Analog-To-Digital Converter is an 8-bit successive approximation A/D Converter consisting of a DAC, voltage reference, clock, comparator, successive approximation register, and output buffers. The Analog-To-Digital Converter's internal reference voltage is compared to the analog input voltage by the internal successive approximation register to set the bits of the internal DAC. The bits latched in the internal DAC are the inputs for the FM Calibration DAC. The

output is dependent upon the analog input. With the offset control input at pin 15 of U22 connected to ground, U22 is operating in the unipolar mode. The A/D's input voltage range is 0.0 Vdc to +10.0 Vdc. The time required for an A to D conversion by U22 is 40 μ s.

At time T7, the FM Enable bit is returned to the state it was at before the FM Calibration cycle was initiated. As shown in the FM Calibration Timing Diagram Figure 1, the FM Enable bit is set low. Frequency modulation is enabled.

At time T8, the DCFM bit is returned to the state it was at before the FM Calibration cycle was initiated. As shown in the FM Calibration Timing Diagram Figure 1, the DCFM bit is set low. DCFM is disabled. The FM Calibration cycle is complete.

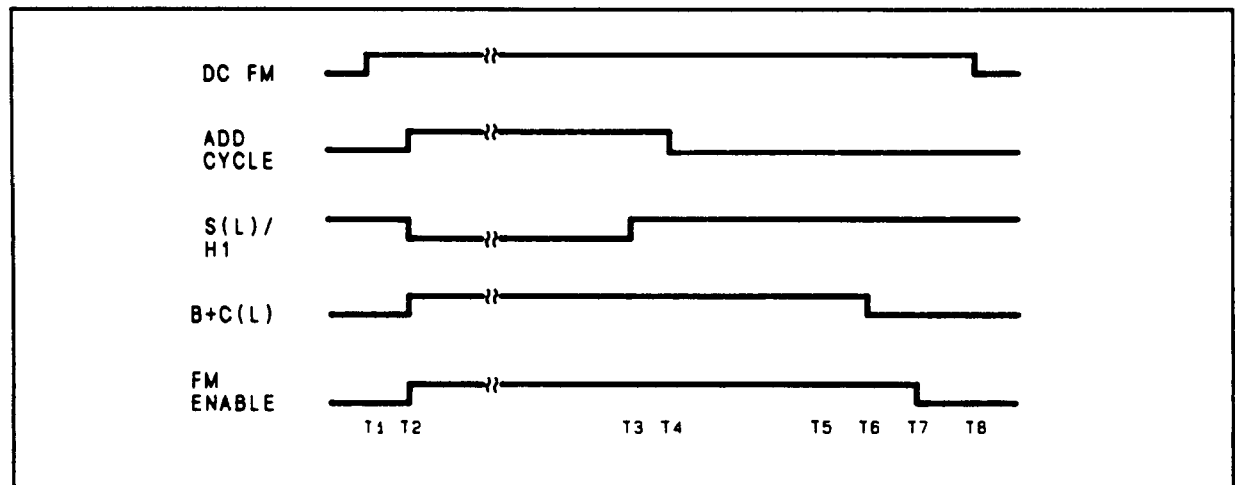


Figure 1. FM Calibration Timing Diagram.

Offset Current

The Low Frequency Loop VCO has the maximum Hz/Volt tuning sensitivity at 60 MHz. This requires that the FM Calibration DAC setting be 0.5 of its range. The VCO tuning voltage for 60 MHz is approximately +9.0V. With the DAC set at 0.5, the voltage input to the DAC would have to be +18.0V. The +18.0V is greater than the possible output voltage swing of the circuit's operational amplifier. The Offset Current circuit compensate for this problem by summing in an offset voltage proportional to the VCO's frequency at the input of the Current-To-Voltage Converter U33B. The D1 bit from the 10 MHz counter's latch is used to determine if 6V is summed at the input of U33B. The bit determines if diode CR602 is turned on or off. When the diode is off, D1 data bit at pin 9 of U13C is low and the switch is closed. The +5 Vdc at pin 10 of U13C is switched through the switch to bias diode CR602 off. When the D1 data bit is high, the diode is on and an offset voltage is summed into the input of U33B. Data bit D1 controls CR602 and when D1 is high, CR602 is biased on and current through R622 sums 6V offset into the input of U33B. When the VCO frequency is 60 MHz, the D1 data bit is high. Diode CR602 is biased on and a 6V offset is summed into the input of U33B. The 6V offset voltage is summed with the output of the FM Calibration DAC. The VCO Tune Voltage for a VCO output frequency of 60 MHz is approximately +9V. The gain of the DAC is set at 0.46, and the DAC input voltage is -8.0 V. The DAC gain and input voltage will vary because of the Low Frequency Loop FM calibration. The offset voltage summed into the input of U33B varies from +6V to 0V as the VCO is tuned across its frequency range. The offset voltage is 6V for VCO frequencies from 60 MHz to 84 MHz, and 0V for 84 MHz to 110 MHz.

TROUBLESHOOTING

Procedures for checking part of the A3 Low Frequency Loop Assembly circuits are given below. The areas or points to check are marked on the schematic by a hexagon with a checkmark and a number inside, for example, $\checkmark 3$.

Troubleshooting Help

- Block Diagram 3
- Table 4-1. Abbreviated Performance Tests
- Table 5-2. Post-Repair Adjustments

Test Equipment

Digital Multimeter	HP 3466A
Oscilloscope	HP 54100A
Oscilloscope 1 Megohm Probe Pod Chan 2	HP 54003A
Oscilloscope Probe	HP 54003-61617
Audio Source	HP 8903B

$\checkmark 1$ FM Summing

1. Remove jumper W3 from the W3A position, and install it in the W3B position (refer to Service Sheet 13). Remove jumper W6 from the A3 Assembly. +5 Vdc is connected to the input of the Sample and Hold circuits by W3. When the Sample and Hold circuits are working correctly, +5 Vdc is input to the FM Summing Amplifier.

2. Set the Oscilloscope as follows:

Chan 1

Ch 1 Display Off

Chan 2

Ch 2 Mode Normal
 Ch 2 Display On
 VOLTS/DIV 5.0V
 OFFSET 0V

Timebase

SEC/DIV 500 ns
 DELAY 0.0s
 Delay Ref at Left
 Sweep Auto

Trigger

Trigger Mode Edge
 Trig Src Chan 2
 TRIG LEVEL 0.0V
 Slope Pos

Display

Display Mode Normal
 DISPLAY TIME 200 ms
 Split Screen Off
 Graticle Grid

3. Connect Chan 2 to pin 12 of U33A. If the amplifier is operating correctly, the output voltage of U33A is approximately -6.8V.
4. Set the Signal Generator as follows:

Frequency	Any Frequency
Amplitude	Any Amplitude
Modulation	FM 50 kHz
Source	1 kHz (Int.)
5. Set the oscilloscope's Chan 2 OFFSET to -5.0 V.
6. Connect Chan 2 to pin 12 of U33A. Check the oscilloscope for a 1 kHz signal of approximately 0.2 Vpp.
7. If a modulation signal is not present, check the Out-Of-Band FM Input switches by inserting a 1 kHz, 10 mV signal at hard-wired jumper W11.

√2 D to A Conversion

1. With jumper W3 in the W3B position as for **√1**, remove jumper W2 the B+C(L) input to U22, and remove jumper W4 the offset input to U33B. With the outputs of U22 open, the input to the FM Calibration DAC U34 is determined by resistors R615 and R616.
2. Set the digital multimeter function to dc and Range to Auto.
3. Connect the digital multimeter to jumper W6 at the output of U33B.
4. Ground the inputs of the FM Calibration DAC at pins 4, 6, 7, 8, 9, 10 and 11, and connect pin 5 to +5 Vdc one at a time. The dc voltage level on the digital multimeter will changes as each pin 4, 6, 7, 8, 9, 10 and 11 are connected to ground, and as pin 5 is connected to +5 Vdc.

NOTE

When the least significant bits are grounded, the voltage change is only a few millivolts.

5. Reinstall the jumpers W2, W3, and W4 (put W3 in the W3A position).

√3 FM Calibration

1. The FM Calibration circuits are checked by placing the Low Frequency Loop in the repeatable FM Cal mode. An FM Calibration is performed every 100 ms.
2. With the instrument ON, connect TP26 to ground (refer to Service Sheet 11). Increment the Signal Generator's frequency by 10 MHz. The Signal Generator will then be in the repeatable FM Cal mode.
3. Remove jumper W6 and connect a 100 Hz, 200 mV peak signal to the input of U27B at pin 7. This connection can be made at the socket of jumper W6, VCO Tune input.
4. The 100 Hz input causes the input to the Analog-To-Digital Converter to change, and the output bits to change.

5. Set the oscilloscope as follows:

Chan 1

Ch 1 Mode Normal
 Ch 1 Display Off
 VOLTS/DIV 2.0V
 OFFSET 0.0V

Chan 2

Ch 2 Mode Normal
 Ch 2 Display On
 VOLTS/DIV 2.0V
 OFFSET 0.0V

Timebase

SEC/DIV 50 ms
 DELAY 0.0s
 Delay Ref at Left
 Sweep Trg'd

Trigger

Trigger Mode Edge
 Trig Src Chan 2
 TRIG LEVEL 1.0V
 Slope Pos

Display

Display Mode Normal
 DISPLAY TIME 200 ms
 Split Screen Off
 Graticle Grid

6. Check the S(L)/H1 and B+C(L) inputs. Pulses are TTL level and at every 100 ms.
7. Check that Q36 is pulsed on and off and that the Gate voltage of Q35 is switched from approximately 0V to approximately -15V. Q35 is gated on and off.
8. Connect Chan 2 to W2, B+C(L), input. Set Chan 1 Display On and connect it to TP14. The signal at TP14 is randomly pulsed high when the B+C(L) input is low.
9. Connect Chan 2 to the output of the Analog-To-Digital Converter (U22) at pins 2 through 9. The output bits randomly change when the B+C(L) input is low. The Analog-To-Digital Converter does a conversion.
10. Remove the ground from TP26. Re-install W6, and turn the Signal Generator to STBY, and back to ON to exit the FM Cal mode.

√4 Offset Current

1. Remove jumper W1 from the W1A position, and install W1 in the W1B position (refer to Service Sheet 13).
2. Jumper W4 must be installed.
3. The voltage input to the FM Calibration DAC at pin 15 is 0.0V. The output of the Current-To-Voltage Converter is the offset voltage from the Offset Current as the Signal Generator's frequency is changed.
4. Set the Signal Generator as follows:
 - a. Frequency to 45 MHz
5. If the offset voltages shown in Table 1 for W6 (pin 1), at the input of U33B, are correct the voltages for U13 are correct. Change the Signal Generator's frequency as indicated in Table 1 and measure the voltage levels as indicated.

Table 1. Input and Output Voltage of Offset Circuits.

Signal Generator Frequency (MHz)	U13 and W6 with W4 Installed		
	Pin 9	Pin 11	W6 Pin 1
45	0	+5	0
70	+5	0	+6

A3 Component Coordinates (1 of 3)

COMP	X,Y	COMP	X,Y	COMP	X,Y	COMP	X,Y	COMP	X,Y	COMP	X,Y
C1	E,1	C213	C,1	C513	A,4	CR1	D,2	FL1	E,2	Q10	D,4
C2	D,2	C300	D,2	C514	A,3	CR2	D,2	FL2	E,2	Q11	D,4
C3	E,2	C301	C,3	C515	A,4	CR3	D,2	FL3	D,2	Q12	A,4
C4	D,2	C302	C,3	C516	A,3	CR4	D,2	FL4	D,2	Q13	B,4
C5	D,1	C303	D,3	C517	A,3	CR5	E,1			Q14	B,4
C6	D,2	C304	D,3	C518	B,3	CR6	D,1	J1	E,4	Q15	B,4
C7	D,1	C305	D,3	C519	A,3	CR7	D,2	J2	A,4	Q16	C,4
C8	D,1	C306	C,2	C520	A,3	CR8	D,2	J3	A,4	Q17	C,4
C9	D,2	C307	C,3	C521	A,3	CR9	E,1	J4	C,2	Q18	C,4
C10	D,2	C308	C,3	C600	B,3	CR10	D,1	J5	C,1	Q19	D,4
C11	E,1	C309	C,3	C601	B,3	CR11	D,1	J6	D,1	Q20	D,4
C12	D,1	C310	C,2	C602	B,3	CR12	D,1	J7	E,1	Q21	D,4
C13	D,2	C311	C,1	C603	B,3	CR15	E,1	J8	E,2	Q22	B,4
C14	D,2	C312	C,1	C604	B,3	CR16	D,1			Q23	C,4
C15	D,1	C313	C,2	C605	B,3	CR17	E,2	L1	E,2	Q24	C,4
C16	D,2	C400	B,3	C606	B,3	CR18	D,2	L2	D,2	Q25	C,4
C17	D,1	C401	D,4	C607	B,3	CR200	C,1	L3	E,2	Q26	B,4
C18	E,1	C402	C,4	C608	B,3	CR201	C,1	L5	E,2	Q27	B,4
C19	E,2	C403	C,3	C609	B,3	CR400	B,4	L6	E,2	Q28	C,4
C20	E,2	C404	B,4	C610	C,3	CR401	C,4	L8	D,2	Q29	A,4
C21	E,1	C405	C,3	C611	C,4	CR402	C,4	L200	E,4	Q30	A,4
C22	E,2	C406	C,4	C612	C,3	CR403	C,4	L201	E,4	Q31	A,4
C23	E,1	C407	C,4	C613	B,3	CR404	C,4	L202	E,4	Q32	A,4
C24	E,2	C408	B,3	C614	B,3	CR405	B,4	L203	E,4	Q33	B,4
C25	E,1	C409	B,4	C615	B,2	CR406	B,4	L204	C,1	Q34	A,3
C26	E,2	C410	C,4	C616	B,3	CR500	B,4	L300	C,1	Q35	B,3
C27	D,1	C411	B,4	C617	B,2	CR501	B,4	L400	B,4	Q36	B,3
C28	E,2	C412	C,4	C618	B,3	CR502	A,4	L401	D,4	Q37	A,3
C29	D,1	C413	B,4	C619	B,3	CR503	A,4	L402	C,3	Q38	A,3
C30	E,1	C414	B,4	C620	B,2	CR504	B,4	L403	C,3	Q39	A,3
C100	A,3	C415	B,4	C621	B,2	CR505	B,4	L404	C,4	Q40	A,3
C101	A,2	C416	B,4	C700	E,3	CR506	B,4	L500	B,4	Q41	A,3
C200	E,4	C500	A,4	C701	E,3	CR600	B,3	L501	A,4	Q42	A,3
C201	E,4	C501	A,4	C702	E,3	CR602	B,3	L502	A,4	Q43	A,3
C202	E,4	C502	B,4	C703	E,2	CR700	D,4	L503	A,4	Q44	A,3
C203	E,4	C503	A,4	C704	E,3	CR701	D,4			Q46	A,2
C204	B,1	C504	A,3	C705	E,4	CR702	D,4	Q1	A,4	Q47	C,1
C205	C,2	C505	B,4	C706	E,4	CR703	D,4	Q2	A,4	Q48	C,2
C206	C,1	C506	B,4	C707	D,4	CR704	D,4	Q3	D,4	Q49	D,1
C207	C,1	C507	A,4	C708	D,4	CR705	D,4	Q4	A,4	Q50	E,1
C208	C,1	C508	B,3	C709	D,4	CR706	D,4	Q5	B,4	Q51	C,1
C209	C,1	C509	B,3	C710	D,4	CR707	D,4	Q6	B,4	Q52	D,1
C210	C,1	C510	A,4	C711	D,4			Q7	B,4	Q53	D,1
C211	C,1	C511	B,3	C712	D,4			Q8	C,4	Q54	E,1
C212	C,1	C512	A,3	C713	E,4	DS500	A,3	Q9	C,4	Q55	E,1

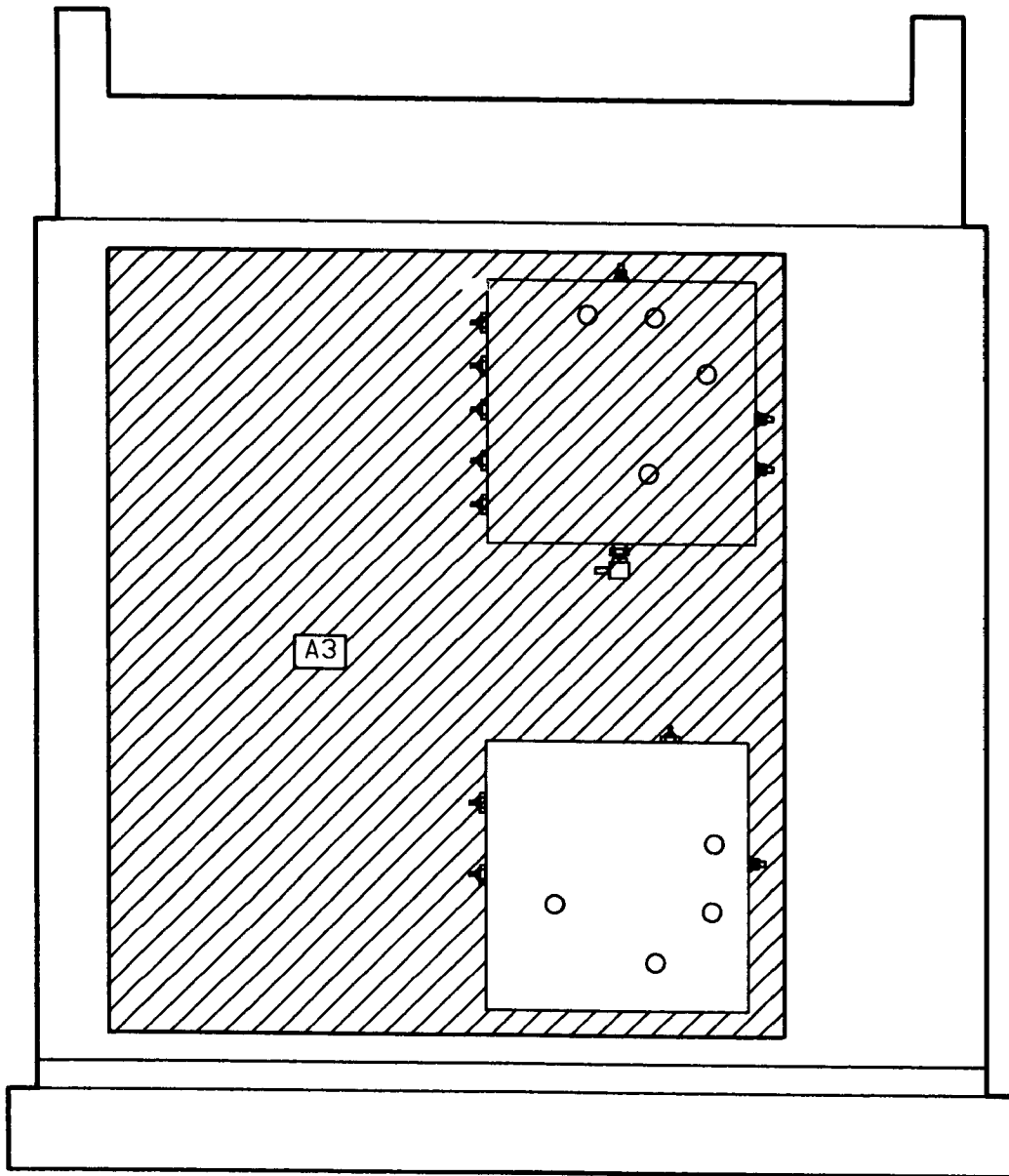
A3 Component Coordinates (2 of 3)

COMP	X,Y	COMP	X,Y	COMP	X,Y	COMP	X,Y	COMP	X,Y	COMP	X,Y
Q56	C,1	R207	C,1	R431	B,4	R523	A,4	R568	A,3	R719	D,4
		R208	C,1	R432	C,3	R524	A,4	R569	B,3	R720	E,4
R1	D,2	R209	B,1	R433	D,4	R525	A,3	R570	A,3	R721	D,4
R2	D,2	R210	C,1	R434	C,4	R526	A,4	R600	B,3	R722	D,4
R3	D,2	R211	C,1	R435	C,3	R527	A,3	R601	B,3	R723	D,4
R4	E,2	R300	C,3	R436	B,4	R528	A,3	R602	B,3	R724	D,4
R5	D,2	R301	C,3	R437	B,4	R529	A,4	R603	B,3	R725	D,4
R6	D,1	R302	C,3	R438	D,4	R530	A,4	R604	B,3	R726	D,4
R7	D,2	R303	C,3	R439	C,3	R531	A,3	R605	B,3	R727	D,4
R8	D,1	R304	C,3	R440	C,4	R532	B,3	R606	B,3	R728	D,4
R9	E,1	R305	C,2	R441	B,4	R533	A,4	R607	B,3	R729	D,4
R10	D,2	R306	D,2	R442	C,4	R534	A,3	R608	A,3	R731	D,4
R11	D,2	R307	C,1	R443	B,4	R535	A,3	R609	B,3	R732	C,4
R12	D,2	R308	C,1	R444	B,4	R536	A,4	R610	B,3	R733	D,4
R13	D,1	R400	C,4	R445	B,4	R537	A,4	R611	B,3	R734	D,4
R14	D,2	R401	C,4	R446	B,4	R538	A,3	R612	C,3	R735	C,4
R15	E,1	R402	B,4	R447	B,4	R539	A,3	R613	B,3	R736	D,4
R16	D,1	R403	B,4	R448	B,4	R540	A,4	R614	B,3	R737	C,4
R17	D,1	R404	B,4	R449	B,4	R541	A,3	R615	B,3	R738	D,4
R18	E,1	R405	B,4	R450	B,4	R542	A,3	R616	C,3	R740	D,4
R19	D,1	R406	C,4	R451	C,4	R543	A,4	R617	B,3	R741	E,4
R20	D,1	R407	C,4	R452	C,4	R544	A,3	R618	B,3		
R21	D,1	R408	C,4	R500	A,4	R545	A,4	R619	B,3	TP1	B,4
R22	D,1	R409	B,4	R501	A,4	R546	A,3	R620	B,3	TP2	A,4
R23	E,1	R410	C,4	R502	A,4	R547	A,4	R621	B,2	TP3	D,4
R24	E,1	R411	C,4	R503	A,4	R548	A,3	R622	B,3	TP4	D,4
R25	E,2	R412	B,4	R504	A,4	R549	A,3	R700	E,4	TP5	D,4
R26	E,2	R413	C,4	R505	A,4	R550	A,3	R701	E,4	TP6	D,4
R27	E,2	R414	B,4	R506	A,4	R551	A,3	R702	E,4	TP7	C,4
R28	D,2	R415	C,4	R507	A,4	R552	A,4	R703	E,4	TP8	D,4
R29	D,1	R416	C,4	R508	A,4	R553	A,3	R704	D,4	TP9	D,4
R30	D,1	R417	C,4	R509	A,4	R554	A,3	R705	E,4	TP10	B,3
R31	D,1	R418	C,4	R510	A,4	R555	A,3	R706	D,4	TP11	A,3
R32	D,1	R419	B,4	R511	A,4	R556	A,3	R707	B,4	TP12	A,3
R33	D,2	R420	B,4	R512	A,4	R557	A,3	R708	E,4	TP13	B,3
R100	A,2	R421	C,4	R513	A,4	R558	A,3	R709	D,4	TP14	B,3
R101	A,2	R422	C,4	R514	A,4	R559	A,3	R710	D,4	TP15	C,3
R104	A,2	R423	C,4	R515	A,4	R560	A,3	R711	D,4	TP16	C,3
R200	B,2	R424	C,4	R516	A,4	R561	A,3	R712	B,4	TP17	C,3
R201	C,1	R425	C,4	R517	A,4	R562	A,3	R713	D,4	TP18	D,3
R202	C,2	R426	C,4	R518	B,4	R563	A,3	R714	D,4	TP19	D,3
R203	C,2	R427	C,4	R519	A,4	R564	A,3	R715	D,4	TP20	C,3
R204	C,1	R428	C,4	R520	A,4	R565	B,3	R716	C,4	TP21	C,3
R205	C,1	R429	B,4	R521	A,3	R566	A,3	R717	D,4	TP22	A,3
R206	C,1	R430	C,3	R522	B,4	R567	A,3	R718	E,4	TP23	A,3

A3 Component Coordinates (3 of 3)

COMP	X,Y	COMP	X,Y	COMP	X,Y	COMP	X,Y	COMP	X,Y
TP24	C,3	U35	C,2						
TP25	C,3	U36	D,2						
TP26	C,2	U37	E,2						
TP27	C,2	U38	C,2						
TP28	C,2	U39	C,2						
TP29	C,2	U40	D,2						
TP30	C,1	U41	C,2						
TP31	C,1	U42	C,2						
TP32	D,1	U43	C,2						
TP33	E,1	U44	C,2						
		U45	D,2						
U1	A,4	U46	C,1						
U2	B,4	U47	C,1						
U3	C,4	U48	D,1						
U4	D,4	U49	C,1						
U5	D,4	U50	C,1						
U6	C,4	U51	C,1						
U7	B,4	U52	D,1						
U8	C,4	U53	E,1						
U9	A,4	U54	C,1						
U10	D,4	U55	C,1						
U11	D,4								
U12	E,3	VR300	C,3						
U13	B,3	VR400	B,4						
U14	B,3	VR401	C,4						
U15	E,3	VR500	A,3						
U16	E,3	VR601	B,3						
U17	C,3								
U18	D,3	W1	B,3						
U19	E,3	W2	C,3						
U20	E,3	W3	A,3						
U21	A,3	W4	B,3						
U22	B,3	W5	A,3						
U23	D,3	W6	A,2						
U24	D,3	W7	D,1						
U25	E,3	W8	C,1						
U26	E,3	W9	C,4						
U27	B,3	W10	C,4						
U28	C,3	W11	B,4						
U29	D,3								
U30	D,3	Y1	E,2						
U31	E,3	Y300	C,2						
U32	E,3								
U33	B,3								
U34	B,3								

TOP INTERNAL VIEW - LEVEL 1

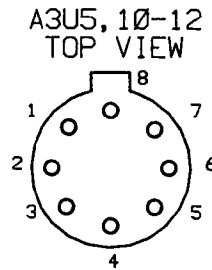
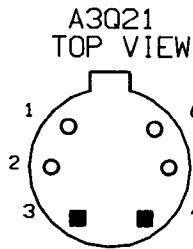


NOTES

1. For an explanation of schematic symbols, see "SCHEMATIC DIAGRAM NOTES" in Section 8.
2. Isolation (guard) trace.
3. Chassis ground is achieved by mechanical contact through nuts holding PC board to cover and W4.
4. Reference designations on this service sheet C, CR, Q, R and U have numbers ranging from 700 to 799 only.

LOGIC LEVELS

	TTL	CMOS
HIGH	2V	3.5V
LOW	0.8V	1.5V
IS MORE NEG. THAN IS MORE POS. THAN		
OPEN	HIGH	UNDEF.
GROUND	LOW	LOW



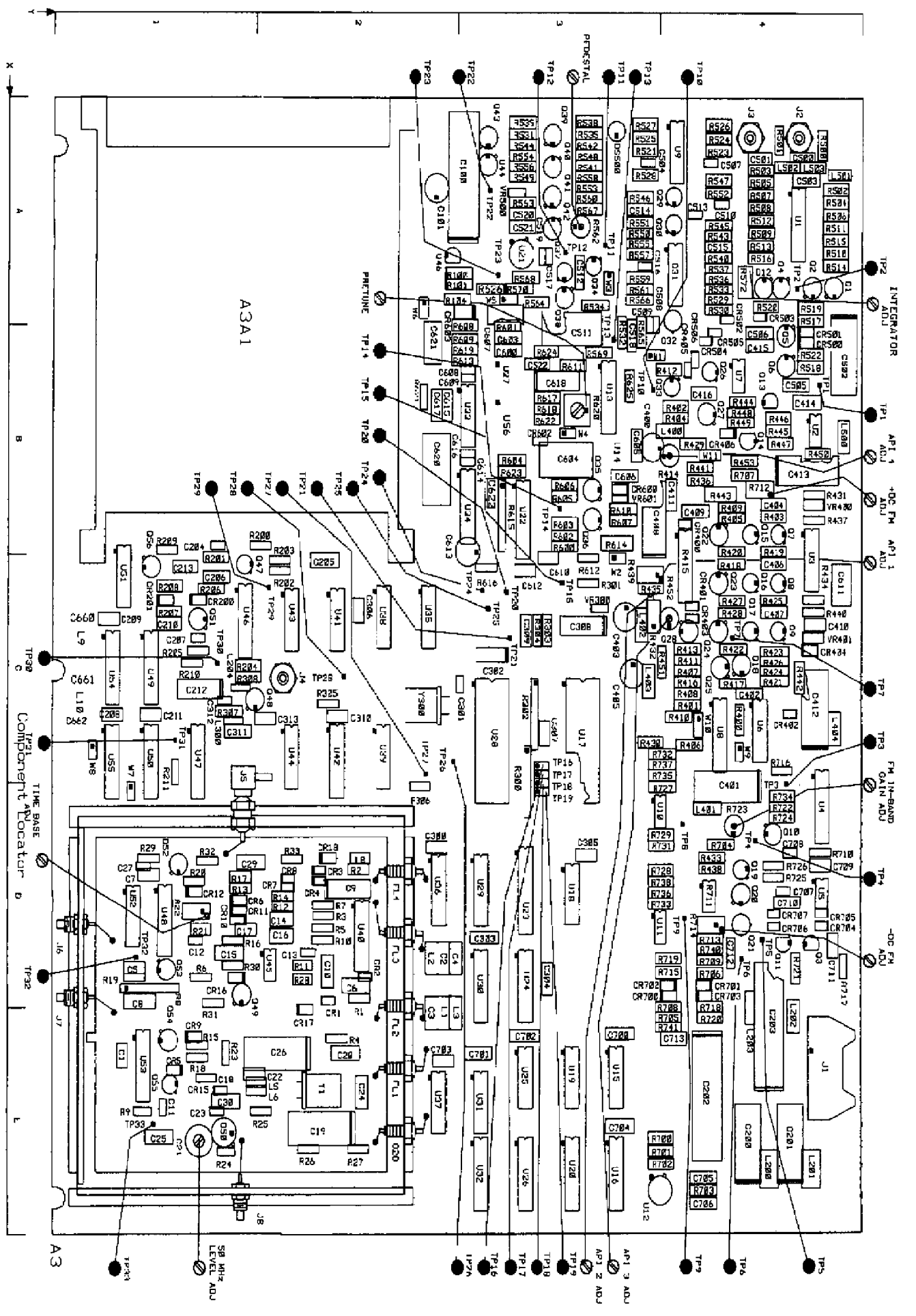
P/O A3

LOW FREQUENCY LOOP
FREQUENCY MODULATION
CALIBRATION
SEE REVERSE SIDE

SS14

Figure 0. Service Sheet 15 Information

Component Locator



P/O A3 LOW FREQUENCY ASSEMBLY (08057-60156)

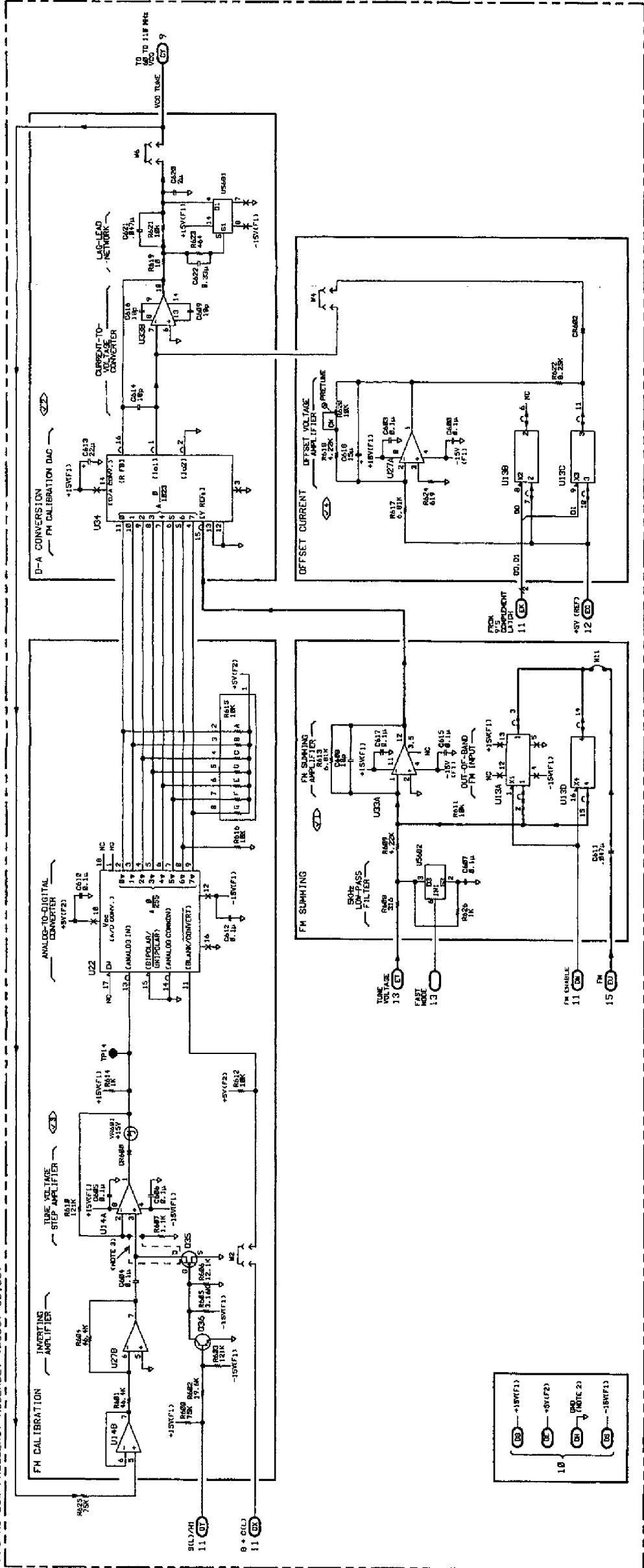


Figure 2
Service Sheet 14 13

Service Sheet 15

LOW FREQUENCY LOOP IN-BAND FREQUENCY MODULATION

PRINCIPLES OF OPERATION

General

Phase detector range, integrator range, and phase lock loop bandwidth are limitations of frequency modulation in a phase lock loop. These limitations are overcome with the addition of circuits to add a cycle and remove a cycle of the Low Frequency Loop's VCO frequency at the Prescaler, and to precisely reset the Integrator (refer to Service Sheet 13). The FM input is applied to Integrator U5. When the output of Integrator U5 crosses the high threshold, +1V, the High Threshold Comparator is set and a Remove Cycle control pulse is generated. The Remove Cycle control pulse is gated to the Prescaler, and a cycle is removed from the VCO Divided-By-N.F. signal. When the output of the integrator crosses the low threshold, -4V, the Low Threshold Comparator is set and an Add Cycle control pulse is generated. The Add Cycle control pulse is gated to the Prescaler, and a cycle is added to the VCO Divided-By-N.F. signal. When a cycle is removed or added, a precise current is directed to the FM Integrator U5. Just enough charge is added to or removed from the Integrator to offset the 360 degrees of phase caused by adding or removing a cycle by the Prescaler.

The FM section operates in a sampled mode. At the time each sample is taken the effects of the Remove Cycle or Add Cycle and the resetting of the integrator have settled. When DC FM is selected and a dc voltage is applied to the MOD INPUT/OUTPUT connector, the dc voltage offsets the VCO frequency a proportional amount. The drift of Integrator U5, without feedback, offsets the VCO center frequency when a dc voltage is not present at the MOD INPUT/OUTPUT connector. With ac FM, it is desirable to frequency modulate the VCO and keep the center frequency locked to a stable reference.

To prevent integrator U5's offset currents from being translated into a frequency shift during ac FM, a feedback voltage to the integrator proportional to the phase offset of the Low Frequency Loop VCO is needed. The Up/Down Counters and DAC reconstruct a staircase voltage approximation of the total VCO phase offset caused by the frequency modulation Remove Cycle and Add Cycle control inputs to the Prescaler. This voltage is fed-back to the integrator. The resistor network of R722, R726, and R734 provides feedback to fill in the spaces between the steps.

The FM Reset Timing and Current Switches reset the Integrator. The Up/Down Counters, Phase Deviation DAC, and Current-To-Voltage Converter keep track of the number of times and the direction which Integrator U5 is reset. The High and Low Threshold Comparators determine when the Integrator is reset and when a frequency modulation remove or Add Cycle control pulse is generated. Figure 1 shows the timing diagram for square wave in-band frequency modulation.

FM Control Gates and Switches

The FM OFF instruction from the Microprocessor U28 at pin 27 (refer to Service Sheet 11), is high when FM is off. With FM selected the FM OFF input at pin 2 of NOR gate U15A is low and the output at pin 1 is high. The load input at pin 11 of the Up/Down Counters, U20, U26, and U32, is high and data at the inputs is not loaded into the Counters. The high output of U15A is also the input of U15B at pin 5 and sets the Buffered FM OFF output at pin 4 low. The low Buffered FM OFF to switch U4B at pin 8 closes the switch to connect the output of the Integrator U5 at pin 6 to the base of Q10.

The DC FM instruction from the Microprocessor U28 at pin 26 is high when DC FM is selected. When the DC FM instruction is high Up/Down Counter U20 is disabled and switch U4A is opened. When the DC FM instruction is low and DC FM is not selected, the Up/Down Counters are enabled, and switch U4A is closed.

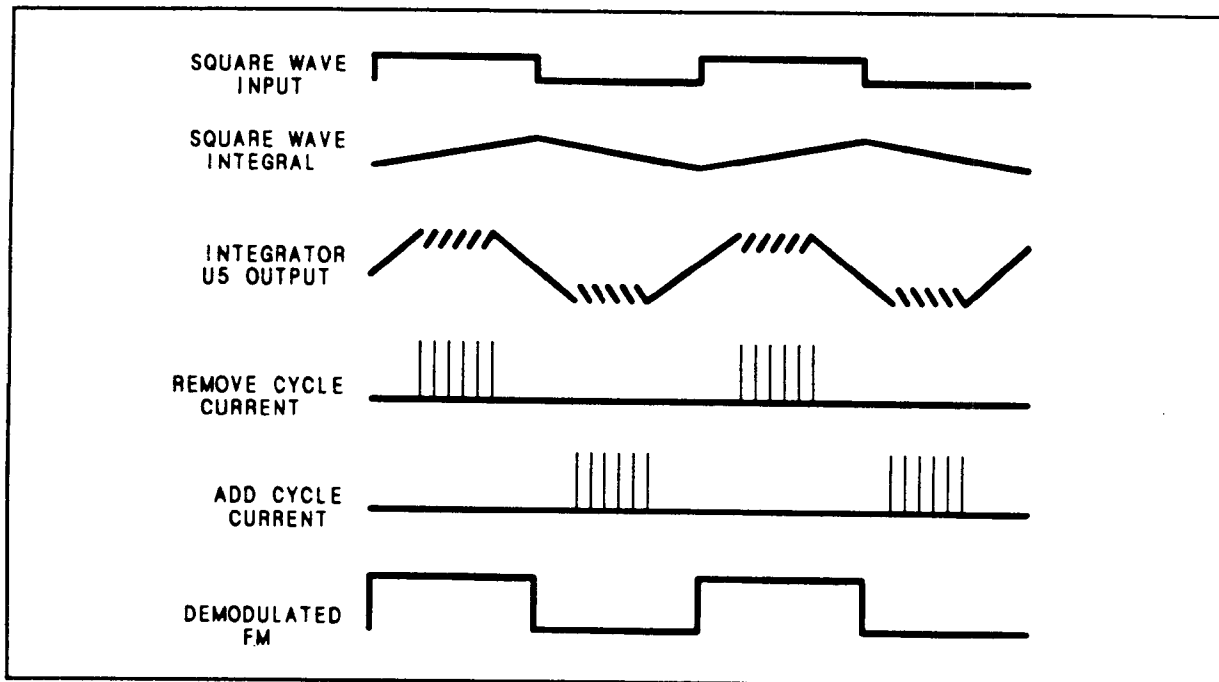


Figure 1. 10 Hz Square Wave In-Band Modulation.

Threshold Comparators

The output of Integrator U5 is applied to the input of the High and Low Threshold Comparators U10 and U11. When the integrated voltage is approximately +1V the High Threshold Comparator's output is switched from low to high. The high output is latched into the Remove Cycle flip-flop U38B (refer to Service Sheet 11). The output of U38B is gated at the correct time in each Low Frequency Loop cycle for the Prescaler to remove a cycle and to clock D flip-flop U25A on the low to high transition. When the integrated voltage is approximately -4V, the Low Threshold Comparator's output is switched from low to high. The high output is latched into the Add Cycle flip-flop U38A (refer to Service Sheet 11). The output of U38A is gated at the correct time in each Low Frequency Loop cycle for the Prescaler to add a cycle and to clock D flip-flop U25B on the low to high transition.

FM Reset Timing

The FM Reset Timing D flip-flops U31 and U37 are clocked at pins 3 and 11 by the 5 MHz Reference input, divided from the 50 MHz Reference (refer to Service Sheet 9). The 5 MHz Reference input is directed to the FM Reset Timing flip-flop's when frequency modulation is selected. The low to high transition of Remove Cycle flip-flop U38B's output at pin 9, clocks the high D input at pin 2 of U25A to the output at pin 5. The output at pin 5 is the D input for U31A, and is clocked to the output at pin 5 by the 5 MHz Reference. The output at pin 5 of U31A is the D input at pin 12 of U31B, and the high input is clocked to the output at pin 9 on the next low to high transition of the 5 MHz Reference. The output at pin 8 of U31B is clocked low, and U25A is reset (the output at pin 5 is low and output at pin 6 is high). The low output at pin 5 of U25A is clocked through U31A and U31B. The output at pin 9 of U31B was set high, and after two cycles of the 5 MHz Reference it is set low. The high output pulse width of U31B at pin 9 is 400 ns, two cycles of the 5 MHz Reference clock. U25A, U31A and U31B generate a 400 ns pulse each time a Remove Cycle control pulse is generated by the High Threshold Comparator U10. During the 400 ns pulse a precise positive current (from the API 2 current source and current mirror) resets Integrator U5. The 400 ns pulse from U31B is also one input to NOR gate U15C, and when high the output of U15C at pin 10 is low. At the termination of the 400 ns pulse, the output of U15C goes high and clocks the Up/Down Counter U20 up one count on the low to high transition. The output of U25A at pin 6 had set the output at pin 8 of U19B low, and enabled the Up/Down Counters to count up when clocked.

The low to high transition from the output of U38A at pin 5 (refer to Service Sheet 11) clocks the high D input at pin 12 of U25B to the output at pin 9. U25B, U37A and U37B generate a precise 400 ns pulse each time an Add Cycle control pulse is generated by the Low Threshold Comparator U11. They function the same as U25A, U31A, and U31B, described above, to generate a 400 ns pulse. During the 400 ns pulse a precise negative current from the API 3 current source resets Integrator U5. The 400 ns pulse from U37B is also one input to NOR gate U15C, and when high the output of U15C at pin 10 is low. At the termination of the 400 ns pulse, the output of U15C goes high and will clock the Up/Down Counter U20 down one count on the low to high transition of the pulse. The output of U25B at pin 8 had reset the output at pin 8 of U19B high, and enabled the Up/Down Counter to count down when clocked.

Up/Down Control

The Up/Down Control, U19B, for the Up/Down Counters of U20, U26, and U32 is controlled by U25A and U25B. When U19B's output at pin 8 is set low by U25A, the Counters are enabled to count up. When U19B's output at pin 8 is reset high by U25B the Counters are enabled to count down. The D flip-flop U25A is clocked each time the High Threshold Comparator's output at pin 7 of U10 is switched high, and the Prescaler removes a cycle. U25A is clocked by the output of U38B. U19B is set and the Up/Down Counters are enabled to count up. The D flip-flop U25B is clocked each time the Low Threshold Comparator's output at pin 7 of U11 is switched high, and the Prescaler adds a cycle. U25B is clocked by the output of U38A. U19B is reset, and the Up/Down Counters are enabled to count down.

Up/Down Counters

The Up/Down Counters counts up each time an FM Remove Cycle control pulse is generated, and counts down each time an FM Add Cycle control pulse is generated. The Up/Down Counters are enabled to count when the DC FM instruction from the microprocessor U28 at pin 26 is low. FM is selected but DC FM is not selected. The enable input at pin 4 of U20 enables the counter to count on each clock from U15C.

The data inputs of the Up/Down Counters are connected to +5 Vdc except bit 10 at pin 1 of U32, and it is connected to ground. The input data is loaded into Up/Down Counters each time Frequency Modulation is selected. The DAC is set to 512, one-half of its maximum value of 1024. The FM OFF instruction from the Low Frequency Loop Microprocessor U28 at pin 27 is low when FM is selected. The low FM OFF instruction is one input to NOR gate U15A at pin 2. Its other input is connected to ground and the output goes high. The input data to the counter is loaded on the low to high transition of U15A's output.

FM Deviation DAC and Current-to-Voltage Converter

Ten output bits of the Up/Down Counters set the bits of the Phase Deviation DAC U16 to 512. The input to the DAC increases when the Counters are counted up for an FM Remove Cycle, and decreases when the Counters are counted down for an FM Add Cycle. The output current of the DAC changes as the bits are changed by the Counters. The output current of the DAC controls the output voltage of the Current-To-Voltage Converter U12 from -5V to +5V. When the Counters are loaded, the DAC is set at one half of its maximum value and the output voltage is approximately 0.0V. The Current-To-Voltage Converter's voltage output is input to Integrator U5 through the resistor network of R704, R726, and R734 as a current. The current input to the Integrator represents the net number of FM Remove Cycles and Add Cycles or the amount the phase of the Low Frequency Loop VCO has been shifted for Frequency Modulation. Each time a cycle is removed or added, 360 degrees of phase, one cycle, of the VCO's frequency divided-by-2 is removed or added by the Prescaler. The Up/Down Counters keeps track of the number of cycles that have been removed or added. The output of the DAC reconstructs the remove or add voltage step to the loop Integrator of Service Sheet 13.

Current Switches

For the duration of the 400 ns pulse, initiated by a Remove Cycle control pulse from the High Threshold Comparator U10 through the Remove Cycle D flip-flop U38B and generated by U25A and U31A/B, a precise positive current is applied to the Integrator U5 to reset its output voltage. The positive 400 ns pulse biases the base of Q11 at approximately +0.3V and the emitter is then approximately +1.0V. Diode CR706 is turned off and diode CR707 is turned on. The positive current from the Current Mirror, transistors Q20 and Q21, is directed through the Integrator. The Current Mirror changes the negative API 3 current to a positive current. When the 400 ns FM Reset Pulse is not active, the bias on the base of Q11 is approximately -1.3V and the emitter is approximately -0.6V. Diode CR706 is turned on and diode CR707 is turned off. The Current is directed through transistor Q11.

For the duration of the 400 ns pulse, initiated by a Add Cycle control pulse from the Low Threshold Comparator U11 through the Add Cycle D flip-flop U38A and generated by U25B and U37A/B, a precise negative current is applied to Integrator U5 to reset its output voltage. The negative 400 ns pulse biases the base of Q3 at approximately -0.3V, and the emitter is approximately -1.0V. Diode CR704 is turned off, and diode CR705 is turned on.

Negative API 2 current is directed through the Integrator. When the 400 ns FM reset pulse is not active, the bias on the base of Q3 is approximately +1.3V and the emitter voltage is approximately +0.6V. Diode CR704 is turned on and diode CR705 is turned off. API 2 current is directed through transistor Q3.

Integrator

When AC FM or DC FM is selected, switches U4C and D are closed. The frequency modulation signal is applied to the FM Summing Amplifier U33A (Service Sheet 14), and to Integrator U5. In a phase lock loop, frequency modulation within the loop bandwidth is canceled and phase modulation within the loop bandwidth is passed. Both properties are used in the Low Frequency Loop for flat frequency modulation by Integrator U5 converting the frequency modulation signal to phase modulation. The phase output of the Integrator is summed at the virtual +5V node of the Current Summing Amplifier U7 (refer to Service Sheet 12). Each Low Frequency Loop cycle, AC FM or DC FM selected and within the bandwidth of the Low Frequency Loop, the output of the Integrator is summed with the Bias Current and API Current to offset the VCO tune voltage phase modulating the VCO. All components of the modulation signal within the loop bandwidth phase modulate the VCO and all components outside the loop bandwidth frequency modulate the VCO. The result is continuous modulation.

The 400 ns pulses from the current switches directs a positive or negative current to reset the Integrator. The Integrator is reset during frequency modulation when its output voltage reaches the high or low threshold voltage. During the same Low Frequency Loop cycle the Integrator is reset, a cycle is removed or added by the Prescaler dependent upon the output voltage of the Integrator being at the high or low threshold. The Prescaler removes or adds a cycle, and the 400 ns of current resets the Integrator's output voltage to remove or add 2 cycles, 720 degrees, from the Low Frequency Loop VCO (one cycle, 360 degrees, of the VCO Divide-By-2 frequency added or removed at the Prescaler). The output of Integrator U5 is summed with the Bias and API currents at the virtual +5V node of the Current Summing Amplifier in-band modulation. The Low Frequency Loop Integrator (refer to Service Sheet 13), is offset by the current from U5 to compensate for the 2 cycles removed or added. The phase of the Low Frequency Loop VCO is continuous when cycles are removed or added for frequency modulation.

The Up/Down Counters and Phase Deviation DAC, U16 with resistors R704, R726 and R734 provide dc current feedback to Integrator U5. When DC FM is selected, the feedback circuits are disabled. The high DC FM input disables the Up/Down Counter U20 and opens switch U4A. The Integrator, Threshold Comparator's, Reset Timing, and current switches are still active. With the feedback resistors disabled, the Integrator has dc offset in the DC FM mode of operation.

TROUBLESHOOTING

Procedures for checking part of the A3 Low Frequency Loop Assembly circuits are shown below. The area or points to check are marked on the schematic by a hexagon with a check mark and a number inside, for example, $\checkmark 3$.

Troubleshooting Help

- Block Diagram 3
- Table 4-1. Abbreviated Performance Tests
- Table 5-2. Post-Repair Adjustments

Test Equipment

Oscilloscope	HP 54100A
Oscilloscope Active Probe, Chan 1	HP 54001A
Oscilloscope 1 Megohm Probe Pod, Chan 2	HP 54003A
Oscilloscope Probe Pod, Chan 3	HP 54002A
Oscilloscope Probe	HP 54003-61617A
Function Generator	HP 3312A

$\checkmark 1$ FM Digital Circuits, In-Band Analog

The FM Integrator and In-Band Analog circuits are checked for proper operation with the Low Frequency Loop locked.

1. Set the Signal Generator as follows:

Frequency	950 MHz
Amplitude	Any
Modulation	AC FM, 3 kHz
Source	EXT

2. Set the Oscilloscope as follows:

Chan 1	
Ch 1 Display	Off
Chan 2	
Ch 2 Mode	Normal
Ch 2 Display	On
VOLTS/DIV	1.0V
OFFSET	0.0V
Timebase	
SEC/DIV	2 ms
DELAY	0.0s
Delay Ref at	Left
Sweep	Trg'd

Trigger

Trigger Mode Edge
 Trig Src Chan 3
 TRIG LEVEL 50 mV
 Slope Pos

Display

Display Mode Normal
 DISPLAY TIME 200 ms
 Split Screen Off
 Graticle Grid

3. Set the Function Generator as follows:
 - a. Function to Square Wave
 - b. Frequency to 100 Hz
 - c. Output Level to 1 Vpk (HI and LO EXT LED's out)
 - d. Connect to Oscilloscope Chan 3, 54002A, input and MOD INPUT/OUTPUT.
4. Connect Chan 2 to TP3 (Φ M INPUT). Verify that the oscilloscope display shown in Figure 2 is correct. If the waveform is not correct continue with $\sqrt{2}$.

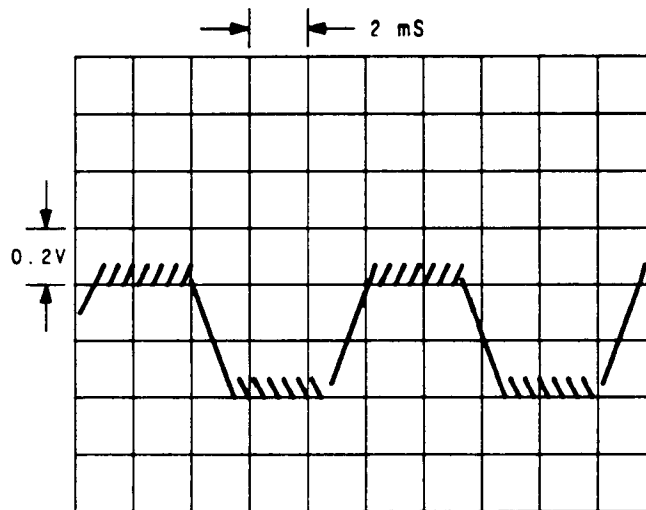


Figure 2. Oscilloscope display of TP3 (dc coupled), Signal Generator's frequency 950 MHz, modulation EXT FM 3 kHz deviation (100 Hz square wave).

$\sqrt{2}$ FM Control Gates and Switches

1. Set up the Signal Generator, oscilloscope, and function generator as shown in $\sqrt{1}$.
2. Check that the DC FM inputs at pin 4 of U20 and at pin 1 of U4A are low, and that switch U4A is closed.
3. Check that the FM OFF input at pin 2 of U15A is low, that the output at pin 1 of U15A is high, and that the output at pin 4 of U15B is low. Check that switch U4B is closed.
4. Check that the FM Enable inputs at pin 9 of U4C and pin 16 of U4D are low, and that switches U4C and U4D are closed.

√3 FM Reset Timing

1. Set up the Signal Generator, oscilloscope, and function generator as shown in **√1**.
2. Check for the 5 MHz Reference input at pin 3 of U31A, the Remove Cycle input at pin 3 of U25A, and the Add Cycle input at pin 11 of U25B.
3. Change the oscilloscope Sec/Div to 0.2 μ s. Check for the positive 400 ns Remove Cycle pulse at pin 9 of U31B, and the negative 400 ns Add Cycle pulse at pin 8 of U37B.
4. Check that the Set (pin 10), and Reset (pin 13) inputs to Up/Down Control U19B are gated low for 200 ns, and that the output at pin 8 is gated.
5. Check that the output of NOR gate U15C is gating to count the Counter U20 up or down.

√4 Up/Down Counters, Phase Deviation DAC, Current-To-Voltage Converter

1. Set-up the Signal Generator, oscilloscope, and function generator as shown in **√1**.
2. Change Chan 2 VOLTS/DIV setting to 100 mV.
3. Set the modulation on the Signal Generator to OFF.
4. Check the input to the Phase Deviation DAC U16. The input at pin 4 is low, and the inputs at pins 5 through 13 are high.
5. Check that the voltage at TP4 (OFFSET ZERO) is approximately 0.0V.
6. Set the Signal Generator as follows:
 - a. Modulation to FM, 99 kHz
 - b. Source to EXT
7. Verify that the oscilloscope displays the same waveform as shown in Figure 3.

√5 Current Switches

1. Set-up the Signal Generator and function generator as shown in **√1**.
2. Set the Oscilloscope as follows:

Chan 1

Ch 1 Display Off

Chan 2

Ch 2 Mode Normal
 Ch 2 Display On
 VOLTS/DIV 500 mV
 OFFSET 0.0V

Timebase

SEC/DIV 200 ns
 DELAY 0.0s
 Delay Ref at Left
 Sweep Trg'd

Trigger

Trigger Mode Edge
 Trig Src Chan 2
 TRIG LEVEL 50 mV
 Slope Pos

Display

Display Mode Normal
 DISPLAY TIME 200 ms
 Split Screen Off
 Graticle Grid

3. Connect Chan 2 to TP5 (POSITIVE CURRENT), select oscilloscope AUTO SCALE, and check for a 400 ns pulse from -1.5V to +0.3V.
4. Set the oscilloscope to trigger on negative slope. Connect Chan 2 to TP6 (NEGATIVE CURRENT), select oscilloscope AUTO SCALE, and check for a 400 ns pulse from +1.5V to -0.3V.
5. Connect Chan 2 between diodes CR706 and CR707. Verify that the oscilloscope displays the same waveform as shown in Figure 4.
6. Set the oscilloscope to trigger on negative slope. Connect Chan 2 between diodes CR704 and CR705. Verify that the oscilloscope displays the same waveform as shown in Figure 5.

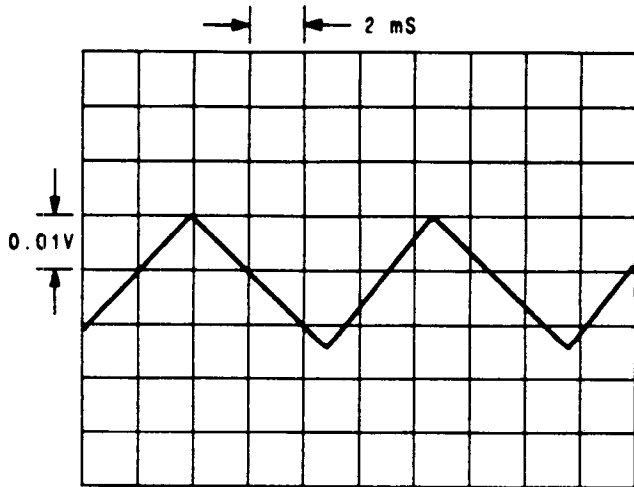


Figure 3. Oscilloscope display of TP4 (dc coupled), Signal Generator's frequency 950 MHz, modulation EXT FM 99 kHz (100 Hz square wave).

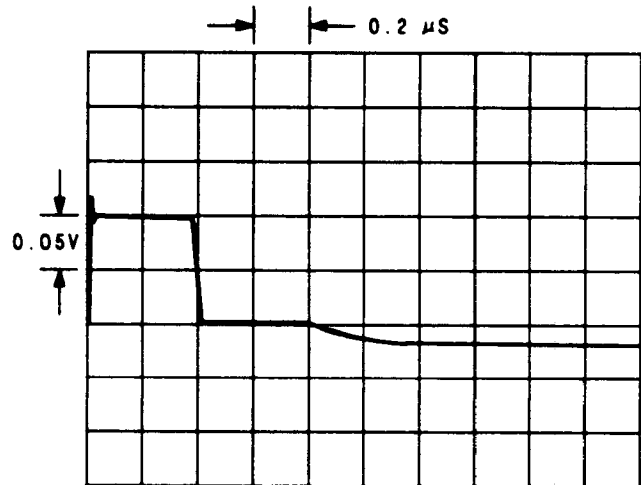


Figure 4. Oscilloscope Display between diodes CR706 and CR707 (dc coupled), Signal Generator's frequency is 950 MHz, modulation EXT FM 99 kHz deviation (100 Hz square wave).

√6 Integrator, High and Low Threshold Comparators

1. Set-up the Signal Generator, oscilloscope, and function generator as shown in √1 .
2. Connect Chan 2 to TP3 (ΦM INPUT), and verify that the waveform shown in Figure 6 is correct. Set Trig Src to Chan 3.

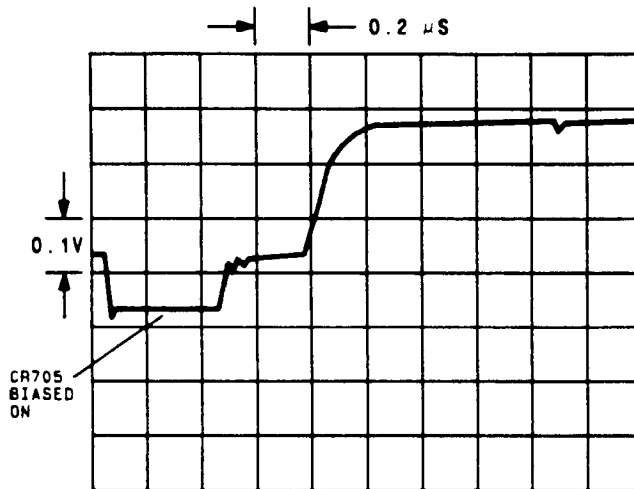


Figure 5. Oscilloscope Display between diodes CR704 and CR705 (dc coupled), Signal Generator's frequency is 950 kHz, modulation EXT FM 99 kHz (100 Hz square wave).

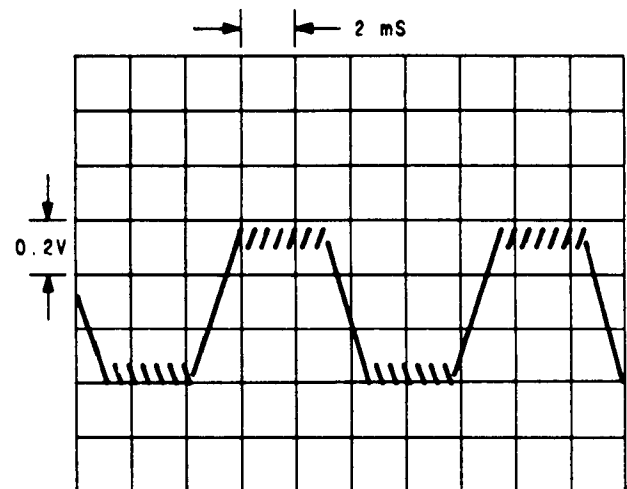


Figure 6. Oscilloscope Display of TP3 (dc coupled), Signal Generator's frequency is 950 MHz, modulation EXT FM 3 kHz deviation (100 Hz square wave).

3. Connect Chan 2 to TP8 (HIGH THRESHOLD). Sets of pulses from approximately 0.0V to approximately +4.5V should be displayed. Pulses are narrow.
4. Connect Chan 2 to TP9 (LOW THRESHOLD). Sets of pulses from approximately 0.0V to approximately +4.5V should be displayed.
5. Connect Chan 2 to TP3, and Chan 1 to pin 3 of U25A. Set the Chan 1 DISPLAY to On, its OFFSET to 4.0V, and its VOLTS/DIV to 2.0V.

There should be a Remove Cycle pulse for every high threshold reset of the Integrator.

6. Connect Chan 2 to TP3, and Chan 1 to pin 11 of U25B. There should be an Add cycle pulse for every low threshold reset of the Integrator.

NOTE

When using the digital oscilloscope, the narrow pulses appear not to be present on every sweep due to the sample rate.

A3 Component Coordinates (1 of 3)

COMP	X,Y	COMP	X,Y	COMP	X,Y	COMP	X,Y	COMP	X,Y	COMP	X,Y
C1	E,1	C213	C,1	C513	A,4	CR1	D,2	FL1	E,2	Q10	D,4
C2	D,2	C300	D,2	C514	A,3	CR2	D,2	FL2	E,2	Q11	D,4
C3	E,2	C301	C,3	C515	A,4	CR3	D,2	FL3	D,2	Q12	A,4
C4	D,2	C302	C,3	C516	A,3	CR4	D,2	FL4	D,2	Q13	B,4
C5	D,1	C303	D,3	C517	A,3	CR5	E,1			Q14	B,4
C6	D,2	C304	D,3	C518	B,3	CR6	D,1	J1	E,4	Q15	B,4
C7	D,1	C305	D,3	C519	A,3	CR7	D,2	J2	A,4	Q16	C,4
C8	D,1	C306	C,2	C520	A,3	CR8	D,2	J3	A,4	Q17	C,4
C9	D,2	C307	C,3	C521	A,3	CR9	E,1	J4	C,2	Q18	C,4
C10	D,2	C308	C,3	C600	B,3	CR10	D,1	J5	C,1	Q19	D,4
C11	E,1	C309	C,3	C601	B,3	CR11	D,1	J6	D,1	Q20	D,4
C12	D,1	C310	C,2	C602	B,3	CR12	D,1	J7	E,1	Q21	D,4
C13	D,2	C311	C,1	C603	B,3	CR15	E,1	J8	E,2	Q22	B,4
C14	D,2	C312	C,1	C604	B,3	CR16	D,1			Q23	C,4
C15	D,1	C313	C,2	C605	B,3	CR17	E,2	L1	E,2	Q24	C,4
C16	D,2	C400	B,3	C606	B,3	CR18	D,2	L2	D,2	Q25	C,4
C17	D,1	C401	D,4	C607	B,3	CR200	C,1	L3	E,2	Q26	B,4
C18	E,1	C402	C,4	C608	B,3	CR201	C,1	L5	E,2	Q27	B,4
C19	E,2	C403	C,3	C609	B,3	CR400	B,4	L6	E,2	Q28	C,4
C20	E,2	C404	B,4	C610	C,3	CR401	C,4	L8	D,2	Q29	A,4
C21	E,1	C405	C,3	C611	C,4	CR402	C,4	L200	E,4	Q30	A,4
C22	E,2	C406	C,4	C612	C,3	CR403	C,4	L201	E,4	Q31	A,4
C23	E,1	C407	C,4	C613	B,3	CR404	C,4	L202	E,4	Q32	A,4
C24	E,2	C408	B,3	C614	B,3	CR405	B,4	L203	E,4	Q33	B,4
C25	E,1	C409	B,4	C615	B,2	CR406	B,4	L204	C,1	Q34	A,3
C26	E,2	C410	C,4	C616	B,3	CR500	B,4	L300	C,1	Q35	B,3
C27	D,1	C411	B,4	C617	B,2	CR501	B,4	L400	B,4	Q36	B,3
C28	E,2	C412	C,4	C618	B,3	CR502	A,4	L401	D,4	Q37	A,3
C29	D,1	C413	B,4	C619	B,3	CR503	A,4	L402	C,3	Q38	A,3
C30	E,1	C414	B,4	C620	B,2	CR504	B,4	L403	C,3	Q39	A,3
C100	A,3	C415	B,4	C621	B,2	CR505	B,4	L404	C,4	Q40	A,3
C101	A,2	C416	B,4	C700	E,3	CR506	B,4	L500	B,4	Q41	A,3
C200	E,4	C500	A,4	C701	E,3	CR600	B,3	L501	A,4	Q42	A,3
C201	E,4	C501	A,4	C702	E,3	CR602	B,3	L502	A,4	Q43	A,3
C202	E,4	C502	B,4	C703	E,2	CR700	D,4	L503	A,4	Q44	A,3
C203	E,4	C503	A,4	C704	E,3	CR701	D,4			Q46	A,2
C204	B,1	C504	A,3	C705	E,4	CR702	D,4	Q1	A,4	Q47	C,1
C205	C,2	C505	B,4	C706	E,4	CR703	D,4	Q2	A,4	Q48	C,2
C206	C,1	C506	B,4	C707	D,4	CR704	D,4	Q3	D,4	Q49	D,1
C207	C,1	C507	A,4	C708	D,4	CR705	D,4	Q4	A,4	Q50	E,1
C208	C,1	C508	B,3	C709	D,4	CR706	D,4	Q5	B,4	Q51	C,1
C209	C,1	C509	B,3	C710	D,4	CR707	D,4	Q6	B,4	Q52	D,1
C210	C,1	C510	A,4	C711	D,4			Q7	B,4	Q53	D,1
C211	C,1	C511	B,3	C712	D,4			Q8	C,4	Q54	E,1
C212	C,1	C512	A,3	C713	E,4	DS500	A,3	Q9	C,4	Q55	E,1

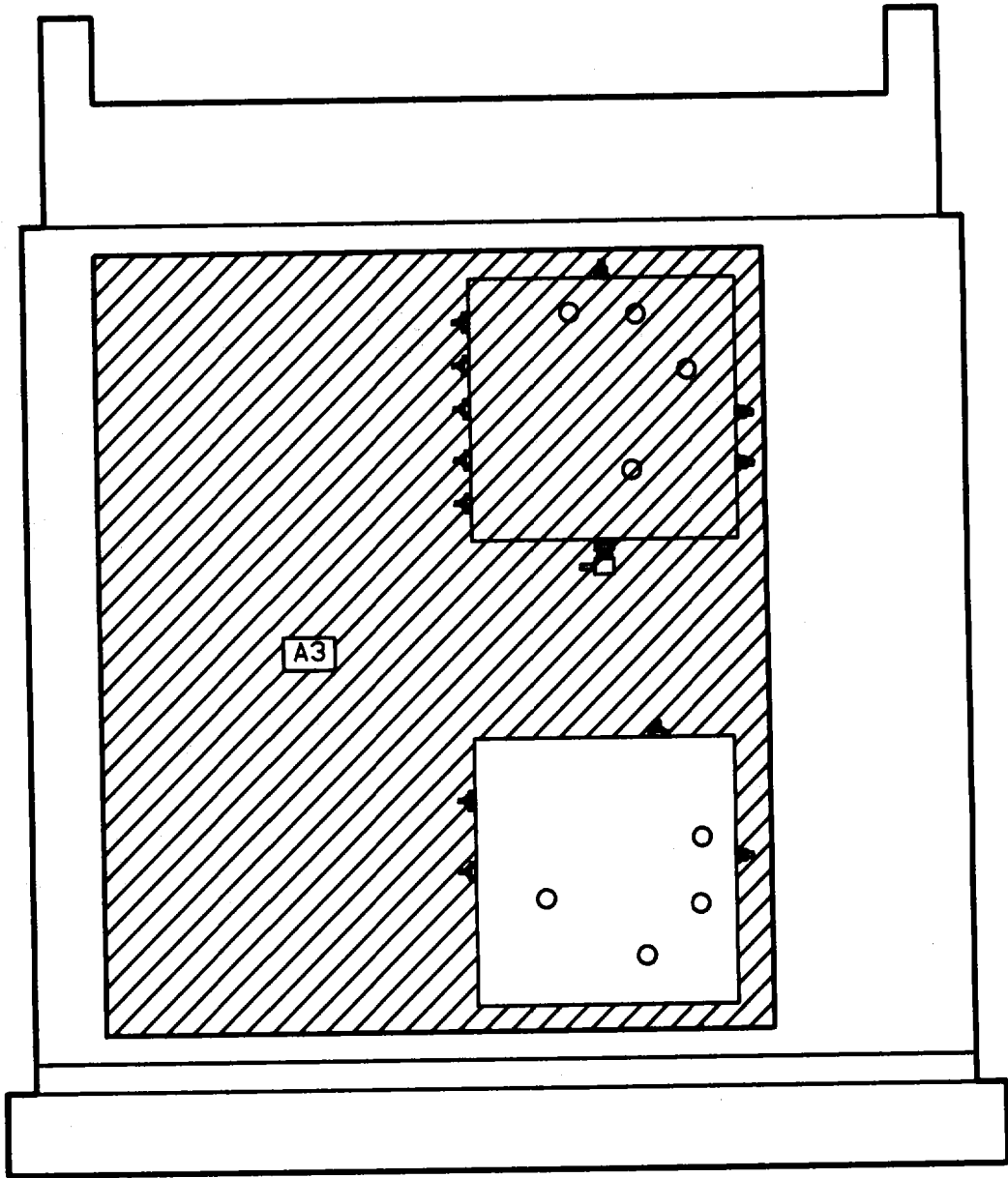
A3 Component Coordinates (2 of 3)

COMP	X,Y	COMP	X,Y	COMP	X,Y	COMP	X,Y	COMP	X,Y	COMP	X,Y
Q56	C,1	R207	C,1	R431	B,4	R523	A,4	R568	A,3	R719	D,4
		R208	C,1	R432	C,3	R524	A,4	R569	B,3	R720	E,4
R1	D,2	R209	B,1	R433	D,4	R525	A,3	R570	A,3	R721	D,4
R2	D,2	R210	C,1	R434	C,4	R526	A,4	R600	B,3	R722	D,4
R3	D,2	R211	C,1	R435	C,3	R527	A,3	R601	B,3	R723	D,4
R4	E,2	R300	C,3	R436	B,4	R528	A,3	R602	B,3	R724	D,4
R5	D,2	R301	C,3	R437	B,4	R529	A,4	R603	B,3	R725	D,4
R6	D,1	R302	C,3	R438	D,4	R530	A,4	R604	B,3	R726	D,4
R7	D,2	R303	C,3	R439	C,3	R531	A,3	R605	B,3	R727	D,4
R8	D,1	R304	C,3	R440	C,4	R532	B,3	R606	B,3	R728	D,4
R9	E,1	R305	C,2	R441	B,4	R533	A,4	R607	B,3	R729	D,4
R10	D,2	R306	D,2	R442	C,4	R534	A,3	R608	A,3	R731	D,4
R11	D,2	R307	C,1	R443	B,4	R535	A,3	R609	B,3	R732	C,4
R12	D,2	R308	C,1	R444	B,4	R536	A,4	R610	B,3	R733	D,4
R13	D,1	R400	C,4	R445	B,4	R537	A,4	R611	B,3	R734	D,4
R14	D,2	R401	C,4	R446	B,4	R538	A,3	R612	C,3	R735	C,4
R15	E,1	R402	B,4	R447	B,4	R539	A,3	R613	B,3	R736	D,4
R16	D,1	R403	B,4	R448	B,4	R540	A,4	R614	B,3	R737	C,4
R17	D,1	R404	B,4	R449	B,4	R541	A,3	R615	B,3	R738	D,4
R18	E,1	R405	B,4	R450	B,4	R542	A,3	R616	C,3	R740	D,4
R19	D,1	R406	C,4	R451	C,4	R543	A,4	R617	B,3	R741	E,4
R20	D,1	R407	C,4	R452	C,4	R544	A,3	R618	B,3		
R21	D,1	R408	C,4	R500	A,4	R545	A,4	R619	B,3	TP1	B,4
R22	D,1	R409	B,4	R501	A,4	R546	A,3	R620	B,3	TP2	A,4
R23	E,1	R410	C,4	R502	A,4	R547	A,4	R621	B,2	TP3	D,4
R24	E,1	R411	C,4	R503	A,4	R548	A,3	R622	B,3	TP4	D,4
R25	E,2	R412	B,4	R504	A,4	R549	A,3	R700	E,4	TP5	D,4
R26	E,2	R413	C,4	R505	A,4	R550	A,3	R701	E,4	TP6	D,4
R27	E,2	R414	B,4	R506	A,4	R551	A,3	R702	E,4	TP7	C,4
R28	D,2	R415	C,4	R507	A,4	R552	A,4	R703	E,4	TP8	D,4
R29	D,1	R416	C,4	R508	A,4	R553	A,3	R704	D,4	TP9	D,4
R30	D,1	R417	C,4	R509	A,4	R554	A,3	R705	E,4	TP10	B,3
R31	D,1	R418	C,4	R510	A,4	R555	A,3	R706	D,4	TP11	A,3
R32	D,1	R419	B,4	R511	A,4	R556	A,3	R707	B,4	TP12	A,3
R33	D,2	R420	B,4	R512	A,4	R557	A,3	R708	E,4	TP13	B,3
R100	A,2	R421	C,4	R513	A,4	R558	A,3	R709	D,4	TP14	B,3
R101	A,2	R422	C,4	R514	A,4	R559	A,3	R710	D,4	TP15	C,3
R104	A,2	R423	C,4	R515	A,4	R560	A,3	R711	D,4	TP16	C,3
R200	B,2	R424	C,4	R516	A,4	R561	A,3	R712	B,4	TP17	C,3
R201	C,1	R425	C,4	R517	A,4	R562	A,3	R713	D,4	TP18	D,3
R202	C,2	R426	C,4	R518	B,4	R563	A,3	R714	D,4	TP19	D,3
R203	C,2	R427	C,4	R519	A,4	R564	A,3	R715	D,4	TP20	C,3
R204	C,1	R428	C,4	R520	A,4	R565	B,3	R716	C,4	TP21	C,3
R205	C,1	R429	B,4	R521	A,3	R566	A,3	R717	D,4	TP22	A,3
R206	C,1	R430	C,3	R522	B,4	R567	A,3	R718	E,4	TP23	A,3

A3 Component Coordinates (3 of 3)

COMP	X,Y	COMP	X,Y	COMP	X,Y	COMP	X,Y	COMP	X,Y
TP24	C,3	U35	C,2						
TP25	C,3	U36	D,2						
TP26	C,2	U37	E,2						
TP27	C,2	U38	C,2						
TP28	C,2	U39	C,2						
TP29	C,2	U40	D,2						
TP30	C,1	U41	C,2						
TP31	C,1	U42	C,2						
TP32	D,1	U43	C,2						
TP33	E,1	U44	C,2						
		U45	D,2						
U1	A,4	U46	C,1						
U2	B,4	U47	C,1						
U3	C,4	U48	D,1						
U4	D,4	U49	C,1						
U5	D,4	U50	C,1						
U6	C,4	U51	C,1						
U7	B,4	U52	D,1						
U8	C,4	U53	E,1						
U9	A,4	U54	C,1						
U10	D,4	U55	C,1						
U11	D,4								
U12	E,3	VR300	C,3						
U13	B,3	VR400	B,4						
U14	B,3	VR401	C,4						
U15	E,3	VR500	A,3						
U16	E,3	VR601	B,3						
U17	C,3								
U18	D,3	W1	B,3						
U19	E,3	W2	C,3						
U20	E,3	W3	A,3						
U21	A,3	W4	B,3						
U22	B,3	W5	A,3						
U23	D,3	W6	A,2						
U24	D,3	W7	D,1						
U25	E,3	W8	C,1						
U26	E,3	W9	C,4						
U27	B,3	W10	C,4						
U28	C,3	W11	B,4						
U29	D,3								
U30	D,3	Y1	E,2						
U31	E,3	Y300	C,2						
U32	E,3								
U33	B,3								
U34	B,3								

TOP INTERNAL VIEW - LEVEL 1



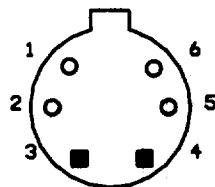
NOTES

1. For an explanation of schematic symbols, see "SCHEMATIC DIAGRAM NOTES" in Section 8.
2. Isolation (guard) trace.
3. Chassis ground is achieved by mechanical contact through nuts holding PC board to cover and W4.
4. Reference designations on this service sheet C, CR, Q, R and U have numbers ranging from 700 to 799 only.

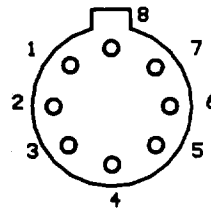
LOGIC LEVELS

	TTL	CMOS
HIGH	2V	3.5V
LOW	0.8V	1.5V
IS MORE NEG. THAN IS MORE POS. THAN		
OPEN	HIGH	UNDEF.
GROUND	LOW	LOW

A3Q21
TOP VIEW



A3U5, 10-12
TOP VIEW

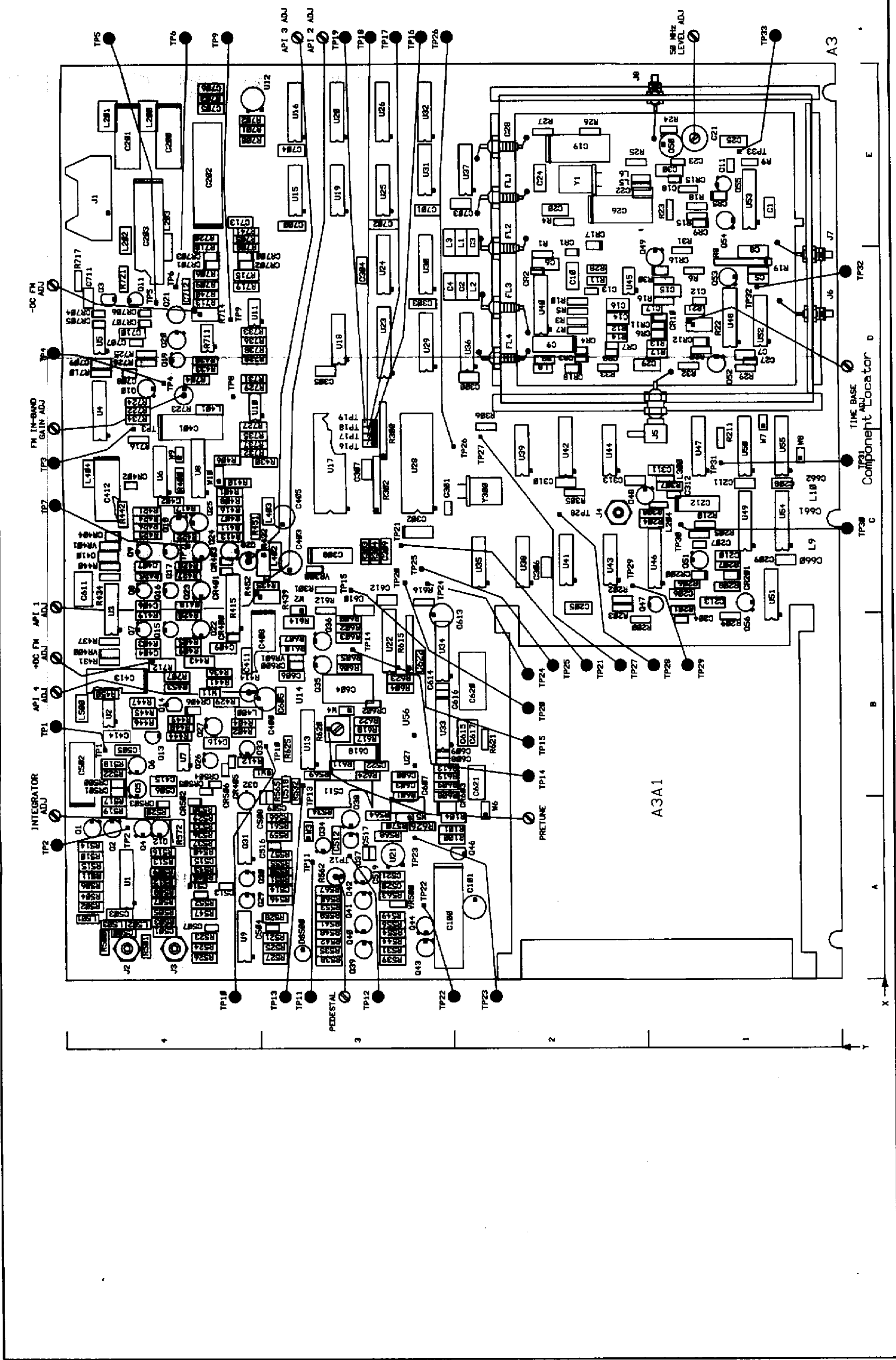


P/O A3

LOW FREQUENCY LOOP
IN-BAND FREQUENCY
MODULATION

SEE REVERSE SIDE

SS15



Component Locator

Figure 0. Service Sheet 16 Information

P/O A3 LOW FREQUENCY LOOP ASSEMBLY (BR657-50158)

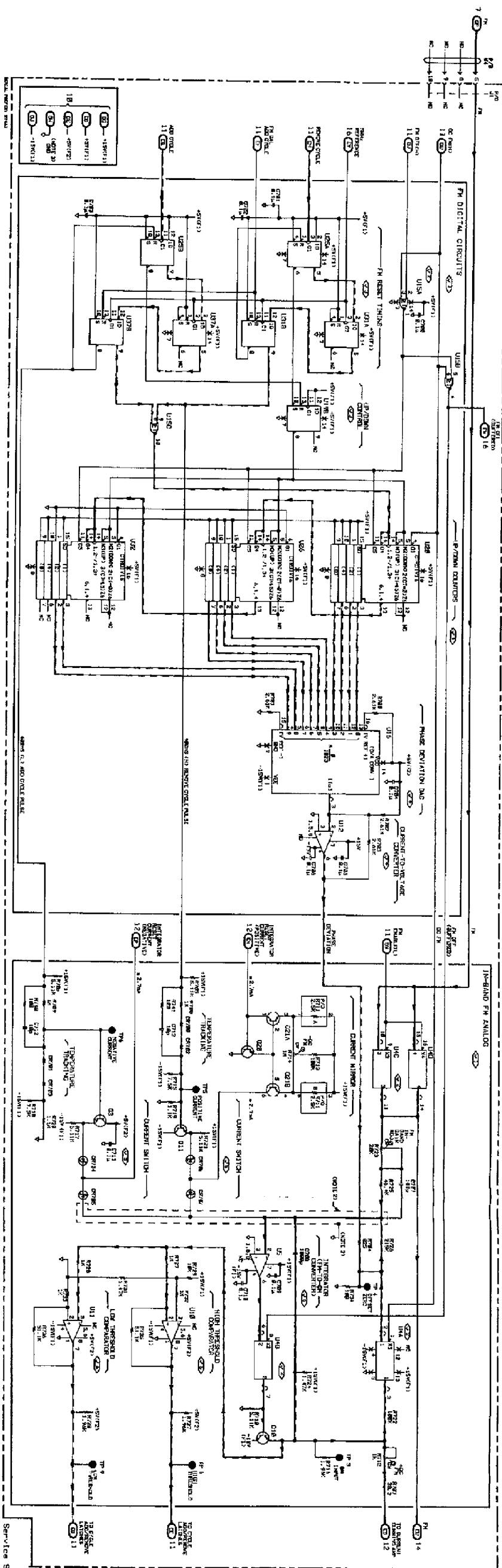


Figure 7
Service Sheet 15 15

Service Sheet 16

LOW FREQUENCY LOOP 50 MHZ REFERENCE OSCILLATOR, PHASE LOCK LOOP

PRINCIPLES OF OPERATION

50 MHz Reference Oscillator

The 50 MHz Reference Oscillator, Q50, is a common-base crystal controlled oscillator. The amount of positive feedback is predetermined by the taps on inductor L7. Inductor L7 is a spiral printed circuit board trace.

The base of Q50 is biased by resistor R24 at approximately 0 Vdc. The emitter is biased by resistors R25 and R26. Resistor R26 is connected to the -15 Vdc supply which biases on diodes CR13 and CR14. This closes the dc current path for the emitter current of Q50 and also closes the tank circuit. The tank circuit consists of the crystal Y1, varactor diode CR15, printed circuit board inductor L7, and capacitors C21 and C23. The output frequency can be adjusted by R22 (TIME BASE ADJ) which controls the voltage across the varactor diode CR15 thereby changing the capacitance of the tank circuit. This tune voltage is applied through resistors R21, R23 and RF chokes L5 and L6. The output level is peaked by capacitor C21 (50 MHZ LEVEL ADJ). Capacitors C18, C19, C20, C24, C25 and C26 are bypass capacitors.

Time Base Divider

The output of the 50 MHz Reference Oscillator is ac coupled by C30 to the Frequency Multiplier Assembly shown on Service Sheet 3. The output is also ac coupled by capacitor C11 to common-base Time Base Buffer Q55. The output of Q55 clocks the Divide-by-10 circuit U53 at pin 7. This divider is made up of a Divide-by-5 and a Divide-by-2 circuit. Note that the set inputs are all tied low. The output, 10 MHz at pin 4, is the 50 MHz Divide-by-5. The 10 MHz output at pin 4 clocks the Divide-by-2 circuit at pin 12, and its output is 5 MHz.

The 5 MHz outputs, at pins 14 and 15 of U53, clocks the ECL-To-TTL Converter transistors Q54 and Q53. Q54 converts the ECL logic levels to TTL logic levels and Q53 provides the current drive. The TTL output of Q53 clocks the Divide-By-5 circuit U48A and its output is 1 MHz at pin 6.

The 1 MHz output of U48A clocks the Divide-by-2 section of U48B and its 500 kHz output at pin 13 clocks the Divide-by-5 section. The output of U48B at pin 9 is 100 kHz.

One of the three divided output frequencies, 10, 5, or 1 MHz may be selected to phase lock the reference oscillator to an internal (Option 001) or external time base. The resistor jumper is shipped in the 10 MHz position and must be moved to the 5 or 1 MHz position depending upon the frequency of the external time base. The Time Base Output follows the frequency selected by the jumper.

The Time Base output is applied to pin 11 of exclusive-or gate U40C. Its other input is tied to +5 Vdc. The output from pin 14 is the input phase shifted 180 degrees. The signal is then detected by diode CR18 and ac coupled to the Time Base Output J4.

100 kHz Reference

The 100 kHz Reference output of U48B clocks the Synchronization D flip-flop U52A, and its output is synchronized with the 5 MHz output of Q53 by U52B. The Pulser circuit, capacitor C27 and transistor Q52, change the output of U52B to a narrow pulse.

5 MHz Switch

The 5 MHz switch transistor Q49 is controlled by the FM OFF input (refer to Service Sheet 15). When frequency modulation is not selected, the FM OFF input is high and Q49 is biased off. When frequency modulation is selected, the FM OFF input is low and Q49 is biased on and off by the 5 MHz input from Q53. The 5 MHz output at the emitter of Q49 clocks the FM Reset Timing D flip-flops (refer to Service Sheet 15).

Reference Phase Lock Circuit

The Time Base Input signal is ac coupled by C6 to resistor R1, and the positive and negative peak limiting diodes of CR1 and CR2. The input is then ac coupled by capacitor C10 to pin 7 of exclusive-or gate buffer U40B. The input goes to ac ground by resistors R2 and R3 and capacitor C9. The output is connected through the resistor R7 to the resistor P/O R8 and diode CR3. CR3 detects the Time Base Input signal, and applies the voltage to the positive input of External Reference Detector U45B. The positive input is increased so it is more positive than the negative input, and the output of U45B switches to +15 Vdc, detecting the presence of a Time Base Input. When the output of U45B switches to +15 Vdc the phase lock operational amplifier U45A is activated by turning off diode CR6 and turning on diode CR11. The inputs of comparator U45B are connected to U40B pin 3, the exclusive-or gate output. Diode CR4 temperature compensates CR3.

The Time Base Input signal from U40B pin 3 is connected to U40A pin 4. The other input, pin 5, is the divided output of the 50 MHz Reference Oscillator. The signal is divided to 10, 5 or 1 MHz depending on the Time Base Input frequency and the subsequent jumper placement. This exclusive-or gate serves as a phase detector with its change in output voltage being proportional to the phase difference of the two inputs. The output is coupled to the 50 MHz Reference Oscillator which serves to phase lock the oscillator to the Time Base Input signal. The correction voltage to U45A is amplified and applied to the oscillator tank circuit through diode CR10. CR10 is turned on when comparator U45B turns CR6 off, and the negative input of U45B changes to approximately +3V. The positive input is fixed and the output goes from +15 Vdc to approximately -7V. CR10 is turned on as are diodes CR7 and CR8 when the phase difference is large enough. Resistor R14 is bypassed which moves the reference oscillator to the correct frequency.

TROUBLESHOOTING

Procedures for checking part of the A3 Low Frequency Loop Assembly circuits are given below. The area or points to check are marked on the schematic by a hexagon with a check mark and a number inside, for example, $\checkmark 3$. Fixed voltages are shown on the schematic inside a hexagon, for example, $2V \pm 0.2V$. Transistor bias voltages are shown without tolerances.

Troubleshooting Help

- Block Diagram 3
- Table 4-1. Abbreviated Performance Tests
- Table 5-2. Post-Repair Adjustments

Test Equipment

- Digital Multimeter HP 3466A
- Oscilloscope HP 54100A
- Oscilloscope Active Probe, Chan 1 HP 54001A

$\checkmark 1$ Reference Phase Lock Circuit

Measure the voltage shown in Table 1. With an external reference oscillator connected to the Time Base Input or with the internal reference oscillator installed, the 50 MHz oscillator should be phase locked.

Table 1. Crystal Phase Lock Circuit Voltages.

Operating Mode		Voltages (dc and ac) on									
		U40-Pin				U45B-Pin			U45A-Pin		
		7	5	2	3	5	6	7	3	2	1
Phase Locked	Vdc	+3.8	+3.8	+3.8	+4.0	+4.0	+3.7	+13	+4	+4	-10
	Vpk	0.4	0.4	0.4	0.4	0.01	0.01	0.01	0.08	0	0.02
Not Phase Locked	Vdc	+3.8	+3.8	+3.8	+3.8	+3.5	+3.7	-13	+4	+3	+14
	Vpk	0.02	0.4	0.2	0.05	0.01	0.01	0.005	0.02	0	0.008

$\checkmark 2$ 50 MHz Reference Oscillator

1. Verify that Q50's bias voltages are correct.
2. Measure the oscillator output at TP33 (50 MHz).

$\checkmark 3$ Time Base Dividers

1. Measure the TIME BASE OUTPUT signals at J7.
2. Measure the 5 MHz signal at pin 15 of U53.
3. Measure the 5 MHz signal at pin 14 of U53 and at TP32.
4. Measure the 1 MHz signal at pin 6 of U48A.
5. Measure the 500 kHz signal at pin 13 of U48B.
6. Measure the 100 kHz signal at pin 9 of U48B.

√4 100 kHz Reference

1. Check the 100 kHz signal at pin 5 of U52A, and at pin 9 of U52B.
2. Check the 100 kHz output pulse of Q52 at J5. The pulse is narrow and approximately 1.5 Vpk.

√5 5 MHz Switch

1. Select Frequency Modulation at the Signal Generator's front-panel and check for a low FM OFF input to FL4.
2. Check that transistor Q49 is biased on.
3. Measure for a 5 MHz signal at feedthrough capacitor C28.

NOTE

A residual FM problem at the RF output may be due to residual FM from the 50 MHz Reference Oscillator. Measuring residual FM of the Reference Oscillator using the test setup found in Section 4 may be inconclusive. The residual FM of the measuring instrument (HP 8902A Measuring Receiver) is normally greater than that of a Reference Oscillator that is operating properly. All connectors to the 50 MHz Oscillator must be tight to prevent noise on the 50 MHz signal.

A3 Component Coordinates (1 of 3)

COMP	X,Y	COMP	X,Y	COMP	X,Y	COMP	X,Y	COMP	X,Y	COMP	X,Y
C1	E,1	C213	C,1	C513	A,4	CR1	D,2	FL1	E,2	Q10	D,4
C2	D,2	C300	D,2	C514	A,3	CR2	D,2	FL2	E,2	Q11	D,4
C3	E,2	C301	C,3	C515	A,4	CR3	D,2	FL3	D,2	Q12	A,4
C4	D,2	C302	C,3	C516	A,3	CR4	D,2	FL4	D,2	Q13	B,4
C5	D,1	C303	D,3	C517	A,3	CR5	E,1			Q14	B,4
C6	D,2	C304	D,3	C518	B,3	CR6	D,1	J1	E,4	Q15	B,4
C7	D,1	C305	D,3	C519	A,3	CR7	D,2	J2	A,4	Q16	C,4
C8	D,1	C306	C,2	C520	A,3	CR8	D,2	J3	A,4	Q17	C,4
C9	D,2	C307	C,3	C521	A,3	CR9	E,1	J4	C,2	Q18	C,4
C10	D,2	C308	C,3	C600	B,3	CR10	D,1	J5	C,1	Q19	D,4
C11	E,1	C309	C,3	C601	B,3	CR11	D,1	J6	D,1	Q20	D,4
C12	D,1	C310	C,2	C602	B,3	CR12	D,1	J7	E,1	Q21	D,4
C13	D,2	C311	C,1	C603	B,3	CR15	E,1	J8	E,2	Q22	B,4
C14	D,2	C312	C,1	C604	B,3	CR16	D,1			Q23	C,4
C15	D,1	C313	C,2	C605	B,3	CR17	E,2	L1	E,2	Q24	C,4
C16	D,2	C400	B,3	C606	B,3	CR18	D,2	L2	D,2	Q25	C,4
C17	D,1	C401	D,4	C607	B,3	CR200	C,1	L3	E,2	Q26	B,4
C18	E,1	C402	C,4	C608	B,3	CR201	C,1	L5	E,2	Q27	B,4
C19	E,2	C403	C,3	C609	B,3	CR400	B,4	L6	E,2	Q28	C,4
C20	E,2	C404	B,4	C610	C,3	CR401	C,4	L8	D,2	Q29	A,4
C21	E,1	C405	C,3	C611	C,4	CR402	C,4	L200	E,4	Q30	A,4
C22	E,2	C406	C,4	C612	C,3	CR403	C,4	L201	E,4	Q31	A,4
C23	E,1	C407	C,4	C613	B,3	CR404	C,4	L202	E,4	Q32	A,4
C24	E,2	C408	B,3	C614	B,3	CR405	B,4	L203	E,4	Q33	B,4
C25	E,1	C409	B,4	C615	B,2	CR406	B,4	L204	C,1	Q34	A,3
C26	E,2	C410	C,4	C616	B,3	CR500	B,4	L300	C,1	Q35	B,3
C27	D,1	C411	B,4	C617	B,2	CR501	B,4	L400	B,4	Q36	B,3
C28	E,2	C412	C,4	C618	B,3	CR502	A,4	L401	D,4	Q37	A,3
C29	D,1	C413	B,4	C619	B,3	CR503	A,4	L402	C,3	Q38	A,3
C30	E,1	C414	B,4	C620	B,2	CR504	B,4	L403	C,3	Q39	A,3
C100	A,3	C415	B,4	C621	B,2	CR505	B,4	L404	C,4	Q40	A,3
C101	A,2	C416	B,4	C700	E,3	CR506	B,4	L500	B,4	Q41	A,3
C200	E,4	C500	A,4	C701	E,3	CR600	B,3	L501	A,4	Q42	A,3
C201	E,4	C501	A,4	C702	E,3	CR602	B,3	L502	A,4	Q43	A,3
C202	E,4	C502	B,4	C703	E,2	CR700	D,4	L503	A,4	Q44	A,3
C203	E,4	C503	A,4	C704	E,3	CR701	D,4			Q46	A,2
C204	B,1	C504	A,3	C705	E,4	CR702	D,4	Q1	A,4	Q47	C,1
C205	C,2	C505	B,4	C706	E,4	CR703	D,4	Q2	A,4	Q48	C,2
C206	C,1	C506	B,4	C707	D,4	CR704	D,4	Q3	D,4	Q49	D,1
C207	C,1	C507	A,4	C708	D,4	CR705	D,4	Q4	A,4	Q50	E,1
C208	C,1	C508	B,3	C709	D,4	CR706	D,4	Q5	B,4	Q51	C,1
C209	C,1	C509	B,3	C710	D,4	CR707	D,4	Q6	B,4	Q52	D,1
C210	C,1	C510	A,4	C711	D,4			Q7	B,4	Q53	D,1
C211	C,1	C511	B,3	C712	D,4			Q8	C,4	Q54	E,1
C212	C,1	C512	A,3	C713	E,4	DS500	A,3	Q9	C,4	Q55	E,1

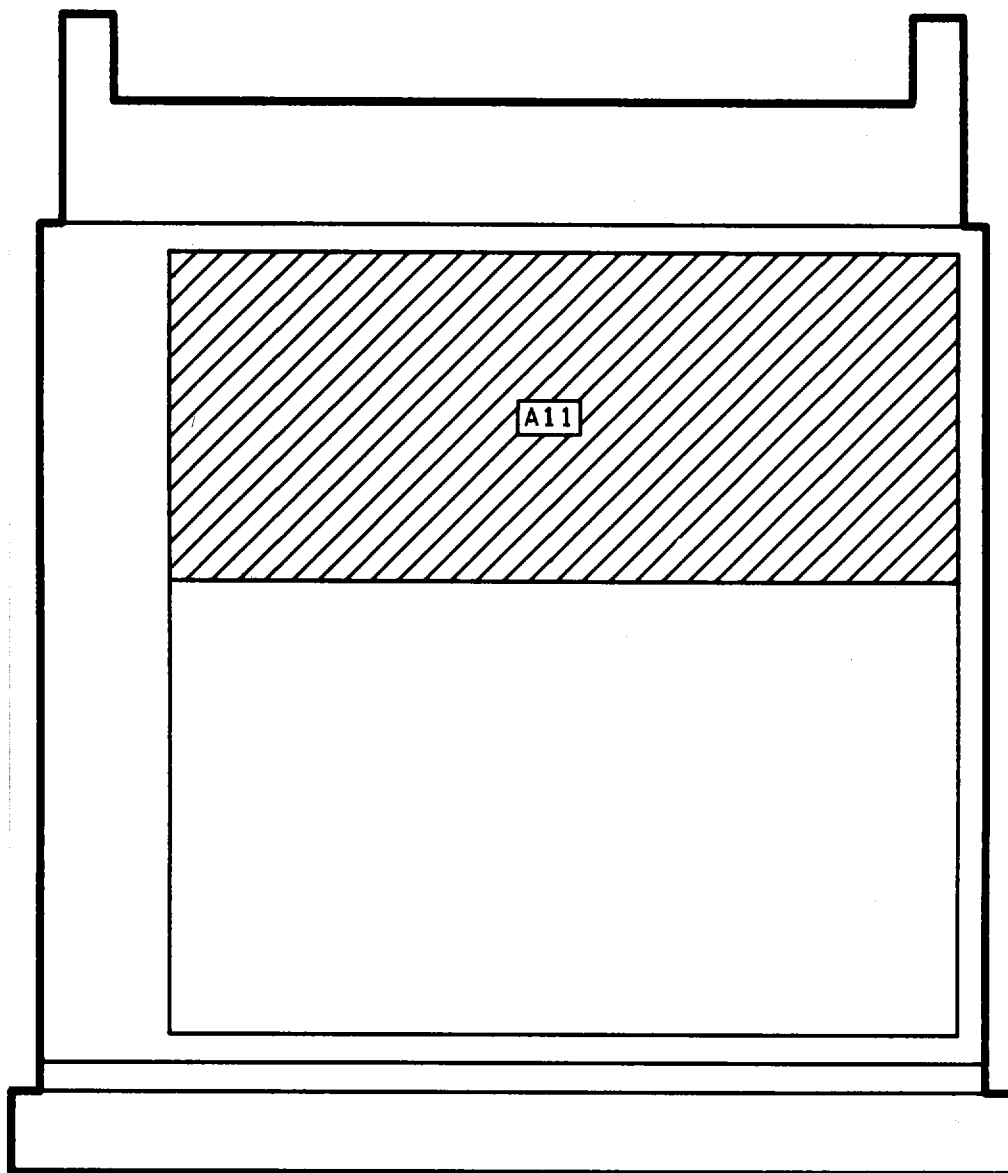
A3 Component Coordinates (2 of 3)

COMP	X,Y	COMP	X,Y	COMP	X,Y	COMP	X,Y	COMP	X,Y	COMP	X,Y
Q56	C,1	R207	C,1	R431	B,4	R523	A,4	R568	A,3	R719	D,4
		R208	C,1	R432	C,3	R524	A,4	R569	B,3	R720	E,4
R1	D,2	R209	B,1	R433	D,4	R525	A,3	R570	A,3	R721	D,4
R2	D,2	R210	C,1	R434	C,4	R526	A,4	R600	B,3	R722	D,4
R3	D,2	R211	C,1	R435	C,3	R527	A,3	R601	B,3	R723	D,4
R4	E,2	R300	C,3	R436	B,4	R528	A,3	R602	B,3	R724	D,4
R5	D,2	R301	C,3	R437	B,4	R529	A,4	R603	B,3	R725	D,4
R6	D,1	R302	C,3	R438	D,4	R530	A,4	R604	B,3	R726	D,4
R7	D,2	R303	C,3	R439	C,3	R531	A,3	R605	B,3	R727	D,4
R8	D,1	R304	C,3	R440	C,4	R532	B,3	R606	B,3	R728	D,4
R9	E,1	R305	C,2	R441	B,4	R533	A,4	R607	B,3	R729	D,4
R10	D,2	R306	D,2	R442	C,4	R534	A,3	R608	A,3	R731	D,4
R11	D,2	R307	C,1	R443	B,4	R535	A,3	R609	B,3	R732	C,4
R12	D,2	R308	C,1	R444	B,4	R536	A,4	R610	B,3	R733	D,4
R13	D,1	R400	C,4	R445	B,4	R537	A,4	R611	B,3	R734	D,4
R14	D,2	R401	C,4	R446	B,4	R538	A,3	R612	C,3	R735	C,4
R15	E,1	R402	B,4	R447	B,4	R539	A,3	R613	B,3	R736	D,4
R16	D,1	R403	B,4	R448	B,4	R540	A,4	R614	B,3	R737	C,4
R17	D,1	R404	B,4	R449	B,4	R541	A,3	R615	B,3	R738	D,4
R18	E,1	R405	B,4	R450	B,4	R542	A,3	R616	C,3	R740	D,4
R19	D,1	R406	C,4	R451	C,4	R543	A,4	R617	B,3	R741	E,4
R20	D,1	R407	C,4	R452	C,4	R544	A,3	R618	B,3		
R21	D,1	R408	C,4	R500	A,4	R545	A,4	R619	B,3	TP1	B,4
R22	D,1	R409	B,4	R501	A,4	R546	A,3	R620	B,3	TP2	A,4
R23	E,1	R410	C,4	R502	A,4	R547	A,4	R621	B,2	TP3	D,4
R24	E,1	R411	C,4	R503	A,4	R548	A,3	R622	B,3	TP4	D,4
R25	E,2	R412	B,4	R504	A,4	R549	A,3	R700	E,4	TP5	D,4
R26	E,2	R413	C,4	R505	A,4	R550	A,3	R701	E,4	TP6	D,4
R27	E,2	R414	B,4	R506	A,4	R551	A,3	R702	E,4	TP7	C,4
R28	D,2	R415	C,4	R507	A,4	R552	A,4	R703	E,4	TP8	D,4
R29	D,1	R416	C,4	R508	A,4	R553	A,3	R704	D,4	TP9	D,4
R30	D,1	R417	C,4	R509	A,4	R554	A,3	R705	E,4	TP10	B,3
R31	D,1	R418	C,4	R510	A,4	R555	A,3	R706	D,4	TP11	A,3
R32	D,1	R419	B,4	R511	A,4	R556	A,3	R707	B,4	TP12	A,3
R33	D,2	R420	B,4	R512	A,4	R557	A,3	R708	E,4	TP13	B,3
R100	A,2	R421	C,4	R513	A,4	R558	A,3	R709	D,4	TP14	B,3
R101	A,2	R422	C,4	R514	A,4	R559	A,3	R710	D,4	TP15	C,3
R104	A,2	R423	C,4	R515	A,4	R560	A,3	R711	D,4	TP16	C,3
R200	B,2	R424	C,4	R516	A,4	R561	A,3	R712	B,4	TP17	C,3
R201	C,1	R425	C,4	R517	A,4	R562	A,3	R713	D,4	TP18	D,3
R202	C,2	R426	C,4	R518	B,4	R563	A,3	R714	D,4	TP19	D,3
R203	C,2	R427	C,4	R519	A,4	R564	A,3	R715	D,4	TP20	C,3
R204	C,1	R428	C,4	R520	A,4	R565	B,3	R716	C,4	TP21	C,3
R205	C,1	R429	B,4	R521	A,3	R566	A,3	R717	D,4	TP22	A,3
R206	C,1	R430	C,3	R522	B,4	R567	A,3	R718	E,4	TP23	A,3


A3 Component Coordinates (3 of 3)

COMP	X,Y	COMP	X,Y	COMP	X,Y	COMP	X,Y	COMP	X,Y
TP24	C.3	U35	C.2						
TP25	C.3	U36	D.2						
TP26	C.2	U37	E.2						
TP27	C.2	U38	C.2						
TP28	C.2	U39	C.2						
TP29	C.2	U40	D.2						
TP30	C.1	U41	C.2						
TP31	C.1	U42	C.2						
TP32	D.1	U43	C.2						
TP33	E.1	U44	C.2						
		U45	D.2						
U1	A.4	U46	C.1						
U2	B.4	U47	C.1						
U3	C.4	U48	D.1						
U4	D.4	U49	C.1						
U5	D.4	U50	C.1						
U6	C.4	U51	C.1						
U7	B.4	U52	D.1						
U8	C.4	U53	E.1						
U9	A.4	U54	C.1						
U10	D.4	U55	C.1						
U11	D.4								
U12	E.3	VR300	C.3						
U13	B.3	VR400	B.4						
U14	B.3	VR401	C.4						
U15	E.3	VR500	A.3						
U16	E.3	VR601	B.3						
U17	C.3								
U18	D.3	W1	B.3						
U19	E.3	W2	C.3						
U20	E.3	W3	A.3						
U21	A.3	W4	B.3						
U22	B.3	W5	A.3						
U23	D.3	W6	A.2						
U24	D.3	W7	D.1						
U25	E.3	W8	C.1						
U26	E.3	W9	C.4						
U27	B.3	W10	C.4						
U28	C.3	W11	B.4						
U29	D.3								
U30	D.3	Y1	E.2						
U31	E.3	Y300	C.2						
U32	E.3								
U33	B.3								
U34	B.3								

BOTTOM INTERNAL VIEW - LEVEL 4



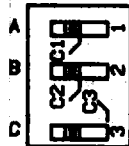
NOTES

1. For an explanation of schematic symbols, see "SCHEMATIC DIAGRAM NOTES" in Section 8.
2. Chassis ground is achieved by A11J4-1 connection and mechanical contact through nuts holding PC board to cover.
3. Address data is transferred positive true from the microprocessor on the uni-directional address bus.
4. Data is transferred positive true to and from the microprocessor on the bi-directional data bus.
5. Chassis ground is represented by 
6. Feedthru capacitor is part of W16P2, W16P3 or W19P1 and is not separately replaceable.

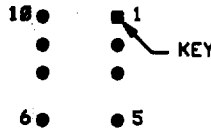
LOGIC LEVELS

	TTL
HIGH	2V
LOW	0.8V
IS MORE NEG. THAN IS MORE POS. THAN	
OPEN	HIGH
GROUND	LOW

A11S1
TOP VIEW

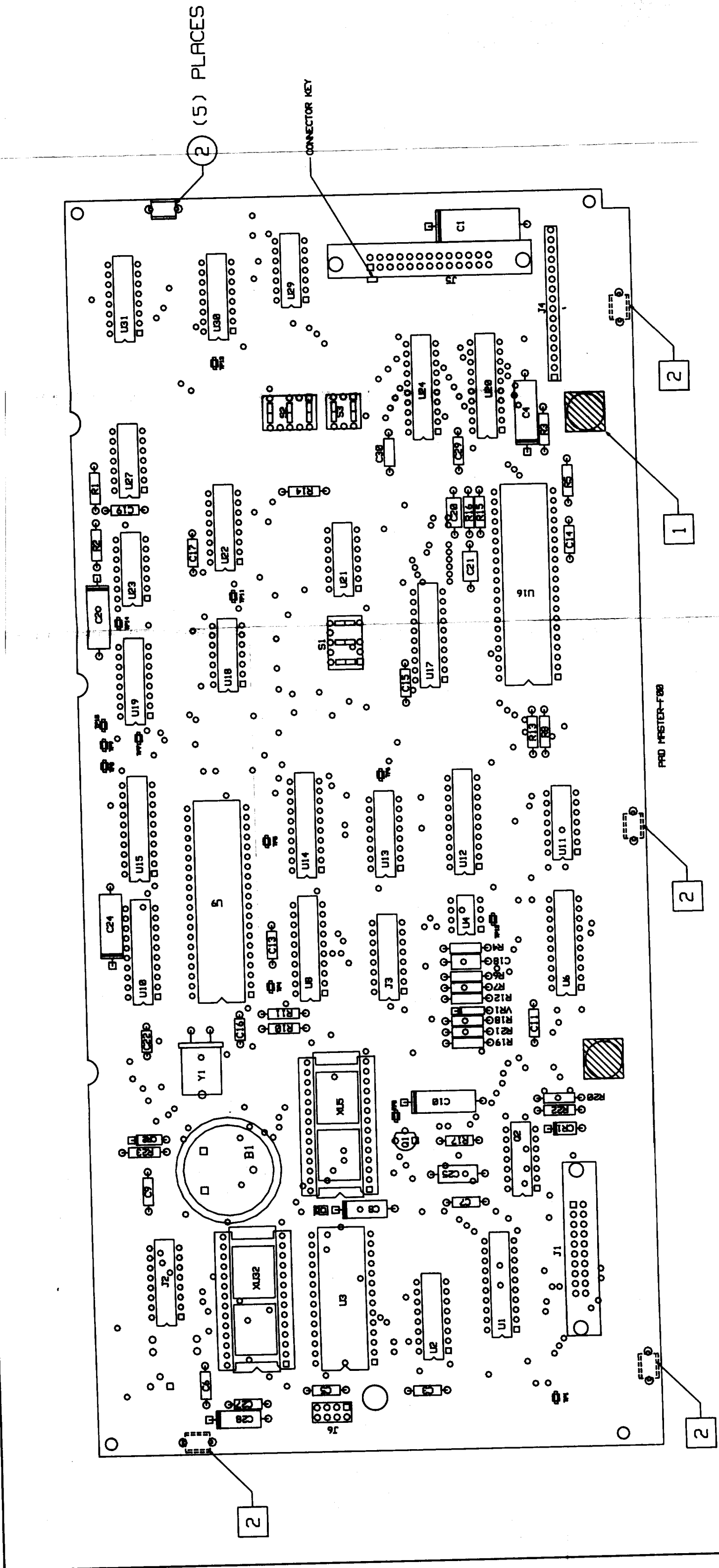


CIRCUIT
BOARD
TOP VIEW



P/O A3, LOW FREQUENCY LOOP
 P/O A16, 50 MHz REFERENCE
 P/O A16, OSCILLATOR AND
 SEE REVERSE SIDE PHASE LOCK LOOP

SS16



Component Locator

Figure 0. Service Sheet 17 Information

P/O A3 LOW FREQUENCY LOOP ASSEMBLY (08657-6015B)

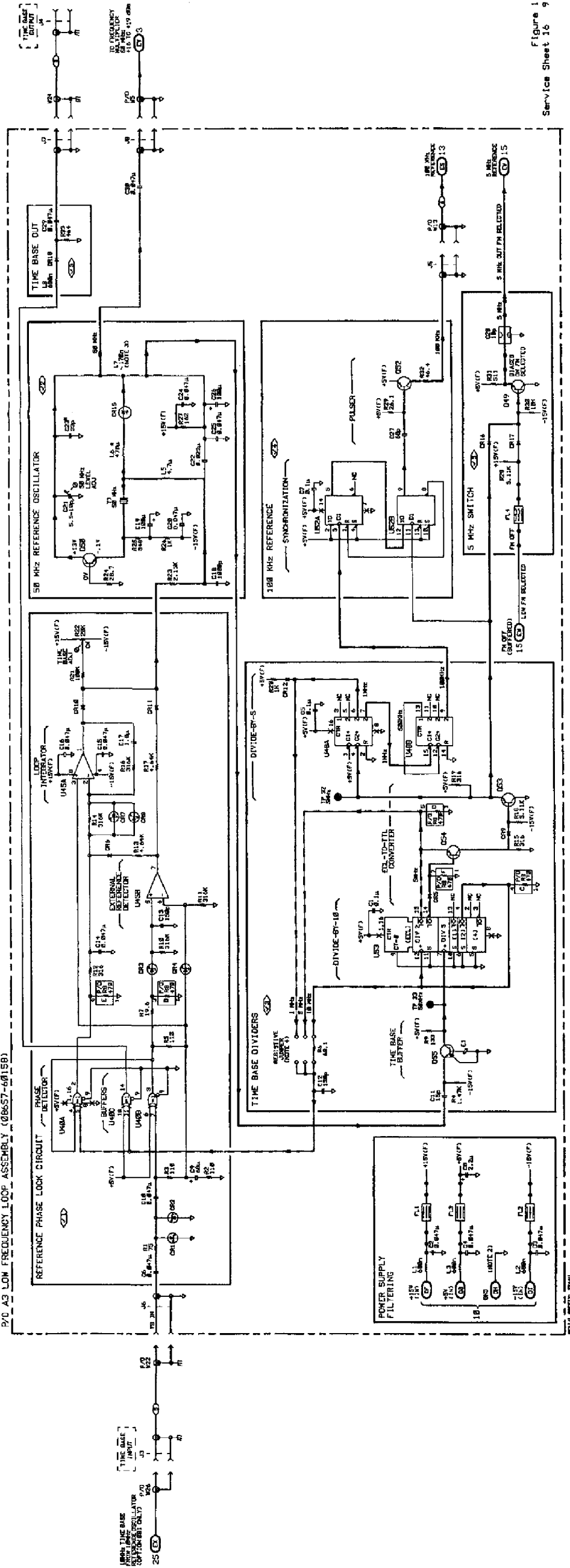


Figure 1
Service Sheet 16 9

Service Sheet 17

MICROPROCESSOR INTERRUPT PROCESSING, AND RESTART

PRINCIPLES OF OPERATION

Microprocessor

Instrument functions are controlled by the Microprocessor U9 as it executes the program instructions stored in ROM (read only memory). The function of the Microprocessor's data bus, address bus, and each of its input/output lines is discussed in the following paragraphs:

Data Bus

The data bus (D0 through D7) consists of 8 bi-directional data lines which transfer 8-bit, positive-true data bytes to and from the Microprocessor (pins 26 through 33). The 3-state lines can be high, low, or at the high impedance state depending on the individual data bit or its buffering conditions. The Microprocessor reads data from memory, the keyboard, the HP-IB interface, etc., via the data bus under the control of its monitor program. Data is written onto the data bus for the displays, RF and modulation circuitry, etc. Information on the data bus is buffered as it enters or exits the Microprocessor. For additional information, refer to the discussion on Data Bus Buffering that follows.

Read/Write Control

The Read/Write signal from the Microprocessor (R(H)/W(L) at pin 34) controls the direction of data transfer on the data bus. When the Microprocessor is halted or available to accept data, this signal is high (indicating that the Microprocessor is in the "read" state). When data is being transferred out onto the data bus, this signal is low (indicating that the Microprocessor is in the "write" state). This signal is buffered by one of the Microprocessor Control Line Buffers in U13A. The buffered Read/Write signal controls the direction of data transfer: through the Data Bus Buffers in U10, to or from RAM memory (refer to Service Sheet 19), and to or from the HP-IB Interface Buffers in U12 (refer to Service Sheet 20).

Address Bus

The address bus (A0 through A15) consists of 16 unidirectional lines which transfer a 16-bit, positive-true address from the Microprocessor (pins 9 through 20 and 22 through 25). After exiting the Microprocessor, information on the address bus is buffered and decoded to produce control strobes for level, modulation, attenuation, and serial I/O data (refer to Service Sheet 18). These buffered address bits are also decoded to select RAM, or ROM memory locations (refer to Service Sheet 19) or one of the HP-IB General Purpose Interface Adapter U16 ports (refer to Service Sheet 20).

Valid Memory Address

The Microprocessor's Valid Memory Address signal (VMA at pin 5) indicates that data on the address lines is valid. Data is valid when VMA is active (high). VMA is buffered by U13A to enable decoding of level and modulation, attenuator, and serial I/O control strobes (refer to Service Sheet 18), and decoding and selection of ROM and RAM memory locations (refer to Service Sheet 19).

System Clock

An external 4 MHz crystal Y1 is directly connected to the Microprocessor (pins 38 and 39). The Microprocessor's internal divide-by-4 circuit develops the 1 MHz system clock E (pin 37). Capacitors C16 and C22 are used to keep the clock frequency stable.

Memory Ready

The Microprocessor's Memory Ready input (MR at pin 3) is tied to +5V to enable the 1 MHz system-clock rate.

RAM Enable

The Microprocessor's RAM Enable input (RE at pin 36) is tied to ground, to disable the internal RAM.

Halt

The Microprocessor's Halt input (HALT at pin 2) is tied to +5V to disable the input.

Reset

The Microprocessor's Reset input (RESET at pin 40) starts the Microprocessor from a power-down condition. This condition exists during initial start-up of the instrument, after a power failure or power supply glitch has occurred, and when the RESET Test Point 12 is momentarily connected to ground. When RESET is active (low), the Microprocessor becomes inactive. When RESET is inactive (high), the internal program counter is loaded with the contents of hexadecimal memory locations FFFE and FFFF. These contents direct program execution to the power-up subroutine. For additional information on the control of this input, refer to the discussion on Restart Circuitry that follows.

Non-Maskable Interrupt

The Microprocessor's Non-Maskable Interrupt input (NMI at pin 6) interrupts program execution. When NMI is active (low), the Microprocessor finishes executing its current instruction, and saves its current status. Then the Microprocessor's internal program counter is loaded with the contents of hexadecimal memory locations FFFC and FFFD. These contents direct program execution to the non-maskable interrupt subroutine. For this Signal Generator, the non-maskable interrupt is used to invoke the Signal Generator's signature analysis subroutine. For additional information on the control of this input, refer to the discussion on Interrupt Processing that follows.

Maskable Interrupt Request

The Microprocessor's Maskable Interrupt Request input (IRQ at pin 4) will also interrupt program execution. When IRQ is active (low), and the interrupt mask bit of the internal condition code register is not set, the Microprocessor finishes executing its current instruction. Then its internal program counter is loaded with the contents of hexadecimal memory locations FFF8 and FFF9. These contents direct program execution to the maskable-interrupt subroutine. For additional information on the control of this input (refer to the discussion on Interrupt Processing that follows).

Data Bus Buffering

Data is transferred (positive-true) to and from the Microprocessor on the bidirectional, 8-bit data bus. Information on the data bus is buffered after it exits or before it enters the Microprocessor. The 3-state, bidirectional Data Bus Buffers in U10 provide asynchronous, 2-way communication between the data bus and the Microprocessor. During normal operation, rocker switch S1C is set to NRM causing the enable input of U10 (pin 19) to be pulled low through the inverter U18A. The enable input of the 3-state buffer U29B is also pulled low through U18A (refer to the discussion on Interrupt Processing that follows).

The direction of data transfer through U10 is controlled by the state of the buffered Read/Write line from the Microprocessor, and by the Data Bus Buffers Read/Write Enable line from the Address Decoders (refer to Service Sheet 18). These two signals are ANDed together by U23A. When the direction-controlling input of U10 (pin 1) is high, information is transferred from the data bus to the Microprocessor (a "read" operation). When this input is low, information is transferred from the Microprocessor to the data bus (a "write" operation).

When U1 is enabled (refer to Service Sheet 18), data bus information is written to the Modulation Control Latches/Mode Selects on the Audio Power Supply Assembly A10 (refer to Service Sheet 6). When U1 is disabled, the data bus information is not written to the Audio Power Supply Assembly.

Sixteen bits of serial keyboard data are transferred from the storage registers on the Display Assembly A2 to the Microprocessor via bit 0 of the data bus (refer to Service Sheet 21). During the keyboard read subroutine, the Keyboard Serial Data Bus Buffer U29D is enabled to couple the serial, keyboard data to the bit 0 input of U10. Buffer enabling occurs when the Microprocessor issues and decodes hexadecimal address 01FA (refer to Service Sheet 18).

Hard-wired NOP

The hard-wired NOP (no operation) instruction is a service feature of this instrument. This 8-bit instruction steps the Microprocessor through its ROM addresses during ROM testing or troubleshooting. When the Microprocessor receives a NOP instruction, its program counter advances once for every two clock cycles without affecting any other operations. The 8 inputs to the 3-state buffer U15 are hard-wired in a configuration to provide the NOP instruction (00000001) to the Microprocessor. During normal operation, rocker switch S1D is set to NRM, (high input at pin 1) disabling the outputs of U15. During ROM testing, S1C is set to ROM to enable the outputs of U15, which places the hard-wired NOP instruction on the data bus. U10 is disabled as a result of U18A inverting the low set up by S1C, which pulls U10 pin 19 high. Disabling U10 inhibits the NOP instruction from being transferred to any circuitry but the Microprocessor.

Restart Circuitry

The Signal Generator employs an internal battery backup to save the contents of RAM, refer to Service Sheet 19, whenever the instrument is in standby or is unplugged. The restart circuitry disables the RAM and directs the Microprocessor to begin its power-up routine when the +5V supply reaches a nominal voltage after a reset. Reset of the Signal Generator occurs:

1. During power-up initialization.
2. During service by briefly connecting TP12 (RESET) to ground.

When the Signal Generator is unplugged or in standby, 2.8V from battery BT1 is applied to the RAM's Vcc input through R23 and CR3. CR2 is biased off to isolate the battery from the +5V supply. Battery voltage is also applied to the RAM SELECT through R22, disabling the RAM. Reset occurs whenever the Signal Generator is turned ON or after A11TP12 is momentarily connected to ground. The +5 volt supply is connected through R4 to the RESIN input of U4 at pin 2. When the voltage at U4 pin 2 comes up to 3.0V, the RESET output of U4 at pin 5 goes low for 195 ms. External timing capacitor C10 determines the time RESET stays low. Capacitor C18 at U4 pin 1 (REF) prevents fast power supply transients from causing resets. The low RESET turns off Q1 and Q2C. The collector of Q2C is set to 0V through R18, setting the RESET input to the Microprocessor low and turning off Q2B and Q2A. The RESET input to the Microprocessor must stay low for at least 100 ms for a valid reset. The RESET output of U4 is open collector. After 195 ms RESET goes high and is set to +0.8V by VR1, R6, and R7, turning on Q1 and Q2C. The collector of Q2C goes to +5V, setting the RESET input to the Microprocessor high, turning on Q2B and setting the base of Q2A to +5V. With Q2B on, Q2D is turned on, and the +5V supply is applied to the RAM's Vcc input. The cathode of CR3 becomes more positive than its anode and CR3 is turned off, isolating BT1 from the +5V supply. The high RESET input to the Microprocessor starts its power-up routine. Address Decoder U19 (refer to Service Sheet 18) sets RAM SELECT ENABLE low. Q2A is turned on and its collector goes to 0V. RAM SELECT is low and the RAM U3 (refer to Service Sheet 19) is enabled.

Interrupt Processing

Two methods are employed to interrupt normal program execution, namely maskable and nonmaskable interrupts. When either type of interrupt is detected, the Microprocessor finishes executing its current instruction before program execution is directed to the respective interrupt subroutine.

Maskable interrupts occur whenever a key on the keyboard is pressed, a reverse-power condition is detected, or an active-low switch closure is applied through the rear-panel sequence connector J5. Whenever one of these conditions is detected and latched, the Microprocessor's Interrupt Request input line (IRQ at pin 4) is forced active (low). The Microprocessor then issues and decodes hexadecimal address 01FC in order to examine (via the data bus) the contents of the Service Request Register U6. The Microprocessor can then determine which one of the three maskable interrupts has occurred. U6 functions as a 3-state buffer. During program execution of the maskable interrupt subroutine, the Microprocessor first checks for a reverse-power interrupt (D7 active low), then a sequence interrupt (D1 and D2 active low), and finally a keyboard interrupt (D2 active low). The methods used to detect and latch the three maskable interrupts are discussed in the following paragraphs.

Keyboard Interrupt

Whenever one of the keys on the Keyboard Assembly A1 is pressed, a keyboard interrupt KIN(L) is issued to the Microprocessor/Memory/HP-IB Assembly A11 (refer to Service Sheet 21). This active-low interrupt is applied to connector J4 at pin 14 and then gated through U23C and U23A to direct-set flip-flop U27A causing the output at pin 6 to go low. This flip-flop debounces the leading edge of KIN and latches the occurrence of the keyboard interrupt. The latched keyboard interrupt is gated through U23B and the enabled, 3-state buffer U29B to generate an interrupt request IRQ(L). U29B is enabled at pin 4 through the inverting driver U18A as long as rocker switch S1C is set to NRM.

When the key is released, KIN is high and U23C pin 12 is pulled high by resistor R1. After an approximate 33 ms delay produced by the RC network of R2 and C2, capacitor C2 charges to pull U23C pin 13 high. This delay debounces the trailing edge of KIN. Once the keyboard interrupt is processed, the Microprocessor issues and decodes hexadecimal address 01FB to clock U27A clear by the KIC input. Clearing U27A clears the keyboard interrupt.

Reverse-Power Interrupt

A reverse-power interrupt RPI(L) occurs when a reverse power condition is detected and latched by the reverse-power-sense circuitry on the Output Assembly A6 (refer to Service Sheet 8). This active-low interrupt is applied through the LC filter of L7 and C7 on the RFI Assembly A7 and through the feedthrough capacitor C16 to connector A11J4 pin 10. Normally, with no interrupt present, U23B pin 10 is pulled high through resistor R8. When a reverse-power interrupt occurs, it is gated through U23B and the enabled 3-state buffer U29B to generate an interrupt request IRQ(L). U29B is enabled at pin 4 through the inverting driver U18A as long as rocker switch S1D is set to NRM.

Sequence Interrupt

A sequence interrupt SQI(L) occurs when an active-low switch closure is applied through the rear-panel connector J5 and through the feedthrough capacitor A14C8 to connector A11J4 pin 3. This interrupt is handled in much the same manner as the keyboard interrupt. Normally, with no interrupt present, U23A pin 4 is pulled high through resistor R5 and inverters U11A and U11B. A 33 ms delay is produced by the RC network of R3 and C4 to debounce the leading edge of SQI. When a sequence interrupt occurs, it is gated through U23B pin 4 to direct-set flip-flop U27A causing the output at pin 6 to go low. This flip-flop latches the occurrence of the sequence interrupt. The latched-sequence interrupt is gated through U23C and the enabled 3-state buffer U29B to generate an interrupt request IRQ(L). U29B is enabled at pin 4 through the inverting driver U18B as long as rocker switch S1D is set to NRM.

When the switch closure is removed, U23A pin 4 is pulled high as soon as capacitor C4 charges. The delay produced by the RC network of R5 and C4 debounces the trailing edge of SQI. Once the

The Microprocessor's Non-Maskable Interrupt input line (NMI at pin 6) is normally pulled high through resistor R10. During signature analysis troubleshooting, this edge-triggered line is momentarily grounded to abort normal program execution and to direct program execution to the non-maskable, interrupt subroutine.

In addition to buffering the three maskable interrupts, the Service Request Register U6 also buffers four status lines which monitor various instrument conditions. These conditions include the state of the LF Loop Out-Of-Lock LFR(L) line (refer to Service Sheet 11), the state of the HI(H) and LO(H) lines from the Over and Under Modulation Comparators (refer to Service Sheet 7), and the state of the HP-IB Interrupt Request IBI(L) line (refer to Service Sheet 20). During normal program execution, the Microprocessor issues and decodes hexadecimal address 01FC to strobe the contents of U6 onto the data bus. If one of these four conditions is active when the Microprocessor strobcs U6, it executes the necessary instructions to service that condition.

TROUBLESHOOTING USING SIGNATURE ANALYSIS

Troubleshooting is done on the circuits of Service Sheet 17 when a defect seems to be related to the Microprocessor. The only troubleshooting information provided is signature analysis. If nothing definite is discovered in performing these checks, refer to Service Sheet 19 (ROM and RAM test) or consider the other possibilities listed on Block Diagram 4.

Troubleshooting Help

- Block Diagram 4
- Table 4-1. Abbreviated Performance Tests
- Table 5-2. Post-Repair Adjustments

Test Equipment

Signature Analyzer HP 5005A

Test 1. Address Check

The Address Check verifies the ability of the Microprocessor to run through the entire address range.

1. Connect the signature analyzer as follows:

GND	GND (A11TP3, refer to Service Sheet 17)
CLK	E (A11TP11, refer to Service Sheet 19)
START	ADR 15 (A11TP5, refer to Service Sheet 18)
STOP	ADR 15 (A11TP5, refer to Service Sheet 18)

2. Set the signature analyzer's controls as follows:

START	Negative Edge
STOP	Positive Edge
CLK	Negative Edge

3. Set up the Signal Generator as follows:

- a. Set switch A11S1C in the ROM position.

4. Connect the signature analyzer probe to each node indicated in Table 1. Verify that each signature is correct and stable.
5. After the signatures are taken, reset switch A11S1C back to the NRM position.

Table 1. Microprocessor Address Signatures.

Node	Correct Signature	Comments
+5V U9#35	0001	Address Lines
A0 U9#9	5555	
A1 U9#10	CCCC	
A2 U9#11	7F7F	
A3 U9#12	5H21	
A4 U9#13	0AFA	
A5 U9#14	UPFH	
A6 U9#15	52F8	
A7 U9#16	HC89	
A8 U9#17	2H70	
A9 U9#18	HPPO	
A10 U9#19	1293	
A11 U9#20	HAP7	
A12 U9#22	3C96	
A13 U9#23	3827	
A14 U9#24	755U	
A15 U9#25*	0000	
+5V	0001	Buffered Address Lines
A0 J3#2	5555	
A1 J3#3	CCCC	
A2 J3#4	7F7F	
A3 J3#5	5H21	
A4 J3#6	0AFA	
A5 J3#7	UPFH	
A6 J3#8	52F8	
A7 J3#9	HC89	
A8 J3#10	2H70	
A9 J3#11	HPP0	
A10 J3#12	1293	
A11 J3#13	HAP7	
A12 J3#14	3C96	
A13 J3#15	3827	
A14 J3#16	755U	
A15 J2#5*	0000	

*Even though the signature equals zero, the probe tip should blink.

Test 2. Data Bus Verification.

1. To test the Microprocessor and circuit board digital logic.
2. Connect the signature analyzer as follows:

GND GND (Refer to Note below)
 CLK E (A11TP11, refer to Service Sheet 19)
 ST/SP SA1 (A11TP7, refer to Service Sheet 18)
 QUAL VMA (A11TP6, refer to Service Sheet 19)

NOTE

Connect to ground as close as possible to the circuitry being probed. Bad grounding can cause unstable signatures.

3. Set the signature analyzer controls as follows:

FUNCTION SIGNATURE	Qual
START	Positive Edge
STOP	Negative Edge
CLK	Negative Edge

4. Set up the Signal Generator as follows:

- a. Disconnect ribbon cable W11 from A10J3 on the Audio/Power Supply Assembly (refer to Service Sheet 8).
- b. Set switch A11S1B to the L/K position.
- c. Set switch A11S1A to the DSA position.

NOTE

If the Signal Generator's HP-IB address switch has been set to anything other than address 07, the signatures taken in this test will be incorrect. In this case, reset the address switches to A1=1, A2=1, A3=1, A4=0 and A5=0. Refer to paragraph 2-7, HP-IB Address Selection in Section 2 for the procedure to change the address switches.

5. Briefly connect A11TP4 (NMI) to A11TP3 (GND).

NOTE

With careless probing it is possible to get the Microprocessor into a program sequence other than that portion intended for signature analysis. If the +5V signature in Table 1 is incorrect, this has probably happened. Restart the test by briefly connecting A11TP12 (RESET) to A11TP3 (GND). Then briefly connect A11TP4 (NMI) to A11TP3 (GND).

6. Connect the signature analyzer probe to the node indicated in Table 2. Verify that each signature is correct and stable.
7. If troubleshooting is completed and the signatures are taken, reset switch A11S1B back to the R/R position, and switch A11S1A back to the DIAG position.

Reconnect ribbon cable W11 to A10J3.

If the HP-IB address switch was changed, reset the address switch (refer to Service Sheet 20) to the original address.

Set the front-panel POWER switch to STBY and back to ON.

Table 2. Microprocessor Data Bus Signatures.

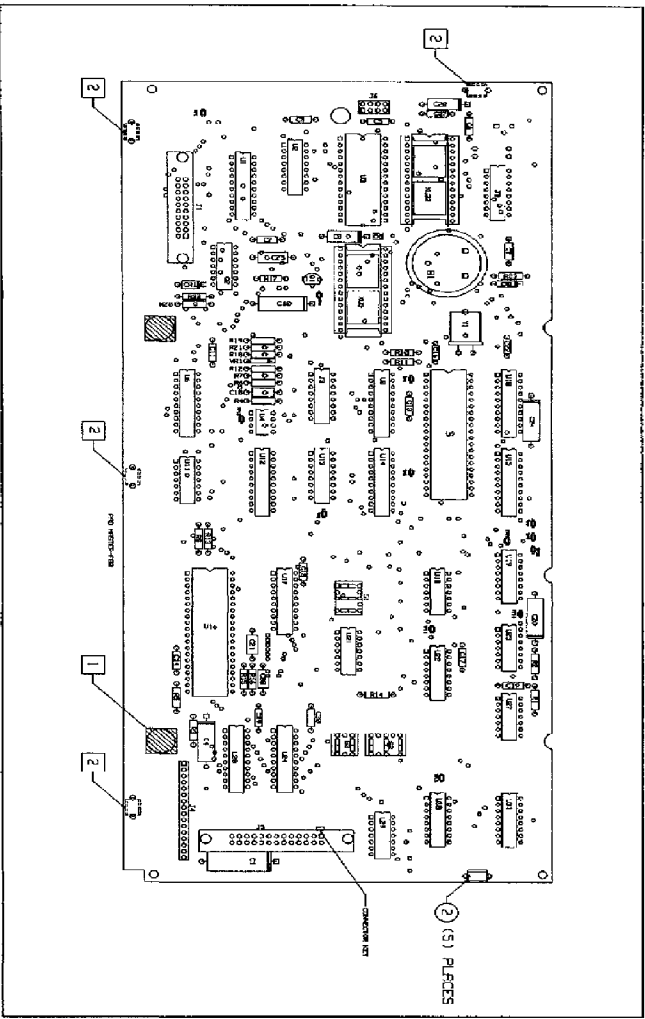
Node	Correct Signature	Comments
+5V D0 U9#33* D1 U9#32 D2 U9#31 D3 U9#30 D4 U9#29 D5 U9#28 D6 U9#27 D7 U9#26	7986 12AC 739A 3A93 18A1 0601 9A47 43AU OP52	Data Bus Signatures are subject to setting of HP-IB address switches.
+5V D0 J2#16* D1 J2#15 D2 J2#14 D3 J2#13 D4 J2#12 D5 J2#11 D6 J2#10 D7 J2#9	7986 12AC 739A C82A 18A1 84C8 18UP F116 8FPC	Buffered Data Bus Signatures are subject to setting of HP-IB address switches.
* This signature may vary from unit to unit due to difference in one-shot timing of A2U28B. If SA6 (A11TP14) is connected to SA7 (A2TP9), the signature should read the same as above.		

A11 Component Coordinates

COMP	X,Y	COMP	X,Y	COMP	X,Y	COMP	X,Y	COMP	X,Y
BT1	A,3	R6	B,1	U10	B,3				
		R7	B,1	U11	B,1				
C1	D,1	R8	C,1	U12	B,1				
C2	C,3	R10	B,2	U13	B,2				
C3	A,2	R11	B,2	U14	B,2				
C4	D,1	R12	B,1	U15	B,3				
C5	A,2	R13	C,1	U16	C,1				
C6	A,3	R14	D,2	U17	C,2				
C7	A,2	R15	C,1	U18	C,3				
C8	A,2	R16	C,1	U19	C,3				
C9	A,3	R17	A,2	U20	C,2				
C10	B,2	R18	B,1	U21	C,2				
C11	B,1	R19	B,1	U22	C,3				
C13	B,3	R20	B,1	U23	C,3				
C14	C,1	R21	B,1	U24	D,1				
C15	C,2	R22	B,1	U25	D,2				
C16	B,3	R23	A,3	U27	D,3				
C17	C,3			U28	D,2				
C18	B,1	S1	C,2	U29	D,2				
C19	D,3	S2	D,2	U30	D,3				
C20	C,1	S3	D,2	U31	D,3				
C21	C,1								
C22	B,3	TP1	A,1	VR1	B,1				
C24	B,3	TP2	A,2						
C25	A,2	TP3	B,2	XU5	B,2				
		TP4	B,3	XU9	B,3				
CR1	B,1	TP5	B,3	XU16	C,1				
CR2	B,3	TP6	C,2						
		TP7	C,3	Y1	B,3				
J1	A,1	TP8	C,3						
J2	A,3	TP9	C,3						
J3	B,2	TP10	C,3						
J4	D,1	TP11	C,3						
J5	D,2	TP12	B,1						
		TP13	D,3						
MP1	D,3	TP14	D,2						
Q1	A,2	U1	A,1						
Q2	A,1	U2	A,2						
		U3	A,2						
R1	D,3	U4	B,1						
R2	C,3	U5	B,2						
R3	D,1	U6	B,1						
R4	B,1	U8	B,2						
R5	D,1	U9	B,3						

Figure 8. Service Sheet 18 (Continued)

Conceptual Location



- NOTES
1. For an explanation of specific symbols, refer to Section 1.1.1.1, Section 1.1.1.2, Section 1.1.1.3, and Section 1.1.1.4.
 2. Mechanical contact between items should be based on cover.
 3. Service ducts (e.g., ducts for air conditioning) should be shown with their own service ducts, but not with their own service ducts.
 4. Service ducts (e.g., ducts for air conditioning) should be shown with their own service ducts, but not with their own service ducts.
 5. Service ducts (e.g., ducts for air conditioning) should be shown with their own service ducts, but not with their own service ducts.

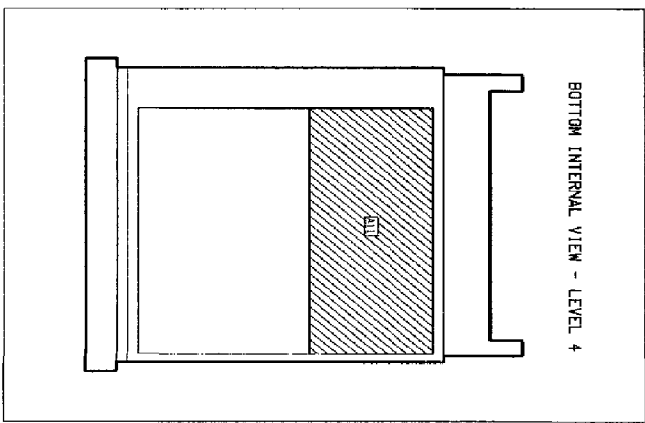
USBLC LEVELS

USBLC	LEVEL	DESCRIPTION
USBLC 1	1st	1st Floor
USBLC 2	2nd	2nd Floor
USBLC 3	3rd	3rd Floor
USBLC 4	4th	4th Floor
USBLC 5	5th	5th Floor

P/O ALL INFORMATION
 PROVISIONAL
 2000-0000-0000-0000
SS17

Service

MSA 1857A



Service Sheet 18

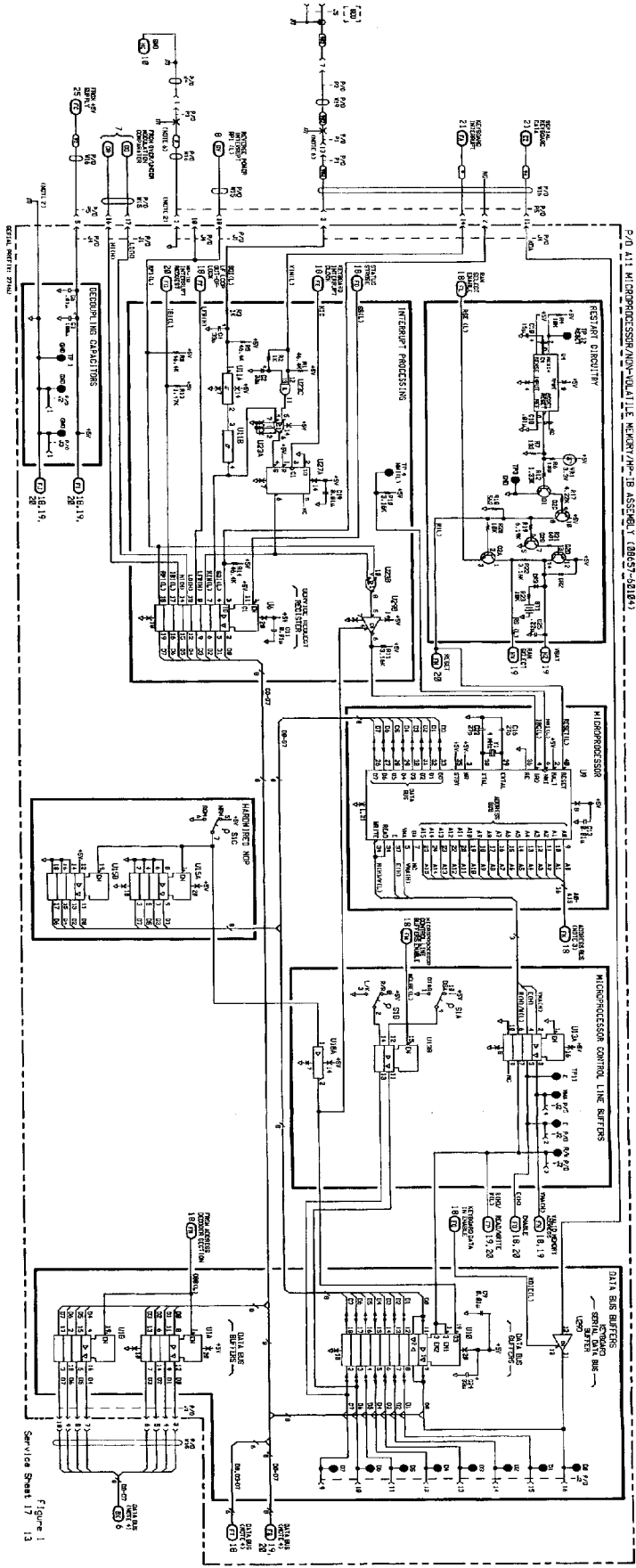


Figure 1
Service Sheet 17

Service Sheet 18

ADDRESS BUFFERING AND DECODING, SERIAL I/O AND CONTROL

PRINCIPLES OF OPERATION

General

The circuits of Service Sheet 18 control the major functions of the Signal Generator. This circuitry has direct control on almost all of the analog functions of the instrument; such as frequency, amplitude, and modulation. Address data from the Microprocessor is decoded; the accompanying data from the data bus (either series or parallel) is manipulated to set various output modes, levels, and frequencies. In addition, many functions that are strictly digital (such as control of keyboard, display, and data bus) are decoded by the Address Decoders.

Address Decoders

De-multiplexer U19 is enabled via VMA(H), A15(L), and E(L). Once enabled, address lines A11, A12, and A13 are decoded. U19 outputs the RAM Select Enable, RSE(L) signal; Interface Bus Select, IB SEL(L); signature analyzer enable signals; and enable signals for de-multiplexers U2 and U22.

Both U2 and U22 are enabled by U19, E(H), and A3(L). Address line A3 determines whether U2 or U22 is active. Address lines A0, A1, and A2 are decoded into control signals. The outputs of U2 are strobe lines which control modulation and attenuation data. The outputs of U22 are series data control strobes to the Serial I/O Control, and Microprocessor related control signals to Service Sheet 17.

Serial I/O Control

The Clock/Strobe Enable Flip-Flop U27B enables the Clock/Strobe Generator U31. U31 controls the flow of serial data for the keyboard, the display, the output, and the low-frequency phase lock loops.

Serial I/O Control Register U30 passes encoded information received from the Data Bus to the Serial I/O Data Bus, and to U31.

TROUBLESHOOTING USING SIGNATURE ANALYSIS

Troubleshooting is done on the circuits of Service Sheet 18 when a defect seems to be related to the Display, Keyboard, or control of the other major sections of the instrument. Examples are the High Frequency Loop, the Output Section and the Low Frequency Loop. If the signatures shown in the tables are correct but the problem is related to another major section of this instrument, refer to:

- Block Diagram 2 for Output or High Frequency Loop 1 problems.
- Block Diagram 3 for Low Frequency Loop problems.

If the signatures are incorrect, the circuits of Service Sheets 17, 19, 20, or 21 (the Microprocessor, ROM and RAM, the Keyboard or the HP-IB Interface) may be defective. As a last resort, return to Block Diagram 4 or possibly Block Diagram 1 and consider the other possibilities shown.

Test Equipment

Signature Analyzer HP 5005A

Address and Data Transmission Test

The Address and Data Transmission Test verifies transmission of encoded addresses, and data from the Microprocessor through the decoders, strobe generators and registers.

1. Connect the signature analyzer as follows:

GND GND (See Note below)
 CLK E (A11TP11, refer to Service Sheet 19)
 START SA1 (A11TP7, refer to Service Sheet 18)
 STOP SA2 (A11TP8, refer to Service Sheet 18)

NOTE

Connect to ground as close to the circuitry being probed as possible. Bad grounding can cause unstable signatures.

2. Set the signature analyzer's controls as follows:

START Positive Edge
 STOP Negative Edge
 CLK Negative Edge

3. Set up the Signal Generator as follows:

- a. Disconnect ribbon cable W11 from A10J3 on the Audio/Power Supply Assembly (refer to Service Sheet 8).
- b. Set switch A11S1B to the L/K position (refer to Service Sheet 17).
- c. Set switch A11S1A to the DSA position (refer to Service Sheet 17).

NOTE

If the Signal Generator's HP-IB address switch has been set to anything other than 07, the signatures taken in this test will be incorrect. In this case, reset the address switches to A1=1, A2=1, A3=1, A4=0 and A5=0. Refer to paragraph 2-7 "HP-IB Address Selection" in Section 2 for the procedure to change the address switches.

4. Briefly connect A11TP4 (NMI) to A11TP3 (GND) (refer to Service Sheet 17).

NOTE

With careless probing, it is possible to get the Microprocessor into a program sequence other than that intended for signature analysis. If the +5V signature in Table 1 is incorrect, this has probably happened. Restart the test by briefly connecting A11TP12 (RESET) to A11TP3 (GND). Then briefly connect A11TP4 (NMI) to A11TP3 (GND).

5. Connect the signature analyzer probe to each node as indicated in Table 1 and verify that the signature is correct and stable as shown.
6. If troubleshooting is completed and the signatures are taken, reset switch A11S1B back to the R/R position, and switch A11S1A back to the DIAG position and reconnect ribbon cable W11 to A10J3.

NOTE

If the HP-IB address switch was changed, reset the address switch back to its original position.

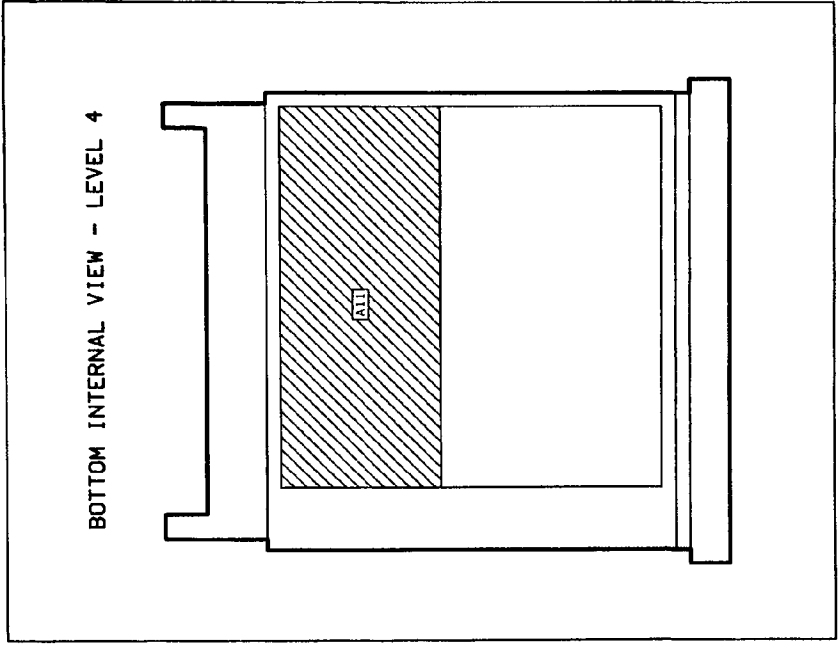
*Reset the Signal Generator by pressing the **SHIFT** key, and then pressing the **0** key.*

Table 1. Interface Signatures.

Node	Correct Signature	Comments
+5V	H6H5	
U19#7	UA17	
U19#12*	8690	SA CLK(RF)
U22#7	330C	SER CLK EN
U22#9	6H08	SER CLK EN
U27#9	42H7	SER LATCH
U31#11	6468	
U31#12	6F77	
+5V	H6H5	
U31#14	C45F	
U31#15	2841	
U30#2	5401	
U30#5	UC8P	
U30#7	9PPA	
U30#10	75UP	
U30#15*	7064	SA Strobe/Stop
U29#8*	FP00	
U29#9*	FP00	
+5V	H6H5	
U2#15	58AP	A10U7 strobe
U2#14	57F4	A10U10 strobe
U2#13	97CC	A10U12 strobe
U2#12	A5FP	A10U15 strobe
U2#11	P1H1	A10U18 strobe
*This node is only used to control the signature analyzer during the display and RF interface test		

A11 Component Coordinates

COMP	X,Y	COMP	X,Y	COMP	X,Y	COMP	X,Y	COMP	X,Y
BT1	A,3	R6	B,1	U10	B,3				
		R7	B,1	U11	B,1				
C1	D,1	R8	C,1	U12	B,1				
C2	C,3	R10	B,2	U13	B,2				
C3	A,2	R11	B,2	U14	B,2				
C4	D,1	R12	B,1	U15	B,3				
C5	A,2	R13	C,1	U16	C,1				
C6	A,3	R14	D,2	U17	C,2				
C7	A,2	R15	C,1	U18	C,3				
C8	A,2	R16	C,1	U19	C,3				
C9	A,3	R17	A,2	U20	C,2				
C10	B,2	R18	B,1	U21	C,2				
C11	B,1	R19	B,1	U22	C,3				
C13	B,3	R20	B,1	U23	C,3				
C14	C,1	R21	B,1	U24	D,1				
C15	C,2	R22	B,1	U25	D,2				
C16	B,3	R23	A,3	U27	D,3				
C17	C,3			U28	D,2				
C18	B,1	S1	C,2	U29	D,2				
C19	D,3	S2	D,2	U30	D,3				
C20	C,1	S3	D,2	U31	D,3				
C21	C,1								
C22	B,3	TP1	A,1	VR1	B,1				
C24	B,3	TP2	A,2						
C25	A,2	TP3	B,2	XU5	B,2				
		TP4	B,3	XU9	B,3				
CR1	B,1	TP5	B,3	XU16	C,1				
CR2	B,3	TP6	C,2						
		TP7	C,3	Y1	B,3				
J1	A,1	TP8	C,3						
J2	A,3	TP9	C,3						
J3	B,2	TP10	C,3						
J4	D,1	TP11	C,3						
J5	D,2	TP12	B,1						
		TP13	D,3						
MP1	D,3	TP14	D,2						
Q1	A,2	U1	A,1						
Q2	A,1	U2	A,2						
		U3	A,2						
R1	D,3	U4	B,1						
R2	C,3	U5	B,2						
R3	D,1	U6	B,1						
R4	B,1	U8	B,2						
R5	D,1	U9	B,3						



NOTES

1. For an explanation of schematic symbols, see "SCHEMATIC DIAGRAM NOTES" in Section 8.
2. Chassis ground is achieved by A11U4-j connection and mechanical contact through nuts holding PC board to cover.
3. Data is transferred positive true from RAM memory (A11U4) to microprocessor on bus (A11U7).
4. Address data is transferred positive true from the microprocessor on the buffered address bus (A11U14).

LOGIC LEVELS

LOGIC	TRUTH
LOW	0
HIGH	1
IS MORE THAN ONE	1
OPEN	1
GROUND	LOW

P/O A11 ADDRESS BUFFERING AND DECODING, AND CONTROL
SEE SERVICE SHEET AND CONTROL
SS18

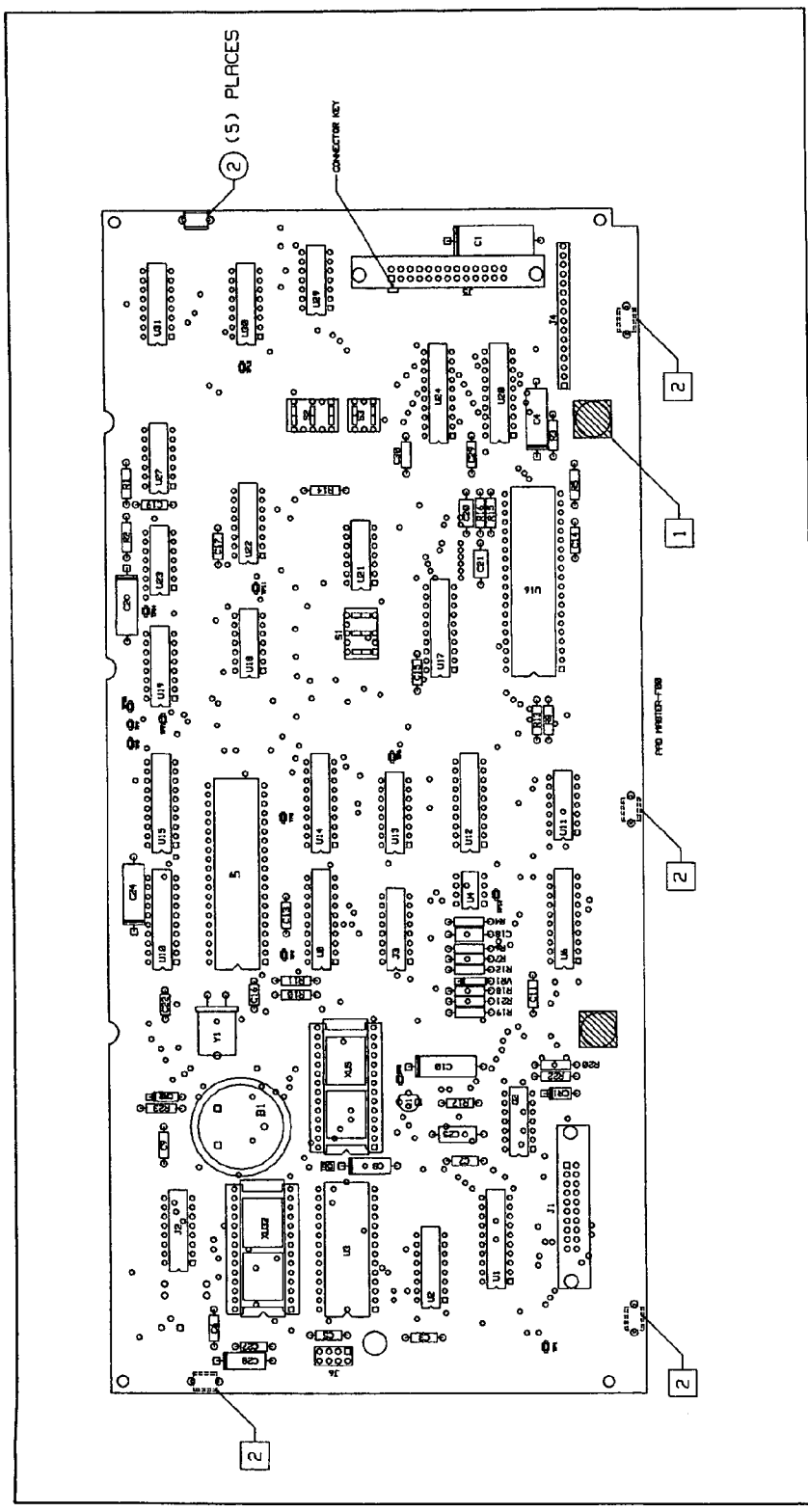


Figure 8. Service Sheet 19 Information

Component Locator

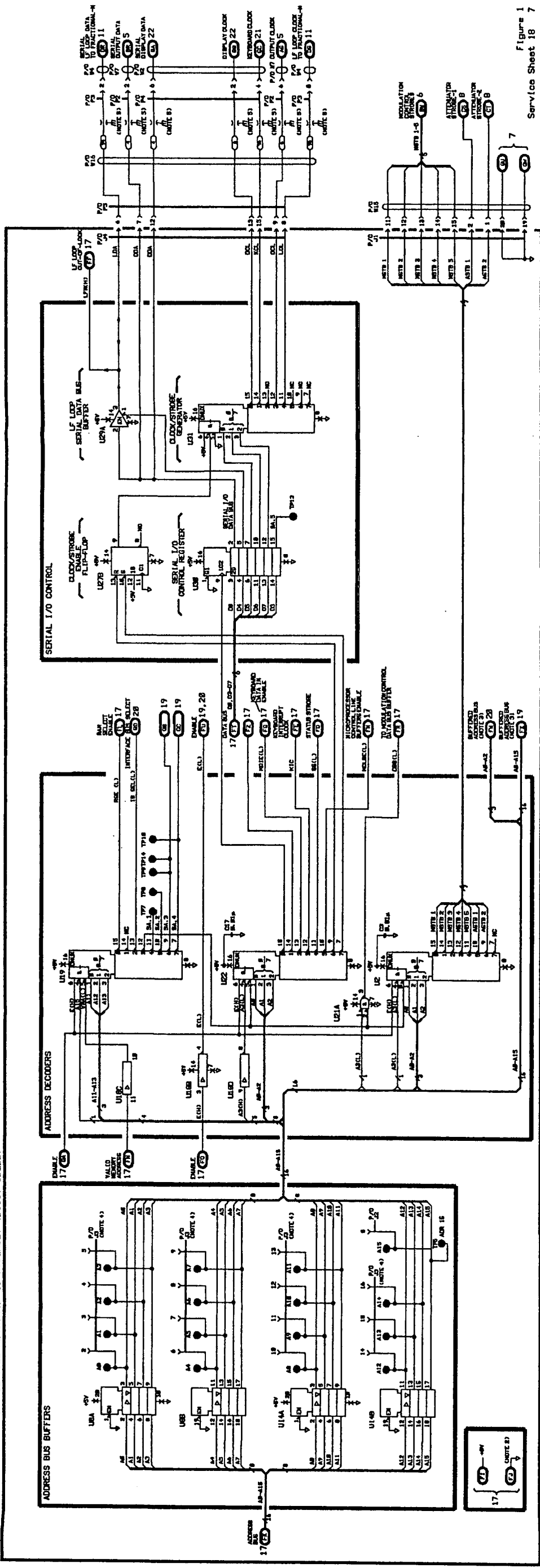


Figure 1
Serv/co Sheet 18 7

Service Sheet 19

MEMORY

PRINCIPLES OF OPERATION

General

The Signal Generator's internal memory consists of 2k bytes of random access memory (RAM) and 64k bytes of read only memory (ROM). The RAM utilizes a battery back-up whenever the Signal Generator is unplugged or in standby. This saves the contents of the RAM until power is restored.

RAM

Valid Memory Address (VMA) and RAM Select (RS) inputs enable RAM U3. VMA is inverted to VMA(L) by U18C before being applied to the RAM's enable input. The read/write mode is selected by a control signal placed on U3 pin 21. The memory location of the RAM is selected by addresses A0 through A10. The RAM data input/output is connected directly to the data bus D0 through D7. VBAT is connected to the RAM VCC input at U3 pin 40. When the Signal Generator is ON, the VBAT input is equal to the +5V supply voltage. When the Signal Generator is in unplugged or in STBY, VBAT is approximately +2.65 Vdc.

ROM

ROM 1 U5 contains calibration data used for level calibration, ROM 2 U32 is instrument operating firmware. ROM 1 is enabled with a low VMA(L) and a low OE(L). VMA(H) is inverted to VMA(L) by U18C and A15 is inverted to A15(L) by U18F. A15(L) and E(L) are applied to the input of AND gate U21B. The output of U21B will be low when both inputs are low. The memory location of the ROM is selected by addresses A0 through A14. The ROM data output is connected directly to the data bus D0 through D7.

ROM 2 is enabled when either A SA3 (L) or SA4 (L) is sent from U19 to U23D. A combination of VMA (L) and U23D pin 3 (L) will enable ROM 2.

TROUBLESHOOTING USING KEYBOARD-INVOKED TEST 5 OR USING SIGNATURE ANALYSIS

Troubleshooting is done to the circuits of Service Sheet 19 when a defect seems to be related to the ROM or RAM circuits. The ROM troubleshooting information provided is firmware initiated tests on power-on, and keyboard-invoked tests. The RAM troubleshooting information provided is done using signature analysis. If nothing definite is discovered in performing these checks, refer to Service Sheet 17 or consider the other possibilities listed on Block Diagram 4.

Test Equipment

Signature Analyzer HP 5005A

Test 1. Microprocessor and ROM Functional Checks

The Microprocessor and ROM Functional Checks verify that ROM and RAM are correctly operating. The following procedure may help to identify any problems in the ROM, RAM, or in the supporting circuitry.

Calibration data is located in the ROM. Therefore, the ROM can not be checked with Signature Analysis. ROM signatures change as firmware changes.

1. Verify enabling of ROM by checking that A11U18F pin 12, A11TP2 (ROM), and A11U18C pin 6 (VMA) are toggled.
2. When the POWER switch is set to ON an internal memory check is initiated. If a memory failure is detected, a RAM or ROM error code is shown in the FREQUENCY Display window. The error code remains displayed until any front-panel key is pressed. Refer to Table 1 for the codes and the respective faults.

Table 1. Power-On Error Codes.

Error Code	Fault	Address
10	RAM Error	0080-07FF
20	ROM Error	7000-FFFF
30	RAM and ROM Error	

The ROM can be checked by entering the Keyboard-Invoked Test subroutine Test 5. Checksums with the ROM are checked and an error code is displayed if appropriate. The test will halt if a failure occurs after checking the entire memory. If an error does not occur, the test is repeated and a pass number in the AMPLITUDE Display is incremented.

- Enter the Keyboard-Invoked Tests by first pressing the **SHIFT** key, and then pressing the **INCR SET** key.
- Press the **AMPTD** ⬆ key until a "5" is shown in the MODULATION Display window. Test 5, ROM Test, is ready to run.
- Press the **INCR SET** key to start the test. The test will repeat until stopped.
- If the ROM is malfunctioning, error code "50" will be shown in the FREQUENCY Display window.
- Press the **AMPTD** ⬆ key to stop the test.
- To exit the Keyboard-Invoked Tests, press the **AMPTD** ⬆ key until a "7" is displayed in the MODULATION Display window. Then press the **INCR SET** key; the Signal Generator is initialized as in Power-On.

Test 2. Microprocessor and RAM Functional Check Using Signature Analysis.

The microprocessor and RAM Functional Check verifies the ability to write and read to the RAM.

NOTE

An abbreviated RAM check is performed at power-on. If a memory failure is detected, a RAM error code is shown in the FREQUENCY Display window. The error code remains displayed until any front-panel key is pressed. Refer to Table 1 for the appropriate error codes.

It is possible to have a defective RAM and not have the error code displayed. If a failure occurs an attempt to display the error code in the FREQUENCY Display is made. The RAM itself is used to display the error code. The RAM may not have the ability to do so.

1. Connect the signature analyzer as follows:

GND	GND (A11TP3, refer to Service Sheet 17)
CLK	E (A11TP11, refer to Service Sheet 19)
START	SA1 (A11TP7, refer to Service Sheet 18)
STOP	SA4 (A11TP10, refer to Service Sheet 18)

2. Set the signature analyzer's controls as follows:

FUNCTION	Signature (Norm)
START	Positive Edge
STOP	Negative Edge
CLK	Negative Edge

3. Set up the Signal Generator as follows:

- a. Disconnect attenuator ribbon cable W11 from A10J3 on the Audio/Power Supply Assembly (refer to Service Sheet 8).
- b. Set switch A11S1B to the R/R position (refer to Service Sheet 17).
- c. Set switch A11S1A to the DSA position (refer to Service Sheet 17).

4. Briefly connect A11TP4 (NMI) to A11TP3 (GND) (refer to Service Sheet 17).

NOTE

The front-panel display does not change when this test is running.

With careless probing it is possible to get the Microprocessor into a program sequence other than that portion intended for signature analysis. If the +5V signature is incorrect this has probably happened. Restart the test by briefly connecting A11TP12 (RESET) to A11TP3 (GND). Then briefly connect A11TP4 (NMI) to A11TP3 (GND).

5. Connect the signature analyzer probe to data lines D0-D7 at J2 (refer to Service Sheet 17). Verify that the RAM Data Transfer Signatures as indicated by Table 2 are correct.

- An incorrect signature may indicate:
 - a. Improper setup
 - b. RAM program aborting
 - c. ROM program is incorrect (+5V signature is incorrect).
 - d. Incorrect addressing to RAM
 - e. Defective RAM.

NOTE

Go to Service Sheet 17 to test the addressing.

Table 2. RAM Data Transfer Signatures.

Node	Correct Signature
+5V	C888
D0 J2#16	059A
D1 J2#15	3698
D2 J2#14	1560
D3 J2#13	HPA3
D4 J2#12	626P
D5 J2#11	PP3H
D6 J2#10	35C7
D7 J2#9	2CC6

6. If the Signal Generator powers up without a ROM error code, then the program is correct.
7. If the +5V signature is correct, then the program is running.
8. If troubleshooting is complete and signatures are taken, reset switch A11S1A back to the DIAG position, and reconnect ribbon cable W11 to A10J3. Reset the Signal Generator by pressing the **SHIFT** key and then pressing the **0** key.

A11 Component Coordinates

COMP	X,Y	COMP	X,Y	COMP	X,Y	COMP	X,Y	COMP	X,Y
BT1	A,3	R6	B,1	U10	B,3				
		R7	B,1	U11	B,1				
C1	D,1	R8	C,1	U12	B,1				
C2	C,3	R10	B,2	U13	B,2				
C3	A,2	R11	B,2	U14	B,2				
C4	D,1	R12	B,1	U15	B,3				
C5	A,2	R13	C,1	U16	C,1				
C6	A,3	R14	D,2	U17	C,2				
C7	A,2	R15	C,1	U18	C,3				
C8	A,2	R16	C,1	U19	C,3				
C9	A,3	R17	A,2	U20	C,2				
C10	B,2	R18	B,1	U21	C,2				
C11	B,1	R19	B,1	U22	C,3				
C13	B,3	R20	B,1	U23	C,3				
C14	C,1	R21	B,1	U24	D,1				
C15	C,2	R22	B,1	U25	D,2				
C16	B,3	R23	A,3	U27	D,3				
C17	C,3			U28	D,2				
C18	B,1	S1	C,2	U29	D,2				
C19	D,3	S2	D,2	U30	D,3				
C20	C,1	S3	D,2	U31	D,3				
C21	C,1								
C22	B,3	TP1	A,1	VR1	B,1				
C24	B,3	TP2	A,2						
C25	A,2	TP3	B,2	XU5	B,2				
		TP4	B,3	XU9	B,3				
CR1	B,1	TP5	B,3	XU16	C,1				
CR2	B,3	TP6	C,2						
		TP7	C,3	Y1	B,3				
J1	A,1	TP8	C,3						
J2	A,3	TP9	C,3						
J3	B,2	TP10	C,3						
J4	D,1	TP11	C,3						
J5	D,2	TP12	B,1						
		TP13	D,3						
MP1	D,3	TP14	D,2						
Q1	A,2	U1	A,1						
Q2	A,1	U2	A,2						
		U3	A,2						
R1	D,3	U4	B,1						
R2	C,3	U5	B,2						
R3	D,1	U6	B,1						
R4	B,1	U8	B,2						
R5	D,1	U9	B,3						

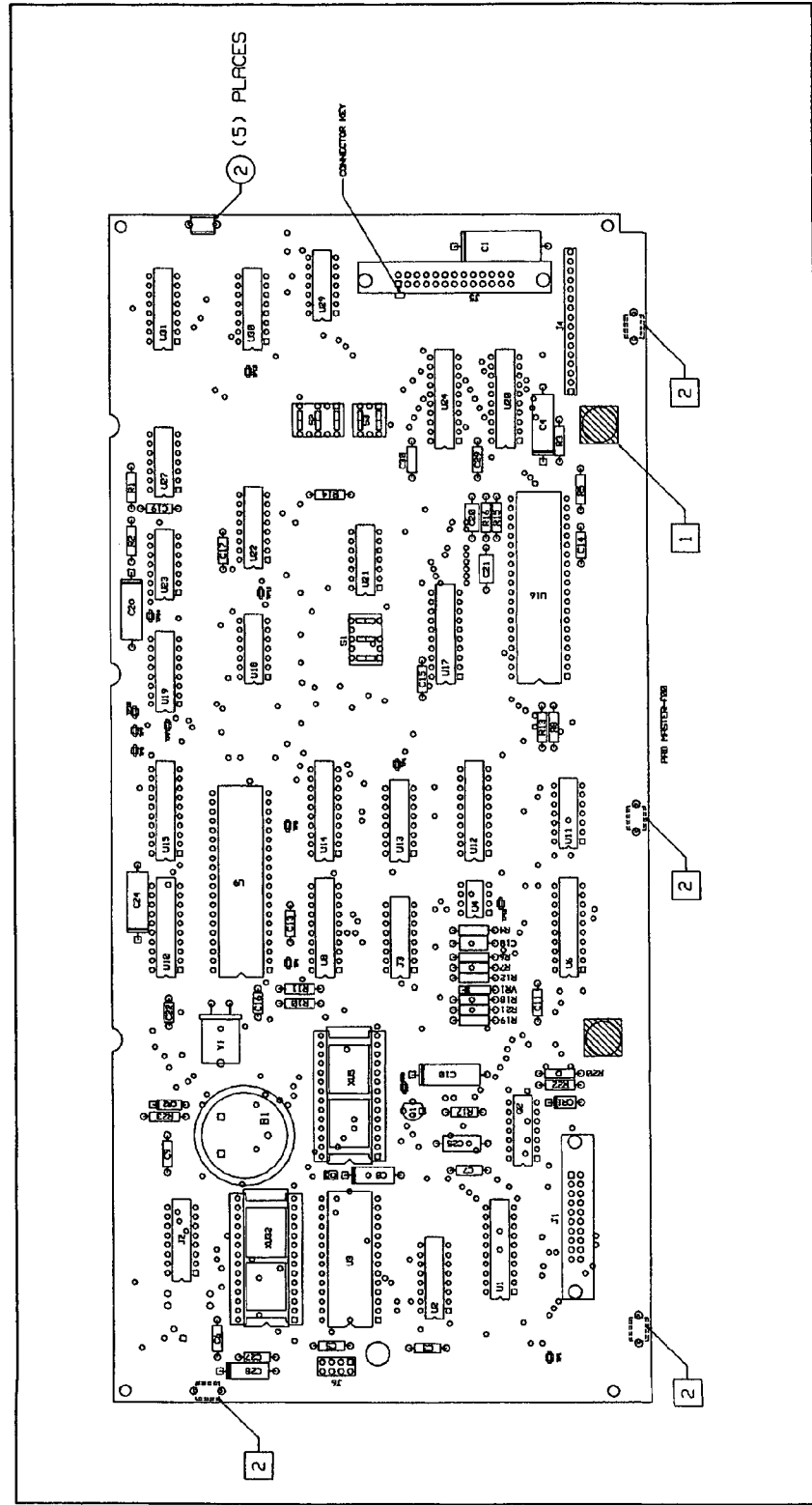
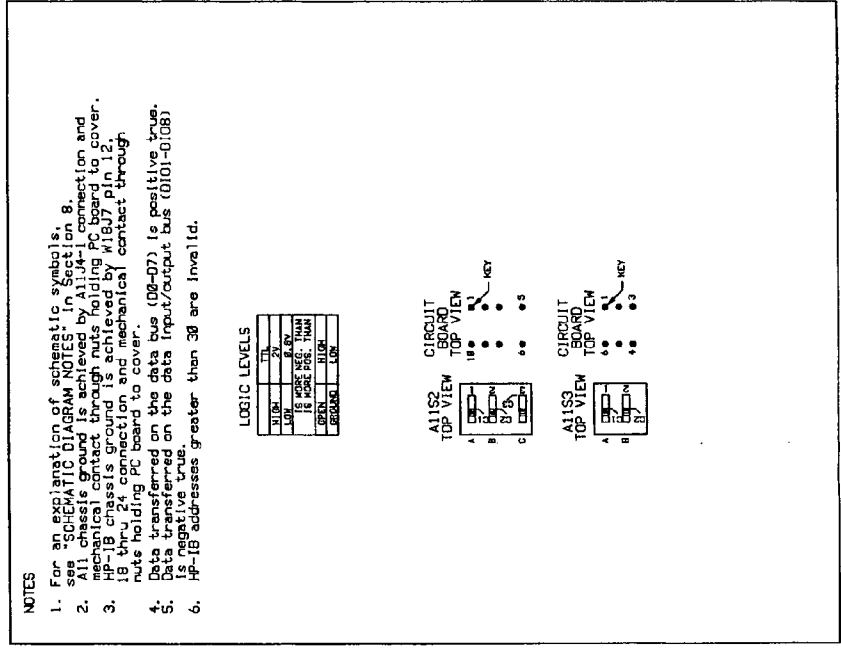
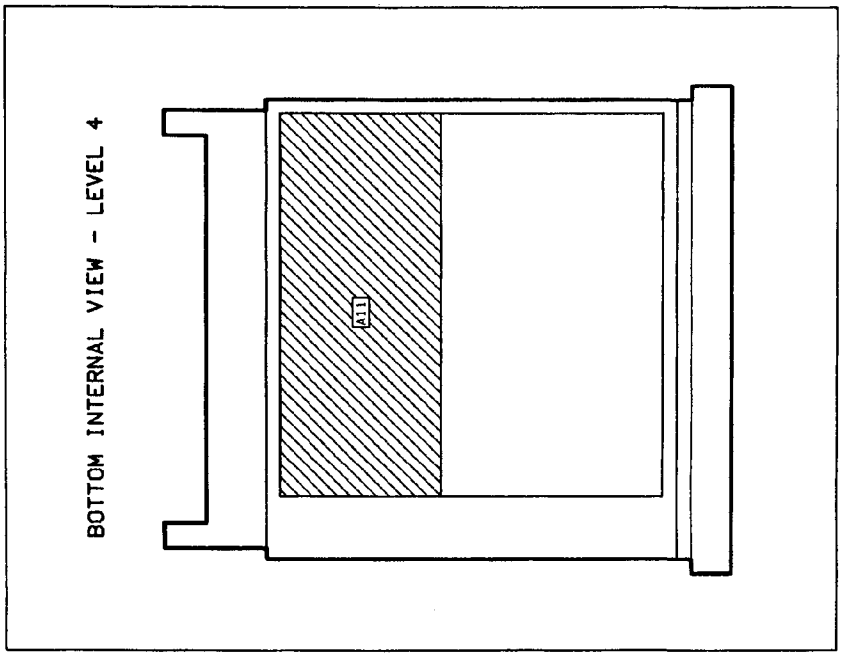


Figure 8. Service Sheet 28 Information



P/O A11 MEMORY SS19
SEE ROSSK SIX



P/O A11 MICROPROCESSOR/ROM-VOLATILE MEMORY/MP-18 ASSEMBLY (89657-6228)

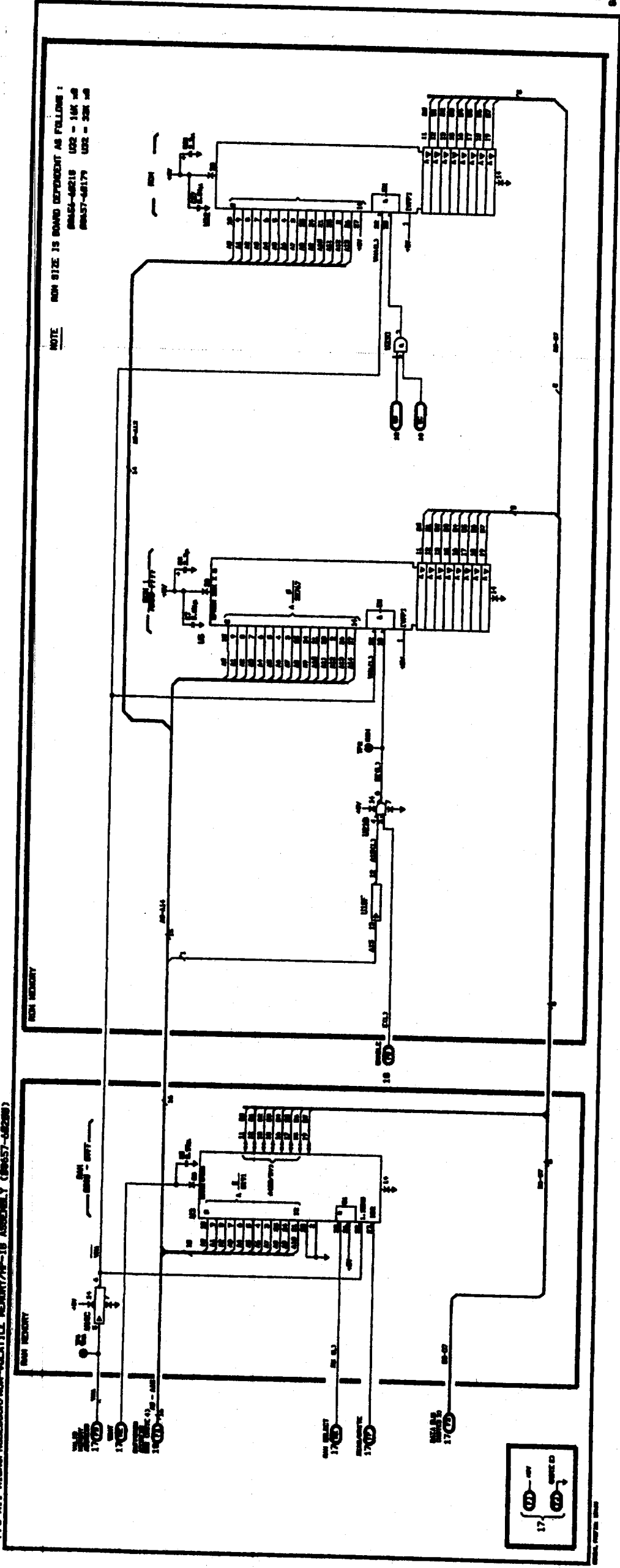


Figure 1
 Service Sheet 19 7

Service Sheet 20

HP-IB INTERFACE

PRINCIPLES OF OPERATION

General

Inputs to the Signal Generator from the external controller are in the form of encoded control and data information. Control information is input to the Signal Generator via five control lines (four are used in this instrument) and three handshake lines. The control lines allow the controller to gain the Signal Generator's attention and impart other appropriate control information. The handshake lines provide asynchronous control information for data transfer between a talker (computer controller) and the listener (Signal Generator).

In the handshake mode, the Signal Generator first indicates when it is ready to listen (receive data). The controller responds by indicating when the data that appears on the data lines, DI01 through DI08, is valid. The Signal Generator then indicates to the controller when the data has been accepted.

Data transferred to the Signal Generator contains all the information required to control each mode of operation. It also contains the level or frequency information for each mode; for example, an AM depth of 50%, an RF output amplitude of -10 dBm, and a frequency of 100 MHz.

The HP-IB Address Switch Buffer U17 sends the Signal Generator's internally-set HP-IB address to U16 via the data lines when enabled by the HP-IB General Purpose Interface Adapter U16. The HP-IB Interface Buffer, U12, is enabled when IB Sel and Enable are low simultaneously. The O-Ring action of U21D enables U12 when IOB Sel (low) is active. The Read/Write mode determines if data is written onto or read from the Data Bus. Note that the Read/Write line is tied in parallel to the HP-IB Interface Buffer U12, and the HP-IB Interface Adapter U16.

HP-IB Data Bus and Control/Handshake Buffers

The HP-IB Data Bus and Control/Handshake Buffers are permanently enabled by hard-wire connections to ground. The HP-IB Data Bus output buffers are disabled (pins 3, 5, 11 and 13 of U28 and U24 are tied high) since the Signal Generator functions as a listener only. The Signal Generator does not have the capability to issue a service request (SRQ on U16 pin 23 and U25 pin 15 is not connected). The only outgoing signals are the handshake control lines NRFD and NDAC. See Figure 1 for more information about the HP-IB Handshake Control.

HP-IB Interface Adapter

The Interface Adapter U16 provides interfacing between the HP-IB connections to the external controller and the Signal Generator's digital circuits. The address select, ASE (L), and HP-IB Interrupt Request, IBI (L), are generated as a result of inputs from the external controller.

The Microprocessor, under the control of the HP-IB subroutines stored in ROM, outputs control and address signals to U16 to control the data input from the external controller. Interface Bus Select, IB SEL (L), selects the HP-IB mode. Addressing to register select lines RS0, RS1 and RS2 is input to U16 on A0, A1 and A2. Data and control information is thus selected to flow to and from the Microprocessor circuits on the data bus. Read/Write, R(H)/W(L), determines if data is written onto the data lines D0 through D7 or if the internal address is read by U16.

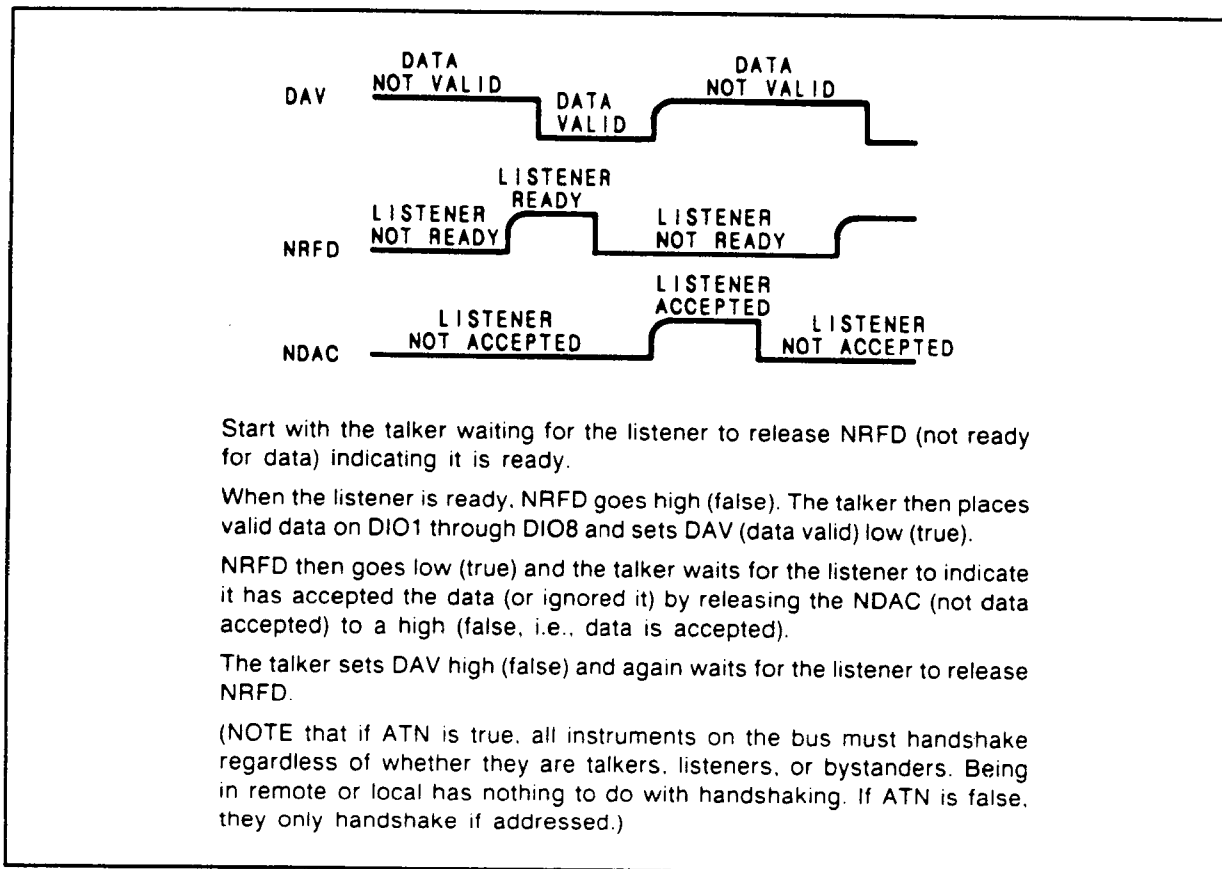


Figure 1. Simplified HP-IB Handshake between a Talker (Computer Controller) and One Listener (Signal Generator).

TROUBLESHOOTING USING SIGNATURE ANALYSIS

Troubleshooting is done on the circuits of Service Sheet 20 when a defect seems to be related to the HP-IB circuits. If the signatures are all correct, the instrument interface circuits from U16 to the Microprocessor are probably functional. Refer to paragraph 3-11 "HP-IB Functional Checks" in Section 3 to verify proper operation of the HP-IB interface circuits. This includes data, control, and handshake connections to the computer controller. Do not overlook the possibility that the HP-IB address switches are set to an address other than what was expected. The address switch setting may be checked by pressing the front-panel **SHIFT** key, and then holding the **LOCAL (ADRS)** key. As a last resort return to Block Diagram 4 and consider the other possibilities shown.

Troubleshooting Help

Block Diagram 4

Test Equipment

Signature Analyzer HP 5005A

Data Transmission Test

The Data Transmission Test verifies transmission of data from the Microprocessor to the HP-IB General Purpose Interface Adapter A11U16.

1. Connect the signature analyzer as follows:

GND	GND (See Note below)
CLK	E (A11TP11, refer to Service Sheet 19)
START	SA1 (A11TP7, refer to Service Sheet 18)
STOP	SA2 (A11TP8, refer to Service Sheet 18)

NOTE

Connect to ground as close as possible to the circuitry being probed. Bad grounding can cause unstable signatures.

2. Set the signature analyzer's controls as follows:

START	Positive Edge
STOP	Negative Edge
CLK	Negative Edge

3. Set up the Signal Generator as follows:

- a. Disconnect attenuator ribbon cable W11 from A10J3 on the Audio/Power Supply Assembly (refer to Service Sheet 8).
- b. Set switch A11S1B to the L/K position (refer to Service Sheet 17).
- c. Set switch A11S1A to the DSA position (refer to Service Sheet 17).

NOTE

If the Signal Generator's HP-IB address switch has been set to anything other than address 07, the signatures taken in this test will be incorrect. In this case, reset the address switches to A1=1, A2=1, A3=1, A4=0, and A5=0. Refer to paragraph 2-7 "HP-IB Address Selection" in Section 2 for the procedure to change the HP-IB address switches.

4. Briefly connect A11TP4 (NMI) to A11TP3 (GND) (refer to Service Sheet 17).

NOTE

With careless probing it is possible to get the Microprocessor into a program sequence other than that portion intended for signature analysis. If the +5V signature is incorrect, this has probably happened. Restart the test by briefly connecting A11TP12 (RESET) to A11TP3 (GND). Then briefly connect A11TP4 (NMI) to A11TP3 (GND).

5. Connect the signature analyzer probe to each node indicated in Table 1. Verify that each signature is correct and stable.

Table 1. Interface Signatures.

Node	Correct Signature
-5V	H6H5
U12#19	39A7
U16#4	6514
U16#7	69F8
U16#8	0444
U16#9	36A9
U16#10	FF2C
U16#11	U939
U16#12	P71U
U16#13	FH9F
U16#14	652F

6. If troubleshooting is completed and the signatures are taken, reset switch A11S1B back to the R/R position, and switch A11S1A back to the DIAG position.

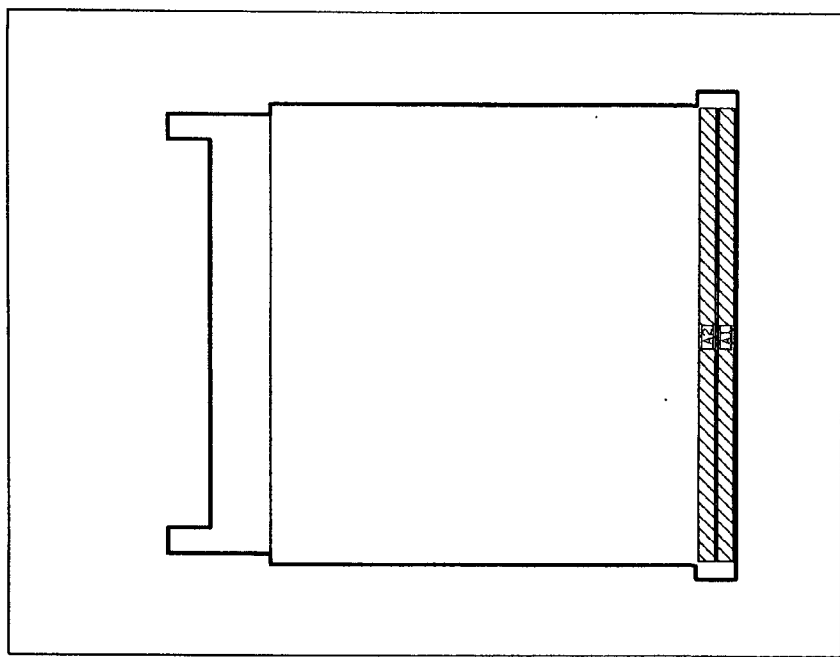
Reconnect attenuator ribbon cable W11 to A10J3.

Reset the Signal Generator by pressing the **SHIFT** key, and then pressing the **0** key.

If the HP-IB address switch was changed, reset the address switch to the original address. Then, set the front-panel **POWER** switch to **STBY** and back to **ON**.

A11 Component Coordinates

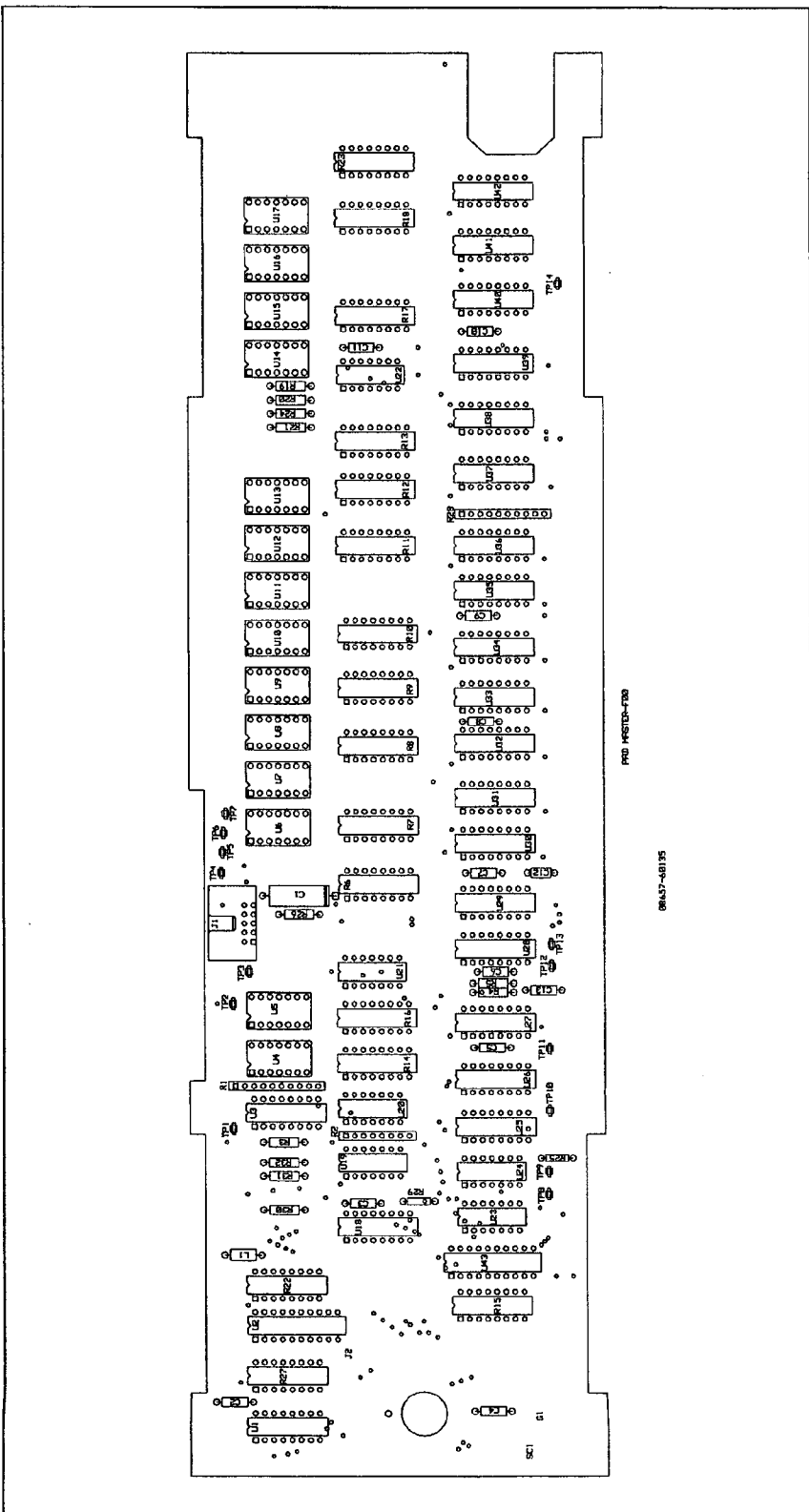
COMP	X,Y	COMP	X,Y	COMP	X,Y	COMP	X,Y	COMP	X,Y
BT1	A,3	R6	B,1	U10	B,3				
		R7	B,1	U11	B,1				
C1	D,1	R8	C,1	U12	B,1				
C2	C,3	R10	B,2	U13	B,2				
C3	A,2	R11	B,2	U14	B,2				
C4	D,1	R12	B,1	U15	B,3				
C5	A,2	R13	C,1	U16	C,1				
C6	A,3	R14	D,2	U17	C,2				
C7	A,2	R15	C,1	U18	C,3				
C8	A,2	R16	C,1	U19	C,3				
C9	A,3	R17	A,2	U20	C,2				
C10	B,2	R18	B,1	U21	C,2				
C11	B,1	R19	B,1	U22	C,3				
C13	B,3	R20	B,1	U23	C,3				
C14	C,1	R21	B,1	U24	D,1				
C15	C,2	R22	B,1	U25	D,2				
C16	B,3	R23	A,3	U27	D,3				
C17	C,3			U28	D,2				
C18	B,1	S1	C,2	U29	D,2				
C19	D,3	S2	D,2	U30	D,3				
C20	C,1	S3	D,2	U31	D,3				
C21	C,1								
C22	B,3	TP1	A,1	VR1	B,1				
C24	B,3	TP2	A,2						
C25	A,2	TP3	B,2	XU5	B,2				
		TP4	B,3	XU9	B,3				
CR1	B,1	TP5	B,3	XU16	C,1				
CR2	B,3	TP6	C,2						
		TP7	C,3	Y1	B,3				
J1	A,1	TP8	C,3						
J2	A,3	TP9	C,3						
J3	B,2	TP10	C,3						
J4	D,1	TP11	C,3						
J5	D,2	TP12	B,1						
		TP13	D,3						
MP1	D,3	TP14	D,2						
Q1	A,2	U1	A,1						
Q2	A,1	U2	A,2						
		U3	A,2						
R1	D,3	U4	B,1						
R2	C,3	U5	B,2						
R3	D,1	U6	B,1						
R4	B,1	U8	B,2						
R5	D,1	U9	B,3						



NOTES

1. For an explanation of schematic symbols, see "SCHEMATIC DIAGRAM NOTES" in Section 8.
2. A1 chassis ground is achieved by A1J1-16 connection and mechanical contact through nuts holding PC board to frame.
3. A2 chassis ground is achieved by A2J1-1 connection and mechanical contact through nuts holding PC board to frame.
4. Second functions (blue) are activated by first pressing the blue "Shift" key.
5. Pressing "Shift" and then "DIAG" (Incr Set) activates the keyboard invoked tests. These tests are referred to in troubleshooting procedures.
6. Feeder capacitor is part of W16P4 and is not separately replaceable.

LOGIC LEVELS	
OPEN	LOW
CLOSED	HIGH
IS MORE POS. THAN	
IS MORE NEG. THAN	
IS MORE POS. THAN	
IS MORE NEG. THAN	



P/O A11 HP-18 INTERFACE SS20
SEE REVERSE SIDE

Component Locator

Figure 2. Service Sheet 21 Information

P/O A11 MICROPROCESSOR/MEMORY/HP-IB ASSEMBLY (08657-68200)

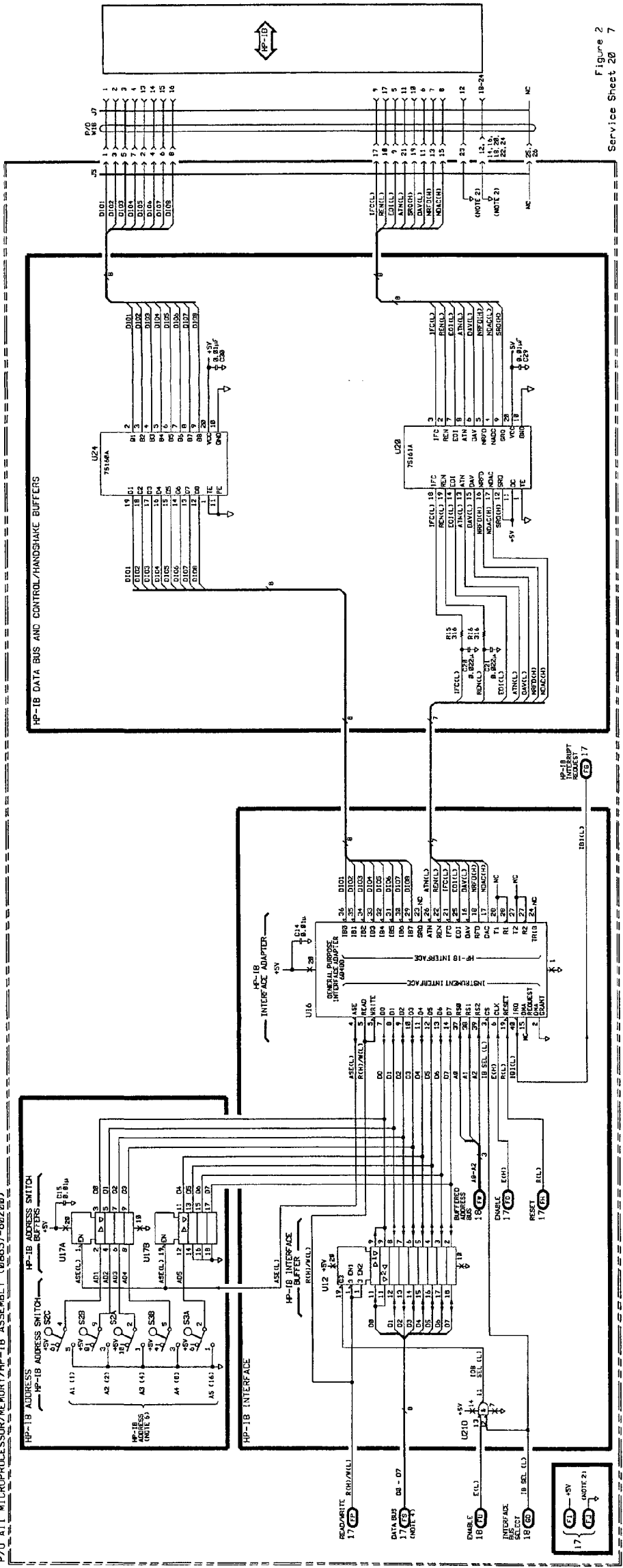


Figure 2
Service Sheet 20 7

Service Sheet 21

KEYBOARD AND ENCODER

PRINCIPLES OF OPERATION

Keyboard Encoding (A1 and A2)

The Keyboard Assembly, A1, is composed of 48 pushbuttons or keys. They are hard-wired in an 8-row by 6-column matrix. With no keys pressed, each of the 8-row lines are pulled high (+5V) through an 470 ohm resistor and each of the 6-column lines are pulled low (0V) through an 820 ohm resistor. The resultant keyboard data is shown in Table 1.

Whenever a key is pressed, a row line is connected to a column line through the dividing network of the 470 ohm and 820 ohm resistors (located on the Display Assembly A2). As long as the key remains pressed, the column line remains high and the keyboard interrupt remains issued to the Microprocessor by the Keyboard Interrupt Generator U19.

When the Microprocessor is interrupted, it enters its keyboard-read subroutine. A 5 μ s keyboard strobe (KSTB1) is decoded (refer to Service Sheet 22) to strobe the high bit found on Col 1 through Col 6 into the Key Column Data Latch/Shift Register U18. The column data consists of seven low bits and one high bit (refer to Table 1 and Service Sheet 21). The high bit is in the bit position that is associated with the column position of the pressed key.

Table 1. Keyboard Data (KDA) With No Keys Pressed.

Column Data (A2U18)									Row Data (A2U3)							
Pin Number	11	12	13	14	3	4	5	6	11	12	13	14	3	4	5	6
Bit Position	15*	14*	13	12	11	10	9	8	7	6	5	4	3	2	1	0
Keyboard Data	0	0	0	0	0	0	0	0	1	1	1	1	1	1	1	1

*Bits 14 and 15 (U18 pins 11 and 12) are hard-wired low.

Once the column data is latched, the Microprocessor issues a Read Key Row Data (RKRD) signal (refer to Service Sheet 24) forcing all 6-column lines low so that the row data can be read. When the column lines are all forced low, the row line associated with the pressed key is also forced low. (Forcing the column lines low also disables the keyboard interrupt.) Next, another 5 μ s keyboard strobe (KSTB2) is decoded (refer to Service Sheet 22) to strobe Row 1 through Row 8 into the Key Row Data Latch/Shift Register U3. The row data consists of seven high bits and one low bit. The low bit is in the bit position that is associated with the row of the pressed key. Once the row data is latched, the Microprocessor clears RKRD.

The Microprocessor is now ready to receive keyboard data via the Serial Keyboard Data line (KDA). A parallel-to-serial conversion takes place as each row bit is shifted out of U3 (pin 9), and each column bit is shifted out of U18 (pin 9) into U3 (pin 10). After 16 keyboard clocks (KCL), all 16 bits of keyboard data is shifted to the Microprocessor. If the **FREQUENCY** key had been pressed, the resultant keyboard data sent to the Microprocessor would be as shown in Table 2.


Decoupling

Capacitors C1 through C10 filter the +5V supply to the Display Assembly circuitry.

Table 2. Keyboard Data (KDA) With Frequency Key Pressed.

Column Data (A2U18)									Row Data (A2U3)							
Pin Number	11	12	13	14**	3	4	5	6	11	12**	13	14	3	4	5	6
Bit Position	15*	14*	13	12**	11	10	9	8	7	6**	5	4	3	2	1	0
Keyboard Data	0	0	0	1**	0	0	0	0	1	0**	1	1	1	1	1	1
*Bits 14 and 15 (U18 pins 11 and 12) are hard-wired low. **Pressed key location.																

TROUBLESHOOTING

Troubleshooting is done on the circuits of Service Sheet 21 when a malfunction seems to have occurred on the keyboard or display. Perform the Troubleshooting Using Signature Analysis on Service Sheets 17, 18, and 19 before attempting to troubleshoot these circuits using this procedure. Procedures for checking the A1 Keyboard Assembly, and part of the A2 Display Assembly are given below. The areas or points to check are marked on the schematic by a hexagon with a checkmark and a number inside, for example, .

Troubleshooting Help

- Block Diagram 4
- Table 4-1. Abbreviated Performance Tests
- Table 5-2. Post-Repair Adjustments

Test Equipment

Oscilloscope	HP 54100A
Oscilloscope Active Probe	HP 54001A

Keyboard Interrupt and Serial Keyboard Data Output to Microprocessor

1. Press any front-panel key.
2. Verify that a negative going TTL pulse occurs at A2TP5 (KIN) each time a key is pressed.
3. Verify that at least one pulse train about 16-bits long occurs at A2TP4 (KDA).

Control Inputs from Microprocessor

1. Press any front-panel key.
2. Verify that a series of keyboard clock pulses appear on A2TP6 (KCL).
3. Verify that keyboard strobes appear on A2TP11 (RKRD), A2TP10 (KSTB 1), and A2TP2 (KSTB 2). Note that the signal on A2TP11 comes from the Amplitude Annunciator Latch A2U43 (shown on Service Sheet 24). The strobes for A2U43 as well as the strobes seen on A2TP10 and A2TP2 come from the strobe decoders A2U25 (shown on Service Sheet 22).

Key Column Data Lines

1. Press a front-panel key.
2. Verify that the column data line which includes the pressed key is a positive-going pulse. The other column data lines should remain low.

Key Row Data Lines

1. Press a front-panel key.
2. Verify that the row data line that includes the pressed key is a negative-going pulse. The other row data lines should remain high.

TROUBLESHOOTING USING KEYBOARD-INVOKED TEST

Troubleshooting is done on the circuits of Service Sheet 21 when a defect seems to be related to the keyboard. If nothing definite is discovered in performing the keyboard-invoked test or signature analysis on this service sheet, consider the other possibilities shown on Service Sheet BD4.

Remember that the serial data from the keyboard encoding circuits does pass through the data bus buffers on the way to the Microprocessor (refer to Service Sheet 17). Also, several of the strobes, clocks, and control signals are decoded on the circuits of Service Sheet 18. The Load Keyboard Data Strobes are decoded on the circuits of Service Sheet 22. The Read Key Row Data Strobe is latched into A2U43 and is shown coming from Service Sheet 24.

Refer to the paragraph 8-8 entitled "REPAIR" for front-panel keyboard disassembly instructions.

Keyboard-Invoked Test Procedure

The Keyboard-Invoked Test verifies transmission of encoded addresses from Keyboard to Microprocessor.

The front-panel keyboard can be checked by entering the Keyboard-Invoked Test subroutine Test 4. This test allows for checking of the actual code which the Microprocessor (A11U9) sees when individual keys are pressed. Running this test will verify correct operation of the front-panel and supporting circuitry to the Microprocessor or will identify two problem areas as follows:

If the key code is incorrect when any front-panel key is pressed, but the last key code shown in the FREQUENCY Display remains, then the last pressed key is at fault.

If the key code is incorrect when any front-panel key is pressed, then the supporting circuitry to the Microprocessor is at fault (refer to Service Sheets 17 and 21).

1. Enter the Keyboard-Invoked Tests by first pressing the **SHIFT** key, and then pressing the **INCR SET** key. A "1" should be shown in the MODULATION Display window.
2. Press the **AMPTD** \uparrow key until a "4" is shown in the MODULATION Display window. Test 4, Keyboard Key Test, is ready to run.
3. Press the **INCR SET** key to start the test. A "26" should be shown in the FREQUENCY Display window.
4. Use Table 3, Keyboard Key Codes, to verify keyboard operation.
5. Whenever the **AMPTD** \uparrow or \downarrow key is pressed it is understood that the test is to be exited. A "00" is shown in the AMPLITUDE Display window, and the correct key code is shown in the FREQUENCY Display window. If the test was not meant to be exited, pressing the **INCR SET** key will immediately reinvoke Test 4.
6. To exit the Keyboard-Invoked Tests, press the **AMPTD** \uparrow key until a "7" is shown in the MODULATION Display window. Then press the **INCR SET** key; the Signal Generator is initialized as in Power-On.

Table 3. Keyboard Key Codes.

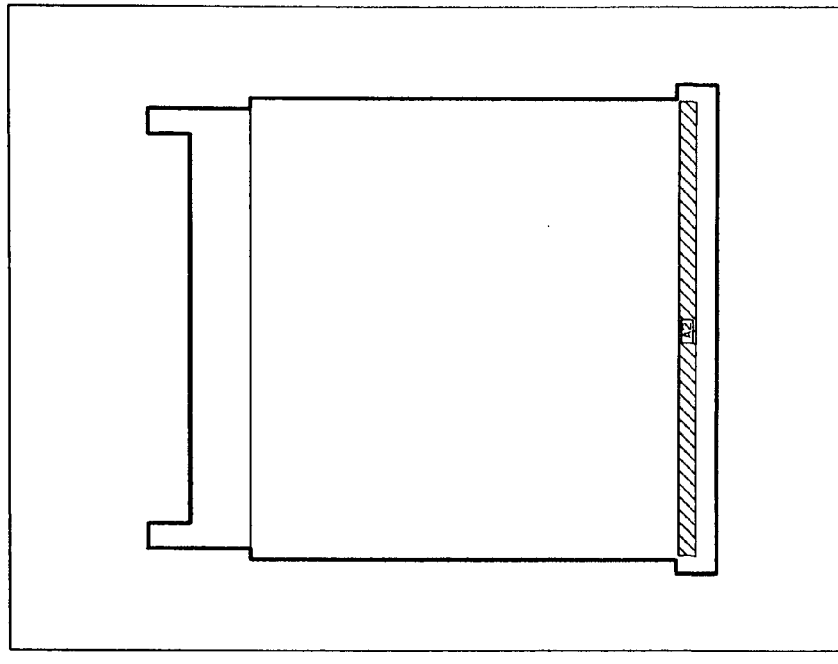
Value Decimal	Key Name	Value Decimal	Key Name
01	RF OFF/ON	25	0
02	LOCAL	26	INCR SET
03	RECALL	27	1
04	μ V	28	DOWN AMPT (.)
05	STORE	29	4
06	mV	30	UP AMPT (^)
07	SEQ	31	7
08	V	32	AMPTD
09	EMF	33	DOWN FM (.)
10	.	34	FINE TUNE
11	dB	35	DOWN FREQ (.)
12	%	36	UP FREQ (^)
13	dBf	37	COARSE TUNE
14	kHz	38	UP FM (^)
15	dBm	39	FREQUENCY
16	MHz	40	FM
17	—	41	DOWN AM (.)
18	.	42	OFF
19	3	43	SHIFT
20	2	44	INT 1 kHz
21	6	45	UP AM (^)
22	5	46	INT 400 Hz
23	9	47	AM
24	8	48	EXT

A2 Component Coordinates

COMP	X,Y	COMP	X,Y	COMP	X,Y	COMP	X,Y	COMP	X,Y
C1	B,3	R27	A,3	U22	D,2				
C2	A,3	R28	C,1	U23	A,1				
C3	A,2	R29	A,2	U24	A,1				
C4	A,1	R30	A,3	U25	A,1				
C5	B,1	R31	A,3	U26	B,1				
C6	B,1	R32	A,3	U27	B,1				
C7	B,1			U28	B,1				
C8	C,1	S1	A,1	U29	B,1				
C9	C,1			U30	B,1				
C10	D,1	TP1	A,3	U31	B,1				
C11	D,2	TP2	B,3	U32	C,1				
C12	B,1	TP3	B,3	U33	C,1				
C13	B,1	TP4	B,3	U34	C,1				
		TP5	B,3	U35	C,1				
J1	B,3	TP6	B,3	U36	C,1				
J2	A,2	TP7	B,3	U37	C,1				
		TP8	A,1	U38	C,1				
L1	A,3	TP9	A,1	U39	D,1				
		TP10	B,1	U40	D,1				
R1	B,3	TP11	B,1	U41	D,1				
R2	A,2	TP12	B,1	U42	D,1				
R3	A,3	TP13	B,1	U43	A,1				
R4	B,1	TP14	D,1						
R5	B,1								
R6	B,2	U1	A,3						
R7	B,2	U2	A,3						
R8	C,2	U3	B,3						
R9	C,2	U4	B,3						
R10	C,2	U5	B,3						
R11	C,2	U6	B,3						
R12	C,2	U7	B,3						
R13	C,2	U8	C,3						
R14	B,2	U9	C,3						
R15	A,1	U10	C,3						
R16	B,2	U11	C,3						
R17	D,2	U12	C,3						
R18	D,2	U13	C,3						
R19	D,3	U14	D,3						
R20	D,3	U15	D,3						
R21	C,3	U16	D,3						
R22	A,3	U17	D,3						
R23	D,2	U18	A,2						
R24	C,3	U19	A,2						
R25	A,1	U20	B,2						
R26	B,3	U21	B,2						

Service

Model 8657A



NOTES

1. For an explanation of schematic symbols, see "SCHEMATIC DIAGRAM NOTES" in Section 8.
2. Chassis ground is achieved by A2J1-1 connection and mechanical contact through nuts holding PCB board to frame.
3. Display data bus (DDP-007) is positive true for numeric data, sign and annunciator data.

LOGIC LEVELS

LOGIC	TRUE
LOW	0
HIGH	1
OPEN	XXXX
UNKNOWN	ZZZ

P/O A1, A2
SEE REVERSE SIDE

SS21

Service Sheet 22

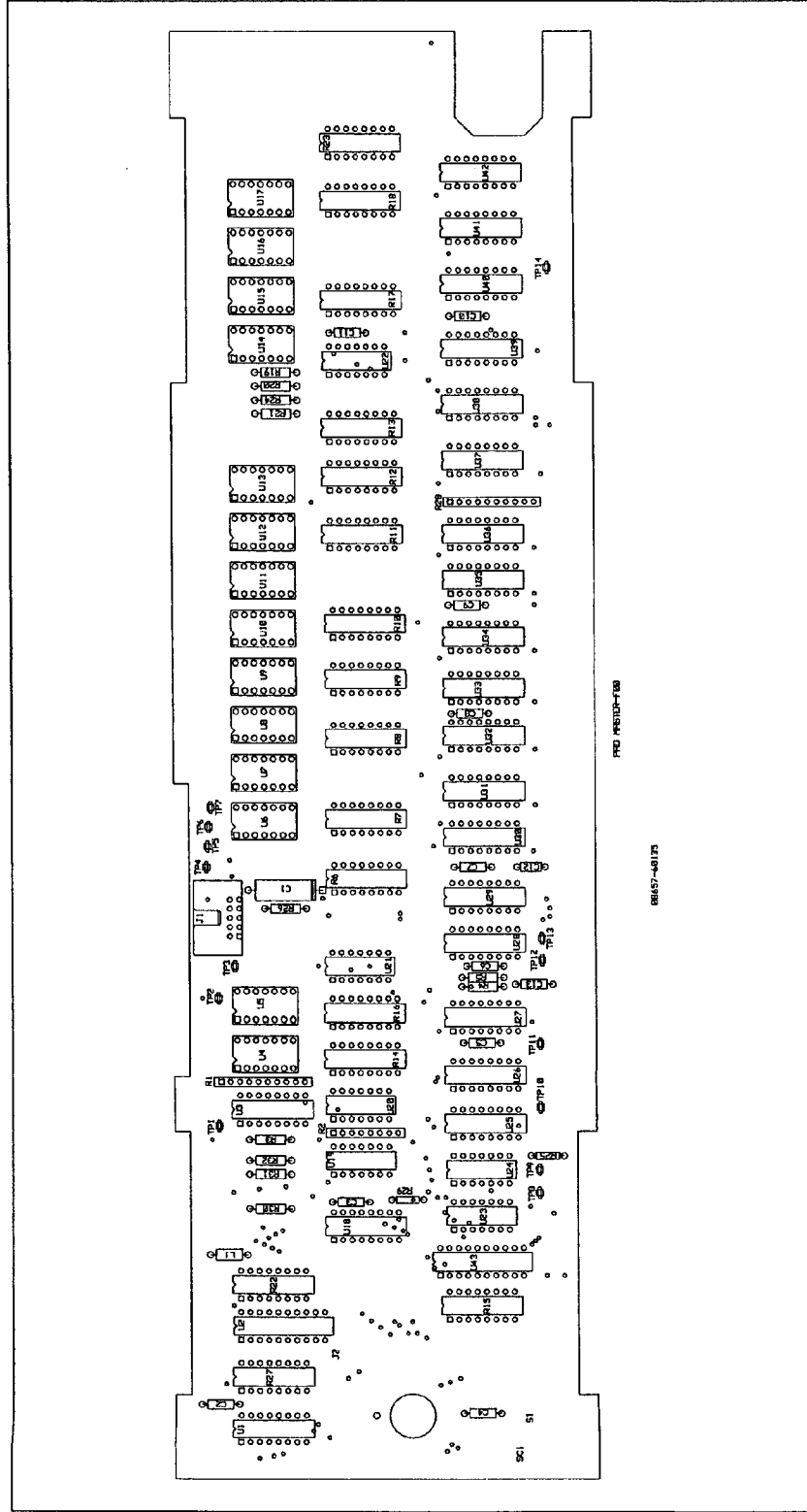


Figure 8. Service Sheet 22 Information

Component Locator

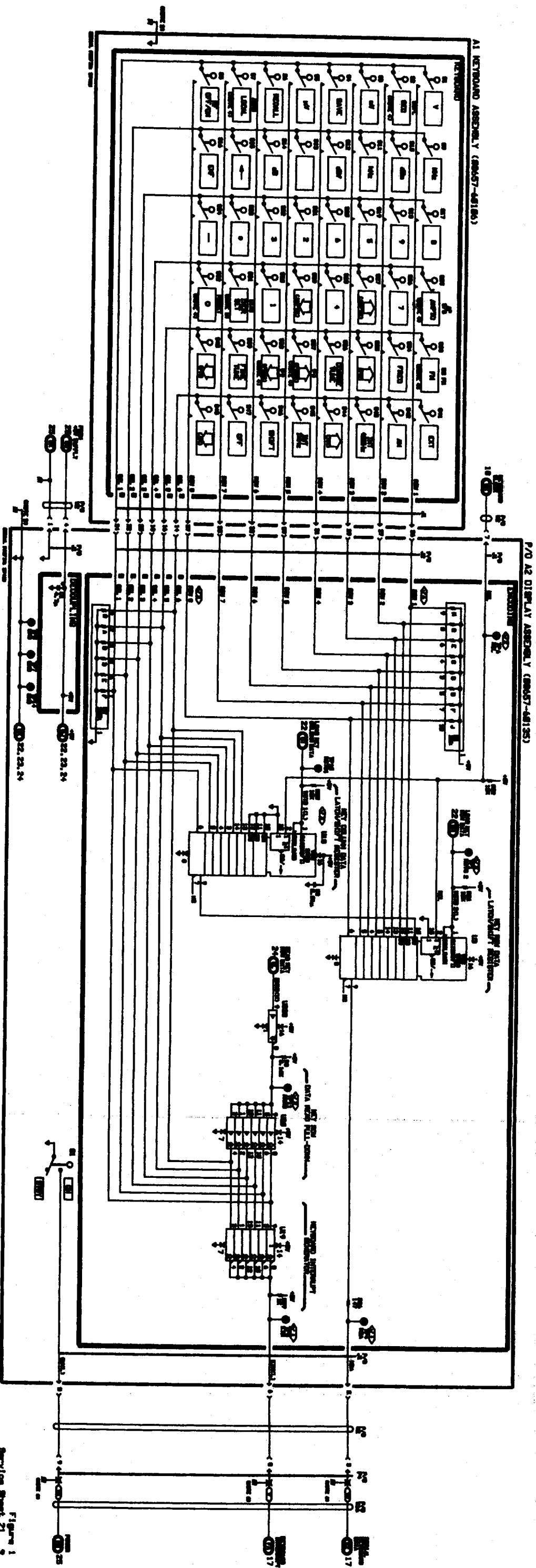


Figure 1
Service Sheet 21 9

Service Sheet 22

DISPLAY CONTROL

PRINCIPLES OF OPERATION

Display Control

Sixteen bits of serial display data (DDA) are sent from the Microprocessor via the Serial I/O control circuits (refer to Service Sheet 18) to Display Data Shift Registers U24 and U23 respectively. Six of the eight bits stored in U24 are decoded to produce twelve display strobes (DSTB1 through DSTB12) and two keyboard strobes (KSTB1 and KSTB2). DSTB1 through DSTB3 are used to strobe modulation display data (refer to Service Sheet 24), DSTB5 through DSTB8 and DSTB12 are used to strobe frequency display data (refer to Service Sheet 23), DSTB8 through DSTB11 are used to strobe amplitude display data (refer to Service Sheet 24), and the two keyboard strobes (KSTB1 and KSTB2) are used to strobe column and row data from the keyboard (refer to Service Sheet 21). Strobe decoding takes place in the Display and Keyboard Strobe Decoders U26 and U25. The decoder outputs remain high until all 16 bits of display data are shifted in and settled.

Display data is shifted into the two shift registers by the display clock (DCL). Each transition of the display clock triggers U28A which forms part of the Serial Data Entry Timing Control circuitry. This circuitry is used to ensure that the data has at least 72 μ s to settle after the last clock pulse clocks the sixteenth data bit into U24. When U28A times out, it clocks U28B which goes high for 5 μ s to cause the bits stored in U24 to be decoded. During the period that the strobe is active (low), the display data stored in U23 will be decoded and latched to drive the respective 7-segment display or LED annunciator (refer to Service Sheets 23 and 24).

Frequency display decimal point drive is developed when display data bits 2 through 7 (DD2-DD7) are strobed into the Frequency Display Decimal Point Latches U30 by DSTB4. The Microprocessor ensures that only one of these bits is active (low) at any given time (except during the power-up subroutine). When one of these bits is active (low), the associated decimal point control line (U6 through U11 pin 9) will be pulled high through the associated network resistor (R6A, R7A, R8A, R9A, R10A, and R11A) to light the respective decimal point (refer to Service Sheet 23). When the bits are inactive (high), the stored output will be inverted by the associated Frequency Display Decimal Point Driver U21B through U21G. This will cause the associated decimal point control line (U6 through U11 pin 9) to be pulled low to inhibit the respective decimal point from being lit.

TROUBLESHOOTING

Troubleshooting is done on the circuits of Service Sheet 22 when a malfunction seems to have occurred in the keyboard or display. Perform the Troubleshooting Using Signature Analysis on Service Sheets 17, 18, and 19 as well as the Troubleshooting on Service Sheet 21 before attempting to troubleshoot these circuits using this procedure. Procedures for checking part of the A2 Display Assembly circuits are given below. The area or points to check are marked on the schematic by a hexagon with a check mark and a number inside, for example, $\checkmark 1$.

Test Equipment

Oscilloscope HP 54100A
 Oscilloscope Active Probe HP 54001A

$\checkmark 1$ **Display Clocks**

1. Verify that the display changes and/or the correct strobe occurs with each keystroke as shown in Table 1.

Table 1. Active Display Strobe versus Change in Displayed Information.

Display Strobe	Change in Displayed Information
DSTB1	HP-IB annunciators REMOTE or ADDRESS Modulation decimal point Modulation annunciators % or kHz DC FM annunciator
DSTB2	Modulation annunciators: EXT AM, INT AM, EXT FM, INT FM, HI EXT, LO EXT, 400 Hz or 1 kHz
DSTB3	Modulation digits 1 or 2
DSTB4	Frequency decimal point
DSTB5	Frequency digit 1 or 2
DSTB6	Frequency digit 3 or 4
DSTB7	Frequency digit 5 or 6
DSTB8	Frequency digit 7 or amplitude digit 2
DSTB9	Amplitude digit 3 or 4
DSTB10	Amplitude digit 1, amplitude digit decimal point or the amplitude sign (plus or minus)
DSTB11	Amplitude annunciators: dBm, dBf, dB, EMF, V, mV, or μ V or RKRD* (Read Key Row Data)
DSTB12	Frequency digit 8
KSTB1	any key*
KSTB2	any key*

*DSTB11 (due to RKRD). KSTB1 and KSTB2 are strobed each time a key is pressed.

$\checkmark 2$ **Serial Data Entry and Timing**

1. Verify that U28B pin 5 goes high for 5 μ s but 72 μ s after the last clock pulse ends.
2. Verify that a clock pulse train occurs at A2TP3 (DCL) for each keystroke.

TROUBLESHOOTING USING SIGNATURE ANALYSIS

Troubleshooting is done on the circuits of Service Sheet 22 when a defect seems to be related to the front-panel displays or keyboard operation. The troubleshooting provided is signature analysis although looking at the various displays or realizing that the problem is due to a keyboard malfunction may provide more information about a possible defect. If all the signatures on this service sheet are correct, take another look at the symptoms which brought you to this service sheet. Determine if the problem may be related to circuitry contained on Service Sheets 21, 23 or 24. If any signatures on this service sheet are incorrect, recall that the data and strobes, clocks, and other control signals are passed through circuitry of Service Sheet 18 before arriving here. As a last resort, return to Block Diagram 4 and consider the other possibilities shown.

Test Equipment

Signature Analyzer HP 5005A

Test 1. Display Data Transmission Check

The Display Data Transmission Check verifies transmission of encoded display data from the Microprocessor to the Display Address and Display Data Shift Registers.

1. Connect the signature analyzer as follows:

GND	GND (A11TP3, refer to Service Sheet 17)
CLK	SA4 (A11TP10, refer to Service Sheet 18)
START	SA5 (A11TP13, refer to Service Sheet 18)
STOP	SA5 (A11TP13, refer to Service Sheet 18)

2. Set the signature analyzer's controls as follows:

START	Negative Edge
STOP	Positive Edge
CLK	Negative Edge

3. Set up the Signal Generator as follows:

- a. Set switch A11S1B to the L/K position (refer to Service Sheet 17).
- b. Set switch A11S1A to the DSA position (refer to Service Sheet 17).
- c. Connect a jumper from T02 (A2TP12) to ground (refer to Service Sheet 22).
- d. Connect a jumper between SA6 (A11TP14, refer to Service Sheet 18), and SA7 (A2TP9, refer to Service Sheet 22).

NOTE

If the Signal Generator's HP-IB address switch has been set to anything other than 07, the signatures taken in this test will be incorrect. In this case, reset the address switches to A1=1, A2=1, A3=1, A4=0 and A5=0. Refer to paragraph 2-7 "HP-IB Address Selection" in Section 2 for the procedure to change the address switches.

4. Briefly connect A11TP4 (NMI) to A11TP3 (GND) (refer to Service Sheet 17).

NOTE

With careless probing it is possible to get the Microprocessor into a program sequence other than that portion intended for signature analysis. If the +5V signature is incorrect, this has probably happened. Restart the test by briefly connecting A11TP12 (RESET) to A11TP3 (GND). Then connect A11TP4 (NMI) to A11TP3 (GND).

5. Connect the signature analyzer probe to each node shown in Table 2 and verify that each signature is correct and stable.

Table 2. Display Data Signatures.

Node	Correct Signature	Comments
+5V	F84P	
U24#8*	F84P	DISP CLK
U24#1	6UPP	DISP DATA
U24#3	8A0H	
U24#4	HCH1	
U24#5	F06F	
U24#6	F672	
U24#10	05C8	
U24#11	2235	
U24#12	6UH4	
U24#13	37PA	
U23#3	2UAU	
U23#4	7241	
U23#5	P6U4	
U23#6	A161	
U23#10	890U	
U23#11	FH78	
U23#12	C382	
U23#13	7758	

*Probe tip should blink.

6. If troubleshooting is completed and the signatures are taken, reset switch A11S1B back to the R/R position, and switch A11S1A back to the DIAG position.

Disconnect the jumper from T02 (A2TP12) to ground, and disconnect the jumper between SA6 (A11TP14) and SA7 (A2TP9).

If the HP-IB address switch was changed, reset the address switch (refer to Service Sheet 20) to the original address.

Reset the Signal Generator by pressing the **SHIFT** key, and then pressing the **0** key.

Test 2. Display Strobe Data Transmission and Decoder Check

The Display Strobe Data Transmission and Decoder Check verifies transmission of encoded display strobe data from the Microprocessor through the Display Strobe Decoders.

1. Connect the signature analyzer as follows:

CLK E (A11TP11, refer to Service Sheet 19)
 START SA1 (A11TP7, refer to Service Sheet 18)
 STOP SA2 (A11TP8, refer to Service Sheet 18)

2. Set the signature analyzer's controls as follows:

START Positive Edge
 STOP Negative Edge
 CLK Negative Edge

3. Set up the Signal Generator as follows:

- a. Set switch A11S1B to the L/K position (refer to Service Sheet 17).
- b. Set switch A11S1A to the DSA position (refer to Service Sheet 17).

4. Connect a jumper between T02 (A2TP12) and ground (refer to Service Sheet 22).

- a. Connect a jumper between SA6 (A11TP14, refer to Service Sheet 18), and SA7 (A2TP9, refer to Service Sheet 22).

NOTE

If the Signal Generator's HP-IB address switch has been set to anything other than 07, the signatures taken in this test will be incorrect. In this case, reset the address switches to A1=1, A2=1, A3=1, A4=0 and A5=0. Refer to paragraph 2-7 "HP-IB Address Selection" in Section 2 for the procedure to change the address switches.

5. Briefly connect A11TP4 (NMI) to A11TP3 (GND) (refer to Service Sheet 17).

NOTE

With careless probing, it is possible to get the Microprocessor into a program routine other than that portion intended for signature analysis. If the +5V signature is incorrect, this has probably happened. Restart the test by briefly connecting A11TP12 (RESET) to A11TP3 (GND). Then briefly connect A11TP4 (NMI) to A11TP3 (GND). All LEDs should be cycling on and off rapidly.

6. Connect the signature analyzer probe to each node shown in Table 3 and verify that each signature is correct and stable.
7. If troubleshooting is completed and the signatures are taken, reset switch A11S1B back to the R/R position, and switch A11S1A back to the DIAG position.

Disconnect the jumper from T02 (A2TP12) to ground, and disconnect the jumper between SA6 (A11TP14) and SA7 (A2TP9).

If the HP-IB address switch was changed, reset the address switch (refer to Service Sheet 20) to the original address.

Reset the Signal Generator by pressing the **SHIFT** key, and then pressing the **0** key.

Table 3. Display and Keyboard Strobe Signatures.

Node	Correct Signature*	Comments
+5V	H6H5	
U26#7	C524	
U26#9	FU10	
U26#10	66UF	
U26#11	1F0A	
U26#12	5A73	
U26#13	P3HA	
U26#14	A128	
U26#4	FP00	
U26#6	H6H5	no blink
-5V	H6H5	
U25#9	H161	
U25#10	CP72	
U25#11	93AH	
U25#12	PH45	
U25#13	FF4P	
U25#14	8H64	
U25#4	FP00	
U25#6	H6H5	no blink

*Probe tip should blink.

Test 3. Decimal Point Data Transmission Check

The Decimal Point Data Transmission Check verifies transmission of encoded decimal point data from the Microprocessor to the Frequency Display Decimal Point Latch.

1. Connect the signature analyzer as follows:

GND GND (A11TP3, refer to Service Sheet 17)
 START SA5 (A11TP13, refer to Service Sheet 18)
 STOP SA5 (A11TP13, refer to Service Sheet 18)
 CLK SA4 (A11TP10, refer to Service Sheet 18)

2. Set the signature analyzer's controls as follows:

START Negative Edge
 STOP Positive Edge
 CLK Negative Edge

3. Set up the Signal Generator as follows:

- a. Set switch A11S1B to the L/K position (refer to Service Sheet 17).
- b. Set switch A11S1A to the DSA position (refer to Service Sheet 17).
- c. Connect a jumper between T02 (A2TP12) and ground (refer to Service Sheet 22).
- d. Connect a jumper between SA6 (A11TP14, refer to Service Sheet 18), and SA7 (A2TP9, refer to Service Sheet 22).

NOTE

If the Signal Generator's HP-IB address switch has been set to anything other than 07, the signatures taken in this test will be incorrect. In this case, reset the address switches to A1=1, A2=1, A3=1, A4=0 and A5=0. Refer to paragraph 2-7 "HP-IB Address Selection" in Section 2 for the procedure to change the address switches.

4. Briefly connect A11TP4 (NMI) to A11TP3 (GND) (refer to Service Sheet 17).

NOTE

With careless probing, it is possible to get the Microprocessor into a program routine other than that portion intended for signature analysis. If the +5V signature is incorrect, this has probably happened. Restart the test by briefly connecting A11TP12 (RESET) to A11TP3 (GND). Then briefly connect A11TP4 (NMI) to A11TP3 (GND). All LEDs should be cycling on and off rapidly.

5. Connect the signature analyzer probe to each node shown in Table 4 and verify that each signature is correct and stable.

Table 4. Decimal Point Signatures.

Node	Correct Signature	Comments
+5V	F84P	
U30#2	F9H9	FR DP 3
U30#5	8C19	FR DP 2
U30#7	54PH	FR DP 1
U30#10	7903	FR DP 4
U30#12	A44F	FR DP 5
U30#15	5FC5	FR DP 6

6. If troubleshooting is completed and the signatures are taken, reset switch A11S1B back to the R/R position, and switch A11S1A back to the DIAG position.

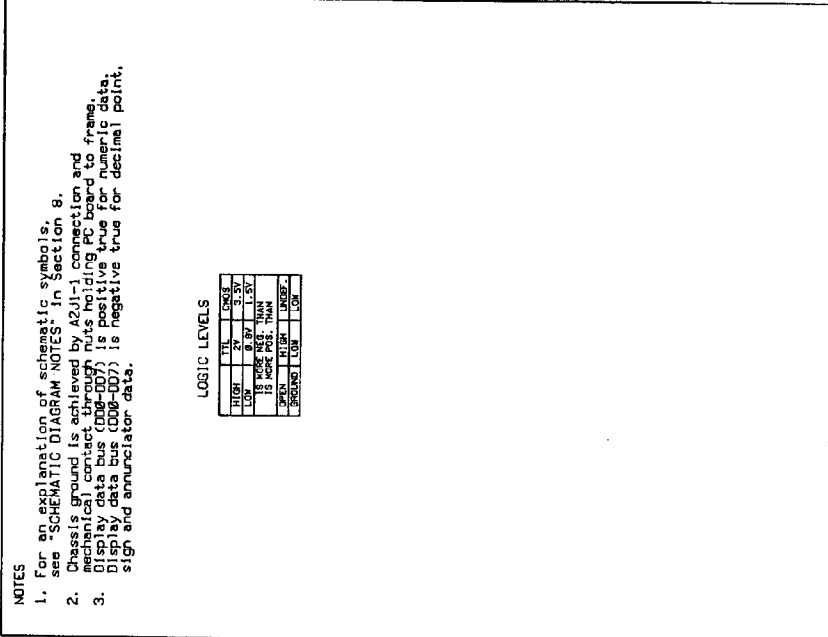
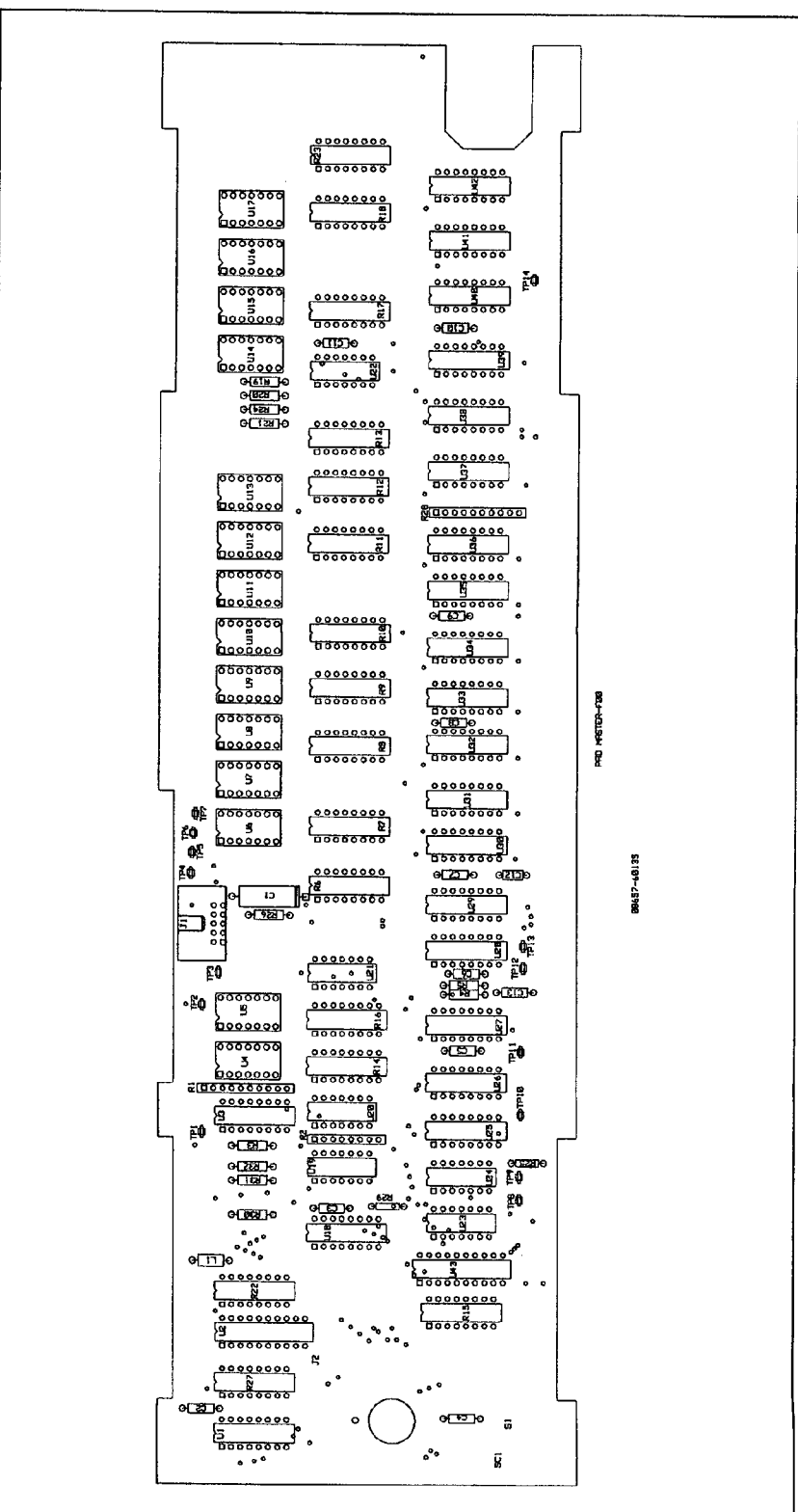
Disconnect the jumper from T02 (A2TP12) to ground, and disconnect the jumper between SA6 (A11TP14) and SA7 (A2TP9).

If the HP-IB address switch was changed, reset the address switch (refer to Service Sheet 20) to the original address.

Reset the Signal Generator by pressing the **SHIFT** key and then pressing the **0** key.

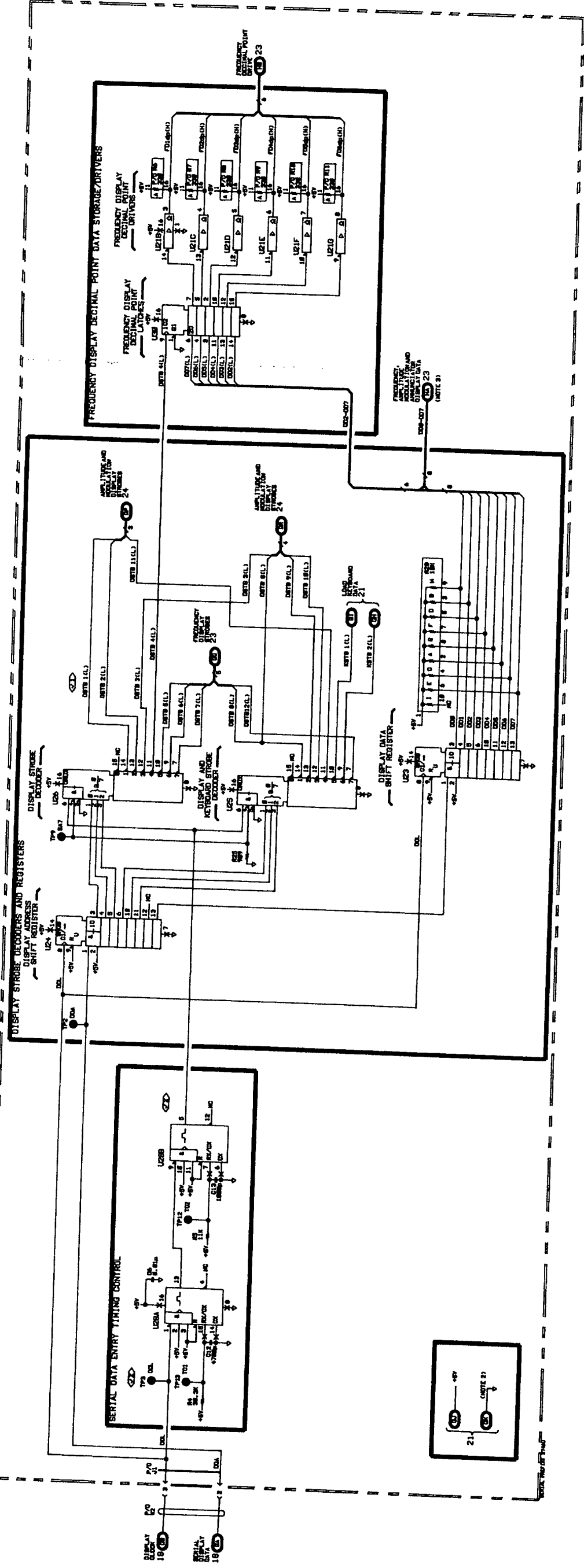
A2 Component Coordinates

COMP	X,Y	COMP	X,Y	COMP	X,Y	COMP	X,Y	COMP	X,Y
C1	B,3	R27	A,3	U22	D,2				
C2	A,3	R28	C,1	U23	A,1				
C3	A,2	R29	A,2	U24	A,1				
C4	A,1	R30	A,3	U25	A,1				
C5	B,1	R31	A,3	U26	B,1				
C6	B,1	R32	A,3	U27	B,1				
C7	B,1			U28	B,1				
C8	C,1	S1	A,1	U29	B,1				
C9	C,1			U30	B,1				
C10	D,1	TP1	A,3	U31	B,1				
C11	D,2	TP2	B,3	U32	C,1				
C12	B,1	TP3	B,3	U33	C,1				
C13	B,1	TP4	B,3	U34	C,1				
		TP5	B,3	U35	C,1				
J1	B,3	TP6	B,3	U36	C,1				
J2	A,2	TP7	B,3	U37	C,1				
		TP8	A,1	U38	C,1				
L1	A,3	TP9	A,1	U39	D,1				
		TP10	B,1	U40	D,1				
R1	B,3	TP11	B,1	U41	D,1				
R2	A,2	TP12	B,1	U42	D,1				
R3	A,3	TP13	B,1	U43	A,1				
R4	B,1	TP14	D,1						
R5	B,1								
R6	B,2	U1	A,3						
R7	B,2	U2	A,3						
R8	C,2	U3	B,3						
R9	C,2	U4	B,3						
R10	C,2	U5	B,3						
R11	C,2	U6	B,3						
R12	C,2	U7	B,3						
R13	C,2	U8	C,3						
R14	B,2	U9	C,3						
R15	A,1	U10	C,3						
R16	B,2	U11	C,3						
R17	D,2	U12	C,3						
R18	D,2	U13	C,3						
R19	D,3	U14	D,3						
R20	D,3	U15	D,3						
R21	C,3	U16	D,3						
R22	A,3	U17	D,3						
R23	D,2	U18	A,2						
R24	C,3	U19	A,2						
R25	A,1	U20	B,2						
R26	B,3	U21	B,2						



P/O A2 DISPLAY CONTROL SS22
SEE FIGURE SIZE

Figure 0. Service Sheet 23 Information Component Locator



Service Sheet 23

FREQUENCY DISPLAYS

PRINCIPLES OF OPERATION

General

Eight 7-segment, common-cathode devices U6 through U13 are used to display the frequency in megahertz. They are also used to display the frequency increment value, to display power-on error codes, and to display information for the keyboard-invoked tests. The decimal points associated with frequency digits 1 through 6 are the only decimal points that can be lit. The frequency display decimal point drive circuitry has been previously discussed (refer to Service Sheet 22). Frequency Digits 7 and 8 have their decimal point control line (U12 and U13 pin 9) tied low which inhibits them from being lit.

Eight Latch/Decoder/Drivers U31 through U38 decode frequency display data, store the decoded data, and drive the associated frequency display digit. The associated resistor networks R6 through R13 are used to limit the amount of drive current applied to the display digit. As previously mentioned 16 bits of serial display data are sent from the Microprocessor to the display circuitry (refer to Service Sheet 22). After a serial-to-parallel conversion, the eight most-significant bits are stored in the Display Data Shift Register U23, and the eight least-significant bits are stored in the Display Address Shift Register U24. Six of the eight display address bits are decoded to produce twelve display strobes and two keyboard strobes. Display strobes DSTB5 through DSTB8 and DSTB12 are used to strobe the frequency display data (DD0 through DD7) into the Latch/Decoder/Drivers. DSTB8 also strobes the display data for Amplitude Digit 2 at the same time it strobes the display data for Frequency Digit 7 (refer to Service Sheet 24). When a strobe is decoded, it will go low for 5 μ s to latch a half byte (4 bits) of frequency display data into the associated Latch/Decoder/Driver. Each Latch/Decoder/Driver is hard-wired to decode and drive the associated digit to display numerals 0 through 9, otherwise the digit remains blanked.

TROUBLESHOOTING

Troubleshooting is done on the circuits of Service Sheet 23 when a malfunction seems to be associated with the FREQUENCY Display. Determine if the malfunction occurs in single digits, pairs (such as frequency digits 1 and 2, 3 and 4, and 5 and 6, or multiple digits including the amplitude and/or modulation digits. If multiple digit displays are incorrect, be sure to:

1. Perform the Troubleshooting Using Signature Analysis on Service Sheets 17, 18.
2. Then, perform the Troubleshooting on Service Sheet 22.

If pairs of digits are incorrect, suspect the shift registers shown on Service Sheet 22. If single digits are incorrect, continue troubleshooting on this service sheet for amplitude or modulation display problems.

Procedures for checking part of the A2 Display Assembly circuits are given below. The area or points to check are marked on the schematic by a hexagon with a check mark and a number inside, for example,

⊠1 .

Test Equipment

Oscilloscope HP 54100A
 Oscilloscope Active Probe HP 54001A

⊠1 Frequency Display Digital Drive Levels versus Visual LED Outputs

1. Verify that the 7-segment drive logic levels from the Latch/Decoder/Drivers matches the visual output for the equivalent segment.
2. Verify that the decimal point drive from the latch and drivers (refer to Service Sheet 22) matches the visual decimal point output.

TROUBLESHOOTING USING SIGNATURE ANALYSIS

Troubleshooting is done on the circuits of Service Sheet 23 when a defect seems to be related to the RF FREQUENCY Display. If nothing definite is discovered in performing these signature analyzer checks, consider the other possibilities shown on Block Diagram 4. If any of the signatures are incorrect, recall that the data passes through circuitry on Service Sheets 18 and 22 before arriving here.

Test Equipment

Signature Analyzer HP 5005A

Display Data Transmission Test

The Display Data Transmission Test verifies transmission of encoded display data from the Microprocessor to the frequency display drivers.

1. Connect the signature analyzer as follows:

GND GND (A11TP3, refer to Service Sheet 17)
 START SA5 (A11TP13, refer to Service Sheet 18)
 STOP SA5 (A11TP13, refer to Service Sheet 18)
 CLK SA4 (A11TP10, refer to Service Sheet 18)

2. Set the signature analyzer's controls as follows:

START Negative Edge
 STOP Positive Edge
 CLK Negative Edge

3. Set up the Signal Generator as follows:
 - a. Set switch A11S1B to the L/K position (refer to Service Sheet 17).
 - b. Set switch A11S1A to the DSA position (refer to Service Sheet 17).
 - c. Connect a jumper between T02 (A2TP12) and ground (refer to Service Sheet 22).
 - d. Connect a jumper between SA6 (A11TP14, refer to Service Sheet 18), and SA7 (A2TP9, refer to Service Sheet 22).

NOTE

If the Signal Generator's HP-IB address switch has been set to anything other than 07, the signatures taken in this test will be incorrect. In this case, reset the address switches to A1=1, A2=1, A3=1, A4=0 and A5=0. Refer to paragraph 2-7 "HP-IB Address Selection" in Section 2 for the procedure to change the address switches.

4. Briefly connect A11TP4 (NMI) to A11TP3 (GND) (refer to Service Sheet 17).

NOTE

With careless probing, it is possible to get the Microprocessor into a program routine other than that portion intended for signature analysis. If the +5V signature is incorrect, this has probably happened. Restart the test by briefly connecting A11TP12 (RESET) to A11TP3 (GND). Then briefly connect A11TP4 (NMI) to A11TP3 (GND). All LEDs should be cycling on and off rapidly.

5. Connect the signature analyzer probe to each node shown in Table 1. Verify that each signature is correct and stable.
6. If troubleshooting is completed and the signatures are taken, reset switch A11S1B back to the R/R position, and switch A11S1A back to the DIAG position.

Disconnect the jumper from T02 (A2TP12) to ground, and disconnect the jumper between SA6 (A11TP14) and SA7 (A2TP9).

If the HP-IB address switch was changed, reset the address switch (refer to Service Sheet 20) to the original address.

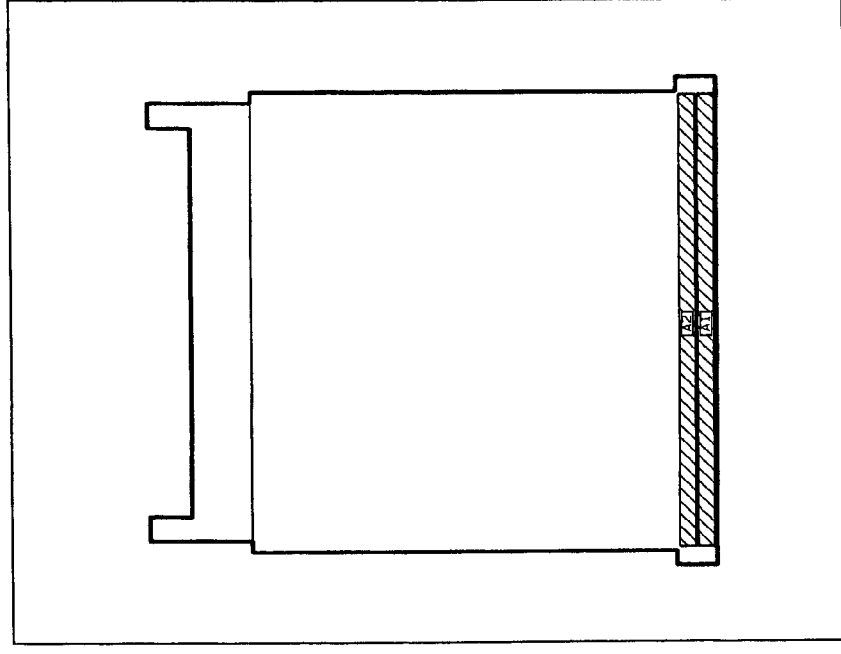
Reset the Signal Generator by pressing the **SHIFT** key, and then pressing the **0** key.

Table 1. Frequency Display Data Signatures.

Node	Correct Signature	Comments	Node	Correct Signature	Comments
-5V	F84P	FR DIG 1	+5V	F84P	FR DIG 5
U31#9	54A0		U35#9	UH23	
U31#10	0H80		U35#10	7880	
U31#11	09FF		U35#11	4135	
U31#12	1HAA		U35#12	55PC	
U31#13	01H8		U35#13	A492	
U31#14	FU58		U35#14	AP11	
U31#15	3A9C	U35#15	8F6F		
-5V	F84P	FR DIG 2	+5V	F84P	FR DIG 6
U32#9	H9PA		U36#9	2C1A	
U32#10	1353		U36#10	3168	
U32#11	UA1C		U36#11	UUU9	
U32#12	PFF5		U36#12	26HP	
U32#13	25F6		U36#13	PHP1	
U32#14	4AH1		U36#14	1U22	
U32#15	5554	U36#15	82C0		
-5V	F84P	FR DIG 3	+5V	F84P	FR DIG 7
U33#9	7059		U37#9	9F11	
U33#10	3P0P		U37#10	1F17	
U33#11	13PC		U37#11	8582	
U33#12	C4P5		U37#12	PUHF	
U33#13	6PC6		U37#13	HUU9	
U33#14	133P		U37#14	A360	
U33#15	CC02	U37#15	6847		
-5V	F84P	FR DIG 4	+5V	F84P	FR DIG 8
U34#9	F3A2		U38#9	F845	
U34#10	C22P		U38#10	F59U	
U34#11	P8U9		U38#11	899F	
U34#12	U339		U38#12	032A	
U34#13	U1H0		U38#13	PH8F	
U34#14	9209		U38#14	6697	
U34#15	2659	U38#15	H71C		

A2 Component Coordinates

COMP	X,Y	COMP	X,Y	COMP	X,Y	COMP	X,Y	COMP	X,Y
C1	B,3	R27	A,3	U22	D,2				
C2	A,3	R28	C,1	U23	A,1				
C3	A,2	R29	A,2	U24	A,1				
C4	A,1	R30	A,3	U25	A,1				
C5	B,1	R31	A,3	U26	B,1				
C6	B,1	R32	A,3	U27	B,1				
C7	B,1			U28	B,1				
C8	C,1	S1	A,1	U29	B,1				
C9	C,1			U30	B,1				
C10	D,1	TP1	A,3	U31	B,1				
C11	D,2	TP2	B,3	U32	C,1				
C12	B,1	TP3	B,3	U33	C,1				
C13	B,1	TP4	B,3	U34	C,1				
		TP5	B,3	U35	C,1				
J1	B,3	TP6	B,3	U36	C,1				
J2	A,2	TP7	B,3	U37	C,1				
		TP8	A,1	U38	C,1				
L1	A,3	TP9	A,1	U39	D,1				
		TP10	B,1	U40	D,1				
R1	B,3	TP11	B,1	U41	D,1				
R2	A,2	TP12	B,1	U42	D,1				
R3	A,3	TP13	B,1	U43	A,1				
R4	B,1	TP14	D,1						
R5	B,1								
R6	B,2	U1	A,3						
R7	B,2	U2	A,3						
R8	C,2	U3	B,3						
R9	C,2	U4	B,3						
R10	C,2	U5	B,3						
R11	C,2	U6	B,3						
R12	C,2	U7	B,3						
R13	C,2	U8	C,3						
R14	B,2	U9	C,3						
R15	A,1	U10	C,3						
R16	B,2	U11	C,3						
R17	D,2	U12	C,3						
R18	D,2	U13	C,3						
R19	D,3	U14	D,3						
R20	D,3	U15	D,3						
R21	C,3	U16	D,3						
R22	A,3	U17	D,3						
R23	D,2	U18	A,2						
R24	C,3	U19	A,2						
R25	A,1	U20	B,2						
R26	B,3	U21	B,2						



NOTES

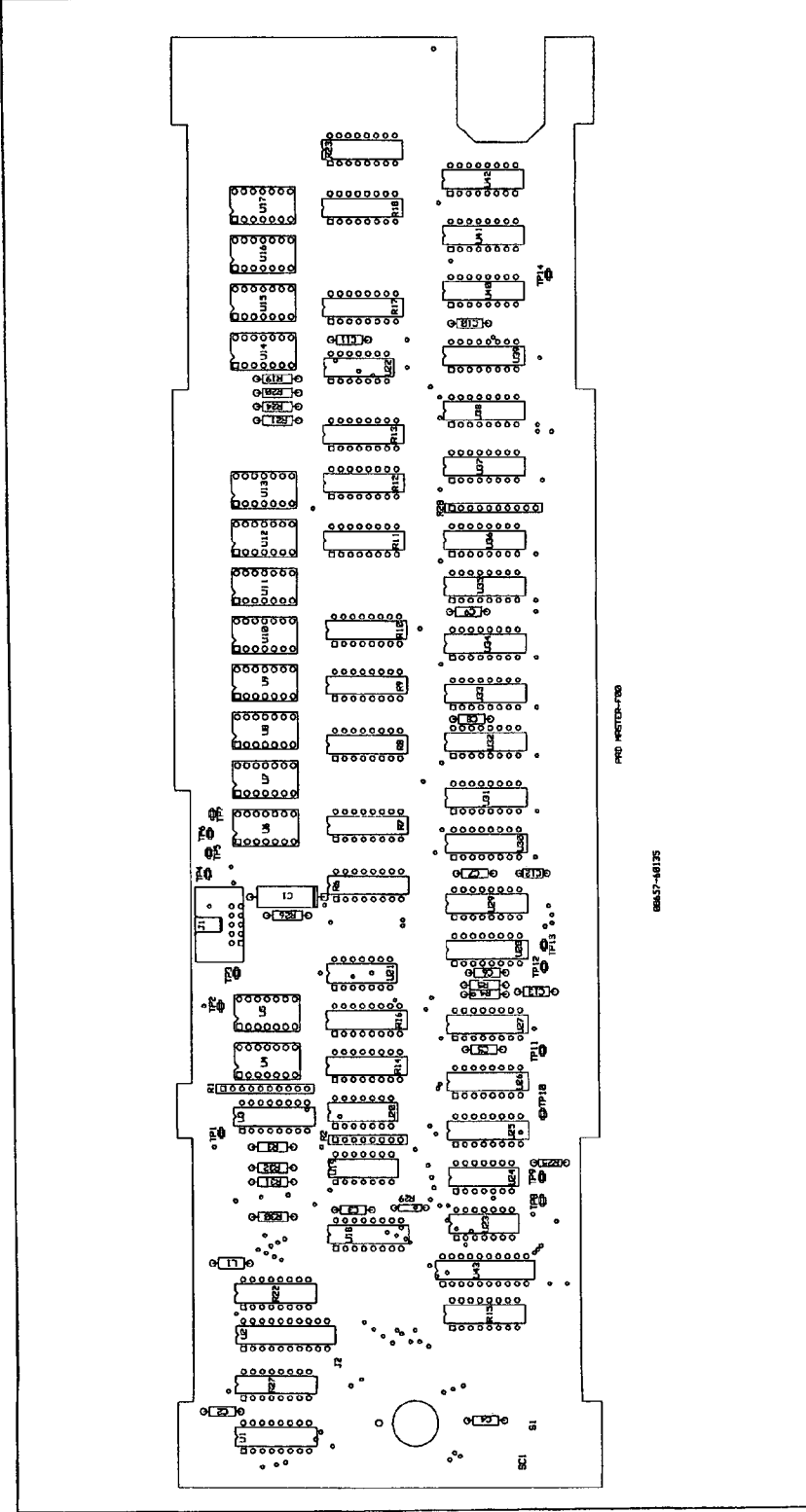
1. For an explanation of schematic symbols, see "SCHEMATIC DIAGRAM NOTES" in Section 8.
2. Chassis ground is achieved by A2J1-1 connection and mechanical contact through nuts holding PC board to chassis.
3. Display data bus (DDA-007) is positive true for numeric data and negative true for decimal point.
4. Numeric segment anodes are indicated by subscript a and cathodes by subscript c as follows:

LOGIC LEVELS	
HIGH	0, 0V
LOW	5.0V, 1.5V
	IS MORE POS. THAN
OPEN	W/OUT
GROUND	0V, 0V

P/O A2
SEE REVERSE SIDE

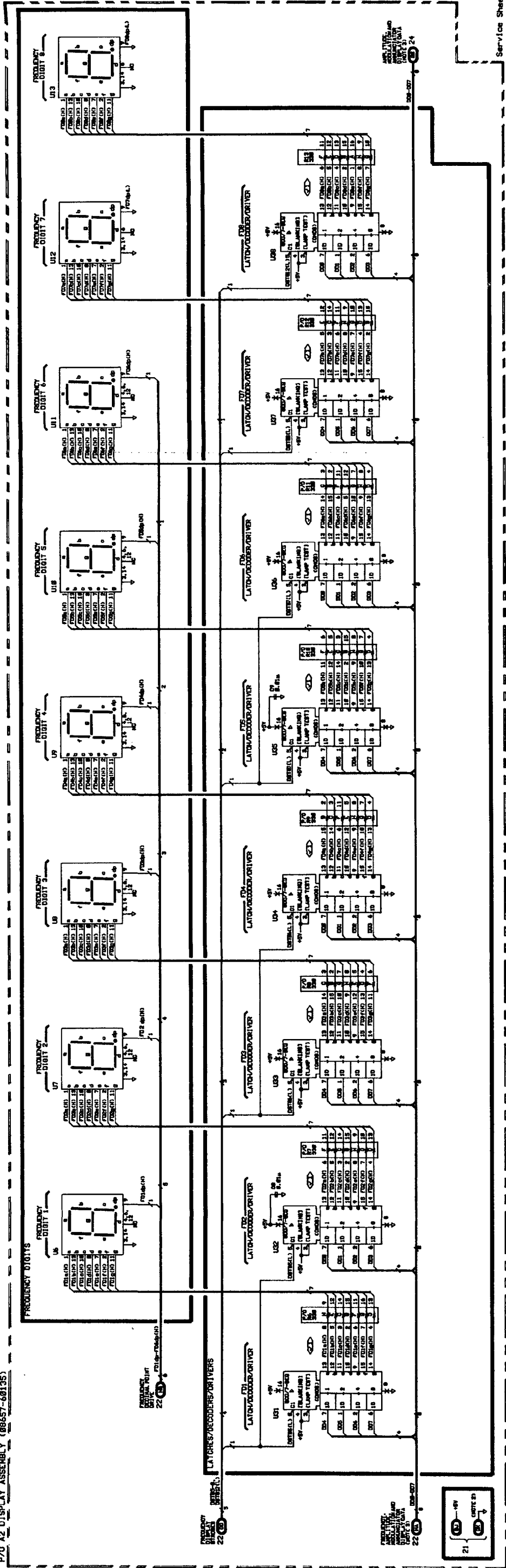
SS23

FREQUENCY DISPLAYS



Component Locator

Figure 8. Service Sheet 24 Information



Service Sheet 24

AMPLITUDE, MODULATION, AND ANNUNCIATOR DISPLAYS

PRINCIPLES OF OPERATION

Modulation Display

Two 7-segment, common-cathode devices U4 and U5 are used to display the level of modulation, either the AM depth in percent or the FM peak deviation in kilohertz. They are also used to display the modulation increment value as well as the internally-set decimal HP-IB address. The decimal point associated with Modulation Digit 1 is the only decimal point that can be lit. Modulation Digit 2 has its decimal point control line (U5 pin 9) tied low which inhibits it from being lit. Decimal point drive is developed when display data bit 5 (DD5) is strobed into the HP-IB/Modulation Annunciator Latches U1 by DSTB1. When DD5 is active (low), the decimal point control line of Modulation Digit 1 (U4 pin 9) will be pulled high by resistor R14B from the +5V power supply to light the decimal point. When DD5 is inactive (high), the stored output will be inverted by the MD1dp Driver U21A. This will cause the decimal point control line of Modulation Digit 1 (U4 pin 9) to be pulled low to inhibit the decimal point from being lit.

Two Latch/Decoder/Drivers U27 and U29 are used to decode modulation display data, store the decoded data, and drive the associated modulation display digit. The associated resistor networks R14 and R16 are used to limit the amount of drive current applied to the display digit. As previously mentioned (refer to Service Sheet 22), 16 bits of serial display data are sent from the Microprocessor to the display circuitry. After a serial-to-parallel conversion, the eight most-significant bits are stored in the Display Data Shift Register U23 and the eight least-significant bits are stored in the Display Address Shift Register U24. Six of the eight display address bits are decoded to produce twelve display strobes and two keyboard strobes. Display strobe DSTB3 is used to strobe the modulation display data (DD0 through DD7) into the two Latch/Decoder/Drivers. When the strobe is decoded, it will go low for 5 μ s to latch a half byte (4 bits) of modulation display data into the associated Latch/Decoder/Driver. Each Latch/Decoder/Driver is hard-wired to decode and drive the associated digit to display only numerals 0 through 9 (otherwise the digit remains blanked).

HP-IB/Modulation Annunciators

There are eleven LED annunciators associated with the MODULATION Display. These annunciators light to indicate modulation units, source selection, or an external source over or under range condition. In addition, there are two LED annunciators used to indicate remote operation status. As in the case of the other displays, 16 bits of serial display data are sent from the Microprocessor, parallel converted, stored, and decoded. Modulation and HP-IB annunciator display data bits are always active low. Display strobe DSTB1 is used to strobe modulation or HP-IB annunciator display data (DD2 through DD7) into the Modulation/HP-IB Annunciator Latches U1, and DSTB2 is used to strobe modulation annunciator display data (DD0 through DD7) into the Modulation Annunciator Latches U2. When a strobe is decoded, it will go low for 5 μ s to latch the modulation or HP-IB annunciator display data. When the stored bit is active (low), the associated LED annunciator DS1 through DS12, and DS20 will light as current is drawn through the associated network resistors R15 and R27.

Amplitude Display

One 5-segment, universal "+1" device U14 and three 7-segment, common-cathode devices U15 through U17 are used to display the RF output amplitude level. They are also used to display the amplitude increment value, as well as the current contents of the sequence counter. The decimal points associated with Amplitude Digits 1 through 3 are the only decimal points that can be lit. Amplitude Digit 4 has its decimal point control line (U17 pin 9) tied low which inhibits it from being lit. Decimal point

drive is developed when display data bits 2, 3, and 4 are strobed into the Amplitude Display Latches U39 by DSTB10. The Microprocessor ensures that only one of these bits is active (low) at any given time (except during the power-up subroutine). When one of these bits is active (low), the associated decimal point control line (U14 pin 8, U15 pin 9, or U16 pin 9) will be pulled high through the series resistor R12A, R17A, or R18A to light the respective decimal point. When the bits are inactive (high) the stored output will be inverted by the associated decimal point driver U22D, U22E, or U22F. This will cause the associated decimal point control line (U14 pin 8, U15 pin 9, or U16 pin 9) to be pulled low to inhibit the respective decimal point from being lit.

Plus or minus sign drive is produced in much the same manner as that used to light the amplitude display decimal points. The minus sign, which is part of Amplitude Digit 1, lights when display data bit 6 (DD6) is strobed into U39 by DSTB10. When DD6 is active (low), the minus sign control line (U14 pin 4) is pulled low through the series resistor R19 to light the minus sign. The plus sign requires that display data bits 6 and 7 (DD6 and DD7) both be strobed into U39 by DSTB10. Just as in the case of the minus sign when DD6 is active (low), the horizontal segment of the plus sign will light. In addition, when DD7 is active (low), the two vertical segment control lines (U14 pins 2 and 6) will be pulled high through the series resistor R21 to light the two vertical segments of the plus sign display. When DD7 is inactive (high), the stored output will be inverted by the AD1 Sign Driver U22B. This will cause the two vertical segment control lines (U14 pins 2 and 6) to be pulled low to inhibit the two vertical segments of the plus sign display from being lit.

Three Latch/Decoder/Drivers U40 through U42 are used to decode amplitude display data, store the decoded data, and drive the associated amplitude display digit. The associated resistor networks R17, R18, and R23 are used to limit the amount of drive current applied to the display digit. As previously mentioned (refer to Service Sheet 22), 16 bits of serial display data are sent from the Microprocessor to the display circuitry. After a serial-to-parallel conversion, the eight most-significant bits are stored in the Display Data Shift Register U23 and the eight least-significant bits are stored in the Display Address Shift Register U24. Six of the eight display address bits are decoded to produce twelve display strobes and two keyboard strobes. Display strobes DSTB8 and DSTB9 are used to strobe the amplitude display data (DD0 through DD7) into the three latch/decoder/drivers. When a strobe is decoded, it will go low for 5 μ s to latch a half byte (4 bits) of amplitude display data into the associated Latch/Decoder/Driver. Each Latch/Decoder/Driver is hard-wired to decode and drive the associated digit to display numerals 0 through 9, otherwise the digit remains blanked.

Amplitude Annunciators

There are seven LED annunciators associated with the AMPLITUDE Display. These annunciators light to display amplitude units information. As in the case of the other displays, 16 bits of serial display data are sent from the Microprocessor, parallel converted, stored, and decoded. Amplitude annunciator display data bits are always active low. Display strobe DSTB11 is used to strobe amplitude annunciator display data (DD1 through DD7) into the Amplitude Annunciator Latches U43. When the strobe is decoded, it will go low for 5 μ s to latch the amplitude annunciator display data. When the stored bit is active (low), the associated LED annunciator DS13 through DS19 will light as current is drawn through the associated network resistor R22.

Display strobe DSTB11 is also used to strobe display data bit 0 (DD0) into the Amplitude Annunciator Latches U43 to force all six keyboard column lines low so that the row data can be read (refer to Service Sheet 21). When DD0 is active (high), a signal to read key row data (RKRD) will be issued to the keyboard encoding circuitry. This signal remains stored until the row data has been latched, then it will be cleared by the Microprocessor.

TROUBLESHOOTING

Troubleshooting is done on the circuits of Service Sheet 24 when a malfunction seems to be associated with the Amplitude or Modulation Displays. Determine if the malfunction occurs in single digits, pairs (such as amplitude digits 3 and 4, digit 1 and the decimal point, and so forth. Refer to Table 1 on Service Sheet 22 for reference, or if the malfunction occurs with multiple digits (including the amplitude and/or modulation digits) be sure to:

- Perform the Troubleshooting Using Signature Analysis on Service Sheets 17, 18, and 19.
- Then, perform the Troubleshooting on Service Sheets 21 and 22.

If pairs of digits are incorrect, perform the troubleshooting on Service Sheet 22. If single digit displays are incorrect, continue troubleshooting on this service sheet for amplitude or modulation display problems.

Procedures for checking part of the A2 Display Assembly circuits are given below. The area or points to check are marked on the schematic by a hexagon with a check mark and a number inside, for example, $\sqrt{1}$.

Test Equipment

Oscilloscope HP 54100A
 Oscilloscope Active Probe HP 54001A

$\sqrt{1}$ **Amplitude and Modulation Display Digital Drive Levels versus Visual LED Output**

1. Verify that the 7-segment drive logic level from the Latch/Decoder/Drivers matches the visual output for the equivalent segment.
2. Verify that the decimal point drive from the latches and drivers matches the visual decimal point output.

$\sqrt{2}$ **Annunciator's Digital Drive Levels versus Visual LED Outputs**

1. If the digital drive level is low, the LED output should be lit.

TROUBLESHOOTING USING SIGNATURE ANALYSIS

Troubleshooting is done on the circuits of Service Sheet 24 when a defect seems to be related to the modulation, amplitude or annunciator displays. If nothing definite is discovered in performing these signature analyzer checks, consider the other possibilities shown on Block Diagram 4. If any of the signatures are incorrect, recall that the display and strobe data transfer passes through circuitry on Service Sheets 18 and 22 before arriving here.

Test Equipment

Signature Analyzer HP 5005A

Display Data Transmission Test

The Display Data Transmission Tests verifies transmission of encoded display data Microprocessor to the modulation, amplitude and annunciator display from the drivers.

1. Connect the signature analyzer as follows:

GND	GND (A11TP3, refer to Service Sheet 17)
START	SA5 (A11TP13, refer to Service Sheet 18)
STOP	SA5 (A11TP13, refer to Service Sheet 18)
CLK	SA4 (A11TP10, refer to Service Sheet 18)

- Set the signature analyzer's controls as follows:

START	Negative Edge
STOP	Positive Edge
CLK	Negative Edge

- Set up the Signal Generator as follows:
- Set switch A11S1B to the L/K position (refer to Service Sheet 17).
- Set switch A11S1A to the DSA position (refer to Service Sheet 17).
- Connect a jumper between T02 (A2TP12) and ground (refer to Service Sheet 22).
- Connect a jumper between SA6 (A11TP14, refer to Service Sheet 18), and SA7 (A2TP9, refer to Service Sheet 22).

NOTE

If the Signal Generator's HP-IB address switch has been set to anything other than 07, the signatures taken in this test will be incorrect. In this case, reset the address switches to A1=1, A2=1, A3=1, A4=0 and A5=0. Refer to paragraph 2-7 "HP-IB Address Selection" in Section 2 for the procedure to change the address switches.

- Briefly connect A11TP4 (NMI) to A11TP3 (GND) (refer to Service Sheet 17).

NOTE

With careless probing, it is possible to get the Microprocessor into a program routine other than that portion intended for signature analysis. If the +5V signature is incorrect, this has probably happened. Restart the test by briefly connecting A11TP12 (RESET) to A11TP3 (GND). Then briefly connect A11TP4 (NMI) to A11TP3 (GND). All LEDs should be cycling on and off rapidly.

- Connect the signature analyzer probe to each node shown in Tables 1, and 2. Verify that each signature is correct and stable.
- If troubleshooting is completed and the signatures are taken, reset switch A11S1B back to the R/R position, and switch A11S1A back to the DIAG position.

Disconnect the jumper from T02 (A2TP12) to ground, and disconnect the jumper between SA6 (A11TP14) and SA7 (A2TP9).

If the HP-IB address switch was changed, reset the address switch (refer to Service Sheet 20) to the original address.

Then reset the Signal Generator by pressing the **SHIFT** key, and then pressing the **0** key.

Table 1. Decoded Amplitude Signatures.

Node	Correct Signature	Comments
+5V U39#2 U39#5 U39#7 U39#10 U39#12 U39#15	F84P P401 9CA4 2AFA 620C 580P 22FC	AP DIG 1 AP: AP DP 1 AP DP 2 AP DP 3
+5V U40#9 U40#10 U40#11 U40#12 U40#13 U40#14 U40#15	F84P UP60 9P35 4CH5 PH98 AA91 71F0 0276	AP DIG 2
+5V U42#9 U42#10 U42#11 U42#12 U42#13 U42#14 U42#15	F84P 0U7H 7P96 CH03 8291 180P 1732 19P2	AP DIG 4

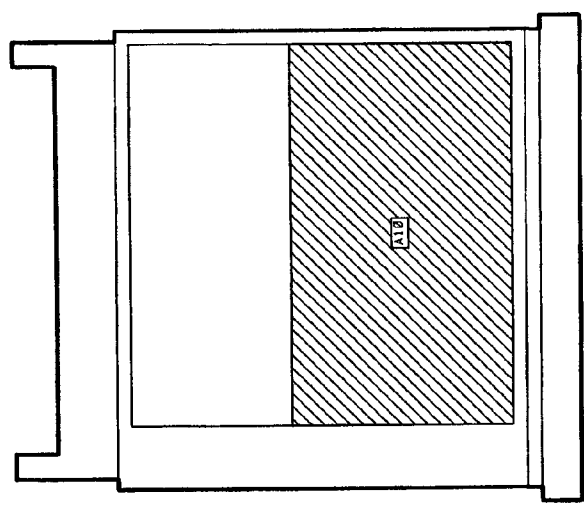
Table 2. Decoded Annunciator Signatures.

Node	Correct Signature	Comments
-5V U1#2 U1#5 U1#7 U1#10 U1#12 U1#15	F84P 4PF5 046A 49UH 27FA C73C 61PO	MD DP 1 ADRS RMT % kHz DC FM
-5V U2#2 U2#5 U2#6 U2#9 U2#12 U2#15 U2#16 U2#19	F84P FP81 34C1 3U35 352H 8405 AFPC UCFP 4489	HI EXT EXT FM LO EXT EXT AM 1 kHz INT AM INT FM 400 Hz
-5V U43#2 U43#5 U43#6 U43#9 U43#12 U43#15 U43#16 U43#19	F84P 3C63 7HC8 FU7A 962P P54A UCU0 PHCC 8U6F	dB dBf EMF dBm RD KY WRD VOLTS mV μV

A2 Component Coordinates

COMP	X,Y	COMP	X,Y	COMP	X,Y	COMP	X,Y	COMP	X,Y
C1	B,3	R27	A,3	U22	D,2				
C2	A,3	R28	C,1	U23	A,1				
C3	A,2	R29	A,2	U24	A,1				
C4	A,1	R30	A,3	U25	A,1				
C5	B,1	R31	A,3	U26	B,1				
C6	B,1	R32	A,3	U27	B,1				
C7	B,1			U28	B,1				
C8	C,1	S1	A,1	U29	B,1				
C9	C,1			U30	B,1				
C10	D,1	TP1	A,3	U31	B,1				
C11	D,2	TP2	B,3	U32	C,1				
C12	B,1	TP3	B,3	U33	C,1				
C13	B,1	TP4	B,3	U34	C,1				
		TP5	B,3	U35	C,1				
J1	B,3	TP6	B,3	U36	C,1				
J2	A,2	TP7	B,3	U37	C,1				
		TP8	A,1	U38	C,1				
L1	A,3	TP9	A,1	U39	D,1				
		TP10	B,1	U40	D,1				
R1	B,3	TP11	B,1	U41	D,1				
R2	A,2	TP12	B,1	U42	D,1				
R3	A,3	TP13	B,1	U43	A,1				
R4	B,1	TP14	D,1						
R5	B,1								
R6	B,2	U1	A,3						
R7	B,2	U2	A,3						
R8	C,2	U3	B,3						
R9	C,2	U4	B,3						
R10	C,2	U5	B,3						
R11	C,2	U6	B,3						
R12	C,2	U7	B,3						
R13	C,2	U8	C,3						
R14	B,2	U9	C,3						
R15	A,1	U10	C,3						
R16	B,2	U11	C,3						
R17	D,2	U12	C,3						
R18	D,2	U13	C,3						
R19	D,3	U14	D,3						
R20	D,3	U15	D,3						
R21	C,3	U16	D,3						
R22	A,3	U17	D,3						
R23	D,2	U18	A,2						
R24	C,3	U19	A,2						
R25	A,1	U20	B,2						
R26	B,3	U21	B,2						

BOTTOM INTERNAL VIEW - LEVEL 4



WARNING
This instrument does not have a primary power switch. The following voltages are always present whenever the instrument is connected to an AC outlet:
A. Line voltage
B. Primary and secondary AC voltages
C. Rectified AC voltages (+24V, +15V, +5V, and -15V)
D. Rectified DC voltages (+5V (STBY/MEMORY)).

CAUTION
Do not connect or disconnect the Audio/Power Supply board (A10) or Voltage Regulator board (A12) with the AC power cord connected, otherwise damage to the instrument may result.

NOTES

- For explanation of schematic symbols, see SCHEMATIC DIAGRAM NOTES, in Section 8.
- Unlabeled ground is achieved by A10J5-1 and 5 connections and mechanical contact through nuts holding PC board to frame.
- Pin 1 of M191 is internally common to the outside shielding of M191. Ground is achieved through pin 1 and then mechanical contact of screw M131 to connector M191.
- Cases of U2, U3 and U4 are insulated from chassis ground.
- This AC voltage measurement is to chassis ground.
- Feedthrough capacitor is part of M192 of M191 and is not separately replaceable.
- Ground is achieved by mechanical contact through screw (M111) and ground lug (M196) fastened to the chassis.
- Ground is achieved by mechanical contact through screw M131 and connector M192.
- Ground is achieved by M192.
- M131 and M192 are connected as a common point ground for the ground circuit grounds 2 through 9.
- Individual adjustment for the +5V supply is +5.25 Vdc measured at A10J1 pin 7 (Refer to Section 5 per 5-7). Typical +5V supply measurement at A10J2 pin 18 +5.4 Vdc.

UI-4 BOTTOM VIEW

BOTTOM VIEW A10K1

1	2	3	4	5	6	7	8	9
○	○	○	○	○	○	○	○	○

P/O A2 AMPLITUDE MODULATION AND DISPLAYS
SEE REVERSE SIDE

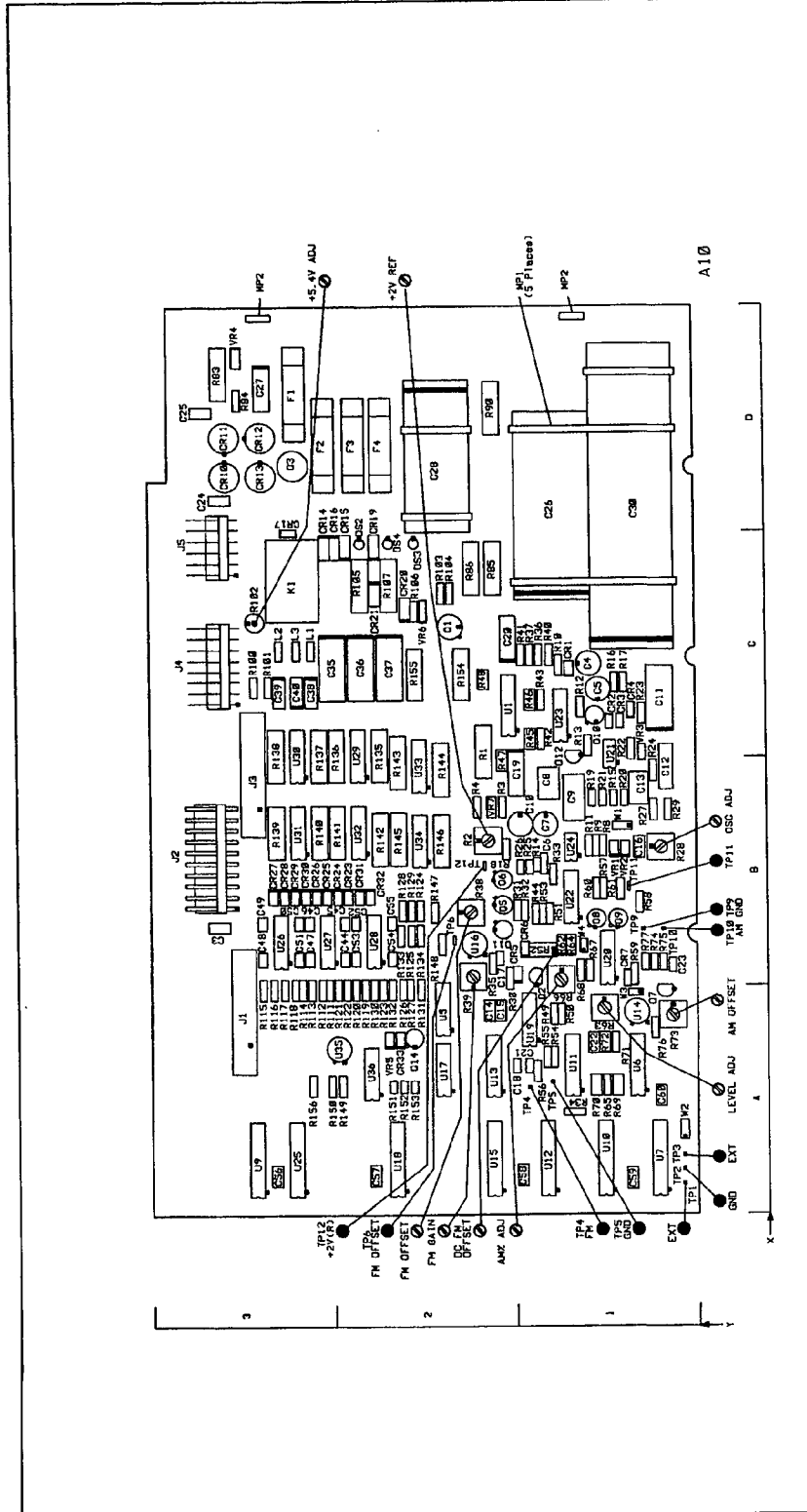


Figure 8. Service Sheet: 25 Information Component Locator

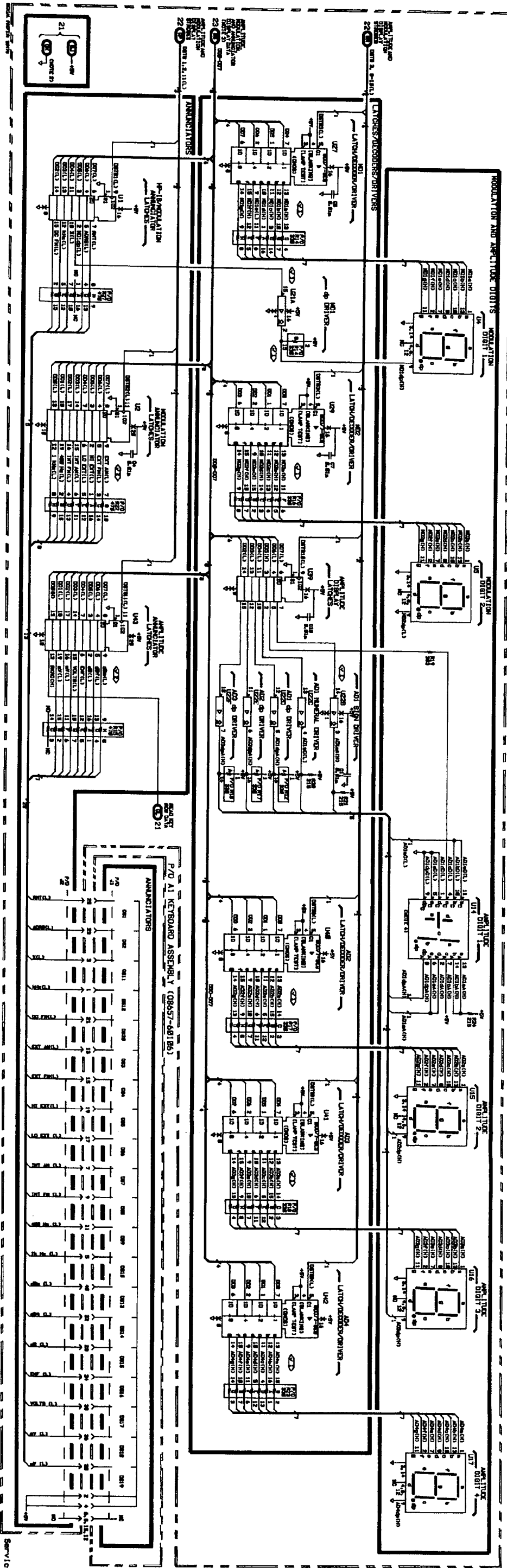


Figure 1
Service Sheet 24 9

Service Sheet 25

POWER SUPPLY

PRINCIPLES OF OPERATION

General

The three dc power supplies are +15 Vdc regulated, +5 Vdc regulated, and -15 Vdc regulated. There are two types of overvoltage protection circuits. The first limits the unregulated voltage input to the ± 15 V supplies. The second type limits the voltage out of the +5V supply to the Signal Generator's circuits.

Regulated +15V, +5V, and -15V Supplies

The ac voltages from the secondary of the power transformer are rectified by diodes A10CR10, CR11, CR12, and CR13 for the +15 Vdc and -15 Vdc unregulated voltages. The +15 Vdc unregulated voltage supplies current for the Option 001 High Stability Time Base, if installed. The +5 Vdc supply's unregulated voltage is from rectifiers, U4, located within the rear-panel. Relay A10K1 is de-energized when the front-panel POWER switch is in the STBY position and the lines to the series regulator are opened.

Diodes A10CR14, CR15, and CR16 protect the series regulators, U1, U2, and U3. If the output voltage of the series regulators goes more positive than the unregulated input voltage the diodes are turned on. This keeps the regulators from being reverse biased if an output is connected to a higher voltage.

The overvoltage protection circuit at the input of the +15 and -15V power supplies (A10VR4, R84, C27 and Q3) protects the supplies from excess line voltage. The unregulated voltages for the +15 and -15 Vdc supplies are about +25 and -25 Vdc. The 68.1V zener diode A10VR4 and its accompanying components is connected between the two supplies. The normal voltage across the zener diode is approximately 50 Vdc. When the voltage exceeds the threshold of 68.1V, the zener turns on. Current is drawn through A10R84 which charges A10C27 until A10Q3 fires and blows the line fuse.

The +5V Crowbar (overvoltage protection) circuit consists of A10VR6, R103, R104 and Q1. The circuit protects the +5V supply if it is shorted to the +15 Vdc supply or other positive voltage greater than the threshold voltage of A10VR6 (+6.2V). In this situation, A10VR6 turns on and draws enough current through A10R103 to fire A10Q1. This blows the +5V supply fuse.

LED's A10DS2, DS3, and DS4 are lit when the power supplies are providing an output voltage. Resistors A10R105, R106, and R107, respectively, set the current through the LEDs. Inductors A10L1, L2, and L3 and capacitors A10C26, C28, C30, C35, C36, C37, C38, C39, and C40 isolate and filter the associated supplies.

The +5 Vdc supply is adjustable from about +4.5 Vdc to +6.2 Vdc with A10R102. The +5 Vdc supply is adjusted for 5.4 Vdc measured on A10J2 pin 10.

TROUBLESHOOTING

Procedures for checking the circuits shown on Service Sheet 25 are given below. The area or points to check are marked on the schematic by a hexagon with a check mark and a number inside, for example, $\sqrt{1}$. Fixed voltages are shown on the schematic inside a hexagon, for example, $\langle 2V \pm 0.2V \rangle$. Transistor bias voltages are shown without tolerances.

Troubleshooting Help

Block Diagram 1

Table 4-1. Abbreviated Performance Tests

Table 5-2. Post-Repair Adjustments

Test Equipment

Digital Multimeter HP 3466A
 Oscilloscope See Note Below

NOTE

An analog oscilloscope, such as the HP 1740A (obsolete), must be used to check the dc power supply peak-to-peak voltage.

$\sqrt{1}$ Voltage Check

1. Verify that the voltages shown in Table 1 are correct.

Table 1. Power Supply Measurements.

Volts	A10J4			A10J2		
	Pin 6	Pin 8	Pin 7	Pin 3	Pin 10	Pin 5
Vdc	+19 to +25	+11	-25 to -19	+13 to +17	+5.2 to +5.6	-17 to -13
Vpp	4.0	3.0	3.0	0.01	0.01	0.01

A10 Component Coordinates (1 of 2)

COMP	X,Y	COMP	X,Y	COMP	X,Y	COMP	X,Y	COMP	X,Y	COMP	X,Y
C3	B,3	C56	A,3	J1	A,3	R21	B,1	R66	B,1	R131	A,2
C4	C,1	C57	A,2	J2	B,3	R22	C,1	R67	B,1	R132	A,2
C5	C,1	C58	A,1	J3	B,3	R23	C,1	R68	B,1	R133	B,2
C6	B,1	C59	A,1	J4	C,3	R24	B,1	R69	A,1	R134	B,2
C7	B,1	C60	A,1	J5	C,3	R25	B,1	R70	A,1	R135	C,2
C8	B,1					R26	B,1	R71	A,1	R136	C,2
C9	B,1	CR1	C,1	K1	C,3	R27	B,1	R72	A,1	R137	C,3
C10	B,1	CR2	C,1			R28	B,1	R73	A,1	R138	C,3
C11	C,1	CR3	C,1	L1	C,3	R29	B,1	R74	B,1	R139	B,3
C12	B,1	CR4	C,1	L2	C,3	R30	B,2	R75	B,1	R140	B,3
C13	B,1	CR5	B,1	L3	C,3	R31	B,1	R76	A,1	R141	B,2
C14	A,2	CR6	B,1			R32	B,1	R77	B,1	R142	B,2
C15	A,2	CR7	B,1	MP1	D,1	R33	B,1	R83	D,3	R143	B,2
C16	B,1	CR10	D,3	MP2	D,1	R34	A,1	R84	D,3	R144	B,2
C17	B,2	CR11	D,3			R35	B,2	R85	C,2	R145	B,2
C18	A,1	CR12	D,3	Q1	C,2	R36	C,1	R86	C,2	R146	B,2
C19	B,1	CR13	D,3	Q2	B,1	R37	C,1	R90	D,2	R147	B,2
C20	C,2	CR14	C,3	Q3	D,3	R38	B,2	R100	C,3	R148	B,2
C21	A,1	CR15	C,2	Q5	B,2	R39	B,2	R101	C,3	R149	A,2
C22	A,1	CR16	C,2	Q6	B,2	R40	C,1	R102	C,3	R150	A,3
C23	B,1	CR17	D,3	Q7	A,1	R41	C,1	R103	C,2	R151	A,2
C24	D,3	CR19	C,2	Q8	B,1	R42	C,1	R104	C,2	R152	A,2
C25	D,3	CR20	C,2	Q9	B,1	R43	C,1	R105	C,2	R153	A,2
C26	D,1	CR21	C,2	Q10	C,1	R44	B,1	R106	C,2	R154	C,2
C27	D,3	CR23	B,2	Q11	B,2	R45	C,1	R107	C,2	R155	C,2
C28	D,2	CR24	B,2	Q12	C,1	R46	C,1	R111	A,3	R156	A,3
C30	D,1	CR25	B,3	Q14	A,2	R47	B,2	R112	A,3		
C35	C,2	CR26	B,3			R48	C,2	R113	A,3	TP1	A,1
C36	C,2	CR27	B,3	R1	C,2	R49	A,1	R114	A,3	TP2	A,1
C37	C,2	CR28	B,3	R2	B,2	R50	A,1	R115	A,3	TP3	A,1
C38	C,3	CR29	B,3	R3	B,2	R51	B,1	R116	A,3	TP4	A,1
C39	C,3	CR30	B,3	R4	B,2	R52	B,1	R117	A,3	TP5	A,1
C40	C,3	CR31	B,2	R8	B,1	R53	B,1	R118	A,3	TP6	B,2
C44	B,2	CR32	B,2	R9	B,1	R54	A,1	R119	A,2	TP9	B,1
C45	B,2	CR33	A,2	R10	C,1	R55	A,1	R120	A,2	TP10	B,1
C46	B,3			R11	B,1	R56	A,1	R121	A,2	TP11	B,1
C47	B,3	DS2	C,2	R12	C,1	R57	B,1	R122	A,2	TP12	B,2
C48	B,3	DS3	C,2	R13	C,1	R58	B,1	R123	A,2		
C49	B,3	DS4	C,2	R14	B,1	R59	B,1	R124	B,2	U1	C,2
C50	B,3			R15	B,1	R60	B,1	R125	B,2	U5	A,2
C51	B,3			R16	C,1	R61	B,1	R126	A,2	U6	A,1
C52	B,2	F1	D,3	R17	C,1	R62	B,1	R127	A,2	U7	A,1
C53	B,2	F2	D,3	R18	B,2	R63	A,1	R128	B,2	U9	A,3
C54	B,2	F3	D,2	R19	B,1	R64	B,1	R129	B,2	U10	A,1
C55	B,2	F4	D,2	R20	B,1	R65	A,1	R130	A,2	U11	A,1

A10 Component Coordinates (2 of 2)

COMP	X,Y	COMP	X,Y	COMP	X,Y	COMP	X,Y	COMP	X,Y	COMP	X,Y
U12	A,1										
U13	A,2										
U14	A,1										
U15	A,2										
U16	B,2										
U17	A,2										
U18	A,2										
U19	A,1										
U20	B,1										
U21	C,1										
U22	B,1										
U23	C,1										
U24	B,1										
U25	A,3										
U26	B,3										
U27	B,3										
U28	B,2										
U29	C,2										
U30	C,3										
U31	B,3										
U32	B,2										
U33	B,2										
U34	B,2										
U35	A,2										
U36	A,2										
VR1	B,1										
VR2	B,1										
VR3	C,1										
VR4	D,3										
VR5	A,2										
VR6	C,2										
VR7	B,2										
W1	B,1										
W2	A,1										
W3	A,1										
W4	B,1										

A15
P/O A10, A16
SEE REVERSE SIDE

POWER
SUPPLY

SS25

