

OPERATING AND SERVICE MANUAL

8654B SIGNAL GENERATOR

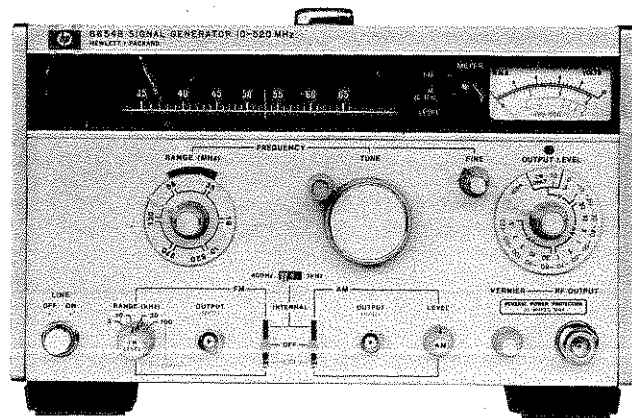

HEWLETT **hp** PACKARD

SIGNAL GENERATOR

MANUAL IDENTIFICATION

Model Number: 8654B
Date Printed: March 1977
Part Number: 08654-90025

This supplement contains important information for correcting manual errors and for adapting the manual to instruments containing improvements made after the printing of the manual.

To use this supplement:

Make all ERRATA corrections

Make all appropriate serial number related changes indicated in the tables below.

Serial Prefix or Number	Make Manual Changes	Serial Prefix or Number	Make Manual Changes
1811A	1		
1842A	1, 2		
1844A	1-3		
1849A	1-4		
1920A	1-5		
▶ 2011A	1-6		

▶ NEW ITEM

ERRATA

Page i, Title Page:

Under **SERIAL NUMBERS**, change the first sentence to read as follows:

This manual applies directly to instruments with serial numbers prefixed 1710A and 1733A.

Page 1-4, Table 1-1:

Under **Frequency Modulation** change the **External FM Sensitivity** specification to read:

External FM Sensitivity (with FM vernier fully clockwise):²

1 volt peak into 600Ω yields maximum peak deviation as indicated in table below:

FM RANGE (kHz)	Meter Scale	Maximum Peak Deviation (kHz)
3	0-3	3.16
10	0-10	10
30	0-3	31.6
100	0-10	100

Under **GENERAL CHARACTERISTICS**, change **Power** specifications to read:

Power: 100 or 120 volts (+5%, -10%) from 48 to 440 Hz; or 220 or 240 volts (+5%, -10%) from 48 to 66 Hz.

Power consumption is 25 VA maximum. 2.29 m (7½ ft) power cable furnished with mains plug to match destination requirements.

NOTE

Manual change supplements are revised as often as necessary to keep manuals as current and accurate as possible. Hewlett-Packard recommends that you periodically request the latest edition of this supplement. Free copies are available from all HP offices. When requesting copies quote the manual identification information from your supplement, or the model number and print date from the title page of the manual.

1 April 1980

7 Pages

HEWLETT  PACKARD

ERRATA (Cont'd)

Page 2-1, paragraph 2-7:

Change the first sentence to read:

"The 8654B Signal Generator requires a power source of 100 or 120 volts (+5%, -10%) from 48 to 440 Hz; or 220 or 240 volts (+5%, -10%) from 48 to 66 Hz, single phase."

In Figure 2-1, add the following after the third sentence:

WARNING

To avoid the possibility of hazardous electrical shock, do not operate this instrument at line voltages greater than 126.5 Vac with line frequencies greater than 66 Hz (leakage currents at these line settings may exceed 3.5 mA).

Page 5-15, paragraph 5-23:

► Add the following as step 10:

"10. Remove jumper wire between A5TP8 and A5TP12."

In step 11, change the voltmeter reading to 0.60 ± 0.10 Vdc.

In step 13, change the adjustment voltage to 0.00 ± 0.10 Vdc.

In step 16, change the voltage at A5TP8 to ± 0.10 Vdc.

Page 6-6, Table 6-2:

Delete the A1A1 08654-60022 and 08654-60051 listings. (Restored 08654-60022 and 08654-60051 Board Assemblies no longer available.)

A1A1: For recommended replacement, see Change 3.

► **NOTE**

When replacing A1A1, part number 08654-60002 or 08654-60050, replace RF Amplifier Cover, A1MP71, and order associated hardware A1MP130, A1MP131 and A1MP132. See Change 3 for part numbers.

► Page 6-10, Table 6-2:

A3U4: For recommended replacement, see Change 6.

► Page 6-13, Table 6-2:

A5U1, U8, and U10: For recommended replacement, see Change 6.

Page 6-17, Table 6-2:

Add MP67 08654-00057 COVER, TRANSFORMER (MP66 not assigned).

Add MP68 7120-7032 LABEL, SAFETY (Check Digit is 5).

Service Sheet 4 (schematic):

In the lower right hand portion of the schematic change **3U** to **3H**.

Service Sheet 6 (schematic):

Add pin number "11" to the junction of A5J2 and A1A5P2 for the line labeled "+29.4V **R**".



OPERATING AND SERVICE MANUAL

8654B SIGNAL GENERATOR

(Including Option 003)

SERIAL NUMBERS

This manual applies directly to instruments with serial numbers prefixed 1710A.

For additional important information about serial numbers, see INSTRUMENTS COVERED BY MANUAL in Section I.

With changes described in Section VII, this manual also applies to instruments with serial numbers prefixed 1512A, 1521A, 1529A, 1531A, 1532A, 1550A, 1612A, 1633A, 1638A, and 1647A.

© HEWLETT-PACKARD COMPANY 1975, 1977
1501 PAGE MILL ROAD, PALO ALTO, CALIFORNIA, U. S. A.

MANUAL PART NO. 08654-90025
Microfiche Part No. 08654-90026
Operating Supplement Part No. 08654-90027

Printed MARCH 1977

MODEL 8654B



POWER CABLE

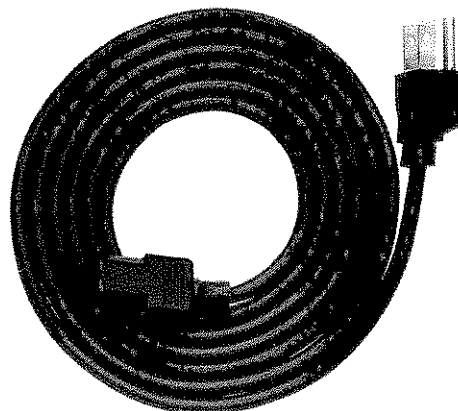

Figure 1-1. HP Model 8654B Signal Generator with Option 003 and Power Cable

SECTION I

GENERAL INFORMATION

1-1. INTRODUCTION

1-2. This manual contains information pertaining to installation, operation, testing, adjustment, and maintenance of the Model 8654B Signal Generator. Figure 1-1 shows the Hewlett-Packard Model 8654B Signal Generator with Reverse Power Protection, Option 003, and the instrument power cable.

1-3. The information in this manual is divided into sections as shown below:

Section I, GENERAL INFORMATION, describes the instruments documented by this manual and covers instrument identification, description, accessories, specifications, and other basic information.

Section II, INSTALLATION, provides information about incoming inspection, power requirements, mounting, storage, and shipping of the instrument.

Section III, OPERATION, provides information about panel features, and gives operating checks, instructions, and maintenance information.

Section IV, PERFORMANCE TESTS, provides information required to ascertain that the instrument is performing in accordance with published specifications.

Section V, ADJUSTMENTS, provides information required to properly adjust and align the instrument after repairs are made.

Section VI, REPLACEABLE PARTS, provides ordering information for replaceable parts and assemblies.

Section VII, MANUAL CHANGES, provides manual change information necessary to document all prefixes listed on the title page. In addition, this section also contains recommended modifications for the earlier instrument configurations.

Section VIII, SERVICE, includes information required to troubleshoot and repair the instrument.

1-4. Packaged with this manual is an Operating Information Supplement. This is simply a copy of

the first three sections of this manual. Additional copies of the Operating Information Supplement may be ordered separately through your nearest Hewlett-Packard office. The part number is listed on the title page of this manual.

1-5. Also listed on the title page of this manual, below the manual part number, is a "Microfiche" part number. This number may be used to order 10 x 15 cm (4 x 6-inch) microfilm transparencies of the manual. Each microfiche contains up to 96 photo duplicates of the manual pages. The microfiche package also includes the latest Manual Changes supplement as well as all pertinent Service Notes.

1-6. SPECIFICATIONS

1-7. Instrument specifications are listed in Table 1-1. These specifications are the performance standards or limits against which the instrument may be tested.

1-8. INSTRUMENTS COVERED BY MANUAL

1-9. This instrument has a two-part serial number. The first four digits and the letter constitute the serial number prefix, which denotes the instrument's configuration. The last five digits form the suffix that is unique to each instrument. The contents of this manual apply directly to instruments having the same serial number prefix as listed under SERIAL NUMBERS on the title page.

1-10. An instrument manufactured after the printing of this manual may have a serial number that is not listed on the title page. This unlisted serial number prefix indicates that the instrument is different from those documented in this manual. The manual for this instrument is supplied with a Manual Changes supplement that contains change information that documents the differences.

1-11. In addition to change information, the supplement may contain information for correcting errors in the manual. To keep this manual as current and accurate as possible, Hewlett-Packard recommends that you periodically request the latest Manual Changes supplement. The supplement for this manual is keyed to this manual's

Instruments Covered by Manual (Cont'd)

print date and part number, both of which appear on the title page. Complimentary copies of the supplement are available from Hewlett-Packard.

1-12. For information concerning a serial number prefix not listed on the title page or in the Manual Changes supplement, contact your nearest Hewlett-Packard office.

1-13. DESCRIPTION

1-14. The HP 8654B Signal Generator is a portable, solid-state RF source providing calibrated and leveled signals from 10 to 520 MHz, and from +10 to -130 dBm (+8 to -130 dBm with Option 003). An internal oscillator provides calibrated amplitude and frequency modulation at 400 and 1000 Hz. Calibrated modulation from an external source is also possible. A front-panel meter indicates output level, percent AM, or FM peak frequency deviation.

1-15. OPTIONS

1-16. Option 003 adds internal reverse power protection for the Signal Generator's output circuitry (guaranteed to protect against reverse power up to 25 watts). The protection circuit uses a limiter and relay to prevent damage to the output circuitry and to automatically restore generator operation when reverse power is removed. Option 003 also protects the instrument when the LINE switch is off.

1-17. EQUIPMENT AVAILABLE

1-18. Information may be obtained on the accessories and equipment, or they may be ordered by contacting your nearest Hewlett-Packard office. Refer to the HP model number.

1-19. Complementary Equipment

1-20. **Modulation Oscillator.** The HP Model 651B Test Oscillator is fully compatible for external modulation of the Signal Generator.

1-21. **Output Amplifier.** The HP Model 8447C Power Amplifier is suitable for increasing the output level of the Signal Generator to >+17 dBm. Typical gain is 30 dB. Typical 3-dB bandwidth is 10-400 MHz.

1-22. **Output Amplifier.** The HP Model 8447E Power Amplifier is suitable for increasing the output level of the Signal Generator to >+15 dBm. Typical gain is 22 dB. Typical 3-dB bandwidth is 0.05 to 1400 MHz.

1-23. **Synchronizer/Counter.** The HP Model 8655A Synchronizer/Counter is designed to monitor and phase lock the output frequency of the Signal Generator. Maximum counter resolution over the generator's frequency range is 100 Hz. Maximum counter resolution when phase locked to the 8654B is 500 Hz.

1-24. Accessories

1-25. **Termination.** The HP Model 11507A Output Termination may be used to match the Signal Generator's 50-ohm output to low impedance circuits (5 ohms minimum), or to allow the generator to drive high impedance circuits at frequencies to 65 MHz. The termination may also be used as a dummy antenna for receiver measurements.

1-26. **75-Ohm Adapter.** The HP Model 11687A 50 to 75-ohm Adapter may be used to match the Signal Generator output to a 75-ohm load. The OUTPUT LEVEL dial and meter scale remain calibrated in volts, but a correction factor is necessary to read output calibrated in dBm.

1-27. **Frequency Doubler.** The HP Model 11690A Frequency Doubler extends the usable range of signal sources to 1 GHz. Conversion loss is <13 dB.

1-28. **Mixer.** The HP Model 10514A Double Balanced Mixer may be used as a current controlled attenuator, an amplitude, pulse, or square-wave modulator, or a phase detector.

1-29. **Transit Case.** A transit case is available to protect the Signal Generator while transporting it from location to location. The case meets the requirements of MIL-C-4150 and may be ordered by specifying HP part number 9211-1895.

1-30. SERVICE AND USER AIDS

1-31. **Video Tapes.** Video tapes covering instrument use, application, and service are available. Contact the nearest Hewlett-Packard Sales and Service office for a list of presently available tapes.

1-32. **Application Notes.** Informative notes concerning the use of signal generators are also available from the nearest Hewlett-Packard Sales and Service office.

1-33. **Service Notes.** Hewlett-Packard makes design improvements to its current line of instruments on a continuing basis. Many of these improvements can be incorporated into earlier produced instru-

Service and User Aids (Cont'd)

ments. Modification and general service information is passed on in the form of Service Notes. To obtain the Service Notes contact the nearest Hewlett-Packard Sales and Service office.

1-34. WARRANTY

1-35. The Signal Generator is warranted and certified as indicated on the inner front cover of this manual. For further information, contact the nearest Hewlett-Packard Sales and Service office; addresses are provided at the back of this manual.

1-36. RECOMMENDED TEST EQUIPMENT

1-37. The equipment recommended for performance testing, adjustments, and troubleshooting is

listed in Table 1-2. Only equipment that meets or exceeds the critical specifications should be used in place of that shown in the table.

NOTE

The 8654B is a safety class I instrument. It has been manufactured and tested in accordance with international standards. This instrument and all related documentation must be reviewed for familiarization with safety markings and instructions before operation. Refer to the Safety Considerations page found at the beginning of this manual for a summary of the safety information. Safety information pertinent to the task at hand (installation, operation, performance testing, adjustments, or service) is found throughout this manual.

Table 1-1. Specifications (1 of 2)

SPECIFICATIONS																							
Specifications apply from 10 to 520 MHz for output power $\leq +10$ dBm and over the top 10 dB of output level vernier range unless otherwise specified.																							
FREQUENCY CHARACTERISTICS			OUTPUT CHARACTERISTICS																				
Range: 10 to 520 MHz in 6 ranges: 10 to 19 MHz 19 to 35 MHz 35 to 66 MHz 66 to 130 MHz 130 to 270 MHz 270 to 520 MHz			Range: 10 dB steps and a 13 dB vernier provide power settings from +10 dBm to -130 dBm (0.7V to 0.07 μ V) into 50 Ω . For Option 003, maximum output level is +8 dBm (0.56V).																				
Accuracy: $\pm 3\%$ after 2-hour warm-up.			Impedance: 50 Ω ac coupled. SWR <1.3 on 0.1V range or lower. With Option 003, SWR <1.5 on 0.1V range or lower.																				
Settability: Settable to within 5 ppm of the desired frequency with an external indicator after 1-hour warm-up.			Level Accuracy:																				
Stability (after 2-hour warm-up and 15 min. after frequency change): <(1 kHz plus 20 ppm)/5 min.			<table border="1" style="width: 100%; border-collapse: collapse;"> <thead> <tr> <th style="width: 15%;"></th> <th colspan="4" style="text-align: center;">Using Top 10 dB of Vernier Range</th> <th style="text-align: center;">Using Full Vernier Range</th> </tr> </thead> <tbody> <tr> <td style="text-align: center;">Output Level (dBm)</td> <td style="text-align: center;">+10* to -7</td> <td style="text-align: center;">-7 to -57</td> <td style="text-align: center;">-57 to -97</td> <td style="text-align: center;">-97 to -127</td> <td style="text-align: center;">+10* to -130</td> </tr> <tr> <td style="text-align: center;">Total Accuracy as Indicated on Level Meter (dB)</td> <td style="text-align: center;">± 1.5</td> <td style="text-align: center;">± 2.0</td> <td style="text-align: center;">± 2.5</td> <td style="text-align: center;">± 3.0</td> <td style="text-align: center;">Add ± 0.5</td> </tr> </tbody> </table>				Using Top 10 dB of Vernier Range				Using Full Vernier Range	Output Level (dBm)	+10* to -7	-7 to -57	-57 to -97	-97 to -127	+10* to -130	Total Accuracy as Indicated on Level Meter (dB)	± 1.5	± 2.0	± 2.5	± 3.0	Add ± 0.5
	Using Top 10 dB of Vernier Range				Using Full Vernier Range																		
Output Level (dBm)	+10* to -7	-7 to -57	-57 to -97	-97 to -127	+10* to -130																		
Total Accuracy as Indicated on Level Meter (dB)	± 1.5	± 2.0	± 2.5	± 3.0	Add ± 0.5																		
SPECTRAL PURITY																							
Harmonic Distortion (output power $\leq +3$ dBm): >20 dB below carrier (dBc). Option 003: >15 dBc.																							
Subharmonics and Non-harmonic Spurious (excluding line related): >100 dBc.																							
Residual AM (average rms): >55 dBc in a 50 Hz to 15 kHz post-detection noise bandwidth.																							
Residual FM on CW (averaged rms deviation): <0.3 ppm in a 0.3 to 3 kHz post-detection noise bandwidth. <0.5 ppm in a 50 Hz to 15 kHz post-detection noise bandwidth.																							
<p style="font-size: small;">Note: Level Accuracy error consists of allowances for meter accuracy, detector linearity, temperature, flatness, attenuator accuracy, and twice the measurement error. All but the attenuator accuracy and the measurement error can be calibrated out with a power meter at a fixed frequency and a fixed vernier setting.</p> <p style="font-size: small;">*For Option 003, maximum output level is +8 dBm (0.56V).</p>																							
Level Flatness: ± 1 dB referenced to the output at 250 MHz for output levels > -7 dBm.																							

Table 1-1. Specifications (2 of 2)

SPECIFICATIONS

OUTPUT CHARACTERISTICS (cont'd)

Auxiliary RF Output: > -7 dBm (100 mV) into 50Ω .

Leakage (with all RF outputs terminated properly):
Leakage limits are below those specified in MIL-I-6181D. Furthermore, with an output level < 0.01 V, less than 0.5μ V is induced in a 2-turn, 25 mm (1-inch) diameter loop 25 mm (1 inch) away from any surface and measured into a 50Ω receiver.

Reverse Power Damage Level:
75 Vdc maximum. Output Range 1V and 0.3V:
250 mW (+24 dBm). All other output ranges:
500 mW (+27 dBm).

Reverse Power Protection (Option 003): Protects signal generator from accidental applications of up to 25W (+44 dBm) of RF power (between 10 and 520 MHz) into generator output.

MODULATION CHARACTERISTICS

Amplitude Modulation: Specifications apply for output power $< +3$ dBm.¹

Depth: 0 to 90%.

Modulation Rate:
Internal, 400 and 1000 Hz $\pm 10\%$.
External 3 dB bandwidth, dc-coupled to > 20 kHz.

External AM Sensitivity:² $(0.1 \pm 0.01)\%$ AM/mVpk into 600Ω , with AM LEVEL vernier at fully cw position.

Indicated AM Accuracy:² $\pm(5\%$ of reading $+5\%$ of full scale).

Peak Incidental Frequency Deviation (30% AM)²: less than 200 Hz.

Envelope Distortion:² $< 3\%$, 0 to 70% modulation; $< 5\%$, 70 to 90% modulation.

Frequency Modulation: fully calibrated.

Peak Deviation:
0 to 30 kHz from 10 to 520 MHz.
0 to 100 kHz from 80 to 520 MHz.

Deviation Ranges: 0 to 3 kHz, 0 to 10 kHz, 0 to 30 kHz, 0 to 100 kHz.

Modulation Rate:
Internal, 400 to 1000 Hz $\pm 10\%$.
External 3 dB bandwidth, dc coupled to > 25 kHz.

FM Distortion:² $< 2\%$ for deviations up to 30 kHz, $< 3\%$ for deviations up to 100 kHz.

External FM Sensitivity:² 1 volt peak yields maximum deviation indicated on peak deviation meter with FM LEVEL vernier at fully cw position.

Sensitivity Accuracy (15° to 35° C)²: $\pm 12\%$. For 100 kHz deviation range above 130 MHz, $\pm 15\%$.

Indicated FM Accuracy (15° to 35° C)²: $\pm(12\%$ of reading $+3\%$ of full scale). For 100 kHz deviation range above 130 MHz, add 3% of reading.

Incidental AM:² $< 1\%$ AM at 30 kHz deviation.

GENERAL CHARACTERISTICS

Power: 100, 120, 220, or 240 volts $+5\%$, -10% , 48 to 440 Hz; 25VA maximum, 2.29 m (7½ ft) power cable furnished with mains plugs to match destination requirements.

Weight: Net, 7.9 kg (17 lb, 6 oz).

Dimensions:³ 266 mm wide x 178 mm high x 305 mm deep (10½" x 7" x 12").

¹ AM is possible above +3 dBm as long as the combination of the AM depth plus carrier output level does not exceed +9 dBm.

² 400 and 1000 Hz modulation rates.

³ Dimensions are for general information only. If dimensions are required for building special enclosures, contact your HP office.

Table 1-2. Recommended Test Equipment (1 of 3)

Instrument Type	Critical Specifications	Suggested Model	Use*
20 dB Amplifier	Range: 10–520 MHz Gain: 20 to 25 dB Flatness over Range: ± 2 dB Impedance: 50Ω Noise Figure: < 5 dB	HP 8447A	P
20 dB Amplifier	Range: 400–1200 MHz Gain: > 20 dB Flatness: ± 2 dB Impedance: 50Ω Noise Figure: < 5 dB to 1 GHz	HP 8447B	P
40 dB Amplifier	Range: 5 Hz to 50 kHz Gain: 20 and 40 dB ± 1 dB Input Impedance: $> 5k\Omega$ Output Impedance: 50Ω Noise: $< 25 \mu\text{Vrms}$ referred to input Output: > 1 Vrms into 50Ω	HP 465A	P
One-Inch Loop Antenna	2-turn, 25 mm (1 inch) dia., 25 mm (1 inch) from end. To ensure measurement accuracy, no substitution is possible. Fabrication depends upon machining and assembling to close tolerances.	HP 08640-60501	P
10 dB Step Attenuator	Attenuation: 0–50 dB in 10 dB steps Range: dc–520 MHz Accuracy: ± 1.5 dB to 50 dB below 520 MHz	HP 355D	P, A
10 dB Attenuator (req'd for Opt. 003 only)	Accuracy: ± 0.5 dB to 520 MHz	HP 8491A Opt. 010	A
Digital Multimeter	Voltage Range: 1V or less Display: 4½ digits or more DC Accuracy: $\pm(0.03\%$ or reading $+0.02\%$ of range) AC Accuracy: $\pm(0.25\%$ of reading $+0.05\%$ of range) Ohms Range: to 1 M Ω	HP 34702A/34740A	P, A, T
Distortion Analyzer	Range: 20 Hz to 10 kHz Distortion Range: $< 0.1\%$ Minimum Input: < 300 mVrms	HP 331A	P, A
Frequency Meter	Ranges: 100 kHz to 10 MHz Linear Analog Output: 1V for full scale	HP 5210A	P, A
Filter Kit	Output Low-pass Filters for HP 5210A Frequency Meter (10 kHz and 100 kHz Butterworth filters)	HP 10531A	
*P = Performance; A = Adjustments; T = Troubleshooting			

Table 1-2. Recommended Test Equipment (2 of 3)

Instrument Type	Critical Specifications	Suggested Model	Use*
4 MHz Low-pass Filter	4 MHz low-pass (3 pole) Impedance: 50Ω	CIR-Q-TEL** FLT/21B-4-3/ 50-3A/3B	P, A
15 kHz Low-pass Filter	15 kHz low-pass (7 pole) Impedance: 50Ω Ripple: <±0.2 dB	CIR-Q-TEL** FLT/21B-15K- 7/50-3A/3B	P
Frequency Counter	Range: to 520 MHz Input Sensitivity: <100 mV Inputs: 50Ω and high impedance (1 MΩ) Accuracy: ±0.1%	HP 5383A	P, A, T
Frequency Counter (If available, substitute for HP 5383A)	Range: to 520 MHz Input Sensitivity: <100 mV Inputs: 50Ω and high impedance (1 MΩ) Accuracy: ±0.1% Short Term Stability: < 2 x 10 ⁻⁹ rms for 1 s. Must be able to display frequency difference measured sequentially between two channels and to produce an external gate pulse at start of each count.	HP 5345A/5354A (HP 5345A/5353A will also serve in this application)	A
Mixer	Double Balanced Range: 10–520 MHz	HP 10514A	P, A
Oscilloscope	50 MHz Real Time Sensitivity: 5 mV/division	HP 1820C/1801A/ 182C	P, T
Power Meter	Input Level: -20 to +20 dBm Accuracy: ±1% of reading	HP 435A	P, A, T
Power Sensor	Range: 10–530 MHz SWR: <1.2:1	HP 8481A	
RMS Voltmeter	Range: 10 Hz to 50 kHz Reading: True rms (ac only) Voltage Range: 1 mV to 10V full scale Accuracy: 1% of full scale 50 Hz to 50 kHz Scale: Voltage and dB	HP 3400A	P
Signal Generator	Range: 10–520 MHz Output: > +7 dBm into 50Ω Drift: <20 ppm/10 min Residual FM: <50 Hz rms in 20 Hz to 15 kHz post-detection noise bandwidth; <30 Hz rms in 0.3–3 kHz post detection noise bandwidth at 270–520 MHz.	HP 8640A	P, A
<p>*P = Performance; A = Adjustments; T = Troubleshooting **CIR-Q-TEL INC./10504 Wheatley/Kensington, MD 20795/Phone 301-946-1800.</p>			

Table 1-2. Recommended Test Equipment (3 of 3)

Instrument Type	Critical Specifications	Suggested Model	Use*
Spectrum Analyzer	Range: 10–1200 MHz Input Impedance: 50Ω Amplitude Calibration: Display Accuracy: ±0.25 dB/dB but not more than 1.5 dB over 70 dB dynamic range Flatness: ±1 dB IF Gain Step Accuracy: ±0.2 dB Vertical Reference Scale: 10 dB/division log, 2 dB/ division-(or less) log, and linear display calibration. Average Noise Level: <-102 dBm with 10 kHz IF bandwidth Spurious Responses: >60 dB down for inputs of -40 dBm or less Maximum Bandwidth: ≥300 kHz Span Width: 0–1 GHz Compatible with Tracking Generator	HP 8558B/182C Opt. 807	P, A
Test Oscillator	Range: 10 Hz to 50 kHz Output Impedance: 600Ω and 50Ω Distortion: >40 dB down Output Level: >1 Vrms	HP 651B	P, A
Tracking Generator (required for Opt. 003 only)	Output: to 0 dBm (50Ω) Flatness: ±0.5 dB Compatible with Spectrum Analyzer HP 8558B/182C	HP 8444A Opt. 058	A
SWR Bridge (required for Opt. 003 only)	Range: 10–520 MHz Directivity: >40 dB Connectors: Type N	Wiltron Model** 60N50	A
FM Deviation Adjust- ment Board	Produces ±0.949V square wave triggered by an exter- nal counter. Resistance substitution circuit. No substitution is possible.	HP 08654-60084	A
50Ω Load (2 req.)		HP 11593A	P
50Ω Load (required for Opt. 003 only)	SWR <1.05 (dc–520 MHz)	HP 908A	A
Coaxial Short (Male Type N)		HP 11512A	A
Double Shielded Cable (BNC, Male, coaxial 2 required)		HP 08708-6033	P
*P = Performance; A = Adjustments; T = Troubleshooting **Wiltron Company/930 E. Meadow Dr./Palo Alto, CA 94303/TWX 9103731156/Phone 415-494-6666			

SECTION II INSTALLATION

2-1. INTRODUCTION

2-2. This section provides information about incoming inspection, selecting the input line voltage, operating environment, and information applicable to bench and rack mounting.

2-3. INITIAL INSPECTION

2-4. Inspect the shipping container for damage. If the shipping container or cushioning material is damaged it should be kept until the contents of the shipment have been checked for completeness and the instrument has been checked mechanically and electrically. The contents of the shipment are as shown in Figure 1-1, and the procedures for checking electrical performance are given in Section IV. If the contents are incomplete, if there is mechanical damage or defects, or if the instrument does not pass the electrical performance test, notify the nearest Hewlett-Packard office. If the shipping container is damaged or the cushioning material shows signs of stress, notify the carrier as well as the Hewlett-Packard office. Keep the shipping materials for the carrier's inspection. The HP office will arrange for repair or replacement without waiting for claim settlements.

2-5. PREPARATION FOR USE

2-6. Power Requirements

2-7. The 8654B Signal Generator requires a power source of 100, 120, 220 or 240 Vac +5% -10%, 48 to 440 Hz single phase. Power consumption is less than 25 VA.

2-8. Line Voltage Selection

2-9. Figure 2-1 provides instructions for line voltage and fuse selection. The line voltage for which the instrument is set is visible in the module window.



CAUTION

To prevent damage to the instrument, make the line voltage and fuse selection before connecting the power cable.

NOTE

The correct fuse rating for the line voltage is shown on the rear panel. Fuse part numbers are given in the Replaceable Parts Table in Section VI. (The reference designator is F1.)

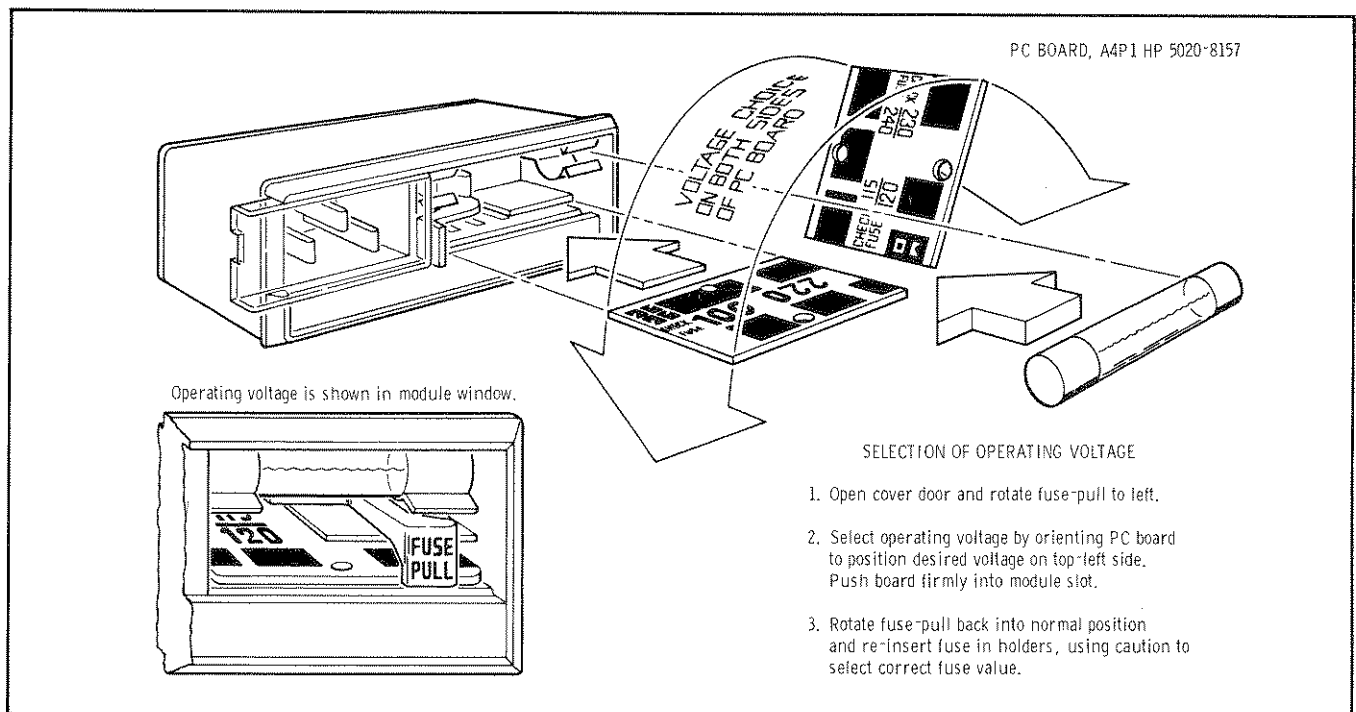

Figure 2-1. Line Voltage Selection

2-10. Power Cable

2-11. In accordance with international safety standards, this instrument is equipped with a three-wire power cable. When connected to an appropriate ac power receptacle, this cable grounds the instrument cabinet. The type of power cable plug shipped with each instrument depends on the country of destination. Refer to Figure 2-2 for the part numbers of the power cable plugs available.

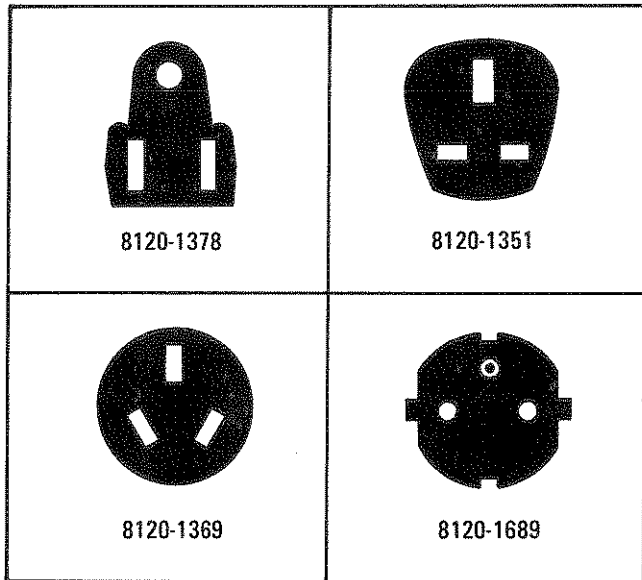

Figure 2-2. Power Cables Available

WARNING

The protection provided by grounding the instrument may be lost if any power cable other than the three-pronged type supplied is used to couple the ac line voltage to the instrument.

2-12. Operating Environment

2-13. The operating environment should be within the following limitations:

- Temperature 0 to +55°C
- Humidity <95% relative
- Altitude <4600 metres (15 000 feet)

2-14. Bench Operation

2-15. The instrument cabinet has plastic feet and foldaway tilt stands for convenience in bench operation. The plastic feet are shaped to ensure self-aligning of the instruments when stacked. The

tilt stands raise the front of the instrument for easier viewing of the control panel.

2-16. Rack Mounting

2-17. **Rack Adapter Frames.** Hewlett-Packard adapter frames are an economical means of rack mounting instruments that are narrower than full rack width. A set of spacer clamps, supplied with each adapter frame, permits instruments of different dimensions to be combined and rack mounted as a unit. Accessory blanks are available for filling unused spaces.

2-18. **Combining Cases.** Model 1051A and 1052A Combining Cases are metal enclosures that allow combinations of third- or half-rack width instruments to be assembled for use on a workbench or for mounting in a rack of 482.5 mm (standard 19-inch) spacing. Each case includes a set of partitions for positioning and retaining instruments, and a rack mounting kit. No tools are required for installing the partitions. For bench use the cases have the same convenience features as full rack width instruments (i.e., foldaway tilt stands and specially-designed feet for easier instrument stacking). Accessories available for the combining cases include fan kits, blank filler panels, and snap-on full width control panel covers.

2-19. STORAGE AND SHIPMENT

2-20. Environment

2-21. The instrument should be stored in a clean, dry environment. The following environmental limitations apply to both storage and shipment.

- Temperature -40 to +75°C
- Humidity <95% relative
- Altitude <7600 metres (25 000 feet)

2-22. Packaging

2-23. **Original Packaging.** Containers and materials identical to those used in factory packaging are available through Hewlett-Packard offices. If the instrument is being returned to Hewlett-Packard for servicing, attach a tag indicating the type of service required, return address, model number, and full serial number. Also, mark the container FRAGILE to assure careful handling. In any correspondence, refer to the instrument by model number and full serial number.

2-24. Other Packaging. The following general instructions should be used for re-packaging with commercially available materials:

a. Wrap the instrument in heavy paper or plastic. (If shipping to a Hewlett-Packard office or service center, attach a tag indicating the type of service required, return address, model number, and full serial number.)

b. Use a strong shipping container. A double-wall carton made of 2.4 MPa (350 psi) test material is adequate.

c. Use enough shock-absorbing material (75-100 mm) around all sides of the instrument to provide a firm cushion and prevent movement inside the container. Protect the control panel with cardboard.

d. Seal the shipping container securely.

e. Mark the shipping container FRAGILE to assure careful handling.

SECTION III OPERATION

3-1. INTRODUCTION

3-2. This section provides complete operating instructions for the HP 8654B Signal Generator. The instructions consist of panel features, operator's checks, operating instructions, and operator's maintenance.

WARNINGS

Before switching on the instrument, the protective earth terminals of the instrument must be connected to the protective conductor of the (mains) power cord. The mains plug shall only be inserted in a socket outlet provided with a protective earth contact. The protective action must not be negated by the use of an extension cord (power cable) without a protective conductor (grounding). Grounding one conductor of a two conductor outlet is not sufficient protection.

Ensure that all devices connected to this instrument are connected to the protective (earth) ground.

Make sure that only fuses with the required rated current and of the specified type (normal blow, time delay, etc.) are used for replacement. The use of repaired fuses and the short-circuiting of fuse holders must be avoided.

CAUTION

Before switching on this instrument, make sure it is set to the proper line voltage.

3-3. PANEL FEATURES

3-4. Front and rear panel features of the 8654B Signal Generator are described in Figures 3-2 and 3-3. These figures contain a detailed description of

the Signal Generator controls, indicators, and connectors.

3-5. OPERATOR'S CHECKS

3-6. Upon receipt of the instrument, or to check the Signal Generator for an indication of normal operation, perform the operational procedures listed in Figure 3-4. These procedures are designed to familiarize the operator with the Signal Generator and permit a determination of operating capabilities.

3-7. OPERATING INSTRUCTIONS

3-8. General operating instructions are contained in Figure 3-5. The instructions will familiarize the operator with basic operating functions of the Signal Generator.

3-9. Auxiliary Output

3-10. The isolation of the AUX RF OUT from the front panel RF OUTPUT is typically 30 dB. Any signal that is coupled into the AUX RF OUT jack may be transmitted to the front panel output. An example of this is an electronic counter used to monitor the RF output frequency. Subharmonic signals at the counter input may be coupled into the AUX RF OUT jack and from there to the front panel output where they are transmitted to the load.

3-11. OPERATOR'S MAINTENANCE

3-12. The maintenance responsibilities of the operator are replacing the primary fuse, the LINE switch lamp and zeroing the meter.

3-13. **Fuses.** The fuse is located on the rear panel within the power module assembly (see Figure 3-3). Figure 2-1, steps 1 and 3, explain how to remove and install the fuse. Proper fuse ratings for selected line voltages are given on the rear panel. Fuse part numbers may be found in the Replaceable Parts Table in Section VI. Reference designator is F1.

3-14. Line Switch Lamp Replacement. The lamp is contained in the white plastic lens which doubles for the pushbutton on the LINE switch. When the instrument is ON, the lamp should be illuminated.

3-15. Figure 3-1 shows the method of removing and installing the lamp. A replacement lamp, DS1, may be ordered under HP Part Number 2140-0244.

3-16. Meter Zeroing. With the power off the meter's pointer should be positioned directly over zero. If the pointer is not at zero, insert a screwdriver into the adjustment screw, (beneath meter), and align the pointer with zero on the meter scale. This adjustment should only be made when necessary. If a large adjustment is required, the meter calibration should be checked.

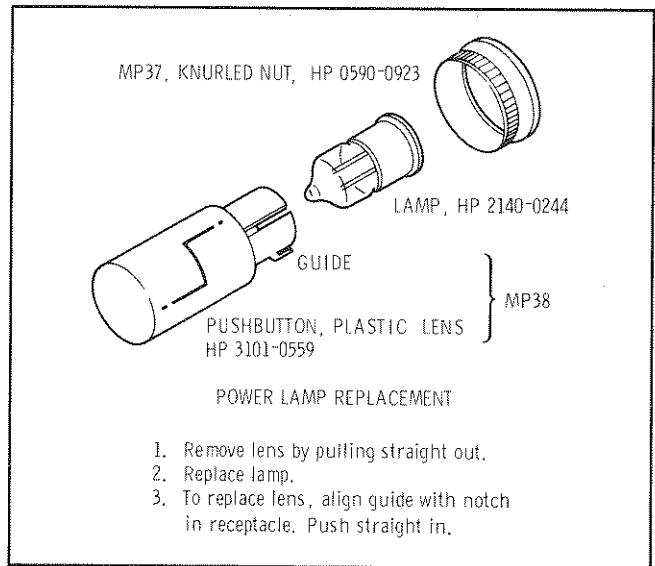
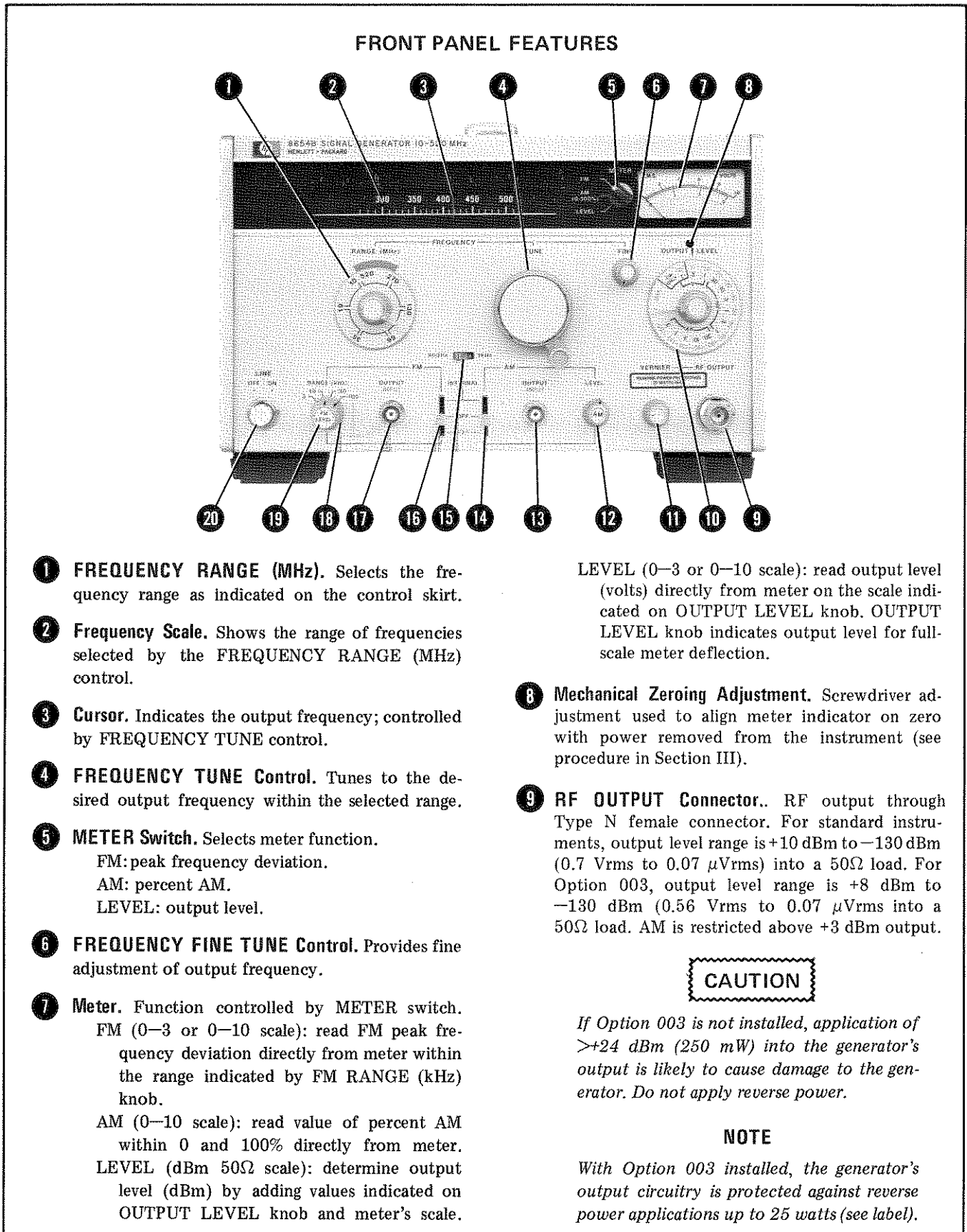

Figure 3-1. Lamp Replacement



- 1 **FREQUENCY RANGE (MHz)**. Selects the frequency range as indicated on the control skirt.
- 2 **Frequency Scale**. Shows the range of frequencies selected by the FREQUENCY RANGE (MHz) control.
- 3 **Cursor**. Indicates the output frequency; controlled by FREQUENCY TUNE control.
- 4 **FREQUENCY TUNE Control**. Tunes to the desired output frequency within the selected range.
- 5 **METER Switch**. Selects meter function.
 FM: peak frequency deviation.
 AM: percent AM.
 LEVEL: output level.
- 6 **FREQUENCY FINE TUNE Control**. Provides fine adjustment of output frequency.
- 7 **Meter**. Function controlled by METER switch.
 FM (0-3 or 0-10 scale): read FM peak frequency deviation directly from meter within the range indicated by FM RANGE (kHz) knob.
 AM (0-10 scale): read value of percent AM within 0 and 100% directly from meter.
 LEVEL (dBm 50Ω scale): determine output level (dBm) by adding values indicated on OUTPUT LEVEL knob and meter's scale.

LEVEL (0-3 or 0-10 scale): read output level (volts) directly from meter on the scale indicated on OUTPUT LEVEL knob. OUTPUT LEVEL knob indicates output level for full-scale meter deflection.

- 8 **Mechanical Zeroing Adjustment**. Screwdriver adjustment used to align meter indicator on zero with power removed from the instrument (see procedure in Section III).
- 9 **RF OUTPUT Connector**. RF output through Type N female connector. For standard instruments, output level range is +10 dBm to -130 dBm (0.7 Vrms to 0.07 μVrms) into a 50Ω load. For Option 003, output level range is +8 dBm to -130 dBm (0.56 Vrms to 0.07 μVrms) into a 50Ω load. AM is restricted above +3 dBm output.

CAUTION

If Option 003 is not installed, application of >+24 dBm (250 mW) into the generator's output is likely to cause damage to the generator. Do not apply reverse power.

NOTE

With Option 003 installed, the generator's output circuitry is protected against reverse power applications up to 25 watts (see label).

Figure 3-2. Front Panel Controls, Connectors, and Indicators (1 of 3)

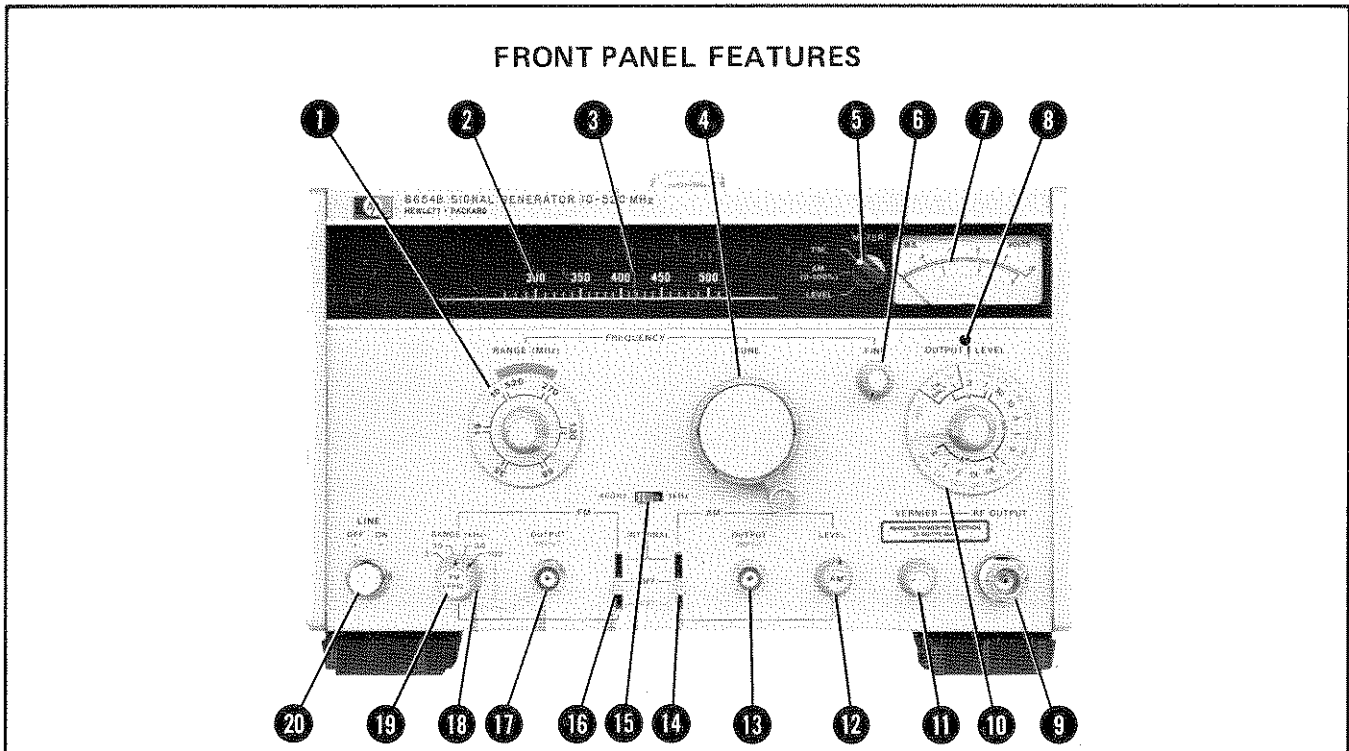

10 **OUTPUT LEVEL Switch.** Selects output range as shown on knob skirt, +10 to -120 dBm (1V to 0.3 μ V).

11 **Output Level VERNIER.** Fine adjusts RF output level continuously within a 13 dB range as indicated by the meter.

12 **AM LEVEL Control.** Varies percent AM of RF signal (internal or external AM mode).

13 **AM OUTPUT/INPUT Connector.** Provides output for internal AM signal or input for external AM signals.

AM INTERNAL mode: open-circuit output level \sim 5 Vrms, output impedance 10 k Ω .
 AM EXT (external) mode: input impedance \sim 600 Ω dc coupled. With AM LEVEL set fully cw, 1V peak input produces 100% AM and full-scale meter deflection (0-10 scale).

CAUTION

Applied voltages greater than 10V peak (ac + dc) can damage the AM circuitry.

14 **AM Source Switch.** Selects amplitude modulation source: INTERNAL, EXT (external), or OFF.

NOTE

A mechanical interlock prevents simultaneous internal AM and FM. However, simultaneous AM and FM is possible if at least one source is external.

15 **400 Hz/1 kHz Switch.** Selects 400 Hz or 1 kHz internal modulation signal.

16 **FM Source Switch.** Selects frequency modulation source: INTERNAL, EXT (external), or OFF.

NOTE

A mechanical interlock prevents simultaneous internal AM and FM. However, simultaneous AM and FM is possible, if at least one source is external.

17 **FM OUTPUT/INPUT Connector.** Provides output for internal FM signal or input for external FM signals.

FM INTERNAL mode: open-circuit output level \sim 5 Vrms, output impedance \sim 10 k Ω .
 FM EXT (external) mode: input impedance \sim 600 Ω , dc coupled. With FM LEVEL set fully cw, 1V peak produces full-scale meter deflection and the maximum peak frequency deviation determined by FM RANGE (kHz). See Table below.

Figure 3-2. Front Panel Controls, Connectors, and Indicators (2 of 3)

FRONT PANEL FEATURES

FM RANGE (kHz)	Meter Scale	Full-Scale Deviation (kHz)
3	0-3	3.16
10	0-10	10
30	0-3	31.6
100	0-10	100

CAUTION

Applied voltages greater than 10 Vpk (ac + dc) can damage the FM circuitry.

18 FM Range (kHz) Switch. Selects one of four peak frequency deviation ranges: 0-3 kHz, 0-10 kHz, 0-30 kHz, or 0-100 kHz. Peak frequency deviation is set with FM LEVEL control.

NOTES

FM is not specified on the 100 kHz range for RF signals less than 80 MHz.

For best FM performance, use lowest range which includes the peak deviation desired.

19 FM LEVEL Control. Varies peak frequency deviation (internal or external FM mode). Maximum peak deviation determined by FM RANGE (kHz) setting.

20 LINE OFF/ON Switch. Controls primary power. Illuminated when switch is set to "ON".

Figure 3-2. Front Panel Controls, Connectors, and Indicators (3 of 3)

REAR PANEL FEATURES

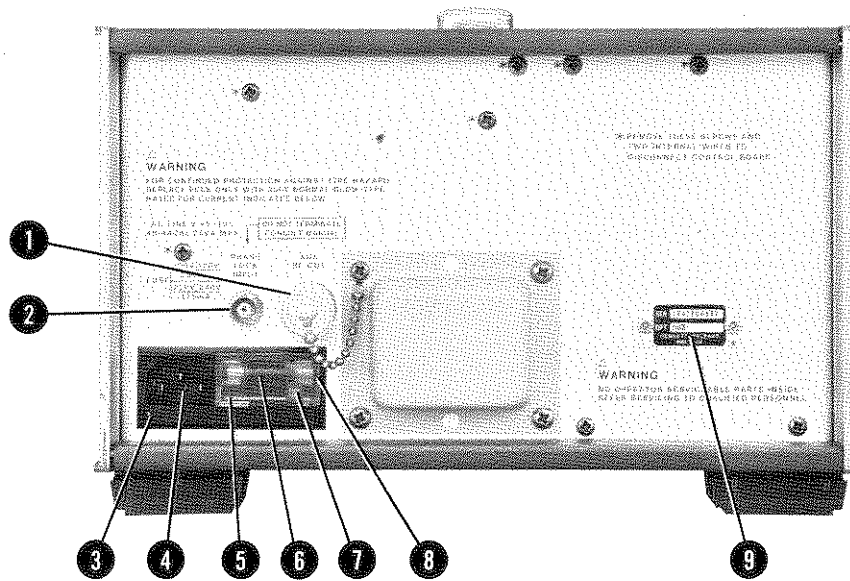

1 **AUX RF OUT Connector.** Provides RF signal, 10–520 MHz at > -7 dBm (fixed level) output into a 50Ω load. Signal is unleveled and does not contain amplitude modulation but does contain calibrated frequency modulation.

NOTE

The isolation of the AUX RF OUT from the front panel RF OUTPUT is typically 30 dB. Any signal that is coupled into the AUX RF OUT may be transmitted to the generator's output. An example of this is an electronic counter used to monitor the RF output frequency. Subharmonic signals at the counter input are coupled into the AUX RF OUT and from there to the front panel output where they are transmitted to the load.

2 **PHASE LOCK INPUT Connector.** Couples output of an external phase lock synchronizer such as HP 8655A to the electronic fine tuning circuit in the Signal Generator. Stability (drift) of generator is then determined primarily by stability of reference oscillator in the synchronizer. (The synchronizer's input can be connected to AUX RF OUT.)

NOTES

Use of a phase lock synchronizer will likely cause some degradation of FM sensitivity accuracy and indicated FM accuracy.

Do not use HP Model 8708A synchronizer or any low-impedance source to drive the PHASE LOCK INPUT port.

3 **Line Module Assembly.** Permits operation from 100, 120, 220 or 240 Vac. The number visible in window indicates nominal line voltage to which instrument must be connected (see Figure 2-1). Center conductor is safety earth ground.

WARNING

Any interruption of the protective (grounding) conductor inside or outside the instrument or disconnection of the protective earth terminal is likely to make the instrument dangerous. Intentional interruption is prohibited. (See Section II.)

4 **Receptacle.** To couple Line Power Cable to instrument.

Figure 3-3. Rear Panel Features (1 of 2)

REAR PANEL FEATURES

- 5 **Line Voltage Selection Card.** Matches transformer primary to available line voltage.
- 6 **Fuse.** 250 mA (250V, Normal Blow for 100/120 Vac. 175 mA (250V, Normal Blow, for 220/240 Vac.
- 7 **FUSE PULL Handle.** Mechanical interlock to guarantee fuse has been removed before Line Voltage Selection Card can be removed.
- 8 **Window.** Safety interlock ensures fuse cannot be removed while power cable is coupled to the 8654B.
- 9 **Serial Number Plate.** First four numbers and letter constitute the prefix that denotes the instrument configuration. The last five digits form the suffix that is unique to each instrument. The Serial Number plate also indicates any options supplied with instrument.

Figure 3-3. Rear Panel Features (2 of 2)

OPERATOR'S CHECKS

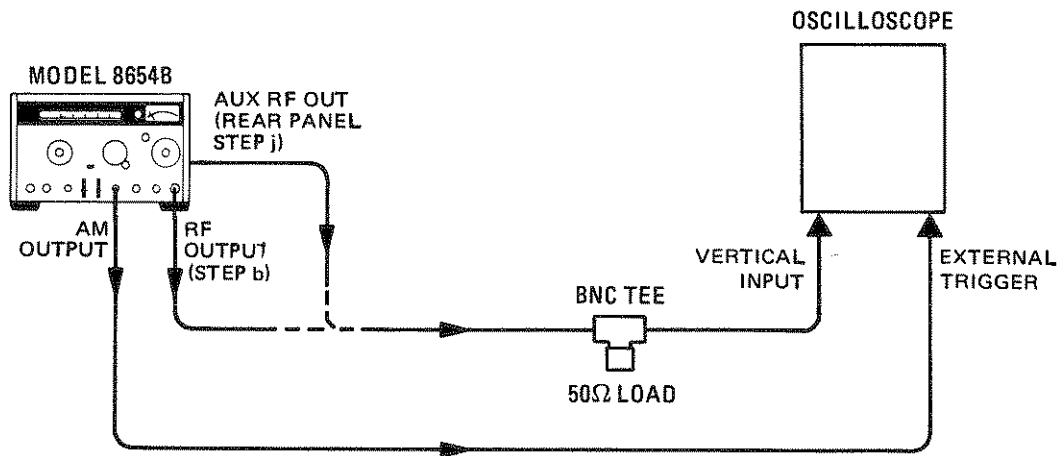

INITIAL SETTINGS

- a. Verify that the power transformer primary is matched to the line voltage and that the correct fuse is installed within the rear panel Line Module Assembly. See Line Voltage Selection in Section II.
- b. Insert the power cable to the power outlet and Line Module receptacles. Set the LINE switch to ON; the lamp within the switch lens should be illuminated.
- c. Set the generator's controls as follows:

METER	LEVEL
FREQUENCY RANGE (MHz)	10–19 MHz
FREQUENCY TUNE	10.0 MHz
OUTPUT LEVEL Switch	0.1 V
Output Level VERNIER	Full scale meter reading (0.1 Vrms)
AM	OFF
FM	OFF
400 Hz/1 kHz	1 kHz

RF OUTPUT

- d. Connect the equipment as shown above and verify that the 10.0 MHz signal has an output level of ~0.3 V_{p-p}.

NOTES

The oscilloscope must have a bandwidth of >10 MHz to perform these checks.

If the oscilloscope has a 50Ω input impedance, the BNC tee and 50Ω load should be omitted.

Figure 3-4. Operator's Checks (1 of 2)

OPERATOR'S CHECKS

AMPLITUDE MODULATION

- e. Set the 8654B AM Source to INTERNAL and set the oscilloscope time base trigger to external.
- f. Set METER Switch to AM and rotate AM LEVEL control cw until the meter indicates 50% modulation depth. Verify that the AM envelope display shows a peak-to-valley voltage difference of about 0.15V with a period of 1.0 ms.

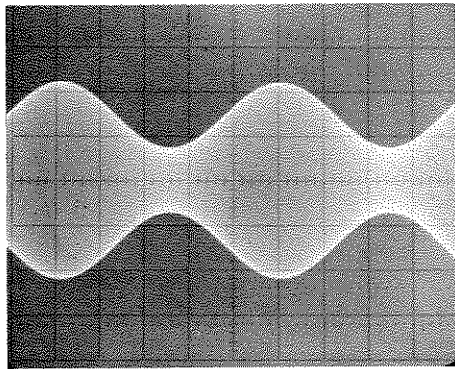

Typical AM Envelope

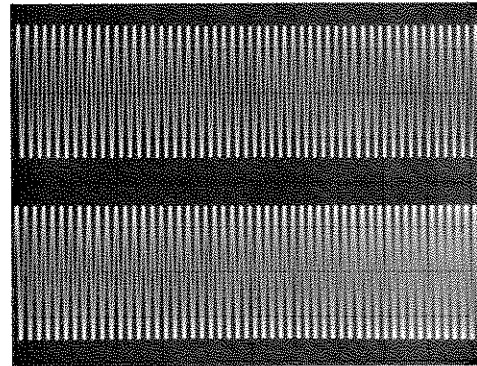

Typical FM Display with
CW Display for Comparison

- g. Set the 400 Hz/1 kHz switch to 400 Hz; verify the AM envelope period is 2.5 ms.

FREQUENCY MODULATION

- h. Set AM Source switch to OFF and set FM Source switch to INTERNAL. Set the oscilloscope time base trigger to internal.
- i. Set METER switch to FM and FM RANGE (kHz) to 30 kHz. Adjust FM LEVEL so that the meter indicates 30 kHz peak frequency deviation. Verify that the oscilloscope shows the typical FM display.

AUX RF OUT

- j. Connect the generator's AUX RF OUT (rear panel) to the oscilloscope's vertical input and verify that a 10.0 MHz signal of > 0.3 V_{p-p} is displayed.

Figure 3-4. Operator's Checks (2 of 2)

OPERATING INSTRUCTIONS

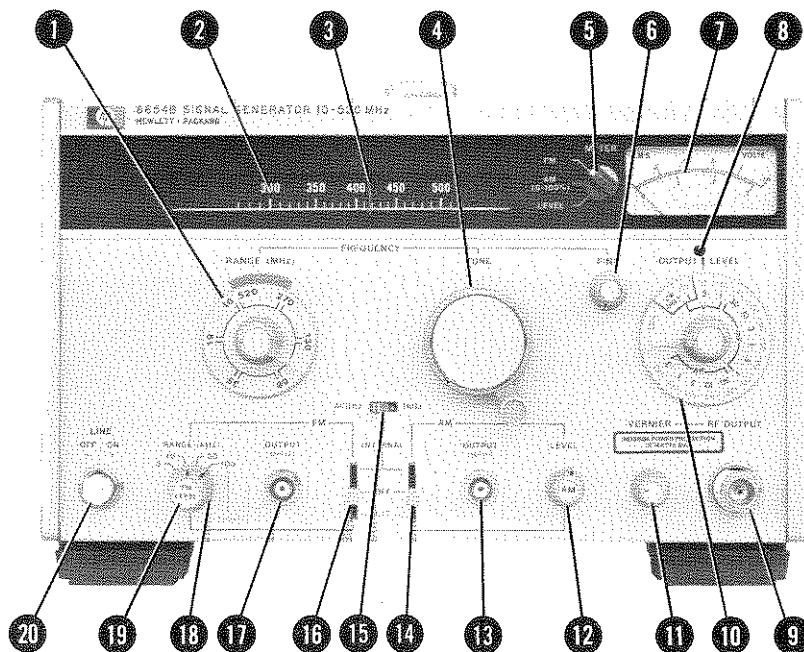

TURN ON

- a. Verify that the power transformer primary is matched to the line voltage. See Line Voltage Selection in Section II.
- b. Check the fuse, which is contained in the Line Module Assembly, for the correct rating. The voltage and current ratings are given in a table on the rear panel. If necessary, change the fuse.
- c. Insert the power cable to the power outlet and the Line Module receptacles. Press the LINE switch (20) and release. The switch should remain in, the lamp within the plastic lens should be illuminated, and the cursor on the curved portion of the button should indicate ON.

NOTE

To ensure the 8654B will perform to the standards set forth in the published specifications, let the instrument warm up for two hours before using.

FREQUENCY SELECTION

- d. Set FREQUENCY RANGE (MHz) (1) to the range which includes the desired carrier frequency.
- e. Tune to the carrier frequency with the FREQUENCY TUNE control (4); FREQUENCY FINE TUNE (6) provides greater tuning resolution. The Cursor (3) indicates the carrier frequency.

Figure 3-5. Operating Instructions (1 of 5)

OPERATING INSTRUCTIONS

OUTPUT LEVEL SELECTION

- f. Set METER switch **5** to LEVEL. Set the OUTPUT LEVEL control **10** and VERNIER **11** to the desired output level. For optimum AM performance and level meter accuracy, the VERNIER control should be set for a meter indication of -7 to $+3$ on the dBm scale ($> 1/3$ full scale). Amplitude modulation is restricted above $+3$ dBm.
- g. Vary the VERNIER control **11** until the level indicated on the OUTPUT LEVEL range control **10** added to the Meter indication **7** equals the desired level. (For voltage, keep in mind that meter full-scale is equivalent to the voltage shown on the OUTPUT LEVEL range control skirt **10**.)

AM – INTERNAL

- h. Set AM Source **14** to INTERNAL.
- i. Select 400 Hz or 1 kHz modulation rate with the 400 Hz/1 kHz frequency switch **15**.
- j. Set METER switch **5** to AM and vary AM LEVEL control **12** until the Meter **7** indicates the desired modulation depth. Use top scale (10 = 100%).

AM – EXTERNAL

- k. Set METER switch **5** to AM, and AM Source **14** to EXT. Apply signal to the AM OUTPUT/INPUT connector **13** (600 ohm load impedance). The Signal Generator requires 1 Vpk (0.707 Vrms) for 100% modulation (AM is specified to 90%). Set percent AM using AM LEVEL **12** and Meter **7**.

CAUTION

Damage to the generator's internal circuitry may occur if inputs greater than 10 Vpk (ac + dc) are coupled into the AM OUTPUT/INPUT connector.

NOTES

*For more precise setting of %AM using an external source, set AM LEVEL **12** fully cw. Monitor the voltage at AM INPUT with an external voltmeter. With AM LEVEL set fully cw, 1 Vpk (0.707 Vrms) produces 100% AM (AM is specified to 90%).*

Amplitude modulation is not recommended when the OUTPUT LEVEL control is set to $+10$ dBm. If AM is necessary, monitor the RF output with an oscilloscope to verify that the distortion is minimal. Frequency modulation is permissible on the $+10$ dBm range.

The AM meter responds to the positive peaks of the modulation signal. If the modulation signal waveform is asymmetrical or if it has a dc component, the meter reading will be in error.

Figure 3-5. Operating Instructions (2 of 5)

OPERATING INSTRUCTIONS

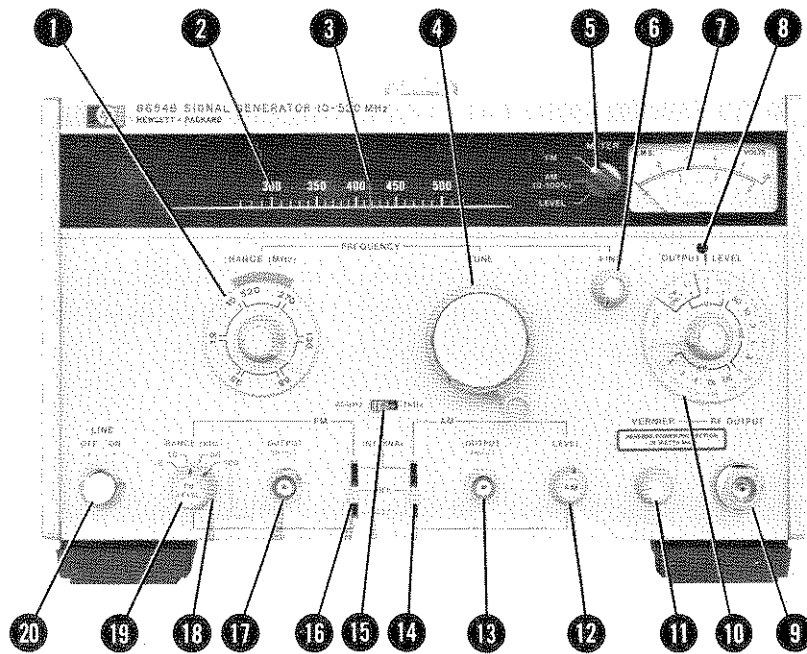

FM – INTERNAL

- l. Set FM Source **16** to INTERNAL.
- m. Select 400 Hz or 1 kHz internal modulating rate with the 400 Hz/1 kHz frequency switch **15**.
- n. Select desired peak deviation range with FM RANGE (kHz) control **18**. Set METER switch **5** to FM and vary FM LEVEL control **19** until the Meter **7** indicates desired deviation.

FM – EXTERNAL

- o. Set METER switch **5** to FM, and FM Source **16** to EXT. Set FM RANGE (kHz) **18** to the lowest range that includes the frequency deviation desired. Apply signal to the FM OUTPUT/INPUT connector **17** (600 ohm load impedance). The Signal Generator requires 1 Vpk (0.707 Vrms) for maximum peak frequency deviation on any FM range (see table below). Set peak frequency deviation using FM LEVEL **19** and Meter **7**.

CAUTION

Damage to the generator's internal circuitry may occur if inputs greater than 10 Vpk (ac + dc) are coupled into the FM OUTPUT/INPUT connector.

Figure 3-5. Operating Instructions (3 of 5)

OPERATING INSTRUCTIONS

FM – EXTERNAL (Cont'd)

NOTES

*For more precise setting of FM peak deviation using an external source, set FM LEVEL **19** fully cw. Monitor the voltage at FM INPUT with an external voltmeter. With FM LEVEL fully cw, 1 Vpk (0.707 Vrms) produces maximum deviation on any FM range (see table below).*

FM RANGE (kHz)	Meter Scale	Full-Scale Deviation (kHz)
3	0-3	3.16
10	0-10	10
30	0-3	31.6
100	0-10	100

FM is not specified on the 100 kHz range for RF signals less than 80 MHz.

SIMULTANEOUS AM AND FM

- p. Simultaneous AM and FM is possible if at least one of the modulation sources is external. Follow the appropriate steps above for internal or external modulation.

PULSE MODULATION

- q. Set FREQUENCY RANGE (MHz) and FREQUENCY TUNE controls to the desired frequency, the AM and FM Source controls to OFF, and AM LEVEL fully cw.
- r. Set OUTPUT LEVEL and VERNIER controls to the desired output level. (This will be the output level during pulse on-time.)
- s. Connect a pulse generator to the AM OUTPUT/INPUT connector.

Figure 3-5. Operating Instructions (4 of 5)

OPERATING INSTRUCTIONS

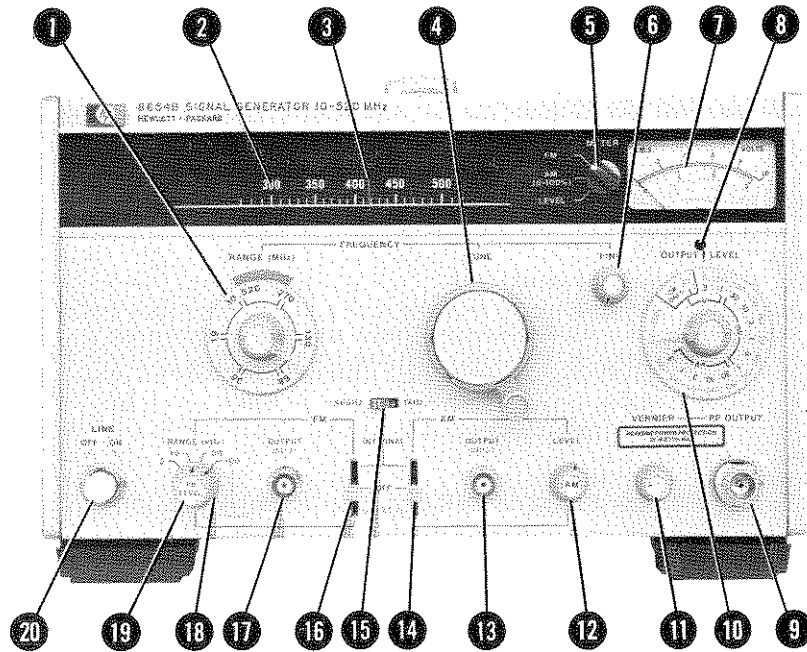

- t. Set the pulse generator controls to produce a pulse on-time voltage of 0.0 Vdc and an off-time voltage of -1.5 Vdc (see waveform below). Set other pertinent pulse generator controls.

CAUTION

Damage to the generator's input circuitry may occur if inputs greater than 10 Vpk (ac + dc) are coupled to the AM OUTPUT/INPUT connector.



NOTES

The pulse-on time voltage must be 0.0 Vdc or the output level during the on-time will not be equal to the preset level.

The on-off ratio is typically >40 dB.

- u. Set AM Source to EXT.

NOTE

Rise time for pulse modulated output is typically 50 μs.

Figure 3-5. Operating Instructions (5 of 5)

