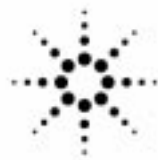


# Notice

---

## **Hewlett-Packard to Agilent Technologies Transition**

This documentation supports a product that previously shipped under the Hewlett-Packard company brand name. The brand name has now been changed to Agilent Technologies. The two products are functionally identical, only our name has changed. The document still includes references to Hewlett-Packard products, some of which have been transitioned to Agilent Technologies.



**Agilent Technologies**

By internet, phone, or fax, get assistance with all your test and measurement needs.

**Table 1-1 Contacting Agilent**

**Online assistance:** [www.agilent.com/find/assist](http://www.agilent.com/find/assist)

**United States**  
(tel) 1 800 452 4844

**Latin America**  
(tel) (305) 269 7500  
(fax) (305) 269 7599

**Canada**  
(tel) 1 877 894 4414  
(fax) (905) 282-6495

**Europe**  
(tel) (+31) 20 547 2323  
(fax) (+31) 20 547 2390

**New Zealand**  
(tel) 0 800 738 378  
(fax) (+64) 4 495 8950

**Japan**  
(tel) (+81) 426 56 7832  
(fax) (+81) 426 56 7840

**Australia**  
(tel) 1 800 629 485  
(fax) (+61) 3 9210 5947

**Asia Call Center Numbers**

Country	Phone Number	Fax Number
Singapore	1-800-375-8100	(65) 836-0252
Malaysia	1-800-828-848	1-800-801664
Philippines	(632) 8426802 1-800-16510170 (PLDT Subscriber Only)	(632) 8426809 1-800-16510288 (PLDT Subscriber Only)
Thailand	(088) 226-008 (outside Bangkok) (662) 661-3999 (within Bangkok)	(66) 1-661-3714
Hong Kong	800-930-871	(852) 2506 9233
Taiwan	0800-047-866	(886) 2 25456723
People's Republic of China	800-810-0189 (preferred) 10800-650-0021	10800-650-0121
India	1-600-11-2929	000-800-650-1101

**HP 8719C  
HP 8720C  
HP 8722A/C  
NETWORK ANALYZER  
OPERATING MANUAL**

**SERIAL NUMBERS**

This manual applies directly to all network analyzers.

For additional information about serial numbers, refer to "Analyzers covered by this manual" in General Information.

©Copyright                      HEWLETT-PACKARD COMPANY                      1991  
1400 FOUNTAINGROVE PARKWAY, SANTA ROSA, CA 95403                      U.S.A.

MANUAL PART NO. 08720-90135  
Manual Set Part Number 08720-90157

Printed: OCTOBER 1995  
EDITION 2



## **CERTIFICATION**

*Hewlett-Packard Company certifies that this product met its published specifications at the time of shipment from the factory. Hewlett-Packard further certifies that its calibration measurements are traceable to the United States National Institute of Standards and Technology (NIST, formerly NBS), to the extent allowed by the Institute's calibration facility, and to the calibration facilities of other International Standards Organization members.*

## **WARRANTY**

This Hewlett-Packard system product is warranted against defects in materials and workmanship for a period corresponding to the individual warranty periods of its component products. Computer and computer peripherals are warranted for a period of 90 days. Instruments are warranted for a period of one year. During the warranty period, Hewlett-Packard Company will, at its option, either repair or replace products which prove to be defective.

Warranty service for products installed by HP and certain other products designated by HP will be performed at Buyer's facility at no charge within HP service travel areas. Outside HP service travel areas, warranty service will be performed at Buyer's facility only upon HP's prior agreement and Buyer shall pay HP's round trip travel expenses. In all other areas, products must be returned to a service facility designated by HP.

For products returned to HP for warranty service, Buyer shall prepay shipping charges to HP and HP shall pay shipping charges to return the product to Buyer. However, Buyer shall pay all shipping charges, duties, and taxes for products returned to HP from another country.

HP warrants that its software and firmware designated by HP for use with an instrument will execute its programming instructions when properly installed on that instrument. HP does not warrant that the operation of the instrument, or software, or firmware will be uninterrupted or error free.

## **LIMITATION OF WARRANTY**

The foregoing warranty shall not apply to defects resulting from improper or inadequate maintenance by Buyer, Buyer-supplied software or interfacing, unauthorized modification or misuse, operation outside of the environmental specifications for the product, or improper site preparation or maintenance.

NO OTHER WARRANTY IS EXPRESSED OR IMPLIED. HP SPECIFICALLY DISCLAIMS THE IMPLIED WARRANTIES OR MERCHANTABILITY AND FITNESS FOR A PARTICULAR PURPOSE.

## **EXCLUSIVE REMEDIES**

THE REMEDIES PROVIDED HEREIN ARE BUYER'S SOLE AND EXCLUSIVE REMEDIES. HP SHALL NOT BE LIABLE FOR ANY DIRECT, INDIRECT, SPECIAL, INCIDENTAL, OR CONSEQUENTIAL DAMAGES, WHETHER BASED ON CONTRACT, TORT, OR ANY OTHER LEGAL THEORY.

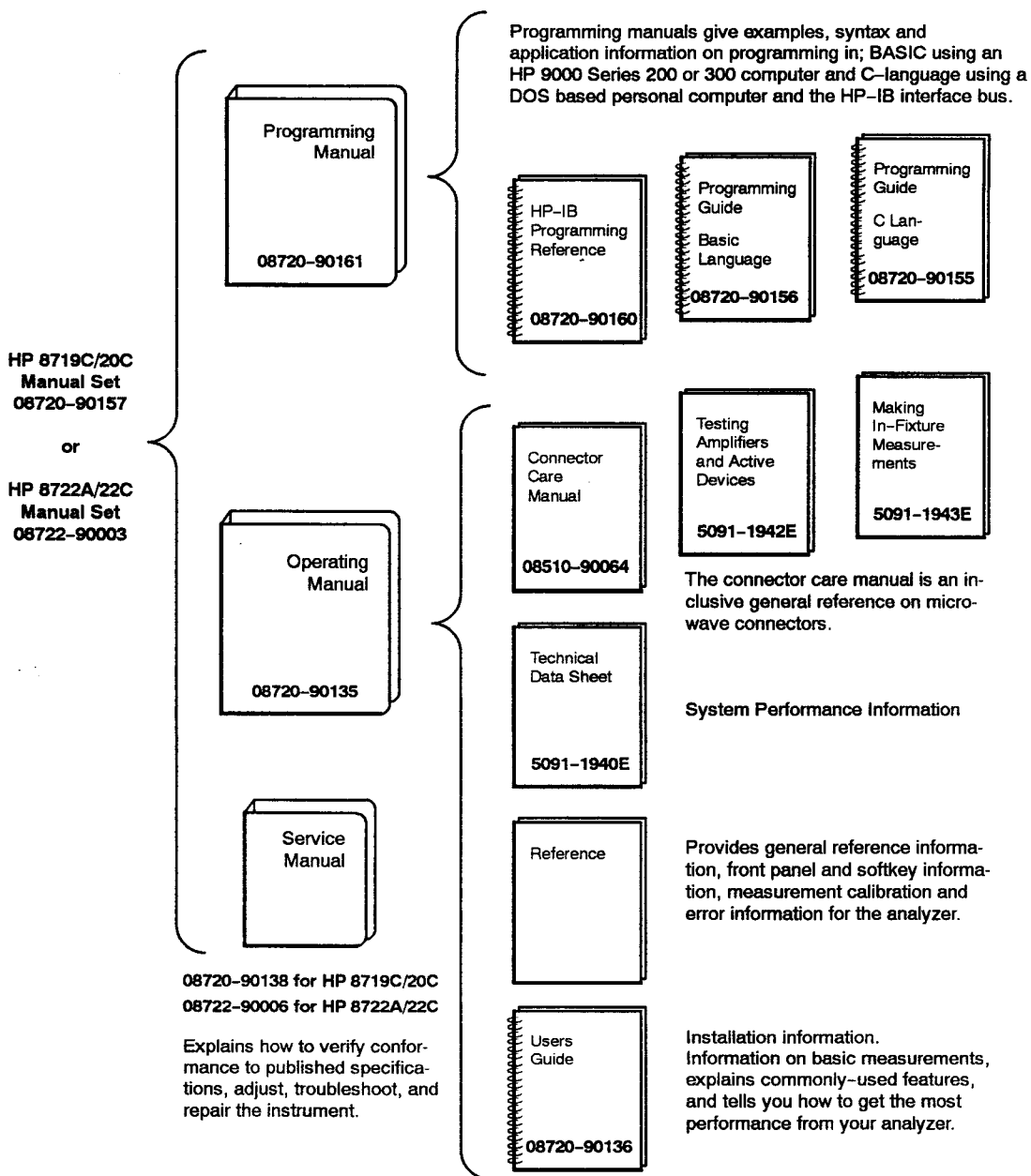
## **ASSISTANCE**

*Product maintenance agreements and other customer assistance agreements are available for Hewlett-Packard products.*

*For any assistance, contact your nearest Hewlett-Packard Sales and Service Office. Addresses are provided at the back of this manual.*

BP24A.2

# HP 8719/20/22 Documentation Map



# DECLARATION OF CONFORMITY

according to ISO/IEC Guide 22 and EN 45014

**Manufacturer's Name:** Hewlett-Packard Co.  
**Manufacturer's Address:** Microwave Instruments Division  
1400 Fountaingrove Parkway  
Santa Rosa, CA 95403-1799  
USA

declares that the product

**Product Name:** Network Analyzer  
**Model Number:** HP 8719C, 8720C, 8722C  
**Product Options:** This declaration covers all options of the above product.

conforms to the following Product specifications:

**Safety:** IEC 348:1978/HD 401 S1:1981  
CAN/CSA-C22.2 No. 231 (Series M-89)

**EMC:** CISPR 11:1990/EN 55011:1991 Group 1, Class A  
IEC 801-2:1984/EN 50082-1:1992 4 kV CD, 8 kV AD  
IEC 801-3:1984/EN 50082-1:1992 3 V/m, 27-500 MHz  
IEC 801-4:1988/EN 50082-1:1992 0.5 kV Sig. Lines, 1 kV Power Lines

## Supplementary Information:

The product herewith complies with the requirements of the Low Voltage Directive 73/23/EEC and the EMC Directive 89/336/EEC.

Santa Rosa, California, USA 11 Oct, 1995

  
Dixon Browder/Quality Manager

European Contact: Your local Hewlett-Packard Sales and Service Office or Hewlett-Packard GmbH, Department HQ-TRE, Herrenberger Strasse 130, D-71034 Böblingen, Germany (FAX +49-7031-14-3143)

# HP 8719C/8720C/8722A/8722C NETWORK ANALYZERS

## CONTENTS

### USER'S GUIDE TAB

#### Installation

INTRODUCTION .....	IN-1
unpacking your instrument .....	IN-1
ENVIRONMENTAL CONSIDERATIONS .....	IN-3
System Heating and Cooling .....	IN-4
SPACE REQUIREMENTS .....	IN-4
POWER CONSIDERATION .....	IN-5
HP-IB CONSIDERATIONS .....	IN-6
HP-IB Addresses .....	IN-6
Checking HP-IB Addresses .....	IN-7
STATIC-FREE WORK STATION .....	IN-8
Static Symbol .....	IN-9
TURNING ON THE ANALYZER .....	IN-9

### REFERENCE TAB

#### Chapter 1. General Information

INTRODUCTION .....	1-1
ITEMS SUPPLIED WITH THE ANALYZER .....	1-1
BRIEF DESCRIPTION OF THE ANALYZER .....	1-2
Hewlett-Packard Interface BUS (HP-IB) .....	1-2
DESCRIPTION OF THE MANUAL SET .....	1-2
Analyzers Covered by This Manual .....	1-2
OPTIONS AVAILABLE .....	1-3
Option 001, 1 Hz Frequency Resolution .....	1-3
Option 006 Solid State Transfer Switch (HP 8719,8720 only) .....	1-3
Option 010, Time Domain .....	1-3
Option 011, 3-Channel Direct-Access Receiver .....	1-3
Option 003, High Forward Dynamic Range (HP 8722 only) .....	1-4
Option 802, Add Disk Drive .....	1-4
Option 910, Extra Manuals .....	1-4
Option 913, Rack Mount With Handles .....	1-4
Service and Support Products .....	1-4
EQUIPMENT REQUIRED .....	1-5
Calibration Kits .....	1-5
Verification Kits .....	1-6
Test Port Return Cables .....	1-7
EQUIPMENT AVAILABLE .....	1-9
Adapter Sets .....	1-9
System Rack .....	1-9
Plotters and Printers .....	1-9

Disk Drives .....	1-10
Computer .....	1-10
System Software .....	1-10
Anti-Static Mat .....	1-11
REQUIRED TEST EQUIPMENT .....	1-11
SAFETY CONSIDERATIONS .....	1-11
<b>Chapter 2. System Description and Data Processing</b>	
SYSTEM DESCRIPTION .....	2-1
DATA PROCESSING .....	2-2
Overview .....	2-2
Processing Details .....	2-3
<b>Chapter 3. Front Panel and Softkey Operation</b>	
INTRODUCTION .....	3-1
ACTIVE FUNCTION .....	3-1
FRONT PANEL KEYS AND SOFTKEY MENUS .....	3-1
FUNCTION BLOCKS .....	3-2
REMOTE OPERATION .....	3-2
ACTIVE CHANNEL KEYS (CHAN1, CHAN2) .....	3-4
ENTRY BLOCK .....	3-5
CRT DISPLAY .....	3-7
REAR PANEL FEATURES AND CONNECTORS .....	3-9
<b>Chapter 4. Stimulus Function Block</b>	
INTRODUCTION .....	4-1
START (STAR) and STOP (STOP) KEYS .....	4-1
CENTER (CENT) and SPAN (SPAN) KEYS .....	4-2
MENU KEY .....	4-2
Stimulus Menu .....	4-4
Trigger Menu .....	4-7
Sweep Type Menu .....	4-9
Segment Menu .....	4-11
Edit List Menu .....	4-12
Edit SubswEEP Menu .....	4-13
<b>Chapter 5. Response Function Block</b>	
INTRODUCTION .....	5-1
MEAS KEY .....	5-3
S-Parameters .....	5-4
S-Parameter Menu .....	5-5
Conversion Menu .....	5-6
Input Ports Menu .....	5-8
FORMAT KEY .....	5-9
Format Menu .....	5-9
GROUP DELAY PRINCIPLES .....	5-14
SCALE REF KEY .....	5-16
Scale Reference Menu .....	5-16



DISPLAY KEY .....	5-19
Display Menu .....	5-19
Display More Menu .....	5-22
Adjust Display Menu .....	5-23
Modify Colors Menu .....	5-24
Tint Brightness Color Menu .....	5-25
Title Menu .....	5-26
AVG KEY .....	5-27
Improvement in Noise Floor Due to Averaging .....	5-27
Improvement in Noise Floor Due to IF Bandwidth .....	5-29
Average Menu .....	5-30
<b>Chapter 6. Measurement Calibration</b>	
INTRODUCTION .....	6-1
ACCURACY ENHANCEMENT .....	6-1
SOURCES OF MEASUREMENT ERRORS .....	6-2
Directivity .....	6-2
Source Match .....	6-3
Load Match .....	6-4
Isolation (Crosstalk) .....	6-4
Frequency Response (Tracking) .....	6-5
CORRECTING FOR MEASUREMENT ERRORS .....	6-5
CAL KEY .....	6-7
Correction Menu .....	6-12
Select Cal Kit Menu .....	6-13
Calibrate More Menu .....	6-15
Reference Plane Menu .....	6-16
Calibration Menu .....	6-17
Response Calibration for Reflection Measurements .....	6-21
Response Calibration for Transmission Measurements .....	6-22
Response and Isolation Calibration for Reflection Measurements .....	6-22
Response and Isolation Calibration for Transmission Measurements .....	6-24
S11 1-Port Calibration for Reflection Measurements .....	6-25
S22 1-Port Calibration .....	6-26
Full 2-Port Calibration for Reflection and Transmission Measurements .....	6-27
TRL*/LRM* 2-Port Calibration .....	6-29
TRL*/LRM* Procedure .....	6-30
POWER METER CALIBRATION .....	6-31
Primary Applications .....	6-32
Calibrated Power Level .....	6-32
Compatible Sweep Types .....	6-32
Loss of Power Meter Calibration Data .....	6-32
Interpolation in Power Meter Calibration .....	6-32
POWER METER CALIBRATION MODE OPERATION .....	6-33
Sample-and-Sweep Correction [TAKE CAL SWEEP] .....	6-33
Other Details .....	6-33
Speed and Accuracy .....	6-34
PERFORMING A POWER METER CALIBRATION .....	6-35
Before Turning Power Meter Calibration On .....	6-35
Using Sample-and-Sweep .....	6-36
Calibration Data Table .....	6-36
Power Meter Calibration Menus .....	6-37

Power Meter Calibration Main Menu .....	6-38
Segment Modify Menu .....	6-38
Segment Edit (Calibration Factor %) Menu .....	6-40
<b>MODIFYING CALIBRATION KITS .....</b>	<b>6-40</b>
Definitions .....	6-41
Procedure .....	6-41
Modify Cal Kit Menu .....	6-42
Define Standard Menus .....	6-43
Specify Offset Menu .....	6-47
Label Standard Menu (LABS) .....	6-48
Specify Class Menus .....	6-50
Label Class Menus .....	6-52
TRL*/LRM* Option Menus .....	6-53
Label Kit Menu .....	6-53
Verify Performance .....	6-53
Example Procedure for Specifying a User-Defined Calibration Kit .....	6-54

## **Chapter 7. Using Markers**

<b>INTRODUCTION .....</b>	<b>7-1</b>
<b>MKR KEY .....</b>	<b>7-2</b>
Marker Menu .....	7-3
Delta Marker Mode Menu .....	7-4
Fixed Marker Menu .....	7-5
<b>MKR FCTN KEY .....</b>	<b>7-7</b>
Marker Search Menu .....	7-8
Target Menu .....	7-9
Bandwidth Menu .....	7-10
Marker Function Menu .....	7-11
Marker Mode Menu .....	7-12
Polar Marker Menu .....	7-14
Smith Marker Menu .....	7-15

## **Chapter 8. Instrument State and Limit Testing**

<b>INTRODUCTION .....</b>	<b>8-1</b>
<b>LOCAL KEY .....</b>	<b>8-2</b>
HP-IB Menu .....	8-2
Address Menu .....	8-5
<b>SYSTEM KEY (MENUSYST) .....</b>	<b>8-7</b>
<b>LIMIT LINES AND LIMIT TESTING .....</b>	<b>8-8</b>
Limits Menu .....	8-10
Edit Limits Menu .....	8-11
Edit Segment Menu .....	8-12
Limit Type Menu .....	8-14
Offset Limits Menu .....	8-15
<b>INSTRUMENT MODE MENU .....</b>	<b>8-16</b>

## **Chapter 9. Time and Frequency Domain Transforms**

<b>INTRODUCTION .....</b>	<b>9-1</b>
<b>GENERAL THEORY .....</b>	<b>9-2</b>
<b>TIME DOMAIN BANDPASS .....</b>	<b>9-4</b>
Reflection Measurements Using Bandpass Mode .....	9-4

Adjusting the Relative Velocity Factor .....	9-6
Transmission Measurements Using Bandpass Mode .....	9-6
Interpreting the Bandpass Transmission Response Horizontal Axis .....	9-7
TIME DOMAIN LOW PASS .....	9-7
Setting Frequency Range for Time Domain Low Pass .....	9-7
Reflection Measurements in Time Domain Low Pass .....	9-8
Fault Location Measurements Using Low Pass .....	9-11
Transmission Measurements in Time Domain Low Pass .....	9-12
TIME DOMAIN CONCEPTS .....	9-14
Masking .....	9-14
Windowing .....	9-15
Range .....	9-17
Resolution .....	9-18
Gating .....	9-20
Setting the Gate .....	9-21
Selecting Gate Shape .....	9-21
TRANSFORMING CW TIME MEASUREMENTS INTO THE FREQUENCY DOMAIN .....	9-22
Forward Transform Measurements .....	9-22
Interpreting the Forward Transform Measurement .....	9-23
Demodulating the Results of the Forward Transform .....	9-23
Forward Transform Range .....	9-25

## **Chapter 10. Making a Hard Copy Output**

INTRODUCTION .....	10-1
COPY KEY .....	10-1
Copy Menu .....	10-2
Select Quadrant Menu .....	10-4
Define Plot Menu .....	10-5
Configure Plot Menu .....	10-7
Screen Menu .....	10-8
Print/Plot Setups Menu .....	10-9

## **Chapter 11. Saving Instrument States**

INTRODUCTION .....	11-1
INSTRUMENT STATE .....	11-2
Instrument State Learn String .....	11-2
Instrument State Variables .....	11-2
Memory Allocation Examples .....	11-4
SAVING AND STORING INSTRUMENT STATES .....	11-5
Saving Instrument States Internally .....	11-5
Storing Instrument States to Disk .....	11-5
Memory Requirements for Storing Information to Disk .....	11-7
Calibration Set Cautions .....	11-7
SAVE AND RECALL KEYS .....	11-8
Save Menu .....	11-10
Clear Register Menu .....	11-11
Title Register Menu .....	11-12
Title Menu .....	11-13
Store File Menu .....	11-14
Define, Init, Purge Menu .....	11-15
Data File Format Menu .....	11-16
Initialize Menu .....	11-17

Purge File Menu .....	11-18
Title File Menu .....	11-19
Recall Menu .....	11-21
Load File Menu .....	11-22

**Chapter 12. HP-IB Remote Programming**

INTRODUCTION .....	12-1
HOW HP-IB WORKS .....	12-2
Talker .....	12-2
Listener .....	12-2
Controller .....	12-2
HP-IB BUS STRUCTURE .....	12-2
Data Bus .....	12-2
Handshake Lines .....	12-2
Control Lines .....	12-3
HP-IB REQUIREMENTS .....	12-4
HP-IB CAPABILITIES OF THE ANALYZER .....	12-5
BUS MODE .....	12-6
SETTING ADDRESSES .....	12-7
VALID CHARACTERS .....	12-7
HP-IB CODE NAMING CONVENTION .....	12-7
UNITS AND TERMINATORS .....	12-8
HP-IB DEBUG MODE .....	12-8
CRT GRAPHICS .....	12-8

**Chapter 13. ~~Instrument History~~ Error Messages**

INTRODUCTION .....	14-1
--------------------	------

*Chapter 14. Instrument History*

**Appendix A. Preset State**

PRESET STATE .....	A-1
--------------------	-----

**Appendix B. Accuracy Enhancement**

CHARACTERIZING MICROWAVE SYSTEMATIC ERRORS .....	B-1
One-Port Error Model .....	B-1
Two-Port Error Model .....	B-5

**DATA SHEET TAB**

System Performance .....	3
Option 011 .....	7
Capabilities .....	9
Software .....	15
Accessories .....	17

**CONNECTOR CARE TAB**

*and APPLICATIONS*  
^

**ACCESSORIES TAB**

## INTRODUCTION

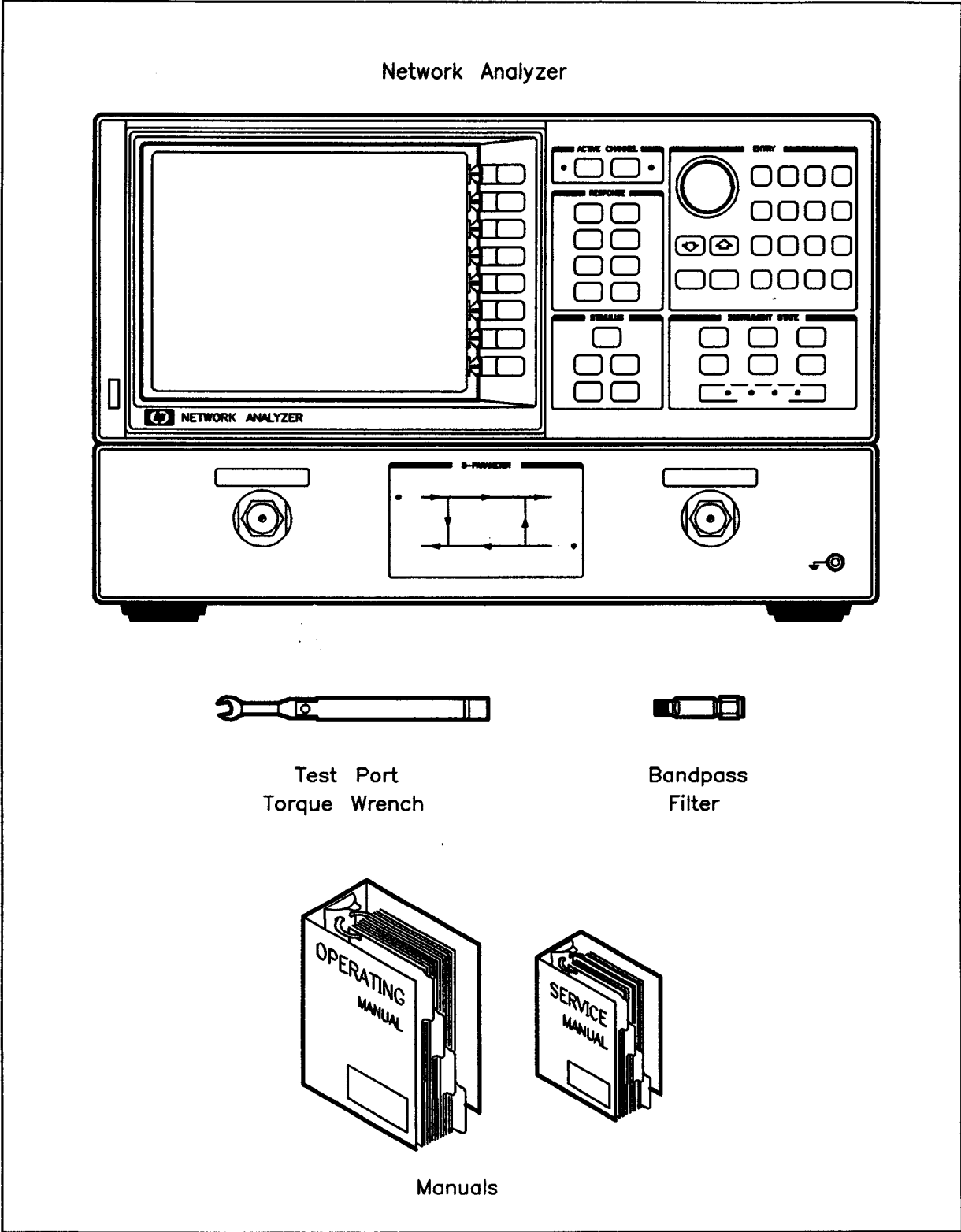
This chapter provides instructions for installing your analyzer. The main topics of this chapter are:

- Unpacking your instrument
- Environmental considerations
- Power considerations
- Checking the HP–IB address
- Static free work station
- Turning on the analyzer

## UNPACKING YOUR INSTRUMENT

This instrument has been carefully inspected both electrically and mechanically before being shipped from the factory. Performing an incoming inspection to check the instrument for signs of physical damage, missing contents, and to check that it passes the electrical performance test. If any discrepancy is found, notify the carrier and Hewlett–Packard. Your HP Sales Office will arrange for repair and replacement without waiting for the claim to be settled.

1. Inspect the shipping container for damage, and keep the shipping materials until the inspection is completed.
2. Verify that the shipping container contains everything shown in Figure IN–1.
3. Make sure the serial number on the analyzer's rear panel matches that on the shipping documents.
4. Inspect the exterior of the analyzer for any signs of damage.
5. Verify that the analyzer is equipped with the options you ordered.
6. To verify the electrical performance, perform the operators test, described in the Verification chapter of the *Service Manual*.



*Figure IN-1. Contents of Shipping Container*

## ENVIRONMENTAL CONSIDERATIONS

The analyzer will operate within a wide range of temperatures, altitudes, and levels of humidity. The environmental conditions are as follows:

*Table IN-1. Environmental Conditions*

<b>Temperature</b>	
For operation	+5°C to +40°C (41°F to 104°F)
For measurement calibration	+20°C to +26°C (+68°F to +79°F)
For performance verification	±1°C (±1.8°F) of the measurement calibration temperature
For storage	-40°C to +70°C (-40°F to +158°F)
<b>Humidity</b>	
For operation	5% to 95% at +40°C or less (non-condensing)
For storage	5% to 95% at +65°C or less (non-condensing)
<b>Pressure Altitude</b>	
For operation	less than 4,600 meters (15,000 feet)
For storage	less than 4,600 meters (15,000 feet)

**NOTE:** Accuracy enhancement is dependent, in part, on a stable temperature environment. If your environment temperature has a tendency to fluctuate more than  $\pm 1^\circ\text{C}$ , periodically perform a verification to ensure that the system has been correctly calibrated.

## System Heating and Cooling

Install air conditioning and heating, if required.

Air conditioning requirements depend on the amount of heat produced by the instruments. Use the BTU/hour ratings from the table below

*Table IN-2. Maximum VA Ratings and BTU/Hour Ratings of HP Instruments*

Instrument	Maximum VA Rating <sup>1</sup>	VA Subtotal	Maximum BTU/hour	BTU/hour Subtotal
<b>Standard Equipment</b>				
HP 87XX Network Analyzer	280		952	
HP 8340 Synthesized Sweeper or	500		1,700	
HP 8360 Synthesized Sweeper or	400		1,360	
HP 8350 with Plug-in	375		1,275	
<b>Standard System Total</b>				
<b>Accessory Equipment</b>				
HP 9000 Series 300	250		850	
19 inch CRT: HP 98751A, 98752A, 98753A, 98754A	420		1,430	
16 inch CRT: HP 98785A, 98789A	200		680	
Typical Hard Disk Drive	65		222	
HP Laser Jet II	170 to 800		580 to 2,720	
HP PaintJet	20		68	
HP 7440A Plotter	100		340	
<b>System Total</b>				
1. Values are based on 120 Vac supplied to each instrument at 60 Hz.				

## SPACE REQUIREMENTS

An area must be provided for the system instruments. The following table lists the space required for different configurations and includes the additional space for proper ventilation.

*Table IN-3. System Space Requirements*

	Height	Width	Depth
<b>HP 85043B System Cabinet</b> (without work surface)	124 cm (49 in)	60 cm (24 in)	80 cm (32 in)
<b>Bench-Top system*</b>	26.7 cm (10.5 in)	42.5 cm (17 in)	51 cm (20 in)

\* Allow 12" of table top in front of the analyzer to provide room for test port cables.



## POWER CONSIDERATION

This is a safety class 1 product (provided with a protective earth terminal). A non-interruptible safety earth ground must be provided from the main power source to the analyzer's power input terminals, power cord, or supplied power cord set. Whenever the safety earth ground has been impaired, the instrument must be made inoperative and secured against any unintended operation. If this instrument is to be energized via an autotransformer (NOT RECOMMENDED) for voltage reduction, make sure that the common terminal is connected to the earth pole of the power source.

Confirm that the analyzer voltage selector (shown in Figure IN-2) is set to match the AC line voltage before plugging in the analyzer.

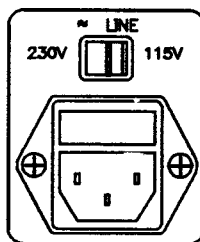


Figure IN-2. Voltage Selector

Table IN-4. AC Line Voltage

Nominal Setting	AC Line Power
115V	90V to 132V (at 47 to 66 Hz)
230V	198V to 264V (at 47 to 66 Hz)

To protect operating personnel, the National Electric Manufacturer's Association (NEMA) recommends that the instrument panel and cabinet be grounded. The analyzer is equipped with a three-conductor power cord that, when plugged into the appropriate AC power receptacle, grounds the instrument. The offset pin on the power cord is the safety ground.

To preserve the protection feature when operating the instrument from a two prong outlet, use a three-prong to two-prong adapter and connect the green pigtail on the adapter to the protective earth connection.

# CAUTION

The power plug must be plugged into an outlet that provides a protective earth connection. DO NOT use an extension cord or power cord that does not have a protective ground.

## HP-IB CONSIDERATIONS

HP-IB enables system instruments to communicate. Connect the system instruments with HP-IB cables in any order. The other system instruments have HP-IB connectors (shown below) similar to that of the analyzer. Tighten the knurled screws on each of the HP-IB cables.

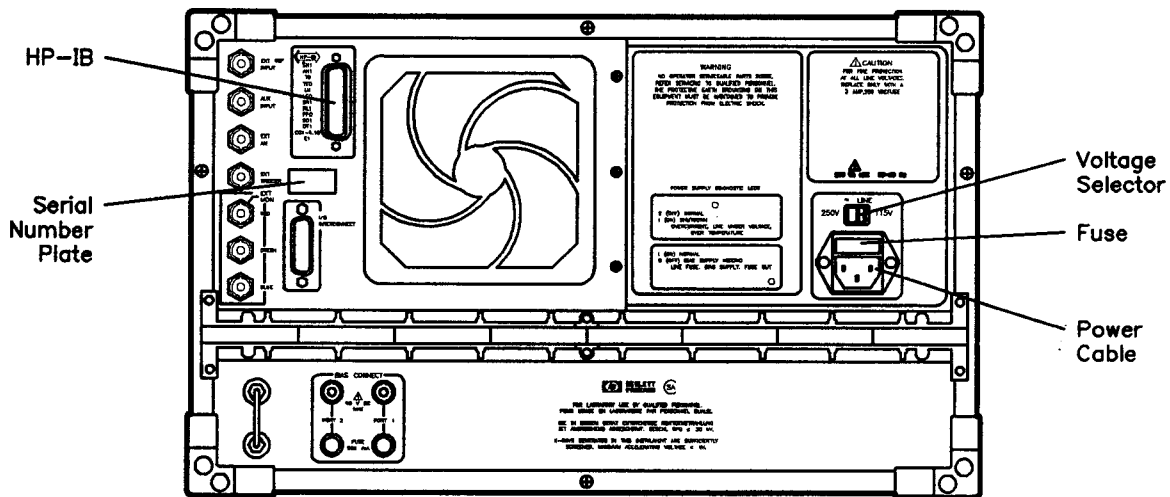


Figure IN-3. HP 8720 Rear Panel

Table IN-5. HP-IB Cable Lengths

Instruments in System	Maximum HP-IB Cable Length	Cable Length (Approximate)	Part Number
Two	4 m	4 m (13 feet)	HP 10833C
Three or more	2 m	2 m (6 feet)	HP 10833B
		1 m (3 feet)	HP 10833A
		0.5 m (1.5 feet)	HP 10833D
Fifteen (max)	20 m (Total)		

## HP-IB Addresses

To communicate via HP-IB, (1) each device must have a unique address and (2) the analyzer must recognize each address. To check each device's HP-IB address, refer to its manual (most addresses are set with switches). To check the analyzer's address, press the **LOCAL** key and the **SET ADDRESSES ADDRESS: INSTRUMENT** softkeys. The analyzer's address will appear.

The HP-IB addresses shown are the factory-set addresses of the devices. They are also the default addresses recognized by the analyzer.

*Table IN-6. HP-IB Addresses*

Device	HP-IB Decimal Address
Network Analyzer	16
Printer	5
Plotter	1
Disk (drive)	0
Controller (computer)	21
P Mtr (power meter)	13

To change an address (recognized by the analyzer) to match a device address, press the device softkey and then enter the address and **[x1]**.

To learn how to use the network analyzer, continue with the next chapter. The analyzer has already passed its self-test and should be ready to make measurements.

If you need to check the instrument more rigorously (incoming inspection, for instance), refer to the *Service Manual*.

## Checking HP-IB Addresses

For hard copy output, an HP-IB cable must connect the analyzer to the printer or plotter.

To communicate by HP-IB, two conditions must be satisfied:

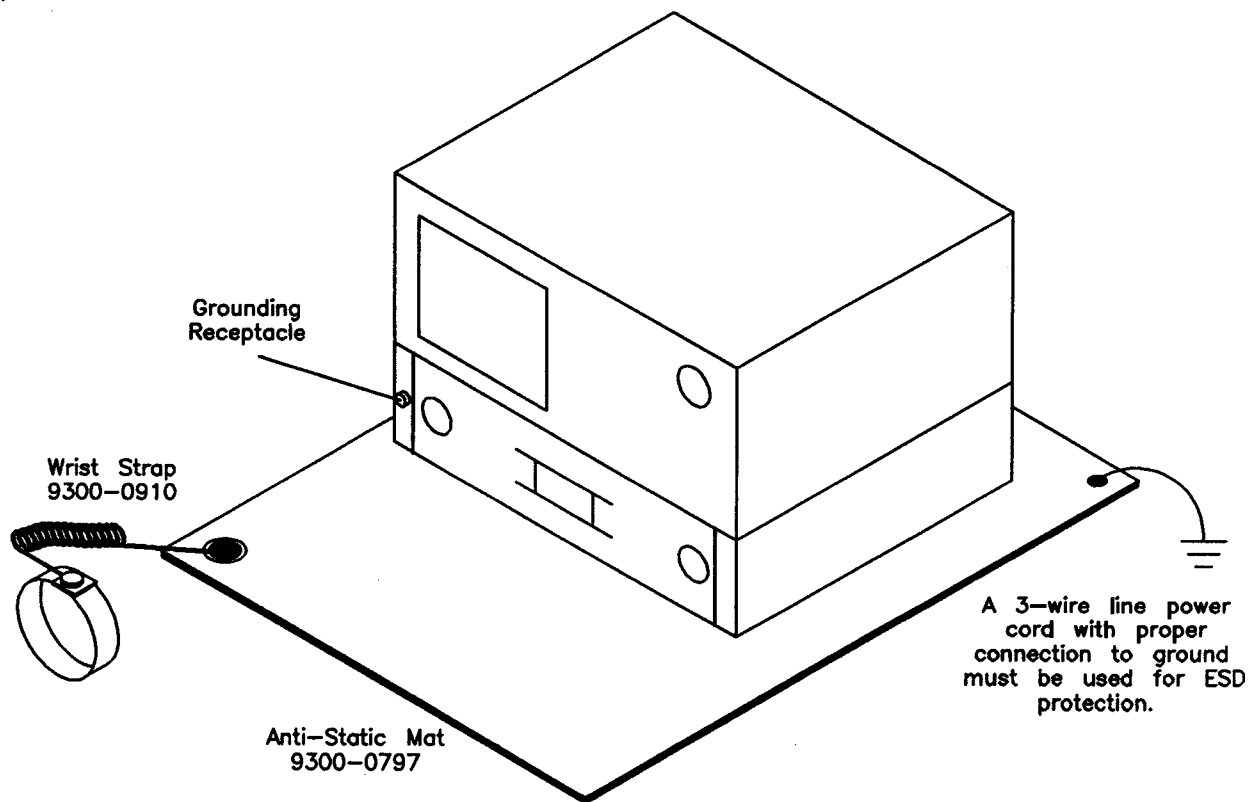
- The analyzer must have a unique address.
- The analyzer must recognize each address.

To check each device's HP-IB address, refer to its manual (most addresses are set with switches). To check the analyzer's address press **[LOCAL] SET ADDRESSES ADDRESS: 87XX**. The analyzer's address will appear.

Table IN-6 shows the factory-set device addresses. They are also the default addresses recognized by the analyzer.

To change an HP-IB address (recognized by the analyzer) to match a device address, press the device softkey and then enter the address and **[x1]**.

## STATIC-FREE WORK STATION



*Figure IN-4*

When installing the analyzer for use on a bench, place it on a grounded anti-static work surface to lessen the chance of ESD damage. The anti-static surface should extend far enough in front of the analyzer to provide effective protection for the test ports and cable ends. A grounding receptacle is provided on the analyzer as an alternate grounding point for your anti-static wrist-strap.

## Static Symbol



### **ATTENTION** **Static Sensitive** **Handle only at Static Safe** **Work Stations**

The static symbol illustrated above may be found used in the manual set as a reminder that the procedures about to be performed could result in ESD damage to the analyzer if certain cautions are not followed. Be aware that there are devices in the analyzer that are easily damaged by ESD.

## TURNING ON THE ANALYZER

Turn the line switch on. The analyzer should power up with no error messages displayed, in which case, the analyzer has passed its internal diagnostics and is functioning properly.

**NOTE:** If an error message is displayed, or if the instrument does not appear to operate properly, refer to "Error Messages" in the Reference section of the *Operating and Programming Manual*

Once the instrument is on and functioning properly:

1. Refer to Chapter 1 of the *Operating and Programming Manual* for information on how the manual is structured, available options and accessories.
2. Refer to the *User's Guide* for a quick tutorial on basic network analyzer operation.

In the documentation, front panel keys (hard keys) are represented by print surrounded by a box: **XXX**. Display softkeys are shown as print on a half-tone background: **XXX**.

For example, "Press **SCALE REF** **REFERENCE POSITION** **-** **1** **0** **x1**" means you should press the **SCALE REF** key, then the **REFERENCE POSITION** softkey, followed by the **-**, **1**, **0** and **x1** keys. The last key, **x1**, terminates the command in basic units (dB, dBm, Hz or degrees).



---

**HP 8719C  
HP 8720C  
HP 8722A  
Network Analyzers**

User's Guide

**50 MHz to 13.5, 20, or 40 GHz**

---

This document is intended to provide an introduction to the operation of the HP 8719C, HP 8720C, and HP 8722A network analyzers. It demonstrates many of the features and capabilities of the analyzers, providing actual operating sequences for common network measurements.

## How to Use This Guide

To gain the most benefit from this guide, it is suggested that you proceed sequentially through the chapters. Each chapter builds upon the information presented in previous chapters. Once a specific measurement is stored in one of the internal registers (let's say, register 1), feel free try out some of the other softkeys/features available. Selecting **[RECALL]** [*RECALL REG1*] will restore the previous measurement and allow you to continue with the measurement examples. An appendix is also included to provide more detailed information on additional topics.

To simplify the execution of the measurements, the keys to be selected are bracketed, capitalized and usually presented flush-right within the column. Front panel "hardkeys" are in bold and will be followed by one or more softkeys in *italics*. For example, **[CAL]** [*CALIBRATE MENU*] [*FULL 2-PORT*], accesses the two-port calibration softkey menu. Sets of key sequences will often be preceded by a paragraph of text describing their function and providing any special instructions.

The equipment that is used in this guide is listed below. Notice that the bandpass filter used in almost every example, is provided with the analyzer to simplify configuring the measurements. The HP 8722A analyzer will also be shipped with two 2.4 to 3.5 mm adapters. When using 2.4 mm cables, such as the HP 85133E/F test port cables with the HP 8722A analyzer, use the adapters to convert the 3.5 mm bandpass filter to a 2.4 mm test device.

### Equipment Used in this Guide<sup>1</sup>

<b>Description</b>	<b>HP Part/Model No.</b>
Bandpass Filter (included with analyzer)	HP P/N 0955-0446
3.5 mm Calibration Kit	HP 85052B/D
3.5 mm Test Port Cables	HP 85131E/F
SMA (1 ft) Semi-Rigid Cable	HP P/N 08340-20123
<b>With HP 8722A:</b>	
2.4 to 3.5 mm Adapters (included with analyzer)	HP 85056A/D/K
2.4 mm Calibration Kit	HP 85133E/F
2.4 mm Test Port Cables	HP 85133E/F
3.5 mm Test Port Cables	HP 85134E/F

<sup>1</sup>Other equipment may be substituted, but may require modifying the procedure.



# Table of Contents

<b>Chapter 1</b>	<b>Front Panel Tour</b>	<b>4</b>
	General Measurement Sequence	
<b>Chapter 2</b>	<b>Transmission Measurements</b>	<b>6</b>
	Insertion Loss and Gain	
	3 dB Bandwidth	
	Passband Flatness	
	Out-of-band Rejection	
	Measuring Phase Response	
	Insertion Phase	
	Electrical Length	
	Phase Distortion	
	Deviation from Linear Phase	
	Group Delay	
<b>Chapter 3</b>	<b>Reflection Measurements</b>	<b>12</b>
	Return Loss	
	Reflection Coefficient	
	SWR	
	Simultaneous Magnitude/Phase Measurements	
	Impedance (using Smith charts)	
	Admittance	
<b>Chapter 4</b>	<b>Time Domain Measurements</b>	<b>15</b>
	Time Domain Reflection Measurements	
	Gating Time Domain Responses	
<b>Chapter 5</b>	<b>Limit Lines for Device Evaluation</b>	<b>18</b>
<b>Appendix</b>		<b>19</b>
	Calibration Tutorial	
	Optimizing Dynamic Range	
	Selecting Power Level	
	Reducing the Noise Floor	
	IF Bandwidth	
	Averaging	
	Creating a Frequency List	
	Setting Up External Peripherals	
	Using Dual-Channel Display	
	Uncoupled Channels	
	Function Index	

# Chapter One

## Front Panel Tour

**Measurement Information**

- \* channel
- \* S-parameter
- \* meas. type

**Display Settings**

- \* scale
- \* ref position

**Marker Statistics**

- \* mean
- \* standard deviation
- \* peak-to-peak ripple
- \* shape factor

**Response**

[MEAS] meas. parameters  
 [FORMAT] meas. format  
 [SCALE REF] adjust display  
 [DISPLAY] define traces  
 [AVG] avg. smoothing, IF BW  
 [CAL] setup calibration  
 [MKR] single, delta markers  
 [MKR FCTN] marker functions

**Data Entry**

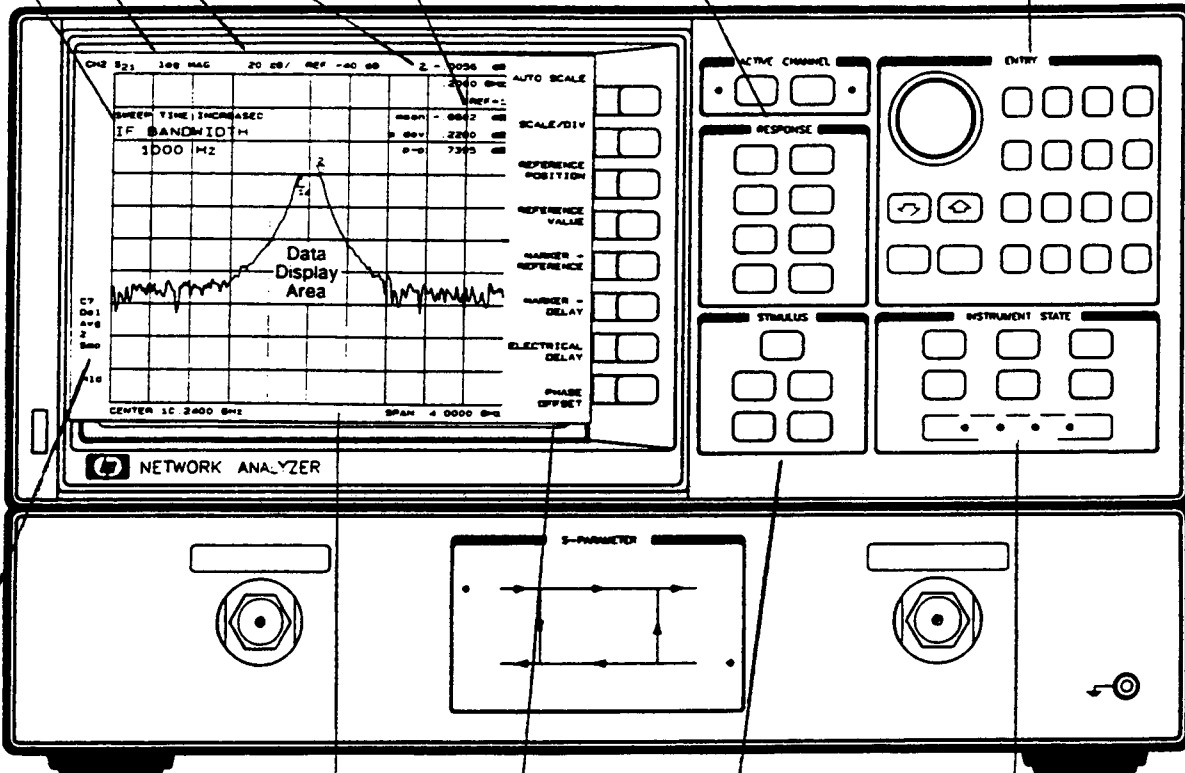
Use the numeric keys with the appropriate terminator, the knob or step keys to enter a chosen parameter.

**Data Entry Terminators**

Key	G/n	M/u	k/m	x1
Freq	GHz	MHz	kHz	Hz
Power	-	-	-	dB(m)
Time	ns	us	ms	s

**Active Entry Area**

**Active Marker Value**



**Status Notations**

- \* parameter changed
- Cor cal is on
- C? cal is may be invalid
- C2 2-port cal is on
- C2? 2-port cal may be invalid
- Hld freeze trace
- ^ fast sweep indicator
- Ext waiting for ext. trigger
- Avg averaging is on
- Smo smoothing is on
- Del electrical delay is on
- Gat gating is on
- PC power meter cal on
- tsH test set hold

**Frequency/ Time Settings**

**Softkey Labels**

**Stimulus Functions**  
 Defines and controls source parameters.

**Instrument State**

This section provides control of channel-independent system functions.

- [SYSTEM] access limit line, service, and time domain menus.
- [LOCAL] define controller modes
- [COPY] access printing and plotting functions
- [SAVE] store or clear registers
- [RECALL] recall measurement or factory preset
- [USER PRESET] return the analyzer to a factory-defined or user-defined state

## General Measurement Sequence

### Factory preset conditions:

Sweep span	0.05 to 13.51 GHz (HP 8719C) 0.05 to 20.05 GHz (HP 8720C) 0.05 to 40.05 GHz (HP 8722A)
Power level	+ 10 dBm -20 dBm (HP 8722A)
No. of trace points	201
Sweep time	auto, 100 ms
Channel 1	S11, On
Channel 2	S21, Off
Format	Log Mag
Scale	10 dB/div
Reference value	0 dB

Even with the analyzer's wide range of capabilities, common measurements are easily set up with relatively few front panel selections. This section describes a general approach for performing network measurements. The following sequence is used throughout this document to illustrate the use of the analyzer in its various operating modes.

### Preset

The factory preset returns the instrument to a known state, as shown in the table. The analyzer also has the capability of storing a user-defined preset. To define a user-preset condition, set up the desired measurement parameters and select [SAVE] [SAVE PRESETS]. Once defined, the analyzer will return to the specified measurement conditions every time [USER PRESET] is selected; then the factory preset can only be recalled by selecting [RECALL] [RECALL FAC PRESET].

To eliminate a "user preset," [SAVE]/[CLEAR REGISTER]/[CLEAR PRESETS] must be selected. Then the factory preset will be recalled every time [USER PRESET] is selected.

### Setup

**Measurement:** Select a measurement parameter.

**Format:** Choose a display format.

**Stimulus:** Select the source parameters to meet the test requirements of the device under test (DUT).

### Calibrate and Save

Calibrate the test system and store the data. System components such as test port cables, adapters, and components within the instrument itself, introduce systematic errors that can mask the actual performance of the DUT. A calibration should be performed at the measurement plane (the point where the DUT is connected to the test system). Calibrations use error-correction algorithms to improve measurement accuracy by removing the effects of repeatable systematic errors in the test system. Refer to *Calibration* in the appendix for more information on calibration types and their uses.

### Connect and Measure

Connect the DUT with a single cable or cable set (see page 6), and adjust the display (scale) of the measurement data as desired.

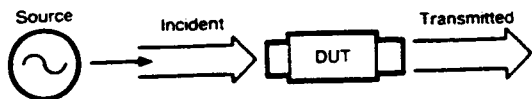
### Store/Output Results

Store the results to a disk or output to a printer/plotter. See individual examples for different storage formats and *Setting Up External Peripherals* in the appendix.

# Chapter Two Transmission Measurements

This chapter demonstrates how to make common transmission measurements. Modify the instrument setups shown to suit your particular needs.

## Insertion Loss and Gain



Insertion loss and gain are the logarithmic ratios of transmitted-to-incident voltage through a two-port test device. Both measurements can be made with the same setup and calibration with the exception of gain measurements which may require lower input power levels to the test device. Select the keys on the right side of the column to setup the measurement. Notice that when a factory preset is performed, maximum output power (+10 or -20 dBm with the HP 8722A) is automatically selected.

Preset (factory) [USER PRESET]

### Setup

Measurement:

[MEAS]/Trans: FWD S21/

Format:

[FORMAT]/LOG MAG/

Stimulus:

[CENTER] 10.24 [G/n]

[SPAN] 4 [G/n]

[MENU]/POWER/[RANGE 1 -10 TO +10] 10 [x1]

[MENU]/NUMBER of POINTS/ 401 [x1]

CH1 S21 log MAG 10 dB/ REF 0 dB

The following information should now be displayed at the top of your screen.

### Calibrate and Save

Since the test device has SMA connectors, the HP 85052B/D 3.5 mm cal kit should be used and selected.

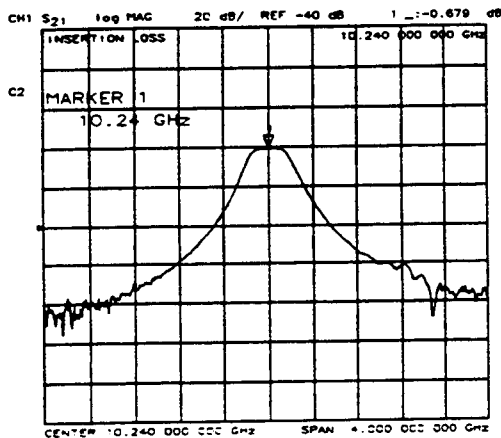
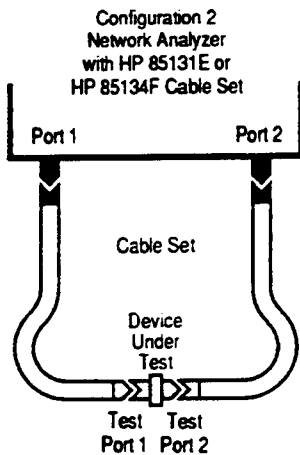
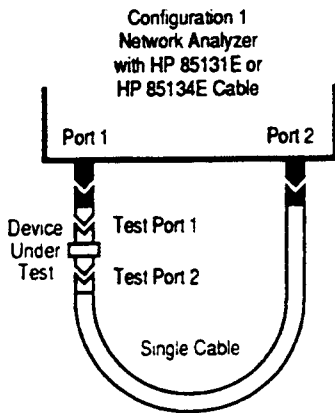
[CAL]/CAL KIT/[3.5 mm]/[RETURN]

To achieve the greatest accuracy, a full two-port calibration sequence is provided. Make sure that all cables and adapters included in the measurement are attached to the test set's measurement ports, so that their associated errors can be removed. Connect each calibration standard (open, short, and load), at the point where the DUT is attached to the test system, in the sequence presented below. Once a standard is attached, select the appropriate softkey, and the analyzer will underline it when the measurement is complete. Repeat this sequence until each standard has been measured at each test port.

[CALIBRATE MENU]/[FULL 2-PORT]  
[REFLECTION]

Attach each standard to test port 1 and select its softkey

[S11: OPEN],[SHORT]  
[LOADS]/[BROADBAND]/[DONE: LOADS]



Attach each standard to test port 2 and select its softkey

[S22: OPEN],[SHORT]  
[LOADS][BROADBAND][DONE: LOADS]  
[REFLECT'N DONE]

Connect thru (attach test ports to each other)

[TRANSMISSION]  
[DO BOTH FWD + REV]

Complete and save the calibration

[ISOLATION][OMIT ISOLATION]  
[DONE 2-PORT CAL]  
[SAVE REG 1]

Upon completion of a two-port calibration "C2" will appear on the left side of your display. If the calibration is compromised by changing stimulus settings, the calibration will be turned off ("C2" disappears) or "C2?" may appear cautioning that something has changed that may affect the calibration data.

### Connect and Measure

Following a two-port calibration, connect the test device (using either configuration) and select [MEAS] or [MEASURE RESTART] to update the forward and reverse S-parameter data. To maximize the life of the internal electro-mechanical switch, it is assumed that the reverse parameters do not change appreciably, thus only the forward parameters are measured from sweep-to-sweep. When a new device is measured, or data changes significantly, it is recommended to remeasure all four S-parameters by selecting the [MEAS] key.

Adjust the display (scale) of the measurement data as desired. Set the marker in the center of the display (passband) to measure insertion loss. The marker value is displayed in the upper right corner of the CRT. The front panel knob may also be used to move the marker along the trace. The analyzer should now display the complete transmission response of the bandpass filter, as shown in the adjacent figure.

Update S-parameter data

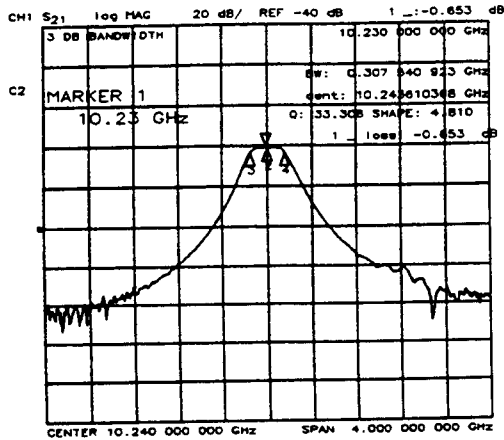
[MEAS]  
[SCALE REF][AUTO SCALE]  
[MKR]/[MARKER 1] 10.24 [G/n]

Read insertion loss from marker value

### Store/Output Results: Plotting

Before proceeding, make sure the analyzer and plotter are properly set up (see appendix). Selecting [COPY] then [PLOT], will plot everything currently displayed, except for the softkey menu. The [DEFINE PLOT] softkey gives users the option of plotting only specific parameters (i.e., [PLOT DATA] ..). Plots can also be customized by adding a descriptive title, selecting the plotter pens, or positioning up to four plots per page.

### 3 dB Bandwidth

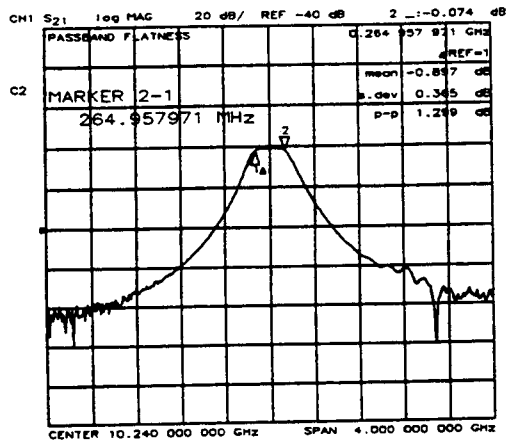


The marker search function can quickly locate a specific amplitude on a trace or a specific bandwidth (i.e., 3 dB or 6 dB). In this example, marker 1 is moved to the highest point on the trace and established as the reference. Then, the -3 dB bandwidth, Q, and shape factor are determined relative to marker 1.

```
[MKR]/[MARKER 1]
[MKR FCTN]/[SEARCH: MAX]
[BANDWIDTH MENU]
[BANDWIDTH VALUE] -3 [x1]
[BW MEASURE ON off]
```

When finished, turn the markers off, [MKR][all OFF].

### Passband Flatness



The following procedure illustrates how to determine passband ripple using the delta marker and marker statistics functions. Use the front panel knob to move marker 1 to the left edge and marker 2 to the right edge of the passband, respectively.

```
[MKR]/[MARKER 1]
Position marker 1
[ΔMODE MENU][ΔREF=1][2]
Position marker 2
[MKR FCTN]/[MKR MODE MENU]
[STATISTICS ON off]
```

The statistics function illustrates the DUT's performance between the active and reference markers (2 and 1, respectively), providing measurement data on mean insertion loss, standard deviation and peak-to-peak ripple. All this information is presented in the upper right region of the display. If reference markers are not set up, statistics are calculated for the entire trace. Upon completion of the measurement turn off the statistics function and the markers, [STATISTICS on OFF], [MKR][all OFF].

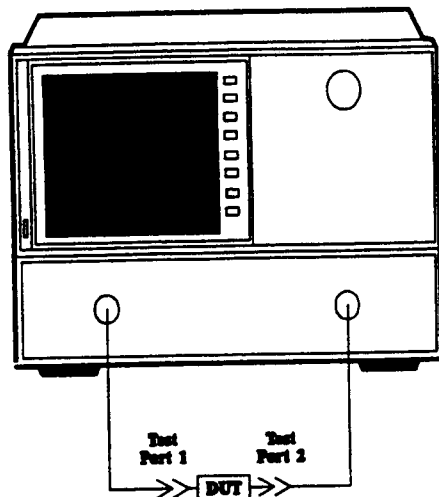
### Out-of-Band Rejection

The analyzer's wide dynamic range allows it to measure stopband rejection over 100 dB below the passband response (> 70 dB on HP 8722A). Obtaining the maximum dynamic range requires proper selection of the test port power level, IF bandwidth, and averaging factor; these topics are discussed in the *Optimizing Dynamic Range* section of the appendix.

Don't hesitate to try out some of the other marker functions before moving on. When finished, return to the original setup by recalling register 1.

```
[RECALL]/[RECALL REG 1]
```

# Measuring Phase Response



To completely characterize a device, phase performance must also be determined. The analyzer can provide information on insertion phase (phase shift), electrical delay and phase distortion.

Since the phase response of the passband of the filter is the primary concern, the following measurement requires a narrower frequency span. The frequency subset feature is used to reduce the frequency span without invalidating the two-port calibration performed at the beginning of this chapter. The feature actually uses the original calibration data points that are within the reduced span, so although the system is still calibrated, only 41 of the original 401 calibration points are used. Note, a higher resolution phase measurement can be achieved by recalibrating the system at the narrower span.

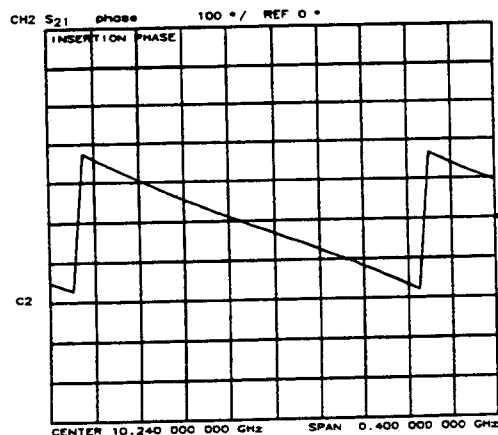
**Recall Cal** [RECALL]/RECALL REG1/

**Adjust Setup** [CH 2]  
**Measurement:** [MEAS]/Trans: FWD S21/  
 [FORMAT]/PHASE/  
**Format:** [CAL]/FRQ SUBSET ON off/  
**Stimulus:** [CENTER] 10.24 [G/n]  
 [SPAN] 400 [M/u]

**Save**  
 Save the instrument configuration and calibration in register 2.

[SAVE] [SAVE REG2]

## Insertion Phase



### Connect and Measure

Connect the test device with a single cable or a cable set and scale the display as desired.

**Update S-parameter data** [MEAS]  
 [SCALE REF]/AUTO SCALE/

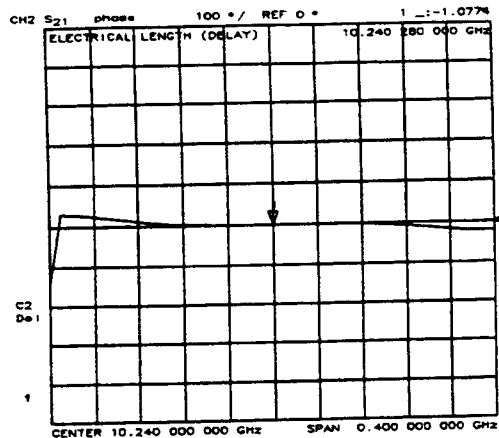
The analyzer's display should exhibit a trace similar to that shown. The analyzer measures and displays phase over the range of  $-180^\circ$  to  $+180^\circ$ . As phase changes beyond these values, a sharp  $360^\circ$  transition occurs in the display data.

### Store/Output Results: Printing

Before proceeding, make sure the analyzer and printer are properly set up (see appendix). Selecting [COPY] then [PRINT], will print everything currently displayed, except for the softkey menu.

## Electrical Length

The linearly changing phase seen in the previous figure is primarily due to the DUT's electrical length. Since the analyzer can simulate a variable length lossless transmission line, the user can determine the DUT's electrical length (delay), by adding electrical length until the phase shift has been reduced to a flat line.



Use marker functions to add delay and reduce the phase shift displayed; make sure the reference value is set to  $0^\circ$ . Fine-tune the measurement until the best flat line is achieved, then read the electrical length from the CRT's active entry area. It represents the electrical length of the DUT relative to the speed of light in free space. The physical length of the DUT is related to this value by the propagation velocity of its medium.

**[MKR FCTN]/[MARKER -> MENU]**

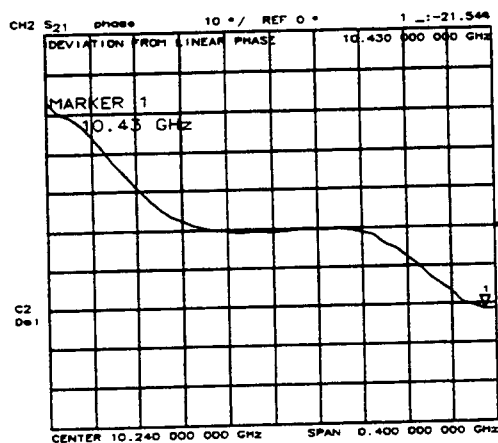
Position marker in passband center

**[MARKER -> DELAY]  
[SCALE REF]/[REFERENCE VALUE] 0 [x1]  
[ELECTRICAL DELAY]**

Rotate knob until best flat line is achieved; then read the electrical delay from the active entry area.

## Phase Distortion

For many devices, the amount of insertion phase is not nearly as important as the linearity of the phase shift over a range of frequencies. The analyzer can measure this linearity and express it in two different ways: as deviation from linear phase or as group delay.



### Deviation From Linear Phase

The ripple seen in the electrical length measurement above, is due to the deviation from linear phase through the device. It can easily be measured by increasing the scale resolution and using the markers to directly measure the maximum deviation from linear phase as shown in the figure.

**[SCALE REF]/[AUTO SCALE]  
[MKR FCTN]/[SEARCH: MAX]  
[MIN]**

Upon completion of the phase linearity measurement, return the electrical delay to 0.

**[SCALE REF]  
[ELECTRICAL DELAY] 0 [x1]**



## Group Delay

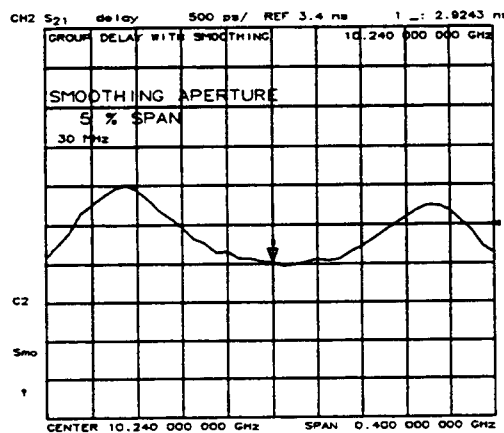
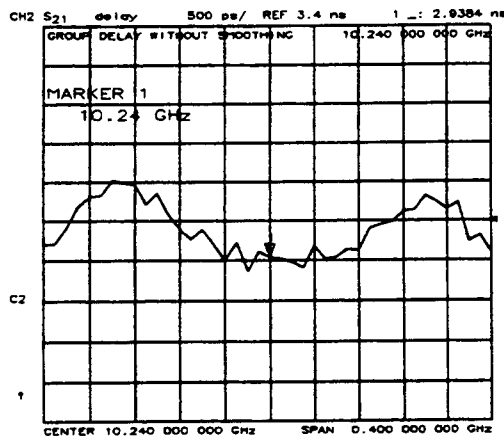
The phase linearity of many devices is specified in terms of group or envelope delay. This is especially true of telecommunications components and systems where phase distortion is critical.

Group delay is a measure of transit time through the DUT as a function of frequency. It is approximated by:  $-\Delta\phi/(\Delta f)(360)$ , where  $\Delta\phi$  is the phase difference between two adjacent frequencies  $\Delta f$ . The quantity  $\Delta f$  is commonly referred to as the aperture. The minimum aperture is equal to the analyzer's frequency span divided by the number of points minus one (4 GHz/400 points). To measure group delay correctly, the phase difference at a specific aperture must be less than  $180^\circ$ , satisfying the following relationship:

$$\text{approximate DUT delay} < \frac{\text{number of points} - 1}{2(\text{frequency span})}$$

The smoothing function can be used to increase the effective group delay aperture without changing the frequency span. It increases the number of points over which group delay is calculated, allowing variation of apertures from minimum (no smoothing) to 20% of the frequency span. Since increasing the aperture removes fine grain variations from the response (see figures), group delay apertures must be specified when comparing measurements.

The following sequence measures the group delay at the center of the passband. The smoothing aperture will be displayed in the active entry area and the group delay as a marker value. Note the trace distortion at high apertures.



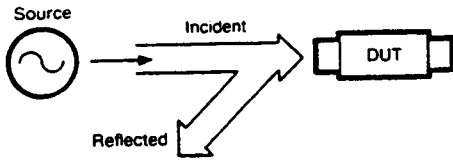
```
[FORMAT]/[DELAY]
[SCALE REF]/[AUTO SCALE]
[MKR] 10.24 [G/n]
[AVG]/[SMOOTHING ON off]
[SMOOTHING APERTURE] 0 [x1]
```

Rotate front panel knob and note changes

In addition to smoothing, group delay measurements can also benefit from the noise reduction techniques discussed in the *Optimizing Dynamic Range* section of the appendix.

# Chapter Three

## Reflection Measurements



This chapter demonstrates how to make reflection measurements. Return loss, reflection coefficient and SWR (standing wave ratio) are the different measurement formats commonly used to exhibit the magnitude of the signal reflected from the DUT. These measurements are mathematically defines as:

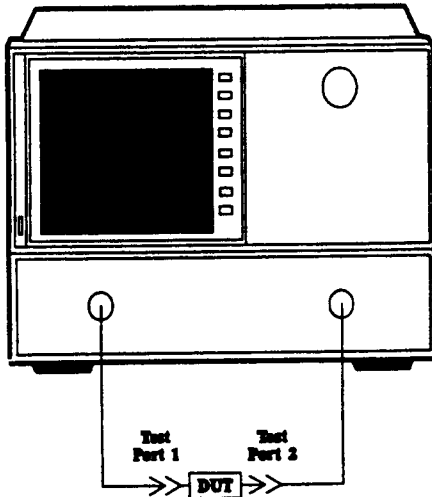
**Reflection coefficient:**  $V_{\text{reflected}}/V_{\text{incident}} = \Gamma = \rho \angle \phi$   
**Return loss (dB):**  $-20 \log \rho$   
**SWR:**  $(1 + \rho)/(1 - \rho)$

Polar and Smith chart display formats are also included to provide information on phase as well as magnitude. Modify the instrument setups shown to suit your particular needs.

Since reflection measurements involve only one port of a test device, it is critical that all unused ports are properly terminated, or measurement errors will result. Multiport devices must be terminated with a 50 ohm load or a 50 ohm test port cable.

### Return Loss

Return loss is the logarithmic ratio of reflected-to-incident voltage for the test device, as shown in the equation above. A large return loss indicates that only a small portion of the incident signal is being reflected from the DUT. Return loss can range from infinity (no reflection) to 0 dB (complete reflection).



The following sequence sets up reflection measurements using the two-port calibration performed in chapter 2. Although the complete setup is presented, only the "measurement" parameters actually need adjustment.

#### Recall Cal

[RECALL]/[RECALL REG1]

#### Adjust Setup

Measurement:

[MEAS]/[Refl: FWD S11]

Format:

[FORMAT]/[LOG MAG]

Stimulus:

[CENTER] 10.24 [G/n]

[SPAN] 4 [G/n]

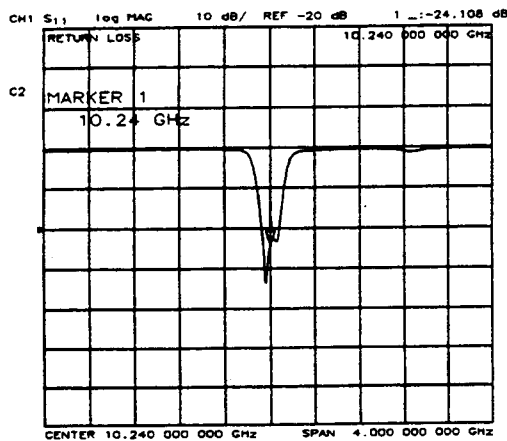
[MENU]/[POWER]/[RANGE 1 -10 TO +10] 10 [x1]

(-20 dBm with HP 8722A)

#### Calibrate and Save

Use or perform the two-port calibration provided in chapter 2. For more information on calibration types and their uses, refer to the *Calibration* section of the appendix. Save the setup in register 3.

[SAVE]/[SAVE REG3]



### Connect and Measure

Connect the test device with a single cable or a cable set and scale the data. Use the marker to determine the return loss of the passband. This filter exhibits the desired response for a bandpass filter, with high return loss (20 to 30 dB) in the passband indicating good match between the filter and the test system, and high reflection (<0.5 dB return loss) in the reject band.

### Update S-parameter data

[MEAS]  
[SCALE REF]/[AUTO SCALE]  
[MKR] 10.24 [G/n]

Move marker where desired with knob

### Store Results

When the calibration is active, the following sequence will initialize the disk and store everything necessary to recreate the data displayed (without the DUT). Before proceeding, make sure the analyzer and disk drive are properly set up, see *Setting Up External Peripherals* in the appendix.

[SAVE]/[STORE TO DISK]  
[DEFINE, INIT, PURGE]  
[INITIALIZE DISK]/[INIT DISK? YES]  
[RAW ARRAY ON off]/[RETURN]  
[STORE FILE1]/[RETURN]

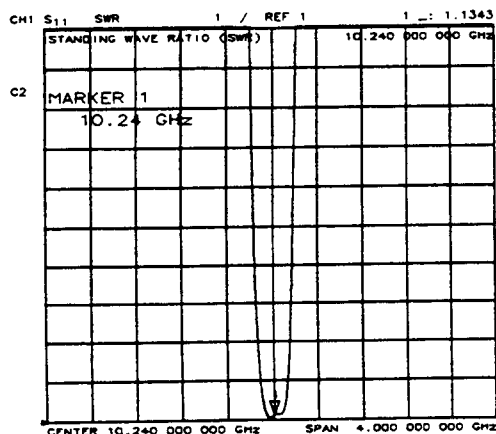
## Reflection Coefficient

Selecting the [LIN MAG] format will display " $\rho$ ", the magnitude of the signal reflected from a test device. A  $\rho = 1$  indicates full reflection while a  $\rho = 0$  indicates a perfect impedance match or no reflection.

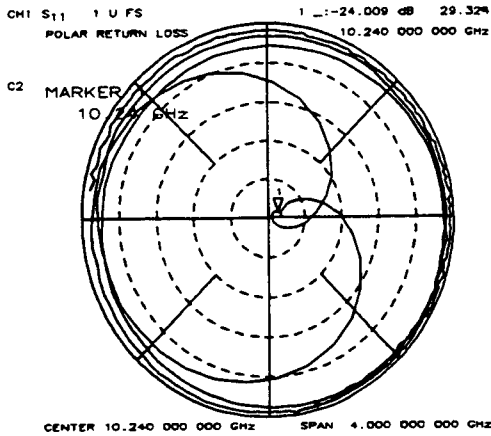
[FORMAT]/[LIN MAG]

## SWR

The Standing Wave Ratio (SWR) is the ratio of maximum to minimum standing wave voltage. To display the reflection measurement as SWR, select the [FORMAT]/[SWR]. SWR varies between 1 and infinity, where 1 represents no reflection and infinity represents 100% reflection.



# Simultaneous Magnitude/Phase Measurements



Magnitude measurements only supply part of the information necessary to fully characterize a device. Selecting a polar format displays the reflection coefficient in terms of magnitude and phase ( $\rho/\phi$ ) simultaneously. The concentric circles are scaled in units of linear magnitude from 0 at the center (no reflection) to 1 at the outer circle (total reflection). Phase is indicated by radial lines where  $0^\circ$  corresponds to the right side of the horizontal axis and  $\pm 180^\circ$  corresponds to the left side of the horizontal axis. Use the markers to obtain accurate measurements of frequency, magnitude, and phase.

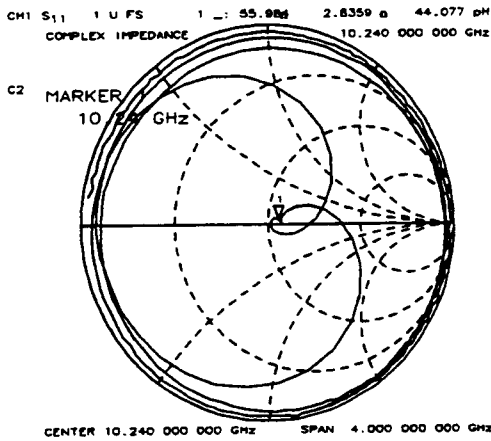
[FORMAT]/POLAR/  
[MKR] 10.24 [G/n]

Move marker with knob to measure different points

When a return loss measurement is desired in a polar format, the magnitude must be displayed in a logarithmic form.

[MKR FCTN]/MKR MODE MENU/  
[POLAR MKR MENU]/LOG MKR]

# Impedance



The amount of power reflected from a device is directly related to the impedances of both the device and the measuring system. In fact each value of the reflection coefficient ( $\rho$ ) uniquely defines a device impedance;  $\rho=0$  only occurs when the device and measurement system impedance are exactly the same. A short circuit has a reflection coefficient of  $\rho=1/180^\circ$ .

Choosing the Smith chart format provides a plot of the complex impedance of the test device as a function of frequency; both the resistive (R) and reactive (X) components ( $R \pm jX$ ) are displayed.

[FORMAT]/SMITH CHART/  
[MKR] 10.24 [G/n]

Move marker with knob to measure different points

CH1 S11 1 U FS	1: 55.9..Ω	+2.5..Ω	37..pH
	10.240 000 000 GHz		

Frequency information is available in this format only with an active marker. Markers are also used to display the resistance, reactance, and the effective capacitance or inductance of a specific measurement point (see the adjacent figure).

# Admittance

CH1 S11 1 U FS	1: 17.9..mS	-850...μS	18...nH
	10.240 000 000 GHz		

When admittance information is desired, changing the markers on a Smith chart to the  $[G \pm jB \text{ MKR}]$  format inverts the display and provides admittance data in Siemens units (equivalent to mhos).

[MKR FCTN]/MKR MODE MENU/  
[SMITH MKR MENU]/[G±jB MKR]

# Chapter Four

## Time Domain Measurements

Time domain (Option 010) analysis uses the inverse Fourier transform of frequency domain data, to isolate responses in time and distance. Time and distance are related by the relative velocity factor of the DUT - the rate at which a signal propagates through a medium relative to the speed of light. Time domain analysis is valuable for identifying:

- \* the location of transmission path discontinuities (faults)
- \* the location and nature of impedance changes
- \* multiple signal paths

In addition, the gating feature of time domain analysis allows users to selectively remove undesirable portions of the time domain response, and view the resulting response in the frequency domain. Thus, gating can significantly reduce the effects of system components which may be obscuring the frequency response of the desired device or component. For example, gating can remove the effects of:

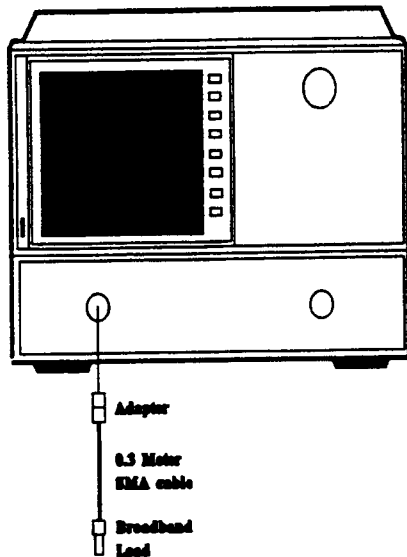
- \* connectors and adapters in reflection measurements
- \* multiple paths in transmission measurements

The frequency span and the number of points selected, will determine the resolution and the range (or distance) that can be measured. Resolution is the minimum distance between two responses which still allows them to be uniquely identified. Higher resolution is achieved as the frequency span increases. The range on the other hand, is inversely proportional to the frequency span:  $range = (number\ of\ points - 1) / (frequency\ span)$ . Thus the user has to trade off resolution for range and determine which is more important for a measurement.

### Time Domain Reflection Measurements

There are two primary modes of time domain operation: low-pass and bandpass. Low-pass mode simulates the magnitude data provided by TDR (time domain reflectometer) measurements. Low-pass mode provides impedance information (bandpass mode does not) and the highest resolution, but requires frequency domain data that is harmonically related and extends to DC. Bandpass mode is most useful for band-limited devices (i.e., waveguide), and can have an arbitrary frequency range and number of data points.

The following example illustrates a time domain measurement of a semi-rigid cable (.3m), using the low-pass impulse mode. Since the measurement is performed at port 1, and a broadband frequency sweep is desired for greater resolution, a one-port calibration is required.



The **[SET FREQ LOW PASS]** softkey automatically adjusts the start and stop frequencies, so that the stop frequency is a harmonic multiple of the start:  
 $frequency_{stop} = (frequency_{start}) \times (number\ of\ points)$ .  
 Notice that the full span of the analyzer has harmonically related frequencies (i.e., 0.05 GHz x 401 pts. = 20.05 GHz). If you require more information on time domain analysis and its measurement modes, refer to chapter nine in the reference section of the manual. Although the complete setup is provided, only the format and the number of points will have to be set, the rest of the keystrokes are already set by the factory preset.

**Preset (factory)**

**[USER PRESET]**

### Setup

Measurement:  
 Format:  
 Stimulus:

**[MEAS]/Ref: FWD S11/  
 [FORMAT]/LIN MAG/  
 [START] 50 [M/u]  
 [STOP] 20.05 [G/n]  
 [MENU]/NUMBER of POINTS] 401 [x1]**

### Calibrate and Save

In turn, connect each of the calibration standards (open, short, and load) at the port 1 connector and select the appropriate softkey. The standard's softkey label will be underlined upon completion of the measurement.

**[CAL]/CAL KIT][3.5 mm][RETURN]  
 [CALIBRATE MENU][SET FREQ LOW PASS]  
 [S11 1-PORT]**

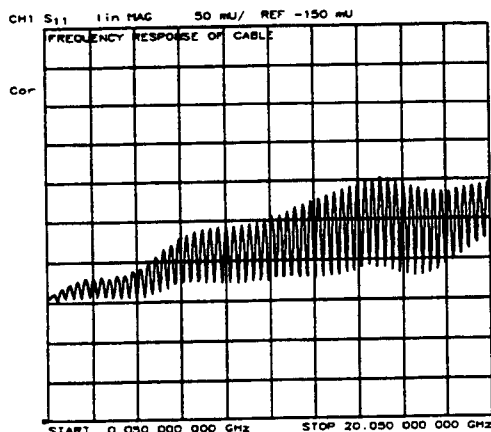
**Connect standards to port 1**

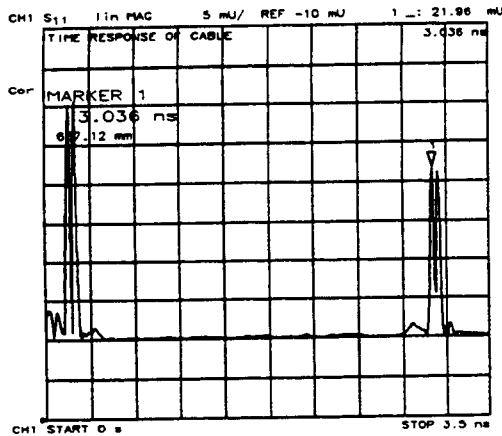
**[S11: OPEN],[SHORT]  
 [LOADS][BROADBAND][DONE: LOADS]  
 [DONE 1-PORT CAL]  
 [SAVE REG 4]**

### Connect and Measure

Connect the semi-rigid cable to the test system as shown, with an adapter and a terminating load. Use **[SCALE REF]/AUTO SCALE]** to adjust the display. The resulting measurement shows the frequency response of the cable, in terms of the reflection coefficient. Notice, the complex ripple pattern from multiple reflections in the DUT.

To determine physical length rather than electrical length in time domain, the velocity factor must be adjusted to reflect the relative velocity of the signal through the medium under test. Polyethylene dielectric cables have a velocity factor around 0.66, while teflon dielectric cable's velocity factor is around 0.7.





Also, a time span should be established that will display the entire length of the cable, within the range limitations [(number of points - 1)/(frequency span)] previously discussed. Since, reflection measurements measure the round trip time and distance to and from the test system components, the analyzer will display twice the actual time and distance.

$$\text{Minimum } T_{\text{round trip}} = \frac{2 \times L_{\text{cable}}}{\text{velocity factor} \times C} = \frac{.6\text{m}}{.7 \times .3\text{m/ns}} = 2.85 \text{ ns}$$

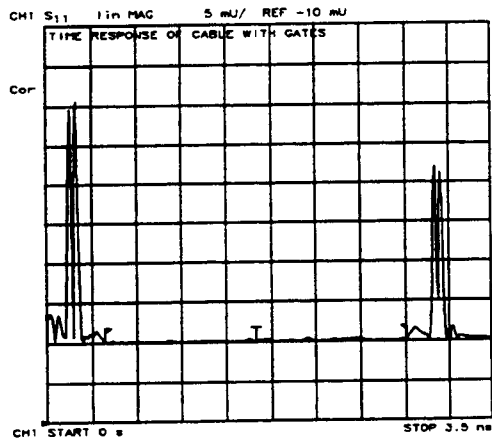
[CAL]/[MORE]  
 [VELOCITY FACTOR] .7 [x1],[RETURN]  
 [SYSTEM]/[TRANSFORM MENU]  
 [LOW PASS IMPULSE]/[TRANSFORM ON off]  
 [START] 0 [x1],[STOP] 3.5 [G/n]  
 [SCALE REF]/[AUTO SCALE]  
 [MKR] 2.85 [G/n]

Use front panel knob to move marker to first peak, read time and distance from active entry area

### Store/Output Results

Store the results to a disk or output to a printer/plotter.

## Gating Time Domain Responses



Gating is a powerful tool, providing the flexibility to selectively remove undesirable responses from time and frequency domain measurements. Use gating to evaluate the performance of individual components of the DUT.

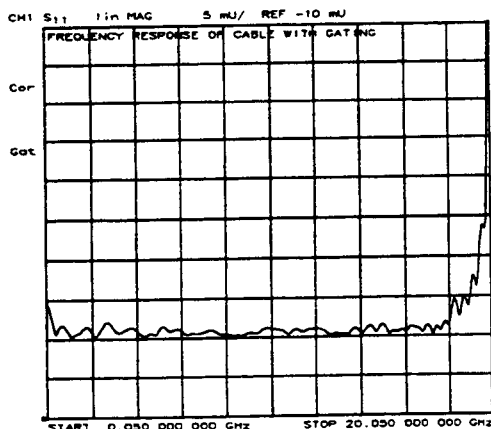
To demonstrate the effects of gating, the following sequence eliminates the responses from the semi-rigid cable's connectors. Enter the gate's start and stop cursors by rotating the front panel knob or through direct entry on the numeric keypad. The start and stop cursors should be at the end of the input connector's response and at the beginning of the connector-load response, respectively (see figure).

[MKR][all OFF]  
 [SYSTEM]/[TRANSFORM MENU]  
 [SPECIFY GATE]/[GATE: START]

Position cursor with knob

[STOP]

Position cursor with knob



Turning the gate on and transform off provides a frequency domain display which represents the response of the cable without the connectors. As expected, the measurement exhibits a much smoother and lower magnitude ripple pattern. Now, reflection coefficient and impedance of just the cable can be determined. When measuring a cable as shown, reduce measurement uncertainty by using high-quality connectors.

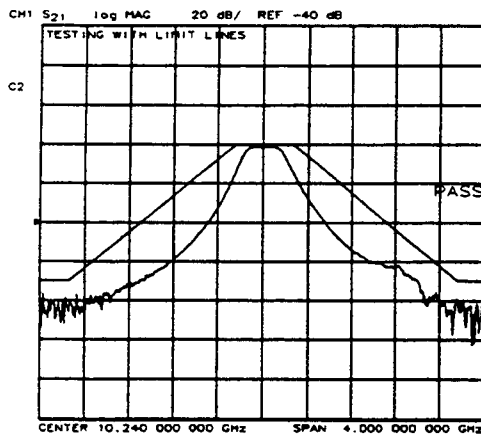
[GATE ON]/[RETURN]  
 [TRANSFORM MENU on OFF]  
 [SCALE REF]/[AUTO SCALE]

# Chapter Five

## Limit Lines for Device Evaluation

Limit testing is a time-saving feature that compares measurement data to user-defined specifications. Depending on the results of the comparison, the DUT will either pass or fail. Limit testing allows you to objectively evaluate the performance of your device, and can ensure that all test devices are aligned and tested to the same specifications at each measurement station.

Limit testing is implemented by creating any combination of flat, sloping, and single point limit lines on the CRT. This section describes how to create limit lines for the transmission response of the bandpass filter provided with the analyzer. If you performed the transmission measurement in chapter one, select **[RECALL]/[REG1]** to retrieve the setup and calibration. If chapter one was skipped, step through the setup and calibration sequence on pages six and seven.



The following sequence enters the first segment displayed in the adjacent figure. Each limit line segment must specify the stimulus value (start frequency), the test limits (upper and lower), and the limit type. Since only an upper test limit is desired, the lower limit is set to -200 dB to ensure that it will not impact the measurement.

```
[SCALE REF]/[AUTO SCALE]
[SYSTEM]/[LIMIT MENU]/[LIMIT LINE ON off]
[EDIT LIMIT LINE]/[ADD]
[STIMULUS VALUE] 8 [G/n]
[UPPER LIMIT] -70 [x1],[LOWER LIMIT] -200 [x1]
[DONE]/[LIMIT TYPE]/[FLAT LINE]/[RETURN]
```

A line should now be displayed just above the noise floor. Notice, that only the start frequency is specified and the segment continues across the screen. To terminate a segment, another segment or a single point must be specified. In the following table the second segment's frequency and test limit (9 GHz/-70 dB) terminates the first segment. The subsequent entries will complete the limit line entries depicted in the figure. When **[ADD]** is selected a replica of the previous segment will appear as a new segment. Change only the necessary parameters, then select **[DONE]** to access the limit type menu. The table below abbreviates the flat and sloped line types as FL and SL respectively.

	Stimulus	Upper	Lower	Type
2	[ADD] 8.5 [G/n]	-70 [x1]	-200 [x1] [DONE]	SL [RETURN]
3	[ADD] 10 [G/n]	0 [x1]	-200 [x1] [DONE]	FL [RETURN]
4	[ADD] 10.5 [G/n]	0 [x1]	-200 [x1] [DONE]	SL [RETURN]
5	[ADD] 12 [G/n]	-70 [x1]	-200 [x1] [DONE]	FL [RETURN]



# Appendix

## Calibration Tutorial

The calibration step effectively characterizes and removes the effects of repeatable measurement variations (or systematic errors) such as:

- \* Frequency Response (Tracking)
- \* Leakages (Directivity and Crosstalk) and
- \* Mismatch (Load Match and Source Match)

The analyzer offers several calibrations techniques that can compensate for one or more of these test imperfections. The following table provides a summary of these techniques and their applications.

Calibration	Application	Errors Removed	Measurement Sequence
<b>Full 2-Port</b> <i>Cal Time:</i> <i>about 5 min.</i>	<ul style="list-style-type: none"> <li>* Most accurate for 2-port devices</li> <li>* All measurement applications</li> </ul>	<b>Reflection errors</b> (ports 1 and 2): Directivity Source Impedance Match Frequency Response  <b>Transmission errors</b> (forward and reverse): Load Impedance Match Frequency Response	[CAL][CALIBRATE MENU] [FULL 2-PORT][REFLECTION] Connect each standard to port 1 [S11][OPEN],[SHORT],[LOAD] <sup>1</sup> [BROADBAND][DONE: LOADS] Connect each standard to port 2 [S22][OPEN],[SHORT],[LOAD] [BROADBAND][DONE: LOADS] [TRANSMISSION] Connect thru [DO BOTH FWD + REV] [ISOLATION][OMIT ISOLATION]
The isolation calibration should be omitted unless it is really necessary - if needed, use the following sequence			
<b>Isolation</b> 10 to 20 dB of the noise floor	<ul style="list-style-type: none"> <li>* May be used when signal is within 10 to 20 dB of the noise floor</li> <li>* Useful for high loss/isolation devices, such as some filters and switches.</li> <li>Try optimizing the dynamic range first</li> </ul>	Leakage Crosstalk (forward and reverse)	[AVG][AVERAGING FACTOR] 16 [x1] [AVERAGING ON] Connect 50 ohm loads to ports 1 & 2 [CAL][RESUME CAL SEQUENCE] [ISOLATION] [FWD ISOL'N ISOL'N STD] [REV ISOL'N ISOL'N STD] [AVG][AVERAGING OFF] [CAL][RESUME CAL SEQUENCE] [ISOLATION DONE] [DONE 2-PORT CAL],[SAVE REG1] [MEAS]
Finish 2-port calibration			
<b>One-Port Reflection</b> <i>Cal Time:</i> <i>about 2 min</i>	<ul style="list-style-type: none"> <li>* Most accurate for 1-port devices.</li> <li>* Reflection measurements.</li> </ul>	Directivity Source Impedance Match Frequency Response	[CAL][CALIBRATE MENU] [S11 1-PORT] or [S22 1-PORT] Connect each standard to the port [Sxx][OPEN],[SHORT],[LOADS] [BROADBAND][DONE: LOADS] [DONE 1-PORT CAL]
<b>Frequency Response</b> <i>Cal Time:</i> <i>about 1 min.</i>	<ul style="list-style-type: none"> <li>* Use when high accuracy is not needed.</li> <li>* Transmission measurements.</li> <li>* Reflection measurements.</li> <li>* Useful for well matched, high insertion loss devices.</li> </ul>	Frequency Response	[CAL][CALIBRATE MENU] [RESPONSE] Reflection: connect one standard to port [OPEN] or [SHORT] - short is preferred Transmission: connect thru [THRU] [DONE RESPONSE]

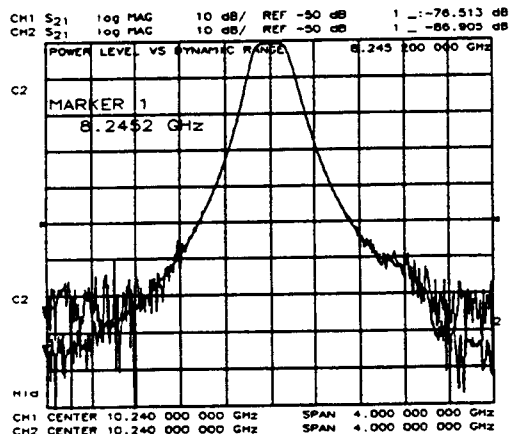
<sup>1</sup>Criteria for load selection: For greatest accuracy at frequencies <3 GHz choose lowband; at frequencies >3 choose sliding load; for full span use both. Broadband loads are convenient, have very good accuracy and are simpler to use (have no frequency restrictions).

## Optimizing Dynamic Range

Network analyzers are often used to simultaneously measure two signals that are widely separated in amplitude. Testing the attenuation of a filter requires measurement of both its transmitted and rejected signals, which may differ by 60 dB or more. System dynamic range is the difference between the measurement port's output power and the analyzer's noise floor. To optimize system dynamic range:

- \* choose the optimum input power for the DUT, and
- \* reduce the analyzer's noise floor

### Selecting Power Level



The analyzer is capable of providing +10 to -65 dBm (in 20 dB power ranges) at the output port; the HP 8722A offers -20 to -65 dBm in 10 dB power ranges. Selecting a higher port power level provides greater usable dynamic range. When choosing the appropriate power level the user must ensure that the test device is not overdriven (active devices only) and that the resulting output signal is within the measurement range of the analyzer. The analyzer can measure signals from +10 to <-100 dBm.

The accompanying figure illustrates how available dynamic range is affected by test port power levels. The input power levels are -10 dBm on trace 1 and +10 dBm on trace 2. As you can see, the additional 20 dB input power provides approximately 20 dB of improvement in dynamic range. Measuring signals below -85 dBm requires lowering the noise floor.

### Reducing the Noise Floor

There are several approaches available to reduce the noise floor. Each method offers its own contributions and limitations. The following table summarizes these issues for each method.

Method	Contributions (+)/Limitations (-)
Reduce IF Bandwidth	<ul style="list-style-type: none"> <li>+ Filters unwanted responses better than averaging</li> <li>+ Generally faster than averaging</li> <li>+ Better than averaging for 2-port error corrected measurements</li> <li>+ Easiest when programming over HP-IB</li> <li>+ Better for frequency list or log sweep measurements</li> <li>- Sweep time is automatically increased as the bandwidth is narrowed</li> <li>- Changing IF bandwidth after calibration may impact measurement accuracy</li> </ul>
Averaging	<ul style="list-style-type: none"> <li>+ Filters out very low frequency noise better than reducing IF bandwidth</li> <li>+ Doesn't impact measurement accuracy if applied after calibration</li> <li>- Takes many sweeps to complete the measurement</li> </ul>
Isolation Calibration	<ul style="list-style-type: none"> <li>+ Removes crosstalk from the measurement</li> <li>+ Doesn't affect accuracy</li> <li>- More difficult to implement</li> </ul>

## IF Bandwidth

The receiver IF bandwidth is selectable from 3 kHz to 10 Hz. Each tenfold reduction in IF bandwidth lowers the noise floor approximately 10 dB. With a 10 Hz bandwidth, a noise floor of -100 dBm can be achieved.

[AVG]/[IF BW] 30 [x1]

## Averaging

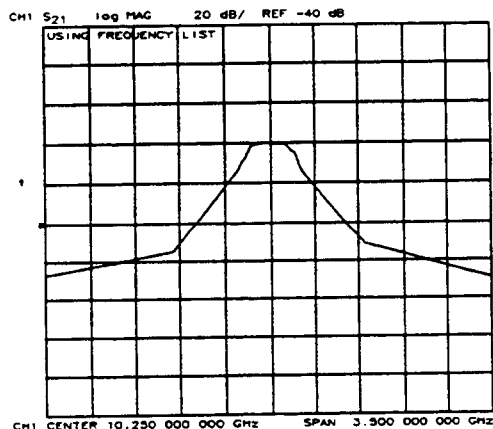
Averaging reduces random noise, by applying weighted vector averaging to successive traces. Doubling the average factor (the number of averages), reduces the noise floor by approximately 3 dB. When averaging is on, each successive sweep reduces the noise level until the sweep count reaches the averaging factor value. Also, "Avg" is displayed in the status notations area of the CRT, and the sweep count is displayed directly below. Users must be careful to make adjustments to the test device only after averaging has been completed. To average 64 successive traces, select the following keys:

[AVG]/[AVERAGING FACTOR] 64 [x1]  
[AVERAGING ON]

## Creating a Frequency List

The frequency list feature can be used to specify arbitrary measurement frequencies. By testing only the points you need, measurement time is reduced and throughput is maximized. To setup a list the user must specify sweep segments. These segments may contain a single point or a frequency span with a fixed number of points or step size. As many as 1,601 measurement frequencies may be contained in up to 30 segments.

The following frequency list, provides some information about the filter's stopband, while focusing on the pass-band with 101 measurement points. Note: the user may choose to only view a specific segment or the entire list. This example displays the complete list, as shown in the figure.



```
[MENU]/[SWEEP TYPE MENU]  
[EDIT LIST][ADD][CW] 8.5 [G/n][DONE]  
[ADD][CW] 9.5 [G/n][DONE]  
[ADD][START] 10 [G/n],[STOP] 10.5 [G/n]  
[NUMBER of POINTS] 101 [x1][DONE]  
[ADD][CW] 11 [G/n][DONE]  
[ADD][CW] 12 [G/n][DONE][DONE]  
[LIST FREQ][ALL SEGS SWEEP][RETURN]
```

As with any other measurement, the system should be calibrated and saved, as previously shown.

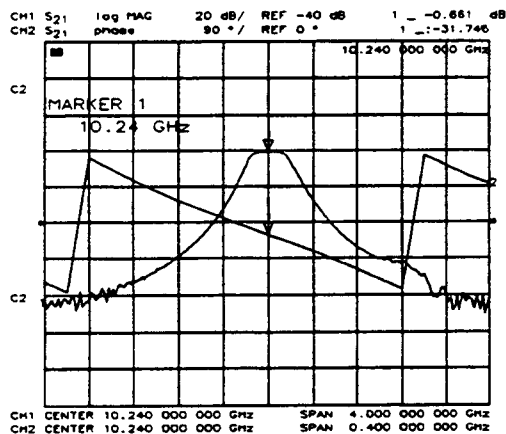
## Setting Up External Peripherals

### Factory-set peripheral addresses

Device	Decimal Address
Plotter	1
Printer	5
Disk (drive)	0

## Using Dual-Channel Display

### Uncoupled Channels



To store and output measurement results on a plotter, printer, or disk drive, the analyzer must be the system controller (when no other controller i.e. computer, is on the system bus). Also, the appropriate HP-IB addresses must be set up on the peripherals.

[LOCAL]/SYSTEM CONTROLLER/  
 [SET ADDRESSES]/[ADDRESS: device name]

The table displays the factory-set addresses for several peripherals. Refer to the peripheral's manual to verify the setting (most addresses are set with switches). To change an address, select the device softkey and enter a new number on the keypad followed by [x1].

In some cases, it is useful to be able to view more than one measured parameter at a time. For example, simultaneous insertion loss and return loss measurements are useful when adjusting the impedance match of a device for maximum power transfer. Such measurements are easily achieved using the dual-channel display feature.

To activate the dual channel feature, select [DISPLAY] [DUAL CHAN ON off]. You will notice that each channel is displayed separately on a split screen. To display the channels on the same graticule, select [MORE] [SPLIT DISP on OFF].

There are times when a user would like to test and compare the response of a device at different stimulus related measurement parameters, such as power or frequency. When dual-channel mode is active, selecting [MENU] [COUPLED CH on OFF] causes the analyzer to alternate between two sets of stimulus values.

The following sequence recalls the transmission measurement performed in chapter 2, then uncouples the channels and sets a phase measurement with a reduced frequency span on channel 2. Now the filter can be easily tuned for optimal transmission and phase performance.

[RECALL]/RECALL REG1/  
 [MENU]/COUPLED CH on OFF/  
 [DISPLAY]/DUAL CHAN ON off/  
 [MORE]/[SPLIT DISP on OFF]  
 [CH 2]/[SCALE REF]/[AUTO SCALE]  
 [CAL]/FREQ SUBSET ON off],[SPAN] 400 [M/u]  
 [FORMAT]/PHASE],[MKR] 10.24 [G/n]

# Function Index

## A

Address, set: [LOCAL]  
Adjust colors/intensity: [DISPLAY]/[MORE]/[ADJUST DISPLAY]  
Admittance, measure: [FORMAT]/[SMITH CHART]/[MKR FCTN]/[MKR MODE MENU]/[G + jB]  
Aperture, smoothing: [AVG]  
Arbitrary sweep (frequency list): [MENU]/[SWEEP TYPE MENU]/[EDIT LIST]  
ASCII format, storing: [SAVE]/[STORE TO DISK]/[DEFINE,INIT,PURGE]/[DISK FILE FORMAT]  
Auto scale: [SCALE REF]  
Average sweeps: [AVG]/[AVERAGING ON off]  
Averages, set: [AVG]/[AVERAGING FACTOR]

## B

Bandpass mode (time domain): [SYSTEM]/[TRANSFORM MENU]  
Bandwidth, 3 dB: [MKR FCTN]/[BANDWIDTH MENU]  
Bandwidth, IF: [AVG]/[IF BW]  
Beep done/warn: [DISPLAY]/[MORE]  
Binary format, storing: [SAVE]/[STORE TO DISK]/[DEFINE,INIT,PURGE]/[DISK FILE FORMAT]  
Blank, frequency: [DISPLAY]/[MORE]

## C

Cal kit, modify: [CAL]/[CAL KIT]  
Calibration, on off: [CAL]/[CORRECTION ON OFF]  
Calibration, setup: [CAL]/[CALIBRATE MENU]  
Characteristic impedance, set: [CAL]/[MORE]  
Clear (storage) register: [SAVE]/[CLEAR REGISTER]  
Color, adjust: [DISPLAY]/[ADJUST DISPLAY]  
Continuous markers: [MKR FCTN]/[MARKER MODE MENU]  
Control system, functions: [LOCAL]  
Convert data, Z/Y formats: [MEAS]/[CONVERSION]  
Couple channels: [MENU]  
Couple markers: [MKR FCTN]/[MARKER MODE MENU]  
Crosstalk, eliminate (w/isolation cal): [CAL]/[CALIBRATE MENU]/[RESPONSE & ISOL'N] or [FULL 2-PORT]  
CW freq, meas. vs time: [MENU]/[CW FREQ]

## D

Data, display: [DISPLAY]  
Define plot: [COPY]/[CONFIGURE PLOT]  
Define sweep: [MENU]/[SWEEP TYPE MENU]  
Delay, aperture: [AVG]/[SMOOTHING APERTURE]  
Delay, electrical: [FORMAT]/[PHASE]/[SCALE REF]/[ELECTRICAL DELAY]  
Delay, group: [FORMAT]/[DELAY]  
Delta markers: [MKR]/[Δ MODE MENU]  
Demodulation (time domain): [SYSTEM]/[TRANSFORM MENU]/[WINDOW]  
Discrete markers: [MKR FCTN]/[MKR MODE MENU]  
Disk (drive), address: [LOCAL]/[SET ADDRESSES]  
Disk, load from: [RECALL]  
Disk, setup: [SAVE]/[STORE TO DISK]/[DEFINE, INIT, PURGE]

Disk, store to: [SAVE]  
Display, adjust: [DISPLAY]/[MORE]  
Display HP-IB commands: [LOCAL]/[HP-IB DIAG ON off]  
Display, setup trace: [DISPLAY]  
Display, simultaneous traces: [DISPLAY]/[DUAL CHAN ON off]/[MORE]/[SPLIT DISP on OFF]  
Dual channel display: [DISPLAY]

## E

Electrical delay (length): [FORMAT]/[PHASE]/[SCALE REF]/[ELECTRICAL DELAY]  
Error correction, applying: [CAL]/[CALIBRATE MENU]  
External Trigger: [MENU]/[TRIGGER MENU]

## F

Fixed marker offset: [MKR]/[Δ MODE MENU]/[FIXED MARKER POSITION]  
Focus: [DISPLAY]/[MORE]/[ADJUST DISPLAY]  
Format disk: [SAVE]/[STORE TO DISK]/[DEFINE, INIT, PURGE]/[INITIALIZE DISK]  
Frequency blank: [DISPLAY]/[MORE]  
Frequency list: [MENU]/[SWEEP TYPE MENU]  
Frequency subset: [CAL]  
Freeze trace: [MENU]/[TRIGGER MENU]/[HOLD]

## G

Gate (time domain), setup: [SYSTEM]/[TRANSFORM MENU]/[SPECIFY GATE]  
Group delay: [FORMAT]/[DELAY]

## H

HP-IB, addresses: [LOCAL]/[SET ADDRESSES]  
HP-IB, control: [LOCAL]/[SYSTEM CONTROLLER]  
Hold: [MENU]/[TRIGGER MENU]

## I

IF bandwidth: [AVG]  
Impedance, system: [CAL]/[MORE]  
Impulse mode (time domain): [SYSTEM]/[TRANSFORM MENU]/[LOW PASS IMPULSE]  
Initialize disk: [SAVE]/[STORE TO DISK]/[DEFINE, INIT, PURGE]  
Intensity, adjust: [DISPLAY]/[MORE]/[ADJUST DISPLAY]  
Invert Smith chart (admittance): [FORMAT]/[SMITH CHART]/[MKR FCTN]/[MKR MODE MENU]/[G + jB]

## L

Limit lines: [SYSTEM]/[LIMIT MENU]  
Line stretcher (simulate): [SCALE REF]/[ELECTRICAL DELAY]  
Linear magnitude format: [FORMAT]  
Linear frequency sweep: [MENU]/[SWEEP TYPE MENU]  
List current operating parameters: [COPY]/[OP PARAM]  
List frequency: [MENU]/[SWEEP TYPE MENU]  
List (trace) values, display: [COPY]  
Log frequency sweep: [MENU]/[SWEEP TYPE MENU]  
Log magnitude format: [FORMAT]  
Low pass frequency, set: [CAL]/[CALIBRATE MENU]  
Low pass mode (time domain): [SYSTEM]/[TRANSFORM MENU]

## M

Marker, delta: [MKR]  
Marker, equals: [MKR FCTN]/[MARKER -> MENU]  
Marker, offset: [MKR]/[ $\Delta$  MODE MENU]/[FIXED MARKER POSITION]  
Marker search functions: [MKR FCTN]  
Marker statistics: [MKR FCTN]/[MKR MODE MENU]  
Marker track (search value): [MKR FCTN]/[TRACKING ON off]  
Marker zero: [MKR]  
Match, load: [FORMAT]/[SWR]  
Max, locate: [MKR FCTN]  
Measurement, restart: [MEAS]  
Memory, display: [DISPLAY]  
Min, locate: [MKR FCTN]  
Modify cal kit:[CAL]/[CAL KIT]  
Modify colors: [DISPLAY]/[MORE]/[ADJUST DISPLAY]

## N

Number of groups (triggered): [MENU]/[TRIGGER MENU]  
Number of points (per sweep): [MENU]

## O

Operating parameters, display list: [COPY]/[OP PARAM]  
Operation, set manual/remote: [LOCAL]  
Output power: [MENU]

## P

Pass (system) control: [LOCAL]  
Pens, plotter: [COPY]/[CONFIGURE PLOT]  
Phase, measure: [FORMAT]  
Plot: [COPY]  
Plot, configure pens/lines: [COPY]/[CONFIGURE PLOT]  
Plot, define: [COPY]/[DEFINE PLOT]  
Plot setup, default: [COPY]/[PRINT/PLOT SETUPS]  
Points, set number: [MENU]  
Polar markers: [MKR FCTN]/[MKR MODE MENU]  
Polar, format: [FORMAT]  
Port extensions: [CAL]/[MORE]  
Power, output: [MENU]  
Preset, factory (w/active user preset): [RECALL]/[RECALL FAC PRESET]  
Preset, re-establish factory: [SAVE]/[CLEAR REGISTER]/[CLEAR PRESETS]  
Preset, store user: [SAVE]/[SAVE PRESETS]  
Print: [COPY]  
Print, define: [COPY]/[PRINT/PLOT SETUPS]

## R

Real, format: [FORMAT]  
Recall default colors: [DISPLAY]/[MORE]/[ADJUST DISPLAY]  
Reference, adjust: [SCALE REF]  
Reflection, measure: [MEAS]  
Resume cal sequence: [CAL]

## S

Search functions (marker): [MKR FCTN]  
Secure system, eliminate freq. info.: [DISPLAY]/[MORE]/[FREQUENCY BLANK]  
Set addresses: [LOCAL]

Set freq. low pass: [CAL]/[CALIBRATE MENU]  
Set Z0: [CAL]/[MORE]  
Scale data (best fit): [SCALE REF]/[AUTO SCALE]  
Shape gate: [SYSTEM]/[TRANSFORM MENU]/[SPECIFY GATE]  
Single sweep: [MENU]/[TRIGGER MENU]  
Smith chart: [FORMAT]  
Smith chart markers: [MKR FCTN]/[MKR MODE MENU]  
Smoothing: [AVG]  
Smoothing, percent: [AVG]/[SMOOTHING APERTURE]  
Split display: [DISPLAY]/[DUAL CHAN ON off]/[MORE]  
Statistics: [MKR FCTN]/[MKR MODE MENU]  
Stimulus, couple: [MENU]/[COUPLED CH ON off]  
Sweep functions: [MENU]  
SWR: [FORMAT]  
System control functions: [LOCAL]

## T

Table, list sweep: [MENU]/[SWEEP TYPE MENU]  
Talker/listener, system control mode: [LOCAL]  
Target, search value: [MKR FCTN]  
Time domain functions: [SYSTEM]/[TRANSFORM MENU]  
Title (display): [DISPLAY]/[MORE]  
Trace functions: [DISPLAY]  
Trace markers: [MKR FCTN]  
Tracking, marker: [MKR FCTN]  
Transform, Fourier: [SYSTEM]  
Transmission, measure: [MEAS]  
Trigger, functions: [MENU]

## U

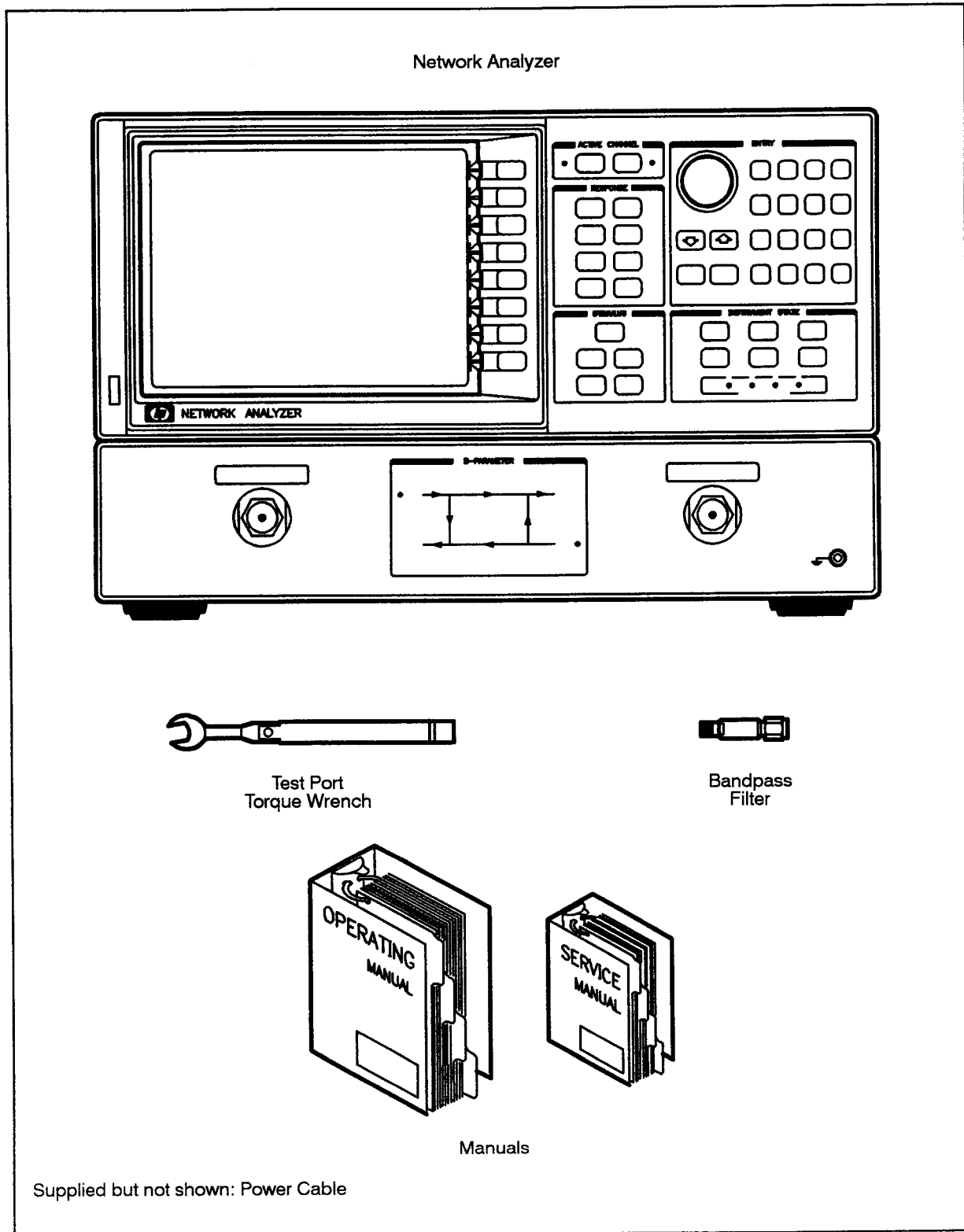
Uncoupled markers: [MKR FCTN]/[MKR MODE MENU]  
User preset, set: [SAVE]/[SAVE PRESETS]  
User preset, remove: [SAVE]/[CLEAR REGISTER]/[CLEAR PRESETS]

## V

Velocity factor: [CAL]/[MORE]

## W

Window, set: [SYSTEM]/[TRANSFORM MENU]



*Figure 1-1. Network Analyzer and Items Supplied*





# Chapter 1. General Information

---

## INTRODUCTION

The *Operating Manual* is a complete reference for operation of the microwave network analyzer using either front panel controls or an external controller. This information reference is intended to supplement the separately bound tutorial documents in this manual with additional details. It is divided into chapters providing the following information:

- Chapter 1 includes a block diagram and functional description of the analyzer system, with descriptions of the front panel features and CRT labels, and the rear panel features and connectors.
- Chapters 2 through 11 provide detailed information on front panel keys and softkeys, their purpose and use, HP-IB equivalents in parentheses, and expected indications and results. Specific areas of operation described in these chapters include calibration procedures for accuracy enhancement, using markers, limit testing, time domain measurements (option 010), plotting and printing, and saving instrument states.
- Chapter 12 contains information for operating the system remotely with a controller through HP-IB. HP-IB is Hewlett-Packard's hardware, software, documentation, and support for IEEE-488.1 and IEC-625, worldwide standards for interfacing instruments. Chapter 13 lists error messages, with explanations.

An appendix at the end of this *Reference* provides a complete listing of the instrument preset state, a map of the operating softkey menu structure and Accuracy Enhancement Fundamentals.

Also provided with the network analyzer, in the *Operating and Programming Manual* binder, are the following documents that provide operating or programming information:

- The *User's Guide* provides tutorial operating information, showing how the instrument is used for the majority of network analysis measurements. It demonstrates the features and capabilities of the system with actual measurement examples.
- The *BASIC Programming Guide* provides tutorial instructions for using the analyzer with a series 300 computer as a controller and HP BASIC programming language. Familiarity with front panel operation is assumed.
- The *Quick-C Programming Guide* provides tutorial instructions for using the analyzer with a DOS based personal computer and Quick-C programming language.
- The *HP-IB Programming Reference* contains a complete list of mnemonics used to program the analyzer.

## ITEMS SUPPLIED WITH THE ANALYZER

Figure 1-1 shows the accessories supplied with the instrument.

## BRIEF DESCRIPTION OF THE ANALYZER

The HP 8719, 8720, and 8722 are high performance microwave network analyzers for measurements of reflection and transmission parameters. The HP 8719 covers the frequency range of 50 MHz to 13.5 GHz; the HP 8720 goes to 20 GHz; the HP 8722 goes to 40 GHz; the HP 8722C is a high power version of the HP 8722. Frequency resolution is 100 kHz (standard) or 1 Hz with option 001. Each integrates a synthesized source, a switching S-parameter test set, and a dual channel receiver to measure and display magnitude, phase, and group delay of transmitted and reflected power. Option 010 provides the capability of transforming measured data from the frequency domain to the time domain.

Digital signal processing and microprocessor controls combine to provide easy operation and measurement improvement. Measurement functions are selected with front panel keys and softkey menus. Two independent display channels and a large screen color CRT display the measurement results of one or both channels, in logarithmic, linear, or Smith chart display formats.

Trace math, data averaging, trace smoothing, electrical delay, and accuracy enhancement provide performance improvement and flexibility. Accuracy enhancement reduces the effects of repeatable measurement variations in the test system.

Displayed measurement results can be printed or plotted directly to a compatible peripheral without the use of an external computer. Instrument states can be saved in internal memory for at least three days without line power to the instrument. In addition, each analyzer can control a compatible disk drive for external storage capability. Built-in service diagnostics are available to simplify troubleshooting procedures.

### Hewlett-Packard Interface BUS (HP-IB)

The analyzer is factory-equipped with a remote programming interface using the Hewlett-Packard Interface Bus (HP-IB). HP-IB is Hewlett-Packard's hardware, software, documentation, and support for IEEE-488.1 and IEC-625, worldwide standards for interfacing instruments. This provides a remote operator with the same control of the instrument available to the local operator, except for control of the line power switch. Remote control is maintained by a controlling computer that sends commands or instructions to and receives data from the analyzer using the HP-IB. A complete general description of the HP-IB is available in *Condensed Description of the Hewlett-Packard Interface Bus* (HP part number 59401-90030), and in *Tutorial Description of the Hewlett-Packard Interface Bus* (HP literature number 5952-0156).

The analyzer itself can use the HP-IB to output measurement results directly to a compatible printer or plotter, or to store instrument states to a compatible disk drive, without the use of an external computer.

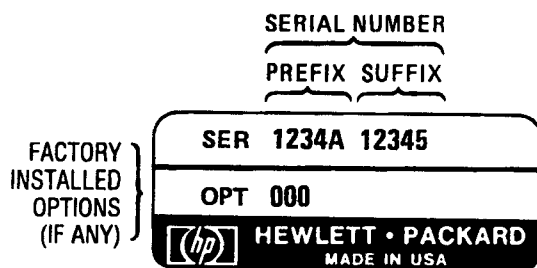
## DESCRIPTION OF THE MANUAL SET

This *Operating Manual* is a complete guide to operating the analyzer alone or in a system. It is part of a two manual set; the *Service Manual* completes the set.

To explore the manuals further, inspect their title pages, tabs, and the "Contents" and "Index" sections.

### Analyzers Covered by This Manual

The analyzer you received with this manual is covered by this manual without change. Any other analyzer with one of the serial number prefixes listed on the title page is also described by this manual. (The serial number plate, shown in Figure 1-2, is attached to the rear panel of the analyzer.)



*Figure 1–2. Typical Serial Number Plate*

Other instruments differ from the instruments covered directly by this manual. Those differences are documented in the “Instrument History” section of this manual. See that section if the serial number prefix of your instrument is not listed on the title page.

## OPTIONS AVAILABLE

### Option 001, 1 Hz Frequency Resolution

Devices that have narrow frequency spans (such as crystal or notch filters) require better frequency resolution than the 100 kHz offered by the standard instrument. Option 001 provides 1 Hz frequency resolution for finer control of start, stop, and marker frequencies. This option can be installed after shipment.

### Option 006 Solid State Transfer Switch (HP 8719,8720 only)

Option 006 replaces the mechanical transfer switch with a solid–state switch in the test set. This allows the instrument to default to continuous switching as required by two port error correction or dual–channel operation, but allows softkey selection of “Fast 2–Port” for better measurement speed. Output power is –7 dBm lower, output power flatness is +/- 4 dB instead of +/- 2 dB, and dynamic range is reduced to 96 dB instead of 103 dB (due to lower maximum power).

### Option 010, Time Domain

Option 010 can display the time domain response of a network by computing the inverse Fourier transform of the frequency domain response. This makes it possible to see the response of a test device as a function of time or distance. Displaying the reflection coefficient of a network versus time determines the magnitude and location of each discontinuity. Displaying the transmission coefficient determines the characteristics of individual transmission paths. Time domain operation retains the calibration that is active in the frequency domain. The time domain capability is useful for designing and characterizing such devices as SAW filters, SAW delay lines, and RF cables. This option can be installed after shipment.

### Option 011, 3–Channel Direct–Access Receiver

Provides a front panel input to each of the samplers. This option provides a convenient means of customizing a test configuration.

### **Option 003, High Forward Dynamic Range (HP 8722 only)**

Extends the dynamic range for forward transmission measurements (S21). This configuration differs from the standard instrument in that the main arm of the port 2 coupler is connected (through a 6 dB attenuator) to the sampler. Reverse dynamic range (S12) is degraded with this configuration.

### **Option 802, Add Disk Drive**

This adds the HP 9122 dual 3.5" disk drive and the HP 10833A 1m (3.3 ft) HP-IB cable. The disk drive is covered under one-year return-to-factory warranty agreements.

### **Option 910, Extra Manuals**

The standard instrument is supplied with an *Operating Manual* and a *Service Manual*. Option 910 provides an additional copy of both of these manuals. To order extra manuals after initial shipment, order by part number, listed on the title page and rear cover of each manual.

### **Option 913, Rack Mount With Handles**

Option 913 is a rack mount kit containing a pair of flanges and the necessary hardware to mount the instrument, with handles attached, in an equipment rack with 482.6 mm (19 inches) spacing.

## **Service and Support Products**

A variety of on-site and return-to-HP service and support products are available. These products cover repair, calibration, and verification. Consult your local HP customer engineer for details.

**System On-Site Service.** The analyzer includes a one year on-site service warranty (where available). In the event of failure, an HP customer engineer will provide on-site service for the analyzer, calibration and verification kits, and super flexible cables. Note that system installation (a straightforward procedure) is not included.

**Three Year Customer Return Repair Coverage (W30)** adds to product warranty to provide a total of three years of customer return repair service from the time of hardware delivery.

**Three Year On-Site Repair Coverage (W31)** adds to product warranty to provide a total of three years of next day on-site coverage from the time of hardware delivery.

**Three Year Customer Return Calibration Coverage (W32)** begins the day of hardware delivery. Includes scheduled calibration at HP's recommended calibration cycle, as well as calibration after a required repair performed by HP.

**Option 1BN** adds a MIL-STD 45662A Certificate of Calibration to the instrument. Must be ordered when the instrument is ordered.

**Option 1BP** adds a MIL-STD 45662A Certificate of Calibration and the corresponding calibration data to the instrument. Must be ordered with the instrument.

**Self-Support Tool Kit.** A dedicated tool kit is available for troubleshooting the analyzer. It consists of extender boards and cables, adapters, and fuses. The parts are listed in the "Replaceable Parts" section of the *Service Manual*.

## EQUIPMENT REQUIRED

Compatible calibration kits and cables are required for full error–corrected system performance in accordance with specifications listed in the “Specifications” section of the *Service Manual*. Additionally, a verification kit is required to verify performance.

### Calibration Kits

The following calibration kits contain precision standards (and required adapters) of the indicated connector type. The standards (known devices) facilitate measurement calibration, also called vector error correction. Refer to the data sheet and ordering guide for additional information. Part numbers for the standards are in their manuals.

**HP 85052B 3.5 mm Calibration Kit** contains precision calibration standards used to calibrate the network analyzer for making error–corrected measurements of devices with 3.5 mm connectors, up to 20 GHz. The standards included are:

- open circuits (male and female)
- short circuits (male and female)
- lowband fixed loads (male and female)
- sliding loads (male and female)

Also contained in the kit are precision adapters for converting the test ports to a 3.5 mm interface of either sex, as well as a 3.5 mm connector gage kit and other tools for maintaining and verifying the integrity of the test port 3.5 mm connector interface.

**HP 85052D 3.5 mm Economy Calibration Kit** provides the most convenient and economical calibration for measurement of devices with a 3.5 mm connector interface. The kit contains the following standards:

- open circuits (male and female)
- short circuits (male and female)
- precision broadband fixed loads (male and female)

Also included are precision adapters, a torque wrench, and an open–end wrench. (No connector gages are included in this kit.)

**HP 85050B 7 mm Calibration Kit** provides the standards used for calibration up to 18 GHz for error–corrected measurement of devices with 7 mm connectors. The kit contains the following standards:

- open circuit short circuit
- lowband fixed load
- precision broadband fixed load
- sliding load

Also included are a connector gage kit and other tools for maintaining and verifying the integrity of the test port 7 mm connector interface.

**HP 85050D 7 mm Economy Calibration Kit** provides convenient and economical calibration for measurement of devices with 7 mm connectors up to 18 GHz. The following standards are included:

- open circuit

- short circuit
- precision broadband
- fixed load

A torque wrench is also provided. (No connector gages are included in this kit.)

**HP 85054B Type–N Calibration Kit** contains a set of precision calibration standards used to calibrate for error–corrected measurement of devices with type–N connectors. The standards included are:

- open circuits (male and female)
- short circuits (male and female)
- fixed loads (male and female)
- sliding loads (male and female)

Also contained in the kit are precision 7 mm to type–N (male and female) adapters, and tools for maintaining and verifying the integrity of the type–N interface.

**HP 85054D Type–N Economy Calibration Kit** provides economical and convenient calibration for measurement of devices with type–N connectors. It contains:

- open circuits (male and female)
- short circuits (male and female)
- precision broadband fixed loads (male and female)

Also included are precision adapters, a torque wrench, and an open–end wrench.

**HP 85056A 2.4 mm Calibration Kit** contains open and short circuits, fixed and sliding loads (2), 2.4 mm to 2.4 mm adapters, 2.4 mm connector tools and gauges.

## Verification Kits

Accuracy–enhanced performance of the system can be verified by measuring known devices other than the standards used in calibration, and comparing the results with recorded data. The following verification kits (with a serial number prefix of 2815A or higher) provide a data disk for specific use with the HP 8719C, HP 8720C, and HP 8722. Kits ordered prior to this serial prefix can be upgraded to include the data disk by recertifying the kit through a local HP Sales and Service office (be sure to request HP 8719C, HP 8720C, or HP 8722 data). The data disk contains the factory–measured S–parameter data for the devices in the kit, and the uncertainty limits used in the system verification procedure. The data is unique to each kit.

For the complete procedure to verify the performance of the network analyzer, refer to the *Verification* section of the *Service Manual*.

**HP 85057S 2.4 mm Verification Kit** contains a precision airline, mismatched airline, 20 and 40 dB attenuators with NIST (National Institute of Standards and Technology) traceable data and uncertainties.

**HP 85053B 3.5 mm Verification Kit** consists of a set of 3.5 mm measured standards, a data disk, and printouts of device data. The two device data printouts are for calibrations using a broadband fixed load and using a sliding load. The following standards are included:

- 7.5 cm 50 $\Omega$  airline

25Ω to 50Ω stepped impedance airline  
 20 dB attenuator 40 dB attenuator

**HP 85051B 7 mm Verification Kit** consists of a set of 7 mm measured standards, a data disk, and printouts of device data. The standards included are:

10 cm 50Ω beadless airline  
 25Ω to 50Ω stepped impedance airline  
 20 dB attenuator, 50 dB attenuator

**HP 85055A Type–N Verification Kit** consists of a set of type–N measured standards, a data disk, and printouts of device data. The standards included are:

50Ω airline  
 25Ω to 50Ω stepped impedance airline  
 20 dB attenuator  
 50 dB attenuator

### Test Port Return Cables

These cables are designed to connect the test ports to the device under test. Cables are available as single long cables for measurements where one port of the device is connected directly to the test port, or as cable sets that contain two cables, one for each port. Semi–flexible cables offer the best performance and are suitable for applications where the connectors of the device are in–line. Super–flexible cables are more rugged and have a tighter bending radius, and are appropriate for manufacturing environments. Semi–flexible cables are warranted for 90 days, and super–flexible cables for one year.

**For Devices with 2.4 mm Connectors**, use the HP 85133 series test port return cables. These 2.4 mm cables are specified from DC to 50 GHz.

HP Model	Description	Length	Connectors
HP 85133C	Semi–flexible single cable	81 cm (32 in)	NMD–2.4 mm to 2.4 mm (f)
HP 85133D	Semi–flexible cable set	53 cm (21 in)	NMD–2.4 mm to 2.4 mm (m and f)
HP 85133E	Super–flexible single cable	94 cm (38 in)	NMD–2.4 mm to 2.4 mm (f)
HP 85133F	Super–flexible cable set	58 cm (23 in)	NMD–2.4 mm to 2.4 mm (m and f)

**For Devices with 3.5 mm Connectors**, use the HP 85131 series test port return cables. These 3.5 mm cables are specified from DC to 26.5 GHz.

HP Model	Description	Length	Connectors
HP 85131C	Semi–flexible single cable	81 cm (32 in)	NMD–3.5 mm to 3.5 mm (f)
HP 85131D	Semi–flexible cable set	53 cm (21 in)	NMD–3.5 mm to 3.5 mm (m and f)
HP 85131E	Super–flexible single cable	94 cm (38 in)	NMD–3.5 mm to 3.5 mm (f)
HP 85131F	Super–flexible cable set	58 cm (23 in)	NMD–3.5 mm to 3.5 mm (m and f)

**For Devices with 7 mm Connectors,** use the HP 85132 series test port return cables. These cables are designed to connect the analyzer's 3.5 mm test ports to a 7 mm device under test. These cables are specified from DC to 18 GHz. For use with the HP 85132C/E single cables, the HP 85130B 7 mm special adapter set is also required.

HP Model	Description	Length	Connectors
HP 85132C	Semi-flexible single cable	81 cm (32 in)	NMD-3.5 mm to 7 mm
HP 85132D	Semi-flexible cable set	53 cm (21 in)	NMD-3.5 mm to 7 mm
HP 85132E	Super-flexible single cable	94 cm (38 in)	NMD-3.5 mm to 7 mm
HP 85132F	Super-flexible cable set	58 cm (23 in)	NMD-3.5 mm to 7 mm

**For Devices with Type-N Connectors,** the HP 85132 series 7 mm cables are recommended. Adapters from 7 mm to type-N (male and female) are included in the HP 85054B and HP 85054D type-N calibration kits. If the type-N device is to be connected directly to the test ports, use the HP 85130C type-N special adapter set and the HP 85132C/E cables.



## **EQUIPMENT AVAILABLE**

### **Adapter Sets**

The following compatible adapter sets are recommended for applications where the device under test is connected directly to the test ports.

**HP 85130D 3.5 mm Special Adapter Set** consists of 3.5 mm to 3.5 mm (male and female) adapters, and is recommended for applications which require many direct connections to the test port. The adapters protect the test ports from damage and wear due to heavy use.

**HP 85130E Special 2.4 mm to 7 mm Adapter Set** is used to convert the 2.4 mm ports of the test set to a 7 mm connector interface, male or female.

**HP 85130F Special 2.4 mm to 3.5 mm Adapter Set** is used to convert the 2.4 mm ports of the test set to a 3.5 mm connector interface, male or female.

**HP 85130G 2.4 mm special Adapter Set** consists of 2.4 mm to 2.4 mm (male and female) adapters, and is recommended for applications which require many direct connections to the test port, the adapters protect the test ports from damage and wear due to heavy use.

**HP 85130B 7 mm Special Adapter Set** converts the test ports to 7 mm.

**HP 85130C Type-N Special Adapter Set** converts the test ports to type-N (male and female).

### **System Rack**

The recommended system rack for the analyzer is the HP 85043B. This metal cabinet measures 124 cm (49 in) high, 60 cm (24 in) wide, and 80 cm (32 in) deep. The rack is equipped with an extendable work surface, a drawer for calibration kits and other hardware, a bookshelf for system manuals, and a locking rear door for secured access. The total depth of the rack with the work surface installed is 115 cm (45 in). Lightweight steel rails support the instruments along their depth. Heavy-duty casters make the cabinet easily movable even with the instruments in place. Screw-down lock feet permit leveling and semi-permanent installation: the cabinet is extremely stable when the lock feet are down. Power is supplied to the cabinet through a heavy-duty grounded primary power cable, and to the individual instruments through special power cables included with the cabinet. Thermal design is such that no rack fan is needed.

### **Plotters and Printers**

The analyzer is capable of plotting or printing displayed measurement results directly to a compatible peripheral without the use of an external computer. Plotters tend to be more accurate, but slower and more expensive than printers. These are compatible:

- HP 7470A Option 002 Two-Pen Graphics Plotter plots on ISO A4 or 8.5 x 11 inch charts.
- HP 7440A Option 002 ColorPro Eight-Pen Color Graphics Plotter plots on ISO A4 or 8.5 x 11 inch charts.
- HP 7475A Option 002 Six-Pen Graphics Plotter plots on ISO A4/A3 or 8.5 x 11 inch or 11 x 17 inch charts.

(Option 002 for the plotters listed above is HP-IB interface capability.)

- HP 7550A High-Speed Eight-Pen Graphics Plotter plots on ISO A4/A3 or 8.5 x 11 inch or 11 x 17 inch plots.
- HP 7090A Measurement Plotting System is a high-performance six-pen programmable digital plotter. It plots on ISO A4/A3 or 8.5 x 11 inch or 11 x 17 inch paper or overhead transparency film.

Printers tend to be faster and less expensive, but also less accurate, than plotters. These are compatible:

- HP 2225A ThinkJet printer
- HP 2227B QuietJet printer
- HP 3630A PaintJet color graphics printer
- HP 2673A thermal graphics printer (obsolete but compatible)
- HP 82906A option 002 graphics printer (obsolete but compatible)
- HP 9876A thermal graphics printer (obsolete but compatible)

## Disk Drives

The analyzer has the capability of storing instrument states directly to disk drive without the use of a computer. Any disk drive that uses CS80 protocol and HP 200/300 series format (LIF, Logical Interchange Format) is compatible. The recommended disk drives are:

- HP 9122C/D/S dual 3.5 inch disk drive
- HP 9153C option 010/011 10 Mbyte Winchester 3.5 inch hard disk drive
- HP 9153C option 020/021 20 Mbyte Winchester 3.5 inch hard disk drive
- HP 9153C option 040/041 40 Mbyte Winchester 3.5 inch hard disk drive

## Computer

The system can be automated with the addition of an HP 200/300 series computer or DOS based personal computer. (The system verification procedure and automated adjustments do not require an external computer.) For more information about compatible computers, consult your Hewlett-Packard customer engineer.

## System Software

The software below requires an HP 200/300 series computer with BASIC 3.0 or higher.

**HP 85014C Active Device Measurements Pac** can make complete automated S-parameter measurements of active devices in-fixture. Use it with the HP 85041A transistor test fixture to measure transistors in 0.070 and 0.100 packages. The software includes models for this fixture and can de-embed fixture responses from the measurement.

**HP 85162A Measurement Automation Software** complements the analyzer by providing all calibration, measurement, and data output capabilities with a minimum of operator interaction.

**HP 85165A Resonator Measurement Software** performs complete characterization of crystals, SAWs, and other resonant devices. The software guides the user through the measurement process and calculates key parameters of the device under test. The analyzer must have option 001 (1 Hz resolution).

### **Anti-Static Mat**

Use of an anti-static mat (such as HP part number 9300-0797), and a wrist strap (such as HP part number 9300-0910) is highly recommended to prevent electrostatic damage to the analyzer or test devices.

### **REQUIRED TEST EQUIPMENT**

The "Service and Equipment Overview" section of the *Service Manual* lists equipment required to test, adjust, and service the system.

### **SAFETY CONSIDERATIONS**

Do not remove the instrument covers. The analyzer should be serviced only by qualified personnel who are aware of the hazards involved. Safety precautions are detailed in the *Service Manual*.

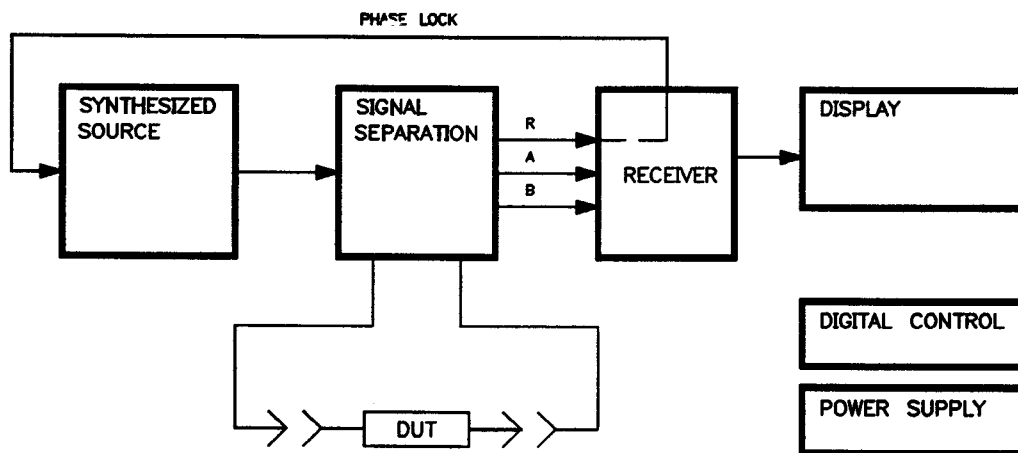


## Chapter 2. System Description and Data Processing

### SYSTEM DESCRIPTION

Network analyzers measure the reflection and transmission characteristics of devices and networks by applying a known swept signal and measuring the responses of the test device. The signal transmitted through the device or reflected from its input is compared with the incident signal generated by a swept RF source. The signals are applied to a receiver for measurement, signal processing, and display. A network analyzer system consists of a source, signal separation devices, a receiver, and a display.

This microwave network analyzer integrates a synthesized source, signal separation devices, and a dual channel receiver to measure and display magnitude, phase, and group delay of transmitted and reflected power. Analyzer Option 010 provides the additional capability of transforming measured data from the frequency domain to the time domain.



*Figure 2–1. Simplified Block Diagram of the Network Analyzer*

The built-in synthesized source of the analyzer generates a swept or CW (continuous wave) signal in the range of 50 MHz to 13.5 GHz (for the HP 8719C) or 20.0 GHz (for the HP 8720C) or 40 GHz (for the HP 8722), with a frequency resolution of 100 kHz. Option 001 provides enhanced frequency resolution of 1 Hz. The source output power is leveled by an internal ALC (automatic leveling control) circuit. To achieve frequency accuracy and phase measuring capability, the analyzer is phase locked to a highly stable crystal oscillator. For this purpose, a portion of the transmitted signal is routed to the R sampler in the receiver, and fed back to the source.

The signal separation devices in the analyzer include a power splitter, a transfer switch, and two directional couplers. The power splitter diverts a portion of the incident signal to the R sampler for reference and phase lock. The transfer switch and the couplers provide the capability for simultaneous transmission and reflection measurements in both the forward and reverse directions. Power control is in 0.05 dB increments. The ALC range is 20 dB for the HP 8719C/20C and 10 dB for the HP 8722. And, a step attenuator allows you to set the ALC range anywhere from +10 to -65 dBm for the HP 8719C and 8720C. Two bias tees allow external biasing of active devices connected to the test ports.

The signal transmitted through or reflected from the DUT is applied to the B and/or A samplers and compared with the incident signal at R.

The receiver contains three identical samplers and second converters (R, A, and B), which convert the input signal to a 4 kHz IF (intermediate frequency), retaining both the magnitude and phase characteristics of the source signal. The three signals are multiplexed into the ADC (analog-to-digital converter) and converted to digital signals, to be measured and processed for display on the CRT.

A microprocessor takes the raw data and performs all the required error correction, trace math, formatting, scaling, and marker operations, according to the instructions from the front panel or controller. The formatted data is then displayed on the CRT. The data processing sequence is described below.

In addition to the analyzer itself, a measurement may require calibration standards for vector accuracy enhancement, and cables for interconnections. Model numbers and details of compatible calibration kits, cables, and other accessories are provided in the *General Information* chapter of this Reference Manual.

A detailed block diagram of the analyzer is provided in the *Service Manual*, together with complete theory of system operation.

## DATA PROCESSING

### Overview

The receiver of the analyzer converts the reflected and transmitted signals from the DUT into useful measurement information. This conversion occurs in two main steps. First, the swept high frequency input signals are translated to fixed low frequency IF signals, using harmonic mixing techniques. (Refer to *Theory of Operation* in the *Service Manual* for details.) Second, the IF signals are converted into digital data by an analog-to-digital-converter (ADC). From this point on, all further signal processing is performed mathematically by microprocessors in the analyzer. The following paragraphs describe the sequence of math operations and the resulting data arrays as the information flows from the ADC to the display. They provide a good foundation for understanding most of the response functions, and the order in which they are performed.

Figure 2-2 is a data processing flow diagram that represents the flow of numerical data from IF detection to display. The data passes through several math operations, denoted in the figure by single-line boxes. Most of these operations can be selected and controlled with the front panel RESPONSE block menus. The data is also stored in arrays along the way, denoted by double-line boxes. These arrays are places in the flow path where data is accessible, usually via HP-IB.

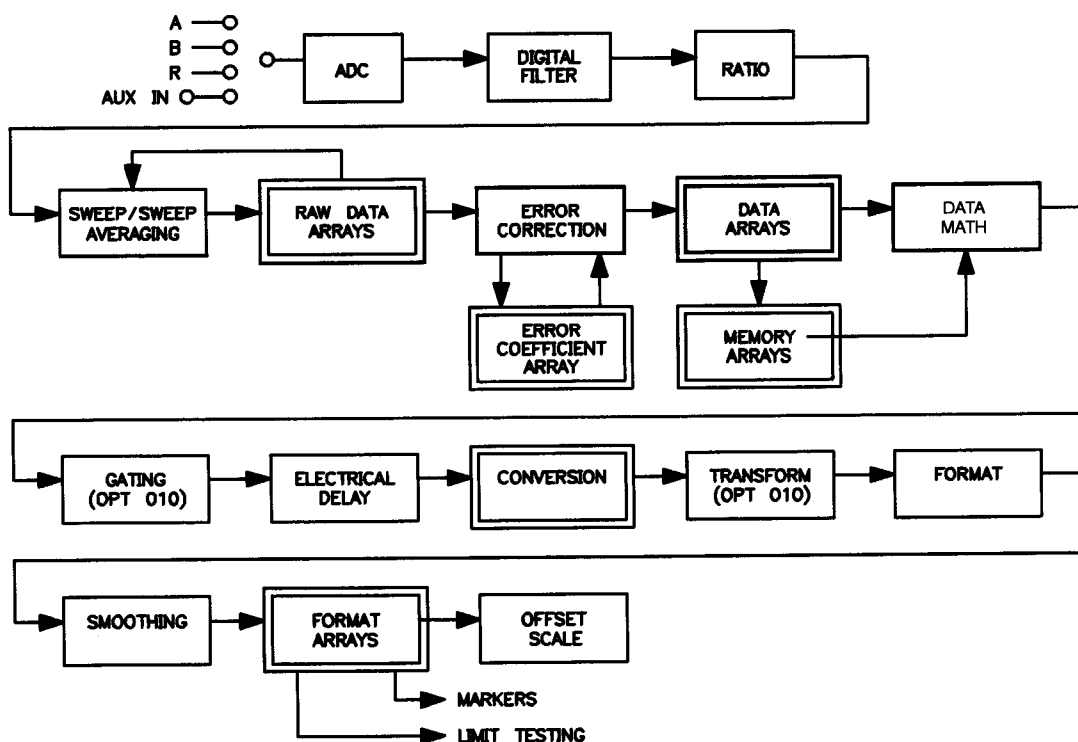


Figure 2-2. Data Processing Flow Diagram

While only a single flow path is shown, two identical paths are available, corresponding to channel 1 and channel 2. When the channels are uncoupled, each channel can be independently controlled, so that the data processing operations for one are different from the other.

Two definitions are necessary:

A “data point” or “point” is a single piece of data representing a measurement at a single source stimulus value. Most data processing operations are performed point-by-point; some involve more than one point.

A “sweep” is a series of consecutive data point measurements, taken over a sequence of source stimulus values. A few data processing operations require that a full sweep of data is available. The number of points per sweep can be defined by the user.

## Processing Details

The **ADC** converts the R, A, and B inputs (already down-converted to a fixed 4 kHz IF) into digital words. (The AUX IN connector on the rear panel is a fourth input.) The ADC switches rapidly between these inputs, so they are converted nearly simultaneously.

**The digital filter** detects the IF and performs the discrete Fourier transform (DFT) on the digital words. The samples are converted into complex number pairs (real plus imaginary). The complex numbers represent both the magnitude and phase of the IF signal. If AUX IN is selected as the input, the imaginary part of the pair is set to zero. The DFT filter shape can be altered by changing the IF bandwidth, which is a highly effective technique for noise reduction. (Refer to **AVG** Key in Chapter 5 for information on different noise reduction techniques.)

**The ratio calculation** (a complex divide operation) is performed if the selected measurement is a ratio of two inputs (as in all S-parameter measurements). If the selected measurement is absolute (AUX IN or a service measurement), no operation is performed. The R, A, and B values are also split into channel data at this point. (Refer to **[MEAS]** Key in Chapter 4 for more information on S-parameters; information on service measurements is provided in the *Service Manual*.)

**Sweep-to-sweep averaging** is another noise reduction technique for ratioed measurements. This calculation involves taking the complex exponential average of several consecutive sweeps. (Refer to **AVG** Key in Chapter 5.)

**The raw data arrays** store the results of all the preceding data processing operations. (Up to this point, all processing is performed real-time with the sweep by the IF processor. The remaining operations are not necessarily synchronized with the sweep, and are performed by the main processor.) When full 2-port error correction is on, the raw arrays contain all four S-parameter measurements required for accuracy enhancement. When the channels are uncoupled (coupled channels off), there may be as many as eight raw arrays. These arrays are directly accessible via HP-IB. Note that the numbers here are still complex pairs.

**Vector error correction** (accuracy enhancement) is performed next, if a measurement calibration has been performed and correction is turned on. Error correction effectively removes repeatable systematic errors (stored in the error coefficient arrays) from the raw arrays. This can vary from simple vector normalization to full 12-term error correction. (Refer to Chapter 6, *Measurement Calibration*, for details.)

The error coefficient arrays themselves are created during a measurement calibration using data from the raw arrays. These are subsequently used whenever correction is on, and are accessible via HP-IB. (Refer to Chapter 11, *Saving Instrument States*, for information on memory allocation.)

**The data arrays** store the results or error correction as complex number pairs. These arrays are accessible via HP-IB.

If the data-to-memory operation is performed, the data arrays are copied into the memory arrays. (Refer to **DISPLAY** Key in Chapter 5.)

**The trace math** operation selects either the data array, memory array, or both to continue flowing through the data processing path. In addition, the complex ratio of the two (data/memory) or the difference (data-memory) can also be selected. If memory is displayed, the data from the memory arrays goes through exactly the same data processing flow path as the data from the data arrays. (Refer to **DISPLAY** Key in Chapter 5 for information on memory math functions.)

**Gating** is a digital filtering operation associated with time domain transformation (option 010 only). Its purpose is to mathematically remove unwanted responses isolated in time. In the time domain, this can be viewed as a time-selective bandpass or band-stop filter. (If both data and memory are displayed, gating is applied to the memory trace only if gating was on when data was stored into memory.) (Refer to Chapter 9.)



**The electrical delay** block involves adding or subtracting phase in proportion to frequency. This is equivalent to “line–stretching” or artificially moving the measurement reference plane. (Refer to **ELECTRICAL DELAY** under **SCALE REF** Key in Chapter 5.)

**Conversion** transforms the measured S–parameter data to the equivalent complex impedance (Z) or admittance (Y) values, or to inverse S–parameters (1/S). (Refer to *Conversion Menu* under **[MEAS]** Key in Chapter 5.)

**The transform** operation converts frequency domain information into the time domain when transform is on (option 010 only). The results resemble time domain reflectometry (TDR) or impulse–response measurements. The transform employs the chirp–Z inverse fast Fourier transform (FFT) algorithm to accomplish the conversion. The windowing operation is performed on the frequency domain data just before the transform. Windowing is a digital filtering operation that prepares (enhances) the frequency domain data for transformation to time domain. A special transform mode is available to “demodulate” CW sweep data, with time as the stimulus parameter, and display spectral information with frequency as the stimulus parameter. (Refer to Chapter 9, *Time and Frequency Domain Transforms*.)

**Formatting** converts the complex number pairs into a scalar representation for display, according to the selected format. This includes group delay calculations. These formats are often easier to interpret than the complex number representation. (Polar and Smith chart formats are not affected by the scalar formatting.) Note that after formatting, the complex data can only be retrieved if the trace is in hold, (or it can be read by the controller over the HP–IB). (Refer to **FORMAT** Key in Chapter 5 for information on the different formats available and on group delay principles.)

**Smoothing** is another noise reduction technique, which smoothes noise on the trace. When smoothing is on, each point in a sweep is replaced by the moving average value of several adjacent (formatted) points. The number of points included depends on the smoothing aperture, which can be selected by the user. (In spectrum analysis, the effect is often called video filtering.) If data and memory are displayed, smoothing is performed on the memory trace only if smoothing was on when the data was stored into memory. (Refer to **AVG** Key in Chapter 5 for information about smoothing.)

**The format arrays** store the current results. It is important to note that marker values and marker functions are all derived from the format arrays. Limit testing is also performed on the formatted data. The format arrays are accessible via HP–IB.

**The offset and scale operations** prepare the formatted data for display on the CRT. This is where the reference line position, reference line value, and scale calculations are performed, as appropriate to the format. (Refer to **SCALE REF** Key in Chapter 5.)

**The display memory** stores the display image for presentation on the CRT. The information here includes graticules, annotation, and softkey labels—everything visible on the CRT—in a form similar to plotter commands. If user display graphics are written, these are also stored in display memory. When hardcopy records are made, the information sent to the plotter or printer is taken from display memory. Display memory has limited access—only the user graphics area is available to the user. Further, this is a write–only address block: data cannot be read out of display memory.

Finally, the display memory data is sent to the CRT display. The display is updated frequently, and asynchronously with the data processing operations.



## Chapter 3. Front Panel and Softkey Operation

---

### INTRODUCTION

This chapter explains how to operate the analyzer using front panel controls and softkey menus. It provides illustrations and descriptions of the front panel features, the CRT display and its labels, and the rear panel features and connectors.

### ACTIVE FUNCTION

The functions of the analyzer are activated from the front panel by the operator using front panel keys or softkeys. (In this manual, all front panel keys are shown as **MENU**; softkey labels are shown as **POWER**.) The function currently activated is called the active function, and is displayed in the active entry area at the upper left of the CRT. As long as a function is active it can be modified with the entry block controls (explained later in this chapter). A function remains active until another function is selected or **ENTRY OFF** is pressed.

### FRONT PANEL KEYS AND SOFTKEY MENUS

Front panel keys are used to change instrument functions directly or to provide access to additional functions available in softkey "menus." These menus are displayed lists of related functions or choices for a particular function, with each choice corresponding to one of the eight softkeys located to the right of the CRT. Pressing one of the softkeys either executes the labeled function and makes it the active function, or changes the current status of a function, or presents another set of menu labels. Generally whenever a menu changes, the present active function is cleared, unless it is an active marker function.

In cases where several possible menu choices are available for a function, they are joined by vertical lines. When a selection has been made from the listed alternatives, that selection is underlined until another selection is made.

Some softkey functions can be toggled on or off, and this is indicated in the softkey label. When one of these functions is turned on, this is indicated by the word ON in capitals in the softkey label. For example, when averaging is on the label reads **AVERAGING ON off**, and when it is off the label reads **AVERAGING on OFF**.

Some softkey labels show the current selected status of a function. For example, the selected value of the IF bandwidth is shown in brackets in the **IF BW** softkey label.

## FUNCTION BLOCKS

The front panel keys that provide access to softkey menus are grouped in function blocks.

- The STIMULUS block keys and softkey menus control all the functions of the network analyzer's source.
- The RESPONSE block keys control the receiver section of the network analyzer, providing measurement and display functions specific to the active channel.
- The INSTRUMENT STATE keys control channel-independent system functions including instrument preset, front panel save/recall memory, HP-IB plotter and printer control, time domain transform (option 010), limit testing, and built-in diagnostic tests.

## REMOTE OPERATION

The functions accessible from the front panel can also be accessed remotely by an external computer/controller using HP-IB. Equivalent HP-IB commands are available for most of the front panel keys and softkey menu selections. In this *Reference Manual*, the HP-IB programming command equivalent to each front panel or softkey function is provided in parentheses after the first reference. Additional information about HP-IB programming is provided in Chapter 12.

The following chapters provide information about all instrument functions and softkeys, presented in function block order. The menus available from each front panel key are illustrated in "menu maps" to show the sequence of keys that must be pressed to access each function. Detailed descriptions of each softkey function are provided with illustrations of the individual menus. Additional background information is provided on network analysis topics related to the individual instrument functions. A complete map of the softkey menu structure is provided in *Appendix A* at the end of this *Reference Manual*, together with an alphabetical index.

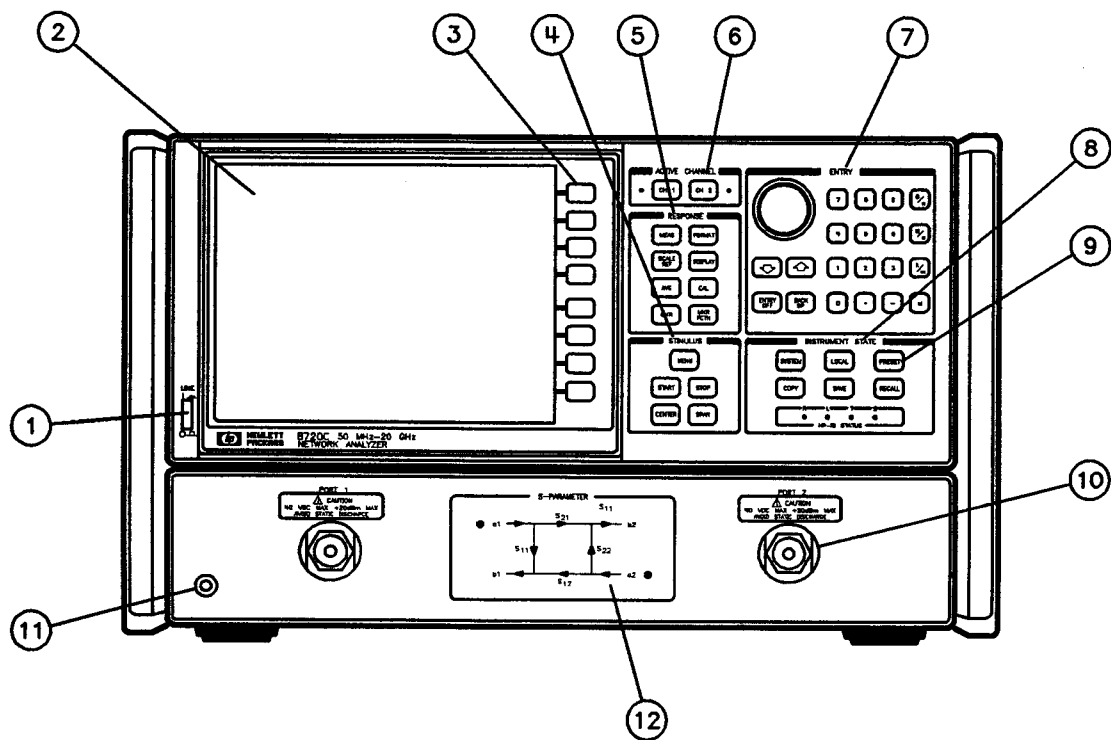


Figure 3-1. Front Panel

Figure 3-1 illustrates the following features and function blocks of the front panel. These features are described in more detail in this and subsequent chapters.

3. **LINE Switch** controls AC power. 1 is on, 0 is off.
4. **CRT Display** shows the of data traces, measurement annotation, softkey labels, and other information. The display is divided into specific information areas (see Figure 3-4).
5. **Softkeys** expand the capabilities of the analyzer with additional functions beyond those of the front panel keys. They provide access to menu selections displayed on the CRT.
6. **STIMULUS Function Block** keys control the signal from the internal source, and other stimulus functions.
7. **RESPONSE Function Block** keys control the measurement and display functions of the active display channel.
8. **ACTIVE CHANNEL Keys** select the active channel. The analyzer has two independent display channels. Any functions that are then entered apply to this active channel.
9. **The ENTRY Block** includes the knob, the step  $\uparrow$   $\downarrow$  keys, and the number pad. These are used for entering numerical data and controlling the markers.
10. **INSTRUMENT STATE Function Block** keys control channel-independent system functions, time domain transform (option 010), and built-in diagnostics. Also included in this block are the HP-IB indicators.

11. The green **USER PRESET** Key can be pressed at any time to return the analyzer to a known condition, previously defined by the user and saved in internal register 5. This user preset first initializes the instrument, then recalls the instrument state and calibration from register 5. (See chapter 11 for details.) It does not initialize the other instruments on the system lows.

A preset to factory default condition is also available using **RECALL FAC PRESET** in the recall menu. This initializes the analyzer and all other instruments on the system bus. A complete listing of the factory preset conditions is provided in Appendix A at the end of this reference.

If a known preset conditions is desired, there is another type of initialization that can be done, Factory Preset. This type of preset initializes all instrument state functions to the default conditions (except for frequency range) and initializes all instruments on the System Bus.

A complete listing of the instrument preset condition is provided in *Appendix A* at the end of this Reference. Most of the conditions can be observed on the CRT or by pressing **COPY** **OP PARAM (MKRS ETC)** on the front panel.

12. **Measurement Ports.** The device under test is connected to one or both of these ports. The network analyzer contains internal signal separation and switching hardware required to make simultaneous transmission and reflection measurements in both the forward and reverse directions.
13. **Chassis Ground Connector** is a convenient place to attach an anti-static wrist strap cord. Work static safe. Many advanced devices, including the analyzer, are susceptible to damage from ESD (electro-static discharge).
14. **S-Parameter Flowgraph** shows the four possible S-parameters and the measurement directions for a two-port device. An explanation of S-parameters is provided in Chapter 5 under **MEAS** Key.

## ACTIVE CHANNEL KEYS (CHAN1, CHAN2)

The analyzer has two digital channels for independent measurement and display of data. Two different sets of data can be measured simultaneously, for example the reflection and transmission characteristics of a device, or one measurement with two different frequency spans. The data can be displayed separately or simultaneously, as described below.

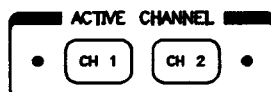


Figure 3-2. The Active Channel Keys

The **CH1** and **CH2** keys illustrated in Figure 3-2 are used to select one channel to be the "active channel". This is the channel currently controlled by the front panel keys, and its trace and data annotations are displayed on the CRT. All channel-specific functions selected apply to the active channel. The current active channel is indicated by an amber LED adjacent to the corresponding channel key.

The analyzer has dual trace capability, so that both the active and inactive channel traces can be displayed, either overlaid or on separate graticules one above the other (split display). When both channel traces are displayed, the annotations of the active channel are brighter. The dual channel and split display features are available in the display menus. Refer to Chapter 5 for illustrations and descriptions of the different display capabilities.

Source values can be coupled or uncoupled between the two channels, independent of the dual channel and split display functions. Refer to *Stimulus Menu* in Chapter 4 for a listing of the source values that are coupled in stimulus-coupled mode.

Another coupling capability is coupled markers. Measurement markers can have the same stimulus values for the two channels, or they can be uncoupled for independent control in each channel. Refer to Chapter 6 for more information about markers.

## ENTRY BLOCK

The ENTRY block, illustrated in Figure 3-3, provides the numeric and units keypad, the knob, and the step keys. These are used in combination with other front panel keys and softkeys to modify the active entry, to enter or change numeric data, and to change the value of the active marker. In general the keypad, knob, and step keys can be used interchangeably.

Before a function can be modified, it must be made the active function by pressing a front panel key or softkey. It can then be modified directly with the knob, the step keys, or the digits keys and a terminator, as described below.

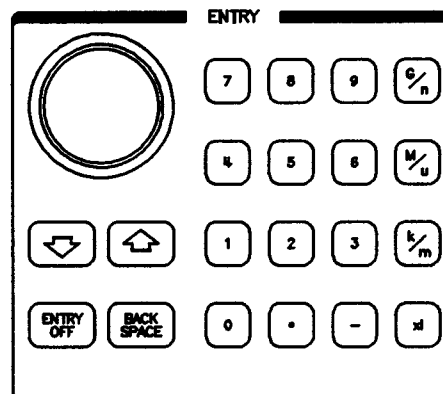


Figure 3-3. The Entry Block

**The Numeric Keypad** is used to select digits, decimal point, and minus sign for numerical entries. A units terminator is required, as described below.

**The Units Terminator Keys** are the four keys in the right-hand column of the keypad. These are used to specify the units for numerical entries from the keypad and at the same time terminate the entries. A numerical entry is incomplete until a terminator is supplied, and this is indicated by the data entry arrow ← pointing at the last entered digit in the active entry area. When the units terminator key is pressed, the arrow is replaced by the units selected. The units are abbreviated on the terminator keys as follows:



**G/n** (HP-IB G, N) = Giga/nano ( $10^9 / 10^{-9}$ )

**M/ $\mu$**  (M, U) = Mega/micro ( $10^6 / 10^{-6}$ )

**k/m** (K, M) = kilo/milli ( $10^3 / 10^{-3}$ )

**x1** (HZ, S, DB, V) = basic units: Hz, seconds, dB, dBm, volts, or degrees (also used to terminate unitless entries such as averaging factor)

The **Knob or RPG** (rotary pulse generator) is used to make continuous adjustments to current values for various functions such as frequency, scale, and others. If there is a marker turned on, and no other function is active, the knob can be used to adjust the marker stimulus values. Values changed by the knob are effective immediately, and require no units terminator.

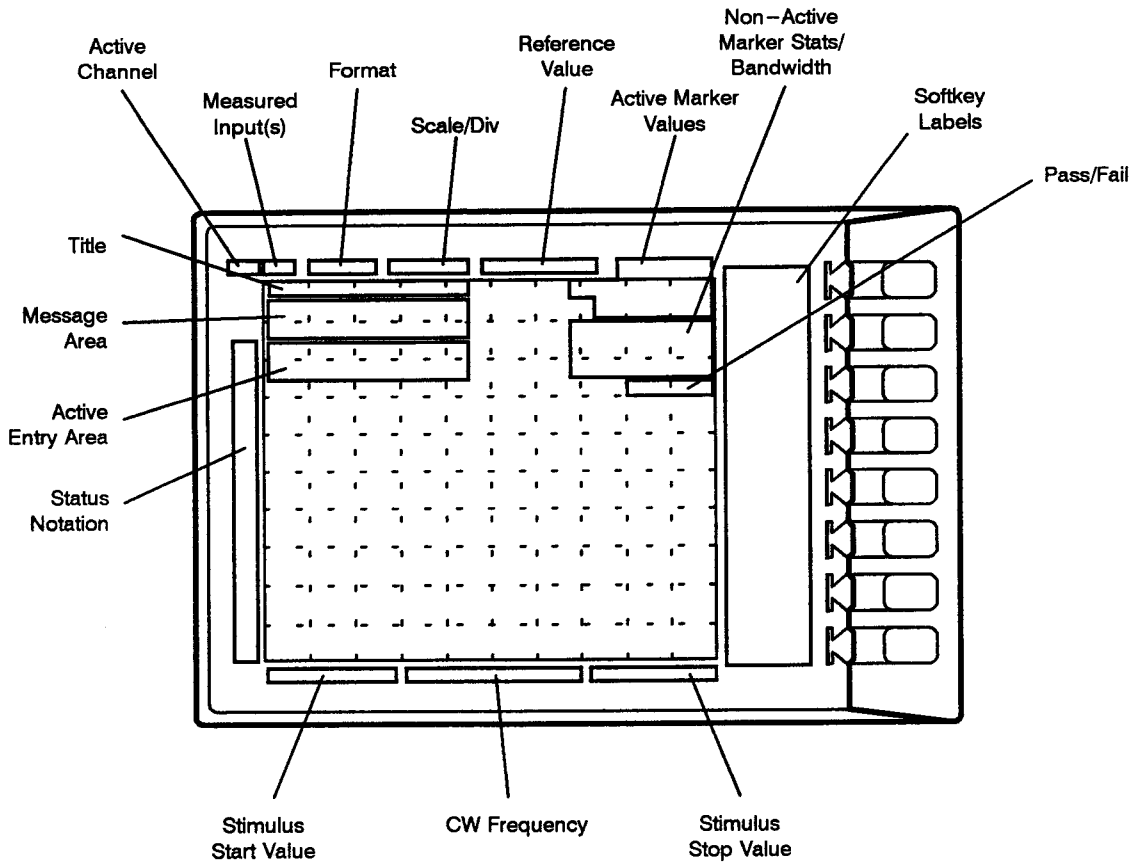
The **Step Keys**  (UP) and  (DOWN) are used to step the current value of the active function up or down. The steps, for most functions, are predefined by the analyzer in increments of 1, 2, and 5, and cannot be altered. No units terminator is required.

**ENTRY OFF** (ENTO) clears and turns off the active entry area, as well as any displayed prompts, error messages, or warnings. Use this function to clear the display before plotting. Another purpose of this key is to prevent changing of active values by accidental movement of the knob. The next selected function turns the active entry area back on.

**BACKSPACE** deletes the last digit entered from the number pad.



## CRT DISPLAY



*Figure 3–4. CRT Display (Single Channel, Cartesian Format)*

The CRT displays the grid on which the measurement data is plotted, the currently selected measurement traces, and other information describing the measurement. Figure 3–4 illustrates the locations of the different CRT information labels, described below.

In addition to the full–screen display shown in Figure 3–4, a split display is available, as described under **DISPLAY** Key, *Display More Menu* in Chapter 5. In this case, information labels are provided for each half of the display.

Display formats for different measurements are illustrated and described in Chapter 5, under **FORMAT** Key.

**Stimulus Start Value** is the start frequency of the source in frequency domain measurements, or the start time in time domain or CW time mode. When the stimulus is in center/span mode, the center stimulus value is shown in this space.

**Stimulus Stop Value** is the stop frequency of the source in frequency domain measurements, or the stop time in time domain or CW time mode. When the stimulus is in center/span mode, the span is shown in this space. The stimulus values can be blanked, as described under **DISPLAY** Key, *Display More Menu*.

**CW Frequency Value.** For CW time measurements, the CW frequency is displayed centered between the start and stop times.

**Status Notations.** This area is used to show the current status of various functions for the active channel. The following notations are used:

- \* = Measurement parameters changed: measured data in doubt until a complete fresh sweep has been taken.
- Cor = Error correction (measurement calibration) is on (see Chapter 6).
- C? = Error correction is on, but the instrument state is not identical to the state when the calibration was performed (see **CAL** Key in Chapter 6).
- C2 = Two-port error correction is on (see Chapter 6).
- C2? = Two-port error correction is on, but the instrument state is not identical to the state when the calibration was performed.
- Hld = Hold sweep (see *Trigger Menu* in Chapter 4).
- ↑ = Fast sweep indicator. Displayed here for sweep times < 1.0 second; moves along the trace for sweep times > 1.0 second.
- Ext = Waiting for an external trigger at the rear panel.
- Avg = Sweep-to-sweep averaging is on. The averaging count is shown immediately below (see **AVG** Key in Chapter 5).
- Smo = Trace smoothing is on (see **AVG** Key in Chapter 5).
- Del = Electrical delay has been added or subtracted (see **SCALE/REF** Key in Chapter 5).
- Gat = Gating is on (time domain option only) (see Chapter 9).
- tsH = Test set hold. Hold mode to protect transfer switch and attenuator against continuous switching. Can be overridden with **NUMBER of GROUPS**.
- PC = Power meter calibration is on.
- PC? = Power meter calibration is being applied with an instrument state not identical to that when the calibration was performed.

**Active Entry Area** displays the active function and its current value.

**Message Area** displays prompts or error messages.

**Title** is a descriptive alpha-numeric string title defined by the user and entered as described under **DISPLAY** Key, *Title Menu*. (In HP-IB, the title block is replaced by HP-IB commands entered from the external controller, if the special debug mode is on. Refer to Chapter 8.)

**Active Channel** is the number of the current active channel, selected with the **ACTIVE CHANNEL** keys. If dual channel is on with an overlaid display, both channel 1 and channel 2 appear in this area.

**Measured Input(s)** shows the S-parameter or other input currently measured, as selected using the **MEAS** key or the service menus. Also indicated in this area is the current display memory status.

**Format** is the display format selected using the **FORMAT** key.

**Scale/Div** is the scale selected using the **SCALE REF** key, in units appropriate to the current measurement.

**Reference Level** is the value of a reference line in Cartesian formats or the outer circle in polar formats, selected using the **SCALE REF** key. The reference position is indicated by a small triangle adjacent to the graticule, at the left for channel 1 and at the right for channel 2.

**Marker Values** are the values of the active marker, in units appropriate to the current measurement. Refer to Chapter 7, *Using Markers*.

**Marker Stats, Bandwidth** are statistical marker values determined using the menus accessed with the **MKR FCTN** key. Refer to Chapter 7.

**Softkey Labels** are menu labels displayed on the CRT that redefine the function of the softkeys immediately to the right of the CRT.

**Pass/Fail** displays the pass or fail status of a device compared to specified limits (see *Limit Lines and Limit Testing* in Chapter 8).

**NOTE:** The information provided here applies to Cartesian formats. In polar and Smith chart formats the labeling may differ.

## REAR PANEL FEATURES AND CONNECTORS

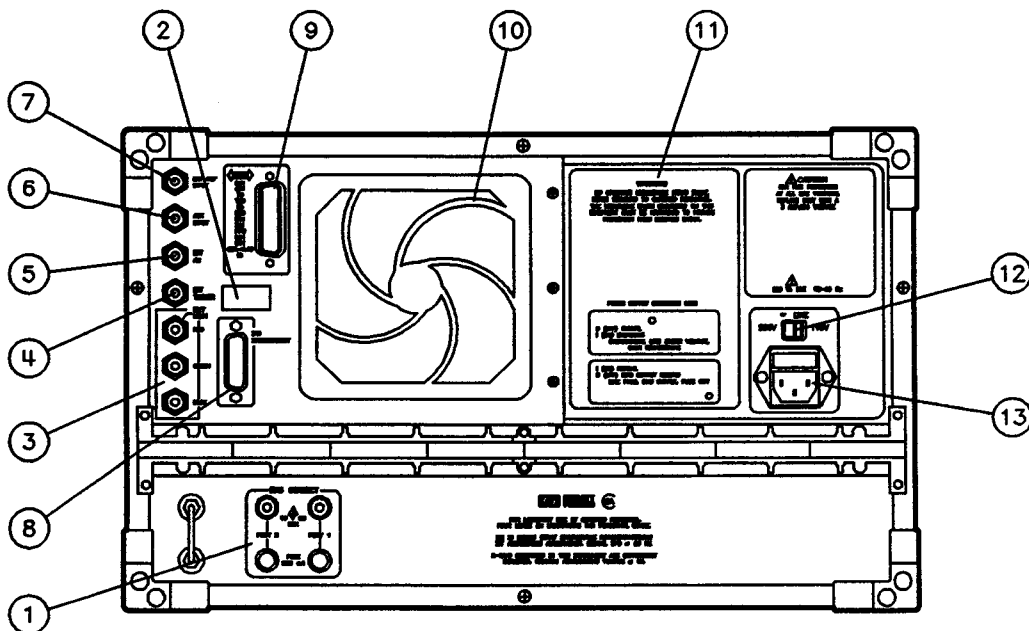


Figure 3-5. Rear Panel

Figure 3–5 illustrates the features and connectors of the rear panel, described below. Requirements for input signals to the rear panel connectors are provided in the *Service Manual, Specifications* section.

1. **BIAS CONNECT.** Two ports are provided to connect an external DC voltage, for biasing active devices through the internal bias tees. Maximum input voltage limits and fuse current values are shown on the rear panel.
2. **Serial Number Plate.** For information about serial numbers, refer to *Description of the Manual Set* in the *General Information* section.
3. **EXT MON Connectors.** The red, green, and blue connectors will drive a suitable external monitor (see table 3 in the *Specifications* section).
4. **EXT TRIGGER Connector.** This is used to connect an external negative–going TTL–compatible signal to trigger a measurement sweep or point. The trigger can be set to external through softkey functions (see Chapter 4, *Trigger Menu*).
5. **EXT AM Connector.** Used to connect an external analog signal to the ALC circuitry of the analyzer to amplitude modulate the source signal.
6. **AUX INPUT Connector.** Used to connect a DC or AC voltage from an external signal source such as a detector or function generator, which can then be displayed and measured using the S–parameter menu (see **MEAS** Key in Chapter 5). (It is also used as an analog output in service routines, as described in the *Service Manual*.)
7. **EXT REF INPUT Connector.** This is used to input a frequency reference signal to phase lock the analyzer to an external frequency standard for increased frequency accuracy. The external frequency reference feature is automatically enabled when a signal is connected to this input. When the signal is removed, the analyzer automatically switches back to its internal frequency reference.
8. **I/O INTERCONNECT.** Provides a standard LS TTL output (active high logic) on pin 17, indicative of pass/fail status during limit testing. The output remains high until a fail condition occurs, then remains low until a pass condition occurs.



**Supply voltages are present on some of the I/O INTERCONNECT pins.  
Use only pin 17.**

9. **HP–IB Connector.** Connects the analyzer to an external controller and other instruments in an automated system. Also used when the analyzer itself is the controller of compatible peripherals. Refer to *HP–IB and Power Considerations* in the *User's Guide* for information and limitations. Information on different controller modes is provided in chapter 7 of this *Reference* under *HP–IB Menu*.
10. **Fan Filter.** This filter helps to protect the instrument from dust contamination, and should be cleaned regularly. Instructions for cleaning the filter, and other routine maintenance, are provided in the *Service Manual*. A minimum clearance of 15 cm (6 inches) should be maintained behind and on both sides of the instrument or rack to allow for air circulation.

11. **Safety Warnings.** Provides warnings to prevent danger to the operator and cautions to prevent damage to the instrument. Also gives replacement fuse values.
12. **Line Voltage Selector Switch.** For more information refer to *HP-IB and Power Considerations* in the *User's Guide*.
13. **Power Cord Receptacle, with Fuse.** For information on replacing the fuse, refer to the *User's Guide*.



## Chapter 4. Stimulus Function Block

---

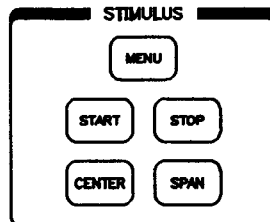


Figure 4-1

### INTRODUCTION

The stimulus function block keys and associated menus are used to define and control the source signal to the device under test. They set source characteristics such as range, sweep time and resolution, sweep type, power level, and the number of data points taken during the sweep.

### START (STAR) and STOP (STOP) KEYS

These keys are used to define the start and stop frequencies of the stimulus (source) or the start and stop times in the time domain (option 010). The source signal can be swept over any portion of the instrument's frequency range. The range can be expressed as either start/stop or center/span (see below). When the **START** or **STOP** key is pressed, its function becomes the active function. The value is displayed in the active entry area and can be changed with the knob, step keys, or number pad. Current stimulus values for the active channel are also displayed along the bottom of the graticule. Frequency values can be blanked for security purposes, using the display menus (see *Display More Menu* in Chapter 5).

The preset stimulus mode is frequency: the stimulus start value is set to 0.050 GHz. For the HP 8720, the stop value is 20.050 GHz. For the HP 8719 (standard or with option 001), the stop value is 13.5100 GHz; the stop value for the HP 8722 is 40.050 GHz. Frequencies are resolved to 100 kHz in the standard instrument, and the frequency span in linear sweep mode is always:

$$100 \text{ kHz} \times (\text{number of points} - 1) \times n \quad \text{where } n = 1, 2, 3, \dots$$

Therefore when **START** is the active function, the stop frequency is automatically set to conform to this span rule. When **STOP** is the active function, the start frequency is appropriately adjusted (except in instruments with option 001).

For information on setting source values in the time domain, refer to Chapter 9.

Because the display channels are independent, the stimulus signals for the two channels can be uncoupled and their values set independently. The values are then displayed separately on the CRT if the instrument is in dual channel display mode. In the uncoupled mode with dual channel display the instrument takes alternate sweeps to measure the two sets of data. Channel stimulus coupling is explained in this chapter, and dual channel display capabilities are explained in Chapter 5 under **DISPLAY** Key, *Display Menu*.

## CENTER (CENT) and SPAN (SPAN) KEYS

These keys define the frequency or time range in terms of a center value and a span. When **SPAN** is the active function, the center frequency is adjusted to conform to the span rule (see page 4–1). When **CENTER** is the active function, the span is adjusted appropriately (except in instruments with option 001).

When **SPAN** is the active function, it can be modified with the numeric keypad, the step **▲** **▼** keys, or the knob. Note, however, that while the step keys change the span values in increments of 1, 2, and 5, the knob adds in increments of the span multiple as in **START** / **STOP** entry (see above).

The minimum span for a standard instrument in a measurement with 201 points is 20 MHz. Refer to **NUMBER of POINTS** under *Stimulus Menu* for a table of minimum frequency spans using different numbers of measurement points. In the option 001 instrument, the frequency span can be defined with 1 Hz resolution.

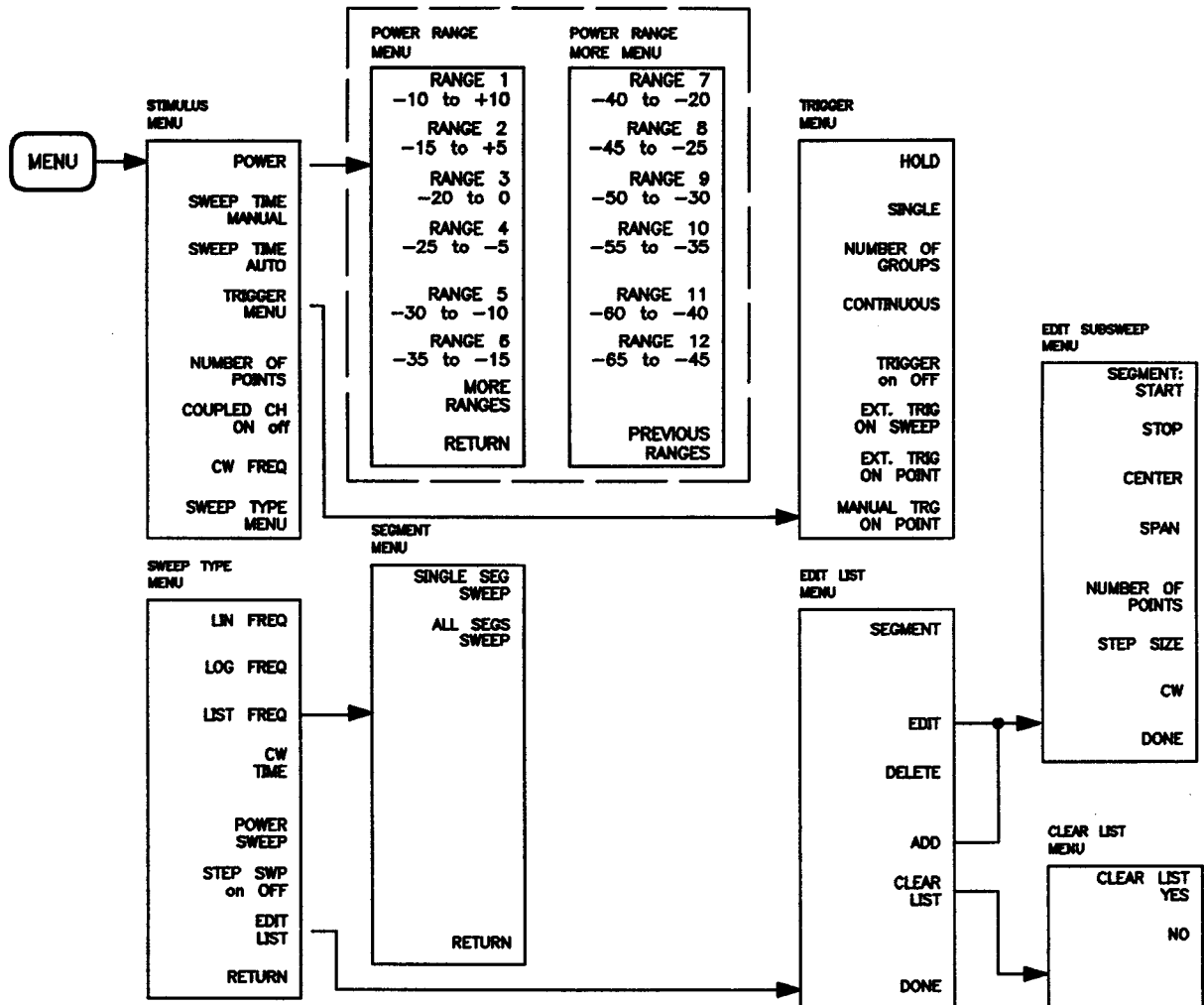
A span of 0 can be specified, which is equivalent to a CW frequency.

## MENU KEY

The **MENU** (MENUSTIM) key provides access to the series of menus illustrated in Figure 4–2, which are used to define and control all stimulus functions other than start, stop, center, and span. When the **MENU** key is pressed, the stimulus menu is displayed. This in turn provides access to the other illustrated softkey menus. The functions available in these menus are described in the following pages.



HP 8719C AND 8720C STANDARD SEE BELOW FOR OTHER POWER RANGES



HP 8719C and HP 8720C  
OPTION 006 ONLY

HP 8722A ONLY

HP 8722C ONLY

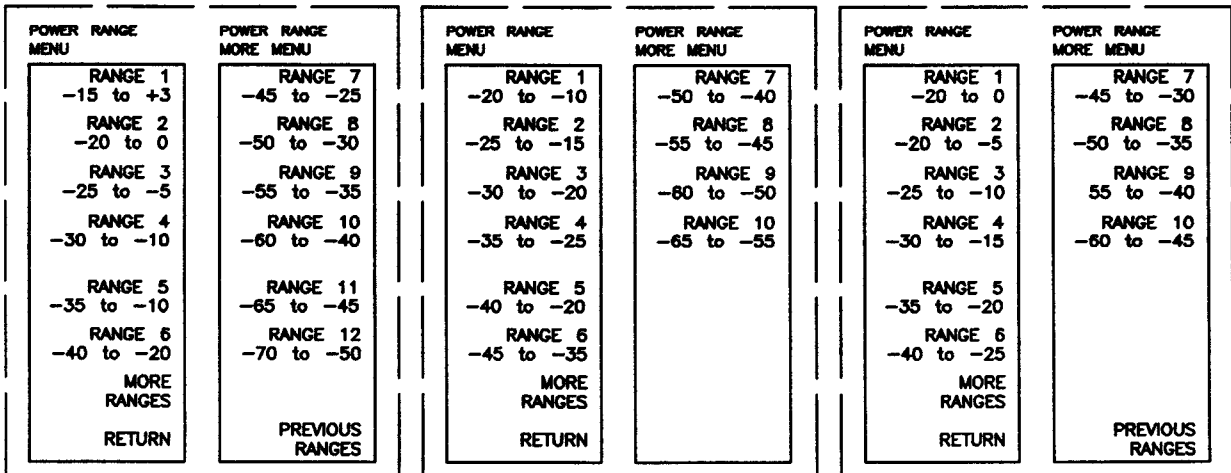


Figure 4-2. Softkey Menus Accessed from the [MENU] Key

## Stimulus Menu

The stimulus menu is used to specify the power level, sweep time, number of measurement points per sweep, and the frequency value for a CW (continuous wave) sweep. It includes the capability to couple or uncouple the stimulus functions of the two display channels. In addition, it leads to other softkey menus that define trigger and sweep type. The individual softkey functions of the stimulus menu are described below.

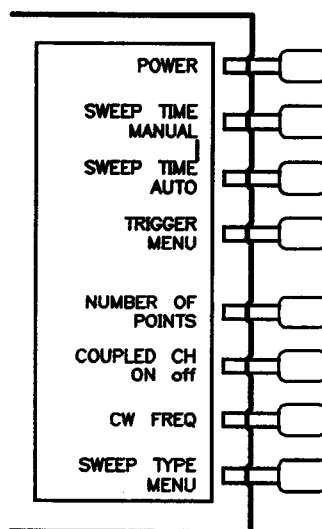


Figure 4–3. Stimulus Menu

**POWER** (POWE) makes test port power level the active function, brings up the power range menu, and sets the output power level of the source from  $-10$  to  $-65$  dBm at the measurement port, by switching the internal programmable attenuator in 5 dB steps, depending on the range selected.

For the HP 8722 option 003 instruments, power is set from  $-30$  to  $-85$  dBm at port 2.

If an input power overload is detected at one of the test ports, the analyzer displays the message "TEST PORT OVERLOAD, REDUCE POWER LEVEL." When this occurs, reset the power at a lower level. Overload occurs with about  $+22$  dBm into either port 1 or port 2 of the standard instrument. Option 003 analyzers overload with about  $+7$  dBm into port 2.

When the channels are uncoupled and a different power level is set for each channel, test set hold mode is implemented. In this mode, the attenuator (and transfer switch) are protected against continuous switching, and the status notation "tsH" appears at the left of the screen. This can be overridden with **NUMBER of GROUPS** (see *Trigger Menu*).

**SWEEP TIME [MANUAL]** (SWET) is used to set the sweep time. This refers only to the time that the instrument is sweeping and taking data, and does not include the time required for internal processing of the data. A sweep speed indicator  $\blacktriangleleft$  is displayed on the trace for sweep times slower than 1.0 second (usually). For sweep times typically faster than 1.0 second the  $\blacktriangleleft$  indicator is displayed in the status notations area at the left of the CRT.

The sweep time increases automatically if the number of points is increased or the IF bandwidth is decreased. (However, the reverse is not the case.) Sweep-to-sweep averaging also increases sweep time in dual channel display mode. Post-processing activities such as smoothing, limit lines, error correction, trace math, marker statistics, and time domain will increase the sweep repetition rate.

**SWEEP TIME AUTO (SWEA)** automatically adjusts to the minimum sweep time available for the set frequency span, IF bandwidth, and number of points.

Sweep time also varies according to the sweep type selected, as explained in *Sweep Type Menu*.

**TRIGGER MENU** goes to the trigger menu, which is used to select the type and number of the sweep trigger.

**NUMBER of POINTS (POIN)** is used to select the number of data points per sweep to be measured and displayed. Using fewer points allows a faster sweep time but the displayed trace shows less horizontal detail. Using more points gives improved trace resolution, but slows the sweep and requires more memory for error correction or saving instrument states.

The possible values that can be entered for number of points are 3, 11, 21, 51, 101, 201, 401, 801, and 1601. The number of points can be different for the two channels if the stimulus values are uncoupled.

In the standard instrument, the smallest increment between points is 100 kHz, therefore increasing the number of points may increase the measurement span. However, if the number of points is then decreased, the span will not change. The frequency span in linear sweep mode is always:

$$100 \text{ kHz} \times (\text{number of points} - 1) \times n \quad \text{where } n = 1, 2, 3, \dots$$

This table shows the minimum frequency span for different numbers of points in a standard instrument (the option 001 has 1 Hz resolution and therefore allows closer spacing of points).

	Number of points								
	3	11	21	51	101	201	401	801	1601
<b>Minimum Span (Mhz)</b>	0.2	1	2	5	10	20	40	80	160

In list frequency sweep, the number of points displayed is the total number of frequency points for the defined list (see *Sweep Type Menu*).

**COUPLED CH ON off (COUCON, COUCOFF)** toggles the channel coupling of stimulus values. With **COUPLED CH ON** (the factory preset condition), both channels have the same stimulus values (the inactive channel defaults to the stimulus values of the active channel).

In the stimulus coupled mode, the following parameters are coupled:

- Frequency                      Number of points
- Source power                  Number of groups
- Sweep time                      IF bandwidth

Trigger type	Time domain transform
Sweep type	Gating

When the channels are uncoupled and a different power level is set for each channel, test set hold mode is implemented. In this mode, the attenuator (and transfer switch) are protected against continuous switching, and the status notation "tsH" appears at the left of the screen. This can be overridden with **NUMBER of GROUPS** (see *Trigger Menu*).

Coupling of stimulus values for the two channels is independent of **DUAL CHAN on OFF** in the display menu and **MARKERS: UNCOUPLED** in the marker mode menu. **COUPLED CH OFF** becomes an alternate sweep function when dual channel display is on: in this mode the analyzer alternates between the two sets of stimulus values for measurement of data, and both are displayed.

**CWFREQ** (CWFREQ) is used to set a CW (continuous wave) frequency for CW time measurements. The set frequency defaults to the nearest multiple of 100 kHz in a standard instrument (1 Hz in option 001).

**SWEEP TYPE MENU** presents the sweep type menu, where one of the available types of stimulus sweep can be selected.

## Trigger Menu

This menu is used to select the type and number of the sweep trigger.

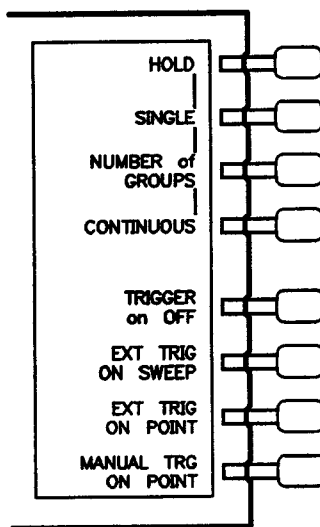


Figure 4-4. Trigger Menu

**HOLD** (HOLD) freezes the data trace on the display, and the analyzer stops sweeping and taking data. The notation "Hld" is displayed at the left of the graticule. If the \* indicator is on at the left side of the CRT, trigger a new sweep with **SINGLE**.

**SINGLE** (SING) takes one sweep of data and returns to the hold mode.

**NUMBER of GROUPS** (NUMG) triggers a user-specified number of sweeps, and returns to the hold mode. This function can be used to override the test set hold mode (indicated by the notation "tsH" at the left of the screen). In this mode, the electro-mechanical transfer switch and attenuator are **NOT** protected against unwanted continuous switching. This occurs in a full two-port calibration, or in a measurement of two different parameters, or when the channels are uncoupled and a different power level is set for each channel.

If averaging is on, the number of groups should be at least equal to the averaging factor selected, to allow measurement of a fully averaged trace. Entering a number of groups resets the averaging counter to 1.

**CONTINUOUS** (CONT) is the standard sweep mode. The sweep is triggered automatically and continuously and the trace is updated with each sweep.

**TRIGGER TRIG OFF** (EXTTOFF) turns off external trigger mode.

**EXT TRIG ON SWEEP** (EXTTON) is used when the sweep is triggered on an externally generated signal connected to the rear panel EXT TRIGGER input. The sweep is started with a high-to-low transition of a TTL signal. If this key is pressed when no external trigger signal is connected, the notation "Ext" is displayed at the left side of the CRT to indicate that the analyzer is waiting for a trigger. When a trigger signal is connected, the "Ext" notation is replaced by the sweep speed indicator  $\uparrow$  either in the status notations area or on the trace. External trigger mode is allowed in every sweep mode.

**EXT TRIG ON POINT** (EXTTPOIN) is similar to the trigger on sweep, but triggers on each data point in a sweep.

**MANUAL TRG ON POINT** (MANTRIG) waits for a manual trigger for each point. Subsequent pressing of this softkey triggers each measurement. The annotation "man" appears at the left side of the CRT when the instrument is waiting for the trigger to occur. This feature is useful in a test sequence when an external device or instrument requires changes at each point.

## Sweep Type Menu

Four basic sweep types are available: linear, logarithmic, and list frequency sweeps, and CW time sweep. In each sweep type, the instrument is fully synthesized. In the linear frequency sweep mode, in option 010 instruments, data can be transformed to the time domain using the inverse Fourier transform technique. In the CW time sweep mode, data can be transformed for frequency domain measurements. Refer to Chapter 9 for detailed information about time domain transform with option 010.

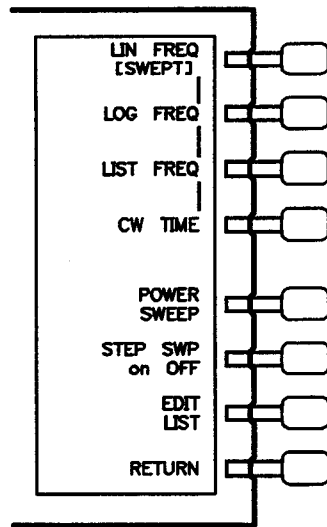


Figure 4–5. Sweep Type Menu

**LIN FREQ** (LINFREQ) activates a linear frequency sweep displayed on a standard graticule with ten equal horizontal divisions. This is the default preset sweep type.

For a linear sweep, sweep time is combined with the channel's frequency span to compute a source sweep rate:

$$\text{sweep rate} = (\text{frequency span}) / (\text{sweep time})$$

Since the sweep time may be affected by various factors (see *Stimulus Menu*), the equation provided here is merely an indication of the ideal (minimum) sweep rate. Narrower IF bandwidths require taking more data points, therefore sweep time increases as the IF bandwidth decreases. If the sweep time is greater than 15 ms times the number of points, the sweep changes from a synthesized ramp sweep to a stepped CW sweep.

**LOG FREQ** (LOGFREQ) activates a logarithmic frequency sweep mode. The source is stepped in logarithmic increments and the data is displayed on a logarithmic graticule. This is slower than a continuous sweep with the same number of points, and the entered sweep time may therefore be changed automatically. For frequency spans of less than two octaves, the sweep type automatically reverts to linear sweep.

**LIST FREQ** (LISTFREQ) provides a user–definable arbitrary frequency list mode. Up to 30 frequency subsweeps (or segments) of several different types can be specified, for a maximum total of 1601 points. One list is common to both channels, and different segments cannot be displayed simultaneously on both channels. Once a frequency list has been defined and a measurement calibration performed on the full frequency list, one or all of the frequency segments can be measured and displayed without loss of calibration. Another powerful calibration aid is *frequency subset*, explained in chapter 5 (see **FRQ SUBSET on OFF**).

When **LIST FREQ** is pressed, the segment menu is presented, for selecting segments of the frequency list. Refer to *Edit List Menu* and *Edit Subsweep Menu* later in this chapter to see how to enter or modify the list frequencies. If no list has been entered, the message “LIST TABLE EMPTY” is displayed.

**CW TIME** (CWTIME) turns on a sweep mode similar to an oscilloscope. The analyzer is set to a single frequency, and the data is displayed versus time. The frequency of the CW time sweep is set with **CW FREQ** in the stimulus menu. In this sweep mode, the data is continuously sampled at precise, uniform time intervals determined by the sweep time and the number of points minus 1. The entered sweep time may be automatically changed if it is less than the minimum required for the current instrument configuration.

In time domain using option 010, the CW time mode data is translated to frequency domain, and the x–axis becomes frequency. This can be used like a spectrum analyzer to measure signal purity, or for low frequency analysis of amplitude or pulse modulation signals. For details, refer to Chapter 9, *Time and Frequency Domain Transforms*.

**POWER SWEEP** (POWS) turns on a power sweep mode that is used to characterize power–sensitive circuits. In this mode, power is swept at a single frequency, from a start power value to a stop power value, selected using the **START** and **STOP** keys and the entry block. This feature is convenient for such measurements as gain compression or AGC (automatic gain control) slope. To set the frequency of the power sweep, use **CW FREQ** in the stimulus menu. Refer to the *User's Guide* for an example of a gain compression measurement.

In power sweep, the entered sweep time may be automatically changed if it is less than the minimum required for the current configuration (number of points, IF bandwidth, averaging, etc.).

Within a power range, both the reference and the test channels see the same power change. Therefore, any calibration is valid, and stays on. However, a change from one power range to another is only seen by the test channel, invalidating and turning off any calibration.

**STEP SWP ON OFF** (STEP SWP on OFF) turns on or off the step sweep mode. In step sweep mode, the frequency is fixed while acquiring data, then ramps to the next data point.

**EDIT LIST** presents the edit list menu. This is used in conjunction with the edit subsweep menu to define or modify the frequency sweep list.

**RETURN** goes back to the stimulus menu.



## Segment Menu

When this menu is presented, the frequency list table is displayed in the center of the CRT. A segment can then be selected to be measured, and the choice of a full-trace measurement or a single-segment measurement can be made. Note that the frequency list table is not drawn on a plot.

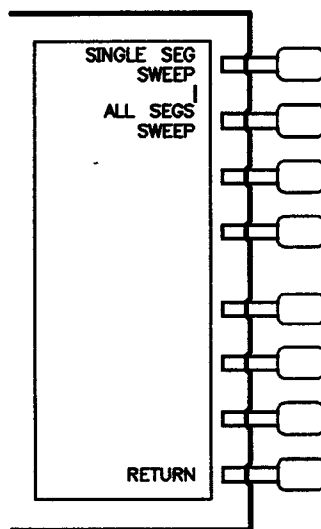


Figure 4-6. Segment Menu

**SINGLE SEG SWEEP** (SSEG) enables a measurement of a single segment of the frequency list, without loss of calibration. The segment to be measured is selected using the entry block, after **SINGLE SEG SWEEP** is pressed.

In single segment mode, beginning a measurement calibration will force the full list sweep before prompting for calibration standards. The calibration will then be valid for any single segment.

If an instrument state is saved in memory with a single-segment sweep, a recall will re-display that segment while also recalling the entire list.

**ALL SEGS SWEEP** (ASEG) retrieves the full frequency list sweep.

**RETURN** goes back to the sweep type menu.

## Edit List Menu

This menu is used to edit the list of frequency segments (subsweeps) defined with the edit subsweep menu, described next. The segments do not have to be entered in any particular order: the analyzer automatically sorts them and lists them on the CRT in increasing order of start frequency. This menu determines which entry on the list is to be modified, while the edit subsweep menu is used to make changes in the frequency or number of points of the selected entry.

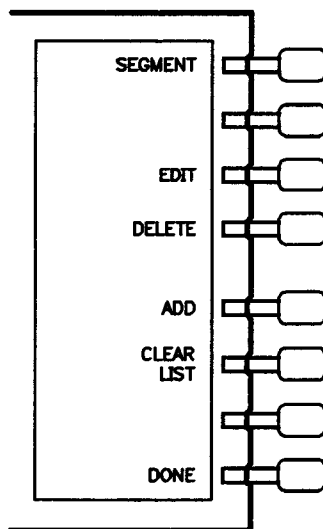


Figure 4-7. Edit List Menu

**SEGMENT** is used to select which segment on the list is to be modified. Enter the number of a segment in the list, or use the step keys to scroll the pointer > at the left to the required segment number. The indicated segment can then be edited or deleted.

**EDIT** goes to the edit subsweep menu, where the selected segment (indicated by the pointer > at the left) can be modified.

**DELETE** deletes the segment indicated by the pointer >.

**CLEAR LIST** (CLEL) clears the entire list.

**ADD** is used to add a new segment to the frequency list. If the list is empty, a default segment is added, and the edit subsweep menu is displayed so it can be modified. If the list is not empty, the segment indicated by the pointer > is copied and the edit subsweep menu is displayed.

**DONE** sorts the segments into CW points in order of ascending frequency and returns to the sweep type menu. (Note that this may change the segment numbers.) If list frequency mode is on, the network analyzer then measures each point and displays a single trace that is a composite of all data taken. If duplicate frequencies exist, the analyzer makes multiple measurements on identical points to maintain the specified number of points for each subsweep. Since the frequency points may not be distributed evenly across the CRT, the display resolution may be uneven, and more compressed in some parts of the trace than in others. However, the stimulus and response readings of the markers are always accurate. Because the list frequency sweep is a stepped CW sweep, the sweep time is slower than for a continuous sweep with the same number of points.

A tabular printout of the frequency list data can be obtained using the **LIST VALUES** function in the copy menu.

### Edit Subsweep Menu

This menu lets you select measurement frequencies arbitrarily. Using this menu it is possible to define the exact frequencies to be measured on a point-by-point basis. For example the sweep could include 100 points in a narrow passband, 100 points across a broad stop band, and 50 points across another frequency range. The total sweep is defined with a list of subsweeps. Up to 30 subsweeps can be defined, with a total of up to 1601 data points.

The only limitation is that measurement points cannot be closer than 100 kHz in the standard instrument. Therefore, the span of each segment must be selected such that:

$$\text{segment span} = 100 \text{ kHz} \times (\text{number of points} - 1) \times n \quad \text{where } n = 1, 2, 3, \dots$$

For example, for a 5 MHz segment, do not use more than 51 points, otherwise the segment span will be readjusted to meet the segment span criteria.

The option 001 instrument with 1 Hz frequency resolution does not have this limitation.

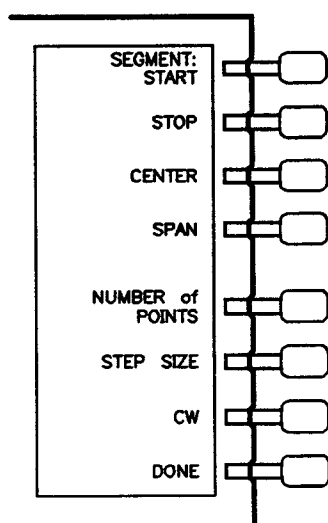


Figure 4-8. Edit Subsweep Menu

The frequency subsweeps, or segments, can be defined in any of the following terms:

- start / stop / number of points
- start / stop / step
- center / span / number of points
- center / span / step
- CW frequency

The subsweeps can overlap, and do not have to be entered in any particular order. The analyzer sorts the segments automatically and lists them on the CRT in order of increasing start frequency, even if they are entered in center/span format. **(Note that this may change the segment numbers.)** If duplicate frequencies exist, the analyzer makes multiple measurements on identical points to maintain the specified number of points for each subsweep. The data is displayed on the CRT as a single trace that is a composite of all data taken, when **ALL SEGS SWEEP** is selected. The trace may appear uneven because of the distribution of the data points, but the frequency scale is linear across the total range.

The list frequency sweep mode is selected with the **LIST FREQ** softkey in the sweep type menu.

**SEGMENT START** sets the start frequency of a subsweep.

**STOP** sets the stop frequency of a subsweep.

**CENTER** sets the center frequency of a subsweep.

**SPAN** sets the frequency span of a subsweep about a specified center frequency.

**NUMBER of POINTS** sets the number of points for the subsweep. The total number of points for all the subsweeps cannot exceed 1601. In a standard instrument, where the measurement points are separated by increments of 100 kHz, take care not to set a high number of points for a narrow subsweep frequency span.

**STEP SIZE** is used to specify the subsweep in frequency steps instead of number of points. Changing the start frequency, stop frequency, span, or number of points may change the step size. Changing the step size may change the number of points and stop frequency in start/stop/step mode; or the frequency span in center/span/step mode. In each case, the frequency span becomes a multiple of the step size. The step size cannot be less than 100 kHz in a standard instrument.

**CW** is used to set a subsweep consisting of a single CW frequency point.

**DONE** returns to the edit list menu.

*add note  
← space here*

## Chapter 5. Response Function Block

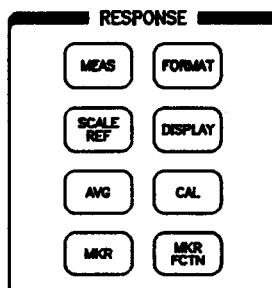


Figure 5-1

### INTRODUCTION

The keys in the RESPONSE block are used to control the measurement and display functions of the active channel. They provide access to many different softkey menus that offer selections for the parameters to be measured, the display mode and format of the data, the control of the display markers, and a variety of calibration functions.

The current values for the major response functions of the active channel are displayed in specific locations along the top of the CRT. In addition, certain functions accessed through the keys in this block are annotated in the status notations area at the left-hand side of the CRT. An illustration of the CRT showing the locations of these information labels is provided in Chapter 3, together with an explanation.

The RESPONSE block keys and their associated menus are described briefly below, and in more detail in this chapter and Chapters 5 (calibration) and 6 (markers). Measurement sequences using these menus are described in the *User's Guide*.

The **MEAS** (MENUMEAS) key leads to the menu used to select the measurement parameters.

The **FORMAT** (MENUFORM) key leads to a menu used to select the display format for the data. Various rectangular and polar formats are available for display of magnitude, phase, impedance, group delay, real data, and SWR.

The **SCALE REF** (MENUSCAL) key displays a menu used to modify the vertical axis scale and the reference line value, as well as to add electrical delay.

The **DISPLAY** (MENDISP) key provides access to a series of menus of instrument and active channel display functions. The first menu defines the displayed active channel trace in terms of the mathematical relationship between data and trace memory. Other functions include dual channel display (overlay or split), display focus and intensity, active channel display title, and frequency blanking.

The **AVG** (MENUAVG) key is used to access three different noise reduction techniques: sweep-to-sweep averaging, trace smoothing, and variable IF bandwidth.

The **CAL** (MENCAL) key leads to a series of menus to perform measurement calibrations for vector error correction (accuracy enhancement), and for specifying the calibration standards used. Calibration procedures are used to improve measurement accuracy by effectively removing systematic errors prior to making measurements. Several different levels of calibration are available for use in a variety of different measurement applications. Each calibration procedure features CRT prompts to guide you through the calibration sequence.

An explanation of vector error correction techniques to enhance measurement accuracy is included with the description of the calibration menus and procedures. Refer to Chapter 6, *Measurement Calibration*, and to *Accuracy Enhancement Fundamentals—Characterizing Microwave Systematic Errors* in the Appendix.

The **MKR** (MENUMARK) key displays an active marker ( $\nabla$ ) on the screen and provides access to a series of menus to control from one to four display markers for each channel. Markers provide numerical readout of measured values at any point on the trace.

The menus accessed from the **MKR** key provide several basic marker operations. These include special marker modes for different display formats, and a marker delta mode that displays marker values relative to a specified value or another marker.

The **MKR FCTN** (MENUMRKF) key provides access to additional marker functions. These use the markers to search the trace for specified information, to analyze the trace statistically, or to quickly change the stimulus parameters.

Menus accessed from the **MKR** and **MKR FCTN** keys are explained in Chapter 7, *Using Markers*.

## MEAS KEY

The **MEAS** (MENUMEAS) key leads to a menu that provides a selection of transmission and reflection measurements, each corresponding to a specific S-parameter. When these measurements are performed, all of the DUT's ports must be properly terminated.

When a 2-port correction is on, pressing this key will cause the instrument to cycle the transfer switch, updating all four S-parameters to give maximum accuracy before reverting to the fast two-port mode.

A third menu converts S-parameters to impedance (Z), admittance (Y), or inverse S-parameters through internal math capabilities.

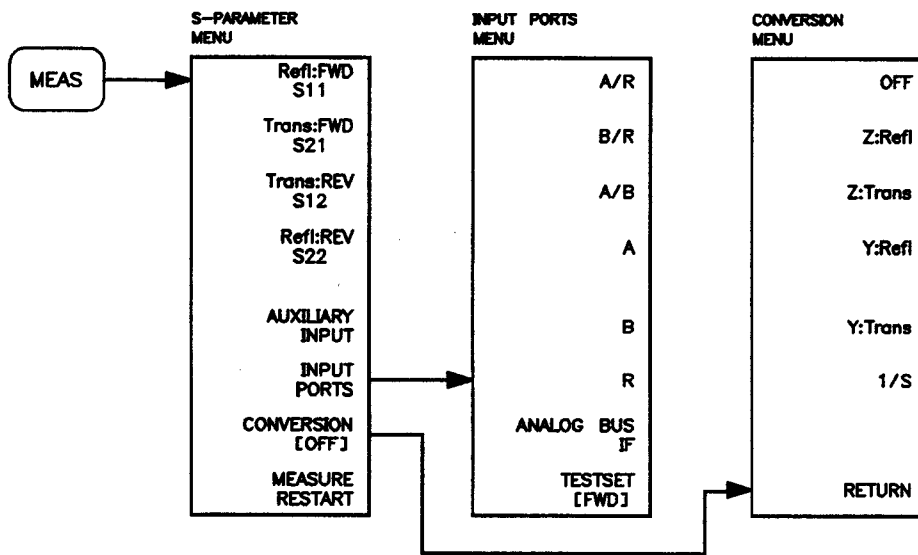


Figure 5-2. Softkey Menus Accessed from the **MEAS** Key

## S-Parameters

S-parameters (scattering parameters) are a convention used to characterize the way a device modifies signal flow. A brief explanation is provided here of the S-parameters of a two-port device. For additional details refer to Hewlett-Packard Application Notes AN 95-1 and AN 154.

S-parameters are ratios of two complex (magnitude and phase) quantities. S-parameter notation identifies these quantities using the numbering convention:

S out in

where the first number (out) refers to the port where the signal is emerging from the DUT, and the second number (in) is the port where the signal is incident. For example, the S-parameter  $S_{21}$  identifies the measurement as the complex ratio of the signal emerging at port 2 to the signal incident at port 1.

Figure 5-3 is a representation of the S-parameters of a two-port device, together with an equivalent flowgraph indicating signal flow. In the illustration, "a" represents the signal entering the device and "b" represents the signal emerging.

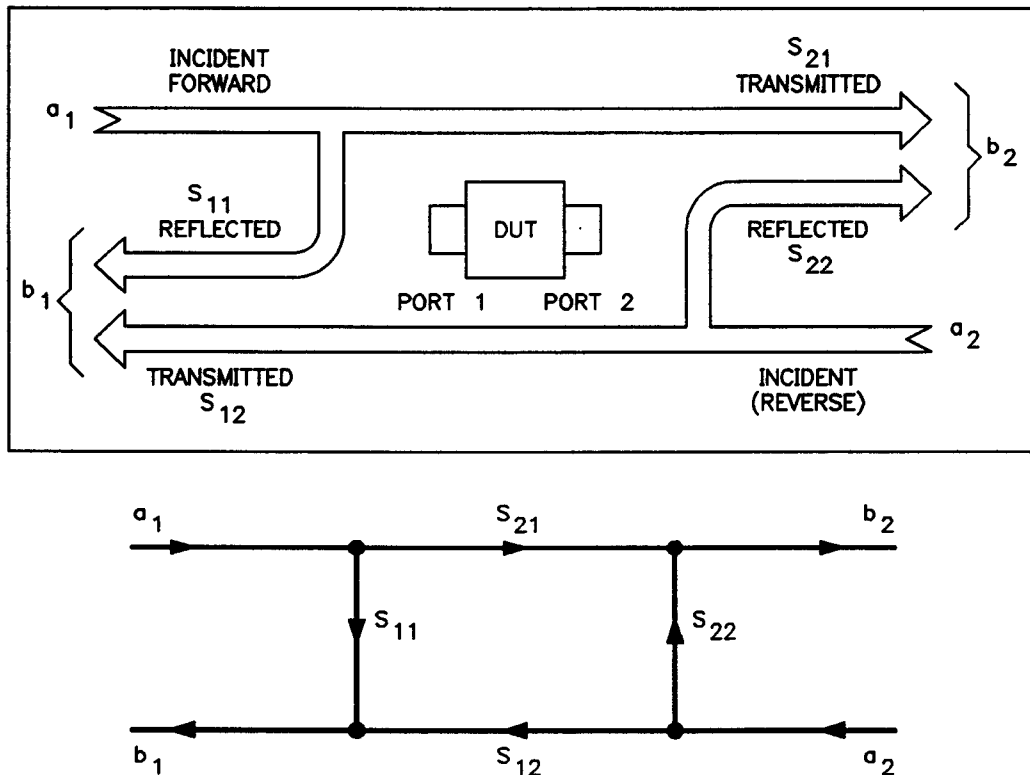


Figure 5-3. S-Parameters of a Two-Port Device

The table on the next page shows the reflection and transmission measurement options and their associated S-parameters. The test direction column in the table indicates which measurement port provides the signal output. For forward (FWD) measurements, the source signal is provided at port 1, and for reverse (REV) measurements, at port 2. The signal path column indicates the ratio measurement made. A, B, and R are the internal receiver/detector inputs.



Measurement	S-Parameter	Test Direction	Signal Path
Input reflection (port 1)	S11	FWD	A/R
Forward gain/loss (transmission)	S21	FWD	B/R
Reverse gain/loss (transmission)	S12	REV	A/R
Output reflection (port 2)	S22	REV	B/R

## S-Parameter Menu

The S-parameter menu is presented when the **MEAS** key is pressed. This menu provides a selection of transmission and reflection measurements, with each choice corresponding to a specific S-parameter. The analyzer automatically switches the direction of the measurement according to the selections made in this menu. All four S-parameters can be measured with a single connection. The S-parameter being measured is labeled at the top left corner of the CRT.

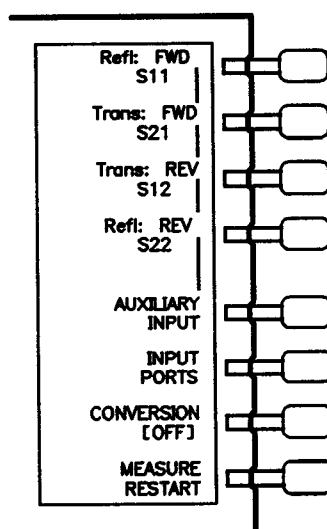


Figure 5-4. S-Parameter Menu

**Ref: FWD S11** (S11) configures the instrument for a measurement of S11, the complex reflection coefficient (magnitude and phase) of the test device input.

**Trans: FWD S21** (S21) configures the instrument for a measurement of S21, the complex forward transmission coefficient (magnitude and phase) of the device under test.

**Trans: REV S12** (S12) configures the instrument for a measurement of S12, the complex reverse transmission coefficient (magnitude and phase) of the device under test.

**Ref: REV S22** (S22) defines the measurement as S22, the complex reflection coefficient (magnitude and phase) of the output of the device under test.

**INPUT PORTS** brings up the Input Ports menu, which is used to define a ratio or single input measurement.

**AUXILIARY INPUT** (ANAI) displays a DC or low frequency AC auxiliary voltage on the vertical axis, using the real format. An external signal source such as a detector or function generator can be connected to the rear panel AUXILIARY INPUT connector. (For service purposes, one of numerous internal voltage nodes on the analog bus can be selected for measurement and display. Applications of this function are described in the *Service Manual*.)

**CONVERSION** brings up the conversion menu which converts the measured data to impedance (Z) or admittance (Y). When a conversion parameter has been defined, it is shown in brackets under the softkey label. If no conversion has been defined, the softkey label reads **CONVERSION [OFF]**.

**MEASURE RESTART** (REST) aborts the sweep in progress, then restarts the measurement. This can be used to update a measurement following an adjustment of the device under test. When a full two-port calibration is in effect, the **MEASURE RESTART** key will initiate another update of both forward and reverse S-parameter data.

If the instrument is taking a number of groups (see *Trigger Menu* in Chapter 4), the sweep counter is reset at 1. If averaging is on, **MEASURE RESTART** resets the sweep-to-sweep averaging and is effectively the same as **AVERAGING RESTART**. If the sweep trigger is in **HOLD** mode, **MEASURE RESTART** executes a single sweep.

## Conversion Menu

This menu converts the measured reflection or transmission data to the equivalent complex impedance (Z) or admittance (Y) values. This is not the same as a two-port Y or Z parameter conversion, as only the measured parameter is used in the equations. Two simple one-port conversions are available, depending on the measurement configuration.

For measurements in an environment that is not 50 ohms, a minimum loss pad or matching transformer should be inserted between the device and the measurement port. In addition, the network analyzer characteristic impedance must be modified using the **SET Z0** softkey in the calibrate more menu.

An S11 or S22 trace measured as reflection can be converted to equivalent parallel impedance or admittance using the model and equations shown in Figure 5-5.

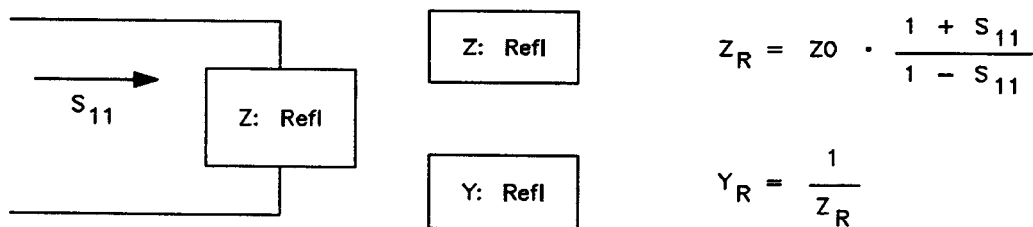


Figure 5-5. Reflection Impedance and Admittance Conversions

In a transmission measurement, the data can be converted to its equivalent series impedance or admittance using the model and equations shown in Figure 5–6.

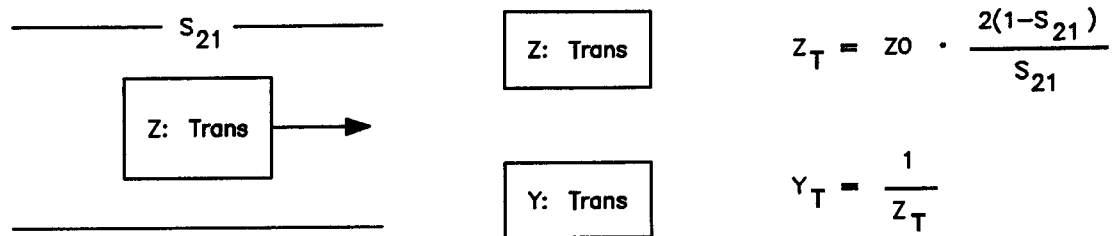


Figure 5–6. Transmission Impedance and Admittance Conversions

Avoid the use of Smith chart, SWR, and delay formats for display of Z and Y conversions, as these formats are not easily interpreted.

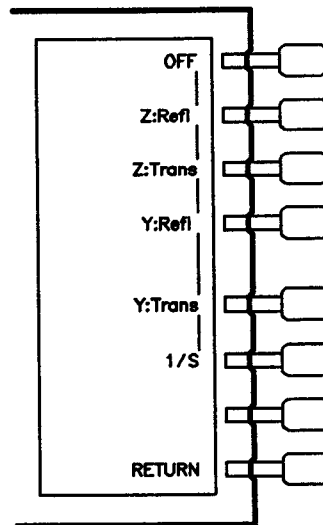


Figure 5–7. Conversion Menu

**OFF** (CONVOFF) turns off all parameter conversion operations.

**Z:Refl** (CONVZREF) converts reflection data to its equivalent parallel impedance values.

**Z:Trans** (CONVZTRA) converts transmission data to its equivalent series impedance values.

**Y:Refl** (CONVYREF) converts reflection data to its equivalent parallel admittance values.

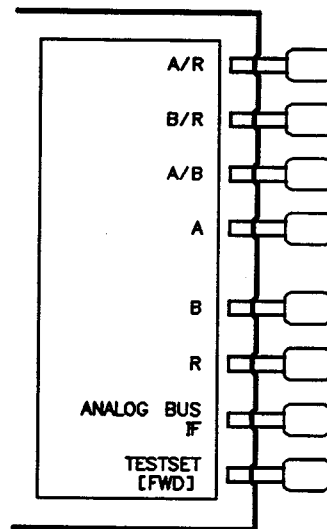
**Y:Trans** (CONVYTRA) converts transmission data to its equivalent series admittance values.

**1/S** (CONV1DS) expresses the data in inverse S–parameter values, for use in amplifier and oscillator design. A convenient way to check for transistor stability is to compare  $S_{11}$  and  $1/S_{22}$  on a Smith chart using a dual channel overlay display (see *Display Menu*).

**RETURN** returns to the S-parameter menu.

## Input Ports Menu

The input ports menu is presented when the **MEAS** key is pressed if there is no S-parameter test set connected and two-port error correction is not on. This menu is used to define the input ports for power ratio measurements, or a single input for magnitude only measurements of absolute power. Single inputs cannot be used for phase or group delay measurements, or any measurements with averaging turned on.



*Figure 5-8. Input Ports Menu*

**A/R** (AR) calculates and displays the complex ratio of the signal at input A to the reference signal at input R.

**B/R** (BR) calculates and displays the complex ratio of input B to input R.

**A/B** (AB) calculates and displays the complex ratio of input A to input B.

**A** (MEASA) measures the absolute power amplitude at input A.

**B** (MEASB) measures the absolute power amplitude at input B.

**R** (MEASR) measures the absolute power amplitude at input R. The R input is part of the source phase locking scheme, and therefore has a limited dynamic range.

**ANALOG BUS** – used in conjunction with the SERVICE functions.

**TEST SET** – used to switch the transfer switch from Forward (FWD) or Reverse (REV). Only functions when an S-Parameter is not selected.

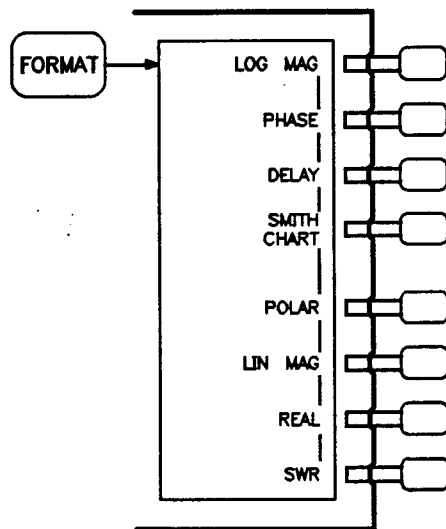
## FORMAT KEY

### Format Menu

The **FORMAT** (MENUFORM) key presents a menu used to select the appropriate display format for the measured data. Various rectangular and polar formats are available for display of magnitude, phase, real data, impedance, group delay, and SWR. The units of measurement are changed automatically to correspond with the displayed format. Special marker menus are available for the polar and Smith formats, each providing several different marker types for readout of values (see Chapter 7).

The format defined for display of a particular S-parameter is remembered with that parameter. Thus if different S-parameters are measured, even if only one channel is used, each parameter is shown in its selected format each time it is displayed.

The illustrations in the following pages show measurements of a bandpass filter displayed in each of the available formats.



*Figure 5-9. Format Menu*

**LOG MAG** (LOGM) displays the log magnitude format. This is the standard Cartesian format used to display magnitude—only measurements of insertion loss, return loss, or absolute power in dBm versus frequency. Figure 5-10 illustrates the bandpass filter reflection data in a log magnitude format.

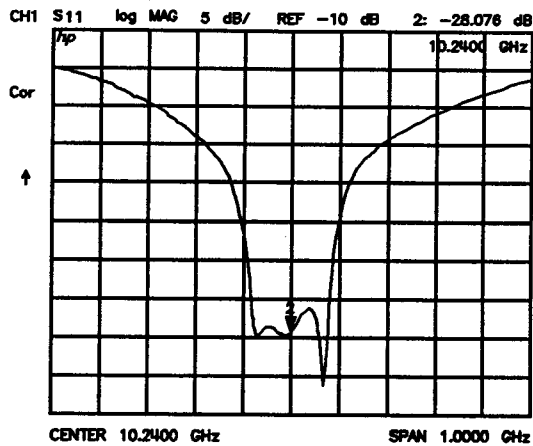


Figure 5-10. Log Magnitude Format

**PHASE** (PHAS) displays the phase shift of the data versus frequency in a Cartesian format, as illustrated in Figure 5-11. A measurement of phase response is described in the *User's Guide*.

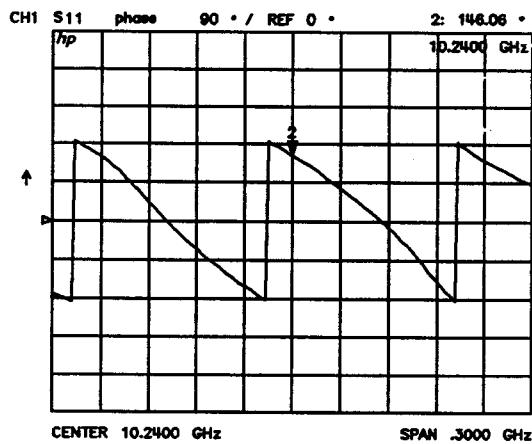


Figure 5-11. Phase Format

**DELAY** (DELA) selects the group delay format, with marker values given in seconds. Figure 5-12 shows the bandpass filter response formatted as group delay. Group delay principles are described in the next few pages.

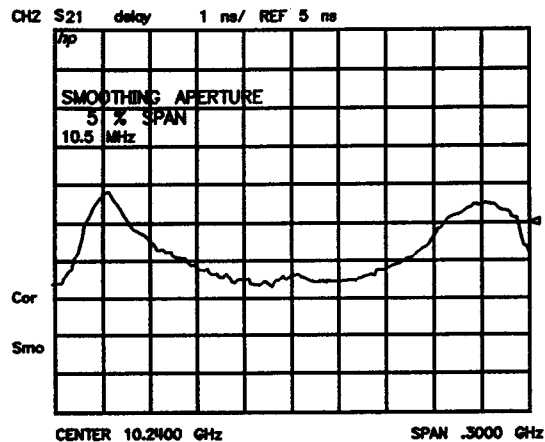


Figure 5-12. Group Delay Format

**SMITH CHART** (SMIC) displays a Smith chart format (Figure 5-13a). This is used in reflection measurements to provide a readout of the data in terms of impedance. The intersecting dotted lines on the Smith chart represent constant resistance and constant reactance values, normalized to the characteristic impedance,  $Z_0$ , of the system. Reactance values in the upper half of the Smith chart circle are positive (inductive) reactance, and in the lower half of the circle are negative (capacitive) reactance. The default marker readout is in units of resistance and reactance ( $R+jX$ ), as well as frequency. Additional marker types are available in the Smith marker menu (refer to Chapter 7, *Using Markers*).

The Smith chart is most easily understood with a full scale value of 1.0. If the scale per division is less than 0.2, the format switches automatically to polar.

For measurements in an environment that is not 50 ohms, modify the impedance value recognized by the analyzer using the **SET Z0** softkey in the calibrate more menu, to set the center value of the Smith chart. Refer to Chapter 6, *Measurement Calibration*.

An inverted Smith chart format for admittance measurements (Figure 5-13b) is also available. Access this by selecting **SMITH CHART** in this format menu, and pressing **MKR FCTN** **MARKER MODE MENU** **SMITH MKR MENU** **G + jB MKR**. The Smith chart is then reversed and marker values are read out in units of conductance and susceptance ( $G+jB$ ).

Procedures for measuring impedance and admittance are provided in the *User's Guide*.

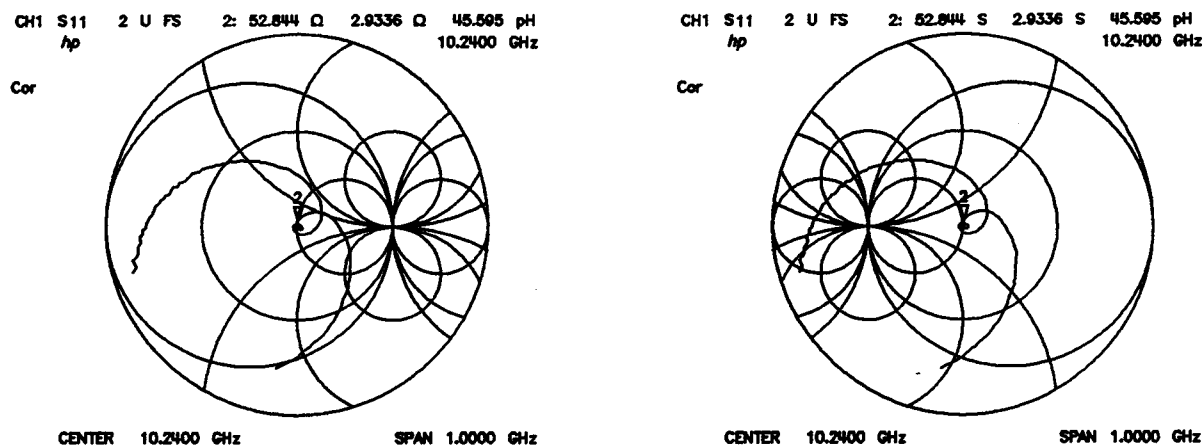


Figure 5-13. Standard and Inverse Smith Chart Formats

**POLAR** (POLA) displays a polar format (Figure 5-14). Each point on the polar format corresponds to a particular value of both magnitude and phase. Quantities are read vectorally: the magnitude at any point is determined by its displacement from the center (which has zero value), and the phase by the angle counterclockwise from the positive x-axis. Magnitude is scaled in a linear fashion, with the value of the outer circle usually set to a ratio value of 1. Since there is no frequency axis, frequency information is read from the markers.

The default marker readout for the polar format is in linear magnitude and phase. A log magnitude marker and a real/imaginary marker are available in the polar marker menu (refer to Chapter 7, *Using Markers*).

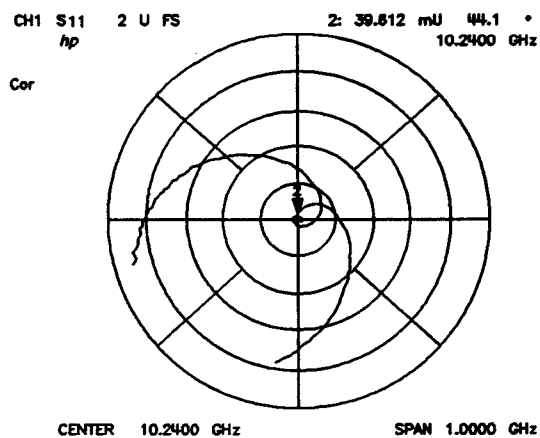


Figure 5-14. Polar Format



**LIN MAG** (LINM) displays the linear magnitude format (Figure 5–15). This is a Cartesian format used for unitless measurements such as reflection coefficient magnitude  $\rho$  or transmission coefficient magnitude  $\tau$ , and for linear measurement units. It is used for display of conversion parameters and time domain transform data.

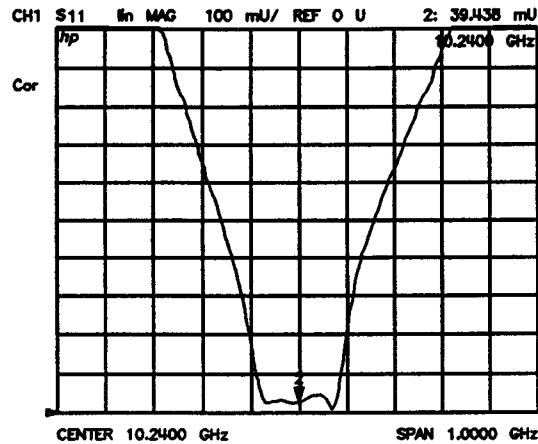


Figure 5–15. Linear Magnitude Format

**REAL** (REAL) displays only the real part of the measured data on a Cartesian format (Figure 5–16). This is similar to the linear magnitude format, but can show both positive and negative values. It is primarily used for analyzing responses in the time domain, or for display of an auxiliary input voltage signal for service purposes.

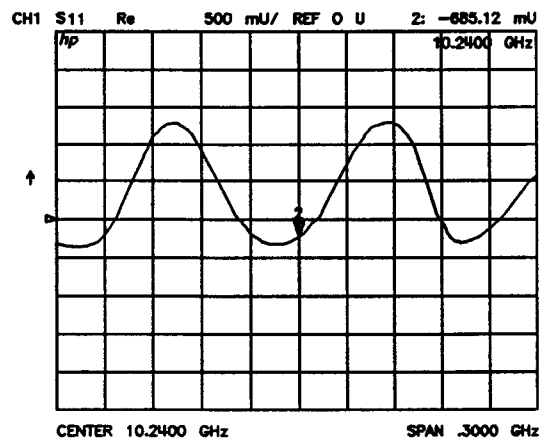


Figure 5–16. Real Format

**SWR** (SWR) reformats a reflection measurement into its equivalent SWR (standing wave ratio) value (Figure 5–17). SWR is equivalent to  $(1+\rho)/(1-\rho)$ , where  $\rho$  is the reflection coefficient. Note that the results are valid only for reflection measurements. If the SWR format is used for measurements of S21 or S12 the results are not valid.

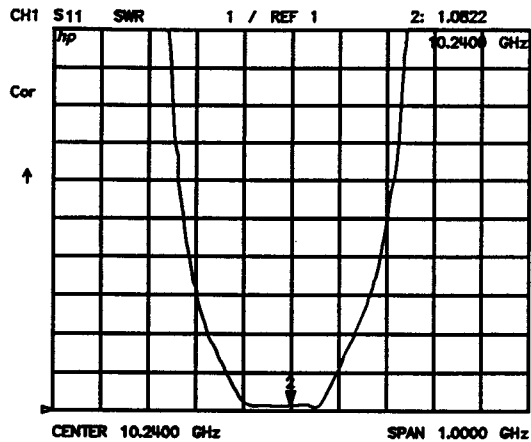


Figure 5-17. Typical

*SWR Display*

**GROUP DELAY PRINCIPLES**

For many networks, the amount of insertion phase is not as important as the linearity of the phase shift over a range of frequencies. The analyzer can measure this linearity and express it in two different ways: directly, as deviation from linear phase, or as group delay, a derived value. Refer to **SCALE/REF** in this chapter for information on deviation from linear phase.

Group delay is the measurement of signal transmission time through a test device. It is defined as the derivative of the phase characteristic with respect to frequency. Since the derivative is basically the instantaneous slope (or rate of change of phase with frequency), a perfectly linear phase shift results in a constant slope, and therefore a constant group delay (Figure 5-18).

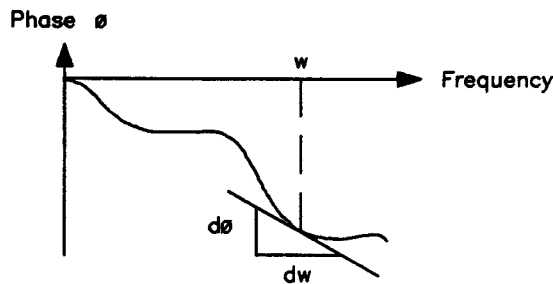


Figure 5-18

Note, however, that the phase characteristic typically consists of both linear and higher order (deviations from linear) components. The linear component can be attributed to the electrical length of the test device, and represents the average signal transit time. The higher order components are interpreted as variations in transit time for different frequencies, and represent a source of signal distortion (Figure 5-19).

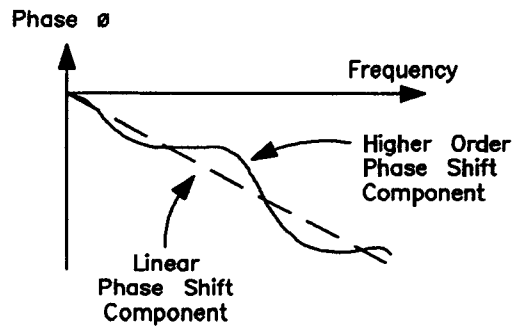


Figure 5-19

The network analyzer computes group delay from the phase slope. Phase data is used to find the phase change,  $\Delta\phi$ , over a specified frequency aperture,  $\Delta f$ , to obtain an approximation for the rate of change of phase with frequency (Figure 5-20). This value,  $\tau_g$ , represents the group delay in seconds assuming linear phase change over  $\Delta f$ . It is important that  $\Delta\phi$  be  $\leq 180^\circ$ , or errors will result in the group delay data. These errors can be significant for long delay devices.

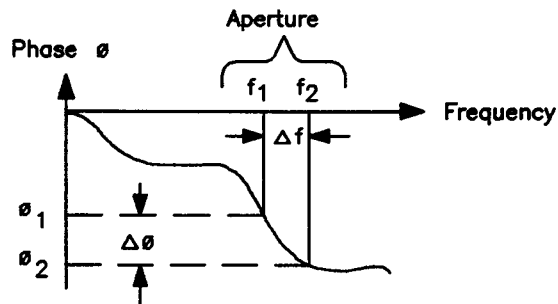


Figure 5-20

When deviations from linear phase are present, changing the frequency step can result in different values for group delay. Note that in this case the computed slope varies as the aperture  $\Delta f$  is increased (Figure 5-21). A wider aperture results in loss of the fine grain variations in group delay. This loss of detail is the reason that in any comparison of group delay data it is important to know the aperture used to make the measurement.

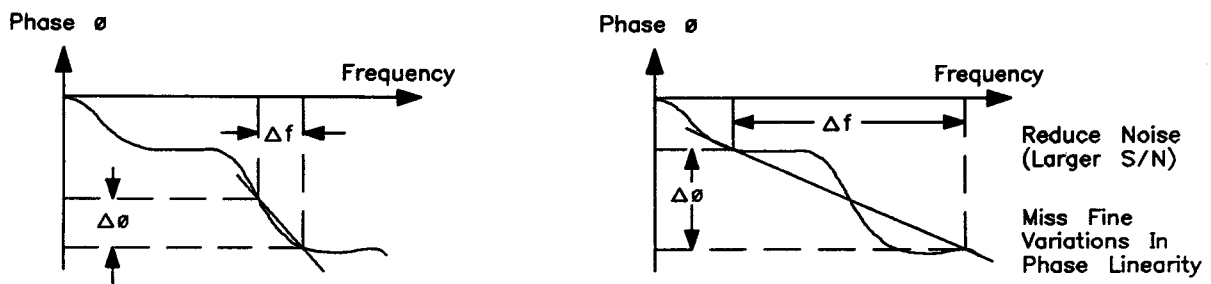


Figure 5-21

In determining the group delay aperture, there is a tradeoff between resolution of fine detail and the effects of noise. Noise can be reduced by increasing the aperture, but this will tend to smooth out the fine detail. More detail will become visible as the aperture is decreased, but the noise will also increase, possibly to the point of obscuring the detail. A good practice is to use a smaller aperture to assure that small variations are not missed, then increase the aperture to smooth the trace.

The default (minimum) group delay aperture is the frequency span divided by the number of points across the display. To increase the aperture, turn on smoothing in the average menu, and vary the smoothing aperture (see **AVG** Key). The aperture can be varied up to 20% of the span swept.

The maximum delay range is limited to measuring no more than  $\pm 180^\circ$  of phase change within the minimum aperture. For example, with a minimum aperture of 100 kHz, the maximum delay that can be measured is 5 microseconds.

Group delay accuracy is a function of the uncertainty in determining the phase change. In general, the following formula can be used to determine the accuracy, in seconds, of a specific group delay measurement:

$$\pm \frac{0.003 \times \text{Phase Accuracy (deg)}}{\text{Aperture (Hz)}}$$

Group delay measurements can be made on linear frequency, log frequency, or list frequency sweep types (not in CW). Group delay aperture varies depending on the frequency spacing and point density, therefore the aperture is not constant in log and list frequency sweep modes. In list frequency mode, extra frequency points can be defined to ensure the desired aperture.

To obtain a readout of aperture values at different points on the trace, turn on a marker. Then press **AVG** **SMOOTHING APERTURE**. Smoothing aperture becomes the active function, and as the aperture is varied its value in MHz is displayed in the active entry area.

## SCALE REF KEY

### Scale Reference Menu

The **SCALE REF** (MENUSCAL) key makes scale per division the active function. The menu displayed is used to modify the vertical axis scale and the reference line value and position. In addition this menu provides electrical delay offset capabilities for adding or subtracting linear phase to maintain phase linearity.

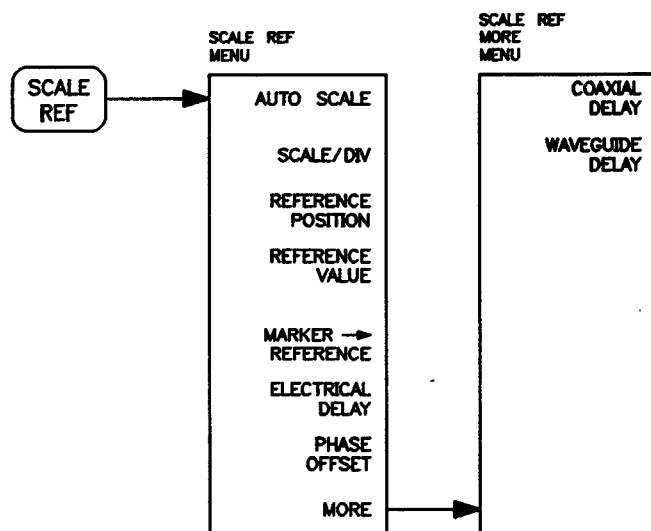


Figure 5-22. Scale Reference Menu

**AUTO SCALE** (AUTO) brings the trace data in view on the CRT with one keystroke. Stimulus values are not affected, only scale and reference values. The analyzer determines the smallest possible scale factor that will put all displayed data onto the vertical graticule. The reference value is chosen to put the trace in center screen, then rounded to an integer multiple of the scale factor.

**SCALE / DIV** (SCAL) changes the response value scale per division of the displayed trace. In polar and Smith chart formats, this refers to the full scale value at the outer circumference, and is identical to reference value.

**REFERENCE POSITION** (REFP) sets the position of the reference line on the graticule of a Cartesian display, with 0 the bottom line of the graticule and 10 the top line. It has no effect on a polar or Smith display. The reference position is indicated with a small triangle just outside the graticule, on the left side for channel 1 and the right side for channel 2.

**REFERENCE VALUE** (REFV) changes the value of the reference line, moving the measurement trace correspondingly. In polar and Smith chart formats, the reference value is the same as the scale, and is the value of the outer circle.

**MARKER → REFERENCE** (MARKREF) makes the reference value equal to the active marker's absolute value (regardless of the delta marker value). The marker is effectively moved to the reference line position. This softkey also appears in the marker function menu accessed from the **MKR FCTN** key. In polar and Smith chart formats this function makes the full scale value at the outer circle equal to the active marker response value.

**ELECTRICAL DELAY** (ELED) adjusts the electrical delay to balance the phase of the DUT. It simulates a variable length lossless transmission line, which can be added to or removed from the analyzer's internal reference port to compensate for interconnecting cables, etc. This function is similar to the mechanical or analog "line stretchers" of other network analyzers. Delay is annotated in units of time with secondary labeling in distance for the current velocity factor. The maximum electrical delay that can be added is 10 microseconds, in standard instrument, 10 seconds with option 001.

With this feature, an equivalent length of air is added or subtracted according to the following formula:

$$\text{Length (metres)} = \frac{\phi}{F(\text{MHz}) \times 1.20083}$$

Once the linear portion of the DUT's phase has been removed, the equivalent length of air can be read out in the active marker area. If the average relative permittivity ( $\epsilon_r$ ) of the DUT is known over the frequency span, the length calculation can be adjusted to indicate the actual length of the DUT more closely. This can be done by entering the relative velocity factor for the DUT using the calibrate more menu. The relative velocity factor for a given dielectric can be calculated by:

$$\text{Velocity factor} = 1/\sqrt{\epsilon_r}$$

assuming a relative permeability of 1.

A procedure for measuring electrical length or deviation from linear phase using the **ELECTRICAL DELAY** or **MARKER → DELAY** features is provided in the *User's Guide*.

**PHASE OFFSET** (PHAO) adds or subtracts a phase offset that is constant with frequency (rather than linear). This is independent of **ELECTRICAL DELAY**.

**COAXIAL DELAY** (COAD) applies a linear phase compensation to the trace. That is, the effect is the same as if a corresponding length of perfect vacuum dielectric coaxial transmission line was added to the reference signal path.

**WAVEGUIDE DELAY** (WAVD) applies a non-linear phase shift which follows the standard dispersive phase equation for rectangular waveguide. When **WAVEGUIDE DELAY** is pressed the active function becomes the WAVEGUIDE CUTOFF frequency, which is used in the phase equation. Choosing a Start frequency less than the Cutoff frequency results in phase errors.

## DISPLAY KEY

The **DISPLAY** (MENUMDISP) key provides access to the memory math functions, and other display functions including dual channel display, active channel display title, frequency blanking, and display adjustments.

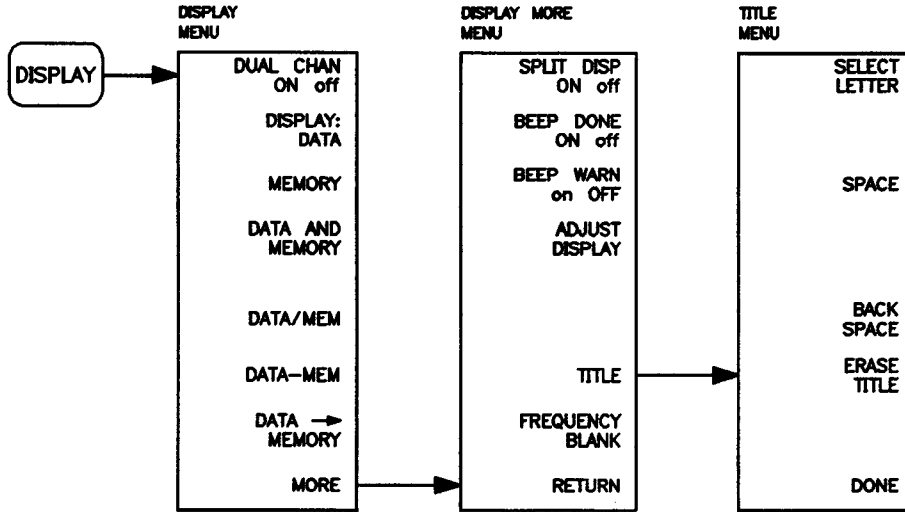


Figure 5–23. Softkey Menus Accessed from the **DISPLAY** Key

## Display Menu

This menu provides trace math capabilities for manipulating data, as well as the capability of displaying both channels simultaneously, either overlaid or split.

The analyzer has two available memory traces, one per channel. Memory traces are totally channel dependent: channel 1 cannot access the channel 2 memory trace or vice versa. Memory traces can be saved with instrument states: one memory trace can be saved per channel per saved instrument state. Five save/recall registers are available for each channel. The memory data is stored as full precision, complex data. (Refer to Chapter 11, *Saving Instrument States*.)

Two trace math operations are implemented, data/memory and data—memory. (Note that normalization is data/memory not data—memory.) Memory trace save and recall and trace math are done immediately after error correction. This means that any additional post-processing done after error correction, including S-parameter conversion, time domain transformation (option 010), scaling, etc., can be performed on the memory trace. (Refer to *Data Processing* in Chapter 2.) Trace math can also be used as a simple means of error correction, although that is not its main purpose.

All data processing operations that occur after trace math, except smoothing and gating, are identical for the data trace and the memory trace.

The actual memory for storing a memory trace is allocated only as needed. The memory trace is cleared on instrument preset, power on, or instrument state recall.

Note that if sweep mode or sweep range is different between the data and memory traces, trace math is allowed, and no warning message is given. If the number of points in the two traces is different, the memory trace is not displayed and the message "CAUTION: NO VALID MEMORY TRACE" appears. However, if the number of points for the data trace is changed back to the number of points in the memory, the memory trace can then be displayed.

If trace math or display memory is requested and no memory trace exists, the message "CAUTION: NO VALID MEMORY TRACE" is displayed.

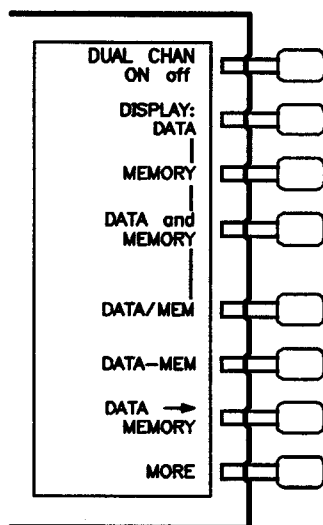


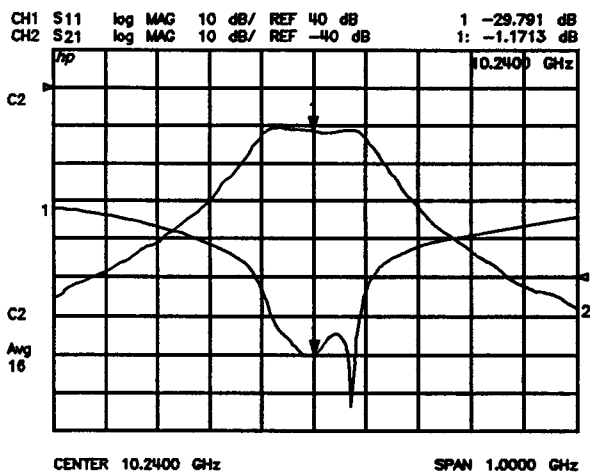
Figure 5-24. Display Menu

**DUAL CHAN on OFF** (DUACON, DUACOFF) toggles between display of both measurement channels or the active channel only. This is used in conjunction with **SPLIT DISP on OFF** in the display more menu to display both channels. With **SPLIT DISP OFF** the two traces are overlaid on a single graticule (Figure 5-25a); with **SPLIT DISP ON** the measurement data is displayed on two half-screen graticules one above the other (Figure 5-25b). Current parameters for the two displays are annotated separately.

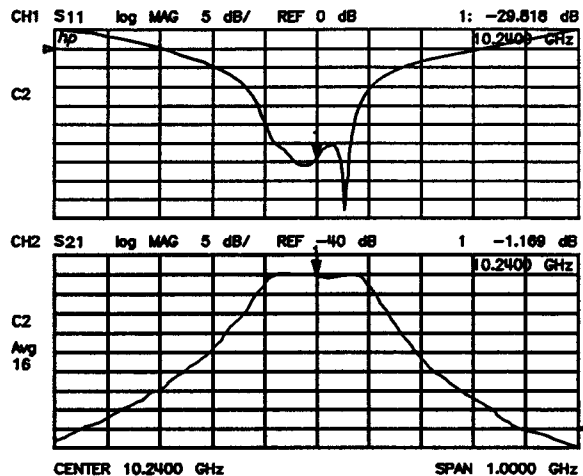
When two different parameters are measured simultaneously, the test set hold mode is implemented. In this mode, the transfer switch and attenuator are protected against continuous switching, and the status notation "tsH" appears at the left of the screen. This can be overridden with **NUMBER of GROUPS** (see *Trigger Menu* in Chapter 4).

The stimulus functions of the two channels can also be controlled independently using **COUPLED CH ON** in the stimulus menu (see Chapter 4). In addition, the markers can be controlled independently for each channel using **MARKERS:UNCOUPLED** in the marker mode menu (Chapter 7).





(a) Overlay Display



(b) Split Display

Figure 5–25. Dual Channel Displays

**DISPLAY DATA** (DISPDATA) displays the current measurement data for the active channel.

**MEMORY** (DISPMEMO) displays the trace memory for the active channel. This is the only memory display mode where the smoothing or gating of the memory trace can be changed. If no data has been stored in memory for this channel, a warning message is displayed.

**DATA and MEMORY** (DISPDATM) displays both the current data and memory traces.

**DATA / MEM** (DISPDDM) divides the data by the memory, normalizing the data to the memory, and displays the result. This is useful for ratio comparison of two traces, for instance in measurements of gain or attenuation.

**DATA – MEM** (DISPDMM) subtracts the memory from the data. The vector subtraction is performed on the complex data. This is appropriate for storing a measured vector error, for example directivity, and later subtracting it from the device measurement.

**DATA → MEMORY** (DATI) stores the current active measurement data in the memory of the active channel. It then becomes the memory trace, for use in subsequent math manipulations or display. If a parameter has just been changed and the \* status notation is displayed at the left of the CRT, the data is not stored in memory until a clean sweep has been executed.

**MORE** leads to the display more menu.

## Display More Menu

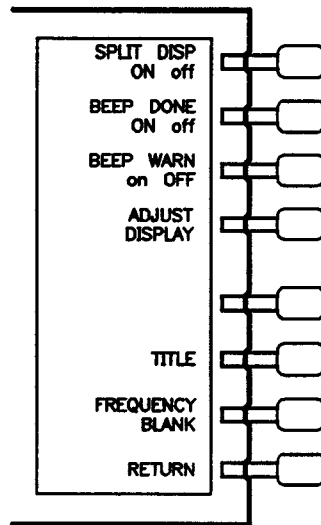


Figure 5–26. Display More Menu

**SPLIT DISP on OFF** (SPLDON, SPLDOFF) toggles between a full-screen single graticule display of one or both channels, and a split display with two half-screen graticules one above the other. Both displays are illustrated in Figure 5–25. The split display can be used in conjunction with **DUAL CHAN ON** in the display menu to show the measured data of each channel simultaneously on separate graticules. In addition, the stimulus functions of the two channels can be controlled independently using **COUPLED CH ON** in the stimulus menu. The markers can also be controlled independently for each channel using **MARKERS:UNCOUPLED** in the marker mode menu.

**BEEP DONE ON off** (BEEPDONEON, BEEPDONEOFF) toggles a low-toned beeper that sounds to indicate completion of certain operations such as calibration or instrument state save.

**BEEP WARN on OFF** (BEEPWARNON, BEEPWARNOFF) toggles the warning beeper. When the beeper is on it sounds a warning when a cautionary message is displayed.

**ADJUST DISPLAY** presents a menu which allows varying the intensity and color of different parts of the CRT display.

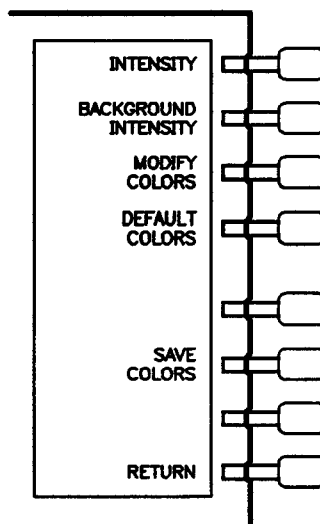
**TITLE** (TITL) presents the title menu in the softkey labels area and the character set in the active entry area. These are used to label the active channel display.

**FREQUENCY BLANK** (FREO) blanks the displayed frequency notation for security purposes. Frequency labels cannot be restored except by instrument preset or cycling power.

**RETURN** goes back to the display menu.

## Adjust Display Menu

Keys in this menu change the overall intensity and background intensity directly, return the CRT to the default colors, and save and recall customized color combinations. **MODIFY COLORS** presents a menu explained below.



*Figure 5–27. Adjust Display Menu*

**INTENSITY** (INTE) adjusts the overall intensity of the CRT.

**BACKGROUND INTENSITY** (BACI) adjusts the background intensity from black (default, 0%) to white (100%).

**MODIFY COLORS** presents a menu of CRT elements which can be individually modified.

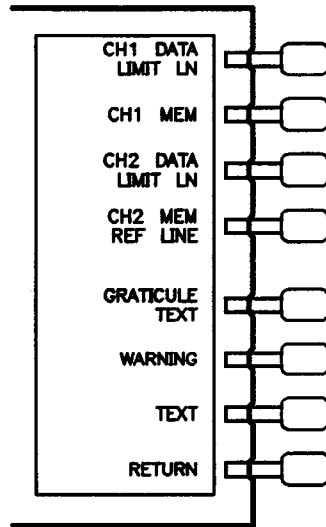
**DEFAULT COLORS** returns the CRT to the factory–set color scheme.

**SAVE COLORS** saves any modifications made in the modify colors menu. These changes are not affected by preset or cycling power.

**RETURN** accesses the previous menu.

## Modify Colors Menu

This menu allows selection of the individual CRT element to be modified by the "tint brightness color" menu. Selecting any softkey but **RETURN** presents the "tint brightness color" menu.



*Figure 5–28. Modify Colors Menu*

**CH1 DATA LIMIT LN** selects the channel 1 data trace and limit line.

**CH1 MEM** selects the channel 1 memory trace.

**CH2 DATA LIMIT LN** selects the channel 2 data trace and limit line.

**CH2 MEM REF LINE** selects the channel 2 memory trace.

**GRATICULE TEXT** selects the graticule and some softkey text.

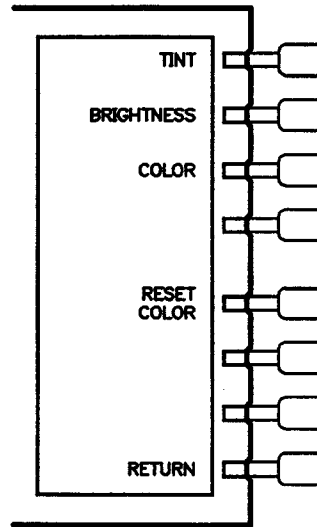
**WARNING** selects the warning annotation (like error messages).

**TEXT** selects all non–data text (like softkey labels, operating parameters).

**RETURN** presents the previous menu.

## Tint Brightness Color Menu

This menu makes the changes to the CRT element selected in the previous menu.



*Figure 5–29. Tint Brightness Color Menu*

**TINT** can be varied from 0% to 100% to change the CRT element from red to orange, yellow, green, blue, violet and back to red. If varying tint has no visible effect, increase the color percentage first.

**BRIGHTNESS** can be varied from 0% (minimum) to 100% (maximum).

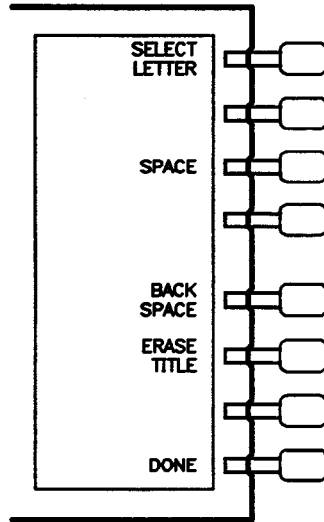
**COLOR** can be varied from 0% (no tint, all white) to 100% (all tint, no white). For example when the tint is red, increasing the color will change it from white (no tint) to pale pink, to pink, dark pink, light red, red, and brilliant red.

**RESET COLORS** returns the CRT element selected to its default setting.


**RETURN** recalls the modify colors menu.

## Title Menu

Use this menu to specify a title for the active channel. The title identifies the display regardless of stimulus or response changes, and is printed or plotted with the data. If the display is saved in a register with the instrument state, the title is saved with it.



*Figure 5–30. Title Menu*

**SELECT LETTER** . The active entry area displays the letters of the alphabet, digits 0 through 9, and mathematical symbols. To define a title, rotate the knob until the arrow  points at the first letter, then press **SELECT LETTER** . Repeat this until the complete title is defined, for a maximum of 50 characters. As each character is selected, it is appended to the title at the top of the graticule.

**SPACE** inserts a space in the title.

**BACK SPACE** deletes the last character entered.

**ERASE TITLE** deletes the entire title.

**DONE** terminates the title entry, and returns to the display more menu.

## AVG KEY

The **AVG** (MENUAVG) key is used to access three different noise reduction techniques: sweep-to-sweep averaging, display smoothing, and variable IF bandwidth. Any or all of these can be used simultaneously. Averaging and smoothing can be set independently for each channel, and the IF bandwidth can be set independently if the stimulus is uncoupled.

**Averaging** computes each data point based on an exponential average of consecutive sweeps weighted by a user-specified averaging factor. Each new sweep is averaged into the trace until the total number of sweeps is equal to the averaging factor, for a fully averaged trace. Each point on the trace is the vector sum of the current trace data and the data from the previous sweep. A high averaging factor gives the best signal-to-noise ratio, but slows the trace update time. Doubling the averaging factor reduces the random noise by 3 dB down to the limit of the receiver. Averaging is used for ratioed measurements: if it is attempted for a single-input measurement (e.g. A or B), the message "CAUTION: AVERAGING INVALID ON NON-RATIO MEASURE" is displayed. Figure 5-31 illustrates the effect of averaging on a log magnitude format trace.

### Improvement in Noise Floor Due to Averaging

Number of Averages	Improvement
1	0 dB
2	3 dB
4	6 dB
8	9 dB
16	12 dB
32	15 dB
64	18 dB
128	21 dB

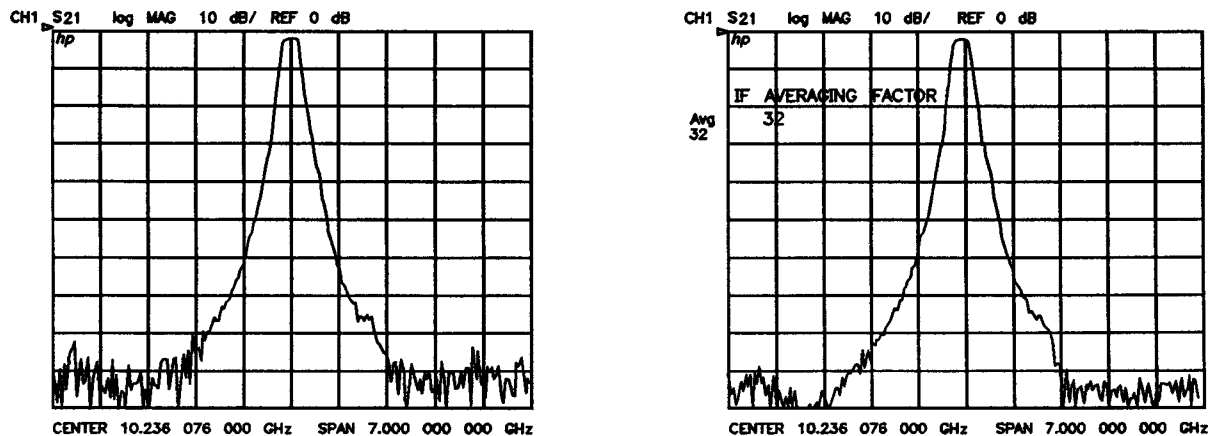
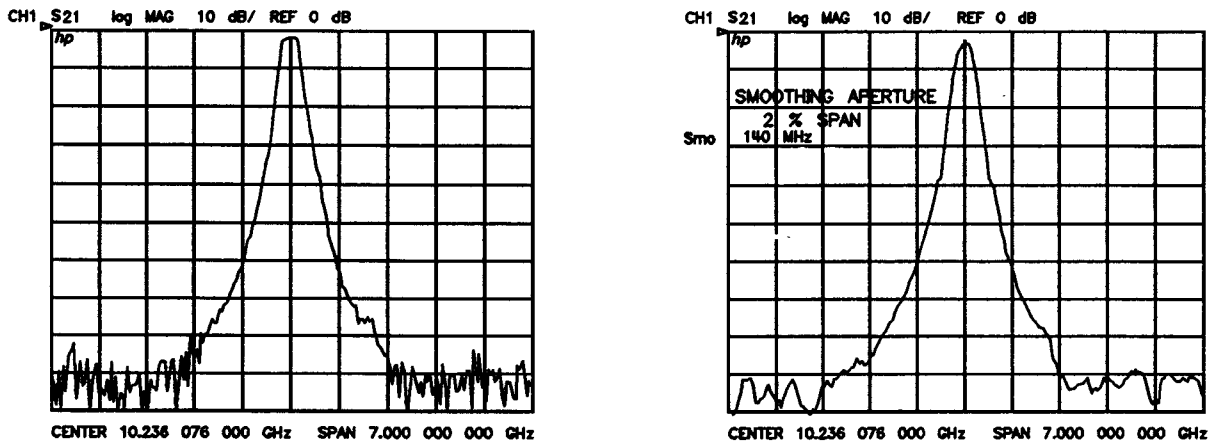


Figure 5-31. Effect of Averaging on a Trace

**Smoothing** (similar to video filtering) averages the formatted active channel data over a portion of the displayed trace. Smoothing computes each displayed data point based on one sweep only, using a moving average of several adjacent data points for the current sweep. The smoothing aperture is a percent of the stimulus span swept, up to a maximum of 20%.

Rather than lowering the noise floor, smoothing finds the mid-value of the data. Use it to reduce relatively small peak-to-peak noise values on broadband measured data. Use a sufficiently high number of display points to avoid misleading results. Do not use smoothing for measurements of high resonance devices or other devices with wide variations in trace, as it will introduce errors into the measurement.

Smoothing is used primarily with Cartesian display formats. It is also the primary way to control the group delay aperture, given a fixed frequency span (refer to *Group Delay Principles* earlier in this chapter). **CAUTION:** in polar display format, large phase shifts over the smoothing aperture will cause shifts in amplitude, since a vector average is being computed. Figure 5–32 illustrates the effect of smoothing on a log magnitude format trace. Smoothing is typically not used with polar and Smith formats.



*Figure 5–32. Effect of Smoothing on a Trace*

**IF Bandwidth Reduction** lowers the noise floor by digitally reducing the receiver input bandwidth. It has an advantage over averaging in reliably filtering out unwanted responses such as spurs, odd harmonics, higher frequency spectral noise, and line-related noise. Sweep-to-sweep averaging, however, is better at filtering out very low frequency noise. A tenfold reduction in IF bandwidth lowers the measurement noise floor by about 10 dB. Bandwidths less than 300 Hz provide better harmonic rejection than higher bandwidths. Choosing 10 Hz or 30 Hz IF bandwidth will put the analyzer in the stepped CW mode. This is useful for testing long electrical delay DUTs.



## Improvement in Noise Floor Due to IF Bandwidth

IF BW	Improvement
3000	0 dB
1000	6 dB
300	10 dB
100	13 dB
30	20 dB
10	23 dB

Another difference between sweep-to-sweep averaging and variable IF bandwidth is the sweep time. Averaging displays the first complete trace faster but takes several sweeps to reach a fully averaged trace. IF bandwidth reduction lowers the noise floor in one sweep, but the sweep time may be slower. Figure 5–33 illustrates the difference in noise floor between a trace measured with a 3000 Hz IF bandwidth and with a 300 Hz IF bandwidth.

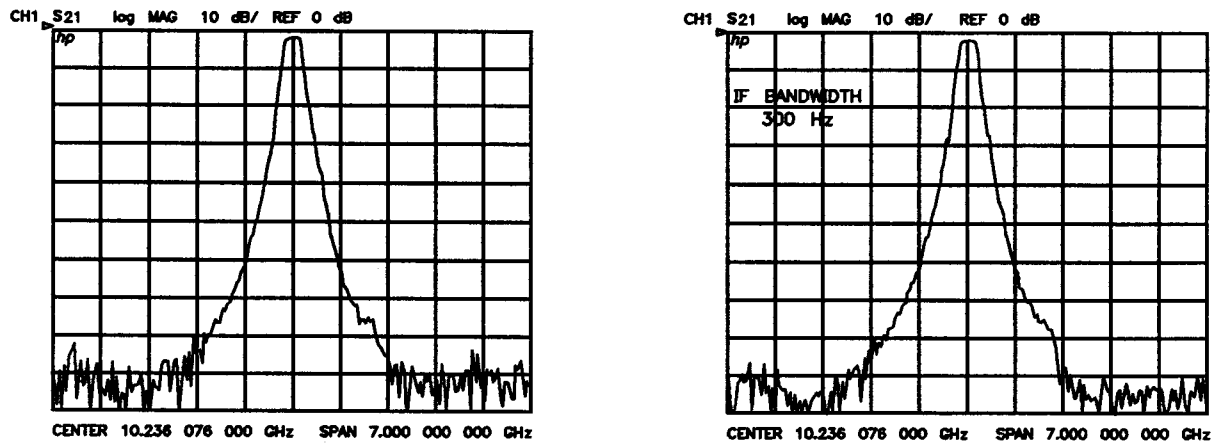


Figure 5–33. IF Bandwidth Reduction

Another capability that can be used for effective noise reduction is the marker statistics function, which computes the average value of part or all of the formatted trace. Refer to Chapter 7, *Using Markers*.

Another way of increasing dynamic range is to increase the input power to the device under test. Refer to the *User's Guide* for an example.

## Average Menu

The average menu (Figure 5–34) is used to select the desired noise–reduction technique, and to set the parameters for the technique selected. It is also used to set the aperture for group delay measurements.

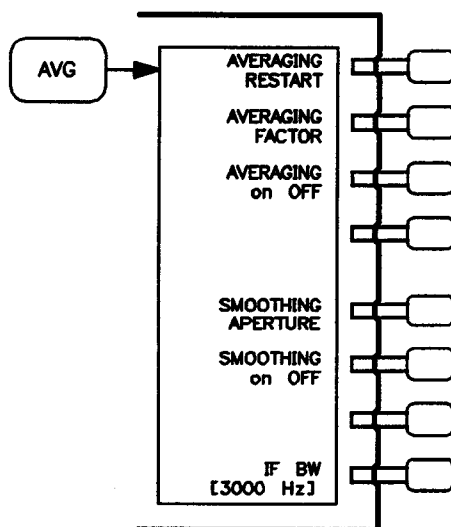


Figure 5–34. Average Menu

**AVERAGING RESTART** (AVERREST) resets the sweep–to–sweep averaging and restarts the sweep count at 1 at the beginning of the next sweep. The sweep count for averaging is displayed at the left of the CRT.

**AVERAGING FACTOR** (AVERFACT) makes averaging factor the active function. Any value up to 999 can be used. The algorithm used for averaging is:

$$A(n) = S(n)/F + (1 - 1/F) \times A(n-1)$$

where

**A(n)** = current average

**S(n)** = current measurement

**F** = sweep count (1, 2, 3 etc. until averaging factor is reached)

**n** = measurement number

**AVERAGING on OFF** (AVERON, AVEROFF) turns the averaging function on or off for the active channel. "Avg" is displayed in the status notations area at the left of the CRT, together with the sweep count for the averaging factor, when averaging is on. The sweep count for averaging is reset to 1 whenever an instrument state change affecting the measured data is made.

At the start of averaging or following **AVERAGING RESTART**, averaging starts at 1 and averages each new sweep into the trace until it reaches the specified averaging factor. The sweep count is displayed in the status notations area below "Avg" and updated every sweep as it increments. When the specified averaging factor is reached, the trace data continues to be updated, weighted by that averaging factor.

**SMOOTHING APERTURE** (SMOOAPER) lets you change the value of the smoothing aperture as a percent of the span. When smoothing aperture is the active function, its value in stimulus units is displayed below its percent value in the active entry area.

Smoothing aperture is also used to set the aperture for group delay measurements (refer to *Group Delay Principles* earlier in this chapter). Note that the displayed smoothing aperture is not the group delay aperture unless smoothing is on.

**SMOOTHING on OFF** (SMOOON, SMOOOFF) turns the smoothing function on or off for the active channel. When smoothing is on, the annotation "Smo" is displayed in the status notations area.

**IF BW** (IFBW) is used to select the bandwidth value for IF bandwidth reduction. Settable values (in Hz) are 3000, 1000, 300, 100, 30, and 10. Any other value will default to the next lowest allowable value. A narrow bandwidth slows the sweep speed but provides better signal-to-noise ratio. The selected bandwidth value is shown in brackets in the softkey label.



# Chapter 6. Measurement Calibration

---

## INTRODUCTION

Measurement calibration is an accuracy enhancement procedure that effectively removes the system errors that cause uncertainty in measuring a device under test. It measures known standard devices, and uses the results of these measurements to characterize the system.

This chapter explains the theoretical fundamentals of accuracy enhancement and the sources of measurement errors. It describes the different measurement calibration procedures available in the analyzer, which errors they correct, and the measurements for which each should be used. An appendix at the end of this reference provides further information on characterizing systematic errors and using error models to analyze overall measurement performance.

## ACCURACY ENHANCEMENT

If it were possible for a perfect measurement system to exist, it would have infinite dynamic range, isolation, and directivity characteristics, no impedance mismatches in any part of the test setup, and flat frequency response. Vector accuracy enhancement, also known as measurement calibration or error correction, provides the means to simulate a perfect measurement system.

In any high frequency measurement there are certain measurement errors or ambiguities associated with the system that contribute uncertainty to the results. Parts of the measurement setup such as interconnecting cables and signal separation devices (as well as the network analyzer itself) all introduce variations in magnitude and phase that can mask the actual performance of the device under test.

For example, crosstalk due to the channel isolation characteristics of the network analyzer can contribute an error equal to the transmission signal of a high-loss test device. Similarly, for reflection measurements, the primary limitation of dynamic range is the directivity of the test setup. The measurement system cannot distinguish the true value of the signal reflected by the device under test from the signal arriving at the receiver input due to leakage in the system. For both transmission and reflection measurements, impedance mismatches within the test setup cause measurement uncertainties that appear as ripples superimposed on the measured data.

Measurement calibration simulates a perfect network analyzer system. It measures the magnitude and phase responses of known standard devices, and compares the measurement with actual device data. It uses the results to characterize the system and effectively remove the system errors from the measurement data of a test device, using vector math capabilities internal to the network analyzer.

When measurement calibration is used, the dynamic range and accuracy of the measurement are limited only by system noise and stability, connector repeatability, and the accuracy to which the characteristics of the calibration standards are known.

## SOURCES OF MEASUREMENT ERRORS

Network analysis measurement errors can be separated into systematic, random, and drift errors.

Correctable systematic errors are the repeatable errors that the system can measure. These are errors due to mismatch and leakage in the test setup, isolation between the reference and test signal paths, and system frequency response.

Random and drift errors are the non-repeatable errors that the system itself cannot measure, and therefore cannot correct for. These errors affect both reflection and transmission measurements. Random errors are measurement variations due to noise and connector repeatability. Drift errors include frequency drift, temperature drift, and other physical changes in the test setup between calibration and measurement.

The resulting measurement is the vector sum of the device under test response plus all error terms. The precise effect of each error term depends upon its magnitude and phase relationship to the actual test device response.

In most high frequency measurements the systematic errors are the most significant source of measurement uncertainty. Since each of these errors can be characterized, their effects can be effectively removed to obtain a corrected value for the test device response. For the purpose of vector accuracy enhancement these uncertainties are quantified as directivity, source match, load match, isolation (crosstalk), and frequency response (tracking). Each of these systematic errors is described below.

Random and drift errors cannot be precisely quantified, so they must be treated as producing a cumulative ambiguity in the measured data.

### Directivity

Normally a device that can separate the reverse from the forward traveling waves (a directional bridge or coupler) is used to detect the signal reflected from the device under test. Ideally the coupler would completely separate the incident and reflected signals, and only the reflected signal would appear at the coupled output, as illustrated in Figure 6–1(a).

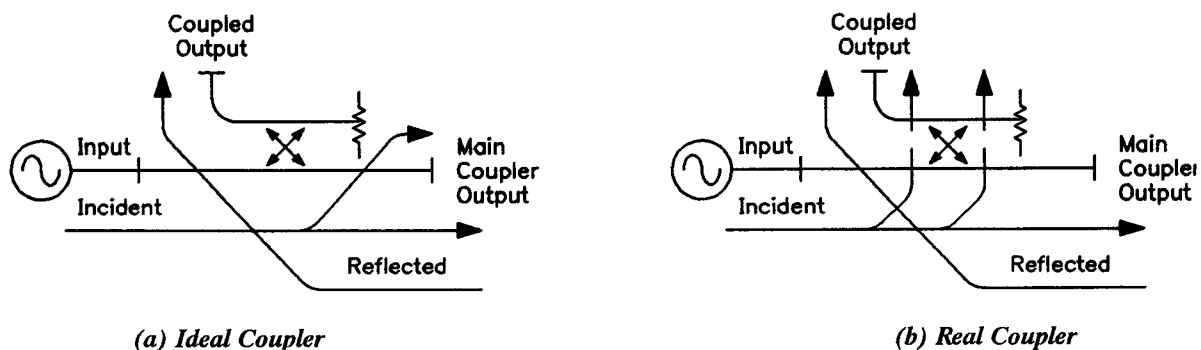
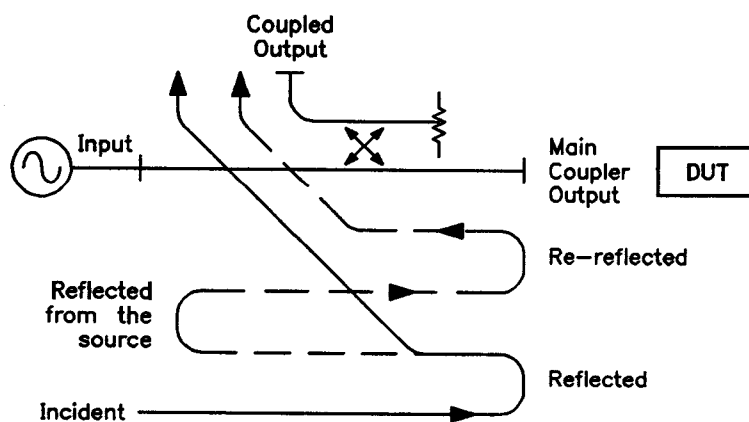


Figure 6–1. Directivity

However, a real coupler is not perfect, as illustrated in Figure 6–1(b). A small amount of the incident signal appears at the coupled output due to leakage as well as to reflection from the termination in the coupled arm. Also reflections from the coupler output connector appear at the coupled output, adding uncertainty to the signal reflected from the device. The figure of merit for how well a coupler separates forward and reverse waves is directivity. The larger the directivity, the better the separation of signals. System directivity is the vector sum of all leakage signals appearing at the network analyzer receiver input due to the inability of the signal separation device to absolutely separate incident and reflected waves, and to residual reflection effects of test cables and adapters between the signal separation device and the measurement plane. The error contributed by directivity is independent of the characteristics of the test device and it usually produces the major ambiguity in measurements of low reflection devices.

## Source Match

Source match is defined as the vector sum of signals appearing at the network analyzer receiver input due to the impedance mismatch at the test device looking back into the source, as well as to adapter and cable mismatches and losses. In a reflection measurement, the source match error signal is caused by some of the reflected signal from the DUT being reflected from the source back towards the DUT, and re-reflected from the DUT (Figure 6–2). In a transmission measurement, the source match error signal is caused by reflection from the test device that is re-reflected from the source. Source match is most often given in terms of return loss in dB: thus the larger the number, the smaller the error.

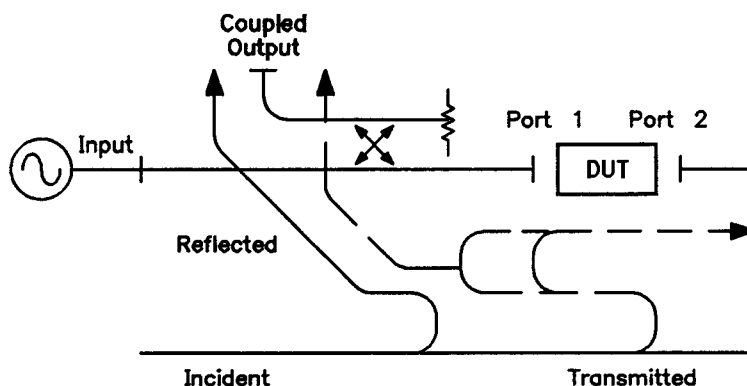


*Figure 6–2. Source Match*

The error contributed by source match is dependent on the relationship between the actual input impedance of the test device and the equivalent match of the source, and it is a factor in both transmission and reflection measurements. Source match is particularly a problem in measurements where there is a large impedance mismatch at the measurement plane.

## Load Match

Load match error results from an imperfect match at the output of the test device. It is caused by impedance mismatches between the test device output port and port 2 of the measurement system. As illustrated in Figure 6–3, some of the transmitted signal is reflected from port 2 back to the test device. A portion of this wave may be re-reflected to port 2, or part may be transmitted through the device in the reverse direction to appear at port 1. If the DUT has low insertion loss (for example a transmission line), the signal reflected from port 2 and re-reflected from the source causes a significant error because the DUT does not attenuate the signal significantly on each reflection. Load match is usually given in terms of return loss in dB: thus the larger the number, the smaller the error.



*Figure 6–3. Load Match*

The error contributed by load match is dependent on the relationship between the actual output impedance of the test device and the effective match of the return port (port 2), and is a factor in all transmission measurements and in reflection measurements of two-port devices. Load and source match are usually ignored when the test device insertion loss is greater than about 6 dB, because the error signal is greatly attenuated each time it passes through the DUT. However, load match effects produce major transmission measurement errors for a test device with a highly reflective output port.

## Isolation (Crosstalk)

Leakage of energy between network analyzer signal paths contributes to error in a transmission measurement much like directivity does in a reflection measurement. Isolation is the vector sum of signals appearing at the network analyzer digitizing detectors due to crosstalk between the reference and test signal paths, including signal leakage in both the RF and IF sections of the receiver.

The error contributed by isolation depends on the characteristics of the device under test. Isolation is a factor in high-loss transmission measurements. However, system isolation is more than sufficient for most measurements, and correction for it may be unnecessary. For measuring devices with high dynamic range, accuracy enhancement can provide improvements in isolation that are limited only by the noise floor.



## Frequency Response (Tracking)

This is the vector sum of all test setup variations in which magnitude and phase change as a function of frequency. This includes variations contributed by signal separation devices, test cables, and adapters, and variations between the reference and test signal paths. This error is a factor in both transmission and reflection measurements.

For further explanation of systematic error terms and the way they are combined and represented graphically in error models, refer to *Accuracy Enhancement Fundamentals—Characterizing Microwave Systematic Errors* in Appendix B.

## CORRECTING FOR MEASUREMENT ERRORS

In all, there are twelve different error terms for a two-port measurement that can be corrected by accuracy enhancement in the analyzer. These are:

directivity	isolation
source match	reflection tracking
load match	transmission tracking

each in both the forward and reverse direction. The analyzer has several different measurement calibration routines to characterize one or more of the systematic error terms and remove their effects from the measured data. The procedures range from a simple frequency response calibration to a full two-port calibration that effectively removes all twelve error terms.

**The Response Calibration** effectively removes the frequency response errors of the test setup for reflection or transmission measurements. This calibration procedure may be adequate for measurement of well matched low-loss devices. This is the simplest error correction to perform, and should be used when extreme measurement accuracy is not a critical factor.

**The Response and Isolation Calibration** effectively removes frequency response and crosstalk errors in transmission measurements, or frequency response and directivity errors in reflection measurements. This procedure may be adequate for measurement of well matched high-loss devices.

**The S11 and S22 One-Port Calibration** procedures provide directivity, source match, and frequency response vector error correction for reflection measurements. These procedures provide high accuracy reflection measurements of one-port devices or properly terminated two-port devices.

**The Full Two-Port Calibration** provides directivity, source match, load match, isolation, and frequency response vector error correction, in both forward and reverse directions, for transmission and reflection measurements of two-port devices. This calibration provides the best magnitude and phase measurement accuracy for both transmission and reflection measurements of two-port devices.

**The TRL\*/LRM\* 2-Port Calibration** performs a complete calibration for measurement of all four S-parameters, of a two port device. Since the analyzer's hardware cannot correct for the effects of source match and load match fully, it is less accurate than the full two-port calibration.

All the calibration procedures described above are accessed from the **CAL** key and are described in detail in the following pages.

The uncorrected performance of the network analyzer is sufficient for many measurements. However, the vector accuracy enhancement techniques described in this chapter will provide a much higher level of accuracy. Figure 6–4, Figure 6–5, and Figure 6–6 illustrate the improvements that can be made in measurement accuracy by using a more complete calibration routine. Figure 6–4(a) shows a measurement in log magnitude format with a response calibration only. Figure 6–4(b) shows the improvement in the same measurement using an S11 one–port calibration. Figure 6–5(a) shows the measurement in a Smith chart format with response calibration only, and Figure 6–5(b) shows the same measurement with an S11 one–port calibration.

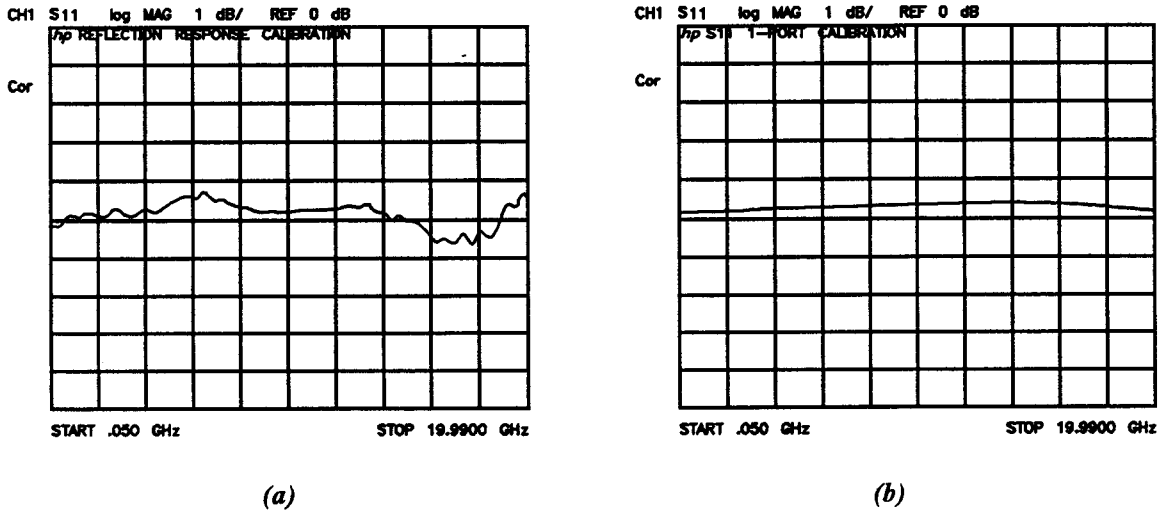


Figure 6–4. Response vs. S11 1–Port Calibration on Log Magnitude Format

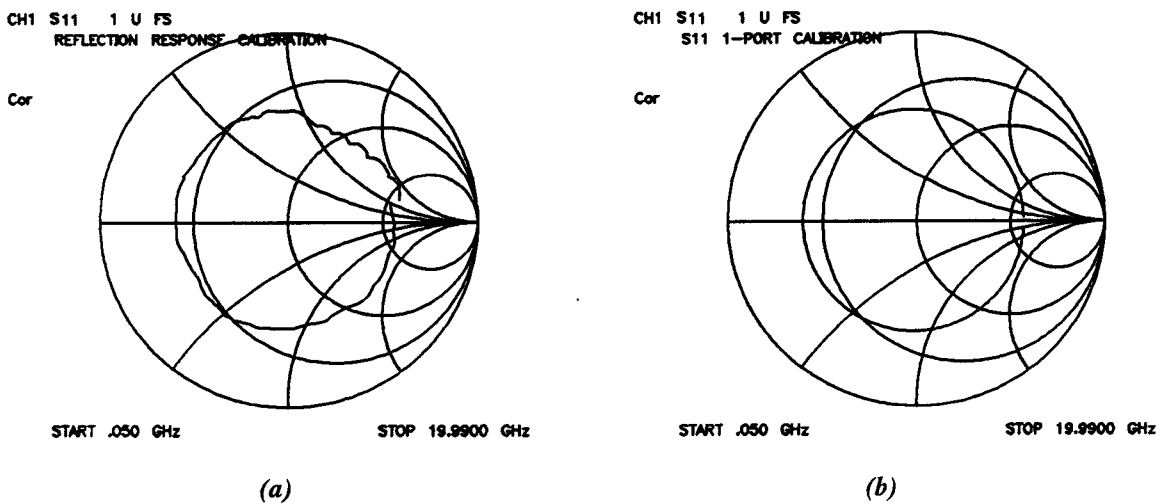


Figure 6–5. Response vs. S11 1–Port Calibration on Smith Chart

Figure 6–6 shows the response of a low–loss device in a log magnitude format, using a response calibration in Figure 6–6(a) and a full two–port calibration in Figure 6–6(b).

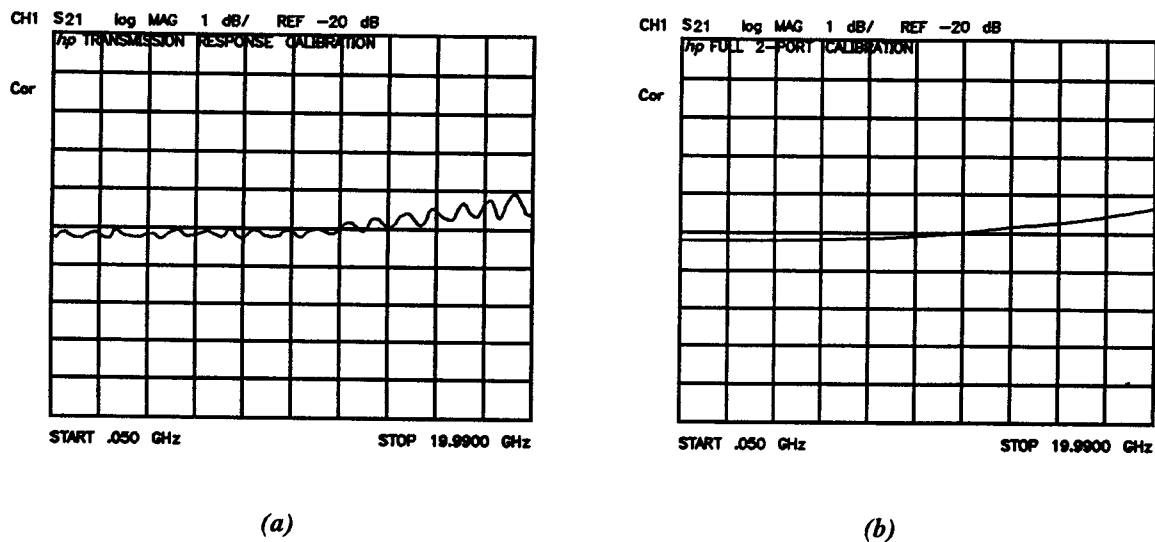


Figure 6-6. Response vs. Full Two-Port Calibration

**NOTE:** At microwave frequencies an open circuit exhibits a change in phase with frequency, caused by fringing capacitance. When an open circuit is measured after calibration, this appears as an arc of varying length in the lower right circumference of the Smith chart. This is normal: at microwave frequencies, a capacitance reading of  $0^\circ$  would be inaccurate. Accuracy enhancement in the analyzer models the open circuit capacitance at all frequencies for the compatible calibration kits, and uses it to determine system errors.

A comparable effect may be observed in measuring an offset short. The result appears as an arc in the upper left circumference of the Smith chart. The short circuits in some of the compatible 3.5 mm and type-N calibration kits are offset shorts: refer to the individual calibration kit manuals for details. Accuracy enhancement models the offsets for the default calibration kits and uses the models to determine system errors.

## CAL KEY

The **CAL** (MENCAL) key leads to a series of menus that implement the accuracy enhancement procedures described in the preceding pages (see Figure 6-7). Accuracy enhancement (error correction) is performed as a calibration step before measurement of a test device, using measurements of known standard devices to solve for the error terms. The analyzer uses one of several different procedures to characterize the systematic, repeatable errors of the system and remove their effects from the measured data. The calibration menus and procedures are described and illustrated in the following pages. Each procedure compensates for one or more of the systematic errors. They range from a simple frequency response calibration to a full two-port calibration that removes all twelve error terms.

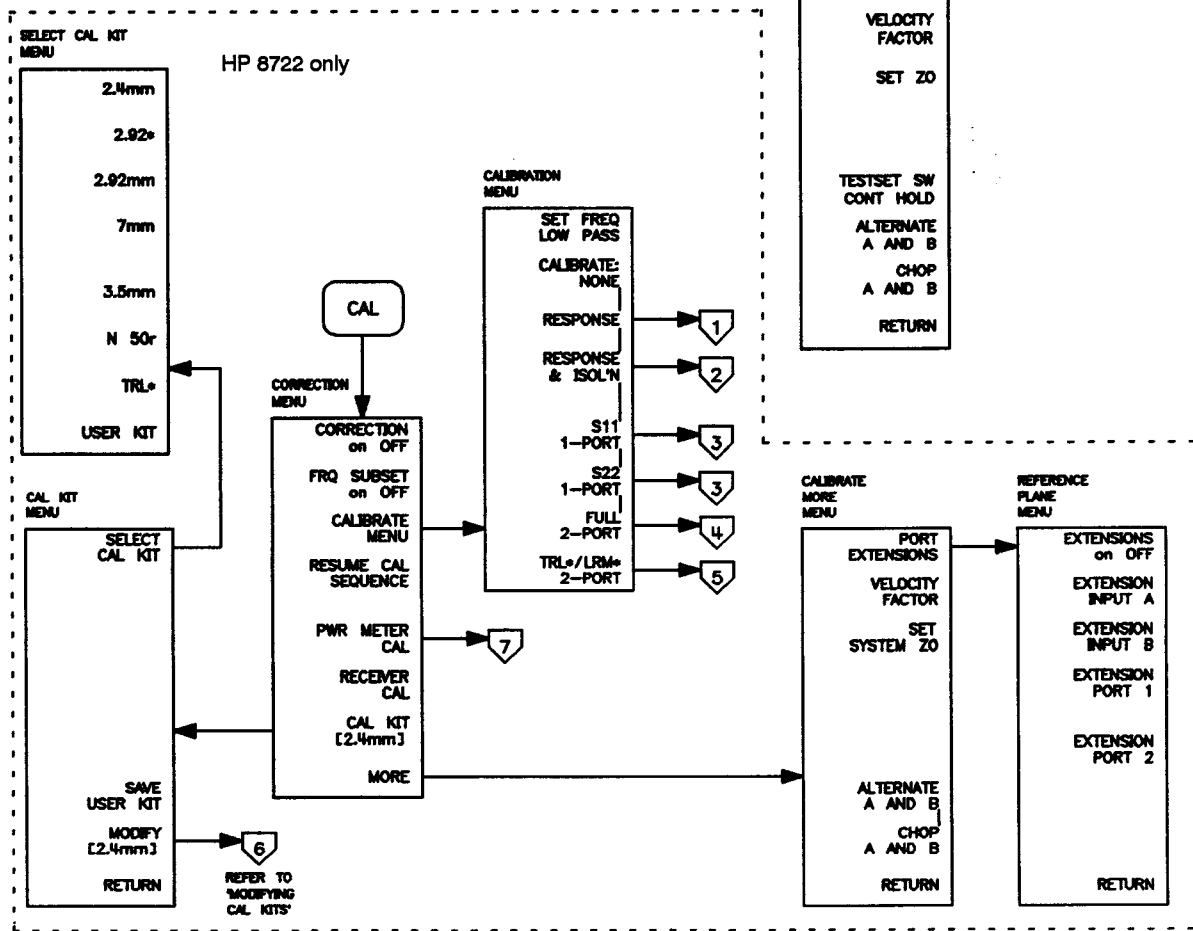
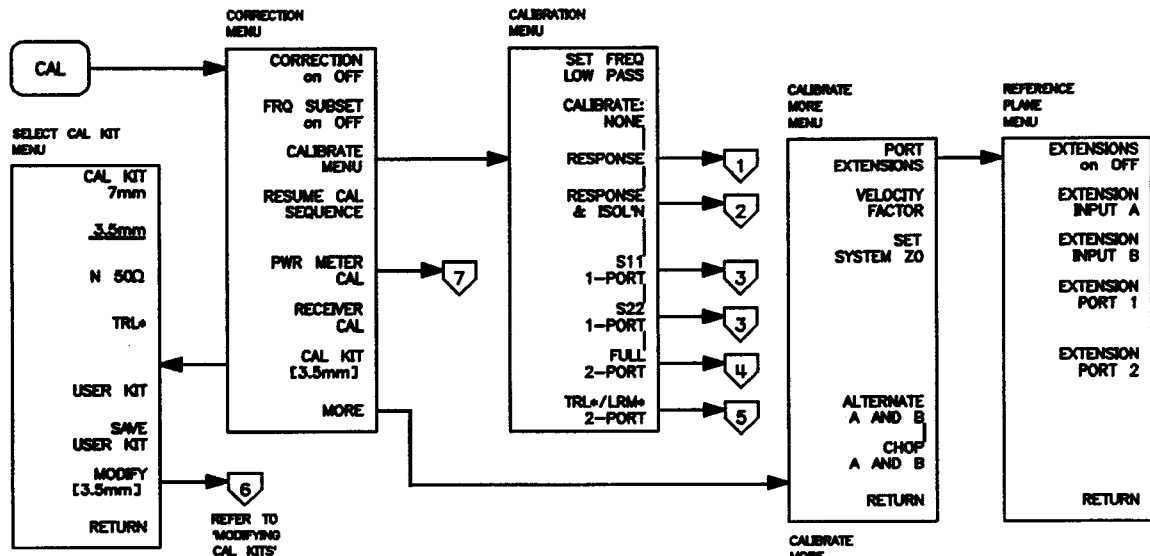


Figure 6-7. Relationship of the Menus Accessed from the **CAL** Key

The precision standard devices required for calibration of the system are available in compatible calibration kits with different connector types. The model numbers and contents of these calibration kits are listed in the *General Information* section of this manual. Each kit contains at least one short circuit, one open circuit, and two impedance-matched loads. In kits that require adapters for interface to the test ports, the adapters are phase-matched for calibration prior to measurement of non-insertable and non-reversible devices. The analyzer provides mathematical models of three predefined calibration kits (see *Select Cal Kit Menu*). Other standard devices can be used by specifying their characteristics in a user-defined kit, as described at the end of this chapter under *Modifying Calibration Kits*.

The accuracy improvement of the correction is limited by the quality of the standard devices, and by the connection techniques used. For information about connector care and connection techniques, refer to the *Microwave Connector Care Manual* in the *Connector Care and Applications* section. For maximum accuracy, use a torque wrench for final connections. The techniques for torquing connections and the part numbers for torque wrenches recommended for different connector types are provided in the connector care documents listed above.

Measurement calibrations are valid only for a specific stimulus state, which must be set before calibration is started. The stimulus state consists of the selected frequency range, number of measurement points, sweep time, power range, and sweep type. Changing the frequency range, number of points, power range, or sweep type with correction on invalidates the calibration and turns it off (except as explained in the next paragraph). Changing the sweep time or IF bandwidth changes the status notation "Cor" at the left of the screen to "C?", to indicate that the calibration is in question. There are other parameters, such as IF bandwidth, that when changed can cause the sweep time to be automatically adjusted. If correction is turned off or in question after the stimulus changes are made, pressing **CORRECTION ON** recalls the original stimulus state for the current calibration.

In frequency subset mode, any part of a calibrated frequency range may be selected without invalidating the calibration. See **FREQ SUBSET**, below, for details.

In the frequency list stimulus mode, if a measurement calibration has been performed on the full frequency list, one or all of the frequency segments can be measured and displayed without loss of calibration. Refer to *Sweep Type Menu* in Chapter 4 for more information on frequency list mode.

Up to two sets of measurement calibration data can be defined for each instrument state, one for each channel. If the two channels are stimulus coupled and the input ports are the same for both channels, they share the same calibration data. If the two channel inputs are different, they can have different calibration data. If the two channels are stimulus uncoupled, the measurement calibration applies to only one channel. For information on stimulus coupling, refer to *Stimulus Menu* in Chapter 4.

Calibration procedures are parameter-specific, rather than channel-specific. When a parameter is selected, the instrument checks the available calibration data, and uses the data found for that parameter. For example, if a transmission response calibration is performed for S21, and a 1-port calibration for S11, the analyzer retains both calibration sets and corrects whichever parameter is displayed. Once a calibration has been performed for a specific parameter, measurements of that parameter remain calibrated in either channel, as long as stimulus values are coupled. In a frequency response calibration, the parameter must be selected before calibration: other correction procedures select parameters automatically. Changing channels during a calibration procedure invalidates the part of the procedure already performed.

In procedures that require measurement of several different devices, for example a short, an open, and a load, the order in which the devices are measured is not critical. Any standard can be re-measured, until the **DONE** key is pressed. The change in trace during measurement of a standard is normal.

A frequency response calibration requires measurement of only one standard device. If more than one device is measured, only the data for the last device is retained.

Isolation calibration can be omitted for most measurements, except where wide dynamic range is a consideration. Use the following guidelines. When the measurement requires a dynamic range of:

- <80 dB: Omit isolation calibration.
- 80 to 90 dB: Isolation calibration is recommended, using an averaging factor  $\geq 16$  for the isolation portion of the calibration.
- >90 dB: Averaging should be on with an averaging factor  $\geq 16$ , both for isolation calibration and for measurement after calibration.

A calibration that is interrupted to go to another menu can be continued with the **RESUME CAL SEQUENCE** key in the correction menu.

It is recommended that calibration data be saved, either in internal, non-volatile memory or on an external disk. Refer to Chapter 11, *Saving Instrument States*. If a calibration is not saved, it will be lost if another calibration procedure is selected for the same channel. Instrument preset, power on, and instrument state recall will also clear the calibration data. If the stimulus values are changed, calibration is turned off: turning calibration back on will recall the original values.

**NOTE:** Caution is necessary in storing instrument state files to an external disk from one instrument and later loading them into another. Measurement calibration compensates for system uncertainties, such as those contributed by interconnecting cables and adapters and the condition of the calibration standards. A calibration stored from one instrument and recalled by a different one will be inaccurate. To ensure maximum accuracy, always recalibrate in these circumstances. Listed specifications apply to the instrument on which a measurement calibration has been performed.

Take particular note of the following conditions that may invalidate the calibration data or cause it to be in doubt:

- Frequencies are incompatible between a standard instrument and an option 001. If an instrument state is stored, with correction on, from an option 001 (high resolution) instrument, and later recalled by a standard instrument, the error correction data is not necessarily valid. It can only be valid if the minimum frequency span (or segment span in frequency list mode) conforms to the equation:

$$\text{span} = 100 \text{ kHz} \times (\text{number of points} - 1) \times n \text{ where } n = 1, 2, 3\dots$$

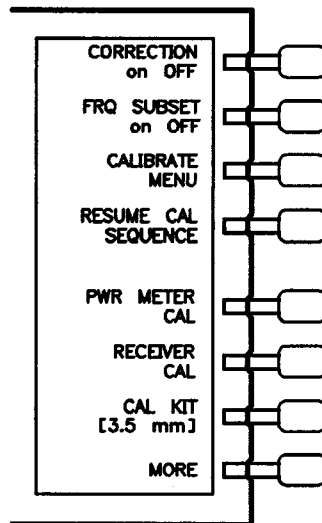
Otherwise, correction is turned off and the message "CAUTION: CORR OFF; FREQ INCOMPATIBLE INST STATE" is displayed.

- No record is kept in memory of the temperature when a calibration set was stored. Instrument characteristics change as a function of temperature, and a calibration stored at one temperature may be inaccurate if recalled and used at a different temperature. Refer to *System Specifications* in the *Specifications* section for allowable temperature ranges for individual specifications.

Refer to Chapter 11, *Saving Instrument States*, for more information about direct storage to an external disc.

## Correction Menu

The correction menu is the first menu presented by the **CAL** key, and it provides access to numerous menus of additional calibration features.



*Figure 6–8. Correction Menu*

**CORRECTION on OFF** (CORRON, CORROFF) turns error correction on or off. The analyzer uses the most recent calibration data for the displayed parameter. If the stimulus state has been changed since calibration, the original state is recalled, and the message "SOURCE PARAMETERS CHANGED" is displayed.

A calibration must be performed before correction can be turned on. If no valid calibration exists, the message "CALIBRATION REQUIRED" is displayed on the CRT. At the completion of a calibration procedure correction is automatically turned on, and the notation "Cor" or "C2" is displayed at the left of the screen.

It is recommended that calibration data be saved, either in internal non-volatile memory or on an external disc, using capabilities described in Chapter 11, *Saving Instrument States*.

**FRQ SUBSET on OFF** (FRESON, FRESOFF) lets you select any part of a previously calibrated frequency range while maintaining all of the accuracy of that measurement calibration. For instance assume you have just calibrated a 1 to 9 GHz frequency span with 1601 points. To focus in on the 2 to 3 GHz span, press **FRQ SUBSET ON** and choose those frequencies with the **START** and **STOP** keys. The analyzer will select the points closest to 2 GHz and 3 GHz and display the original data points used in that 1 GHz part of the calibration.

**CALIBRATE MENU** leads to the calibration menu, which provides several accuracy enhancement procedures ranging from a simple frequency response calibration to a full two-port calibration for maximum accuracy.



**RESUME CAL SEQUENCE (RESC)** eliminates the need to restart a calibration sequence that was interrupted to access some other menu. This softkey goes back to the point where the calibration sequence was interrupted.

**PWR METER CAL** leads to the power meter calibration menu.

**RECEIVER CAL** leads to a menu which prompts to connect the calibration standard, set the reference value, and then take the receiver Cal sweep.

**CAL KIT** leads to the select cal kit menu, which is used to select one of the default compatible calibration kits available for different connector types. This in turn leads to additional menus used to define calibration standards other than those in the default kits (refer to *Modifying Calibration Kits* later in this chapter). When a calibration kit has been specified, its connector type is displayed in brackets in the softkey label.

**MORE** provides access to the calibrate more menu, which is used to extend the test port reference plane, to specify the characteristic impedance of the system, and to specify the relative propagation velocity factor for distance-to-fault measurements using the time domain option.

## Select Cal Kit Menu

The select cal kit menu is used to select the calibration kit to be used for a measurement calibration. Selecting a cal kit chooses the model that mathematically describes the standard devices actually used. (Refer to the beginning of this chapter, and the appendix at the end of this chapter, for more background on measurement calibrations and error correction.)

The analyzer has the capability to calibrate with several predefined cal kit models in different connector types. The cal kit models correspond to the standard calibration kits available as accessories for the HP 8720:

- 7 mm calibration kit
- 3.5 mm calibration kit
- 50 ohm type-N calibration kit
- TRL\* calibration kit
- 2.4 mm calibration kit
- 2.92 mm calibration kit

How closely must the model match the actual device? The answer depends on the accuracy required. Certainly *any* calibration provides better accuracy than none at all, yet simple normalization is often quite adequate for many applications. The errors introduced by using the internal 3.5 mm model with a Hewlett-Packard 3.5 mm cal kit other than the HP 85052B/D are vanishingly small. Yet for the highest accuracy, the more closely the model matches the device, the better.

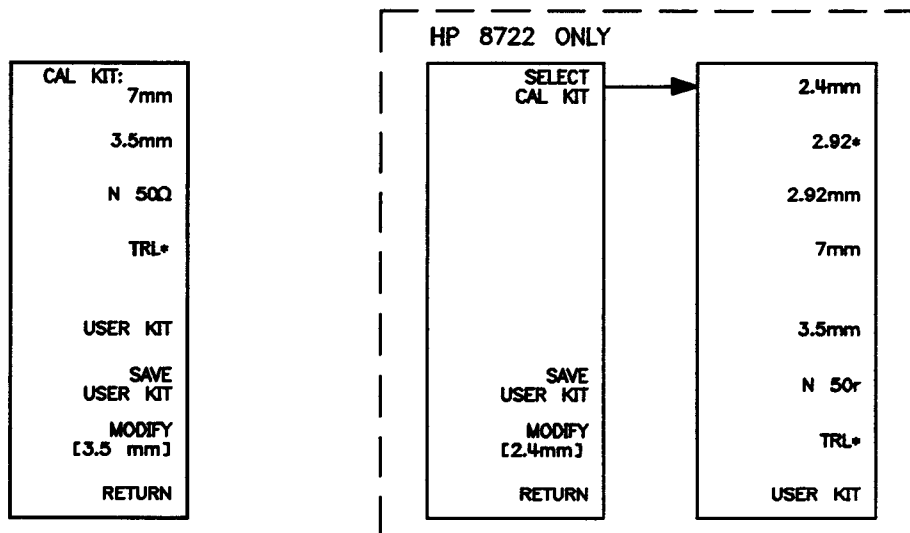


Figure 6-9. Select Cal Kit Menu

In addition to the predefined cal kits, a “user kit” may be defined or modified by the user. This is described under *Modifying Calibration Kits* at the end of this chapter.

**CAL KIT [7 mm]** (CALK7MM) selects the 7 mm calibration kit model.

**CAL KIT [3.5 mm]** (CALK35MM) selects the 3.5 mm calibration kit model.

**CAL KIT [2.92 mm]** (CAL292MM) selects the 2.92 mm calibration kit model.

**CAL KIT [2.92\*]** Adapter cal. Select this cal and use 2.4 mm devices, then put 2.4 mm to 2.92 mm adapter on test port to measure 2.92 mm devices.

**CAL KIT [2.4 mm]** (CAL24MM) selects the 2.4 mm calibration kit model.

**N50Ω** (CALKN50) selects the 50 ohm type-N calibration kit model.

**NOTE:** If **N50Ω** is selected, additional menus are provided during calibration procedures to select the connector sex. (This is the connector sex of the instrument test port, not the actual calibration standard.)

**TRL\*** (CALKTRLK) selects the TRL\* template kit. TRL\* calibration is recommended only in fixture microstrip measurements.

**USER KIT** (CALKUSED) selects a cal kit model defined or modified by the user. Refer to *Modifying Calibration Kits* at the end of this chapter for information.

**SAVE USER KIT** (SAVEUSEK) stores the user-modified or user-defined kit into memory, after it has been modified.

**MODIFY** (MODI1) leads to the modify cal kit menu (see the end of this chapter), where a predefined cal kit can be user-modified.

**RETURN** goes back to the correction menu.

## Calibrate More Menu

This menu is used to extend the test port reference plane, to specify the characteristic impedance of the system, and to specify the relative propagation velocity factor for distance-to-fault measurements.

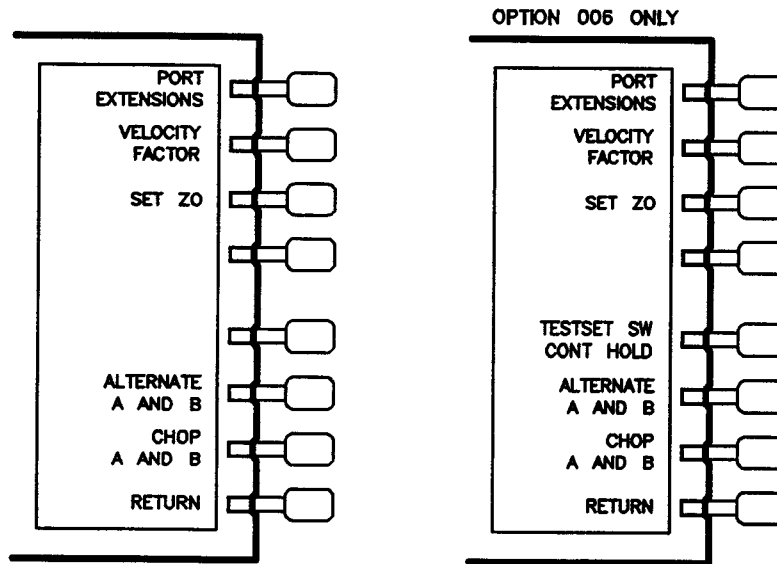


Figure 6-10. Calibrate More Menu

**PORT EXTENSIONS** goes to the reference plane menu, which is used to extend the apparent location of the measurement reference plane.

Table 6-7. Differences between **PORT EXTENSIONS** and **ELECTRICAL DELAY**

	PORT EXTENSIONS	ELECTRICAL DELAY
<b>Main Effect</b>	The end of a cable becomes the test port plane for all S-parameter measurements.	Compensates for the electrical length of a cable for the current type of measurement only. Reflection = 2 times cable's electrical length Transmission = 1 times cable's electrical length.
<b>Measurements Affected</b>	All S-parameters.	Only the currently selected S-parameter.
<b>Electrical Compensation</b>	Intelligently compensates for 1 times or 2 times the cable's electrical delay, depending on which S-parameter is computed.	Only compensates as necessary for the currently selected S-parameter.

**VELOCITY FACTOR (VELOFACT)** enters the velocity factor used by the analyzer to calculate equivalent electrical length in distance-to-fault measurements using the time domain option. Velocity factor is also used to compute equivalent distance while adjusting electrical delay (explained in chapter 4). Values entered should be less than 1. For example, the velocity factor of teflon is:

$$V_1 = \frac{1}{\sqrt{\epsilon_r}} = 0.666$$

**SYSTEM Z<sub>0</sub> (SETZ)** modifies the characteristic impedance value Z<sub>0</sub> recognized by the analyzer (the default value is 50Ω). This characteristic impedance sets the center value of the Smith chart, and is used by the network analyzer in calculating impedance measurements. In addition, it is used in calculating parameter conversions (refer to *Conversion Menu* in Chapter 5 for more information).

If the characteristic impedance of the calibration standards is not 50 ohms, a minimum loss pad or matching transformer should be inserted at the measurement port. The characteristic impedance must be set correctly before calibration procedures are performed.

**TESTSET SW CONT HOLD (CSWI ON/OFF) Option 006 Only.** This selection toggles the internal solid state switch from a continuously switching mode to a hold mode.

**ALTERNATE A AND B (ALTAB)** measures only one input per frequency sweep, in order to reduce spurious signals. Thus, this mode optimizes the dynamic range for all four S-parameter measurements.

The disadvantages of this mode are associated with simultaneous transmission/reflection measurements or full two-port calibrations: this mode takes twice as long as the chop mode to make these measurements.

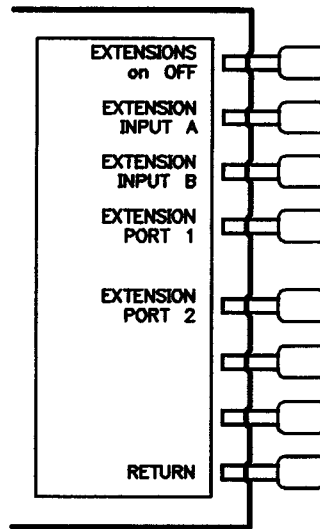
**CHOP A AND B (CHOPAB)** measures both inputs A and B during each sweep. Thus, if each channel is measuring a different parameter and both channels are displayed, the chop mode offers the fastest measurement time. This is the preferred measurement mode for full two-port calibrations because both inputs remain active. This is the default measurement mode.

The disadvantage of this mode is that in measurements of high rejection devices, such as filters with a low-loss passband (>400 MHz wide), maximum dynamic range may not be achieved.

**RETURN** goes back to the correction menu.

## Reference Plane Menu

This menu adds electrical delay in seconds to the measurement ports to extend the apparent location of the measurement reference plane to the ends of the cables. This is equivalent to adding a length of perfect air line, and makes it possible to measure the delay response of the device only, instead of the device plus the cable.



*Figure 6–11. Reference Plane Menu*

**EXTENSIONS on OFF** (POREON, POREOFF) toggles the reference plane extension mode. When this function is on, the port extensions defined below are enabled.

**EXTENSION PORT 1** (PORT1) extends the reference plane at port 1 for measurements of S11, S21, and S12.

**EXTENSION PORT 2** (PORT2) extends the reference plane at port 2 for measurements of S22, S12, and S21.

**EXTENSION INPUT A** extends the reference plane at the A input.

**EXTENSION INPUT B** extends the reference plane at the B input.

**RETURN** goes back to the calibrate more menu.

## Calibration Menu

The calibration menu is used to select the appropriate accuracy enhancement procedure for calibration before a measurement is performed. Five different calibration routines are available, each of which effectively removes from one to twelve systematic errors from the measurement data. Each procedure features CRT prompts to guide you through the calibration sequence. The available calibrations are described below, and a comparative summary is provided in Table 6–9. Procedures for performing each of the calibrations are provided in the following pages, with illustrations of the corresponding menus.

Note that all instrument parameters should be established before a calibration procedure is started, including stimulus values, calibration kit, and system characteristic impedance  $Z_0$ . (To modify  $Z_0$ , refer to *Calibrate More Menu*, above).

Measurement calibrations requiring load standards provide additional menus to specify the load(s). For broadband calibrations, use either a broadband load or, for the highest level of accuracy, a combination of lowband and sliding loads. For measurements above 3 GHz in 3.5 mm (2 GHz in 7 mm or type-N), the lowband load calibration can be omitted. For measurements below 3 GHz in 3.5 mm (2 GHz in 7 mm or type-N), the lowband load alone is sufficient (see Table 6–8). If you try to use only a sliding load or only a lowband load beyond these frequency cutoff points, the message “CAUTION: ADDITIONAL STANDARDS NEEDED” will be displayed to indicate that both loads are required.

Table 6–8. Load Cutoff Frequencies

Connector Type	Broadband Load (50 MHz to 20 GHz)	
	Lowband Load	Sliding Load
3.5 mm	50 MHz to 3 GHz	3 GHz to 20 GHz
7 mm	50 MHz to 2 GHz	2 GHz to 20 GHz
type-N	50 MHz to 2 GHz	2 GHz to 20 GHz
2.4 mm	50 MHz to 4 GHz	4 GHz to 40 GHz

**NOTE:** By convention, when the connector sex is provided in parentheses for a calibration standard, it refers to the sex of the test port connector, not the actual standard. For example, short (m) indicates that the test port connector, not the short circuit connector, is male.

For measurement of test devices following calibration, refer to the *User's Guide*.

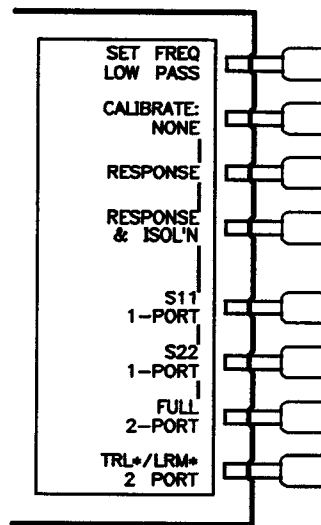


Figure 6–12. Calibration Menu

**SET FREQ LOW PASS** changes the frequency sweep to harmonic intervals to accommodate time domain low-pass operation in option 010 instruments.

**NOTE:** If time domain low-pass mode is to be used, the frequencies must be set **before calibration**. Refer to Chapter 8, *Time and Frequency Domain Transforms*, for more information.

**CALIBRATE NONE** is underlined if no calibration has been performed or if the calibration data has been cleared. Unless a calibration is saved in memory, the calibration data is lost on instrument preset, power on, or instrument state recall. If stimulus values are changed, calibration is turned off: turning it back on will recall the original values.

**RESPONSE** (CALIRESP) leads to the frequency response calibration. This is the simplest and fastest accuracy enhancement procedure, and should be used when extreme accuracy is not a factor. It effectively removes the frequency response errors of the test setup for reflection or transmission measurements.

For transmission-only measurements or reflection-only measurements, only a single calibration standard is required with this procedure. The standard for transmission measurements is a thru, and for reflection measurements can be either an open or a short. If more than one device is measured, only the data for the last device is retained. The procedures for response calibration for a reflection measurement and a transmission measurement are described in the following pages.

**RESPONSE & ISOL N** (CALIRAI) leads to the menus used to perform a frequency response and isolation measurement calibration, for measurement of devices with wide dynamic range. This procedure effectively removes the same frequency response errors as the response calibration. In addition, it effectively removes the isolation (crosstalk) error in transmission measurements or the directivity error in reflection measurements. As well as the devices required for a simple response calibration, an isolation standard is required. The standard normally used to correct for isolation in this procedure is a broadband impedance-matched load (usually 50 ohms). Response and isolation calibration procedures for reflection and transmission measurements are provided in the following pages.

**S11 1-PORT** (CALIS111) provides a measurement calibration for reflection-only measurements of one-port devices or properly terminated two-port devices at test port 1. This procedure effectively removes the directivity, source match, and frequency response errors of the test setup, and provides a higher level of measurement accuracy than the frequency response and isolation calibration. It is the most accurate calibration procedure for reflection-only measurements. The standard devices required are a short, an open, and usually either a broadband load or a sliding and a lowband load. The procedure for performing an S11 1-port calibration is described in the following pages.

**S22 1-PORT** (CALIS221) is similar to **S11 1-PORT**. It is used for reflection-only measurements of one-port devices or properly terminated two-port devices in the reverse direction: that is, for devices connected to port 2.

**FULL 2-PORT** (CALIFUL2) leads to the series of menus used to perform a complete calibration for measurement of all four S-parameters of a two-port device. This is the most accurate calibration for measurements of two-port devices. It effectively removes all correctable systematic errors (directivity, source match, load match, isolation, reflection tracking, and transmission tracking) in both the forward and reverse directions. Isolation correction can be omitted for measurements of devices with limited dynamic range.

**TRL/LRM 2-PORT** (CALITRL2) leads to a series of menus used to perform a complete calibration for measurement of all four S-parameters of a two port device. Since the network analyzer's hardware cannot correct for the effects of source match and load match fully, it is less accurate than the Full 2-Port method.

The standards for this procedure are a short, an open, a thru, and an impedance–matched load (two loads if isolation correction is required). The load(s) used are usually either a broadband load or a sliding and a lowband load, depending on the frequency range and the level of accuracy required. The procedure is described in the following pages.

*Table 6–9. Purpose and Use of Different Calibration Procedures*

<b>Calibration Procedure</b>	<b>Corresponding Measurement</b>	<b>Errors Removed</b>	<b>Standard Procedure</b>
Response	Transmission or reflection measurement when the highest accuracy is not required.	Freq. response	Thru for trans., open OR short for reflection
Response & isolation	Transmission of high insertion loss devices or reflection of high return loss devices. Not as accurate as 1–port or 2–port calibration	Freq. response PLUS isolation in transmission or directivity in reflection	Same as response PLUS isolation std (load)
S11 1–port	Reflection of any one–port device or well terminated two–port device	Directivity, source match, freq. response	Short AND open AND load(s)
S22 1–port	Reflection of any one–port device or well terminated two–port device	Directivity, source match, freq. response	Short AND open AND load(s)
Full 2–port	Transmission or reflection of highest accuracy for two–port devices	Directivity, source match, load match, isolation, freq. response (forward and reverse)	Short AND open AND load(s) AND thru (2 loads for isolation)
TRL*/LRM* 2–port	Transmission or reflection when highest accuracy is not required.	Directivity, isolation, frequency response (forward and reverse)	Thru reflect line (See Product Note 8720–2)



## Response Calibration for Reflection Measurements

The procedure described here uses the menu illustrated in Figure 6–13 to perform a frequency response only calibration for a measurement of S11. It can also be used for S22 by substituting the corresponding softkey in the S–parameters menu.

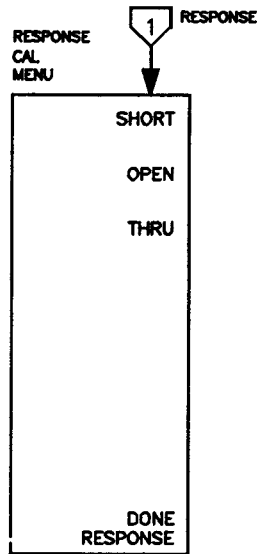


Figure 6–13

- Press **MEAS** Refl: FWD S11 .
- Press **CAL** .
- Select the proper calibration kit. If the connector type or cal kit name shown in the **CAL KIT** softkey label is not the same as the calibration kit to be used, refer to *Select Cal Kit Menu*.
- Press **CALIBRATE MENU RESPONSE** .
- At port 1, connect either a short OR an open circuit.
- When the trace settles, press **SHORT** or , depending on the standard used. (If more than one device is measured, only the data for the last device is retained.)
- The message "WAIT—MEASURING CAL STANDARD" is displayed while the data is measured. The softkey label **SHORT** or **OPEN** is then underlined.
- Press **DONE RESPONSE** . The calibration coefficients are computed and stored. A corrected trace is displayed and the notation "Cor" appears at the left side of the screen.
- The save menu is displayed. (It is recommended that calibration data be saved, either in internal nonvolatile memory or on an external disk. Refer to Chapter 11, *Saving Instrument States*, for more information.)
- This completes the frequency response calibration for a reflection measurement. Now the test device can be connected and measured.

## Response Calibration for Transmission Measurements

The procedure described here uses the menu in Figure 6–13 to perform a frequency response only calibration for a measurement of S21. To calibrate for a combined transmission and reflection measurement, perform the transmission calibration on one channel and the reflection calibration described previously on the other channel.

- Press **MEAS** **Trans: FWD S21** .
- Press **CAL** .
- Select the proper calibration kit. If the connector type or cal kit name shown in the **CAL KIT** softkey label is not the same as the calibration kit to be used, refer to *Select Cal Kit Menu*.
- Press **CALIBRATE MENU** **RESPONSE** .
- Make a thru connection (connect together the points at which the test device will be connected).
- When the trace settles, press **THRU** .
- The message “WAIT—MEASURING CAL STANDARD” is displayed while the S21 data is measured. The softkey label **THRU** is then underlined.
- Press **DONE:RESPONSE** . The calibration coefficients are computed and stored. Corrected S21 data is displayed and the notation “Cor” appears at the left side of the screen.
- The save menu is displayed. (It is recommended that calibration data be saved, either in internal nonvolatile memory or on an external disk. Refer to Chapter 11, *Saving Instrument States*, for more information.)
- This completes the frequency response calibration for a transmission measurement. Now the test device can be connected and measured.

## Response and Isolation Calibration for Reflection Measurements

The procedure described here effectively removes the frequency response and directivity errors for reflection measurements. The menus illustrated in Figure 6–14 are used to perform a calibration for a measurement of S11. The same calibration can be used for S22 by substituting the corresponding softkey in the S–parameters menu.

**NOTE:** Corrected directivity is limited to the return loss of the termination. For measurements below 3 GHz in 3.5 mm (2 GHz in 7 mm or type–N), use the lowband load (see Table 6–8). For measurements above 3 GHz in 3.5 mm (2 GHz in 7 mm or type–N), the best directivity correction is provided by a sliding load with the slide fixed.

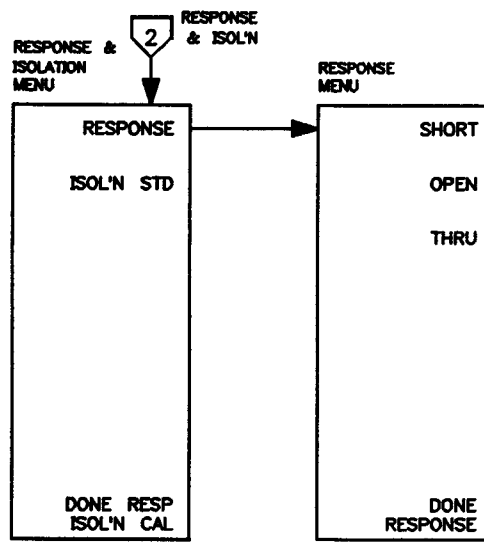


Figure 6-14

- Press **MEAS** Ref: FWD S11 .
- Press **CAL** .
- Select the proper calibration kit. If the connector type or cal kit name shown in the **CAL KIT** softkey label is not the same as the calibration kit to be used, refer to *Select Cal Kit Menu*.
- Press **CALIBRATE MENU** **RESPONSE & ISOL'N** **RESPONSE** .
- At port 1, connect either a short OR an open circuit.
- When the trace settles, press **SHORT** or **OPEN** , depending on the standard used. (If more than one standard is measured, only the data for the last device is retained.)
- The message "WAIT—MEASURING CAL STANDARD" is displayed while the response data is measured. The softkey label **SHORT** or **OPEN** is then underlined.
- Press **DONE:RESPONSE** . The calibration coefficients are computed and stored. The response and isolation menu is displayed.
- Connect the isolation standard (impedance—matched termination) to port 1 (see *NOTE* above).
- Press **ISOL'N STD** . The S11 isolation data is measured. The softkey label is underlined.
- Press **DONE RESP ISOL'N CAL** . The directivity error coefficients are computed and stored. A corrected trace is displayed and the notation "Cor" appears at the left side of the screen.
- The save menu is displayed. (It is recommended that calibration data be saved, either in internal nonvolatile memory or on an external disk. Refer to Chapter 11, *Saving Instrument States*, for more information.)
- This completes the response and isolation calibration for correction of frequency response and directivity errors for reflection measurements. Now the test device can be connected and measured.

## Response and Isolation Calibration for Transmission Measurements

The procedure described here effectively removes the frequency response and isolation errors for transmission measurements of devices with wide dynamic range, using the menus illustrated in Figure 6–14. To calibrate for a combined transmission and reflection measurement, perform the transmission calibration on one channel and the reflection calibration described above on the other channel.

- Press **MEAS** **Trans: FWD S21** .
- Press **AVG** **IF BW** **1** **0** **0** **x1** to reduce the IF bandwidth.
- Press **CAL**
- Select the proper calibration kit. If the connector type or cal kit name shown in the **CAL KIT** softkey label is not the same as the calibration kit to be used, refer to *Select Cal Kit Menu*.
- Press **CALIBRATE MENU** **RESPONSE & ISOL'N** **RESPONSE** .
- Make a thru connection between port 1 and port 2 (connect together the points at which the test device will be connected).
- When the trace has settled, press **THRU** . S21 response data is measured. The softkey label **THRU** is underlined.
- Press **DONE:RESPONSE** .
- Press **AVG** **AVERAGING ON** .\*
- Press **CAL** **RESUME CAL SEQUENCE** .
- Disconnect the thru and connect impedance–matched terminations to port 1 and port 2. Press **ISOL'N STD** . S21 isolation is measured and averaged over 16 sweeps, and the softkey label is underlined.
- Press **AVG** **AVERAGING OFF** .
- Press **CAL** **RESUME CAL SEQUENCE** .
- Press **DONE RESP ISOL'N CAL** . The S21 error coefficients are computed and stored. Corrected S21 data is displayed and the notation "Cor" at the left of the screen indicates that correction is on for this channel.
- The save menu is displayed. (It is recommended that calibration data be saved, either in internal nonvolatile memory or on an external disk. Refer to Chapter 11, *Saving Instrument States*, for more information.)

\* For maximum dynamic range use an averaging factor of 32.

A similar procedure is used to calibrate for measurement of S12, using the **Trans: REV S12** softkey in the S–parameters menu.

## S11 1–Port Calibration for Reflection Measurements

This procedure uses the S11 1–port menus illustrated in Figure 6–15 to perform a complete vector error correction for reflection measurements of one–port devices or properly terminated two–port devices. This is a high–accuracy calibration that effectively removes the directivity, source match, and frequency response errors from the measured data.

**NOTE:** For broadband reflection measurements, use either a broadband load or, for the highest level of accuracy, a combination of lowband and sliding loads. For measurements above 3 GHz in 3.5 mm (2 GHz in 7 mm or type–N), the lowband load calibration can be omitted. For measurements below 3 GHz in 3.5 mm (2 GHz in 7 mm or type–N), the lowband load alone is sufficient (see Table 6–8). If you try to use only a sliding load or only a lowband load beyond these frequency cutoff points, the message “CAUTION: ADDITIONAL STANDARDS NEEDED” will be displayed to indicate that both loads are required.

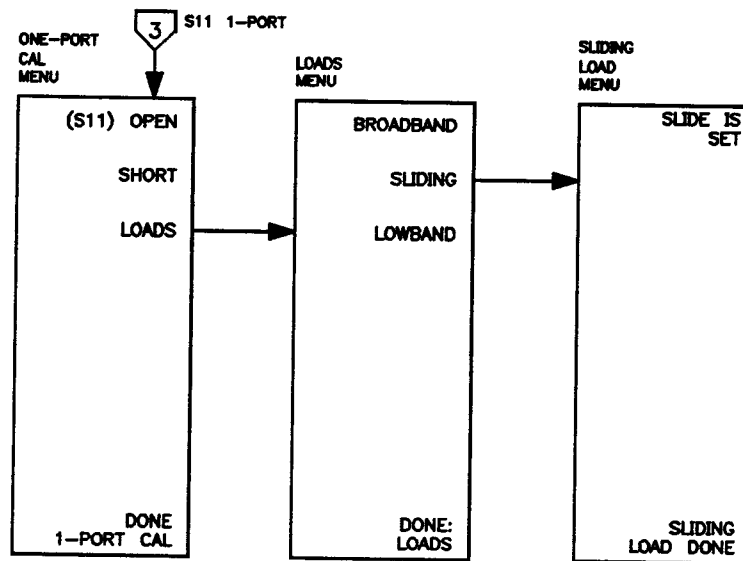


Figure 6–15. Menus for S11 1–Port Calibration

- Press **CAL**.
- Select the proper calibration kit. If the connector type or cal kit name shown in the **CAL KIT** softkey label is not the same as the calibration kit to be used, refer to *Select Cal Kit Menu*.
- Press **CALIBRATE MENU S11 1–PORT**. (S11 will now be measured regardless of any other S–parameter previously selected.)
- Connect an open circuit to port 1.
- When the trace settles, press (S11) **OPEN**.
- The message “WAIT—MEASURING CAL STANDARD” is displayed while the open circuit data is measured. The softkey label **OPEN** is then underlined.

- Disconnect the open, and connect a short circuit to port 1.
- When the trace settles, press **SHORT**. The short circuit data is measured and the softkey label is underlined.
- Disconnect the short, and connect an impedance–matched load (see *NOTE* above) at port 1.
- Press **LOADS**. The loads menu is displayed. When the trace settles, press the softkey corresponding to the load used. If a sliding load is used, the sliding load menu is displayed. Position the slide and press **SLIDE IS SET**. The sliding load must be set and measured five times before **SLIDING LOAD DONE** is pressed. Otherwise, the message "CAUTION: MORE SLIDES NEEDED" is displayed.
- When all the appropriate load measurements are complete, press **DONE:LOADS**. The load data is measured and the **LOADS** softkey label is underlined.
- Press **DONE 1–PORT CAL**. (If you press **DONE** without measuring all the required standards, the message "CAUTION: ADDITIONAL STANDARDS NEEDED" will be displayed.) The calibration coefficients are computed and stored. A corrected S11 trace is displayed, and the notation "Cor" appears at the left side of the screen.
- The save menu is displayed. (It is recommended that calibration data be saved, either in internal nonvolatile memory or on an external disk. Refer to Chapter 11, *Saving Instrument States*, for more information.)
- This completes the S11 1–port calibration. The test device can now be connected and measured.

## S22 1–Port Calibration

This procedure performs a complete vector error correction for a reverse reflection measurement of a one–port device or a properly terminated two–port device. It is similar to the S11 1–port calibration except that S22 is selected automatically.

## Full 2–Port Calibration for Reflection and Transmission Measurements

This procedure uses the menu sequence illustrated in Figure 6–16 to perform complete vector error correction for measurement of all four S–parameters. This is the most accurate calibration for measurements of two–port devices, and effectively removes all correctable systematic errors in both the forward and reverse directions.

**NOTE:** For broadband measurements, use either a broadband load or, for the highest level of accuracy, a combination of lowband and sliding loads. For measurements above 3 GHz in 3.5 mm (2 GHz in 7 mm or type–N), the lowband load calibration can be omitted. For measurements below 3 GHz in 3.5 mm (2 GHz in 7 mm or type–N), the lowband load alone is sufficient (see Table 6–8). If you try to use only a sliding load or only a lowband load beyond these frequency cutoff points, the message “CAUTION: ADDITIONAL STANDARDS NEEDED” will be displayed to indicate that both loads are required.

To maximize the lifetime of the electro–mechanical transfer switch in the network analyzer, switching occurs only once in a measurement sequence using full two–port error correction. On the first sweep all four S–parameters are measured. On subsequent sweeps, the assumption is made that the reverse parameters have not changed, and only the forward parameters are measured. It is possible to override this protection feature for applications where the data changes significantly with time, for example with tuning or drift. To perform an override, use **MEASURE RESTART** in the S–parameter menu (see Chapter 5). Alternatively, for repeated update of all four S–parameters, set an appropriate number of groups using the trigger menu (see Chapter 4).

Isolation calibration can be omitted for most measurements, except where wide dynamic range is a consideration. Refer to the explanation under **CAL** Key.

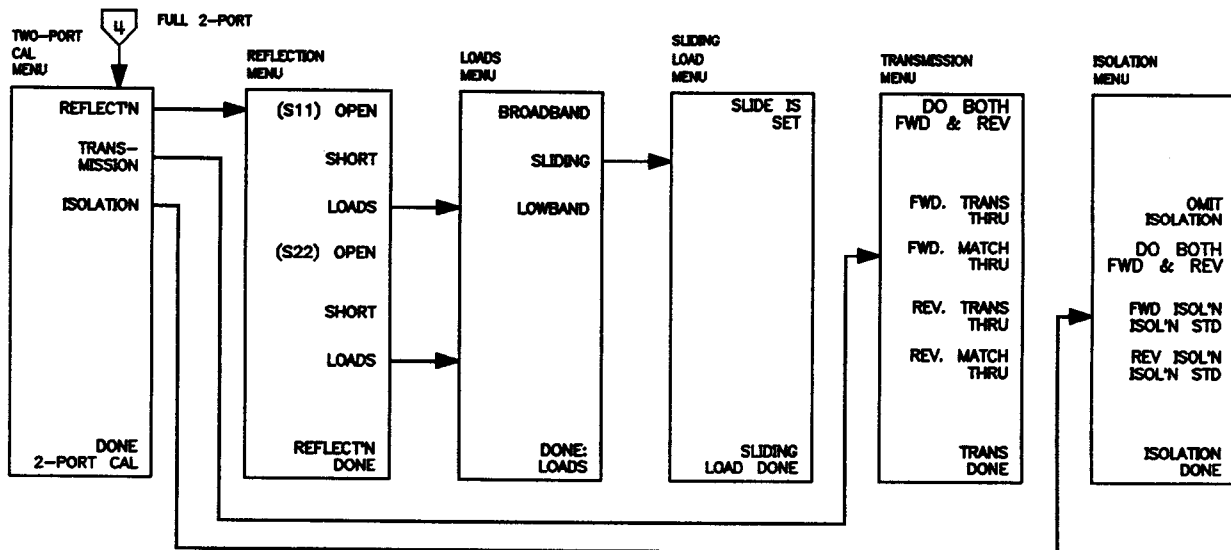


Figure 6–16. Menus for Full 2–Port Calibration

- Press **AVG**, **IF BW** to reduce the IF bandwidth.
- Press **CAL**.

- Select the proper calibration kit. If the connector type or cal kit name shown in the **CALKIT** softkey label is not the same as the calibration kit to be used, refer to *Select Cal Kit Menu*.
- Press **CALIBRATE MENU FULL 2-PORT REFLECTN**.
- Connect an open circuit to port 1.
- When the trace settles, press (S11) **OPEN**. The open circuit data is measured, and the softkey label **[OPEN]** is underlined.
- Disconnect the open, and connect a short circuit to port 1.
- When the trace settles, press (S11) **SHORT**. The short circuit data is measured and the softkey label **SHORT** is underlined.
- Disconnect the short, and connect an impedance–matched load (see *NOTE* above) at port 1.
- Press (S11) **LOADS**. The loads menu is displayed. When the trace settles, press the softkey corresponding to the load used. If a sliding load is used, the sliding load menu is displayed. Position the slide and press **SLIDE IS SET**. The sliding load must be set and measured five times before **SLIDING LOAD DONE** is pressed. Otherwise, the message "CAUTION: MORE SLIDES NEEDED" is displayed.
- When all the appropriate load measurements are complete, press **DONE LOADS**. The load data is measured, and the **LOADS** softkey label is underlined.
- Repeat the open–short–load measurements described above, connecting the devices in turn to port 2 and using the (S22) softkeys.
- Press **REFLECTN DONE**. (If you press **DONE** without measuring all the required standards, the message "CAUTION: ADDITIONAL STANDARDS NEEDED" is displayed.)
- The reflection calibration coefficients are computed and stored. The two–port cal menu is displayed, with the **REFLECTN** softkey underlined.
- Press **TRANSMISSION**.
- Make a thru connection between port 1 and port 2 (connect together the points at which the test device will be connected).
- Press **DO BOTH FWD & REV**. When both are completed the measurement has been made. The softkeys for the individual classes are underlined.
- Press **TRANS:DONE**. The transmission coefficients are computed and stored. The two–port cal menu is displayed, with the **TRANSMISSION** softkey underlined.
- Disconnect the thru.
- If correction for isolation is not required, press **ISOLATION OMIT ISOLATION ISOLATION DONE**.



- If correction for isolation is required, press **AVG** **AVERAGING ON** .\*
- Press **CAL** **RESUME CAL SEQUENCE** **ISOLATION** .
- Connect impedance–matched loads to port 1 and port 2 (broadband or lowband loads are sufficient).
- Press **DO BOTH FWD & REV** to measure both the forward and reverse isolation. When this is complete, the softkeys will be underlined.
- Press **ISOLATION DONE** . The isolation error coefficients are stored. The two–port cal menu is displayed, with the **ISOLATION** softkey underlined.
- Press **AVG** **AVERAGING OFF** .
- Press **CAL** **RESUME CAL SEQUENCE** .
- Press **DONE 2–PORT CAL** . (If you press **DONE** without measuring all the required standards, the message “CAUTION: ADDITIONAL STANDARDS NEEDED” will be displayed.) The calibration coefficients are computed and stored. A corrected trace is displayed, and the notation “C2” at the left of the screen indicates that two–port error correction is on.

The save menu is displayed. (It is recommended that calibration data be saved, either in internal non-volatile memory or on an external disk. Refer to Chapter 11, *Saving Instrument States*, for more information.)

- \* For maximum dynamic range use an averaging factor of 32.
- This completes the full two–port calibration procedure. Now the test device can be connected. Press the **MEAS** key to measure all four S–parameters.

## TRL\*/LRM\* 2–Port Calibration

This procedure uses the menu sequence illustrated in Figure 6–17 to perform complete vector error correction for measurement of all four S–parameters of a microstrip package in a fixture. Coaxial TRL\*/LRM\* measurements are not recommended.

To maximize the lifetime of the electro–mechanical transfer switch in the network analyzer, switching occurs only once in a measurement sequence using full two–port error correction. On the first sweep, all four S–parameters are measured. On subsequent sweeps, the assumption is made that the reverse parameters have not changed, and only the forward parameters are measured. It is possible to override this protection feature for applications where the data changes significantly with time, for example with tuning or drift. To perform an override, use **MEASURE RESTART** in the S–parameter menu (see Chapter 5). Alternatively, for repeated update of all four S–parameters, set an appropriate number of groups using the trigger menu (see Chapter 4.)

Isolation calibration can be omitted for most measurements, except where wide dynamic range is a consideration. Refer to the explanation under **CAL** Key.

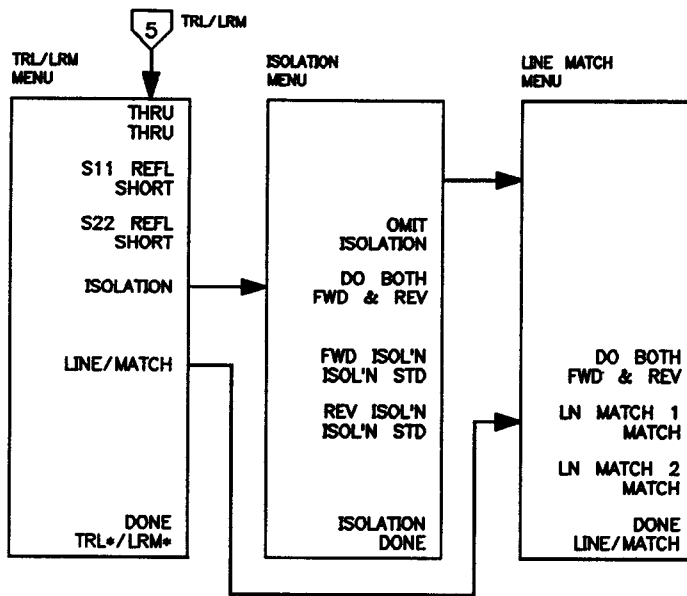


Figure 6-17. Menus for a full 2-Port TRL/LRM Calibration

## TRL\*/LRM\* Procedure

- Press **AVG** **IF BW** to reduce the IF bandwidth to the desired level.
- Press **CAL**.
- Select the proper calibration kit. A "template" kit can be selected under **CAL KIT**, labeled **TRL\***. (Refer to *Select Cal Kit Menu*.)
- Press **CALIBRATE MENU**, **TRL\*/LRM\* 2-PORT**.
- The following steps assume usage of the "template" kit mentioned above and the HP 85052D calibration kit:
- Make a thru connection between port 1 and port 2 (connect together the points at which the test device will be connected).
- Press **THRU THRU**. All four S-parameters are measured, and the softkey label is underlined.
- Connect a short circuit to port 1.
- Press **S11 REFL SHORT**. The short circuit data is measured, and the softkey label is underlined.
- Connect a short circuit to port 2.
- Press **S22 REFL SHORT**. The short circuit data is measured, and the softkey label is underlined.

- If correction for isolation is not required, press **ISOLATION** **OMIT ISOLATION** and ignore the next 3 steps.
- If correction for isolation is required, press **AVG** **AVERAGING ON** .
- Press **CAL** **RESUME CAL SEQUENCE** , **ISOLATION** .
- Press **DO BOTH FWD & REV** ; or select **FWD ISOL'N** **ISOL'N STD** and **REV ISOL'N** **ISOL'N STD** individually with **ISOLATION DONE** when both are completed. The isolation standards are measured, and the softkeys for the individual classes are underlined.
- Press **LINE MATCH** , which selects the line match menu.
- Connect broadband loads to both port 1 and port 2.
- Press **DO BOTH FWD & REV** ; or select **LN/MATCH 1 MATCH** and **LN/MATCH 2 MATCH** individually with **DONE LINE/MATCH** when both are completed. The loads are measured, and the softkeys for the individual classes are underlined.
- If you want to re-measure any of the classes/standards above, return to the step described above. The old data only for that class/standard will be overwritten with the new measurement.
- When you are satisfied with the measurement above, proceed by pressing **DONE TRL\*/LRM\*** .
- The **SAVE** menu is displayed. It is recommended that calibration data be saved, either in nonvolatile memory or on an external disk. Refer to Chapter 11, *Saving Instrument States*, for more information.
- This completes the TRL\*/LRM\* 2-port calibration procedure. Connect the test device, then press the **MEAS** key. With a two-port calibration on, the **MEAS** key performs the same function as **MEASURE RESTART** . You can now make measurements.

## POWER METER CALIBRATION

An HP-IB compatible power meter can monitor and correct RF source power to achieve leveled power at the test port. To correct the power going to the DUT, power meter calibration samples the power at each measurement point across the frequency band of interest. It then constructs a correction data table which the instrument uses to correct the power output of the internal source. The correction table may be saved in an instrument state register with the **SAVE** key.

The correction table is created during a single sweep. In the sample-and-sweep mode the power meter is not needed for subsequent sweeps. The correction table may be read or modified through HP-IB. Refer to the *HP-IB Quick Reference Guide* for details.

## Primary Applications

- When using a test system with significant frequency response errors. For example, a coupler with significant roll-off, or a long cable with a significant amount of loss.
- When measuring devices that are very sensitive to actual input power for proper operation.
- To allow measurements where power meter accuracy is required to meet a specification.

## Calibrated Power Level

By setting the analyzer calibrated power to the desired value at the power meter, this power level will be maintained at that port during the entire sweep. It is recommended that the operator first set the source power such that the power at the DUT is approximately correct. This reduces residual power errors when only one number of readings is taken (see **NUMBER of READINGS** softkey). When power meter calibration is on, the annotation "PC" is displayed. This indicates that the source power is being changed during the sweep. Calibrated power level becomes the active entry when **CAL POWER** is selected.

Regardless of the measurement application, the analyzer's source can only supply power within a power range. (See Power Menu.)

## Compatible Sweep Types

Power meter calibration may be used in linear, log, list, CW, and power sweep modes. In power sweep, the power at each point is the true power at the power meter.

## Loss of Power Meter Calibration Data

**Turning Power Off.** Turning off the instrument erases the power meter calibration table unless the instrument state has been saved in a save/recall register.

**Changing Frequency.** Power meter calibration data will be lost if the frequency is changed in log or list mode, but it is retained and interpolated over frequency in linear sweep mode. See "Interpolation," below.

**Pressing **PRESET**.** Presetting the instrument will erase power meter calibration data. If the instrument state has been saved in a register using the **SAVE** key, the user may recall the instrument state and the data will be restored.

## Interpolation in Power Meter Calibration

If the frequency is changed in linear sweep, or the start/stop power is changed in power sweep, then the calibration data is interpolated for the new range.

If calibration power is changed in any of the sweep types, the data array is increased or decreased to reflect the new power level. Some accuracy is lost when this occurs.

## POWER METER CALIBRATION MODE OPERATION

### Sample-and-Sweep Correction [TAKE CAL SWEEP]

Refer to Figure 6-18. Simply remove the DUT and measure the power at that point in the measurement setup. The sample-and-sweep allows you to measure the power characteristics across the frequency band of interest with a single sweep. The speed of the calibration will be slow while power meter readings are taken (see the *Typical Speed and Accuracy* table shown on a following page). However, once the sample sweep is finished, subsequent sweeps are power-corrected using the data table, and sweep speed increases significantly.

If the calibrated power level is changed after the initial measurement sweep is done, the entire correction table is increased or decreased by that amount and the annotation "PC?" appears on the display. The resulting power will no longer be as accurate as the original calibration.

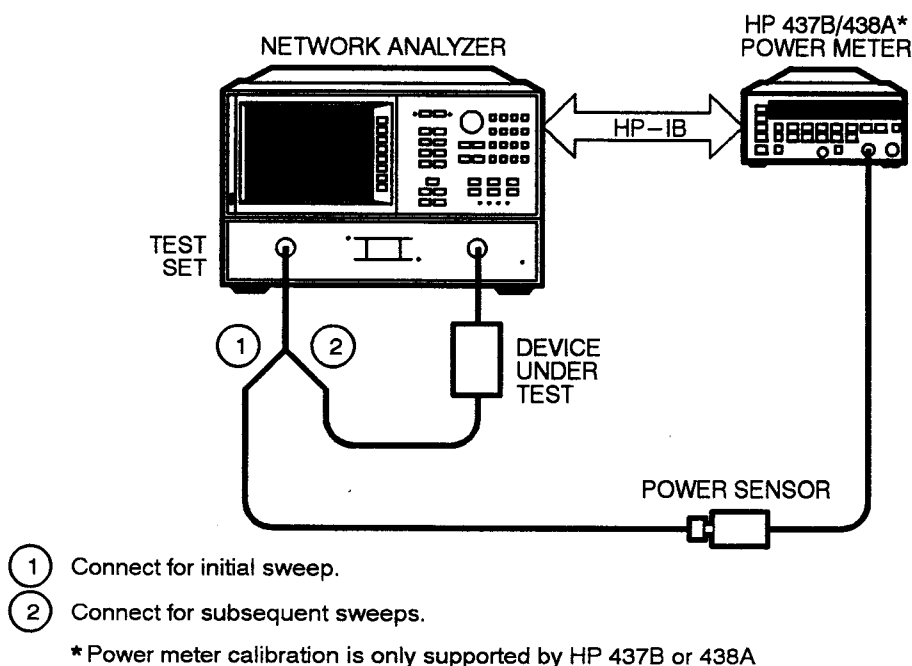


Figure 6-18. Typical Test Setup for Sample-and-Sweep Correction

### Other Details

**Power Meter HP-IB Address.** Before using power meter calibration, you must select the power meter address using the **LOCAL** **SET ADDRESSES** keys and address menu.

**System Controller Mode.** The analyzer must be set to the system controller mode using the **LOCAL** **SYSTEM CONTROLLER** keys.

**Power Sensor Calibration Factor List.** Refer to the **SET CAL FACTOR** menu explained later in this chapter.

## Speed and Accuracy

The speed and accuracy of a power meter calibration vary depending on the test setup and the measurement parameters. When the number of readings = 1, accuracy is improved if the operator sets the source power such that it is approximately correct at the measurement port. Power meter calibration should then be turned on.

Table 6–10 shows typical sweep speed and power accuracy. The times given apply only to the test setup described for the **TAKE CAL SWEEP**. Several power levels and numbers of readings are shown.

The typical values given in the table were derived under the following conditions:

**Test Setup:** The test setup used the following instruments:

- Instrument/Test Set: HP 8720C.
- Power Meter/Power Sensor: HP 437B with HP 8482A.

**Stimulus Parameters:** The time required to perform a power meter calibration is greatly affected by the source power and number of points tested. The parameters used to derive the typical values in Table 6–10 are as follows:

- Number of Points: 51.
- Source Power: +10 dBm.

Sweep time is linearly proportional to the number of points measured. For example, a sweep taking 33 seconds at 51 points will take approximately 66 seconds if 101 points are measured.

*Table 6–10. Typical Speed and Accuracy*

Power Desired at Test Port (dBm)	Number of Readings	Sweep Time (seconds)	Typical Accuracy (dB)
	1	33	±0.7
+5	2	64	±0.2
	3	95	±0.2
	1	48	±0.7
–10	2	92	±0.2
	3	123	±0.2

**Notes on Accuracy.** The accuracy values in Table 6–10 were derived by combining the accuracy of the power meter and linearity of the analyzer's internal source, as well as the mismatch uncertainty associated with the test set and the power sensor.

Power meter calibration measures the source power output (at the measurement port) at a single stimulus point, and compares it to the calibrated power selected by the operator. If the two values are different, power meter calibration changes the source output power by the difference. This process is repeated at every stimulus point. The accuracy of the result depends on the amount of correction required. If the selected number of readings = 1, the final measurement accuracy is significantly affected by a large power change. However, if the selected number of readings is > 1, the power change on the second or third reading is much smaller; thus accuracy is much better.

Two methods can be used to perform power meter calibration. If the selected number of readings is  $> 1$ , then it makes little difference which method is used. However, if number of readings = 1, then the first method provides better accuracy. The values in Table 6–10 were derived using the second (worst case) method.

- **Set source power approximately correct at the measurement port, then perform power meter calibration.** This method can significantly increase the accuracy of the measurement when the selected number of readings = 1. Smaller accuracy improvements occur with a higher number of readings. Remember that mismatch errors affect accuracy as well.
- **Perform power meter calibration independent of the source's current power setting.** There may be a large difference between the current power level and the desired calibrated power level. Power meter calibration will automatically adjust the power at the measurement port to match the desired calibrated power level. However, a large change in power affects accuracy, especially if the number of readings = 1. The accuracy values given in Table 5–4 were calculated with an initial power setting of +10 dB.

## PERFORMING A POWER METER CALIBRATION

To use power meter calibration you must perform the following steps:

### Before Turning Power Meter Calibration On

- Zero and calibrate the power meter.
- Enter the HP–IB address of the power meter into the analyzer. Press **LOCAL** **SET ADDRESSES** **POWER MTR** **#** **#** **x1**, where ## is the two digit HP–IB address currently in use by the power meter.
- Set the analyzer to system controller mode. Press **LOCAL** **SYSTEM CONTROLLER**.
- Enter the power sensor calibration data. Press **CAL** **PWR METER CAL** **SET CAL FACTOR** and enter the power sensor calibration factors for each desired frequency segment. Details on the segment edit menus are provided later in this chapter.
- Press **DONE** to return to the power meter calibration menu.

## Using Sample–and–Sweep

- **CAL POWER**. Choose the desired test port power level and range (the power level you wish to maintain at the input to the DUT). Make sure that this power level is less than the maximum power level of the sensor.
- Choose the appropriate measurement parameters.
- Connect the power sensor to the active test port.
- For more than one power measurement at each frequency point in the stimulus range, press **NUMBER of READINGS**  . (Note that this will increase the power meter calibration time.)
- Press **TAKE CAL SWEEP**. The actual power at each frequency point will be measured with the initial sweep. During this sweep, sweep speed will slow significantly.

Pressing **TAKE CAL SWEEP** causes the initial measurement sweep to occur, which updates the power calibration data table. After that, remove the power meter sensor and connect the DUT. Subsequent sweeps will use the data table to correct the output power level at each point. A typical setup is shown in Figure 6–18.

- Activate the power meter calibration. A “PC” will appear to the left of the display to indicate that the power meter calibration is on.
- Save the calibration to an instrument state register or to an external disk drive.
- Remove the power sensor and connect the device under test.

## Calibration Data Table

Valid calibration data will be in the power correction table if one of the following has occurred:

- **TAKE CAL SWEEP** has been pressed.
- Calibration data has been placed in the table via HP–IB.

If desired, save the power meter calibration data in one of the SAVE/RECALL registers. This data is stored in non–volatile memory.



# Power Meter Calibration Menus

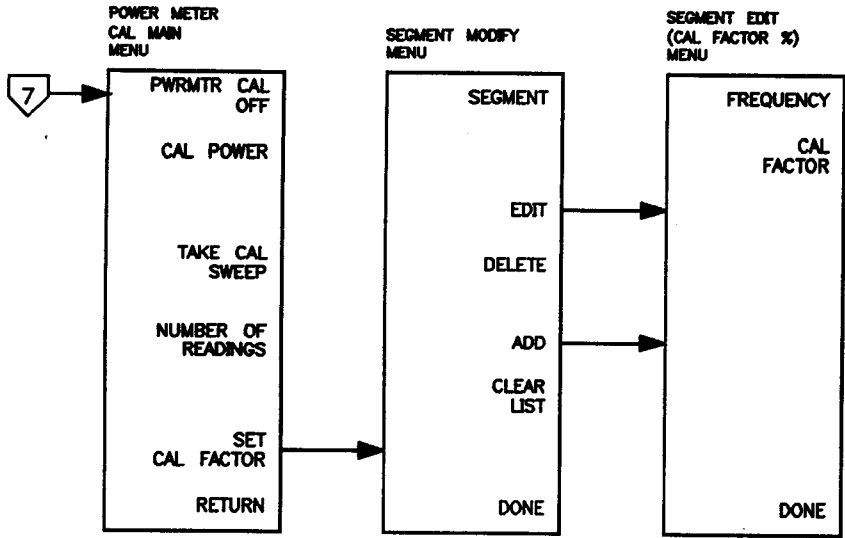


Figure 6-19. Softkey Menus Accessed from the PWR METER CAL Softkey

## Power Meter Calibration Main Menu

Refer to Figure 6–19.

**PWR MTR CAL ON OFF** (PWMCON ON/PWMCOFF) turns off power meter calibration.

**CAL POWER** . Enter the desired test port power; i.e., the power desired for input to the DUT.

**TAKE CAL SWEEP** (TAKCS) Each data point is measured during the initial sweep and the correction data is placed in the power meter correction table.

**NUMBER of READINGS** (NUMR) determines the number of measurement/correction iterations performed on each point. This feature helps eliminate residual power errors after the initial correction. The amount of residual error is directly proportional to the magnitude of the initial correction. The user should initially set the source power so that it is approximately correct when it arrives at the DUT. If power uncertainty at the DUT is expected to be greater than a few dB, it is recommended that the number of readings be greater than 1.

**SET CAL FACTOR** presents the set cal factor menu. This menu allows calibration factor data to be entered for the power sensor. This information is typically listed on a label attached to the power sensor.

Up to 12 separate frequency points, called segments, may be entered, at which the user may enter a different calibration factor. The instrument interpolates between the selected points.

**RETURN** goes back to the main calibration menu.

## Segment Modify Menu

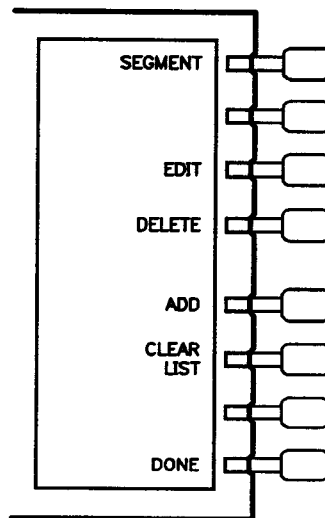


Figure 6–20. Segment Modify Menu

This menu allows the user to enter power sensor calibration data for the power sensor.

The user may select from 1 to 12 frequency segments. Multiple segments do not have to be entered in any particular order: the analyzer automatically sorts them and lists them on the display in increasing order of frequency.

You may wish to use only one segment. In this case, the analyzer assumes that the single value is valid over the entire frequency range of the calibration.

For high accuracy, actual measured power loss and/or power sensor calibration data may be entered for as many as 12 separate frequency points (segments). The frequencies between the points are interpolated by the instrument.

**Using the Segment Modify Menu.** Before any segment information is entered in the list, the word "EMPTY" is displayed. You can create the first segment by pressing either **EDIT** or **ADD**. Enter the desired frequency and cal factor data when the appropriate segment edit menu appears.

For example, in the edit (power loss) menu, press: **FREQUENCY** **1** **G/n** **CAL FACTOR** **9** **8** **x1** to add a segment to the cal factor list. Now press **DONE**.

Once an entry has been made, use the **ADD** softkey to enter additional segments. The default segment number when **ADD** is pressed is the next consecutive number. Follow the above instructions to define the next segment in the list.

To delete an entry in the list, press **SEGMENT** and use the entry block controls to select the desired segment. Press **DELETE**.

To erase all entries, press the **CLEAR LIST** softkey.

**SEGMENT** specifies which segment in the list is to be modified. A maximum of two segments is displayed at one time, and the list can be scrolled up or down with the RPG or the **▲** **▼** keys to show other segment entries. Use the entry block controls to move the pointer > to the desired segment number. The selected segment can now be edited or deleted.

**EDIT** (SEDIn, where "n" is the segment number). This softkey brings up the appropriate segment edit menu described in the following pages. The edit command modifies the segment previously selected with the **SEGMENT** softkey.

**DELETE** (SDEL) Deletes the segment previously selected with the **SEGMENT** softkey.

**ADD** (SADD) adds another segment to the bottom of the list and presents the appropriate segment edit menu described in the following pages. When done adding a segment, the list is automatically reordered by frequency.

**CLEAR LIST** (CLEL) deletes all segments in the list.

**DONE** (EDITDONE) goes back to the power loss/sensor list menu.

## Segment Edit (Calibration Factor %) Menu

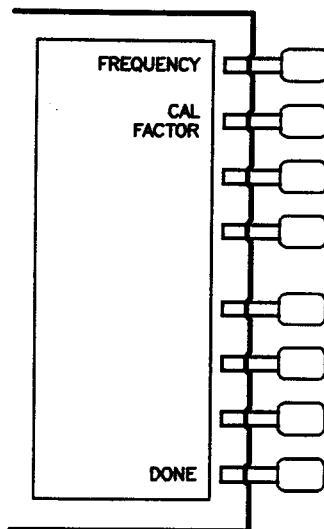


Figure 6–21. Segment Edit (Calibration Factor %) Menu

This menu defines the frequency and calibration factor % for the segment being added or edited.

**FREQUENCY** (CALFFREQ) accepts a frequency value for the segment.

**CAL FACTOR** (CALFCALF) accepts a calibration factor % for the segment.

**DONE** (SDON) goes back to the segment modify menu and sorts the list according to increasing frequency.

### MODIFYING CALIBRATION KITS

For most applications, use the default cal kit models provided in the select cal kit menu described earlier in this chapter. Modifying calibration kits is necessary only if unusual standard devices are used, or a calibration kit is used with standards that have different values than the default kit. Unless a cal kit model is provided with the calibration devices used, a solid understanding of error correction and the system error model are absolutely essential to making modifications. Read the introductory part of this chapter for more information, and refer to the *Appendix*.

**NOTE:** Numerical data for most Hewlett–Packard calibration kits is provided in the calibration kit manuals.

During measurement calibration, the analyzer measures actual, well–defined standards and mathematically compares the results with ideal “models” of those standards. The differences are separated into error terms which are later removed during error correction. Most of the differences are due to systematic, repeatable errors introduced by the network analyzer and connecting cables, which are correctable. However, differences between the model for a standard and the actual characteristics of the standard reduce the system’s ability to remove systematic errors, and thus degrade error–corrected accuracy. Therefore, in addition to the predefined default cal kit models, a “user kit” is provided that can be modified to an alternate calibration standards model.

Several situations exist that may require a user-defined cal kit:

- The user wants to examine the definitions for a standard in an existing cal kit.
- A calibration may be required for a connector interface different from the three built-in cal kits. (Examples: 2.4 mm, SMA, TNC, or waveguide.)
- A calibration with standards (or combinations of standards) that are different from the predefined cal kits may be required. (Example: Using the HP 85052A 3.5 mm calibration kit instead of the HP 85052B/D.)
- The built-in standard models for predefined kits can be improved or refined. Remember that the more closely the model describes the actual performance of the standard, the better the calibration. (Example: A 7 mm load may be determined to measure 50.4 ohms instead of 50.0 ohms.)
- Unused standards for a given cal type can be eliminated from the predefined set, to eliminate possible confusion during calibration. (Example: A certain application requires calibrating a male test port. The standards used to calibrate a female test port can be eliminated from the set, and will not be displayed during calibration.)

## Definitions

It is necessary to define some of the terms used:

- A "standard" is a specific, well-defined, physical device used to determine systematic errors. Each standard has a precisely known or predictable magnitude and phase response as a function of frequency. The response of each standard is mathematically defined in the error models used by the network analyzer.
- A standard "type" is one of five basic types that define the form or structure of the model to be used with that standard. The file types are: short, open, load, delay/thru, and arbitrary impedance.
- Standard "coefficients" are numerical characteristics of the standards used in the model selected.
- A standard "class" is a grouping of one or more standards that determines which standards are used in a particular calibration procedure.

## Procedure

Basically, the following steps are used to modify or define a user kit:

1. **Select Standards.** To modify a cal kit, first select the *predefined* kit to be modified. This is not necessary for defining a new cal kit.
2. **Define the Standards.** For each standard, define which "type" of standard it is and its electrical characteristics.
3. **Specify the Class** where the standard is to be assigned.
4. **Store** the modified cal kit. To make a backup copy, store the modified cal kit to disk while the cal kit is active.

Following the descriptions of the menus for modifying calibration kits, a procedure is provided that enters the HP 85052A 3.5 mm calibration kit values as a "user kit."

## Modify Cal Kit Menu

This menu is accessed from the **CAL** key (refer to Figure 6–27), and leads in turn to additional series of menus associated with modifying cal kits (Figure 6–23). All of these menus and their functions are described in the following pages.

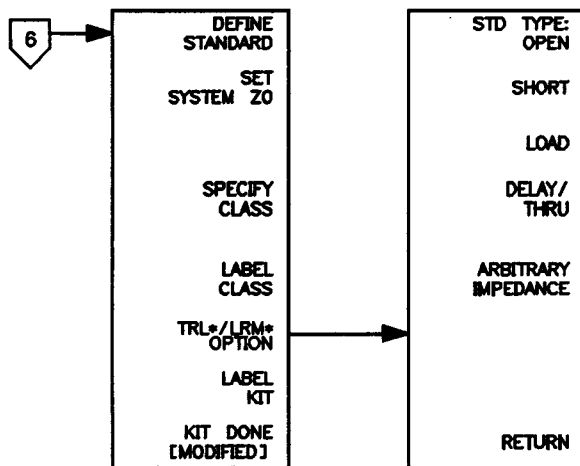


Figure 6–22. Modify Cal Kit Menu

**SYSTEM Z0** (SETZ) modifies the characteristic impedance value  $Z_0$  recognized by the analyzer (the default value is  $50\Omega$ ). This characteristic impedance sets the center value of the Smith chart, and is used by the network analyzer in calculating impedance measurements. In addition, it is used in calculating parameter conversions (refer to *Conversion Menu* in Chapter 5 for more information).

If the characteristic impedance of the calibration standards is not 50 ohms, a minimum loss pad or matching transformer should be inserted at the measurement port. The characteristic impedance must be set correctly before calibration procedures are performed.

**DEFINE STANDARD** (DEFS) makes the standard number the active function, and brings up the define standard menus. The standard number (1 to 8) is an arbitrary reference number used to reference standards while specifying a class. The standard numbers for the predefined calibration kits are as follows:

The DEFINE can only “define” 5 types: short, open, load, delay/thru, arbitrary impedance.

1	short	5	load
2	open	6	load
3	load	7	short
4	delay/thru	8	open

**SPECIFY CLASS** leads to the specify class menu. Class assignment groups the standards into classes that correspond to the systematic errors to be corrected by a particular measurement calibration procedure. Define the standards first, then use this key to specify the standards to be grouped in a specific class.

**TRL\*/LRM\* OPTION** brings up a menu that allows you to choose the calibration, line or system impedance.

**LABEL CLASS** leads to the label class menu, which is used to give the class a meaningful label for future reference.

**LABEL KIT** (LBEK) leads to a menu to generate a label for the user-modified cal kit. If a label is supplied, it will appear as one of the softkey choices in the select cal kit menu. It will also be used as the file label for a cal kit definition stored to disc. The approach is similar to defining a display title, except that the kit label is limited to eight characters.

**KIT DONE** (KITD) terminates the cal kit modification process, after all standards are defined and all classes are specified. Be sure to save the kit with the **SAVE USER KIT** softkey in the select cal kit menu, if it is to be used later.

### Define Standard Menus

Standard definition is the process of mathematically modeling the electrical characteristics (delay, attenuation, and impedance) of each calibration standard. These electrical characteristics (coefficients) can be mathematically derived from the physical dimensions and material of each calibration standard or from its actual measured response. The parameters of the standards can be listed in the *Standards Definition Table*, Table 6–11. The menus illustrated in Figure 6–23 are used to specify the type and characteristics for each user-defined standard.

Table 6–11. Standard Definitions Table

Standard		C0 x10 <sup>-15</sup> F	C1 x10 <sup>-27</sup> F/Hz	C2 x10 <sup>-36</sup> F/Hz <sup>2</sup>	C3 x10 <sup>-45</sup> F/Hz <sup>3</sup>	Fixed or Sliding	Offset			Frequency (GHz)		Coax or Wave- guide	Stand- ard Label
NO.	TYPE						Delay ps	Loss MΩ/s	Z <sub>0</sub> Ω	Minimu m	Maxdum		
1													
2													
3													
4													
5													
6													
7													
8													

Each standard must be identified as one of five "types": open, short, load, delay/thru, or arbitrary impedance.

After a standard number is entered with the **DEFINE STANDARD** softkey, selection of the standard type will present one of five menus for entering the electrical characteristics corresponding to that standard type. These menus are tailored to the current type, so that only characteristics applicable to that standard type can be modified.

Any standard type can be further defined with offsets in delay, loss, and standard impedance; assigned minimum or maximum frequencies over which the standard applies; and defined as coax or waveguide. Press the **SPECIFY OFFSET** softkey, and refer to *Specify Offset Menu*.

A distinct label can be defined and assigned to each standard, so that the analyzer can prompt the user with explicit standard labels during calibration (e.g. "SHORT"). Press the **LABEL STD** key to present a menu similar to the one used in defining a display title.

After each standard is defined, including offsets, press **STD DONE (DEFINED)** to terminate the standard definition.



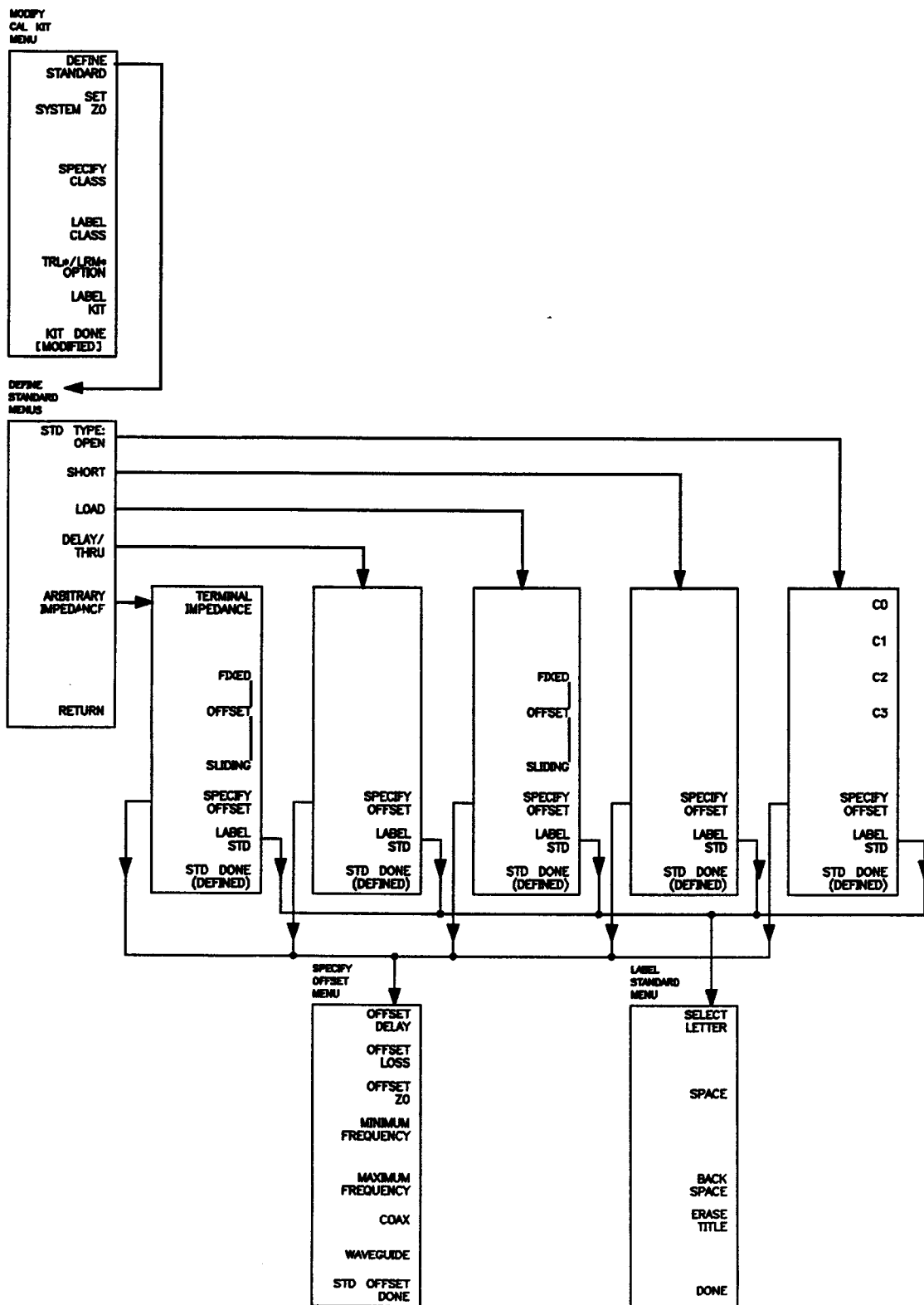


Figure 6-23. Modify Cal Kit/Define Standard Menus

**OPEN** (STDTOPEN) defines the standard type as an open circuit, used for calibrating reflection measurements. Pressing this key also presents a menu to define the open, including its capacitance. An open circuit is assigned a terminal impedance of infinity ohms, but delay and loss offsets may still be added.

As a reflection standard, an open circuit offers the advantage of broadband frequency coverage. At microwave frequencies, however, an open rarely has perfect reflection characteristics because the fringing capacitance effects cause phase shift that varies with frequency. This can be observed in measuring an open circuit after calibration, when an arc in the lower right circumference of the Smith chart indicates capacitive reactance. These effects are impossible to eliminate, but the calibration kit models include the open circuit capacitance at all frequencies for the analyzer compatible calibration kits. The capacitance model is a cubic polynomial, as a function of frequency, where the polynomial coefficients are user-definable. The capacitance model equation is:

$$C = (C0) + (C1 * F) + (C2 * F^2) + (C3 * F^3)$$

where F is the measurement frequency.

The terms in the equation are defined with the specify open menu as follows:

**C0** (C0) is used to enter the C0 term, which is the constant term of the cubic polynomial and is scaled by  $10^{-15}$  Farads.

**C1** (C1) is used to enter the C1 term, expressed in F/Hz (Farads/Hz) and scaled by  $10^{-27}$ .

**C2** (C2) is used to enter the C2 term, expressed in F/Hz<sup>2</sup> and scaled by  $10^{-36}$ .

**C3** (C3) is used to enter the C3 term, expressed in F/Hz<sup>3</sup> and scaled by  $10^{-45}$ .

**SHORT** (STDTSHOR) defines the standard type as a short, for calibrating reflection measurements. Shorts are assigned a terminal impedance of 0 ohms, but delay and loss offsets may still be added.

**LOAD** (STDTLOAD) defines the standard type as a load (termination). Loads are assigned a terminal impedance equal to the system characteristic impedance  $Z_0$  (usually  $50\Omega$ ), but delay and loss offsets may still be added. If the load impedance is not  $Z_0$ , use the arbitrary impedance standard definition.

**FIXED** (FIXE) defines the load as a fixed (not sliding) load. **SLIDING** (SLIL) defines the load as a sliding load. In calibration sequences that use a sliding load, the analyzer will prompt for several load positions, and use the measurement results from all of them to calculate the ideal load value.

**DELAY/THRU** (STDTDELA) defines the standard type as a transmission line of specified length, for transmission calibrations.

**ARBITRARY IMPEDANCE** (STDTARBI) defines the standard type to be a load, but with an arbitrary impedance different from the system  $Z_0$ .

**TERMINAL IMPEDANCE** (TERI) is used to specify the (arbitrary) impedance of the standard, in ohms.

**FIXED** (FIXE) defines the load as a fixed (not sliding) load.

**SLIDING** (SLIL) defines the load as a sliding load. In calibrations that use a sliding load, the analyzer will prompt for several load positions to calculate the ideal load value.

**OFFSET** (OFLD) defines the load so that it is treated as an offset load during a calibration sequence. The offset load then requires two sets of measurements to compute the load.

## Specify Offset Menu

The specify offset menu (Figure 6–24) allows additional specifications for a user–defined standard. Features specified in this menu are common to all five types of standards.

An offset is equivalent to a uniform length of transmission line between the standard being defined and the actual measurement plane. (Example: a waveguide short circuit terminator, offset by a short length of waveguide.) For reflection standards, the offset is assumed to be between the measurement plane and the standard (one–way only). For transmission standards, the offset is assumed to exist between the two reference planes (in effect, the offset is the thru). Three characteristics of the offset can be defined: its delay (length), loss, and impedance. An offset can be specified with any standard type.

The frequency range over which a particular standard is valid can be defined with a minimum and maximum frequency. This is particularly important for a waveguide standard, since its behavior changes rapidly beyond its cutoff frequency. Note that several band–limited standards can together be defined as the same “class” (see specify class menu). Then, if a measurement calibration is performed over a frequency range exceeding a single standard, additional standards can be used for each portion of the range.

Lastly, the standard must be defined as either coaxial or waveguide. If it is rectangular waveguide, dispersion effects are calculated automatically and included in the standard model.

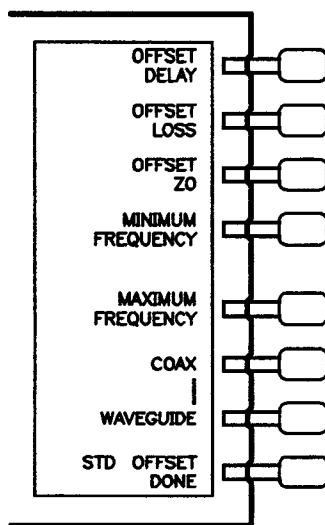


Figure 6–24. Specify Offset Menu

**OFFSET DELAY** (OFSD) is used for a standard that has electrical length relative to the calibration plane. Offset delay is entered as the one–way travel time through an offset from the measurement (reference) plane to the standard, in seconds (s). (In a transmission standard, offset delay is the delay from plane to plane.) Delay can be calculated from the precise physical length of the offset, the permittivity constant of the medium, and the speed of light.

In coax, group delay is considered constant. In waveguide, however, group delay is dispersive, that is, it changes significantly as a function of frequency. Hence, for a waveguide standard, offset delay must be defined at an infinitely high frequency.

**OFFSET LOSS** (OFSL) is used to specify energy loss, due to skin effect, along a one-way length of coax offset. The value of loss is entered as ohms/nanosecond (or Gigohms/second) at 1 GHz. (Such losses are negligible in waveguide, so enter 0 as the loss offset.)

**OFFSET Z<sub>0</sub>** (OFSZ) is used to specify the characteristic impedance of the coax offset. (Note: This is *not* the impedance of the standard itself.) (For waveguide, the offset impedance is always assigned a value equal to the system Z<sub>0</sub>.)

**MINIMUM FREQUENCY** (MINF) is used to define the lowest frequency at which the standard can be used during measurement calibration. In waveguide, this *must* be the lower cutoff frequency of the standard, so that the analyzer can calculate dispersive effects correctly (see **OFFSET DELAY** above).

**MAXIMUM FREQUENCY** (MAXF) is used to define the highest frequency at which the standard can be used during measurement calibration. In waveguide, this is normally the upper cutoff frequency of the standard.

**COAX** (COAX) defines the standard (and the offset) as coaxial. This causes the analyzer to assume linear phase response in any offsets.

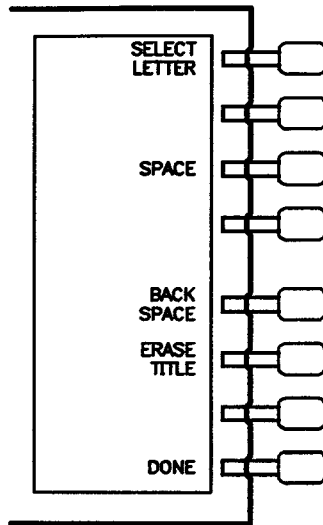
**WAVEGUIDE** (WAVE) defines the standard (and the offset) as rectangular waveguide. This causes the analyzer to assume a dispersive delay (see **OFFSET DELAY** above).

## Label Standard Menu (LABS)

This menu (Figure 6–25) is used to label individual standards for reference during the menu-driven measurement calibration sequence. The labels are user-definable using a character set displayed on the CRT that includes letters, numbers, and some symbols, and they may be up to eight characters long. The analyzer will prompt you to connect standards using these labels, so they should be meaningful to you, and distinct for each standard.

It is recommended that the label include information carried on the standard, such as the serial number, to avoid confusing multiple standards that are similar in appearance.

By convention, when sexed connector standards are labeled male (m) or female (f), the designation refers to the test port connector sex, not the connector sex of the standard.



*Figure 6–25. Label Standard Menu*

Standard labels are created in exactly the same way as titles. Refer to **DISPLAY** Key, *Title Menu* in Chapter 5.

## Specify Class Menus

Once a standard is defined, it must be assigned to a standard "class." This is a group of from one to seven standards that is required to calibrate for a single error term. The standards within a single class are assigned to locations A through G as listed on the *Standard Class Assignments Table*, Table 6–12. A class often consists of a single standard, but may be composed of more than one standard if band–limited standards are used. (Example: The predefined 3.5 mm cal kit model for the analyzer has a single short circuit standard and a single open circuit standard. However, the load standard class includes three standards: a broadband load, a sliding load for high frequencies, and a lowband load.)

*Table 6–12. Standard Class Assignments Table*

	A	B	C	D	E	F	G	STANDARD CLASS LABEL
S <sub>11</sub> A								
S <sub>11</sub> B								
S <sub>11</sub> C								
S <sub>22</sub> A								
S <sub>22</sub> B								
S <sub>22</sub> C								
Forward Transmission								
Reverse Transmission								
Forward Match								
Reverse Match								
Response								
Response & Isolation								

The number of standard classes required depends on the type of calibration being performed, and is equal to the number of error terms corrected. (Examples: A response calibration requires only one class, and the standards for that class may include an open and/or short and/or thru. A 1–port calibration requires three classes. A full 2–port calibration requires ten classes, not including two for isolation.)

The number of standards that can be assigned to a given class may vary from none (class not used) to one (simplest class) up to seven. When a certain class of standards is required during calibration, the analyzer will display the labels for all the standards in that class (except when the class consists of a single standard). This does not, however, mean that all standards in a class must be measured during calibration. Unless band–limited standards are used (such as a lowband load and a sliding load), only a single standard per class is required. Note that it is often simpler to keep the number of standards per class to the bare minimum needed (often one) to avoid confusion during calibration.

Standards are assigned to a class simply by entering the standard's reference number (established while defining a standard) under a particular class. Each class can be given a user–definable label as described under *Label Class Menus*, below.

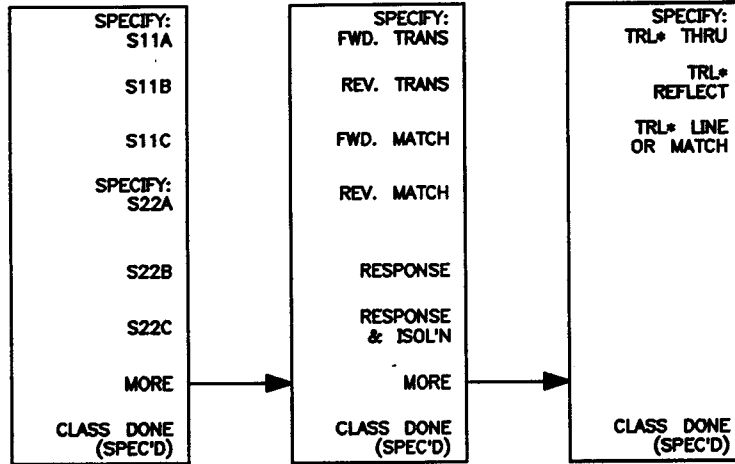


Figure 6–26. Specify Class Menus

**SPECIFY S11A** (SPECS11A) is used to enter the standard number(s) for the first class required for an S11 1–port calibration. (For predefined cal kits, this is the open.)

**S11B** (SPECS11B) is used to enter the standard number(s) for the second class required for an S11 1–port calibration. (For predefined cal kits, this is the short.)

**S11C** (SPECS11C) is used to enter the standard number(s) for the third class required for an S11 1–port calibration. (For predefined kits, this is the load.)

**SPECIFY S22A** (SPECS22A) is used to enter the standard number(s) for the first class required for an S22 1–port calibration. (For predefined cal kits, this is the open.)

**S22B** (SPECS22B) is used to enter the standard number(s) for the second class required for an S22 1–port calibration. (For predefined cal kits, this is the short.)

**S22C** (SPECS22C) is used to enter the standard number(s) for the third class required for an S22 1–port calibration. (For predefined kits, this is the load.)

**MORE** leads to the following softkeys.

**FWD TRANS** (SPECFWDT) is used to enter the standard number(s) for the forward (port 1 to port 2) transmission thru calibration. (For predefined kits, this is the thru.)

**REV TRANS** (SPECREVT) is used to enter the standard number(s) for the reverse (port 2 to port 1) transmission (thru) calibration. (For predefined kits, this is the thru.)

**FWD MATCH** (SPECFWDM) is used to enter the standard number(s) for the forward match (thru) calibration. (For predefined kits, this is the thru.)

**REV MATCH** (SPECREVM) is used to enter the standard number(s) for the reverse match (thru) calibration. (For predefined kits, this is the thru.)

**RESPONSE** (SPECRESP) is used to enter the standard number(s) for a response calibration. This calibration corrects for frequency response in either reflection or transmission measurements, depending on the parameter being measured when a calibration is performed. (For predefined kits, the standard is either the open or short for reflection measurements, or the thru for transmission measurements.)

**RESPONSE & ISOL'N** (SPECRESI) is used to enter the standard number(s) for a response & isolation calibration. This calibration corrects for frequency response and directivity in reflection measurements, or frequency response and isolation in transmission measurements.

**SPECIFY TRL\* THRU** is used to enter the standard number(s) for the TRL\* THRU class.

**TRL\* REFLECT** is used to enter the standard number(s) of the TRL\* REFLECT class.

**TRL\* LINE OR MATCH** is used to enter the standard number(s) for the TRL + LINE OR MATCH class.

## Label Class Menus

The label class menus are used to define meaningful labels for the calibration classes. These then become softkey labels during a measurement calibration. Labels can be up to eight characters long.

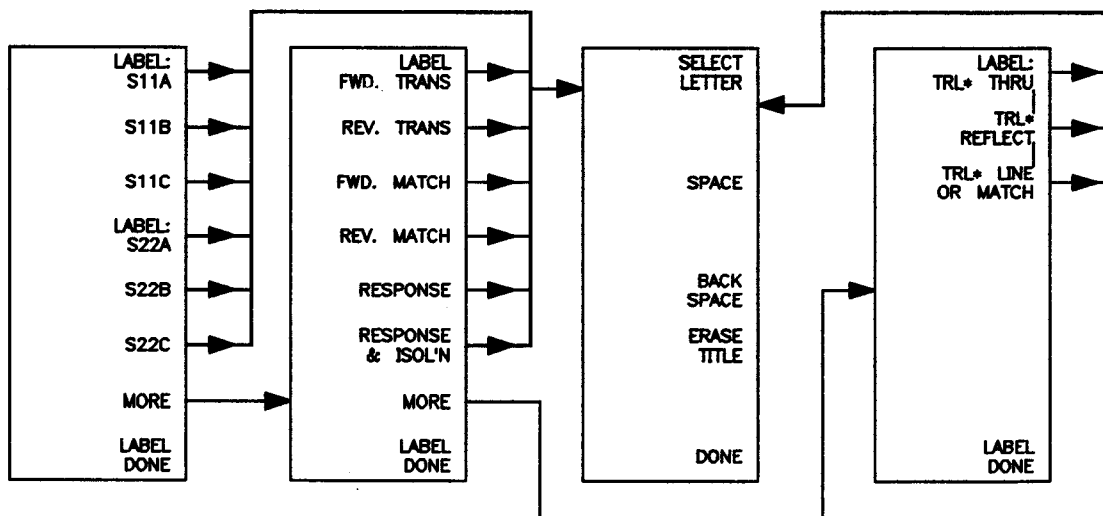


Figure 6-27. Label Class Menus

Labels are created in exactly the same way as display titles. Refer to **DISPLAY** Key, Title Menu in Chapter 5.



## TRL\*/LRM\* Option Menus

The TRL\*/LRM\* option menus are used to set the system and line impedance when doing a TRL\* or LRM\* calibration. Also allow a reference to set as a thru or a reflection measurement.

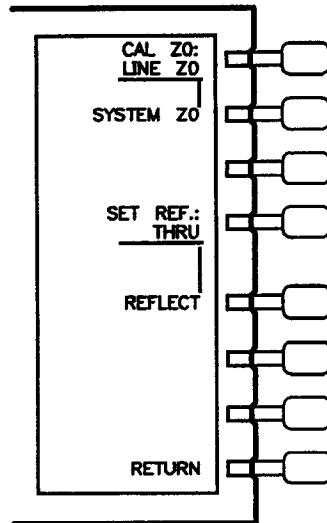


Figure 6–28. TRL/LRM Options Menu

**CAL Z0 LINE Z0** establishes the TRL\* LINE/MATCH standard as the characteristic impedance (default).

**CAL Z0 SYSTEM Z0** establishes the value set under SET SYSTEM  $Z_0$  as the characteristic impedance.

**SET REF THRU** – the measurement reference plane is to be set by the TRL\* REFLECT standard.

**SET REF REFLECT** – the measurement reference plane is to be set by the TRL\* THRU standard.

## Label Kit Menu

After a new calibration kit has been defined, be sure to specify a label for it. Choose a label that describes the connector type of the calibration devices. This label will then appear in the **CALKIT** softkey label in the correction menu and the **MODIFY** label in the select cal kit menu. It will be saved with calibration sets.

This menu is accessed with the **LABEL KIT** softkey in the modify cal kit menu, and is identical to the label class menu and the label standard menu described above. It allows definition of a label up to eight characters long.

## Verify Performance

Once a measurement calibration has been generated with a user–defined calibration kit, its performance should be checked before making device measurements. To check the accuracy that can be obtained using the new calibration kit, a device with a well–defined frequency response (preferably unlike any of the standards used) should be measured. The verification device must not be one of the calibration standards: measurement of one of these standards is merely a measure of repeatability.

To achieve more complete verification of a particular measurement calibration, accurately known verification standards with a diverse magnitude and phase response should be used. NBS traceable or HP standards are recommended to achieve verifiable measurement accuracy.

**NOTE:** The published specifications for the network analyzer system include accuracy enhancement with compatible calibration kits. Measurement calibrations made with user-defined or modified calibration kits are not subject to those analyzer specifications, although a procedure similar to the system verification procedure may be used.

## Example Procedure for Specifying a User-Defined Calibration Kit

The following procedure enters the HP 85052A 3.5 mm calibration kit values as a "user kit." This is provided as an example to illustrate the steps required in defining a calibration kit model.

The first keystroke sequence enters the values for standard #1, the short circuit.

- **CAL** **CALKIT MODIFY**
- **DEFINE STANDARD** **SHORT**
- **SPECIFY OFFSET** **OFFSET DELAY** **.** **0** **1** **6** **6** **8** **4** **G/n**
- **STD OFFSET DONE** **STD DONE (DEFINED)**

The next sequence specifies standard #2, the open circuit.

- **DEFINE STANDARD** **2** **x1** **OPEN**
- **C0** **5** **6** **x1**
- **C1** **2** **0** **0** **x1**
- **C2** **0** **x1**
- **C3** **0** **x1**
- **SPECIFY OFFSET** **OFFSET DELAY** **.** **0** **1** **4** **4** **4** **8** **G/n**
- **STD OFFSET DONE** **STD DONE (DEFINED)**

The next sequence specifies standard #5, the sliding load.

- **DEFINE STANDARD** **5** **x1** **LOAD**
- **SPECIFY OFFSET** **MINIMUM FREQUENCY** **1** **.** **9** **9** **9** **G/n**
- **STD OFFSET DONE** **STD DONE (DEFINED)**

The next sequence specifies standard #6, the lowband load.

- **DEFINE STANDARD** **6** **x1** **LOAD**
- **[SPECIFY OFFSET] [MAXIMUM FREQUENCY]** **2** **.** **0** **0** **1** **G/M**
- **STD OFFSET DONE** **STD DONE (DEFINED)**

The final sequence labels the kit and saves it in memory.

- **LABEL KIT**
- \* Use the knob and softkeys to modify the label to read "3.5mmA"
- **DONE** **KIT DONE MODIFIED**
- **CAL**
- **CAL KIT [3.5 mm] A**
- **SAVE USER KIT** **USER KIT**

The **USER KIT** softkey is now underlined, and the user-specified kit definition is saved in non-volatile memory.



# Chapter 7. Using Markers

## INTRODUCTION

The **MKR** (MENUMARK) key displays a movable active marker ( $\nabla$ ) on the screen and provides access to a series of menus to control from one to five display markers for each channel. Markers are used to obtain numerical readings of measured values. They also provide capabilities for reducing measurement time by changing stimulus parameters, searching the trace for specific values, or statistically analyzing part or all of the trace. Figure 7–1 illustrates the displayed trace with all markers on and marker 1 the active marker.

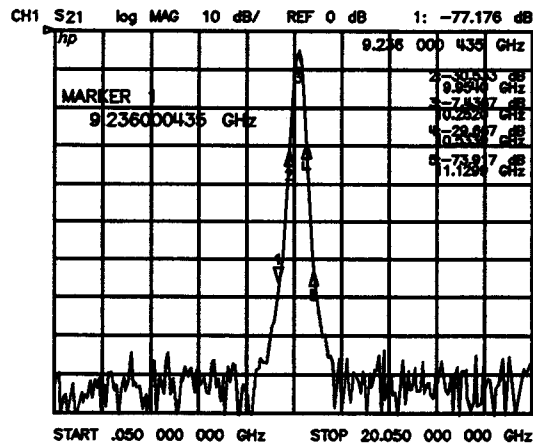


Figure 7–1. Markers on Trace

Markers have a stimulus value (the x-axis value in a Cartesian format) and a response value (the y-axis value in a Cartesian format). In a polar or Smith chart format, the second part of a complex data pair is also provided as an auxiliary response value. When a marker is turned on and no other function is active, its stimulus value is displayed in the active entry area and can be controlled with the knob, the step keys, or the numerical keypad. The active marker can be moved to any point on the trace, and its response and stimulus values are displayed at the top right corner of the graticule for each displayed channel, in units appropriate to the display format. The displayed marker response values are valid even when the measured data is above or below the range displayed on the graticule.

Marker values are normally continuous: that is, they are interpolated between measured points, with 100 kHz resolution in the standard instrument and 1 Hz in the option 001. Alternatively, they can be set to read only discrete measured points. The markers for the two channels normally have the same stimulus values, or they can be uncoupled so that each channel has independent markers, regardless of whether stimulus values are coupled or dual channel display is on.

If both data and memory are displayed, the marker values apply to the data trace. If memory only is displayed, the marker values apply to the memory trace. In a memory math display (data/memory or data—memory), the marker values apply to the trace resulting from the memory math function.

To see or copy (to plotter or printer) the response and stimulus values of all markers, press **COPY** **OP PARAM (MKRS ETC)**.

With the use of a reference marker, a delta marker mode is available that displays both the stimulus and response values of the active marker relative to the reference. Any of the markers or a fixed point can be designated as the delta reference marker. If the delta reference is one of the markers, its stimulus value can be controlled by the user and its response value is the value of the trace at that stimulus value. If the delta reference is a fixed marker, both its stimulus value and its response value can be set arbitrarily by the user anywhere in the display area (not necessarily on the trace).

Markers can be used to search for the trace maximum or minimum point or any other point on the trace. The markers can be used together to search for specified bandwidth cutoff points and calculate the bandwidth and Q values (see *Marker Search Menu*). Statistical analysis uses markers to provide a readout of the mean, standard deviation, and peak-to-peak values of all or part of the trace (see *Marker Function Menu*).

## MKR KEY

Basic marker operations are available in the menus accessed from the **MKR** key. The marker search and statistical functions, together with the capability for quickly changing stimulus parameters with markers, are provided in the menus accessed from the **MKR FCTN** key.

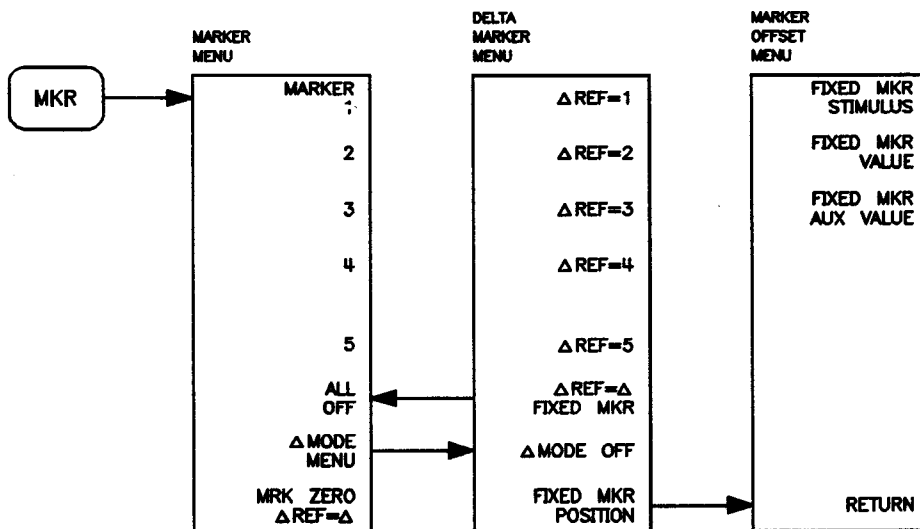


Figure 7-2. Menus Accessed from the **MKR** Key

The menus accessed from the **MKR** key (Figure 7-2) provide several basic marker operations. These include different marker modes for different display formats, and the delta marker mode that displays marker values relative to a specified value.

## Marker Menu

The marker menu (Figure 7-3) is used to turn the display markers on or off, to designate the active marker, and to gain access to the marker delta mode and other marker modes and formats.

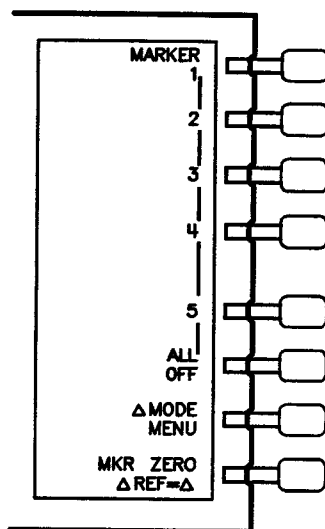


Figure 7-3. Marker Menu

**MARKER 1 (MARK1)** turns on marker 1 and makes it the active marker. The active marker appears on the CRT as  $-$ . The active marker stimulus value is displayed in the active entry area, together with the marker number. If there is a marker turned on, and no other function is active, the stimulus value of the active marker can be controlled with the knob, the step keys, or the number pad. The marker response and stimulus values are displayed in the upper right corner of the screen.

**MARKER 2 (MARK2)** turns on marker 2 and makes it the active marker. If another marker is present, that marker becomes inactive and is represented on the CRT as  $\Delta$ .

**MARKER 3 (MARK3)** turns on marker 3 and makes it the active marker.

**MARKER 4 (MARK4)** turns on marker 4 and makes it the active marker.

**MARKER 5 (MARK5)** turns on marker 5 and makes it the active marker.

**all OFF (MARKOFF)** turns off all the markers and the delta reference marker, as well as the tracking and bandwidth functions that are accessed with the **MKR FCTN** key.

**Δ MODE MENU** goes to the delta marker menu, which is used to read the difference in values between the active marker and a reference marker.

**MKR ZERO (MARKZERO)** puts a fixed reference marker at the present active marker position, and makes the fixed marker stimulus and response values at that position equal to zero. All subsequent stimulus and response values of the active marker are then read out relative to the fixed marker. The fixed marker is shown on the CRT as a small triangle  $\Delta$  (delta), smaller than the inactive marker triangles. The softkey label changes from **MKR ZERO** to **MKR ZERO Δ REF = Δ** and the notation "ΔREF=Δ" is displayed at the top right corner of the graticule. Marker zero is canceled by turning delta mode off in the delta marker menu or turning all the markers off with the **all OFF** softkey.

**MARKER MODE MENU** provides access to the marker mode menu, where several marker modes can be selected including special markers for polar and Smith formats.

## Delta Marker Mode Menu

The delta marker mode is used to read the difference in stimulus and response values between the active marker and a designated delta reference marker. Any of the markers or a fixed point can be designated as the reference marker. If the reference is one of the markers, its stimulus value can be controlled by the user and its response value is the value of the trace at that stimulus value. If the reference is a fixed marker, both its stimulus value and its response value can be set arbitrarily by the user anywhere in the display area. The delta reference is shown on the CRT as a small triangle  $\Delta$  (delta), smaller than the inactive marker triangles. If one of the markers is the reference, the triangle appears next to the marker number on the trace.

The marker values displayed in this mode are the stimulus and response values of the active marker minus the reference marker. If the active marker is also designated as the reference marker, the marker values are zero.

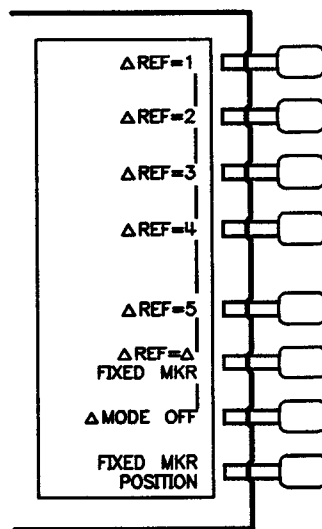


Figure 7-4. Delta Marker Mode Menu

$\Delta$  REF = 1 (DELR1) establishes marker 1 as a reference. The active marker stimulus and response values are then shown relative to this delta reference. Once marker 1 has been selected as the delta reference, the softkey label  $\Delta$  REF = 1 is underlined in this menu, and the marker menu is returned to the screen. In the marker menu, the first key is now labeled **MARKER  $\Delta$  REF = 1**. The notation " $\Delta$ REF=1" appears at the top right corner of the graticule.

$\Delta$  REF = 2 (DELR2) makes marker 2 the delta reference. Active marker stimulus and response values are then shown relative to this reference.

$\Delta$  REF = 3 (DELR3) makes marker 3 the delta reference.

$\Delta$  REF = 4 (DELR4) makes marker 4 the delta reference.

$\Delta$  REF = 5 (DELR5) makes marker 5 the delta reference.



**Δ REF = Δ FIXED MKR** (DELRFIXM) sets a user-specified fixed reference marker. The stimulus and response values of the reference can be set arbitrarily, and can be anywhere in the display area consistent with the 100 kHz frequency resolution of the standard instrument (1 Hz in the option 001). Unlike markers 1 to 5, the fixed marker need not be on the trace. The fixed marker is indicated by a small triangle Δ, and the active marker stimulus and response values are shown relative to this point. The notation "ΔREF=Δ" is displayed at the top right corner of the graticule.

Pressing this softkey turns on the fixed marker. Its stimulus and response values can then be changed using the fixed marker menu, which is accessed with the **FIXED MKR POSITION** softkey described below. Alternatively, the fixed marker can be set to the current active marker position, using the **MKR ZERO** softkey in the marker menu.

**Δ MODE OFF** (DELO) turns off the delta marker mode, so that the values displayed for the active marker are absolute values.

**FIXED MKR POSITION** leads to the fixed marker menu, where the stimulus and response values for a fixed reference marker can be set arbitrarily.

Alternatively, the current position of the active marker can be entered as the fixed reference by using **MKR ZERO** in the marker menu.

**RETURN** goes back to the marker menu.

## Fixed Marker Menu

This menu (Figure 7-5) is used to set the position of a fixed reference marker, indicated on the display by a small triangle Δ. Both the stimulus value and the response value of the fixed marker can be set arbitrarily anywhere in the display area, and need not be on the trace. The units are determined by the display format, the sweep type, and the marker type.

There are two ways to turn on the fixed marker. One way is with the **Δ REF = Δ FIXED MKR** softkey in the delta marker menu. The other is with the **MKR ZERO** function in the marker menu, which puts a fixed reference marker at the present active marker position and makes the marker stimulus and response values at that position equal to zero.

The softkeys in this menu make the values of the fixed marker the active function. The marker readings in the top right corner of the graticule are the stimulus and response values of the active marker minus the fixed reference marker. Also displayed in the top right corner is the notation "ΔREF=Δ."

The stimulus value, response value, and auxiliary response value (the second part of a complex data pair) can be individually examined and changed. This allows active marker readings that are relative in amplitude yet absolute in frequency, or any combination of relative/absolute readouts. Following a **MKR ZERO** operation, this menu can be used to reset any of the fixed marker values to absolute zero for absolute readings of the subsequent active marker values.

If the format is changed while a fixed marker is on, the fixed marker values become invalid. For example, if the value offset is set to 10 dB with a log magnitude format, and the format is then changed to phase, the value offset becomes 10 degrees. However, in polar and Smith chart formats, the specified values remain consistent between different marker types for those formats. Thus an R+jX marker set on a Smith chart format will retain the equivalent values if it is changed to any of the other Smith chart markers.

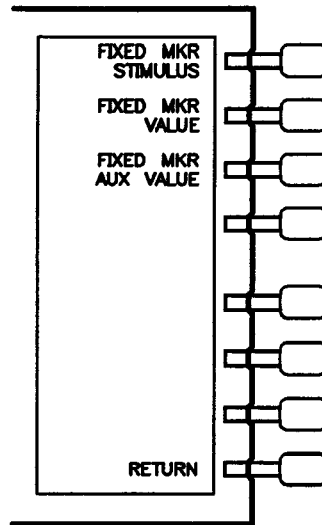


Figure 7-5. The Fixed Marker Menu

**FIXED MKR STIMULUS** (MARKFSTI) changes the stimulus value of the fixed marker. In the standard instrument, this value must be divisible by 100 kHz. Fixed marker stimulus values can be different for the two channels if the channel markers are uncoupled using the marker mode menu.

To read absolute active marker stimulus values following a **MKR ZERO** operation, the stimulus value can be reset to zero.

**FIXED MKR VALUE** (MARKFVAL) changes the response value of the fixed marker. In a Cartesian format this is the y-axis value. In a polar or Smith chart format with a magnitude/phase marker, a real/imaginary marker, an  $R+jX$  marker, or a  $G+jB$  marker, this applies to the first part of the complex data pair. Fixed marker response values are always uncoupled in the two channels.

To read absolute active marker response values following a **MKR ZERO** operation, the response value can be reset to zero.

**FIXED MKR AUX VALUE** (MARKFAUV) is used only with a polar or Smith format. It changes the auxiliary response value of the fixed marker. This is the second part of a complex data pair, and applies to a magnitude/phase marker, a real/imaginary marker, an  $R+jX$  marker, or a  $G+jB$  marker. Fixed marker auxiliary response values are always uncoupled in the two channels.

To read absolute active marker auxiliary response values following a **MKR ZERO** operation, the auxiliary value can be reset to zero.

**RETURN** goes back to the delta marker menu.

## MKR FCTN KEY

The **MKR FCTN** (MENUMRKF) key activates a marker if one is not already active, and provides access to additional marker functions. These can be used to quickly change the measurement parameters, to search the trace for specified information, and to analyze the trace statistically.

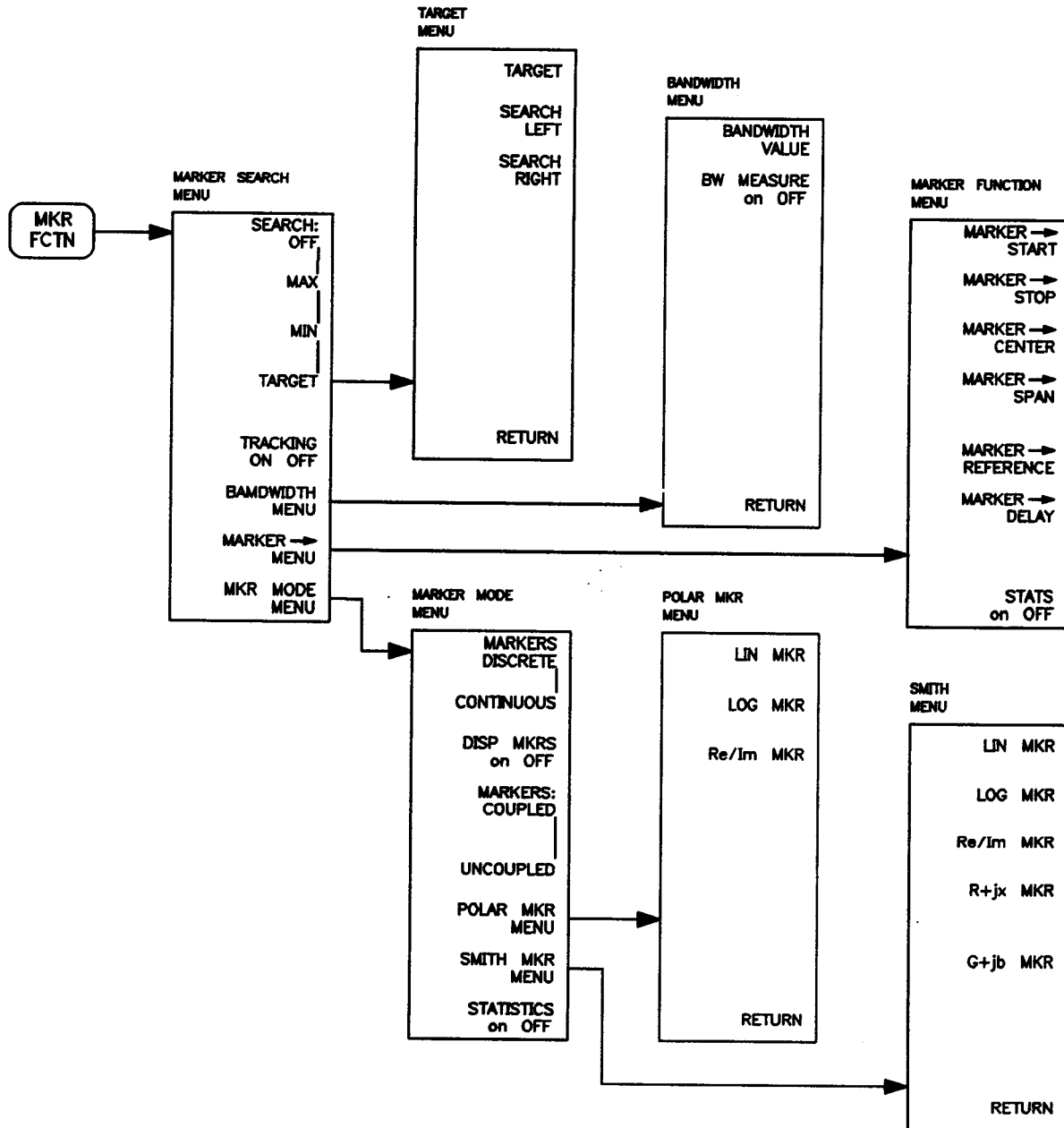


Figure 7-6. Menus Accessed from the **MKR FCTN** Key

## Marker Search Menu

This menu is used to search the trace for a specific magnitude—related point, and place the marker on that point. The capability of searching for a specified bandwidth is also provided. Tracking is available for a continuous sweep—to—sweep search. If there is no occurrence of a specified value or bandwidth, the message "TARGET VALUE NOT FOUND" is displayed.

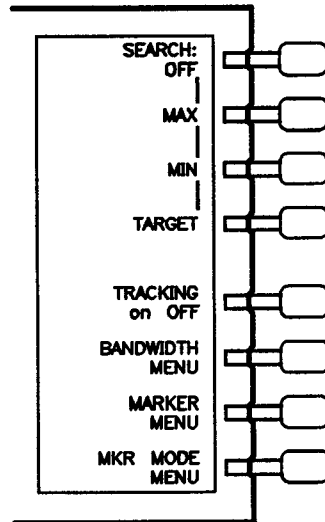


Figure 7–7. Marker Search Menu

**SEARCH: OFF** (SEAOFF) turns off the marker search function.

**MAX** (SEAMAX) moves the active marker to the maximum point on the trace.

**MIN** (SEAMIN) moves the active marker to the minimum point on the trace.

**TARGET** (SEATARG) makes target value the active function, and places the active marker at a specified target point on the trace. The default target value is  $-3$  dB. The target menu is presented, providing search right and search left options to resolve multiple solutions.

For relative measurements, a search reference must be defined with a delta marker or a fixed marker before the search is activated.

All markers are turned on, and each has a dedicated use. Marker 1 is a starting point from which the search is begun. Marker 2 goes to the bandwidth center point. Marker 3 goes to the bandwidth cutoff point on the left, and marker 4 to the cutoff point on the right.

If a delta marker or fixed marker is on, it is used as the reference point from which the bandwidth magnitude is measured. For example, if marker 1 is the delta marker and is set at the passband maximum, and the width value is set to  $-3$  dB, the bandwidth search finds the bandwidth cutoff points 3 dB below the maximum and calculates the 3 dB bandwidth and Q.

If marker 2 (the dedicated bandwidth center point marker) is the delta reference marker, the search finds the points 3 dB down from the center.

If no delta reference marker is set, the bandwidth values are absolute values.

**TRACKING on OFF** (TRACKON, TRACKOFF) is used in conjunction with other search features to track the search with each new sweep. Turning tracking on makes the HP 8720 search every new trace for the specified target value and put the active marker on that point. If bandwidth search is on, tracking searches every new trace for the specified bandwidth, and repositions the dedicated bandwidth markers.

When tracking is off, the target is found on the current sweep and remains at the same stimulus value regardless of changes in trace response value with subsequent sweeps.

A maximum and a minimum point can be tracked simultaneously using two channels and uncoupled markers.

**BANDWIDTH MENU** brings up the bandwidth menu.

**MARKER → MENU** brings up the marker function menu which provides softkeys that use markers to quickly modify certain measurement parameters.

**MARKER MODE MENU** Brings up the marker mode menu. This menu provides different marker modes.

## Target Menu

The target menu places the marker at a specified target response value on the trace, and provides search right and search left options. If there is no occurrence of the specified value, the message "TARGET VALUE NOT FOUND" is displayed.

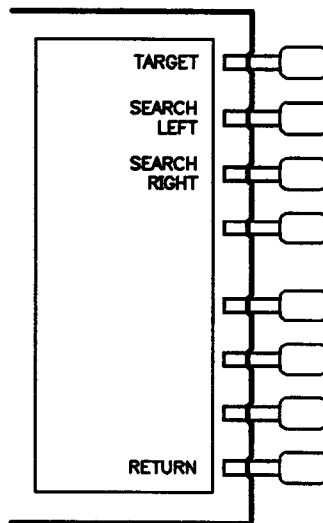


Figure 7-8. Target Menu

**TARGET** (SEATARG) places the marker at the specified target response value. If tracking is on (see previous menu) the target is automatically tracked with each new trace. If tracking is off, the target is found each time this key is pressed. The target value is in units appropriate to the current format. The default target value is  $-3$  dB.

In delta marker mode, the target value is the value relative to the reference marker. If no delta reference marker is on, the target value is an absolute value.

**SEARCH LEFT** (SEAL) searches the trace for the next occurrence of the target value to the left.

**SEARCH RIGHT** (SEAR) searches the trace for the next occurrence of the target value to the right.

**RETURN** goes back to the marker search menu.

## Bandwidth Menu

The bandwidth menu sets the bandwidth value that sets the start and stop points for a marker bandwidth search.

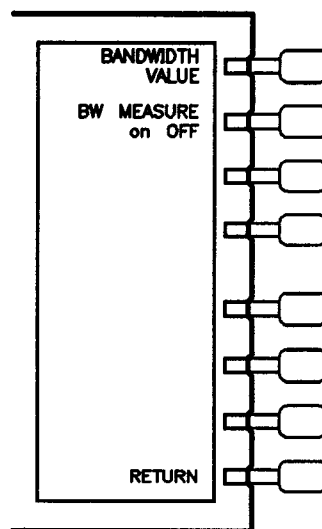


Figure 7-9. Bandwidth Menu

**BANDWIDTH VALUE** (WIDV) is used to set the amplitude parameter (for example 3 dB) that defines the start and stop points for a bandwidth search. The bandwidth search feature analyzes a bandpass or band reject trace and calculates the center point, bandwidth, and Q (quality factor) for the specified bandwidth. Bandwidth units are the units of the current format.

**BW MEASURE on OFF** (WIDTON, WIDTOFF) turns on the bandwidth search feature and calculates the center stimulus value, bandwidth, Q and shape factor, (ratio of -6 and -60 dB bandwidths) of a bandpass or band reject shape on the trace. The amplitude value that defines the passband or rejectband is set using the **BANDWIDTH VALUE** softkey.

Four markers are turned on, and each has a dedicated use. Marker 1 is a starting point from which the search is begun. Marker 2 goes to the bandwidth center point. Marker 3 goes to the bandwidth cutoff point on the left, and marker 4 to the cutoff point on the right.

**NOTE:** If a delta marker or fixed marker is on, it is used as the reference point from which the bandwidth amplitude is measured. For example, if marker 1 is the delta marker and is set at the passband maximum, and the width value is set to -3 dB, the bandwidth search finds the bandwidth cutoff points 3 dB below the maximum and calculates the 3 dB bandwidth and Q.

If marker 2 (the dedicated bandwidth center point marker) is the delta reference marker, the search finds the points 3 dB down from the center.

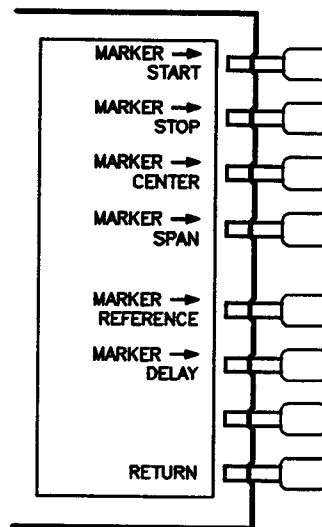
If no delta reference marker is set, the bandwidth values are absolute values.

**RETURN** returns to the marker search menu.

## Marker Function Menu

This menu provides softkeys that use markers to quickly modify certain measurement parameters without going through the usual key sequence. In addition, it provides access to two additional menus used for searching the trace and for statistical analysis.

The **MARKER →** functions change certain stimulus and response parameters to make them equal to the current active marker value. Use the knob or the keypad to move the marker to the desired position on the trace, and press the appropriate softkey to set the specified parameter to that trace value. When the values have been changed, the marker can again be moved within the range of the new parameters.



*Figure 7–10. Marker Function Menu*

**MARKER → START** (MARKSTAR) changes the stimulus start value to the stimulus value of the active marker.

**MARKER → STOP** (MARKSTOP) changes the stimulus stop value to the stimulus value of the active marker.

**MARKER → CENTER** (MARKCENT) changes the stimulus center value to the stimulus value of the active marker, and centers the new span about that value.

**MARKER → SPAN** (MARKSPAN) changes the start and stop values of the stimulus span to the values of the active marker and the delta reference marker. If there is no reference marker, the message "NO MARKER DELTA—SPAN NOT SET" is displayed.

**MARKER → REFERENCE** (MARKREF) makes the reference value equal to the active marker's response value, without changing the reference position. In a polar or Smith chart format, the full scale value at the outer circle is changed to the active marker response value. This softkey also appears in the scale reference menu.

**MARKER → DELAY** (MARKDELA) adds electrical delay, up to a maximum of 10  $\mu$ sec, to balance the phase of the DUT. This is performed automatically, regardless of the format and the measurement being made. Enough line length is added to or subtracted from the receiver input to compensate for the phase slope at the active marker position. This effectively flattens the phase trace around the active marker, and can be used to measure electrical length or deviation from linear phase. Additional electrical delay adjustments are required on DUTs without constant group delay over the measured frequency span. Refer to *Scale Reference Menu* in Chapter 5 for more information on electrical delay.

## Marker Mode Menu

This menu provides different marker modes and makes available two additional menus of special markers for use with Smith chart or polar formats.

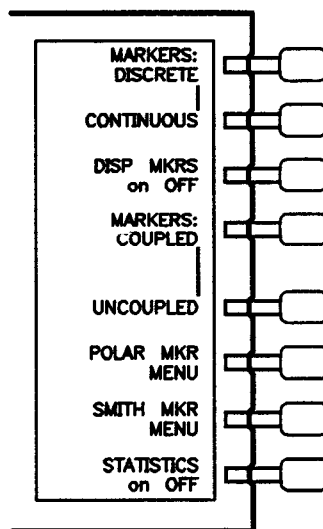


Figure 7–11. Marker Mode Menu

**MARKERS: DISCRETE** (MARKDISC) places markers only on measured trace points determined by the stimulus settings.

**CONTINUOUS** (MARKCONT) interpolates between measured points to allow the markers to be placed at any point on the trace. The marker readout values are also interpolated, with 100 kHz resolution in a standard instrument and 1 Hz in an option 001. This is the default marker mode.

**DISP MKRS on OFF** (DISM) displays response and stimulus values for all markers that are turned on. Available only if no marker functions are on.

**MARKERS: COUPLED** (MARKCOUP) couples the marker stimulus values for the two display channels. Even if the stimulus is uncoupled and two sets of stimulus values are shown, the markers track the same stimulus values on each channel as long as they are within the displayed stimulus range. Markers are normally coupled.



**UNCOUPLED** (MARKUNCO) allows the marker stimulus values to be controlled independently on each channel.

**POLAR MKR MENU** leads to a menu of special markers for use with a polar format.

**SMITH MKR MENU** leads to a menu of special markers for use with a Smith chart format.

**RETURN** goes back to the marker menu.

**STATS on OFF** (MEASTAT) calculates and displays the mean, standard deviation, and peak-to-peak values of the section of the displayed trace between the active marker and the delta reference marker. If there is no delta reference, the statistics are calculated for the entire trace. A convenient use of this feature is to find the peak-to-peak value of passband ripple without searching separately for the maximum and minimum values. The *User's Guide* provides an example of such a measurement, illustrated here in Figure 7-12.

The statistics are absolute values: the delta marker here serves to define the span. For polar and Smith formats the statistics are calculated using the first value of the complex pair (magnitude, real part, resistance, or conductance).

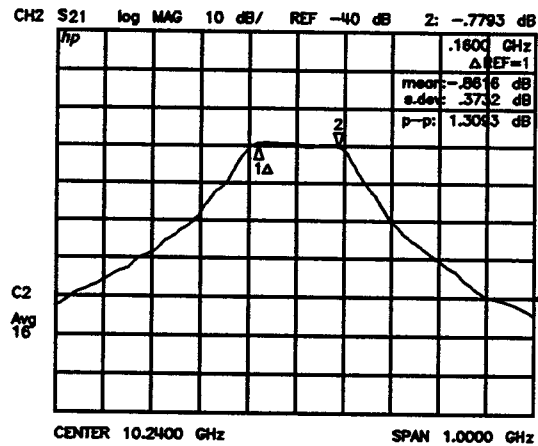


Figure 7-12. Measurement Using Marker Statistics

## Polar Marker Menu

This menu is used only with a polar display format, selectable using the **FORMAT** key. In the polar format, the magnitude at the center of the circle is zero and the outer circle is the full-scale value set in the scale reference menu. Phase is measured as the angle counterclockwise from 0° at the positive x-axis. The analyzer automatically calculates different mathematical forms of the marker magnitude and phase values, selected using the softkeys in this menu. Marker frequency is displayed in addition to other values regardless of the selection of marker type.

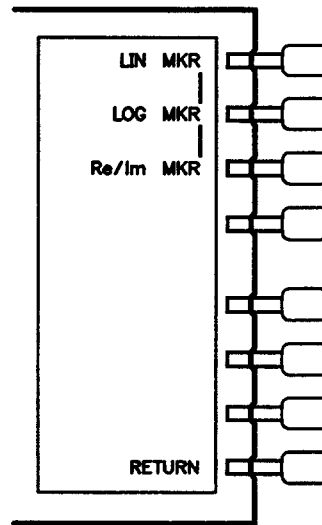


Figure 7-13. Polar Marker Menu

**LIN MKR** (POLMLIN) displays a readout of the linear magnitude and the phase of the active marker. This is the preset marker type for a polar display. Magnitude values are read in units and phase in degrees.

**LOG MKR** (POLMLOG) displays the logarithmic magnitude and the phase of the active marker. Magnitude values are expressed in dB and phase in degrees. This is useful as a fast method of obtaining a reading of the log magnitude value without changing to log magnitude format.

**Re/Im MKR** (POLMRI) displays the values of the active marker as a real and imaginary pair. The complex data is separated into its real part and imaginary part. The first marker value given is the real part  $M \cos \Theta$ , and the second value is the imaginary part  $M \sin \Theta$ , where  $M$  = magnitude and  $\Theta$  = phase angle.

**RETURN** goes back to the marker mode menu.

## Smith Marker Menu

This menu is used only with the Smith chart format, selected from the format menu. The analyzer automatically calculates different mathematical forms of the marker magnitude and phase values, selected using the softkeys in this menu. Marker frequency is displayed in addition to other values for all marker types.

For additional information about the Smith chart display format, refer to **FORMAT** Key in Chapter 5.

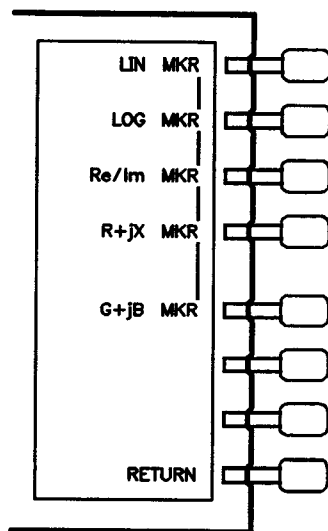


Figure 7-14. Smith Marker Menu

**LIN MKR** (SMIMLIN) displays a readout of the linear magnitude and the phase of the active marker. Marker magnitude values are expressed in units and phase in degrees.

**LOG MKR** (SMIMLOG) displays the logarithmic magnitude value and the phase of the active marker. Magnitude values are expressed in dB and phase in degrees. This is useful as a fast method of obtaining a reading of the log magnitude value without changing to log magnitude format.

**Re/Im MKR** (SMIMRI) displays the values of the active marker on a Smith chart as a real and imaginary pair. The complex data is separated into its real part and imaginary part. The first marker value given is the real part  $M \cos \Theta$ , and the second value is the imaginary part  $M \sin \Theta$ , where  $M$  = magnitude and  $\Theta$  = phase angle.

**R+jX MKR** (SMIMRX) converts the active marker values into rectangular form. The complex impedance values of the active marker are displayed in terms of resistance, reactance, and equivalent series capacitance or inductance. This is the default Smith chart marker.

For measurements in an environment that is not 50 ohms, the network analyzer characteristic impedance must be modified using the **SET Z0** softkey in the calibrate more menu (Chapter 6).  $Z_0$  sets the center value of the Smith chart, and is used in calculating impedance measurements. In addition, a minimum loss pad or matching transformer must be inserted between the device and the measurement port.

**G+JB MKR** (SMIMGB) displays the complex admittance values of the active marker in rectangular form. The active marker values are displayed in terms of conductance (in Siemens), susceptance, and equivalent parallel circuit capacitance or inductance. Siemens are the international units of admittance, and are equivalent to mhos (the inverse of ohms).

**RETURN** goes back to the marker mode menu.

## Chapter 8. Instrument State and Limit Testing

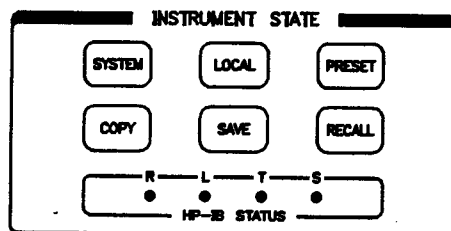


Figure 8-1

### INTRODUCTION

The **LOCAL** key and the **SYSTEM** key are part of the instrument state function block. The keys in this block, and their associated menus, provide control of channel-independent system functions.

The **LOCAL** key leads to the menus used to define controller modes, instrument addresses, and HP-IB status information. (Additional HP-IB information is provided in Chapter 12.)

The **SYSTEM** key provides access to the limit testing feature, which compares measured data with user-defined limits. It also leads to the option 010 time domain transform function, the instrument mode menu, and the service menus. Limit testing is described in this chapter, and time domain is explained in Chapter 9. The *Service Manual* provides complete information on the service menus.

Other functions provided by the instrument state block and its associated menus are plotting and printing, and saving instrument states either in internal memory or on an external disc. The printing and plotting capabilities available using the **COPY** key are described in Chapter 10. Chapter 11 explains the use of instrument state save registers and external storage files, and the **SAVE** and **RECALL** keys.

## LOCAL KEY

This key is used to return the analyzer to local (front panel) operation from remote (computer controlled) operation. In this local mode, with a controller still connected on HP-IB, the analyzer can be operated manually (locally) from the front panel. This is the only front panel key that is not disabled when the analyzer is remotely controlled over HP-IB by a computer. The exception to this is when local lockout is in effect: this is a remote command that disables the **LOCAL** key, making it difficult to interfere with the network analyzer while it is under remote control.

In addition, this key gives access to the HP-IB menu, which sets the controller mode, and to the address menu, where the HP-IB addresses of peripheral devices are entered.

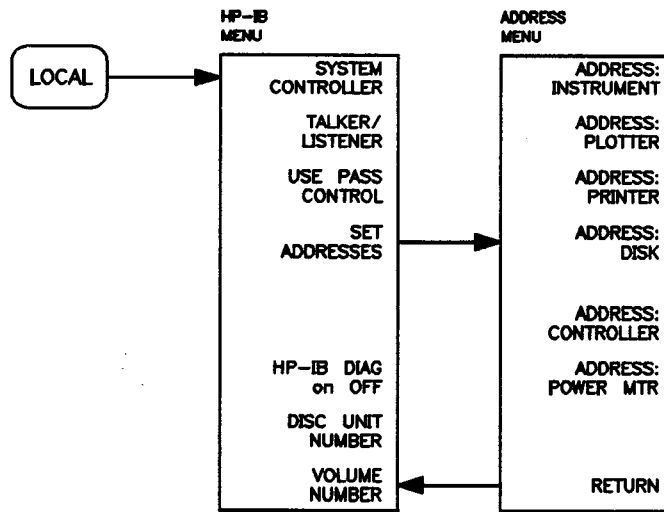


Figure 8-2. Softkey Menus Accessed from the **LOCAL** Key

## HP-IB Menu

The analyzer is factory-equipped with a remote programming interface using the Hewlett-Packard Interface Bus (HP-IB). This enables communication between the network analyzer and a controlling computer and other peripheral devices. This menu indicates the present HP-IB controller mode of the analyzer. Three HP-IB modes are possible: system controller, talker/listener, and pass control.

Talker/listener is the normal mode of operation. In this mode, a computer controller communicates with the network analyzer and other compatible peripherals over the bus. The computer sends commands or instructions to and receives data from the analyzer. All of the capabilities available from the analyzer front panel can be used in this remote operation mode, except for control of the power line switch and some internal tests.

In the system controller mode, the analyzer itself can use HP-IB to control compatible peripherals, without the use of an external computer. It can output measurement results directly to a compatible printer or plotter, and store instrument states using a compatible disk drive.

A third mode of HP-IB operation is the pass control mode. In an automated system with a computer controller, the controller can pass control of the bus to the analyzer on request from the network analyzer. The analyzer is then the controller of the peripherals, and can direct them to plot, print, or store without going through the computer. When the peripheral operation is complete, control is passed back to the computer. Only one controller can be active at a time. The computer remains the system controller, and can regain control at any time.

Preset does not affect the selected controller mode, but cycling the power returns the network analyzer to talker/listener mode.

Information on compatible peripherals is provided in the *General Information* section of this manual.

**HP-IB Status Indicators.** When the analyzer is connected to other instruments over HP-IB, the HP-IB STATUS indicators in the instrument state function block light up to display its current status.

- R = Remote operation.
- L = Listen mode.
- T = Talk mode.
- S = Service request (SRQ) asserted by the analyzer.

Refer to Chapter 12 for additional information on HP-IB operation of the analyzer.

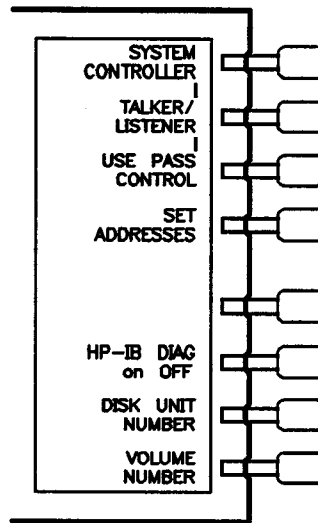


Figure 8-3. HP-IB Menu

**SYSTEM CONTROLLER** is the mode used when peripheral devices are to be used and there is no external controller. In this mode, the analyzer can directly control peripherals (plotter, printer, or disk drive). System controller mode must be set in order for the network analyzer to access peripherals from the front panel to plot, print, or store on disc. It is set automatically if there is no active controller present on the bus.

The system controller mode can be used without knowledge of HP-IB programming. However, the HP-IB addresses displayed in the address menu must match the addresses set in the peripheral instruments.

This mode can be used only if no active computer controller is connected to the system through HP-IB. If you try to set system controller mode when another controller is present, the message "CAUTION: CAN'T CHANGE—ANOTHER CONTROLLER ON BUS" is displayed. Do not attempt to use this mode for programming.

**TALKER/LISTENER** (TALKLIST) is the mode normally used for remote programming of the analyzer. In this mode, the network analyzer and all peripheral devices are controlled by the external controller. The controller can command the analyzer to talk, and the plotter or other device to listen. The analyzer and peripheral devices cannot talk directly to each other unless the computer sets up a data path between them.

This mode allows the analyzer to be either a talker or a listener, as required by the controlling computer for the particular operation in progress.

A talker is a device capable of sending out data when it is addressed to talk. There can be only one talker at any given time. The analyzer is a talker when it sends information over the bus.

A listener is a device capable of receiving data when it is addressed to listen. There can be any number of listeners at any given time. The analyzer is a listener when it is controlled over the bus by a computer.

**USE PASS CONTROL** (USEPASC) lets you control the analyzer with the computer over HP-IB as with the talker/listener mode, and also allows the network analyzer to become the active controller in order to plot, print, or directly access an external disc. During this peripheral operation, the host computer is free to perform other internal tasks that do not require use of the bus (the bus is tied up by the network analyzer during this time).

The pass control mode requires that the external controller is programmed to respond to a request for control and to issue a take control command. When the peripheral operation is complete, the analyzer passes control back to the computer. Refer to Chapter 12 for more information.

In general, use the talker/listener mode for programming the analyzer unless direct peripheral access is required.

**SET ADDRESSES** goes to the address menu, which is used to set the HP-IB address of the analyzer, and to display and modify the addresses of peripheral devices in the system.

**HP-IB DIAG on OFF** (DEBUON, DEBUOFF) toggles the HP-IB diagnostic feature (debug mode). This mode should only be used the first time a program is written: if a program has already been debugged, it is unnecessary.

When diagnostics is on, the network analyzer scrolls a history of incoming HP-IB commands across the display in the title line. Nonprintable characters are represented as  $\pi$ . Any time a syntax error is received, the commands halt and a pointer  $\wedge$  indicates the misunderstood character. To clear a syntax error, refer to the *Basic Programming Guide*, or the *HP-IB Programming Reference*.

**DISK UNIT NUMBER** (DISCUNIT) specifies the number of the disk unit in the disk drive that is to be accessed in an external disk store or load routine. This is used in conjunction with the HP-IB address of the disk drive, and the volume number, to gain access to a specific area on a disc. The access hierarchy is:



HP-IB address disk unit number disk volume number. More information on storing information to an external disk is provided in Chapter 11, *Saving Instrument States*.

**VOLUME NUMBER** (DISCVOLU) specifies the number of the disk volume to be accessed. In general, all 3.5" floppy discs are considered one volume (volume 0). For hard disk drives, such as the HP 9153, a switch in the disk drive must be set to define the number of volumes on the disc. For more information, refer to the manual for the individual disk drive.

## Address Menu

In communications through the Hewlett-Packard Interface Bus (HP-IB), each instrument on the bus is identified by an HP-IB address. This decimal-based address code must be different for each instrument on the bus.

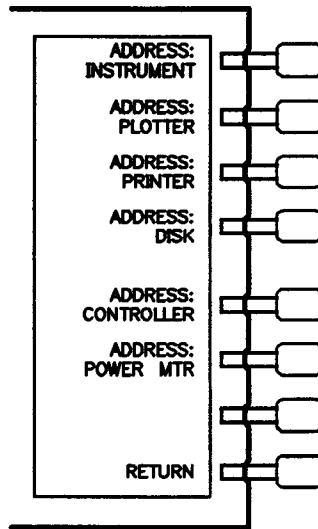
This menu is used to set the HP-IB address of the analyzer, and to enter the addresses of peripheral devices so that the analyzer can communicate with them.

Most of the HP-IB addresses are set at the factory and need not be modified for normal system operation. The standard factory-set addresses for instruments that may be part of the system are as follows:

Instrument	HP-IB Address (decimal)
Instrument	16
Plotter	05
Printer	01
External Disk Drive	00
Controller	21
Power Meter	13

The address displayed in this menu for each peripheral device must match the address set on the device itself. If the addresses do not match, they can be matched in one of two ways. Either the address displayed on the CRT for the device can be modified using the entry controls; or the address of the device can be changed using instructions provided in the device manual. The analyzer does not have an HP-IB address switch: its address is set only from the front panel. **An address change becomes effective after the next preset.**

These addresses are stored in short-term non-volatile memory and are not affected by preset or by cycling the power.



*Figure 8-4. Address Menu*

**ADDRESS: INSTRUMENT** sets the HP-IB address of the analyzer, using the entry controls. There is no physical address switch.

**ADDRESS: PLOTTER** (ADDRPLOT) sets the HP-IB address the analyzer will use to communicate with the plotter.

**ADDRESS: PRINTER** (ADDRPRIN) sets the HP-IB address the analyzer will use to communicate with the printer.

**ADDRESS: DISK** (ADDRDISC) sets the HP-IB address the analyzer will use to communicate with the disk drive.

**ADDRESS: CONTROLLER** (ADDRCONT) sets the HP-IB address the analyzer will use to communicate with the external controller.

**ADDRESS: POWER MTR** (ADDRPOWM) sets the HP-IB address the analyzer will use to communicate with the power meter.

**RETURN** goes back to the HP-IB menu.

## SYSTEM KEY (MENUSYST)

This key presents the system menu, which provides access to three additional series of menus (four in the option 010).

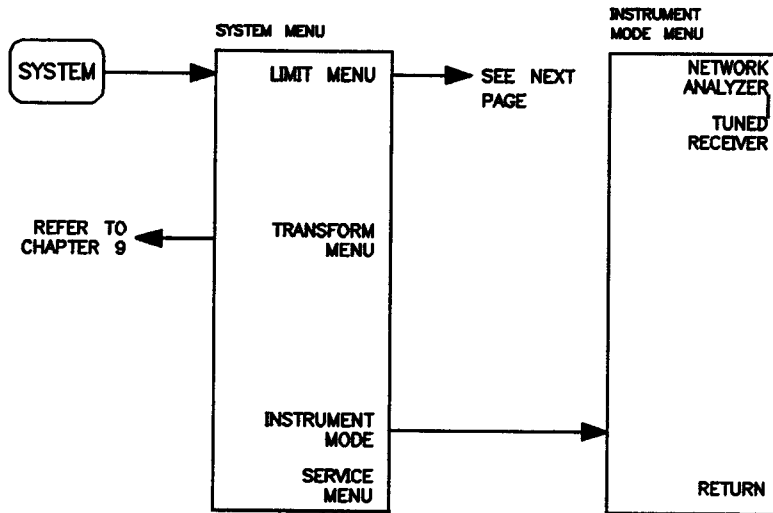


Figure 8–5. System Menu

**LIMIT MENU** leads to a series of menus used to define limits or specifications with which to compare a device under test. Refer to *Limit Lines and Limit Testing* on the next page.

**TRANSFORM MENU** (option 010) leads to a series of menus that transform the measured data from the frequency domain to the time domain. Time domain modes and features are explained in Chapter 9, *Time and Frequency Domain Transforms*. This softkey is present only in instruments with option 010.

**INSTRUMENT MODE** leads to a menu that contains softkeys that allow the instrument to be switched to a network analyzer or tuned receiver mode.

**SERVICE MENU** leads to a series of service menus described in detail in the *Service Manual*.

## LIMIT LINES AND LIMIT TESTING

Limit lines are lines drawn on the CRT to represent upper and lower limits or device specifications with which to compare the device under test. Limits are defined in segments, where each segment is a portion of the stimulus span. Each limit segment has an upper and a lower starting limit value. Three types of segments are available: flat line, sloping line, and single point. Figure 8–6 illustrates limit lines defined for a bandpass filter.

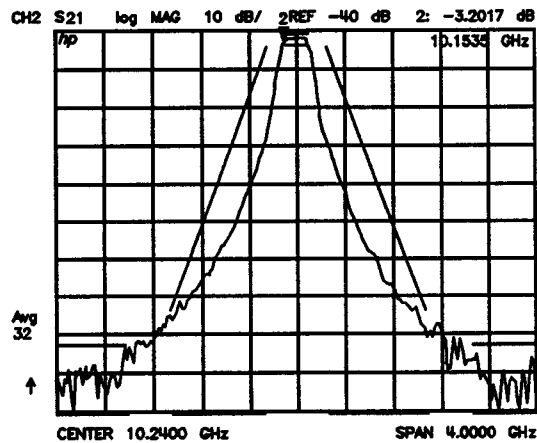


Figure 8–6. *Limit Lines for Bandpass Filter Testing*

Limits can be defined independently for the two channels, up to 22 segments for each channel. These can be in any combination of the three limit types.

Limit testing compares the measured data with the defined limits, and provides pass or fail information for each measured data point. An out-of-limit test condition is indicated in several different ways: with a FAIL message on the screen, with a beep, by blanking of portions of the trace, with an asterisk in tabular listings of data, with a bit in the HP-IB event status register B, and with a TTL low on pin 17 of the IO interconnect.

Limit lines and limit testing can be used simultaneously or independently. If limit lines are on and limit testing is off, the limit lines are displayed on the CRT for visual comparison and adjustment of the measurement trace. However, no pass/fail information is provided. If limit testing is on and limit lines are off, the specified limits are still valid and the pass/fail status is indicated even though the limit lines are not displayed on the CRT.

Limits are entered in tabular form. Limit lines and limit testing can be either on or off while limits are defined. As new limits are entered, the tabular columns on the CRT are updated, and the limit lines (if on) are modified to the new definitions. The complete limit set can be offset in either stimulus or amplitude value.

Limits are checked only at the actual measured data points. It is possible for a device to be out of specification without a limit test failure indication if the point density is insufficient. Be sure to specify a high enough number of measurement points in the stimulus menu.

Limit lines are displayed only on Cartesian formats. In polar and Smith chart formats, limit testing of one value is available: the value tested depends on the marker mode and is the magnitude or the first value in a complex pair. The message "NO LIMIT LINES DISPLAYED" is shown on the CRT in polar and Smith formats.

The list values feature in the copy menu provides tabular listings to the CRT or a printer for every measured stimulus value. These include limit line and/or limit test information if these functions are turned on. If limit testing is on, an asterisk \* is listed next to any measured value that is out of limits. If limit lines are on, and other listed data allows sufficient space, the upper limit and lower limit are listed, together with the margin by which the device data passes or fails the nearest limit. For more information about the list values feature, refer to Chapter 10, *Making a Hard Copy Output*.

If limit lines are on, they are plotted with the data on a plot. If limit testing is on, the PASS or FAIL message is plotted, and the failing portions of the trace that are blanked on the CRT are also blanked on the plot. If limits are specified, they are saved in memory with an instrument state.

An example of a measurement using limit lines and limit testing is provided in the *User's Guide*.

The menus for defining limits, illustrated in Figure 8-7, are accessed from the **SYSTEM** key.

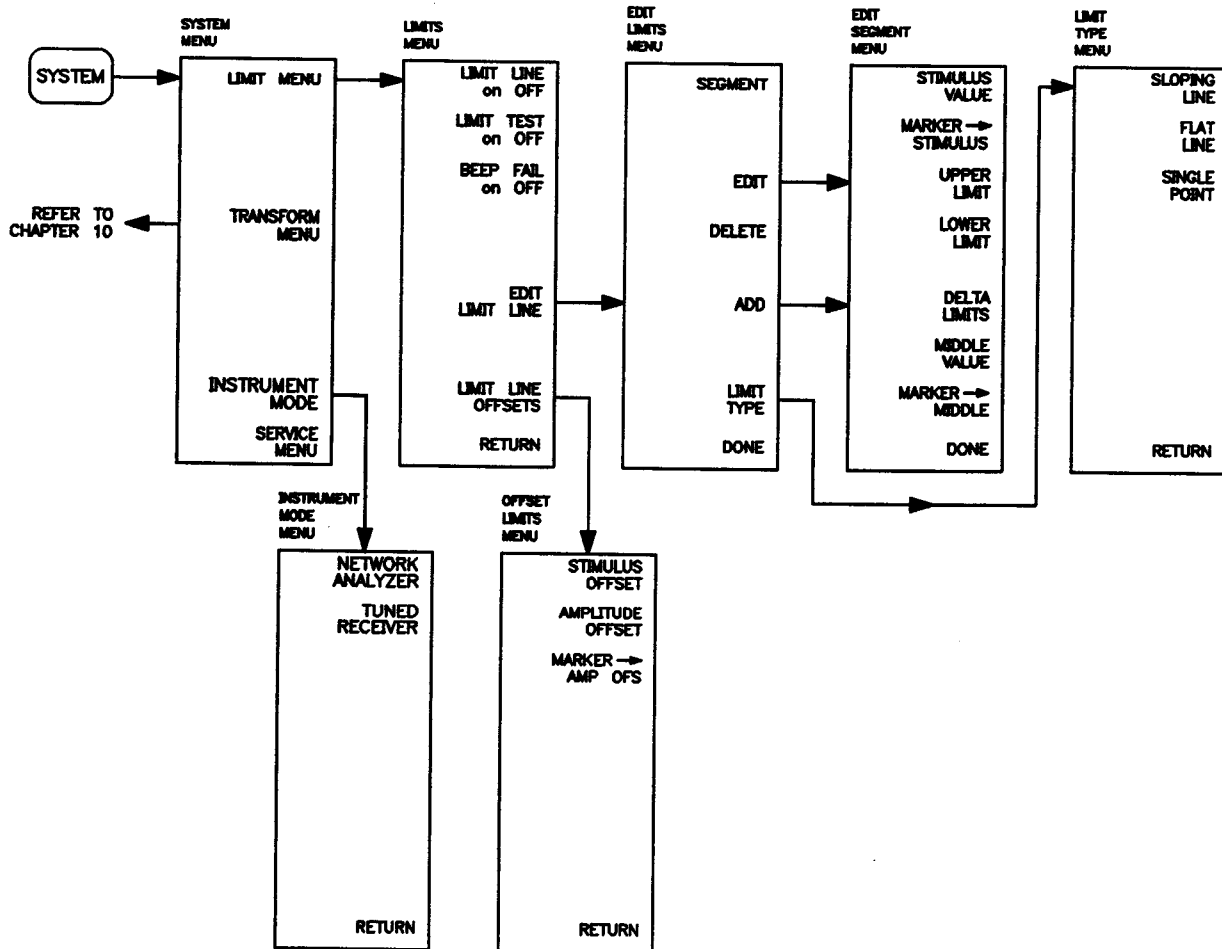


Figure 8-7. *The Limit Softkey Menu Series*

## Limits Menu

This menu independently toggles the limit lines, limit testing, and limit fail beeper. In addition, it leads to the menus used to define and modify the limits.

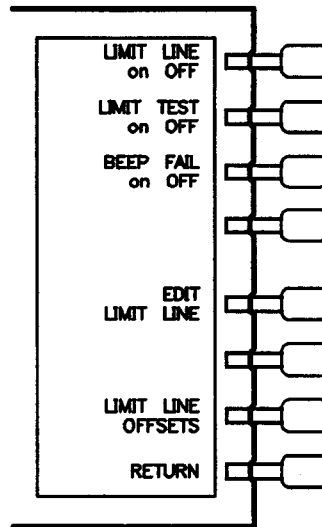


Figure 8–8. Limits Menu

**LIMIT LINE on OFF** (LIMILINEON, LIMILINEOFF) turns limit lines on or off. To define limits, use the

**EDIT LIMIT LINE** softkey described below. If limits have been defined and limit lines are turned on, the limit lines are displayed on the CRT for visual comparison of the measured data in all Cartesian formats.

If limit lines are on, they are plotted with the data on a plot, and saved in memory with an instrument state. In a listing of values from the copy menu with limit lines on, the upper limit and lower limit are listed together with the pass or fail margin, as long as other listed data allows sufficient space.

**LIMIT TEST on OFF** (LIMITESTON, LIMITESTOFF) turns limit testing on or off. When limit testing is on, the data is compared with the defined limits at each measured point. Limit tests occur at the end of each sweep, whenever the data is updated, when formatted data is changed, and when limit testing is first turned on.

Limit testing is available for both magnitude and phase values in Cartesian formats. In polar and Smith chart formats, the value tested depends on the marker mode and is the magnitude or the first value in a complex pair. The message "NO LIMIT LINES DISPLAYED" is displayed in polar and Smith formats if limit lines are turned on.

Several indications of pass or fail status are provided when limit testing is on. A PASS or FAIL message is displayed at the right of the CRT. The trace vector leading to any measured point that is out of limits is blanked at the end of every limit test, both on a CRT plot and a hard copy plot. The limit fail beeper sounds if it is turned on. In a listing of values using the copy menu, an asterisk \* is shown next to any measured point that is out of limits. A bit is set in the HP–IB status byte. Pin 17 of the IO interconnect is set at TTL low for a fail condition and TTL high for a pass condition.

**BEEP FAIL on OFF** (BEEPFAILON, BEEPFAILOFF) turns the limit fail beeper on or off. When limit testing is on and the fail beeper is on, a beep is sounded each time a limit test is performed and a failure detected. The limit fail beeper is independent of the warning beeper and the operation complete beeper, both of which are set in the display more menu (Chapter 5).

**EDIT LIMIT LINE** (EDITLIML) displays a table of limit segments on the CRT, superimposed on the trace. The edit limits menu is presented so that limits can be defined or changed. It is not necessary for limit lines or limit testing to be on while limits are defined, although it is helpful to turn on limit lines as a visual aid. Note that the table of limit segments is not plotted with the display.

**LIMIT LINE OFFSETS** leads to the offset limits menu, which is used to offset the complete limit set by a user-defined amount in either stimulus or amplitude value.

**RETURN** goes back to the system menu.

## Edit Limits Menu

This menu (Figure 8-9) is used to specify limits for limit lines and/or limit testing, and presents a table of limit values on the CRT. Limits are defined in segments, where each segment is a portion of the stimulus span. Up to 22 limit segments can be specified for each channel. The limit segments do not have to be entered in any particular order: the analyzer automatically sorts them and lists them on the CRT in increasing order of start stimulus value.

For each segment, the table lists the segment number, the starting stimulus value, upper limit, lower limit, and limit type. The ending stimulus value is the start value of the next segment, or a segment can be terminated with a single point segment. Limit values are entered as upper and lower limits or delta limits and middle value. As new limit segments are defined the tabular listing is updated, and if limit lines are switched on they are drawn on the CRT.

If no limits have been defined, the table of limit values shows the notation "EMPTY." Limit segments are added to the table using the **ADD** key or edited with the **EDIT** key, as described below. The last segment on the list is followed by the notation "END."

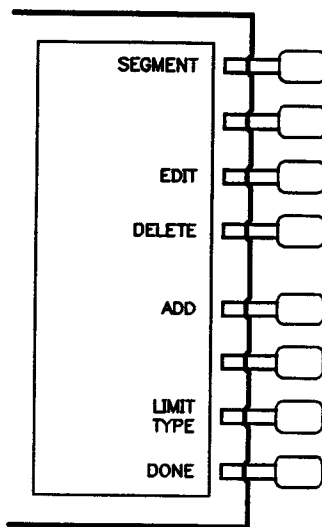


Figure 8-9. Edit Limits Menu

**SEGMENT** specifies which limit segment in the table is to be modified. A maximum of three sets of segment values are displayed at one time, and the list can be scrolled up or down to show other segment entries. Use the entry block controls to move the pointer > to the required segment number. The indicated segment can then be edited or deleted. If the table of limits is designated "EMPTY," new segments can be added using the **ADD** or **EDIT** softkey.

**EDIT** (SEDI) displays the edit segment menu, which is used to define or modify the stimulus value and limit values of a specified segment. If the table was empty, a default segment is displayed. The default segment is a sloping line with zero limits and stimulus values that vary according to the current stimulus mode (frequency or time).

**DELETE** (SDEL) deletes the limit segment indicated by the pointer >.

**ADD** (SADD) displays the edit segment menu and adds a new segment to the end of the list. The new segment is initially a duplicate of the segment indicated by the pointer > and selected with the **SEGMENT** softkey. If the table was empty, a default segment is displayed, as described under **EDIT** above.

**LIMIT TYPE** leads to the limit type menu, where one of three segment types can be selected.

**DONE** (EDITDONE) sorts the limit segments and displays them on the CRT in increasing order of stimulus value. The limits menu is returned to the screen.

## Edit Segment Menu

This menu (Figure 8–10) sets the values of the individual limit segments. The segment to be modified, or a default segment, is selected in the edit limits menu. The stimulus value can be set with the controls in the entry block or with a marker (the marker is turned on automatically when this menu is presented). The limit values can be defined as upper and lower limits, or delta limits and middle value. Both an upper limit and a lower limit (or delta limits) must be defined: if only one limit is required for a particular measurement, force the other out of range (for example +200 dB or –200 dB).

As new values are entered, the tabular listing of limit values is updated.

Segments do not have to be listed in any particular order: the analyzer sorts them automatically in increasing order of start stimulus value when the **DONE** key in the edit limits menu is pressed. However, the easiest way to enter a set of limits is to start with the lowest stimulus value and define the segments from left to right of the display, with limit lines turned on as a visual check.

Phase limit values can be specified between +500° and –500°. Limit values above +180° and below –180° are mapped into the range of –180° to +180° to correspond with the range of phase data values.



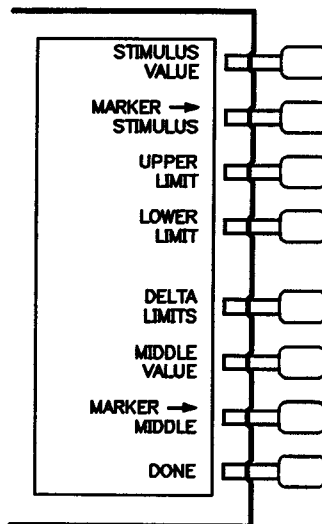


Figure 8-10. Edit Segment Menu

**STIMULUS VALUE** (LIMS) sets the starting stimulus value of a segment, using entry block controls. The ending stimulus value of the segment is defined by the start of the next segment. No more than one segment can be defined over the same stimulus range. In a standard instrument, the starting stimulus value must be a multiple of 100 kHz (this limitation does not apply to option 001 instruments).

**MARKER -> STIMULUS** (MARKSTIM) sets the starting stimulus value of a segment using the active marker. Move the marker to the desired starting stimulus value before pressing this key, and the marker stimulus value is entered as the segment start value.

**UPPER LIMIT** (LIMU) sets the upper limit response value for the start of the segment. If a lower limit is specified, an upper limit must also be defined. If no upper limit is required for a particular measurement, force the upper limit value out of range (for example +200 dB).

When **UPPER LIMIT** or **LOWER LIMIT** is pressed, all the segments in the table are displayed in terms of upper and lower limits, even if they were defined as delta limits and middle value.

If you attempt to set an upper limit that is lower than the lower limit, or vice versa, both limits will be automatically set to the same value.

**LOWER LIMIT** (LIML) sets the lower limit response value for the start of the segment. If an upper limit is specified, a lower limit must also be defined. If no lower limit is required for a particular measurement, force the lower limit value out of range (for example -200 dB).

**DELTA LIMITS** (LIMD) sets the limits an equal amount above and below a specified middle value, instead of setting upper and lower limits separately. This is used in conjunction with **MIDDLE VALUE** or **MARKER -> MIDDLE**, to set limits for testing a device that is specified at a particular value plus or minus an equal tolerance.

For example, a device may be specified at 0 dB  $\pm$ 3 dB. Enter the middle value as 0 dB and the delta limits as 3 dB.

When **DELTA LIMITS** or **MIDDLE VALUE** is pressed, all the segments in the table are displayed in these terms, even if they were defined as upper and lower limits.

**MIDDLE VALUE** (LIMM) sets the midpoint for **DELTA LIMITS**. It uses the entry controls to set a specified magnitude value vertically centered between the limits.

**MARKER → MIDDLE** (MARKMIDD) sets the midpoint for **DELTA LIMITS** using the active marker to set the middle magnitude value of a limit segment. Move the marker to the desired value or device specification, and press this key to make that value the midpoint of the delta limits. The limits are automatically set an equal amount above and below the marker.

**DONE** (SDON) terminates a limit segment definition, and returns to the edit limits menu.

## Limit Type Menu

This menu defines the selected limit segment as a sloping line, a flat line, or a single point.

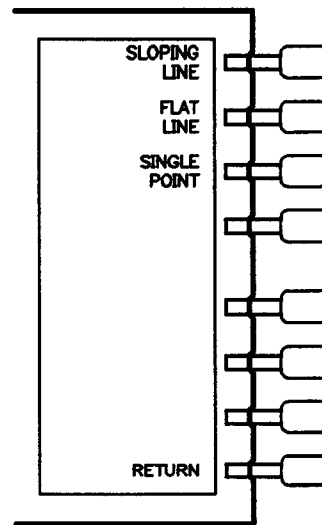


Figure 8–11. Limit Type Menu

**SLOPING LINE** (LIMTSL) defines a sloping limit line segment that is linear with frequency or other stimulus value, and is continuous to the next stimulus value and limit. If a sloping line is the final segment it becomes a flat line terminated at the stimulus stop value. A sloping line segment is indicated as SL on the displayed table of limits. A sloping line limit must be terminated by a single point for the sloping line to be displayed properly.

**FLAT LINE** (LIMTFL) defines a flat limit line segment whose value is constant with frequency or other stimulus value. This line is continuous to the next stimulus value, but is not joined to a segment with a different limit value. If a flat line segment is the final segment it terminates at the stimulus stop value. A flat line segment is indicated as FL on the table of limits.

**SINGLE POINT** (LIMTSP) sets the limits at a single stimulus point. If limit lines are on, the upper limit value of a single point limit is displayed as  $\nabla$ , and the lower limit is displayed as  $\wedge$ . A limit test at a single point not terminating a flat or sloped line tests the nearest actual measured data point. In a standard instrument, single point limits can only be defined at frequencies that are multiples of 100 kHz (this limitation does not apply to option 001 instruments).

A single point limit should be used as a termination for a flat line or sloping line limit segment. When a single point terminates a sloping line or when it terminates a flat line and has the same limit values as the flat line, the single point is not displayed as  $\nabla$  and  $\wedge$ . The indication for a single point segment in the displayed table of limits is SP.

**RETURN** goes back to the edit limits menu.

## Offset Limits Menu

This menu allows the complete limit set to be offset in either stimulus value or amplitude value. This is useful for changing the limits to correspond with a change in the test setup, or for device specifications that differ in stimulus or amplitude. It can also be used to move the limit lines away from the data trace temporarily for visual examination of trace detail.

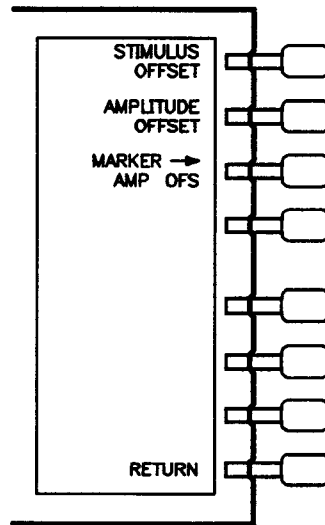


Figure 8-12. Offset Limits Menu

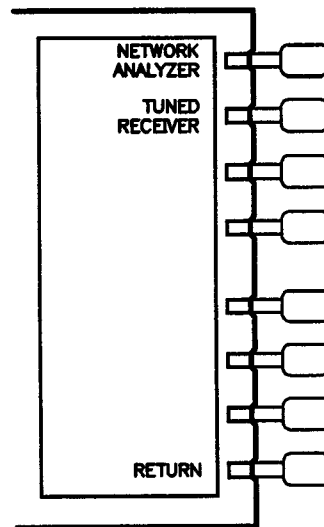
**STIMULUS OFFSET** (LIMISTIO) adds or subtracts an offset in stimulus value. This allows limits already defined to be used for testing in a different stimulus range. Use the entry block controls to specify the offset required. In a standard instrument, the stimulus offset must be a multiple of 100 kHz (this limitation does not apply to an option 001 instrument).

**AMPLITUDE OFFSET** (LIMIAMPO) adds or subtracts an offset in amplitude value. This allows limits already defined to be used for testing at a different response level. For example, if attenuation is added to or removed from a test setup, the limits can be offset an equal amount. Use the entry block controls to specify the offset.

**MARKER → AMP OFFSET** (LIMIMAOF) uses the active marker to set the amplitude offset. Move the marker to the desired middle value of the limits and press this key. The limits are then moved so that they are centered an equal amount above and below the marker at that stimulus value.

**RETURN** goes back to the limits menu.

## INSTRUMENT MODE MENU



*Figure 8–13. Instrument Mode Menu*

There are two modes of operation in the analyzer:

**NETWORK ANALYZER MODE** is the standard mode of operation for the analyzer, and is active after preset or power-on. This mode uses the analyzer's built-in source.

**TUNED RECEIVER MODE** – in tuned receiver mode, the analyzer receiver operates independently of any signal source. All phase lock routines are bypassed, increasing sweep speed significantly, this function works in CW time sweep.

The following features and limitations apply to this mode:

- the internal source is turned off
- the receiver's LO is fully synthesized, but it is not phase-locked to any internal or external source.
- it functions in all sweep types
- it requires a synthesized CW source that can drive the analyzer's external frequency reference.
- the analyzer's phase-lock routines are bypassed, increasing the sweep speed significantly.

# Chapter 9. Time and Frequency Domain Transforms

---

## INTRODUCTION

With option 010, the analyzer can transform frequency domain data to the time domain or time domain data to the frequency domain. In normal operation, the analyzer measures the characteristics of a device under test (DUT) as a function of frequency. Using a mathematical technique (the inverse Fourier transform), it transforms frequency domain information into the time domain, with time as the horizontal display axis. Response values (measured on the vertical axis) now appear separated in time or distance, providing valuable insight into the behavior of the DUT beyond simple frequency characteristics.

**NOTE:** The analyzer can be ordered with option 010, or the option can be added at a later date using a time domain retrofit kit.

The transform used by the analyzer resembles time domain reflectometry (TDR) measurements. TDR measurements, however, are made by launching an impulse or step into the DUT and observing the response in time with a receiver similar to an oscilloscope. In contrast, the network analyzer makes swept frequency response measurements, and mathematically transforms the data into a TDR-like display.

The analyzer has three frequency-to-time transform modes:

**Time Domain Bandpass Mode** is designed to measure band-limited devices and is the easiest mode to use. This mode simulates the time domain response to an impulse input.

**Time Domain Low Pass Step Mode** simulates the time domain response to a step input. As in a traditional TDR measurement, the distance to the discontinuity in the DUT, and the type of discontinuity (resistive, capacitive, inductive) can be determined.

**Time Domain Low Pass Impulse Mode** simulates the time domain response to an impulse input (like the bandpass mode). Both low pass modes yield better time domain resolution for a given frequency span than does the bandpass mode. In addition, using the low pass modes you can determine the type of discontinuity. However, these modes have certain limitations that are defined in the low pass section of this chapter.

The analyzer has one time-to-frequency transform mode:

**Forward Transform Mode** transforms CW signals measured over time into the frequency domain, to measure the spectral content of a signal. This mode is known as the CW time mode.

In addition to these transform modes, this chapter discusses special transform concepts such as masking, windowing, and gating.

## GENERAL THEORY

The relationship between the frequency domain response and the time domain response of a network analyzer is defined by the Fourier transform. Because of this transform, it is possible to measure, in the frequency domain, the response of a linear DUT and mathematically calculate the inverse Fourier transform of the data to find the time domain response. The analyzer's internal computer makes this calculation using the chirp-Z Fourier transform technique. The resulting measurement is the fully error-corrected time domain reflection or transmission response of the DUT, displayed in near real time.

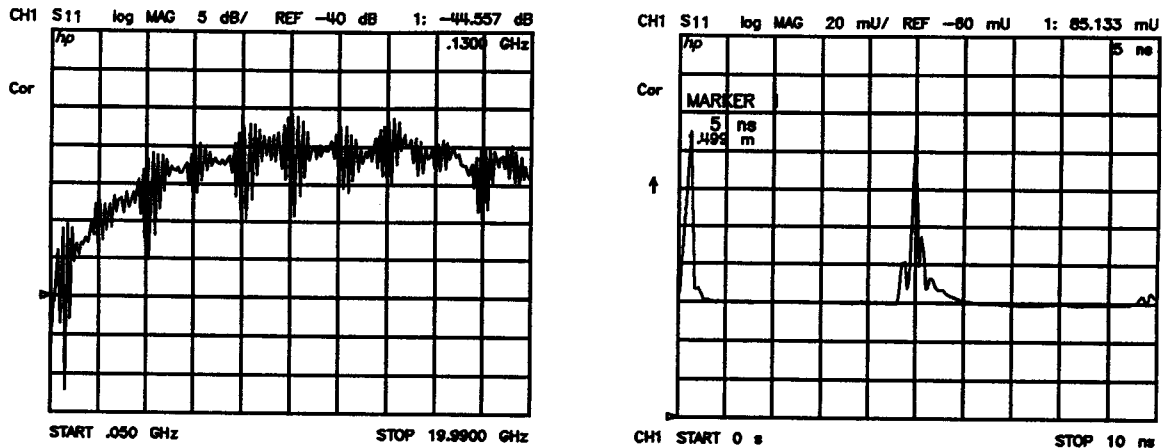
Table 9-1 lists the useful formats for time domain reflection measurements. Time domain transmission measurements are displayed using the linear magnitude or log magnitude formats, as described later in this chapter.

*Table 9-1. Time Domain Reflection Formats*

Format	Parameter
LIN MAG	Reflection Coefficient (unitless) ( $0 < \rho < 1$ )
REAL	Reflection Coefficient (unitless) ( $-1 < \rho < 1$ )
LOG MAG	Return Loss (dB)
SWR	Standing Wave Ratio (unitless)

Figure 9-1 illustrates the frequency and time domain reflection responses of a device. The frequency domain reflection measurement is the composite of all the signals reflected by the discontinuities present in the DUT over the measured frequency range.

**NOTE:** In this chapter, all points of reflection are referred to as discontinuities.



(a) Frequency Domain (b) Time Domain Bandpass

Figure 9-1. Device Frequency Domain and Time Domain Reflection Responses

The time domain measurement shows the effect of each discontinuity as a function of time (or distance), and shows that the device response consists of three separate impedance changes. The second discontinuity has a reflection coefficient magnitude of 0.085 (i.e. 8.5% of the incident signal is reflected). Marker 1 on the time domain trace shows the round-trip time to the discontinuity and back to the reference plane (where the calibration standards are connected): 5 nanoseconds. The distance shown (1.499 metres) assumes that the signal travels at the speed of light. The signal travels slower than the speed of light in most media (e.g. coax cables). This slower velocity (relative to light) can be compensated for by adjusting the relative velocity factor. This procedure is described later in this chapter.

Figure 9-2 illustrates the transform menus, which are accessed from the **SYSTEM** key.

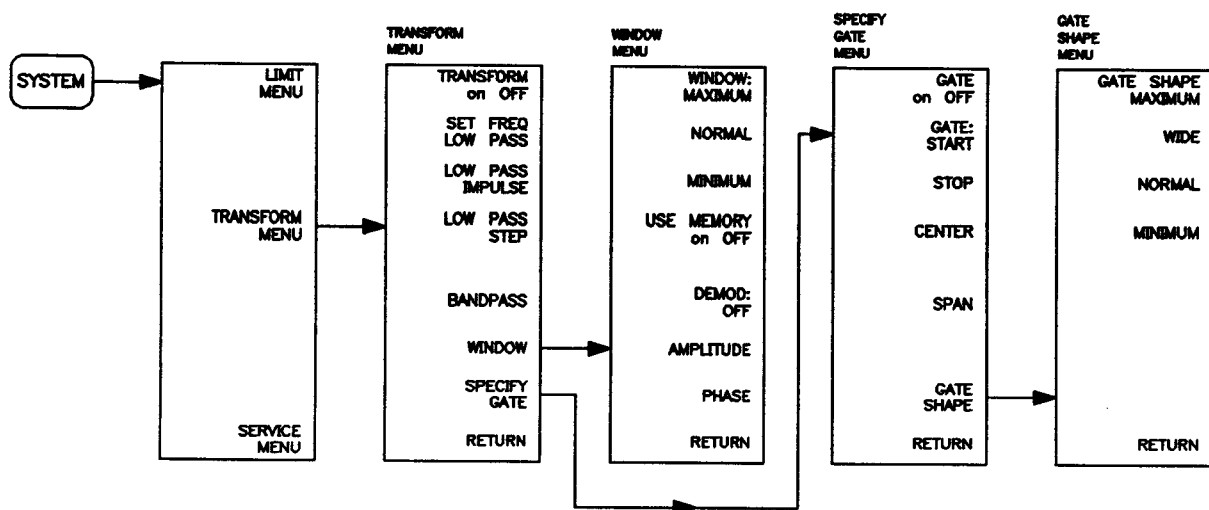


Figure 9-2. The Time Domain Transform Menus

## TIME DOMAIN BANDPASS

This mode is called bandpass because it works with band-limited devices. Traditional TDR requires that the DUT be able to operate down to DC. Using bandpass mode, there are no restrictions on the measurement frequency range. Bandpass mode characterizes the DUT impulse response.

### Reflection Measurements Using Bandpass Mode

**NOTE:** Before making time domain reflection measurements, perform the appropriate calibration.

Example:

1. Press **PRESET**. The default measurement at preset is S11 on channel 1.
2. Press **CAL** **CALIBRATE MENU** **S11 1-PORT** and perform an S11 1-port calibration using an open, a short, and a load connected to port 1. Press **DONE 1-PORT CAL**, then save the configuration in one of the save registers.
3. Connect one or more lengths of cable, with adapters between cable sections, as shown at the top of Figure 9-3.
4. Press **SYSTEM** **TRANSFORM MENU** **BANDPASS** **TRANSFORM ON**.
5. Press **START** **0** **x1** to select a start time of zero seconds.
6. Press **STOP** **1** **0** **G/n** to select a stop time of 10 nanoseconds.

**NOTE:** In the time domain, the STIMULUS keys (**START**, **STOP**, **CENTER** and **SPAN**) refer to time, and can be used to change the horizontal (time) axis of the display, independent of the chosen frequency range. To set the STOP time long enough to let you "see" the end of the cable under test, enter a STOP time of 10 nanoseconds per metre of cable under test. This is a good rule-of-thumb number that accounts for the approximate round-trip time for most cables.

7. Press **FORMAT** **LIN MAG** for a display of reflection coefficient versus time (or distance).
8. Press **SCALE REF** **AUTO SCALE**.
9. Figure 9-3 shows typical frequency and time domain responses of a reflection measurement of two sections of cable.



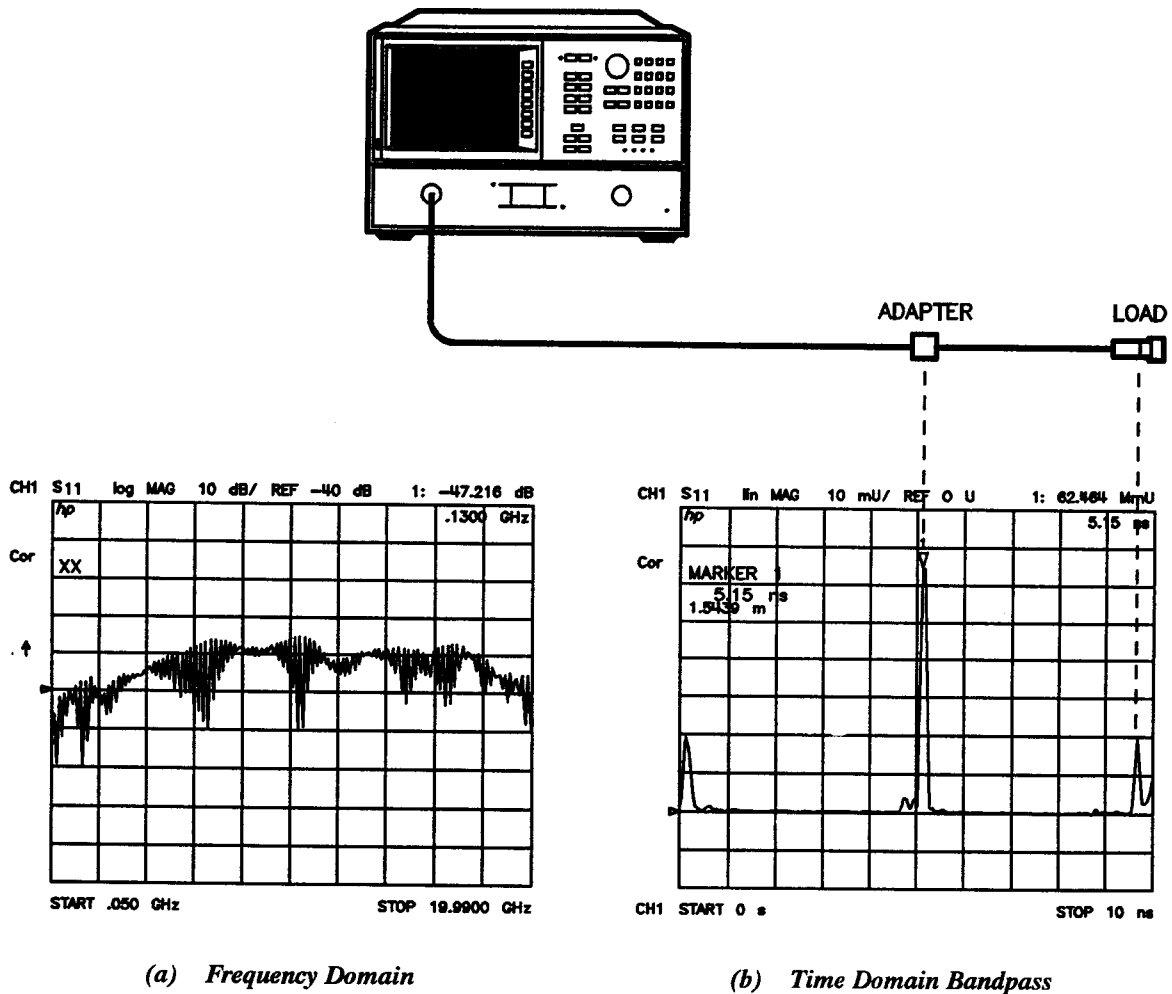


Figure 9-3. A Reflection Measurement of Two Cables

The ripples in reflection coefficient versus frequency in the frequency domain measurement are caused by the reflections at each connector "beating" against each other.

One at a time, loosen the connectors at each end of the cable and observe the response in both the frequency domain and the time domain. The frequency domain ripples grow as each connector is loosened, corresponding to a larger reflection adding in and out of phase with the other reflections. The time domain responses grow as you loosen the connector that corresponds to each response.

**Interpreting the Bandpass Reflection Response Horizontal Axis.** In bandpass reflection measurements, the horizontal axis represents the time it takes for an impulse launched at the test port to reach a discontinuity and return to the test port (the two-way travel time). In Figure 9-3, each connector is a discontinuity.

**Interpreting the Bandpass Reflection Response Vertical Axis.** The quantity displayed on the vertical axis depends on the selected format. The default format is LOG MAG (logarithmic magnitude), which displays the return loss in decibels (dB). LIN MAG (linear magnitude) is a format that displays the response as reflection coefficient ( $\tau$ ). This can be thought of as an average reflection coefficient of the discontinuity over the frequency range of the measurement. Use the REAL format only in low pass mode. The common formats are listed in Table 9–1.

### Adjusting the Relative Velocity Factor

A marker provides both the time (x2) and the electrical length (x2) to a discontinuity. To determine the physical length, rather than the electrical length, change the velocity factor to that of the medium under test:

1. Press **CAL** **MORE VELOCITY FACTOR**.
2. Enter a velocity factor between 0 and 1.0 (1.0 corresponds to the speed of light in a vacuum). Most cables have a velocity factor of 0.66 (polyethylene dielectrics) or 0.70 (teflon dielectrics).

**NOTE:** To cause the markers to read the actual one-way distance to a discontinuity, rather than the round trip distance, enter one-half the actual velocity factor.

### Transmission Measurements Using Bandpass Mode

The bandpass mode can also transform transmission measurements to the time domain. For example, this mode can provide information about a surface acoustic wave (SAW) filter that is not apparent in the frequency domain. Figure 9–4 illustrates a time domain bandpass measurement of a 321 MHz SAW filter.

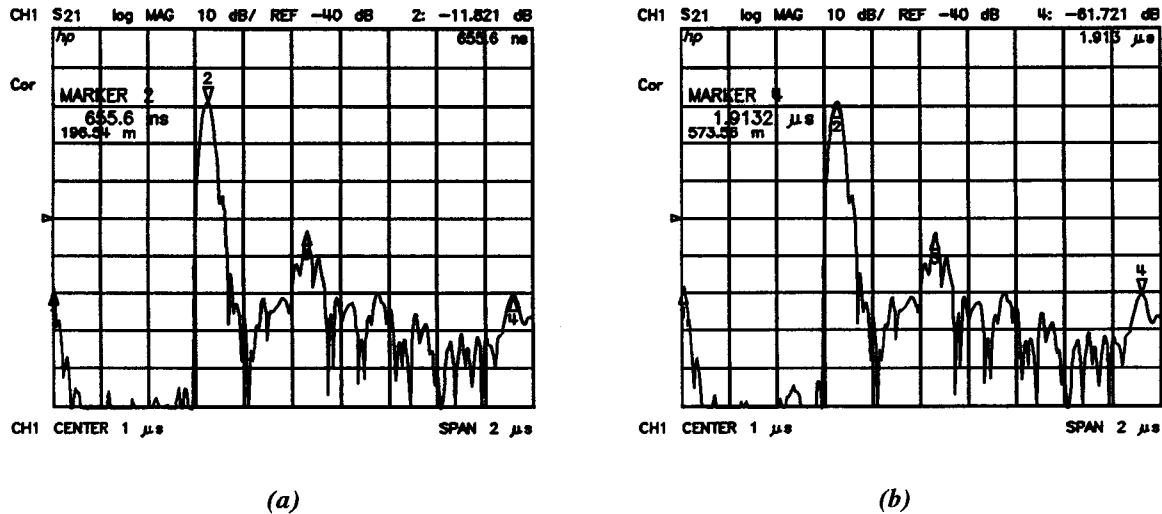


Figure 9–4. Transmission Measurement in Time Domain Bandpass Mode

## Interpreting the Bandpass Transmission Response Horizontal Axis

In time domain transmission measurements, the horizontal axis is displayed in units of time. The time axis indicates the propagation delay through the device. Note that in time domain transmission measurements, the value displayed is the actual delay (not  $\times 2$ ). The marker provides the propagation delay in both time and distance.

Marker 2 in Figure 9–4 (a) indicates the main path response through the device, which has a propagation delay of 655.6 ns, or about 196.5 meters in electrical length. Marker 4 in Figure 9–4 (b) indicates the triple–travel path response at 1.91  $\mu$ s, or about 573.5 meters. The response at marker 1 (at 0 seconds) is an RF feedthrough leakage path. In addition to the triple travel path response, there are several other multi–path responses through the device, which are inherent in the design of a SAW filter.

**Interpreting the Bandpass Transmission Response Vertical Axis.** In the log magnitude format, the vertical axis displays the transmission loss or gain in dB; in the linear magnitude format it displays the transmission coefficient ( $\rho$ ). Think of this as an average of the transmission response over the measurement frequency range.

## TIME DOMAIN LOW PASS

This mode is used to simulate a traditional time domain reflectometry (TDR) measurement. It provides information to determine the type of discontinuity (resistive, capacitive, or inductive) that is present. Low pass provides the best resolution for a given bandwidth in the frequency domain. It may be used to give either the step or impulse response of the DUT.

The low pass mode is less general–purpose than the bandpass mode because it places strict limitations on the measurement frequency range. The low pass mode requires that the frequency domain data points are harmonically related from DC to the stop frequency. That is,  $\text{stop} = n \times \text{start}$ , where  $n = \text{number of points}$ . For example, with a start frequency of 50 MHz and 201 points, the stop frequency would be 10.05 GHz. Since the frequency range of the analyzer starts at 50 MHz, the DC frequency response is extrapolated from the lower frequency data. The requirement to pass DC is the same limitation that exists for traditional TDR.

## Setting Frequency Range for Time Domain Low Pass

Before a low pass measurement is made, the measurement frequency range must meet the ( $\text{stop} = n \times \text{start}$ ) requirement described above. The following steps must be taken, in this order:

- Set the start and stop frequencies close to the intended values.
- Press **SET FREQ LOW PASS**.
- Perform a calibration.

The start and stop frequencies should be set as close as possible to the intended values, especially at the low end, to avoid distortion of the measurement results. When **SET FREQ LOW PASS** is pressed, the network analyzer automatically sets the start and stop frequencies so that the stop frequency is a harmonic multiple of the start. The stop frequency is set close to the entered stop frequency, and the start frequency is set equal to stop/n. For example, if you select 101 points across the display and a stop frequency of 19.9900 GHz in a standard instrument, when you press **SET FREQ LOW PASS** the start frequency changes to 0.1979 GHz and the stop frequency changes to 19.9879 GHz. (The procedure below instead sets the start frequency to 50 MHz and the stop frequency to 10.05 GHz with 201 points.) For convenience in setting the sweep frequency before beginning a calibration, the **SET FREQ LOW PASS** softkey is in both the transform menu and the calibration menu.

If the start and stop frequencies do not conform to the low pass requirement before one of the low pass modes (step or impulse) is selected and transform is turned on, the analyzer resets the start and stop frequencies. If error correction is on when the frequency range is changed, this turns it off.

The analyzer's lowest measurement frequency is 50 MHz, therefore for each value of n there is a minimum allowable stop frequency that can be used. That is, the minimum stop frequency = n x 50 MHz. Because of this limitation, the largest number of points that can be used in time domain low pass is 401 (with 401 points, an additional point is extrapolated at 25 MHz). If the number of points exceeds 801, the network analyzer automatically reverts to bandpass mode. Table 9–2 lists the minimum frequency range that can be used for each value of n when making low pass time domain measurements.

*Table 9–2. Minimum Frequency Ranges for Time Domain Low Pass*

Number of Points	Minimum Frequency Range
3	50 MHz to 150 MHz
11	50 MHz to .55 GHz
21	50 MHz to 1.05 GHz
51	50 MHz to 2.55 GHz
101	50 MHz to 5.05 GHz
201	50 MHz to 10.05 GHz
401	50 MHz to 20.05 GHz
801	50 MHz to 20.05 GHz

## Reflection Measurements in Time Domain Low Pass

**NOTE:** Before making time domain measurements in the low pass mode, perform the appropriate calibration.

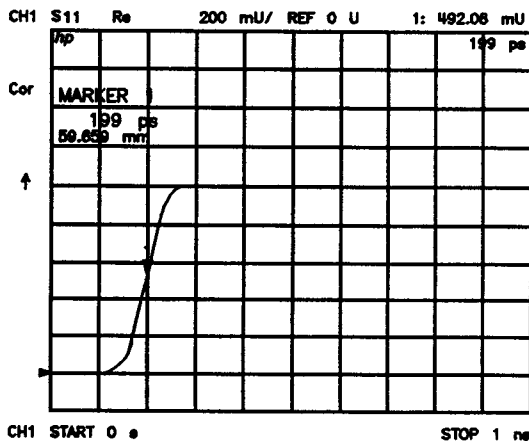
Example:

1. Press **USER PRESET**. The default measurement at preset is S11 on channel 1, with a start frequency of 50 MHz.

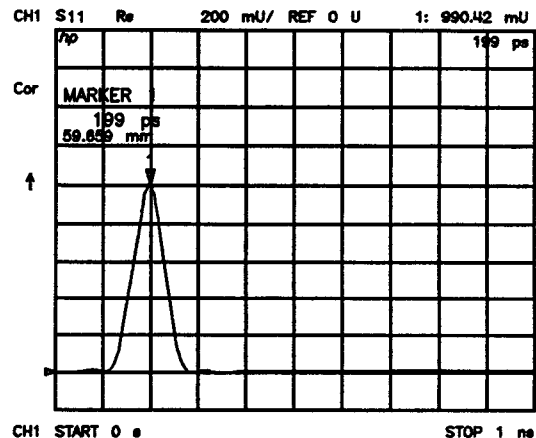
2. Press **STOP** **1** **0** **.** **0** **5** **G/n** to set a stop frequency of 10.05 GHz.
3. Press **MENU** **NUMBER of POINTS** **2** **0** **1** **x1**.
4. Press **CAL** **CALIBRATE MENU** **SET FREQ LOW PASS** and perform an S11 1–port calibration.
5. Connect an airline or cable to port 1 and leave the other end unterminated.
6. Press **SYSTEM** **TRANSFORM MENU** **LOW PASS STEP** **TRANSFORM ON**.
7. Press **START** **0** **x1** to select a start time of 0 seconds.
8. Press **STOP** **1** **G/n** to select a stop time of 1 nanosecond.

**NOTE:** In the time domain, the STIMULUS keys **START**, **STOP**, **CENTER** and **SPAN** refer to time, and can be used to change the horizontal (time) axis of the display, independent of the chosen frequency range.

9. Press **FORMAT** **REAL** **SCALE REF** **AUTO SCALE** to view the step response, as shown in Figure 9–5 (a). (The step response is reflected back from the unterminated cable.)
10. Press **SYSTEM** **TRANSFORM MENU** **LOW PASS IMPULSE** to view the impulse response, shown in Figure 9–5 (b).



(a) *Low Pass Step*



(b) *Low Pass Impulse*

*Figure 9–5. Time Domain Low Pass Measurements of an Unterminated Cable*

11. Now connect a short circuit to the end of the airline or cable and press **SCALE REF** **AUTO SCALE**. The polarity of the impulse response is now reversed.
12. Press **SYSTEM** **TRANSFORM MENU** **LOW PASS STEP** to view the low pass step response with the polarity reversed.

**Interpreting the Low Pass Response Horizontal Axis.** The low pass measurement horizontal axis is the two-way travel time to the discontinuity (as in the bandpass mode). Also, the marker displays both the two-way time and the electrical length along the trace. To determine the actual physical length, enter the appropriate velocity factor as described earlier in this chapter under *Adjusting the Relative Velocity Factor*.

**Interpreting the Low Pass Response Vertical Axis.** The vertical axis depends on the chosen format. In the low pass mode, the frequency domain data is taken at harmonically related frequencies and extrapolated to DC. Because this results in the inverse Fourier transform having only a real part (the imaginary part is zero), the most useful low pass step mode format in this application is the real format. It displays the response in reflection coefficient units. This mode is similar to the traditional TDR response, which displays the reflected signal in a real format (volts) versus time (or distance) on the horizontal axis.

The real format can also be used in the low pass impulse mode, but for the best dynamic range for simultaneously viewing large and small discontinuities, use the log magnitude format.

## Fault Location Measurements Using Low Pass

As described, the low pass mode can simulate the TDR response of the device under test. This response contains information useful in determining the type of discontinuity present. Review the low pass responses of known discontinuities as shown in Figure 9–6. Each circuit element was simulated to show the corresponding low pass time domain S11 response waveform. The low pass mode gives the device response either to a step or to an impulse stimulus. Mathematically, the low pass impulse stimulus is the derivative of the step stimulus.





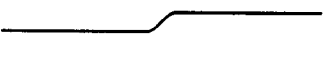
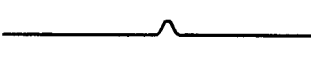

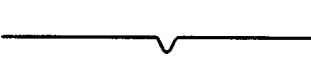

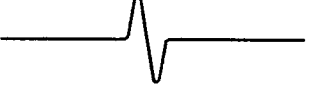

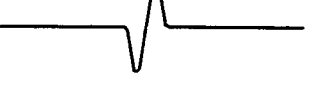
Element	Step Response	Impulse Response
Open	 Unity Reflection	 Unity Reflection
Short	 Unity Reflection, $-180^\circ$	 Unity Reflection, $-180^\circ$
Resistor $R > Z_0$	 Positive Level Shift	 Positive Peak
Resistor $R < Z_0$	 Negative Level Shift	 Negative Peak
Inductor	 Positive Peak	 Positive Then Negative Peaks
Capacitor	 Negative Peak	 Negative Then Positive Peaks

Figure 9–6. Simulated Low Pass Step and Impulse Response Waveforms (Real Format)

Figure 9–7 shows example cables with discontinuities (faults) using the low pass step mode with the real format.

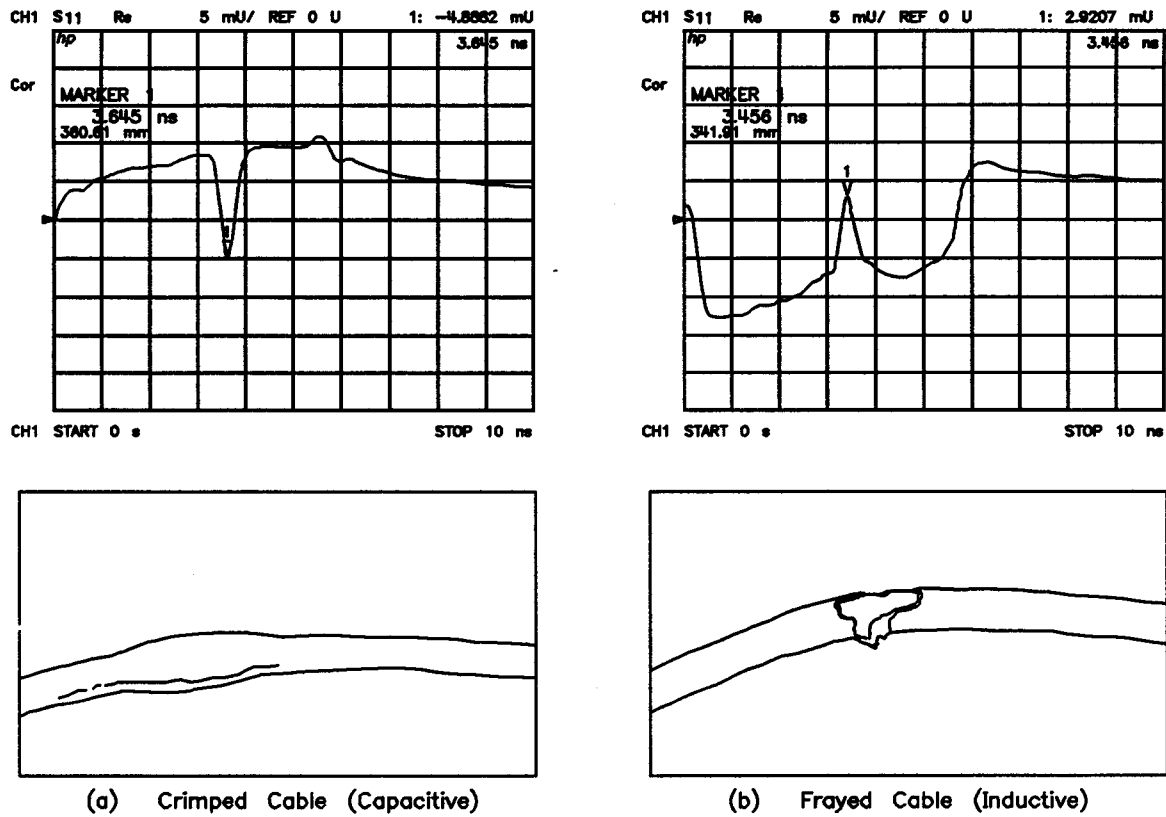


Figure 9–7. Low Pass Step Measurements of Common Cable Faults (Real Format)

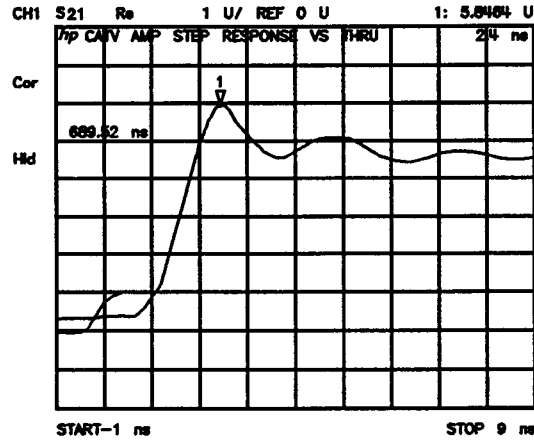
## Transmission Measurements in Time Domain Low Pass

**Measuring Small Signal Transient Response Using Low Pass Step.** Use the low pass mode to analyze the DUT small signal transient response. The transmission response of a device to a step input is often measured at lower frequencies, using a function generator (to provide the step to the DUT) and sampling oscilloscope (to analyze the DUT output response). The low pass step mode extends the frequency range of this type of measurement to 20 GHz.

The step input shown in Figure 9–8 is actually the inverse Fourier transform of the frequency domain response of a thru measured at calibration. The step rise time is proportional to the highest frequency in the frequency domain sweep; the higher the frequency, the faster the rise time. The frequency sweep in Figure 9–8 is from 50 MHz to 1 GHz.



Figure 9–8 also illustrates the time domain low pass response of an amplifier under test. The average group delay over the measurement frequency range is the difference in time between the step and the amplifier response. This time domain response simulates an oscilloscope measurement of the amplifier’s small signal transient response. Note the ringing in the amplifier response that indicates an underdamped design.



**Figure 9–8. Time Domain Low Pass Measurement of an Amplifier Small Signal Transient Response**

**Interpreting the Low Pass Step Transmission Response Horizontal Axis.** The low pass transmission measurement horizontal axis displays the average transit time through the device over the frequency range used in the measurement. The response of the thru connection used in the calibration is a step that reaches 50% unit height at time = 0. The rise time is determined by the highest frequency used in the frequency domain measurement. The step is a unit high step, which indicates no loss for the thru calibration. When a device is inserted, the time axis indicates the propagation delay or electrical length of the device. The markers read the electrical delay in both time and distance. The distance can be scaled by an appropriate velocity factor as described earlier in this chapter under *Adjusting the Relative Velocity Factor*.

**Interpreting the Low Pass Step Transmission Response Vertical Axis.** In the real format, the vertical axis displays the transmission response in real units (e.g. volts). For the amplifier example in Figure 9–8, if the amplifier input is a step of 1 volt, the output, 2.4 nanoseconds after the step (indicated by marker 1), is 5.84 volts.

In the log magnitude format, the amplifier gain is the steady state value displayed after the initial transients die out.

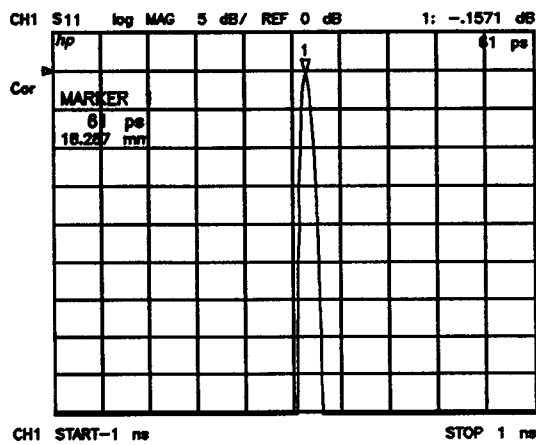
# TIME DOMAIN CONCEPTS

## Masking

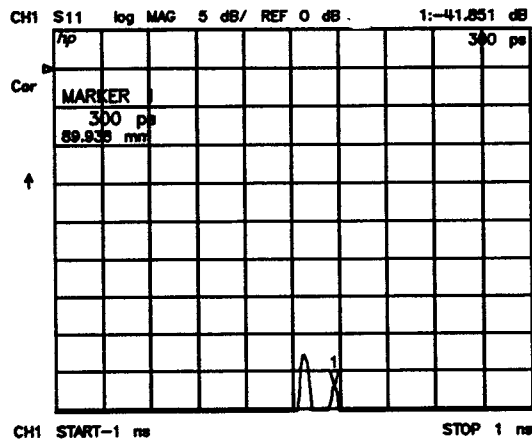
Masking occurs when a discontinuity (fault) closest to the reference plane affects the response of each subsequent discontinuity. This happens because the energy reflected from the first discontinuity never reaches subsequent discontinuities. For example, if a transmission line has two discontinuities each with a  $\tau$  of 0.5, the time domain response (real format) shows the correct reflection coefficient for the first discontinuity ( $\tau = .50$ ). However, the second discontinuity appears as a 25% reflection ( $\tau = .25$ ) because only half the incident voltage reached the second discontinuity.

**NOTE:** This example assumes a lossless transmission line. Real transmission lines, with non-zero loss, attenuate signals as a function of the distance from the reference plane.

As an example of masking due to line loss, consider the time domain response of a 20 dB attenuator and a short circuit. The impulse response (log magnitude format) of the short circuit alone is a return loss close to 0 dB, as shown in Figure 9-9 (a). When the short circuit is placed at the end of the 20 dB attenuator, the return loss is -41 dB, as shown in Figure 9-9 (b). This value actually represents the forward and return path loss through the attenuator, and illustrates how a lossy network can affect the responses that follow it. In Figure 9-9 (b), the response of the short circuit is in fact slightly masked by the response of the connector, causing a return loss greater than the expected 40 dB.



(a). Short Circuit



(b). Short Circuit at the End of a 20 dB Pad

Figure 9-9. Masking Example

## Windowing

Windowing makes time domain measurements more useful for isolating and identifying individual responses. Windowing is needed because of the abrupt transitions in a frequency domain measurement at the start and stop frequencies. The band limiting of a frequency domain response causes overshoot and ringing in a time domain response, and causes a non-windowed impulse stimulus to have a  $\sin(kt)/kt$  shape, where  $k = \pi/\text{frequency span}$  (see Figure 9–10). This has two effects that limit the usefulness of the time domain measurement:

1. Finite impulse width (or rise time). This limits the ability to resolve between two closely spaced responses. The effects of the finite impulse width cannot be improved without increasing the frequency span of the measurement (see Table 9–3).
2. Sidelobes. The impulse sidelobes limit the dynamic range of the time domain measurement by hiding low-level responses within the sidelobes of higher level responses. The effects of sidelobes can be improved by windowing (see Table 9–3).

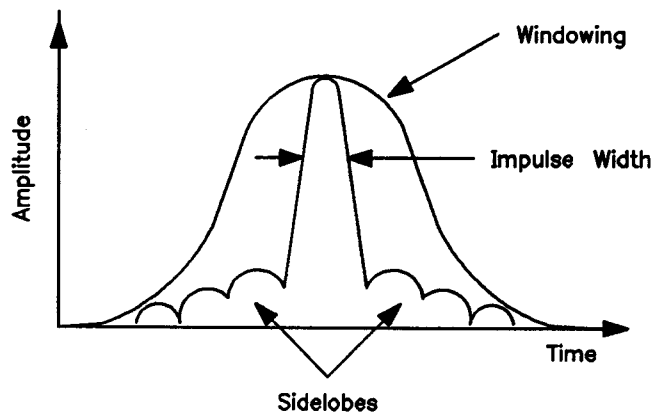


Figure 9–10. Impulse Width, Sidelobes, and Windowing

Windowing improves the dynamic range of a time domain measurement by filtering the frequency domain data prior to converting it to the time domain, producing an impulse stimulus that has lower sidelobes. This makes it much easier to see time domain responses that are very different in magnitude. The sidelobe reduction is achieved, however, at the expense of increased impulse width. The effect of windowing on the step stimulus (low pass mode only) is a reduction of overshoot and ringing at the expense of increased rise time.

To select a window, press **SYSTEM** **TRANSFORM MENU** **WINDOW**. A menu is presented that allows the selection of three window types (see Table 9–3).

Table 9–3. Impulse Width, Sidelobe Level, and Windowing Values

Window Type	Sidelobe Level		Impulse Width		Step Rise Time	Response Resolution		
	Impulse	Step	Low Pass	Bandpass	Low Pass	Impulse		Step
						Low Pass	Bandpass	Low Pass
Minimum	–13 dB	–21 dB	$\frac{0.6}{\text{Freq Span}}$	$\frac{1.2}{\text{Freq Span}}$	$\frac{0.45}{\text{Freq Span}}$	$\frac{0.3}{\text{Freq Span}}$	$\frac{0.6}{\text{Freq Span}}$	$\frac{0.23}{\text{Freq Span}}$
Normal	–44 dB	–60 dB	$\frac{0.96}{\text{Freq Span}}$	$\frac{1.92}{\text{Freq Span}}$	$\frac{0.99}{\text{Freq Span}}$	$\frac{0.48}{\text{Freq Span}}$	$\frac{0.96}{\text{Freq Span}}$	$\frac{0.49}{\text{Freq Span}}$
Maximum	–90 dB	–90 dB	$\frac{1.38}{\text{Freq Span}}$	$\frac{2.76}{\text{Freq Span}}$	$\frac{1.49}{\text{Freq Span}}$	$\frac{0.69}{\text{Freq Span}}$	$\frac{1.38}{\text{Freq Span}}$	$\frac{0.74}{\text{Freq Span}}$

**NOTE:** The bandpass mode simulates an impulse stimulus. Bandpass impulse width is twice that of lowpass impulse width. The bandpass impulse sidelobe levels are the same as lowpass impulse sidelobe levels.

Choose one of the three window shapes listed in Table 9–3. Or you can use the knob to select any windowing pulse width (or rise time for a step stimulus) between the softkey values. The time domain stimulus sidelobe levels depend only on the window selected.

**MINIMUM** is essentially no window. Consequently, it gives the highest sidelobes.

**NORMAL** (the preset mode) gives reduced sidelobes and is the mode most often used.

**MAXIMUM** window gives the minimum sidelobes, providing the greatest dynamic range.

**USE MEMORY on OFF** remembers a user–specified window pulse width (or step rise time) different from the standard window values.

A window is turned on only for viewing a time domain response, and does not affect a displayed frequency domain response. Figure 9–11 shows the typical effects of windowing on the time domain response of a short circuit reflection measurement.

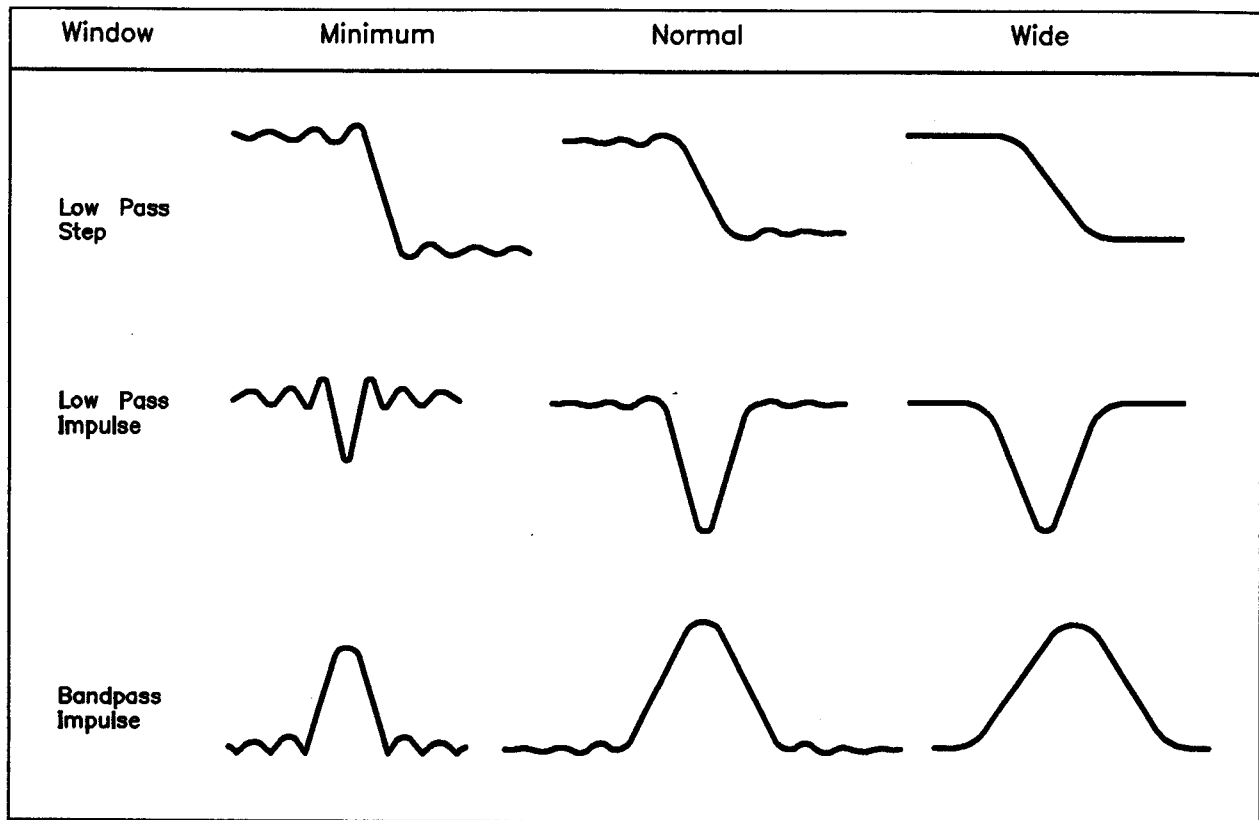


Figure 9-11. The Effects of Windowing on the Time Domain Responses of a Short Circuit

## Range

In the time domain, range is defined as the length in time that a measurement can be made without encountering a repetition of the response, called aliasing. A time domain response repeats at regular intervals because the frequency domain data is taken at discrete frequency points, rather than continuously over the frequency band.

Measurement range is equal to  $1/\Delta F$  ( $\Delta F$  is the spacing between frequency data points). Measurement range = (Number of Points - 1)/Frequency Span (Hz).

Example:

$$\begin{aligned}
 \text{Measurement} &= 201 \text{ points} \\
 & \quad 1.00 \text{ GHz to } 3.00 \text{ GHz} \\
 \text{Range} &= 1/\Delta F \text{ or } (\text{Number of Points} - 1)/\text{Frequency Span} \\
 &= 1/(10 \times 10^6) \text{ or } (201 - 1)/(2 \times 10^9) \\
 &= 100 \times 10^{-9} \text{ seconds} \\
 \text{Electrical length} &= \text{range} \times \text{the speed of light } (3 \times 10^8 \text{ m/s}) \\
 &= (100 \times 10^{-9} \text{ s}) \times (3 \times 10^8 \text{ m/s}) \\
 &= 30 \text{ metres}
 \end{aligned}$$

In this example, the range is 100 ns, or 30 metres electrical length. To prevent the time domain responses from overlapping, the DUT must be 30 metres or less in electrical length for a transmission measurement (15 metres for a reflection measurement). The analyzer limits the stop time to prevent the display of aliased responses.

To increase the time domain measurement range, first increase the number of points, but remember that as the number of points increases, the sweep speed decreases. Decreasing the frequency span also increases range, but reduces resolution.

## Resolution

In the time domain, there are two different resolution terms:

1. Response Resolution
2. Range Resolution

**Response Resolution.** Time domain response resolution is defined as the ability to resolve two closely-spaced responses, or a measure of how close two responses can be to each other and still be distinguished from each other. For responses of equal amplitude, the response resolution is equal to the 50% (–6 dB) impulse width. It is inversely proportional to the measurement frequency span, and is also a function of the window used in the transform. The approximate formulas for calculating the 50% impulse width are given in Table 9–3.

For example, using the formula for the bandpass mode with a normal windowing function for a 1 GHz to 4 GHz measurement (3 GHz span):

$$\begin{aligned} \text{50\% calculated impulse width} &= 1.2 \times (1/3 \text{ GHz}) \times 1.6 \\ &= 0.64 \text{ nanoseconds} \\ \text{Electrical length (in air)} &= (0.64 \times 10^{-9} \text{ s}) \times (30 \times 10^9 \text{ cm/s}) \\ &= 19.2 \text{ centimetres} \end{aligned}$$

With this measurement, two equal responses can be distinguished when they are separated by at least 19.2 centimetres.

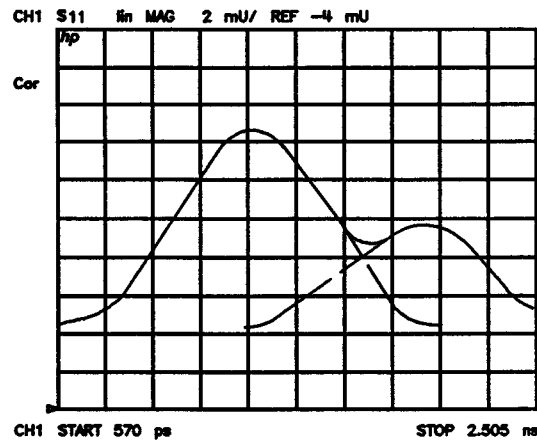
Using the low pass mode (the low pass frequencies are slightly different) with a minimum windowing function, you can distinguish two equal responses that are about 6 centimetres or more apart.

For reflection measurements, which measure the round trip time to the response, divide the response resolution by 2. Using the example above, you can distinguish two faults of equal magnitude provided they are 3 centimetres (electrical length) or more apart.

**NOTE:** Remember, to determine the physical length, enter the relative velocity factor of the transmission medium under test.

For example, a cable with a teflon dielectric (0.7 relative velocity factor), measured under the conditions stated above, has a fault location measurement response resolution of 2.1 centimetres. This is the maximum fault location response resolution. Factors such as reduced frequency span, greater frequency domain data windowing, and a large discontinuity shadowing the response of a smaller discontinuity, all act to degrade the effective response resolution.

Figure 9–12 illustrates the effects of response resolution. The solid line shows the actual reflection measurement of two approximately equal discontinuities (the input and output of an SMA barrel). The dashed line shows the approximate effect of each discontinuity, if they could be measured separately.



*Figure 9–12. Response Resolution*

While increasing the frequency span increases the response resolution, keep the following points in mind:

1. The time domain response noise floor is directly related to the frequency domain data noise floor. Because of this, if the frequency domain data points are taken at or below the measurement noise floor, the time domain measurement noise floor is degraded.
2. The time domain measurement is an average of the response over the frequency range of the measurement; if the frequency domain data is measured out-of-band, the time domain measurement is also the out-of-band response.

You may (with these limitations in mind) choose to use a frequency span that is wider than the DUT bandwidth to achieve better resolution.

**Range Resolution.** Time domain range resolution is defined as the ability to locate a single response in time. If only one response is present, range resolution is a measure of how closely you can pinpoint the peak of that response. The range resolution is equal to the digital resolution of the display, which is the time domain span divided by the number of points on the display. To get the maximum range resolution, center the response on the display and reduce the time domain span. The range resolution is always much finer than the response resolution.

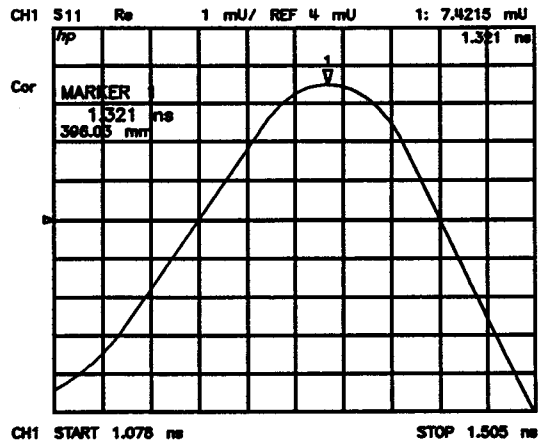


Figure 9-13. Range Resolution of a Single Discontinuity

## Gating

Gating provides the flexibility of selectively removing time domain responses. The gated time domain responses can then be transformed back to the frequency domain. For reflection (or fault location) measurements, use this feature to remove the effects of unwanted discontinuities in the time domain. You can then view the frequency response of the remaining discontinuities. In a transmission measurement, you can remove the effects of multiple transmission paths.

Figure 9-14 illustrates the time domain response of a SAW filter. Gating has been applied in the time domain to remove the effects of all but the main signal path response. When the gated response is transformed back to the frequency domain, the display shows only the direct path response.

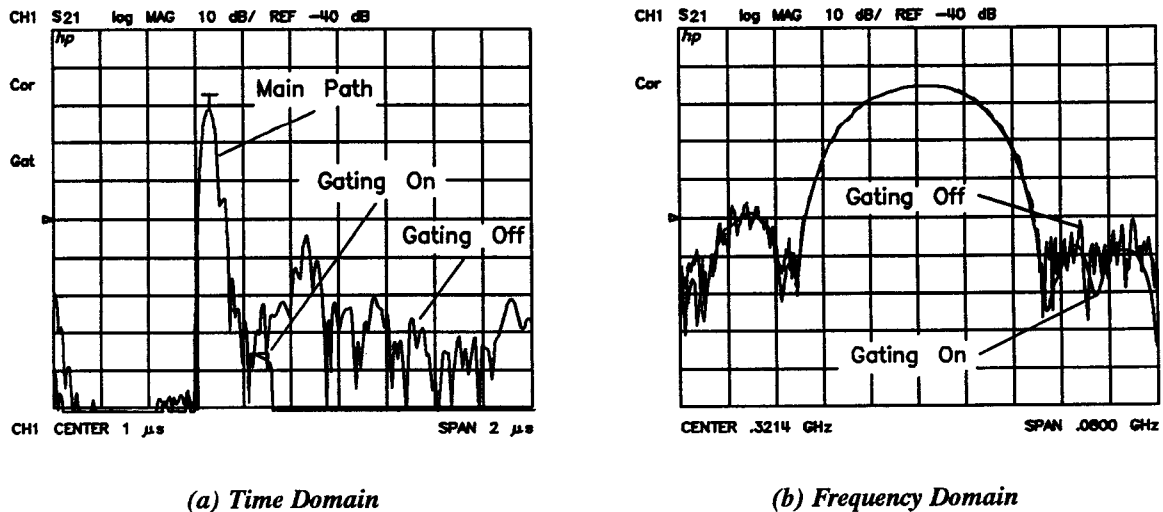


Figure 9-14. SAW Filter Transmission Measurement with Gating



## Setting the Gate

Think of a gate as a bandpass filter in the time domain (Figure 9–15). When the gate is on, responses outside the gate are mathematically removed from the time domain trace. Enter the gate position as a start and stop time (not frequency) or as a center and span time. The start and stop times are the bandpass filter —6 dB cutoff times. Gates can have a negative span, in which case the responses inside the gate are mathematically removed.

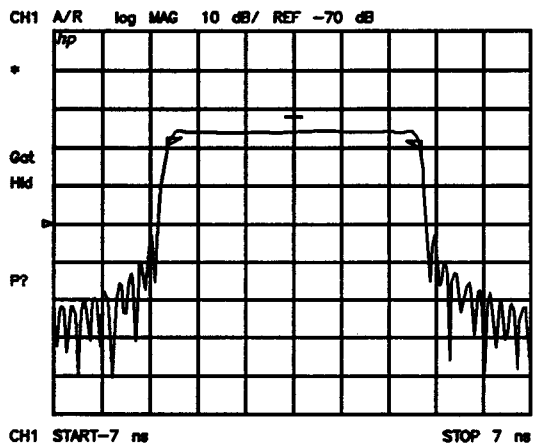


Figure 9–15. Gate Shape

## Selecting Gate Shape

The four gate shapes available are listed in Table 9–4. Each gate has a different passband flatness, cutoff rate, and sidelobe levels.

Table 9–4. Gate Characteristics

Gate Shape	Passband Ripple	Sidelobe Levels	Cutoff Time	Minimum Gate Span
Minimum	±0.40 dB	—24 dB	0.6/Freq Span	1.2/Freq Span
Normal	±0.04 dB	—45 dB	1.4/Freq Span	2.8/Freq Span
Wide	±0.02 dB	—52 dB	4.0/Freq Span	8.0/Freq Span
Maximum	±0.01 dB	—80 dB	11.2/Freq Span	22.4/Freq Span

The passband ripple and sidelobe levels are descriptive of the gate shape. The cutoff time is the time between the stop time (—6 dB on the filter skirt) and the peak of the first sidelobe, and is equal on the left and right side skirts of the filter. Because the minimum gate span has no passband, it is just twice the cutoff time. Always choose a gate span wider than the minimum. For most applications, do not be concerned about the minimum gate span, simply use the knob to position the gate markers around the desired portion of the time domain trace.

## TRANSFORMING CW TIME MEASUREMENTS INTO THE FREQUENCY DOMAIN

The analyzer can display the amplitude and phase of continuous wave (CW) signals versus time. For example, use this mode for measurements such as amplifier gain as a function of warm-up time (i.e. drift). In the past, drift measurements were often made using strip chart recorders. The analyzer can display the measured parameter (e.g. amplifier gain) for periods of up to 24 hours and then output the data to a digital plotter for hardcopy results.

These "strip chart" plots are actually measurements as a function of time (time is the independent variable), and the horizontal display axis is scaled in time units. Transforms of these measurements result in frequency domain data. Such transforms are called forward transforms because the transform from time to frequency is a forward Fourier transform, and can be used to measure the spectral content of a CW signal. For example, when transformed into the frequency domain, a pure CW signal measured over time appears as a single frequency spike (Figure 9-16). The transform into the frequency domain yields a display that looks similar to a spectrum analyzer display of signal amplitude versus frequency.

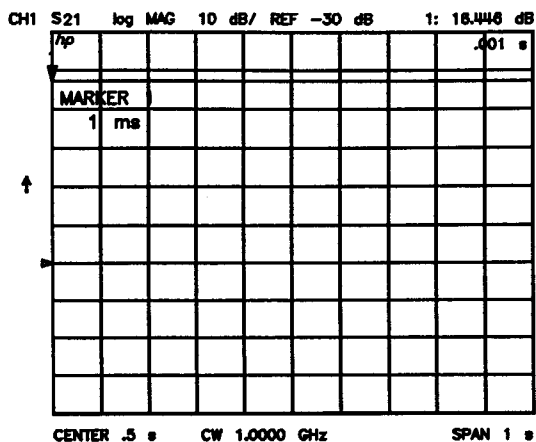
### Forward Transform Measurements

This is an example of a measurement using the Fourier transform in the forward direction from time domain to frequency domain (see Figure 9-16):

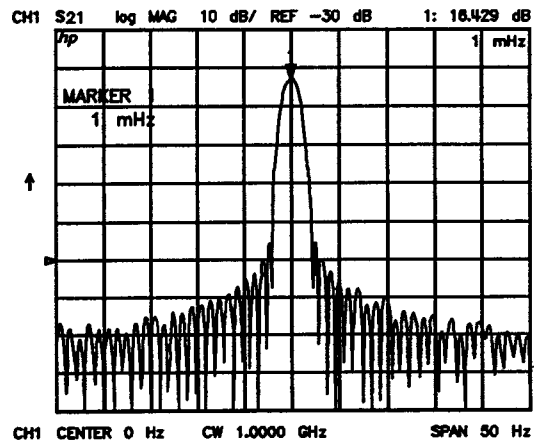
1. Press **PRESET**.
2. Press **MEAS** **Trans: FWD S21**.
3. Press **MENU** **CW FREQ** and set the CW frequency to the desired value (in this case, the default CW frequency of 1 GHz). The CW time mode is now active.
4. Press **SWEEP TIME (MANUAL)** **2** **0** **0** **k/m** to increase the sweep time to 200 milliseconds.
5. Press **SYSTEM** **TRANSFORM MENU** **TRANSFORM ON** to transform the data into the frequency domain.
6. Press **SPAN** **1** **0** **0** **0** **x1** to increase the frequency span to 1 kHz. The center frequency of  $\approx 0$  Hz represents the CW frequency of 1 GHz entered earlier.

**NOTE:** In the forward transform mode, the k/m, M/ $\mu$ , and G/n keys terminate a selection as millihertz, microhertz, and nanohertz.

7. Press **SCALE REF** **0** **x1** to view the trace centered on the screen.
8. Press **MKR FCTN** **MKR SEARCH** **MAX** to see the peak value.



(a) CW Time



(b) Transform to Frequency Domain

Figure 9–16. Amplifier Gain Measurement

## Interpreting the Forward Transform Measurement

With the log magnitude format selected, the vertical axis displays dB. This format simulates a spectrum analyzer display of power versus frequency. In a frequency domain transform of a CW time measurement, the horizontal axis is measured in units of frequency. The center frequency is the offset of the CW frequency. For example, if you enter a center frequency value of 0 Hz with the transform on, the center of the display shows the CW frequency (1 GHz in the example on the previous page). A positive center frequency value entered with the transform on shifts the CW frequency to the left half of the display; a negative value shifts it to the right half of the display. The span value entered with the transform on is the total frequency span shown on the display. Alternatively, the frequency display values can be entered as start and stop.

## Demodulating the Results of the Forward Transform

The forward transform can separate the effects of the CW frequency modulation amplitude and phase components. For example, if a DUT modulates the transmission response (S21) with a 300 Hz AM signal, you can see the effects of that modulation as shown in Figure 9–17. To simulate this effect, connect a 300 Hz sine wave to the modulation input of a PIN modulator connected between port 1 and port 2.

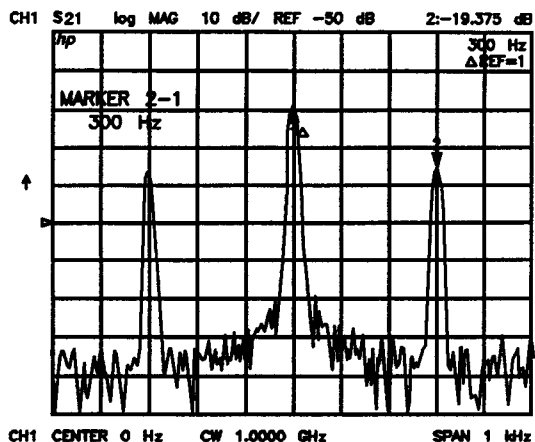


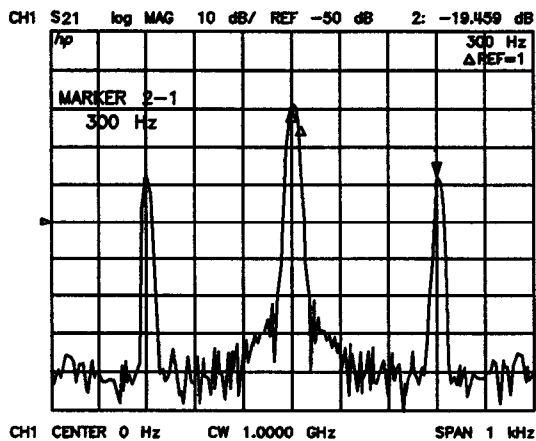
Figure 9-17. Combined Effects of Amplitude and Phase Modulation

Using the demodulation capabilities of the analyzer, it is possible to view the amplitude or the phase component of the modulation separately. The window menu (see Figure 9-2) includes the following softkeys to control the demodulation feature:

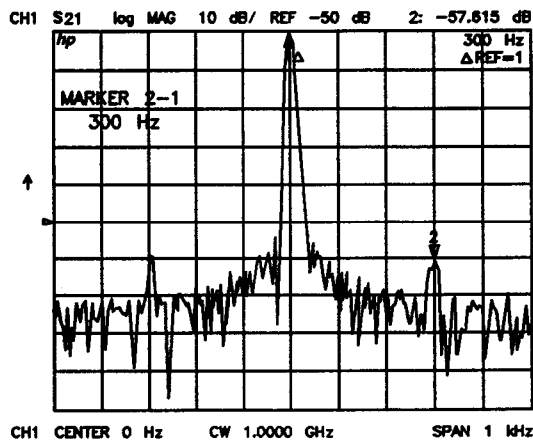
**DEMOD: OFF** This is the normal preset state, in which both the amplitude and phase components of any DUT modulation appear on the display.

**AMPLITUDE** displays only the amplitude modulation (AM), as illustrated in Figure 9-18(a).

**PHASE** displays only the phase modulation (PM), as shown in Figure 9-18 (b).



(a) Amplitude Modulation Component



(b) Phase Modulation Component

Figure 9-18. Separating the Amplitude and Phase Components of DUT-Induced Modulation

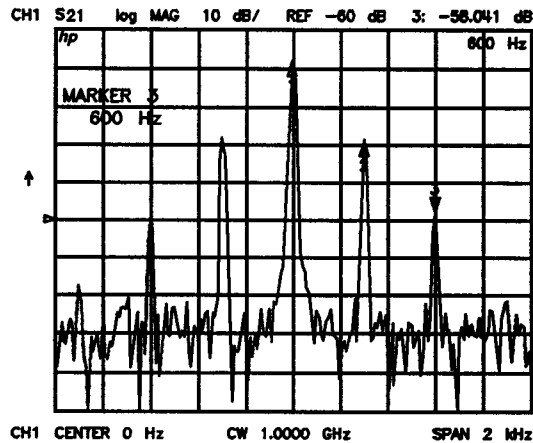
## Forward Transform Range

In the forward transform (from CW time to the frequency domain), range is defined as the frequency span that can be displayed before aliasing occurs, and is similar to range as defined for time domain measurements. In the range formula, substitute time span for frequency span.

Example:

$$\begin{aligned}\text{Range} &= (\text{Number of points} - 1) / \text{Time Span} \\ &= (201 - 1) / (200 \times 10^{-9}) \\ &= 1000 \text{ Hertz}\end{aligned}$$

For the example given above, a 201 point CW time measurement made over a 200 ms time span, choose a span of 1 kHz or less on either side of the center frequency (Figure 9–19). That is, choose a total span of 2 kHz or less.



*Figure 9–19. Range of a Forward Transform Measurement*

To increase the frequency domain measurement range, increase the span. The maximum range is inversely proportional to the sweep time, therefore it may be necessary to increase the number of points or decrease the sweep time. Because increasing the number of points increases the auto sweep time, the maximum range is 2 kHz on either side of the selected CW time measurement center frequency (4 kHz total span). To display a total frequency span of 4 kHz, enter the span as 4000 Hz.



# Chapter 10. Making a Hard Copy Output

---

## INTRODUCTION

The analyzer can use HP-IB to output measurement results directly to a compatible printer or plotter, without the use of an external controller. The information displayed on the CRT can be copied to a compatible Hewlett-Packard plotter or graphics printer. Refer to the *General Information* section of this manual for information about compatible plotters and printers.

To generate a plot or printout from the front panel when there is no other controller on the bus, the analyzer must be in system controller HP-IB mode. To take control from the computer and initiate a plot or printout, the analyzer must be in pass control mode. If it is not in one of these modes, the message "CHANGE HP-IB to SYS CTRL or PASS CTRL" is displayed. Refer to **LOCAL** Key in Chapter 8 for information on HP-IB controller modes and setting addresses.

## COPY KEY

The **COPY** key provides access to the menus used for controlling external plotters and printers and defining the plot parameters.

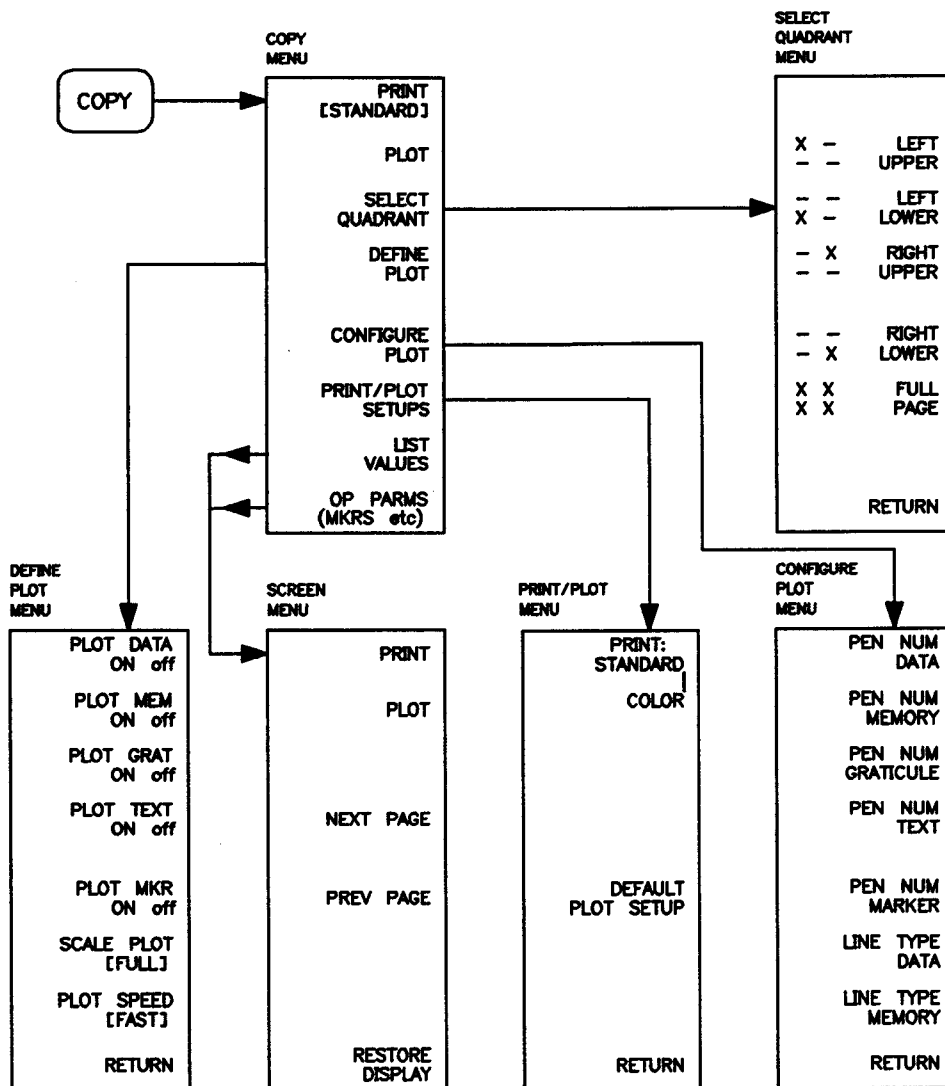


Figure 10-1. Softkey Menus Accessed from the **COPY** Key

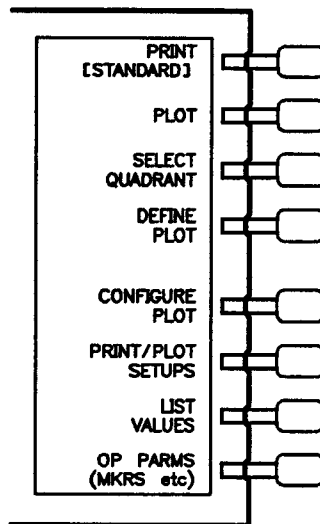
## Copy Menu

The copy menu can be used to copy to a printer or to plot using default plot parameters, without the need to access other menus. For user-defined plot parameters, a series of additional menus is available.

This menu also provides tables of operating parameters and measured data values, which can be copied from the screen to a printer or plotter.

To abort a plot or print, press **LOCAL**. The analyzer will stop the copying process, and the message "CAUTION: PRINT (PLOT) ABORTED" will be displayed. An aborted plot or printout cannot be continued: if a copy is still required, the process should be initiated again.





*Figure 10–2. Copy Menu*

**PRINT** (PRINALL) copies the CRT display to a compatible HP graphics printer. Tabular listings or data displays can be printed, although a plotter provides better resolution for data displays. All information from the CRT display is printed except the softkey labels.

**PLOT** (PLOT) plots the CRT display to a compatible HP graphics plotter, using the currently defined plot parameters (or default parameters). Any or all displayed information can be plotted, except a frequency list table or limit table, or the softkey labels. If a printer is not available, tabular listings can be plotted, although plotting is considerably slower than printing. To achieve the fastest plotting time, place the analyzer in HOLD mode, limit pen changes, and limit complex functions such as averaging.

**SELECT QUADRANT** leads to the the select quadrant menu, which provides the capability of drawing quarter–page plots. This is not used for printing.

**DEFINE PLOT** leads to the define plot menu, which is used to specify which elements of the display are to be plotted. This is not used for printing.

**CONFIGURE PLOT** leads to the configure plot menu, which defines the pen number and line type for each of the plot elements. This is not used for printing.

**PRINT/PLOT SETUPS** presents a menu to select a standard (non–color) or color printer as the default, and lets you reset the print and plot definitions.

**LIST VALUES** (LISV) provides a tabular listing of all the measured data points and their current values, together with limit information if it is turned on. At the same time, the screen menu is presented, to enable hard copy listings and access new pages of the table. 30 lines of data are listed on each page, and the number of pages is determined by the number of measurement points specified in the stimulus menu.

Up to five columns of data are provided. The specific information listed for each measured data point varies depending on the display format, the limit testing status, and whether or not dual channel display or stimulus coupling is selected. If limit testing is on, an asterisk \* is listed next to any measured value that is out of limits. If limit lines are on, and other listed data allows sufficient space, the limits are listed together with the margin by which the device data passes or fails the nearest limit.

**OP PARAM (MKRS ETC)** (OPEP) provides a tabular listing of key parameters for both channels. The screen menu allows printing or plotting of the parameters visible or paging through the 4 pages of information. The information consists of marker parameters, operating parameters, and system parameters. System parameters relate to control of peripheral devices.

## Select Quadrant Menu

This menu offers the selection of a full-page plot, or a quarter-page plot in any quadrant of the page.

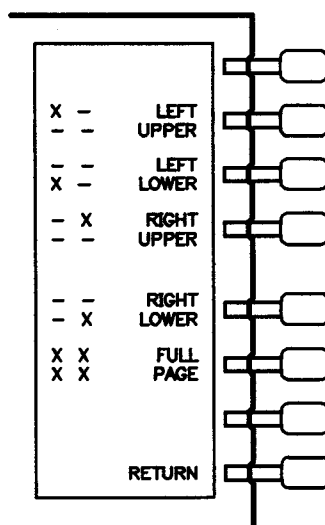


Figure 10-3. Select Quadrant Menu

**LEFT UPPER** (LEFU) draws a quarter-page plot in the upper left quadrant of the page.

**LEFT LOWER** (LEFL) draws a quarter-page plot in the lower left quadrant of the page.

**RIGHT UPPER** (RIGU) draws a quarter-page plot in the upper right quadrant of the page.

**RIGHT LOWER** (RIGL) draws a quarter-page plot in the lower right quadrant of the page.

**FULL PAGE** (FULP) draws a full-size plot according to the scale defined with **SCALE PLOT** in the define plot menu.

**RETURN** goes back to the copy menu.

## Define Plot Menu

This menu allows selective plotting of portions of the measurement display. Different plot elements can be turned on or off as required. In addition, different selections are available for plot speed and plot scale, to allow plotting on transparencies and preprinted forms.

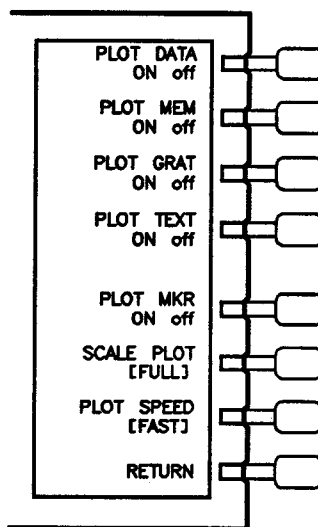


Figure 10-4. Define Plot Menu

**PLOT DATA ON/off** (PDATAON, PDATAOFF) specifies whether the data trace is to be drawn (on) or not drawn (off) on the plot.

**PLOT MEM ON/off** (PMEON, PMEMOFF) specifies whether the memory trace is to be drawn (on) or not drawn (off) on the plot. Memory can only be plotted if it is displayed (refer to *Display Menu* in Chapter 5).

**PLOT GRAT ON/off** (PGRATON, PGRATOFF) specifies whether the graticule and the reference line are to be drawn (on) or not drawn (off) on the plot. Turning **PLOT GRAT ON/off** and all other elements off is a convenient way to make preplotted grid forms. However, when data is to be plotted on a preplotted form, **PLOT GRAT ON/off** should be selected.

**PLOT TEXT ON/off** (PTEXTON, PTEXTOFF) selects plotting of all displayed text except frequency list table, limits table, softkeys, and marker values. (Softkey labels can be plotted under the control of an external controller. The frequency list table and limits table can be printed from an external controller. Refer to the *HP-IB Programming Reference*.)

**PLOT MKR ON/off** (PMKRON, PMKROFF) specifies whether the markers and marker values are to be drawn (on) or not drawn (off) on the plot.

**SCALE PLOT** (SCAPFULL, SCAPGRAT) provides two selections for plot scale, **FULL** and **GRAT**. **FULL** is the normal scale selection for plotting on blank paper, and includes space for all display annotations such as marker values, stimulus values, etc. The entire CRT display fits within the user-defined boundaries of P1 and P2 on the plotter, while maintaining the exact same aspect ratio as the CRT display.

With the selection of **GRAT**, the horizontal and vertical scale are expanded or reduced so that the graticule lower left and upper right corners exactly correspond to the user-defined P1 and P2 scaling points on the plotter. This is convenient for plotting on preprinted rectangular or polar forms (for example, on a Smith chart).

To plot on a rectangular preprinted graticule, set P1 of the plotter at the lower left corner of the preprinted graticule, and set P2 at the upper right corner.

To plot on a polar format, set P1 to either the left (or bottom) end point of a diameter and P2 to the right (or top) end point. The analyzer will then compute and set new P1 and P2 values to obtain the current circularity. If P1 and P2 are set to within 10% of already being a perfect square, the analyzer will not change the boundaries but will distort the circles to fit the user-defined boundaries.

The procedure for plotting on a Smith chart format depends on the plotter capabilities. Some HP plotters have a 90° rotate feature that enables plotting on a portrait (vertical) format rather than a landscape (horizontal) format. Since most Smith charts are printed in portrait format, this rotate feature should be used prior to setting the P1 and P2 points, as described above for a polar format.

**PLOT SPEED** (PLOSFAST, PLOSSLOW) provides two plot speeds, **FAST** and **SLOW**. Fast is the proper plot speed for normal plotting. Slow plot speed is used for plotting directly on transparencies: the slower speed provides a more consistent line width. A color plot can be prepared directly on a transparency so that the color is not lost in converting a paper plot to a transparency.

**RETURN** goes back to the copy menu.

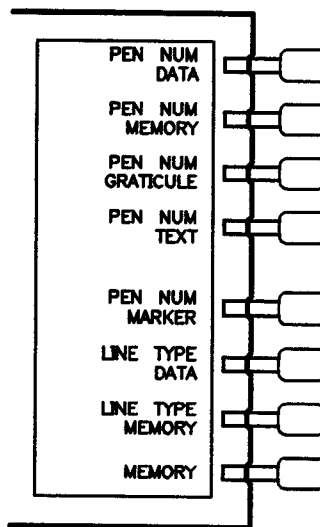
## Configure Plot Menu

This menu is used to select the pens to be used for plotting different elements of a plot, and the line types for the data and memory traces.

Pen numbers 0 through 10 can be selected (0 indicates no pen). It is possible to select a pen number higher than the number of pens in the plotter used. The convention in most Hewlett–Packard plotters is that when the pen number count reaches its maximum number it starts again at 1. Thus in a four–pen plotter, pen #5 actually calls pen #1.

The default pen numbers for the different plot elements vary between channels 1 and 2, so that when a color plotter is used the plots for the two channels can be identified quickly by their colors.

Line types 0 through 10 can be selected. The line types depend on the model of plotter used. In general, however, line type 0 specifies dots only at the points that are plotted; line types 1 through 6 specify broken lines with different spacing; and lines 7 through 10 are solid lines. Refer to the plotter manual for specific line type information.



*Figure 10–5. Configure Plot Menu*

**PEN NUM DATA** (PENNDATA) selects the number of the pen to plot the data trace. The default pen for channel 1 is pen #1, and for channel 2 is pen #2.

**PEN NUM MEMORY** (PENMEMO) selects the number of the pen to plot the memory trace. The default pen for channel 1 is pen #1, and for channel 2 is pen #2.

**PEN NUM GRATICULE** (PENGRAT) selects the pen number for plotting the graticule. The default pen for channel 1 is pen #3, and for channel 2 is pen #4.

**PEN NUM TEXT** (PENNTXT) selects the pen number for plotting the text. The default pen for channel 1 is pen #1, and for channel 2 is pen #2.

**PEN NUM MARKER** (PENMARK) selects the pen number for plotting both the markers and the marker values. The default pen for channel 1 is pen #5, and for channel 2 is pen #6.

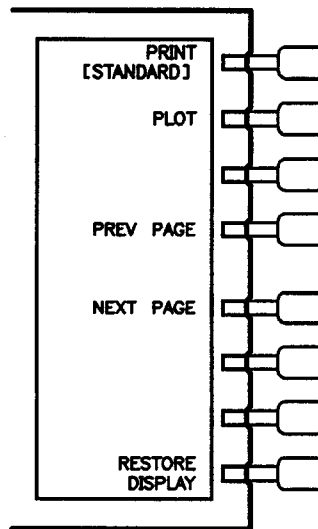
**LINE TYPE DATA** (LINTDATA) selects the line type for the data trace plot. The default line type is 7, which is a solid unbroken line.

**LINE TYPE MEMORY** (LINTMEMO) selects the line type for the memory trace plot. The default line type is 7.

**RETURN** goes back to the copy menu.

## Screen Menu

This menu is used in conjunction with the **LIST VALUES** and **OP PARAM (MKRS ETC)** features, to make hard copy listings of the tables displayed on the screen. To make copies from the front panel, make sure that the analyzer is in system controller or pass control mode (see Chapter 8).



*Figure 10-6. Screen Menu*

**PRINT** (PRINALL) copies one page of the tabular listings to a compatible HP graphics printer connected to the analyzer over HP-IB.

**PLOT** (PLOT) makes a hard copy plot of one page of the tabular listing on the CRT, using a compatible HP plotter connected to the analyzer through HP-IB. This is much slower than printing.

**NEXT PAGE** (NEXP) displays the next page of information in a tabular listing onto the CRT.

**PREV PAGE** (PREV) displays the previous page of information in a tabular listing onto the CRT.

**RESTORE DISPLAY** (RESA) turns off the tabular listing and returns the measurement display to the screen.

## Print/Plot Setup Menu

This menu allows selection of printer type and plot setup.

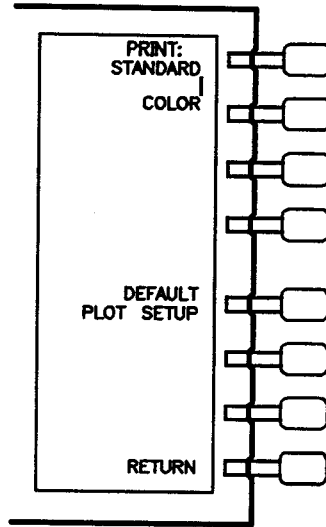


Figure 10-7. Print/Plots Setups Menu

**PRINT [STANDARD]** (PRIS) is used with non-color printers.

**COLOR** (PRIC) is used with color printers.

**DEFAULT PLOT SETUP** (DFLT) resets the plotting parameters to their default values.

Select quadrant:	Full page
Define plot:	All plot elements on
Plot scale:	Full
Plot speed:	Fast
Line type:	7 (solid line)
Pen numbers:	Default values

Default plot setups do not apply to prints.





# Chapter 11. Saving Instrument States

---

## INTRODUCTION

The analyzer has the capability of saving complete instrument states for later retrieval. It has five internal registers for this purpose, and can use direct disk access as an extension to internal memory. Because instrument states can be of varying complexities, it is possible to fill the available internal memory with less than five states. Also, it is possible to fill memory with instrument states and prevent such memory-intensive functions as two-port error correction, time domain (option 010), or 1601 measurement points.

This chapter discusses instrument state definition, memory allocation, and the treatment of saved calibration data. Refer to the *HP-IB Programming Guide* for information on external disk storage using an external controller.

The analyzer can utilize three types of memory for the storage of instrument states:

- Volatile memory. This is dynamic read/write memory, containing the current instrument state, and the variables listed in Table 2. It is cleared upon power cycle to the instrument and, except as noted, upon instrument preset.
- Non-volatile memory. This is CMOS read/write memory, providing short term (minimum 72 hour) storage of display memory and calibration sets.
- External memory. This utilizes disk media for unlimited storage of instrument states, as well as calibration and measurement data.

*Table 11-1. Memory Usage*

<p><b>Volatile Memory (see Table 2)</b> Current instrument state Variables</p> <p><b>Non-Volatile Memory</b> Five learn string registers CRT intensity default HP-IB configuration User calibration kit definition Calibration sets</p> <p><b>External Memory</b> Instrument states Calibration sets (if calibration on) Measurement data (select all) User calibration kit (if being used) Display Memory (if being used);</p>
---

## **INSTRUMENT STATE**

An instrument state consists of two types of data: (1) the learn string and, (2) variables.

### **Instrument State Learn String**

The learn string is an encoded array. It contains only the data needed to set up the analyzer to make a specific measurement. That data consists of stimulus and response parameters and operating modes status. Each measurement point is not recorded. For example, to re-create a frequency list the analyzer needs to save only the start frequency, frequency span, and number of points in each segment. Thus the size of the learn string is constant, not proportional to the number of points in the sweep.

Learn strings are saved in non-volatile, short-term (72 hour minimum) memory. Learn strings will survive instrument preset and cycling power.

### **Instrument State Variables**

The instrument state variables are calibration sets, measurement data, and operating modes data. They vary in size with the number of points and compete with other instrument functions and modes for volatile memory space. This size may be approximated with the information in Table 11-2.

The variables are stored in volatile memory. Measurement data and operating modes data will not survive preset or cycling power.

Table 11–2. Instrument State Variables Stored in Volatile Memory

Variable	Data Length (bytes)		
<b>Measurement Data</b>			
Raw data array(s)			
1 port or less correction	N x 6 + 52		
2 port	4 (N x 6 + 52)		
Data array(s)			
1 port or less correction	N x 6 + 52		
2 port	4 (N x 6 + 52)		
Formatted array*	N x 6 + 52		
Scratchpad array**	N x 6 + 52		
<b>Operating Modes Data</b>			
Smoothing ON*	<2000		
(20% aperture, 1601 points)			
Frequency list mode*	N x 12		
Log frequency mode*	N x 12		
Time domain			
	With Additional Features		
FFT array		Window and Chirp Array	Gating Array
≤ 51 points	768	972	1612
101 points	1536	1940	3233
201 points	3072	3876	6456
401 points	6144	7748	12913
801 points	12288	15492	25820
1601 points	24576	26177	43628
<b>Notes:</b>			
User allocatable memory: ≈ 960 Kbytes			
N = number of points			
* This variable is allocated once per active channel.			
** Insufficient memory for allocation of this array is not fatal. The array is used to recalculate the data for display any time formatting factors are changed. If sufficient memory is not allocated, trace data will not be redisplayed after a scaling change until a new sweep occurs.			

Table 11–3. Instrument State Variables Stored in Non–Volatile Memory

Variable	Data Length (bytes)
<b>Calibration Sets</b>	
Response	$N \times 6 + 52$
Response and isolation	$N \times 6 \times 2 + 52$
1 port	$N \times 6 \times 3 + 52$
2 port	$N \times 6 \times 12 + 52$
Power Meter Cal*	$N \times 2 + 208$
Memory array*	$N \times 6 + 52$
<b>Notes:</b>	
User allocatable memory: $\approx 240$ Kbytes	
N = number of points	
* This variable is allocated once per active channel.	

## Memory Allocation Examples

The following examples show the basic memory requirements of various memory–intensive instrument states, and the extra memory needed as features are added. These examples assume that no other instrument states or calibration sets are saved.

	Total (Bytes)
• 401 points, 2 channels, full 2–port cal, no interpolated cal, no time domain, no list mode, no memory arrays	93k
add memory trace	100k
add interpolated cal	1 58k
add time domain, with windowing and gating	199k
add frequency list mode	21 5k
• 401 points, 1 channel, full 2–port interpolated cal with original cal arrays at 1601 points, no time domain, no list mode, no memory arrays	1 59k
add memory trace	1 62k
add frequency list mode	1 69k
add time domain, with windowing and gating	189k
all of the above on both channels	378k
• 801 points, 1 channel, full 2–port cal, no interpolated cal, no time domain, no list mode, no memory arrays	93k
add memory trace	100k
add interpolated cal	1 58k
add time domain, with windowing and gating	1 99k
add frequency list mode	21 2k
all of the above on both channels	41 8k

- 1601 points, 1 channel, full 2–port cal, no interpolated cal, no time domain, no list mode, no memory arrays 1 83k
- add memory trace 196k
- add interpolated cal 311 k
- add time domain, with windowing and gating 361k
- add list mode 387k
- all of the above on both channels 773k

## SAVING AND STORING INSTRUMENT STATES

Instrument states can be saved internally or stored to external disks. Each method has advantages and disadvantages.

### Saving Instrument States Internally

Data saved internally requires no external equipment. But cycling power erases measurement data and operating modes data saved in volatile memory. Thus storing instrument states to disk (see *Instrument States* below) is more appropriate at times. That aside, up to six instrument states can reside in internal memory at any one time: five saved states in nonvolatile memory; and the active state in volatile memory. Calibration sets are linked to the instrument state and measurement parameter for which the calibration was done. Up to 12 calibrations can exist (the actual may be limited by available memory). When an instrument state is cleared (deleted) from memory (see **CLEAR REGISTER**), the associated calibration set is also deleted, as long as its use is not required by another register.

### Storing Instrument States to Disk

With the analyzer in system controller or pass control mode, instrument state and user selectable data can be stored to an external disk drive.

Note that instrument states stored to disk by one instrument may be recalled by another. This can be a convenient method for transferring limit line data and frequency lists. Frequencies stored by an option 001 (high resolution) instrument and recalled by a standard instrument may be incompatible. And storing calibration sets requires caution (see below).

In local mode (no controller), the analyzer displays on the CRT one file name for each stored instrument state. This single file name is the root name for several associated files which have distinct suffixes. When the disk catalogue is accessed using **RECALL**, **LOAD FROM DISK**, **FILE DIRECTORY**, **COMPLETE FILE DIREC**, the directory will show all of the files associated with a particular instrument state. The total number of files stored on a disk may not exceed 512.

Disk files created by the HP 8720 consist of a state name of up to 8 characters, such as FILTER, appended with up to two characters, which indicate what is in the file. Data and calibration files form 3 data (without a header) which can be read off the disk. The other files are not meant to be decoded, and it is recommended that disk registers not be created or modified with a computer.

**Raw data (uncorrected).** Included with disk store if enabled; must be stored (with cal arrays) to perform later time domain analysis; file suffix Rn.

**Data (corrected).** Included with disk store if enabled; if loaded from disk, puts analyzer in HOLD to prevent erasing data; file suffix Dn.

**Formatted.** Corrected data after formatting (e.g. log mag, phase, etc); included with disk store if enabled; file suffix Fn.

**Memory ("trace memory").** 2 maximum, 1 per channel; ~6 Bytes/point; included with disk store if MEM or DATA/MEM or DATA-MEM is displayed; file suffix Mn.

**Calibration Arrays ("cal sets").** 12 maximum or up to 5 full 2-port calibrations; linked to registers, and to parameters within register (except for full 2-port, which applies to all four parameters); ~6 Bytes/point per error term; included with disk store if correction is on; file suffix nn.

**FILTERXX**



The first character is the file type, telling the kind of information in the file

The second character is a data index, used to distinguish files of the same type.

Char 1	Meaning	Char 2	Meaning
I	Instrument State		
G	Graphics	1 0	Display graphics Graphics index
D	Error corrected data	1 2	Channel 1 Channel 2
R	Raw Data	1 to 4 5 to 8	Channel 1, raw arrays 1 to 4 Channel 2, raw arrays 1 to 4
F	Formatted data	1 2	Channel 1 Channel 2
C	Cal	K	Cal kit
1	Cal data, channel 1	0 1 to 9 A B C	Stimulus state Coefficients 1 to 9 Coefficient 10 Coefficient 11 Coefficient 12
2	Cal data, channel 2	0 to C	Same as channel 1
M	Memory Data	1 2	Channel 1 Channel 2

## Memory Requirements for Storing Information to Disk

Information (data, instrument states, etc.) can be stored on disk using an external disk drive using Hewlett–Packard's standard LIF format.

The following table describes the memory required to store various types of data. The numbers given for machine dump, user display, and delay table are considered to be maximum possible numbers, though normally these numbers are considerably smaller. All numbers are rounded and are not exact. Use these numbers as guidelines when allocating memory space.

The HP defaults to binary format, so all of the numbers listed in the table below are for binary files. When storing data in the binary format, the file format takes an additional sector of space (256). The 8720 stores all information as a single operation (one common file name plus a suffix). The numbers in the table are given individually to allow you to add up the values for your particular set–up. For example: The memory required for a full 2–port calibration with 201 points, storing 1 channel of corrected data (1 S–parameter) is 40 (CalSet) +3 (Instrument State) +3.5 (Data) =46.5 Kbytes.

Type of Data to be Stored	Memory Required (Kbytes) HP 8720
Calibration Set (full 2–port, 801pts)	155
Calibration Set (full 2–port, 401 pts)	80
Calibration Set (full 2–port, 201 pts)	40
Calibration Set (1–port, 801 pts)	40
Calibration Set (1–port, 401 pts)	20
Calibration Set (1–port, 201 pts)	10
Calibration Kit	2
Instrument State	3
Data Data (201 pts) 1 S–parameter	3.5
Data Data (401 pts) 1 S–parameter	7
Data Formatted, Raw or Memory (201 pts) 1 S–parameter	3.5
User Display	33

## Calibration Set Cautions

Calibration sets stored by one instrument and recalled by another instrument are not valid. Watch out for situations like this:

- Correction is ON when analyzer A stores instrument state A to disk,
- Analyzer B recalls instrument state A from disk; as a result,
- Analyzer B recalls calibration set A, and
- Analyzer B turns correction ON (but it is not valid; recalibrate).

Calibration sets should not be recalled at one temperature if stored (by the same or different instrument) at another temperature. Refer to the "Specifications" section for allowable temperature ranges for individual specifications.

## SAVE AND RECALL KEYS

The **SAVE** key provides access to all the menus used for saving instrument states in internal memory and for storing to external disk. This includes the menus used to define titles for internal registers and external files, to define the content of external files, to initialize disks for storage, and to clear data from the registers or purge files from an external disk.

The **RECALL** key leads to the menus that recall the contents of internal registers, or load files from external disk back into the analyzer.



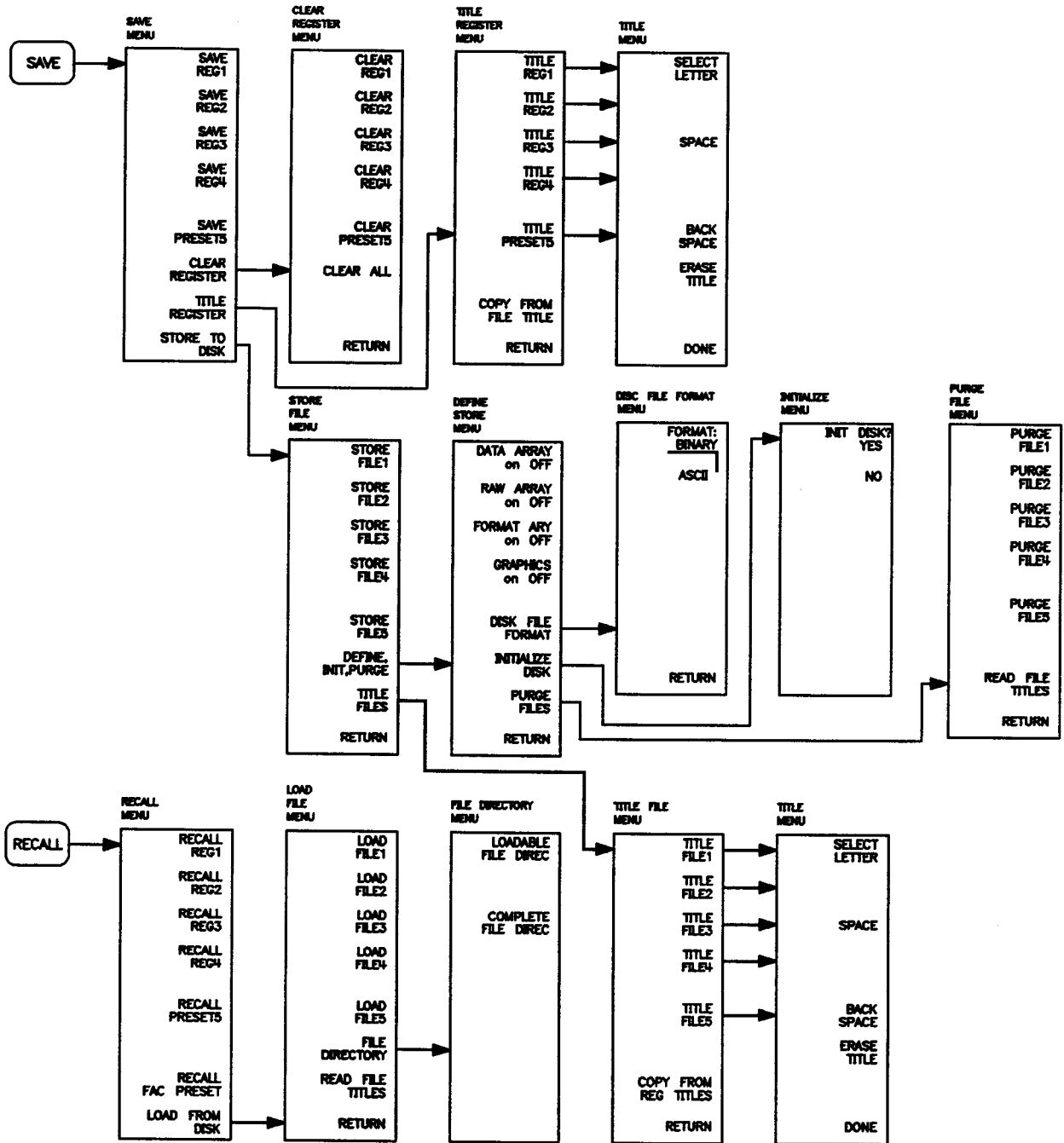


Figure 11-1. Softkey Menus Accessed from the **SAVE** and **RECALL** Keys

## Save Menu

This menu (Figure 11–2) selects an internal memory register to store the current instrument state. If a register contains a previously saved instrument state, the softkey label changes to **RE-SAVE**. This is intended to prevent inadvertent destruction of saved states.

This also leads to the series of menus for external disk storage.

The default titles for the save registers are REG1 through REG5, but these titles can be modified using the title register menu and the title menu.

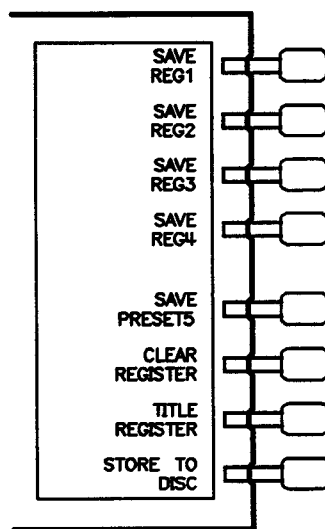


Figure 11–2. Save Menu

If correction is on, the associated calibration set is saved in non-volatile memory, if display memory is being used, it is also saved in non-volatile memory.

**SAVE REG1** (SAVE1) saves the present instrument state in an internal register titled REG1.

**SAVE REG2** (SAVE2) saves the present instrument state in internal register REG2.

**SAVE REG3** (SAVE3) saves the present instrument state in internal register REG3.

**SAVE REG4** (SAVE4) saves the present instrument state in internal register REG4.

**SAVE PRESET5** (SAVE5) saves the present instrument state in internal register PRESET5.

The instrument state and associated calibration saved in this register will be automatically recalled during power on or **USER PRESET**.

**CLEAR REGISTER** leads to the clear register menu, described on the next page.

**TITLE REGISTER** leads to the title register menu, where the default register titles can be modified.

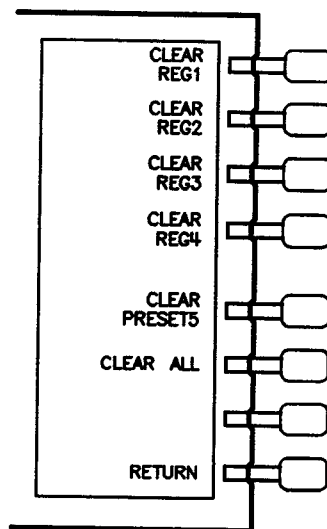
**STORE TO DISK** leads to the store file menu, which introduces a series of menus for external disk storage.

## Clear Register Menu

This menu (Figure 11–3) allows unused instrument states to be cleared from save registers, making the assigned memory available for other uses. When an instrument state is deleted from memory, the associated calibration set is also deleted. You can choose to selectively clear individual registers, or clear all registers with one keystroke.

Clearing of registers is performed internally with 100 alternating 0 and 1 rewrite operations over the entire non-volatile portion of the specified register memory.

Only registers that have instrument states previously stored in them are listed in this menu.



*Figure 11–3. Clear Register Menu*

**CLEAR REG1** (CLEA1) clears a previously saved instrument state from register 1.

**CLEAR REG2** (CLEA2) clears a saved instrument state from register 2.

**CLEAR REG3** (CLEA3) clears a saved instrument state from register 3.

**CLEAR REG4** (CLEA4) clears a saved instrument state from register 4.

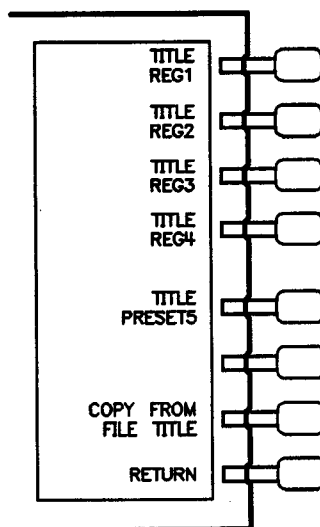
**CLEAR PRESET5** (CLEA5) clears a saved instrument state from preset 5.

**CLEAR ALL** (CLEARALL) clears all instrument states.

**RETURN** goes back to the save menu.

## Title Register Menu

This menu can be used to select a register to be retitled. All registers are listed, regardless of whether or not they contain saved instrument states. When any of the title register softkeys is pressed, the title menu is presented and the character set is displayed in the active entry area.



*Figure 11–4. Title Register Menu*

**TITLE REG1** (TITR1) selects register 1 to be retitled and presents the title menu and the character set.

**TITLE REG2** (TITR2) selects register 2 to be retitled.

**TITLE REG3** (TITR3) selects register 3 to be retitled.

**TITLE REG4** (TITR4) selects register 4 to be retitled.

**TITLE PRESET5** (TITR5) selects register 5 to be retitled.

**COPY FROM FILE TITLE** (COPYFRFT) renames the internal registers to match the current names of the store files. For example, the default names of the internal registers are REG1 through REG5. The default names of the store files are FILE1 through FILE5. Pressing this key would rename the internal registers FILE1 through FILE5. If you have modified the names of the store files, the modified names would be copied to the internal save register names.

**RETURN** goes back to the save menu.

## Title Menu

Use this menu (Figure 11–5) to define a title for the register selected in the title register menu. The title replaces the default register title in the softkey label, and is recalled with the saved instrument state.

This is similar to the menu used to set the display title (described in Chapter 5), except that certain restrictions apply. The register title is limited to eight characters. If more than eight characters are selected, the last character is repeatedly written over. The title must be all alpha–numeric, and must start with an alpha character. If the first character selected is not an alpha character, the message “CAUTION: FIRST CHARACTER MUST BE A LETTER” is displayed when the **DONE** key is pressed. No special characters or spaces are allowed. If a disallowed character is selected, the message “CAUTION: ONLY LETTERS & NUMBERS ARE ALLOWED” is displayed. (The special characters are used only for the display title.)

The save register title is independent of the display title, which is also saved and recalled as part of the display.

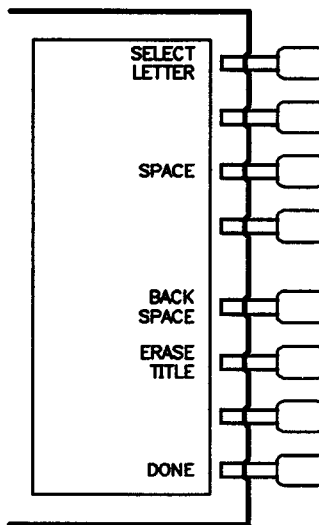


Figure 11–5. Title Menu

**SELECT LETTER** . The active entry area displays the letters of the alphabet, digits 0 through 9. The mathematical symbols are not used in register titles. To define a title, rotate the knob until the arrow ↑ points at the first letter, then press **SELECT LETTER** . Repeat this until the complete title is defined, for a maximum of eight characters. As each character is selected, it is appended to the title at the top left corner of the graticule.

**SPACE** . This softkey does not function when defining a register title.

**BACK SPACE** deletes the last character entered.

**ERASE TITLE** deletes the entire register title.

**DONE** terminates the title entry, and returns to the title register menu. The new title appears in the softkey label in all applicable menus.

## Store File Menu

This menu (Figure 11–6) is used to store instrument states to an external disk rather than to internal memory registers. The analyzer can use HP–IB to store directly to a compatible external disk drive, without the use of an external controller. Refer to the *General Information* section of this manual for information about compatible disk drives. Refer to the first part of this chapter for information about disk storage.

To store information on an external disk from the front panel when there is no other controller on the bus, the analyzer must be in system controller HP–IB mode. To take control from the computer and initiate a store operation, the analyzer must be in pass control mode. If it is not in one of these modes, the message "CHANGE HP–IB to SYS CTRL or PASS CTRL" is displayed. Refer to **LOCAL** Key in Chapter 8 for information on HP–IB controller modes and setting addresses.

If you attempt to store a file and the message "CAUTION: DISK: not on, not connected, wrong addr" is displayed, check the disk drive line power and HP–IB cable connection. Also make sure that the HP–IB address of the disk drive matches the address set in the address menu (see Chapter 8).

The analyzer uses one file name per instrument state for communicating with the user via the front panel display. In reality, several files can actually be stored to the disk when an instrument state is saved, depending on the functions being saved. This does not affect operation from the front panel. The default names for the stored files are FILE1 through FILE5. These file names can be modified using the title file menu.

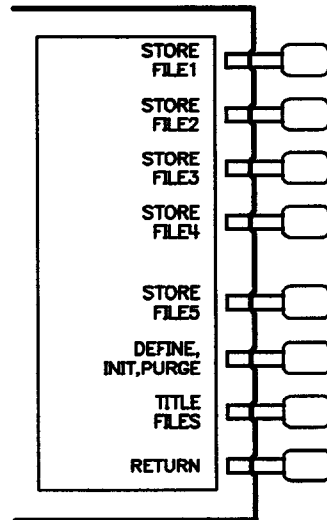


Figure 11–6. Store File Menu

**STORE FILE 1** (STOR1) stores the current instrument state in external file 1, together with any data specified in the define, init, purge menu (see page 11–15).

**STORE FILE 2** (STOR2) stores the current instrument state and specified data in file 2.

**STORE FILE 3** (STOR3) stores the current instrument state and specified data in file 3.

**STORE FILE 4** (STOR4) stores the current instrument state and specified data in file 4.

**STORE FILE 5** (STOR5) stores the current instrument state and specified data in file 5.

**DEFINE INIT PURGE** leads to the define store menu. Use this menu to specify what data is to be stored on disk in addition to the instrument state.

**TITLE FILES** leads to the title file menu, where the default file titles can be modified.

**RETURN** goes back to the save menu.

## Define, Init, Purge Menu

Data and user graphics can be stored on disk along with the basic instrument state. The data can be stored from different points in the data processing flow. It is possible to store raw, error-corrected, or formatted data, or any combination of the three. This menu allows the option of specifying what data is to be stored. Refer to *Data Processing Flow* in Chapter 2 for more information about data arrays and the sequence of data processing events.

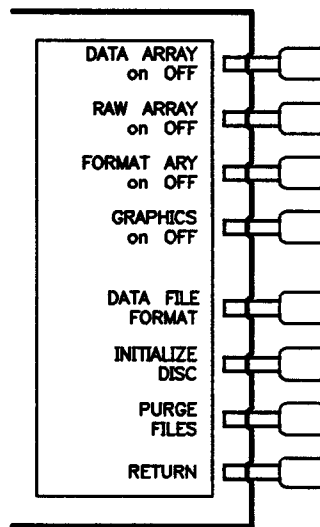


Figure 11-7. Define Store Menu

**DATA ARRAY on OFF** (EXTMDATAON, EXTMDATAOFF) specifies whether or not to store the error-corrected data on disk with the instrument state.

**RAW ARRAY on OFF** (EXTMRAWON, EXTMRAWOFF) specifies whether or not to store the raw data (ratioed and averaged) on disk with the instrument state.

**FORMAT ARRAY on OFF** (EXTMFORMON, EXTMFORMOFF) specifies whether or not to store the formatted data on disk with the instrument state.

**GRAPHICS on OFF** (EXTMGRAPON, EXTMGRAPOFF) specifies whether or not to store display graphics on disk with the instrument state.

**DATA FILE FORMAT** leads to the data file format menu.

**INITIALIZE DISK** (INID) leads to the initialize menu. Before data can be stored on a disk, the disk must be initialized for format compatibility. If you attempt to store without initializing the disk, the message "CAUTION: DISK MEDIUM NOT INITIALIZED" is displayed.

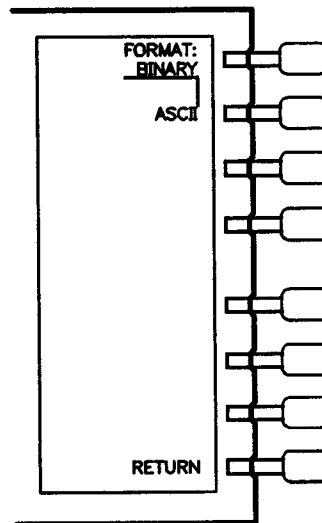
**PURGE FILES** leads to the purge files menu, which is used to purge the information stored on an external disk.

**RETURN** goes back to the store file menu.

## Data File Format Menu

Use this menu to select one of two *data* file formats for disk storage. The data file format refers to how the data is encoded (formatted). The advantages of each is explained below. Remember that data may be stored selectively as previously explained in "Define, Init, Purge Menu".

The learn string, calibration kit, and user graphics display data are always stored in binary format because it is useful only to the network analyzer. They should not be modified with an external computer.



*Figure 11-8. Data File Format Menu*

**FORMAT: BINARY** (SAVUBINA) selects binary data format, the faster, more compact data storage format. When selected, this data is formatted in binary:

- Data arrays (corrected)
- Raw data arrays
- Formatted array
- Display memory array
- Calibration sets



**ASCII** (SAVUASCII) selects an ASCII data format known as CITIFile (Common Instrumentation Transfer and Interchange file). This ASCII data format is useful when data will be exchanged with a compatible computer (see next page) to run, for instance, the HP 85150A/B Microwave Design System. See "Equipment Available" in the "General Information" section for additional software information.

When selected, the following data is formatted in CITIFile ASCII. Each array is stored separately.

- Data arrays (corrected)
- Raw data arrays
- Formatted array
- Display memory array
- Calibration sets

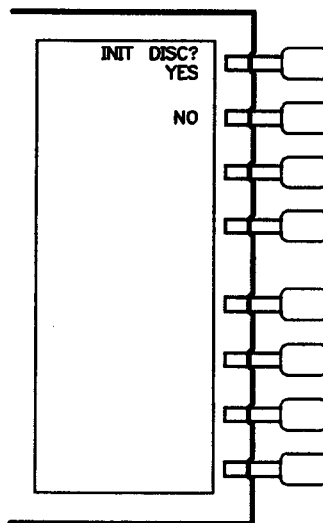
**RETURN** goes back to the define store menu.

## Initialize Menu

Initializing a disk erases all existing data and prepares it to store data. The preparation places a specific arrangement (format) of tracks and sectors on the disk. The disk format used by the analyzer is LIF (logical interchange format).

- LIF is compatible with HP series 9000 model 200/300 computers.
- LIF is compatible with the HP Vectra Personal computer with HP 82300 HP BASIC language processor.
- LIF is not compatible with most PCs. The analyzer will not read from or write to disks formatted by PCs. However, disk utility programs are available that can convert to MS-DOS format and vice versa.

For information on transferring the contents of a disk from a LIF disk to a PC-compatible disk, contact your local HP Sales and Service Office.



*Figure 11-9. Initialize Menu*

**INIT DISK? YES** initializes the disk unit number and volume number selected in the HP-IB menu (see Chapter 8), then returns to the define store menu. If more than one volume is to be initialized, each volume must be selected and initialized individually.

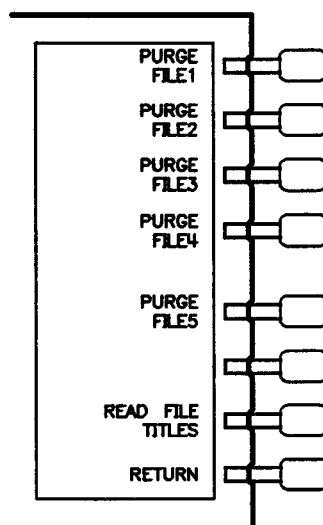
If the disk is damaged, the message "INITIALIZATION FAILED" is displayed. During the initialization process, the message "WAITING FOR DISK" is displayed. This is normal.

**NO** leaves this menu without initializing the disk, and returns to the define store menu.

## Purge File Menu

This menu is used to remove (purge) instrument states from a disk. When the purge file menu is entered, the file titles currently in memory are displayed. (File titles are stored in non-volatile memory.) These titles may or may not reside on the disk currently being used. The file titles can be updated to match the files on disk by reading the disk's directory with the **READ FILE TITLES** key.

The purge file menu is the disk equivalent of the clear register menu.



*Figure 11-10. Purge File Menu*

**PURGE FILE1** (PURG1) purges FILE1 from disk. If no file of that name exists on the disk, the message "CAUTION: NO FILE(S) FOUND ON DISK" will appear.

**PURGE FILE2** (PURG2) purges FILE2 from disk.

**PURGE FILE3** (PURG3) purges FILE3 from disk.

**PURGE FILE4** (PURG4) purges FILE4 from disk.

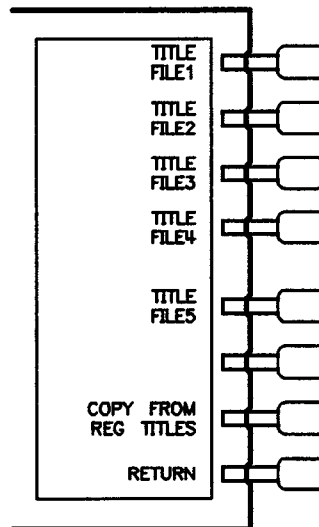
**PURGE FILE5** (PURG5) purges FILE5 from disk.

**READ FILE TITLES** (REFT) searches the directory of the disk for file names recognized as belonging to an instrument state. No more than five titles are displayed at one time. If there are more than five, repeatedly pressing this key causes the next five to be displayed. If there are fewer than five, the remaining softkey labels are blanked.

**RETURN** goes back to the define store menu.

## Title File Menu

This menu is used to select a disk file to be retitled. When the softkey for the selected file is pressed, the title menu is presented and the character set is displayed in the active entry area. The title menu is described earlier in this chapter. The same restrictions apply to file titles as to internal register titles: that is, a file title is limited to eight characters, must be all alpha numeric, and must begin with an alpha character.



*Figure 11-11. Title File Menu*

**TITLE FILE1** (TITF1) selects file 1 to be retitled, and leads to the title menu.

**TITLE FILE2** (TITF2) selects file 2 to be retitled.

**TITLE FILE3** (TITF3) selects file 3 to be retitled.

**TITLE FILE4** (TITF4) selects file 4 to be retitled.

**TITLE FILE5** (TITF5) selects file 5 to be retitled.

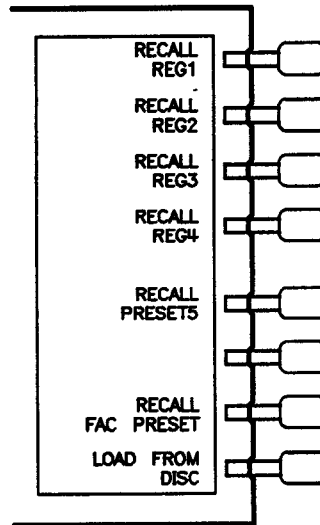
**COPY FROM REG TITLES** renames the store files to match the current names of the internal registers. (It does not alter the names of any files already stored to disk). For example, the default names of the internal registers are REG1 through REG5. The default file names of the store files are FILE1 through FILE5. Pressing this key would rename the store files REG1 through REG5. If you have modified the names of the internal save registers, the modified names would be copied to the store file names.

**RETURN** goes back to the store file menu.

## Recall Menu

This menu is used to recall instrument states from internal memory. It is also used to access the load file menu, which loads files from external disk.

When the recall menu is displayed, only the names of registers containing instrument states are displayed in the top five softkey labels. Any register that does not currently contain a saved instrument state has its softkey label blanked.



*Figure 11–12. Recall Menu*

**RECALL REG1** (RECA1) recalls the instrument state saved in register 1. The current instrument state is overwritten.

**RECALL REG2** (RECA2) recalls the instrument state saved in register 2.

**RECALL REG3** (RECA3) recalls the instrument state saved in register 3.

**RECALL REG4** (RECA4) recalls the instrument state saved in register 4.

**RECALL PRESET5** (RECA5) recalls the instrument state saved in register 5.

**LOAD FROM DISK** accesses the load file menu. Use this menu to restore instrument states previously stored to disk.

**RECALL FAC PRESET** (PRES) recalls the instrument state that conforms to defaults, factory.

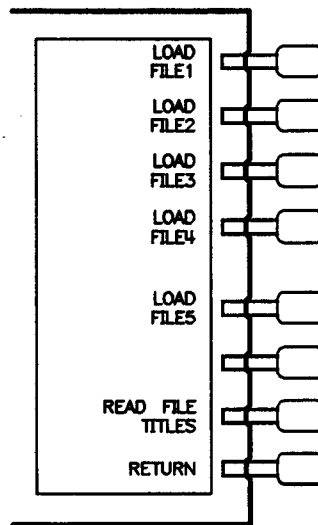
## Load File Menu

This menu (Figure 11–13) is used to search the directory of a disk and to restore instrument states previously stored to that disk.

There are three ways to locate a file on disk.

1. The analyzer remembers the names of the last five files it previously found on any disk. (File titles are stored in non–volatile memory.) Therefore, when you enter this menu, the file titles in memory will appear in the top five softkeys, whether or not they reside on the disk currently in the drive.
2. The **READ FILE TITLES** key causes the analyzer to search the directory of the current disk and display any recognized file titles.

From the store file menu, use the **TITLE FILE1** key to title a store file softkey with the name of the file you want to restore. Return to the load file menu. The title you just created will appear in one of the load file softkey labels. Press that softkey. If the file does not exist, the message “CAUTION: NO FILE(S) FOUND ON DISK” will be displayed. This method is useful if you know the exact name of the instrument state to be restored. Using **READ FILE TITLES** is a more efficient method of finding file names, unless a large number of instrument states have been stored to the disk.



*Figure 11–13. Load File Menu*

**LOAD FILE1** (LOAD1) restores the instrument state contained in FILE1. The current instrument state is overwritten.

**LOAD FILE2** (LOAD2) restores the instrument state contained in FILE2.

**LOAD FILE3** (LOAD3) restores the instrument state contained in FILE3.

**LOAD FILE4** (LOAD4) restores the instrument state contained in FILE4.

**LOAD FILES** (LOAD5) restores the instrument state contained in FILE5.

**READ FILE TITLES** (REFT) searches the directory of the disk for file names recognized as belonging to an instrument state. No more than five titles are displayed at one time. If there are more than five, repeatedly pressing this key causes the next five to be displayed. If there are fewer than five, the remaining softkey labels are blanked.

**RETURN** goes back to the recall menu.





# Chapter 12. HP-IB Remote Programming

---

## INTRODUCTION

The analyzer is factory-equipped with a remote programming digital interface using the Hewlett-Packard Interface Bus (HP-IB). (HP-IB is Hewlett-Packard's hardware, software, documentation, and support for IEEE 488.1 and IEC-625, worldwide standards for interfacing instruments.) This allows the analyzer to be controlled by an external computer that sends commands or instructions to and receives data from the analyzer using the HP-IB. In this way, a remote operator has the same control of the instrument available to a local operator from the front panel, except for control of the line power switch.

In addition, the analyzer itself can use HP-IB to directly control compatible peripherals, without the use of an external controller. It can output measurement results directly to a compatible printer or plotter, or store instrument states to a compatible disk drive.

This chapter provides an overview of HP-IB operation. Chapter 8 provides information on different controller modes, and on setting up the analyzer as a controller of peripherals. Chapters 10 and 11 explain how to use the analyzer as a controller to print, plot, and store to an external disc. In addition, HP-IB equivalent mnemonics for front panel functions are provided in parentheses throughout this *Reference*.

More complete information on programming the analyzer remotely over HP-IB is provided in the following documents:

- *BASIC Programming Guide*. This is a tutorial introduction to remote operation of the network analyzer using an HP 9000 series 200 or 300 computer. It includes examples of remote measurements using BASIC programming. The *BASIC Programming Guide* assumes familiarity with front panel operation of the instrument.
- *Quick-C Programming Guide*. This is a tutorial introduction to remote operation of the network analyzer using a DOS based personal computer. It includes examples of remote measurements using Quick-C programming.
- *HP-IB Programming Reference*. This is a complete reference summary for remote operation of the analyzer with a controller. It includes both functional and alphabetical lists of all HP-IB commands. This guide is intended for use by those familiar with HP-IB programming and the basic functions of the analyzer.

A complete general description of the HP-IB is available in *Tutorial Description of the Hewlett-Packard Interface Bus*, HP publication 5952-0156. For more information on the IEEE-488.1 standard refer to *IEEE Standard Digital Interface for Programmable Instrumentation*, published by the Institute of Electrical and Electronics Engineers, Inc., 345 East 47th Street, New York, New York 10017.

## HOW HP-IB WORKS

The HP-IB uses a party-line bus structure in which up to 15 devices can be connected on one contiguous bus. The interface consists of 16 signal lines and 8 ground lines in a shielded cable. With this cabling system, many different types of devices including instruments, computers, plotters, printers, and disk drives can be connected in parallel.

Every HP-IB device must be capable of performing one or more of the following interface functions:

### Talker

A talker is a device capable of sending device-dependent data when addressed to talk. There can be only one talker at any given time. Examples of this type of device are voltmeters, counters, and tape readers. The analyzer is a talker when it sends trace data or marker information over the bus.

### Listener

A listener is a device capable of receiving device-dependent data when addressed to listen. There can be any number of listeners at any given time. Examples of this type of device are printers, power supplies, and signal generators. The analyzer is a listener when it is controlled over the bus by a computer.

### Controller

A controller is a device capable of managing the operation of the bus and addressing talkers and listeners. There can be only one active controller at any time. Examples of controllers include desktop computers and minicomputers. In a multiple-controller system, active control can be passed between controllers, but there can only be one *system controller*, which acts as the master, and can regain active control at any time. The analyzer is an active controller when it plots, prints, or stores to an external disk drive in the pass control mode. The analyzer is a system controller when it is in the system controller mode. These modes are discussed in more detail in Chapter 8 under *HP-IB Menu*.

## HP-IB BUS STRUCTURE

### Data Bus

The data bus consists of eight bidirectional lines that are used to transfer data from one device to another. Programming commands and data are typically encoded on these lines in ASCII, although binary encoding is often used to speed up the transfer of large arrays. Both ASCII and binary data formats are available. In addition, every byte transferred over HP-IB undergoes a *handshake* to ensure valid data.

### Handshake Lines

A three-line handshake scheme coordinates the transfer of data between talkers and listeners. This technique forces data transfers to occur at the speed of the slowest device, and ensures data integrity in multiple listener transfers. With most computing controllers and instruments, the handshake is performed automatically, which makes it transparent to the programmer.

## Control Lines

The data bus also has five control lines that the controller uses both to send bus commands and to address devices.

**IFC.** Interface Clear. Only the system controller uses this line. When this line is true (low), all devices (addressed or not) unaddress and go to an idle state.

**ATN.** Attention. The active controller uses this line to define whether the information on the data bus is a *command* or is *data*. When this line is true (low), the bus is in the command mode and the data lines carry bus commands. When this line is false (high), the bus is in the data mode and the data lines carry device-dependent instructions or data.

**SRQ.** Service Request. This line is set true (low) when a device requests service: the active controller services the requesting device. The analyzer can be enabled to pull the SRQ line for a variety of reasons.

**REN.** Remote Enable. Only the system controller uses this line. When this line is set true (low), the bus is in the remote mode, and devices are addressed either to listen or to talk. When the bus is in remote and a device is addressed, it receives instructions from HP-IB rather than from its front panel (the **LOCAL** key returns the device to front panel operation). When this line is set false (high), the bus and all devices return to local operation.

**EOI.** End or Identify. This line is used by a talker to indicate the last data byte in a multiple byte transmission, or by an active controller to initiate a parallel poll sequence. The analyzer recognizes the EOI line as a terminator, and it pulls the EOI line with the last byte of a message output (data, markers, plots, prints, error messages). The analyzer does not respond to parallel poll.

Figure 12-1 illustrates the structure of the HP-IB bus lines.

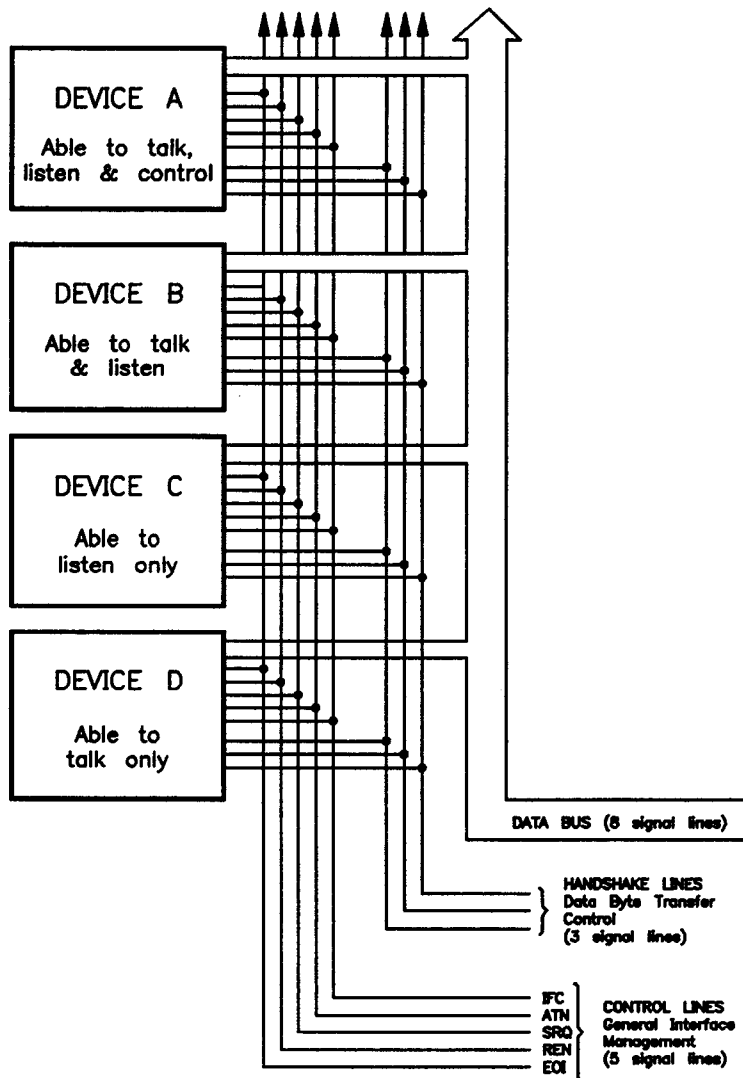


Figure 12-1. HP-IB Structure

## HP-IB REQUIREMENTS

- Number of Interconnected Devices:** 15 maximum.
- Interconnection Path/  
Maximum Cable Length** 20 metres maximum or 2 metres per device, whichever is less.
- Message Transfer Scheme:** Byte serial/bit parallel asynchronous data transfer using a 3-line handshake system.
- Data Rate:** Maximum of 1 megabyte per second over limited distances with tri-state drivers. Actual data rate depends on the transfer rate of the slowest device involved.

<b>Address Capability:</b>	Primary addresses: 31 talk, 31 talk, 31 listen. A maximum of 1 talker and 14 listeners at one time.
<b>Multiple Controller Capability:</b>	In systems with more than one controller (like the network analyzer system), only one can be active at a time. The active controller can pass control to another controller, but only the system controller can assume unconditional control. Only one system controller is allowed. The system controller is hard-wired to assume bus control after a power failure.

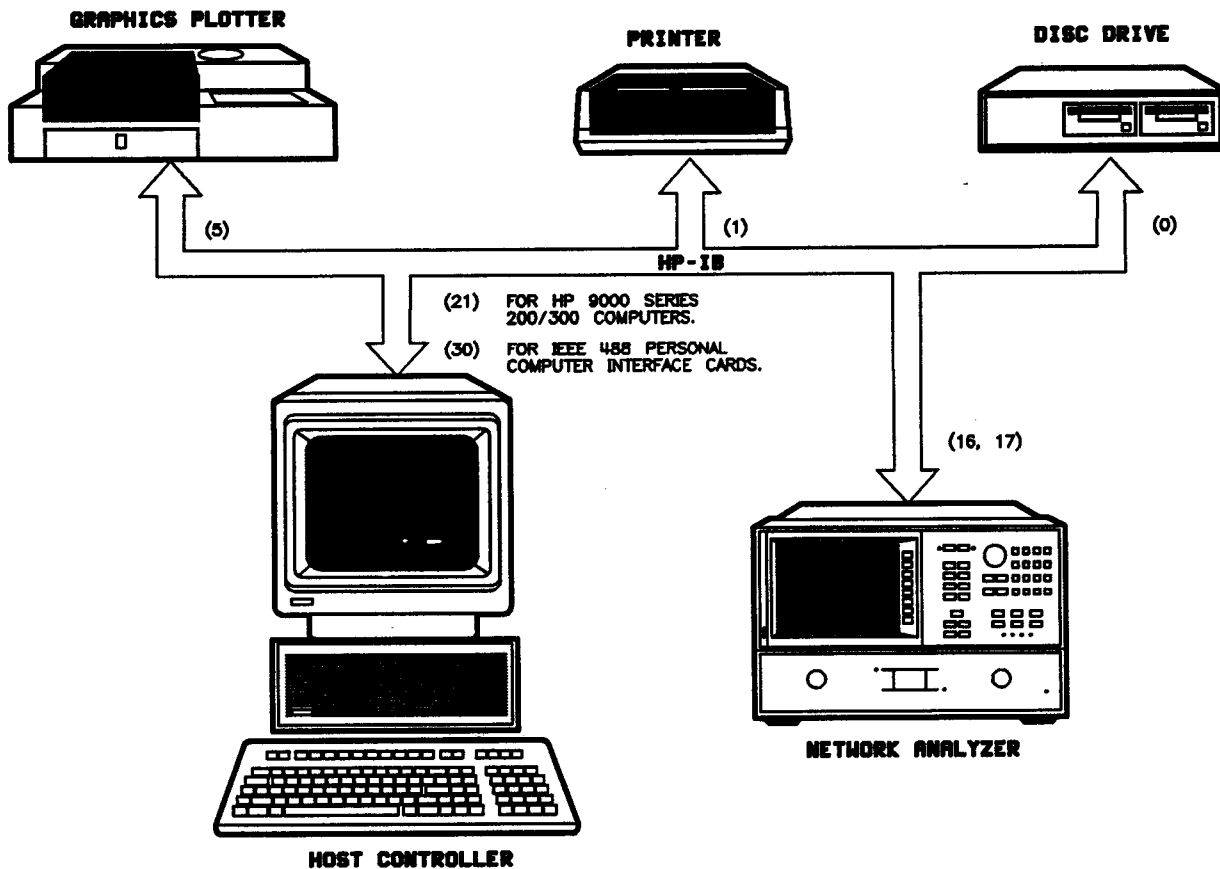
## HP-IB CAPABILITIES OF THE ANALYZER

As defined by the IEEE 488.1 standard, the analyzer has the following capabilities:

<b>SH1</b>	Full source handshake.
<b>AH1</b>	Full acceptor handshake.
<b>T6</b>	Basic talker, answers serial poll, unaddresses if MLA is issued. No talk-only mode.
<b>L4</b>	Basic listener, unaddresses if MTA is issued. No listen-only mode.
<b>SR1</b>	Complete service request (SRQ) capabilities.
<b>RL1</b>	Complete remote/local capability including local lockout.
<b>PP0</b>	Does not respond to parallel poll.
<b>DC1</b>	Complete device clear.
<b>DT1</b>	Responds to a group execute trigger in the hold trigger mode.
<b>C1,C2,C3</b>	System controller capabilities in system controller mode.
<b>C10</b>	Pass control capabilities in pass control mode.
<b>E2</b>	Tri-state drivers.

## BUS MODE

The analyzer uses a single-bus architecture. The single bus allows both the analyzer and the host controller to have complete access to the peripherals in the system.



*Figure 12-2. Analyzer Single Bus Concept*

Three different controller modes are possible, system controller, talker/listener, and pass control.

**System Controller.** This mode allows the analyzer to control peripherals directly in a stand-alone environment (without an external controller). This mode can only be selected manually from the network analyzer front panel. Use this mode for operation when no computer is connected to the analyzer. Do not use this mode for programming.

**Talker/Listener.** This is the traditional programming mode, in which the computer is involved in all peripheral access operations. Peripheral access (plotting and printing only) is also possible by addressing the analyzer to talk, addressing the peripheral to listen, and placing the HP-IB in the data mode.

**Pass Control.** This mode allows you to control the analyzer over HP-IB as with the talker/listener mode, and also allows the analyzer to take or pass control in order to plot, print, and access a disc. During the peripheral operation, the host computer is free to perform other internal tasks such as data or display manipulation (the bus is tied up by the analyzer during this time). After a task is completed, the host controller accepts control again when the analyzer returns it.

In general, use the talker/listener mode for programming the analyzer unless you desire direct peripheral access. Preset does not affect the selected bus mode, but the bus mode returns to talker/listener if power is cycled.

Chapter 8 explains the three different bus modes in detail, and provides information on setting the correct bus mode. Programming information for talker/listener mode and pass control mode is provided in the *HP-IB Programming Guide*.

## SETTING ADDRESSES

In communications through HP-IB, each instrument on the bus is identified by an HP-IB address. This address code must be different for each instrument on the bus. Refer to *Address Menu* in Chapter 8 for information on default addresses, and on setting and changing addresses. These addresses are stored in short-term non-volatile memory and are not affected when you press **PRESET** or cycle the power (although the **PRESET** key must be pressed to implement a change to the analyzer address).

## VALID CHARACTERS

The analyzer accepts ASCII letters, numbers, decimal points, +/—, semicolons, quotation marks ("), carriage returns (CR), and linefeeds (LF). Both upper and lower case are acceptable. Leading zeros, spaces, carriage returns, and unnecessary terminators are ignored, except those within a command or appendage. Carriage returns are ignored. An invalid character causes a syntax error. Syntax errors are described in more detail under in the *HP-IB Programming Guide*.

## HP-IB CODE NAMING CONVENTION

The HP-IB commands are derived from their front panel key titles (where possible), according to the naming convention below.

Convention	Key Title	For HP-IB Code Use	Example
One Word	Power Start	First Four Letters	POWE STAR
Two Words	Electrical Delay Search Right	First Three Letters of First Word First Letter of Second Word	ELED SEAR
Two Words in a Group	Marker →Center Gate→Span	First Four Letters of Both	MARKCENT GATESPAN
Three Words	Cal Kit N 50Ω Pen Num Data	First Three Letters of First Word First Letter of Second Word First Four Letters of Third Word	CALKN50 PENNDATA

Some codes require appendages (on, off, 1, 2, etc.). Codes that have no front panel equivalent are HP-IB only commands, and use a similar convention based on the common name of the function. Where possible, these codes are compatible with HP 8510 codes.

Front panel equivalent codes and HP-IB only codes are summarized in the *HP-IB Programming Reference*.

## UNITS AND TERMINATORS

The analyzer outputs data in basic units and assumes these basic units when it receives an input, unless the input is otherwise qualified. The basic units and allowable expressions follow; either upper or lower case is acceptable.

Basic Units	Allowable Expressions
Seconds	S
Milliseconds	MS
Microseconds	US
Nanoseconds	NS
Picoseconds	PS
Femtoseconds	FS
Hertz	HZ
Kilohertz	KHZ
Megahertz	MHZ
Gigahertz	GHZ
dB or dBm	DB
Volts	V

Terminators are used to indicate the end of a command to allow the analyzer to recover to the next command in the event of a syntax error. The semicolon is the recommended command terminator. The line feed (LF) character and the HP-IB EOI line can also be used as terminators. The analyzer ignores the carriage return (CR) character.

## HP-IB DEBUG MODE

An HP-IB diagnostic feature (debug mode) is available in the HP-IB menu. Activating the debug mode causes the analyzer to scroll incoming HP-IB commands across the display. Nonprintable characters are represented with a  $\pi$ . Any time the analyzer receives a syntax error, the commands halt, and a pointer  $\wedge$  indicates the misunderstood character. The *HP-IB Programming Reference* explains how to clear a syntax error.

## CRT GRAPHICS

The CRT can be used as a graphics display for displaying connection diagrams or custom instructions to an operator. The CRT accepts a subset of Hewlett-Packard Graphics Language (HP-GL) commands.



**NOTE:** The CRT occupies an additional address on the HP-IB. Determine the CRT bus address by adding 1 to the analyzer address if it is an even number, or subtracting 1 if it is an odd number. Thus the factory default CRT address for graphics is 17.



# Chapter 13. Error Messages

---

## INTRODUCTION

This section lists the error messages that may be displayed on the analyzer display or transmitted by the instrument over HP-IB. Each error message is accompanied by an explanation, and suggestions are provided to help in solving the problem. Where applicable, references are given to related sections of the Operation and Maintenance manuals.

When displayed, error messages are usually preceded with the word **CAUTION:**. That part of the error message has been omitted here for the sake of brevity. Some messages are for information only, and do not indicate an error condition. Two listings are provided: the first is in alphabetical order, and the second in numerical order.

In addition to error messages, instrument status is indicated by status notations in the left margin of the display. Examples are "\*", "msH", and "↓". Sometimes these appear in conjunction with error messages. A complete listing of status and notations and their meanings is provided in "Front and Rear Panel" in the *Reference Manual*.

## ERROR MESSAGES IN ALPHABETICAL ORDER

### 68 ADDITIONAL STANDARDS NEEDED

Error correction for the selected calibration class cannot be computed without measuring the necessary standards.

### 31 ADDRESSED TO TALK WITH NOTHING TO SAY

An enter command was sent to the analyzer without first requesting data with an appropriate output command (such as "OUTPDATA"). The analyzer has no data in the output queue to satisfy the request.

### 20 AIR FLOW RESTRICTED: CHECK FAN FILTER

An inadequate air flow condition has been detected. Clean the fan filter. For most efficient cooling, the instrument covers should be in place. If the problem persists, troubleshoot the power supply.

### 60 ANALOG INPUT OVERLOAD

The maximum input voltage level to the rear panel AUX INPUT has been exceeded.

### 37 ANOTHER SYSTEM CONTROLLER ON HP-IB

Selection of SYSTEM CONTROLLER under  LOCAL could not be accomplished because another System Controller is already connected on HP-IB.

### 83 ASCII: MISSING 'CITIFILE' statement

In reading an ASCII file from disk, the reserved word "CITIFILE" was not found.

### 84 ASCII: MISSING 'VAR' statement

In reading an ASCII file from disk, the reserved word "VAR" was not found.

### 85 ASCII: MISSING 'DATA' statement

In reading an ASCII file from disk, the reserved word "DATA" was not found.

### 86 ASCII: MISSING 'BEGIN' statement

In reading an ASCII file from disk, the reserved word "BEGIN" was not found.

## 13 AVERAGING INVALID ON NON-RATIO MEASURE

This error occurs only in single-input measurements using an auxiliary input signal or a service input. Sweep-to-sweep averaging is valid only for ratioed (S-parameter) measurements. Other noise reduction techniques are available for single input measurements. Refer to **AVG** Key in Chapter 4 for a discussion of trace smoothing and variable IF bandwidths.

## 34 BLOCK INPUT ERROR

The analyzer did not receive a complete data transmission. This is usually caused by an interruption of the bus transaction. Clear by pressing the **LOCAL** key or aborting the IO process at the controller.

## 35 BLOCK INPUT LENGTH ERROR

The length of the header received by the analyzer did not agree with the size of the internal array block. Refer to the HP-IB Programming Guide for instructions on using input commands.

## 74 CALIBRATION ABORTED

The calibration in progress was terminated due to change of the active channel.

## 63 CALIBRATION REQUIRED

A calibration set could not be found that matched the current stimulus state or measurement parameter. A calibration should be performed.

## 36 CHANGE HP-IB to SYST CTRL or PASS CTRL

A command (front panel or HP-IB) has been received that requests the network analyzer to take control of the HP-IB, but it is in TALKER/LISTENER mode. Change selection under **LOCAL**.

## 10 CONTINUOUS SWITCHING NOT ALLOWED

An instrument state is set up such that continuous switching of the transfer switch would be necessary; a "testset hold" condition has been placed on the non-active channel.

### 3 CORRECTION CONSTANTS NOT STORED

The results of a service adjustment have not been stored in the network analyzer.

### 66 CORRECTION TURNED OFF

A major change to the stimulus values has forced error correction to be turned off.

### 64 CURRENT PARAMETER NOT IN CAL SET

The measurement parameter could not be found in a calibration set. Perform a calibration for that parameter.

### 17 DEMODULATION NOT VALID

The demodulation transform can only be performed when the sweep type is CW Time.

### 39 DISK HARDWARE PROBLEM

The disk drive is properly connected, but has returned a service related error message when accessed.

### 48 DISK IS WRITE PROTECTED

The write-protect feature on a disk has been enabled.

### 40 DISK MEDIUM NOT INITIALIZED

The floppy disk must be initialized in order to store files. Perform an initialization ( **INITIALIZE DISK** under **SAVE** , **STORE TO DISK** , **DEFINE, INIT, PURGE** )

### 19 DISK MESSAGE LENGTH ERROR

The number of bytes transferred to or from the disk is inconsistent with the number specified in the previously sent disk command.

### 49 DISK WEAR-REPLACE DISK SOON

The floppy disk surface is wearing out; replace with a new disk to prevent data loss.

### 38 DISK: not on, not connected, wrong addr

The disk drive does not respond to control. Verify power to the disk drive, and check the HP-IB connection between the analyzer and the disk drive. Ensure that the disk address recognized by the network analyzer matches the HP-IB address set on the disk drive itself ( **LOCAL** ).

### 72 EXCEEDED 7 STANDARDS PER CLASS

When specifying a calibration class, an attempt has been made to exceed the maximum of 7 standards for a specific class.

### 42 FIRST CHARACTER MUST BE A LETTER

When titling a register or file, the first character must be a letter. Rename the register/file appropriately.

## **75 FORMAT NOT VALID FOR MEASUREMENT**

A conversion to Y or Z parameters has been selected, and the format selected is Smith chart or SWR. In these formats, the conversion trace value is not consistent with the graphical display.

## **14 FUNCTION NOT VALID**

The requested function is incompatible with the current instrument state.

## **46 ILLEGAL UNIT OR VOLUME NUMBER**

The disk unit or volume number set in the analyzer is not valid. Refer to the disk drive operating manual.

## **47 INITIALIZATION FAILED**

Disk initialization failed, usually due to a damaged disk.

## **32 INPUT ATTEMPTED WITHOUT SELECTING INPUT TYPE**

An "INPU" command has not been received, but an attempt to transfer data occurred.

## **56 INSTRUMENT STATE MEMORY CLEARED**

The five instrument state registers have been cleared from memory along with any calibration data or calibration kit definitions.

## **51 INSUFFICIENT MEMORY**

The last front panel or HP-IB request could not be implemented due to insufficient memory space. See the chapter on memory allocation.

## **82 INSUFFICIENT MEMORY, PWR MTR CAL OFF**

The memory allocation for power meter calibration arrays failed due to insufficient memory space. See the chapter on memory allocation.

## **2 INVALID KEY**

An undefined softkey was pressed.

## **9 LIST TABLE EMPTY**

The frequency list is empty. To implement list frequency mode, add segments to the list table.

## **18 LOW PASS MODE NOT ALLOWED**

Low pass time domain mode is allowed only with 801 points or less.

## **71 MORE SLIDES NEEDED**

At least five positions of the sliding load are required to complete the calibration.

**69 NO CALIBRATION CURRENTLY IN PROGRESS**

The **RESUME CAL SEQUENCE** softkey is not valid unless a calibration was previously in progress. Start a new calibration.

**41 NO DISK MEDIUM IN DRIVE**

No disk was found in the current disk unit. Insert a disk, or check the disk unit number stored in the analyzer.

**45 NO FILE(S) FOUND ON DISK**

No files of the type created by the analyzer store operation were found on the disk.

**5 NO IF FOUND: CHECK R INPUT LEVEL**

The first intermediate frequency (IF) for the R sampler was not detected during pretune. This signal must be present for phase lock and operation of the network analyzer.

**76 NO LIMIT LINES DISPLAYED**

Limit lines have been enabled, but the format (polar, Smith Chart) is not valid with limit line displays.

**15 NO MARKER DELTA – SPAN NOT SET**

The **MARKER – SPAN** softkey function requires that delta marker mode be turned on, with at least two markers displayed.

**70 NO SPACE FOR NEW CAL. CLEAR REGISTERS**

The amount of available memory for storing calibration arrays has been exceeded. Clear one or more save/recall registers. (**CLEAR REGISTER** under **SAVE**)

**44 NOT ENOUGH SPACE ON DISK FOR STORE**

The disk is full; purge files or replace with another disk.

**54 NO VALID MEMORY TRACE**

A request to display a memory or trace math operation has occurred, but a data trace has not been previously stored in memory. (See **DATA → MEMEMORY** under **DISPLAY**.)

**55 NO VALID STATE IN REGISTER**

A request to recall an internal register has occurred, but an instrument state has not been previously saved. (See **SAVE**)

**43 ONLY LETTERS AND NUMBERS ARE ALLOWED**

When titling a register or file, only alphanumeric characters are allowed. Rename the register/file appropriately.

#### **1 OPTIONAL FUNCTION; NOT INSTALLED**

An attempt has been made to use an optional function for which that option has not been installed.

#### **4 PHASE LOCK CAL FAILED**

The phase lock calibration procedure failed; measurement data is questionable.

#### **7 PHASE LOCK FAILURE**

One of the phase lock loops has failed.

#### **8 PHASE LOCK LOST**

One of the phase lock loops has lost lock.

#### **26 PLOTTER: not on, not connected, wrong addr**

The plotter does not respond to control. Verify power to the plotter, and check the HP-IB connection between the analyzer and the plotter. Ensure that the plotter address recognized by the network analyzer matches the HP-IB address set on the plotter itself (**LOCAL**).

#### **28 PLOTTER NOT READY-PINCH WHEELS UP**

The plotter is not ready to plot; the paper has not been properly inserted or loaded.

#### **6 POSSIBLE FALSE LOCK**

Phase lock loop may have locked onto the wrong harmonic; measurement data is questionable.

#### **78 POWER METER INVALID**

The power meter has been identified by the network analyzer as one which is incompatible with the power meter calibration procedure.

#### **79 POWER METER NOT SETTLED**

The power meter readings have not stabilized in order to continue with the power meter calibration procedure.

#### **80 POWER METER NOT FOUND**

The power meter does not respond to control. Verify AC power to the power meter, and check the HP-IB connection between the analyzer and the power meter. Ensure that the power meter address recognized by the network analyzer matches the HP-IB address set on the power meter itself (**LOCAL**).

#### **21 POWER SUPPLY HOT!**

The power supply temperature has been sensed by the post regulator test or during self test. Turn off the network analyzer immediately, and contact your Hewlett-Packard Service Center.

#### **24 PRINTER: not on, not connected, wrong addr**

The printer does not respond to control. Verify power to the printer, and check the HP-IB connection between the analyzer and the printer. Ensure that the printer address recognized by the network analyzer matches the HP-IB address set on the printer itself (**LOCAL**).



### **30 REQUESTED DATA NOT CURRENTLY AVAILABLE**

The analyzer does not currently contain the data being requested. For example, this condition occurs when error term arrays are requested and no calibration is active.

### **81 SAVE FAILED. INSUFFICIENT MEMORY**

Insufficient memory is available to save the current instrument state, which includes power meter calibration arrays, to internal memory. Reduce memory usage if possible, then repeat the measurements.

### **73 SLIDES ABORTED (MEMORY REALLOCATION)**

Insufficient memory is available for sliding load measurements. Reduce memory usage if possible, then repeat the sliding load measurements.

### **61 SOURCE PARAMETERS CHANGED**

Some of the stimulus parameters of the instrument state have been changed, due to a request to turn correction on. A calibration set for the current measurement parameter was found and activated. The instrument state was updated to match the stimulus parameters of the calibration state.

### **11 SWEEP TIME INCREASED**

Sweep time is automatically increased to compensate for other instrument state changes. Some parameter changes that cause an increase in sweep time are narrower IF bandwidth, an increase in the number of points, and a change in sweep type.

### **33 SYNTAX ERROR**

An improperly formatted or misspelled command was received over HP-IB.

### **52 SYSTEM IS NOT IN REMOTE**

The analyzer is in local mode. In this mode, it will not respond to HP-IB commands with front panel key equivalents. It will, however, respond to commands that have no such equivalents, such as status requests.

### **57 TEST PORT OVERLOAD, REDUCE POWER**

Whenever the power level at the "R" measurement sampler exceeds approximately +20 dBm, the source power level must be reduced.

### **58 TEST PORT OVERLOAD, REDUCE POWER**

Whenever the power level at the "A" measurement sampler exceeds approximately +20 dBm, the source power level must be reduced.

### **59 TEST PORT OVERLOAD, REDUCE POWER**

Whenever the power level at the "B" measurement sampler exceeds approximately +20 dBm, the source power level must be reduced.

**50 TOO MANY SEGMENTS OR POINTS**

Frequency list mode is limited to 30 segments and/or 1601 points.

**16 TRANSFORM, GATE NOT ALLOWED**

Transformation to time domain is not allowed for sweep types other than linear and CW.

**77 WRONG DISK FORMAT, INITIALIZE DISK**

The disk has not been formatted according to the Logical Interchange Format (LIF).

**ERROR MESSAGES IN NUMERICAL ORDER**

**1 OPTIONAL FUNCTION; NOT INSTALLED**

An attempt has been made to use an optional function for which that option has not been installed.

**2 INVALID KEY**

An undefined softkey was pressed.

**3 CORRECTION CONSTANTS NOT STORED**

The results of a service adjustment have not been stored in the network analyzer.

**4 PHASE LOCK CAL FAILED**

The phase lock calibration procedure failed; measurement data is questionable.

**5 NO IF FOUND: CHECK R INPUT LEVEL**

The first intermediate frequency (IF) for the R sampler was not detected during pretune. This signal must be present for phase lock and operation of the network analyzer.

**6 POSSIBLE FALSE LOCK**

Phase lock loop may have locked onto the wrong harmonic; measurement data is questionable.

**7 PHASE LOCK FAILURE**

One of the phase lock loops has failed.

**8 PHASE LOCK LOST**

One of the phase lock loops has lost lock.

**9 LIST TABLE EMPTY**

The frequency list is empty. To implement list frequency mode, add segments to the list table.

## 10 CONTINUOUS SWITCHING NOT ALLOWED

An instrument state is set up such that continuous switching of the transfer switch would be necessary; a "testset hold" condition has been placed on the non-active channel.

## 11 SWEEP TIME INCREASED

Sweep time is automatically increased to compensate for other instrument state changes. Some parameter changes that cause an increase in sweep time are narrower IF bandwidth, an increase in the number of points, and a change in sweep type.

## 13 AVERAGING INVALID ON NON-RATIO MEASURE

This error occurs only in single-input measurements using an auxiliary input signal or a service input. Sweep-to-sweep averaging is valid only for ratioed (S-parameter) measurements. Other noise reduction techniques are available for single input measurements. Refer to [AVG] Key in Chapter 4 for a discussion of trace smoothing and variable IF bandwidths.

## 14 FUNCTION NOT VALID

The requested function is incompatible with the current instrument state.

## 15 NO MARKER DELTA – SPAN NOT SET

The **MARKER → SPAN** softkey function requires that delta marker mode be turned on, with at least two markers displayed.

## 16 TRANSFORM, GATE NOT ALLOWED

Transformation to time domain is not allowed for sweep types other than linear and CW.

## 17 DEMODULATION NOT VALID

The demodulation transform can only be performed when the sweep type is CW Time.

## 18 LOW PASS MODE NOT ALLOWED

Low pass time domain mode is allowed only with 801 points or less.

## 19 DISK MESSAGE LENGTH ERROR

The number of bytes transferred to or from the disk is inconsistent with the number specified in the previously sent disk command.

## 20 AIR FLOW RESTRICTED: CHECK FAN FILTER

An inadequate air flow condition has been detected. Clean the fan filter. For most efficient cooling, the instrument covers should be in place. If the problem persists, troubleshoot the power supply.

## 21 POWER SUPPLY HOT!

The power supply temperature has been sensed by the post regulator test or during self test. Turn off the network analyzer immediately, and contact your Hewlett-Packard Service Center.

**24 PRINTER: not on, not connected, wrong addr**

The printer does not respond to control. Verify power to the printer, and check the HP-IB connection between the analyzer and the printer. Ensure that the printer address recognized by the network analyzer matches the HP-IB address set on the printer itself (**LOCAL**).

**26 PLOTTER: not on, not connected, wrong addr**

The plotter does not respond to control. Verify power to the plotter, and check the HP-IB connection between the analyzer and the plotter. Ensure that the plotter address recognized by the network analyzer matches the HP-IB address set on the plotter itself (**LOCAL**).

**28 PLOTTER NOT READY-PINCH WHEELS UP**

The plotter is not ready to plot; the paper has not been properly inserted or loaded.

**30 REQUESTED DATA NOT CURRENTLY AVAILABLE**

The analyzer does not currently contain the data being requested. For example, this condition occurs when error term arrays are requested and no calibration is active.

**31 ADDRESSED TO TALK WITH NOTHING TO SAY**

An enter command was sent to the analyzer without first requesting data with an appropriate output command (such as "OUTPDATA"). The analyzer has no data in the output queue to satisfy the request.

**32 INPUT ATTEMPTED WITHOUT SELECTING INPUT TYPE**

An "INPU" command has not been received, but an attempt to transfer data occurred.

**33 SYNTAX ERROR**

An improperly formatted or misspelled command was received over HP-IB.

**34 BLOCK INPUT ERROR**

The analyzer did not receive a complete data transmission. This is usually caused by an interruption of the bus transaction. Clear by pressing the **LOCAL** key or aborting the IO process at the controller.

**35 BLOCK INPUT LENGTH ERROR**

The length of the header received by the analyzer did not agree with the size of the internal array block. Refer to the HP-IB Programming Guide for instructions on using input commands.

**36 CHANGE HP-IB to SYST CTRL or PASS CTRL**

A command (front panel or HP-IB) has been received that requests the network analyzer to take control of the HP-IB, but it is in TALKER/LISTENER mode. Change selection under **LOCAL**.

**37 ANOTHER SYSTEM CONTROLLER ON HP-IB**

Selection of SYSTEM CONTROLLER under **[[LOCAL]]** could not be accomplished because another System Controller is already connected on HP-IB.

**38 DISK: not on, not connected, wrong addr**

The disk drive does not respond to control. Verify power to the disk drive, and check the HP-IB connection between the analyzer and the disk drive. Ensure that the disk address address recognized by the network analyzer matches the HP-IB address set on the disk drive itself (**LOCAL**).

**39 DISK HARDWARE PROBLEM**

The disk drive is properly connected, but has returned a service related error message when accessed.

**40 DISK MEDIUM NOT INITIALIZED**

The floppy disk must be initialized in order to store files. Perform an initialization (**INITIALIZE DISK** under **SAVE**, **STORE TO DISK**, **DEFINE, INIT, PURGE**).

**41 NO DISK MEDIUM IN DRIVE**

No disk was found in the current disk unit. Insert a disk, or check the disk unit number stored in the analyzer.

**42 FIRST CHARACTER MUST BE A LETTER**

When titling a register or file, the first character must be a letter. Rename the register/file appropriately.

**43 ONLY LETTERS AND NUMBERS ARE ALLOWED**

When titling a register or file, only alphanumeric characters are allowed. Rename the register/file appropriately.

**44 NOT ENOUGH SPACE ON DISK FOR STORE**

The disk is full; purge files or replace with another disk.

**45 NO FILE(S) FOUND ON DISK**

No files of the type created by the analyzer store operation were found on the disk.

**46 ILLEGAL UNIT OR VOLUME NUMBER**

The disk unit or volume number set in the analyzer is not valid. Refer to the disk drive operating manual.

**47 INITIALIZATION FAILED**

Disk initialization failed, usually due to a damaged disk.

**48 DISK IS WRITE PROTECTED**

The write-protect feature on a disk has been enabled.

**49 DISK WEAR-REPLACE DISK SOON**

The floppy disk surface is wearing out; replace with a new disk to prevent data loss.

## 50 TOO MANY SEGMENTS OR POINTS

Frequency list mode is limited to 30 segments and/or 1601 points.

## 51 INSUFFICIENT MEMORY

The last front panel or HP-IB request could not be implemented due to insufficient memory space. See the chapter on memory allocation.

## 52 SYSTEM IS NOT IN REMOTE

The analyzer is in local mode. In this mode, it will not respond to HP-IB commands with front panel key equivalents. It will, however, respond to commands that have no such equivalents, such as status requests.

## 54 NO VALID MEMORY TRACE

A request to display a memory or trace math operation has occurred, but a data trace has not been previously stored in memory. (See **DATA → MEMEMORY** under **DISPLAY**.)

## 55 NO VALID STATE IN REGISTER

A request to recall an internal register has occurred, but an instrument state has not been previously saved. (See **SAVE**.)

## 56 INSTRUMENT STATE MEMORY CLEARED

The five instrument state registers have been cleared from memory along with any calibration data or calibration kit definitions.

## 57 TEST PORT OVERLOAD, REDUCE POWER

Whenever the power level at the "R" measurement sampler exceeds approximately +20 dBm, the source power level must be reduced.

## 58 TEST PORT OVERLOAD, REDUCE POWER

Whenever the power level at the "A" measurement sampler exceeds approximately +20 dBm, the source power level must be reduced.

## 59 TEST PORT OVERLOAD, REDUCE POWER

Whenever the power level at the "B" measurement sampler exceeds approximately +20 dBm, the source power level must be reduced.

## 60 ANALOG INPUT OVERLOAD

The maximum input voltage level to the rear panel AUX INPUT has been exceeded.

## 61 SOURCE PARAMETERS CHANGED

Some of the stimulus parameters of the instrument state have been changed, due to a request to turn correction on. A calibration set for the current measurement parameter was found and activated. The instrument state was updated to match the stimulus parameters of the calibration state.

**63 CALIBRATION REQUIRED**

A calibration set could not be found that matched the current stimulus state or measurement parameter. A calibration should be performed.

**64 CURRENT PARAMETER NOT IN CAL SET**

The measurement parameter could not be found in a calibration set. Perform a calibration for that parameter.

**66 CORRECTION TURNED OFF**

A major change to the stimulus values has forced error correction to be turned off.

**68 ADDITIONAL STANDARDS NEEDED**

Error correction for the selected calibration class cannot be computed without measuring the necessary standards.

**69 NO CALIBRATION CURRENTLY IN PROGRESS**

The **RESUME CAL SEQUENCE** softkey is not valid unless a calibration was previously in progress. Start a new calibration.

**70 NO SPACE FOR NEW CAL. CLEAR REGISTERS**

The amount of available memory for storing calibration arrays has been exceeded. Clear one or more save/recall registers. (**CLEAR REGISTER** under **SAVE**)

**71 MORE SLIDES NEEDED**

At least five positions of the sliding load are required to complete the calibration.

**72 EXCEEDED 7 STANDARDS PER CLASS**

When specifying a calibration class, an attempt has been made to exceed the maximum of 7 standards for a specific class.

**73 SLIDES ABORTED (MEMORY REALLOCATION)**

Insufficient memory is available for sliding load measurements. Reduce memory usage if possible, then repeat the sliding load measurements.

**74 CALIBRATION ABORTED**

The calibration in progress was terminated due to change of the active channel.

**75 FORMAT NOT VALID FOR MEASUREMENT**

A conversion to Y or Z parameters has been selected, and the format selected is Smith chart or SWR. In these formats, the conversion trace value is not consistent with the graphical display.

**76 NO LIMIT LINES DISPLAYED**

Limit lines have been enabled, but the format (polar, Smith Chart) is not valid with limit line displays.

**77 WRONG DISK FORMAT, INITIALIZE DISK**

The disk has not been formatted according to the Logical Interchange Format (LIF).

**78 POWER METER INVALID**

The power meter has been identified by the network analyzer as one which is incompatible with the power meter calibration procedure.

**79 POWER METER NOT SETTLED**

The power meter readings have not stabilized in order to continue with the power meter calibration procedure.

**80 POWER METER NOT FOUND**

The power meter does not respond to control. Verify AC power to the power meter, and check the HP-IB connection between the analyzer and the power meter. Ensure that the power meter address recognized by the network analyzer matches the HP-IB address set on the power meter itself (**LOCAL**).

**81 SAVE FAILED. INSUFFICIENT MEMORY**

Insufficient memory is available to save the current instrument state, which includes power meter calibration arrays, to internal memory. Reduce memory usage if possible, then repeat the measurements.

**82 INSUFFICIENT MEMORY, PWR MTR CAL OFF**

The memory allocation for power meter calibration arrays failed due to insufficient memory space. See the chapter on memory allocation.

**83 ASCII: MISSING 'CITIFILE' statement**

In reading an ASCII file from disk, the reserved word "CITIFILE" was not found.

**84 ASCII: MISSING 'VAR' statement**

In reading an ASCII file from disk, the reserved word "VAR" was not found.

**85 ASCII: MISSING 'DATA' statement**

In reading an ASCII file from disk, the reserved word "DATA" was not found.

**86 ASCII: MISSING 'BEGIN' statement**

In reading an ASCII file from disk, the reserved word "BEGIN" was not found.



## Chapter 14. Instrument History

---

### INTRODUCTION

This manual applies directly to the instrument it came with, specifically to network analyzers with the serial number prefixes on the title page.

If your instrument were to have a lower serial number prefix and need additional documentation, it would be located in this section. For additional information see *Analyzers Covered by this Manual* in the *General Information* section.



### PRESET STATE

When the **RECALL** **RECALL FAC PRESET** keys are pressed, or nothing has been saved in SAVE/RECALL PRESET5, the analyzer reverts to a known state. This state is defined in Table A-1, below. There are subtle differences between the preset state and the power-up state. These differences are documented in Table A-2.

When line power is cycled, or the **RECALL** **RECALL FAC PRESET** keys are pressed, the analyzer performs a self-test routine. Upon successful completion of that routine, the instrument state is set to the following preset conditions. The same conditions are true following a "PRES;" or "RST;" command over HP-IB, although the self-test routines are not executed.

Table A-1. Preset Conditions (1 of 2)

Operating Parameter	Preset Value	Operating Parameter	Preset Value
<b>Stimulus Conditions</b>		<b>Response Conditions (Cont'd)</b>	
SWEEP TYPE	linear frequency	INTENSITY AND FOCUS	last active state
DISPLAY MODE	start/stop	MODIFY COLORS	last state
TRIGGER TYPE	continuous	IF BANDWIDTH	3000 Hz
EXTERNAL TRIGGER MODES	off	IF AVERAGING FACTOR	16: off
SWEEP TIME auto/manual	auto	SMOOTHING APERTURE	1% span; off
SWEEP TIME (auto) (HP 8719C)	100 milliseconds	PHASE OFFSET	0 degrees
auto (HP 8720C, HP 8722A)	100 milliseconds	ELECTRICAL DELAY	0 degrees (all parameters)
START FREQUENCY (standard)	.050 GHz	<b>Calibration</b>	
(option 001)	.050 000 000 GHz	CORRECTION	off
STOP FREQUENCY		CALIBRATION TYPE	none
(standard HP 8719C)	13.5100 GHz	CALIBRATION KIT	3.5 mm (8722 - 2.4 mm)
(option 001 HP 8719C)	13.510 000 000 GHz	SYSTEM Z0	50 ohms
STOP FREQUENCY		VELOCITY FACTOR	1
(standard HP 8720C)	20.0500 GHz	EXTENSIONS	off
(option 001 HP 8720C)	20.050 000 GHz	PORT 1, 2, A, B	0
STOP FREQUENCY		<b>Markers (coupled)</b>	
(standard HP 8722A)	40.050 GHz	MARKERS 1, 2, 3, 4, 5	1 GHz; all markers off
(option 001 HP 8722A)	40.050 000 000 GHz	REFERENCE MARKER	none
NUMBER OF POINTS	201	MARKER MODE	continuous
CW FREQUENCY	1 GHz	DELTA MARKER MODE	off
START TIME	0	MARKER SEARCH	off
TIME SPAN	100 milliseconds	MARKER TARGET VALUE	-3 dB
SOURCE POWER (8719C/20C)	+10 dBm	MARKER WIDTH VALUE	-3 dB; off
(8722A)	-15 dBm		
POWER RANGE (8719C/20C)		MARKER TRACKING	off
(8722A)	1		
COUPLED CHANNELS	on	MARKER STIMULUS OFFSET	0
STEP SWEEP	off	MARKER VALUE OFFSET	0
<b>Frequency List</b>		MARKER AUX OFFSET (PHASE)	0 degrees
FREQUENCY LIST	empty	MARKER STATISTICS	off
EDIT MODE	start/stop, # of points	POLAR MARKER	lin mkr
<b>Response Conditions</b>		SMITH MARKER	R+jX
PARAMETER	Channel 1: S11	MARKER COUPLING	on
	Channel 2: S21	DISPLAY MARKERS	coupled
CONVERSION	off	<b>Limit Lines</b>	
FORMAT	log magnitude	LIMIT LINES	off
DISPLAY	data	LIMIT TESTING	off
DUAL CHANNEL	off	LIMIT LIST	empty
ACTIVE CHANNEL	channel 1	EDIT MODE	upper/lower limits
FREQUENCY BLANK	disabled	STIMULUS OFFSET	0 Hz
SPLIT DISPLAY	on	AMPLITUDE OFFSET	0
BEEPER: DONE	on	LIMIT TYPE	sloping line
BEEPER: WARNING	on	BEEP FAIL	off

Table A-1. Preset Conditions (2 of 2)

Operating Parameter	Preset Value		Operating Parameter	Preset Value
<b>Time Domain</b>				
TRANSFORM	off		PLOT DATA	on
TRANSFORM TYPE	bandpass		PLOT MEMORY	on
START TRANSFORM	-1 nanosecond		PLOT GRATICULE	on
STOP TRANSFORM	4 nanoseconds		PLOT TEXT	on
GATING	off		PLOT MARKER	on
GATE SHAPE	normal		PLOT QUADRANT	full page
GATE START	-500 picoseconds		SCALE PLOT	full
GATE STOP	+500 picoseconds		PLOT SPEED	fast
DEMODULATION	off		<b>System Parameters</b>	
WINDOW	normal		HP-IB ADDRESSES	last active state
USE MEMORY	off		HP-IB MODE	last active state
			SOURCE PHASE-LOCKED LOOP	on
<b>Plot</b>	<b>Channel 1</b>	<b>Channel 2</b>	SPUR AVOIDANCE	on
PEN NUMBER:			AUX INPUT RESOLUTION	high
Data	1	2	ANALOG BUS NODE	11 (auxiliary input)
Memory	1	2	<b>External Memory Array</b>	
Graticule	3	4	(Define Store)	
Text	1	2	DATA	off
Marker	5	6	RAW DATA	off
LINE TYPE			FORMATTED DATA	off
Data, Memory	7	7	GRAPHICS	off
			<b>Service Modes</b>	
			HP-IB DIAGNOSTICS	off
			<b>Reference</b>	<b>Marker</b>
<b>Format Table</b>	<b>Scale</b>		<b>Position</b>	<b>Value</b>
				<b>Offset</b>
LOG MAGNITUDE (dB)	10.0		5.0	0.0
PHASE (degree)	90.0		5.0	0.0
GROUP DELAY (nsec)	10.0		5.0	0.0
SMITH CHART	1.00		-	0.0
POLAR	1.00		-	0.0
LINEAR MAGNITUDE	0.1		0.0	0.0
REAL	2.0		5.0	0.0
SWR	1.00		0.0	0.0

Table A-2. Power-On Conditions (versus Preset)

HP-IB MODE is talker/listener	
INTENSITY value is set to factory encoded value. The factory value can be changed by running the appropriate service routine. Refer to <i>Adjustments</i> in the <i>Service Manual</i> .	
If short term memory is lost or new firmware is installed, or <b>SYSTEM, SERVICE, PEEK/POKE, RESET MEMORY</b> is pressed prior to power-up of the instrument the following is true:	
HP-IB ADDRESSES are set to the following defaults:	
NETWORK ANALYZER .....	16
USER DISPLAY .....	17
PLOTTER .....	5
PRINTER .....	1
DISK .....	0
DISK UNIT NUMBER .....	0
DISK VOLUME NUMBER .....	0
INTERNAL REGISTER TITLES are set to defaults: REG1 through REG5	
EXTERNAL FILE TITLES (store files) are set to defaults: FILE1 through FILE5.	

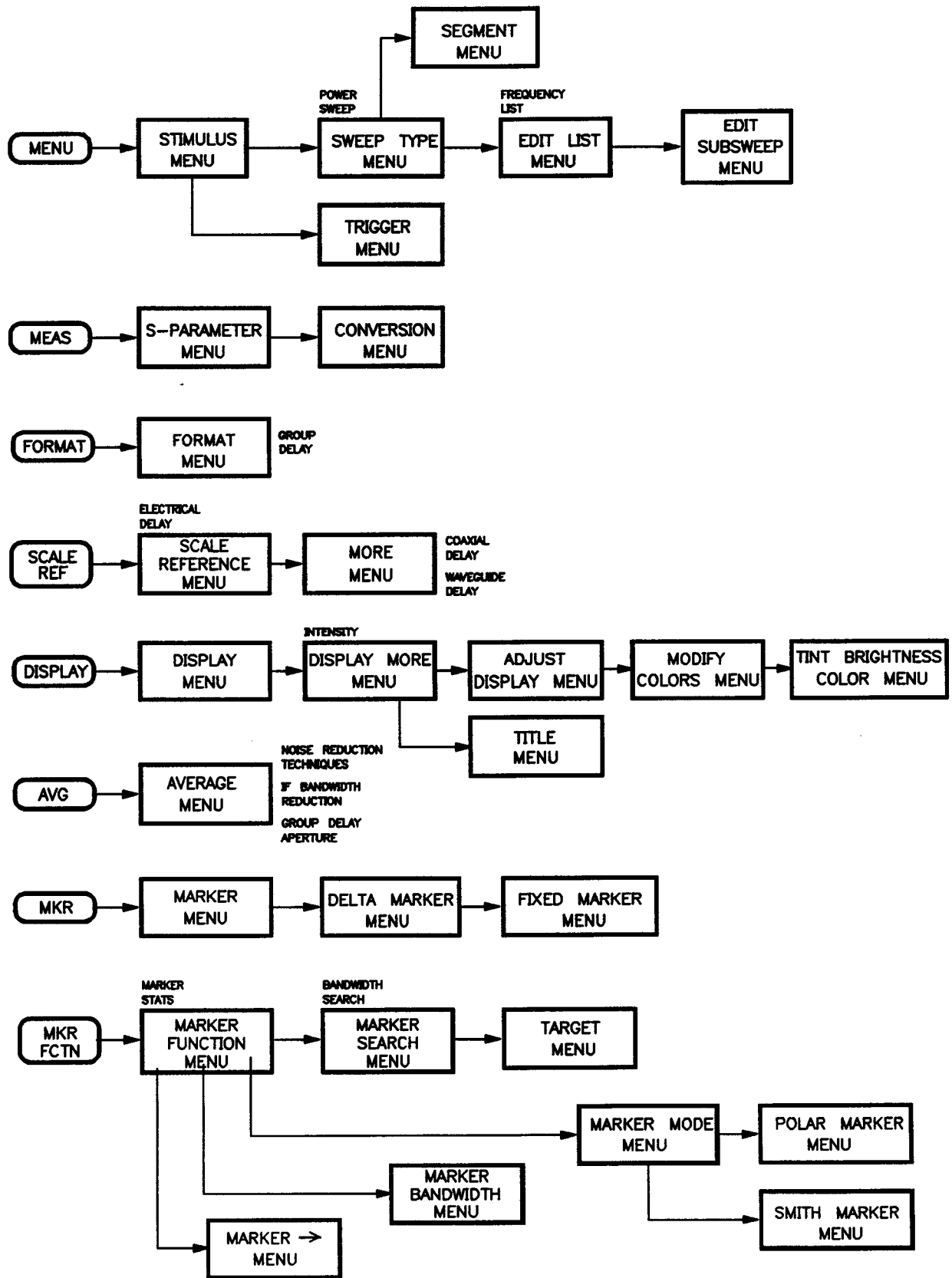


Figure A-1. Operating Softkey Menu Map (1 of 3)

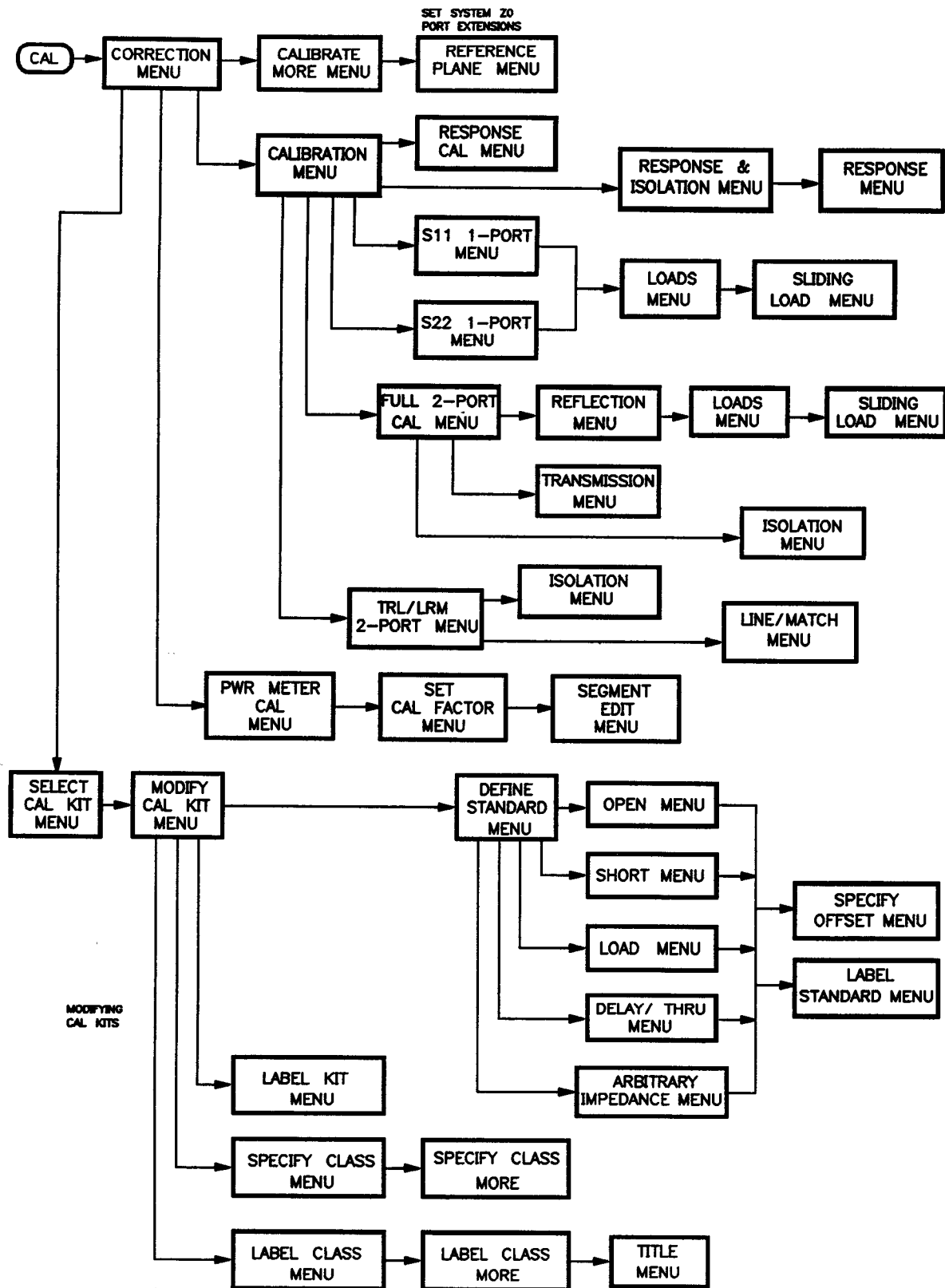


Figure A-1. Operating Softkey Menu Map (2 of 3)

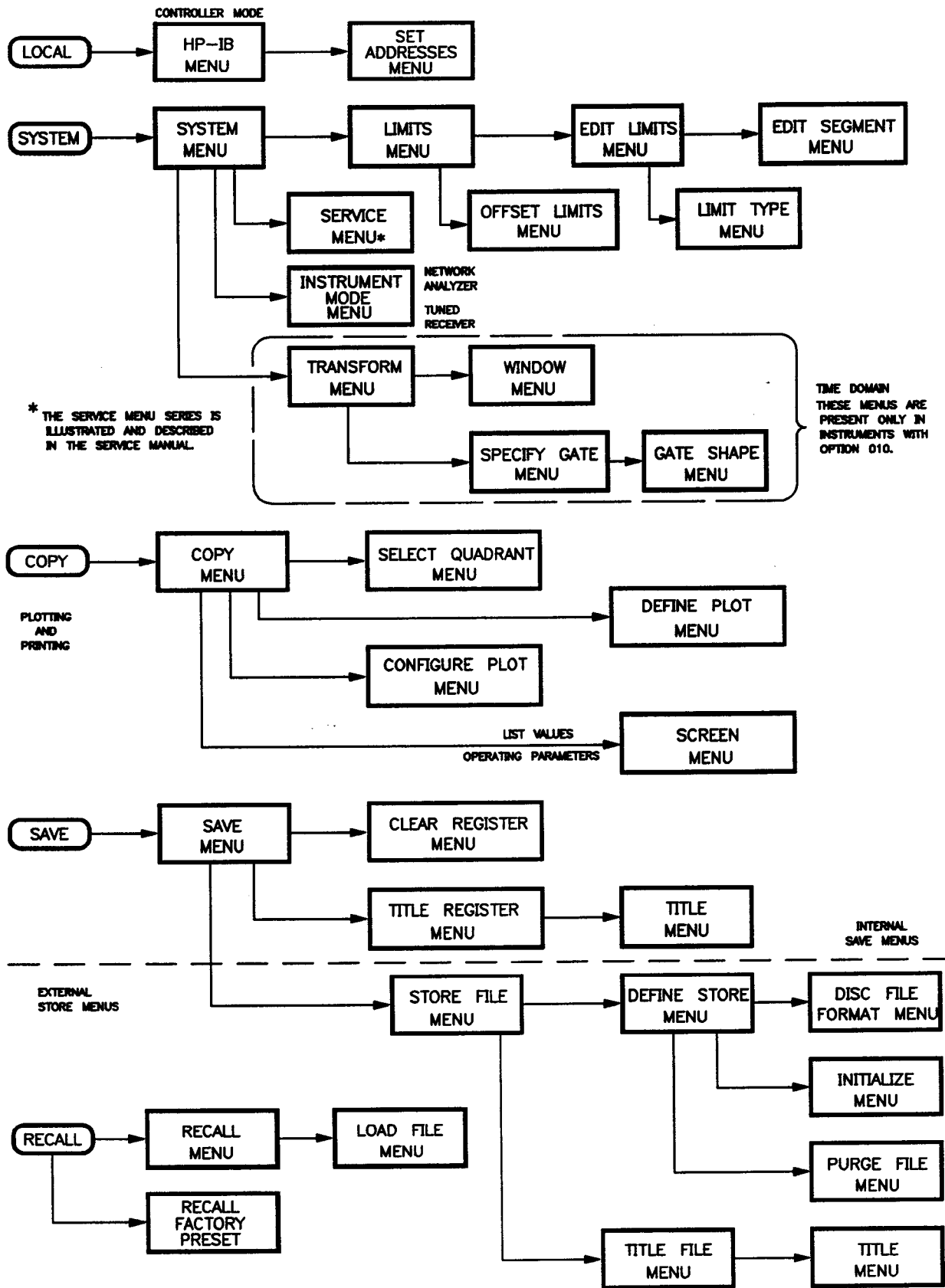


Figure A-1. Operating Softkey Menu Map (3 of 3)



# Appendix B. Accuracy Enhancement

## CHARACTERIZING MICROWAVE SYSTEMATIC ERRORS

This appendix explains how the systematic errors in a measurement can be characterized in a flow-graph model and used to reduce measurement uncertainty. These errors are directivity, source match, load match, isolation (crosstalk), and frequency response (tracking). Refer to *Sources of Measurement Errors* at the beginning of Chapter 6 for more information on each of the systematic errors.

### One-Port Error Model

First consider a measurement of the complex reflection coefficient of an unknown one-port device. The complex reflection coefficient,  $S_{11}$ , is measured by first separating the incident signal (I) from the reflected signal (R), then taking the ratio of the two values (Figure B-2). No matter how carefully the device is measured, the measured value  $S_{11M}$  will differ from the actual value  $S_{11A}$ , because of the presence of systematic errors.

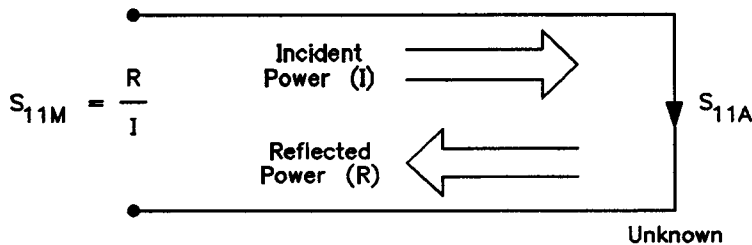


Figure B-2

In such a measurement, all of the incident signal does not always reach the unknown (see Figure B-3). Some of (I) may appear at the measurement system input due to leakage through the signal separation devices. Also, some of (I) may be reflected by imperfect adapters between signal separation and the measurement plane. The vector sum of the leakage and miscellaneous reflections is directivity,  $E_{DF}$ . The measurement is distorted when the directivity signal combines vectorally with the actual reflected signal from the unknown,  $S_{11A}$ .

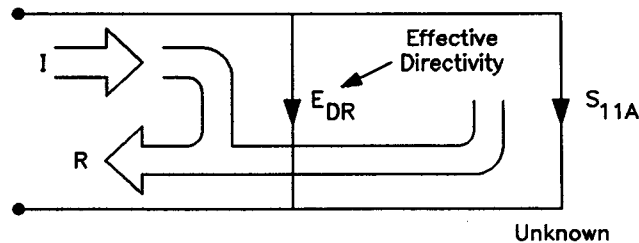


Figure B-3

Since the measurement system test port is never exactly the characteristic impedance (50 ohms), some of the reflected signal bounces off the test port, or other impedance transitions further down the line, and back to the unknown, adding to the original incident signal (I). This effect causes the magnitude and phase of the incident signal to vary as a function of  $S_{11A}$  and frequency. Leveling the source to produce constant (I) reduces this error, but since the source cannot be exactly leveled at the test device input, leveling cannot eliminate all power variations. This re-reflection effect and the resultant incident power variation are caused by the source match error,  $E_{SF}$  (Figure B-4).

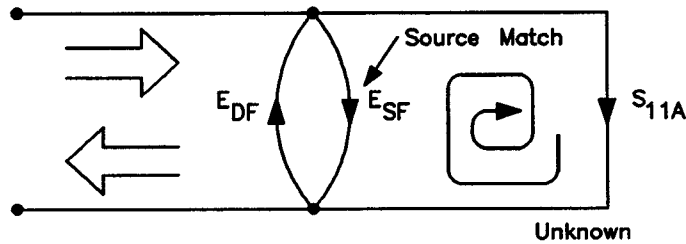


Figure B-4

Frequency response (tracking) error is caused by variations in magnitude and phase flatness versus frequency between the test and reference signal paths. These are due mainly to imperfectly matched samplers and differences in length and loss between incident and test signal paths. The vector sum of these variations is the reflection signal path tracking error,  $E_{RF}$  (Figure B-5).

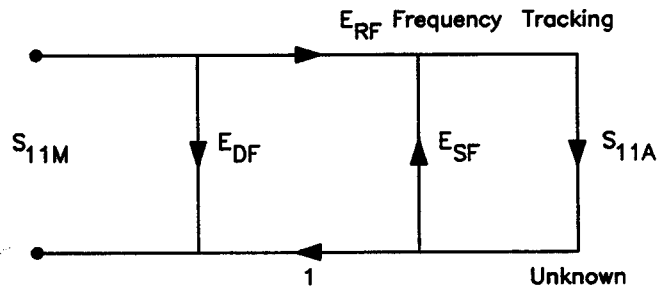


Figure B-5

These three errors are mathematically related to the actual data,  $S_{11A}$ , and measured data,  $S_{11M}$ , by the following equation:

$$S_{11M} = E_{DF} + \frac{S_{11A}(E_{RF})}{1 - E_{SF}S_{11A}}$$

If the value of these three “E” errors and the measured test device response is known, the above equation can be solved for  $S_{11A}$  to obtain the actual test device response. Measurement calibration is the process of characterizing these terms. The errors are vector quantities that can be measured by the system and used in accuracy enhancement equations to reduce or eliminate their effects.

However, each of these errors changes with frequency, and their values must be determined at each test frequency over the range of interest. These values are found by measuring the response of at least three independent standards whose characteristics are known at all frequencies.

The first standard applied is a “perfect load”, which makes  $S_{11A} = 0$  and essentially measures directivity (Figure B-6). “Perfect load” implies a reflectionless termination at the measurement plane. All incident energy is absorbed. With  $S_{11A} = 0$  the equation can be solved for  $E_{DF}$  the directivity term. In practice, of course, the “perfect load” is difficult to achieve, although the terminations in the analyzer compatible calibration kits are of a very high quality.

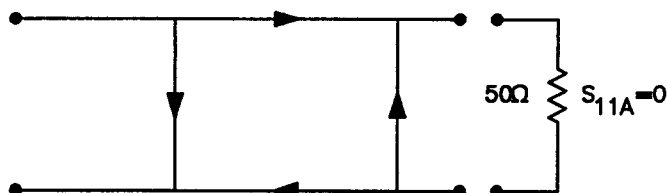


Figure B-6

In measurement calibrations with the network analyzer system, different loads are used depending on the frequency range of the measurements. At frequencies below 3 GHz in 3.5 mm (2 GHz in 7 mm or type-N) a fixed  $Z_0$  lowband load is used. For measurements of frequencies both below and above 3 GHz (2 GHz), a high quality fixed  $Z_0$  broadband load is available in the HP 85052D and 85050D calibration kits. For the highest level of accuracy (the best directivity) in calibration for measurements above 3 GHz (2 GHz), a sliding load is used. This is available in the 2.4 mm, 3.5 mm, 7 mm, and type-N calibration kits.

At any single frequency, the measured value for directivity is the vector sum of the actual directivity and the reflection coefficient  $\Gamma$  of the load (Figure B-7).

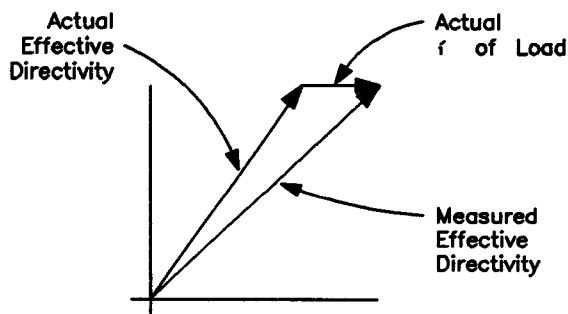


Figure B-7

At higher frequencies, the sliding load is used at each test frequency to separate the reflection of the termination from the actual effective directivity. Moving the load element with respect to the reference plane produces a change in the measured phase angle. Moving the load element one-half wavelength of the test frequency produces a complete 360° change in the phase of  $S_{11M}$ . The center of the resulting circle is the tip of the directivity vector, and its radius is the reflection coefficient of the sliding load (Figure B-8). The sliding load calibration sequence used in the accuracy enhancement program measures the sliding load at five or more positions, computes the center of the circle, then stores that value as system effective directivity  $E_{DF}$ . It is recommended that the sliding load element positions be unequally spaced to reduce the possibility of overlapping data points.

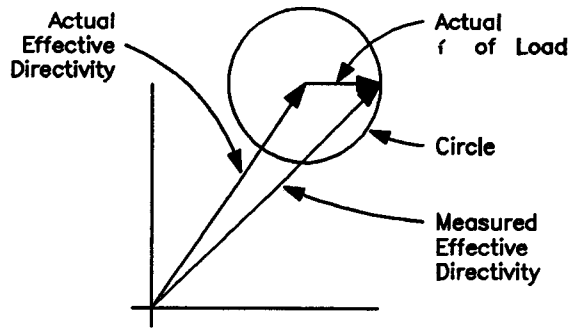


Figure B-8

After the response of the load has been measured and the directivity error term  $E_{DF}$  is known, the remaining errors can be determined by measuring two additional standards. The second standard to be measured is a short circuit with a reflection coefficient of  $1 \angle 180^\circ$  at all frequencies (Figure B-9). This establishes the first condition ( $S_{11A} = -1$ ) of a two-equation, two-unknown solution to find  $E_{SF}$  (source match) and  $E_{RF}$  (reflection tracking).

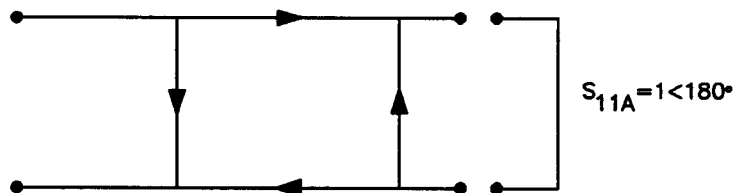


Figure B-9

The open circuit is the third independent measurement standard. It provides the second condition ( $S_{11A} = 1$ ) needed to solve the equations. An ideal open circuit would have a reflection coefficient of  $1 \angle 0^\circ$  at all frequencies. In practice, however, the reflection from a real open circuit has a magnitude near 1 and a phase response that varies with frequency, causing the apparent reference plane to shift with frequency. The open circuits in the analyzer compatible calibration kits are shielded to reduce the magnitude and phase variations with frequency (the open circuit capacitance is different with each connector type). Now the values for  $E_{DF}$  directivity,  $E_{SF}$  source match, and  $E_{RF}$  reflection frequency response, are computed and stored (Figure B-10).

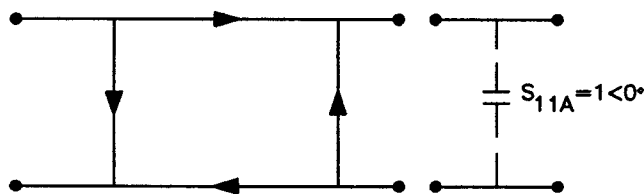


Figure B-10

Now the unknown is measured to obtain a value for the measured response,  $S_{11M}$ , at each frequency (Figure B-11).

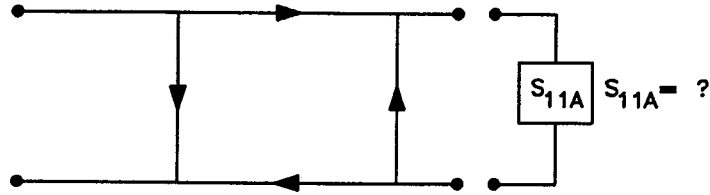


Figure B-11

This is the one-port error model equation solved for  $S_{11A}$ . Since the three errors and  $S_{11M}$  are now known for each test frequency,  $S_{11A}$  can be computed as follows:

$$S_{11A} = \frac{S_{11M} - E_{DF}}{E_{SF}(S_{11M} - E_{DF}) + E_{RF}}$$

For reflection measurements on two-port devices, the same technique can be applied, but the test device output port must be terminated in the system characteristic impedance. This termination should be at least as good (have as low a reflection coefficient) as the load used to determine directivity. The additional reflection error caused by an improper termination at the test device output port is not incorporated into the one-port error model.

## Two-Port Error Model

The error model for measurement of the transmission coefficients (magnitude and phase) of a two-port device is derived in a similar manner. The major sources of error are frequency response (tracking), source match, load match, and isolation. These errors are effectively removed using the full two-port error model.

The transmission coefficient is measured by taking the ratio of the incident signal (I) and the transmitted signal (T) (Figure B-12). Ideally, (I) consists only of power delivered by the source, and (T) consists only of power emerging at the test device output.

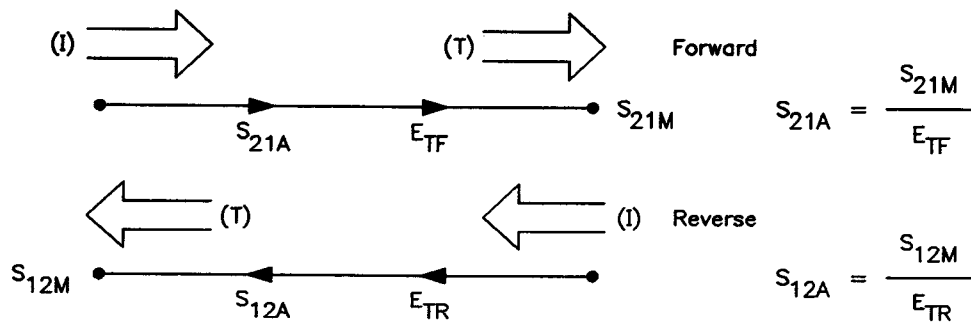


Figure B-12

As in the reflection model, source match can cause the incident signal to vary as a function of test device  $S_{11A}$ . Also, since the test setup transmission return port is never exactly the characteristic impedance, some of the transmitted signal is reflected from test port 2, and from other mismatches between the test device output and the receiver input, to return to the test device. A portion of this signal may be re-reflected at port 2, thus affecting  $S_{21M}$ , or part may be transmitted through the device in the reverse direction to appear at port 1, thus affecting  $S_{11M}$ . This error term, which causes the magnitude and phase of the transmitted signal to vary as a function of  $S_{22A}$ , is called load match,  $E_{LF}$  (Figure B-13).

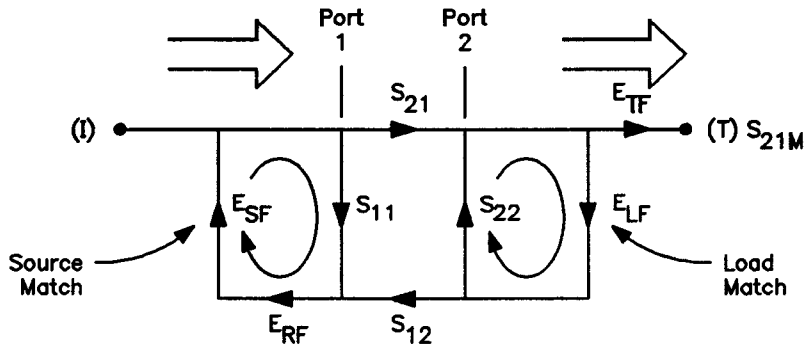


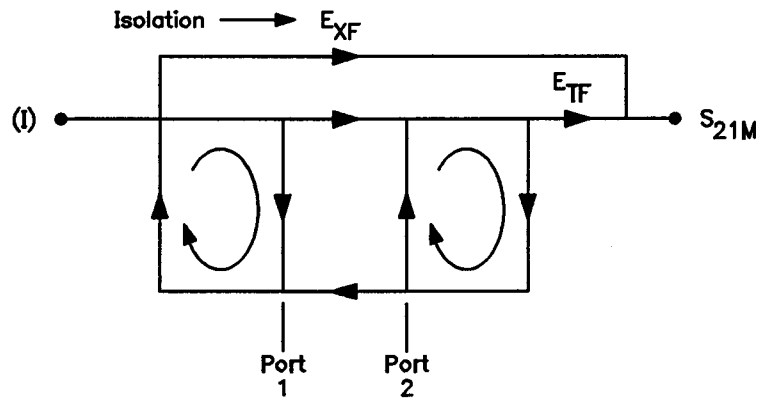
Figure B-13

The measured value,  $S_{21M}$ , consists of signal components that vary as a function of the relationship between  $E_{SF}$  and  $S_{11A}$  as well as  $E_{LF}$  and  $S_{22A}$ , so the input and output reflection coefficients of the test device must be measured and stored for use in the  $S_{21A}$  error correction computation. Thus, the test setup is calibrated as described above for reflection to establish the directivity,  $E_{DF}$ , source match,  $E_{SF}$  and reflection frequency response,  $E_{RF}$  terms for the reflection measurements.

Now that a calibrated port is available for reflection measurements, the thru is connected and load match,  $E_{LF}$  is determined by measuring the reflection coefficient of the thru connection.

Transmission signal path frequency response is then measured with the thru connected. The data is corrected for source and load match effects, then stored as transmission frequency response,  $E_{TF}$ .

Isolation,  $E_{XF}$  represents the part of the incident signal that appears at the receiver without actually passing through the test device (Figure B-14). Isolation is measured with the network analyzer in the transmission configuration and with terminations installed at the points where the test device will be connected.



**Figure B-14**

Thus there are two sets of error terms, forward and reverse, with each set consisting of six error terms, as follows:

- Directivity,  $E_{DF}$  (forward) and  $E_{DR}$  (reverse)
- Isolation,  $E_{XF}$  and  $E_{XR}$
- Source match,  $E_{SF}$  and  $E_{SR}$
- Load match,  $E_{LF}$  and  $E_{LR}$
- Transmission tracking,  $E_{TF}$  and  $E_{TR}$
- Reflection tracking,  $E_{RF}$  and  $E_{RR}$ .

The network analyzer can measure both the forward and reverse characteristics of the test device without the need to manually remove and physically reverse it. The full two-port error model illustrated in Figure B-15 effectively removes both the forward and reverse error terms for transmission and reflection measurements.

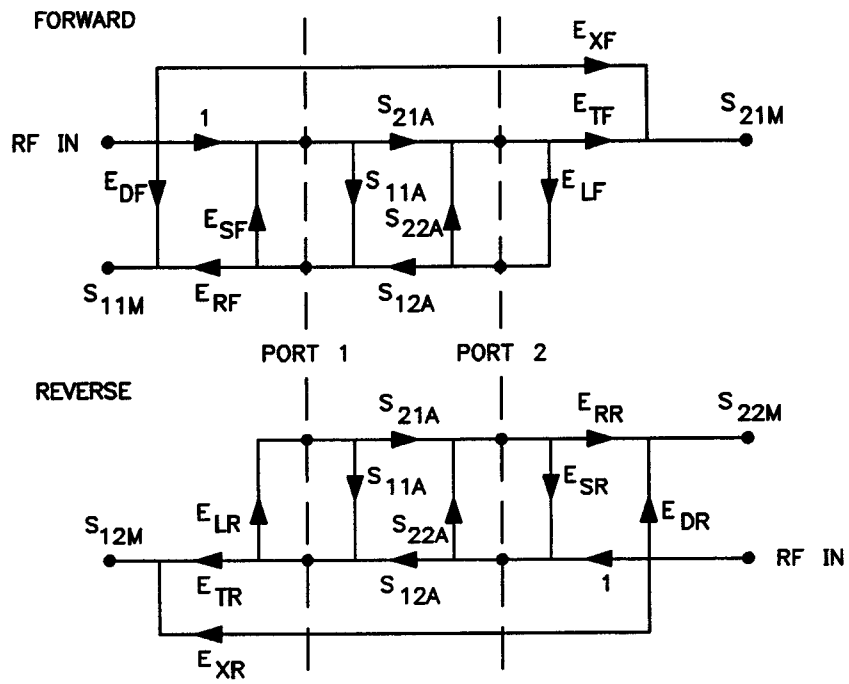


Figure B-15



Figure B-16 shows the full two-port error model equations for all four S-parameters of a two-port device. Note that the mathematics for this comprehensive model use all forward and reverse error terms and measured values. Thus, to perform full error correction for any one parameter, all four S-parameters must be measured.

Applications of these error models are provided in the calibration procedures described in Chapter 6.

$$S_{11A} = \frac{\left[\left(\frac{S_{11M}-E_{DF}}{E_{RF}}\right)\left[1 + \left(\frac{S_{22M}-E_{DR}}{E_{RR}}\right)E_{SR}\right]\right] - \left[\left(\frac{S_{21M}-E_{XF}}{E_{TF}}\right)\left(\frac{S_{12M}-E_{XR}}{E_{TR}}\right)E_{LF}\right]}{\left[1 + \left(\frac{S_{11M}-E_{DF}}{E_{RF}}\right)E_{SF}\right]\left[1 + \left(\frac{S_{22M}-E_{DR}}{E_{RR}}\right)E_{SR}\right] - \left[\left(\frac{S_{21M}-E_{XF}}{E_{TF}}\right)\left(\frac{S_{12M}-E_{XR}}{E_{TR}}\right)E_{LF}E_{LR}\right]}$$

$$S_{21A} = \frac{\left[1 + \left(\frac{S_{22M}-E_{DR}}{E_{RR}}\right)(E_{SR} - E_{LF})\right]\left(\frac{S_{21M}-E_{XF}}{E_{TF}}\right)}{\left[1 + \left(\frac{S_{11M}-E_{DF}}{E_{RF}}\right)E_{SF}\right]\left[1 + \left(\frac{S_{22M}-E_{DR}}{E_{RR}}\right)E_{SR}\right] - \left[\left(\frac{S_{21M}-E_{XF}}{E_{TF}}\right)\left(\frac{S_{12M}-E_{XR}}{E_{TR}}\right)E_{LF}E_{LR}\right]}$$

$$S_{12A} = \frac{\left[1 + \left(\frac{S_{11M}-E_{DF}}{E_{RF}}\right)(E_{RF} - E_{LR})\right]\left(\frac{S_{12M}-E_{XR}}{E_{TR}}\right)}{\left[1 + \left(\frac{S_{11M}-E_{DF}}{E_{RF}}\right)E_{SF}\right]\left[1 + \left(\frac{S_{22M}-E_{DR}}{E_{RR}}\right)E_{SR}\right] - \left[\left(\frac{S_{21M}-E_{XF}}{E_{TF}}\right)\left(\frac{S_{12M}-E_{XR}}{E_{TR}}\right)E_{LF}E_{LR}\right]}$$

$$S_{22A} = \frac{\left[\left(\frac{S_{22M}-E_{DR}}{E_{RR}}\right)\left[1 + \left(\frac{S_{11M}-E_{DF}}{E_{RF}}\right)E_{SF}\right]\right] - \left[\left(\frac{S_{21M}-E_{XF}}{E_{TF}}\right)\left(\frac{S_{12M}-E_{XR}}{E_{TR}}\right)E_{LR}\right]}{\left[1 + \left(\frac{S_{11M}-E_{DF}}{E_{RF}}\right)E_{SF}\right]\left[1 + \left(\frac{S_{22M}-E_{DR}}{E_{RR}}\right)E_{SR}\right] - \left[\left(\frac{S_{21M}-E_{XF}}{E_{TF}}\right)\left(\frac{S_{12M}-E_{XR}}{E_{TR}}\right)E_{LF}E_{LR}\right]}$$

Figure B-16



# HP 8719C/8720C/8722A/8722C Network Analyzer

## INDEX

### Symbols

- "Avg" Notation, 5-30
- "Hld" Notation, 4-7
- "tsH" Notation, 4-4, 4-6, 4-7
- \* in Table of Measured Values, 10-4
- \* Notation, 4-7

### Numbers

- 1/S Inverse S-Parameter Values, 5-7
- 1/S Softkey, 5-7
- 2.4 mm
  - Calibration Kits, 1-6
  - Verification Kits, 1-6
- 3.5 mm
  - Calibration Kits, 1-5
  - Verification Kits, 1-6
- 7 mm
  - Calibration Kits, 1-5
  - Verification Kit, 1-7

### A

- A Softkey, 5-8
- A/B Softkey, 5-8
- A/R Softkey, 5-8
- Accuracy, Notes on, 6-34
- Accuracy Enhancement, 6-1, B-1
- Accuracy Enhancements, B-1
- Active Channel, 3-3, 3-4, 3-8
- Active Entry Area, 3-8
- Active Function, 3-1
- Active Marker, 7-1
- Adapter Sets. *See* Equipment Available
- Adapters, Phase-Matched, 6-9
- ADC, 2-3
- Add Softkey, 4-12, 6-39, 8-12
- Address Controller Softkey, 8-6
- Address Disk Softkey, 8-6
- Address Instrument Softkey, 8-6
- Address Menu, 8-5, 8-6
  - Address Controller, 8-6
  - Address Disk, 8-6
  - Address Instrument, 8-6
  - Address Plotter, 8-6
  - Address Power Mtr, 8-6
  - Address Printer, 8-6
- Address Plotter Softkey, 8-6
- Address Power Mtr Softkey, 8-6
- Address Printer Softkey, 8-6
- Addresses, Setting, 12-7
- Adjust Display Menu, 5-23
  - Background Intensity, 5-23
  - Default Colors, 5-23
  - Intensity, 5-23
  - Modify Colors, 5-23
  - Save Colors, 5-23
- Adjust Display Softkey, 5-22

- Admittance Measurements, 5-11
- ALC, 2-1
- Aliasing, 9-17
- All Off Softkey, 7-3
- All Segs Sweep Softkey, 4-11
- Allocatable Memory, 11-3
- Alternate A and B Softkey, 6-16
- Alternate Sweep, 4-6
- Amplitude Offset Softkey, 8-15
- Amplitude Softkey, 9-24
- Analog Bus Softkey, 5-8
- Analyzer, description of, 1-2
- Anti-Static, 1N-8
- Arbitrary Frequency List, 4-10, 4-11
- arbitrary impedance, 6-42
- Arbitrary Impedance Softkey, 6-46
- ASCII Format, 11-17
- ASCII Softkey, 11-17
- Attenuator, 4-4
- Auto Scale Softkey, 5-17
- AUX INPUT Connector, 3-10
- Auxiliary Input Softkey, 5-6
- Auxiliary Input Voltage, 5-13
- Average Menu, 5-30
  - Averaging Factor, 5-30
  - Averaging On Off, 5-30
  - Averaging Restart, 5-30
  - IF BW, 5-31
  - Smoothing Aperture, 5-31
  - Smoothing On Off, 5-31
- Averaging, 5-27
- Averaging Factor, 5-27
- Averaging Factor Softkey, 5-30
- Averaging On Off Softkey, 5-30
- Averaging Restart Softkey, 5-30
- Averaging, Sweep-to-sweep, 2-4
- Avg. *See* Status Notations
- AVG Key, 5-27

### B

- B Softkey, 5-8
- B/R Softkey, 5-8
- Back Space Softkey, 5-26, 11-13
- Background Intensity Softkey, 5-23
- Backspace Key, 3-6
- Band-Limited Standards, 6-47
- Bandpass Mode, 9-1, 9-4, 9-18
- Bandwidth Menu, 7-10
  - Bandwidth Value, 7-10
  - BW Measure On Off, 7-10
- Bandwidth Menu Softkey, 7-9
- Bandwidth Search, 7-8, 7-9, 7-10
- Bandwidth Value Softkey, 7-10
- Bandwidth, IF, 5-27
- Basic Programming Guide, 1-1
- Beep Done On Off Softkey, 5-22

- Beep Fail on off Softkey, 8-11
- Beep Warn On Off Softkey, 5-22
- Bias Connect, 3-10
- Bias Tees, 2-2
- Binary Format, 11-16
- Block Diagram, Simplified, 2-1
- Brightness Softkey, 5-25
- Broadband Loads, 6-31
- Broadband Reflection Measurements, 6-25
- Bus Mode, 12-6
- Bus Structure, 12-2
- BW Measure On Off Softkey, 7-10

### C

- C?, 6-9
  - See also* Status Notations
- C2, 6-12
  - See also* Status Notations
- C2?. *See* Status Notations
- Cable Faults, 9-12
- Cal Factor Softkey, 6-40
- CAL Key, 6-7
- Cal Kit, 6-13
- Cal Kit [2.4 mm] Softkey, 6-14
- Cal Kit [2.92 mm] Softkey, 6-14
- Cal Kit [2.92\*] Softkey, 6-14
- Cal Kit [3.5 mm] Softkey, 6-14
- Cal Kit [7 mm] Softkey, 6-14
- Cal Kit Models, Predefined, 6-41
- Cal Power Softkey, 6-38
- Cal Z0 Line Z0 Softkey, 6-53
- Cal Z0 System Z0 Softkey, 6-53
- Calibrate Menu Softkey, 6-12
- Calibrate More Menu, 6-15
  - Alternate A and B, 6-16
  - Chop A and B, 6-16
  - Port Extensions, 6-15
  - System Z0, 6-16
  - Testset Sw Cont Hold, 6-16
  - Velocity Factor, 6-16
- Calibrate None Softkey, 6-19
- Calibrated Power Level, 6-32
- Calibration
  - 1-Port Reflection, 6-25-6-26
  - Full 2-Port Reflection and Transmission, 6-27-6-29
  - Interpolation in Power Meter, 6-32
  - Invalid, 6-10
  - Isolation, Omitting, 6-10
  - Loss of Power Meter Data, 6-32
  - Power Meter, 6-31
  - Procedures, Purpose and Use of, 6-20
  - Response
    - For Reflection Measurements, 6-21
    - For Transmission Measurements, 6-22

- Response and Isolation
    - For Reflection Measurements, 6–22
    - For Transmission Measurements, 6–24
  - TRL\*/LRM\* 2-Port, 6–29–6–31
  - Calibration Arrays, 11–6
  - Calibration Kits, 1–5
    - 2.4 mm, 1–6
    - 3.5 mm, 1–5
    - 7 mm, 1–5
  - Modifying, 6–40
  - Type-N, 1–6
  - Calibration Menu, 6–17, 6–18
    - Calibrate None, 6–19
    - Full 2-Port, 6–19
    - Response, 6–19
    - Response & Isol'n, 6–19
    - S11 1-Port, 6–19
    - S22 1-Port, 6–19
    - Set Freq Low Pass, 6–18
    - TRL/LRM 2-Port, 6–19
  - Calibration Procedures, Purpose and Use of, 6–20
  - Calibration Sets, Saving, 11–4
  - Calibration Temperature, 6–10
  - Capacitance at Microwave Frequencies, 6–7
  - Capacitance Model, 6–46
  - Cartesian Format, 5–13
  - Center and Span Keys, 4–2
  - Center Softkey, 4–14
  - Ch1 Data Limit Ln Softkey, 5–24
  - Ch1 Mem Softkey, 5–24
  - Ch2 Data Limit Ln Softkey, 5–24
  - Ch2 Mem Ref Line Softkey, 5–24
  - Change in Data as Function of Temperature, 6–10
  - Changing Channels During Calibration, 6–9
  - Characteristic Impedance, 6–13, 6–15
  - Characterizing the System, 6–1
  - Chassis Ground Connector, 3–4
  - Chop A and B Softkey, 6–16
  - CITIFile, 11–17
  - Class
    - Specify, 6–41
    - Standard, 6–41
  - Class Assignments, Standard, 6–50
  - Clear List Softkey, 4–12, 6–39
  - Clear Register Menu, 11–11
  - Clear Register Softkey, 11–10
  - Coax Softkey, 6–48
  - Coaxial Delay Softkey, 5–18
  - Coefficients, Standard, 6–41
  - Color Softkey, 5–25, 10–9
  - Compatible Sweep Types, 6–32
  - Computer, 1–10
  - Configure Plot Menu, 10–7
    - Line Type Data, 10–8
    - Line Type Memory, 10–8
    - Pen Num Data, 10–7
    - Pen Num Graticule, 10–7
    - Pen Num Marker, 10–7
    - Pen Num Memory, 10–7
    - Pen Num Text, 10–7
  - Configure Plot Softkey, 10–3
  - Connection Techniques, 6–9
  - Connector Care, 6–9
  - Connector Interface, Non-Standard, 6–41
  - Connector Sex, 6–48
  - Connector Types of Cal Kits, 6–9, 6–13
  - Connectors, 3–10
  - Continuous Softkey, 4–7, 7–12
  - Continuous Sweep, 4–9, 4–13
  - Control Lines, 12–3
    - ATN, 12–3
    - EOI, 12–3
    - IFC, 12–3
    - REN, 12–3
    - SRQ, 12–3
  - Controller, 12–2
  - Controller Modes, 8–1
  - Conversion, 2–5
  - Conversion Menu, 5–6
    - 1/S, 5–7
    - Off, 5–7
    - Y:RefI, 5–7
    - Y:Trans, 5–7
    - Z:RefI, 5–7
    - Z:Trans, 5–7
  - Conversion Softkey, 5–6
  - Copy from File Title Softkey, 11–12
  - Copy From Reg Titles Softkey, 11–20
  - Copy Key, 10–1
    - Softkey menus accessed from, 10–2
  - Copy Menu, 10–2, 10–3
    - Configure Plot, 10–3
    - Define Plot, 10–3
    - List Values, 10–3
    - Op Param [Mkrs Etc], 10–4
    - Plot, 10–3
    - Print, 10–3
    - Print/Plot Setups, 10–3
    - Select Quadrant, 10–3
  - Cor. See Status Notations
  - Cor Notation, 6–12
  - Correctable Errors, 6–2
  - Corrected Data, 11–6
  - Correcting for Measurement Errors, 6–5
  - Correction Menu, 6–12
    - Cal Kit, 6–13
    - Calibrate Menu, 6–12
    - Correction On Off, 6–12
    - Frq Subset On Off, 6–12
    - Pwr Meter Cal, 6–13
    - Receiver Cal, 6–13
    - Resume Cal Sequence, 6–13
  - Correction On Off Softkey, 6–12
  - Coupled Ch On off Softkey, 4–5
  - Coupled Parameters, 4–5
  - Couplers, 2–2
  - Coupling, Stimulus, 4–5
  - Crosstalk, 6–4
  - CRT Display, 3–3
  - CRT Graphics, 12–8
  - Cutoff Frequency of Standards, 6–47
  - CW Freq Softkey, 4–6
  - CW Frequency, 4–6
  - CW Frequency Value, 3–8
  - CW Mode, Stepped, 5–28
  - CW Softkey, 4–14
  - CW Time, 4–6, 9–22
  - CW Time Softkey, 4–10
- ## D
- Data
    - Corrected, 11–6
    - Raw (uncorrected), 11–6
  - Data → Memory Softkey, 5–21
  - Data and Memory Softkey, 5–21
  - Data Array On Off Softkey, 11–15
  - Data Arrays, 2–4
    - Raw, 2–4
  - Data Bus, 12–2
  - Data File Format Menu, 11–16
    - ASCII, 11–17
    - Format Binary, 11–16
  - Data File Format Softkey, 11–16
  - Data Point Definition, 2–3
  - Data Processing, 2–3
  - Data-Mem Softkey, 5–21
  - Data/Mem Softkey, 5–21
  - Default Colors Softkey, 5–23
  - Default Plot Setup Softkey, 10–9
  - Defile, Init, Purge Menu, 11–15
    - Data Array On Off, 11–15
    - Data File Format, 11–16
    - Format Array On Off, 11–15
    - Graphics On Off, 11–16
    - Initialize Disk, 11–16
    - Purge Files, 11–16
    - Raw Array On Off, 11–15
  - Define Plot Menu, 10–5
    - Plot Data On Off, 10–5
    - Plot Grt On Off, 10–5
    - Plot Mem On Off, 10–5
    - Plot Mkr On Off, 10–5
    - Plot Speed, 10–6
    - Plot Text On Off, 10–5
    - Scale Plot, 10–5
  - Define Plot Softkey, 10–3
  - Define Standard Menus, 6–43, 6–45
    - Arbitrary Impedance, 6–46
    - Delay/Thru, 6–46
    - Fixed, 6–46
    - Load, 6–46
    - Offset, 6–47
    - Open, 6–46
    - Short, 6–46
    - Sliding, 6–46
    - Terminal Impedance, 6–46
  - Define Standard Softkey, 6–42
  - Define, Init, Purge Softkey, 11–15
  - Del. See Status Notations
  - Delay Format, 5–10
  - Delay Range, Maximum, 5–16
  - Delay Softkey, 5–10
  - Delay, Group, 5–11, 5–14
  - Delay/Thru, 6–42
  - Delay/Thru Softkey, 6–46
  - Delete Softkey, 4–12, 6–39, 8–12
  - Delta Limits Softkey, 8–13
  - Delta Marker Mode, 7–2, 7–10

- Delta Marker Mode Menu, 7-4
  - Delta Mode Off, 7-5
  - Delta Ref = Softkeys, 7-4
  - Fixed Mkr Position, 7-5
  - Mkr Zero, 7-5
- Delta Mode Menu Softkey, 7-3
- Delta Mode Off Softkey, 7-5
- Delta Ref = Softkeys, 7-4
- Demod Off Softkey, 9-24
- Demodulating Forward Transform, 9-23
- Digital Filter, 2-4
- Digital signal processing, 1-2
- Directivity, 6-2
- Disk Catalogue, 11-5
- Disk Directory, 11-5
- Disk Drives, 1-10
- Disk File Format, 11-16
- Disk Unit Number Softkey, 8-4
- Disk Volume Number, 8-4
- Disp Mkrs On Off Softkey, 7-12
- Dispersion Effects in Waveguide, 6-47
- Display Adjustments, 5-19
- Display Data Softkey, 5-21
- Display Key, 5-19
  - Softkey Menus Accessed from, 5-19
- Display Markers, 7-1
- Display Memory, 2-5
- Display Menu, 5-19
  - Data -> Memory, 5-21
  - Data and Memory, 5-21
  - Data-Mem, 5-21
  - Data/Mem, 5-21
  - Display Data, 5-21
  - Dual Chan On Off, 5-20
  - Memory, 5-21
- Display More Menu, 5-22
  - Adjust Display, 5-22
  - Beep Done On Off, 5-22
  - Beep Warn On Off, 5-22
  - Frequency Blank, 5-22
  - Split Disp On Off, 5-22
  - Title, 5-22
- Display, Overlay, 5-7
- Done Softkey, 4-13
- Drift Errors, 6-2
- Dual Chan On Off Softkey, 5-20
- Dual Channel Display, 5-19
- Dynamic Range, Optimizing, 5-29

## E

- Edit Limit Line, 8-11
- Edit Limit Line Softkey, 8-10, 8-11
- Edit Limits Menu, 8-11
  - Add, 8-12
  - Delete, 8-12
  - Edit, 8-12
  - Limit Type, 8-12
  - Segment, 8-12
- Edit List Menu, 4-12
  - Add, 4-12
  - Clear List, 4-12
  - Delete, 4-12
  - Done, 4-13
  - Edit, 4-12

- Segment, 4-12
- Edit Segment Menu, 8-12, 8-13
  - Delta Limits, 8-13
  - Lower Limit, 8-13
  - Marker -> Middle, 8-13, 8-14
  - Marker -> Stimulus, 8-13
  - Middle Value, 8-14
  - Stimulus Value, 8-13
  - Upper Limit, 8-13
- Edit Softkey, 4-12, 6-39, 8-12
- Edit Sub sweep Menu, 4-13
  - Center, 4-14
  - CW, 4-14
  - Number of Points, 4-14
  - Segment Start, 4-14
  - Span, 4-14
  - Step Size, 4-14
  - Stop, 4-14
- Electrical Delay, 2-5, 5-16
- Electrical Delay Devices, Long, 5-28
- Electrical Delay Softkey, 5-17
- Electrical Length, 5-18
- Encoded Array, 11-2
- Entry Block, 3-3, 3-5
- Entry Off Key, 3-6
- Environmental Conditions, IN-3
- Equipment Available, 1-9
  - Adapter Sets, 1-9
    - HP 85130B, 1-9
    - HP 85130C, 1-9
    - HP 85130D, 1-9
    - HP 85130E, 1-9
    - HP 85130F, 1-9
  - Anti-Static Mat, 1-11
  - Computer, 1-10
  - Disk Drives, 1-10
  - Plotters and Printers, 1-9
  - System Rack, 1-9
  - System software, 1-10
    - Active Device Measurements Pac, 1-10
    - Measurement Automation Software, 1-11
    - Resonator Measurement Software, 1-11
- Equivalent Parallel Impedance, Admittance, 5-6
- Equivalent Series Impedance, Admittance, 5-7
- Erase Softkey, 11-13
- Erase Title Softkey, 5-26
- Error Model
  - One-Port, B-1
  - Two Port, B-5
- Error Terms, 6-5
- Errors
  - Correctable, 6-2
  - Non-Repeatable, 6-2
  - Systematic, Random, and Drift, 6-2
  - Tracking, 6-19
- ESD, IN-8, IN-9
- Example Procedure, Specifying a Cal Kit, 6-54
- Ext. See Status Notations
- EXT AM Connector, 3-10
- Ext notation, 4-8

- EXT REF INPUT Connector, 3-10
- Ext Trig On Point Softkey, 4-8
- Ext Trig On Sweep Softkey, 4-8
- EXT TRIGGER Connector, 3-10
- Extension Input A Softkey, 6-17
- Extension Input B Softkey, 6-17
- Extension Port 1 Softkey, 6-17
- Extension Port 2 Softkey, 6-17
- Extensions On Off Softkey, 6-17
- Extensions, Port, 6-15
- External Memory, 11-1
- EXTMON Connectors, 3-10

## F

- Factor List, Power Sensor Calibration, 6-33
- Factory Preset, 3-4
- Fail Beeper, 8-10
- Fan Filter, 3-10
- Fast Sweep Indicator, 3-8
- File Location on Disk, 11-22
- Fixed Marker, 7-2
- Fixed Marker Menu, 7-5, 7-6
  - Fixed Mkr Aux Value, 7-6
  - Fixed Mkr Stimulus, 7-6
  - Fixed Mkr Value, 7-6
- Fixed Mkr Aux Value, 7-6
- Fixed Mkr Position Softkey, 7-5
- Fixed Mkr Stimulus Softkey, 7-6
- Fixed Mkr Value Softkey, 7-6
- Fixed Softkey, 6-46
- Flat Line Softkey, 8-14
- Flowgraph, Signal, 5-4
- Format, 3-9
- Format Array On Off Softkey, 11-15
- Format Arrays, 2-5
- Format Binary Softkey, 11-16
- Format Key, 5-9
- Format Menu, 5-9
  - Delay, 5-10
  - Lin Mag, 5-13
  - Log Mag, 5-9
  - Phase, 5-10
  - Polar, 5-12
  - Real, 5-13
  - Smith Chart, 5-11
  - SWR, 5-13
- Formatting, 2-5
- Forward Transform, 9-22
- Forward Transform Mode, 9-1
- Forward Transform Range, 9-25
- Fourier Transform, 9-1
- Frequency Blank Softkey, 5-22
- Frequency Blanking, 5-19
- Frequency List, 4-10, 4-11
- Frequency List Calibration, 6-9
- Frequency Response (Tracking), 6-5
- Frequency Softkey, 6-40
- Frequency Span, 4-1, 4-9
- Frequency Sub sweeps, 4-14
- Front Panel Features, 3-1
- Frq Subset On Off Softkey, 6-12
- Full 2-Port Calibration, 6-27

Full 2-Port Softkey, 6-19  
Full Page Softkey, 10-4  
Full Two-Port Calibration, 6-5  
Function Blocks, 3-2  
  Instrument State, 3-2  
  Response, 3-2  
  Stimulus, 3-2  
Fwd Match Softkey, 6-51  
Fwd Trans Softkey, 6-51

## G

G + jB Mkr Softkey, 7-16  
G/n Key, 3-6  
Gat. *See* Status Notations  
Gate Shape  
  Characteristics, 9-21  
  Setting, 9-21  
Gating, 2-4, 9-20  
Graphics Array On Off Softkey, 11-16  
Graticule Text Softkey, 5-24  
Group Delay, 5-14  
Group Delay Aperture, 5-16, 5-28, 5-31  
Group Delay in Waveguide, 6-48

## H

Handshake Lines, 12-2  
Hard Copy Output, Making, 10-1  
Hardkeys, 3-1  
Harmonic Rejection, 5-28  
Heating and Cooling, IN-4  
Hewlett-Packard Interface Bus, 1-2  
Hld. *See* Status Notations  
Hold, 4-7  
Hold Softkey, 4-7  
HP 85052A 3.5 mm Cal Kit, Specifying, 6-54  
HP-IB, 1-2  
  Addresses, IN-7, 8-3, 8-5  
  Checking, IN-7  
  Bus Structure, 12-2  
  Control Lines, 12-3  
  Data Bus, 12-2  
  Handshake Lines, 12-2  
  Cable Lengths, IN-6  
  Code Naming Convention, 12-7  
  Connector, 3-10  
  Considerations, IN-6  
  Debug Mode, 12-8  
  Diagnostics, 8-4  
  How HP-IB Works, 12-2  
  HP-IB Menu, 8-2  
  Menu, 8-2, 8-3  
  Modes, System Controller,  
    Talker/Listener, Pass Control, 8-2  
  Remote Programming, 12-1  
  Requirements, 12-4  
  Status Indicators, 8-3  
  Tutorials, 12-1  
HP-IB Diag On Off Softkey, 8-4  
HP-IB Programming Reference, 1-1

## I

I/O Interconnect, 3-10

IF Bandwidth Reduction, 5-28, 5-29, 5-31  
IF BW Softkey, 5-31  
Impedance Measurements, 5-11  
Impedance Mismatch, 6-3  
Impedance, Characteristic, 6-13, 6-17  
Impedance, Terminal, of Short and Load, 6-46  
Impulse and Step Modes, 9-1  
Inductive Reactance, 5-11  
Init Disk? Yes Softkey, 11-18  
Initialize Disk Softkey, 11-16  
Initialize Menu, 11-17  
  Init Disk? Yes, 11-18  
  No, 11-18  
Initializing Disks, 11-17  
Input Ports Key, 5-6  
Input Ports Menu, 5-8  
  A, 5-8  
  A/B, 5-8  
  A/R, 5-8  
  Analog Bus, 5-8  
  B, 5-8  
  B/R, 5-8  
  R, 5-8  
  Test Set, 5-8  
Insertion Phase, 5-14  
Installation, IN-1  
Instrument Mode Menu, 8-16  
  Network Analyzer Mode, 8-16  
  Tuned Receiver Mode, 8-16  
Instrument Mode Softkey, 8-7  
Instrument Preset Condition, 3-4  
Instrument State, 3-3, 11-2  
  *See also* Function Blocks  
  Learn String, 11-2  
  Variables, 11-2  
    Stored in Volatile Memory, 11-3  
Instrument State Keys, 8-1  
Instrument States  
  Saving, 11-5  
  Storing, 11-5  
Intensity Softkey, 5-23  
Intensity, Display, 5-22  
Internal Save, 11-12  
Internal Voltage Nodes, 5-6  
Interpolated Markers, 7-12  
Interpolation in Power Meter Calibration, 6-32  
Interpreting Forward Transform, 9-23  
Invalid Calibration Data, 6-10  
Inverse S-Parameters, 5-3  
Inverted Smith Chart, 5-11  
Isolation (Crosstalk), 6-4

## K

k/m Key, 3-6  
Kit Done Softkey, 6-43  
Knob, 3-6

## L

Label Class Softkey, 6-43  
Label Kit Menu, 6-53

Label Kit Softkey, 6-43, 6-53  
Label Standard Menu (LABS), 6-48, 6-49  
LABS, 6-48  
Learn String, 11-2  
Left Lower Softkey, 10-4  
Left Upper Softkey, 10-4  
LIF, 11-17  
Limit Fail Indications, 8-10  
Limit Line Offsets Softkey, 8-11  
Limit Line on off Softkey, 8-10  
Limit Lines and Limit Testing, 8-8  
Limit Menu Softkey, 8-7  
Limit Segments, 8-11  
Limit Test on off Softkey, 8-10  
Limit Type Menu, 8-14  
  Flat Line, 8-14  
  Single Point, 8-15  
  Sloping Line, 8-14  
Limit Type Softkey, 8-12  
Limit Values, 8-11, 8-15  
Limits Menu, 8-10  
  Beep Fail on off, 8-11  
  Edit Limit Line, 8-10  
  Limit Line Offsets, 8-11  
  Limit Line on off, 8-10  
  Limit Test on off, 8-10  
Lin Freq Softkey, 4-9  
Lin Mag Softkey, 5-13  
Lin Mkr Softkey, 7-14, 7-15  
Line Stretchers, 5-17  
Line Switch, 3-3  
Line Type Data Softkey, 10-8  
Line Type Memory Softkey, 10-8  
Line Types, 10-7  
Line Voltage Selector Switch, 3-11  
Linear Frequency, 4-9  
Linear Magnitude Format, 5-13  
Linear Phase, Deviation from, 5-14, 5-18  
Linear Sweep, 4-1, 4-9  
List Freq Softkey, 4-10  
List Frequency, 4-5, 4-13, 4-14  
List Table, 4-10  
List Values Softkey, 10-3  
Listener, 12-2  
Listing Measured Data, 10-3  
Load, 6-42  
Load File Menu, 11-22  
  Read File Titles, 11-23  
Load From Disk Softkey, 11-21  
Load Match, 6-4  
Load Softkey, 6-46  
Local Key, 8-2  
  Disk Unit Number, 8-4  
  HP-IB Diag On Off, 8-4  
  HP-IB Menu, 8-2  
  HP-IB Status Indicators, 8-3  
  Set Addresses, 8-4  
  System Controller, 8-3  
  Talker/Listener, 8-4  
  Use Pass Control, 8-4  
  Volume Number, 8-5  
Log Freq Softkey, 4-9

Log Mag, 5-9  
Log Magnitude Format, 5-27  
Log Mkr Softkey, 7-14, 7-15  
Logical Interchange Format, 11-17  
Low Pass Mode, 9-1  
Lower Limit Softkey, 8-13

## M

M/u Key, 3-6  
Magnitude, 5-4  
Manual Trg On Point Softkey, 4-8  
Manual, description of, 1-2  
Marker -> Amp Offset Softkey, 8-16  
Marker -> Center Softkey, 7-11  
Marker -> Delay Softkey, 7-12  
Marker -> Menu Softkey, 7-9  
Marker -> Middle Softkey, 8-13, 8-14  
Marker -> Reference Softkey, 5-17, 7-12  
Marker -> Span Softkey, 7-11  
Marker -> Start Softkey, 7-11  
Marker -> Stimulus Softkey, 8-13  
Marker -> Stop Softkey, 7-11  
Marker 1-5 Softkeys, 7-3  
Marker Bandwidth Search, 7-2  
Marker Function Menu, 7-11  
  Marker -> Center, 7-11  
  Marker -> Delay, 7-12  
  Marker -> Reference, 7-12  
  Marker -> Span, 7-11  
  Marker -> Start, 7-11  
  Marker -> Stop, 7-11  
Marker Menu, 7-3  
  All Off, 7-3  
  Delta Mode Menu, 7-3  
  Marker 1-5 Softkeys, 7-3  
  Marker Mode Menu, 7-4  
  Mkr Zero, 7-3  
Marker Mode Menu, 7-12  
  Continuous, 7-12  
  Disp Mkrs On Off, 7-12  
  Markers Coupled, 7-12  
  Markers: Discrete, 7-12  
  Polar Mkr Menu, 7-13  
  Smith Mkr Menu, 7-13  
  Stats On Off, 7-13  
  Uncoupled, 7-13  
Marker Mode Menu Softkey, 7-9  
Marker Search, 7-2  
Marker Search Menu, 7-8  
  Bandwidth Menu, 7-9  
  Marker -> Menu, 7-9  
  Marker Mode Menu, 7-9  
  Max, 7-8  
  Min, 7-8  
  Search Off, 7-8  
  Target, 7-8  
  Tracking On Off, 7-9  
Marker Statistics, 5-29  
Marker Stats, Bandwidth, 3-9  
Marker Values, 3-9  
Markers Coupled Softkey, 7-12  
Markers: Discrete Softkey, 7-12  
Masking, 9-14

Math Capabilities, 5-3, 5-19  
Max Softkey, 7-8  
Maximum Frequency Softkey, 6-48  
Maximum Softkey, 9-16  
MEAS Key, 5-3  
  Softkey Menus Accessed from, 5-3  
Measure Restart Softkey, 5-6  
Measured Input(s), 3-8  
Measurement Accuracy, Improvements in, 6-6  
Measurement Errors, Correcting for, 6-5  
Measurement Errors, Sources of, 6-2  
Measurement Ports, 3-4  
Measurement Uncertainty, 6-2  
Mechanical Switch, Protection of, 6-27  
Memory  
  "Trace Memory", 11-6  
  Short Term, 11-2  
Memory Allocation, 11-3  
Memory Math, 5-19  
Memory Softkey, 5-21  
Memory Trace, 5-19, 5-20, 5-21  
Memory Usage, 11-2  
Menu Key, 4-2  
  Softkey Menus Accessed from, 4-3  
Message Area, 3-8  
Middle Value Softkey, 8-14  
Min Softkey, 7-8  
Minimum Frequency Softkey, 6-48  
Minimum Frequency Span, 4-2, 4-5  
Minimum Softkey, 9-16  
Mismatch Errors, 6-35  
MKR FCTN Key, 7-7  
  Menus Accessed From, 7-7  
MKR Key, 7-1, 7-2  
Mkr Mode Menu Softkey, 7-4  
Mkr Zero Softkey, 7-3, 7-5  
Modify Colors Menu, 5-24  
  Ch1 Data Limit Ln, 5-24  
  Ch1 Mem, 5-24  
  Ch2 Data Limit Ln, 5-24  
  Ch2 Mem Ref Line, 5-24  
  Graticule Text, 5-24  
  Text, 5-24  
  Warning, 5-24  
Modify Colors Softkey, 5-23  
Modify Softkey, 6-14  
Modifying Cal Kit Menu, 6-42  
  Define Standard, 6-42  
  Kit Done, 6-43  
  Label Class, 6-43  
  Label Kit, 6-43  
  Specify Class, 6-42  
  System Z0, 6-42  
  TRL\*/LRM\* Option, 6-43

## N

N50 Ohm Softkey, 6-14  
Network Analyzer Mode, 8-16  
Next Page Softkey, 10-8  
No Softkey, 11-18  
Noise Floor, Time Domain, 9-19  
Noise Reduction Techniques, 5-27  
Non-Insertable Devices, 6-9

Non-Repeatable Errors, 6-2  
Non-Reversible Devices, 6-9  
Non-volatile Memory, 11-1  
Normal Softkey, 9-16  
Normalization, 5-19  
Number of Groups Softkey, 4-4, 4-6, 4-7  
Number of Points, 4-5  
Number of Points Softkey, 4-5, 4-14  
Number of Readings Softkey, 6-38  
Numeric Keypad, 3-5

## O

Off Softkey, 5-7  
Offset and Scale Operations, 2-5  
Offset Circuit, Measured as Arc, 6-7  
Offset Delay Softkey, 6-47  
Offset Impedance, 6-48  
Offset Limits Menu, 8-15  
  Amplitude Offset, 8-15  
  Marker -> Amp Offset, 8-16  
  Stimulus Offset, 8-15  
Offset Loss Softkey, 6-48  
Offset Softkey, 6-47  
Offset Z0 Softkey, 6-48  
Offsets, Definitions, 6-43  
Omitting Isolation Calibration, 6-10  
On-Site Service, 1-4  
Op Param [Mkrs Etc] Softkey, 10-4  
Open, 6-42  
Open Circuit Capacitance, 6-46  
Open Circuit Measured as Arc, 6-7, 6-46  
Open Softkey, 6-46  
Operating Parameters Listing, 10-4  
Option 001, Frequency Compatibility, 11-5  
Option 001 Frequency Compatibility, 6-10  
Option 010, 2-1  
Options Available, 1-3  
  Option 001, 1 Hz Frequency Resolution, 1-3  
  Option 003, High Forward Dynamic Range, 1-4  
  Option 006, Solid State Transfer Switch, 1-3  
  Option 010, Time Domain, 1-3  
  Option 011, 3-Channel Direct-Access Receiver, 1-3  
  Option 802, Add Disk Drive, 1-4  
  Option 910, Extra Manuals, 1-4  
  Option 913, Rack Mount With Handles, 1-4  
  Service and Support Products, 1-4  
Output Power, 4-4

## P

Parameter Conversions, 5-6  
Pass Control, 8-2, 8-3, 12-7  
Pass/Fail, 3-9  
Pass/Fail Testing, 8-9, 8-10  
PC. See Status Notations

PC?, 6–33  
   *See also* Status Notations  
 Pen Num Data Softkey, 10–7  
 Pen Num Graticule Softkey, 10–7  
 Pen Num Marker Softkey, 10–7  
 Pen Num Memory Softkey, 10–7  
 Pen Num Text Softkey, 10–7  
 Pen Numbers, 10–7  
 Permittivity, Relative, 5–18  
 Phase, 5–4  
 Phase Limit Values, 8–12  
 Phase Offset Softkey, 5–18  
 Phase Response Measurement, 5–10  
 Phase Shift Linearity, 5–14  
 Phase Softkey, 5–10, 9–24  
 Plot Data On Off Softkey, 10–5  
 Plot Grat On Off Softkey, 10–5  
 Plot Mem On Off Softkey, 10–5  
 Plot Mkr On Off Softkey, 10–5  
 Plot Scale, 10–5  
 Plot Softkey, 10–3, 10–8  
 Plot Speed, 10–5  
 Plot Speed Softkey, 10–6  
 Plot Text On Off Softkey, 10–5  
 Plotters and Printers, 1–9  
 Plotting, 10–3  
 Plotting on Preprinted Forms, 10–5  
 Plotting on Transparencies, 10–6  
 Plotting Parameters, Default, 10–3  
 Polar Format, 5–12  
 Polar Marker Menu, 7–14  
   Lin Mkr, 7–14  
   Log Mkr, 7–14  
   Re/IM Mkr, 7–14  
 Polar Mkr Menu Softkey, 7–13  
 Polar Softkey, 5–12  
 Port Extensions Softkey, 6–15  
 Power Cord Receptacle, with Fuse,  
   3–11  
 Power Meter Calibration, 6–31  
   Main Menu, 6–38  
   Cal Power, 6–38  
   Number of Readings, 6–38  
   Pwr Mtr Cal On Off, 6–38  
   Set Cal Factor, 6–38  
   Take Cal Sweep, 6–38  
   Menus, 6–37  
   Mode Operation, 6–33  
   Performing, 6–35  
 Power Sensor Calibration Factor List,  
   6–33  
 Power Softkey, 4–4  
 power splitter, 2–2  
 Power Sweep Softkey, 4–10  
 Power–On Conditions, A–3  
 Predefined Cal Kit Models, 6–41  
 Preset Conditions, A–2  
 Preset State, A–1  
 Prev Page Softkey, 10–8  
 Print [Standard] Softkey, 10–9  
 Print Softkey, 10–3, 10–8  
 Print/Plot Controller Modes, 10–1  
 Print/Plot Setups Menu, 10–9  
   Color, 10–9

Default Plot Setup, 10–9  
 Print [Standard], 10–9  
 Print/Plot Setups Softkey, 10–3  
 Purge File Menu, 11–18  
   Read File Titles, 11–19  
 Purge Files Softkey, 11–16  
 Pwr Meter Cal Softkey, 6–13  
 Pwr Mtr Cal On Off Softkey, 6–38

## Q

Quick–C Programming Guide, 1–1

## R

R + jX Mkr Softkey, 7–15  
 R Softkey, 5–8  
 Random Errors, 6–2  
 Range, 9–17  
 Range Resolution, 9–18  
 Ratio Calculation, 2–4  
 Raw Array On Off Softkey, 11–15  
 Raw Data (uncorrected), 11–6  
 Re/IM Mkr Softkey, 7–14, 7–15  
 Reactance Values, 5–11  
 Read File Titles, 11–19  
 Read File Titles Softkey, 11–23  
 Real Format, 5–13  
 Real Softkey, 5–13  
 Recall Fac Preset Softkey, 11–21  
 Recall Key, 11–8  
 Recall Menu, 11–21  
   Load From Disk, 11–21  
   Recall Fac Preset, 11–21  
 Receiver Cal Softkey, 6–13  
 Reference Level, 3–9  
 Reference Plane Menu, 6–16, 6–17  
   Extension Input A, 6–17  
   Extension Input B, 6–17  
   Extension Port 1, 6–17  
   Extension Port 2, 6–17  
   Extensions On Off, 6–17  
 Reference Position, 5–17  
 Reference Position Softkey, 5–17  
 Reference Value, 5–17  
 Reference Value Softkey, 5–17  
 Refl: FWD S11 Softkey, 5–5  
 Refl: REV S22 Softkey, 5–5  
 Relative Permittivity, 5–18  
 relative velocity, 5–18  
 Remote Operation, 3–2  
 Reset Colors Softkey, 5–25  
 Resistance Values, 5–11  
 Resolution, 9–18  
 Response, 3–3  
   *See also* Function Blocks  
 Response & Isol'n Softkey, 6–19, 6–52  
 Response and Isolation Calibration, 6–5  
 Response Calibration, 6–5  
 Response Function Block Keys, 5–1  
 Response Resolution, 9–18  
 Response Softkey, 6–19, 6–52  
 Response Value Scale, 5–17  
 Restore Display Softkey, 10–8

Resume Cal Sequence Softkey, 6–13  
 Rev Match Softkey, 6–51  
 Rev Trans Softkey, 6–51  
 Right Lower Softkey, 10–4  
 Right Upper Softkey, 10–4  
 Rotary Pulse Generator, 3–6  
 RPG, 3–6

## S

S–Parameter Flowgraph, 3–4  
 S–Parameter Menu, 5–5  
   Auxiliary Input, 5–6  
   Conversion, 5–6  
   Input Ports Key, 5–6  
   Measure Restart, 5–6  
   Refl: FWD S11, 5–5  
   Refl: REV S22, 5–5  
   Trans: FWD S21, 5–5  
   Trans: REV S12, 5–5  
 S–Parameters, 5–3, 5–4  
 S11 1–Port Softkey, 6–19  
 S11 and S22 One–Port Calibration, 6–5  
 S11, S12, S21, S22, 5–5  
 S11B Softkey, 6–51  
 S11C Softkey, 6–51  
 S22 1–Port Softkey, 6–19  
 S22B Softkey, 6–51  
 S22C Softkey, 6–51  
 Safety Considerations, 1–11  
 Safety Warnings, 3–11  
 Sample–and–Sweep, Using, 6–36  
 Sample–and–Sweep Correction, 6–33  
 Save Colors Softkey, 5–23  
 Save Key, 11–8  
 Save Menu, 11–10  
   Clear Register, 11–10  
   Store to Disk, 11–11  
   Title Register, 11–10  
 Save User Kit Softkey, 6–14  
 Saving Instrument States, 11–1  
 Scale Plot Softkey, 10–5  
 Scale Ref Key, 5–16  
 Scale Reference Menu, 5–16, 5–17  
   Auto Scale, 5–17  
   Coaxial Delay, 5–18  
   Electrical Delay, 5–17  
   Marker → Reference, 5–17  
   Phase Offset, 5–18  
   Reference Position, 5–17  
   Reference Value, 5–17  
   Scale/Div, 5–17  
   Waveguide Delay, 5–18  
 Scale/Div, 3–9  
 Scale/Div Softkey, 5–17  
 Scattering Parameters, 5–4  
 Screen Menu, 10–8  
   Next Page, 10–8  
   Plot, 10–8  
   Prev Page, 10–8  
   Print, 10–8  
   Restore Display, 10–8  
 Search Left Softkey, 7–10  
 Search Off Softkey, 7–8  
 Search Right Softkey, 7–10



- Segment Edit Menu, 6-40
  - Cal Factor, 6-40
  - Frequency, 6-40
- Segment Menu, 4-11
  - All Segs Sweep, 4-11
  - Single Seg Sweep, 4-11
- Segment Modify Menu, 6-38
  - Add, 6-39
  - Clear List, 6-39
  - Delete, 6-39
  - Edit, 6-39
  - Segment, 6-39
  - Using, 6-39
- Segment Softkey, 4-12, 6-39, 8-12
- Segment Span, 4-13
- Segment Start Softkey, 4-14
- Segments, 4-14
- Select Cal Kit Menu, 6-13, 6-14
  - Cal Kit [2.4 mm], 6-14
  - Cal Kit [2.92 mm], 6-14
  - Cal Kit [2.92\*], 6-14
  - Cal Kit [3.5 mm], 6-14
  - Cal Kit [7 mm], 6-14
  - Modify, 6-14
  - N50 Ohm, 6-14
  - Save User Kit, 6-14
  - TRL, 6-14
  - User Kit, 6-14
- Select Letter Softkey, 5-26, 11-13
- Select Quadrant Menu, 10-4
  - Full Page, 10-4
  - Left Lower, 10-4
  - Left Upper, 10-4
  - Right Lower, 10-4
  - Right Upper, 10-4
- Select Quadrant Softkey, 10-3
- Serial Number Plate, 3-10
- Service and Support Products, 1-4
  - System On-Site Service, 1-4
- Service Menu Softkey, 8-7
- Set Addresses Softkey, 8-4
- Set Cal Factor Softkey, 6-38
- Set Freq Low Pass Softkey, 6-18
- Set Ref Reflect Softkey, 6-53
- Set Ref Thru Softkey, 6-53
- Short, 6-42
- Short Softkey, 6-46
- Short-Term Memory, 11-2
- Signal Purity, 4-10
- Signal Separation, 2-2
- Single Point Softkey, 8-15
- Single Seg Sweep Softkey, 4-11
- Single Softkey, 4-7
- Sliding Softkey, 6-46
- Sloping Line Softkey, 8-14
- Smith Chart Format, 5-11, 5-12
- Smith Chart Softkey, 5-11
- Smith Marker Menu, 7-15
  - G + jB Mkr, 7-16
  - Lin Mkr, 7-15
  - Log Mkr, 7-15
  - R + jX Mkr, 7-15
  - Re/IM Mkr, 7-15
- Smith Mkr Menu Softkey, 7-13
- Smo. See Status Notations
- Smoothing, 2-5, 5-27, 5-28
- Smoothing Aperture, 5-31
- Smoothing Aperture Softkey, 5-31
- Smoothing On Off Softkey, 5-31
- Softkey Labels, 3-9
- Softkey Menus, 3-1
- Softkeys, 3-1, 3-3
- Source Match, 6-3
- Space Requirements, IN-4
- Space Softkey, 5-26, 11-13
- Span Rule, 4-1
- Span Softkey, 4-14
- Specify Class Menus, 6-50, 6-51
  - Fwd Match, 6-51
  - Fwd Trans, 6-51
  - Resonse & Isol'n, 6-52
  - Response, 6-52
  - Rev Match, 6-51
  - Rev Trans, 6-51
  - S11B, 6-51
  - S11C, 6-51
  - S22B, 6-51
  - S22C, 6-51
  - Specify S11A, 6-51
  - Specify S22A, 6-51
  - Specify Trl\* Thru, 6-52
  - Trl\* Line or Match, 6-52
  - Trl\* Reflect, 6-52
- Specify Class Softkey, 6-42
- Specify Offset Menu, 6-47
  - Coax, 6-48
  - Maximum Frequency, 6-48
  - Minimum Frequency, 6-48
  - Offset Delay, 6-47
  - Offset Loss, 6-48
  - Offset Z0, 6-48
  - Waveguide, 6-48
- Specify S11A Softkey, 6-51
- Specify S22A Softkey, 6-51
- Specify Trl\* Thru Softkey, 6-52
- Split Disp On Off Softkey, 5-22
- Standard
  - Class, 6-41
  - Coefficients, 6-41
  - Physical Device, 6-41
  - Type, 6-41
- Standards
  - Define, 6-41
  - Select, 6-41
  - Unused, Elimination of, 6-41
- Start and Stop Hardkeys, 4-1
- Static Symbol, IN-9
- Static-Free, IN-8
- Stats On Off, 7-13
- Status Notations, 3-8
  - Avg, 3-8
  - C?, 3-8
  - C2, 3-8
  - C2?, 3-8
  - Cor, 3-8
  - Del, 3-8
  - Ext, 3-8
  - Gat, 3-8
  - Hld, 3-8
  - PC, 3-8
  - PC?, 3-8
- Smo, 3-8
- tsH, 3-8
- Step and Impulse, 9-11
- Step Keys, 3-6
- Step Size Softkey, 4-14
- Step Swp On Off Softkey, 4-10
  - Edit List Softkey, 4-10
- Stepped CW Mode, 5-28
- Stimulus, 3-3
  - See also Function Blocks
- Stimulus Coupled Mode, 4-5
- Stimulus Function Block Keys, 4-1
- Stimulus Menu, 4-4
  - Coupled Ch On off, 4-5
  - CW Freq, 4-6
  - Number of Points, 4-5
  - Power, 4-4
  - Sweep Time [Auto], 4-5
  - Sweep Time [Manual], 4-4
  - Sweep Type Menu, 4-6
  - Trigger Menu, 4-5
- Stimulus Offset Softkey, 8-15
- Stimulus Parameters, 6-34
- Stimulus Start Value, 3-7
- Stimulus Stop Value, 3-7
- Stimulus Value Softkey, 8-13
- Stop Softkey, 4-14
- Store File Menu, 11-14
  - Define, Init, Purge, 11-15
- Store to Disk Softkey, 11-11
- Sweep Rate, 4-9
- Sweep Repetition Rate, 4-5
- Sweep Speed Indicator, 4-8
- Sweep Time, 4-9
- Sweep Time [Auto] Softkey, 4-5
- Sweep Time [Manual] Softkey, 4-4
- Sweep Type Menu, 4-9
  - CW Time, 4-10
  - Edit List, 4-10
  - Lin Freq, 4-9
  - List Freq, 4-10
  - Log Freq, 4-9
  - Power Sweep, 4-10
  - Step Swp On Off, 4-10
- Sweep Type Menu Softkey, 4-6
- Sweep Types, Four Basic, 4-9
- Sweep-to-Sweep Averaging, 2-4, 5-28, 5-29
- Switching in 2-Port Cal, 6-27
- SWR Format, 5-13
- SWR Softkey, 5-13
- System Characteristic Impedance, 6-17
- System Controller, 8-2, 12-6
- System Controller Mode, 6-33
- System Controller softkey, 8-3
- System Description, 2-1
- System key, 8-7
  - Installment Mode, 8-7
  - Limit Menu, 8-7
  - Service Menu, 8-7
  - Transform Menu, 8-7
- System menu, 8-7
- System Rack, 1-9
- System Software. See Equipment Available

System Z0 Softkey, 6-16, 6-42  
Systematic Errors, 6-2, 6-41  
Microwave, B-1

## T

Take Cal Sweep Softkey, 6-38  
Talker, 12-2  
Talker/Listener, 8-2, 12-6  
Talker/Listener Softkey, 8-4  
Target Menu, 7-9  
  Search Left, 7-10  
  Search Right, 7-10  
Target Softkey, 7-8, 7-9  
TDR, 9-1  
Temperature  
  Calibration at, 6-10  
  Change in Data as a Function of, 6-10  
  Change of Data with, 11-7  
  Ranges, Allowable, 6-10  
Terminal Impedance of Short and Load,  
  6-46  
Terminal Impedance Softkey, 6-46  
Test Port Overload, 4-4  
Test Port Reference Plane, 6-13, 6-15  
Test Port Return Cables, 1-7  
Test Set Hold, 4-4, 5-20  
Test Set Softkey, 5-8  
Testset Sw Cont Hold Softkey, 6-16  
Text Softkey, 5-24  
Time Domain, 9-1-9-21  
  Bandpass, 9-4  
  Reflection Measurements, 9-4  
  Transmission Measurements, 9-6  
  Gate Shape Characteristics, 9-21  
  Gating, 9-20  
  Low Pass, 9-7  
  Fault Location Measurements, 9-11  
  Frequency Range, Setting, 9-7  
  Reflection Measurements, 9-8  
  Transmission Measurements, 9-12  
  Masking, 9-14  
  Range, 9-17  
  Resolution, 9-18  
  Range Resolution, 9-19  
  Response Resolution, 9-18  
  Windowing, 9-15  
Time Domain Retrofit Kit, 9-1  
Time/Frequency Transforms, 9-1  
Tint Brightness Color Menu, 5-25  
  Reset Colors, 5-25  
Tint Softkey, 5-25  
Title, 3-8  
Title File Menu, 11-19  
  Copy From Reg Titles, 11-20  
Title Menu, 5-26, 11-13  
  Back Space, 5-26, 11-13  
  Erase Title, 5-26, 11-13  
  Select Letter, 5-26, 11-13  
  Space, 5-26, 11-13  
Title Register Menu, 11-12  
  Copy from File Title, 11-12  
Title Register Softkey, 11-10  
Title Softkey, 5-22  
Torque Wrenches, 6-9  
Trace Math, 2-4

Tracking, 6-5  
Tracking Errors, 6-19  
Tracking On Off Softkey, 7-9  
Trans: FWD S21 Softkey, 5-5  
Trans: REV S12 Softkey, 5-5  
Transfer Switch, 2-2  
Transform, 2-5  
Transform Menu Softkey, 8-7  
Transit Time, 5-14  
Trigger Menu, 4-7  
  Continuous, 4-7  
  Ext Trig On Point, 4-8  
  Ext Trig On Sweep, 4-8  
  Hold, 4-7  
  Manual Trg On Point, 4-8  
  Number of Groups, 4-7  
  Single, 4-7  
  Trigger: Trig Off, 4-8  
Trigger Menu Softkey, 4-5  
Trigger: Trig Off Softkey, 4-8  
TRL Softkey, 6-14  
Tri\* Line or Match Softkey, 6-52  
Tri\* Reflect Softkey, 6-52  
TRL\*/LRM\* 2-Port Calibration, 6-5  
Tri\*/Lrm\* Option Menus, 6-53  
  Cal Z0 Line Z0, 6-53  
  Cal Z0 System Z0, 6-53  
  Set Ref Reflect, 6-53  
  Set Ref Thru, 6-53  
TRL\*/LRM\* Option Softkey, 6-43  
TRL\*/LRM\* Procedure, 6-30  
TRL/LRM 2-Port Softkey, 6-19  
tsH. See Status Notations  
Tuned Receiver Mode, 8-16  
Type, Standard, 6-41  
Type-N  
  Calibration Kits, 1-6  
  Verification Kit, 1-7

## U

Uncertainty, 6-1  
Uncoupled Softkey, 7-13  
Units Terminator Keys, 3-5  
Unused Standards, Elimination of, 6-41  
Upper Limit Softkey, 8-13  
Use Memory On Off Softkey, 9-16  
Use Pass Control Softkey, 8-4  
User Kit Softkey, 6-14  
User Preset Key, 3-4  
User's Guide, 1-1

## V

Valid Characters, 12-7  
Vector Accuracy Enhancement, 6-1  
Vector Error Correction, 2-4  
Vector Error Correction, Complete, 6-25  
Velocity Factor Softkey, 6-16  
Verification Kits, 1-6  
  2.4 mm, 1-6  
  3.5 mm, 1-6  
  7 mm, 1-7  
  Type-N, 1-7  
Verify Performance, 6-53

Volatile Memory, 11-1  
Voltage Nodes, Internal, 5-6  
Volume Number, 8-5  
Volume Number Softkey, 8-5

## W

Warning Beeper, 5-22  
Warning Softkey, 5-24  
Waveguide Delay Softkey, 5-18  
Waveguide Softkey, 6-48  
Windowing, 9-15

## X

x1 Key, 3-6

## Y

Y:RefI Softkey, 5-7  
Y:Trans Softkey, 5-7  
Y-Parameter Conversion, 5-3, 5-6

## Z

Z:RefI Softkey, 5-7  
Z:Trans Softkey, 5-7  
Z-Parameter Conversion, 5-3, 5-6  
Z0, 6-16