

HP 8902A Measuring Receiver

Basic Operation and Application Guide

HP 8902A Operation Made Easy!

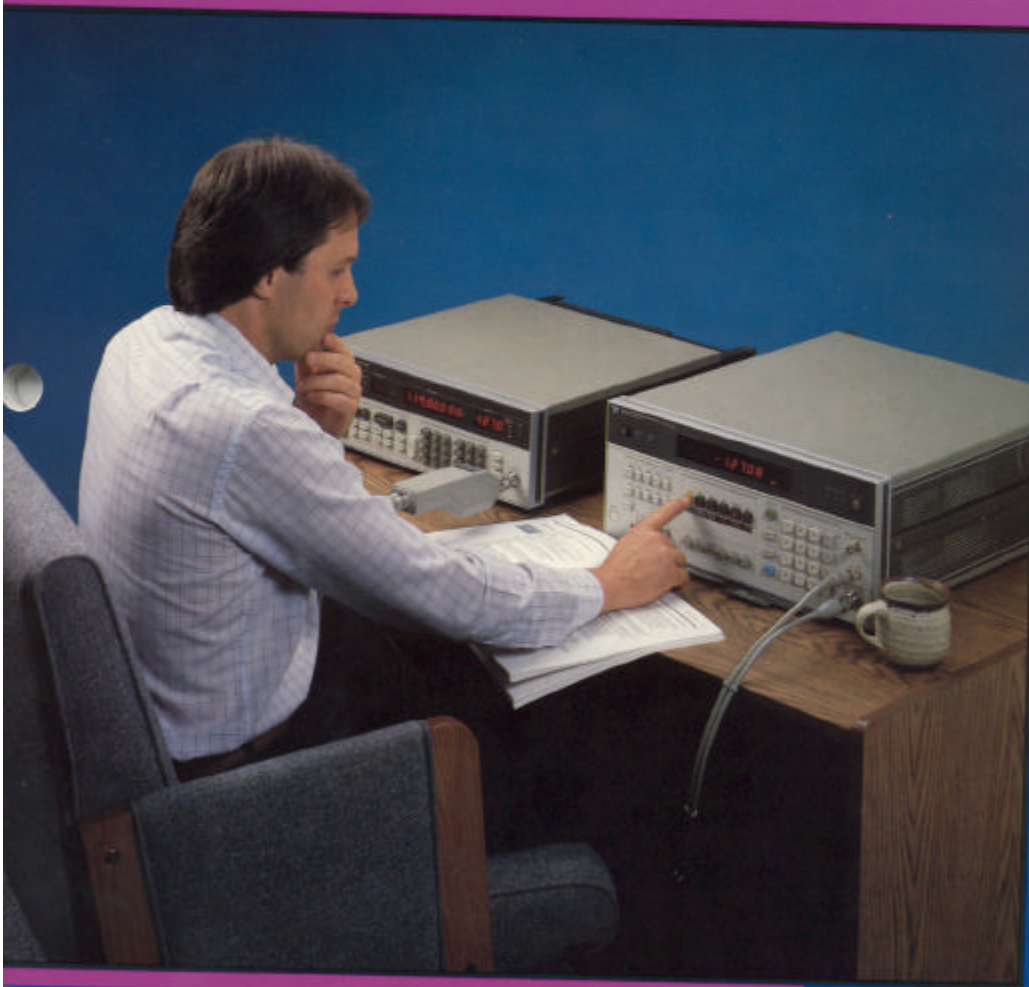

Table of Contents

1. Learning to Operate the HP 8902A

Chapter 1 provides an easy step-by-step guide to learning each of the HP 8902A's basic measurement capabilities.

2. More about RF Frequency and Frequency Error Measurements

Chapter 2 describes the HP 8902A's special capabilities that enable you to adapt the RF Frequency and Frequency Error measurements to the special conditions of your application.

3. More about Modulation and Audio Measurements

Chapter 3 describes the HP 8902A's special capabilities that enable you to adapt the Modulation and Audio measurements to the special conditions of your application.

4. More about RF Level and Tuned RF Level Measurements

Chapter 4 describes the HP 8902A's special capabilities that enable you to adapt the RF Power and Tuned RF Level measurements to the special conditions of your application.

5. Measurement Examples

Chapter 5 contains specific measurement examples that demonstrate how the versatility of the HP 8902A enables you to use it in a wide range of measurement applications.

Appendix A - Installation

Appendix B - Calibration Factors

Appendix C - Index

Appendix D - Other Publications

1

Learning to Operate the HP 8902A

The Easy Way

This Basic Operation and Application Guide is designed to provide a quick and easy way to learn to operate the HP 8902A Measuring Receiver. *Chapter 1* will provide you with all the information you need to use the HP 8902A's basic measurement capabilities: RF Frequency, Modulation, Audio, RF Power, and RF Level. The subsequent reference chapters (2 through 4) are devoted to the special functions and features that enable you to extend the operation of the HP 8902A. We strongly recommend that you first familiarize yourself with *Chapter 1* before referring to the reference chapters. Once you are comfortable with the basic operation of the instrument, it will be easier for you to understand and implement the many additional features that the HP 8902A has to offer.

The HP 8902A Solution

The hands-on approach in this chapter demonstrates the extreme versatility of the HP 8902A. Placing the HP 8902A on your bench actually puts the capabilities of several instruments at your fingertips. Many of the measurement capabilities of the following products are included in the HP 8902A.

- RF Frequency Counter, to 1 Hz resolution(1-5)
- Modulation Analyzer, AM, FM, and Φ M (1-9)
- Audio Analyzer, frequency, distortion, and level(1-15)
- RF Power Meter, as accurate as the best(1-18)
- RF Level Meter, unprecedented accuracy to -127 dBm .(1-21)

The HP 8902A combines many of the capabilities required for calibration, troubleshooting, and design into a single instrument. In addition, the HP 8902A's many special function capabilities enable you to adapt its measurements to the demands of a wide range of test conditions.

The Setup

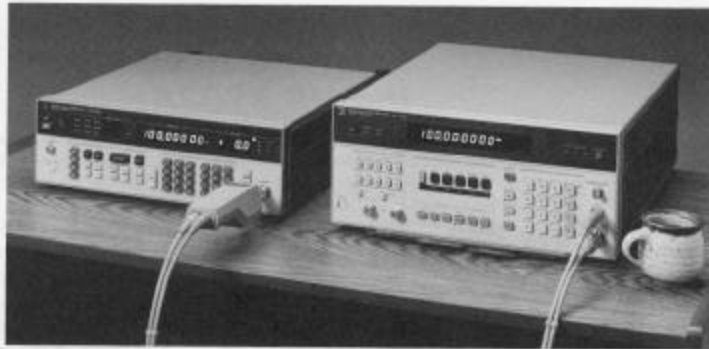

Diagram 1-1. Setup for Learning Basic Operation

To get ready to learn to use the HP 8902A, connect the HP 8902A, an HP 11722A Sensor Module, and a signal generator together as shown in Diagram 1-1.

The HP 8902A

If you are unpacking a new HP 8902A you will want to refer to the installation suggestions provided in *Appendix A*.

The HP 11722A

The procedures in this guide are written for use with an HP 11722A Sensor Module. There are many power sensors that can be used with the HP 8902A as well. If you are using a power sensor (rather than a Sensor Module), refer to your HP 8902A Operation and Calibration Manual for information on which power sensors can be used and how to operate them with the HP 8902A.

The Calibration Data

Once the HP 8902A is up and running, you will need to first determine if the calibration data for the Sensor Module you are using has been stored in the HP 8902A. *Appendix B* contains a procedure for determining whether the correct calibration data has been entered into the HP 8902A. (Refer to *Appendix B* if you are not certain that the calibration data for the Sensor Module you are using has been entered into the HP 8902A.)

The Signal Generator

The procedures in this guide are best performed using a signal generator that generates a single, stable RF signal that is tunable in 1 MHz steps from at least 100 MHz to 200 MHz. The signal generator should also have AM, FM and (if available) Φ M capability at a 1 kHz rate.

And You

If you are now sitting comfortably in front of your HP 8902A, you are ready to begin. Start on the next page and follow the step-by-step guide to learning to operate the HP 8902A. You will soon discover how the HP 8902A can increase both the ease and speed of many of your measurements.

**Note**

If you plan to selectively refer to portions of Chapter 1, rather than perform all of the procedures in sequence, we recommend that you complete the procedures in the Frequency Counter portion of this chapter first. The Frequency Counter portion contains an introduction to the tuning and reset capabilities that are important to all of the HP 8902A's measurements.



1. Take a look at the HP 8902A's Front Panel. Notice that label brackets have been placed over each key group to help you quickly find the function desired.
2. Note the gold and blue keys. These keys will enable you to select the "shifted" functions. As this guide will demonstrate, the shifted functions are selected by pressing the gold or blue key and then the desired function key.
3. Switch the HP 8902A from **STBY** to **ON**. Notice that as the HP 8902A powers up, it performs a self-test that includes turning on all front panel lights.

The Display

The HP 8902A keeps you informed of its operating status by the dashes and error codes it places in its display.

Interpreting the Dashes

4. Adjust your signal generator to -40 dBm. This causes the HP 8902A to place two dashes in its display. Two dashes indicate that the level of the input signal is too low for the instrument to detect in its current measurement mode.
5. Set the signal generator to 0.0 dBm. Once the HP 8902A detects an input signal, it removes the two dashes from its display. Sometimes you will see the HP 8902A replace the two dashes with four dashes. Four dashes indicate that the instrument is involved in internally setting up the measurement. If the HP 8902A displays four dashes for more than a few seconds, the instrument may be having difficulty tuning to an unstable input signal. (The HP 8902A's Track Mode tuning, described later in this chapter, is typically a good choice for tuning to unstable signals.)

--	Input signal not sensed
----	HP 8902A setting up measurement



Interpreting Error Codes

6. Press the **CALIBRATE** key. (See the adjacent instrument diagram for the key location.) The HP 8902A will display Error 21 to inform you that you have attempted to select an operating condition that is not compatible with the measurement you are making. Error codes like this will keep you informed of both operator errors and input signal problems. The reference chapters (2, 3, and 4) list the error codes that can be encountered for each measurement along with recommended recovery actions.



When your signal source testing requires an accurate RF frequency counter, the HP 8902A is a convenient solution. The HP 8902A makes it easy to tune to and measure the frequency of complex modulated signals.

If you haven't setup your HP 8902A, Sensor Module, and signal generator as shown in Diagram I-1 (page 1-2) you will need to do so in order to perform the following procedures.

Adjust Your Signal Generator

RF Frequency 100 MHz
 Frequency Increment 1 MHz
 Amplitude 0.0 dBm
 Modulation Off

Measuring RF Frequency

1. Press the **FREQ** key and the green **AUTOMATIC OPERATION** key on the HP 8902A. That's all it takes to configure the HP 8902A as an RF counter. Notice that the HP 8902A automatically tunes to and displays the frequency of the input signal (approximately 100 MHz; the absolute value depends on the accuracy of your signal generator and the accuracy of the HP 8902A's time base reference.) Note also that **AUTO TUNING** (the green LED on the front panel) is on. This LED lets you know that the instrument is in its automatic tuning mode.

1 Hz Resolution



2. To increase the HP 8902A's display resolution to 1 Hz, key in **7.4 SPCL** * by pressing the digit keys **7 * 4** and the **SPCL** key (see the adjacent instrument diagram for key locations). If you enter a wrong digit, simply press the **CLEAR** key and begin again. Note that the **SPCL** key remains lit to show that a special function has been manually set.
- * If the HP 8902A displays Error 23 when you enter 7.4 SPCL, it is not equipped to provide 1 Hz counter resolution. Enter 7.1 SPCL instead to select 10 Hz display resolution.

Measurement Ranges

That's all it takes to make an accurate frequency count on a stable signal throughout the following ranges:

Input Frequency	Amplitude Range
150 kHz to 650 MHz	+30 to -25 dBm
650 MHz to 1300 MHz	+30 to -20 dBm

Choosing a Tuning Mode

Proper tuning is the key to making successful RF Frequency as well as other tuned measurements with the HP 8902A. The optimum tuning mode for your measurement will depend on the characteristics of the input signal.

3. **Adjust your signal generator to 110 MHz.** The HP 8902A should automatically tune to the new input signal. (Note that four dashes are placed in the display while the HP 8902A is tuning to the input signal.)

Manual Tuning Mode

4. **Key 110 MHz into the HP 8902A by pressing the digit keys 1 1 0 and the MHz key.** Note that AUTO TUNING (the green LED) is now off. By keying in an RF frequency and pressing the MHz key, you have selected the instrument's Manual Tuning mode. The HP 8902A's tuning is now set at 110 MHz.

The Manual Tuning mode can also be selected by pressing the MHz key by itself. When you press the MHz key without keying in a frequency value, the HP 8902A's tuning is set at the frequency currently being displayed.

5. **Adjust your signal generator to 112 MHz.** The HP 8902A will display an Error 01 to let you know that the input signal is no longer within the tuning range of the frequency (110 MHz) that the instrument was manually set to.

Auto Tuning Mode

6. **Press the Blue Shift key and the AUTO TUNING (TRACK MODE) key.** You have placed the instrument back in its Auto Tuning mode. (Notice that the AUTO TUNING, green LED is on again.) The HP 8902A is now tuned to the frequency of the input signal. (The Auto Tuning mode is the right choice when measuring a single, stable input signal.)

Track Mode

7. **Press the TRACK MODE key.** In Track Mode, the HP 8902A is locked to the input signal.

8. **Increment your signal generator from 112 MHz to 100 MHz in 1 MHz steps.** The HP 8902A is now able to track the input signal as it changes frequency. (Track Mode is the right choice when you are measuring a drifting or noisy signal.)

Measurement Selected	Input Condition	Tuning Mode to Select	HP 8902A Operation
RF Frequency, Modulation, or Audio	Single, stable signal	Auto Tuning	Tuned to frequency of input signal
	Multiple, stable signals	Manual Tuning	Tuning set at manually tuned frequency
	Single, drifty or noisy signal > 10 MHz	Auto Tuning Track Mode	Tuning locked to input signal
	Multiple, drifty or noisy signals > 10 MHz	Manual Tuning Track Mode	Tuning locked to input signal
Frequency Error, RF Power, or Tuned RF Level	All Cases	Manual Tuning	Tuning set at manually tuned frequency

Measuring Frequency Error



The HP 8902A makes checking RF frequency error a simple two-step process. Adjust your signal generator to 100 MHz.

1. Key **100 MHz** into the HP 8902A to manually tune it to the frequency of your signal generator (100 MHz).
2. Press the gold **S** key, and then the **FREQ ERROR (FREQ)** key (both keys should remain lit). The HP 8902A is now displaying the frequency difference (in kHz) between the manually tuned frequency (100 MHz) and the actual output frequency of your signal generator. (Note that the instrument displays a negative difference when the input frequency is less than the HP 8902A's manual setting and a positive difference when the input frequency is greater.)

Remember



Manual tuning is always the right choice when measuring Frequency Error because it establishes a known frequency reference. Also, the Frequency Error measurement should only be made on a stable input signal.

That's all it takes to make Frequency Error measurements with the HP 8902A.

10 Hz Resolution

3. To display 10 Hz counter resolution, enter 7.1 SPCL by pressing the digit keys **7 • 1** and the **SPCL** key. Note that the SPCL key remains lit to indicate that a special function has been invoked.

Reset

The HP 8902A provides you with two ways to return its operating functions to their automatic operating condition. The following procedures demonstrate the two reset functions.

- Automatic Operation**
4. Press the green **AUTOMATIC OPERATION** key. You have placed the instrument back in its Auto Tuning mode (green LED on) and you have disabled Special Function 7.1 (SPCL key no longer lit). Pressing the **AUTOMATIC OPERATION** key resets Special Functions 1 through 10 to their Automatic Operation condition and returns the instrument to its Auto Tuning mode (not the best choice for Frequency Error measurements, remember). Note that the instrument is still in the Frequency Error measurement mode (gold S key lit).

- Instrument Preset**
5. Now press the Blue Shift key and then the green **INSTR PRESET (AUTOMATIC OPERATION)** key. Note that the instrument is reset to the Frequency measurement mode (gold S key off). **INSTR PRESET** resets the entire instrument to its power-up default condition.

Key	Function	Contribution
AUTOMATIC OPERATION	<ol style="list-style-type: none"> 1. Selects Auto Tuning Mode. 2. Resets special functions 1 through 10 to their Automatic Operation condition. 	Provides operator error recovery by resetting the operating functions that can cause an error condition.
INSTR PRESET	Resets <i>all</i> operating functions.	Sets all operating functions to their defined power-up condition.



To Learn More...

Chapter 2 in this guide provides reference information about the RF Frequency and Frequency Error measurements and the HP 8902A's tuning capabilities. Refer to Chapter 2 when you want to find out more about:

- **Tuning Modes** - Further information about the HP 8902A's tuning modes.
- **Extending Operation** - The special operating capabilities that enable you to adapt the RF Frequency and Frequency Error measurements to the specific conditions of your input signal.
- **Help** - Solutions to setup or operating problems encountered when making RF Frequency or Frequency Error measurements.

Refer to Chapter 5 for examples of RF Frequency measurement applications.

Modulation Analyzer



The HP 8902A offers complete modulation analyzer capability to meet your AM, FM and Φ M measurement needs. Even difficult measurements such as signal-to-noise and incidental AM and FM can be made with ease and superb accuracy using the HP 8902A.

Set up your HP 8902A, Sensor Module, and signal generator as shown in Diagram 1-1.

Adjust Your Signal Generator

RF Frequency	100 MHz
Amplitude	0.0 dBm
Modulation	AM
Depth	50%
Rate	1 kHz

Measuring AM



1. Press the **AM** key, the green **AUTOMATIC OPERATION** key, and the **PEAK+** detector key. The instrument should display an AM index of approximately 50%. Notice that the instrument is in the Auto Tuning mode (green **AUTO TUNING** LED on). The HP 8902A automatically found and tuned to the modulated RF signal. (The Auto Tuning mode is a good choice for making most modulation and audio measurements.)
2. Key in 100 MHz by pressing the digit keys **1 0 0** and the **MHz** key. The instrument is now manually tuned to the frequency of the input signal (green LED off). (Manual Tuning is a good choice when measuring modulation in the presence of multiple RF input signals.)

Selecting a Detector

The HP 8902A provides six detector functions for measuring your modulation and audio signals.

**Peak Detector**

3. Press the **PEAK-** key. Switching between the Peak+ and Peak- detector allows you to check modulation symmetry.
4. Press both the **PEAK+** and **PEAK-** keys at the same time. Pressing both detector keys at the same time allows you to display the average value of the positive and negative peak readings. (PEAK $\pm/2$).
5. Press the **PEAK+** key and then the **PEAK HOLD** key. The Peak Hold detector captures and holds the peak modulation level detected by the Peak+ or Peak- detector.
6. Increase the modulation depth of the signal generator to 75% and then reduce it back to 50%. Notice that the HP 8902A continues to display the maximum modulation level. The Peak Hold detector is ideal for detecting short modulation transients.

Average Detector

7. Now press the **AVG** key to select the average-responding detector. You have selected an average responding detector that is calibrated to read the rms value of a sinewave. The HP 8902A should be displaying approximately 35% AM with the signal generator set at 50% AM.

RMS Detector

8. Press the **Blue Shift** key and then the **RMS (AVG)** key (the red LED below the RMS key will come on). You have now selected a true-RMS detector. The Average detector and the RMS detector are good choices when measuring noise or residual modulation where the rms value is generally more desirable than the peak value. The true-RMS detector can be used to measure modulation rates up to 40 kHz and provides one more digit of resolution than the Average Detector. The true-RMS detector is also a good choice for measuring non-sinusoidal signals.

AM Measurement Ranges

Simply select AM and any of the above detector functions to make AM measurements within the following ranges:

RF Carrier Frequency	Modulation Rate	Max. Depth
150 kHz to 9.999999 MHz	20 Hz to 10 kHz	99%
10 MHz to 1300 MHz	20 Hz to 100 kHz	

Measuring FM



1. Turn off AM on the signal generator and turn on 25 kHz of FM deviation at a 1 kHz rate.
2. Press the **FM** key, the green **AUTOMATIC OPERATION** key, and the **PEAK+** detector key. The HP 8902A should display a reading of about 25 kHz. Notice that in the upper right corner of the instrument the yellow **FM MODULATION OUTPUT** LED is lit. This indicates that the demodulated FM signal is available at the front-panel **MODULATION OUTPUT/AUDIO INPUT** port. (Connecting another audio analyzer to this port will enable you to make audio measurements on the demodulated signal while monitoring modulation with the HP 8902A.)

Measuring Pre-Emphasized FM



To accommodate your pre-emphasized FM signals, the HP 8902A is equipped with four separate de-emphasis filters. (Each **FM DE-EMPHASIS** key is labeled with a time constant corresponding to the 3 dB corner frequency of that de-emphasis filter.)

3. Press the **75 μ s FM DE-EMPHASIS** key (if the **PRE-DISPLAY** key is not lit, press it too). The display now shows the level of the demodulated signal after it has been de-emphasized. (The de-emphasized FM signal is now available at the front-panel **MODULATION OUTPUT/AUDIO INPUT** port.)
4. Press the **PRE-DISPLAY** key again to turn Pre-Display off. Notice that the display now shows the level of the demodulated FM signal before it is de-emphasized. The demodulated signal is now being applied to the de-emphasis filter after it is measured by the HP 8902A. (The de-emphasized signal is still present at the **MODULATION OUTPUT/AUDIO INPUT** port, however.)
5. Press the **75 μ s** key again to turn off the **FM De-emphasis** function. Repeat step 3 to select any of the four de-emphasis filters.

Inserting Audio Filters



To remove undesired signals such as harmonics, noise, and spurs from the demodulated signal, insert the selectable high-pass and low-pass audio filters when making modulation or audio measurements. To minimize overshoot from square-wave modulation, such as frequency shift keying (FSK), select the >20 kHz Bessel Filter.

6. Press the **300 Hz** key and the **3 kHz** key to set a typical measurement bandwidth of 300 Hz to 3 kHz. Diagram 1-2 shows the typical frequency response of each audio filter.

7. Press the 300 Hz key and the 3 kHz key again to remove these filters.

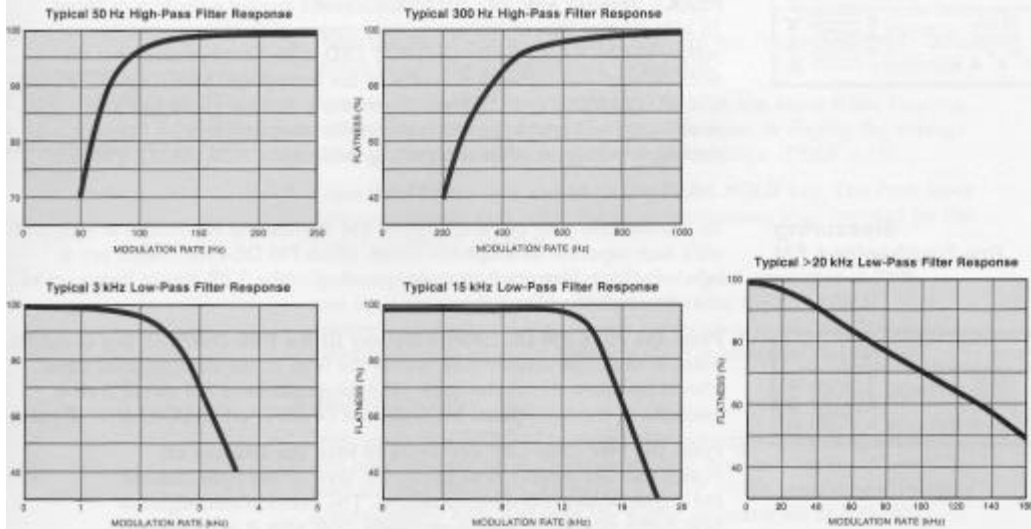

Diagram 1-2. The typical frequency response of each Audio Filter

FM Measurement Ranges

That's all it takes to make FM measurements and select audio filters throughout the following ranges:

RF Carrier Frequency	Modulation Rates	Max. Deviation
150 kHz to 9.99999 MHz	20 Hz to 10 kHz	40 kHz peak
10 MHz to 1300 MHz	20 Hz to 200 kHz	400 kHz peak

Measuring ϕM

1. Turn off the FM on the signal generator and select 10 radians phase modulation at the rate of 1 kHz. (If your signal generator does not have ΦM capability, set modulation to FM, 10 kHz deviation at a 1 kHz rate.)

In Radians



2. Press the ΦM key, the green **AUTOMATIC OPERATION** key, and the **PEAK+** detector key. The HP 8902A should display a reading of about 10 radians. Notice that the yellow ΦM MODULATION OUTPUT LED is now lit to indicate that the demodulated ΦM signal is available at the MODULATION OUTPUT/AUDIO INPUT port. (An audio measurement device, such as an oscilloscope, can be connected to this port for monitoring the demodulated audio signal.)

In Degrees



3. Key in 1.745 and then press the **RATIO** key. The HP 8902A is now displaying the phase deviation in degrees. (If the display is reading in dB, press the **LOG/LIN** key to get %. The instrument should display approximately 570 degrees for 10 radians of ΦM .)

ϕM Measurement Ranges

Select the ΦM measurement mode to simplify your phase modulation measurements throughout the following ranges:

RF Carrier Frequency	Modulation Rates
150 kHz to 9.999999 MHz	200 Hz to 10 kHz
10 MHz to 1300 MHz	200 Hz to 20 kHz

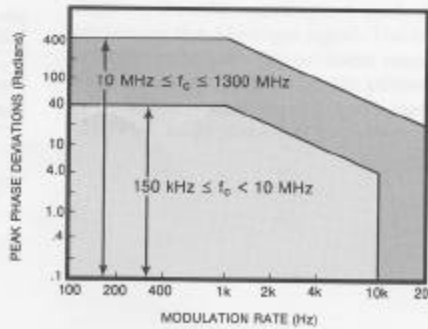



To Learn More...

Chapter 3 in this guide provides additional information about the modulation measurements. Refer to *Chapter 3* when you want to find out more about:

- **Calibration** - The procedure to calibrate your AM and FM measurements.
- **Extending Operation** - The special operating capabilities that enable you to adapt the Modulation measurements to the specific conditions of your input signal.
- **Help** - Solutions to setup and operating problems encountered when making modulation measurements.

Refer to *Chapter 5* for examples of modulation measurement applications.



The HP 8902A enables you to measure your audio signal sources as well as your RF signal sources. Use the HP 8902A to make audio frequency, distortion, and level measurements.

Set up your HP 8902A, Sensor Module, and signal generator as shown in Diagram 1-1.

Adjust Your Signal Generator

RF Frequency 100 MHz
 Amplitude 0.0 dBm
 Modulation AM
 Depth 50%
 Rate 1 kHz

Measuring Audio Frequency

The HP 8902A enables you to accurately count the frequency of the internally-demodulated audio signal or of an external audio signal connected to the MODULATION OUTPUT/AUDIO INPUT port.

Demodulated Audio



1. Press the **AM** key and then the green **AUTOMATIC OPERATION** key. Entering the AM measurement mode first, selects the AM demodulator for measuring the AM input signal. The HP 8902A uses the last demodulator selected before entering an audio measurement mode to make its audio measurements. (Notice that the yellow AM MODULATION OUTPUT LED is lit. When you are making audio measurements, the MODULATION OUTPUT LEDs will show you which demodulator is selected.)



2. Press the gold **S** key and then **AUDIO FREQ (AM)** key (both keys should remain lit). The HP 8902A is now displaying the frequency of the demodulated audio signal (approximately 1 kHz). The demodulated audio signal is also available at the front-panel MODULATION OUTPUT/AUDIO INPUT port.

External Audio

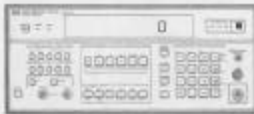

3. Press the **AUDIO INPUT** key (key lit) to convert the MODULATION OUTPUT port to an AUDIO INPUT port. The HP 8902A is now able to make its audio measurements on an external audio signal source connected to the AUDIO INPUT port. Press the AUDIO INPUT key again to convert the port back to a modulation output and continue measuring the internally demodulated audio signal.

Audio Frequency Measurement Ranges

That's all it takes to measure internally-demodulated or external audio frequencies throughout the following ranges:

Audio Frequency	Max. External Input Voltage
20 Hz to 250 kHz (usable to 600 kHz)	3 Vrms

Measuring Audio Distortion



Use the HP 8902A to measure distortion on either a 400 Hz or a 1 kHz signal. Distortion measurements can be made on either the internally demodulated signal or on an external audio signal connected to the AUDIO INPUT port.

1. Press the gold **S** key and the **AUDIO DISTN (FM)** key (both keys should remain lit). The instrument is now displaying the measured distortion of the 1 kHz demodulated signal. Notice that in the display, the 1 kHz annunciator is lit. The true-RMS detector is used to make this measurement.
2. Press the **Blue Shift** key and the **400 Hz DISTN (PEAK-)** key (the 400 Hz annunciator should be lit in the display). The instrument is now ready to measure the distortion level of a 400 Hz signal.

Audio Distortion Measurement Ranges

That's all it takes to measure audio distortion throughout the following measurement ranges:

Audio Frequency	Max. External Input Voltage	Display Range
400 Hz and 1 kHz	3 Vrms	0.01% (-80.0 dB) to 100.0% (0.00 dB)

Measuring Audio Level

The HP 8902A is able to measure the rms voltage level of external audio signals applied directly to the AUDIO INPUT port. (Audio level measurements cannot be made on internally demodulated signals.)



1. **When you need to measure audio level, connect an audio source to the AUDIO INPUT port.**
2. **Key in 30.0 SPCL.** The instrument will display the rms voltage level of the input signal. (Press the Blue Shift key and the voltage unit keys μ V (4), mV (5), or Volts (6) to select the desired voltage units.)
3. **Press any measurement function key to exit the Audio Level measurement mode.**

Audio Level Measurement Ranges

That's all it takes to measure audio level throughout the following ranges:

Audio Frequency	Input Voltage
50 Hz to 40 kHz	100 mV to 3V



To Learn More...

Chapter 3 in this guide provides additional information about the HP 8902A Audio measurement capabilities. Refer to Chapter 3 when you want to know more about:

- **Extending Operation** - The special operating capabilities that enable you to adapt the Audio measurements to the specific conditions of your input signal.
- **Help** - Solutions to setup and operating problems encountered when making Audio measurements.

Refer to Chapter 5 for examples of Audio measurement applications.



The HP 8902A provides you with the capability and accuracy of the best power meters. With a single keystroke, the HP 8902A autoranges to the input signal, measures its power, compensates for power sensor flatness, and displays the results in the units of your choice.

Adjust Your Signal Generator

RF Frequency 100 MHz
 Amplitude 0.0 dBm
 Modulation Off

RF Power Calibration

Like all power meters, the HP 8902A must first be calibrated. An internal RF Power Calibrator enables you to calibrate the Sensor Module and the HP 8902A's Power Meter to an internal 50 MHz, 1.00 mW reference signal. The following calibration procedure must be performed only one time to calibrate your Sensor Module. This means you do not need to perform this procedure again as long as you are using the same Sensor Module. To ensure the highest possible measurement accuracy, allow the HP 8902A to warm up for at least thirty minutes before performing the calibration procedure.

1. Press the **RF POWER** key on your HP 8902A.

Error 15

If the HP 8902A is displaying Error 15, it has not yet been configured to make RF Power measurements. (Refer to *Appendix B* and perform the Calibration Factor Entry procedure before going on with this procedure.)



Note

The calibration factors for the Sensor Module you are using must be stored in the HP 8902A in order for it to make calibrated, automatic RF Power measurements. If you are not certain that the correct calibration factors are stored in the instrument, refer to Appendix B.

**Remember**

2. Connect the HP 11722A Sensor Module to the RF POWER OUTPUT port on the HP 8902A. This port outputs the 1.00 mW reference signal. (Disregard Error 11 when it is displayed.)
3. Press the ZERO key. Wait approximately 8 seconds for the zeroed sensor reading to be displayed briefly. The HP 8902A is correcting for any dc offset error inherent within the measurement system.

As a good rule of thumb, press the ZERO key approximately every 10 minutes when making RF Power or Tuned RF Level measurements to compensate for any changes in the ambient operating conditions. The zeroing process is most effective if the ZERO key is pressed with the HP 11722A Sensor Module connected to the signal source being measured.

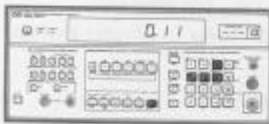

4. Press the CALIBRATE key. Wait for a stable, calibrated reference reading to be displayed. The HP 8902A is creating a correction factor that enables the instrument to equate its power measurement reading to the 1.00 mW reference.
5. Press the Blue Shift key and then the SAVE CAL (CALIBRATE) key. This stores the calibrated reference in the instruments non-volatile memory.
6. Press the CALIBRATE key again. This turns off the calibrator. You have completed the calibration procedure.
7. Connect the Sensor Module to the signal generator. The HP 8902A is now calibrated to make accurate power measurements with the Sensor Module you are using. From now on, you need only repeat step 2 to maintain RF Power calibration.

Measuring RF Power

1. Press the RF POWER key. The instrument should read approximately 1000 -06W (1000 μ W) with the signal generator set to 0.0 dBm.
2. Press the LOG/LIN key to toggle the display reading between logarithmic (dBm) and linear (watts) units. The instrument also converts measurement readings to voltage units when you select the Blue Shift key and a voltage units key such as μ V (4), mV (5), or V (6). Press the Blue Shift key and then the WATTS (9) key to exit the voltage units mode.

Changing Frequency

3. Adjust the frequency of the signal generator to 119 MHz.

Manual Tuning

Key the new output frequency of the signal generator into the HP 8902A by pressing the digit keys 1 1 9 and then the MHz key. The HP 8902A must be set to the same frequency as the input signal to enable the instrument to select the correct calibration factor.



Auto Tuning

5. You can also allow the HP 8902A to automatically tune to the new input frequency, by pressing the **FREQ** key, the **Blue Shift** key, and the **AUTO TUNING (TRACK MODE)** key. After the HP 8902A displays the new input frequency, press the **MHz** key and then the **RF POWER** key to re-enter the RF Power measurement mode.

Remember



If the frequency of the input signal changes, always change the frequency setting of the HP 8902A as well.



6. To verify that the frequency setting of the HP 8902A is the same as the frequency of the signal generator, press the **Blue Shift** key and then the **DISP FREQ (kHz ↑)** key. You can use this method to check frequency tuning when in any of the measurement modes.

RF Power Measurement Ranges

From now on, simply select RF Power to make accurate, calibrated RF Power measurements throughout the following ranges using an HP 11722A Sensor Module:

Input Frequency	Input Amplitude
100 kHz to 2.6 GHz (HP 11722A)	-20 dBm (10 μ W) to +30 dBm (1 W)

To Learn More...



Chapter 4 in this guide provides information about the HP 8902A's additional capabilities when in the RF Power mode. Refer to Chapter 4 when you want to find out more about:

- **Calibration** - The RF Power calibration technique.
- **Extending Operation** - The special operating capabilities that enable you to adapt the RF Power measurement to the specific conditions of your input signal.
- **Help** - Solutions to setup or operating problems when making RF Power measurements.

Refer to Chapter 5 for examples of RF Power measurement applications.



The HP 8902A offers unprecedented low-level measurement capability. Select the Tuned RF Level measurement to make precise, narrowband RF level measurements down to -127 dBm. The Tuned RF Level measurement is an excellent choice for performing low-level accuracy tests.

Set up your HP 8902A, Sensor Module, and signal generator as shown in Diagram 1-1.

Adjust Your Signal Generator

RF Frequency 119 MHz
 Amplitude 0.0 dBm
 Amplitude Increment 10 dB
 Modulation Off

Tuned RF Level Calibration

To make accurate low-level measurements down to -127 dBm, the HP 8902A uses a precise, IF signal substitution technique. This technique creates three RF measurement ranges within the full measurement range of the tuned RF Level measurement (0 to -127 dBm). Tuned RF Level calibration involves the creation of a calibration factor for each of the three ranges at the tuned frequency. The following simple procedure creates these calibration factors. (More information about the calibration technique is provided in *Chapter 4*.)



1. Press the **FREQ** key and then the green **AUTOMATIC OPERATION** key on the HP 8902A. This tunes the HP 8902A to the input signal. When the HP 8902A displays the input frequency, press the **MHz** key (to select Manual Tuning), the gold **S** key, and then the **TUNED RF LEVEL (RF POWER)** key. (Both the gold **S** key and the **TUNED RF LEVEL** key should remain lit.) You may see the HP 8902A place six dashes in its display prior to displaying the measurement reading. The instrument displays six dashes only when in the TRFL measurement mode. Six dashes indicate that the HP 8902A is searching for an input signal at the frequency that it has been tuned to.



2. Press the **Blue Shift** key and the **DISPLAY FREQ (kHz ↑)** key to check that the HP 8902A is tuned to the output frequency of the signal generator (119 MHz). If it is not, manually tune it by keying in 119 MHz. (Manual Tuning is the right choice for TRFL measurements.)

3. Both the **RECAL** and the **UNCAL** annunciators should be lit in the display. The **UNCAL** annunciator indicates that the displayed reading is not yet calibrated. The **RECAL** annunciator indicates that calibration is possible at the current input signal level. (If the HP 8902A has already been calibrated at 119 MHz, the annunciators will not be lit. You can enter 39.9 SPCL to clear the calibration factors for 119 MHz so that you can continue with this demonstration.)

Range 1



4. Press the **CALIBRATE** key. After the instrument completes the calibration process, both annunciators will go out. You have just calibrated Range 1 (0 to -40 dBm). (No further calibration is required to accurately measure input levels within this range.)

Note



It is very important that the level of the input signal remain stable during the calibration process (while the CALIBRATE key is lit).

5. Press the **LOG/LIN** key to select either linear (Watts) or logarithmic (dBm) units.

6. Decrement the signal generator level in 10 dB steps down to -40 dBm. Note that neither the **RECAL** or **UNCAL** annunciator is lit until you get to -40 dBm. This means that each of the displayed readings down to -40 dBm is a fully calibrated measurement.

7. At -40 dBm, the instrument displays the **RECAL** annunciator again. The **RECAL** annunciator indicates that the HP 8902A needs to be recalibrated now in order to make accurate level measurements within its next RF measurement range (approximately -40 to -80 dBm). Note that the **UNCAL** annunciator is not displayed. This means that the displayed reading is still a fully calibrated measurement.

Range 2

8. Press the **CALIBRATE** key. After the instrument completes the TRFL calibration, the **RECAL** annunciator will go out. You have now calibrated Range 2 (-40 to -80 dBm).

9. Continue decrementing the signal generator to -80 dBm. The **RECAL** annunciator will be displayed again.

Range 3

10. Press the **CALIBRATE** key again to calibrate Range 3. The instrument is now calibrated to make level measurements (at 119 MHz) over its entire measurement range (0 to -127 dBm).

You can now adjust the output level of the signal generator to any level between 0 and -127 dBm and no further calibration will be needed to measure the 119 MHz signal.

Measuring Tuned RF Level

The following information is provided to help you quickly complete your Tuned RF Level measurements.

Changing Frequency

Achieving the accuracy of the Tuned RF Level (TRFL) measurement requires that the calibration procedure be repeated at each frequency to be measured. The following chart will help you remember the key steps to performing TRFL measurements.

Key Steps	Considerations
1. Set the level of your signal source to between 0 and -20 dBm (0 dBm is optimum).	The three RF measurement ranges must be calibrated sequentially beginning with the first range Range 1 0 dBm Range 2 -40 dBm Range 3 -80 dBm
2. Tune the HP 8902A to the frequency of your signal source.	Manually: Key in the frequency and press the MHz key, or Automatically: Press the FREQUENCY key and select Auto Tuning. After the frequency is displayed, press the MHz key to select Manual Tuning and then re-enter the TRFL measurement mode.
3. Press the CALIBRATE key each time the RECAL annunciator lights.	The RECAL annunciator will only appear three times for each frequency (once for each measurement range). Remember not to change the input signal level during calibration (while the CALIBRATE key is lit).

RECAL UNCAL

The UNCAL annunciator indicates that the currently displayed measurement is uncalibrated. The HP 8902A displays the UNCAL annunciator when a change in the frequency or level of the input signal requires the instrument to use an RF measurement range that is not yet calibrated. The RECAL annunciator is displayed when the input signal is at a level where it can be used to calibrate the next (uncalibrated), RF measurement range. The following chart will help you to quickly interpret these annunciators.

RECAL	UNCAL	Description	Action
OFF	OFF	The displayed measurement is calibrated.	No action is required unless the RECAL or UNCAL annunciator is lit.
ON	OFF	The displayed measurement is calibrated, and calibration of the next measurement range is possible.	Press the CALIBRATE key to calibrate the next RF measurement range.
ON	ON	The displayed measurement is uncalibrated, but calibration is possible.	Press the CALIBRATE key to calibrate the RF measurement range you are in.
OFF	ON	The displayed measurement is uncalibrated, but calibration is not possible at the current input level.	Perform steps 1 through 3 in the chart above to calibrate each RF range. (Note the range calibration levels specified in step 1 under "Considerations".)

**Tuned RF Level
Measurement Ranges**

That's all it takes to make accurate Tuned RF Level measurements throughout the following frequency and level ranges using an HP 11722A Sensor Module:

Frequency	Level
2.5 MHz to 1300 MHz	0 dBm to -127 dBm

**To Learn More...**

Chapter 4 in this guide provides additional information about the TRFL measurement and the extended capabilities that will help you adapt the measurement to your needs. Refer to *Chapter 4* when you want to find out more about:

- **Calibration** - Understanding the TRFL calibration technique.
- **Extending Operation** - The special operating capabilities that enable you to adapt the TRFL measurement to the specific conditions of your input signal.
- **Help** - Solutions to setup and operating problems encountered when making TRFL measurements.

Refer to *Chapter 5* for examples of Tuned RF Level measurement applications.



Most measurements made with the HP 8902A require only a keystroke to invoke. There is no need to adjust levels, or select ranges because the HP 8902A's microprocessor determines the optimum instrument settings automatically. However, in some applications it is desirable to override the automatic selection. Special functions provide you with manual control of instrument operation, selection of additional measurement modes, and the ability to extend measurement ranges. The HP 8902A's special functions are described in the following chart.

Capability	Codes	Application
To extend instrument operation	1 to 10	These special functions enable you to select and adjust specific portions of circuitry within the HP 8902A. Use these special functions to adapt the instrument's operation to the special needs of your application.
To select the instrument's additional measurement capabilities	11 to 39	These special functions extend the measurement capabilities of the HP 8902A by providing additional measurement modes and functions. Use these special functions to make measurements such as SINAD, Audio Level, and LO Frequency. You can also use them for setting limits, setting references, and manipulating calibration data.
To access service-related operation information	40 to 99	These special functions assist in servicing the HP 8902A by enabling the instrument to display internal voltages and frequencies. Use these special functions to verify operation of the HP 8902A. (Refer to your HP 8902A Service Manual for details on using service special functions.)

The Special Display



Special function modes are selected first by entering the appropriate code (prefix, decimal point, suffix) and then pressing the SPCL key (lower right corner on the front panel).

1. **Key in 7.2 SPCL.** The SPCL key remains lit to indicate that a special function has been invoked.



2. Now press the **SPCL** key alone. Pressing the SPCL key without entering a number causes the HP 8902A to display which special functions (1-10) have been set. If you previously entered the 7.2 special function, a 2 should now appear in the seventh display digit position. The display shows a zero in each of the other display positions to indicate that these special functions are still set to their automatic (default) operating condition. Use this capability to review or verify the special function settings that you have selected.



3. Press the **SPCL** key again. Pressing the SPCL key twice without entering a number causes the instrument to display the special function setting (1-10) actually being used. (Note that a 2 still appears in the seventh display digit position.) The other digits represent the settings automatically selected for the measurement mode the HP 8902A is currently in. Use this capability when you are interested in knowing what settings the instrument is currently using to make its measurements.

4. Press the **CLEAR** key to exit the special function display and return to the previously selected measurement mode.

The Special Function Information Pull-Out Card

The Special Function Information pull-out card enables an experienced user to quickly access special function operating information. A block diagram on the card shows which portions of the circuitry are controlled by special functions 1-10. A table of operating conditions for each special function (1-10) is provided below the block diagram. Special functions 11-39 are listed above the block diagram along with a brief description of their function. (Refer to the measurement reference chapters (2 through 4) and the applications chapter (5) to find out how special functions can help you expand your measurement capabilities.)

Errors, Dashes and Other Help

The HP 8902A Measuring Receiver keeps you informed of its operating status by placing error and dash codes in its display. The Operating Information pull-out card enables you to quickly access a brief description of each code. The measurement reference chapters (2 through 4) in this guide provide a listing of the errors and problem conditions for each of the measurement modes. Each code listing includes a description and recommended recovery action. (Refer to reference chapters (2 through 4) for help in solving your measurement problems.)

Congratulations



You are now familiar with each of the basic measurement capabilities of the HP 8902A. From now on, you can rely on the HP 8902A for making your frequency, modulation, audio, power, and level measurements. The rest of this guide will enable you to expand and extend the HP 8902A's measurement capabilities even further. If the scope of your applications goes beyond the contents of this guide, refer to the HP 8902A Operating and Calibration Manual for further details.

2

More about RF Frequency and Frequency Error Measurements

In This Chapter

This chapter introduces the HP 8902A's special operating capabilities that enable you to tailor its RF Frequency and Frequency Error measurements to your specific test conditions. (To use these special capabilities effectively, you should first become familiar with the basic operating capabilities and measurement ranges described in *Chapter 1* for the RF Frequency and Frequency Error measurements.)

This chapter enables you to reference directly to the information you are interested in. The information is organized into three subject areas.

- **Tuning Modes** - Refer here for further understanding of the HP 8902A's tuning modes.
- **Extending Operation** - Refer here for the special operating capabilities that enable you to adapt the HP 8902A to the specific conditions of your input signal.
- **Help** - Refer here for help in solving setup or operating problems encountered in RF Frequency or Frequency Error measurements.

The Directory

Use the directory diagram below to quickly locate the subject you are interested in. A look-up table is located on the first page of each subject area. Use the look-up table to reference to the topics included for that subject.

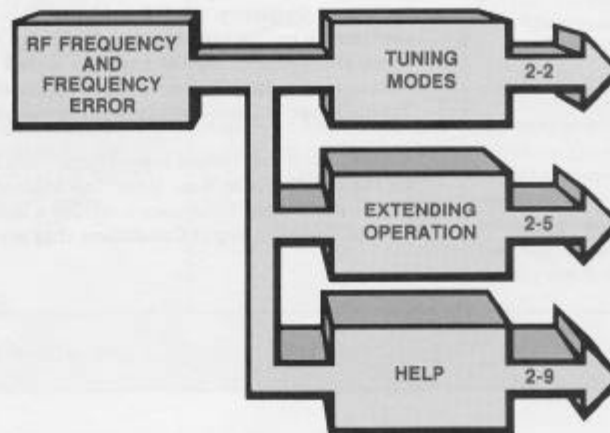

Tuning Modes

If You Need to Know:	Refer to:
• How the Auto Tuning Mode operates	Auto Tuning (2-2)
• How the Manual Tuning Mode operates	Manual Tuning (2-4)
• How Track Mode operates	Track Mode (2-4)

Auto Tuning

Auto tuning allows the HP 8902A to automatically find and tune to the input signal. It is automatically selected on Power-Up, or when the **AUTOMATIC OPERATION** or **INSTR PRESET** key is pressed. Auto Tuning mode is also selected by pressing the **Blue Shift** key and then the **AUTO TUNING** key.

When the HP 8902A enters the Auto Tuning mode, it first checks for an input signal below 2.5 MHz. If no signal is detected below 2.5 MHz, the instrument then begins sweeping its local oscillator (LO) from 1300 MHz down to 2.5 MHz. The LO continues sweeping until a different frequency, created by the mixing of the LO and the RF input signal, appears within the IF passband. If no signal is detected after multiple sweeps, the instrument places two dashes in its display while it continues to sweep.

When a signal does appear within the IF passband, the instrument performs a series of tests to determine whether the signal it has found is the appropriate signal to tune to. This testing enables the HP 8902A to Auto Tune to the fundamental in harmonically-rich spectrums or to a carrier with high-depth AM. Once the instrument determines that it is tuned to the correct frequency, the HP 8902A's LO is locked to an internal crystal oscillator to ensure high-stability, low-noise measurements. If the input signal changes after the LO has been locked to the crystal oscillator in Auto Tuning mode, the LO automatically begins the sweep search again. Auto Tuning mode is a good choice when measuring a single, stable input signal.

Keep in mind that certain input signal conditions can make it difficult for the HP 8902A to Auto Tune. The Manual Tuning mode is a good choice when these conditions exist. For a listing of these conditions, refer to *Table 2-1. Input Conditions that may Require Manual Tuning.*

Table 2-1. Input Conditions That May Require Manual Tuning.

Input Condition	Description	HP 8902A's Response	Recommendation
Multiple input signals	For input signals whose amplitudes are all between -25 dBm and +30 dBm, and are within approximately 15 dB of one another, the HP 8902A may auto tune to the signal at the highest frequency rather than the signal with the highest level.	Instrument will measure and display characteristics of input signal at the highest frequency.	If the desired signal is not the highest-frequency signal, manually tune to the desired frequency or place a bandpass filter at the HP 8902A's input to block the unwanted signals.
Level of 2nd or 3rd harmonic is greater than -10 dBc*	The HP 8902A may interpret these as fundamental signals and tune to the signal at the highest frequency.	Instrument may measure and display characteristics of input signal at the highest frequency.	If the desired signal is not the highest-frequency signal, manually tune to the desired frequency.
Input signals above measurement range (1300 MHz).	Harmonics from the HP 8902A's LO may mix with signals above 1300 MHz to produce beat frequencies within the IF passband.	Instrument may measure and display characteristics of signal above 1300 MHz.	Manually tune to the RF signal below 1300 MHz, or place a low pass filter at the HP 8902A's input to block the unwanted high frequencies.
Low-rate, high-deviation FM	While auto tuning, the HP 8902A may mistake low rate (< 20 Hz) high-deviation (> 400 kHz) FM for signal drift.	Instrument may continuously display four dashes.	Manually tune to the carrier frequency or remove the FM until the instrument has auto tuned to the signal.
Low-level carrier with low-rate, high-depth (percentage) amplitude modulation	The AM may cause the carrier level to move in and out of the HP 8902A's measurement range.	Instrument may continuously display two dashes or 0 MHz, or it may alternately display two dashes then four dashes.	Manually tune to the carrier frequency to increase measurement sensitivity. (Refer to <i>Increasing Sensitivity</i> in this chapter to extend the measurement range further.)

* dBc = decibels referenced to the carrier level.

Manual Tuning

The Manual Tuning mode allows you to set the HP 8902A's tuning at a desired frequency. This is done by keying in the desired frequency and then pressing the **MHz** key. The manual tuning mode can also be entered by pressing the **MHz** key by itself. This locks the instrument at the frequency it is currently tuned to.

In Manual Tuning mode, the HP 8902A's local oscillator (LO) is locked to the HP 8902A's internal crystal oscillator whether an input signal is present or not. Once the LO is locked to the crystal oscillator in Manual Tuning mode, tuning does not change unless a new frequency is keyed in and the **MHz** key is pressed, or tuning is incremented up or down using one of the increment keys, \uparrow **kHz** or \downarrow **kHz**. (Set an increment by keying in the desired increment value and pressing one of the increment keys. The instrument will increment by the keyed-in value each time one of the increment keys is pressed.) Press the **AUTO TUNING** key or the **AUTOMATIC OPERATION** key to exit the Manual Tuning mode.

Manual Tuning is a good choice when measuring an input signal whose amplitude is less than -25 dBm or unstable, or where multiple RF signals are present. If the input signal is drifty, however, it may be necessary to select the Track Mode function.

Track Mode

The Track Mode function enables the HP 8902A to track drifting input signals from 10 MHz to 1300 MHz. Track mode can be selected with either Auto Tuning or Manual Tuning by pressing the **TRACK MODE** key. (A drifting signal will cause the HP 8902A to place four dashes in its display when Auto Tuning is selected or Error 01 when the instrument is manually tuned.)

In Track Mode the Local Oscillator (LO) is locked to the input signal. The instrument remains locked to the signal throughout each of the LO's tuning octaves. When an input frequency change causes the LO to cross into a new octave, lock may be broken. If the instrument is in Auto Tuning Track Mode, the HP 8902A will relock to the input signal. If the instrument is in Manual Tuning Track Mode, the LO will return to the manually tuned setting after lock is broken. The octave boundaries occur at 2.5, 5, 10, 20, 40, 80, 160, 320, 640, and 1280 MHz.

Track Mode is the right choice when measuring drifty input signals. However, certain operating limitations are present when using Track Mode. These limitations are listed below:

- Not allowed below 10 MHz
- Not allowed with 455 kHz IF
- Raises residual FM level
- Attenuates low-rate FM on input signal (use for FM rates >1 kHz only)

Extending Operation

If You Need to Know:	Refer to:
Frequency	
• How to tune to the input signal when other RF signals or harmonics are present	Increasing Selectivity (2-5)
• How to retune to a new input frequency	Changing Frequency (2-6)
• How to tune to a noisy input signal ..	Noisy Signal (2-6)
• How to track a drifty input signal ..	Drifty Signal (2-7)
• How to measure the frequency of input signals above 1300 MHz	Frequency Overrange (2-7)
• How to measure the frequency of input signals below 150 kHz	Frequency Underrange (2-7)
Amplitude	
• How to tune to an input signal below -30 dBm	Increasing Sensitivity (2-7)
• How to tune to an input signal whose amplitude is very unstable	Unstable Signal (2-8)

Increasing Selectivity

The HP 8902A's Auto Tuning mode is able to automatically find and tune to the fundamental in a harmonically-rich spectrum as long as the fundamental is at least 10 dB above the level of the second and third harmonics. The HP 8902A will also auto tune to the input signal if it is at least 30 dB above all non-harmonically-related RF signals. If, however, your input signal does not meet these criteria, the HP 8902A may have difficulty auto tuning to the desired input signal. If the instrument does not display the frequency of the desired input signal, manually tune the HP 8902A to the input frequency by keying in the frequency of the input signal and then pressing the **MHz** key.

To minimize the possibility of unwanted low-frequency, harmonic, or spurious signals entering the IF passband, a high-pass RF filter and bandpass IF filters can be selected. Table 2-2 shows the possible filter combination selections.

Table 2-2. Filter Configurations

RF High-Pass Filter (5.25 MHz)	Wide IF Filter	Narrow IF Filter (30 kHz BW)	IF Frequency	Key Sequence
OUT	Automatic Selection			3.0 SPCL
OUT	200 kHz BW	OUT	455 kHz	3.1 SPCL
OUT	2.5 MHz Low-Pass	OUT	1.5 MHz	3.2 SPCL
IN	200 kHz BW	OUT	455 kHz	3.3 SPCL
IN	2.5 MHz Low-Pass	OUT	1.5 MHz	3.4 SPCL
OUT	200 kHz BW	IN	455 kHz	3.5 SPCL
OUT	2.5 MHz Low-Pass	IN	455 kHz	3.6 SPCL
IN	200 kHz BW	IN	455 kHz	3.7 SPCL
IN	2.5 MHz Low-Pass	IN	455 kHz	3.8 SPCL

Changing Frequency

Although the HP 8902A is not designed for swept measurement applications, its Auto Tuning mode does enable it to automatically search for the input signal after the frequency of the input signal is changed. The instrument will place four dashes in its display while it is searching for the input signal.

Image Signals

If the frequency of the signal is increased by an increment equal to twice the IF signal frequency (for example, 2×1.5 MHz), the image frequency will appear within the IF passband. If the switching speed of the input signal is too fast, the HP 8902A will *not* detect a change in the input frequency and will continue to erroneously display the previous frequency. If you suspect that this has happened, press the **Blue Shift** key and then the **AUTO TUNING** key after the input frequency has changed. This causes the HP 8902A to retune to the input signal.

Increasing measurement selectivity by selecting the narrow-band 30 kHz IF filter can reduce the possibility of image signals appearing in the IF passband (refer to **Increasing Selectivity** in this chapter for filter selection information). (For details on the capabilities and limitations of Auto Tuning mode operation, refer to **Auto Tuning** in this chapter.)

Noisy Signal

Excessive noise or low-rate (below 20 Hz), high-deviation (greater than 400 kHz) FM on the carrier signal can make it difficult for the HP 8902A to auto tune to the carrier. If you know that your input signal is noisy, or if the HP 8902A indicates it is having difficulty setting up the measurement by continuously displaying four dashes, manually tune the HP 8902A to the frequency of the input signal. Simply key in the frequency of the input signal and then press the **MHz** key. If the HP 8902A does not display a measurement reading, press the **TRACK MODE** key.

Drifty Signal

A drifty or noisy input signal can cause the instrument to continuously display four dashes (Auto Tuning mode) or display Error 01 (Manual Tuning mode). Press the **TRACK MODE** key to select the wide-IF-bandwidth track mode function. Track Mode can be selected with either the Auto or Manual tuning modes. Note that the Track Mode function reduces the low frequency response of modulation measurements and increases the level of residual modulation. (For details on the capabilities and limitations of Track Mode operation, refer to **Track Mode** in this chapter.)

Frequency Overrange

There are three techniques for extending the HP 8902A's frequency range above 1300 MHz: internal harmonic mixing, external local oscillator and mixer down-conversion, and down-conversion with a spectrum analyzer. All three techniques extend the measurement capabilities of the HP 8902A to microwave frequencies. (Refer to *Chapter 5* for measurement examples using these tuning techniques.)

Frequency Underrange

If the input frequency is below the HP 8902A's frequency measurement range, the instrument will display Error 10. The specified low frequency limit of the RF Frequency measurement is 150 kHz. However, you can extend this measurement range to 20 Hz by simply selecting the Audio Counter. Connect your signal source to the MODULATION OUTPUT/AUDIO INPUT port and press the **AUDIO INPUT** key (key should remain lit). Press the gold **S** key and the **AUDIO FREQ** key. The Audio Counter will accurately count input signals from 20 Hz to 250 kHz.

Increasing Sensitivity

Two dashes or 0 MHz in the display indicates that the level of the input signal is below the HP 8902A's present measurement range. However, the HP 8902A's special function capabilities enable you to make RF Frequency and Frequency Error measurements on input signals down to -100 dBm.

The special function codes and their respective ranges are shown in Diagram 2-1. Keep in mind that these special functions add gain in the RF and IF paths. If the input signal level exceeds the designated range for the special function you select (as shown in Diagram 2-1) the instrument may overrange and display Error 02. Therefore, if you do not know the output level of your source, simply sequence down through the special function range settings until Error 02 is replaced by a measurement reading.

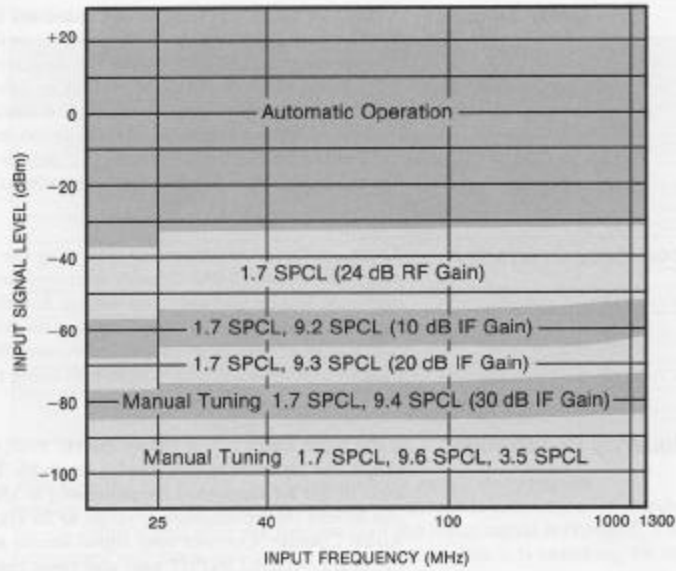

Diagram 2-1. Typical Frequency Measurement Ranges

Unstable Signal

If you are measuring an input signal whose RF level does not remain above -20 dBm to -25 dBm, (for example, a low level signal with high-depth AM or a signal that is being pulsed on and off), select the Manual Tuning mode by keying in the frequency of your input signal and pressing the **MHz** key. In Manual Tuning mode, the instrument will remain locked at the manually tuned frequency after the input signal is turned off.

Help

If You Need to Know:	Refer to:
Setup	
• <i>How to measure frequency without using a Sensor Module.....</i>	No Sensor Module (2-9)
• <i>How to make automated frequency measurements.....</i>	HP-IB (2-9)
• <i>How to connect an external time base</i>	Time Base (2-9)
Measurement	
• <i>How to interpret an error code, dashes or questionable measurement.....</i>	Solving Measurement Problems (2-10)

No Sensor Module

A Sensor Module is not required for making RF Frequency or Frequency Error measurements. To make measurements without a Sensor Module, simply connect a 50Ω cable and Type-N adapter from the HP 8902A's INPUT port to the output of your signal source.

HP-IB

The HP 8902A enables you to fully automate your measurements. Refer to your HP 8902A Operation and Calibration Manual for setup and programming information.

Time Base

A time base input is provided on the rear panel of the HP 8902A. This input allows you to connect the HP 8902A to an external 10 MHz time base. The time base circuitry within the HP 8902A automatically switches to the external time base and turns off its time base output when an external time base of sufficient amplitude (0.5 Vpp) is applied at the input. To verify that an external time base is being used, key in **15.1 SPCL**. The instrument will display a 1 if the external time base is being used or a 0 if the internal time base is being used.

Solving Measurement Problems

The HP 8902A has been designed to feed back information about its operating status. When the HP 8902A detects that the input signal or operating conditions are preventing it from making accurate, reliable measurement, it alerts you by placing an error or dash code in its display.

The circumstances that can cause the HP 8902A to display an error code are classified into one of two categories:

- **Input Problem**, caused by input signal conditions, or
- **Operating Problem**, caused by the selection of incompatible operating functions.

Certain errors are caused *only by an input problem*, other errors are caused *only by an operating problem*, and some errors can be caused by either.

The errors that can be caused *only by an input problem* and the errors that can be caused *only by an operating problem* are listed in the chart below.

If your instrument is displaying one of these errors, proceed directly to **Table 2-3. RF Frequency and Frequency Error, Error Codes**, and take the recovery action recommended.

	Input Problem	Operating Problem
Error	10	09, 12, 20 thru 25, 30, or 32

If you did not find your error listed in the chart or if your instrument is displaying dashes or a questionable measurement, continue with the following procedure.

1. Press the **green AUTOMATIC OPERATION** key. This cancels all function settings that can cause the HP 8902A to display an error code.
2. Compare the operating status of your HP 8902A *after pressing the AUTOMATIC OPERATION* key with the following condition descriptions. After you have identified the description that best describes your instrument's condition, take the action recommended for that condition.

Same Error If the error or reading remains the same after the **AUTOMATIC OPERATION** key has been pressed, the error is being caused by an input problem. Look up the error code in Table 2-3 and take the action recommended for "Input Problem".

No Error If the error goes away after the **AUTOMATIC OPERATION** key has been pressed, the error was caused by an operating problem. Look up the error code in Table 2-3 and take the action recommended for "Operating Problem".

New Error If the error is replaced by a different error or dash code after the **AUTOMATIC OPERATION** key has been pressed, the original error was being caused by a combined input problem and operating problem. Look up the error code displayed by the instrument *after* the **AUTOMATIC OPERATION** key was pressed. Take the action recommended for "Input Problem".



Remember

Because of the wide variety of input signals and the operating flexibility of the HP 8902A, it is not possible to list all recovery actions for each error code. After using the table to determine the cause of the problem, you may discover other error recovery procedures that are better suited to your application.

Table 2-3. RF Frequency and Frequency Error, Error Codes (1 of 2)

Display Code	Problem Description	Input Problem	Operating Problem
Questionable Measurement	Instrument does not display frequency of the input signal.	Check tuning mode. Refer to Increasing Selectivity (2-5) or Drifty Signal (2-7) .	Recheck operating conditions being used.
-- or 0 MHz	Input signal level out of measurement range.	Adjust input signal level or change measurement sensitivity. Refer to Increasing Sensitivity (2-7) .	Decrease RF attenuation or gain. Refer to Increasing Sensitivity (2-7) .
----	Instrument has detected an input signal and is attempting to set up measurement. Continuous display indicates instrument is having difficulty tuning to input signal	Manually tune to input signal. Refer to Noisy Signal (2-6) .	Re-check operating conditions being used.
01	IF signal within IF passband but not centered well enough to guarantee measurement accuracy (due to manual tuning). High AM depth (>95%) on low-level carrier.	Increase input signal level or decrease AM. Refer to Increasing Sensitivity (2-7) .	Press the MHz key to center IF signal in IF passband. If problem persists, signal may be drifting. Refer to Drifty Signal (2-7) .

Table 2-3. RF Frequency and Frequency Error, Error Codes (2 of 2)

Display Code	Problem Description	Input Problem	Operating Problem
02	Input circuits overdriven.	Increase RF input attenuation. Refer to Increasing Sensitivity (2-7) .	Decrease RF and/or IF gain setting. Refer to Increasing Sensitivity (2-7) .
03	Input circuits underdriven.	Increase gain. Refer to Increasing Sensitivity (2-7) .	Decrease RF input attenuation or increase IF gain. Refer to Increasing Sensitivity (2-7) .
06	Input circuits overdriven.	Input level exceeds 7 Vrms (1W peak). Decrease level of input signal.	Decrease RF and/or IF gain setting. Refer to Increasing Sensitivity (2-7) .
09	High stability time base problem (Option 002 instruments only).		Check internal time base for malfunction.
10	Frequency of input signal is not within measurement range.	Adjust frequency of input signal to within measurement range, or increase measurement range. Refer to Frequency Overrange (2-7) and Frequency Underrange (2-7) .	
12	Indicates internal time base oven cold (Option 002 instruments only).		Wait for oven to warm for highest accuracy.
17	IF level not within its measurement range.	Input signal level during reference measurement must be between 1.25V and 2.50V. (Option 030 only.)	Check selected RF or IF gain. Refer to Increasing Sensitivity (2-7) . (When making Ratio measurements, allow instrument to complete the reference measurement.)
20	Frequency entered exceeds measurement range.		Re-enter frequency within measurement range. (In Ratio mode, a reference measurement of zero is invalid.)
21	Invalid entry.		Check compatibility of function(s) with selected measurement mode.
22	Invalid Special Function prefix entered.		Check Special Function number and re-enter.
23	Invalid Special Function suffix entered.		Check Special Function number and re-enter.
25	Selected Special Function not compatible with measurement mode Special Function(s).		Check Special Function compatibility with measurement.
30	Inappropriate RF attenuation or gain setting.		Check RF attenuation and gain settings.
32	Inappropriate IF gain setting.		Check IF gain setting.

3

More about Modulation and Audio Measurements

In This Chapter

This chapter introduces the HP 8902A's special operating capabilities that enable you to adapt its modulation and audio measurements to your specific test conditions. (To use these special capabilities effectively, you should first become familiar with the basic operating capabilities and measurement ranges described in *Chapter 1* for the Modulation and Audio measurements.)

This chapter enables you to reference directly to the information you are interested in. The information is organized into three subject areas.

- **Calibration** - Refer here for the procedure to calibrate your AM and FM measurements.
- **Extending Operation** - Refer here for the special operating capabilities that enable you to adapt the HP 8902A to meet the specific conditions of your input signal.
- **Help** - Refer here for help in solving setup or operating problems encountered in Modulation or Audio measurements.

The Directory

Use the directory diagram below to quickly locate the subject you are interested in. A look-up table is located on the first page of each subject area. Use the look-up table to reference to the topics included for that subject.

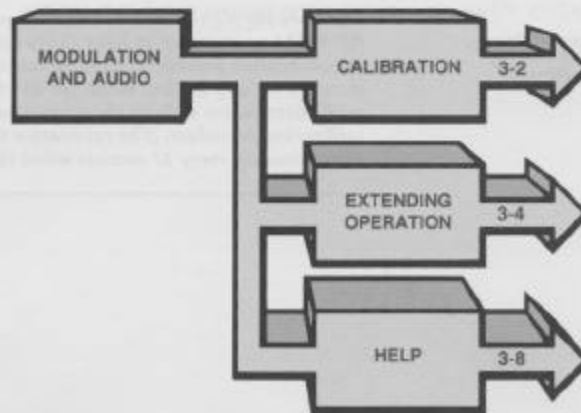

Calibration

The HP 8902A meets its specified AM and FM measurement accuracy without needing any additional calibration other than the recommended procedure performed annually to re-calibrate the entire instrument. The following calibration procedure allows you to further enhance the accuracy of your AM and FM measurements, however.

AM and FM Calibration

By making comparative measurements against a known modulation level (provided by the AM/FM CALIBRATION output port), the instrument creates a calibration factor that can be used to minimize measurement error. Once the calibration factor has been created, you have control over when it is used by the instrument. (There is not a calibration procedure for the Φ M measurement.)

The following chart lists the special function codes for enabling, disabling, or displaying the calibration factor. After you have enabled the calibration factor, the HP 8902A will automatically apply it to its AM or FM measurements.

Calibration Factor	AM	FM
Disable	16.0 SPCL	17.0 SPCL
Enable	16.1 SPCL	17.1 SPCL
Display	16.2 SPCL	17.2 SPCL



Note

To ensure the highest possible measurement accuracy, allow the HP 8902A to warm up at least thirty minutes before performing the calibration procedure. Also, to ensure that the measurement circuitry is fully settled, allow the HP 8902A to update the calibration factor at least three times before completing the calibration procedure. (The calibration factor is updated approximately every 17 seconds while the Calibrator is on.)

1. Connect the HP 11722A Sensor Module (or a 50 ohm cable and Type-N adapter) from the INPUT 50Ω port to the AM/FM CALIBRATION output port (lower left corner on front panel).
2. Press the AM or FM key to select the measurement you wish to calibrate. You will need to repeat this entire procedure twice if you wish to calibrate both your AM and FM measurements.
3. Press the CALIBRATE key to turn on the Calibrator. Wait for the Calibration Factor to be displayed. The calibration factor will be displayed as a percentage. This percentage indicates the relationship between the HP 8902A's measurement and the actual output of the Calibrator. (For example, a calibration factor of 100% indicates that the measured value is exactly the same as the calibrator output value. Likewise, a calibration factor of 100.17% indicates that the HP 8902A is measuring .17% above the Calibrator's actual output.)

Remember

While the HP 8902A is in the Calibration mode (Calibrator key lit), the calibration factor is stored in the instrument's non-volatile memory each time it is updated (approximately every 17 seconds). To ensure that the measurement circuitry is fully settled, allow the instrument to update the calibration factor at least three times before proceeding.

4. Press the Blue Shift key and then the SAVE CAL key (only when in the Calibration mode) to enable the calibration factor (the same as entering 16.1 or 17.1 SPCL when not in the Calibration mode). Wait for the calibration factor to be displayed.
5. Press the CALIBRATE key to turn off the Calibrator. The calibration procedure is complete. You can now connect the HP 8902A to your signal source and be assured that you are making the most accurate modulation measurements possible with the HP 8902A.

Extending Operation

If You Need to Know:

Refer to:

Frequency

- *How to make sure you are tuned to the carrier* **Check Tuning (3-4)**
- *How to tune to the carrier when other RF signals or harmonics are present* **Increasing Selectivity (3-5)**
- *How to retune to a new input frequency* **Changing Frequency (3-5)**
- *How to tune to a noisy carrier* **Noisy Carrier (3-6)**
- *How to track a drifty carrier* **Drifty Carrier (3-6)**
- *How to measure modulation on a carrier above 1300 MHz* **Frequency Overrange (3-6)**
- *How to measure modulation on a carrier below 150 kHz* **Frequency Underrange (3-6)**

Amplitude

- *How to tune to a carrier below -30 dBm* **Increasing Sensitivity (3-7)**
- *How to tune to a carrier whose amplitude is very unstable* **Unstable Carrier (3-7)**

Check Tuning

For most applications, the HP 8902A's Auto Tuning mode enables the instrument to automatically tune to the input signal. (Auto Tuning mode is the right choice for measuring modulation on a single, stable carrier.) The HP 8902A will inform you that it is having difficulty tuning by placing dashes, error codes, or a very inaccurate reading in its display.

You can check what frequency the HP 8902A is currently tuned to at any time during the measurement by pressing the **Blue Shift** key and then the **DISPLAY FREQ** (\uparrow kHz) key. A way to ensure that the instrument is tuned to the desired frequency is to manually tune it by keying in the input frequency and then pressing the **MHz** key. (If you are interested in details on how the instrument operates in its Manual Tuning mode, refer to *Chapter 2*.)

Increasing Selectivity

The selectivity of your modulation and audio measurements above 10 MHz can be increased by selecting the 455 kHz IF. Key in 3.1 SPCL to select the 455 kHz IF with a 200 kHz bandwidth, or key in 3.7 SPCL to select 455 kHz IF with maximum selectivity of 30 kHz. (Note that the 455 kHz IF should only be selected for measuring modulation rates below 10 kHz.) To further increase the selectivity of your measurement, select low-pass, high-pass, or bandpass audio filtering using the Audio Filter keys on the front panel.

The HP 8902A's Auto Tuning mode is able to automatically find and tune to the fundamental in a harmonically-rich spectrum as long as the fundamental is at least 10 dB above the level of the second and third harmonics. The HP 8902A will also auto tune to the carrier if the carrier is at least 30 dB above all non-harmonically related RF signals. If, however, your input signal does not meet these criteria, the HP 8902A may have difficulty auto tuning to the carrier. If the HP 8902A tunes to a signal other than the carrier, it will cause the instrument to display modulation and audio readings for that signal rather than the carrier.

To check what RF frequency the HP 8902A is actually tuned to, press the **FREQ** key. If the instrument does not display the correct carrier frequency, manually tune the HP 8902A to the carrier frequency; key in the frequency of the carrier and then press the **MHz** key. (Refer to *Chapter 2* for details on the Auto Tuning and Manual Tuning modes.)

Changing Frequency

Although the HP 8902A is not designed for swept measurement applications, its Auto Tuning mode does enable it to automatically search for the carrier signal when carrier frequency is changed. (For details on the capabilities and limitations of Auto Tuning mode operation, refer to *Chapter 2*.)

Noisy Carrier

Excessive noise or low-rate (below 20 Hz), high-deviation (greater than 400 kHz) FM on the carrier signal can make it difficult for the HP 8902A to auto tune to the carrier. If you know that your carrier is noisy, or if the HP 8902A indicates it is having difficulty setting up the measurement by continuously displaying four dashes, manually tune the HP 8902A to the carrier frequency. Simply key in the frequency of the carrier and then press the **MHz** key. If the HP 8902A does not display a measurement reading, press the **TRACK MODE** key. (Refer to *Chapter 2* if you are interested in details on how the instrument operates in Manual Tuning mode and Track mode.)

Drifty Carrier

The HP 8902A is able to track drifting or noisy RF signals without sacrificing measurement bandwidth or level sensitivity. A drifting input signal can cause the instrument to continuously display four dashes (Auto Tuning mode) or display Error 01 (Manual Tuning mode). Press the **TRACK MODE** key to select the wide IF-bandwidth track mode function. Track Mode can be selected with either the Auto or Manual tuning modes. Note that the Track Mode function reduces the low frequency response of modulation measurements and increases the level of residual modulation. (For details on the capabilities and limitations of Track Mode operation, refer to *Chapter 2*.)

Frequency Overrange

There are three techniques for extending the HP 8902A's frequency range above 1300 MHz: internal harmonic mixing, external local oscillator and mixer down-conversion, and down-conversion with a spectrum analyzer. All three techniques extend the AM, FM, and Φ M measurement capabilities of the HP 8902A to microwave frequencies. Refer to *Chapter 5* for measurement examples using these tuning techniques.

Frequency Underrange

The specified low frequency limit of the HP 8902A is 150 kHz. However, you can extend this measurement range to below 50 kHz. The procedure is simple. First, manually tune the HP 8902A to 100 MHz and override Error 01 by keying in **8.1 SPCL**. This enables the input signal to pass directly through the input mixer without frequency conversion. Next, suppress IF feedthrough by selecting the 3 kHz or 15 kHz low-pass filter. The analyzer is now ready to make modulation measurements. If you wish to display the carrier frequency, key in **34.0 SPCL** (press the **AM** key to return to the AM measurement mode).

Increasing Sensitivity

Two dashes or 0 MHz in the display indicates that the level at the input signal is below the HP 8902A's present measurement range. However, the HP 8902A's special function capabilities enable you to make modulation and audio measurements on carrier signals down to -75 dBm.

The special function codes and their respective ranges are shown in Diagram 3-1. (Keep in mind that these special functions add gain in the RF and IF paths. Enabling them for an input signal that exceeds the designated range for that special function (as shown in Diagram 3-1) may cause the instrument to overrange and display Error 02.) If you do not know the output level of your source, sequence through the ranges until the HP 8902A displays a measurement reading.

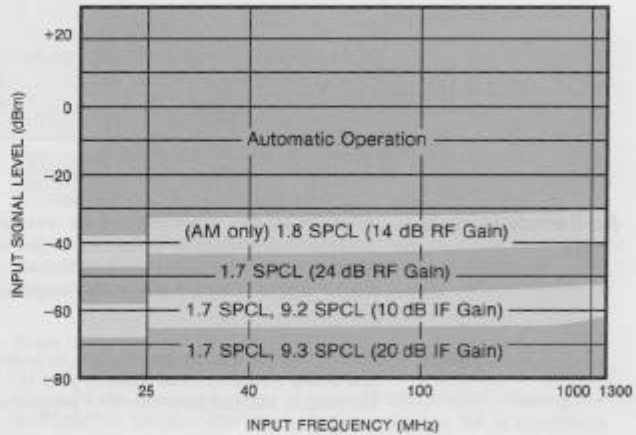

Diagram 3-1. Typical Modulation and Audio Measurement Ranges

Unstable Carrier

If you are measuring modulation on a carrier signal whose RF level does not remain above -20 to -25 dBm (for example, a carrier that is being pulsed on and off), select the Manual Tuning mode by keying in the frequency of your carrier signal and then pressing the **MHz** key. In Manual Tuning mode, the instrument will remain locked at the frequency of the carrier after the carrier is turned off. (For details on the instrument's operation when in the Manual Tuning mode, refer to Chapter 2.)

Help

If You Need to Know:

Refer to:

Setup

- *How to measure modulation or audio without using a Sensor Module* **No Sensor Module (3-8)**
- *How to make automated modulation or audio measurements* **HP-IB (3-8)**
- *How to connect an external time base* **Time Base (3-8)**

Measurement

- *How to interpret an error code, dashes, or questionable measurement* **Solving Measurement Problems (3-8)**

No Sensor Module

A Sensor Module is not required for making modulation or audio measurements. To make measurements without a Sensor Module, simply connect a 50 Ω cable and Type-N adapter from the HP 8902A's INPUT port to the output of your signal source.

HP-IB

The HP 8902A enables you to fully automate your modulation and audio measurements. Refer to your HP 8902A Operation and Calibration Manual for set-up and programming information.

Time Base

A time base input is provided on the rear panel of the HP 8902A. This input allows you to connect the HP 8902A to an external 10 MHz time base. The time base circuitry within the HP 8902A automatically switches to the external time base and turns off the time base output when an external time base of sufficient amplitude (0.5 Vpp) is applied at the input. To verify that an external time base is being used, key in **15.1 SPCL**. The instrument will display a 1 if the external time base is being used or a 0 if the internal time base is being used.

Solving Measurement Problems

The HP 8902A has been designed to feed back information about its operating status. When the HP 8902A detects that the input signal or operating conditions are preventing it from making an accurate, reliable measurement, it alerts you by placing an error or dash code in its display.

The circumstances that can cause the HP 8902A to display an error code are classified into one of two categories:

- **Input Problem**, caused by input signal conditions, or
- **Operating Problem**, caused by the selection of incompatible operating functions.

Certain errors are caused *only by an input problem*, other errors are caused *only by an operating problem*, and some errors can be caused by either.

The errors that can be caused *only by an input problem* and the errors that can be caused *only by an operating problem* are listed in the chart below.

If your instrument is displaying one of these errors, proceed directly to **Table 3-1. Modulation and Audio Error Codes** and take the recovery action recommended.

	Input Problem	Operating Problem
Error	05, 08, 10, or 16	09, 11, 12, 20 thru 25, 30, or 32

If you did not find your error listed in the chart, or if your instrument is displaying dashes or a questionable measurement, perform the following procedure.

1. Press the **green AUTOMATIC OPERATION** key. This cancels all function settings that can cause the HP 8902A to display an error code.
2. Compare the operating status of your HP 8902A after pressing the **AUTOMATIC OPERATION** key with the following list of conditions. After you have identified the description that best describes your instrument's condition, take the action recommended for that condition.

Same Error

If the error or reading remains the same after the **AUTOMATIC OPERATION** key has been pressed, the error is being caused by an input problem. Look up the error code in Table 3-1 and take the action recommended for "Input Problem".

No Error

If the error goes away after the **AUTOMATIC OPERATION** key has been pressed, the error was caused by an operating problem. Look up the error code in Table 3-1 and take the action recommended for "Operating Problem".

New Error

If the error is replaced by a different error or dash code after the **AUTOMATIC OPERATION** key has been pressed, the original error was being caused by a combined input problem and operating problem. Look up the error code displayed by the instrument *after* the **AUTOMATIC OPERATION** key was pressed. Take the action recommended for "Input Problem".



Remember

Because of the wide variety of input signals and the operating flexibility of the HP 8902A, it is not possible to list all recovery actions for each error code. After using the table to determine the cause of the problem, you may discover other error recovery procedures that are better suited to your application.

Table 3-1 Modulation and Audio Error Codes (1 of 3)

Display Code	Problem Description	Input Problem	Operating Problem
Questionable Measurement	1. Measurement is very inaccurate. 2. Measurement is slightly inaccurate.	1. Check tuning mode. Refer to Increasing Selectivity (3-5) or Drifty Carrier (3-6) . Check modulation source. 2. Check Calibration (3-2) .	Recheck operating conditions being used.
-- or 0 MHz	Input signal level below measurement range.	Increase input signal level or increase measurement sensitivity. Refer to Increasing Sensitivity (3-7) .	Decrease RF attenuation. Refer to Increasing Sensitivity (3-7) .
----	Instrument has detected an input signal and is attempting to set up measurement. Continuous display indicates instrument is having difficulty tuning to the input signal.	Manually tune to input signal. Refer to Noisy Carrier (3-6) .	Re-check operating conditions being used.
01	IF signal within IF passband but not centered well enough to guarantee measurement accuracy (due to manual tuning). High AM depth (>95%) on low-level carrier.	Increase carrier signal level or decrease AM. Refer to Increasing Sensitivity (3-7) .	Press the MHz key to center IF signal in IF passband. If problem persists, signal may be drifting. Refer to Drifty Carrier (3-6) .

Table 3-1 Modulation and Audio Error Codes (2 of 3)

Display Code	Problem Description	Input Problem	Operating Problem
02	Input circuits overdriven.	Increase RF input attenuation. Refer to <i>Increasing Sensitivity (3-7)</i> .	Decrease RF and/or IF gain setting. Refer to <i>Increasing Sensitivity (3-7)</i> .
03	Input circuits underdriven.	Increase gain. Refer to <i>Increasing Sensitivity (3-7)</i> .	Decrease RF input attenuation or increase IF gain. Refer to <i>Increasing Sensitivity (3-7)</i> .
04	Modulation level on input signal exceeds modulation range limit.	Decrease modulation level on input signal to within measurement range.	Increase range limit setting, Special Function 2.N.
05	AM depth is too high (>90%) for carrier level while making FM or Ψ M measurements.	Increase carrier level or decrease AM depth (<90%).	
06	Input circuits overdriven.	Input level exceeds 7 Vrms (1W peak). Decrease level of input signal.	Decrease RF and/or IF gain setting. Refer to <i>Increasing Sensitivity (3-7)</i> .
07	Modulation on input signal exceeds measurement range.	Decrease modulation level on input signal.	Increase limit setting, Special Function 2.N.
08	Calibrator output not sensed at INPUT.	Check connection to Calibrator. Check for Calibrator malfunction.	
09	High stability time base problem (Option 002 instruments only).		Check internal time base for malfunction.
10	Frequency of input signal is not within measurement range.	Adjust frequency of input signal to within measurement range, or increase measurement range. Refer to <i>Frequency Overrange (3-6)</i> and <i>Frequency Underrange (3-6)</i> .	

Table 3-1 Modulation and Audio Error Codes (3 of 3)

Display Code	Problem Description	Input Problem	Operating Problem
11	dB Ratio measurement results in calculated value ≤ 0 (log 0 not allowed).		Key in a different ratio reference.
12	Indicates internal time base oven cold (Option 002 instruments only).		Wait for oven to warm for highest accuracy.
16	Level of audio signal at Audio Input too low.	Increase audio signal level.	
17	IF level not within its measurement range.	Input signal level during reference measurement must be between 1.25V and 2.50V.	Check selected RF or IF gain level. Refer to Increasing Sensitivity (3-7) . (When making Ratio measurements, allow instrument to complete the reference measurement.)
20	Frequency entered exceeds measurement range.		Re-enter frequency within measurement ranges. (In Ratio mode, a reference measurement of zero is invalid.)
21	Invalid entry.		Check compatibility of function(s) with selected measurement mode.
22	Invalid Special Function prefix entered.		Check Special Function number and re-enter.
23	Invalid Special Function suffix entered.		Check Special Function number and re-enter.
25	Selected Special Function not compatible with measurement mode Special Function(s).		Check Special Function compatibility with measurement.
30	Inappropriate RF attenuation or gain setting.		Check RF attenuation and gain settings.
32	Inappropriate IF gain setting.		Check IF gain setting.

4

More about RF Power and Tuned RF Level Measurements

In this Chapter

This chapter introduces the HP 8902A's special operating capabilities that enable you to adapt its RF Power and Tuned RF Level (TRFL) measurements to your specific test conditions. (To use these special capabilities effectively, you should first become familiar with the basic operating capabilities and measurement ranges described in *Chapter 1* for the RF Power and TRFL measurements.)

This chapter enables you to reference directly to the information you are interested in. The information is organized into three subject areas.

- **Calibration** - Refer here for information about the RF Power and TRFL calibration technique.
- **Extending Operation** - Refer here for the special operating capabilities that enable you to adapt the HP 8902A to meet the specific conditions of your input signal.
- **Help** - Refer there for help in solving setup or operating problems encountered in RF Power or TRFL measurements.

The Directory

Use the directory diagram below to quickly locate the subject you are interested in. A look-up table is located on the first page of each subject area. Use the look-up table to reference to the topics included for that subject.

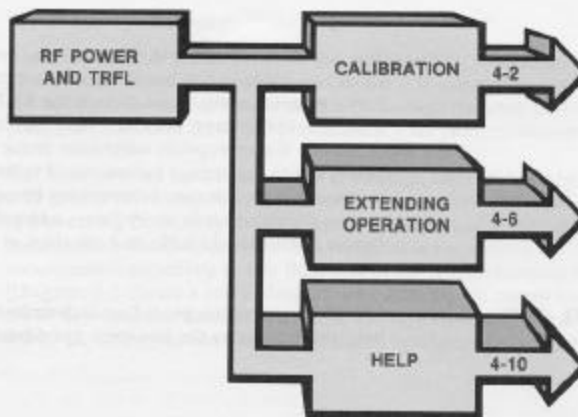

Calibration

If You Need to Know:	Refer to:
• <i>How to maintain RF Power calibration</i>	RF Power Calibration (4-2)
• <i>More about the TRFL calibration technique</i>	TRFL Calibration (4-3)
• <i>The accuracy of TRFL measurements</i>	TRFL Accuracy (4-5)

RF Power Calibration

The RF Power calibration procedure is shown in *Chapter 1* of this guide. Once the procedure has been completed it does not need to be repeated again unless you change Sensor Modules or the calibration factors for the Sensor Module you are using change (due to repair or recalibration of the Sensor Module). (If the Sensor Module or the calibration factors are changed, you will need to complete the calibration factor entry procedure provided in *Appendix B* before proceeding with the calibration procedure shown in *Chapter 1*.)

To Maintain Accuracy

To maintain calibration accuracy, it is necessary to periodically press the **ZERO** key (approximately once every ten minutes while making RF Power measurements is recommended and each time you connect the sensor to a different output port). Pressing the **ZERO** key enables the HP 8902A to compensate for any inherent, dc-offset error in the measurement system caused by changes in the ambient operating temperature.

Tuning

You may remember that in *Chapter 1* you were told that the HP 8902A should be tuned to the frequency of the input signal when making RF Power measurements. Even though the RF Power measurement is not a tuned measurement, the instrument uses the frequency setting to determine the appropriate calibration factor to select from the table of power sensor calibration factors stored in its memory. (If a calibration factor is not stored for the specific frequency being measured, the HP 8902A derives a calibration factor by linear interpolation between the closest calibration factors in the storage table on both sides of the measurement frequency.)

TRFL Calibration

The TRFL calibration procedure is described in *Chapter 1*. Table 4-1 will help you remember the key steps to calibrating your TRFL measurements.

Table 4-1. Tuned RF Level Calibration Procedure

Key Steps	Considerations		
1. Set the level of your signal source to between 0 and -20 dBm (0 dBm is optimum).	The three RF measurement ranges must be calibrated sequentially beginning with Range 1.		
	IF Detector		
	Range	Synchronous	Average
	1	0 dBm	0 dBm
	2	-40 dBm	-15 dBm
	3	-80 dBm	-50 dBm
2. Tune the HP 8902A to the frequency of your signal source.	<p>Manually: Key in the frequency and press the MHz key, or</p> <p>Automatically: Press the FREQ key and select Auto Tuning. After the frequency is displayed, press the MHz key to select Manual Tuning and then re-enter the TRFL measurement mode.</p>		
3. Press the CALIBRATE key each time the RECAL annunciator lights.	The RECAL annunciator will only appear three times for each frequency (once for each measurement range). Remember not to change the input signal level during calibration (while the CALIBRATE key is lit).		

The IF Synchronous Detector

The calibration procedure described in *Chapter 1* enables you to make TRFL measurements using the HP 8902A's IF Synchronous detector. The IF Synchronous detector makes a very narrow band (200 Hz) power measurement and provides the greatest TRFL measurement sensitivity (-127 dBm). (The IF Synchronous detector is the default selection for the HP 8902A.)

The IF Average Detector

A second detector is also available for making TRFL measurements. This detector is the IF Average detector and it is selected by keying in **4.4 SPCL**. After you have selected the IF Average detector, perform the procedure shown in Table 4-1 to calibrate your TRFL measurements.

The measurement bandwidth of the IF Average detector is set by a 30 kHz IF filter. (A 200 kHz IF filter can also be selected, refer to **Increasing Selectivity** in this chapter for details). The increased measurement bandwidth of the IF Average detector reduces its measurement sensitivity to less than that of the IF Synchronous detector. (Diagram 4-1 shows a comparison of the measurement ranges for the IF Synchronous detector and the IF Average detector.) Key in **4.0 SPCL** when you wish to reselect the IF Synchronous detector.

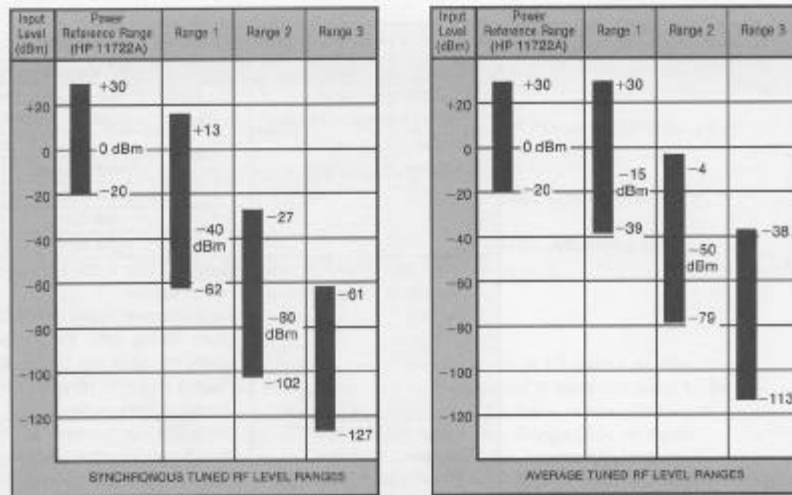

Diagram 4-1. The Measurement Ranges for the IF Synchronous and IF Average Detectors

The Calibration Technique

You may remember, that in the TRFL calibration procedure in Chapter 1 you were instructed to adjust the input signal to specific levels (0, -40, and -80 dBm). Note in Diagram 4-1 that each of the specified levels is within the overlap (calibration) region between two RF measurement ranges for the IF Synchronous detector. When you adjusted the input signal to each of these levels the RECAL annunciator in the display was lit and you were instructed to press the **CALIBRATE** key.

Range 1

When you pressed the **CALIBRATE** key to calibrate Range 1, the HP 8902A measured the level of the input signal twice. Once using its RF Power meter circuitry and once using the IF Synchronous detector and the Range 1 circuit configuration. By comparing the two measurements, the HP 8902A created a TRFL calibration factor for Range 1 that equated the Range 1 measurement to the calibrated RF Power measurement. This TRFL calibration factor transferred the absolute accuracy of the RF Power measurement to all Range 1 TRFL measurements made at that frequency.

Remember



*This double measurement technique makes it very important that the level of the input signal remain stable throughout the calibration process (while the **CALIBRATE** key is lit).*

Relative TRFL Measurements

The RF Power measurement-to-Range 1 transfer uncertainty is ± 0.06 dB. This transfer uncertainty can be eliminated by using the HP 8902A's SET REF mode to make relative power measurements. When the **SET REF** key is pressed, the HP 8902A establishes the current level of the input signal as the 0 dB-reference for Range 1. The SET REF mode enables the HP 8902A to measure relative level changes of linear devices, such as attenuators, directly and accurately. (Refer to Chapter 5 for an example of how the SET REF mode is used for attenuator testing.)

Ranges 2 and 3

The double measurement calibration technique is also used to transfer measurement accuracy from Range 1 to Range 2 and from Range 2 to Range 3. The Range 1 to Range 2 and Range 2 to Range 3 transfer uncertainty is ± 0.04 dB.

IF Ranges

In addition to the operating changes that occur within the HP 8902A to produce the three RF measurement ranges, there are also operating changes that occur within each of the three RF measurement ranges. These changes occur as 10 dB amplifiers in the IF path are switched in, and as the selected IF detector is stepped over its 15 dB measurement range. Because the amplifiers and IF detector are very linear, the typical range-to-range error for the amplifiers is less than ± 0.02 dB per change, and detector linearity uncertainty (for the IF Synchronous detector) is less than ± 0.02 dB over each RF measurement range (1 through 3).

TRFL Accuracy

Although calculating precise measurement uncertainty for a TRFL measurement can involve several uncertainty factors, Graph 4-1 demonstrates that even for worst case the total TRFL measurement uncertainty is minimal.

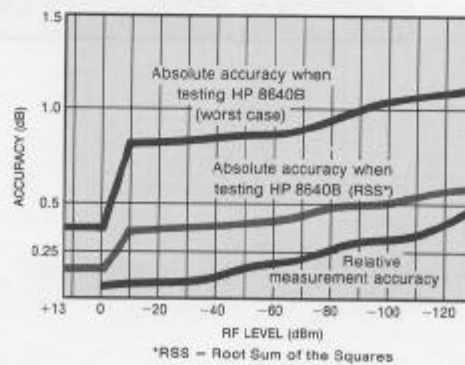

Graph 4-1. Tuned RF Level Measurement Accuracy.

Extending Operation

If You Need to Know:

Refer to:

Frequency

- How to tune to the input signal **Tuning (4-7)**
- How to measure TRFL when other RF signals or spurs are present **Increasing Selectivity (4-7)**
- How to quickly repeat TRFL measurements at various frequencies..... **Repeating Measurements (4-8)**
- How to measure the TRFL of a noisy input signal **Noisy Signal (4-8)**
- How to measure the TRFL of a drifty input signal **Drifty Signal (4-9)**
- How to measure the TRFL of an input signal above 1300 MHz **Frequency Overrange (4-9)**
- How to measure the TRFL of a signal below 2.5 MHz **Frequency Underrange (4-9)**

Amplitude

- How to measure a low-level signal source that can not be increased to above -20 dBm **Low-Level Signal (4-9)**
- How to minimize measurement uncertainty due to SWR **Input Impedance (4-9)**

Tuning

Both the RF Power and TRFL calibration techniques require that the HP 8902A is tuned to the frequency of the input signal. As shown in Chapter 1, there are two ways to tune to the input signal. If you know the frequency of your input signal, the most direct way to tune is by keying in the frequency of the input signal and then pressing the **MHz** key. If you do not know the input frequency, set the input signal level to between 0 and -20 dBm, then press the **FREQ** key, the **Blue Shift** key, and the **AUTO TUNING** key on the HP 8902A. When the HP 8902A displays the frequency of the input signal, press the **MHz** key to select Manual Tuning, and then re-enter the TRFL measurement mode and proceed with your measurement.

Increasing Selectivity

To minimize the possibility of unwanted low frequency and spurious signals entering the passband of the TRFL measurement, a high-pass RF filter and bandpass IF filter can be selected. (Table 4-2 shows the filter configurations possible for the TRFL measurement.) Remember that when using the IF Average detector, the IF filters determine measurement bandwidth. (Be sure to select the desired filters before performing the TRFL calibration.)

Table 4-2. Filter Configurations

RF High-Pass Filter (5.25 MHz)	Wide IF Filter	Narrow IF Filter (30 kHz BW)	Key Sequence
OUT	Automatic Selection		3.0 SPCL
OUT	200 kHz BW	OUT	3.1 SPCL
IN	200 kHz BW	OUT	3.3 SPCL
OUT	200 kHz BW	IN	3.5 SPCL
OUT	2.5 MHz Low-Pass	IN	3.6 SPCL
IN	200 kHz BW	IN	3.7 SPCL
IN	2.5 MHz Low-Pass	IN	3.8 SPCL

Repeating Measurements

You can quickly repeat TRFL measurements at various frequencies using the HP 8902A's eight storage registers. After you have completed the TRFL calibration procedure at a given frequency, set the level of the input signal to between 0 and -20 dBm (so that the HP 8902A is in measurement Range 1). Then press the **Blue Shift** key, the **STORE (7)** key and a digit key (**1-8**) to store the instrument's complete operating condition including calibration data into one of the instrument's storage registers.

All of the HP 8902A's current operating conditions including calibration data will be retained in the selected storage register through power down. Whenever you wish to repeat the TRFL measurement at the given stored frequency, select the appropriate register by pressing the **Blue shift** key, the **RECALL (8)**, key and the appropriate digit key. The instrument will restore all of its operating conditions to the configuration that existed when the storage register was selected. This means the instrument is once again configured to make TRFL measurement at the previously calibrated frequency. (Keep in mind that calibration is not source dependent; that is, once the HP 8902A has been calibrated at a given frequency it can be used to measure your other signal sources set at the same frequency as well.)

Noisy Signal

If the input signal is noisy, unstable, or has greater than 100 Hz FM, the narrow-band IF Synchronous detector may have difficulty remaining locked to the input signal. The instrument will indicate that the input signal is not stable enough for the IF Synchronous detector to tune to by continuously displaying six dashes, or by alternating six dashes then four dashes in its display. To measure the TRFL of noisy signals, select the wider-band IF Average detector by keying in **4.4 SPCL**. After the IF Average detector is selected, the calibration procedure is the same as for the IF Synchronous detector (as shown in **Calibration** in this chapter). (Note that the IF Average detector must be selected prior to calibrating Range 1.) The measurement bandwidth of the IF Average detector is determined by the IF filter selected (refer to **Increasing Selectivity** for filter information).

For added noise correction when using the IF Average detector to measure low-level signals, key in **31.1 SPCL*** when you select the IF Average detector (that is prior to calibrating Range 1). (This function should only be used when a Sensor Module is being used with the HP 8902A.) This function causes the instrument to create an additional calibration factor for Range 3 (-60 to -100 dBm) which it uses to compensate for any residual noise inherent within the measurement system.

The noise correction function (31.1) is maintained through instrument power down. To turn off noise correction, key in **31.0 SPCL**.

* This capability is available on instruments serial prefixed 2535A and above.

Drifty Signal

If the input signal is drifting, the IF Synchronous detector may have difficulty remaining locked to the input signal. The instrument will indicate that it is having difficulty by placing six dashes or Error 01 in its display.

The wider measurement bandwidth of the IF Average detector makes it more tolerant of signal drift. Press the green **AUTOMATIC OPERATION** key and then key in **4.4 SPCL** to select the IF Average detector for your TRFL measurements. (Note that the Track Mode function is not available for TRFL measurements.)

Frequency Overrange

There are three techniques for extending the HP 8902A's frequency range above 1300 MHz; internal harmonic mixing, external local oscillator and mixer down conversion, and down-conversion with a spectrum analyzer. All three techniques extend the measurement capabilities of the HP 8902A to microwave frequencies. Refer to *Chapter 5* for measurement examples using these tuning techniques.

Frequency Underrange

The specified low frequency limit of the TRFL measurement is 2.5 MHz. However, you can extend this measurement range to approximately 900 kHz; the procedure is simple. Connect your signal source to the HP 8902A and adjust the source level to between 0 and -20 dBm. Press the **Blue Shift** key and the **INSTR PRESET** key on the HP 8902A. Manually tune the HP 8902A to 5 MHz. When Error 01 is displayed, select the TRFL measurement. Manually tune the HP 8902A to the frequency of the input signal. When the signal level is display, proceed with TRFL calibration.

Low-Level Signal

To measure the TRFL of a signal source that can not be set to a level between 0 and -20 dBm, simply use a second signal source whose level can be set between 0 and -20 dBm to perform the calibration procedure. Connect the HP 8902A to the second signal source and adjust the signal source frequency to the frequency of the signal to be tested. After you have completed the calibration procedure using the second source, reconnect the HP 8902A to the signal source to be tested and measure its TRFL.

Input Impedance

To improve the SWR characteristics of your TRFL measurements, an internal, fixed 10 dB pad can be inserted at the INPUT of the HP 8902A. Inserting this pad enables the HP 8902A to maintain a constant input impedance over its entire measurement range. Key in **1.9 SPCL** to insert the fixed 10 dB pad. (Note that the SPCL key does not remain lit.) The instrument continues to operate in its Automatic Operation mode except that the 10 dB pad is now always inserted. (Note that Special Function 1.9 decreases the sensitivity of Range 3 by 10 dB.)

Help

If You Need to Know:	Refer to:
Setup	
• How to change to another Sensor Module	Changing Sensor Modules (4-10)
• How to measure RF Power or TRFL without using a Power Sensor	No Power Sensor (4-11)
• How to automate your RF Power or TRFL measurements	HP-IB (4-12)
• How to connect an external time base	Time Base (4-12)
Measurement	
• Which measurement to choose for your application	RF Power vs TRFL (4-12)
• How to interpret an error code, dashes or questionable measurement	Solving Measurement Problems (4-13)

Changing Sensor Modules

Long Term

If you are replacing the Sensor Module with another Sensor Module, refer to *Appendix B* in this guide for the procedure for entering the calibration data for the new Sensor Module into the HP 8902A.

Short Term

If you are only using the new Sensor Module temporarily, you can manually enter the appropriate cal factor for each RF Power measurement. (Refer to your HP 8902A Operation and Calibration Manual for the procedure and considerations for manually entering cal factors.)

Interchangeably

If you plan to use two sensors interchangeably, a second storage table is available in the HP 8902A's non-volatile memory. This table is designed to be used in the instrument's Frequency Offset Mode. (In this mode an external local oscillator (LO), a microwave down-converter, and a mixer are typically used to extend the frequency range of the HP 8902A. Refer to your HP 8902A Operation and Calibration Manual for details on using the Frequency Offset Mode.)

By specifying an offset frequency of zero, the Frequency Offset table can also be accessed for measurements when an external LO is not being used. Simply key in **27.3 SPCL** and then **0 MHz** (the FOFS annunciator will light in the display). The instrument is now ready to store the calibration factors (up to 22) for the second Sensor Module in the Frequency Offset table using the entry procedure shown in *Appendix B*.

Once the cal factors have been stored, key in **27.0 SPCL** when you wish to exit the Frequency Offset Mode and use the first Sensor Module. To re-enter the Frequency Offset Mode and use the second Sensor Module, key in **27.1 SPCL**.

No Power Sensor**RF Level (uncalibrated)**

To make an uncalibrated RF power measurement without a power sensor, connect a 50 Ω cable and Type-N connector from the HP 8902A's INPUT port to the output of your signal source. Press the **RF POWER** key. The HP 8902A will make an uncalibrated broadband power measurement using its RF Peak detector. (Note that the HP 8902A lights the **SPCL** key rather than the **RF POWER** key when it is using the uncalibrated RF Peak detector to measure power.) Although the accuracy of this measurement is significantly lower than a calibrated power measurement made using a power sensor, it can be useful as a means of determining if there is any input signal present at the HP 8902A's input. If a Sensor Module is connected to the HP 8902A, the RF Peak detector can be selected by keying in **35.0 SPCL**.

Tuned Level (uncalibrated)

To make an uncalibrated Tuned Level measurement (either with a Sensor Module connected to the HP 8902A or with a BNC cable and Type-N connector connected at the INPUT port) tune the HP 8902A to the frequency of the input signal and key in **36.0 SPCL**. The HP 8902A will make an uncalibrated Peak Tuned Level measurement. Although the accuracy of this measurement is significantly lower than a calibrated TRFL measurement, it can be useful for measuring input signals that are drifting.

TRFL (calibrated)

The relative power measurement mode (SET REF) allows you to make calibrated TRFL measurements without using a power sensor. An example of this measurement technique is provided in *Chapter 5*.

HP-IB

The HP 8902A enables you to fully automate your RF Power and TRFL measurements. Refer to your HP 8902A Operation and Calibration Manual for set up and programming information.

Time Base

A time base input is provided on the rear panel of the HP 8902A. This input allows you to connect the HP 8902A to an external 10 MHz time base reference. The time base circuitry within the HP 8902A automatically switches to the external time base and turns off its time base output when an external time base of sufficient amplitude (0.5 Vpp) is applied at the input. To verify that an external time base is being used, key in **15.1 SPCL**. The instrument will display a 1 if the external time base is being used or a 0 if the internal time base is being used.

RF Power vs TRFL**Bandwidth**

The fundamental difference between the RF Power and TRFL measurement is their measurement bandwidth. The measurement bandwidth for the RF Power measurement is set by the bandwidth of the power sensor being used. For instance, the measurement bandwidth of the power sensor used in the HP 11722A Sensor Module is 4 GHz, therefore the RF Power measurement bandwidth of the HP 8902A is 4 GHz when used with the HP 11722A. Select the RF Power measurement when you wish to measure total power of all modulation, sidebands, harmonics, and spurious on the signal (as you would using an HP 436A or HP 438A type power meter).

The measurement bandwidth of the TRFL measurement is much narrower than that of the RF Power measurement. When the IF Synchronous detector is used to make a TRFL measurement, measurement bandwidth is 200 Hz.

When the IF Average detector is selected, measurement bandwidth is determined by the bandwidth of the IF filter being used (30 kHz or 200 kHz). (The 30 kHz filter is automatically chosen by the instrument when the IF Average detector is selected; refer to **Increasing Selectivity** in this chapter for filter selection information.) The IF Average detector measures the total power of the signals and noise present within the IF filter passband. Select the TRFL measurement mode when you want to make calibrated tuned level measurements of discrete input signals.

Sensitivity

The most apparent difference between the TRFL measurement and the RF Power measurement is the increased measurement sensitivity offered by the TRFL measurement. Since sensitivity is directly related to measurement bandwidth, TRFL measurements using the IF Synchronous detector offer the greatest measurement sensitivity (-127 dBm). When you select the IF Average detector for your TRFL measurements, measurement sensitivity is determined by the bandwidth of the selected IF filter. That is, the 30 kHz IF filter offers 8 dB greater sensitivity than the 200 kHz IF filter. (The IF Average detector offers -100 dBm measurement sensitivity with the automatically selected 30 kHz filter.)

Like other RF power meters, the sensitivity of the HP 8902A's RF Power measurement is determined by the dynamic range of the power sensor being used. The dynamic range of the HP 11722A Sensor Module, for instance, is -20 to +30 dBm. Using other sensors, the sensitivity of the HP 8902A's RF Power measurement can be extended from -70 to +40 dBm. (Refer to your HP 8902A Operation and Calibration Manual for information on which power sensors can be used with the HP 8902A.)

Solving Measurement Problems

The HP 8902A has been designed to feedback information about its operating status. When the HP 8902A detects that the input signal or operating conditions are preventing it from making an accurate, reliable measurement, it alerts you by placing an error or dash code in its display. The circumstances that can cause the HP 8902A to display an error code are classified into one of two categories:

- **Input Problem** - caused by input signal conditions, or
- **Operating Problem** - caused by the selection of incompatible operating functions.

Certain errors are caused *only by an input problem*, other errors are caused *only by an operating problem*, and some errors can be caused by either.

The errors that can be caused *only by an input problem* and the errors that can be caused *only by an operating problem* are listed in the following chart.

If your instrument is displaying one of these errors, proceed directly to *Table 4-3. RF Power and TRFL Error Codes* and take the recovery action recommended.

	Input Problem	Operating Problem
Error	08, 10, 13, 34 or 35	01, 09, 12, 14, 15, 18 thru 32

If you did not find your error listed in the chart, or if your instrument is displaying dashes or a questionable measurement, perform the following procedure.

1. Press the green **AUTOMATIC OPERATION** key. This cancels all function settings that can cause the HP 8902A to display an error code.
2. Compare the operating status of your HP 8902A after pressing the **AUTOMATIC OPERATION** key with the conditions described below. After you have identified the description that best fits your instrument's condition, take the action recommended for that condition.

Same Error

If the error or reading remains the same after the **AUTOMATIC OPERATION** key has been pressed, the error is being caused by an input problem. Look up the error code in Table 4-2 and take the action recommended for "Input Problem".

No Error

If the error goes away after the **AUTOMATIC OPERATION** key has been pressed, the error was caused by an operating problem. Look up the error code in Table 4-2 and take the action recommended for "Operating Problem".

New Error

If the error is replaced by a different error or dash code after the **AUTOMATIC OPERATION** key has been pressed, the original error was being caused by a combined input problem and operating problem. Look up the error code displayed by the instrument after the **AUTOMATIC OPERATION** key was pressed. Take the action recommended for "Input Problem".

Remember

Because of the wide variety of input signals and the operating flexibility of the HP 8902A, it is not possible to list all recovery actions for each error code. After using the table to determine the cause of the problem, you may discover other recovery procedures that are better suited to your application.

Table 4-3. RF Power and TRFL Error Codes (1 of 2)

Display Code	Problem Description	Input Problem	Operating Problem
Questionable Measurement	1. Measurement is very inaccurate 2. Measurement is slightly inaccurate.	1. Check tuning. Refer to <i>Tuning (4-7)</i> and <i>Increasing Selectivity (4-7)</i> . Check signal source. 2. Check RF Power calibration (4-2)	Recheck operating conditions being used.
--	Instrument is unable to find an input signal.	Set input signal level to between 0 and -20 dBm, and check tuning. Refer to <i>Tuning (4-7)</i> .	
----	Instrument has detected an input signal and is attempting to set up measurement. Continuous display indicates instrument is having difficulty tuning to input signal	Manually tune to input signal. Refer to <i>Noisy Signal (4-8)</i> and <i>Drifty Signal (4-9)</i> .	Re-check operating conditions being used.
-----	IF Synchronous Detector is searching for input signal. Continuous display (>30 sec) may indicate unstable input signal or incorrect tuning.	Check tuning. Refer to <i>Tuning (4-7)</i> , <i>Noisy Signal (4-8)</i> , and <i>Drifty Signal (4-9)</i> .	Re-check special operating conditions being used.
01	IF signal within IF passband but not centered well enough to guarantee measurement accuracy (due to manual tuning).		Ensure that the level of the input signal remains stable during TRFL calibration. If problem persists, signal may be drifting. Refer to <i>Drifty Signal (4-9)</i> .
02	Input circuits overdriven.	Decrease level of input signal.	Decrease selected RF and/or IF gain setting.
03	Input circuits underdriven.	Increase level of input signal.	Decrease selected RF input attenuation or increase IF gain. If Range Hold is being used, check range limits.
06	TRFL - Input level exceeds 7 Vrms (1W peak), or RF amplifier selected with >0 dBm at input. RF Power - Input level exceeds measurement range of power sensor being used.	Decrease level of input signal and press the CLEAR key.	Decrease selected RF or IF gain. If Range Hold is being used, check range limits.
07	Voltmeter is being overdriven.	Decrease level of input signal and press the CLEAR key.	Decrease selected RF or IF gain. If Range Hold is being used, check range limits.
08	Calibrator output not sensed at INPUT.	Check connection to Calibrator. Check for Calibrator malfunction.	
09	High stability time base problem (Option 002 instruments only).		Check internal time base for malfunction.
10	Frequency of input signal is not within measurement range. TRFL circuits being overdriven.	Set the input level to between 0 and -20 dBm. Select the Frequency mode. When the instrument displays the frequency of the input signal, press the MHz key and re-enter the TRFL mode.	
11	1. Attempting to measure RF power (dBm) with no power at sensor input. 2. Mathematics error (log 0 not allowed).	1. Select linear (Watts) units, or disregard error when there is no power present at sensor input.	2. Key in a different ratio reference.

Table 4-3. RF Power and TRFL Error Codes (2 of 2)

Display Code	Problem Description	Input Problem	Operating Problem
12	Indicates internal time base oven cold (Option 002 instruments only).		Wait for oven to warm for highest accuracy.
13	Power sensor was disconnected during RF Power measurement.	Secure connection at SENSOR input.	
14	Cannot zero power sensor.		Remove power from power sensor input during zeroing process.
15	Indicates Sensor Module's Reference Calibration Factor not stored in instrument.		Refer to <i>Appendix B</i> for entry and verification information.
17	IF level not within its measurement range.	Input signal level during reference measurement must be between 1.25V and 2.50V. (Option 030 only.)	Check selected RF or IF gain level. (When making Ratio measurements, allow instrument to complete the reference measurement.)
18	Indicates power level at Sensor Module input is not 0.0 dBm (1 mW) during calibration process.		Check sensor connection at RF POWER OUTPUT port.
19	TRFL circuits underdriven.		Increase IF gain.
20	Entered value out of range.		Check limits of function.
21	Invalid key entry.		Check compatibility of function(s) with selected measurement mode.
22	Invalid special function prefix entered.		Check special function number and re-enter.
23	Invalid special function suffix entered.		Check special function number and re-enter.
24	Invalid HP-IB code.		Check function codes.
25	Selected special function not compatible with measurement mode.		Check special function combination compatibility with measurement.
26	End of RF Power calibration table. (If displayed after first attempt to read table using 37.6 SPCL, the table is empty.)		Refer to <i>Appendix B</i> for cal factor entry and verification procedures.
30	Inappropriate RF attenuation or gain setting due to selected special functions or Range Hold function.		Change RF attenuation and gain or Range Hold setting.
31	RF Power calibration necessary in order to perform TRFL calibration.		Refer to RF Power Calibration in <i>Chapter 1</i> .
32	Inappropriate IF gain setting due to selected special functions or Range Hold function.		Change IF gain or Range Hold setting.
33	Instrument unable to make RF Power reference measurement during TRFL calibration.	Maintain stable frequency and level during calibration. Check SENSOR connection.	Check RF Power calibration. Refer to RF Power in <i>Chapter 1</i> .
34	Input signal lost during TRFL calibration.	Maintain stable frequency during TRFL calibration.	
35	Input signal level unstable during TRFL calibration.	Use a stable signal source for TRFL calibration.	

5

Measurement Examples

In This Chapter

This chapter contains examples of measurement applications using the HP 8902A. The intent of this chapter is to demonstrate the flexibility of the HP 8902A's measurement capability. (To perform the measurements, an understanding of the HP 8902A's basic operating capabilities as described in *Chapter 1* is necessary.)

This chapter enables you to reference directly to the measurements you are interested in. The examples are organized into the three measurement groups.

- RF Frequency and Frequency Error measurements
- Modulation and Audio measurements
- RF Power and Tuned RF Level (TRFL) measurements

The Directory

Use the directory diagram below to quickly locate the measurement you are interested in. A look-up table is located on the first page of each measurement group. Use the look-up table to reference to the examples provided for that group.

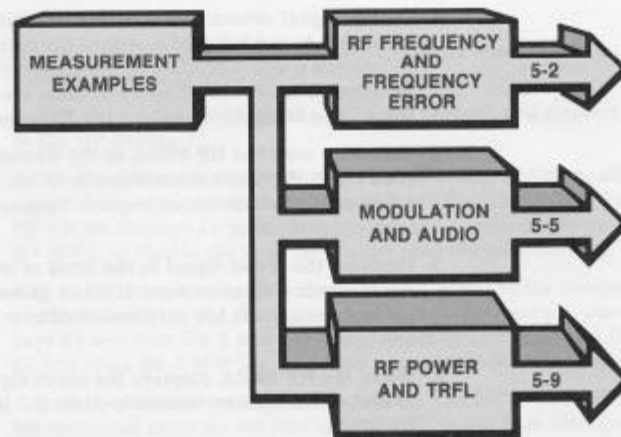

RF Frequency and Frequency Error

If you need to know:	Refer to:
• A convenient way to set up low-level frequency measurements	Low-Level Frequency (5-2)
• A way to accurately characterize the frequency response of an RF device .	Output Flatness (5-3)
• A way to quickly measure multi channel transmitters	Multi channel Testing (5-3)
• A way to measure frequency accuracy in parts-per-million (PPM)	Frequency Error (PPM) (5-4)
• A way to measure signals above 1300 MHz using an external LO mixer	Frequency Offset Mode (5-4)

Low-Level Frequency

Here is a convenient way to measure the frequency stability of low-level signals, below -60 dBm (remember that the Manual Tuning mode provides measurement sensitivity to -60 dBm). You may remember that in *Chapter 2* the special function codes were given for setting up the instrument for low-level RF frequency measurements. This procedure allows the instrument to automatically select the appropriate special function settings for you.

1. **Set the signal source to the desired output frequency and connect it to the HP 8902A.** Adjust the output level of the source to between 0 and -20 dBm. (If the source under test cannot be adjusted to between 0 and -20 dBm, use a second source that can be adjusted to perform the TRFL measurement first.)
2. **Manually tune the HP 8902A to the frequency of the input signal and then select the TRFL measurement.** In the TRFL mode, the instrument automatically selects the appropriate measurement range settings for low-level measurements.
3. **Decrease the input signal to the level at which you wish to make the frequency measurement.** It is not necessary to calibrate the TRFL measurement if you are only interested in making an RF frequency measurement.
4. **When the HP 8902A displays the input signal level at which you wish to measure frequency accuracy, press the RANGE HOLD key on the HP 8902A.**
5. **Select the Frequency measurement on the HP 8902A.** (If you wish to check frequency error, select the Frequency Error measurement.)

Output Flatness

The following procedure demonstrates a way to use the HP 8902A to characterize the frequency response of RF devices. This technique enables you to accurately characterize output flatness from 100 kHz to 2.6 GHz at levels between -20 and +30 dBm.

1. Connect the HP 8902A and Sensor Module to the output of your RF signal source. Adjust the source to the frequency at which you wish to establish the reference level.
2. Select the RF Frequency measurement and press the green AUTOMATIC OPERATION key on the HP 8902A.
3. When the HP 8902A displays the frequency of the input signal, select RF Power on the HP 8902A. The previous frequency measurement enables the instrument to automatically select the correct calibration factor for its power measurement. (Use the LOG/LIN key if you wish to toggle between Watts and dBm units.)
4. Press the RATIO key. This establishes the current measurement level as the reference level.
5. Change the frequency of the signal source, and re-select the RF Frequency measurement on the HP 8902A.
6. When the HP 8902A displays the input frequency, select RF Power.
7. Press the Blue Shift key and then the PREVIOUS RATIO (RATIO) key to reference this measurement to the reference level previously set in step 4.
8. Repeat steps 5, 6 and 7 to check output flatness across the output frequency range of your device.

Multi-channel Testing

Use the HP 8902A to quickly measure an evenly spaced multi-channel transmitter (such as a CB radio).

1. Adjust the transmitter to its first (lowest) channel and connect its output to the HP 8902A.
2. Select the desired measurement on the HP 8902A and manually tune it to the frequency of the transmitter's first channel. If the HP 8902A displays Error 01 (IF Frequency not centered), key in 8.1 SPCL to disable the error so you can read the measurement.
3. Key an increment value into the HP 8902A equal to the channel spacing of the transmitter and then press \uparrow kHz key. (For example, press the digit keys 25 and then the \uparrow kHz key to increment in 25 kHz steps.) From now on just press the \uparrow kHz key each time you want to increment up by 25 kHz.
4. Adjust the transmitter to its next channel. The HP 8902A will display the measured value for the next channel. (Press the Blue Shift key and the DISPLAY FREQ key if you wish to check the HP 8902A's tune setting.)
5. Continue to adjust the transmitter and then increment the HP 8902A to check each of the remaining channels.

Frequency Error (PPM)

The HP 8902A's Ratio Mode allows you to verify frequency accuracy specifications given in parts-per-million.

1. Connect the HP 8902A to the output of your signal source, and manually tune the HP 8902A to the expected output frequency of the source.
2. Select Frequency Error on the HP 8902A. To increase display resolution to 10 Hz, key in 7.1 SPCL.
3. Key one-tenth the manually tuned input frequency value (from step 1) into the HP 8902A and then press the **RATIO** key. (For example, if the manually tuned frequency was 179.0 MHz, you would key in 17.9 and then press the **RATIO** key.)
4. The HP 8902A is now displaying frequency error in parts-per-million.

Frequency Offset Mode

This procedure demonstrates how the HP 8902A's Frequency Offset Mode allows you to measure input signals above 1300 MHz using an external oscillator and mixer. (This is one of three techniques available for extending the RF frequency range of the HP 8902A. The other two are also shown in this chapter.) Diagram 5-1 shows the setup for this down-conversion technique.

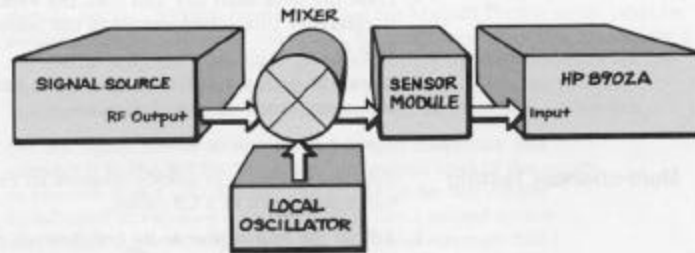

Diagram 5-1. Setup for Frequency Down Conversion

1. Set the signal source to the desired frequency at an amplitude of about -5 dBm. (The optimum level will depend on the mixer being used; select a level that will prevent mixer compression.)
2. Set the external LO to equal the output frequency of the signal source plus 120.53 MHz. (For instance, if the signal source frequency was 2.5 GHz, the LO should be set to 2620.53 MHz.) This positions the HP 8902A's internal IF in the center of a tuning octave.
3. Set the output level of the external LO to $+8$ dBm.
4. Press the **AUTOMATIC OPERATION** key and then key in 27.3 SPCL, the external LO frequency, and the **MHz** key on the HP 8902A. If you make a mistake, press the **CLEAR** key and re-enter the keystrokes.

5. Manually tune the HP 8902A to the expected frequency of the signal source by keying in the source frequency and then pressing the MHz key. The Manual Tuning Mode is always the right choice for this measurement technique.
6. Now select the desired measurement on the HP 8902A. If you are making RF Power or Tuned RF Level measurements, the calibration factors for the Sensor Module that you are using need to be stored in the Frequency Offset cal factor storage table. Refer to *Appendix B* for the storage procedure.
7. When you want to exit the Frequency Offset Mode, key in 27.0 SPCL. If you wish to re-enter the Frequency Offset Mode and maintain the same external LO frequency set in step 4, key in 27.1 SPCL.

Modulation and Audio

If you need to know:	Refer to:
• A way to measure FM bursts	Tone Burst FM (5-5)
• An easy way to measure the residual modulation of a transmitter	Residual Modulation (5-6)
• A way to measure SINAD on internally demodulated or external audio signals	SINAD (5-7)
• A quick way to measure signal-to-noise	Signal-to-Noise (5-7)
• A way to use the Ratio Mode to check modulation flatness	Modulation Flatness (5-8)
• A way to measure frequencies above 1300 MHz using a spectrum analyzer as a fixed-tuned receiver	SA Down-Conversion (5-8)

Tone Burst FM

This procedure enables you to configure the HP 8902A as a Tone Burst receiver by setting a time delay between when the HP 8902A senses an RF signal at its INPUT and when it enables the output at the MODULATION OUTPUT/AUDIO INPUT port.

1. Connect your transmitter (modulated source) to the HP 8902A's INPUT. Connect an audio counter to the MODULATION OUTPUT/AUDIO INPUT port.
2. Press the FM key on the HP 8902A.
3. Select a detector, and if desired, Audio Filters, and an FM De-Emphasis filter.
4. Key on the transmitter. Allow the HP 8902A to range and tune automatically.

5. Press the **RANGE HOLD** key to hold all ranges and tuning.
6. Key in **18.NN SPCL** to set the time delay. Where NN equals the desired delay in milliseconds (from 1 to 99). (For instance, if a 5ms delay is desired, enter 18.5 SPCL, if a 50ms delay is desired, enter 18.50 SPCL.) The special function value will remain in the display.
7. Key on the transmitter. The audio counter should display the modulation rate present at the end of the delay period.

Residual Modulation

Residual modulation is a measure of the hum and noise of the unmodulated transmitter. For FM mobile transmitters, hum and noise is defined as the ratio of the output of a standard receiver with de-emphasis when the transmitter is modulated and then unmodulated. (Hum and noise is usually expressed in dB referenced to 3 kHz peak deviation.)

1. Connect your transmitter to the HP 8902A and turn off FM modulation.
2. Press the **50 Hz HP filter** key. The 50 Hz high-pass filter is recommended for this measurement. The HP 8902A's residual FM is low enough that it can measure the hum and noise of most transmitters directly. Diagram 5-2 shows the typical residual FM characteristics for the HP 8902A.
3. Press the **PRE-DISPLAY** key and then the **750 μ s** key. The 750 μ s filter attenuates a 1 kHz signal by 13.66 dB (a factor of 0.2076).
4. Press the **FM** key on the HP 8902A to measure residual FM.
5. Press the **Blue Shift** key and the **RMS (AVG)** key. This selects the true RMS detector.
6. Key in **.44** and then the **RATIO** key. For standard modulation, the ratio reference is 0.440 (that is, $3.0 \times 1/\sqrt{2} \times 0.2076 = 0.440$).
7. Use the **LOG/LIN** key to select dB units. The display now indicates FM hum and noise in dB relative to 3 kHz peak deviation.

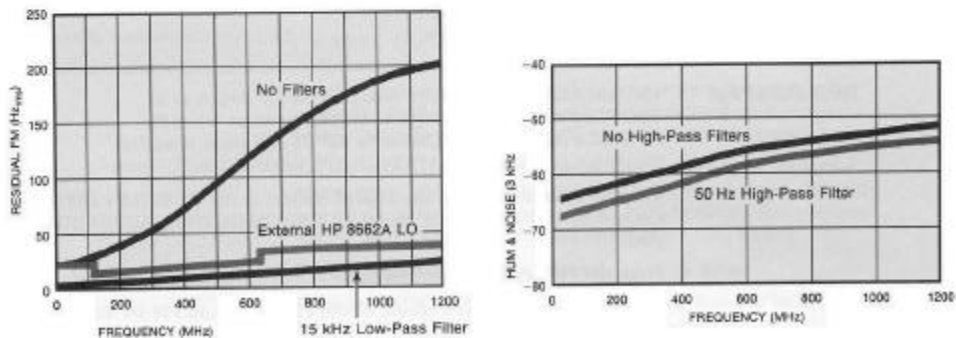

Diagram 5-2. Typical HP 8902A Residual FM Characteristics

SINAD

The HP 8902A allows you to make SINAD measurements (at 1 kHz or 400 Hz) on the internally *demodulated audio* signal or on an *external audio* signal applied to the MODULATION OUTPUT/AUDIO INPUT port.

Demodulated Audio

1. Connect your modulated signal source to the HP 8902A's INPUT port.
2. Select the appropriate modulation mode (AM, FM or Φ M).
3. Key in 29.0 SPCL, the Blue Shift key, and then the 1 kHz **DISTN (PEAK+)** or 400 Hz **DISTN (PEAK-)** key. An annunciator in the display indicates which frequency is being measured.
4. Use the LOG/LIN key if you wish to toggle between % and dB units.
5. Press the appropriate Audio Filter keys to set the desired measurement bandwidth for the internally demodulated audio signal.

External Audio

6. Connect your audio source to the MODULATION OUTPUT/AUDIO INPUT port on the HP 8902A.
7. Press the **AUDIO INPUT** key (key should remain lit).
8. Perform steps 3 and 4 above to measure the SINAD of the external audio signal.

Signal-to-Noise

The HP 8902A's Ratio Mode makes it easy to make relative measurements such as signal-to-noise on AM transmitters or hum and noise on FM transmitters.

1. Connect your signal source to the INPUT port on the HP 8902A and turn the modulation off.
2. Select the appropriate modulation measurement on the HP 8902A, (AM, or FM) and the RMS detector.
3. Press the **RATIO** key to establish the unmodulated input signal as the reference measurement.
4. Press the LOG/LIN key if you wish to toggle between % and dB units.
5. Turn on the modulation at the modulation source. The HP 8902A will compute and display the signal-to-noise ratio.

Modulation Flatness

The HP 8902A's Ratio Mode makes it easy to make relative measurements such as modulation flatness.

1. Connect your modulated source to the HP 8902A's INPUT.
2. Select the appropriate modulation measurement on the HP 8902A, (AM, FM, or Φ M).
3. Key in a reference modulation and press the **RATIO** key. (For instance, press **3** and then the **RATIO** key to establish a reference of 3% AM depth, or 3 kHz FM deviation.) Or, simply press the **RATIO** key by itself to establish the signal present at the HP 8902A's INPUT as the reference.
4. Press the **LOG/LIN** key if you wish to toggle between % and dB units.
5. Vary the modulation rate of your source across the audio spectrum. The HP 8902A will display modulation flatness as the change in measured modulation relative to the reference.

SA Down-Conversion

The measurement range of the HP 8902A can be extended above 1300 MHz for modulation and audio frequency measurements by using a spectrum analyzer as a fixed-tuned receiver. (This is one of three techniques available for extending the RF frequency range of the HP 8902A. The other two are also shown in this chapter.)

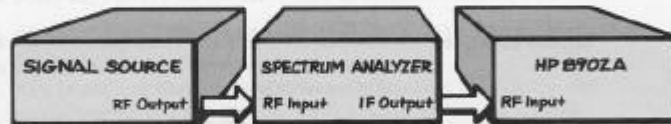

1. Connect the signal source, spectrum analyzer and HP 8902A as shown above.
2. Tune the spectrum analyzer to the output frequency of the signal source. Set the spectrum analyzer in its zero span mode with linear detection, and select a resolution bandwidth that is wide enough to pass the input signal (e.g. 3 MHz).
3. Adjust the spectrum analyzer fine frequency control to peak the signal on the spectrum analyzer display.
4. Tune the HP 8902A to the IF output frequency of the spectrum analyzer and select the desired modulation or audio measurement. (Note that residual FM measurements will generally be limited by the phase noise characteristics of the spectrum analyzer's local oscillator.)

RF Power and TRFL

If you need to know:	Refer to:
• A way to use the SET REF mode for attenuator testing	Attenuator Testing (5-9)
• A way to measure low-level signals that can not be adjusted to between 0 and -20 dBm	Low-Level Signals (5-10)
• A way to measure a noisy signal source using the IF Synchronous detector ..	Noisy Source (5-11)
• A way to measure frequencies above 1300 MHz using harmonics of the HP 8902A's LO	Harmonic Mixing (5-11)

Attenuator Measurement

This measurement technique will enable you to measure the relative level change of devices, such as attenuators, directly and accurately.



Diagram 5-3. Attenuator Measurement Setup

1. Tune the signal source to the desired frequency.
2. Set the level of the output signal from the device under test to 0 dBm and connect it to the HP 8902A.
3. When the HP 8902A displays the input signal frequency, press the MHz key, the gold S key, and then the Tuned RF Level key on the HP 8902A.

4. After the measurement has settled, press the **Blue Shift** key and the **SET REF (ZERO)** key. This establishes the current input level as the 0 dB reference for the TRFL measurement. Note that the RECAL and UNCAL annunciators are now off.
5. Press the **LOG/LIN** key if you wish to toggle between % and dB.
6. Begin stepping down the output level of the device under test by increments of 10 dB or less. Press the **CALIBRATE** key each time the RECAL annunciator is displayed.
7. When you want to exit the relative measurement mode, key in **26.0 SPCL**. Key in **26.1 SPCL** if you wish to re-enter the relative measurement mode and continue to use the previously established 0 dB reference.

Low-Level Signals

This procedure will enable you to measure low-level signals that can not be adjusted to between 0 and -20 dBm (such as spurs) down to -110 dBm; even in the presence of larger signals as close as 2 MHz. This example also demonstrates how the Store and Recall functions help you quickly repeat TRFL measurements at various frequencies.

1. Connect the HP 8902A to a signal generator and adjust its output to 0 dBm at the frequency of the spurious signal.
2. Manually tune the HP 8902A to the input signal and perform the TRFL calibration. Performing TRFL calibration is actually optional. If you do not perform the calibration, the HP 8902A will make uncalibrated measurements with approximately ± 1.5 dB accuracy.
3. When the TRFL calibration is complete, return the signal generator level to between 0 and -20 dBm.
4. Press the **Blue Shift** key, the **STORE (7)** key, and the **1** digit key. This stores the current frequency setting and calibration data in register 1. Repeat steps 1 through 3 at the frequency of each spur to be tested (up to eight). (If you wish to check more than eight frequencies, use an external controller and the 38.N special functions to create a TRFL calibration factor data base and the 39.N special functions to re-enter the calibration factors as they are needed to check each frequency.)
5. Connect the HP 8902A to the spur source, and press the **Blue Shift** key, the **RECALL (8)** key and the **1** digit key. This causes the instrument to recall the frequency setting and TRFL calibration data stored in register 1. The HP 8902A now automatically ranges to and displays the level of the spur. Press the **LOG/LIN** key if you wish to toggle between Watts and dBm units.

Noisy Source

Diagram 5-4 shows how to set-up TRFL measurements for an extremely noisy signal source. Using this setup, signal levels with many MHz of residual FM deviation can be measured to -100 dBm.

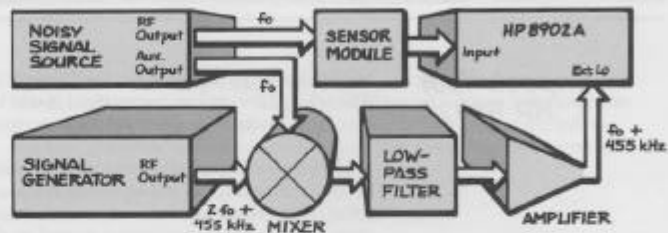

Diagram 5-4. Setup for Measuring the TRFL of an Extremely Noisy Source.

The only requirement on the signal source is that it have an auxiliary output. The auxiliary output is down-converted and substitutes as the local oscillator (LO) for the HP 8902A. With this setup, the same residual FM, drift, or instability present at the signal source output is also present on the LO input to the HP 8902A. This enables the IF Synchronous detector in the HP 8902A to automatically track the noisy input signal.

Harmonic Mixing

In normal operation, the HP 8902A uses the fundamental mixing of its internal local oscillator (LO) to make measurements to 1300 MHz. You can extend the measurement range to 2.1 GHz by using harmonic mixing of the internal LO. (Because harmonic mixing produces higher conversion loss, measurement sensitivity begins to degrade above 1300 MHz to -105 dBm at 2.1 GHz.) This is one of three techniques available for extending the RF frequency range of the HP 8902A. The other two are also shown in this chapter.

1. Connect the HP 8902A to the signal source and set the source level to between 0 and -20 dBm. Disregard Error 10 if it is displayed.
2. Press the Blue Shift key, the INSTR PRESET key, the gold S key, and the TUNED RF LEVEL key.
3. Key in 3.6 SPCL to select the narrow-band 455 kHz IF filter.
4. Press the Blue Shift key and the DISABLE ERROR (RANGE HOLD) key to disable Error 01 if it remains in the display.
5. Manually tune the HP 8902A to a frequency equal to 0.30333 MHz less than one third of the signal to be measured. (For example, to tune to a 2100 MHz signal, manually tune the HP 8902A to 699.6867 MHz: $(2100/3) - 0.30333 \text{ MHz} = 699.6867 \text{ MHz}$.)
6. Decrease the level of the input signal and perform the TRFL calibration. Press the LOG/LIN key if you wish to toggle between Watts and dBm units.

A

Installation

Unpack Your HP 8902A

Inspect the shipping container for damage. If the shipping container is damaged or the cushioning material inside is stressed, keep them until you have checked the shipment for completeness and proper operation.

If components are missing from your shipment, or if there is mechanical damage or defect, notify the nearest Hewlett-Packard office. If the shipping container or cushioning material shows signs of stress, notify the carrier as well as the Hewlett-Packard office. Keep the shipping materials for inspection by the carrier.

Connect Power

If you are not sure of the power or fuse requirements for your instrument, refer to *Section 2* of the HP 8902A Operation and Calibration Manual for further information.

Connect the Sensor

Connect the Sensor Module to the SENSOR and INPUT ports. (Refer to *Appendix B* in this guide for information on configuring the HP 8902A to operate with your Sensor Module.)

Turn On Instrument

If you are operating this instrument in extreme environmental conditions, refer to *Section 2* of the HP 8902A Operation and Calibration Manual for specific operating limitations.

B

Calibration Factors

What to Do

The calibration data for the Sensor Module you are using must be entered into the HP 8902A before it can make calibrated RF Power measurements. To determine the appropriate action to take, find the description below that best describes your circumstances and take the action recommended.

Descriptions

New HP 8902A (Option 021, E02, or E04) or HP 8902S

If your HP 8902A and Sensor Module were ordered together as an Option 021, E02, E04, or as part of a system, the calibration factors for the Sensor Module have already been entered into the HP 8902A. (You can return to *Chapter 1* to begin making measurements with the HP 8902A.)

No Cal Factors Entered (Error 15)

If the HP 8902A displays Error 15 when you press the RF Power key, no cal factors have been entered. Perform the *Entry Procedure* now.

Sensor or Cal Factors Changed

If you are changing sensor modules or if the cal factors for your Sensor Module have changed (due to repair or calibration), perform the *Entry Procedure* to enter the new cal factors.

Not Certain If Correct Cal Factors Entered

If you are not certain that the cal factors in the HP 8902A match the cal factors of the Sensor Module you are using, perform the *Verification Procedure* provided in this section. If the cal factors in the instrument do not match those listed on the label of your Sensor Module, perform the *Entry Procedure*.

Microwave Sensor Module

If you are entering calibration data for a microwave Sensor Module, such as the HP 11792A, key in **27.1 SPCL** to enter the Frequency Offset Mode and then perform the *Entry Procedure*. (When you get to step 7, enter the calibration data directly from the Sensor Module's label.)

Entry Procedure



1. Find the Reference Calibration Factor on the label of your Sensor Module (REF CAL FAC). Record that value in the space provided in step 6 of this procedure.
2. Find the Calibration Factors listed on the Sensor Module label (CAL FACTOR %). Record each value in the appropriate space provided in step 7 of this procedure.
3. Connect the Sensor Module to your HP 8902A and press the **Blue Shift** key and then the green **AUTOMATIC OPERATION** key on the front panel of the HP 8902A.
4. Key in **37.9 SPCL** (press the **37.9** digit keys and then the **SPCL** key, lower right corner). This clears the HP 8902A's non-volatile, cal factor storage table in case it contained any incorrect data.
5. Press the **RF POWER** key. The instrument will display Error 15. (Error 15 will go away once the calibration data is entered.)

Enter Reference Cal Factor

6. Key in **37.3 SPCL**, _____, the **Blue Shift** key, and then the **MHz** key.



Remember

*Press the **CLEAR** key if you miskey a digit. If you suspect that you have entered wrong data, complete the **Entry Procedure** and then perform the **Verification Procedure** to check the stored data. The **Error Correction Procedures** will enable you to change any incorrect data.*

Enter Frequency/Cal Factor Pairs

7. Enter the frequencies and cal factors using the key sequence (Entry Code, Frequency, then Cal Factor%) shown in the table below. Repeat the procedure for each frequency/cal factor pair listed.

Entry Code	Frequency	Cal Factor %
3 7 . 3 SPCL	.1 MHz	_____ Blue key, MHz
3 7 . 3 SPCL	.3 MHz	_____ Blue key, MHz
•	1 •	_____ •
•	3 •	_____ •
•	10 •	_____ •
•	30 •	_____ •
•	100 •	_____ •
•	300 •	_____ •
•	1000 •	_____ •
•	2600 •	_____ •

8. Press the green **AUTOMATIC OPERATION** key to reset the instrument to normal operation. You have completed the cal factor **Entry Procedure**. The following **Verification Procedure** will enable you to verify that the data in the cal factor storage table is correct.

Verification Procedure

1. Press the green **AUTOMATIC OPERATION** key and then the **RF POWER** key. If the HP 8902A displays Error 15, there is no calibration data stored in the instrument; perform the *Entry Procedure*.

Verify Reference Cal Factor

2. Key in **37.5 SPCL**, the **Blue Shift** key, and then the **MHz** key. If the displayed Reference Cal Factor does not match the Reference Cal Factor (REF CAL FAC) on your sensor module, perform step 1 and step 6 in the *Entry Procedure*.

Verify Frequency/Cal Factor Pairs

3. Repeat the key sequence shown below to display each frequency and Cal Factor stored in the HP 8902A's non-volatile memory. Check each frequency and cal factor pair against those listed on your sensor module. (If you want to review the cal factor storage table more than once, enter 37.5 SPCL to return to the beginning of the table.)

Display Code	Display Frequency	Display Cal Factor %
37.6 SPCL	Blue key, kHz	Blue key, MHz

4. Press the green **AUTOMATIC OPERATION** key to reset the instrument to normal operation. You have completed the verification procedures. You will not need to repeat the *Entry Procedure* again unless you use the HP 8902A with another Sensor Module or change the cal factors for this Sensor Module (due to repair or recalibration).

Error Correction Procedures**Cal Factor**

- If the frequency is correct but the cal factor is not, perform step 7 in the *Entry Procedure* for that frequency and enter its correct cal factor only. (The HP 8902A will place the new entry in the correct position in the table and remove the incorrect cal factor.) (For example, if an incorrect cal factor value was entered for 10 MHz, you would correct it by entering **37.3 SPCL, 10 MHz**, the correct cal factor value. **Blue Shift** key, **MHz**. The HP 8902A automatically positions the new cal factor in the 10 MHz position in the table.)

Frequency

- If an incorrect frequency is stored in the table, remove the incorrect frequency by performing step 7 of the entry procedure using the incorrect frequency and entering 0 as the cal factor.

Both

- If you need to add both a frequency and its cal factor to the storage table, perform the entry procedure (step 7) for the correct frequency and cal factor. (The HP 8902A will place the new entry in the correct position in the table.)

C

Index

A

AM, 1-9
 calibration, 3-2
Attenuator Measurement, 5-9
Audio, 3-1
 distortion, 1-16
 filters, 1-11
 frequency, 1-15
 level, 1-17
Auto Tuning, 1-6, 2-2
Automatic Operation, 1-8

C

Calibration,
 AM and FM, 3-2
 RF Power, 1-18, 4-2
 TRFL, 1-21, 4-3
Calibration Factors, B-1

D

Dashes, 1-4
 two, 1-4
 four, 1-4
 six, 1-21
Detectors,
 audio, 1-10
 TRFL, 4-3
Drift,
 RF Frequency Measurements, 2-7
 Modulation and Audio Measurements, 3-6
 TRFL Measurements, 4-9

E

Error Codes, 1-4
 RF Frequency and Frequency Error, 2-10
 Modulation and Audio, 3-8
 RF Power and TRFL, 4-13

F

FM, 1-11
 calibration, 3-2
 de-emphasis, 1-11
 residual characteristics, 5-6
Frequency Error, 1-7, 2-1
 resolution, 1-7
 parts-per-million, 5-4
Frequency Offset Mode, 5-4
(See also RF Frequency).

H

Harmonics, 2-3
Harmonic Mixing, 5-11
HP-IB, 2-9, 3-8, 4-12

I

IF Average Detector, 4-3
IF Filters, 2-5, 4-7
IF Synchronous Detector, 4-3
Image Signals, 2-6
Instrument Preset, 1-8

M

Manual Tuning, 1-6, 2-4
Modulation, 1-9, 3-1
 flatness, 5-8
MODULATION OUTPUT/AUDIO INPUT, 1-11, 1-16

N

Noise,
 RF Frequency Measurements, 2-6
 Modulation and Audio Measurements, 3-6
 TRFL Measurements, 4-8

O

Output Flatness, 5-3

P

Phase Modulation, 1-13
Power (See RF Power).

R

Range Hold, 5-2, 5-5
Ratio, 5-3, 5-7, 5-8
Recal, 1-24, 4-4
Relative TRFL Measurements, 4-5
Residual Modulation, 5-6
RF Frequency, 1-5, 2-1
 low-level, 5-2
 resolution, 1-5
RF Power, 1-19, 4-1
 calibration, 1-18, 4-2
 calibration factors, B-1
 tuning, 4-7
 versus TRFL, 4-12

S

Selectivity,
 RF Frequency Measurements, 2-5
 Modulation and Audio Measurements, 3-5
 TRFL Measurements, 4-7
Sensitivity, 2-7, 3-7, 4-13
 RF Frequency Measurements, 2-7
 Modulation and Audio Measurements, 3-7
 TRFL measurements, 4-13
Sensor Module, B-1
 changing, 4-10
 microwave, B-1
 without, 2-9, 3-8, 4-11
SET REF, 4-5
Signal-to-Noise, 5-7
SINAD, 5-7
Special Functions, 1-26
 special display, 1-26
Store, 4-8

T

Time Base, 2-9, 3-8, 4-12
Tone Burst FM, 5-5
Track Mode, 1-6, 2-4
Tuned RF Level, 1-21, 4-1
 accuracy, 4-5
 calibration, 1-21, 4-3
 detectors, 4-3
 measurement ranges, 4-4
 noisy source, 5-11
 spur measurements, 5-10
 tuning, 4-7
 versus RF Power, 4-12
Tuning Modes, 1-6
 auto tuning, 1-6, 2-2
 manual tuning, 1-6, 2-4
 selection, 1-7

U

Uncal, 1-24

Z

Zero key, 1-19

D

Index

Other Publications

Precision Measuring Receiver,
(Data Sheet) November 1985
5953-8437 Spokane Division

HP 8902A Measuring Receiver,
(Flyer) March 1983
5953-8380

Accurate Characteristics at Millimeter-Wave Frequencies,
(Product Note) November 1985
5953-8436

HP 8902A Measuring Receiver Operation and Calibration Manual,
December 1985
08902-90029

HP 8902A Measuring Receiver Service Manual,
08902-90031

HP 8902S Microwave Measurement System Manual,
December 1985
08902-90046

*HP 8902A Microwave Signal Generator Calibration System
Option E04 Manual,*
08902-90048

HP 11722A Sensor Module Operating and Service Manual,
October 1983
11722-90009

HP 11792A Sensor Module Operating and Service Manual,
March 1983
11792-90008

For information about Hewlett-Packard products and services, telephone the local Hewlett-Packard sales and support office listed in your telephone directory. Or write to the appropriate address listed here.

United States
Hewlett-Packard Company
Microwave and
Communications Group
3000 Hanover Street
Palo Alto, CA 94304

Hewlett-Packard Company
4 Choke Cherry Road
Rockville, MD 20850

Hewlett-Packard Company
5201 Tollview Drive
Rolling Meadows, IL 60008

Hewlett-Packard Company
5161 Lankershim Blvd.
North Hollywood, CA 91601

Hewlett-Packard Company
2000 South Park Place
Atlanta, GA 30339

Canada
Hewlett-Packard (Canada) Ltd.
6877 Goreway Drive
Mississauga, Ontario
Canada, L4V1M8

Europe and Africa
Hewlett-Packard S.A.
P.O. Box 529
1180 AM Amstelveen
The Netherlands

Australasia
Hewlett-Packard Australia Ltd.
31-41 Joseph Street
Blackburn, Victoria 3130
Australia

Japan
Yokagawa-Hewlett-Packard Ltd.
29-21, Takido-Higashi, 3-Chome
Suginami-ku, Tokyo 168
Japan

Far East Area
Hewlett-Packard Asia Headquarters
47th F, China Resources Bldg.
26 Harbour Road, Wanchai
Hong Kong

Latin America
Hewlett-Packard Company
3495 Deer Creek Road
Palo Alto, CA 94304 U.S.A.