

HP 8920A & HP 8920B
RF Communications Test Set,
Application Handbook

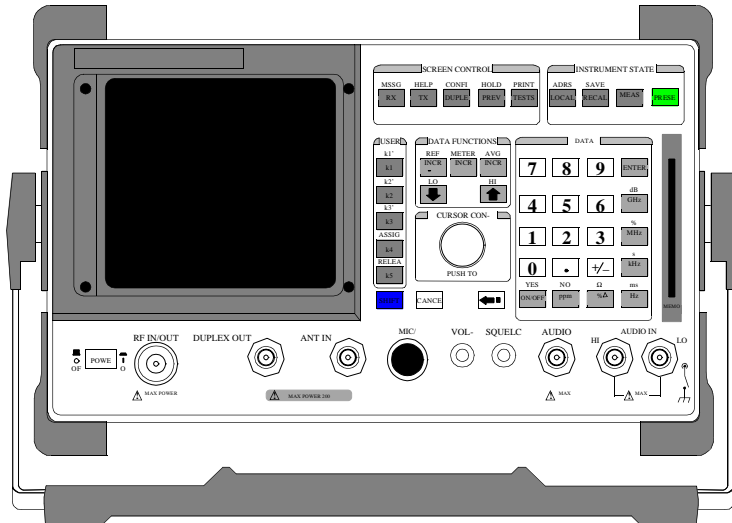

HP Part No. 08920-90212

Printed in U. S. A.

May 1997

Rev B

Copyright © Hewlett-Packard Company 1996

Notice

Information contained in this document is subject to change without notice.

All Rights Reserved. Reproduction, adaptation, or translation without prior written permission is prohibited, except as allowed under the copyright laws.

This material may be reproduced by or for the U.S. Government pursuant to the Copyright License under the clause at DFARS 52.227-7013 (APR 1988).

Hewlett-Packard Company
Learning Products Department
24001 E. Mission
Liberty Lake, WA 99019-9599
U.S.A.

Manufacturer's Declaration

This statement is provided to comply with the requirements of the German Sound Emission Directive, from 18 January 1991. This product has a sound pressure emission (at the operator position) < 70 dB(A).

- Sound Pressure $L_p < 70$ dB(A).
- At Operator Position.
- Normal Operation.
- According to ISO 7779:1988/EN 27779:1991 (Type Test).

Herstellerbescheinigung

Diese Information steht im Zusammenhang mit den Anforderungen der Maschinenlärminformationsverordnung vom 18 Januar 1991.

- Schalldruckpegel $L_p < 70$ dB(A).
- Am Arbeitsplatz.
- Normaler Betrieb.
- Nach ISO 7779:1988/EN 27779:1991 (Typprüfung).

Safety Considerations

GENERAL

This product and related documentation must be reviewed for familiarization with safety markings and instructions before operation.

This product is a Safety Class I instrument (provided with a protective earth terminal).

SAFETY EARTH GROUND

A uninterruptible safety earth ground must be provided from the main power source to the product input wiring terminals, power cord, or supplied power cord set.

CHASSIS GROUND TERMINAL

To prevent a potential shock hazard, always connect the rear-panel chassis ground terminal to earth ground when operating this instrument from a dc power source.

SAFETY SYMBOLS



Indicates instrument damage can occur if indicated operating limits are exceeded.



Indicates hazardous voltages.



Indicates earth (ground) terminal

WARNING

A WARNING note denotes a hazard. It calls attention to a procedure, practice, or the like, which, if not correctly performed or adhered to, could result in personal injury. Do not proceed beyond a WARNING sign until the indicated conditions are fully understood and met.

CAUTION

A CAUTION note denotes a hazard. It calls attention to an operation procedure, practice, or the like, which, if not correctly performed or adhered to, could result in damage to or destruction of part or all of the product. Do not proceed beyond an CAUTION note until the indicated conditions are fully understood and met.

Safety Considerations for this Instrument

WARNING

Any interruption of the protective (grounding) conductor (inside or outside the instrument) or disconnection of the protective earth terminal will cause a potential shock hazard that could result in personal injury. (Grounding one connector of a two conductor outlet is not sufficient protection.)

Whenever it likely that the protection has been impaired, the instrument must be made inoperative and be secured against any unintended operation.

If this instrument is to be energized via an auto transformer (for voltage reduction), make sure the common terminal is connected to the earth terminal of the power source.

Servicing instructions are for use by service trained personnel only. To avoid dangerous electric shock, do not perform any servicing unless qualified to do so.

Adjustments described in the manual are performed with power supplied to the instrument while protective covers are removed. Energy available at many points may, if contacted, result in personal injury.

Capacitors inside the instrument may still be charged even if the instrument has been disconnected from its source of supply.

For Continued protection against fire hazard, replace the line fuse(s) only with 250 V fuse(s) or the same current rating and type (for example, normal blow or time delay). Do not use repaired fuses or short circuited fuseholders.

WARNING

Always use the three-prong ac power cord supplied with this product. Failure to ensure adequate earth grounding by not using this cord may cause product damage.

This product is designed for use in Installation Category II and Pollution Degree 2 per *IEC 1010* and *IEC 664* respectively. For indoor use only.

This product has autoranging line voltage input, be sure the supply voltage is within the specified range.

To prevent electrical shock, disconnect instrument from mains (line) before cleaning. Use a dry cloth or one slightly dampened with water to clean the external case parts. Do not attempt to clean internally.

Ventilation Requirements: When installing the product in a cabinet, the convection into and out of the product must not be restricted. The ambient temperature (outside the cabinet) must be less than the maximum operating temperature of the product by 4° C for every 100 watts dissipated in the cabinet. If the total power dissipated in the cabinet is greater than 800 watts, then forced convection must be used.

Product Markings CE - the CE mark is registered trademark of the European Community . A CE mark accompanied by a year indicated the year the design was proven.

CSA - the CSA mark is a registered trademark of the Canadian Standards Association.

CERTIFICATION *Hewlett-Packard Company certifies that this product met its published specifications at the time of shipment from the factory. Hewlett-Packard further certifies that its calibration measurements are traceable to the United States National Institute of Standards and Technology, to the extent allowed by the Institute's calibration facility, and to the calibration facilities of other International Standards Organization members*

Hewlett-Packard Warranty Statement for Commercial Products

HP 8920A RF Communications Test Set

Duration of Warranty: 1 year

1. HP warrants HP hardware, accessories and supplies against defects in materials and workmanship for the period specified above. If HP receives notice of such defects during the warranty period, HP will, at its option, either repair or replace products which prove to be defective. Replacement products may be either new or like-new.
2. HP warrants that HP software will not fail to execute its programming instructions, for the period specified above, due to defects in material and workmanship when properly installed and used. If HP receives notice of such defects during the warranty period, HP will replace software media which does not execute its programming instructions due to such defects.
3. HP does not warrant that the operation of HP products will be uninterrupted or error free. If HP is unable, within a reasonable time, to repair or replace any product to a condition as warranted, customer will be entitled to a refund of the purchase price upon prompt return of the product.
4. HP products may contain remanufactured parts equivalent to new in performance or may have been subject to incidental use.
5. The warranty period begins on the date of delivery or on the date of installation if installed by HP. If customer schedules or delays HP installation more than 30 days after delivery, warranty begins on the 31st day from delivery.

- 6 Warranty does not apply to defects resulting from (a) improper or inadequate maintenance or calibration, (b) software, interfacing, parts or supplies not supplied by HP, (c) unauthorized modification or misuse, (d) operation outside of the published environmental specifications for the product, or (e) improper site preparation or maintenance.
- 7 TO THE EXTENT ALLOWED BY LOCAL LAW, THE ABOVE WARRANTIES ARE EXCLUSIVE AND NO OTHER WARRANTY OR CONDITION, WHETHER WRITTEN OR ORAL IS EXPRESSED OR IMPLIED AND HP SPECIFICALLY DISCLAIMS ANY IMPLIED WARRANTIES OR CONDITIONS OR MERCHANTABILITY, SATISFACTORY QUALITY, AND FITNESS FOR A PARTICULAR PURPOSE.
- 8 HP will be liable for damage to tangible property per incident up to the greater of \$300,000 or the actual amount paid for the product that is the subject of the claim, and for damages for bodily injury or death, to the extent that all such damages are determined by a court of competent jurisdiction to have been directly caused by a defective HP product.
9. TO THE EXTENT ALLOWED BY LOCAL LAW, THE REMEDIES IN THIS WARRANTY STATEMENT ARE CUSTOMER'S SOLE AND EXCLUSIVE REMEDIES. EXCEPT AS INDICATED ABOVE, IN NO EVENT WILL HP OR ITS SUPPLIERS BE LIABLE FOR LOSS OF DATA OR FOR DIRECT, SPECIAL, INCIDENTAL, CONSEQUENTIAL (INCLUDING LOST PROFIT OR DATA), OR OTHER DAMAGE, WHETHER BASED IN CONTRACT, TORT, OR OTHERWISE.

FOR CONSUMER TRANSACTIONS IN AUSTRALIA AND NEW ZEALAND: THE WARRANTY TERMS CONTAINED IN THIS STATEMENT, EXCEPT TO THE EXTENT LAWFULLY PERMITTED, DO NOT EXCLUDE RESTRICT OR MODIFY AND ARE IN ADDITION TO THE MANDATORY STATUTORY RIGHTS APPLICABLE TO THE SALE OF THIS PRODUCT TO YOU.

In this Book

This book is a guide for performing common radio tests using the Test Set. This guide contains the following chapters and appendices.

Chapter 1, Getting Started With The Test Set

This chapter contains a description of the manual contents, a general description of the Test Set, and a general description of the front and rear panel controls, indicators, and connectors.

Chapter 2, Measurement Considerations

This chapter contains a description of guidelines that must be adhere to when performing the measurements with the Test Set.

Chapter 3, Testing FM Radios

This chapter contains the information required to use the Test Set to perform FM Transmitter and Receiver measurements.

Chapter 4, Testing AM Radios

This chapter contains the information required to use the Test Set to perform AM Transmitter and Receiver measurements.

Chapter 5, Testing SSB Radios

This chapter contains the information required to use the Test Set to perform SSB Transmitter and Receiver measurements.

Chapter 6, Spectrum Analyzer Measurements

This chapter contains the information about system measurements using the Spectrum Analyzer and Tracking Generator.

Chapter 7, Spectrum Analyzer Measurements

This chapter contains the information about system measurements using the Spectrum Analyzer and Tracking Generator.

Chapter 7, Oscilloscope Measurements

This chapter contains the information about system measurements using the Oscilloscope.

Chapter 8, Configuring For Measurements

This chapter contains the information required to install the Test Set in preparation of performing measurements. Information provided includes instructions for power and printer connection, and initial power-up and configuration.

Chapter 9, References

This chapter lists any manuals, application notes, specifications, and standards referenced in this guide.

Chapter 10, HP 8920A Specifications

This chapter provides abbreviated specifications for the HP 8920A.

Chapter 11, HP 8920B Specifications

This chapter provides abbreviated specifications for the HP 8920B.

Glossary

This information lists the acronyms, abbreviations, and common terms used in this guide.

1 Getting Started With The Test Set

Conventions Used In This Manual 24

Product Description 25

The Test Set's Features 28

2 Measurements Considerations

Measurement Guideline 1 44

Measurement Guideline 2 45

Measurement Guideline 3 46

Measurement Guideline 4 48

3 Testing FM Radios

Introduction 50

List of Tests 51

FM Transmitters 52

FM Receivers 79

4 Testing AM Radios

Introduction 116

List of Tests 117

AM Transmitters 118

AM Receivers 136

5 Testing SSB Radios

Introduction 160

List of Tests 161

SSB Transmitters 162

SSB Receivers 173

6 Spectrum Analyzer Measurements

Introduction 186

List of Measurements 187

Using the Spectrum Analyzer 188

Using the Tracking Generator 203

7 Oscilloscope Measurements

Introduction 232

Using the Oscilloscope 233

8 Configuring for Measurements

Preparing the Test Set for DC Operation 242

9 References

Manuals 248

Application Note 249

Specifications and Standards 250

10 HP 8920A Specifications

Signal Generator Specifications	253
Audio Source Specifications	259
RF Analyzer Specifications	260
AF Analyzer Specifications	266
Oscilloscope Specifications	269
Spectrum Analyzer Specifications (Option 102)	270
Signaling (Option 004)	274
DC Current Meter (Option 103)	275
Remote Programming (Option 103)	276
Reference Oscillator Specifications	277
Save/Recall Registers	278
General Specifications	279

11 HP 8920B Specifications

Signal Generator Specifications 283

Audio Source Specifications 289

RF Analyzer Specifications 290

AF Analyzer Specifications 295

Oscilloscope Specifications 298

Spectrum Analyzer Specifications (Option 102) 299

Signaling (Option 004) 302

DC Current Meter 303

Remote Programming 304

Memory Card Specifications 305

Reference Oscillator Specifications 306

General Specifications 307

Getting Started With The Test Set

This chapter provides the user with a general introduction to the instrument. Information provided includes a general description of the Test Set, and a general description of the front and rear panel features.

Conventions Used In This Manual

The Test Set keys, screen titles, fields, and shifted functions are shown using the following conventions: (Refer to the **RX TEST** screen and the instrument front panel.)

- Screen titles are shown in bold upper-case type –**RX TEST**
- Field names and some measurements (such as AC Level) are indicated in lowercase bold type –**RF Gen Freq**
- The contents of a field, and some measurements (such as SINAD) are shown in italics – *-100.000000* or underlined – RF In
- Key caps are shown in all capital letters – PRESET
- The SHIFT key is pressed and released to access the blue-labeled functions printed above the keys. When a SHIFTEd function is called-out in this manual, *the use of the SHIFT key is assumed* and is not usually indicated. The function to be accessed is shown in boxed italics text upper-case letters: **MSSG**.

Product Description

The Test Set is a single instrument that combines the features of 22 individual radio test instruments. The Test Set is designed to meet the communication test needs of both service and manufacturing environments, and the capability to test land mobile radios, cellular phones, and various other communications systems.

Test and troubleshooting time is decreased by simplifying standard measurement tasks and providing the required measurement capability in a single instrument. Transmitters and receivers are characterized with single-key RX, TX and duplex tests. Each of these tests displays a specialized screen that provides access to the necessary controls and measurement results. Measured results may be displayed as digital readouts and/or bar graphs. All settings and measurements are easily accessed and changed using the front-panel knob and keys. If desired, all settings can be saved in nonvolatile save/recall registers for future access.

The various ports on the Test Set allow the receiver/transmitter being tested to be quickly connected. A receiver with $2\ \mu\text{V}$ sensitivity (typically $<1\ \mu\text{V}$) is available through the ANT IN port, for off-the-air monitoring of low-level signals. Transmitter measurements of high-power signals of up to 100 W intermittently (for 10 seconds) or 60 W continuous can be performed without the use of external attenuators.

Features

The features currently available for the Test Set include:

- Synthesized AM/FM signal generator to 1000 MHz
- Function generator (HP 8920A option)
- AM/FM modulation analyzer
- Duplex offset generator
- Signalling encoder and decoder (HP 8920A option)
- SSB demodulator
- RF power meter
- RF frequency counter/frequency error meter
- Audio frequency counter
- AF power meter
- AC/DC voltmeter
- DC current meter (HP 8920A option)
- SINAD meter
- Distortion meter
- Two variable audio sources
- Digital oscilloscope
- Spectrum analyzer and tracking generator (*optional*)
- 2 μV sensitivity (typically $<1 \mu\text{V}$)
- Cellular-phone test capability (*optional*)
- Built-in I-BASIC controller
- HP-IB/RS-232 interface buses for remote programming (*optional*)
- Radio test software (*optional*)
- Radio interface card (HP 8920A option)
- Adjacent channel power

Specifications

Abbreviated specifications for the Test Set are provided in "**HP 8920A Specifications**" on page 251 and "**HP 8920B Specifications**" on page 281. See the *HP 8920A /B RF Communications Test Set Assembly Level Repair Guide* for a complete list of specifications.

The Test Set's Features

This section contains a brief description of the Test Set's keys, connectors, controls, and screens. Additional operating information for all keys, connectors, controls, and screens can be found in the Test Set's user guide.

Feature Contents

"The Test's Sets Front-Panel Features" on page 29.

- **"Screens" on page 29.**
- **"Data Function Keys" on page 33.**
- **"Knobs" on page 34.**
- **"Screen Control Keys" on page 35.**
- **"Instrument State Keys" on page 36.**
- **"Data Keys" on page 37.**
- **"Connectors" on page 38.**
- **"Non-Bracketed Keys and Memory Card Slot" on page 39.**

"The Test Set's Rear-Panel Features" on page 40

- **"Connectors" on page 40.**
- **"Key and Fuse Holders" on page 41.**

The Test's Sets Front-Panel Features

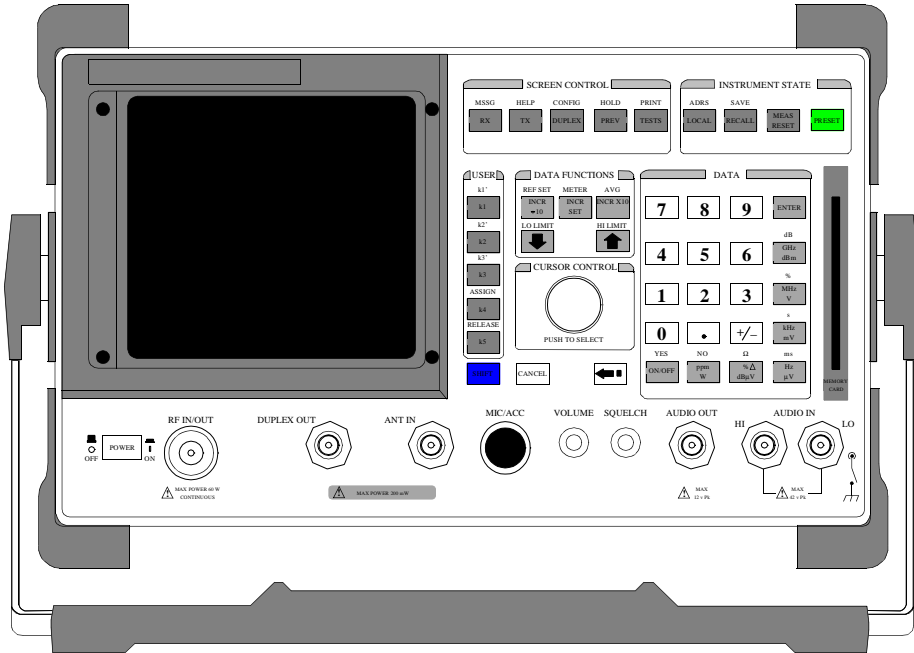

Screens

The CRT displays the various test screens, measurement results, waveforms, and messages. The a brief description is provided in the following:

- **“Screens that are Standard to the Test Set” on page 30.**
- **“Screens that Require an Option” on page 31.**
- **“Screens that Require an Optional Instrument” on page 31.**

Screens that are Standard to the Test Set

- RX Test – receiver test screen with RF and audio output controls and receiver measurement results.
- TX Test – transmitter test screen with RF and audio input/output controls and transmitter measurement results.
- Duplex Test – transmitter and receiver simultaneous test screen with RF and audio input/output controls and transmitter and receiver measurement results.
- Tests – access to creation, editing, copying, and execution of automated test programs loaded from Memory Cards, internal ROM/RAM, or an external disk drive.
- RF Generator – used to control and display the RF and modulation signals.
- RF Analyzer – used to process and display RF signal measurements.
- AF Analyzer – used to process and display audio signal measurements.
- Oscilloscope – used to display the oscilloscope measurement function, with vertical, time, trigger, and marker controls.
- Configure – used to control the various functions including date, screen intensity, various RF controls, etc.
- I/OConfigure – used to control the various functions including HP-IB, serial parameter, etc.
- Print Configure – used to setup a printer.
- Adjacent Channel Power – used to control measuring power of signals at a specific channel spacing above and below the RF Analyzer's center frequency.

Screens that Require an Option

- Spectrum Analyzer – used to display the spectrum analyzer measurement function, with center frequency, span, reference level, marker, and tracking generator controls.
- Encoder – used to display the signalling encoder function, with function generator, tone sequence, DTMF, CDCSS, digital paging, cellular and LTR and EDACS trunking subscreens.
- Decoder – used to display the decoded data signalling with function generator, tone sequence, DTMF, CDCSS, digital paging, cellular and LTR and EDACS trunking subscreens.
- Radio Interface – used to control the various functions of the optional radio interface.
- Call Control – used to test AMPS TACS Cellular radios.

Screens that Require an Optional Instrument

- TDMA Test
- PDC Test
- PHP Test
- CDMA Test
- CDMA Analyzer
- CDMA Generator
- Code Domain
- Call Control

User Keys

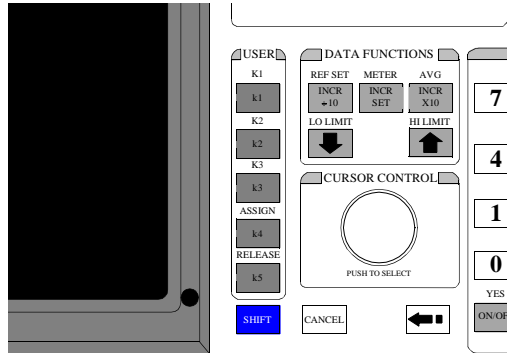

User k1 - k5 keys – referred to as local keys, these keys enable you to instantly enable a field for fast or repetitive access. Local keys function for fields on the screen being displayed only.

User k1' - k3' keys – referred to as global keys, these keys enable you to display and control a field from another screen while viewing another screen.

To Assign a User Key



1. Select the screen which the desired field is on.
2. Position the cursor at the desired field using the Knob.
3. Press the ASSIGN key.
4. Press the desired k1-k5 or k1'-k3' key.

To Un-assign a User Key

1. Select the screen which the desired field is on.
2. Position the cursor at the desired field using the Knob.
3. Press and release the SHIFT key.
4. Press the RELEASE key.
5. Press the ENTER key.

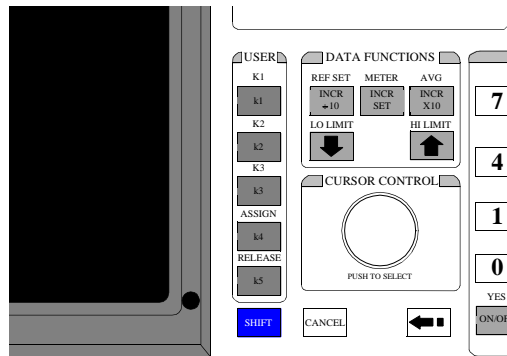
Data Function Keys



- The INCR \div 10, INCR SET, and INCR X10 keys change the increment/decrement field value (units, tens, hundreds, etc).
- The   keys increment/decrement field values, select among various field choices, or move the cursor within fields.
- The LO LIMIT and HI LIMIT keys set measurement limits for PASS/FAIL indications.
- The REF SET key sets or removes a measurement reference for relative AF and RF measurements.
- The METER key enables/disables the analog bar-graph meter.
- The AVG key enables/disables measurement averaging.

Knobs

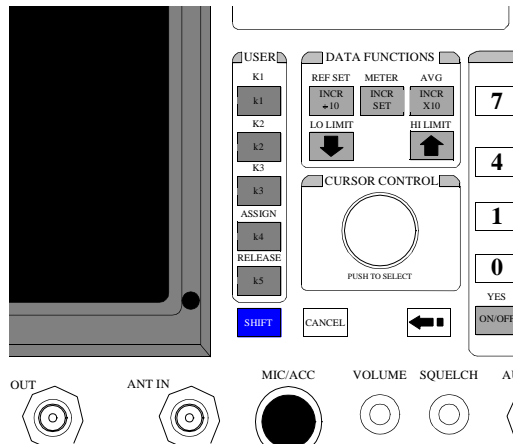

The Cursor Control Knob

- Moves the cursor to another field (rotate CW/CCW).
- Selects fields, screens, and settings from a list of choices. (push).
- Increments and decrements numeric field values (push to select, rotate the knob to increment or decrement the value, then push again to enter).

Volume and Squelch Knobs

VOLUME Control – adjusts the speaker volume for monitoring.

SQUELCH Control – adjusts the squelch threshold for AM, FM, or SSB signals.

Screen Control Keys

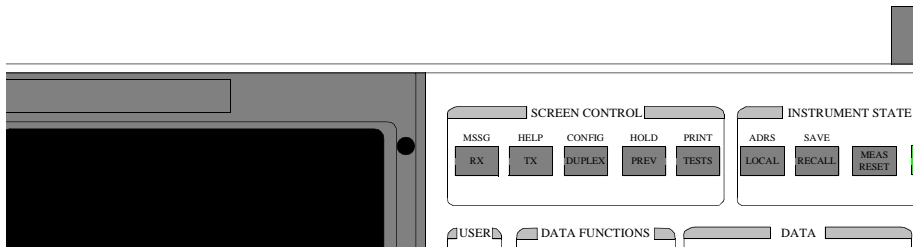

These keys are used to access several instrument control and information screens.

- RX key – displays the RX TEST screen for test of receivers.
- TX key – displays the TX TEST screen for test of transmitters.
- DUPLEX key – displays the DUPLEX TEST screen for simultaneous test of transmitters/receivers.
- PREV key – returns the display to the previous screen.
- TESTS key – displays the TESTS (MAIN) screen used to access automated test program functions.
- MSSG key – displays any error or operation messages since power-up.
- HELP key – displays the HELP screen that provides operating assistance.
- CONFIG key – displays the CONFIGURE screen defining general operating functions.
- HOLD key – stops all measurements. Selecting again resumes measurement.
- PRINT key – prints the entire contents of the displayed screen, the time and date, and any previously defined print title (if a printer is connected).

Instrument State Keys

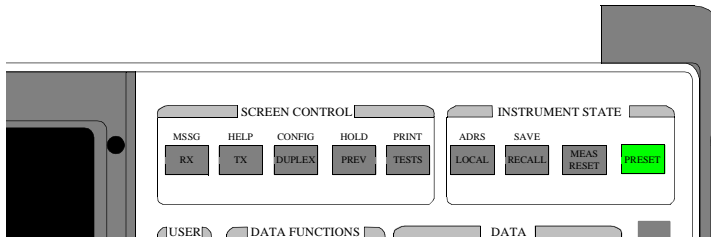

- LOCAL key – returns the instrument to manual control after HP- IB control is used.
- RECALL key – lists and selects a previously stored instrument setup.
- MEAS RESET key – clears the measurement “history” for all of the instrument’s measurement algorithms, and re-starts all measurements that were in progress.
- PRESET key – restores most instrument settings to their factory default states. (Configure settings are not affected.)
- ADRS key – displays the current HP-IB address.
- SAVE key – stores an instrument setup.

Data Keys

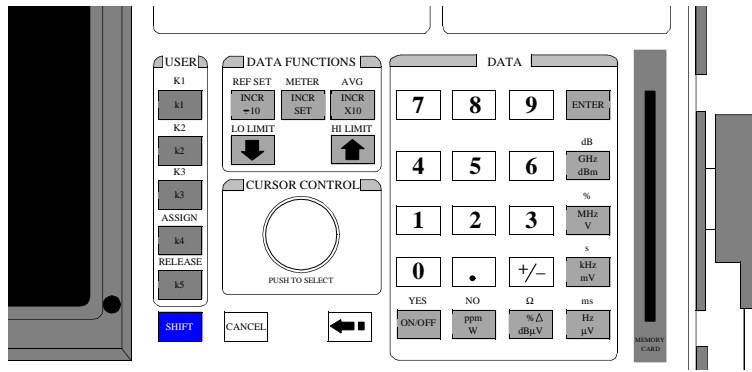

Data Entry keys– used to enter or change alphanumeric data (0-9, A-F, “.”, “+”, or “-”) for measurements or field entries. The EEX key is used to enter the exponent for scientific notation.

Termination keys– used to input the entered data in the units selected. Also allows entry of “YES” or “NO” to confirm selected operations before they are executed.

- ENTER key – selects a field or screen, and enters numbers when the unit-of-measure is not changed or not specified.
- ON/OFF key – enables and disables measurements, and turns numeric fields (such as Amplitude) on and off.

Connectors

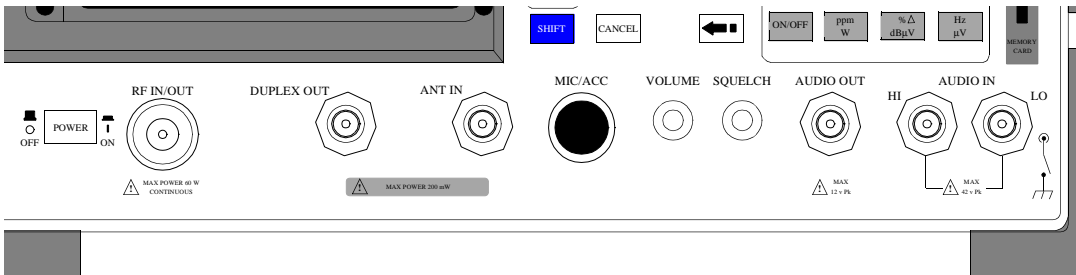

RF IN/OUT Connector – type-N female connector for output signals from the RF Generator, and input signals (60 Watts continuous, or 100 Watts for 10 sec/min) to the RF Analyzer. Nominal impedance is 50Ω.

DUPLEX OUT Connector – female BNC connector for output RF Generator and Tracking Generator signals. Nominal impedance is 50Ω.

ANT IN Connector – female BNC connector for input and analysis of low-power RF signals (≤ 200 m Watts), and for off-the-air measurements. Nominal impedance is 50Ω.

MIC/ACC Connector – 8-pin female DIN connector provides various connections including:

- Audio microphone input for modulation of the RF output signal
- Control of the RF Generator's output state
- Switching between the **TX TEST** and **RX TEST** screens
- Provides keying signal to control a transmitter under test

AUDIO OUT Connector – female BNC connector to output signals from AF Generators 1 and 2 (including encoder functions). Nominal output impedance is $< 1\Omega$ at 1 kHz.

AUDIO IN Connectors – two female BNC connectors to input audio signals to the AF Analyzer. Nominal impedance is 1 MΩ or 600Ω.

- HI is the signal input for both grounding and floating input configurations.
- LO may be selected to connect the signal reference to ground or float. The connectors and controls located on the rear panel are as follows:

Non-Bracketed Keys and Memory Card Slot

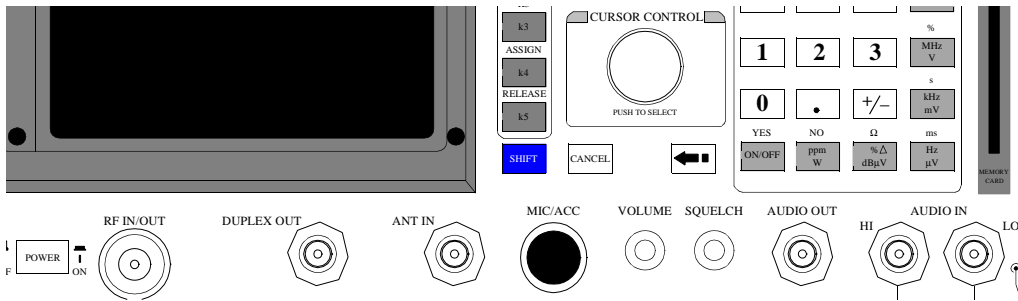

Non-Bracketed Keys

The POWER key – turns the instrument on or off.

The SHIFT key is used to select the blue-labeled functions listed above certain keys.

The CANCEL key is used to cancel an entry in progress, or stop a running IBASIC program.

The  key is used to move the cursor to the left when entering numbers in a field, thereby erasing the previous characters.

The Memory Card Slot

Slot for memory cards that are inserted to load software, or to record test results.

The Test Set's Rear-Panel Features

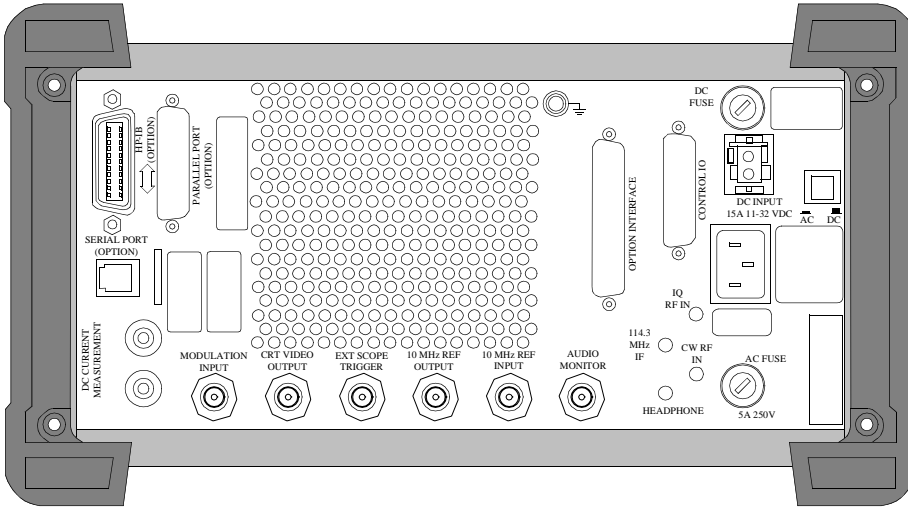

Connectors

- **HP-IB Connector** (*optional*) – 24-pin connector provides communication between the Test Set and other instruments or a computer using the IEEE 488 Hewlett-Packard Interface Bus (HP-IB).
- **SERIAL PORT Connector** (*optional*) – 6-pin RJ-11 dual serial (RS-232C) port for entering programs, printing test results and screen images, and sending test results to external devices.
- **DC CURRENT MEASUREMENT Terminals** (*optional*) – dual banana jacks to measure from 0 to +10 ADC.
- **MODULATION INPUT Connector** – female BNC connector to input an external signal to the modulators. Maximum input level is 12 V peak (full scale input = 1 V peak), and nominal input impedance is 600Ω.
- **CRT VIDEO OUTPUT Connector** – female BNC connector provides CRT video to an external “multisync” video monitor.

- EXT SCOPE TRIGGER INPUT Connector – female BNC connector to input an external oscilloscope trigger. Maximum input level is ≈ 20 V peak.
- 10 MHz REF OUTPUT Connector – female BNC connector outputs a 10 MHz reference signal for locking external instruments.
- 10 MHz REF INPUT Connector – female BNC connector to input an external 1, 2, 5, or 10 MHz reference signal.
- AUDIO MONITOR OUTPUT Connector – female BNC connector provides an output from the AF Analyzer. Level is not affected by the VOLUME control, but is affected by the SQUELCH control.
- Chassis Ground Terminal – provides a chassis connection. Also provides a safety ground when DC power is used.
- RADIO INTERFACE Connector (*optional*) – 37 pin “D” style connector for parallel and serial communications, and audio/transmitter control lines between the Test Set and external radio equipment.
- DC INPUT Connector – 2-pin female connector to input 11-28 Vdc @ 120W (maximum) for DC operation.
- AC INPUT Connector – 3-pin male connector to input 100 to 240 Vac for AC operation.

Key and Fuse Holders

- AC/DC– selects the instrument's power source.
- DC FUSE Holder – 15A 250V fuse for DC operation.
- AC FUSE Holder – 5A 250V fuse for AC operation.

Measurements Considerations

The following guidelines must be adhered to when performing any of the FM/AM/SSB Transmitter and Receiver, Spectrum Analyzer, or Oscilloscope Measurements.

Measurement Guideline 1

Connector Considerations

CAUTION: The RF present at any Test Set input connector must not exceed the specified level or permanent instrument damage may result. If necessary, use an external attenuator. If overpower occurs, disconnect the Transmitter, then cycle Test Set power OFF/ON to reset the protection circuitry.

RF IN/OUT

The RF present at the Test Set RF IN/OUT connector must not exceed 60W continuous (or 100 Watts for 10 sec/minute) or permanent instrument damage may result.

ANT IN

The RF present at the Test Set ANT IN connector must not exceed 200 mW or permanent instrument damage may result.

Measurement Guideline 2

Cabling and Adapter Considerations

For most FM, AM, and SSB measurements, only the standard Test Set with correct interconnecting cables and adapters are required.

Output Power

If output power is greater than 60W (continuous), an external attenuator is also required. Any other additional equipment or Test Set options that are required to perform the measurement are listed in the procedure.

Cabling Test Loads

When measuring audio output, a Test Load with a resistance value dependent on the Receiver's output impedance (normally 8 Ω) is required. In most cases, a non-inductive resistor with a power rating sufficient for the Receiver's rated output power and resistance that matches the speaker impedance can be used. Typically, the test load is connected at the Test Set AUDIO IN connector using a BNC to dual banana adapter.

Spectrum Analyzer

For Spectrum Analyzer measurements, the Spectrum Analyzer/Tracking Generator option (002) must be installed in the Test Set.

Oscilloscope

For Oscilloscope Measurements, Hewlett-Packard's HP 104XX series passive Oscilloscope probes can be used to input signals to the Oscilloscope via the front panel Audio Input or rear panel MODULATION INPUT connectors.

Measurement Guideline 3

Special Test Considerations

Information for performing any of the FM, AM, or SSB measurements:

Coaxial Cable

Use short runs of high quality coaxial cable and high quality adapters when connecting the device connected to the Test Set to ensure the most accurate power measurement. Double shielded coaxial cable is recommended when performing measurements on Cavities and Duplexers.

Cable and Adapter Loss

Remember that cable and adapter losses and mismatch must be considered when measuring RF power at VHF/UHF frequencies. If losses are known, they can be entered using the CONFIGURATION screen. Once entered, the measurement results are adjusted accordingly.

Incidental Audio

Incidental audio into a built-in or attached microphone may cause inaccurate readings. Whenever possible, disable the microphone input or minimize ambient audio during the measurement.

Transmitter's DTMF, CTCSS, and or CDCSS Functions

Verify that the Transmitter's DTMF, CTCSS, and/or CDCSS functions are OFF (if equipped), unless otherwise specified.

Receiver Test Loads

If using the Test Load, the measurement must be performed with only the load connected to the Receiver's audio output circuitry (internal speaker disconnected). If the external speaker jack does not break the

internal speaker connection, either the Test Set AUDIO IN signal must be connected across the speaker (in this case, enter the impedance value of the speaker in lieu of the test load resistance), or the internal speaker must be physically disconnected.

Measuring Audio Output Power

When measuring audio output power in watts, always set **Ext Load R** field to the Receiver's audio output impedance or to the test load resistance (when connected). Failure to do so will cause the measurement to be incorrect.

Coded Squelch

Certain receivers use CTCSS, CDCSS, or trunked radio signalling coded squelch. If the receiver is equipped with a coded squelch device that cannot be easily overridden, then the instruments **AFGen2** or **Encoder** must be used to open the squelch for measurement. Also, if any of these are used, set Filter1 to 300Hz HPF to remove the tone used to open the squelch prior to measurement. Refer to the "RX" or "Encoder" screen sections in the Test Set User's Guide supplied with the instrument for more information.

Measurement Guideline 4

Additional Measurement Considerations

Pressing the PRESET and TX or RX keys at the beginning of each test automatically configures the Test Set for “standard” transmitter/receiver measurements. The controls and settings that need to be adjusted during performance of the measurement are discussed in each procedure. Additional parameters or controls that may need to be adjusted when testing a particular radio are described in the “TX”, “RX”, “Spectrum Analyzer”, “Encoder”, and “Decoder” screen sections of the Test Set User’s Guide supplied with the instrument.

Testing FM Radios

Introduction

Each procedure may contain the following information:

- A brief measurement overview and a reference to applicable TIA/EIA specifications for each test.
- A list of the Test Set options and additional test equipment required to perform the procedure.
- Any special test considerations that need to be considered for safety, measurement accuracy, etc.
- Step by step procedures required to perform each measurement (with illustrations).

Refer to "[Configuring for Measurements](#)" on page 241, or the Test Set's User Guide on preparing the Test Set for operation.

List of Tests

FM Transmitter Measurements

"FM Off The Air Monitoring/Determining Unknown Transmitter Carrier Frequency" on page 53.

"FM Output Power, Deviation, and Frequency/Frequency Error Measurement" on page 56.

"FM Deviation and Symmetry Measurement" on page 59.

"FM Microphone Sensitivity and Modulation Limiting Measurement" on page 62.

"FM CTCSS Encoder Frequency and Deviation Measurement" on page 65.

"FM CDCSS Coding and Deviation Measurements" on page 67.

"FM DTMF Encodes and Deviation Measurement" on page 70.

"FM Audio Distortion Measurement" on page 74.

"FM Harmonics and Spurious Output Measurement" on page 76.

FM Receiver Measurements

"FM Audio Output Power Measurement" on page 80.

"FM SINAD, Receiver Center Frequency, and Modulation Acceptance Bandwidth Measurement" on page 83.

"FM Variation Of Sensitivity With Signal Frequency Measurement" on page 87.

"FM 20 dB Quieting Sensitivity Measurement" on page 91.

"FM Critical and Maximum Squelch Sensitivity Measurement" on page 94.

"FM CTCSS Sensitivity and Bandwidth Measurement" on page 97.

"FM CDCSS Sensitivity Measurement" on page 101.

"FM Audio Frequency Response Measurement" on page 105.

"FM Audio Distortion Measurement" on page 108.

"FM Spurious Response Attenuation Measurement" on page 111.

FM Transmitters

The following measurements are provided for testing FM Transmitters. The procedures are arranged in the order that tests are typically performed.

FM Off The Air Monitoring/Determining Unknown Transmitter Carrier Frequency

Description

This procedure is used to locate, demodulate, and measure an FM signal's output carrier frequency. The low level signal is input to the front-panel **ANT IN** connector, located, then demodulated using the spectrum analyzer function.

NOTE:

For performing an FM Off the Air Monitoring on a Known Transmitter Carrier Frequency, see page 55.

If attempting to determine the unknown frequency of a Transmitter connected to the RF IN/OUT connector, see "Output Power, Deviation, and Frequency or Frequency Error Measurement" provided later in this chapter for the measurement procedure.

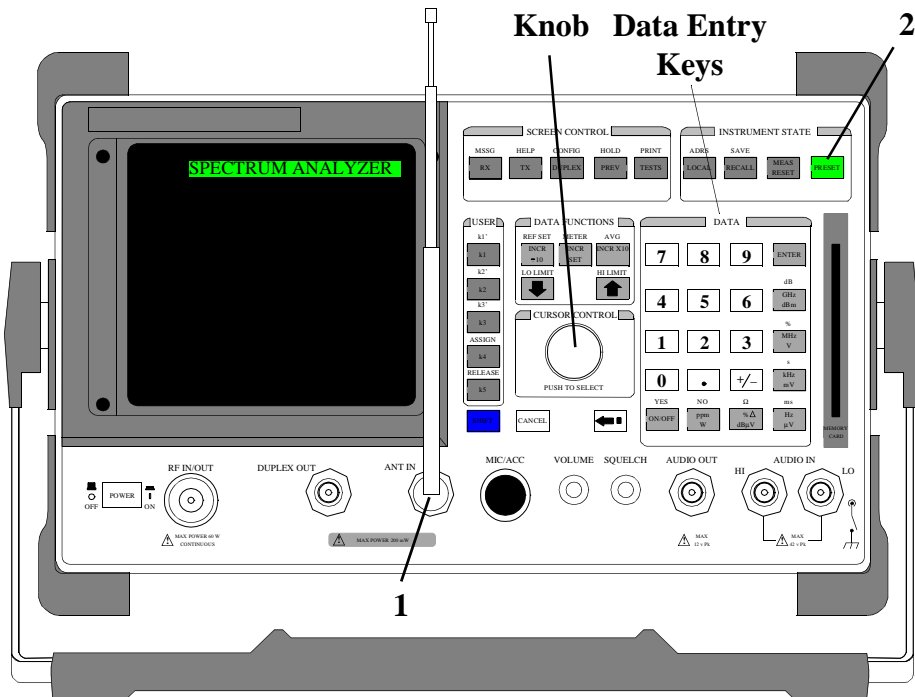

Test Set Options Required	Spectrum Analyzer/Tracking Generator (option 102)
Additional Equipment Required	Whip antenna

Measurement Procedure:

1. Connect the Antenna to the ANT IN connector.

CAUTION:

Do not exceed the connector's rated input or permanent instrument damage may result.

On the Test Set:

2. Press the PRESET key.
 - If monitoring an FM broadcast signal perform the following steps:
 - a. Press the TX key.
 - b. Use the knob to change IF Filter to 230 kHz.
 - c. Continued to **step 3.**
 - If not proceed to **step 3.**

Using the knob and data entry keys:

3. Select the **SPEC ANL** screen.
4. From the **Controls** select Ant.
5. Set **Center Freq** and **Span** fields to view desired spectrum.
6. Set **Ref Level** from -30 dBm to -50 dBm as required to view the desired signal.

Once the desired carrier is found:

7. From **Controls**, select **Main**.
8. Select **Marker** from the **Choices** field.
9. Use the **Marker To** field to select the desired carrier.

On the Test Set frequency and level are displayed as shown.

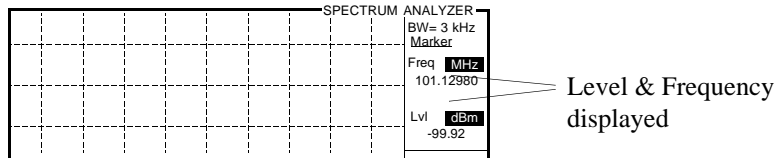

10. To demodulate the carrier:

- a. With the marker on the desired carrier, select **Marker To** to **Center Freq**.
- b. From **Controls**, select **Main**.
- c. Select **Marker** from the **Choices** field.
- d. Decrease the **Span** to *1.5 MHz* (or less).
- e. Adjust the Volume and Squelch controls to listen to the demodulated carrier.

FM Off The Air Monitoring on a Known Transmitter Carrier Frequency

1. Press the PRESET key.
2. Press the TX key.
3. Set **Tune Mode** to Manual.
4. Set **Tune Freq** to known frequency.
5. Set **Input Port** to Ant
6. Set **IF Filter** to *230 kHz* (if necessary).

FM Output Power, Deviation, and Frequency/Frequency Error Measurement

Description

This procedure is used to measure an FM Transmitter's output carrier power and frequency (or frequency error) into 50 Ω. For FM Transmitters, deviation and modulating frequency are also measured. FM reference is ANSI/EIA-RS-152-C-1988, RS-316-C.

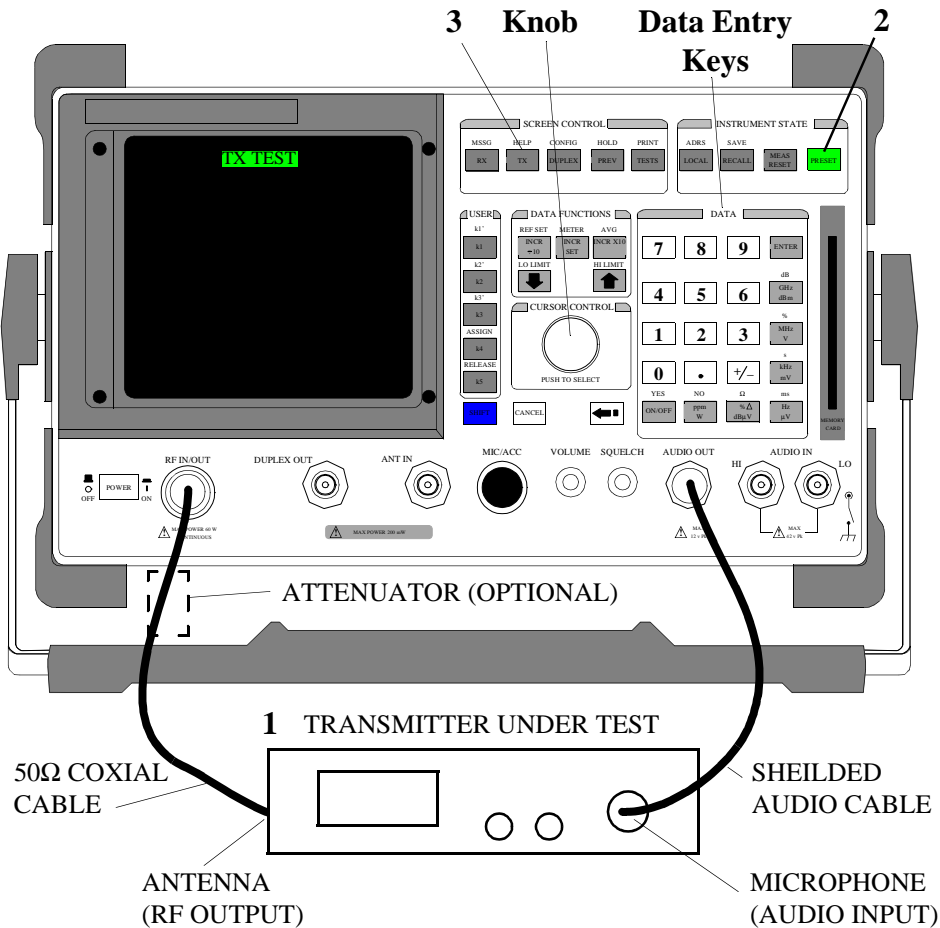

Test Set Options Required	The typical error for the standard Test Set timebase is 2-3 Hz per 1 MHz (when measuring carrier frequency). If greater accuracy is required, use a Test with Option 001 (High Stability Timebase).
Special Test Considerations	"Cable and Adapter Loss" on page 46.

Measurement Procedure:

1. Connect the Transmitter Under Test as shown.

CAUTION:

The RF present at the Test Set RF IN/OUT connector must not exceed 60W continuous (or 100 Watts for 10 sec/minute).

On the Test Set:

2. Press the PRESET key.
3. Press the TX key.

Using the knob and data entry keys:

4. Set **AFGen1 Lvl** to the correct output level for the desired frequency deviation (refer to microphone sensitivity and deviation specifications for the Transmitter being tested).
5. Set **Filter 1** to *300 Hz HPF*.
6. Set **Filter 2** to *3 kHz LPF*.
7. Set **De-Emphasis** to Off.

NOTE:

If the Test Set is equipped with the CCITT filter option, set **Filter 1** to <20 Hz HPF and **Filter 2** to *CCITT*.

8. Determine if actual frequency readout or frequency error is the desired measurement.
 - For actual frequency readout, continue with **step 9**.
 - For frequency error:
 - Set **Tune Mode** to Manual.
 - Set **Tune Freq** to the expected carrier frequency.

On the Radio:

9. Key the Transmitter.

As long as the Transmitter is keyed the measurement results will display.

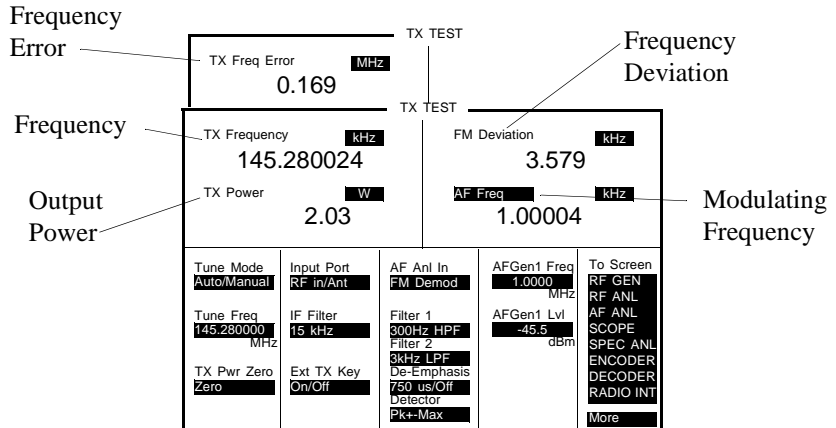

FM Deviation and Symmetry Measurement

This procedure is used to measure an FM Transmitter's frequency deviation and deviation symmetry. FM deviation is displayed on the Test Set. Deviation symmetry requires measuring the plus and minus peaks, then calculating symmetry.

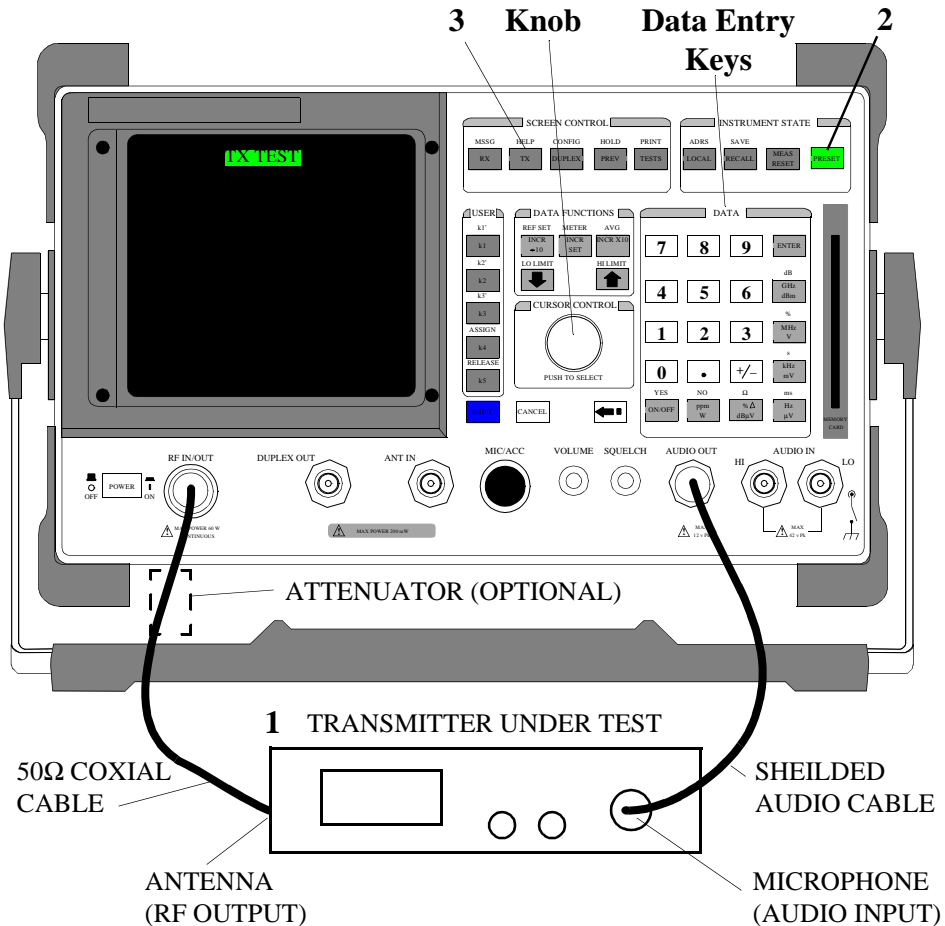

Measurement Procedure:

1. Connect the Transmitter Under Test as shown.

CAUTION:

The RF present at the Test Set RF IN/OUT connector must not exceed 60W continuous (or 100 Watts for 10 sec/minute).

On the Test Set:

2. Press the PRESET key.
3. Press the TX key.

On the Radio:

4. Key the Transmitter and keep keyed until the remaining steps are complete.

On the Test Set using the knob and data entry keys:

5. Set **AFGen1 Lvl** so that displayed FM deviation is 60% of the Transmitter's specified maximum frequency deviation (typically 3 kHz).

On the Test Set measured **FM Deviation** is displayed as shown.

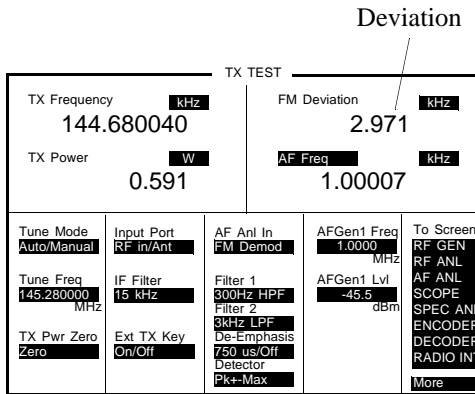

To measure FM symmetry on the Test Set:

6. Set **Detector** to Pk-.
7. Record the displayed FM Deviation as Pk-.
8. Set **Detector** to Pk+.

9. Record the displayed FM Deviation as Pk+.

Calculate the Measurement:

10. Calculate the Deviation Symmetry as follows:

$$\text{Deviation Symmetry (in percent)} = \frac{(\text{Pk}+) - (\text{Pk}-)}{(\text{Pk}+)} \times 100$$

$$\text{For example,} = \frac{(3.010) - (2.971)}{(3.010)} \times 100 = 1.29$$

FM Microphone Sensitivity and Modulation Limiting Measurement

Description

This procedure is used to measure an FM Transmitter's audio input sensitivity, and modulation limiting capability (if available). Modulation limiting is verified over the Transmitter's audio frequency range. FM reference is ANSI/EIA-RS-152-C-1988 RS-316-B.

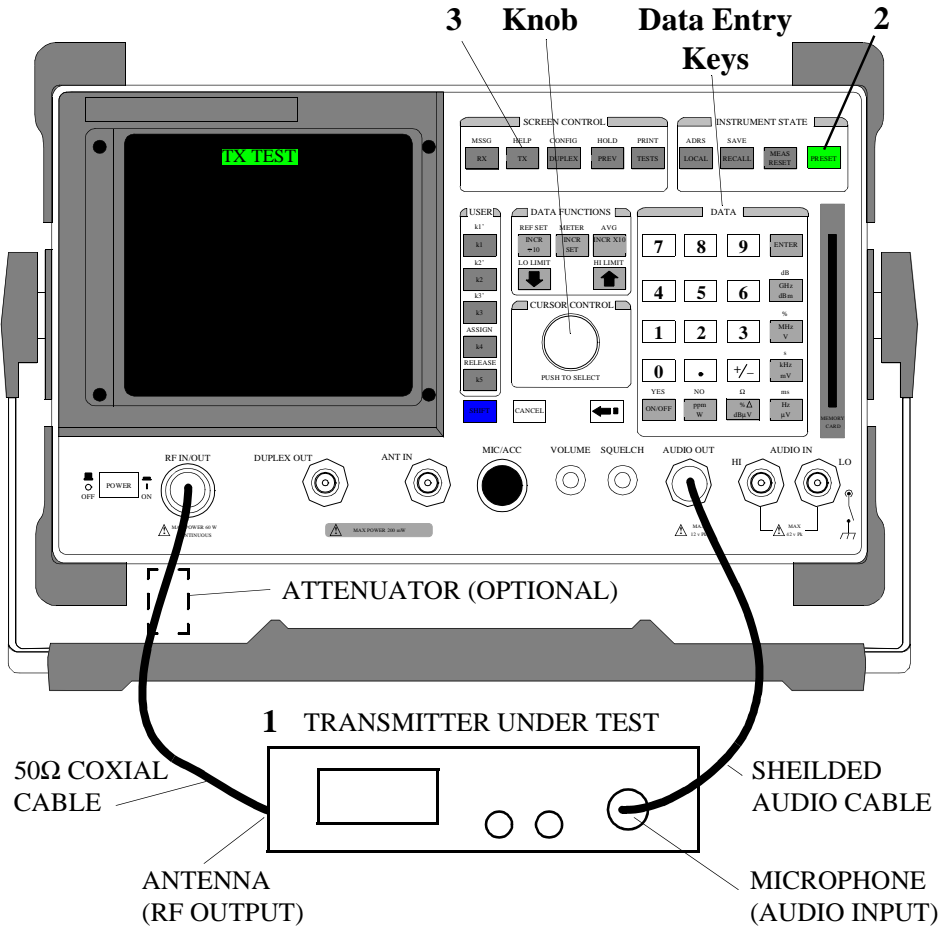

Special Test ConsiderationsSee "**Incidental Audio**" on page 46.**Measurement Procedure:**

1. Connect the Transmitter as shown.

CAUTION:

The RF present at the Test Set RF IN/OUT connector must not exceed 60W continuous (or 100 Watts for 10 sec/minute).

On the Test Set:

2. Press the PRESET key.
3. Press the TX key.

Using the knob and data keys:

4. Set **Filter 1** to 300 Hz HPF.
5. Set **Filter 2** to 3 kHz LPF.

On the Radio:

6. Key the Transmitter and keep keyed until the remaining steps are completed

On the Test Set using the knob and data entry keys:

7. Set **AFGen1 Lvl** so that displayed FM deviation is 60% of the Transmitter's specified frequency deviation (typically 3 kHz).

On the Test Set Microphone Sensitivity is shown as **AFGen1 Lvl**.

TX TEST				
TX Frequency kHz 145.280024		FM Deviation kHz 2.965		
TX Power W 2.03		AF Freq kHz 1.00004		
Tune Mode Auto/Manual	Input Port RF In/Ant	AF Anl In FM Demod	AFGen1 Freq 1.0000 MHz	To Screen RF GEN RF ANL AF ANL SCOPE SPEC ANL ENCODER DECODER RADIO INT More
Tune Freq 145.280000 MHz	IF Filter 15 kHz	Filter 1 300Hz HPF Filter 2 3kHz LPF De-Emphasis 750 us/Off Detector Pk+-Max	AFGen1 Lvl -45.5 dBm	
TX Pwr Zero Zero	Ext TX Key On/Off			

Microphone
Sensitivity

8. Set **AFGen1 Lvl** measurement units to *dBm*.
9. Increase **AFGen1 Lvl** by *20 dB*.
 Displayed FM deviation should not exceed the Transmitter’s maximum specified deviation.
10. Change **AFGen1 Freq** from *300 Hz to 3 kHz* (in 100 Hz increments).
11. Verify that the displayed FM deviation does not exceed the Transmitter’s maximum specified deviation.

FM CTCSS Encoder Frequency and Deviation Measurement

Description

This procedure is used to measure an FM Transmitter's Continuous Tone Coded Squelch System (CTCSS) encoder frequency and frequency deviation. Both frequency and deviation are read directly off the Test Set screen. FM reference is ANSI/EIA RS-220-A.

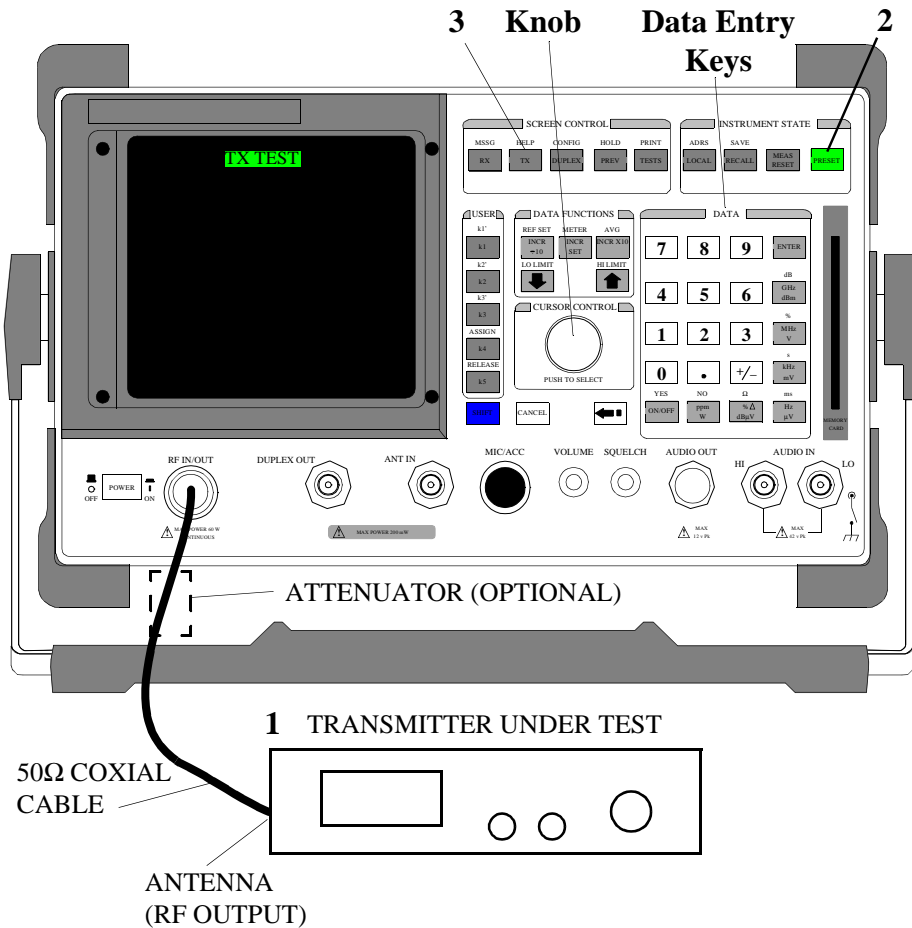

Measurement Procedure:

1. Connect the Transmitter as shown.

CAUTION:

The RF present at the Test Set RF IN/OUT connector must not exceed 60W continuous (or 100 Watts for 10 sec/minute).

On the Test Set:

2. Press the PRESET key.
3. Press the TX key.

On the Radio:

4. Key the Transmitter and keep keyed until the remaining steps are completed.

On the Test Set using the knob and data entry keys:

5. Set **Filter 2** to 300 Hz LPF.

On the Test Set Tone frequency deviation is displayed as **FM Deviation** as shown.

On the Test Set Tone frequency is displayed as **AF Freq.**

TX TEST				
TX Frequency kHz 145.890058		FM Deviation kHz 0.980		
TX Power W 0.587		AF Freq kHz 0.10354		
Tune Mode Auto/Manual	Input Port RF in/Ant	AF Anl In FM Demod	AFGen1 Freq 1.0000 MHz	To Screen RF GEN
Tune Freq 145.280000 MHz	IF Filter 15 kHz	Filter 1 300Hz HPF	AFGen1 Lvl -45.5 dbm	RF ANL
TX Pwr Zero Zero	Ext TX Key On/Off	Filter 2 3kHz LPF		AF ANL
		De-Emphasis 750 us/Off		SCOPE
		Detector Pk+Max		SPEC ANL
				ENCODER
				DECODER
				RADIO INT
				More

Tone Deviation

Tone Frequency

FM CDCSS Coding and Deviation Measurements

Description

This procedure is used to analyze an FM Transmitter's Continuous Digital Coded Squelch System (CDCSS) digital data stream and frequency deviation. The data rate, binary data stream, and octal code are all displayed on the Test Set screen.

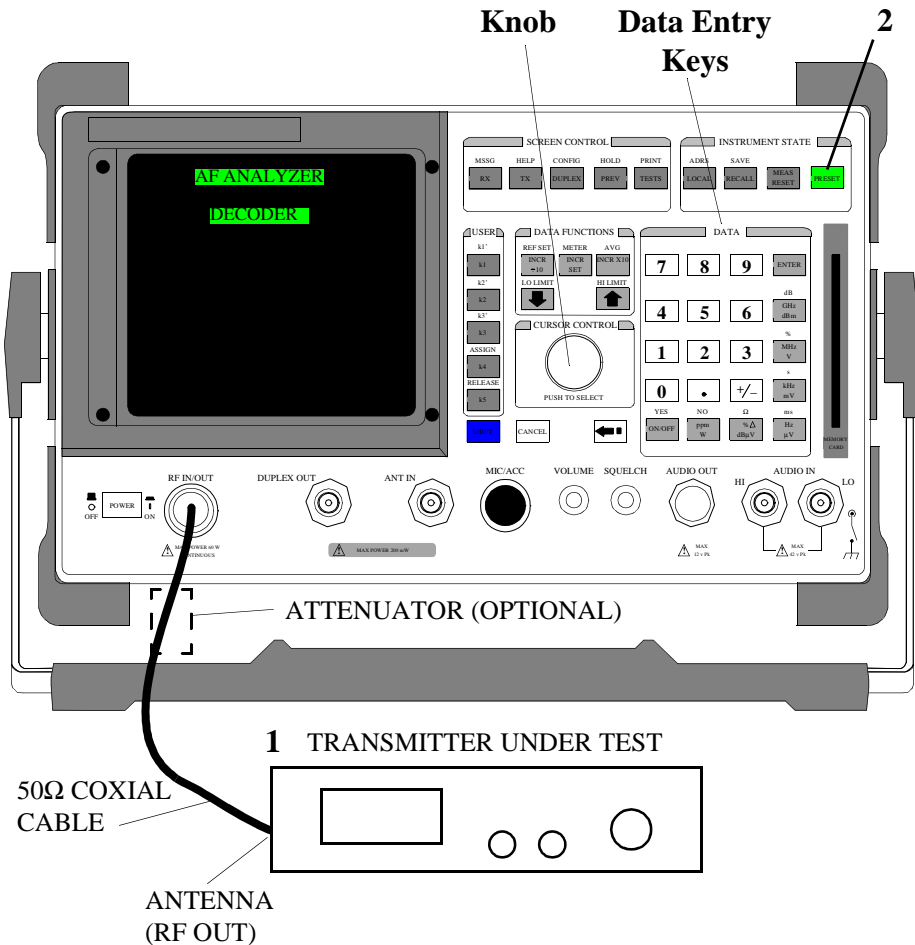

Test Set Options Required	Decoder Option
----------------------------------	----------------

Measurement Procedure:

1. Connect the Transmitter as shown.

CAUTION:

The RF present at the Test Set RF IN/OUT connector must not exceed 60W continuous (or 100 Watts for 10 sec/minute).

On the Test Set:

2. Press the PRESET key.

Using the knob and the data entry keys:

3. Select the **AF ANL** screen.
4. Set **Filter 1** to *<20 Hz HPF* setting.
5. Set **Filter 2** to *300 Hz LPF* setting.
6. Set **Settling** to Slow setting.
7. Select the **DECODER** screen.
8. Set **Mode** to *CDCSS*.
9. Set **Standard** to *CDCSS*.
10. Set **Input Level** to *0.95 kHz*.
11. Set **Arm Meas** to Cont.

On the Radio:

12. Key the Transmitter and keep keyed until the remaining steps are completed.

Data rate, binary data (bin), and the Octal Code(s) are displayed on the Test Set as shown.

NOTE:

Because framing information to indicate when a code word is not sent, the decoded data displayed can result in several possible code combinations as shown. NPC may appear, indicating that no primary code matches the decoded data.

SIGNALING DECODER		
Data Rate	134.400	Arm Meas
Binary Data	1101100011000010101111	Single/Cont
Octal Code(s)	143	Stop Meas
	333	
		AF Anl In
		Audio Out
		Inout Level
		1.0
		Trig Level
		242 mV
		Polarity
		Norm/Invert
		Status: Computing
		Mode
		CDCSS
		Standard
		CDCSS
		To Screen
		RF GEN
		RF ANL
		AF ANL
		SCOPE
		SPEC ANL
		ENCODER
		DECODER
		RADIO INT
		More

To measure deviation of the data stream on the Test Set:

13. Press the TX key.

Data stream deviation is displayed as **FM Deviation**.

FM DTMF Encodes and Deviation Measurement

Description

This procedure is used to measure an FM Transmitter's Dual Tone Multi-Frequency (DTMF) frequency, deviation and frequency sequence (if desired).

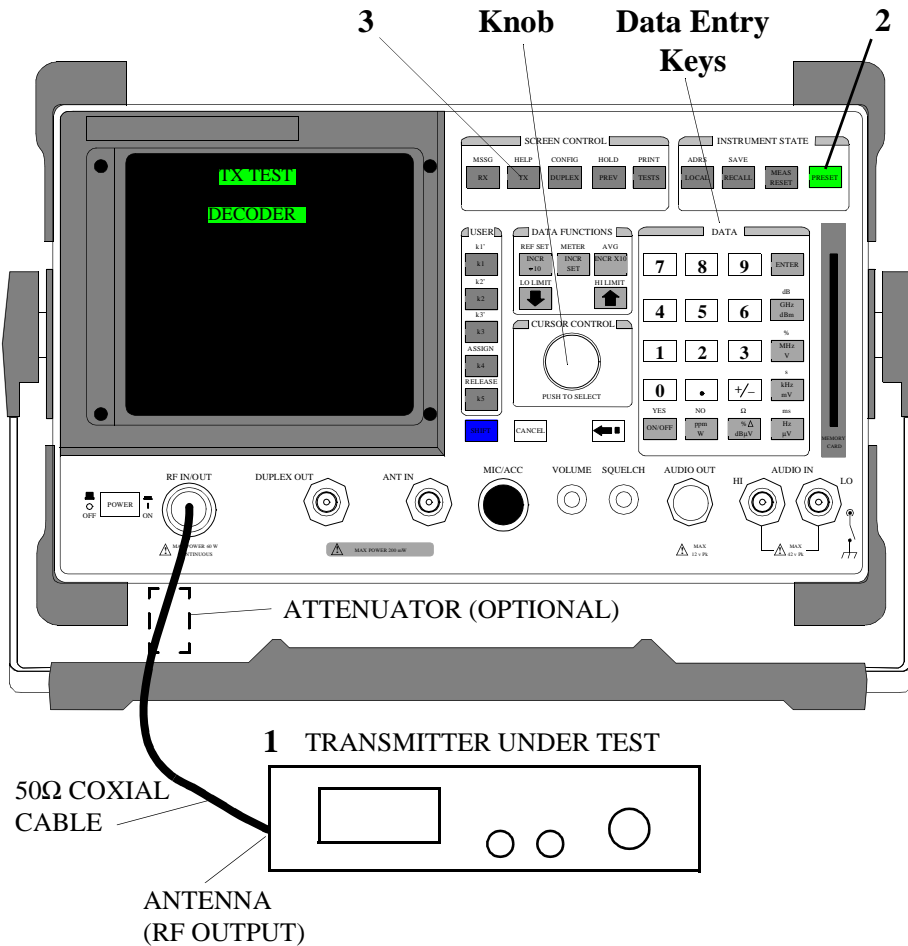

Test Set Options Required	Decoder Option
Additional Equipment Required	None
Special Test Considerations	None

Measurement Procedure:

1. Connect the Transmitter as shown.

CAUTION:

The RF present at the Test Set RF IN/OUT connector must not exceed 60W continuous (or 100 Watts for 10 sec/minute).

On the Test Set:

2. Press the PRESET key.
3. Press the TX key.

Using the knob and data entry keys:

4. Set **Filter 1** to *300 Hz HPF*.
5. Set **Filter 2** to *3 kHz LPF*.
6. Select the **DECODER** screen.
7. Set **Mode** to *DTMF*.
8. Set **Input Level** to *0.95 kHz*.
9. Set **Gate Time** to desired value (typically 100 ms).
10. Set **Arm Meas** to Cont.

On the Test Set:

11. Adjust Volume control to desired level.
12. Adjust Squelch control until just closed.

On the Radio:

13. Key the Transmitter and keep keyed until the remaining steps are completed.
14. Press the desired DTMF key.

The symbol and tone pair frequencies will be displayed on the Test Set as shown.

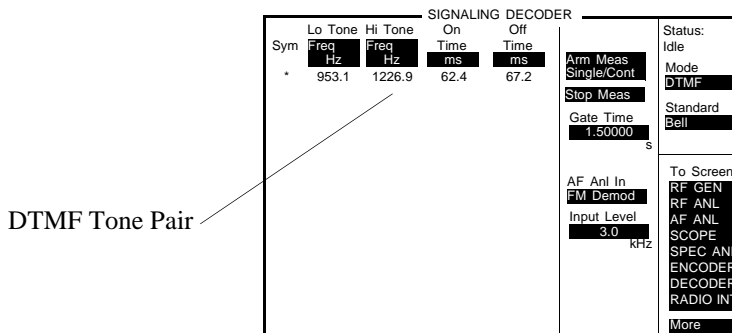

To Measure deviation of the DTMF on the Test Set:

15. Press the TX key.

Tone deviation is displayed as **FM Deviation**.

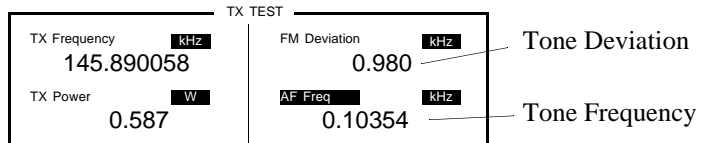

- If decoding a sequence of DTMF tones, proceed as follows:
 - a. Set **Gate Time** to a value long enough to capture the entire sequence (typically 1 to 5 seconds).
 - b. Set **Arm Meas** to Single.
 - c. Set **Arm Meas** (status message will change to “ARMED”).

On the Radio:

- d. Key the Transmitter.
- e. Send DTMF sequence.

The symbols and tone pair frequencies will be displayed on the Test Set as shown.

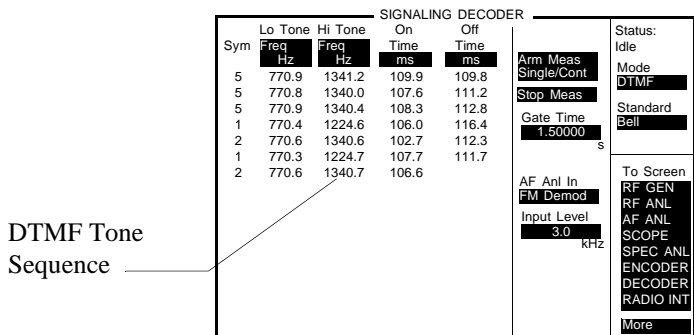

FM Audio Distortion Measurement

Description

This procedure is used to measure an FM Transmitter's audio frequency harmonic distortion level. FM reference is ANSI/EIA-RS-152-C, RS-316-B.

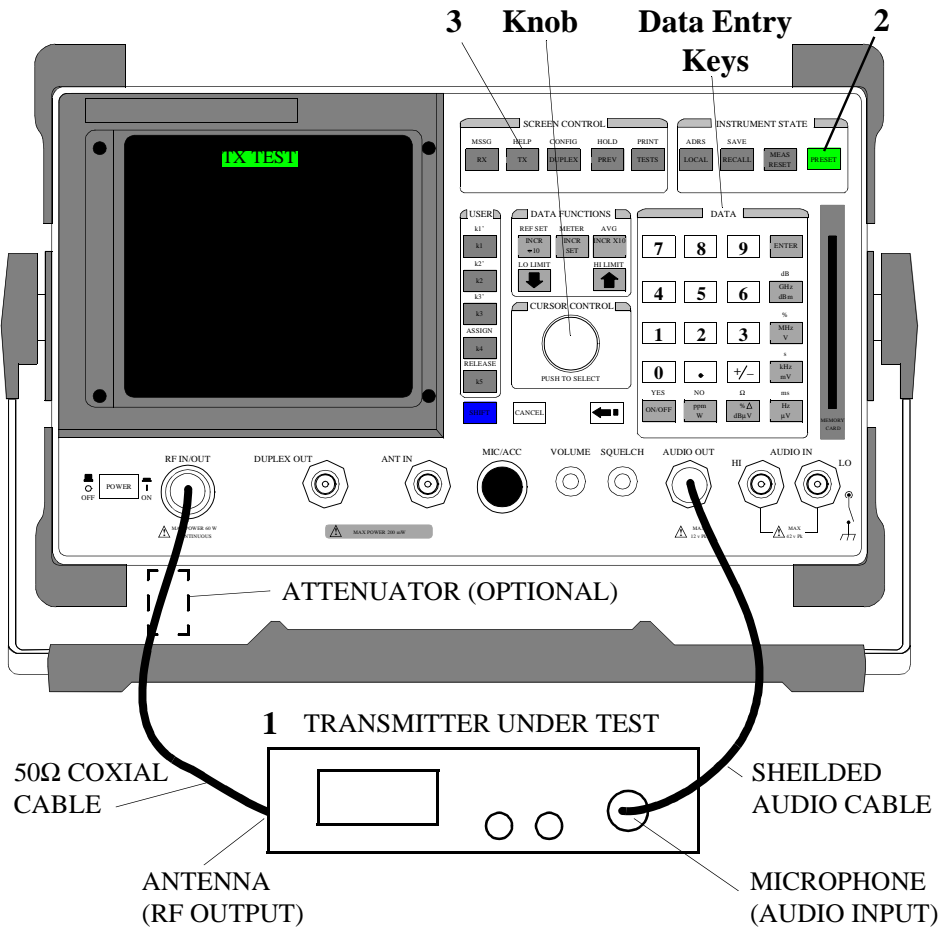

Measurement Procedure:

1. Connect the Transmitter as shown.

CAUTION:

The RF present at the Test Set RF IN/OUT connector must not exceed 60W continuous (or 100 Watts for 10 sec/minute) or permanent instrument damage may result.

On the Test Set:

2. Press the PRESET key.
3. Press the TX key.

Using the knob and data entry keys:

4. Set **Filter 1** to *300 Hz HPF*.
5. Select the **AF Freq Meter**.
6. Select **Distn** from the **Choices** field.
7. Set **AFGen1 Lvl** so that displayed FM deviation is *100%* of the Transmitter's specified maximum frequency deviation.

NOTE:

Do not exceed the specified input level that causes maximum frequency deviation, or the Transmitter's modulation limiting circuits will cause added distortion. Refer to the input level/deviation specifications for the Transmitter being tested.

On the Radio:

8. Key the Transmitter and keep keyed until reading displays.

Distortion (in percent, or dB) is displayed on the Test Set as shown.

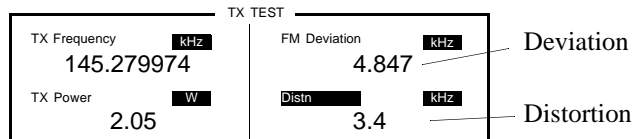

FM Harmonics and Spurious Output Measurement

Description

This procedure is used to measure an FM Transmitter's conducted harmonic and spurious emissions. The spectrum analyzer option is used to display harmonic and spurious components from 400 kHz to 1000 MHz. FM reference is ANSI/EIA-RS-152-C, RS-316-B.

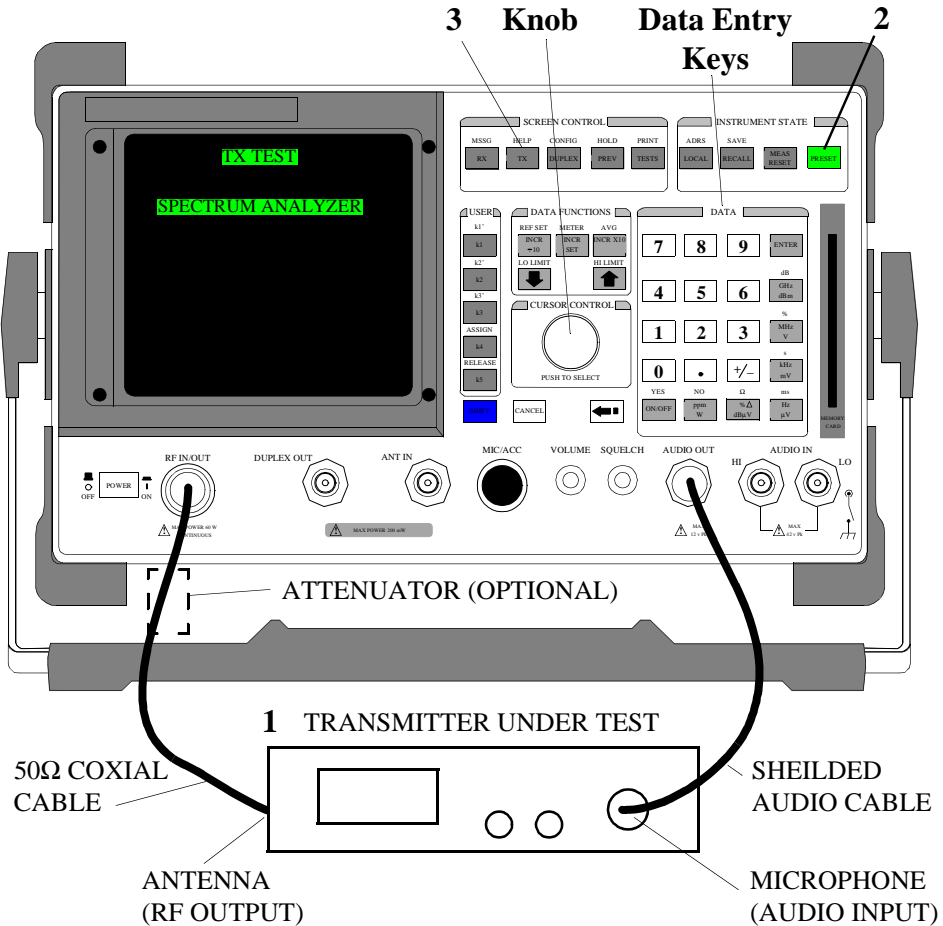

Test Set Options Required	Spectrum Analyzer/Tracking Generator (option 102)
Special Test Considerations	Cable and adapter mismatch must be considered when measuring harmonics and spurious emissions of a transmitter. If an external attenuator is used, special care must be taken to ensure the attenuator is not causing any spurious or harmonic emission. Also, if spurious emissions are located, verify that the transmitter is the source, and not another object radiated emissions near the test site.

Measurement Procedure:

1. Connect the Transmitter as shown.

CAUTION:

The RF present at the Test Set RF IN/OUT connector must not exceed 60W continuous (or 100 Watts for 10 sec/minute) or permanent instrument damage may result.

On the Test Set:

2. Press the PRESET key.
3. Press the TX key.

On the Radio:

4. Key the Transmitter and keep keyed until the remaining steps are completed.

On the Test Set using the knob and data entry keys:

5. Set **AFGen1 Lvl** so that displayed FM deviation is 50% of the Transmitter's specified maximum frequency deviation (typically 2.5 kHz).
6. Set **AFGen1 Lvl** units to *dBm*.
7. Increase (more positive) **AFGen1 Lvl** by 16 *dB*.
8. Select **SPEC ANL**.
9. Set **Span** to 1.1 *MHz*.
10. Set **Ref Level** to place the carrier peak at the top graticule line.

To set **Ref Level**:

- From the Marker screen, select **Marker To Peak**
- Select **Marker To Ref Level**

11. Tune Center Freq in 1 MHz steps anywhere from 400 kHz to 1 GHz in search of harmonics, sub-harmonics, multiples, or spurious emissions.

NOTE:

If spurious emissions are suspect, un-key the Transmitter, and verify that emissions are from the transmitter and not another source.

To measure spurious emission of the transmitter under test:

- Place at center frequency.
- Or perform the following:
 - a. Select **Main** from the Controls field.
 - b. Select **Markers** from the Choices field.
 - c. Position the marker on the desired peak. (**Position** or **Next Peak**)

Marker frequency and level are displayed as shown.

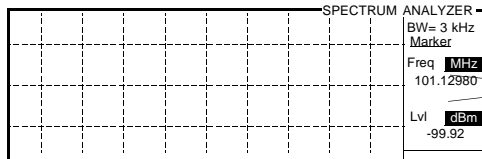

Spurious or Harmonic Level & Frequency

FM Receivers

The following measurements are provided for testing FM Receivers. The procedures are arranged in the order that tests are typically performed.

FM Audio Output Power Measurement

Description

This procedure is used to measure an FM Receiver's maximum audio output power (or rated output power) into a Test Load. Output power is displayed (in various measurement units, including watts) on the Test Set screen. The FM reference is RS-204D and RS-316B.

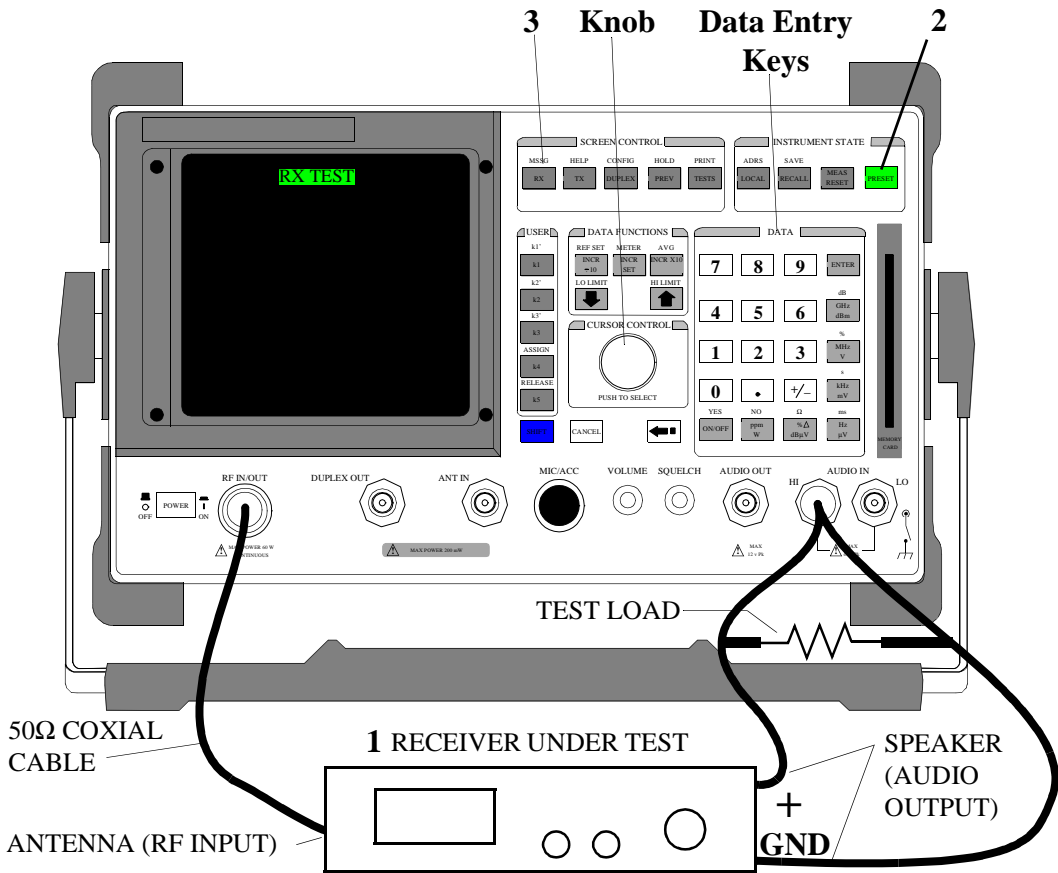

Additional Equipment Required	Test Load
Special Test Considerations	See " Receiver Test Loads " on page 46.

Measurement Procedure:

1. Connect the Receiver as shown.

On the Test Set:

2. Press the PRESET key.
3. Press the RX key.

Using the knob and data entry keys:

4. Set **RF Gen Freq** to the receiver operating frequency.
5. Set **Amplitude** to -47 dBm (1 mV).
6. Set **AFGen1 To** 60% of the Receiver's specified maximum frequency deviation (typically 3 kHz).
7. Set **Ext Load R** to the test load resistance.
8. Set **AC Level** meter to measure **Watts**.

On the Radio set the Receiver's Controls as follows:

9. Set power to ON.
10. If required, set frequency to the same value as [step 4](#).
11. Set squelch to minimum.
12. Set RF Gain to maximum (if equipped).
13. Set coded squelch feature (if equipped) to OFF.
 Refer to "[Coded Squelch](#)" on [page 47](#) for information on opening Receivers with coded squelch.
14. Slowly increase volume control until the AC Level reaches the Receiver's rated output power, or reaches a maximum level (stops increasing).
 Refer to audio output specifications for the Receiver being tested as required.

NOTE:

If the rated output cannot be obtained, troubleshoot and repair the Receiver's audio stages is necessary.

Measurement results are displayed on the Test Set as shown.

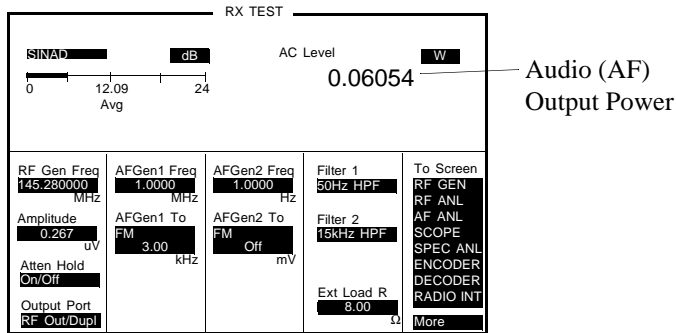

FM SINAD, Receiver Center Frequency, and Modulation Acceptance Bandwidth Measurement

Description

This procedure is used to measure an FM Receiver's sensitivity (for 12dB SINAD), center frequency, and modulation acceptance bandwidth. All measurements are read from the Test Set screen. Reference is RS-204D.

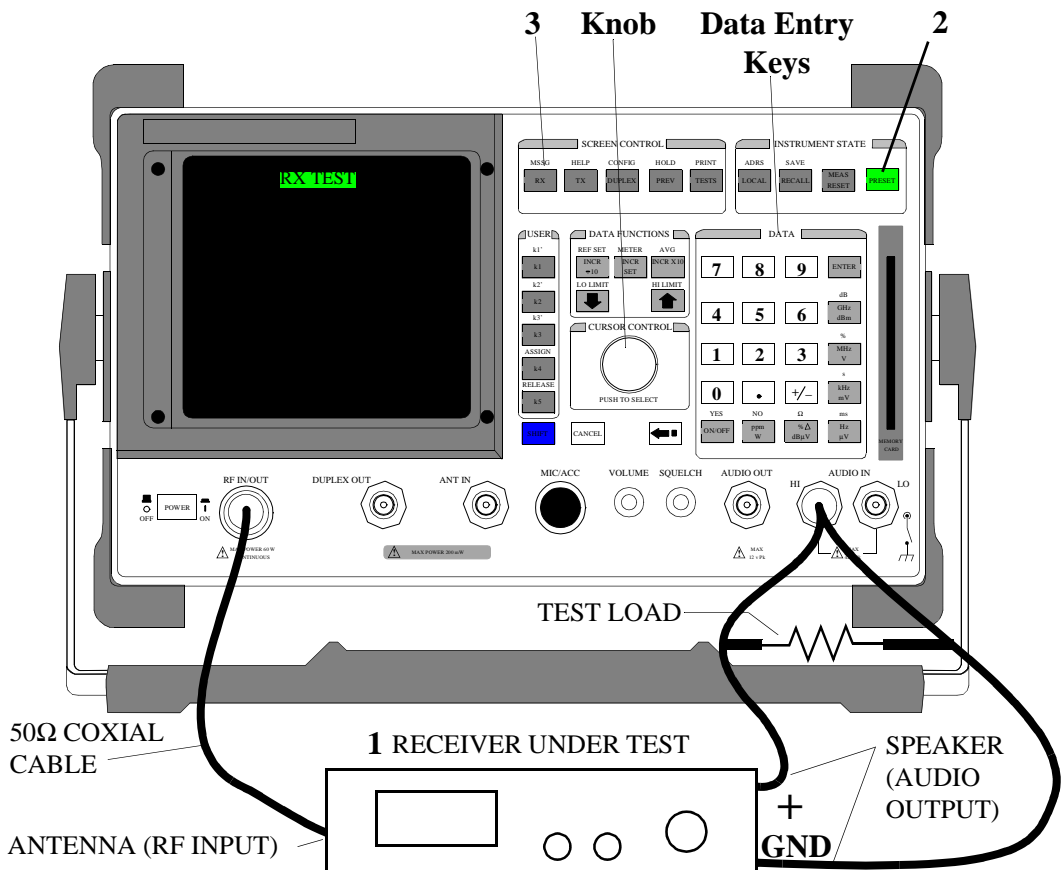

Additional Equipment Required	Test Load
Special Test Considerations	See " Receiver Test Loads " on page 46.

Measurement Procedure:

1. Connect the Receiver as shown.

On the Test Set:

2. Press the PRESET key.
3. Press the RX key.

Using the knob and data entry keys:

4. Set **RF Gen Freq** to the receiver operating frequency.
5. Set **Amplitude** to -47 dBm (1 mV).
6. Set **AFGen1 To** 60% of the Receiver's specified maximum frequency deviation (typically 3 kHz).
7. Set **Ext Load R** to the test load resistance.
8. Set **AC Level** meter to measure **Watts**.

On the Radio set the Receiver's Controls as follows:

9. Set power to ON.
10. If required, set frequency to the same value as [step 4](#).
11. Set squelch to minimum.
12. Set RF Gain to maximum (if equipped).
13. Set coded squelch feature (if equipped) to OFF.

NOTE:

Failure to set coded squelch to off will cause the SINAD measurement to be incorrect.

14. Set the volume control until the AC Level reads 100% of the Receiver's rated audio output power.

Refer to the audio output specifications for the receiver being tested.

On the Test Set using the knob and data entry keys:

15. Decrease **Amplitude** until the SINAD meter reads 12 dB.

Sensitivity (12dB SINAD) is displayed as **Amplitude** as shown.

- Record the level (in dBm) for use in **step 17.**

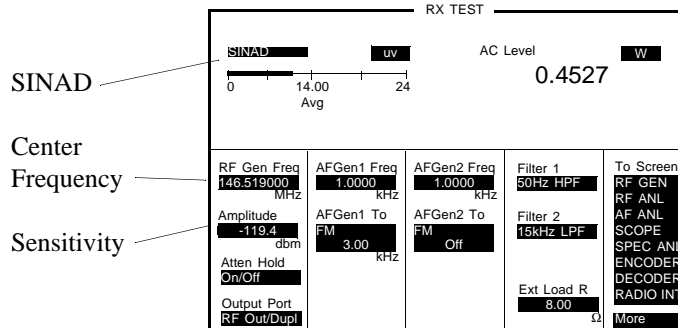

- If desired, use the meter averaging function for the SINAD indicator.
 - Select dB on the SINAD meter.
 - Press the AVG key.
 - If desired, select the number of readings to average.
 - Enter the number of readings to average.

Higher number of readings averaged will require longer to reach the final indication.

- If desired, verify that the Receiver is tuned to a specific frequency (Receiver Center Frequency)
 - Slowly increase or decrease **RF Gen Freq** (in 100 Hz steps) until SINAD meter reads maximum.

Receiver Center Frequency is displayed as **RF Gen Freq** as shown above.

16. If changed because of the previous steps, reset **RF Gen Freq** to receiver operating frequency.

17. Set **Amplitude** to a level 6 dB higher (more positive) than the level recorded in **step 5.**

18. Increase **AFGen1 To** Deviation until SINAD meter reads 12 dB.

On the Test Set modulation acceptance bandwidth is displayed as **AFGen1 To Deviation** as shown.

Modulation
Acceptance
Bandwidth

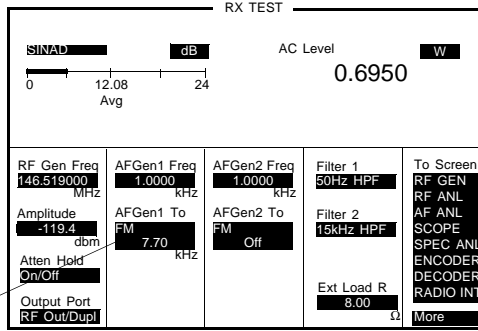

FM Variation Of Sensitivity With Signal Frequency Measurement

Description

This procedure is used to measure an FM Receiver's usable bandwidth (at 12 dB SINAD). A reference is established (at 12 dB SINAD), then the level is increased by 6 dB. Frequency is increased and decreased until the SINAD of 12 dB is again obtained. Usable bandwidth is then calculated. Reference is EIA-204-D.

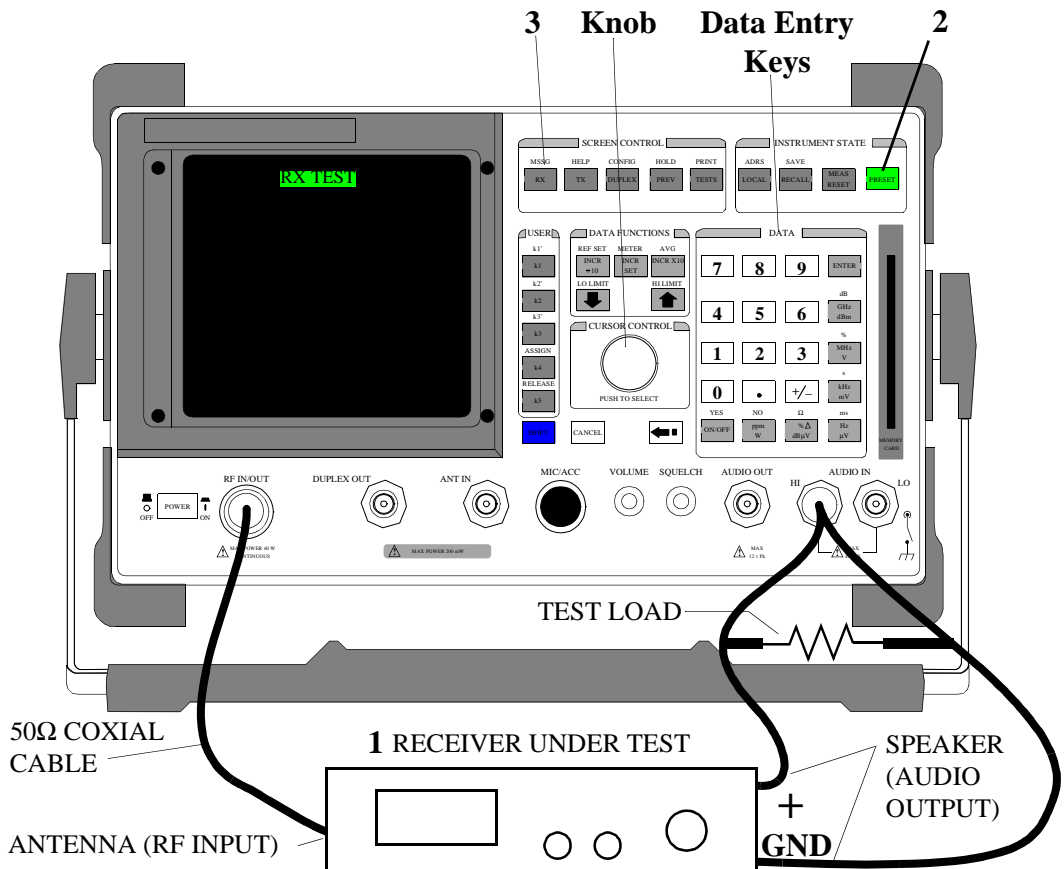

Additional Equipment Required	Test Load
Special Test Considerations	See " Receiver Test Loads " on page 46.

Measurement Procedure:

1. Connect the Receiver as shown.

On the Test Set:

2. Press the PRESET key.
3. Press the RX key.

Using the knob and data entry keys:

4. Set **RF Gen Freq** to the receiver operating frequency.
5. Set **Amplitude** to -47 dBm (1 mV).
6. Set **AFGen1 To** 60% of the Receiver's specified maximum frequency deviation (typically 3 kHz).
7. Set **Ext Load R** to the test load resistance.
8. Set **AC Level** meter to measure **Watts**.

On the Radio set the Receiver's Controls as follows:

9. Set power to ON.
10. If required, set frequency to the same value as **step 4**.
11. Set squelch to minimum.
12. Set RF Gain to maximum (if equipped).
13. Set coded squelch feature (if equipped) to OFF.

NOTE:

Failure to set coded squelch to off will cause the SINAD measurement to be incorrect.

14. Set the volume control until the AC Level reads 100% of the Receiver's rated audio output power.

Refer to the audio output specifications for the receiver being tested.

On the Test Set using the knob and data entry keys:

15. Decrease **Amplitude** until the SINAD meter reads 12 dB.

Sensitivity (12dB SINAD) is displayed as **Amplitude** as shown.

- Record the frequency as Assigned Freq for use later in the procedure.

Assigned High, Low Frequency

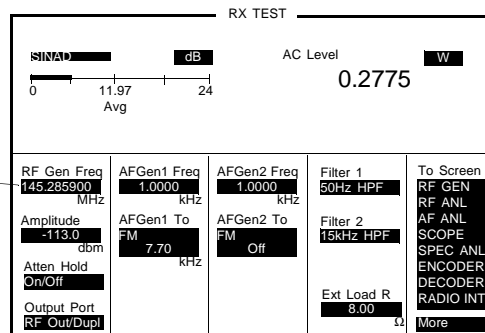

- If desired, use the meter averaging function for the SINAD indicator.
 - a. Select dB on the SINAD meter.
 - b. Press the AVG key.
- If desired, select the number of readings to average.
 - Enter the number of readings to average.

Higher number of readings averaged will require longer to reach the final indication.

16. Increase **Amplitude** (more positive) by 6 dB.

17. Increase **RF Gen Freq** (in 100 Hz steps) until the SINAD meter again reads 12 dB.

- Record the frequency as High Freq for use later in the procedure.

18. Decrease **RF Gen Freq** (in 100 Hz steps) until the SINAD meter again reads 12 dB.

- Record the frequency as Low Freq for use later in the procedure.

Calculate the measurement:

19. *High Freq – Assigned Freq and Assigned Freq – Low Freq*

The minimum usable bandwidth is the smaller result.

FM 20 dB Quieting Sensitivity Measurement

Description

This procedure is used to measure an FM Receiver's quieting sensitivity (20 dB reduction in noise). A reference is established with no signal at the Receiver's antenna, then an un-modulated carrier is applied and the RF amplitude is increased until a 20 dB reduction in noise is measured at the audio output.

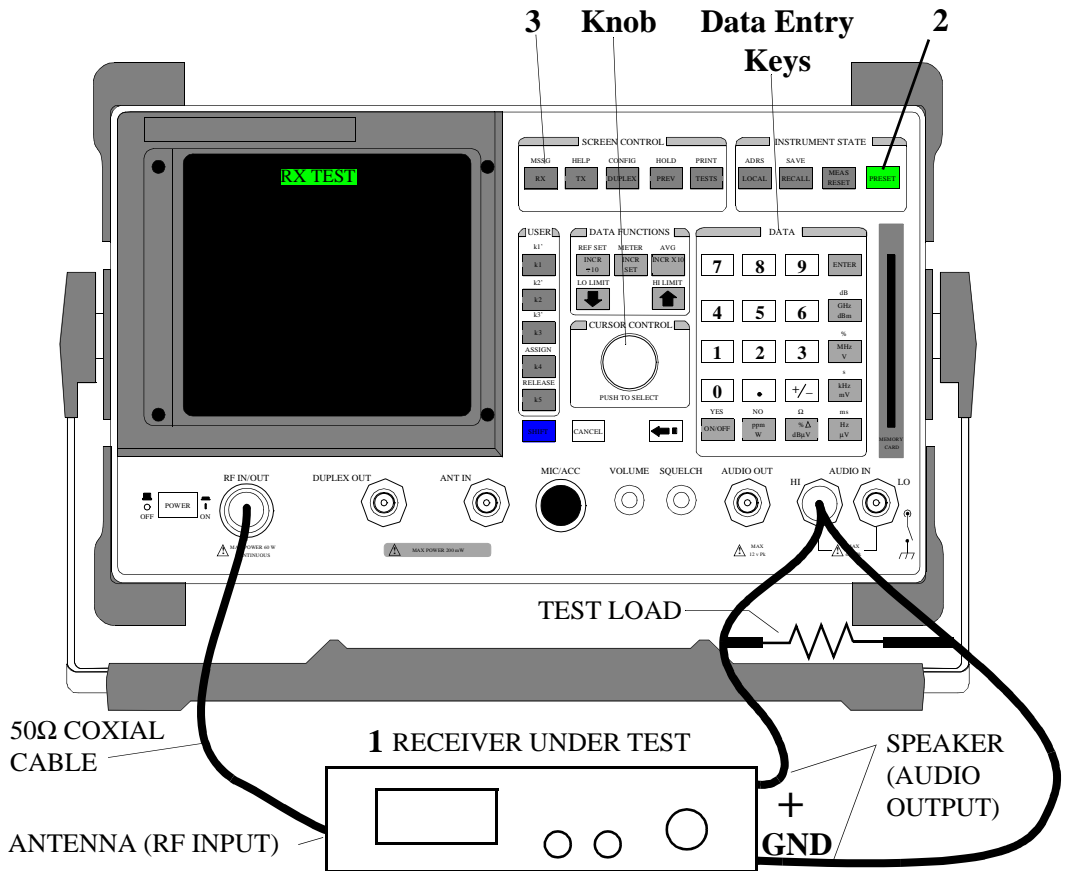

<p>Additional Equipment Required</p>	<p>Test Load</p>
<p>Special Test Considerations</p>	<p>See "Receiver Test Loads" on page 46.</p>

Measurement Procedure:

1. Connect the Receiver as shown.
 On the Test Set:
2. Press the PRESET key.
3. Press the RX key.
 Using the knob and data entry keys:
4. Set **RF Gen Freq** to receiver operating frequency.
5. Set **AFGen1** to OFF.
6. Set **Amplitude** to OFF.
7. Set **Ext Load R** to the test load resistance.
8. Set **AC Level** meter to measure **Watts**.

On the Radio set the Receiver's Controls as follows:

9. Set power to ON.
10. If required, set frequency to same value as [step 4.](#)
11. Set squelch to minimum.
12. Set RF Gain to maximum (if equipped).
13. Set coded squelch feature (if equipped) to OFF.

Refer to "[Coded Squelch](#)" on page 47 for information on opening Receivers with coded squelch.

14. Set the volume control until the AC Level reads 25% of the Receiver's rated audio output power.

Refer to the audio output specifications for the receiver being tested.

On the Test Set using the knob and data entry keys:

15. Select **AC Level**
16. Press the REF SET key.
17. Increase **Amplitude** until the AC Level meter reads -20.00 dB.

On the Test Set 20 dB Quieting Sensitivity is displayed as **Amplitude** as shown.

20 dB Quieting Sensitivity

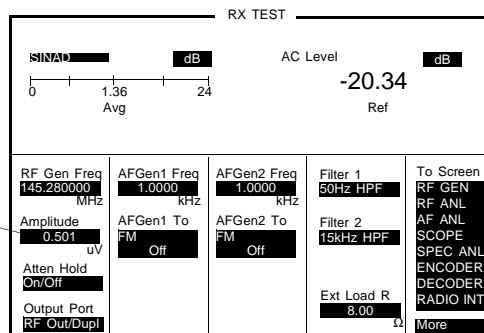

FM Critical and Maximum Squelch Sensitivity Measurement

Description

This procedure is used to measure an FM Receiver's critical squelch and maximum squelch sensitivity. For critical squelch, the receiver is just squelched with minimum modulated input at the Receiver's antenna, then the input is increased until the squelch is opened. Maximum squelch is the amount of modulated signal required to open the squelch when the control is set to maximum. Minimum and maximum squelch hysteresis is also measured and calculated. The FM reference is EIA/TIA-204-D.

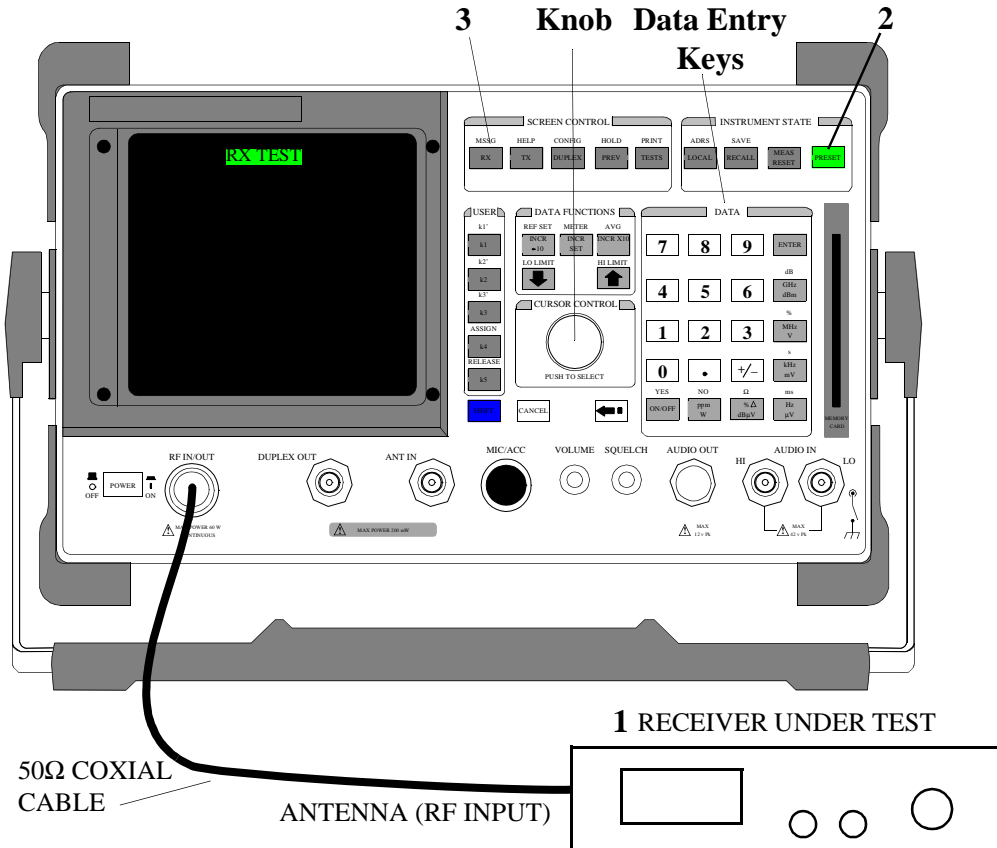

Special Test ConsiderationsSee "**Coded Squelch**" on page 47.**Measurement Procedure:**

1. Connect the Receiver as shown.

On the Test Set:

2. Press the PRESET key.
3. Press the RX key.

Using the knob and data entry keys:

4. Set **RF Gen Freq** to the receiver operating frequency.
5. Set **Amplitude** to -137 dBm.

On the Radio set the Receiver's Controls as follows:

6. Set power to ON.
7. If required, set frequency to the same value as **step 4**.
8. Set squelch to minimum.
9. Set RF Gain to maximum (if equipped).
10. Set coded squelch feature (if equipped) to OFF.
11. Set the volume control until noise is at a comfortable level.
12. Increase the Receiver's squelch control until audio is just squelched.

On the Test Set using the knob and data entry keys:

13. Slowly increase the **Amplitude** until squelch just remains open.

Critical Squelch is displayed as **Amplitude** as shown.

- Record this level.

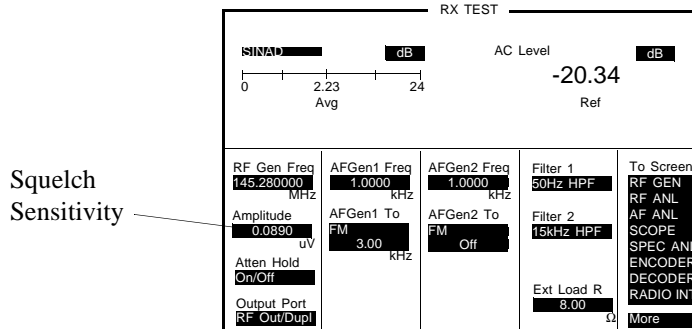

14. Decrease **Amplitude** until the Receiver’s squelch just closes.

- Record this level.

Calculate the measurement:

15. Critical Squelch Hysteresis is the difference between the two readings.

On the Radio set the Receiver’s Controls as follows:

16. Set the Receiver’s squelch control to maximum.

On the Test Set using the knob and data entry keys:

17. Increase **Amplitude** until the Receiver’s squelch just opens.

- Record this level.

18. Record the maximum squelch sensitivity is displayed as **Amplitude** as shown.

19. Decrease **Amplitude** until the Receiver’s squelch just closes.

- Record this level.

Calculate the reading:

20. Maximum Squelch Hysteresis is the difference between the two readings.

FM CTCSS Sensitivity and Bandwidth Measurement

Description

This procedure is used to measure an FM Receiver's Continuous Tone Coded Squelch System (CTCSS) sensitivity and bandwidth. For sensitivity, the minimum signal input at the Receiver's antenna (modulated with tone) that opens the squelch is measured and displayed. Squelch hysteresis is also measured and calculated. Tone frequency is then increased and decreased until the squelch boundaries are determined and the Bandwidth is calculated. Reference is ANSI/EIA RS-220A.

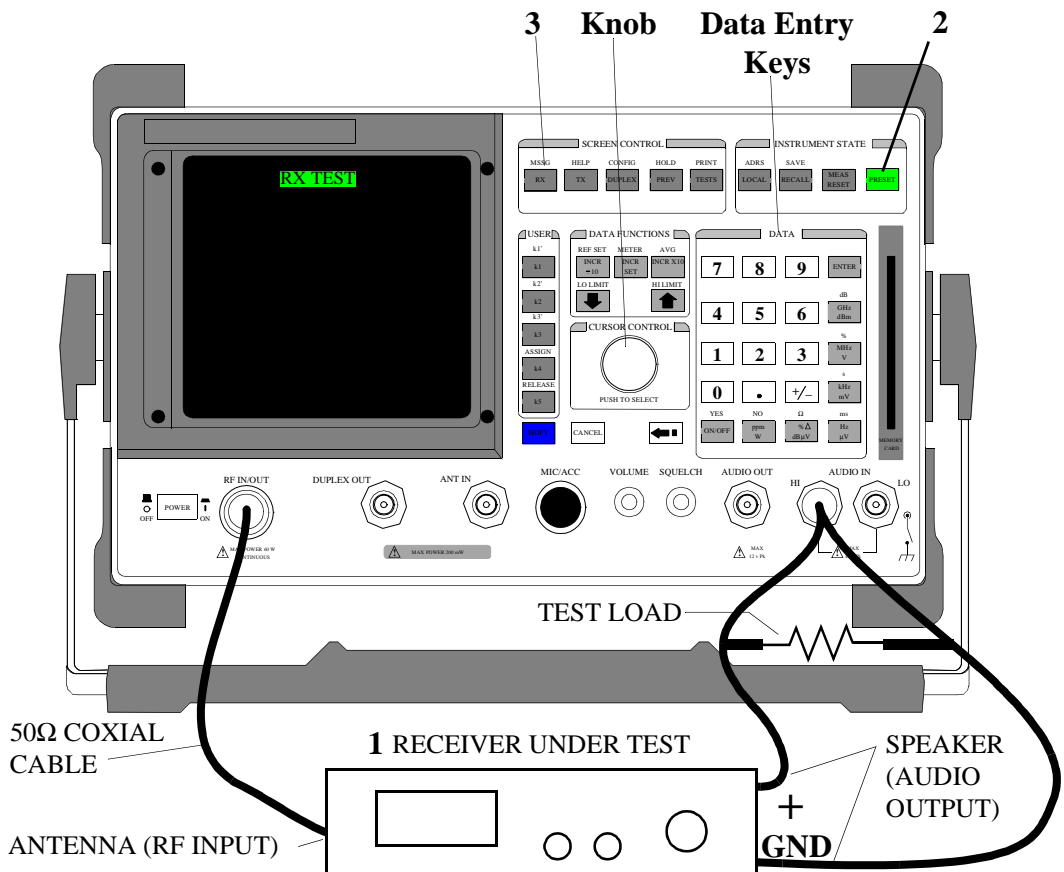

Additional Equipment Required	Test Load
Special Test Considerations	See " Receiver Test Loads " on page 46.

Measurement Procedure:

1. Connect the Receiver as shown.

On the Test Set:

2. Press the PRESET key.
3. Press the RX key.

Using the knob and data entry keys:

4. Set **RF Gen Freq** to the receiver operating frequency.
5. Set **Amplitude** to -47 dBm (1 mV).
6. Set **AFGen1 To** 60% of the Receiver's specified maximum frequency deviation (typically 3 kHz).
7. Set **AFGen2 Freq** to the Receiver's CTCSS tone frequency.
8. Set **AFGen2 To** to the 500 Hz.
9. Set **Ext Load R** to the test load resistance.
10. Set **AC Level** meter to measure **Watts**.

On the Radio set the Receiver's Controls as follows:

11. Set power to ON.
12. If required, set frequency to the same value as [step 4](#).
13. If required, set CTCSS tone frequency to the same value as [step 4](#).
14. Set RF Gain to maximum (if equipped).
15. Set squelch control to minimum (if equipped).
16. Set the volume control until the AC Level reads 100% of the Receiver's specified audio output.

Refer to the audio output specifications for the receiver being tested.

17. Verify Receiver's squelch is closed.

On the Test Set using the knob and data entry keys:

18. Set **Amplitude** to *-137 dBm*.
19. Slowly increase the **Amplitude** until the squelch remains open and the SINAD indicator shows 10 dB (minimum).

CTCSS Sensitivity is displayed as **Amplitude** as shown.

- Record this level.

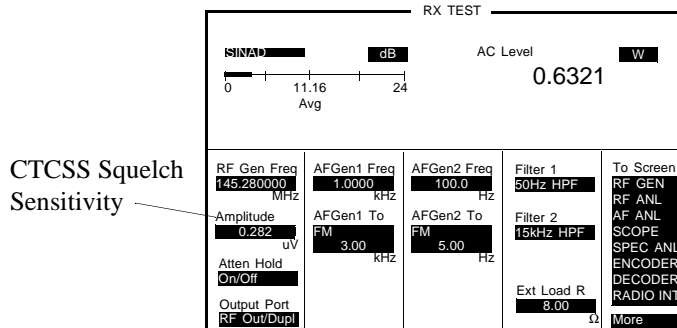

20. Set **Amplitude** to *-47 dBm*.
21. Slowly increase the **AFGEN2 Freq** in 0.1 Hz increments until the squelch just closes.
 - Record the frequency.

22. Slowly decrease the **AFGen2 Freq** in 0.1 Hz increments until the squelch just closes.

- Record the frequency.

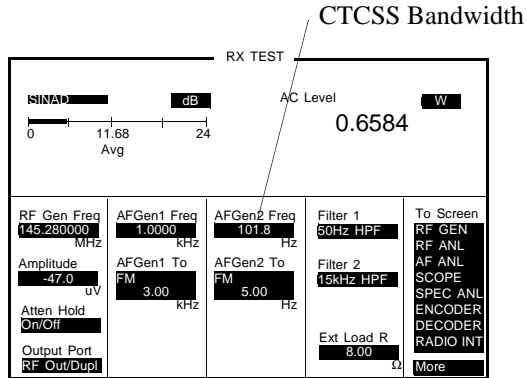

Calculate the Bandwidth:

23. Bandwidth = Larger AFGen2 Freq - Smaller AFGen2 Freq

NOTE:

Calculated bandwidth should be no less than 1% or no more than 6% of the encoder frequency.

FM CDCSS Sensitivity Measurement

Description

This procedure is used to measure an FM Receiver's Continuous Digital Coded Squelch System (CTCSS) sensitivity. The minimum signal input at the Receiver's antenna (modulated with digital code) that opens the squelch is measured and displayed. Squelch hysteresis is also measured and calculated.

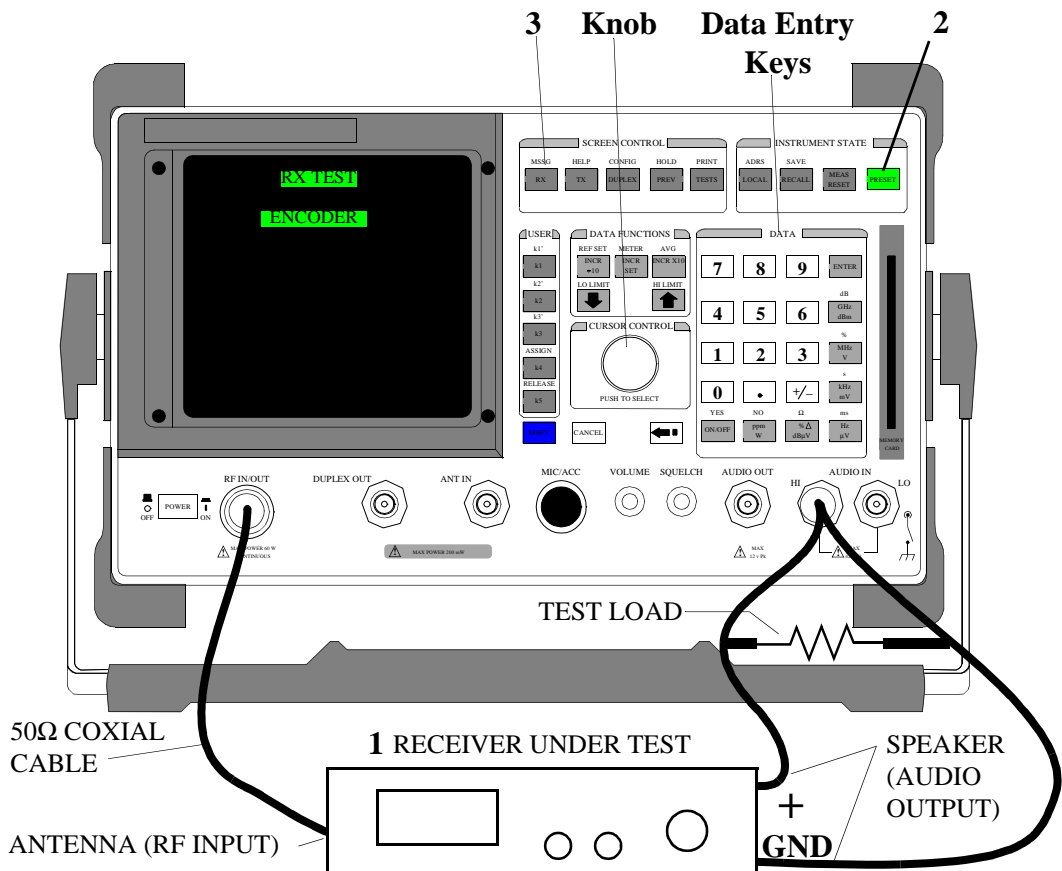

<p>Additional Equipment Required</p>	<p>Test Load</p>
<p>Special Test Considerations</p>	<p>See "Receiver Test Loads" on page 46.</p>

Measurement Procedure:

1. Connect the Receiver as shown.

On the Test Set:

2. Press the PRESET key.
3. Press the RX key.

Using the knob and data keys:

4. Select the **ENCODER** screen.
5. Set **Mode** to *CDCSS*.
6. Set **Standard** to *CDCSS*.
7. Set **Code** to the Receiver's CDCSS 3-digit octal code.
8. Set **Send Mode** to *Cont.*
9. Set **FM Coupling** to DC.
10. Set **AFGen2 To** to *500 Hz*.
11. Select **Send**.
12. Verify the **Status Flag** indicates Sending.

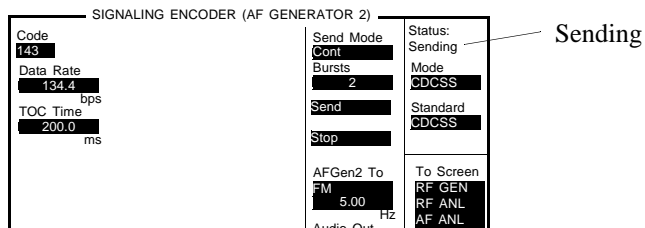

Once the Sending:

- 13.** Press the PREV key to return to the **RX TEST** screen.
- 14.** Set **RF Gen Freq** to the receiver operating frequency.
- 15.** Set **Amplitude** to -47 dBm (1 mV).
- 16.** Set **AFGen1 To** 60% of the Receiver's specified maximum frequency deviation (typically 3 kHz).
- 17.** Set **Ext Load R** to the test load resistance.
- 18.** Set **AC Level** meter to measure **Watts**.

On the Radio set the Receiver's Controls as follows:

- 19.** Set power to ON.
- 20.** If required, set frequency to the same value as step 4j.
- 21.** Set RF Gain to maximum (if equipped).
- 22.** Set squelch control to minimum (if equipped).
- 23.** Set the volume control until the AC Level reads 100% of the Receiver's specified audio output.

Refer to the audio output specifications for the receiver being tested.

On the Test Set using the knob and data entry keys:

- 24. Verify Receiver's squelch is closed.
- 25. Set **Amplitude** to -137 dBm.
- 26. Slowly increase the **Amplitude** until the squelch remains open and the SINAD indicator shows 10 dB (minimum).

CDCSS Sensitivity is displayed as **Amplitude** as shown.

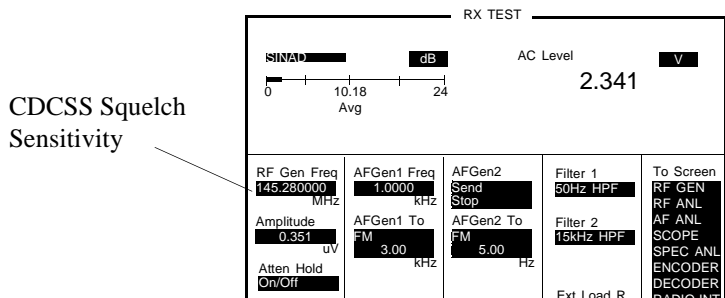

FM Audio Frequency Response Measurement

Description

This procedure is used to measure an FM Receiver's audio frequency response. A reference is established at 50% of the Receiver's rated audio output, then the output is measured while the audio frequency is varied over the receivers range. The FM reference is ANSI/EIA/TIA-204D.

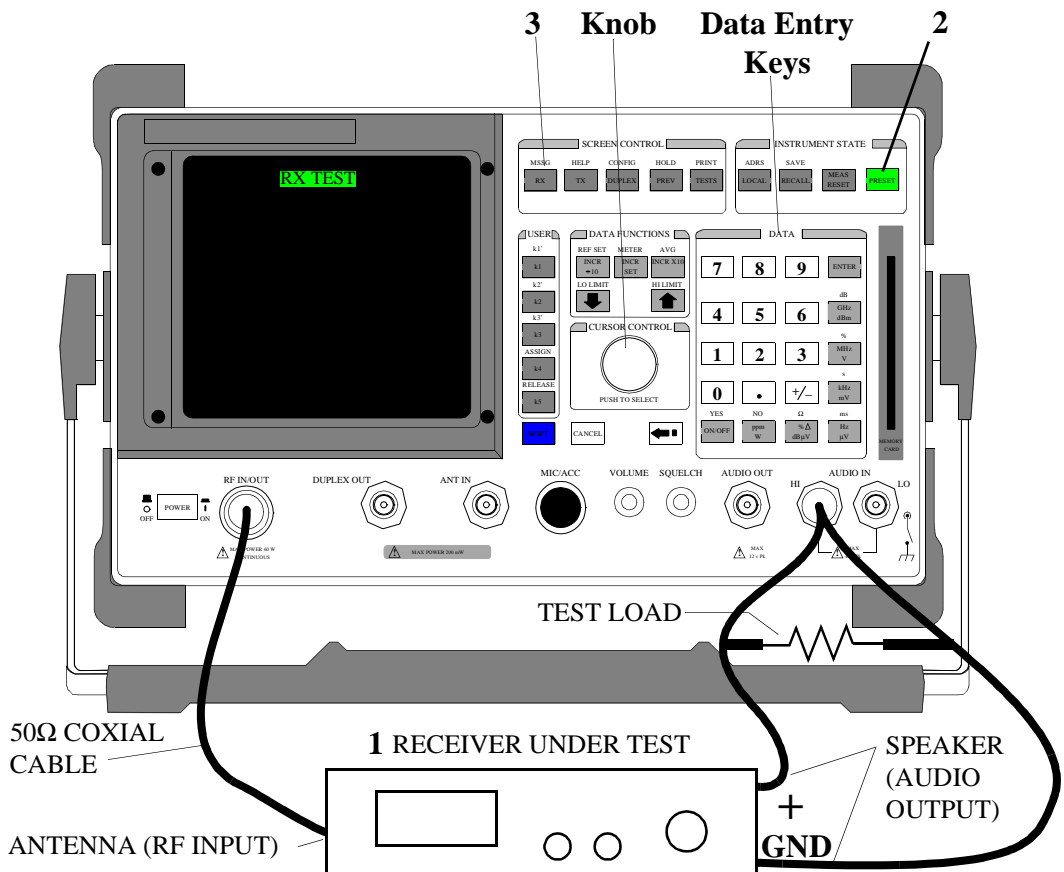

Additional Equipment Required	Test Load
Special Test Considerations	See " Receiver Test Loads " on page 46 and " Coded Squelch " on page 47.

Measurement Procedure:

1. Connect the Receiver as shown.

On the Test Set:

2. Press the PRESET key.
3. Press the RX key.

Using the knob and data entry keys:

4. Set **RF Gen Freq** to the receiver operating frequency.
5. Set **Amplitude** to -47 dBm (1 mV).
6. Set **AFGen1 To** 60% of the Receiver's specified maximum frequency deviation (typically 3 kHz).
7. Set **Filter 1** to <20 Hz HPF.
8. Set **Ext Load R** to the test load resistance.
9. Set **AC Level** meter to measure **Watts**.

On the Radio set the Receiver's Controls as follows:

10. Set power to ON.
11. If required, set frequency to the same value as **step 4.**
12. Set RF Gain to maximum (if equipped).
13. Set coded squelch feature to minimum (if equipped).
14. Set the volume control until the AC Level reads 50% of the Receiver's specified audio output.

Refer to the audio output specifications for the receiver being tested.

On the Test Set using the knob and data entry keys:

15. Set **AFGen1 To** 20% of the Receiver's maximum frequency deviation (1 kHz for Receivers with specified maximum frequency deviation of 5 kHz).
16. Select AC Level.
17. Press the REF SET key.
18. Change **AFGen1 Freq** from 300 Hz to 3 kHz while observing AC Level Meter.

Frequency Response is displayed on the screen as **AC Level** in relative **dB** (from 300Hz to 3 kHz) as shown.

NOTE:

The audio response should not vary more than +2 to -8 dB (Receiver's with loudspeakers) or +1 to -3 dB (Receivers with headphones or feed-line) from a standard 6 dB per octave de-emphasis curve over the frequency range of 300 to 3000 Hz.

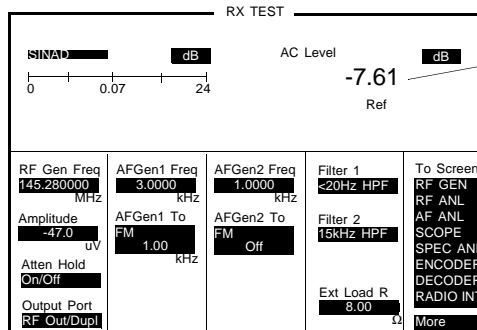

Audio Frequency Response

FM Audio Distortion Measurement

Description

This procedure is used to measure an FM Receiver's audio distortion. Distortion is measured at full rated audio output and 17 dB below full rated audio output. Measurement is read directly from the HP 8920A screen. The FM reference is ANSI/EIA/TIA-204D.

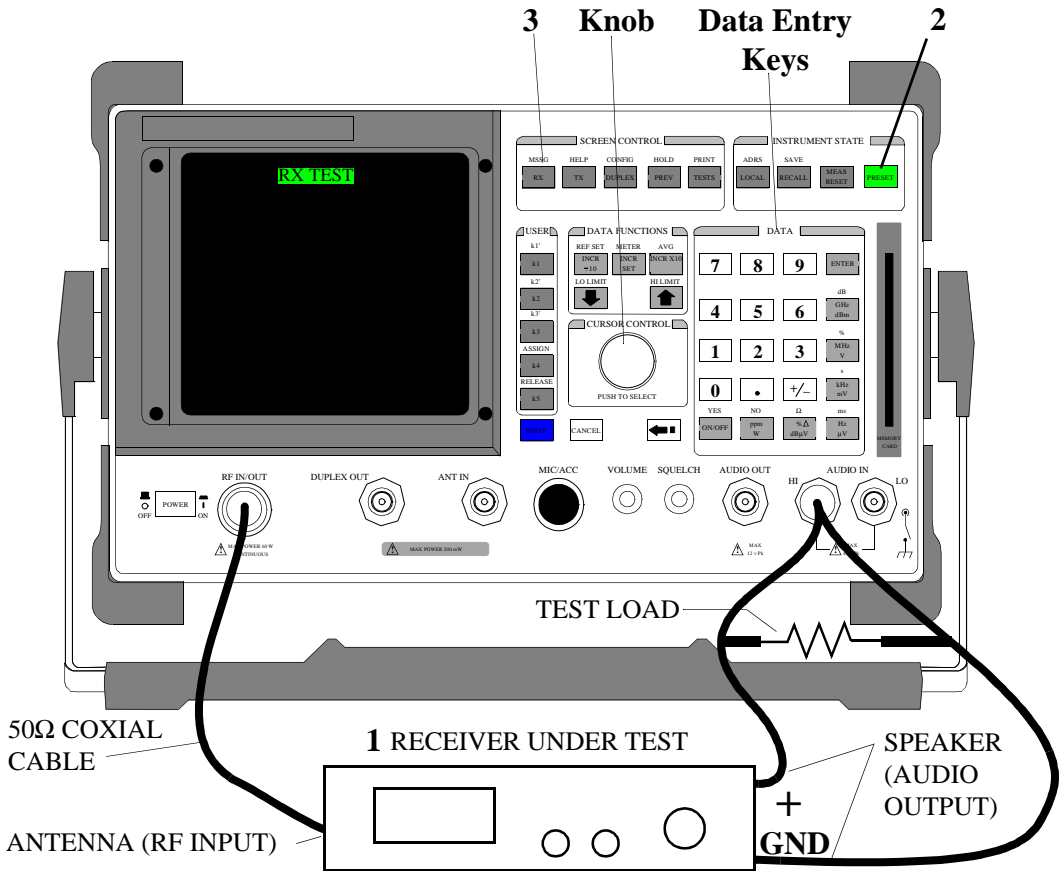

Additional Equipment Required	Test Load
Special Test Considerations	See " Receiver Test Loads " on page 46 and " Coded Squelch " on page 47.

Measurement Procedure:

1. Connect the Receiver as shown.

On the Test Set:

2. Press the PRESET key.
3. Press the RX key.

Using the knob and data entry keys:

4. Set **RF Gen Freq** to the receiver operating frequency.
5. Set **Amplitude** to -47 dBm (1 mV).
6. Set **AFGen1 To** 60% of the Receiver's specified maximum frequency deviation (typically 3 kHz).
7. Set **Ext Load R** to the test load resistance.
8. Set **AC Level** meter to measure **Watts**.

On the Radio set the Receiver's Controls as follows:

9. Set power to ON.
10. If required, set frequency to the same value as **step 4.**
11. Set RF Gain to maximum (if equipped).
12. Set coded squelch feature to minimum (if equipped).
13. Set the volume control until the AC Level reads 100% of the Receiver's specified audio output.

Refer to the audio output specifications for the receiver being tested.

On the Test Set using the knob and data entry keys:

14. Change SINAD meter to read Distortion.

Distortion is displayed as shown.

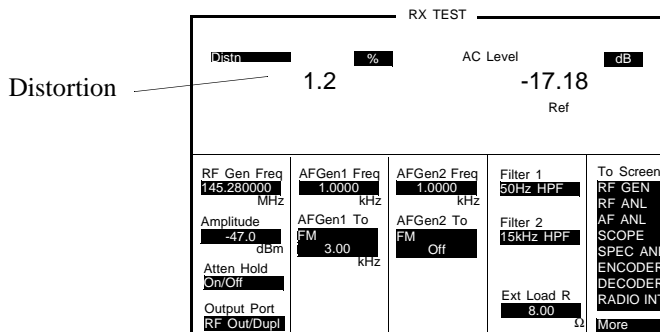

15. Select AC Level.

16. Press the REF SET key.

17. Decrease the Receiver's volume control until the Test Set's AC Level meter reads -17 dB.

Distortion displayed as shown above.

FM Spurious Response Attenuation Measurement

Description

This procedure is used to measure an FM Receiver's spurious response attenuation (the receiver's ability to prevent unwanted signals from causing response in the audio output). A reference is established, and high level modulated signals from 1 MHz to 1000 MHz (or as required) are input to the Receiver while audio output response is measured. FM reference is ANSI/EIA/TIA-204D.

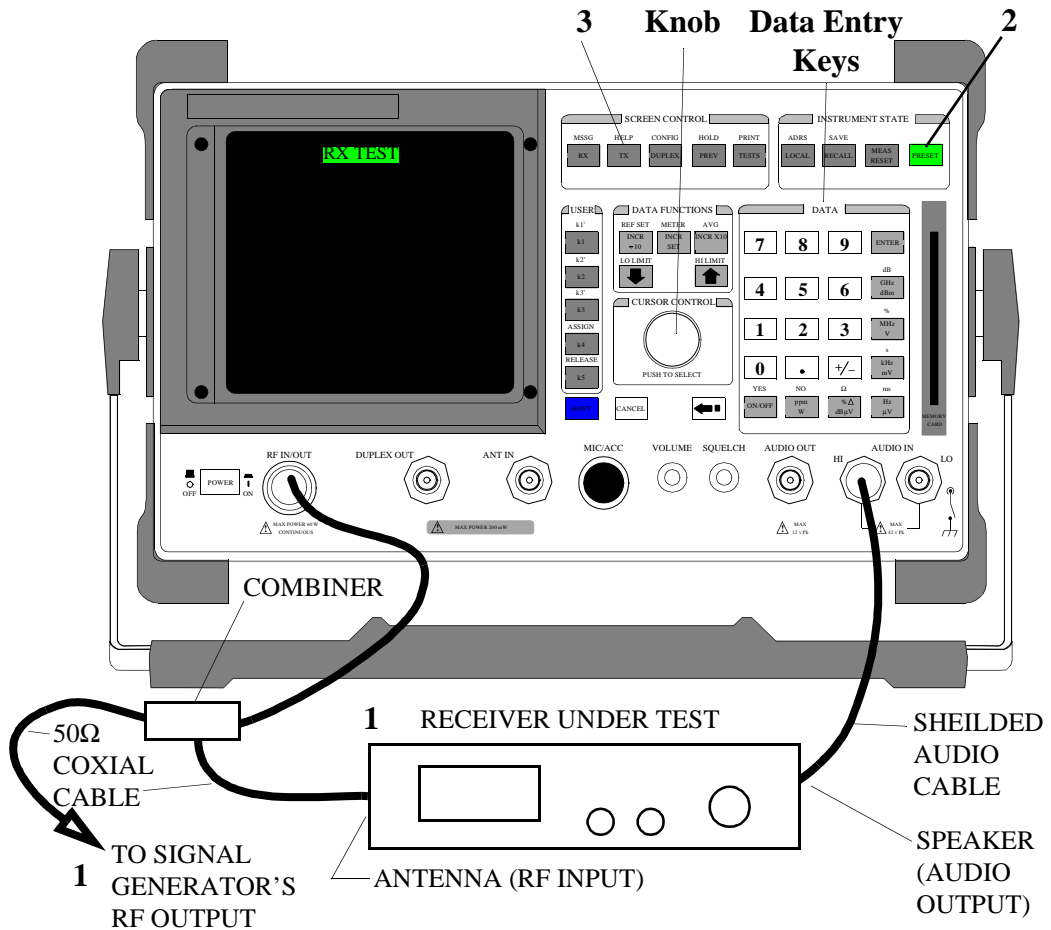

Additional Equipment Required	Signal Generator (HP 8647A) and a Power Splitter/Combiner (HP 11636A).
Special Test Considerations	See " Coded Squelch " on page 47.

Measurement Procedure:

CAUTION: Before connecting the Signal Generator, set RF Output power to OFF (or maximum attenuation).

1. Connect the Receiver and Signal Generator as shown.

On the Test Set:

2. Press the PRESET key.
3. Press the RX key.

Using the knob and data entry keys:

4. Set **RF Gen Freq** to the receiver operating frequency.
5. Set **Amplitude** to -47 dBm (1 mV).
6. Set **AFGen1 To** 60% of the Receiver's specified maximum frequency deviation (typically 3 kHz).
7. Set **Ext Load R** to the specified audio output impedance (typically 8 ohms).
8. Set **AC Level** meter to measure **Watts**.

On the Radio set the Receiver's Controls as follows:

9. Set power to ON.
10. If required, set frequency to the same value as **step 4.**
11. Set RF Gain to maximum (if equipped).
12. Set coded squelch feature to minimum (if equipped).
13. Set the volume control until the AC Level reads 100% of the Receiver's specified audio output.

Refer to the audio output specifications for the receiver being tested.

On the Test Set using the knob and data entry keys:

14. Decrease **Amplitude** until the SINAD meter reads 12 dB.

- If desired, use the meter averaging function for the SINAD indicator.
 - a. Select dB on the SINAD meter.
 - b. Press the AVG key.
- If desired, select the number of readings to average.
 - Enter the number of readings to average.

Higher number of readings averaged will require longer to reach the final indication.

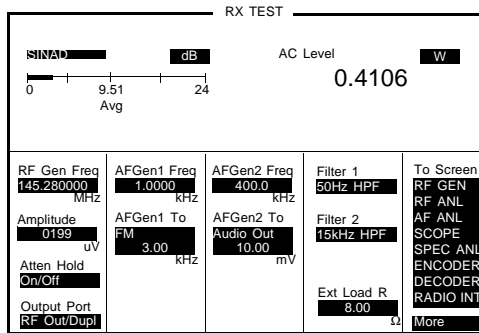

15. Set **Amplitude** units to *dBm*.

16. Increase **Amplitude** (more positive) by 3 *dB*.

- Record Amplitude setting for later use.

On the Signal Generator:

17. Set RF Power to ON.
18. Set Output Level to 31.6 mV.
19. Set Output Frequency to lowest frequency being checked (typically <1 MHz).
20. Set Modulation to internal FM.
21. Set Modulation rate to 400 Hz.
22. Set Modulation Deviation to 3 kHz.
23. Tune the Signal Generator in 1 kHz steps from the minimum to maximum frequency and note frequencies where SINAD decreases below 12 dB.
 - If necessary, increase tuning resolution on the Signal Generator and adjust as required to locate frequency causing maximum degradation of the SINAD reading.
24. For each frequency where SINAD is degraded, reduce the Signal Generator RF output level until SINAD of 12 dB is obtained.
 - Record the Signal Generator frequency and level.
25. Repeat **step 23.** and **step 24.** until all spurious responses are measured.

Calculate the Spurious Response:

26. The minimum result is the calculated spurious response attenuation.

$$\frac{\text{Each Spurious response level recorded in step 25}}{\text{— Amplitude level recorded step 17}}$$

calculated spurious response attenuation

Testing AM Radios

Introduction

Each procedure may contain the following information:

- A brief measurement overview and a reference to applicable TIA/EIA specifications for each test.
- A list of the Test Set options and additional test equipment required to perform the procedure.
- Any special test considerations that need to be considered for safety, measurement accuracy, etc.
- Step by step procedures required to perform each measurement (with illustrations).

Refer to "[Configuring for Measurements](#)" on page 241, or the Test Set's User Guide on preparing the Test Set for operation.

List of Tests

AM Transmitter Measurements

"AM Off The Air Monitoring/Determining Unknown Transmitter Carrier Frequency" on page 119.

"AM Output Power, Deviation, and Frequency/Frequency Error Measurement" on page 122.

"AM Microphone Sensitivity and Modulation Limiting Measurement" on page 125.

"AM Audio Distortion Measurement" on page 128.

"AM Harmonics and Spurious Output Measurement" on page 130.

"AM Envelope Display Measurement" on page 133.

AM Receiver

"AM Audio Output Power Measurement" on page 137.

"AM Sensitivity Measurement" on page 140.

"AM Audio Output Power Measurement" on page 137.

"AM AGC Measurement" on page 143.

"AM Squelch Sensitivity Measurement" on page 146.

"AM Audio Frequency Response Measurement" on page 149.

"AM Audio Distortion Measurement" on page 152.

"AM Spurious Response Attenuation Measurement" on page 155.

AM Transmitters

The following measurements are provided for testing AM Transmitters. The procedures are arranged in the order that tests are typically performed.

AM Off The Air Monitoring/Determining Unknown Transmitter Carrier Frequency

Description

This procedure is used to locate, demodulate, and measure an AM signal's output carrier frequency. The low level signal is input to the front-panel **ANT IN** connector, located, then demodulated using the spectrum analyzer function.

NOTE:

For Performing an AM Off the Air Monitoring on a Known Transmitter Carrier Frequency, [page 121](#).

If attempting to determine the unknown frequency of a Transmitter connected to the RF IN/OUT connector, see “Output Power, Deviation, and Frequency or Frequency Error Measurement” provided later in this chapter for the measurement procedure.

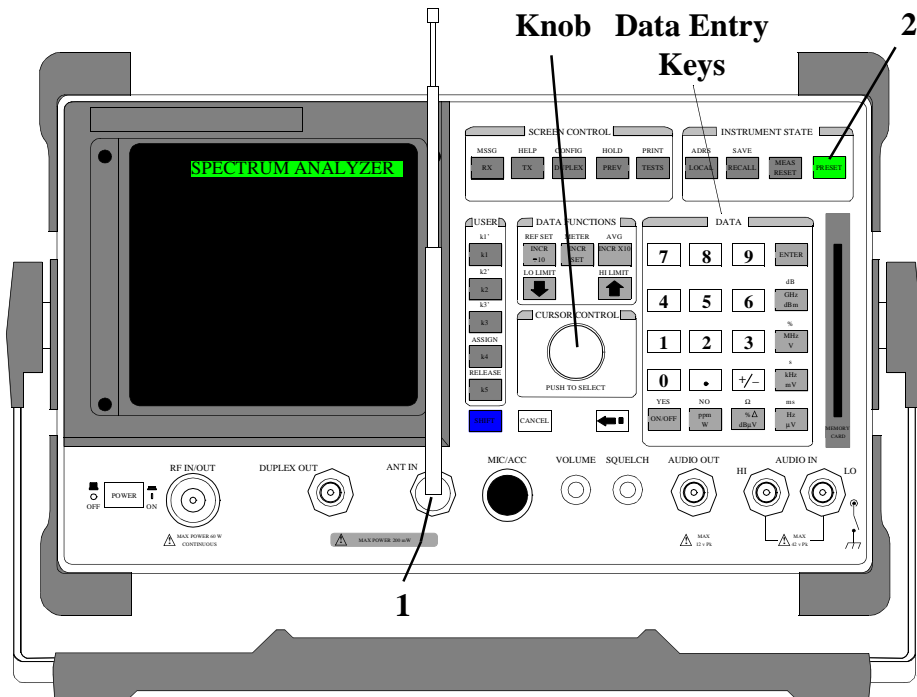

Test Set Options Required	Spectrum Analyzer/Tracking Generator (option 102)
Additional Equipment Required	Whip antenna

Measurement Procedure:

1. Connect the Antenna to the ANT IN connector.

CAUTION:

Do not exceed the connector's rated input or permanent instrument damage may result.

On the Test Set:

2. Press the PRESET key.

Using the knob and data entry keys:

3. Set **AF Anl In** to *AM Demod*.
4. Select the **SPEC ANL** screen.
5. From the **Controls** select Ant.
6. Set **Center Freq** and **Span** fields to view desired spectrum.
7. Set **Ref Level** from -30 dBm to -50 dBm as required to view the desired signal.

Once the desired carrier is found:

8. From **Controls**, select **Main**.
9. Select **Marker** from the **Choices** field.
10. Use the **Marker To** field to select the desired carrier.

On the Test Set frequency and level are displayed as shown.

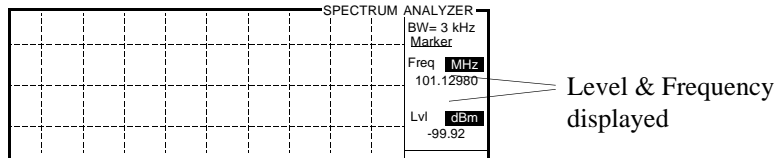

11. To demodulate the carrier:
 - a. With the marker on the desired carrier, select **Marker To** to **Center Freq**.
 - b. From **Controls**, select **Main**.
 - c. Select **Marker** from the **Choices** field.
 - d. Decrease the **Span** to *1.5 MHz* (or less).
 - e. Adjust the Volume and Squelch controls to listen to the demodulated carrier.

AM Off The Air Monitoring on a Known Transmitter Carrier Frequency

1. Press the PRESET key.
2. Press the TX key.
3. Set **AF Anl In** to *AM Demod*
4. Set **Tune Mode** to Manual
5. Set **Tune Freq** to desired frequency
6. Set **Input Port** to Ant

AM Output Power, Deviation, and Frequency/Frequency Error Measurement

Description

This procedure is used to measure an AM Transmitter's output carrier power and frequency (or frequency error) into 50 Ω. For AM Transmitters, modulation depth and modulating frequency are measured.

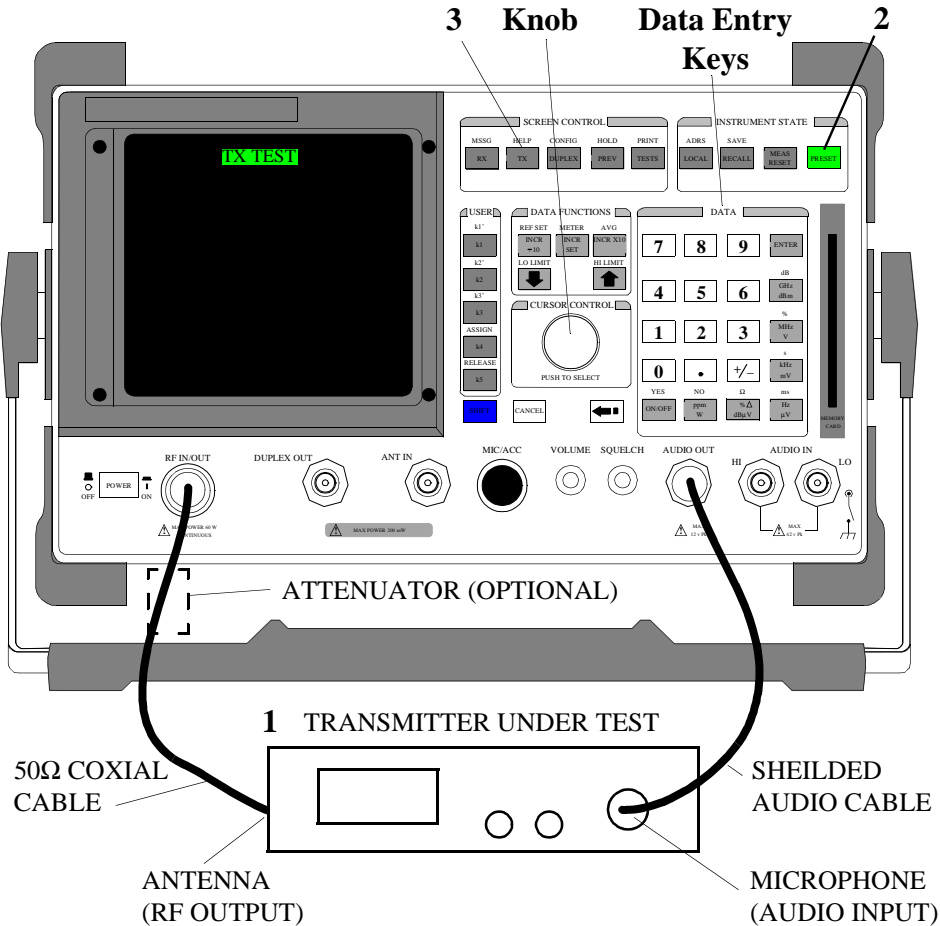

Test Set Options Required	The typical error for the standard Test Set timebase is 2-3 Hz per 1 MHz (when measuring carrier frequency). If greater accuracy is required, use a Test with Option 001 (High Stability Timebase).
Special Test Considerations	See " Cable and Adapter Loss " on page 46.

Measurement Procedure:

1. Connect the Transmitter Under Test as shown.

CAUTION:

The RF present at the Test Set RF IN/OUT connector must not exceed 60W continuous (or 100 Watts for 10 sec/minute).

On the Test Set:

2. Press the PRESET key.
3. Press the TX key.

Using the knob and data entry keys:

4. Set **AF Anl In** to *AM Demod*.
5. Set **AFGen1 Lvl** to the correct output level for the desired frequency deviation (refer to microphone sensitivity and deviation specifications for the Transmitter being tested).
6. Set **Filter 1** to *300 Hz HPF*.
7. Set **Filter 2** to *3 kHz LPF*.
8. Set **De-Emphasis** to Off.

NOTE:

If the Test Set is equipped with the CCITT filter option, set **Filter 1** to <20 Hz HPF and **Filter 2** to *CCITT*.

9. Determine if actual frequency readout or frequency error is the desired measurement.

- For actual frequency readout, continue with [step 10](#).
- For frequency error:
 - Set **Tune Mode** to Manual.
 - Set **Tune Freq** to the expected carrier frequency.

On the Radio:

10. Key the Transmitter.

As long as the Transmitter is keyed the measurement results will display.

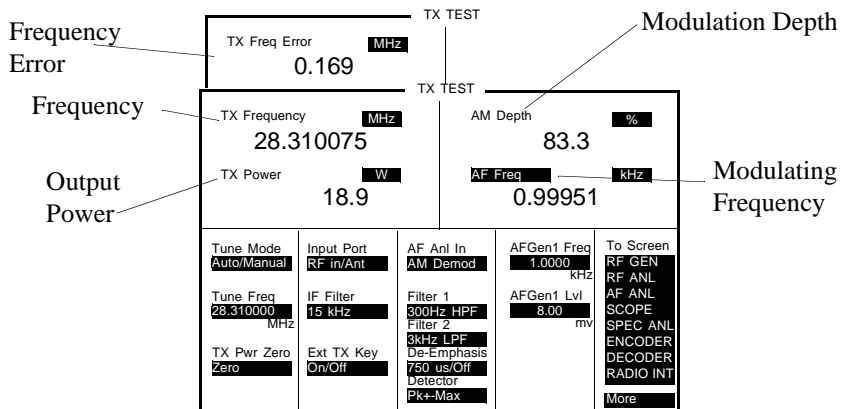

AM Microphone Sensitivity and Modulation Limiting Measurement

Description

This procedure is used to measure an AM Transmitter’s audio input sensitivity, and modulation limiting capability (if available). Modulation limiting is verified over the Transmitter’s audio frequency range.

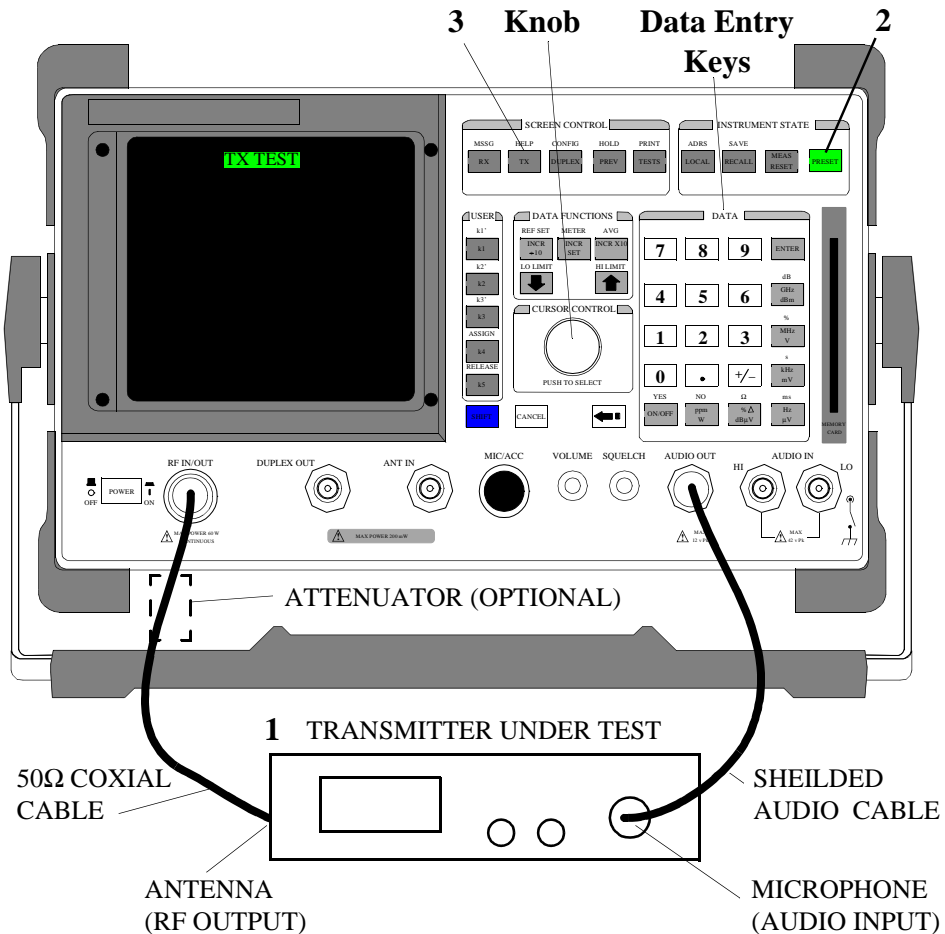

Special Test Considerations	See " Incidental Audio " on page 46.
-----------------------------	---

Measurement Procedure:

1. Connect the Transmitter as shown.

CAUTION:

The RF present at the Test Set RF IN/OUT connector must not exceed 60W continuous (or 100 Watts for 10 sec/minute).

On the Test Set:

2. Press the PRESET key.
3. Press the TX key.

Using the knob and data keys:

4. Set **AF Anl In** to *AM Demod.*
5. Set **Filter 1** to *300 Hz* HPF.
6. Set **Filter 2** to *3 kHz* LPF.

On the Radio:

7. Key the Transmitter and keep keyed until the remaining steps are completed

On the Test Set using the knob and data entry keys:

8. Set **AFGen1 Lvl** so that displayed AM depth is *30%*.

On the Test Set Microphone Sensitivity is shown as **AFGen1 Lvl**.

TX TEST				
TX Frequency 28.310176 MHz		AM Depth 31.2 %		
TX Power 18.3 W		AF Freq 0.99852 kHz		
Tune Mode Auto/Manual	Input Port RF in/Ant	AF Anl In AM Demod	AFGen1 Freq 1.0000 kHz	To Screen RF GEN
Tune Freq 28.310000 MHz	IF Filter 15 kHz	Filter 1 300Hz HPF	AFGen1 Lvl 3.00 mV	RF ANL
TX Pwr Zero Zero	Ext TX Key On/Off	Filter 2 3kHz LPF		AF ANL
		De-Emphasis 750 us/Off		SCOPE
		Detector		SPEC ANL
		PK+Max		ENCODER
				DECODER
				RADIO INT
				More

Microphone
Sensitivity

9. Set **AFGen1 Lvl** measurement units to *dBm*.
10. Increase **AFGen1 Lvl** by *20 dB*.
Displayed AM depth should not exceed 100%.
11. Change **AFGen1 Freq** from *300 Hz* to *3 kHz* (in 100 Hz increments).
12. Verify that the displayed AM depth does not exceed 100%.

AM Audio Distortion Measurement

Description

This procedure is used to measure an AM Transmitter's audio frequency harmonic distortion level.

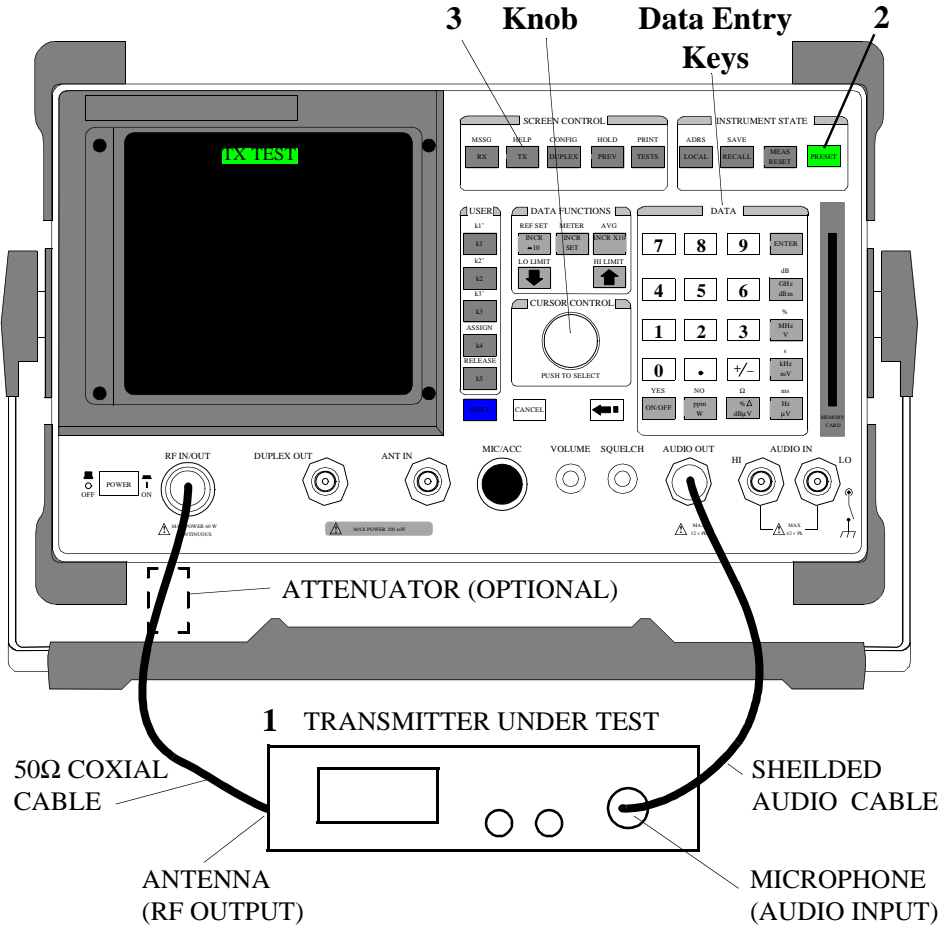

Measurement Procedure:

1. Connect the Transmitter as shown.

CAUTION:

The RF present at the Test Set RF IN/OUT connector must not exceed 60W continuous (or 100 Watts for 10 sec/minute) or permanent instrument damage may result.

On the Test Set:

2. Press the PRESET key.
3. Press the TX key.

Using the knob and data entry keys:

4. Set **AF Anl In** to *AM Demod*.
5. Set **Filter 1** to *300 Hz HPF*.
6. Select the **AF Freq Meter**.
7. Select **Distn** from the **Choices** field.
8. Set **AFGen1 Lvl** so that displayed AM depth is 80%.

NOTE:

Do not exceed the specified input level that causes 100% depth, or the Transmitter's modulation limiting circuits will cause added distortion. Refer to the input level specifications for the Transmitter being tested.

On the Radio:

9. Key the Transmitter and keep keyed until reading displays.

Distortion (in percent, or dB) is displayed on the Test Set as shown.

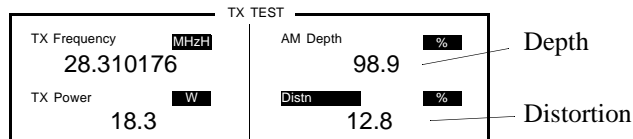

AM Harmonics and Spurious Output Measurement

Description

This procedure is used to measure an AM Transmitter's conducted harmonic and spurious emissions. The spectrum analyzer option is used to display harmonic and spurious components from 400 kHz to 1000 MHz.

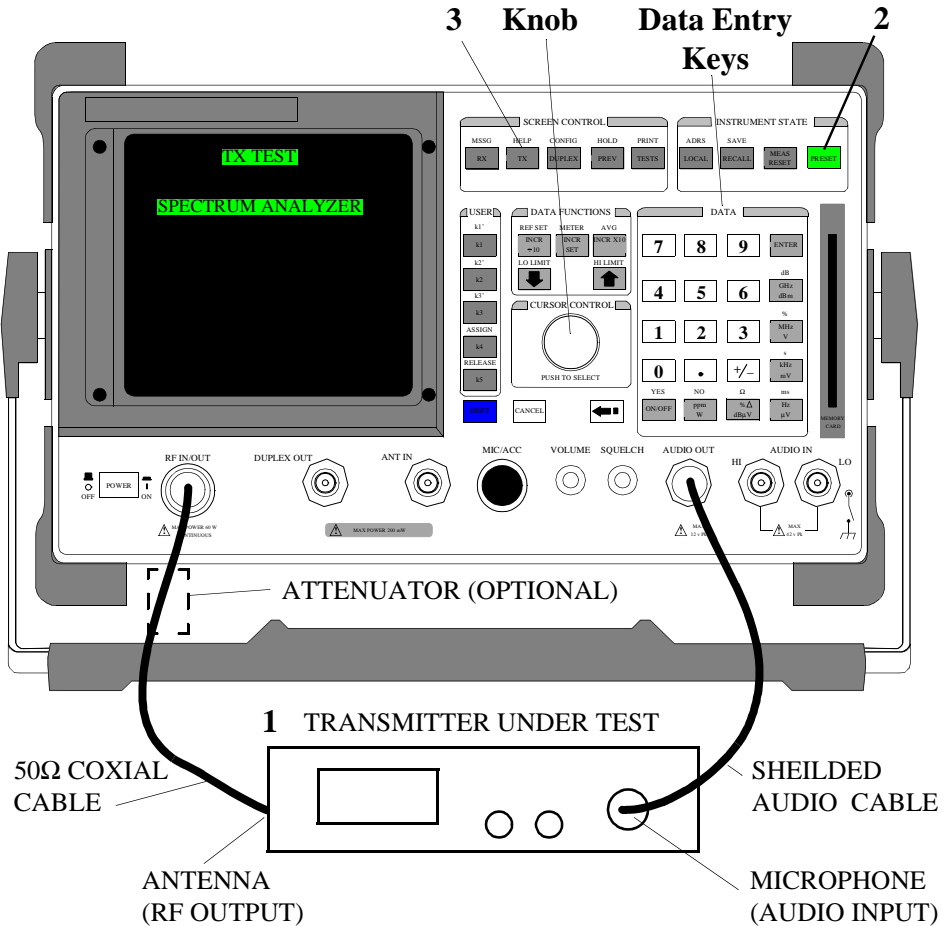

Test Set Options Required	Spectrum Analyzer/Tracking Generator (option 102)
Special Test Considerations	Cable and adapter mismatch must be considered when measuring harmonics and spurious emissions of a transmitter. If an external attenuator is used, special care must be taken to ensure the attenuator is not causing any spurious or harmonic emission. Also, if spurious emissions are located, verify that the transmitter is the source, and not another object radiated emissions near the test site.

Measurement Procedure:

1. Connect the Transmitter as shown.

CAUTION:

The RF present at the Test Set RF IN/OUT connector must not exceed 60W continuous (or 100 Watts for 10 sec/minute) or permanent instrument damage may result.

On the Test Set:

2. Press the PRESET key.
3. Press the TX key.

Using the knob:

4. Set **AF Anl In** to *AM Demod*.

On the Radio:

5. Key the Transmitter and keep keyed until the remaining steps are completed.

On the Test Set using the knob and data entry keys:

6. Set **AFGen1 Lvl** so that displayed AM depth is 85%.

7. Select **SPEC ANL** screen.
8. Set **Span** to *1.1 MHz*.
9. Set **Ref Level** to place the carrier peak at the top graticule line.
To set **Ref Level**:
 - From the Marker screen, select **Marker To Peak**
 - Select **Marker To Ref Level**
10. Tune **Center Freq** in *1 MHz* steps anywhere from *400 kHz* to *1 GHz* in search of harmonics, subharmonics, multiples, or spurious emissions.
11. Un-key the Transmitter.

NOTE:

If spurious emissions are suspect and verify that emissions are from the transmitter and not another source.

To measure spurious emission of the transmitter under test:

- Place at center frequency.
- Or perform the following:
 - a. Select **Main** from the Controls field.
 - b. Select **Markers** from the Choices field.
 - c. Position the marker on the desired peak. (**Position** or **Next Peak**)

Marker frequency and level are displayed as shown.

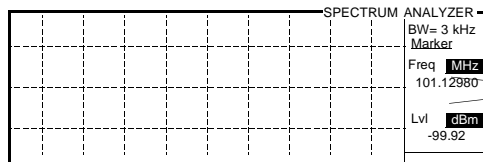

Spurious or Harmonic
Level & Frequency

AM Envelope Display Measurement

Description

This procedure is used to measure an AM Transmitter's AM envelope. In order to display the envelope on the Oscilloscope, the SSB demodulator is used to down convert the incoming RF signal to an IF frequency of 20 Hz.

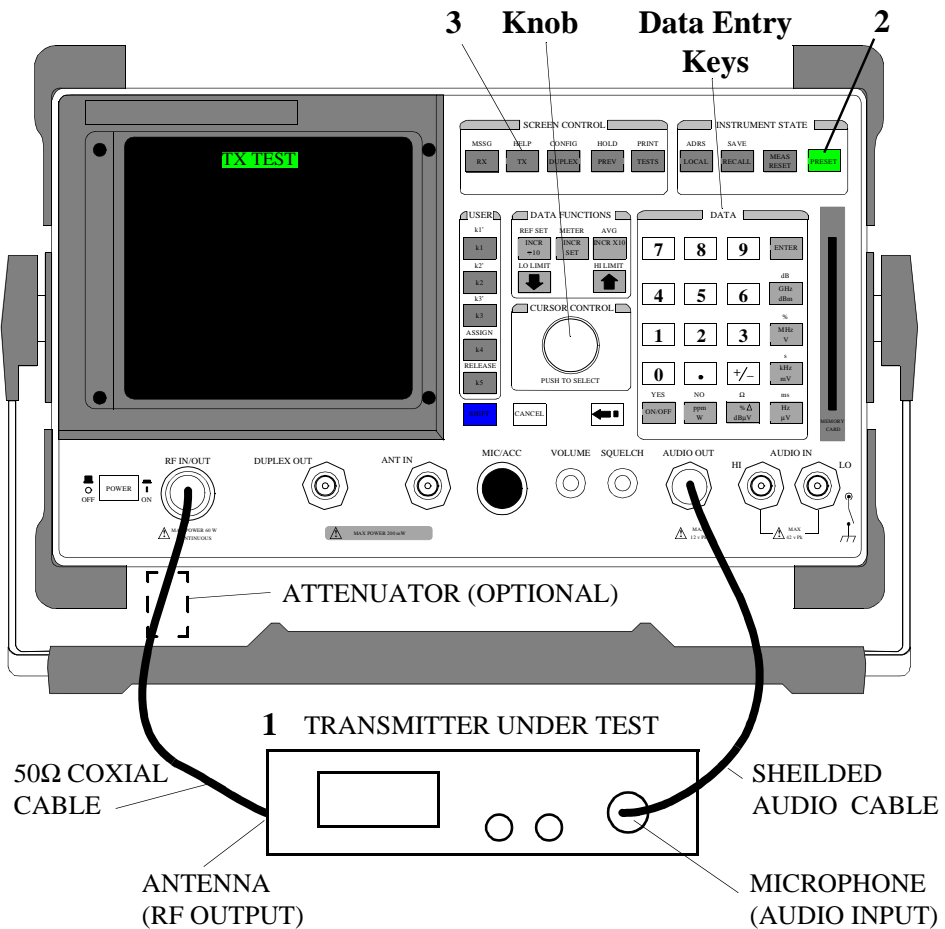

Measurement Procedure:

1. Connect the Transmitter as shown.

CAUTION:

The RF present at the Test Set RF IN/OUT connector must not exceed 60W continuous (or 100 Watts for 10 sec/minute) or permanent instrument damage may result.

On the Test Set:

2. Press the PRESET key.
3. Press the TX key.

On the Radio:

4. Key the Transmitter.

On the Test Set using the knob and data entry keys:

5. Set **AF Anl In** to **AM Demod**.
6. Adjust **AFGen1 Lvl** until **AM Depth** is 80%.

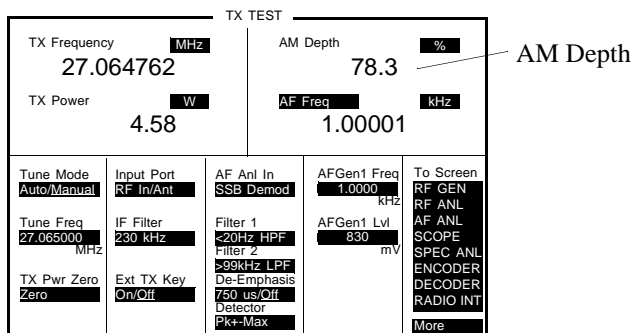

On the Radio:

7. Un-key the Transmitter.

On the Test Set using the knob and data entry keys:

8. Set **Tune Mode** to Manual.
9. Set **Tune Freq** to a frequency *20 kHz* higher than presently indicated (e.g., if current Tune Freq is 120.540000 MHz, change to 120.560000 MHz).
10. Set **AF Anl In** to *SSB Demod.*
11. Set **IF Filter** to *230 kHz.*
12. Set **Filter 1** to *<20 Hz HPF.*
13. Set **Filter 2** to *>99 kHz LP.*
14. Set **De-Emphasis** to Off.
15. Select **SCOPE**.

On the Radio:

16. Key the Transmitter and keep it keyed until the remaining steps are completed.

On the Test Set using the knob and data entry keys:

17. Set **Vert/div** to optimize the displayed waveform (typically 200 mV).
18. Select **Main** from the **Controls** field.
19. Select **Trigger** from the Choices field.
20. Set **Level (div)** until the displayed waveform is stable (typically 1.9).

AM Receivers

The following measurements are provided for testing AM Receivers. The procedures are arranged in the order that tests are typically performed.

AM Audio Output Power Measurement

Description

This procedure is used to measure an AM Receiver's maximum audio output power (or rated output power) into a Test Load. Output power is displayed (in various measurement units, including watts) on the Test Set screen.

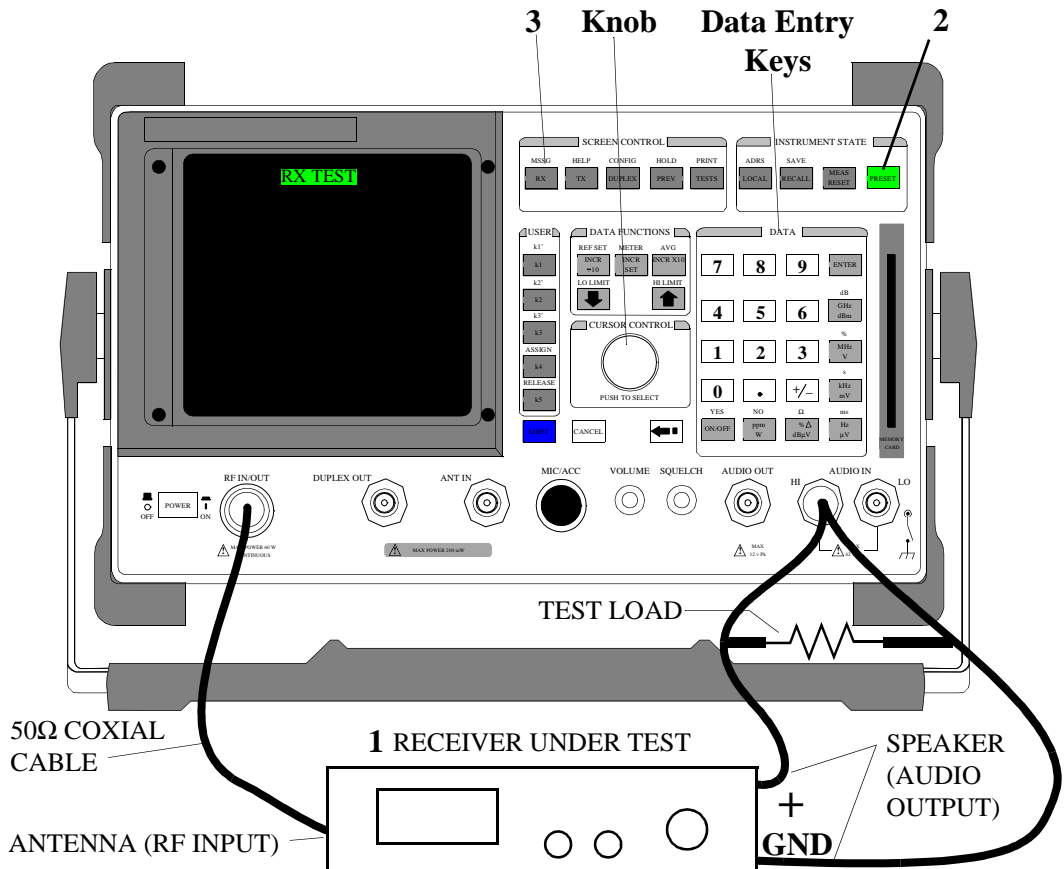

Additional Equipment Required	Test Load
Special Test Considerations	See " Receiver Test Loads " on page 46.

Measurement Procedure:

1. Connect the Receiver as shown.

On the Test Set:

2. Press the PRESET key.
3. Press the RX key.

Using the knob and data entry keys:

4. Set **RF Gen Freq** to the receiver operating frequency.
5. Set **Amplitude** to -47 dBm (1 mV).
6. Set **AFGen1 To AM** at the desired modulation depth (typically 30%).
7. Set **Ext Load R** to the test load resistance.
8. Set **AC Level** meter to measure **Watts**.

On the Radio set the Receiver's Controls as follows:

9. Set power to ON.
10. If required, set frequency to the same value as **step 4**.
11. Set squelch to minimum.
12. Set RF Gain to maximum (if equipped).
13. Slowly increase volume control until the AC Level reaches the Receiver's rated output power, or reaches a maximum level (stops increasing).

Refer to audio output specifications for the Receiver being tested as required.

NOTE:

If the rated output cannot be obtained, troubleshoot and repair the Receiver's audio stages is necessary.

Measurement results are displayed on the Test Set as shown.

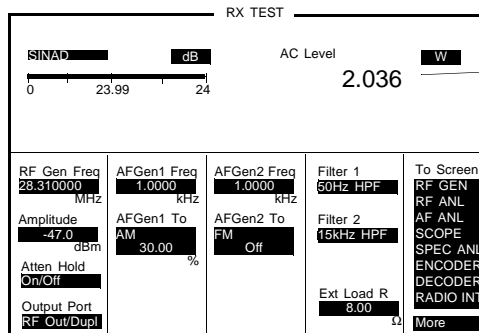

Audio (AF) Output Power

AM Sensitivity Measurement

Description

This procedure is used to measure an AM Receiver's receiver sensitivity. Sensitivity is displayed (in various measurement units) on the Test Set screen.

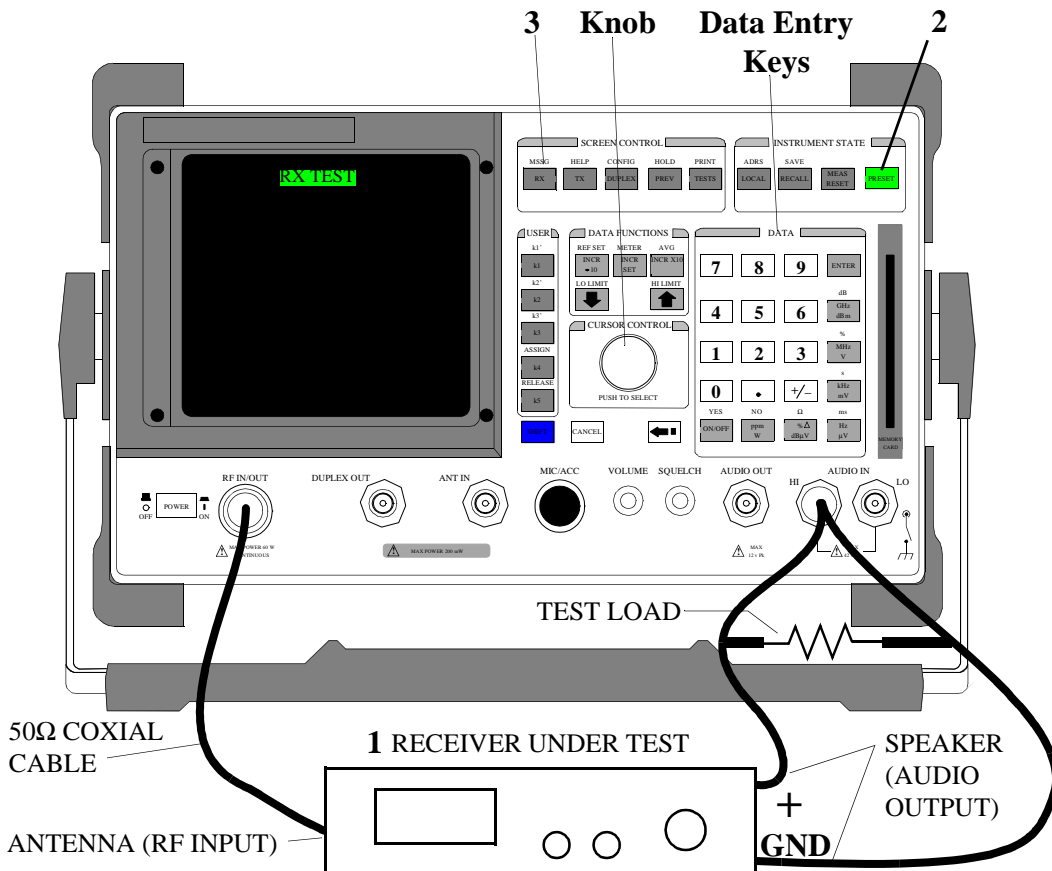

Additional Equipment Required	Test Load
Special Test Considerations	See " Receiver Test Loads " on page 46.

Measurement Procedure:

1. Connect the Receiver as shown.

On the Test Set:

2. Press the PRESET key.
3. Press the RX key.

Using the knob and data entry keys:

4. Set **RF Gen Freq** to the receiver operating frequency.
5. Set **Amplitude** to -47 dBm (1 mV).
6. Set **AFGen1 To AM** at the desired modulation depth (typically 30%).
7. Set **Ext Load R** to the test load resistance.
8. Set **AC Level** meter to measure **Watts**.

On the Radio set the Receiver's Controls as follows:

9. Set power to ON.
10. If required, set frequency to the same value as [step 4](#).
11. Set squelch to minimum.
12. Set RF Gain to maximum (if equipped).
13. Set the volume control until the AC Level reads 100% of the Receiver's specified audio output.

Refer to the audio output specifications for the receiver being tested.

On the Test Set using the knob and data entry keys:

14. Decrease **Amplitude** until the SINAD meter reads 10 dB.

Sensitivity (10dB SINAD) is displayed as **Amplitude** as shown.

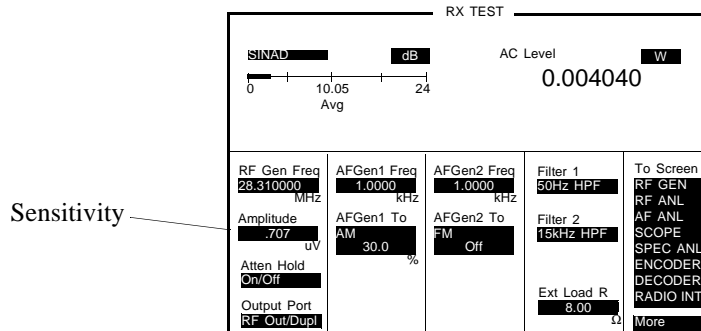

- If desired, use the meter averaging function for the SINAD indicator.
 - a. Select dB on the SINAD meter.
 - b. Press the AVG key.
 - If desired, select the number of readings to average.
 - Enter the number of readings to average.

Higher number of readings averaged will require longer to reach the final indication.

AM AGC Measurement

Description

This procedure is used to measure an AM Receiver's Automatic Gain Control (AGC). A reference is established at 13 dB below full rated audio output, and the Receiver's output level and distortion are measured with inputs varying from 500 mV to 5 Ω V.

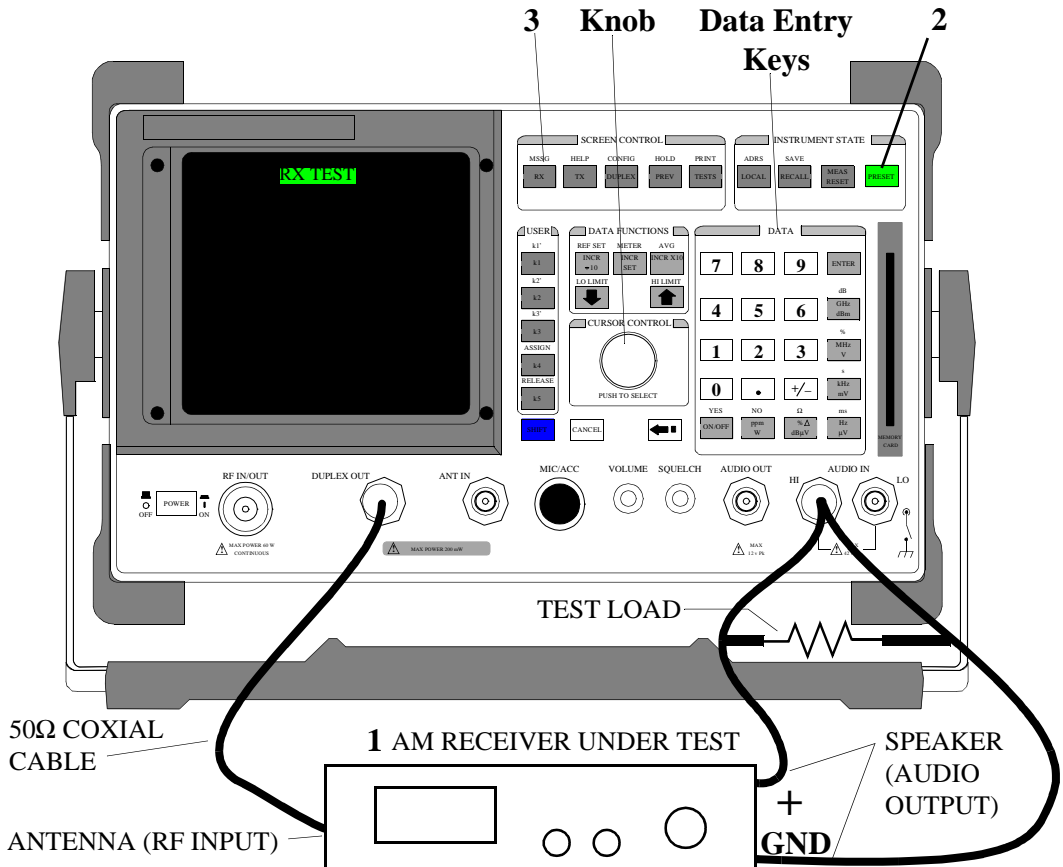

Additional Equipment Required	Test Load
Special Test Considerations	See " Receiver Test Loads " on page 46.

Measurement Procedure:

1. Connect the Receiver as shown.

On the Test Set:

2. Press the PRESET key.
3. Press the RX key.

Using the knob and data entry keys:

4. Set **RF Gen Freq** to the receiver operating frequency.
5. Set **Amplitude** to -47 dBm (1 mV).
6. Set **Output Port** to Dupl.
7. Set **AFGen1 To AM** at the desired modulation depth (typically 30%).
8. Set **Ext Load R** to the test load resistance.
9. Set **AC Level** meter to measure **Watts**.

On the Radio set the Receiver's Controls as follows:

10. Set power to ON.
11. If required, set frequency to same value as [step 4](#).
12. Set squelch to minimum.
13. Set RF Gain to maximum (if equipped).
14. Set the volume control until the AC Level reads 100% of the Receiver's specified audio output.

Refer to the audio output specifications for the receiver being tested.

On the Test Set using the knob and data entry keys:

15. Select **AC Level**
16. Press the REF SET key.

17. Decrease the receiver's volume control until the **AC Level** meter reads -13 dB .

18. Select **AC Level**

19. Press the REF SET key.

20. Change **SINAD** meter to read *Distortion*.

21. Tune **Amplitude** over the range of 500 mV to $5\ \Omega\text{ V}$.

Distortion (for given input) is displayed as shown (should not exceed $\pm 10\%$).

Relative output level (for given input) is displayed as **AC Level** (should not exceed $\pm 10\text{ dB}$).

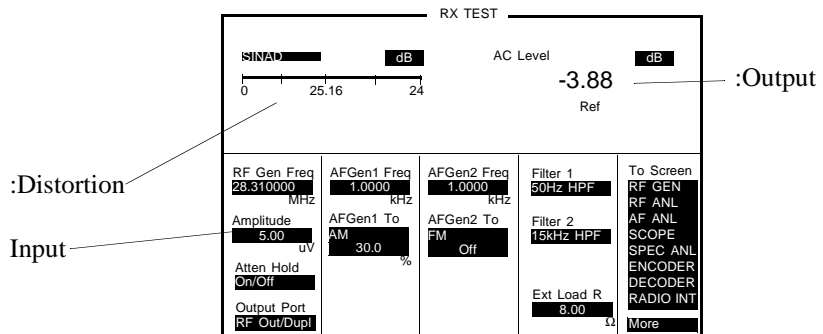

AM Squelch Sensitivity Measurement

Description

This procedure is used to measure an AM Receiver's critical squelch and maximum squelch sensitivity. For critical squelch, the receiver is just squelched with minimum modulated input at the Receiver's antenna, then the input is increased until the squelch is opened. Maximum squelch is the amount of modulated signal required to open the squelch when the control is set to maximum. Minimum and maximum squelch hysteresis is also measured and calculated.

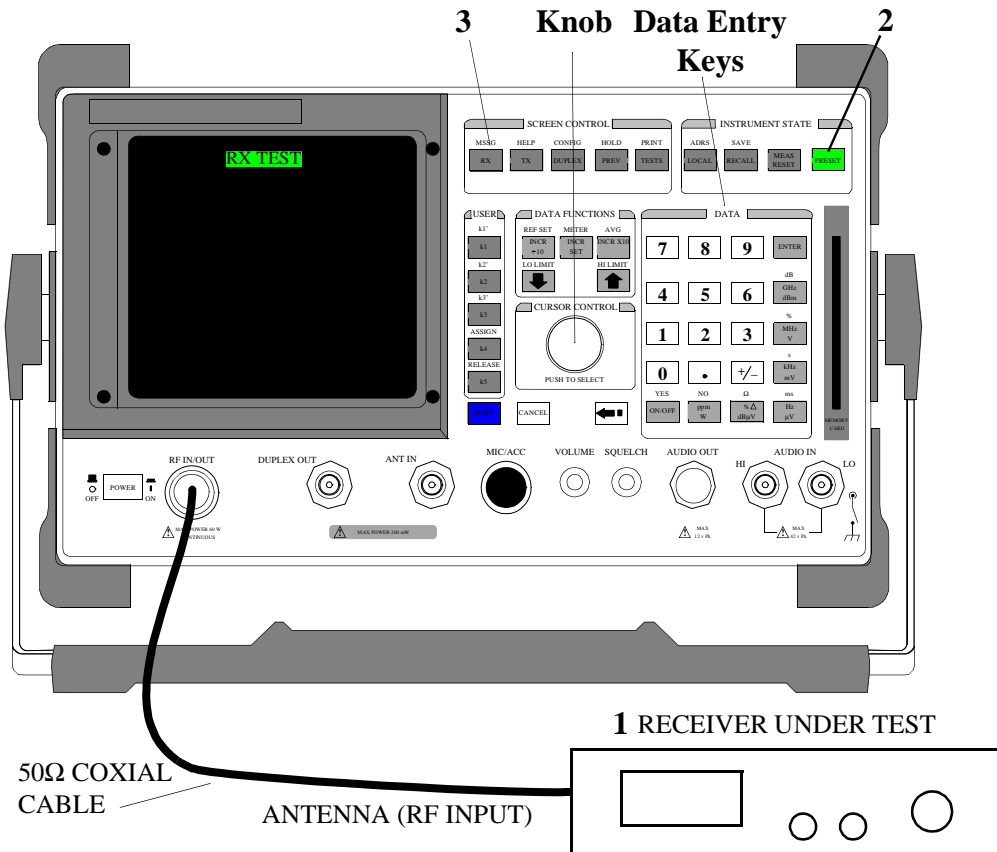

Measurement Procedure:

1. Connect the Receiver as shown.

On the Test Set:

2. Press the PRESET key.
3. Press the RX key.

Using the knob and data entry keys:

4. Set **RF Gen Freq** to the receiver operating frequency.
5. Set **Amplitude** to -137 dBm.
6. Set **AFGen1 To AM** at desired modulation depth (typically 30%).

On the Radio set the Receiver's Controls as follows:

7. Set power to ON.
8. Set **AFGen1 To AM** at desired modulation depth (typically 30%).
9. If required, set frequency to the same value as **step 4**.
10. Set squelch to minimum.
11. Set RF Gain to maximum (if equipped).
12. Set coded squelch feature (if equipped) to OFF.
13. Set the volume control until noise is at a comfortable level.
14. Increase the Receiver's squelch control until audio is just squelched.

On the Test Set using the knob and data entry keys:

15. Slowly increase the **Amplitude** until squelch just remains open.

Critical Squelch is displayed as **Amplitude** as shown.

- Record this level.

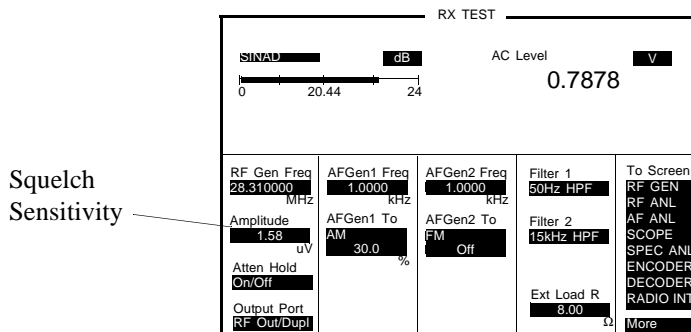

16. Decrease **Amplitude** until the Receiver’s squelch just closes.

- Record this level.

Calculate the measurement:

17. Critical Squelch Hysteresis is the difference between the two readings.

On the Radio set the Receiver’s Controls as follows:

18. Set the Receiver’s squelch control to maximum.

On the Test Set using the knob and data entry keys:

19. Increase **Amplitude** until the Receiver’s squelch just opens.

- Record this level.

20. Record the maximum squelch sensitivity is displayed as **Amplitude** as shown.

21. Decrease **Amplitude** until the Receiver’s squelch just closes.

- Record this level.

Calculate the reading:

22. Maximum Squelch Hysteresis is the difference between the two readings.

AM Audio Frequency Response Measurement

Description

This procedure is used to measure an AM Receiver's audio frequency response. A reference is established at 50% of the Receiver's rated audio output, then the output is measured while the audio frequency is varied over the receiver's range.

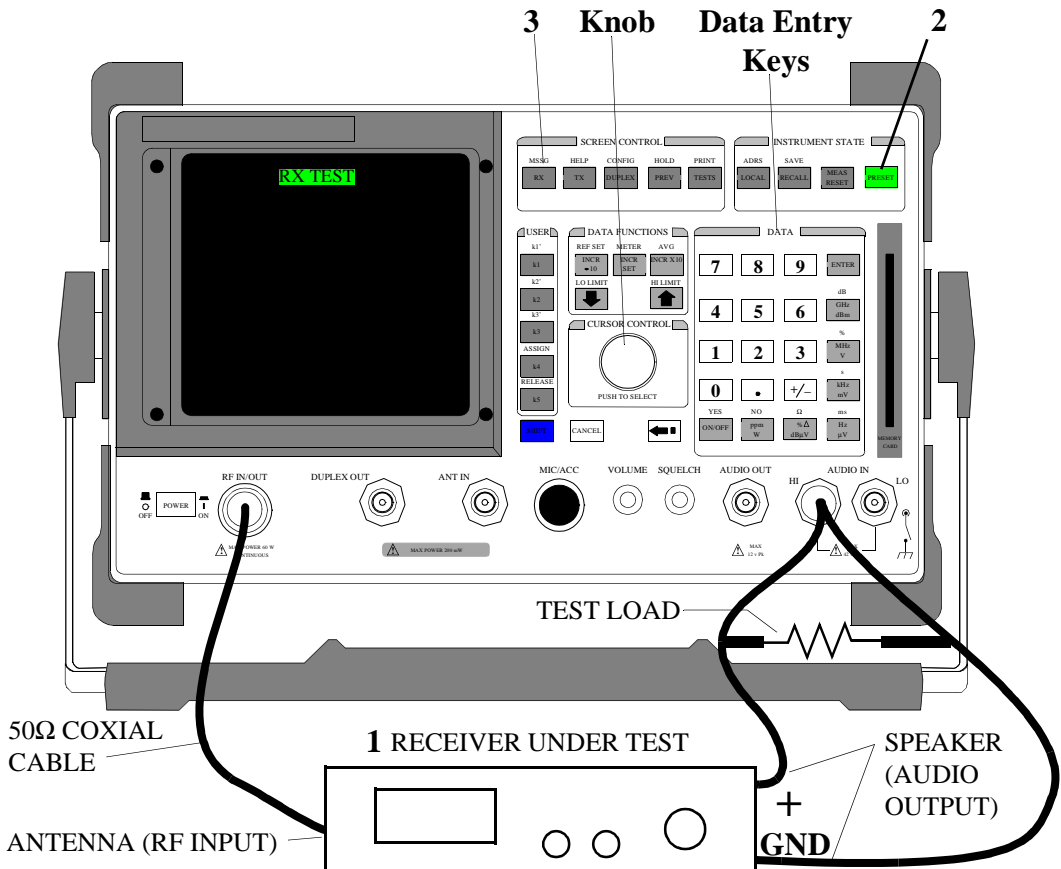

Additional Equipment Required	Test Load
Special Test Considerations	See " Receiver Test Loads " on page 46.

Measurement Procedure:

1. Connect the Receiver as shown.

On the Test Set:

2. Press the PRESET key.
3. Press the RX key.

Using the knob and data entry keys:

4. Set **RF Gen Freq** to the receiver operating frequency.
5. Set **Amplitude** to -47 dBm (1 mV).
6. Set **AFGen1 To AM** at desired modulation depth (typically 30%).
7. Set **Filter 1** to <20 Hz HPF.
8. Set **Ext Load R** to the test load resistance.
9. Set **AC Level** meter to measure **Watts**.

On the Radio set the Receiver's Controls as follows:

10. Set power to ON.
11. If required, set frequency to the same value as [step 4](#).
12. Set RF Gain to maximum (if equipped).
13. Set squelch control to minimum (if equipped).
14. Set the volume control until the AC Level reads 50% of the Receiver's specified audio output.

Refer to the audio output specifications for the receiver being tested.

On the Test Set using the knob and data entry keys:

15. Select AC Level.
16. Press the REF SET key.
17. Change **AFGen1 Freq** from 300 Hz to 3 kHz while observing AC Level Meter.

Frequency Response is displayed on the screen as **AC Level** in relative **dB** (from 300Hz to 3 kHz) as shown.

NOTE:

The audio response should not vary more than +2 to -14 dB (Receiver's with loudspeakers) or +1 to -8 dB (Receivers with headphones or feed a line) from a standard 6 dB per octave de-emphasis curve over the frequency range of 300 to 3 kHz.

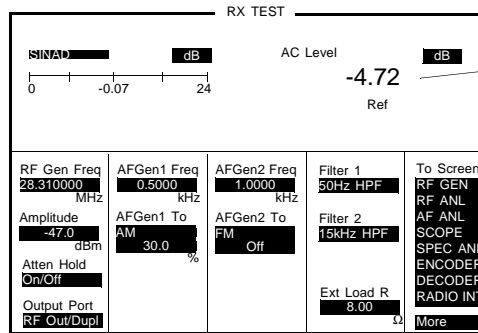

Audio Frequency Response

AM Audio Distortion Measurement

Description

This procedure is used to measure an AM Receiver's audio distortion. Distortion is measured at full rated audio output and 17 dB below full rated audio output. Measurement is read directly from the Test Set screen.

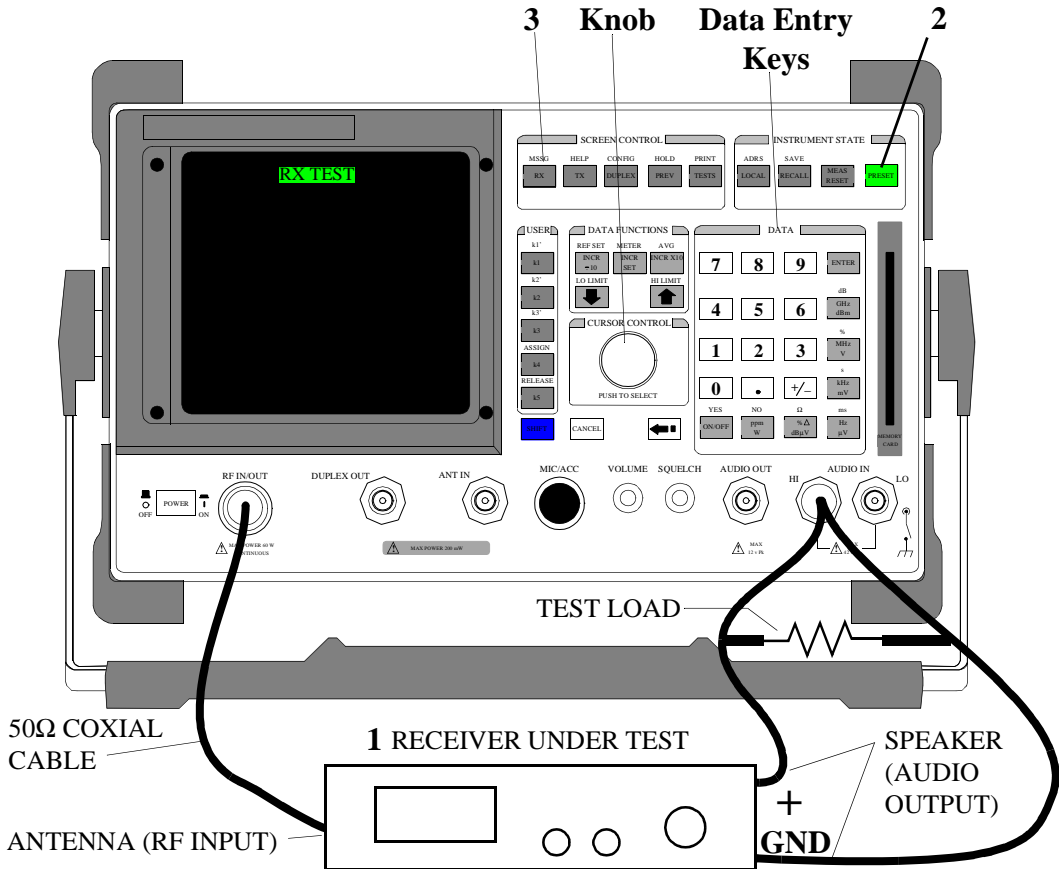

Additional Equipment Required	Test Load
Special Test Considerations	See " Receiver Test Loads " on page 46.

Measurement Procedure:

1. Connect the Receiver as shown.

On the Test Set:

2. Press the PRESET key.
3. Press the RX key.

Using the knob and data entry keys:

4. Set **RF Gen Freq** to the receiver operating frequency.
5. Set **Amplitude** to -47 dBm (1 mV).
6. Set **AFGen1 To AM** at desired modulation depth (typically 30%).
7. Set **Ext Load R** to the test load resistance.
8. Set **AC Level** meter to measure **Watts**.

On the Radio set the Receiver's Controls as follows:

9. Set power to ON.
10. If required, set frequency to the same value as **step 4**.
11. Set RF Gain to maximum (if equipped).
12. Set squelch control to minimum (if equipped).
13. Set the volume control until the AC Level reads 100% of the Receiver's specified audio output.

Refer to the audio output specifications for the receiver being tested.

On the Test Set using the knob and data entry keys:

14. Change SINAD meter to read Distortion.

Distortion is displayed as shown.

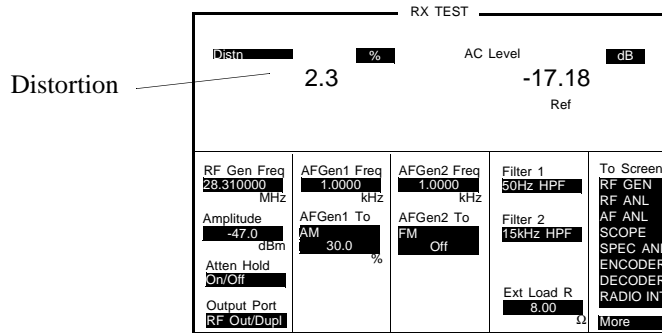

15. Select AC Level.

16. Press the REF SET key.

17. Decrease the Receiver's volume control until the Test Set's AC Level meter reads -17 dB.

Distortion displayed as shown above.

AM Spurious Response Attenuation Measurement

Description

This procedure is used to measure an AM Receiver's spurious response attenuation (the receiver's ability to prevent unwanted signals from causing response in the audio output). A reference is established, and high level modulated signals from 1 MHz to 1000 MHz (or as required) are input to the Receiver while audio output response is measured.

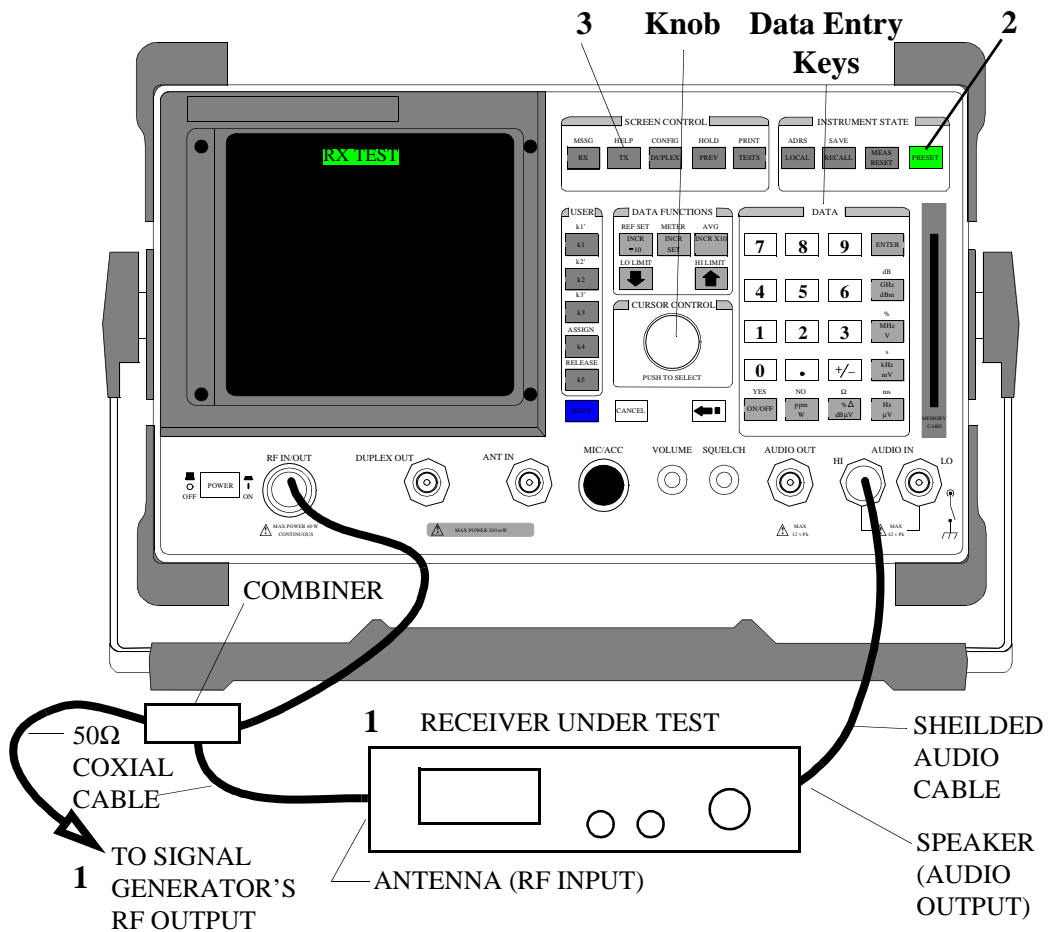

Additional Equipment Required	Signal Generator (HP 8647A) and a Power Splitter/Combiner (HP 11636A).
--------------------------------------	--

Measurement Procedure:

CAUTION: Before connecting the Signal Generator, set RF Output power to OFF (or maximum attenuation).

1. Connect the Receiver and Signal Generator as shown.

On the Test Set:

2. Press the PRESET key.
3. Press the RX key.

Using the knob and data entry keys:

4. Set **RF Gen Freq** to the receiver operating frequency.
5. Set **Amplitude** to -47 dBm (1 mV).
6. Set **AFGen1 To AM** at desired modulation depth (typically 30%).
7. Set **Ext Load R** to the specified audio output impedance (typically 8 ohms).
8. Set **AC Level** meter to measure **Watts**.

On the Radio set the Receiver's Controls as follows:

9. Set power to ON.
10. If required, set frequency to the same value as **step 4**.
11. Set RF Gain to maximum (if equipped).
12. Set squelch control to minimum (if equipped).
13. Set the volume control until the AC Level reads 100% of the Receiver's specified audio output.

Refer to the audio output specifications for the receiver being tested.

On the Test Set using the knob and data entry keys:

14. Decrease **Amplitude** until the SINAD meter reads 10 dB.

- If desired, use the meter averaging function for the SINAD indicator.
 - a. Select dB on the SINAD meter.
 - b. Press the AVG key.
- If desired, select the number of readings to average.
 - Enter the number of readings to average.

Higher number of readings averaged will require longer to reach the final indication.

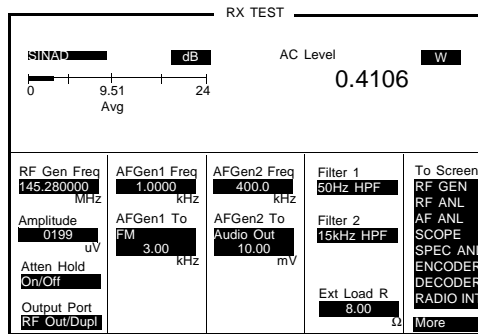

15. Set **Amplitude** units to *dBm*.

16. Increase **Amplitude** (more positive) by *3 dB*.

- Record Amplitude setting for later use.

On the Signal Generator:

17. Set RF Power to ON.
18. Set Output Level to 31.6 mV.
19. Set Output Frequency to lowest frequency being checked (typically <1 MHz).
20. Set Modulation to internal AM.
21. Set Modulation rate to 400 Hz.
22. Set Modulation Depth to 30%.
23. Tune the Signal Generator in 1 kHz steps from the minimum to maximum frequency and note frequencies where SINAD decreases below 10 dB.
 - If necessary, increase tuning resolution on the Signal Generator and adjust as required to locate frequency causing maximum degradation of the SINAD reading.
24. For each frequency where SINAD is degraded, reduce the Signal Generator RF output level until SINAD of 10 dB is obtained.
 - Record the Signal Generator frequency and level.
25. Repeat **step 23.** and **step 24.** until all spurious responses are measured.

Calculate the Spurious Response:

26. The minimum result is the calculated spurious response attenuation.

Each Spurious response level recorded in step 25

— Amplitude level recorded step 17

calculated spurious response attenuation

Testing SSB Radios

Introduction

Each procedure may contain the following information:

- A brief measurement overview and a reference to applicable TIA/EIA specifications for each test.
- A list of the Test Set options and additional test equipment required to perform the procedure.
- Any special test considerations that need to be considered for safety, measurement accuracy, etc.
- Step by step procedures required to perform each measurement (with illustrations).

Refer to "[Configuring for Measurements](#)" on page 241, or the Test Set's User Guide on preparing the Test Set for operation.

List of Tests

SSB Transmitter Measurements

"SSB Frequency or Frequency Error Measurement" on page 163.

"SSB Rated Output Power/Carrier Suppression Measurement" on page 166.

"SSB Harmonics and Spurious Output Measurement" on page 170.

SSB Receiver Measurements

"SSB Audio Output Power and Distortion Measurement" on page 174.

"SSB Sensitivity Measurement" on page 178.

"SSB Squelch Sensitivity Measurement" on page 181.

SSB Transmitters

The following measurements are provided for testing SSB Transmitters. The procedures are arranged in the order that tests are typically performed.

SSB Frequency or Frequency Error Measurement

This procedure is used to measure a SSB Transmitter's frequency (or frequency error) into 50 Ω. The transmitted signal frequency is measured, then dependent on the side-band (upper or lower) used, the actual frequency or frequency error is calculated.

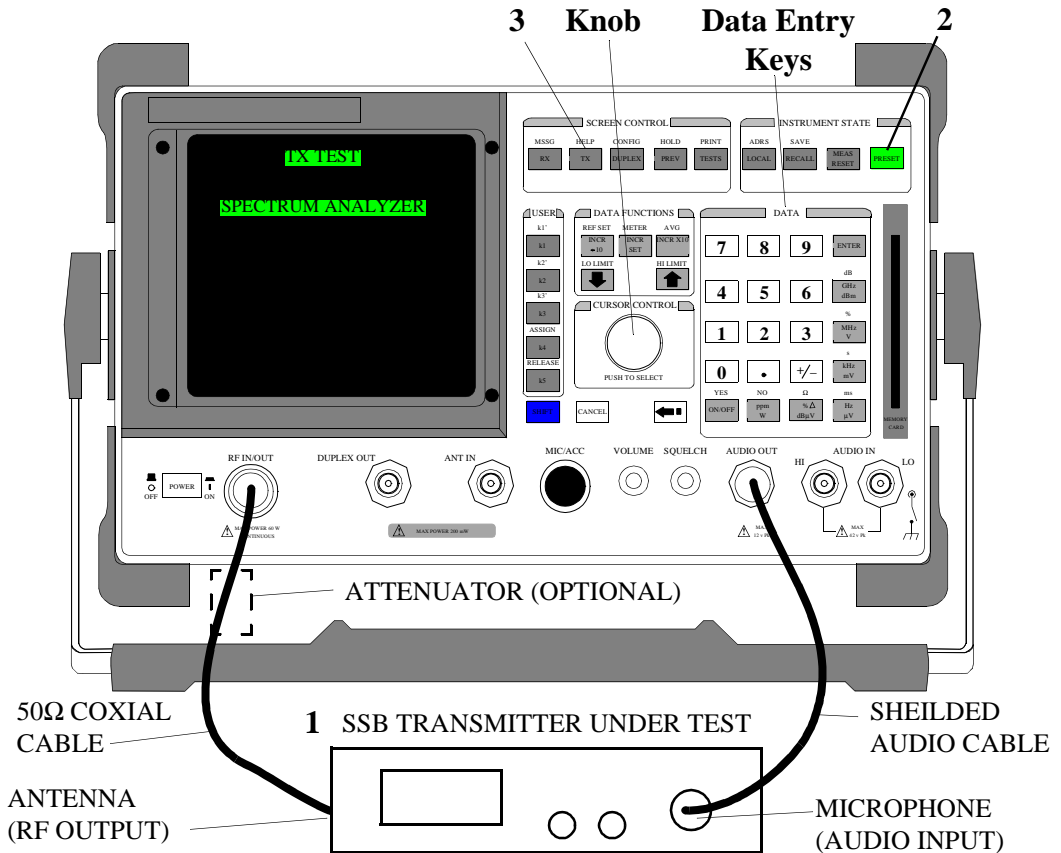

<p>Test Set Options Required</p>	<p>The typical error for the standard Test Set timebase is 2-3 Hz per 1 MHz (when measuring carrier frequency). If greater frequency accuracy is required, use an Test Set with Option 001 (High Stability Timebase).</p>
<p>Special Test Considerations</p>	<p>The accuracy and stability of both the AF source and the RF counter, and knowledge of the transmitter’s carrier suppression and the current operating side-band selection are required for precise frequency/frequency error measurements.</p>

Measurement Procedure:

1. Connect the Transmitter Under Test as shown.

CAUTION:

The RF present at the Test Set RF IN/OUT connector must not exceed 60W continuous (or 100 Watts for 10 sec/minute) or permanent instrument damage may result.

On the Test Set:

2. Press the PRESET key.
3. Press the TX key.

Using the knob and data entry keys:

4. Set **AF Anl In** to *SSB Demod.*

Determine readout measurement:

5. For actual frequency readout, continue with **step 7.**
6. For frequency error:

- a. Set **Tune Mode** to Manual.
- b. Set **Tune Freq** to the expected carrier frequency.

On the Radio:

7. Key the Transmitter and keep keyed until the remaining steps are complete.

On the Test Set using the knob and data entry keys:

8. Set **AFGen1 Lvl** until a measurable RF signal is displayed (typically >5-10 mV).

Frequency or frequency error is displayed as shown.

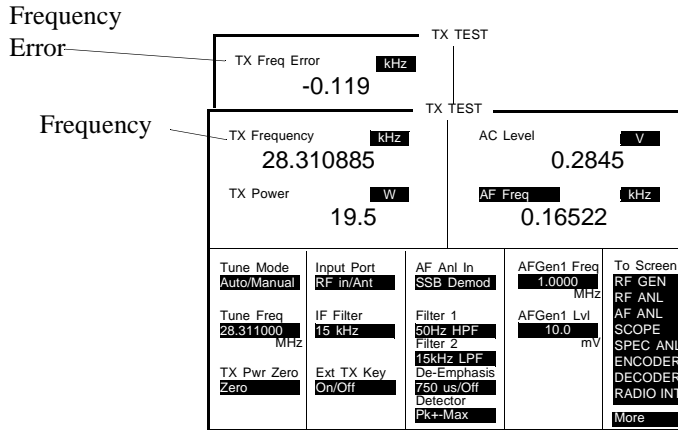

Calculate the Measurement:

NOTE:

Do not use the displayed AF Freq for the AFGen1 Freq in the calculation.

- Calculate the frequency or frequency error as follows:

$$\text{Frequency} = \text{TX Frequency} - \text{AFGen1 Freq}$$

For example, 28.310885 MHz – 1 kHz = 28.309885 MHz

$$\text{Frequency Error} = \text{TX Freq Error} - \text{AFGen1 Freq}$$

For example, –0.119 kHz – 1 kHz = –1.119 kHz

SSB Rated Output Power/Carrier Suppression Measurement

Description

This procedure is used to measure a SSB Transmitter's rated output power into 50 Ω. The transmitter is modulated with two separate audio signals at different frequencies. The amplitude of each audio signal is adjusted until the transmitted side-band signals are equal as displayed on the spectrum analyzer screen. Once properly adjusted, the RF Output power is measured. A reference is then established, and the carrier suppression is measured by removing all audio to the microphone input.

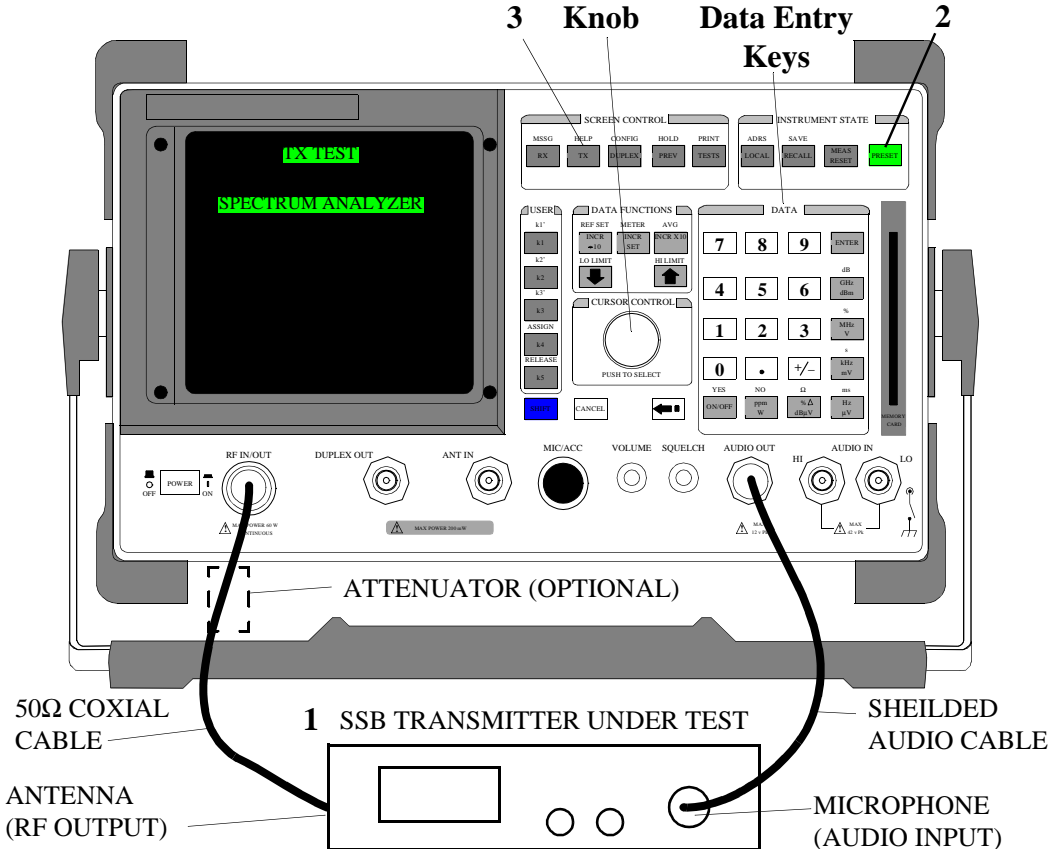

Test Set Options Required	Spectrum Analyzer/Tracking Generator (option 102)
Special Test Considerations	See " Cable and Adapter Loss " on page 46. Also, the accuracy and stability of both the AF source and the RF power measurement device, and knowledge of the transmitter's carrier suppression and the current operating side-band selection are required for precise measurements.

Measurement Procedure:

1. Connect the Transmitter as shown.

CAUTION:

The RF present at the Test Set RF IN/OUT connector must not exceed 60W continuous (or 100 Watts for 10 sec/minute) or permanent instrument damage may result.

On the Test Set:

2. Press the PRESET key.
Using the knob and data entry keys:
3. Set **Amplitude** to *Off*.
4. Set **AFGen1 To** to *Audio Out*.
5. Assign global key k1' to **AFGen1 To**.
 - a. Select **AFGen1 To** mV field.
 - b. Press the SHIFT key.
 - c. Press the ASSIGN key.
 - d. Press the k1' key.
6. Set **AFGen2 Freq** to *1.6 kHz*.
7. Set **AFGen2 To** to *Audio Out* at *50 mV*.
8. Set **AFGen2 To** to *Audio Out*.
9. Assign global key k2' to **AFGen2 To**.
Assign like in **step 5**.
10. Select **SPEC ANL** screen.

11. Set **Center Freq** to transmitter frequency + 1 kHz (USB) or - 1 kHz (LSB) depending on side-band mode.
12. Set **Ref Level** to +50 dBm.
 - To set **Ref Level**:
 - From the Marker screen, select **Marker To Peak**
 - Select **Marker To Ref Level**
13. Set **Span** to 5 kHz.
 - On the Radio:
14. Key the Transmitter.
 - On the Test Set using the knob and data entry keys:
15. Adjust **Ref Level** and/or **Span** as required to display the signal.
16. Use global keys k1' and/or k2' to adjust AFGen1 and AFGen2 output levels until two side-band signals of equal RF levels are produced as shown.

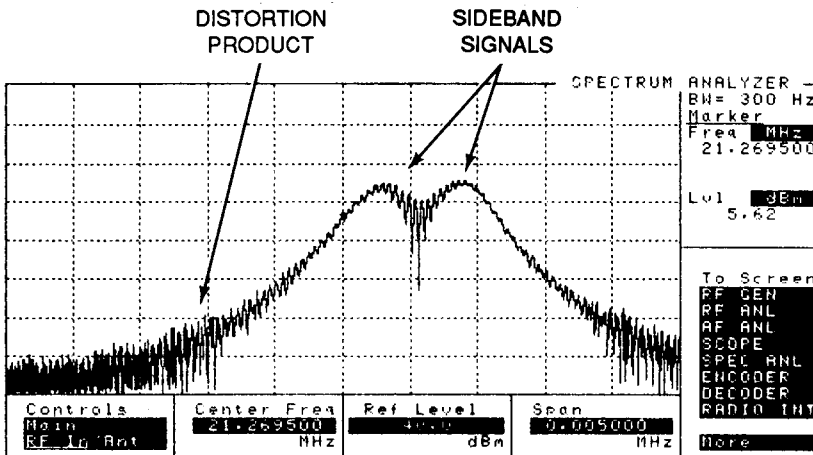

NOTE: Test set up and cabling for this test are critical. RF feedback into the Transmitter audio input may cause the displayed waveform to be distorted. Use caution to carefully bypass input lines at the microphone connector when performing this test.

17. Verify that the distortion products (smaller signals to either side of the side-band signals) do not exceed the Transmitter’s specification.

If incorrect, repeat step 4 using reduced modulation levels until the distortion products meet specified limits.

NOTE: If the distortion product specification is expressed as a percentage, it must be converted to dB for use in this measurement. A rating of 10% distortion products corresponds to a reduction of 20 dB, 5% is 26 dB, and 3% is 30 dB. If the distortion product specification is unknown, use 30 dB.

On the Test Set:

18. Select **TX Power W**.

19. Press the REF SET key.

Measurement results are displayed as **TX Power**.

Carrier Suppression is displayed as **TX Power** as shown.

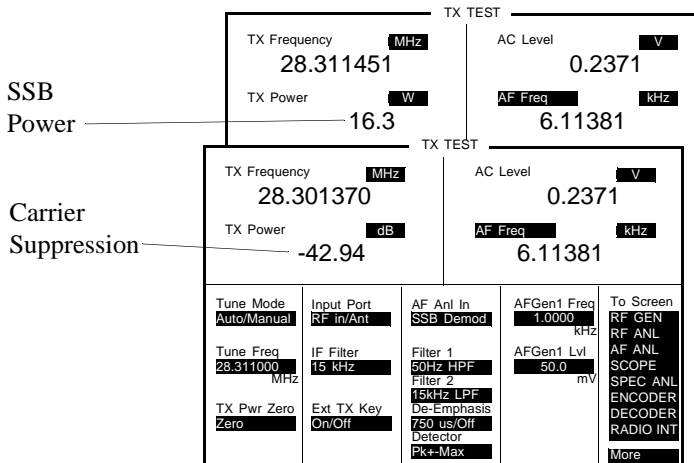

SSB Harmonics and Spurious Output Measurement

Description

This procedure is used to measure an SSB Transmitter's conducted harmonic and spurious emissions. The spectrum analyzer option is used to display harmonic and spurious components from 400 kHz to 1000 MHz.

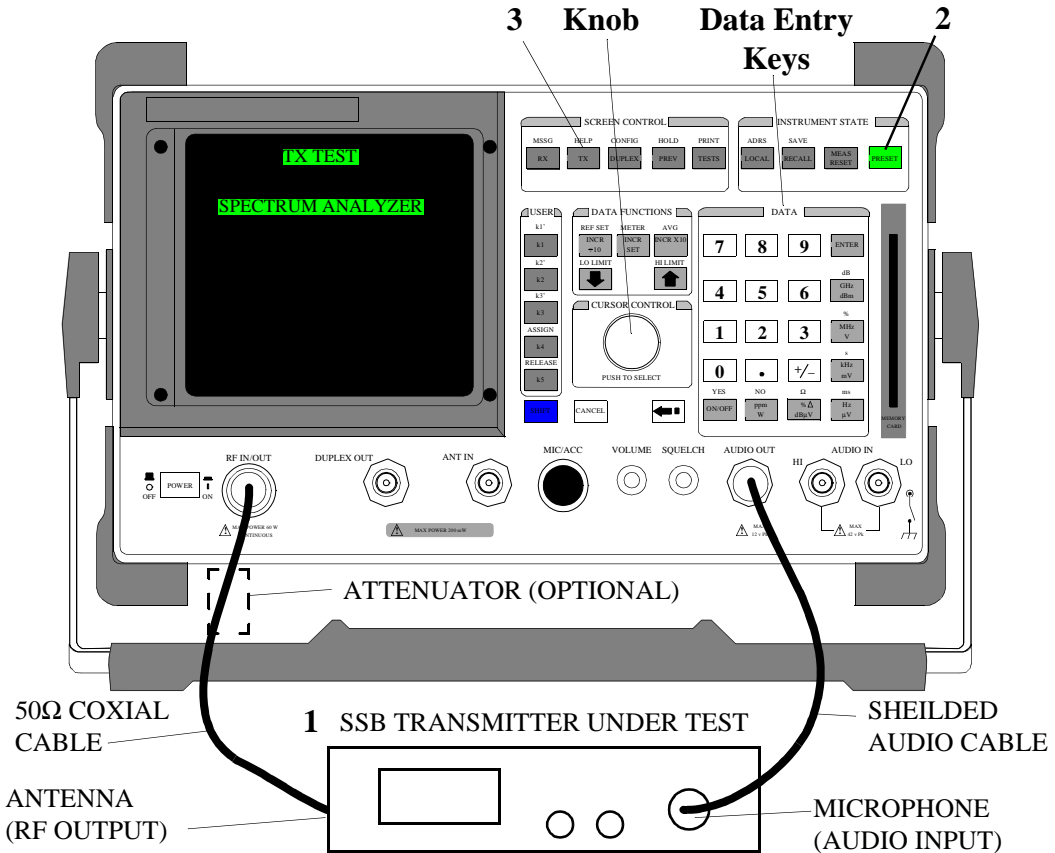

Test Set Options Required	Spectrum Analyzer/Tracking Generator (option 102)
Special Test Considerations	Cable and adapter mismatch must be considered when measuring harmonics and spurious emissions of a transmitter. If an external attenuator is used, special care must be taken to ensure the attenuator is not causing any spurious or harmonic emission. Also, if spurious emissions are located, verify that the transmitter is the source, and not another object radiated emissions near the test site.

Measurement Procedure:

1. Connect the Transmitter as shown.

CAUTION:

The RF present at the Test Set RF IN/OUT connector must not exceed 60W continuous (or 100 Watts for 10 sec/minute) or permanent instrument damage may result.

On the Test Set:

2. Press the PRESET key.
3. Press the TX key.

Using the knob:

4. Set **AF Anl In** to *SSB Demod.*

On the Radio:

5. Key the Transmitter and keep keyed until the remaining steps are completed.

On the Test Set using the knob and data entry keys:

6. Set **AFGen1 Lvl** until a measurable RF signal is displayed (typically >5-10 mV).
7. Select **SPEC ANL** screen.
8. Set **Span** to *1.1 MHz*.
9. Set **Ref Level** to place the carrier peak at the top graticule line.

To set **Ref Level**:

- From the Marker screen, select **Marker To Peak**
- Select **Marker To Ref Level**

10. Tune Center Freq in 1 MHz steps anywhere from 400 kHz to 1 GHz in search of harmonics, subharmonics, multiples, or spurious emissions.

NOTE:

If spurious emissions are suspect, un-key the Transmitter, and verify that emissions are from the transmitter and not another source.

To measure spurious emission of the transmitter under test:

- Place at center frequency.
- Or perform the following:
 - a. Select **Main** from the Controls field.
 - b. Select **Markers** from the Choices field.
 - c. Position the marker on the desired peak. (**Position** or **Next Peak**)

Marker frequency and level are displayed as shown.

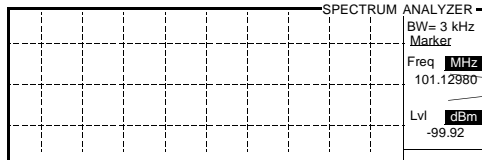

Spurious or Harmonic Level & Frequency

SSB Receivers

The following measurements are provided for testing SSB Receivers. The procedures are arranged in the order that tests are typically performed.

SSB Audio Output Power and Distortion Measurement

Description

This procedure is used to measure an SSB Receiver's audio output power and distortion into a Test Load. Output power is displayed (in various measurement units, including watts) on the Test Set screen. Distortion is measured and displayed at one-half the rated audio output. Reference is IEC 489-5, paragraph 3.1.2.

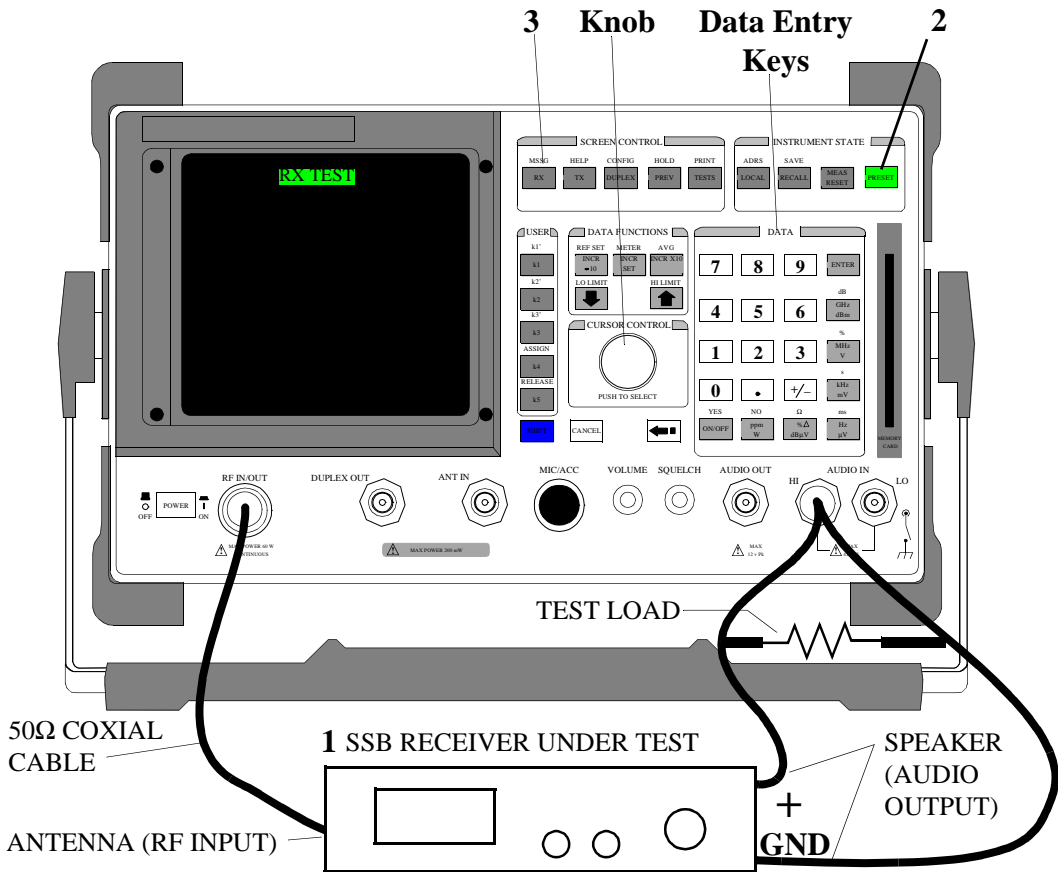

Additional Equipment Required	Test Load
Special Test Considerations	See " Receiver Test Loads " on page 46.

Measurement Procedure:

1. Connect the Receiver as shown.

On the Test Set:

2. Press the PRESET key.
3. Press the RX key.

Using the knob and data entry keys:

4. Set **RF Gen Freq** to the receiver operating frequency.

NOTE:

RF Gen Freq is dependent on the Receiver's mode (LSB/USB) and the audio frequency desired (normally 1 kHz). When setting for LSB, set RF Gen FREQ to a setting 1 kHz less than the normal carrier frequency. For USB, set to 1 kHz higher.

5. Set **Amplitude** to -47 dBm (1 mV).
6. Set **AFGen1 To OFF**.
7. Set **Ext Load R** to the test load resistance.
8. Set **AC Level** meter to measure **Watts**.
9. Set **SINAD** meter to measure **AF Freq**.

On the Radio set the Receiver's Controls as follows:

10. Set power to ON.
11. Set mode to LSB or USB.
12. If required, set frequency to the same value as [step 4](#).
13. Set squelch to minimum.
14. Set RIT to center or disable (if equipped).

15. Set RF Gain to maximum (if equipped).

On the Test Set using the knob and data entry keys:

16. Change the value of **RF Gen Freq** until the **AF Freq** meter reads *1 kHz*.

On the Radio set the Receiver's Controls as follows:

17. Set the Receiver's volume control until the **AC Level** meter indicates the Receiver's rated output power.

Refer to audio output specifications for the Receiver being tested as required. If unknown, increase the volume control until the **AC Level** meter stops increasing (or at maximum).

Measurement results are displayed on the Test Set as shown.

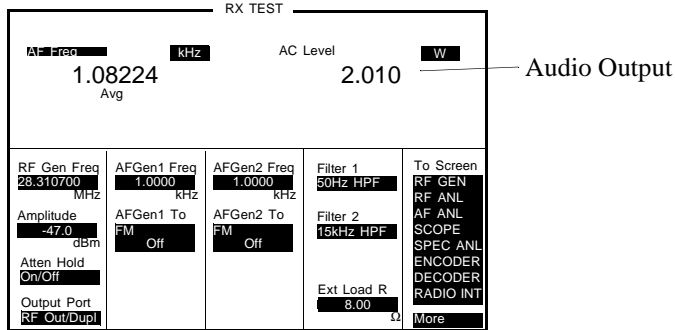

On the Test Set using the knob and data entry keys:

18. Set **AF Freq** meter to measure **Distortion**.

19. Select **AC Level**.

20. Press the REF SET key.

On the Radio set the Receiver's Controls as follows:

21. Decrease the Receiver's volume control until the **AC Level** meter reads *-3 dB*.

Distortion measurement results are displayed on the screen as shown.

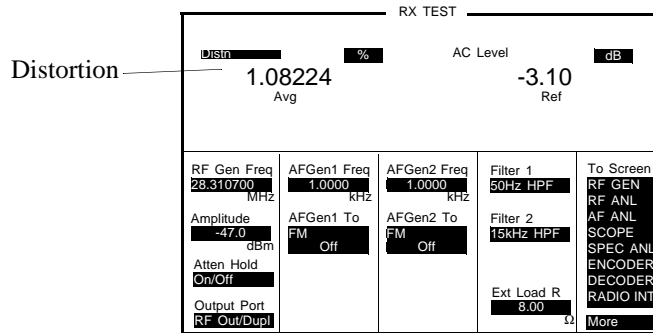

SSB Sensitivity Measurement

Description

This procedure is used to measure an SSB Receiver's receiver sensitivity. Sensitivity is displayed (in various measurement units) on the Test Set screen.

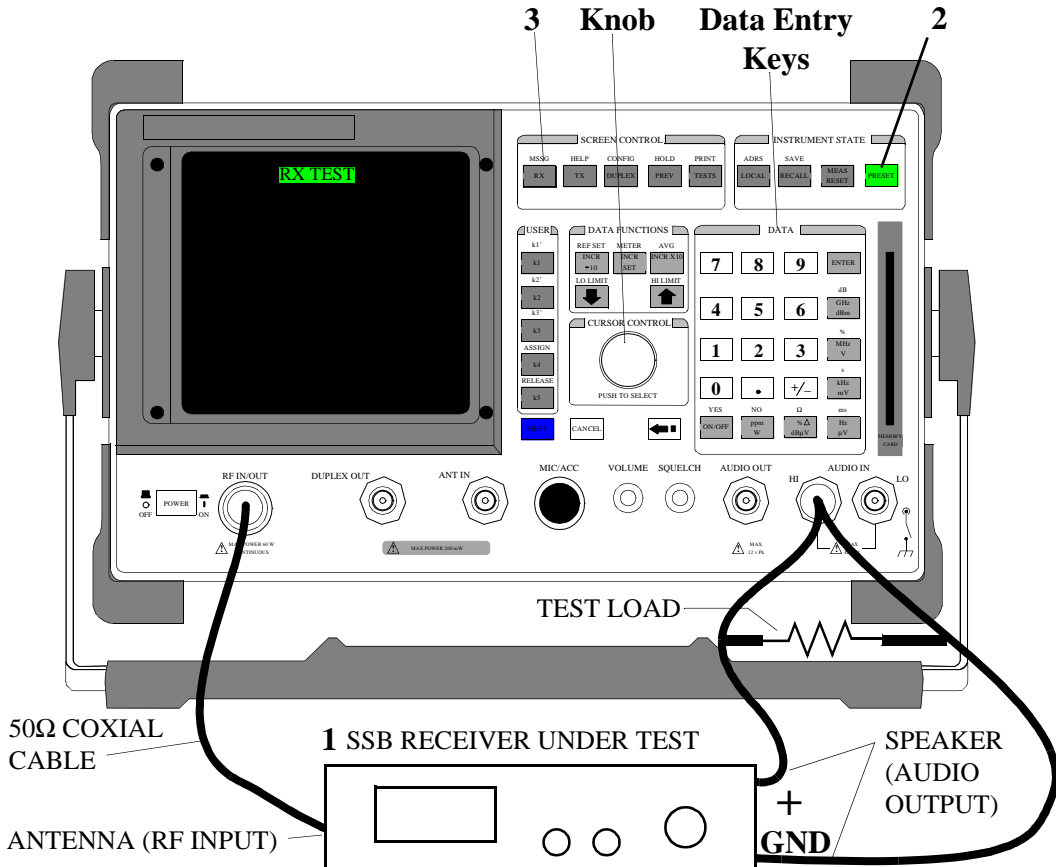

Additional Equipment Required	Test Load
Special Test Considerations	See " Receiver Test Loads " on page 46.

Measurement Procedure:

1. Connect the Receiver as shown.

On the Test Set:

2. Press the PRESET key.
3. Press the RX key.

Using the knob and data entry keys:

4. Set **RF Gen Freq** to the receiver operating frequency.
5. Set **Amplitude** to -47 dBm (1 mV).
6. Set **AFGen1 To OFF**.
7. Set **Ext Load R** to the test load resistance.
8. Set **AC Level** meter to measure **Watts**.
9. Set **SINAD** meter to measure **AF Freq**.

On the Radio set the Receiver's Controls as follows:

10. Set power to ON.
11. Set mode to LSB or USB.
12. If required, set frequency to the same value as [step 4](#).
13. Set squelch to minimum.
14. Set RIT to center or disable (if equipped).
15. Set RF Gain to maximum (if equipped).

On the Test Set using the knob and data entry keys:

16. Change the value of **RF Gen Freq** until the **AF Freq** meter reads 1 kHz.

On the Radio set the Receiver's Controls as follows:

17. Set the Receiver's volume control until the AC Level meter indicates the

Receiver's rated output power.

Refer to audio output specifications for the Receiver being tested as required. If unknown, increase the volume control until the **AC Level** meter stops increasing (or at maximum).

On the Test Set using the knob and data entry keys:

18. Set **AF Freq** meter to measure **SINAD**.

19. Select **AC Level**.

20. Press the REF SET key.

On the Radio set the Receiver's Controls as follows:

21. Decrease the Receiver's volume control until the **AC Level** meter reads **-6 dB**.

On the Test Set using the knob and data entry keys:

22. Decrease **Amplitude** until the SINAD meter reads 12 dB.

Sensitivity (at 12dB SINAD) is displayed on the screen as **Amplitude** as shown.

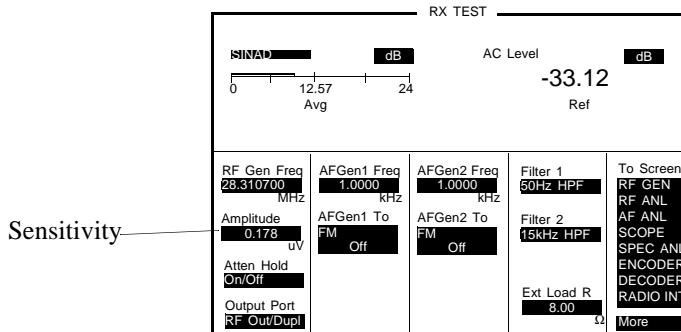

- If desired, use the meter averaging function for the SINAD indicator.
 - a. Select dB on the SINAD meter.
 - b. Press the AVG key.
 - If desired, select the number of readings to average.
 - Enter the number of readings to average.

Higher number of readings averaged will require longer to reach the final indication.

SSB Squelch Sensitivity Measurement

Description

This procedure is used to measure an SSB Receiver's critical squelch and maximum squelch sensitivity. For critical squelch, the receiver is just squelched with minimum modulated input at the Receiver's antenna, then the input is increased until the squelch is opened. Maximum squelch is the amount of modulated signal required to open the squelch when the control is set to maximum. Minimum and maximum squelch hysteresis is also measured and calculated. The SSB reference is IEC 489-5, paragraph 11.

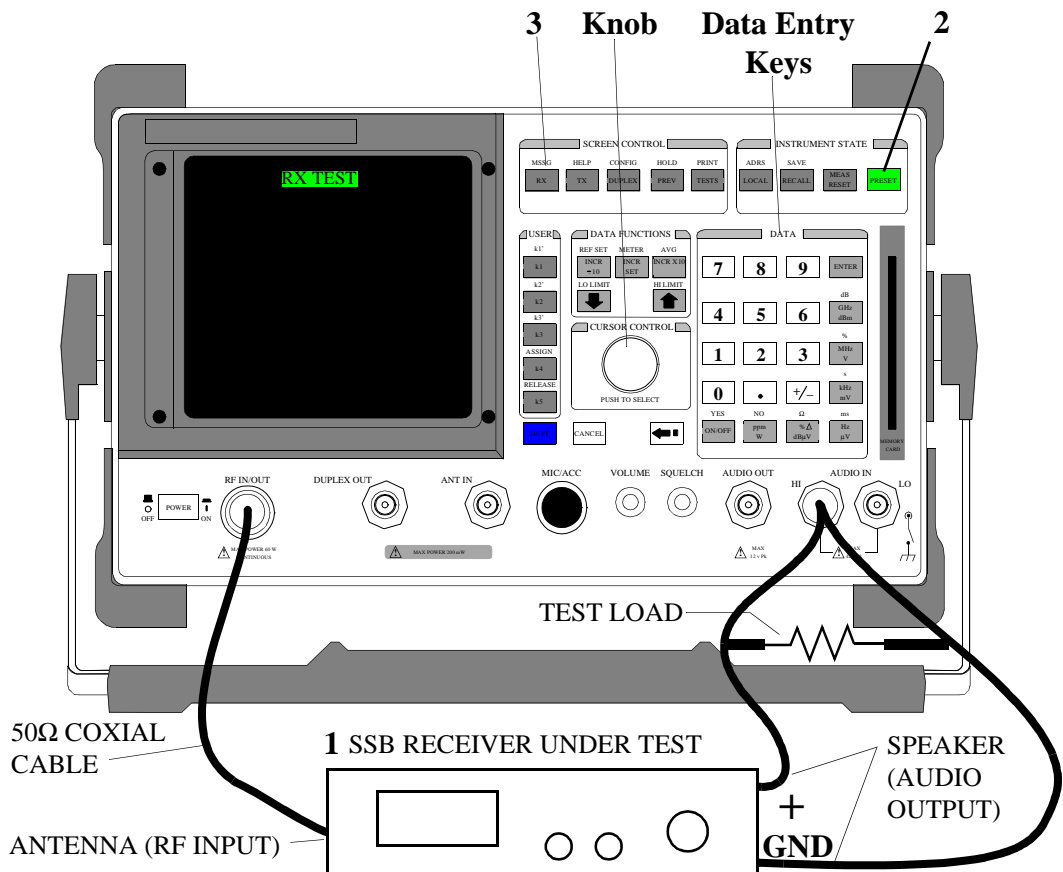

Additional Equipment Required	Test Load
Special Test Considerations	See " Receiver Test Loads " on page 46.

Measurement Procedure:

1. Connect the Receiver as shown.

On the Test Set:

2. Press the PRESET key.
3. Press the RX key.
Using the knob and data entry keys:
4. Set **RF Gen Freq** to the receiver operating frequency.
5. Set **Amplitude** to -47 dBm (1 mV).
6. Set **AFGen1 To OFF**.
7. Set **Ext Load R** to the test load resistance.
8. Set **AC Level** meter to measure **Watts**.
9. Set **SINAD** meter to measure **AF Freq**.

On the Radio set the Receiver's Controls as follows:

10. Set power to ON.
11. Set mode to LSB or USB.
12. If required, set frequency to the same value as [step 4](#).
13. Set squelch to minimum.
14. Set RIT to center or disable (if equipped).
15. Set RF Gain to maximum (if equipped).

On the Test Set using the knob and data entry keys:

16. Change the value of **RF Gen Freq** until the **AF Freq** meter reads 1 kHz.

On the Radio set the Receiver's Controls as follows:

17. Set the Receiver's volume control until the AC Level meter indicates the

Receiver's rated output power.

Refer to audio output specifications for the Receiver being tested as required. If unknown, increase the volume control until the **AC Level** meter stops increasing (or at maximum).

On the Test Set using the knob and data entry keys:

18. Set **Amplitude** to -137 dBm.

On the Radio set the Receiver's Controls as follows:

19. Set the Receiver's squelch control until the squelch just closes.

On the Test Set using the knob and data entry keys:

20. Increase **Amplitude** until the Receiver's squelch just opens.

Minimum Squelch Sensitivity is displayed on the screen as **Amplitude** as shown.

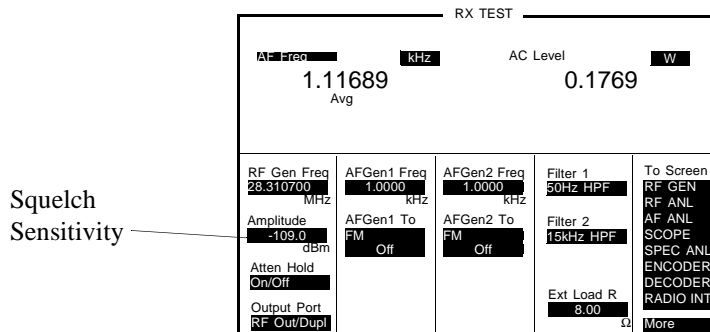

21. Set **Amplitude** to -137 dBm and verify squelch closes.

If not, repeat [step 19.](#) & [step 20.](#)

22. Increase until the Receiver's squelch just opens.

- Record this level.

23. Decrease **Amplitude** until the Receiver's squelch just closes.

- Record this level.

Calculate the reading:

24. Minimum Squelch Hysteresis is the difference between the two readings.

On the Test Set using the knob and data entry keys:

25. Increase **Amplitude** until the Receiver's squelch just opens.

- Record this level.

Maximum Squelch Sensitivity is displayed on the screen as **Amplitude** as shown.

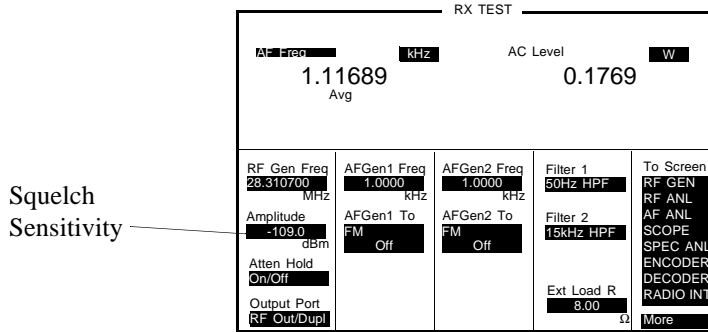

26. Decrease **Amplitude** until the Receiver's squelch just closes.

- Record this level.

Calculate the reading:

27. Maximum Squelch Hysteresis is the difference between the two readings.

Spectrum Analyzer Measurements

Introduction

Each procedure may contain the following information:

- A brief measurement overview and a reference to applicable TIA/EIA specifications for each test.
- A list of the Test Set options and additional test equipment required to perform the procedure.
- Any special test considerations that need to be considered for safety, measurement accuracy, etc.
- Step by step procedures required to perform each measurement (with illustrations).

Refer to "[Configuring for Measurements](#)" on page 241, or the Test Set's User Guide on preparing the Test Set for operation.

List of Measurements

Spectrum Analyzer Measurements

"Measuring Transmitter High/Low Power Signals" on page 189.

"Field Strength Measurements" on page 194.

"Analyzing External Transmitter Inter-modulation Distortion" on page 198.

Tracking Generator Measurements

"Basic Measurements with the Tracking Generator" on page 204.

"Antenna Return Loss (VSWR) Measurement & Tuning" on page 208.

"1/4 Wave Coaxial Filter Tuning (Swept)" on page 212.

"Cable Fault Locations" on page 216.

"Passive Cavity Insertion and Return Loss Measurement" on page 220.

"Repeater System Effective Sensitivity Measurement" on page 226.

Using the Spectrum Analyzer

The Spectrum Analyzer can be used to measure signals from 400 kHz to 1 GHz, with variable spans from 5 kHz to 1 GHz (full span). A tunable marker is provided for automatic readout of frequency and amplitude, or relative frequency and amplitude from a reference. Other marker functions include marker to peak, marker to next peak, marker to center frequency, and marker to reference level; all of which speed up and simplify signal searching and measurement.

Inputs to the Spectrum Analyzer are connected to either the front panel RF IN/OUT or ANT IN connector, can range from 60W (RF IN/OUT) to 2 μ V (ANT IN). All the Spectrum Analyzer functions are accessed from one of three screens.

- Main Screen – main sweep controls.
- Marker Screen – marker positioning controls.
- Auxiliary Screen – input attenuation, sensitivity, and trace controls.

Measuring Transmitter High/Low Power Signals

This procedure is provided as an overview of the optional Spectrum Analyzer's operation. The screen choices and displayed parameters are described and illustrated.

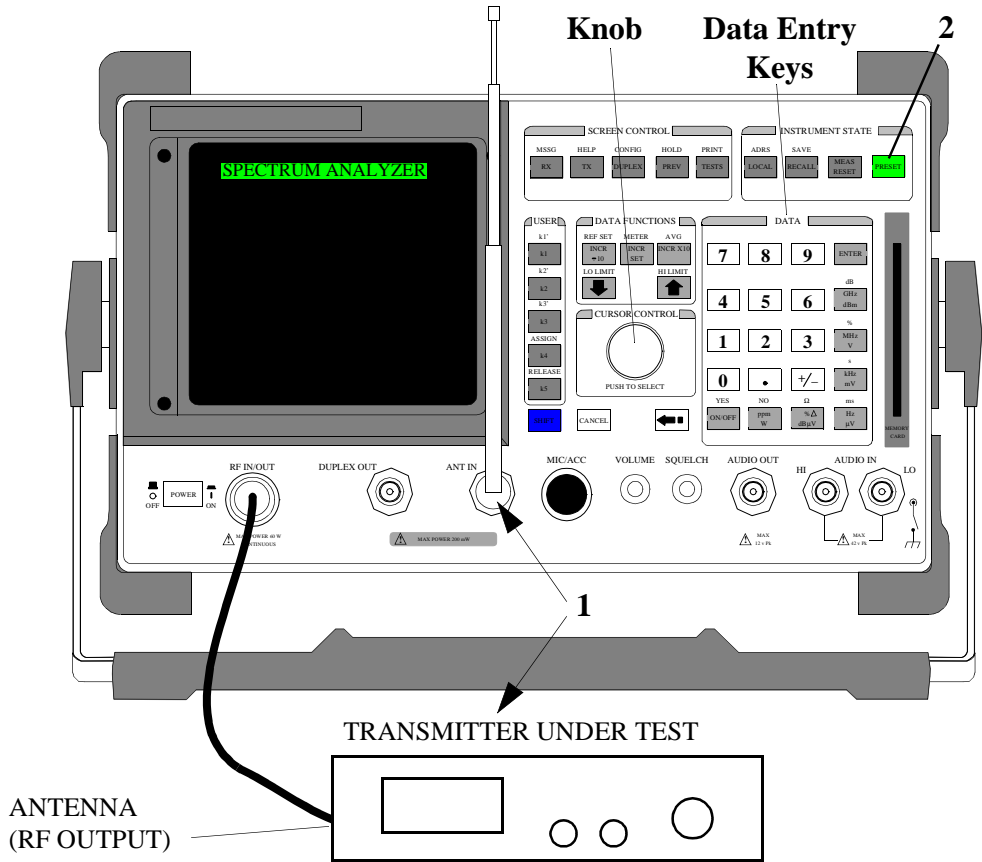

Test Set Options Required	Spectrum Analyzer/Tracking Generator (option 102)
----------------------------------	---

Measurement Procedure:

1. Connect the signal input to the RF IN/OUT or ANT IN connector.
 - Use the RF IN/OUT connector for measuring Transmitter output or other high-power signals.
 - Use the ANT IN connector for all other low level signals (provides higher sensitivity).

CAUTION: Do not exceed the connector's rated input or permanent instrument damage may result.

On the Test Set:

2. Press the PRESET key.

Using the knob:

3. Select **SPEC ANL** screen.
4. Select **Controls** field.
5. Continue the measurement by selecting a control screen from the list of choices and referring to the following:
 - For sweep control, see "[Measurements Using the Main Control Fields:](#)" on page 191.
 - For marker positioning, see "[Measurement Using the Marker Control Fields:](#)" on page 192.
 - For input attenuation, sensitivity, and trace control, see "[Measurements Using the Auxiliary Control Fields:](#)" on page 193.

Measurements Using the Main Control Fields:

- From **Controls** select RF In if the input signal is connected to the RF IN/OUT connector.
- From **Controls** select Ant if the input signal is connected to the ANT IN connector.
- **Center Freq** sets the frequency at the center of the screen.
- **Ref Level** sets the amplitude reference level (top line of the display).
- **Span** sets the span of frequencies displayed on the screen.

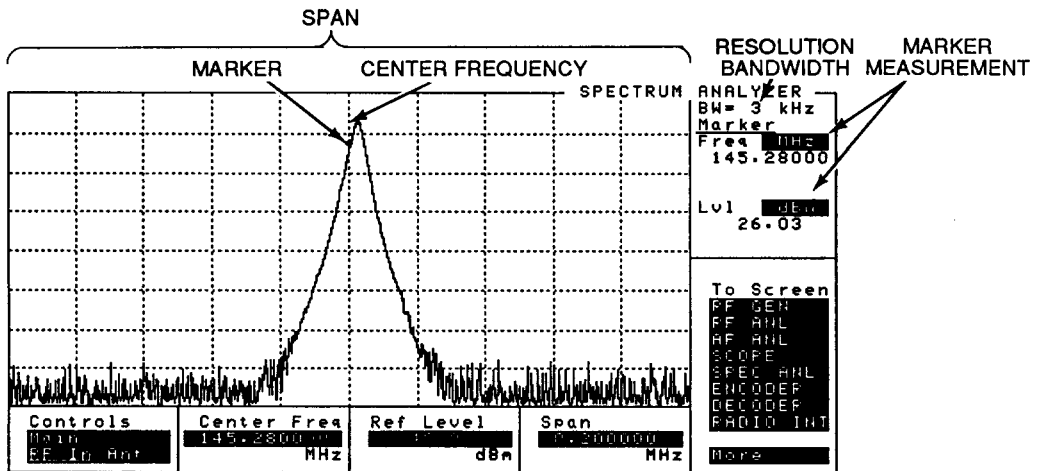
**Marker Indicators:**

- Marker Freq **MHz** indicates the marker frequency position.
- Marker Lvl **dBm** indicates the marker amplitude position.

Measurement Using the Marker Control Fields:

- **Position** positions the marker on the screen. Displayed marker Freq and Lvl are automatically updated.
- **Marker To** sets the marker to the signal with the largest Peak, the signal with the Next largest Peak, to the Center Frequency, or to the Reference Level.

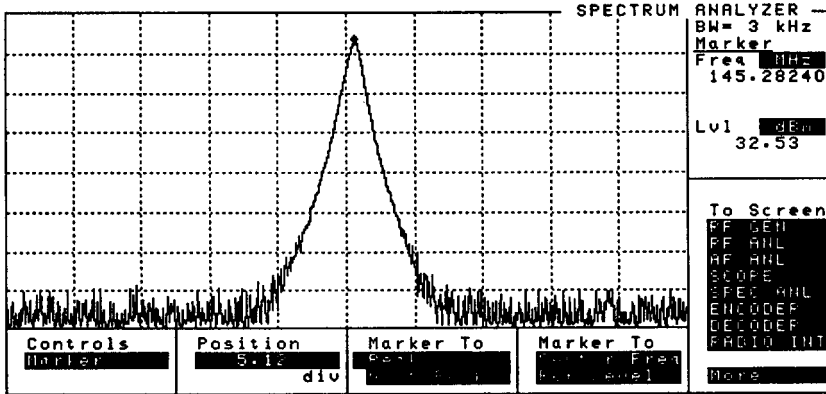

Relative frequency and amplitude measurements such as filter bandwidth, duplexer rejection/insertion loss, or harmonic level can be performed using the “Delta” marker function.

The Delta marker function is performed by:

1. Setting the marker to the first point desired.
2. Position the cursor to the marker frequency and/or amplitude indicators.
3. Press the REF SET key.

Note that the readout now displays 0 and “Ref” below it.

4. Position the cursor to the **Position** field.
5. Move the marker along the displayed response.

The marker readout now displays the delta from the set reference point.

To turn the reference set off:

- Press the REF SET key.
- Press the ON/OFF key.

Measurements Using the Auxiliary Control Fields:

- From **Controls** select Off to update the display after each sweep, or Pk Hold to retain the highest input value for each point in successive sweeps.
- **Input Atten** sets the input attenuator to Automatic or Hold. If Hold is selected, a specific level can also be selected.
- From **Sensitivity** select Normal for normal input sensitivity, or High for increased input sensitivity ($<1 \mu\text{V}$) to locate low level signals. Sensitivity also is used to set the vertical scale (dB/Div).

NOTE:

Using High Sensitivity may cause erroneous amplitude or AM side-band amplitude measurements.

- From **Normalize**
 - select **Save B** to save the current trace (can only be performed when A Only is selected).
 - select to display a continuously updated screen (normal operation).
 - select to display the difference between the trace saved (using Save B) and the current trace.

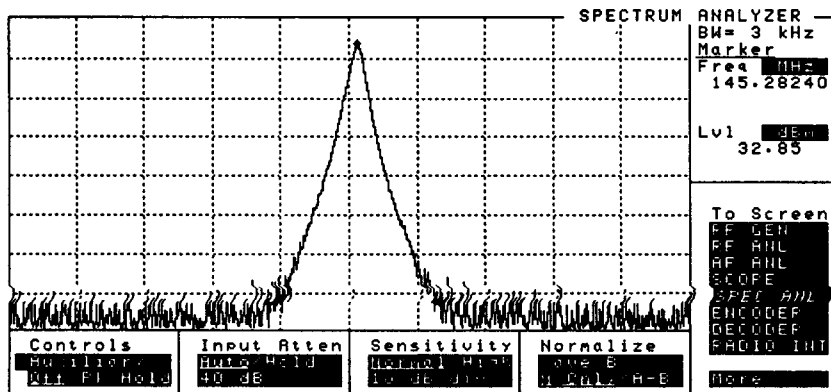
**Marker Indicators:**

- Marker Freq **MHz** changes the units that the marker frequency is displayed in.
- Marker Lvl **dBm** changes the units that the marker amplitude is displayed in.

Field Strength Measurements

Description

This procedure is used to measure and calculate field strength with the Spectrum Analyzer/Tracking Generator option. A calibrated antenna is connected to the ANT IN connector, a measurement is performed, and the field strength is calculated (in dB μ V/m or μ V/m).

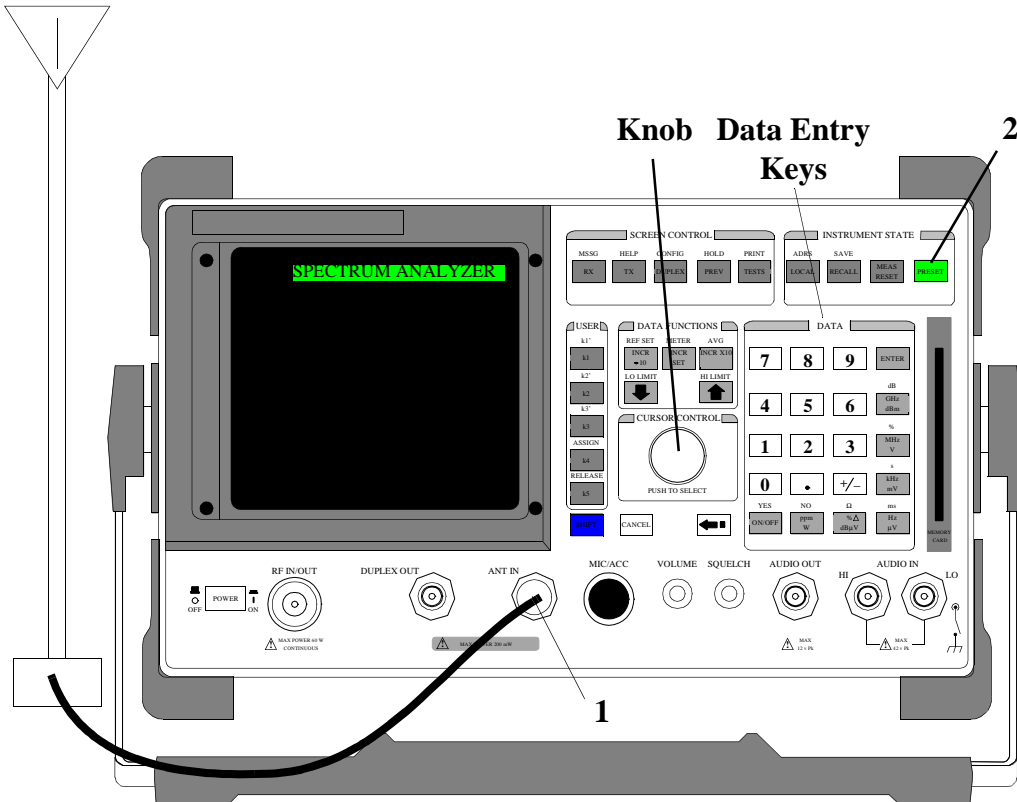

Test Set Options Required	Spectrum Analyzer/Tracking Generator (option 102)
Additional Equipment Required	Calibrated antenna
Special Test Considerations	The antenna should be resonant at the frequency of interest. Also, to accurately calculate field strength, the antenna factor or gain of the antenna must be known, and losses in the cable connecting the antenna to the Test Set should be factored in (depending on cable length and/or operating frequency).

Measurement Procedure:

1. Connect the Antenna to the ANT IN connector.

CAUTION:

Do not exceed the connector's rated input or permanent instrument damage may result.

On the Test Set:

2. Press the PRESET key.

Using the knob and data entry keys:

3. Select the **SPEC ANL** screen.
4. From the **Controls** select Ant.
5. Select **Lvl** to measure in units of *dBuV*.
6. Set **Ref Level** from -30 dBm to -50 dBm as required to view the desired signal.

On the Radio:

7. Key Transmitter that drives the antenna being tested and keep it keyed until the remaining steps are completed (if applicable).

On the Test using the knob and data entry keys:

8. Set **Ref Level** as required to view the desired signal.
9. From **Controls**, select **Main**.
10. Select **Marker** from the **Choices** field.
11. Select **Marker To** to select the desired signal peak.

Antenna:

12. Rotate the Calibrated Antenna on each axis until the maximum input signal strength is achieved.

Record the signal level (in dB μ V) as shown.

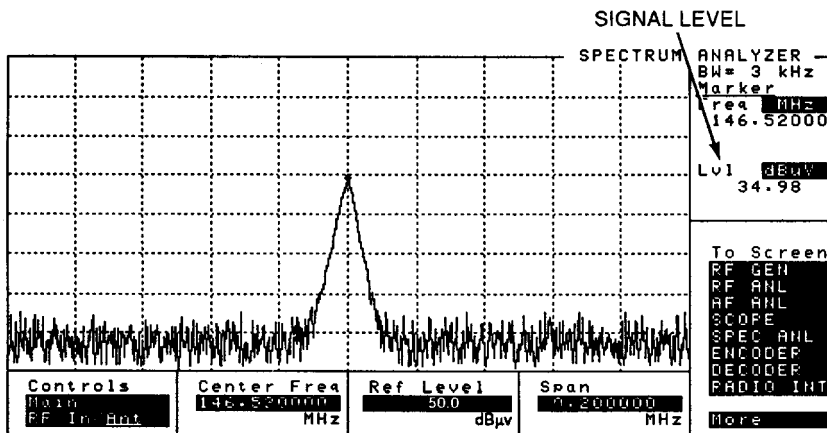

Calculate the Field Strength:**13.** Calculate Field Strength as follows:

Field Strength (in dB μ V) = Signal Level (step 7) + Antenna Factor

For example, (34.98 dB μ V) + (+7.4 dB/m) = 42.38 dB μ V/m

- If Antenna Factor is not known, calculate using Antenna Gain as follows:

Antenna Factor (50 Ω) = 20 log freq (MHz) – Gain (db) – 29.8dB

Antenna Factor (75 Ω) = 20 log freq (MHz) – Gain (db) – 31.5dB

For example, Ant Factor = 20 log 144.68 – 6db – 29.8 dB = 7.4 dB/m

- Convert Field Strength from dB μ V/m to μ V/m as follows:

Field Strength (in μ V/m) = 10 (Field Strength in dB μ V/m)/20

For example, 10 (42.38 dB μ V/m)/20 = 131.52 μ V/m

Analyzing External Transmitter Inter-modulation Distortion

This procedure is used to display, measure, and demodulate high-order inter-modulation distortion products using the Spectrum Analyzer/Tracking Generator option.

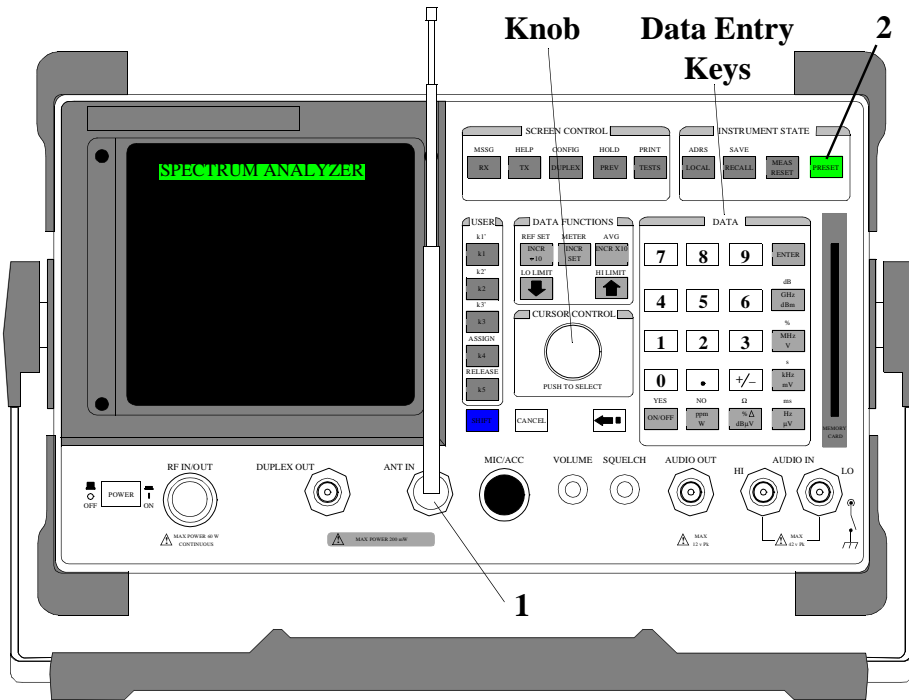

Test Set Options Required	Spectrum Analyzer/Tracking Generator (option 102)
Additional Equipment Required	Whip Antenna

NOTE:

When two signals F_1 and F_2 are present in a system, they can mix with the second harmonics generated $2F_1$ and $2F_2$ and create higher order inter-modulation distortion products. Because these distortion products are usually

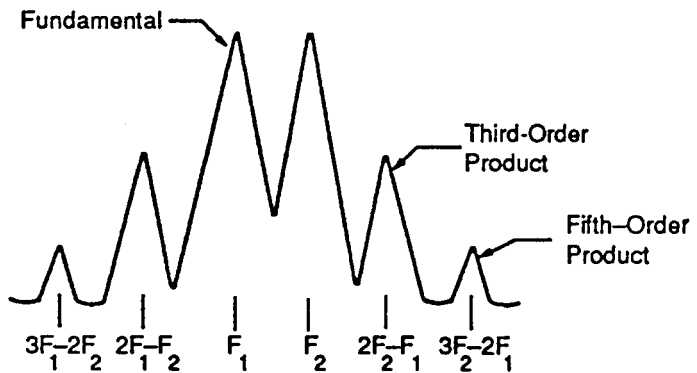

located close to the original signals at $2F_2 - F_1$ and $2F_1 - F_2$, span should be reduced to as narrow as possible while still allowing the distortion products to be displayed.

Measurement Procedure:

1. Connect the Antenna to the ANT IN connector.

CAUTION:

Do not exceed the connector's rated input or permanent instrument damage may result.

On the Test Set:

2. Press the PRESET key.

Using the knob and data entry keys:

3. Select the **SPEC ANL** screen.
4. From the **Controls** select Ant.
5. Set **Center Freq** and **Span** fields to view desired frequency range.
6. Set **Ref Level** from -30 dBm to -50 dBm as required to view the desired signal.

On the Radio:

7. Key the Transmitters and keep it keyed until the remaining steps are completed (if applicable).

Determine Distortion Products:

8. Record the frequency and level of all signals of interest. If further analysis is desired:

On the **SPECTRUM ANALYZER** screen:

9. From the **Controls** select **Main**.
10. Select **Marker** from the **Choices** field.
11. Use the **Marker To** to select the desired carrier.

Frequency and level are displayed as shown.

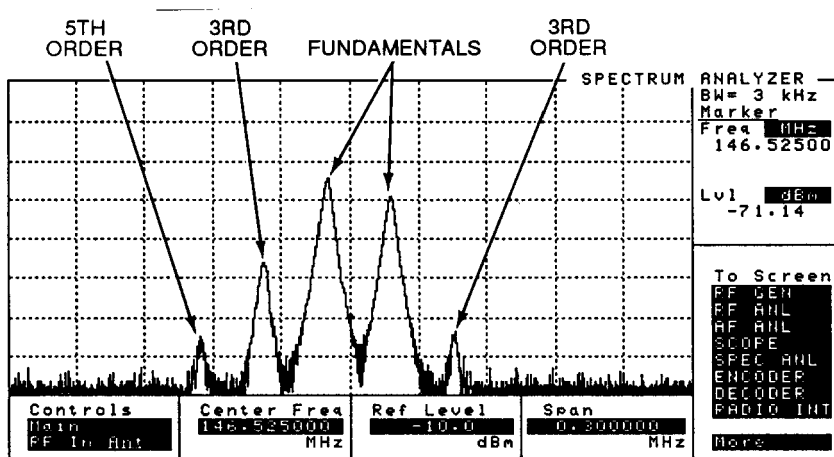

To Demodulate the Product:

These steps are used to help determine which transmitter is causing the distortion.

12. Position the marker on the desired carrier.
13. Select **Marker To** to **Center Freq.**
14. From the **Controls** select **Marker**.
15. Select **Main** from the **Choices** field.
16. Decrease the **Span** to *1.5 MHz* (or less).
17. Adjust the Volume and Squelch controls to listen to the demodulated product.

NOTE:

On the TX TEST screen change the **IF Filter** to *230 kHz* and/or **AF Anl In** if necessary (e.g. to AM for aircraft).

Using the Tracking Generator

The Optional Tracking Generator allows for quick and accurate characterization of filters, duplexers, combiners, and RF to IF conversions. Broadband RF devices can be characterized with single sweeps due to the full-span sweep capability to 1 GHz. The tracking generator also includes amplitude and frequency offset. Output from the Tracking Generator are provided at either the front panel RF IN/OUT or DUPLEX OUT connector.

Basic Measurements with the Tracking Generator

This procedure is provided as an overview of the optional Spectrum Analyzer/Tracking Generator's operation. The screen choices and displayed parameters are described and illustrated.

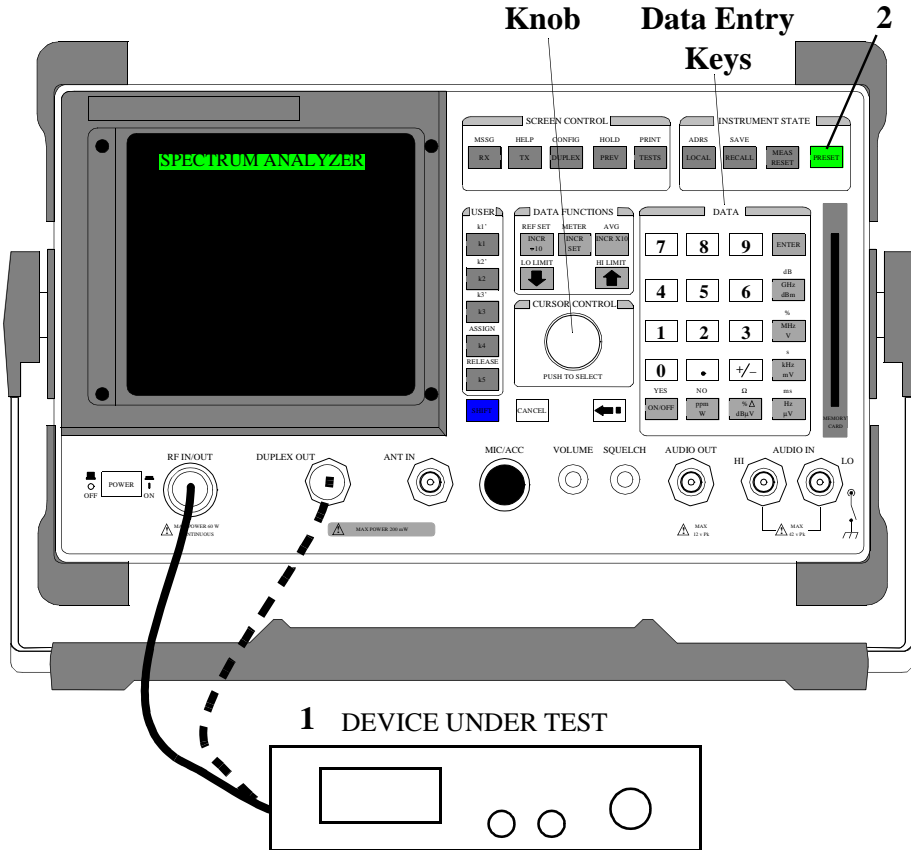

Test Set Options Required	Spectrum Analyzer/Tracking Generator (option 102)
----------------------------------	---

Measurement Procedure:

1. Connect the signal input to the RF IN/OUT or DUPLEX OUT connector.

CAUTION:

Do not exceed the connector's rated input or permanent instrument damage may result.

On the Test Set:

2. Press the PRESET key.

Using the knob and data entry keys:

3. Select **SPEC ANL** screen.
4. From the **Controls** field, select **Main**.
5. Select **RF Gen** from the **Choices** field.
6. Continue the measurement by selecting one of the following **Controls** field choices and referring to the following:
 - For a swept RF output at the offset and amplitude at the specified RF output port, [see "Measurements Using the Track Control Fields:" on page 206](#).
 - For a "Inverted" sweep mode which is useful when testing super-hetrodyned receivers where sweeping the RF upward sweeps the IF downward, [see "Measurements Using the Fixed Control Fields:" on page 207](#).

Measurements Using the Track Control Fields:

- From **Controls** select **Track**.
- **Offset Freq** sets the difference between the instantaneous frequencies of the Tracking Generator RF output and the Center Frequency of the Spectrum Analyzer. The frequency range is determined by the Spectrum Analyzer's Span setting.

NOTE:

The offset function is useful when looking at frequency translating devices, or anytime you need to sweep around a frequency while analyzing another. During normal operation, offset is set to "0.00".

- **Amplitude** sets the RF output amplitude.
- **Port/Sweep** routes the RF output to the RF Out or Duplexer Out connector.

This field also is used to select if the tracking generator sweeps from low to high frequencies (Norm) or from high to low (Invert). The Spectrum Analyzer always sweeps from low to high.

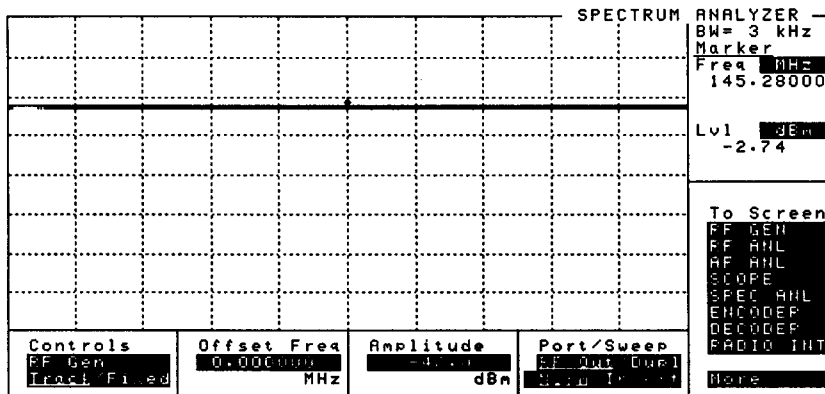

Measurements Using the Fixed Control Fields:

- From **Controls** select **Fixed**.
- **RF Gen Freq** sets the RF output frequency.
- **Amplitude** sets the RF output amplitude.
- **Output Port** routes the RF output to the RF Out or Duplexer Out connector.

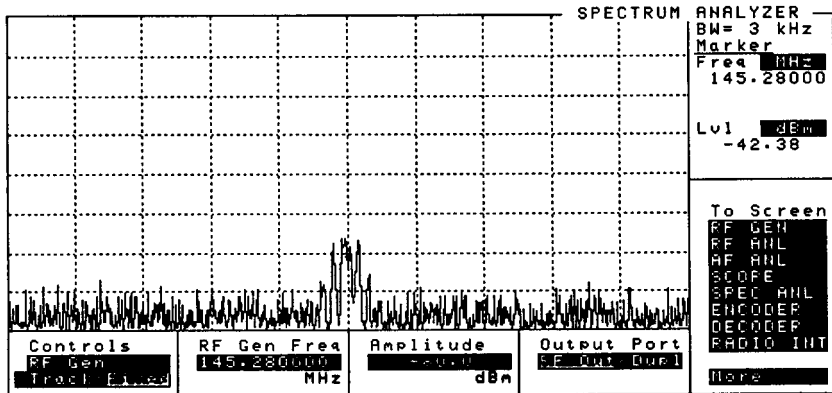

Antenna Return Loss (VSWR) Measurement & Tuning

Description

This procedure is used to measure the return loss of an antenna through a directional bridge and the Spectrum Analyzer/Tracking Generator option. Return loss is measured and can be converted into VSWR using a table.

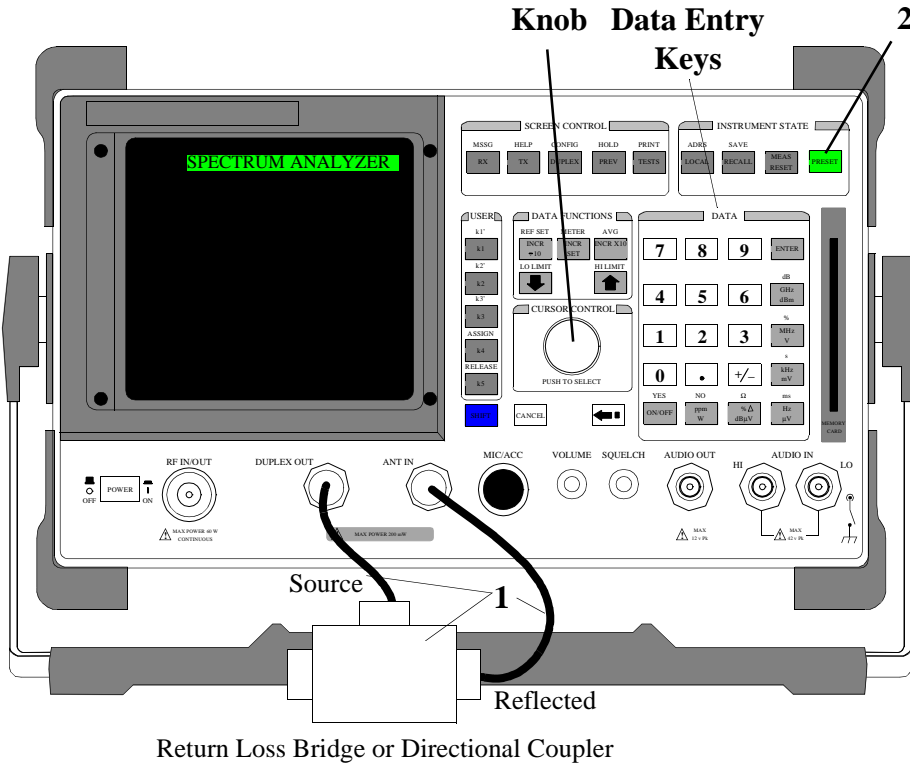

Test Set Options Required	Spectrum Analyzer/Tracking Generator (option 102)
Additional Equipment Required	Return Loss Bridge or Directional Coupler and an Antenna

Measurement Procedure:

1. Connect the bridge or coupler as shown.

CAUTION:

Do not exceed the connector's rated input or permanent instrument damage may result.

On the Test Set:

2. Press the PRESET key.

Using the knob and data entry keys:

3. Select the **SPEC ANL** screen.
4. From the **Controls** select Ant.
5. Set **Center Freq** to the center frequency of the antenna under test.
6. Set **Span** to view desired frequency range.
7. Set **Ref Level** to 0 dB (or greater).
8. From **Controls**, select **Main**, then select **RF Gen** from the **Choices** field.
9. From **Controls** select Track.
10. Set **Amplitude** to 0 dBm.

NOTE:

Amplitude default of 0 dBm is typically sufficient for performing measurements. The level can be changed as required to suit measurement needs (e.g. increase measurement range, minimize incident input from other sources, etc.). If **Amplitude** is changed, **Ref Level** will also have to be changed.

On the Directional Coupler:

11. Verify that the LOAD port is open (or shorted).

Normalize (to remove the effects of the cables, bridge/coupler, etc.) as follows:

- 12. From **Controls**, select **RF Gen**.
- 13. Select **Auxiliary** from the **Choices** field.
- 14. From **Normalize** select **A Only**.
- 15. From **Normalize** select **Save B**.
- 16. From **Normalize** select **A-B**.
- 17. From **Controls**, select **Auxiliary**.
- 18. Select **Main** from the **Choices** field.

Antenna:

- 19. Connect the antenna-under-test as shown.

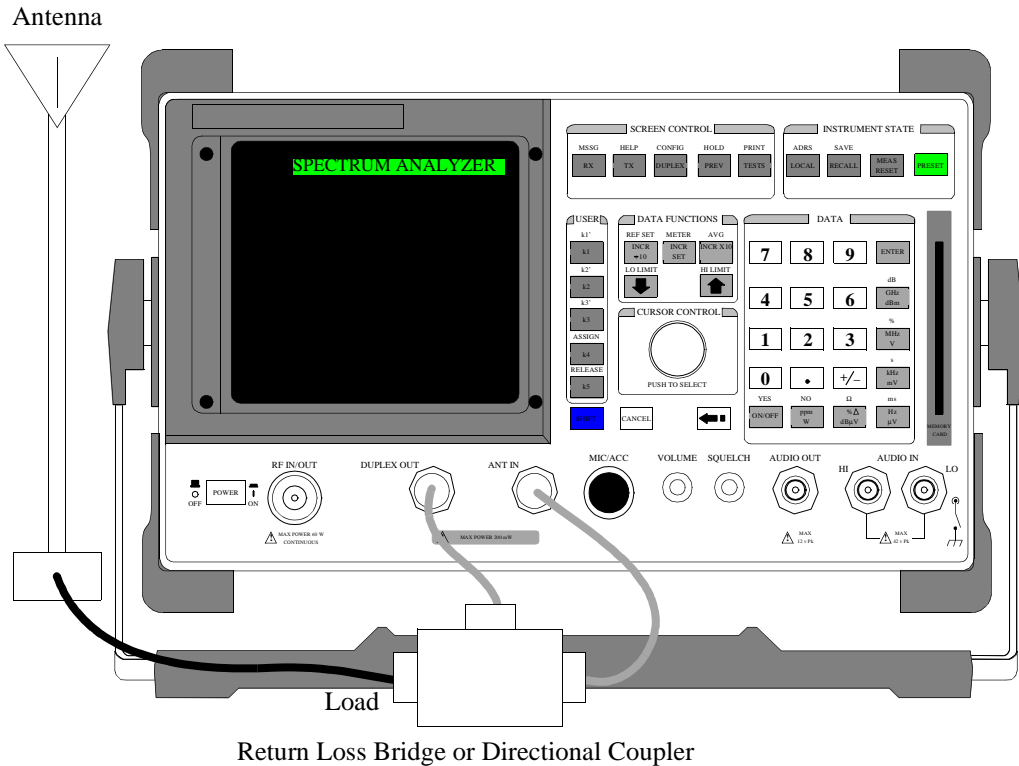

On the Test Set using the knob and data entry keys:

20. From **Controls**, select **Main**.
21. Select **Marker** from the **Choices** field.
22. From **Marker To** select **Ref Level**.
23. Use the **Marker** position to measure the response to the frequency(s) of interest.

Return loss is displayed as **Lvl** as shown.

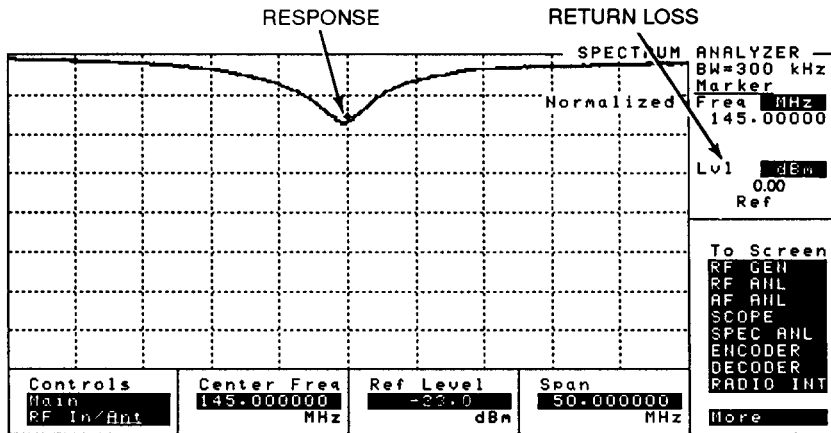

Calculate the Return Loss in VSWR:

24. Use the following chart to convert calculated return loss into VSWR:

Return Loss	VSWR
5.0 dB	3.6
10.0 dB	1.9
15.0 dB	1.4
20.0 dB	1.2
25.0 dB	1.12
30.0 dB	1.07

1/4 Wave Coaxial Filter Tuning (Swept)

This procedure is used to measure the notch depth and or band-pass of a 1/4 wave coaxial filter using the Spectrum Analyzer/Tracking Generator option. Pass frequency is measured, and can be adjusted by trimming length from the coaxial filter.

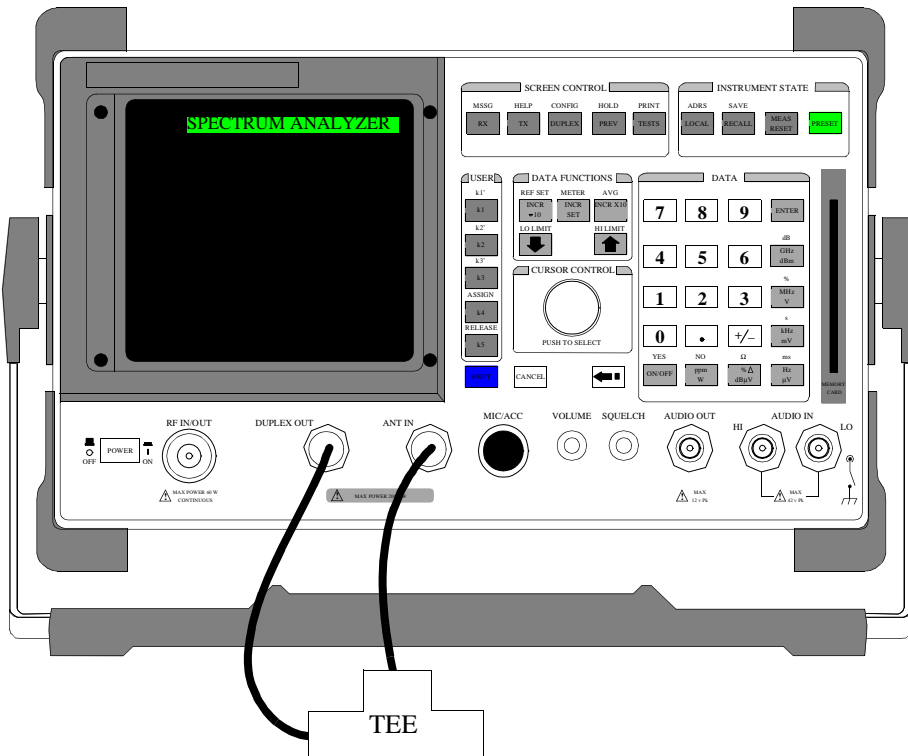

Test Set Options Required	Spectrum Analyzer/Tracking Generator (option 102)
Additional Equipment Required	Tee Adapter and Coax Stub

Measurement Procedure:

1. Connect the Tee as shown.

CAUTION:

Do not exceed the connector's rated input or permanent instrument damage may result.

On the Test Set:

2. Press the PRESET key.

Using the knob and data entry keys:

3. Select the **SPEC ANL** screen.
4. From the **Controls** select Ant.
5. Set **Center Freq** to the center frequency of the Coaxial Filter.

NOTE:

The 1/4 wave length at the desired frequency for the coax filter can be calculated using the following formula:

$$(1/f * 11811 * 10 * K/4)$$

Where: f = Frequency in MHz, 11811= Speed of light in inches, and K = Velocity Factor of coax.

6. Set **Span** to view desired spectrum.
7. From **Controls**, select **Main**.
8. Select **RF Gen** from the **Choices** field.
9. From **Controls** select Track.
10. Set **Amplitude** to 0 dBm.

NOTE:

Amplitude default of 0 dBm is typically sufficient for performing measurements on 1/4 Wave Coaxial Filters. The level can be changed as required to suit measurement needs (e.g. increase measurement range, minimize incident input from other sources, etc.). If **Amplitude** is changed, **Ref Level** will also have to be changed.

11. From the **Controls** select **RF Gen.**
 12. Select **Main** from the **Choices** field.
 13. Set **Ref Lvl** to place the signal close to the top graticule line.
Normalize (to remove the effects of the cables, bridge/coupler, etc.) as follows:
 14. From **Controls**, select **Main**.
 15. Select **Auxiliary** from the **Choices** field.
 16. From **Normalize** select **A Only**.
 17. From **Normalize** select **Save B**.
 18. From **Normalize** select **A-B**.
 19. From **Controls**, select **Auxiliary**.
 20. Select **Main** from the **Choices** field.
- Coax Stub:
21. Connect the stub as shown.

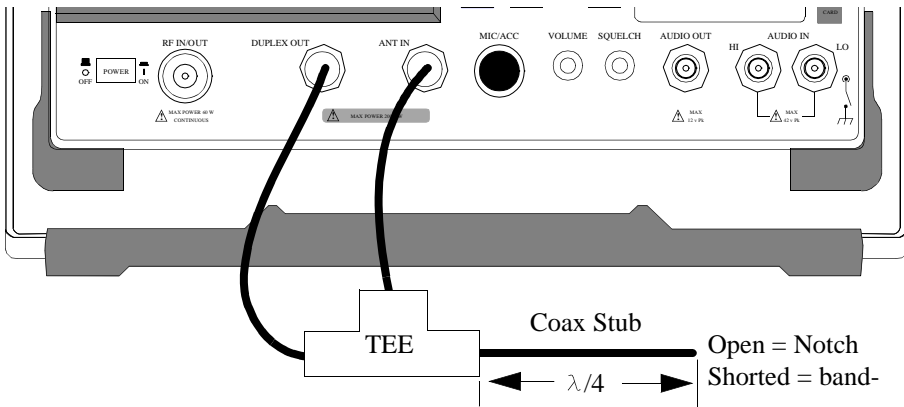

On the Test Set using the knob and data entry keys:

22. From **Controls**, select **Main**.
23. Select **Marker** from the **Choices** field.
24. Use the **Marker** position to measure the response.

Notch depth is displayed as **Lvl**.

Bandwidth (3 dB points) is measured using the **LVL** and **Freq** display.

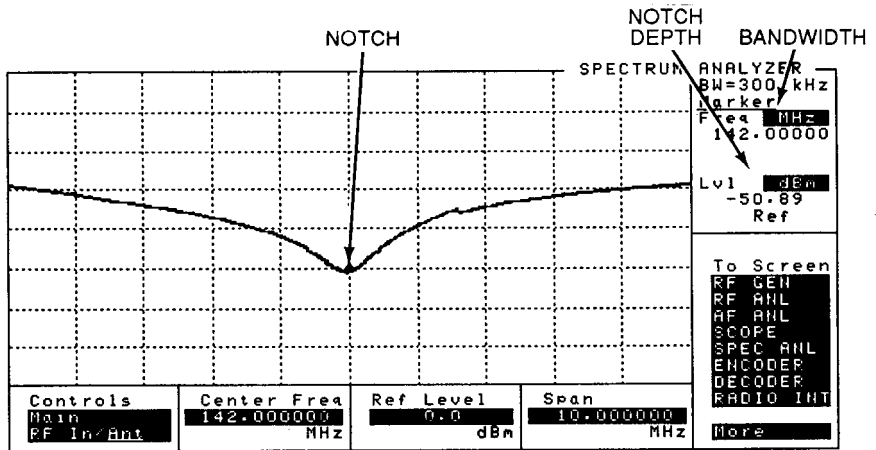

The notch or band-pass frequency can be changed by trimming the coaxial filter in small increments.

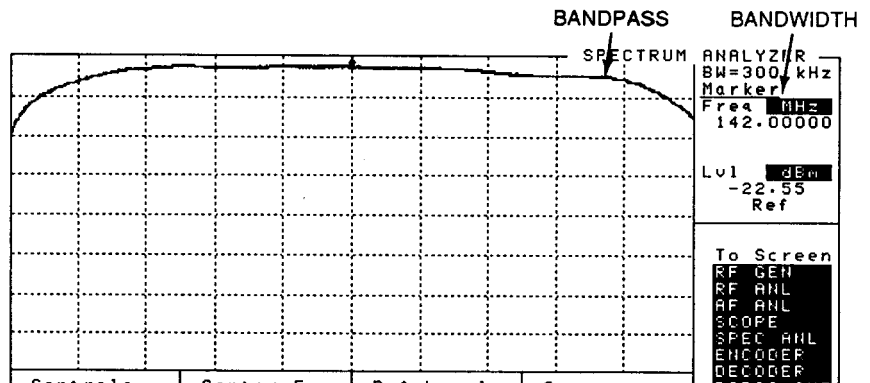

Cable Fault Locations

This procedure is used to locate breaks in coaxial cables using the Spectrum Analyzer/Tracking Generator option and System Support Software Test Card, HP 11807A option 100. Suspected faults are displayed as data (indicating the fault length) or plotted on the screen.

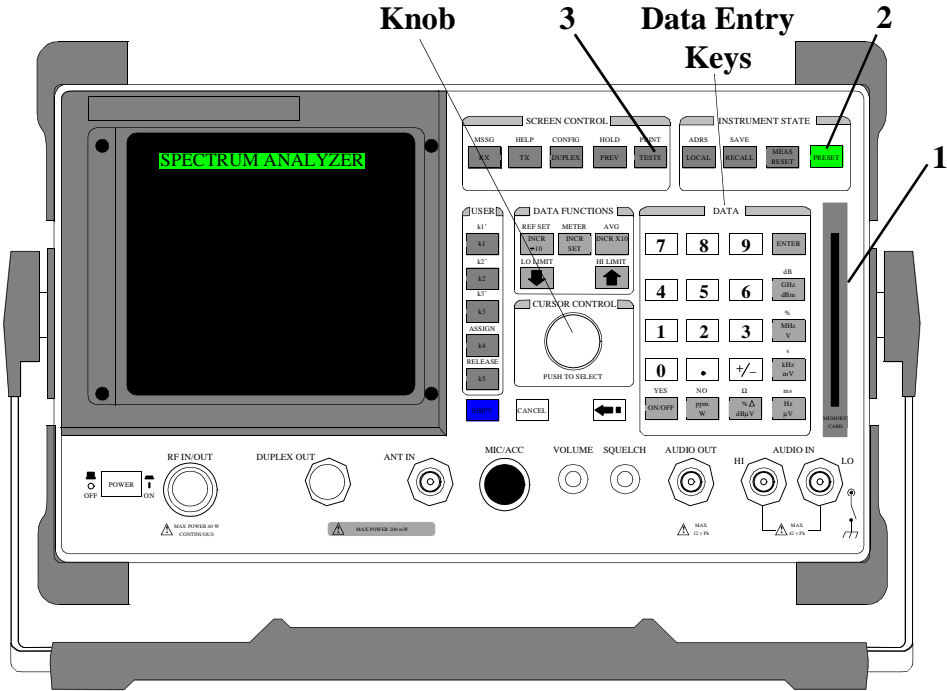

Test Set Options Required	Spectrum Analyzer/Tracking Generator (option 102)
Additional Equipment Required	HP 11807A Option 100, a Power Splitter/Combiner (HP 11636A), and a 50W Load.
Special Test Considerations	Cable fault must be within 1000 feet of the Test Set.

Measurement Procedure:

On the Test Set:

1. Insert the System Support Test Card (HP 11807A Option 100) into the Memory Card Slot.
2. Press the PRESET key.
3. Press the TESTS key.

Using the knob and data entry keys:

4. Select **Card** from the **Location** field.
5. Select **CABLE_FLT** from the **Procedure** field.
6. Select **Edit Parm** from the **Test Function** field.
7. Set cable length units to feet (0.000000) or meters (1.000000).
8. Enter cable type.
9. Enter length of cable under test (in feet or meters). Set this value to approximately 1.5 times the estimated maximum length.

10. Press the PREV key to return to the TEST (Main Screen).
11. Select **Run Test**.
12. When prompted, connect the equipment as shown on the screen, then select **Continue**.

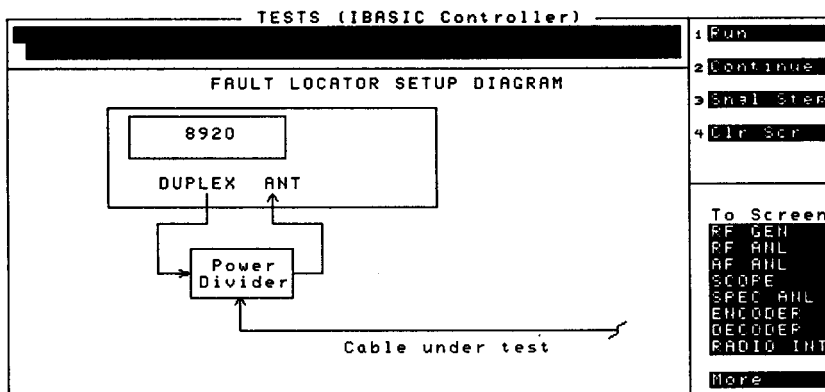

13. Follow the displayed instructions to connect and remove the 50 Ω Termination at the Power Divider cable test port. Remember to select **Continue** after each step.

After the test has completed, test results are displayed on the screen in a table form or plotted in graphical form.

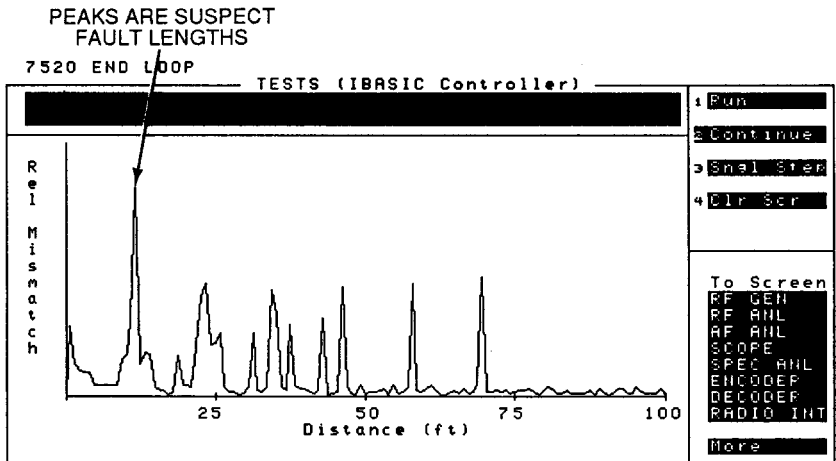
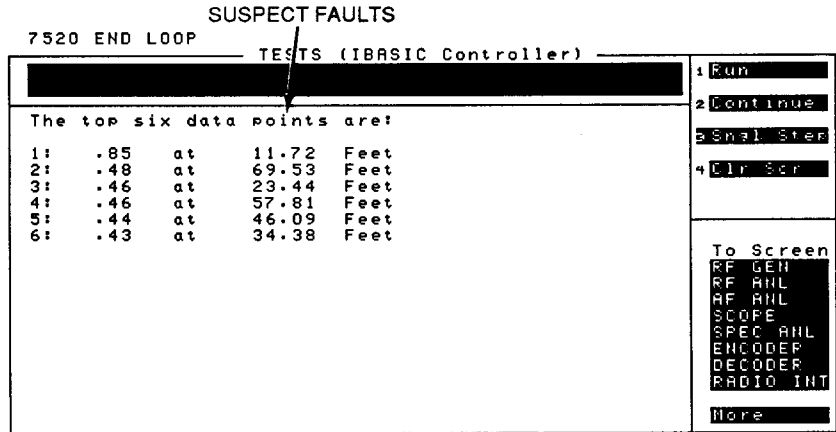

Passive Cavity Insertion and Return Loss Measurement

This procedure is used to measure the insertion loss and return loss of passive cavities using the Spectrum Analyzer/Tracking Generator option. The cavities are tuned to the desired pass frequency and band-pass/insertion loss. Once properly tuned, insertion loss and return loss are measured. Return loss can be converted into VSWR.

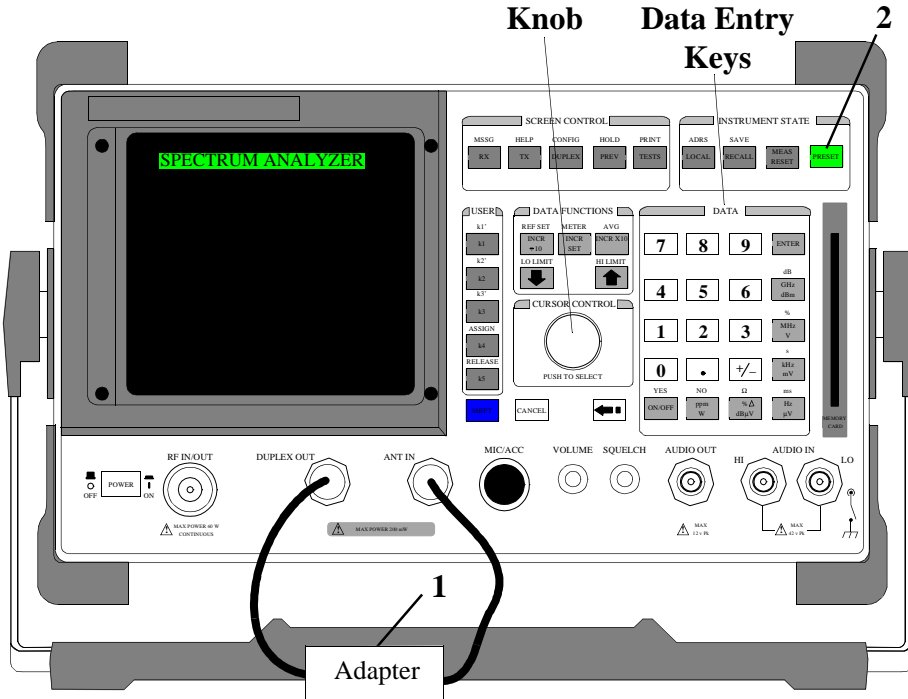

Test Set Options Required	Spectrum Analyzer/Tracking Generator (option 102)
Additional Equipment Required	Return Loss Bridge and a 50W Load.
Special Test Considerations	See " Coaxial Cable " on page 46.

Measurement Procedure:

1. Connect the Adapter as shown.

CAUTION:

Do not exceed the connector's rated input or permanent instrument damage may result.

On the Test Set:

2. Press the PRESET key.

Using the knob and data entry keys:

3. Select the **SPEC ANL** screen.
4. From the **Controls** select Ant.
5. Set **Center Freq** to the pass frequency of the cavity under test.
6. Set **Span** to view desired frequency range.
7. Set **Ref Level** to -10 dB (or greater).
8. From **Controls**, select **Main**.
9. Select **RF Gen** from the **Choices** field.
10. From **Controls** select Track.

NOTE:

Amplitude default of -10 dBm is typically sufficient for performing measurements on passive cavities, however higher levels may be needed to measure the cavity notch depth. The level can be changed to suit measurement needs (e.g. increase measurement range, minimize incident input from other sources, etc.). If **Amplitude** is changed, **Ref Level** will also have to be changed.

11. From the **Controls** select **RF Gen**.
12. Select **Auxiliary** from the **Choices** field.
13. From **Normalize** select **A Only**.
14. From **Normalize** select **Save B**.
15. From **Normalize** select **A-B**.
16. From **Controls**, select **Auxiliary**.

17. Select **Main** from the **Choices** field.

Pass Cavity:

18. Connect the pass cavity as shown.

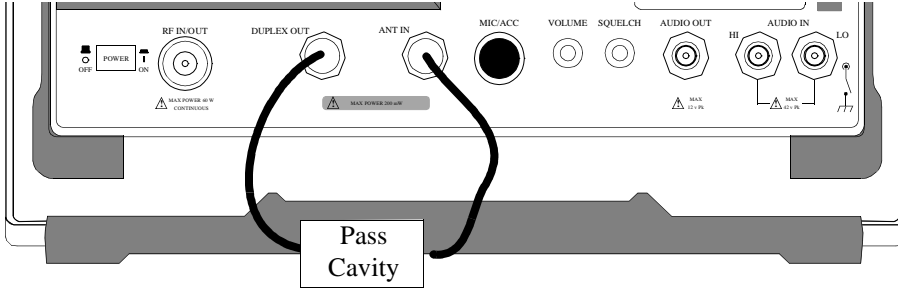

19. Adjust the tuning rod to the desired pass frequency.

20. Adjust the coupling loops for desired band-pass/insertion loss.

NOTE:

If **Sensitivity dB/div** is changed from 10 dB/div the coaxial cables must be shorten, and the previous steps performed on the **Auxiliary** screen must be repeated to re-normalize the display for the new setting.

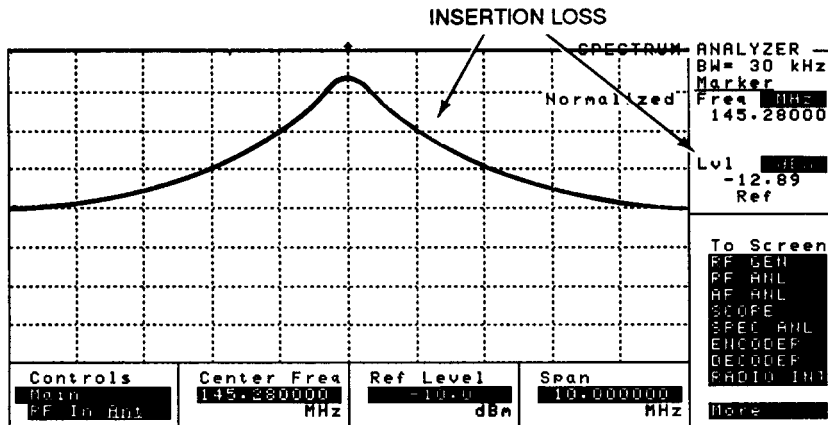

Return Loss Bridge:

21. Connect the Return Loss Bridge as shown.

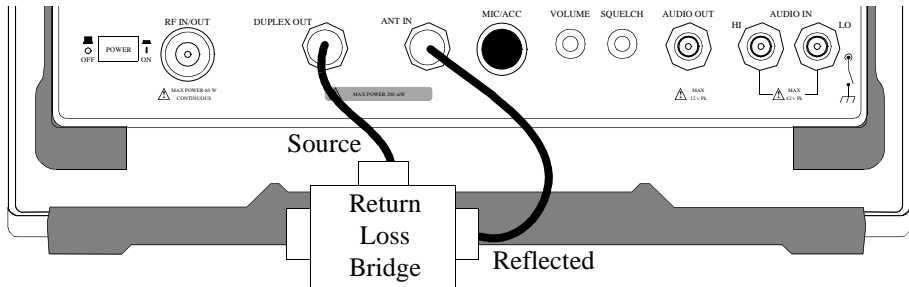

22. From the **Controls** select **Main**.

23. Select **Auxiliary** from the **Choices** field.

24. From **Normalize** select **A Only**.

25. From **Normalize** select **Save B**.

26. From **Normalize** select **A-B**.

27. From **Controls**, select **Auxiliary**.

28. Select **Main** from the **Choices** field.

Pass Cavity and 50 Ω Load:

29. Connect the Pass Cavity and 50Ω Load as show.

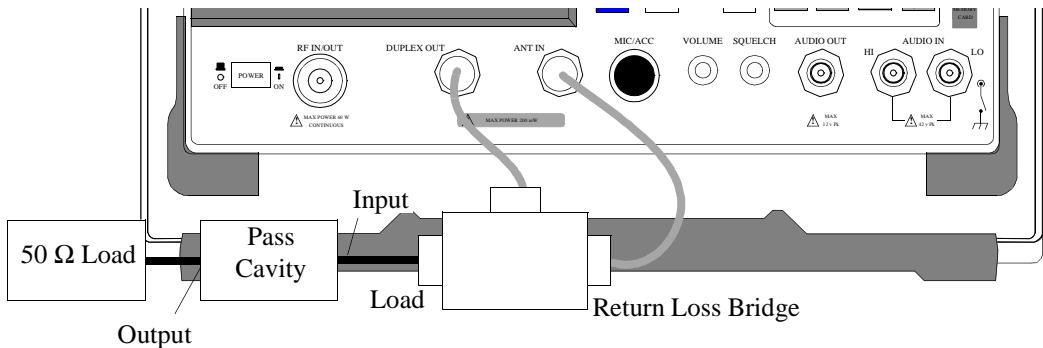

Measure/Adjust Return Loss as follows:

30. Measure and record return loss

31. Reverse the Pass Cavity output and input as shown.

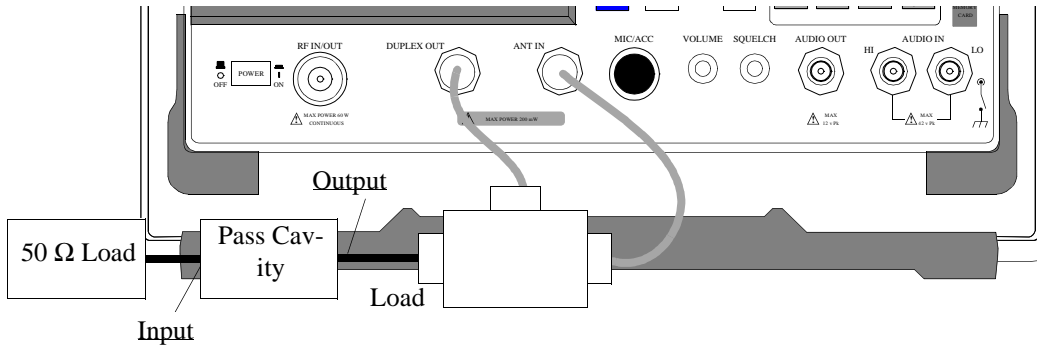

32. Measure and record return loss.

33. Repeat step while adjusting the Pass Cavity coupling loops for maximum (but balanced) return loss in both directions.

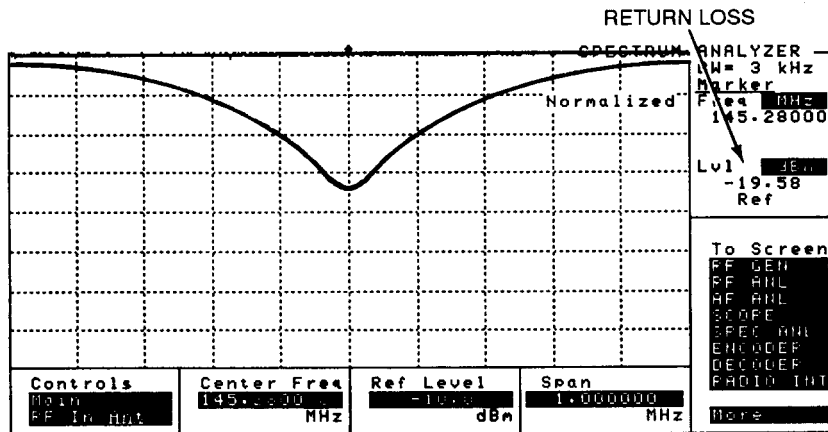

Calculate the Return Loss in VSWR:

34. Use the following chart to convert loss into VSWR:

Return Loss	VSWR
46.0 dB	1.0
26.4 dB	1.1
20.7 dB	1.2
17.7 dB	1.3
15.5 dB	1.4
14.0 dB	1.5
11.7 dB	1.7
9.5 dB	2.0
6.0 dB	3.0

If Pass Cavity coupling loops were changed:

- Repeat steps 1 through 20 to measure insertion loss (perform at 1 or 2 dB/Div).
- Repeat steps 21 through 33 to measure return loss.

Repeater System Effective Sensitivity Measurement

Description

This procedure is used to measure the effective sensitivity of a repeater system using the Spectrum Analyzer/Tracking Generator option. Once effective sensitivity measured, receiver sensitivity degradation is calculated.

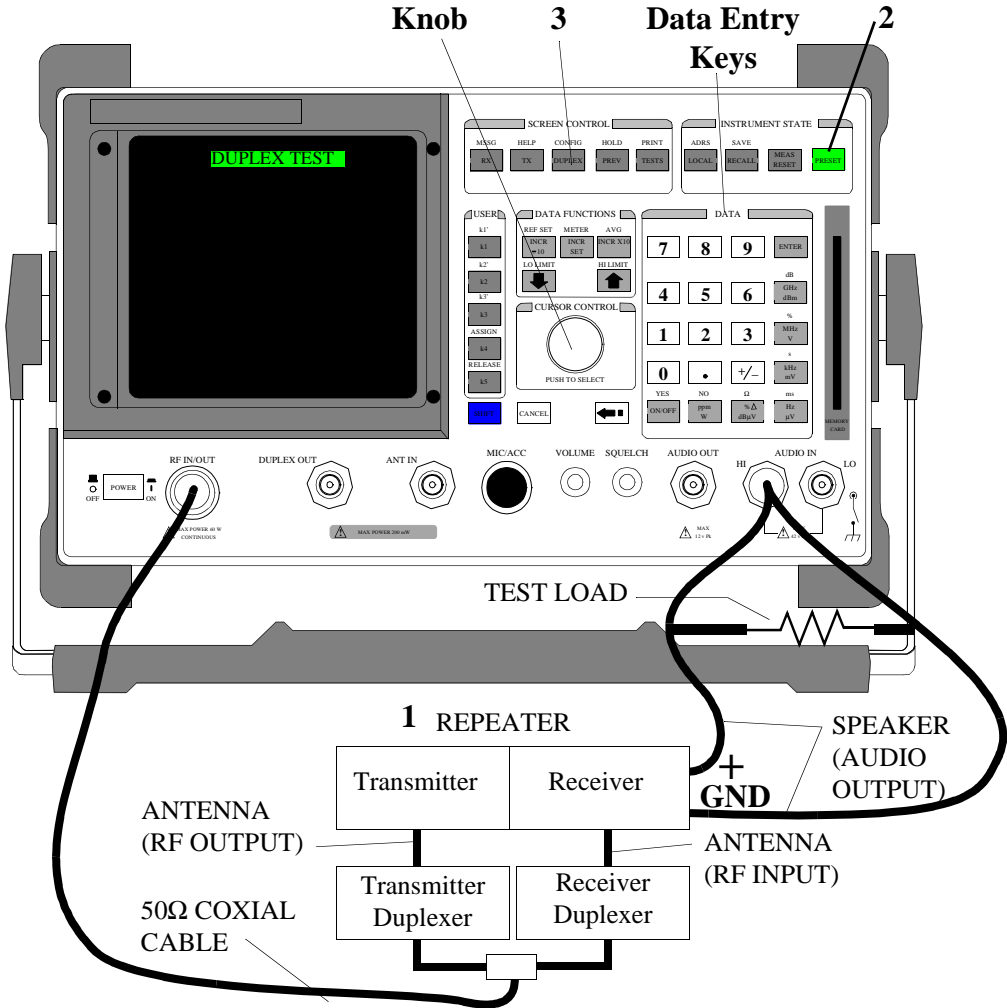

Additional Equipment Required	Test Load
Special Test Considerations	See " Receiver Test Loads " on page 46 and " Coaxial Cable " on page 46.

Measurement Procedure:

1. Connect the Repeater as shown.

**ALTERNATE
CONNECTIONS**

If your repeater does not employ a duplexer as shown in the connection diagram, connect the Test Set DUPLEX OUTPUT port to the Repeaters RF INPUT port, and the Test Set RF IN/OUT port to the Repeaters RF OUTPUT port.

On the Test Set:

2. Press the PRESET key.
3. Press the DUPLEX key.

Using the knob and data entry keys:

4. Set **Tune Freq** to the transmitter operating frequency.
5. Set **RF Gen Freq** to the receiver operating frequency.
6. Set **Amplitude** to -47 dBm (1 mV).
7. Set **AFGen1 To** 60% of the Receiver's specified maximum frequency deviation (typically 3 kHz).
8. Set **AC Level** meter to measure **Watts**.

NOTE:

If the test load resistance is not 8Ω , select the **AF ANL** screen and change **Ext Load R** to the correct test load resistance.

On the Repeater set the Receiver's Controls as follows:

9. Set power to ON.
10. If required, disable the COR (Carrier Operated Relay) or equivalent device that keys the transmitter when a signal is present at the receiver.
11. If required, set frequency to the same value as **step 5**.
12. Set squelch to minimum.
13. Set RF Gain to maximum (if equipped).
14. Set coded squelch feature (if equipped) to OFF.

Failure to set coded squelch to off will cause the SINAD measurement to be incorrect.

15. Slowly increase volume control until the AC Level reads 100% of the Receiver's rated audio output power.

Refer to audio output specifications for the Receiver being tested as required.

- If desired, use the meter averaging function for the SINAD indicator.
 - a. Select dB on the SINAD meter.
 - b. Press the AVG key.
 - If desired, select the number of readings to average.
 - Enter the number of readings to average.

Higher number of readings averaged will require longer to reach the final indication.

16. Key the Transmitter by enabling the COR or equivalent.

On the Test Set using the knob and data entry keys:

17. Increase **Amplitude** until the SINAD meter again reads 12 dB.

Effective Sensitivity is displayed as **Amplitude**.

Record the level (in dBm) for use later in the procedure.

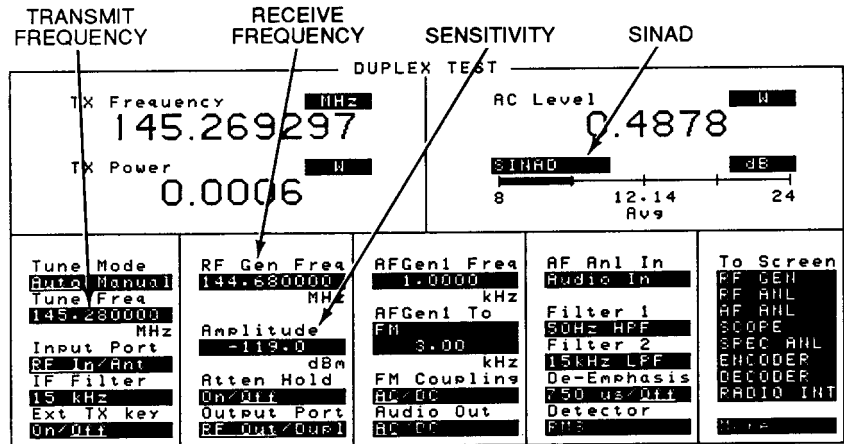

Calculate the Receiver Sensitivity Degradation:

18. Calculate as follows:

$$\text{Sensitivity Degradation} = \text{Step 5 Sensitivity} - \text{Step 7 Sensitivity}$$

For example, (-119 dBm) - (-114 dBm) = 5 dB

Oscilloscope Measurements

Introduction

Each procedure may contain the following information:

- A brief measurement overview and a reference to applicable TIA/EIA specifications for each test.
- A list of the Test Set options and additional test equipment required to perform the procedure.
- Any special test considerations that need to be considered for safety, measurement accuracy, etc.
- Step by step procedures required to perform each measurement (with illustrations).

Refer to "[Configuring for Measurements](#)" on page 241, or the Test Set's User Guide on preparing the Test Set for operation.

Using the Oscilloscope

The built-in 50 kHz digital oscilloscope provides

- multiple triggering formats (internal, external, and encoder)
- single-shot and pre-trigger viewing for single events
- full marker capability with automatic level and time readout

Time/division, volts/division, and vertical offset are displayed and can be changed using the front-panel knob.

Input to the Oscilloscope is provided from various sources, including direct inputs to the Audio Input and Modulation Input connectors. Oscilloscope functions are access from the **AF AL** and **OSCILLOSCOPE** screens.

Oscilloscope Overview

This procedure is provided as an overview of the Oscilloscope’s operation. The screen choices and displayed parameters are described and illustrated.

Measurement Procedure:

1. Connect the signal to the appropriate connector.

Table 1

Transmitter Under Test	Off the Air Transmission	Receiver Under Test	Passive Oscilloscope Probe
Connect Transmitter’s RF OUTPUT to Test Set’s RF IN/OUT	Connect an Antenna to Test Set’s ANT	Connect Receiver’s AUDIO OUTPUT to Test Set’s AUDIO IN (HI)	Connect the Probe to AUDIO IN (HI)

CAUTION: Do not exceed the connector’s rated input or permanent instrument damage may result.

On the Test Set:

2. Press the PRESET key.

Using the knob:

3. Select the **AF ANL** screen.
4. Based on the connection in step 1, select from the **AF Anl In** field’s list of choices the desired input to the Oscilloscope.
 - **FM Demod** for FM demodulated audio from input signals connected to the RF IN/OUT or ANT IN connectors.
 - **AM Demod** for AM demodulated audio from input signals connected to the RF IN/OUT or ANT IN connectors.
 - **SSB Demod** for SSB demodulated audio from input signals connected

- to the RF IN/OUT or ANT IN connectors.
- **Audio In** for a signal connected to the AUDIO IN connector.
 - **Radio Int** for a signal connected to the optional rear panel Radio Interface connector.
 - **Ext Mod** for a signal connected to the rear panel MODULATION INPUT connector.
 - **Mic Mod** for a signal connected to the MIC/ACC connector "MIC" pin.
 - **FM Mod** for the FM modulated audio from the RF Gen section.
 - **AM Mod** for the AM modulated audio from the RF Gen section.
 - **Audio Out** for the signal present at the AUDIO OUT connector
5. Select from the **Scope To** field's list of choices where in the AF Analyzer's circuitry the signal is routed to the Oscilloscope.

NOTE:

All choices except **Input** are capacitive coupled. Use **Input** if the signal being measured is $\leq 1\text{Hz}$.

- **Input** to route the audio to the Oscilloscope without being processed.
 - **Filters** to route the audio to the Oscilloscope after passing through Filters #1 and #2.
 - **De-emp** to route the audio to the Oscilloscope after passing through Filters #1 and #2, and the De-Emphasis circuitry.
 - **Notch** to route the audio to the Oscilloscope after passing through Filters #1 and #2, the De-Emphasis circuitry, and Notch circuitry.
6. Select the **SCOPE** screen.
7. Select the **CONTROLS** field.
8. Continue the measurement by selecting a control screen from the list of choices and referring to the following:
- [see "Measurements Using the Main Control Fields:" on page 236.](#)
 - [see "Measurement Using the Trigger Control Fields:" on page 237.](#)
 - [see "Measurements Using the Marker Control Fields:" on page 238.](#)

Measurements Using the Main Control Fields:

- **Vert/div** selects the vertical amplitude per division.
Units for this field are in Volts, kHz, or percent depending on the AF Anl In selection.
- **Vert Offset** moves the displayed signal above or below the center graticule line.
- **Time/div** selects the horizontal sweep time per division.

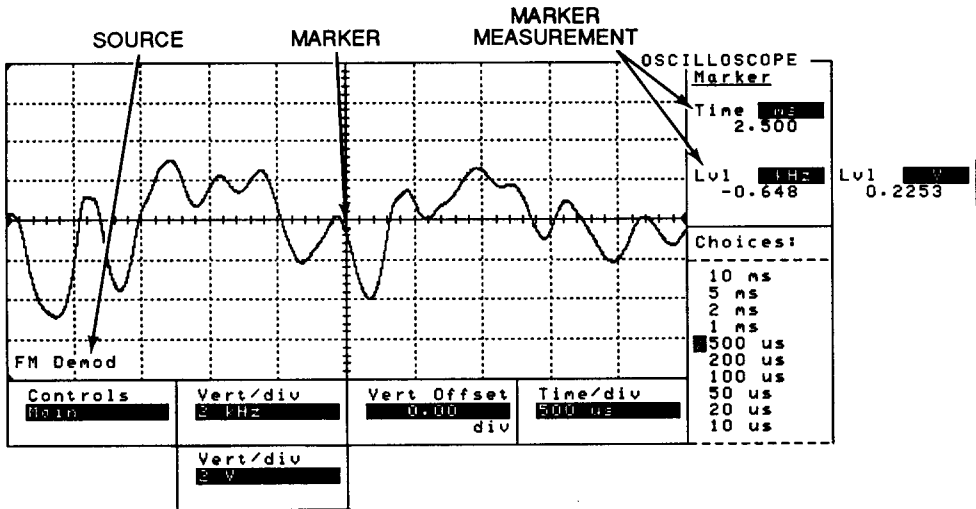

Indicators:

- Input source is displayed in the lower left corner of the display.
- Marker Time **ms** changes the units that the marker position is displayed in. Displayed value is the time elapsed from the trigger point to the current position.
- Marker Lvl **V/kHz/%** changes the units that the marker position is displayed in. Displayed value is the signal level at the current position.

Measurement Using the Trigger Control Fields:

- From **Controls** select the desired trigger source:
 - **Internal** uses the signal being displayed.
 - **Ext (TTL)** uses the signal connected to the rear panel EXT SCOPE TRIGGER INPUT connector.
 - **Encoder** uses the optional signaling encoder.
- Trigger mode is selected as follows:
 - In Auto, a trigger is automatically generated every 50ms (unless a normal trigger is received).
 - In Norm, a defined trigger required.
 - In Cont, the oscilloscope sweeps on each trigger occurrence.
 - In Single, the oscilloscope sweeps once on a trigger occurrence after Reset is selected.
- **Level (div)** sets the internal trigger level (vertical divisions). Pos selects triggering for positive going signals. Neg selects triggering for negative going signals. Pointer indicates level.
- **Pre-Trig** sets the number of horizontal divisions to be displayed prior to the trigger. Pointer indicates pre-trigger point.

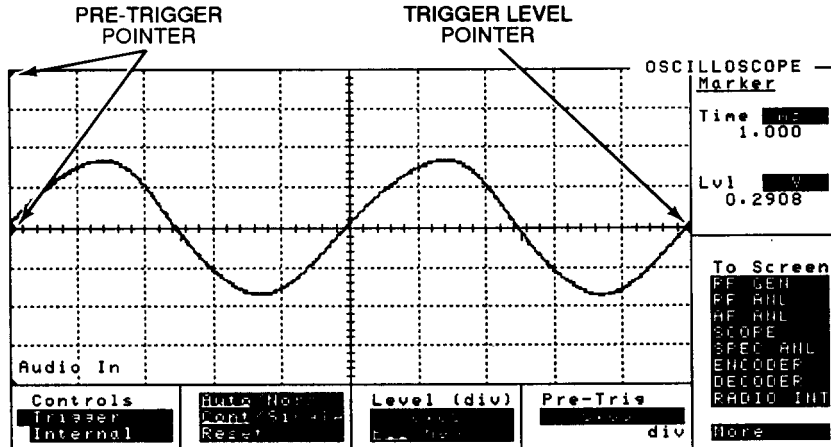
**Indicators:**

- Marker Time **ms** changes the units that the marker position is displayed in. Displayed value is the time elapsed from the trigger point to the current position.
- Marker Lvl **V/kHz/%** changes units that the marker position is displayed in. Displayed value is signal level at current position.

Measurements Using the Marker Control Fields:

- **Position** positions the marker on the screen. Displayed marker Time and Lvl are automatically updated.
- **Marker To** sets the marker to the signal with the largest Peak (Peak+) or the signal with the most negative peak (Peak-).

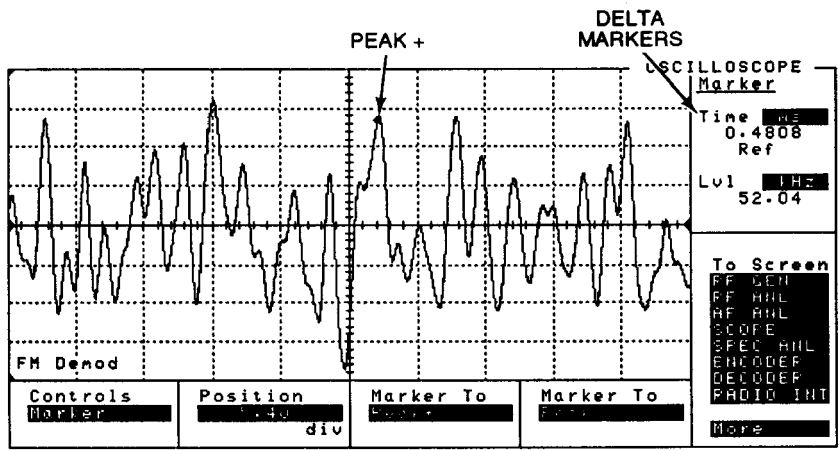

Indicators:

- Marker Time **ms** changes the units that the marker position is displayed in. Displayed value is the time elapsed from the trigger point to the current position.
- Marker Lvl **V/kHz/%** changes the units that the marker position is displayed in. Displayed value is the signal level at the current position.

The Delta marker function is performed by:

1. Setting the marker to the first point desired.
2. Position the cursor to the marker time and/or lvl readouts.
3. Press the REF SET key.

Note that the readout now displays 0 and “Ref” below it.

4. Position the cursor to the **Position** field.
5. Move the marker along the displayed response.

The marker readout now displays the delta from the set reference point.

To turn the reference set off:

- Press the REF SET key.
- Press the ON/OFF key.

Configuring for Measurements

This chapter provides the information to configure and connect the Test Set to DC power and configure the instrument for operation.

Preparing the Test Set for DC Operation

NOTE:

Instructions for connecting the Test Set to AC power, or to an optional printer (if desired) are provided in the Test Set's User Guide.

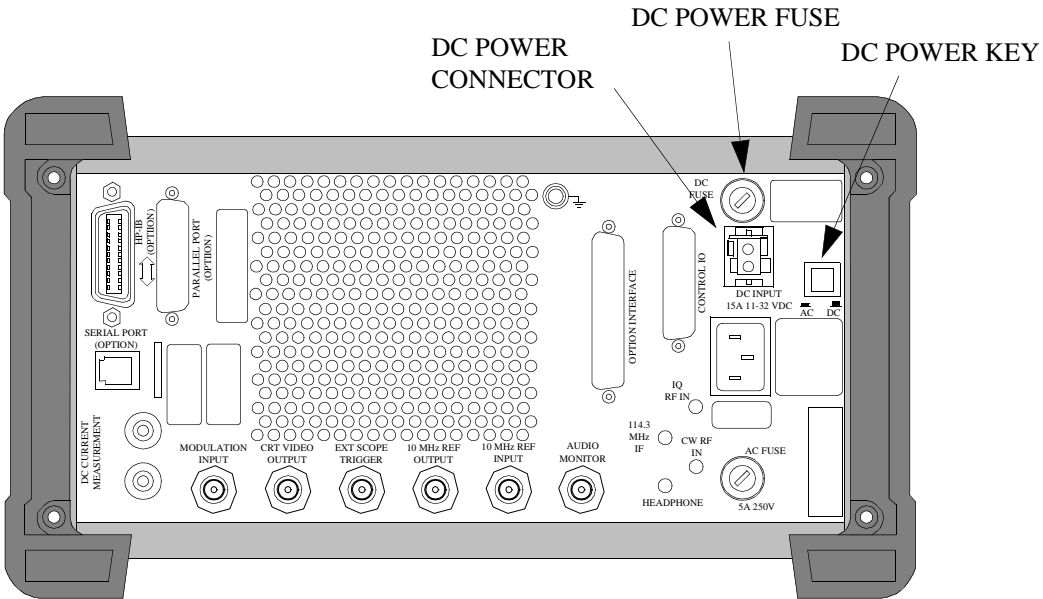

Connection/Configuration for DC Power

1. Verify that the front panel power switch is off.
2. Set the rear panel AC/DC switch to the DC position (out).
3. Connect the user supplied power cable (HP P/N 08920-61078) to the rear panel DC power connector. A DC connector is provided in the accessory kit (optional). Connect the other end to facility DC power (11-32 Vdc @ 15A).

***CABLING
RESTRICTIONS***

When cabling the DC connector, remember that varying wire gauge, type, and length will yield different resistive losses. Proper operation of the Test Set requires that a minimum of 11 Vdc @ 12 A be present at the DC input connector. A typical DC connection should consist of a cable made from 16 gauge stranded wire (20 feet in length maximum) with a power source of 13.8 Vdc @ 15A.

-
4. Turn the POWER ON (in). After approximately 15 seconds, verify that the CRT screen displays “All self tests passed” and that the “**RX TEST**” screen is displayed.

If correct, the instrument is ready for operation.

NOTE:

If DC power-up appears incorrect, turn OFF the POWER switch. Verify that DC fuse is not blown. Replace if required.

Replacing a fuse with a different type, size, or rating than supplied with the instrument can cause a fire hazard and/or electrical shock.

Preparing the Test Set for Operation

1. Verify that the instrument is connected and configured to the appropriate power source.

NOTE:

Because most parameters are saved when power is removed, setting configuration is NOT necessary every time power is applied to the Test Set. Perform these procedures only if changes to the fields are required.

2. Turn the Test Set POWER ON (in). After approximately 15 seconds, verify that the CRT screen displays “All self tests passed” and that the “RX TEST” screen is displayed.
3. Press the CONFIG key to display the CONFIGURE screen.

CONFIGURE				
RX/TX Cntl Auto/Manual	Intensity 8	RF Display Freq/Chan	RF Level Offset	Firmware B.01.01
Carrier/PTT	Beeper Quiet	RF Chan Std MS AMPS	On/Off	Total RAM 928 kB
RF Offset On/Off	Low Battery 10 min	User Def Base Freq	RF In/Out 0.0	Serial No. 2324R00136
(Gen)-(Anl) 0.000000	Date 120794	800.000000	Duplex Out 0.0	To Screen
MHz	MDDYY	MHz	Antenna In 0.0	RF GEN
RFGen Volts 50 ohm/ewf	Time 8.22	Chan Space 30.0000	dB	RF ANL
Range Hold Auto All	HH.MM	kHz	dB	RF ANL
4 Hold All		(Gen)-(Anl) 45.000000		SCOPE
State:Auto		MHz		SPEC ANL
Notch Coupl AFGen1/None				ENCODER
				DECODER
				RADIO INT
				SERVICE
				More

cnfgscrn.wmf

4. In the **CONFIGURE** screen, use the knob and data entry keys to set the following parameters (as required):
 - Intensity – adjust to comfortable level.
 - Beeper – adjust to comfortable level.
 - RFGen Volts – sets RF and Tracking Generator amplitudes reference for $50\ \Omega$ or an open circuit voltage.
 - Date – set if incorrect.
 - Time – set if incorrect.
5. Press the front panel PRESET key.
6. The Test Set is now ready for operation.

References

This chapter contains a listing of all documents that have been referenced in this manual.

Manuals

- HP 8920A User's Guide
- HP 8920B User's Guide
- HP 11807A Option 001 Reference Guide
- System Support Tests, HP 11807A Option 100 User's Guide

Application Note

- Demonstration Procedures, HP 8920A RF Communications Test Set

Specifications and Standards

- ANSI/EIA 152-C-1988 - Minimum Standards for Land Mobile Communication FM or PM Transmitters, 25-866 MHz.
- ANSI/EIA/TIA 204-D-1989 - Minimum Standards for Land Mobile Communication FM or PM Receivers, 25-866 MHz.
- EIA RS-382 - Minimum Standards Citizens Radio Service AM Transceivers Operating in the 27 MHz Band.

HP 8920A Specifications

Specifications describe the Test Set's warranted performance and are valid over the entire operating/environmental range unless otherwise noted.

Supplemental Characteristics are intended to provide additional information useful in applying the instrument by giving typical, but non-warranted performance parameters. These characteristics are shown in *italics* and are sometimes labeled "typical", "usable to", or "nominal".

Signal Generator Specifications

RF Frequency

Range: 250 kHz to 1 GHz

Accuracy and Stability: Same as reference oscillator ± 0.015 Hz

Switching Speed: <150 ms to within 100 Hz of carrier frequency

Resolution: 1 Hz

Output

RF IN/OUT Connector:

Standard:

Level Range: -137 to -19 dBm into 50Ω

Level Accuracy:

± 1.8 dB (level ≥ -127 dBm) (typical ± 1.0 dB for all levels)

Reverse Power:

60 W continuous

100 W for 10 seconds/minute

Option 007:

Level Range: -137 to -5 dBm into 50Ω

Reverse Power:

2.4 W continuous

4.0 W for 10 seconds/minute

Option 008:

Level Range: -137 to -9 dBm into 50Ω

Reverse Power:

6.0 W continuous

10 W for 10 seconds/minute

DUPLEX OUT Connector:

Level Range: -127 to $+7$ dBm into 50Ω

Level Accuracy: ± 1.5 dB (*typical ± 1.0 dB for all levels*)

Reverse Power: 200 mW maximum

SWR:

RF IN/OUT: $< 1.5:1$

DUPLEX OUT: $< 2.0:1$ (level < -4 dBm)

Resolution: 0.1 dB

Spectral Purity

Spurious Signals:

For ≤ 1 dBm output level at DUPLEX OUT or ≤ -25 dBm output level at RF IN/OUT:

Harmonics: < -30 dBc

Non-Harmonic Spurious: < -60 dBc (at > 5 kHz offset from carrier)

Residual FM (rms, CCITT):

Table 2

Frequency Range	HP 8920A Standard	HP 8920A Opt. 050 or HP8920D
$250 \text{ kHz} \leq f_c$ $< 249 \text{ MHz}$	$< 20 \text{ Hz}$	$< 7 \text{ Hz}$
$249 \text{ MHz} \leq f_c$ $< 501 \text{ MHz}$	$< 10 \text{ Hz}$	$< 4 \text{ Hz}$
$501 \text{ MHz} \leq f_c$ $\leq 1000 \text{ MHz}$	$< 20 \text{ Hz}$	$< 7 \text{ Hz}$

SSB Phase Noise:

Table 3

Offset (1 GHz carrier)	HP 8920A Standard	HP 8920A Opt.050 or HP 8920D
$> 20 \text{ kHz}$	$< -110 \text{ dBc/Hz}$	$< -116 \text{ dBc/Hz}$

FM

FM Deviation:

Rates >25 Hz

100 kHz: for f_c from 0.25 to < 249 MHz

50 kHz: for f_c from 249 to < 501 MHz

100 kHz: for f_c from 501 to 1000 MHz

FM not specified for (f_c minus FM dev.) <250 kHz

FM Rate:

1 kHz reference:

Internal: DC to 25 kHz (1 dB BW)

External, AC Coupled: 20 Hz to 75 kHz (*typical 3 dB BW*)

External, DC Coupled: dc to 75 kHz (*typical 3 dB BW*)

FM Accuracy:

≤10 kHz dev, 1 kHz rate:

±7.5% of setting ±50 Hz

±3.5% of setting ±50 Hz (with HP 8920A Option 050 or HP 8920D)

>10 kHz dev, 1 kHz rate:

±7.5% of setting ±500 Hz

±3.5% of setting ±500 Hz (with HP 8920A Option 050 or HP 8920D)

FM Distortion:

THD + Noise, 0.3 to 3 kHz BW:

<1.0% at >4 kHz deviation and 1 kHz rate

<0.5% at >4 kHz deviation and 1 kHz rate (HP 8920A Option 050 or HP 8920D)

Center Frequency Accuracy in DC FM Mode:

External source impedance <1 k Ω :

±500 Hz (after DCFM zero) (*typical ±50 Hz*)

Ext. Mod. Input Impedance: 600 Ω nominal

Resolution:

50 Hz for <10 kHz deviation

500 Hz for ≥10 kHz deviation

AM

Frequency Range: 1.5 to 1000 MHz (*usable to 250 kHz*)

AM Depth:

For RF IN/OUT levels ≤ -25 dBm or DUPLEX OUT levels $\leq +1$ dBm:

0 to 90% (*usable to 99%*)

0 to 70% (*usable to 99%*) (HP 8920A Option 050 or HP 8920D)

AM Rate: 20 Hz to 25 kHz (3 dB bandwidth)

AM Accuracy:

$\leq 10\%$ AM: $\pm 5\%$ of setting $\pm 1.0\%$ AM at 1 kHz rate

$> 10\%$ AM: $\pm 5\%$ of setting $\pm 1.5\%$ AM at 1 kHz rate

AM Distortion:

THD+Noise, 0.3 to 3 kHz BW:

$< 2\%$ at 1 kHz rate, $< 30\%$ AM

$< 3\%$ at 1 kHz rate, $\leq 90\%$ AM

Ext. Mod. Input Impedance: 600 Ω nominal

Residual AM: $< 0.1\%$ in a 50 Hz to 15 kHz BW

Resolution:

0.05% AM for 0 to 10% AM

0.5% AM for 10 to 100% AM

TDMA Signal Generator

(HP 8920D or 8920A with Option 050 and HP 83201A)

Frequency Range: 824 MHz to 894 MHz

Output Level Range:

RF In/Out: -22 dBm to -127 dBm

Duplex Out: +4 dBm to -127 dBm

Residual Error Vector Magnitude: <3.0%

Residual Phase Error: <2.6°

Residual Magnitude Error: <2.6%

IQ Origin Offset: <-30 dBc within 15°C of last calibration

Frequency Error: ±4 Hz plus reference

Audio Source Specifications

(These specifications apply to both internal sources)

Frequency

Range: dc to 25 kHz

Accuracy: 0.025% of setting

Resolution: 0.1 Hz

Output Level

Range: 0.1 mV to 4 Vrms

Maximum Output Current: 20 mA peak

Output Impedance: $<1\Omega$ (1 kHz)

Accuracy: $\pm 2\%$ of setting plus resolution

Residual Distortion: 0.125%; for tones 20 Hz to 25 kHz in an 80 kHz BW
(THD plus noise, amplitude >200 mVrms)

Resolution:

Level ≤ 0.01 V: ± 50 μ V

Level ≤ 0.1 V: ± 5 mV

Level ≤ 1 V: ± 5 mV

Level < 10 V: ± 50 mV

Offset in DC Coupled Mode: <50 mV

RF Analyzer Specifications

RF Power Measurement

Standard

Frequency Range: 400 kHz to 1 GHz

Measurement Range:

1 mW to 60 W continuous

100 W for 10 seconds/minute (measured at RF IN/OUT connector)

Accuracy: $\pm 10\%$ of reading ± 1 mW

SWR: $< 1.5:1$

Resolution:

Power < 10 W: 1 mW

Power ≥ 10 W: 10 mW

Option 007

Frequency Range: 400 kHz to 1 GHz

Measurement Range:

40 μ W to 2.4 W continuous

4.0 W for 10 seconds/minute

Accuracy: $\pm 10\%$ of reading ± 40 μ W

SWR: $< 1.5:1$

Resolution:

P < 400 mW: 40 μ W

P ≥ 400 mW: 400 μ W

Option 008

Frequency Range: 400 kHz to 1 GHz

Measurement Range:

0.1 mW to 6 W continuous

10 W for 10 seconds/minute

Accuracy: $\pm 10\%$ of reading ± 0.1 mW

SWR: $< 1.5:1$

Resolution:

P < 1 W: 0.1 mW

P ≥ 1 W: 1.0 mW

RF Frequency Measurement

Measurement Range: 400 kHz to 1 GHz

Level Range:

RF IN/OUT:

Standard:

1 mW to 60 W continuous

100 W for 10 seconds/minute

Option 007:

40 μ W to 2.4 W continuous

4.0 W for 10 seconds/minute

Option 008:

0.1 mW to 6 W continuous

10 W for 10 seconds/minute

ANT IN: -36 dBm to +20 dBm

Accuracy: ± 1 Hz plus timebase accuracy

Frequency Resolution: 1 Hz

FM Measurement

Frequency Range: 5 MHz to 1 GHz (*usable to 400 kHz*)

Deviation: 20 Hz to 75 kHz

Sensitivity: $2\mu\text{V}$ (15 kHz IF BW, High Sensitivity Mode, 0.3 to 3 kHz BW)
(*typical $<1\mu\text{V}$ (12 dB SINAD, $f_c \geq 10\text{ MHz}$)*)

Accuracy: $\pm 4\%$ of reading plus residual FM and noise contribution (20 Hz to 25 kHz rates, deviation $\leq 25\text{ kHz}$)

Bandwidth: 2 Hz to 70 kHz (3 dB) DCFM measurements also available

THD+Noise: $< 1\%$ for $\geq 5\text{ kHz}$ deviation and 1 kHz rate in a 0.3 to 3 kHz BW

Input Level Range for Specified Accuracy:

Standard:

-18 to +50 dBm at RF IN/OUT (0.016 mW to 100 W)

-50 to +14 dBm at ANT IN

Option 007:

-32 to 36 dBm at RF IN/OUT (0.63 μW to 4.0 W)

Option 008:

-28 to 40 dBm at RF IN/OUT (1.6 μW to 10 W)

Residual FM and Noise:

0.3 to 3 kHz, rms:

$< 20\text{ Hz}$

$< 7\text{ Hz}$ (HP 8920A Option 050 or HP 8920D)

Resolution:

$f < 10\text{ kHz}$: 1 Hz

$f \geq 10\text{ kHz}$: 10 Hz

AM Measurement

Frequency Range: 10 MHz to 1 GHz (*usable to 400 kHz*)

Depth: 0 to 95%

Accuracy: $\pm 5\%$ of reading $\pm 1.5\%$ AM (50 Hz to 10 kHz rates, modulation $\leq 80\%$)

THD+Noise: $< 2\%$ rms for modulation $\leq 80\%$ AM (1 kHz rate in a 0.3 to 3 kHz BW)

Input Level for Specified Accuracy (levels in PEP):

Standard:

–18 to +50 dBm at RF IN/OUT (0.016 mW to 100 W)

–50 to +14 dBm at ANT IN

Option 007:

–32 to 36 dBm at RF IN/OUT (0.63 μ W to 4.0 W)

Option 008:

–28 to 40 dBm at RF IN/OUT (1.6 μ W to 10 W)

Residual AM: $< 0.2\%$ in a 0.3 to 3 kHz BW

Resolution: 0.1%

SSB Measurement

Frequency Range: 400 kHz to 1 GHz

Bandwidth (3 dB): 20 Hz to 70 kHz

Distortion and Noise: <3% at 1 kHz rate in a 0.3 to 3 kHz BW

TDMA Analyzer

(HP 8920D or 8920A with Option 050 and HP 83201A)

Frequency Range: 824 MHz to 894 MHz

Input Level Range:

RF In/Out: 1 mW to 60W (0 to +47.8 dBm)

Antenna: -36 to +17 dBm

Input Frequency Setting Error: 1 kHz

RX DSP Level Setting Range: -23 to 0 dB full scale

Residual Error Vector Magnitude: <1.3%

Error Vector Magnitude Measurement Accuracy: $\pm 0.4\%$ plus 2% of reading

Residual Phase Error: $<1.0^\circ$

Residual Magnitude Error: $<0.9\%$

I/Q Origin Offset Accuracy: ± 0.5 dB for values to -40 dBc

Frequency Error Accuracy: ± 2.5 Hz plus timebase accuracy

AF Analyzer Specifications

Frequency Measurement

Measurement Range: 20 Hz to 400 kHz

Accuracy: $\pm 0.02\%$ plus resolution plus timebase accuracy

External Input: 20 mV to 30 Vrms

Resolution:

$f < 10$ kHz: 0.01 Hz

$f < 100$ kHz: 0.1 Hz

$f \geq 100$ kHz: 1 Hz

AC Voltage Measurement

Measurement Range: 0 to 30 Vrms

Accuracy: $\pm 3\%$ of reading (20 Hz to 15 kHz, inputs ≥ 1 mV)

Residual Noise: 150 μ V (15 kHz BW)

3 dB Bandwidth: Typically 2 Hz to 100 kHz

Nominal Input Impedance: switchable between 1 M Ω in parallel with 95 pF, and 600 Ω floating

Resolution:

4 digits for inputs ≥ 100 mV

3 digits for inputs < 100 mV

DC Voltage Measurement

Voltage Range: 100 mV to 42 V

Accuracy: $\pm 1.0\%$ of reading plus DC offset

DC Offset: ± 45 mV

Resolution: 1 mV

Distortion Measurement

Fundamental Frequency: 1 kHz \pm 5 Hz

Optional Frequency Range: 300 Hz to 10 kHz \pm 5% (Option 019)

Input Level Range: 30 mV to 30 Vrms

Display Range: 0.1% to 100%

Accuracy:

\pm 1 dB (0.5 to 100% distortion) for tones from 300 to 1500 Hz measured with the 15 kHz LPF

\pm 1.5 dB (1.5 to 100% distortion) for tones from 300 Hz to 10 kHz measured with the >99 kHz LPF

Residual THD+Noise:

-60 dBc or 150 μ V, whichever is greater, for tones from 300 to 1500 Hz measured with the 15 kHz LPF

-57 dBc or 450 μ V, whichever is greater, for tones from 300 Hz to 10 kHz measured with the >99 kHz LPF

Resolution: 0.1% Distortion

SINAD Measurement

Fundamental Frequency: 1 kHz \pm 5 Hz

Optional Frequency Range: 300 Hz to 10 kHz \pm 5% (Option 019)

Input Level Range: 30 mV to 30 Vrms

Display Range: 0 to 60 dB

Accuracy:

\pm 1 dB (0 to 46 dB SINAD) for tones from 300 to 1500 Hz measured with the 15 kHz LPF

\pm 1.5 dB (0 to 36 dB SINAD) for tones from 300 Hz to 10 kHz measured with the >99 kHz LPF

Residual THD+Noise:

-60 dB or 150 μ V, whichever is greater, for tones from 300 to 1500 Hz measured with the 15 kHz LPF

-57 dBc or 450 μ V, whichever is greater, for tones from 300 Hz to 10 kHz measured with the >99 kHz LPF

Resolution: 0.01 dB

Audio Filters

Standard

- < 20 Hz HPF
- 50 Hz HPF
- 300 Hz HPF
- 300 Hz LPF
- 3 kHz LPF
- 15 kHz LPF
- > 99 kHz LPF
- 750 μ de-emphasis
- 1 kHz notch

Optional

- C-Message
- CCITT
- 400 Hz HPF
- 4 kHz BPF
- 6 kHz BPF
- 300 Hz to 10 kHz (variable, option 019)

Audio Detectors:

RMS, RMS*SQRT2, Pk+, Pk-, Pk+hold, Pk-hold, Pk \pm /2, Pk \pm /2 hold, Pk \pm max, Pk \pm maxhold

Oscilloscope Specifications

Frequency Range: 2 Hz to 50 kHz (3 dB BW)

Scale/Division: 10 mV to 10 V

Amplitude Accuracy: $\pm 1.5\%$ of reading ± 0.1 division. (20 Hz to 10 kHz)

Time/Division: 1 μ sec to 200 msec

3 dB Bandwidth: Typically >100 kHz

Internal DC Offset: ≤ 0.1 div (≥ 50 μ V/div sensitivity)

Spectrum Analyzer Specifications (Option 102)

Frequency

Frequency Range: 400 kHz to 1 GHz

Frequency Span/Resolution Bandwidth (coupled):

Table 4

Span	Bandwidth
< 50 kHz	300 Hz
< 200 kHz	1 kHz
< 1.5 MHz	3 kHz
< 18 MHz	30 kHz
≥ 18 MHz	300 kHz
Full span	

Display: Log with 10 dB/div, 2 dB/div, or 1 dB/div

Display Range: 80 dB

Reference Level Range: +50 to -50 dBm

Residual Responses: <-70 dBm (no input signal, 0 dB attenuation)

Image Rejection: >50 dB

Non-harmonic Spurious Responses: >70 dB (for input signals ≤ -30 dBm)

Level Accuracy: ±2.5 dB

Displayed Average Noise Level: <-114 dBm for ≤ 50 kHz spans

Log Scale Linearity: ±2 dB (for input levels ≤ -30 dBm or 60 dB range)

Tracking Generator

(Included with Option 102)

Frequency Range: 400 kHz to 1 GHz

Frequency Offset: Frequency span endpoints \pm frequency offset cannot be < 400 kHz or ≥ 1 GHz

Output Level Range: Same as signal generator

Sweep Modes: Normal and inverted

Adjacent Channel Power

(Included with Option 102)

Relative Measurements:

Level Range:

Antenna In: -40 dBm to +20 dBm

RF/Input: 0.16 mW (-8 dBm) to 60 W (47.8 dBm) continuous; or up to 100 mW (50 dBm) for 10 seconds/minute

Dynamic Range: Typical values for channel offsets

Table 5

Channel Offset	Resolution Bandwidth	Dynamic Range
12.5 kHz	8.5 kHz	- 65 dBc
20 kHz	14 kHz	- 68 dBc
25 kHz	16 kHz	- 68 dBc
30 kHz	16 kHz	- 68 dBc
60 kHz	30 kHz	- 65 dBc

Relative Accuracy: ± 2.0 dB

Absolute Level Measurements:

Level: Results of absolute power in Watts or dBm are met by adding the ACP ratio from the spectrum analyzer to the carrier power from the input section RF power detector.

Level Range:

Antenna: Not applicable

RF/Input: 1 mW (0 dBm) to 60 W (47.8 dBm) continuous; or up to 100 W

(50 dBm) for 10 seconds/minute

Dynamic Range: Typical values for channel offsets

Table 6

Channel Offset	Resolution Bandwidth	Dynamic Range
<i>12.5 kHz</i>	<i>8.5 kHz</i>	<i>- 65 dBc</i>
<i>20 kHz</i>	<i>14 kHz</i>	<i>- 68 dBc</i>
<i>25 kHz</i>	<i>16 kHz</i>	<i>- 68 dBc</i>
<i>30 kHz</i>	<i>16 kHz</i>	<i>- 68 dBc</i>
<i>60 kHz</i>	<i>30 kHz</i>	<i>- 65 dBc</i>

Absolute Accuracy: RF power measurement accuracy for absolute in-channel power: (for inputs > 200 mW): $\pm 10\%$ of reading ± 1 mW (in dB) plus ACP relative accuracy of ± 2.0 dB

Signaling (Option 004)

Capability for generating and analyzing the following formats:

CDCSS, DTMF, 1 TONE, 2 TONE, 5/6 TONE SEQUENTIAL, RPC1, POCSAG, EIA, CCITT, CCIR, ZVEI, DZVEI, GOLAY, EEA, AMPS/EAMPS/NAMPS, TACS/ETACS, JTACS/NTACS, NMT-450, NMT-900, LTR^{®1}, EDACS[™], MPT 1327, and TDMA dual-mode

LTR[®] is a registered trademark of the E. F. Johnson Company;
EDACS[™] is a trademark of Ericsson/GE.

¹ over 15° to 35°C for analyzing

A General Purpose Function Generator with the following waveforms is included: sine, square, triangle, ramp, dc, Gaussian white noise, uniform white noise.

Frequency Range and Level: Same as audio source

DC Current Meter (Option 103)

Measurement Range: 0 to 10 A (*usable to 20 A*)

Accuracy: The greater of 10% of reading after zeroing or 30 mA (levels > 100 mA)

Remote Programming (Option 103)

HP-IB: Hewlett-Packard's implementation of IEEE Standard 488.2

Functions Implemented: SH1, AH1, T6, L4, SR1, RL1, LE0, TE0, PP0, DC1, DT1, C4, C11, E2

RS-232: Six-wire RJ-11 connector provides two three-wire serial ports for serial data in and out (no hardware handshake capability).

Baud Rates: 150, 300, 600, 1200, 2400, 4800, 9600, and 19200 Hz

Parallel (Centronics) connector: A standard 25-pin, sub-min D female connector with right-angle adapter is included. NOTE: Retrofittable only for HP 8920A units with serial number prefix of 3501 and greater.

Reference Oscillator Specifications

TCXO (Standard)

Temperature: 1 ppm (0 to +55°C)

Aging: < 2 ppm/year

Warm-up Time: < 30 seconds to be within ± 2 ppm of final frequency

OCXO (Option 001)

Temperature: 0.05 ppm (0 to +55°C)

Aging: < 0.5 ppm/year (< 1 ppm in first year)

Warm-up Time: < 15 minutes to be within ± 0.1 ppm of final frequency

Rear Panel BNC connectors:

Input Frequency: 1,2,5,10 MHz

Input Level¹: > 0.15 Vrms

Output Frequency: 10 MHz

Output Level: > 0.5 Vrms

-
1. Electrostatic Discharges to the 10 MHz Ref Input port of 0.5 kV or above may cause degradation of performance, requiring operator intervention.

Save/Recall Registers

Approximately 128 kilobytes RAM available for non-volatile save/recall of settings. This typically will allow you to save >100 sets of instrument settings, depending on the type of information saved. Additional save/recall storage memory can be added by ordering Option 005.

General Specifications

Size: 7.5 H x 13 W x 19 inches (188 H x 330 W x 456 D mm)

Weight: 35 lbs (17.1 kg) fully optioned

CRT Size: 7 x 10 cm

Operating Temperature: 0 to +55°C

Storage Temperature: -55 to +75°C

Power:

AC: 100 to 240 V, 48 to 440 Hz, *nominally 80 watts*

DC: 11 to 28 V, *nominally 120 watts*

Leakage: At Signal Generator output frequency and level <-40 dBm, typical leakage is <0.5 μ V induced in a resonant dipole antenna 1 inch from any surface except the rear panel. This corresponds to approximately 0.05 μ V when measured with a 25-mm, two-turn loop. Spurious leakage levels are typically < 1 μ V in a resonant dipole antenna.

HP 8920B Specifications

Specifications describe the Test Set's warranted performance and are valid over the entire operating/environmental range unless otherwise noted.

Supplemental Characteristics are intended to provide additional information useful in applying the instrument by giving typical, but non-warranted performance parameters. These characteristics are shown in *italics* and are sometimes labeled “typical”, “usable to”, or “nominal”.

Signal Generator Specifications

RF Frequency

Range: 250 kHz to 1 GHz

Accuracy and Stability: Same as reference oscillator ± 0.015 Hz

Switching Speed: <150 ms to within 100 Hz of carrier frequency

Resolution: 1 Hz

Output

RF IN/OUT Connector:

Standard:

Level Range: -137 to -19 dBm into 50Ω

Level Accuracy:

± 1.2 dB (level ≥ -127 dBm) (*typical ± 1.0 dB for all levels*)

Reverse Power:

60 W continuous

100 W for 10 seconds/minute

Option 007:

Level Range: -137 to -5 dBm into 50Ω

Reverse Power:

2.4 W continuous

4.0 W for 10 seconds/minute

DUPLEX OUT Connector:

Level Range: -127 to $+7$ dBm into 50Ω

Level Accuracy: ± 1.0 dB

Reverse Power: 200 mW maximum

SWR:

RF IN/OUT: $< 1.5:1$

DUPLEX OUT: $< 2.0:1$ (level < -4 dBm)

Resolution: 0.1 dB

Spectral Purity

Spurious Signals:

For ≤ 1 dBm output level at DUPLEX OUT or ≤ -25 dBm output level at RF IN/OUT:

Harmonics: < -30 dBc

Non-Harmonic Spurious: < -60 dBc (at > 5 kHz offset from carrier)

Residual FM (rms, CCITT):

< 7 Hz for $250 \text{ kHz} \leq f_c < 249 \text{ MHz}$

< 4 Hz for $249 \text{ MHz} \leq f_c < 501 \text{ MHz}$

< 7 Hz for $501 \text{ MHz} \leq f_c \leq 1000 \text{ MHz}$

SSB Phase Noise:

$> 20 \text{ kHz Offset (1 GHz carrier): } < -116 \text{ dBc/Hz}$

FM

FM Deviation:

Rates >25 Hz

100 kHz: for f_c from 0.25 to < 249 MHz

50 kHz: for f_c from 249 to < 501 MHz

100 kHz: for f_c from 501 to 1000 MHz

FM not specified for (f_c minus FM dev.) <250 kHz

FM Rate:

1 kHz reference:

Internal: DC to 25 kHz (1 dB BW)

External, AC Coupled: 20 Hz to 75 kHz (*typical 3 dB BW*)

External, DC Coupled: dc to 75 kHz (*typical 3 dB BW*)

FM Accuracy:

≤10 kHz dev, 1 kHz rate:

±3.5% of setting ±50 Hz

>10 kHz dev, 1 kHz rate:

±3.5% of setting ±500 Hz

FM Distortion:

THD + Noise, 0.3 to 3 kHz BW:

<0.5% at >4 kHz deviation and 1 kHz rate

Center Frequency Accuracy in DC FM Mode:

External source impedance <1 k Ω

±500 Hz (after DCFM zero) (*typical ±50 Hz*)

Ext. Mod. Input Impedance: 600 Ω nominal

Resolution:

50 Hz for <10 kHz deviation

500 Hz for ≥10 kHz deviation

AM

Frequency Range: 1.5 to 1000 MHz (*usable to 250 kHz*)

AM Depth:

For RF IN/OUT levels ≤ -25 dBm or DUPLEX OUT levels $\leq +1$ dBm:

0 to 90% (*usable to 99%*)

0 to 70% (*usable to 99%*) (HP 8920B Option 051)

AM Rate: 20 Hz to 25 kHz (3 dB bandwidth)

AM Accuracy:

$\leq 10\%$ AM: $\pm 5\%$ of setting $\pm 1.0\%$ AM at 1 kHz rate

$> 10\%$ AM: $\pm 5\%$ of setting $\pm 1.5\%$ AM at 1 kHz rate

AM Distortion:

THD+Noise, 0.3 to 3 kHz BW:

$< 2\%$ at 1 kHz rate, $< 30\%$ AM

$< 3\%$ at 1 kHz rate, $\leq 90\%$ AM

Ext. Mod. Input Impedance: 600 Ω nominal

Residual AM: $< 0.1\%$ in a 50 Hz to 15 kHz BW

Resolution:

0.05% AM for 0 to 10% AM

0.5% AM for 10 to 100% AM

TDMA Signal Generator

HP 8920B Option 500 (includes HP 83201B)

Frequency Range: 824 MHz to 894 MHz

Output Level Range:

RF In/Out: -22 to -127 dBm

Duplex Out: +4 to -127 dBm

Residual Error Vector Magnitude: % < 3.0%

Residual Phase Error: < 2.6°

Residual Magnitude Error: < 2.6%

IQ Origin Offset: < -30dBc within 15°C of last calibration

Frequency Error: ±4 Hz plus reference error

Audio Source Specifications

(These specifications apply to both internal sources)

Frequency

Range: dc to 25 kHz

Accuracy: 0.025% of setting

Resolution: 0.1 Hz

Output Level

Range: 0.1 mV to 4 Vrms

Maximum Output Current: 20 mA peak

Output Impedance: $<1 \Omega$ (1 kHz)

Accuracy: $\pm 2\%$ of setting plus resolution

Residual Distortion: 0.125%; for tones 20 Hz to 25 kHz in an 80 kHz BW
(THD plus noise, amplitude >200 mVrms)

Resolution:

Level ≤ 0.01 V: $\pm 50 \mu\text{V}$

Level ≤ 0.1 V: ± 5 mV

Level ≤ 1 V: ± 5 mV

Level < 10 V: ± 50 mV

Offset in DC Coupled Mode: <50 mV

RF Analyzer Specifications

RF Power Measurement¹

Standard

Frequency Range: 400 kHz to 1 GHz

Measurement Range:

1 mW to 60 W continuous

100 W for 10 seconds/minute (measured at RF IN/OUT connector)

Accuracy: $\pm 5\%$ of reading ± 0.01 mW (for temp $25^\circ\text{C} \pm 10^\circ\text{C}$)

Accuracy: $\pm 10\%$ of reading for operating temperature range.

SWR: $< 1.5:1$

Resolution:

Power < 10 W: 1 mW

Power ≥ 10 W: 10 mW

Option 007

Frequency Range: 400 kHz to 1 GHz

Measurement Range:

40 μW to 2.4 W continuous

4.0 W for 10 seconds/minute

Accuracy: $\pm 5\%$ of reading ± 400 nW (for temp $25^\circ\text{C} \pm 10^\circ\text{C}$)

SWR: $< 1.5:1$

Resolution:

$P < 400$ mW: 40 μW

$P \geq 400$ mW: 400 μW

-
1. To achieve the specified accuracy when measuring power at the RF IN/OUT port, the internal signal generator level must be 60 dB below the measured power or less than -20 dBm at the DUPLEX port.

RF Frequency Measurement

Measurement Range: 400 kHz to 1 GHz

Level Range:

RF IN/OUT:

Standard:

1 mW to 60 W continuous

100 W for 10 seconds/minute

Option 007:

40 μ W to 2.4 W continuous

4.0 W for 10 seconds/minute

ANT IN: -36 dBm to +20 dBm

Accuracy: ± 1 Hz plus timebase accuracy

Frequency Resolution: 1 Hz

FM Measurement

Frequency Range: 5 MHz to 1 GHz (*usable to 400 kHz*)

Deviation: 20 Hz to 75 kHz

Sensitivity: 2 μV (15 kHz IF BW, High Sensitivity Mode, 0.3 to 3 kHz BW) (*typical <1 μV (12 dB SINAD, $f_c \geq 10$ MHz)*)

Accuracy: $\pm 4\%$ of reading plus residual FM and noise contribution (20 Hz to 25 kHz rates, deviation ≤ 25 kHz)

Bandwidth: 2 Hz to 70 kHz (3 dB) DCFM measurements also available

THD+Noise: <1% for ≥ 5 kHz deviation and 1 kHz rate in a 0.3 to 3 kHz BW

Input Level Range for Specified Accuracy:

Standard:

-18 to +50 dBm at RF IN/OUT (0.016 mW to 100 W)

-50 to +14 dBm at ANT IN

Option 007:

-32 to 36 dBm at RF IN/OUT (0.63 μW to 4.0 W)

Residual FM and Noise:

0.3 to 3 kHz, rms:

< 7 Hz

Resolution:

$f < 10$ kHz: 1 Hz

$f \geq 10$ kHz: 10 Hz

AM Measurement

Frequency Range: 10 MHz to 1 GHz (*usable to 400 kHz*)

Depth: 0 to 95%

Accuracy: $\pm 5\%$ of reading $\pm 1.5\%$ AM (50 Hz to 10 kHz rates, modulation $\leq 80\%$)

THD+Noise: $< 2\%$ rms for modulation $\leq 80\%$ AM (1 kHz rate in a 0.3 to 3 kHz BW)

Input Level for Specified Accuracy (levels in PEP):

Standard:

–18 to +50 dBm at RF IN/OUT (0.016 mW to 100 W)

–50 to +14 dBm at ANT IN

Option 007:

–32 to 36 dBm at RF IN/OUT (0.63 μ W to 4.0 W)

Residual AM: $< 0.2\%$ in a 0.3 to 3 kHz BW

Resolution: 0.1%

SSB Measurement

Frequency Range: 400 kHz to 1 GHz

Bandwidth (3 dB): 20 Hz to 70 kHz

Distortion and Noise: $< 3\%$ at 1 kHz rate in a 0.3 to 3 kHz BW

TDMA Analyzer

HP 8920B Option 500 (includes HP 83201B)

Frequency Range: 824 MHz to 894 MHz

Input Level Range:

RF In/Out: 1mW to 60W (0 to 47.8 dBm)

Antenna In: -36 to +17 dBm

Input Frequency Setting Error: 1kHz

RX DSP Level Setting Range: -23 to 0dB full scale

Residual Error Vector Magnitude: <1.3%

Error Vector Magnitude Measurement Accuracy: $\pm 4\%$ plus 2% of reading

Residual Phase Error: $<1.0^\circ$

Residual Magnitude Error: $<0.9\%$

I/Q Origin Offset Accuracy: ± 0.5 dB for values to -40 dBc

Frequency Error Accuracy: ± 2.5 Hz plus reference accuracy

AF Analyzer Specifications

Frequency Measurement

Measurement Range: 20 Hz to 400 kHz

Accuracy: $\pm 0.02\%$ plus resolution plus timebase accuracy

External Input: 20 mV to 30 Vrms

Resolution:

$f < 10$ kHz: 0.01 Hz

$f < 100$ kHz: 0.1 Hz

$f \geq 100$ kHz: 1 Hz

AC Voltage Measurement

Measurement Range: 0 to 30 Vrms

Accuracy: $\pm 3\%$ of reading (20 Hz to 15 kHz, inputs ≥ 1 mV)

Residual Noise: 150 μ V (15 kHz BW)

3 dB Bandwidth: Typically 2 Hz to 100 kHz

Nominal Input Impedance: switchable between 1 M in parallel with 95 pF, and 600 Ω floating

Resolution:

4 digits for inputs ≥ 100 mV

3 digits for inputs < 100 mV

DC Voltage Measurement

Voltage Range: 100 mV to 42 V

Accuracy: $\pm 1.0\%$ of reading plus DC offset

DC Offset: ± 45 mV

Resolution: 1 mV

Distortion Measurement

Fundamental Frequency Range: 300 Hz to 10 kHz $\pm 5\%$

Input Level Range: 30 mV to 30 Vrms

Display Range: 0.1% to 100%

Accuracy:

± 1 dB (0.5 to 100% distortion) for tones from 300 to 1500 Hz measured with the 15 kHz LPF

± 1.5 dB (1.5 to 100% distortion) for tones from 300 Hz to 10 kHz measured with the >99 kHz LPF

Residual THD+Noise:

-60 dBc or 150 μ V, whichever is greater, for tones from 300 to 1500 Hz measured with the 15 kHz LPF

-57 dBc or 450 μ V, whichever is greater, for tones from 300 Hz to 10 kHz measured with the >99 kHz LPF

Resolution: 0.1% Distortion

SINAD Measurement

Fundamental Frequency Range: 300 Hz to 10 kHz $\pm 5\%$

Input Level Range: 30 mV to 30 Vrms

Display Range: 0 to 60 dB

Accuracy:

± 1 dB (0 to 46 dB SINAD) for tones from 300 to 1500 Hz measured with the 15 kHz LPF

± 1.5 dB (0 to 36 dB SINAD) for tones from 300 Hz to 10 kHz measured with the >99 kHz LPF

Residual THD+Noise:

-60 dB or 150 μ V, whichever is greater, for tones from 300 to 1500 Hz measured with the 15 kHz LPF

-57 dBc or 450 μ V, whichever is greater, for tones from 300 Hz to 10 kHz measured with the >99 kHz LPF

Resolution: 0.01 dB

Audio Filters

Standard

- < 20 Hz HPF
- 50 Hz HPF
- 300 Hz HPF
- 300 Hz LPF
- 3 kHz LPF
- 15 kHz LPF
- > 99 kHz LPF
- 750 μ s de-emphasis
- 300 Hz to 10 kHz (Variable Frequency Notch filter)

Optional

- C-Message
- CCITT
- 400 Hz HPF
- 4 kHz BPF
- 6 kHz BPF

Audio Detectors:

RMS, RMS*SQRT2, Pk+, Pk-, Pk+hold, Pk-hold, Pk \pm /2, Pk \pm /2 hold, Pk \pm max, Pk \pm maxhold

Oscilloscope Specifications

Frequency Range: 2 Hz to 50 kHz (3 dB BW)

Scale/Division: 10 mV to 10 V

Amplitude Accuracy: $\pm 1.5\%$ of reading ± 0.1 division. (20 Hz to 10 kHz)

Time/Division: 1 μ sec to 200 msec

Trigger Delay Range: 20 μ sec to 3.2 sec

3 dB Bandwidth: Typically >100 kHz

Internal DC Offset: ≤ 0.1 div (≥ 50 μ V/div sensitivity)

Spectrum Analyzer Specifications (Option 102)

Frequency

Frequency Range: 400 kHz to 1 GHz

Frequency Span/Resolution Bandwidth (coupled):

Table 7

Span	Bandwidth
< 50 kHz	300 Hz
< 200 kHz	1 kHz
< 1.5 MHz	3 kHz
< 18 MHz	30 kHz
≥ 18 MHz	300 kHz
Full span	

Display: Log with 10 dB/div, 2 dB/div, or 1 dB/div

Display Range: 80 dB

Reference Level Range: +50 to -50 dBm

Residual Responses: <-70 dBm (no input signal, 0 dB attenuation)

Image Rejection: >50 dB

Non-harmonic Spurious Responses: >70 dB (for input signals ≤ -30 dBm)

Level Accuracy: ±2.5 dB

Displayed Average Noise Level: <-114 dBm for ≤ 50 kHz spans

Log Scale Linearity: ±2 dB (for input levels ≤ -30 dBm or 60 dB range)

Tracking Generator

(Included with Option 102)

Frequency Range: 400 kHz to 1 GHz

Frequency Offset: Frequency span endpoints \pm frequency offset cannot be < 400 kHz or ≥ 1 GHz

Output Level Range: Same as signal generator

Sweep Modes: Normal and inverted

Adjacent Channel Power

(Included with Option 102)

Relative Measurements:

Level Range:

Antenna In: -40 dBm to $+20$ dBm

RF/Input: 0.16 mW (-8 dBm) to 60 W (47.8 dBm) continuous; or up to 100 mW (50 dBm) for 10 seconds/minute

Dynamic Range: Typical values for channel offsets

Table 8

Channel Offset	Resolution Bandwidth	Dynamic Range
<i>12.5 kHz</i>	<i>8.5 kHz</i>	<i>- 65 dBc</i>
<i>20 kHz</i>	<i>14 kHz</i>	<i>- 68 dBc</i>
<i>25 kHz</i>	<i>16 kHz</i>	<i>- 68 dBc</i>
<i>30 kHz</i>	<i>16 kHz</i>	<i>- 68 dBc</i>
<i>60 kHz</i>	<i>30 kHz</i>	<i>- 65 dBc</i>

Relative Accuracy: ± 2.0 dB

Absolute Level Measurements:

Level: Results of absolute power in Watts or dBm are met by adding the ACP ratio from the spectrum analyzer to the carrier power from the input section RF power detector.

Level Range:

Antenna: Not applicable

RF/Input: 1 mW (0 dBm) to 60 W (47.8 dBm) continuous; or up to 100 W (50 dBm) for 10 seconds/minute

Dynamic Range: Typical values for channel offsets

Table 9

Channel Offset	Resolution Bandwidth	Dynamic Range
<i>12.5 kHz</i>	<i>8.5 kHz</i>	<i>- 65 dBc</i>
<i>20 kHz</i>	<i>14 kHz</i>	<i>- 68 dBc</i>
<i>25 kHz</i>	<i>16 kHz</i>	<i>- 68 dBc</i>
<i>30 kHz</i>	<i>16 kHz</i>	<i>- 68 dBc</i>
<i>60 kHz</i>	<i>30 kHz</i>	<i>- 65 dBc</i>

Absolute Accuracy: RF power measurement accuracy for absolute in-channel power: (for inputs > 200 mW): $\pm 10\%$ of reading ± 1 mW (in dB) plus ACP relative accuracy of ± 2.0 dB

Signaling (Option 004)

Capability for generating and analyzing the following formats:

CDCSS, DTMF, 1 TONE, 2 TONE, 5/6 TONE SEQUENTIAL, RPC1, POCSAG, EIA, CCITT, CCIR, ZVEI, DZVEI, GOLAY, EEA, AMPS/EAMPS/NAMPS, TACS/ETACS, JTACS/NTACS, NMT-450, NMT-900, LTR^{®1}, EDACS[™], MPT 1327, and TDMA dual-mode

LTR[®] is a registered trademark of the E. F. Johnson Company;
EDACS[™] is a trademark of Ericsson/GE.

¹ over 15° to 35°C for analyzing

A General Purpose Function Generator with the following waveforms is included: sine, square, triangle, ramp, dc, Gaussian white noise, uniform white noise.

Frequency Range and Level: Same as audio source

DC Current Meter

Measurement Range: 0 to 10 A (*usable to 20 A*)

Accuracy: The greater of 10% of reading after zeroing or 30 mA (levels > 100 mA)

Remote Programming

HP-IB: Hewlett-Packard's implementation of IEEE Standard 488.2

Functions Implemented: SH1, AH1, T6, L4, SR1, RL1, LE0, TE0, PP0, DC1, DT1, C4, C11, E2

RS-232: Six-wire RJ-11 connector provides two three-wire serial ports for serial data in and out (no hardware handshake capability).

Baud Rates: 150, 300, 600, 1200, 2400, 4800, 9600, and 19200 Hz

Parallel (Centronics) connector: A standard 25-pin, sub-min D female connector with right-angle adapter is included.

Memory Card Specifications

Card Compatibility: Single industry standard PCMCIA slot accepts Type I or Type II SRAM and ROM memory cards.

Storage Capability: Allows for the storage and retrieval of IBASIC program parameter and results data, input of new calibration data, and long-term storage of Store/Recall information.

Firmware Upgrades: Accepts PCMCIA flash memory cards (4 Mbytes) to allow automatic loading of new firmware for the host CPU from the front panel. Upgrade time is approximately two minutes.

Reference Oscillator Specifications

TCXO (Standard)

Temperature: 1 ppm (0 to +55°C)

Aging: < 2 ppm/year

Warm-up Time: < 30 seconds to be within ± 2 ppm of final frequency

OCXO (Option 001)

Temperature: 0.05 ppm (0 to +55°C)

Aging: < 0.5 ppm/year (< 1 ppm in first year)

Warm-up Time: < 15 minutes to be within ± 0.1 ppm of final frequency

Rear Panel BNC connectors:

Input Frequency: 1,2,5,10 MHz

Input Level¹: > 0.15 Vrms

Output Frequency: 10 MHz

Output Level: > 0.5 Vrms

-
1. Electrostatic Discharges to the 10 MHz Ref Input port of the 0.5 kV or the above may cause degradation of performance, requiring operator intervention.

General Specifications

Size: 7.5 H x 13 W x 19 inches (188 H x 330 W x 456 D mm)

Weight: 37 lbs (16.8 kg) fully optioned

CRT Size: 7 x 10 cm

Operating Temperature: 0 to +55°C

Storage Temperature: -55 to +75°C

Power:

AC: 100 to 240 V, 48 to 440 Hz, *nominally 80 watts*

DC: 11 to 28 V, *nominally 120 watts*

Leakage: At Signal Generator output frequency and level <-40 dBm, typical leakage is <0.5 μ V induced in a resonant dipole antenna 1 inch from any surface except the rear panel. This corresponds to approximately 0.05 μ V when measured with a 25-mm, two-turn loop. Spurious leakage levels are typically < 1 μ V in a resonant dipole antenna.

TERMS-

Access- Accessing a screen or field means to display or go to it.

Select To choose a selection within a field or screen.

Set Choose a specific parameter or value within a field.

ACRONYMS-

AMPS-TACS Advanced Mobile Phone Service - Total Access Communication System.

CDCSS Continuous Digital Coded Squelch System.

CTCSS Continuous Tone Coded Squelch System.

DTMF Dual Tone Multi-Frequency.

EIA Electronic Industries Association

NMT Nordic Mobile Telephone

SINAD Signal plus noise plus distortion to noise plus distortion ratio.

TIA Telecommunications Industry Association.

ABBREVIATIONS-

> Greater Than

< Less Than

ADC Amperes Direct Current.

AF Audio Frequency

AFGen Audio Frequency Generator

AGC Automatic Gain Control

AM Amplitude Modulation

ANSI American National Standards Institute

BW Bandwidth

CCW Counter-Clockwise

CW Clockwise

FM Frequency Modulation

HPF High Pass Filter

IF Intermediate Frequency

LPF Low Pass Filter

LSB Lower-side-band

NPC No Primary Code

OSC Oscilloscope

RF Radio Frequency

RFGen Radio Frequency Generator

RIT Receiver Incremental Tuning

RX Receiver

SSB Single Side Band

TX Transmitter

USB Upper-side-band

VAC Volts Alternating Current

VDC Volts Direct Current

Numerics

1/4 Wave Coaxial Tuning (Swept), [212](#)
20 dB Quieting Sensitivity Measurement, [91](#)

A

Additional Measurement Information, [48](#)
Additional Test Equipment Requirements, [44](#)
AGC Measurement, [143](#)
AM
AGC Measurement, [143](#)
Audio Distortion Measurement, [128](#), [152](#)
Audio Frequency Response Measurement, [149](#)
Audio Output Power Measurement, [137](#)
Determining Unknown AM Transmitter Carrier Frequency, [119](#)
Envelope Display Measurement, [133](#)
Frequency/Frequency Error Measurement, [122](#)
Harmonic Measurement, [130](#)
Modulation Depth Measurement, [122](#)
Off The Air Monitoring, [119](#)
Output Power Measurement, [122](#)
Spurious Output Measurement, [130](#)
Spurious Response Attenuation Measurement, [155](#)
Squelch Sensitivity Measurement, [146](#)
AM Radio Testing, [115](#)
AM Receiver Testing, [136](#)
AM Transmitter Testing, [118](#)
Analyzing External Transmitter Intermodulation Distortion, [198](#)
Antenna Return Loss (VSWR) Measurement and Tuning, [208](#)
Audio Distortion Measurement, [74](#), [108](#), [128](#), [152](#)
Audio Frequency Response Measurement, [105](#), [149](#)
Audio Output Power Measurement, [80](#), [137](#), [174](#)

C

Cable Fault Location, [216](#)
Cabling Restrictions, [242](#)
Carrier Suppression Measurement, [166](#)
CDCSS Coding Measurement, [67](#)
CDCSS Sensitivity Measurement, [101](#)
Coaxial Tuning (Swept), [212](#)
Configuration Menu, [244](#)
Configuring the HP 8920A for Measurement, [243](#)
Considerations, Measurement, [50](#), [116](#), [160](#), [186](#), [232](#)
Critical Squelch Sensitivity Measurement, [93](#), [145](#)
CTCSS Encoder Frequency Measurement, [65](#)
CTCSS Sensitivity and Bandwidth Measurement, [97](#)
Cursor Control, [34](#)

D

Data Entry Keys, 33
DC Power Configuration, 242
Determining Unknown AM Transmitter
Carrier Frequency, 119
Deviation Measurement, 56, 59, 65,
67, 70
Distortion Measurement, 174
DTMF Encoding Measurement, 70

E

Envelope Display Measurement, 133

F

Features, 26
Field Strength Measurement, 194
FM
20 dB Quieting Sensitivity Measure-
ment, 91
Audio Distortion Measurement, 74,
108
Audio Frequency Response Measure-
ment, 105
Audio Output Power Measurement,
80
CDCSS Coding Measurement, 67
CDCSS Sensitivity Measurement,
101
Critical Squelch Sensitivity Measure-
ment, 93, 145
CTCSS Encoder Frequency Measure-
ment, 65
CTCSS Sensitivity and Bandwidth
Measurement, 97
Deviation Measurement, 56, 59, 65,
67, 70
DTMF Encoding Measurement, 70
Frequency/Frequency Error Measure-
ment, 56
Harmonic Measurement, 76
Maximum Squelch Sensitivity Mea-
surement, 93, 145
Microphone Sensitivity Measure-
ment, 62, 125
Modulation Acceptance Bandwidth
Measurement, 83
Modulation Limiting Measurement,
62, 125
Output Power Measurement, 56
Receiver Center Frequency Measure-
ment, 83
SINAD Measurement, 83
Spurious Output Measurement, 76
Spurious Response Attenuation Mea-
surement, 111
Symmetry Measurement, 59
Variation Of Sensitivity With Signal

-
- Frequency Measurement, [87](#), [140](#)
- FM Radio Testing, [48](#)
- FM Receiver Testing, [79](#), [173](#)
- FM Transmitter Testing, [52](#), [162](#)
- Frequency Error Measurement, [163](#)
- Frequency Measurement, [163](#)
- Frequency/Frequency Error Measurement, [56](#), [122](#)
- Front Panel, [28](#)
- Front Panel Connectors, [38](#)
- Front Panel Controls, [28](#)
- Fuse, [243](#)
- G**
- Guidelines for Measurements, [50](#), [116](#), [160](#), [186](#), [232](#)
- H**
- Harmonic Measurement, [76](#), [130](#)
- Harmonic Output Measurement, [170](#)
- HP 8920A Description, [10](#), [25](#)
- HP 8920A Features, [26](#)
- HP 8920A Option Requirements, [44](#)

-
- I**
Installation, [242](#)
Intermodulation Distortion, [198](#)
- M**
Manual Conventions, [24](#)
Maunal Contents, [24](#)
Maximum Squelch Sensitivity Measurement, [93](#), [145](#)
Measurement Considerations, [50](#), [116](#), [160](#), [186](#), [232](#)
Measurement Information, [48](#)
Measurements, Performing, [245](#)
Memory Card Slot, [39](#)
Microphone Sensitivity Measurement, [62](#), [125](#)
Modulation Acceptance Bandwidth Measurement, [83](#)
Modulation Depth Measurement, [122](#)
Modulation Limiting Measurement, [62](#), [125](#)
- O**
Off The Air Monitoring, [119](#)
Oscilloscope
 Using, [233](#)
Output Power Measurement, [56](#), [122](#)

P

Passive Cavity
 Insertion Loss Measurement, 220
 Return Loss Measurement, 220
Performing Measurements, 245
Presets, 48

R

Rated RF Output Power Measurement, 166
Rear Panel Connectors, 40
Rear Panel Features, 40
Receiver Center Frequency Measurement, 83
Receiver Testing, 48
Repeater System Effective Sensitivity Measurement, 226

S

Screen Control Keys, 35
Screen Description, 29
Sensitivity Measurement, 178
Setting Date, 244
Setting Time, 244
Shift Functions, 23
SINAD Measurement, 83
Special Test Considerations, 46
Specifications, 25
 AF analyzer, 266, 295
 audio source, 259, 289
 dc current meter, 275, 303
 description, 251, 281
 general, 279, 307
 HP 8920A, 252, 282
 HP 8920B, 279
 HP 8921A, 307
 oscilloscope, 269, 298
 reference oscillator, 277, 306
 remote programming, 276, 304
 RF analyzer, 260, 290
 save/recall registers, 278
 signal generator, 253, 283
 signaling, 274, 302
 spectrum analyzer, 270, 299
Spectrum Analyzer
 1/4 Wave Coaxial Tuning (Swept), 212
 Analyzing External Transmitter Intermodulation Distortion, 198
 Antenna Return Loss (VSWR) Measurement and Tuning, 208
 Cable Fault Location, 216
 Field Strength Measurement, 194
 Passive Cavity Insertion Loss Measurement, 220
 Repeater System Effective Sensitivity Measurement, 226
 Using, 188
Spectrum Analyzer Measurements, 185, 231
Spurious Output Measurement, 76, 130, 170

Spurious Response Attenuation Measurement, [111](#), [155](#)
Squelch Sensitivity Measurement, [146](#), [181](#)
SSB
 Audio Output Power Measurement, [174](#)
 Carrier Suppression Measurement, [166](#)
 Distortion Measurement, [174](#)
 Frequency Error Measurement, [163](#)
 Frequency Measurement, [163](#)
 Harmonic Output Measurement, [170](#)
 Rated RF Output Power Measurement, [166](#)
 Sensitivity Measurement, [178](#)
 Spurious Output Measurement, [170](#)
 Squelch Sensitivity Measurement, [181](#)
Symmetry Measurement, [59](#)

T

Test Load Requirement, [46](#)
Testing AM Radios, [115](#)
Testing FM Radios, [48](#)
Tracking Generator
 1/4 Wave Coaxial Tuning (Swept), [212](#)
 Antenna Return Loss (VSWR) Measurement and Tuning, [208](#)
 Cable Fault Location, [216](#)
 Passive Cavity Return Loss Measurement, [220](#)
 Repeater System Effective Sensitivity Measurement, [226](#)
 Using, [203](#)
Transmitter High Power, [189](#), [204](#), [234](#)
Transmitter Low Power, [189](#), [204](#), [234](#)
Transmitter Testing, [48](#)

U

User Keys, [32](#)
Using the Oscilloscope, [233](#)
Using the Spectrum Analyzer, [188](#)
Using the Tracking Generator, [203](#)

V

Variation Of Sensitivity With Signal
Frequency Measurement, [87](#), [140](#)