

HP 8920A RF Communications Test Set

User's Guide

Firmware Version A.15.00 and above

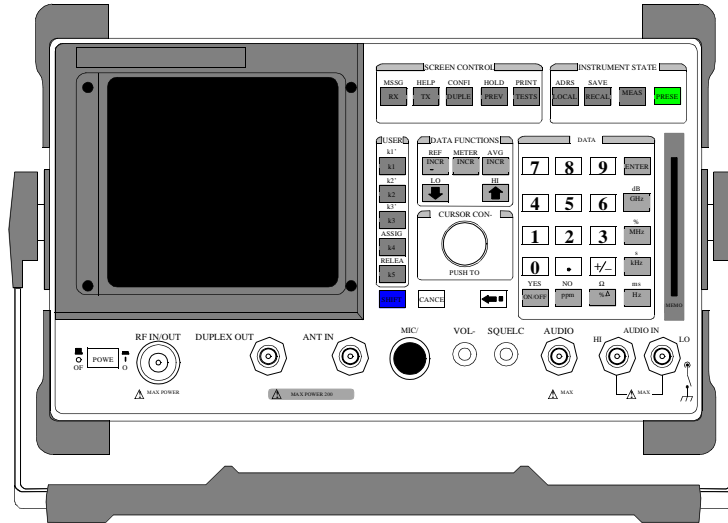

HP Part No. 08920-90219

Printed in U. S. A.

March 1998

Rev. B

Copyright © Hewlett-Packard Company 1995

Notice

Information contained in this document is subject to change without notice.

All Rights Reserved. Reproduction, adaptation, or translation without prior written permission is prohibited, except as allowed under the copyright laws.

This material may be reproduced by or for the U.S. Government pursuant to the Copyright License under the clause at DFARS 52.227-7013 (APR 1988).

Hewlett-Packard Company
Learning Products Department
24001 E. Mission
Liberty Lake, WA 99019-9599
U.S.A.

Manufacturer's Declaration

This statement is provided to comply with the requirements of the German Sound Emission Directive, from 18 January 1991.

This product has a sound pressure emission (at the operator position) < 70 dB(A).

- Sound Pressure $L_p < 70$ dB(A).
- At Operator Position.
- Normal Operation.
- According to ISO 7779:1988/EN 27779:1991 (Type Test).

Herstellerbescheinigung

Diese Information steht im Zusammenhang mit den Anforderungen der Maschinenlärminformationsverordnung vom 18 Januar 1991.

- Schalldruckpegel $L_p < 70$ dB(A).
- Am Arbeitsplatz.
- Normaler Betrieb.
- Nach ISO 7779:1988/EN 27779:1991 (Typprüfung).

Safety Considerations

GENERAL

This product and related documentation must be reviewed for familiarization with safety markings and instructions before operation.

This product has been designed and tested in accordance with *IEC Publication 1010*, "Safety Requirements for Electronic Measuring Apparatus," and has been supplied in a safe condition. This instruction documentation contains information and warnings which must be followed by the user to ensure safe operation and to maintain the product in a safe condition.

SAFETY EARTH GROUND

A uninterruptible safety earth ground must be provided from the main power source to the product input wiring terminals, power cord, or supplied power cord set.

CHASSIS GROUND TERMINAL

To prevent a potential shock hazard, always connect the rear-panel chassis ground terminal to earth ground when operating this instrument from a dc power source.

SAFETY SYMBOLS



Indicates instrument damage can occur if indicated operating limits are exceeded. Refer to the instructions in this guide.



Indicates hazardous voltages.



Indicates earth (ground) terminal

WARNING

A WARNING note denotes a hazard. It calls attention to a procedure, practice, or the like, which, if not correctly performed or adhered to, could result in personal injury. Do not proceed beyond a WARNING sign until the indicated conditions are fully understood and met.

CAUTION

A CAUTION note denotes a hazard. It calls attention to an operation procedure, practice, or the like, which, if not correctly performed or adhered to, could result in damage to or destruction of part or all of the product. Do not proceed beyond a CAUTION note until the indicated conditions are fully understood and met.

Safety Considerations for this Instrument

WARNING

This product is a Safety Class I instrument (provided with a protective earthing ground incorporated in the power cord). The mains plug shall only be inserted in a socket outlet provided with a protective earth contact. Any interruption of the protective conductor inside or outside of the product is likely to make the product dangerous. Intentional interruption is prohibited.

Whenever it is likely that the protection has been impaired, the instrument must be made inoperative and be secured against any unintended operation.

If this instrument is to be energized via an autotransformer (for voltage reduction), make sure the common terminal is connected to the earth terminal of the power source.

If this product is not used as specified, the protection provided by the equipment could be impaired. This product must be used in a normal condition (in which all means for protection are intact) only.

No operator serviceable parts in this product. Refer servicing to qualified personnel. To prevent electrical shock, do not remove covers.

Servicing instructions are for use by qualified personnel only. To avoid electrical shock, do not perform any servicing unless you are qualified to do so.

The opening of covers or removal of parts is likely to expose dangerous voltages. Disconnect the product from all voltage sources while it is being opened.

Adjustments described in the manual are performed with power supplied to the instrument while protective covers are removed. Energy available at many points may, if contacted, result in personal injury.

The power cord is connected to internal capacitors that may remain live for 5 seconds after disconnecting the plug from its power supply.

For Continued protection against fire hazard, replace the line fuse(s) only with 250 V fuse(s) or the same current rating and type (for example, normal blow or time delay). Do not use repaired fuses or short circuited fuseholders.

WARNING:

Always use the three-prong ac power cord supplied with this product. Failure to ensure adequate earth grounding by not using this cord may cause product damage.

This product is designed for use in Installation Category II and Pollution Degree 2 per *IEC 1010* and *IEC 664* respectively. For indoor use only.

This product has autoranging line voltage input, be sure the supply voltage is within the specified range.

To prevent electrical shock, disconnect instrument from mains (line) before cleaning. Use a dry cloth or one slightly dampened with water to clean the external case parts. Do not attempt to clean internally.

Ventilation Requirements: When installing the product in a cabinet, the convection into and out of the product must not be restricted. The ambient temperature (outside the cabinet) must be less than the maximum operating temperature of the product by 4° C for every 100 watts dissipated in the cabinet. If the total power dissipated in the cabinet is greater than 800 watts, then forced convection must be used.

Product Markings

CE - the CE mark is a registered trademark of the European Community. A CE mark accompanied by a year indicated the year the design was proven.

CSA - the CSA mark is a registered trademark of the Canadian Standards Association.

Hewlett-Packard Warranty Statement for Commercial Products

HP 8920A RF Communications Test Set

Duration of Warranty: 1 year

1. HP warrants HP hardware, accessories and supplies against defects in materials and workmanship for the period specified above. If HP receives notice of such defects during the warranty period, HP will, at its option, either repair or replace products which prove to be defective. Replacement products may be either new or like-new.
2. HP warrants that HP software will not fail to execute its programming instructions, for the period specified above, due to defects in material and workmanship when properly installed and used. If HP receives notice of such defects during the warranty period, HP will replace software media which does not execute its programming instructions due to such defects.
3. HP does not warrant that the operation of HP products will be uninterrupted or error free. If HP is unable, within a reasonable time, to repair or replace any product to a condition as warranted, customer will be entitled to a refund of the purchase price upon prompt return of the product.
4. HP products may contain remanufactured parts equivalent to new in performance or may have been subject to incidental use.
5. The warranty period begins on the date of delivery or on the date of installation if installed by HP. If customer schedules or delays HP installation more than 30 days after delivery, warranty begins on the 31st day from delivery.
6. Warranty does not apply to defects resulting from (a) improper or inadequate maintenance or calibration, (b) software, interfacing, parts or supplies not supplied by HP, (c) unauthorized modification or misuse, (d) operation outside of the published environmental specifications for the product, or (e) improper site preparation or maintenance.
7. TO THE EXTENT ALLOWED BY LOCAL LAW, THE ABOVE WARRANTIES ARE EXCLUSIVE AND NO OTHER WARRANTY OR CONDITION, WHETHER WRITTEN OR ORAL IS EXPRESSED OR IMPLIED AND HP SPECIFICALLY DISCLAIMS ANY IMPLIED WARRANTIES OR CONDITIONS OR MERCHANTABILITY, SATISFACTORY QUALITY, AND FITNESS FOR A PARTICULAR PURPOSE.
8. HP will be liable for damage to tangible property per incident up to the greater of \$300,000 or the actual amount paid for the product that is the subject of the claim, and for damages for bodily injury or death, to the extent that all such damages are determined by a court of competent jurisdiction to have been directly caused by a defective HP product.

9. TO THE EXTENT ALLOWED BY LOCAL LAW, THE REMEDIES IN THIS WARRANTY STATEMENT ARE CUSTOMER'S SOLE AND EXCLUSIVE REMEDIES. EXCEPT AS INDICATED ABOVE, IN NO EVENT WILL HP OR ITS SUPPLIERS BE LIABLE FOR LOSS OF DATA OR FOR DIRECT, SPECIAL, INCIDENTAL, CONSEQUENTIAL (INCLUDING LOST PROFIT OR DATA), OR OTHER DAMAGE, WHETHER BASED IN CONTRACT, TORT, OR OTHERWISE.

FOR CONSUMER TRANSACTIONS IN AUSTRALIA AND NEW ZEALAND: THE WARRANTY TERMS CONTAINED IN THIS STATEMENT, EXCEPT TO THE EXTENT LAWFULLY PERMITTED, DO NOT EXCLUDE RESTRICT OR MODIFY AND ARE IN ADDITION TO THE MANDATORY STATUTORY RIGHTS APPLICABLE TO THE SALE OF THIS PRODUCT TO YOU.

DECLARATION OF CONFORMITY

according to ISO/IEC Guide 22 and EN 45014

Manufacturer's Name: Hewlett-Packard Co.

Manufacturer's Address: Spokane Division
24001 E. Mission Avenue
declares that the product Liberty Lake, Washington 99019-9599
USA

Product Name: RF Communications Test Set / Cell Site Test Set

Model Number: HP 8920A, HP 8920B, and HP 8921A

Product Options: This declaration covers all options of the above product.

conforms to the following Product specifications:

Safety: IEC 348:1978 / HD 401S1:1981¹⁾

EMC: CISPR 11:1990 / EN 55011:1991 Group 1, Class A
EN50082-1:1992
IEC 801-2:1991 - 4 kV CD, 8 kV AD
IEC 801-3:1984 - 3V/m
IEC 801-4:1988 - 0.5 kV Sig. Lines, 1 kV Power Lines

Supplementary Information:

This product herewith complies with the requirements of the Low Voltage Directive 73/23/EEC and the EMC Directive 89/336/EEC and carries the CD-marking accordingly.

1) The product was introduced prior to 12/1993

Spokane, Washington USA

Date October 17, 1996



Vince Roland/Quality Manager

European Contact: Your local Hewlett-Packard Sales and Service Office or Hewlett-Packard GmbH
Department ZQ/Standards Europe, Herrenberger Strasse 130, D-71034 Böblingen, Germany (FAX+49-7031-14-3143)

Table 1 Regional Sales and Service Offices

<p>United States of America U.S. Instrument Support Center For Test & Measurement Equipment Repair & Calibration. Hewlett-Packard Company Englewood, Colorado 80112</p> <p>Telephone: (800) 403-0801 Fax: (888) 857-8161</p>	<p>United States of America Customer Information Center For Assistance On All HP Products. Hewlett-Packard Company Tel: (800) 752-0900</p> <p>6:00 am to 5:00 pm Pacific Time Parts Direct: 1-800-227-8164</p>	<p>United Kingdom Sales and Service Hewlett-Packard Ltd. Cain Road Amen Corner Bracknell, Berkshire RG12 1HN United Kingdom</p> <p>Telephone: 44 344 360000 Fax: 44 344 363344</p>
<p>South Eastern Europe Sales and Service Hewlett-Packard Ges. m.b.h. Liebigasse 1 P.O. Box 72 A-1222 Vienna, Austria</p> <p>Telephone: 43 222 2500 0 Telex: 13 4425</p>	<p>European Multicountry Region Sales and Service Hewlett-Packard S.A. P.O. Box 95 150, Route dv Nant_dl_AVRIL CH-1217 Meyrin 2 Geneva, Switzerland</p> <p>Telephone: (41/22) 780-8111 Fax: (41/22) 780-8542</p>	<p>Northern Europe Sales and Service Hewlett-Packard Nederland B.V. Startbaan 16 1187 XR Amstelveen, The Netherlands P.O. Box 667</p> <p>Telephone: 31/20 5476911 X 6631 Fax: 31-20-6471825NL</p>
<p>Asia Sales and Service Hewlett-Packard Asia Ltd. 22-30/F Peregrine Tower Lippo Center 89 Queensway, Central Hong Kong G.P.O. Box 863 Hong Kong</p> <p>Telephone: 852-848-7777 Fax: 852-868-4997</p>	<p>Japan Sales and Service Yokogawa-Hewlett-Packard Ltd. 3-29-21, Takaido-Higashi Suginami-Ku, Tokyo 168</p> <p>Telephone: 81 3 3331-6111 Fax: 81 3 3331-6631</p>	<p>International Sales Branch Headquarters Sales and Service Hewlett-Packard S.A. 39 Rue Veyrot P.O. Box 365 1217 Meyrin 1 Geneva, Switzerland</p> <p>Telephone: 41-22-780-4111 Fax: 41-22-780-4770</p>
<p>Australia, New Zealand Sales and Service Hewlett-Packard Ltd. P.O. Box 221 31-41 Joseph Street Blackburn, Victoria 3130</p> <p>Telephone: (61/3) 895-2895 Fax: (61/3) 898-9257</p>	<p>Canada Sales and Service Hewlett-Packard (Canada) Ltd. 5150 Spectrum Way Mississauga, Ontario L4W 5G1 Canada</p> <p>Telephone: (416) 206-4725 Fax: (416) 206-4739</p>	<p>Canada Service Center Hewlett-Packard Company 17500 Transcanada Highway S. Serv Road Kirkland, Quebec H9J 2X8 Canada</p> <p>Telephone: (416) 206-3295</p>

Table 1**Regional Sales and Service Offices (Continued)**

Canada
Service Center
Hewlett-Packard Ltd.
11120 178 Street
Edmonton, Alberta T5S 1P2
Canada

Telephone: (403) 486-6666
Fax: (403) 489-8764

Latin America
Hewlett-Packard Company
LAHQ Mexico City
Col. Lomas de Virreyes
11000 Mexico D.F.
Mexico

Telephone: (52/5) 326-4000
Fax: (52/5) 202 7718

United Kingdom
Sales and Service
Hewlett-Packard Ltd.
Cain Road
Amen Corner
Bracknell, Berkshire
RG12 1HN
United Kingdom

Telephone: 44 344 360000
Fax: 44 344 363344

In this Book

The HP 8920A is referred to in this document as "Test Set."

Chapter 1, Get Started

This chapter describes the basic operation of the Test Set. It also provides a quick check that verifies that the Test Set is operating properly.

Chapter 2, Configuring Your Test Set

This chapter describes various instrument configuration settings that affect the general operation of the instrument.

Chapter 3, Operating Overview

This chapter contains detailed operating instructions and examples for using several instrument features.

Chapters 4 through 23, Screen and Field Descriptions

These chapters contain reference information for each screen and its fields. Many of the descriptions contain signal flow diagrams that relate the screen's fields to the functions they perform. The screens are arranged in alphabetical order by title at the top of the screen; Signaling Encoder and Signaling Decoder are alphabetized by the names Encoder and Decoder.

Chapter 24, Connector, Key, and Knob Descriptions

This chapter describes the purpose and use of each connector and control.

Chapter 25, Modifications, Accessories, Manuals, Support

This chapter describes retrofit kits, accessories, manuals, and customer support available for your Test Set.

Error Messages

This section discusses error and operating messages.

Contents

1 Get Started

Before Connecting a Radio 40

Accessing the Test Set's Screens 41

Changing A Field's Setting 43

How do I Verify that the Test Set is Operating Properly? 46

Instrument Functional Diagram 47

Contents

2 Configuring Your Test Set

General Operating Information 50

3 Operating Overview

Interaction Between Screens 54

Displaying Measurements 57

Entering and Changing Numbers 63

Printing A Screen 66

Using Measurement Limit Indicators 67

Averaging Measurements 69

Setting A Measurement Reference 70

Using Memory Cards 71

Saving and Recalling Instrument Setups 76

Using USER Keys 80

Setting an RF Generator/Analyzer Offset 84

Using Remote Control 85

Contents

4 Adjacent Channel Power Screen

How the Test Set Measures Adjacent Channel Power (ACP) 90

Field Descriptions 91

Contents

5 AF Analyzer Screen

Block Diagram 100

6 Call Processing Subsystem

Description of the Call Processing Subsystem 114

Using the Call Processing Subsystem 118

The CALL CONTROL Screen 122

Using the CALL CONTROL Screen to Test Call Processing Functions 140

Using the CALL CONTROL Screen to test AMPS Authentication 151

AUTHENTICATION Screen 162

CALL DATA Screen 165

CALL DATA Screen Message Field Descriptions 170

Using the CALL DATA Screen 186

CALL BIT Screen 194

CALL BIT Screen Message Field Descriptions 201

Using the CALL BIT Screen 239

ANALOG MEAS Screen 244

Using the ANALOG MEAS Screen 247

CALL CONFIGURE Screen 250

Contents

7 Configure Screen

Field Descriptions 254

8 Signaling Decoder Screen

Field Descriptions for Decoder Modes	270
AMPS-TACS, NAMPS-NTACS Decoder	271
Using the AMPS/TACS, NAMPS/NTACS Decoder	276
Continuous Digital Controlled Squelch System Decoder	280
Using the CDCSS Decoder	284
Digital Paging Decoder	285
Dual-Tone Multi-Frequency (DTMF) Decoder	289
Using the DTMF Decoder	294
EDACS Decoder	295
Using the EDACS Decoder	298
Function Generator Decoder	301
Using the Function Generator Decoder	304
LTR Decoder	305
Using the LTR Decoder	309
MPT 1327 Decoder	311
NMT Decoder	316
Using the NMT Decoder/Encoder	321
Creating NMT Tests	326
Tone Sequence Decoder	335

Contents

9 Duplex Test Screen

Block Diagram 340

Field Descriptions 341

10 Signaling Encoder (AF Generator 2)

Field Descriptions for Encoder Modes 354

AMPS-TACS NAMPS-NTACS Encoder 355

Using the AMPS-TACS, NAMPS-NTACS Encoder 367

CDCSS Encoder 368

Using the CDCSS Encoder 372

Digital Paging Encoder 373

DTMF Sequence Encoder 378

EDACS Encoder 382

Using the EDACS Encoder 388

Function Generator Encoder 393

LTR Encoder 396

Using the LTR Encoder 400

MPT 1327 Encoder 404

Using the MPT 1327 Encoder 417

Nordic Mobile Telephone (NMT) Encoder 420

Tone Sequence Encoder 432

Contents

11 Help Screen

Field Descriptions 436

Contents

12 I/O Configure Screen

Field Descriptions 438

Contents

13 Message Screen

Field Descriptions 444

Contents

14 Oscilloscope Screen

Field Descriptions 446

Using the Oscilloscope 452

Contents

15 Print Configure Screen

Field Descriptions 454

Contents

16 Radio Interface Screen

Radio Interface Functional Description 458

Field Descriptions 460

Using the Radio Interface (Manual Operation) 463

Using The Radio Interface (Remote Operation) 469

Contents

17 RF Analyzer Screen

Block Diagram 472

Field Descriptions 473

Contents

18 RF Generator Screen

Block Diagram 484

Field Descriptions 485

Contents

19 RX Test Screen

Block Diagram 494

Field Descriptions 495

Contents

20 Service Screen

Field Descriptions 502

Contents

21 Spectrum Analyzer Screen

Field Descriptions 506

Using the Spectrum Analyzer 518

22 Tests Screen

Description of the Tests Subsystem 520

TESTS (Main Menu) 522

TESTS (Channel Information) 525

TESTS (Test Parameters) 527

TESTS (Order of Tests) 528

TESTS (Pass/Fail Limits) 530

TESTS (Save/Delete Procedure) 532

TESTS (Execution Conditions) 535

TESTS (External Devices) 538

TESTS (Printer Setup) 541

TESTS (IBASIC Controller) 544

ROM Programs 546

Contents

23 TX Test Screen

Block Diagram 550

Field Descriptions 551

Contents

24 Connector, Key, and Knob Descriptions

Connector Descriptions 562

Key Descriptions 580

Knob Descriptions 584

Contents

25 Modifications, Accessories, Manuals, Support

Modifications 586

Accessories 589

HP Support for Your Instrument 602

Contents

Index 619

1

Get Started

Before Connecting a Radio

The RF IN/OUT port should be used for all transmitter tests when the radio is connected directly to the Test Set. (All UUT transmitter power measurements are made through this port). Off-the-air measurements can be made using the ANT IN port.

CAUTION: *Overpower Damage* — Refer to the Test Set's front panel for maximum input power level. Exceeding this level can cause permanent instrument damage.

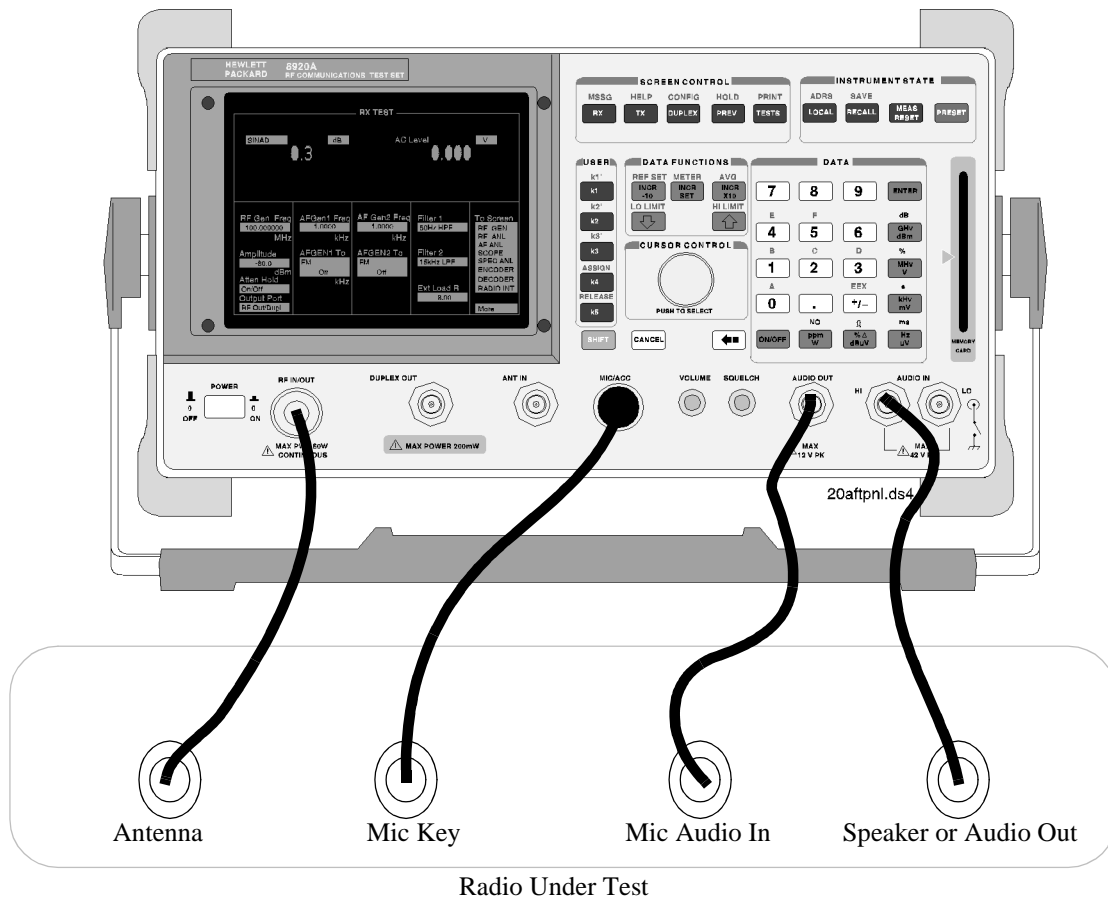

Figure 1 Connecting a Radio to the Test Set

Accessing the Test Set's Screens

List of Screens

The following table lists all the screens that could be provided by the Test Set.

Table 2

Analog Measurement Screens	Instrument Configuration Screens
Adjacent Channel Power	Configure
AF Analyzer	I/O Configure
Decoder	Print Configure
Duplex	User Assistance Screens
Encoder	Help
Oscilloscope	Message
Radio Interface	Service Assistance Screen
RF Analyzer	Service
RF Generator	Call Processing Screens
RX Test	Call Control
Spectrum Analyzer	Call Data
TX Test	Call Bit
Software Control Screens	Call Configure
Tests	Analog Measure
Tests (IBASIC Controller)	Authentication

Accessing Screens

Test Set's screens can be accessed through

- Front-panel keys
- The front-panel Cursor Control knob (using the **To Screen** menu, see item 5 in [figure 3 on page 43](#))
- HP-IB, using the DISPlay subsystem.

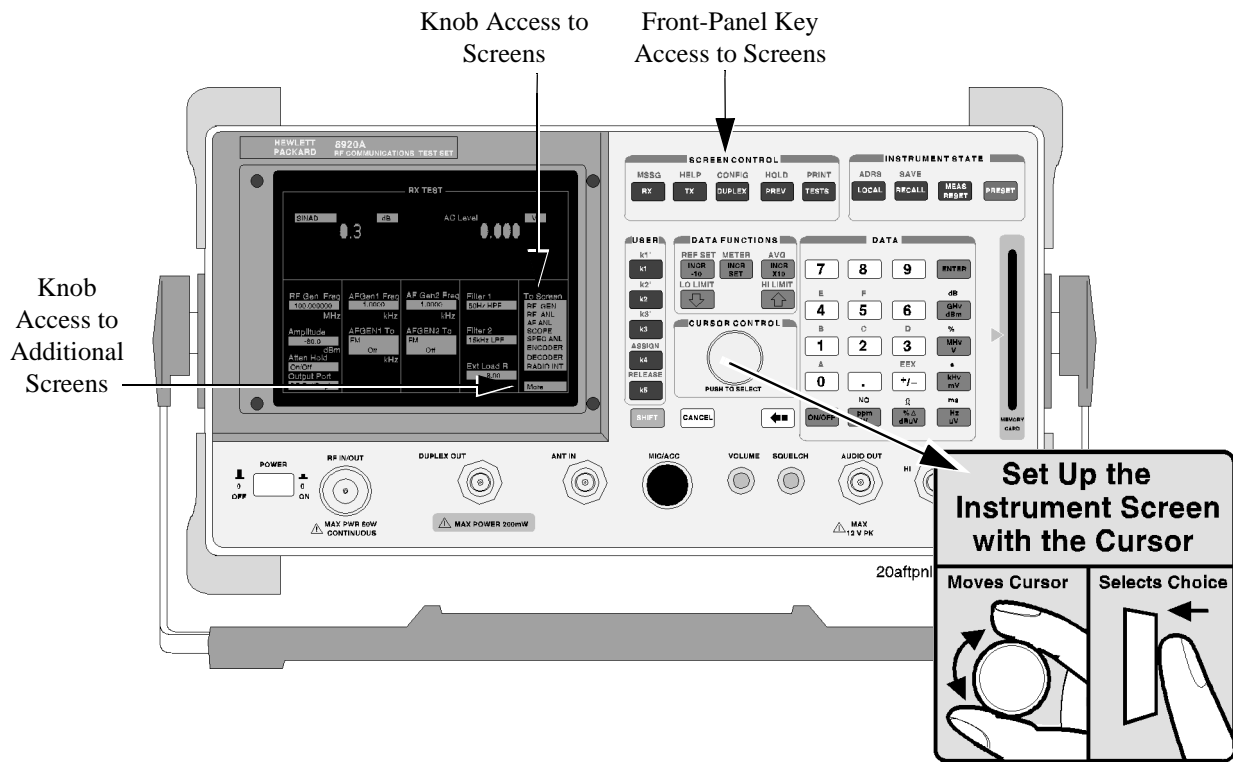

Figure 2 Accessing the Screens

Changing A Field's Setting

There are several types of CRT display fields in the Test Set. This section describes some of the different types of fields.

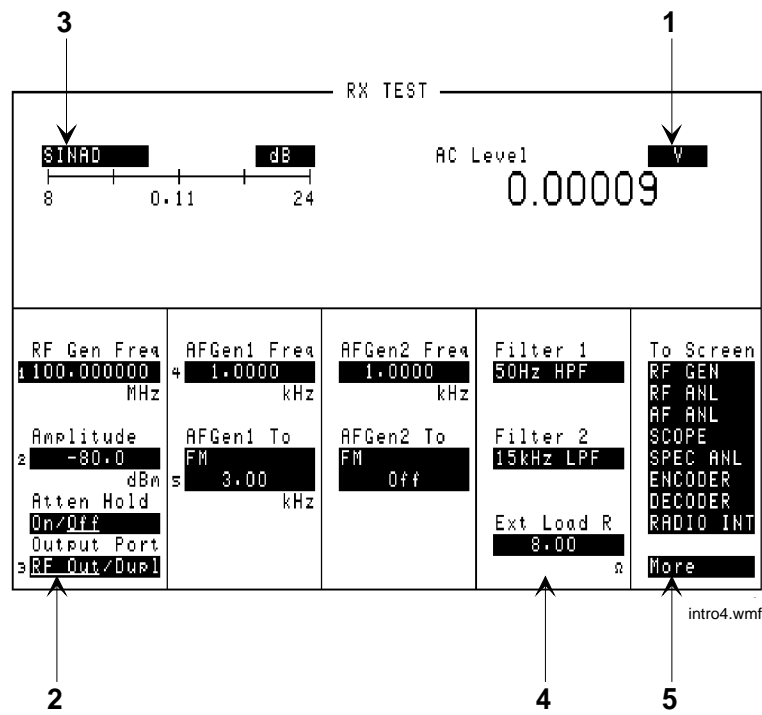

Figure 3 Different Types of Fields

Unit-of-Measure Field

Unit-of-measure can be changed to display measurements in different values or magnitudes. See item 1 in [figure 3](#) to see an example of a units-of-measure field.

To change a unit-of-measure

1. Position the cursor at the unit field on the display.
2. Press a key labeled with a different unit-of-measure (such as W).

If the new units are valid, the measurement value is displayed in the unit.

Underlined Immediate-Action Field

Underlined immediate action fields provide a choice of two settings. See item 2 in [figure 3](#) to see an example of an underlined immediate-action field.

To change an underlined entry

1. Position the cursor at the field.
2. Push the CURSOR CONTROL knob or the ENTER key to move the underline under the desired choice.

The underlined setting is immediately activated when selected.

One-of-Many Field

One-of-many fields display a list of choices when selected. See item 3 in [figure 3](#) to see an example of a one-of many field.

To make a one-of-many choice

1. Position the cursor at the field.
2. Push the Cursor Control knob or the ENTER key to display the choices.
3. Move the cursor through the choices by turning the knob.
4. Push the Cursor Control knob or the ENTER key to make the choice.

The choice is immediately activated when selected.

The **To screen** menu (see item 5 in [figure 3](#)) is a variation of the one-of-many field.

Numeric-Entry Field

Numeric-entry fields contain values for settings like External Load Resistance and RF Generator Frequency. See item 4 in [figure 3](#) to see an example of a numeric-entry field.

To change a value

1. Position the cursor at the field.
2. Key in the desired number using the DATA keys.
3. Press ENTER to select the choice.

OR

1. Position the cursor at the field.
2. Push the Cursor Control knob to highlight the desired choice.
3. Turn the knob to increment or decrement the value.
4. Push the Cursor Control knob or the ENTER key to select the choice.

How do I Verify that the Test Set is Operating Properly?

If your Test Set powers-up and displays the RX TEST screen, but you suspect an instrument problem, use the Instrument Quick Check to verify operation of the basic instrument functions.

If no failure is indicated by this test, but you still suspect a problem, refer to the “Performance Tests” information in the *Assembly Level Repair Manual*.

Instrument Quick Check

1. Set up the quick check:
 - a. Connect a cable between the DUPLEX OUT and ANT IN ports.
 - b. Turn instrument power on (if it is not already on).
 - c. Press PRESET.
 - d. Press DUPLEX to access the DUPLEX TEST screen.
 - e. Set the **Tune Mode** field to Manual.
 - f. Set the **Tune Freq** field to 825 MHz.
 - g. Set the **Input Port** field to Ant.
 - h. Set the **RF Gen Freq** field to 825 MHz.
 - i. Set the **Amplitude** field to -10 dBm.
 - j. Set the **Output Port** field to Dupl.
 - k. Verify that **AFGen1 Freq** is set to 1.0000 kHz, and that **AFGen1 To** is set to **FM** and 3.00 kHz.
 - l. Set the **AF An1 In** field to **FM Demod**.
 - m. Set the **Filter 1** field to 300Hz HPF.
 - n. Set the **Filter 2** field to 3kHz LPF.
 - o. Verify that **De-Emphasis** is **Off**.
 - p. Set the **Detector** field to **Pk+-/2**.
 - q. Turn the VOLUME knob clockwise until you hear a tone (1 kHz default for AFGen1 Freq).
2. Check the following readings:
 - SINAD should be >35 dB.
 - FM Deviation should be about 3.0 kHz.
3. Access the OSCILLOSCOPE screen using the **To Screen** menu. With the default **Vert/div** setting of 2 kHz and a default **Time/div** setting of 200 μ s, you should see two complete sinewaves across the screen.
4. Access the SPECTRUM ANALYZER¹ using the **To Screen** menu. You should see an 850 MHz FM carrier.
 1. Optional on some Test Set models.

Instrument Functional Diagram

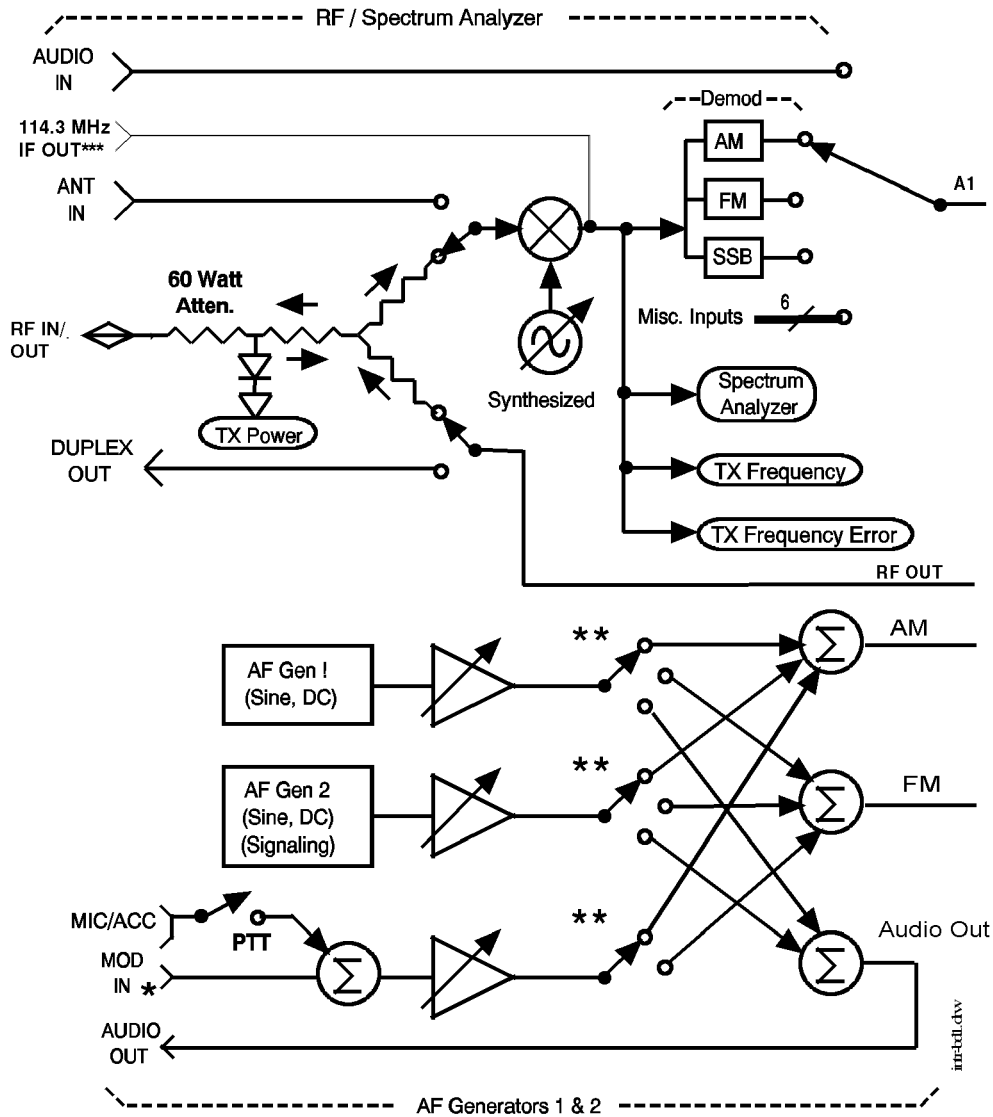

Figure 4 Instrument Functional Diagram (1 of 2)

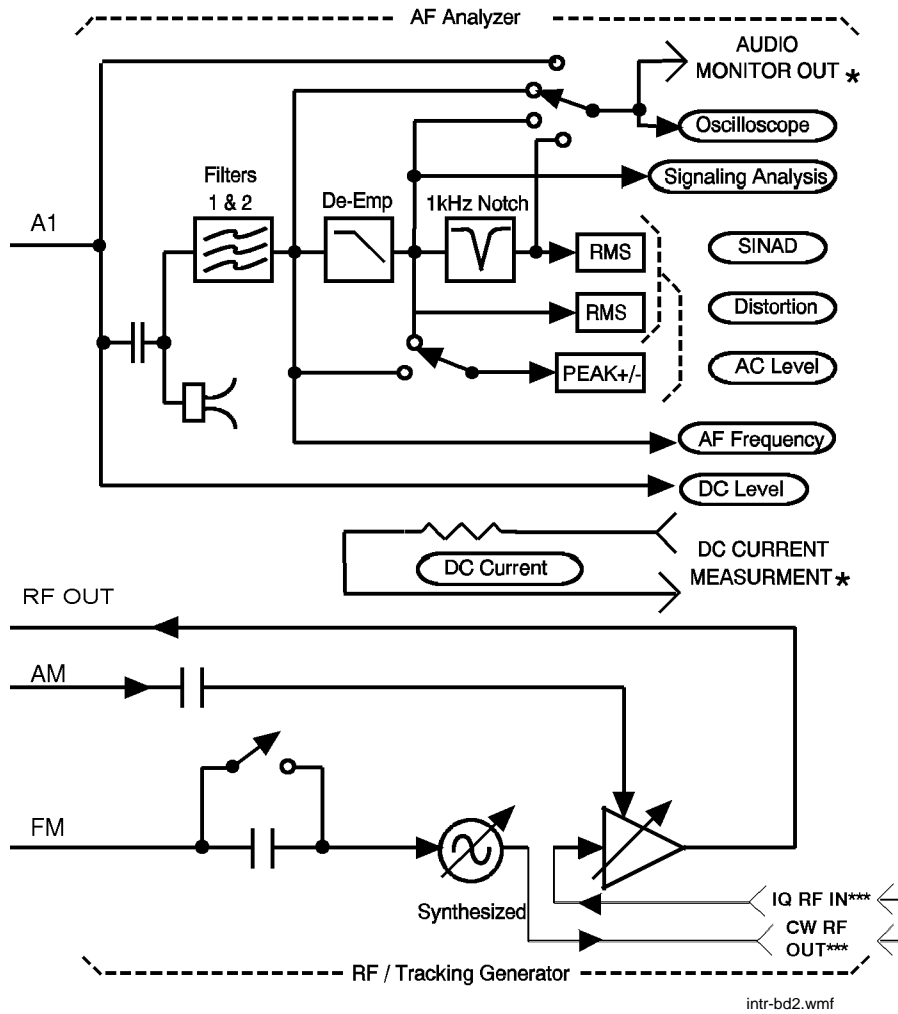

Figure 5 Instrument Functional Diagram (2 of 2)

Configuring Your Test Set

The CONFIGURE and I/O CONFIGURE screens contain a number of settings used to alter instrument operation and hardware communication settings. The HP-IB address, screen intensity, serial communication parameters, and several other settings, are changed in these screens.

Most CONFIGURE and I/O CONFIGURE screen entries are saved when the instrument is turned off.

General Operating Information

The following configuration information discusses general operating information for some of the fields in these screens.

To Set Screen Intensity

1. Access the CONFIGURE screen.
2. Select the **Intensity** field.
3. Rotate the knob to change the setting (1=dim, 8=bright).

To Set RF Voltage Interpretation (50 Ω /emf)

1. Access the CONFIGURE screen.
2. Position the cursor in front of the **RFGen Volts** field.
3. Press the Cursor Control knob or press ENTER to select **50 ohm** or **emf**.

Voltage settings can control either:

- the voltage across a 50-ohm load, or
- the open circuit voltage (emf).

This setting affects the RF Generator's and the Tracking Generator's amplitudes.

To Set the Date and Time

1. Access the CONFIGURE screen.
2. Select the **Date** field and use the DATA keys to enter the date in the format shown below the field.
3. Select the **Time** field and use the DATA keys to enter the time in the format shown below the field.

The Test Set has a built-in clock that keeps track of the date and time. It is powered by an internal battery to keep it operating when the instrument is off.

To Change the Beeper Volume

1. Access the CONFIGURE screen.
2. Select the **Beeper** field to display the volume choices.
3. Select the desired choice.

The beeper alerts you to important operating and measurement conditions. It beeps any time a message is displayed at the top of the screen. These messages warn you of conditions such as exceeding the RF input level or trying to set a field to an unacceptable value. Therefore, it is recommended that you do not disable the beeper.

To Verify or Change the Low-Battery Setting

1. Access the CONFIGURE screen.
2. The current time setting is shown under the **Low Battery** field.
3. Select that field to display a list of setting choices.
 - Select the desired time, or
 - Select **Disable** to eliminate the low-battery warning.

The low-battery warning system is used to alert you when you have not used any front-panel controls within a specified amount of time. This setting is only used with DC power. It does not actually monitor the DC supply voltage. Since batteries are most often used for a DC supply, this function helps you conserve power by reminding you that the Test Set is still turned on.

When the specified time has elapsed between front-panel entries, the Beeper sounds and a message appears at the top of the screen alerting you to the condition.

This setting is saved when the instrument is turned off.

Operating Overview

The information in this section discusses some frequently used operating features of the Test Set.

From reading [chapter 1, "Get Started"](#) you should understand:

- What “fields” and “screens” are.
- How to use the Cursor Control knob to select different fields and screens.

Interaction Between Screens

Most fields operate *globally*; changing the setting in any screen automatically changes that setting in *all* screens where it is available. **AFGen1 Freq** is an example of this field type.

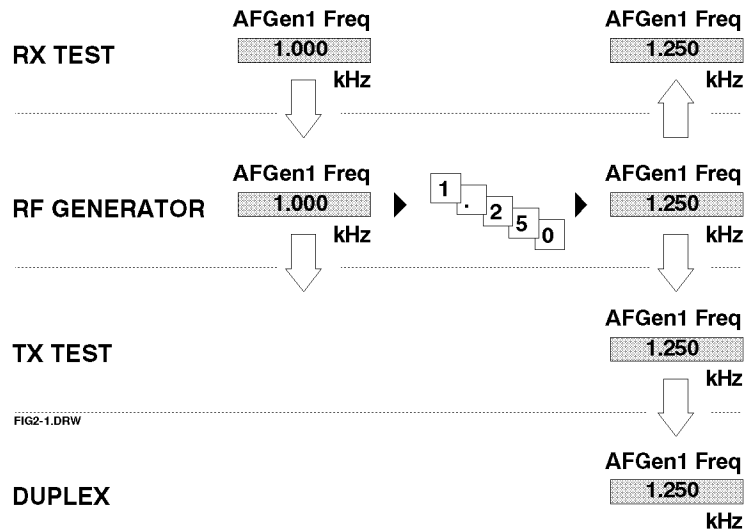

Figure 6 Example of How Global Fields Work

Priority fields give the RX TEST and TX TEST screens priority control of their settings. No matter what these fields were set to in other screens, if the RX TEST or TX TEST screen is accessed, the field changes to whatever it was last set to in these screens. The RF Generator's **Amplitude** field is an example of this field type. These fields and their preset values are listed in [table 3](#).

Table 3 Priority RX TEST and TX TEST Fields

Priority Field	RX TEST	TX TEST
RF Gen Amplitude	Presets to -80 dBm (changeable)	Always Off
AFGen1 To	Presets to FM (changeable)	Always Audio Out
AF Anl In	Always Audio In	Presets to FM Demod (changeable)
Detector	Always RMS	Presets to Pk +- Max (changeable)
De-emphasis	Always Off	Presets to 750 μ s (changeable)
AF Anl Measurement	Presets to SINAD (changeable)	Presets to Audio Freq (changeable)

Using your Test Set, duplicate the steps in [figure 7](#) to demonstrate how the Priority fields operate.

1. Access the RX TEST screen and set the Amplitude to -50 dBm.

Amplitude
-50



2. Access the RF GENERATOR screen and change the Amplitude to -75 dBm.

Amplitude -50 → [-] 7 → [5] → Amplitude -75



3. Return to the RX TEST screen. Notice that the Amplitude changes back to -50 dBm.

Amplitude
-50



4. Return to the RF GENERATOR screen. The Amplitude is no longer where you set it in step 2 (-75 dBm). The Amplitude is -50 dBm.

Amplitude
-50

Since the RX TEST screen has priority control over this field, the RF GENERATOR screen's Amplitude setting changed when RX TEST was accessed.

fig2-2.wmf

Figure 7

Example of How Priority Fields Work

Displaying Measurements

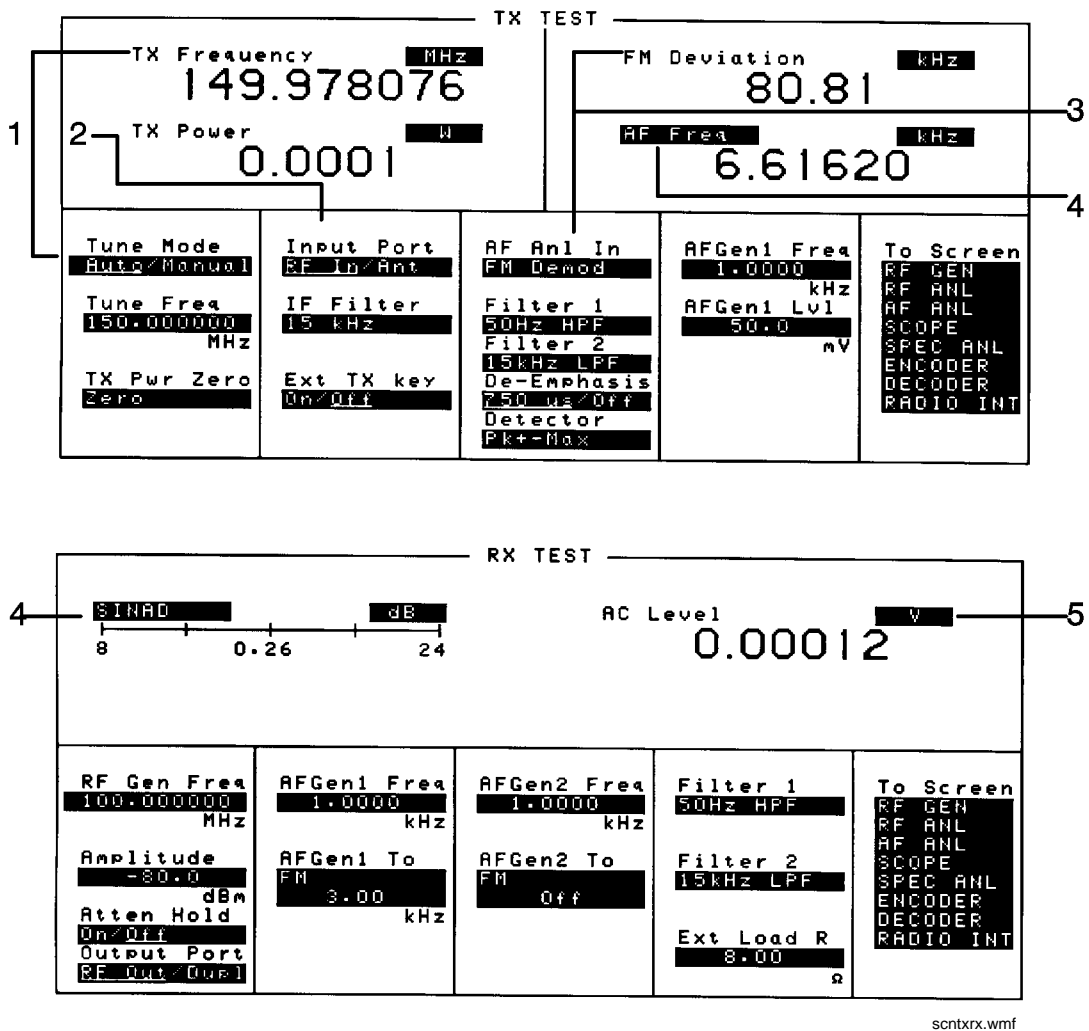

Figure 8 Where To Access Measurements

Displaying RF Measurements

Transmitter Frequency

TX Frequency is displayed when **Tune Mode** is set to **Auto**. (Refer to item (1) in [figure 8 on page 57](#).)

Transmitter Frequency Error

TX Freq Error is displayed when **Tune Mode** is set to **Manual**. (Refer to item (1) in [figure 8 on page 57](#).)

Transmitter Power

TX Power is only measured and displayed here when the **Input Port** is set to **RF In** (Refer to item (2) in [figure 8 on page 57](#)). If **Ant** (antenna) is selected, the measurement is replaced by four dashes (- - - -).

You can measure low power levels on the ANT IN port using the Spectrum Analyzer.¹

Refer to the [TX Power field description, on page 559](#) and the [TX Pwr Zero field description, on page 560](#) for more information on measuring transmitter power.

CAUTION:

Connecting a signal of >200 mW to the ANT IN (antenna) port can cause instrument damage (although internal protection circuits can typically withstand a short-duration signal of 1 or 2 Watts). If the overpower circuit is triggered, remove the signal from the ANT IN port and turn the Test Set off and on to reset it.

1. Optional on some Test Set models.

Displaying AF Measurements

FM Deviation, AM Depth, AC Level

The **AF An1 In** setting determines the AF Analyzer's input and the measurement displayed in the top-right corner of the measurement area (see [table 4](#)). These measurements are available in the TX TEST, DUPLEX TEST, RF GENERATOR, RF ANALYZER, and AF ANALYZER screens. (Refer to item (3) in [figure 8 on page 57](#).)

Table 4 AF Measurements Selected by AF Analyzer Input Setting

Measurement	AF An1 In Setting
FM Deviation	FM Demod, FM Mod
AM Depth	AM Demod, AM Mod
AM Depth ^a	SSB Demod, AudioIn, Radio Int, Ext Mod, Mic Mod, Audio Out

- a. AC Level is also measured in the RX TEST screen, but always uses the AUDIO IN connector as the input. (Refer to item (5) in [figure 8 on page 57](#).)

SINAD, Distortion, SNR, AF Frequency, DC Level, DC Current

Selecting the currently-displayed measurement causes the **To Screen** menu to be replaced by a list of measurement choices. Select the new choice to replace the old measurement. These measurements are available in the RX TEST, TX TEST, DUPLEX TEST, RF GENERATOR, RF ANALYZER, and AF ANALYZER screens. (Refer to item (4) in [figure 8 on page 57](#))

The Distortion measurement is only for a 1 kHz tone.

The SINAD measurement is normally shown using an analog-type meter and small digits, but can be changed to display in large digits only. (See ["To Use the Analog METER Format" on page 62.](#))

DC Current can only be measured using the rear-panel DC CURRENT MEASUREMENT connections.¹

Selecting SNR (Signal/Noise Ratio) turns off the other audio measurement. For more information on making this measurement, see the [RF Gen Freq field description, on page 499.](#)

AF Power

AF Power is measured in the RX TEST screen by specifying the external load resistance, **Ext Load R**, and changing the unit of measure for the **AC Level** measurement to W (Watts), mW, or dBm. (The milliwatt (mW) unit is selected by pressing SHIFT, ENTER) Refer to item (5) [figure 8 on page 57.](#)

1. Optional on some Test Set models.

To Change the Measurement's Unit-of-Measure

1. Position the cursor in front of the present unit-of-measurement.
2. Press the key labeled with the desired unit.

All measurements allow you to change the associated unit-of-measure. For instance; the **TX Power** measurement is usually displayed in Watts, but can be changed to display in mW, dBm, V, mV, or dB μ V.

Select mW by pressing SHIFT, ENTER.

For example; to display transmitter power in units of dBm instead of Watts:

1. Move the cursor in front of the unit-of-measure for the **TX Power** measurement (**W**).
2. Press the dBm key. The measurement value is changed immediately to display in dBm.

To Use the Analog METER Format

To display measurement results using the analog meter format, use the following procedure.

1. Position the cursor in front of the unit-of-measure for the measurement you want to display.
2. Press and release the **SHIFT** key, then the **INCR SET** key to display the Meters menu in the lower-right corner of the screen.
3. Select **On/Off** to display the meter.
4. Repeat steps 1 and 2 to enter each meter end point and the meter intervals.
5. Repeat steps 1, 2, and 3 to cancel the METER function.

The METER function displays an equivalent analog display. (This is the SINAD measurement's default state when the instrument is turned on or preset). As the measurement is displayed graphically on the meter, the value is also displayed in small digits below the meter.

You can specify the high and low end points and display interval, or you can use the default meter settings.

This function is only available for measurements displayed using the large digits, such as the measurements displayed in the RX TEST and TX TEST screens.

To Make Beat Frequency Measurements

1. Select the DUPLEX TEST screen to set up for beat frequency oscillator measurements.
2. Set the **AF An1 In** field to **SSB Demod**.
3. Manually adjust the **Tune Freq** field to the desired carrier frequency.

Entering and Changing Numbers

Values for numeric entry fields can be entered and changed using various methods, depending on your testing needs. The unit-of-measure for some of these fields can also be changed (such as changing the RF Generator's **Amplitude** units from dBm to μV).

To Enter Numbers

1. Position the cursor in front of the numeric entry field to be changed.
2. Use one of the following methods:
 - a. enter the number and unit-of-measure directly using the keypad,
or
 - b. press the Cursor Control knob or ENTER to highlight the field, and use the knob,
or
 - c. use the down-arrow or the up-arrow keys to increment or decrement the present value.

Decimal Values

Decimal values are used for most numeric entry fields, such as the **RF Gen Freq** setting. The acceptable entries for decimal values are 0 through 9, ., +/-, and EEX.

The +/- key is used for entering negative numbers. For example; when entering the RF Generator **Amplitude** you can enter this sequence to set the value to -47 dBm: +/- 4 7 dBm.

The EEX key can be used when entering exponential notation. For example; to enter 1.25×10^3 kHz you could use the sequence: 1 . 2 5 EEX 3 kHz.

Hexadecimal Values

Hexadecimal (Hex) values are used for entering some signaling parameters in the ENCODER, such as AMPS **Filler** data field, and for specifying remote communications parameters, such as the RADIO INTERFACE **Output Data** field. The acceptable entries for decimal values are 0 through 9 and A through F. No unit-of-measure is associated with these values.

Hexadecimal values are either entered from the keypad (A through F are shifted functions), or by using the **Choices** menu displayed when certain fields are selected (such as the AMPS **Filler** field).

To Enter and Change the Unit-of-Measure

Entering the Unit-of-Measure for Settings

When a number is entered, the unit-of-measure is either specified or implied.

When the unit is implied, the current unit is used. For example; if the present RF frequency is 250 MHz, and you want to change it to 225 MHz, you would enter this sequence: 2 2 5 ENTER.

When the unit is specified, the units change to whatever you specify. For example; if the present **RF Gen Freq** setting is 250 MHz, and you want to change it to 455 kHz, you would enter this sequence: 4 5 5 kHz.

Changing the Unit-of-Measure for Settings

To change the present unit-of-measure, position the cursor in front of the field and press the key labeled with the desired unit. For example, position the cursor in front of the **RF Gen Freq** field and push GHz or kHz to display the setting in either of these units.

To Change the Increment or Decrement Setting

Using the Pre-Defined Increment/Decrement Keys

The INCR $\times 10$] and INCR $\div 10$] keys change the increment/decrement value by a factor of 10.

For example; if the **Tune Freq** presently changes by 10 MHz for every click of the knob or push of the down-arrow or up-arrow keys, pushing INCR $\times 10$] once changes the increment value to 100 MHz.

Specifying An Increment Value

The INCR SET key is used to assign a specific increment value. The increment value may use different units than the field you are incrementing/decrementing. For instance; if the RF Generator **Amplitude** setting is displayed in dB μ V, you could increment in units of dB or mV.

To change the increment value;

1. Move the cursor to the numeric entry field to be changed.
2. Press INCR SET, and enter the desired value and unit-of-measure using the DATA keys.
3. Use the down-arrow and up-arrow keys or CURSOR CONTROL knob to change the field's value by the increment value you set.

Example of Setting an Increment Value

This example changes the **Tune Freq** in increments of 15 MHz.

1. Access the TX TEST screen and position the cursor in front of the **Tune Freq** field.
2. Press 1 0 0 MHz to set the frequency at 100 MHz.
3. Press INCR SET 1 5 MHz.
4. Turn the Cursor Control knob. The field's value changes by 15 MHz for each knob click.

Printing A Screen

To Print A Screen's Contents

1. Connect a printer to the appropriate rear-panel connector.
2. Access the PRINT CONFIGURE screen from the **More** menu and set the **Printer Port** field to the appropriate type of printer connection.

If HP-IB is selected, enter the HP-IB **Printer Address** of the printer.

3. Select the type of printer you are using in the **Model** field. If your printer is not listed, configure your printer to emulate one that is listed.
4. Enter a **Print Title** using the knob, if desired. This text will appear at the top of your printout.
5. Display the screen you want to print and press and release the SHIFT key, then the TESTS key to access the PRINT function.

To interrupt printing, select the **Abort Print** field on the PRINT CONFIGURE screen.

Using Measurement Limit Indicators

The LO LIMIT and HI LIMIT functions are used to define a measurement “window” to alert you to measurements that are outside these limits. When limits are assigned, Lo and/or Hi appear by the measurement.

A measurement that goes above or below the defined limits causes three things to happen:

1. A message appears at the top of the screen indicating a limit was exceeded.
2. The Lo or Hi indicator by the measurement flashes.
3. The Beeper beeps if it is has been enabled in the CONFIGURE screen.

Limits are helpful when you can't watch the Test Set's display while you are making an adjustment on the equipment you are testing or repairing. They are also a convenient way of alerting you to long-term measurement drift without having to observe the screen.

To Set A HI and/or LO LIMIT

1. Position the cursor in front of the unit-of-measure for the measurement that you are setting limits for.
2. Press and release the SHIFT key, then the down-arrow key to access the LO LIMIT function, and enter the measurement's low-limit value and its unit-of-measure.¹
3. Press and release the SHIFT key, then the up-arrow key to access the HI LIMIT function, and enter the measurement's high-limit value and its unit-of-measure.¹

1. The fundamental unit for the LIMITs does not have to be the same as the measurement's units. For instance; when measuring AC Level in Volts, you can set HI and LO LIMITs in units of dBm.

To Reset or Remove Limits

To *reset* a limit that has been exceeded

1. Position the cursor in front of the measurement's unit-of-measure.
2. Press and release the SHIFT key, then the down-arrow (or up-arrow key) to access the LO LIMIT (or HI LIMIT) function, then press ENTER or MEAS RESET.

To *remove* a limit

1. Position the cursor in front of the unit-of-measure for the assigned limit.
2. Press and release the SHIFT key, then the down-arrow (or up-arrow key) to access the LO LIMIT (or HI LIMIT) function, then press ON/OFF.

Example of Setting HI and LO LIMITs

This example sets limits for the **TX Freq Error** measurement. Limits are being set to indicate if a 100 MHz carrier varies more than ± 10 kHz.

1. Position the cursor in front of the unit-of-measure for the **TX FREQ ERROR** measurement (the default is **kHz**).
2. Press and release the SHIFT key, then the down-arrow to access the LO LIMIT function, then enter 1 0 kHz.
3. Press and release the SHIFT key, then the up-arrow to access the HI LIMIT function, then enter 1 0 kHz.

Averaging Measurements

The AVG (average) function allows you to display the average value of a number of measurements. You enter the number of measurement samples used to calculate and display the measurement average. This dampens the effects of rapidly changing measurements, providing a more usable measurement display.

To Use Measurement Averaging

1. Position the cursor in front of the measurement's unit-of-measure.
2. Press and release the SHIFT key, then the INCR $\times 10$ key to access the AVG function. The default number of average samples is displayed below the measurement.
 - Enter the desired number of measurement samples to be used for calculating the average, or
 - Press ON/OFF to use the currently-displayed number of samples.
3. To turn averaging off, position the cursor in front of the unit-of-measure and press and release the SHIFT key, then the INCR $\times 10$ key to access the AVG function, then press the ON/OFF key.

When the averaging function is first enabled, a numeric average is calculated and displayed each time a measurement is made. This continues until the specified number of samples is reached. From that point on, the averaging function performs an exponential filtering operation that mimics an RC filter.

Because of the exponential response, any large measurement changes result in a displayed value that ramps up or down to the actual measured value.

Pressing MEAS RESET clears the measurement history for all measurements and starts the averaging process over.

For more information on the theory of this filtering technique, refer to the April 1986 issue of the *HP Journal*, page 24.

Example of Using Measurement Averaging

This example enables the SINAD measurement to be averaged using 25 samples.

1. Press PRESET and wait for the instrument to display the RX TEST screen.
2. Position the cursor in front of the unit-of-measure for the SINAD measurement (default is dB).
3. Press and release the SHIFT key, then the INCR $\times 10$ key to access the AVG function, enter 25, then press the ENTER key. **avg** appears below the displayed measurement value to indicate that averaging is being used.

Setting A Measurement Reference

The REF SET function establishes a measurement reference point. This allows you to make a direct comparison between two measurement results, or between a measurement standard and the actual measurement results.

Referenced measurements are displayed in one of two ways, depending on the type of measurement:

Displayed value = Measurement – Reference. The difference between the measured value and the reference value is displayed in the same unit-of-measure.

or

Displayed value = Measurement ÷ Reference. A ratio of the measured value to the reference value is displayed in dB.

To Use the Present Value as a Reference

Position the cursor in front of the unit-of-measure for the measurement you want to set the reference for.

1. Press and release the SHIFT key, then the INCR ÷10 key to access the REF SET function; then press enter ENTER.
2. **Ref** appears below the measurement.

The measurement displayed is now referenced to the measurement value present when the reference was set.

To Set a Specific Reference

1. Position the cursor in front of the unit-of-measure for the measurement you want to set the reference for.
2. Press and release the SHIFT key, then the INCR ÷10 key to access the REF SET function.
3. Enter a reference value.
4. **Ref** appears below the measurement value to indicate a reference has been set.

The measurement displayed is now referenced to the value you entered.

Using Memory Cards

OTP (One Time Programmable) cards provide removable read-only storage. File editing and erasure are not possible. These cards cannot be programmed by the Test Set; they require a special memory card programmer to save files.

SRAM cards provide removable read/write memory for your files, similar to a flexible disk. Data can be stored, re-stored, read, or erased as needed.

SRAM memory cards require a battery to maintain stored information.

Table 5 **Memory Card Part Numbers**

Memory	Type	Part Number
32 kilobytes	SRAM	HP 85700A
128 kilobytes	OTP	HP 85701A
128 kilobytes	SRAM	HP 85702A
256 kilobytes	OTP	HP 85703A
256 kilobytes	SRAM	HP 85704A
512 kilobytes	SRAM	HP 85705A
512 kilobytes	OTP	HP 85706A

Inserting and Removing Memory Cards

Figure 9 illustrates how to insert a memory card into the Test Set's front panel. To remove a memory card, simply pull it out.

The Test Set's memory-card label is marked with an arrow that must be inserted on the same side as the arrow shown on the front-panel slot.

Memory cards may be inserted and removed with the Test Set powered on or off.

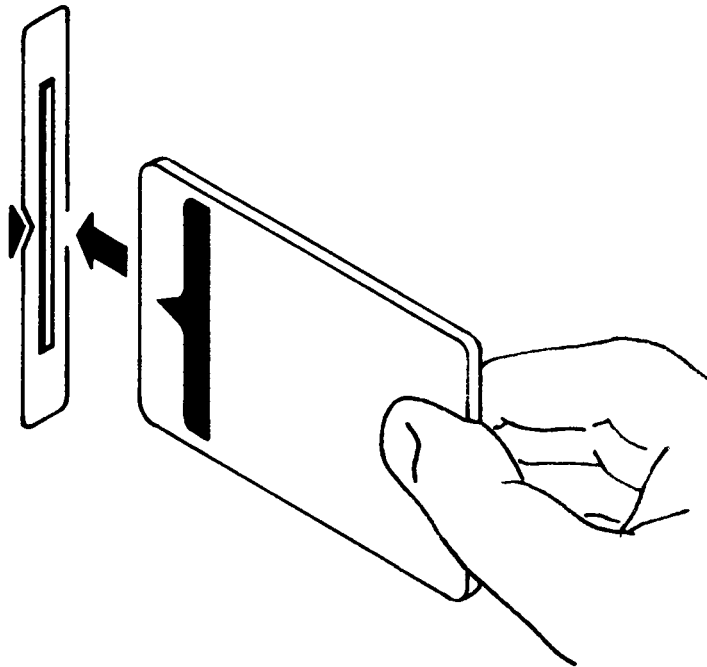

Figure 9 **Inserting a Memory Card**

Setting the Write-Protect Switch

The SRAM memory card's write-protect switch lets the user secure its contents from being overwritten or erased. The switch has two positions (see [figure 10](#)):

- *Read-write* – The memory-card contents can be changed or erased, and new files may be written on the card.
- *Read-only* – The memory-card contents can be read by the Test Set, but cannot be changed or erased.

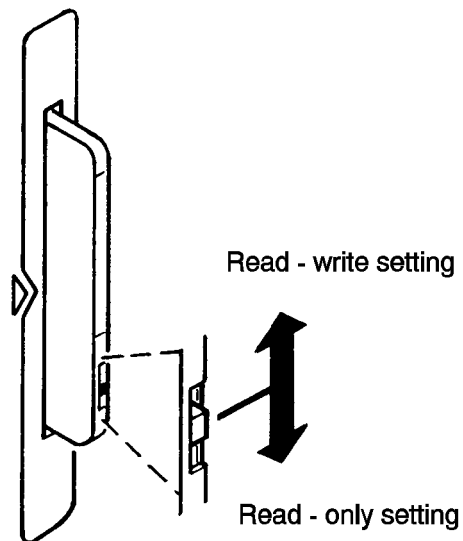

Figure 10 **Setting the SRAM Write-Protect Switch**

The Memory Card Battery

SRAM memory cards use a lithium battery to power the card. Listed below are the batteries for the Test Set's SRAM cards. SRAM cards typically retain data for over 1 year at 25° C. To retain data, the battery should be replaced annually.

SRAM Card Battery Part Numbers - CR2016 or HP 1420-0383

Replacing the Battery

Turn the Test Set on and insert the memory card. An inserted memory card takes power from the Test Set, preventing the card's contents from being lost.

5. Hold the memory card in the slot with one hand and pull the battery holder out with your other hand. (See [figure 11](#) .)
6. Install the battery with the side marked "+" on the same side marked "+" on the battery holder. Avoid touching the flat sides of the battery, finger oils may contaminate battery contacts in the memory-card.
7. Re-insert the battery holder into the memory card.
8. Remove the memory card from the Test Set.

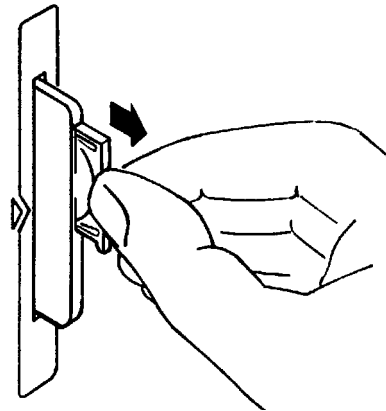

Figure 11 **Replacing the Memory Card's Battery**

WARNING: Do not mutilate, puncture, or dispose of batteries in fire. The batteries can burst or explode, releasing hazardous chemicals. Discard unused batteries according to the manufacturer's instructions.

Memory Card Initialization

All new SRAM cards must be initialized before they can be used to store information. The RAM_MANAGER procedure stored on the internal ROM Disk can be used to quickly initialize any SRAM memory card.

SRAM Memory Cards can also be initialized from the TESTS screen by inserting the memory card into the front-panel slot and selecting the Save/Delete field, then selecting **Init Card** or pressing the **K3** USER key to initialize a card. Follow the on screen instructions to complete the process.

If the error message **ERROR 85 Medium uninitialized** appears on the screen the memory card has not been properly initialized. Check the SRAM battery to ensure that it's charged and inserted correctly in the battery holder.

Saving and Recalling Instrument Setups

The SAVE and RECALL functions allow you to store different instrument setups and retrieve them later, eliminating the task of re-configuring the Test Set.

The number of available save registers depends on how many changes were made to the *base* instrument setup for each save. (See "**BASE Settings**" on page 79.) The smaller the number of changes, the greater the number of save registers that can be used (typically over 200).

Save/Recall register settings can be saved to several types of mass storage. This allows you to “back up the settings in case you need to clear them from memory (see "**Memory Considerations**" on page 79) for running large programs, or when a firmware upgrade is performed (see "**Save/Recall**" on page 441).

To Save an Instrument Setup

Use the **More** menu to access the I/O CONFIGURE screen.)

1. Select the storage media using the **Save/Recall** field. (The default is internal memory.)
2. Make any changes to the instrument that you want to save in a register.
3. Press and release the SHIFT key then the RECALL key to access the SAVE function.
4. Use the DATA keys or the **save** menu at the bottom right of the screen to enter the register's name.

To Recall an Instrument Setup

Use the **More** menu to access the I/O CONFIGURE screen.

1. Select the media to recall settings from using the **Save/Recall** field. The default is internal memory.
2. Press RECALL.
3. Use the knob to select the desired setup to be recalled from the **Recall** menu at the bottom-right of the screen.

Example of Saving and Recalling an Instrument Setup

This example SAVES changes made to the RX TEST screen, and then RECALLS them. The register is saved to wherever the **Save/Recall** field is set (**internal** memory - unless you have changed it).

1. Access the RX TEST screen and set the **RF Gen Freq** to 500 MHz.
2. Set **Amplitude** to -35 dBm.
3. Press and release the SHIFT key then the RECALL key to access the SAVE function. A prompt appears at the top of the screen asking you to enter a name.
4. Using the DATA keys, press 1 2 3 ENTER to assign a name to these changes.
5. Press PRESET and wait for the instrument to return to normal operation.
6. If not already displayed, access the RX TEST screen. Notice that the **RF Gen Freq** and **Amplitude** settings are reset to their preset values.
7. Press RECALL 1 2 3 ENTER. The **RF Gen Freq** and **Amplitude** are changed to the settings you saved in register 123 (500 MHz and -35 dBm).

To Remove (Clear) an Individual Save Register

Specify where the register is stored using the **Save/Recall** field on the I/O CONFIGURE screen.

1. Press RECALL.
2. Use the knob to position the cursor in front of the register to be removed from the **Recall** menu at the bottom-right of the screen. The register name and percentage of memory occupied by that register are indicated at the top of the screen.
3. Press ON/OFF. A prompt appears, asking if you want to delete the save register.
4. Press YES.

To Clear All Save Registers

1. Press RECALL.
2. Use the knob to position the cursor in front of the ***Clr All*** entry in the **Recall** menu at the bottom-right of the screen.
3. Press the knob or press ENTER. A prompt appears at the top of the screen to verify that you want to clear all registers.
4. Press YES.

Register Names

You can use any number, letter, or combination of numbers and letters as a name for storing instrument settings. For instance; if you want to save a setup for testing a “Vulcan7” radio, you can save the setting as “VULCAN7”.

Two register names are reserved for special purposes: POWERON and BASE.

POWERON Settings

When the Test Set is turned on, it uses a set of instrument setup parameters specified at the time of manufacture. You can have the instrument power up in a different state by making the desired changes to the original settings, and then saving them using the name POWERON.

The next time the instrument is turned on, the instrument returns to the state present when you saved the POWERON setting. For instance; if the OSCILLOSCOPE screen was displayed when POWERON was saved, it is the screen that is displayed when you turn the instrument on.

BASE Settings

The *BASE* register contains any field settings the user has saved that are different from the instrument preset state. It establishes a reference point for all future saves. If a base is not saved, the preset state is used as the reference.

When you save an instrument setup, the new setup is compared to the base settings, and any *differences* are stored under the register name you supply. Because only differences are stored, a much larger number of instrument setups can be saved than if the contents of every field was saved.

When you recall an instrument setting, every field is reset to the base settings. The saved settings are then used to re-establish the desired instrument setup.

CAUTION:

Since each save/recall register only contains the differences between the setup being saved and the present *base* register settings, changing the base settings causes all other saved setups to be erased from memory (including the POWERON setting if one has been saved).

Unless you consistently change the same fields to the same value each time you use the instrument, you should avoid creating your own BASE settings.

Memory Considerations

When the **Save/Recall** field of the I/O CONFIGURE screen is set to **Internal**, programs are saved to the same non-volatile RAM used to create RAM Disk(s) and run IBASIC programs. By saving a large number of instrument setups, you reduce the amount of RAM available to run programs. If you get a “memory overflow” message while trying to load a program, you must clear one or more save/recall registers to free RAM space.

Instrument Hardware Changes

Recalling a saved register that uses a hardware option that has been removed (such as an audio filter) results in unspecified operation. Re-install the needed option before attempting to recall the associated register(s).

Using USER Keys

User keys instantly access instrument settings without using the knob. You can use user keys to move quickly between fields on the same screen, and to access field settings that are not normally available on the screen you are using.

Local user keys are used to move between settings on the screen that is displayed. When the user key is pressed, the cursor instantly moves to, and selects, the assigned field; eliminating the need to turn and push the knob. Five local user keys are available for each screen: k1, k2, k3, k4, and k5.

Five factory-assigned local user keys are available in each screen; however, using these keys removes any other local user keys you may have already set up.

Global user keys are used to access settings that are not available on the current screen. Three global user keys are available: k1', k2', and k3'. (These are shifted functions of the local user keys.)

When defining user keys, the *ASSIGN* function is used to create key definitions; the *RELEASE* function removes the definitions. Re-assigning a user key to a different field setting automatically releases it from the setting it was previously associated with.

To Use the Pre-Assigned Local USER Keys

1. Press and release the SHIFT key, then the k4 key to access the ASSIGN function; then press the ENTER key. The numbers 1 through 5 appear in front of various fields. (See [figure 12](#).)
2. Press the different local user keys (k1 to k5) and notice how the cursor immediately moves to the corresponding field.
3. To stop using the default local user keys, press and release the SHIFT key, then the k5 key to access the RELEASE function; then press the ENTER key.

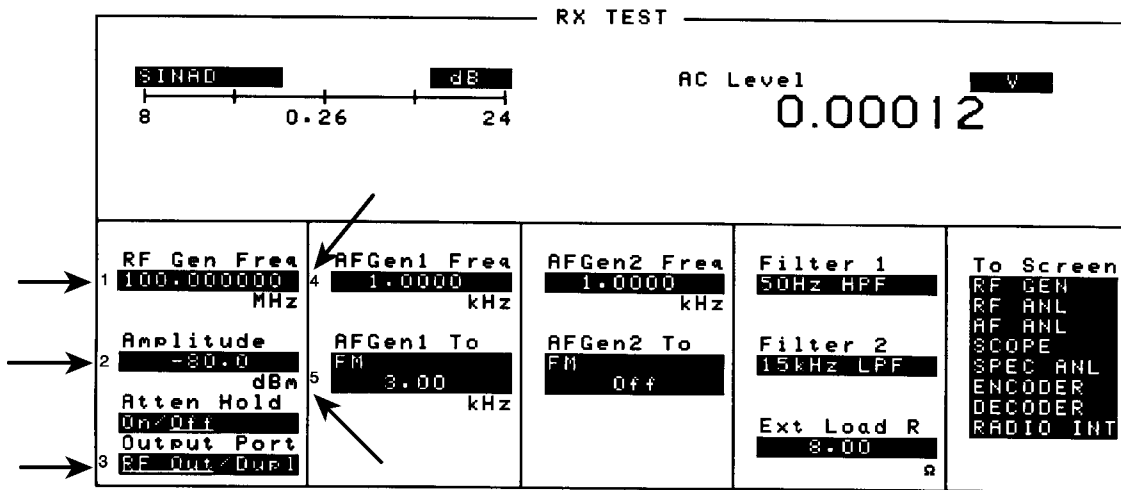

scnusr.wmf

Figure 12 An Example of Pre-Assigned Local User Keys

To Assign Local USER Keys

1. Move the cursor to the field you want to assign a local user key to.
2. Press and release the SHIFT key, then the k4 key to access the ASSIGN function. Then press a local USER key (k1-k5). The user key number appears in front of the field you assigned it to.

Example of Assigning a Local USER Key

Use this example to assign local USER key k1 to the **Filter 1** field in the RX TEST screen.

1. Access the RX TEST screen and position the cursor in front of the **Filter 1** field.
2. Press and release the SHIFT key, then the k4 key to access the ASSIGN function; then press k1. A small **1** appears next to the field indicating that USER key k1 has been assigned to it.
3. Move the cursor to any other field on the screen and press k1. The cursor immediately returns to the **Filter 1** field. The field is also highlighted to change the entry using the CURSOR CONTROL knob or arrow keys.

To Release Local USER Keys

1. Display the screen containing the user key assignment to be removed.
2. Press and release the SHIFT key, then the k5 key to access the RELEASE function; then press the USER key (k1-k5).

To Assign Global USER Keys

1. Move the cursor to the field you want to assign a global user key to.
2. Press and release the SHIFT key, then the k4 key to access the ASSIGN function. Then press SHIFT and a global USER key (k1' - k3'). Unlike a local user key, the user key number *does not* appear at this field; instead, a prompt appears at the top of the screen confirming the key assignment.

Example of Assigning a Global USER Key

Use this example to assign global USER key k1' to the **AF An1 In** field, and then access this field from the OSCILLOSCOPE screen.

1. Access the AF ANALYZER screen and position the cursor in front of the **AF An1 In** field.
2. Press and release the SHIFT key, then the k4 key to access the ASSIGN function.
3. Press SHIFT, k1'. Notice the prompt **Global User key 1 assigned.** at the top of the screen.
4. Access the OSCILLOSCOPE screen.
5. Press SHIFT, k1'.

AF An1 Input, FM Demod is displayed at the top of the screen (assuming the present input is set to FM Demod). To change the input, use the arrow keys (down-arrow or up-arrow), or press ENTER to access the **Choices** menu.

A field that is accessed using a global user key is only displayed at the top of the screen while it is being accessed. Moving the cursor to any other field in the screen causes the user key field to disappear until it is accessed again.

To Release Global USER Keys

1. Move the cursor to the field with the global user key assigned to it.
2. Press and release the SHIFT key, then the k5 key to access the RELEASE function. Then press SHIFT and the USER key to be released (k1'-k3').

Setting an RF Generator/Analyzer Offset

You can set a fixed frequency offset between the RF Generator and the RF Analyzer. This feature is convenient for testing radios with a fixed transmit/receive frequency offset.

To Set an RF Offset

1. Access the CONFIGURE screen.
2. Position the cursor in front of the **RF Offset** field, and press the Cursor Control knob, or press ENTER to turn the offset On or Off.
3. Select the **(Gen) - (An1)** field and enter the frequency offset value.

Example of Setting an RF Offset

1. Access the CONFIGURE screen.
2. Set the **RF Offset** to **On**.
3. Enter an offset frequency (**(Gen) - (An1)**) of 10 MHz.
4. Access the DUPLEX screen.
5. Set the **Tune Mode** to **Manual**.¹
6. Select the **RF Gen Freq** field, and rotate the Cursor Control knob to vary the RF Generator's frequency.
7. Notice that the **Tune Freq** value changes to maintain the 10 MHz difference between the generator and the analyzer.

1. Manual tuning is used in this example to prevent possible unexpected Tune Frequency changes during the procedure.

Using Remote Control

The Test Set can be remotely controlled several ways:

- Using HP-IB control from a computer/controller.
- Using IBASIC programs on memory cards.
- Using an ASCII terminal connected to the serial port.

Using HP-IB Control

The *Programmer's Guide* contains information on writing HP-IB control programs for the Test Set. Programming examples and a syntax listing provide general HP-IB operation guidelines.

Running IBASIC Programs from Memory Cards

The documentation shipped with HP 11807 software packages explains how to run those programs from memory cards. Refer to the *Programmer's Guide* for detailed information on using memory cards with your own IBASIC programs.

Using an ASCII Terminal

Connecting an ASCII terminal to the serial port allows you to remotely operate the Test Set by entering characters that represent each front-panel control.

Before you can use this feature, you must first set the required serial port settings in the I/O CONFIGURE screen, and make any hardware connections.

The Serial Port connections are described in [chapter 24, "Connector, Key, and Knob Descriptions"](#).

To Configure for Serial Port Operation

1. Access the I/O CONFIGURE screen.
2. Set the **Serial In** field to **Inst**.
3. Set the **IBASIC Echo** field to **On**.
4. Set the **Inst Echo** field to **On**.
5. Set the remaining serial communications fields according to your terminal/computer's serial communication requirements. These fields include:
 - Serial Baud
 - Parity
 - Data Length
 - Stop Length
 - Rcv Pace
 - Xmt Pace
6. The Test Set now responds to the equivalent characters sent to it by the terminal/computer.

Equivalent Front-Panel Control Characters

[Table 6 on page 87](#) lists the terminal/computer keystrokes that equate to front-panel controls. *Each sequence must be preceded by the **Escape** key.*

For example, to remotely access the CONFIGURE screen, press the Esc key, then press the C key on your terminal/computer. Be sure to use upper-case C for this example.

Table 6 **Equivalent Front-Panel Control Characters**

Function	Equivalent ESC Character	Function	Equivalent ESC Character
CANCEL	!	A	X
PERCENT MHZ_V	(EEX	Z
S_KHZ_MV)	YES_ON_OFF	[
BACKSPACE	-	NO_PPM_W]
ENTER	.	RX	a
RELEASE	0	TX	b
K1	1	DUPLEX	c
K2	2	PREV	d
K3	3	TESTS_MAIN	e
K4	4	LOCAL	f
K5	5	RECALL	g
K1_PRIME	6	MEAS_RESET	h
K2_PRIME	7	PRESET	i
K3_PRIME	8	INCR_DIV_10	j
ASSIGN	9	INCR_SET	k
KNOB_TURN_CCW	<	INCR_TIMES_10	l
KNOB_TURN_CW	>	DOWN	m
MSSG	A	UP	n
HELP	B	SEVEN	o
CONFIG	C	EIGHT	p
HOLD	D	NINE	q
PRINT	E	FOUR	r
ADRS	F	FIVE	s
SAVE	G	SIX	t
REF_SET	J	ONE	u
METER	K	TWO	v
AVG	L	THREE	w
LO_LIMIT	M	ZERO	x
HI_LIMIT	N	POINT	y

Table 6 **Equivalent Front-Panel Control Characters (Continued)**

Function	Equivalent ESC Character	Function	Equivalent ESC Character
E	R	PLUS_MINUS	z
F	S	OHM_PCT_DEL_DBUV	
B	U	DB_GHZ_DBM	
C	V	MS_HZ_UV	
D	W		

Alternate sequences for 5 commonly-used functions are also available. Hold down the Cntl (control) key and select the corresponding key for the desired function. Example: Cntl H moves the cursor to the left one space.

ENTER - J or M

CANCEL - C

BACKSPACE - H

KNOB_TURN_CW - R

KNOB_TURN_CCW - L

Adjacent Channel Power Screen

NOTE:

This screen is displayed on the Test Set with Option 102, Spectrum Analyzer.

This screen is used to measure Adjacent Channel Power. This is a measurement of the power of signals at a specific channel spacing above and below the RF Analyzer's center frequency. This screen is accessed by selecting **AD CH PWR** from the **To Screen** menu.

How the Test Set Measures Adjacent Channel Power (ACP)

When you access this screen, the Test Set automatically starts a multi-step process for measuring ACP:

1. AF Generator 1 is turned off if the **Carrier Ref** field is set to **Unmod**.
2. The amplitude of the center frequency (**Tune Freq**) is measured to establish a reference.
3. AF Generator 1 is turned back on if it was previously turned off.
4. The power in each of the adjacent channels is analyzed.
5. Adjacent Channel Power is calculated and displayed. This value can be displayed as an absolute power level or as a ratio referenced to the center frequency's level.

Which Input Port to Use. The TX Power measurement is used to calculate absolute Adjacent Channel Power. Since TX Power can only be measured using the RF IN/OUT port, you must use this port to measure ACP Level. ACP Ratio can be measured using either the RF IN/OUT or the ANT IN port.

Measuring ACP on AM Transmitters. When measuring AM signals, the reference level must be measured on an *unmodulated* carrier; so the **Carrier Ref** field must be set to **Unmod**. After the reference is measured, the power in the adjacent channels must be measured *with modulation*. This requires the modulating signal to be turned off and on repeatedly as measurements are being calculated and displayed. Since the Test Set automatically turns AFGen1 on and off when the **Carrier Ref** field is set to **Unmod**, you must use AFGen1 and the AUDIO OUT port as the modulation source for making AM ACP measurements.

Field Descriptions

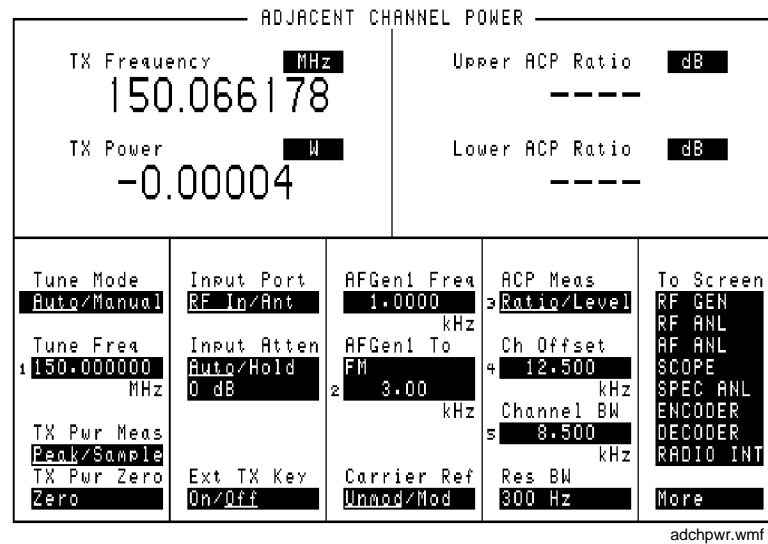

Figure 13 The Adjacent Channel Power Screen

ACP Meas

This field selects the format for displaying upper and lower adjacent channel power levels.

- **Ratio** displays the power levels relative to the power around the center frequency (**Tune Freq**). Levels can be displayed in dB or as a percentage (%).
- **Level** displays the absolute power levels in mW, W, dBm, V, mV, and dBmV.

Operating Considerations

TX Power and **ACP Level** can only be measured through the RF IN/OUT port. Four dashes are displayed for these measurements when the **Input Port** is set to **Ant** (ANT IN).

ACP Ratio can be measured on either the ANT IN port or RF IN/OUT port.

For more information, refer to "[How the Test Set Measures Adjacent Channel Power \(ACP\)](#)" on page 90.

AFGen1 Freq

This field sets the frequency for the first audio frequency sinewave generator.

AFGen1 To

This field sets two values:

- The upper field determines whether the AFGen1 signal modulates the RF Generator or is output through the AUDIO OUT connector.
- The lower field sets the depth of modulation for FM and AM in kilohertz and amplitude (including **OFF**) for audio out. The AUDIO OUT level is always in volts rms.

Operating Considerations

This is a priority control field. Accessing the RX TEST or TX TEST screen overrides any changes made to this field in other screens.

See Also

["Interaction Between Screens" on page 54](#)

Carrier Ref

Use the carrier reference field to indicate whether the carrier (**Tune Freq**) being measured should be unmodulated or modulated when making the ACP reference measurement. (For more information, refer to ["How the Test Set Measures Adjacent Channel Power \(ACP\)" on page 90.](#))

Operating Considerations

- FM transmitters can be measured with the carrier modulated or unmodulated.
- For AM transmitters, the carrier must be measured while *unmodulated*. AFGen1 and the AUDIO OUT port must be used as the modulation source whenever **Unmod** is selected.

Channel BW

Use the channel bandwidth field to specify the bandwidth of the carrier and adjacent channels to be measured. (See [figure 14](#) .)

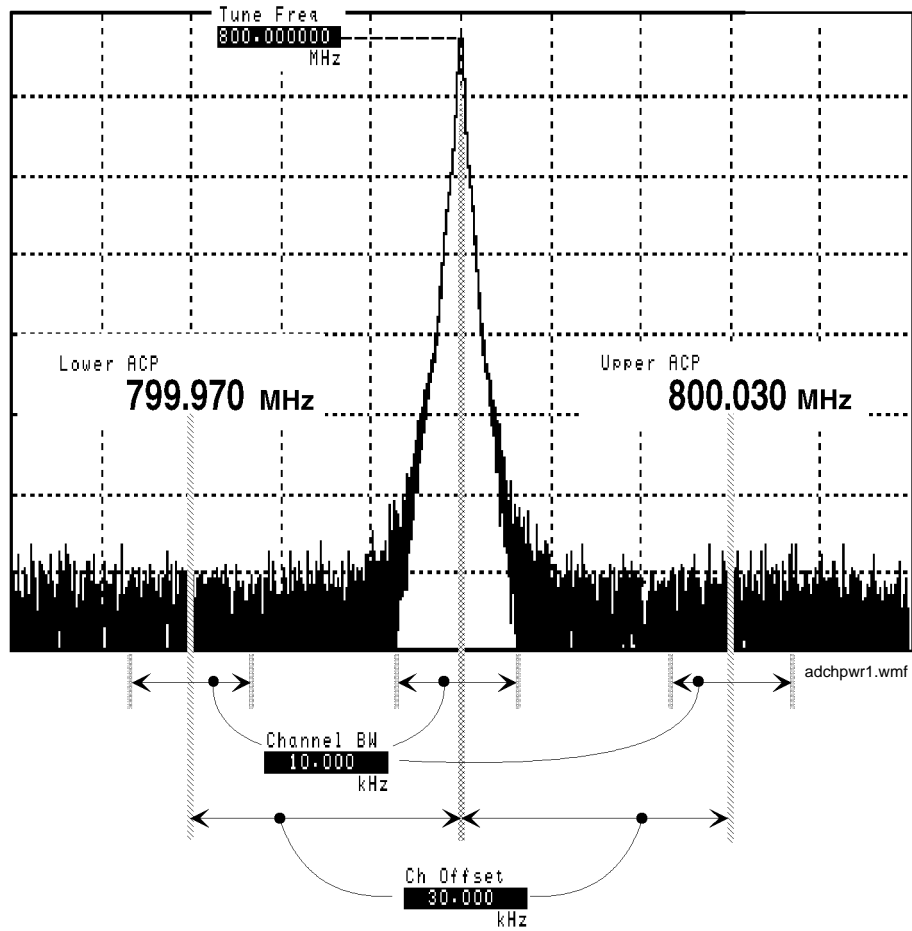

Figure 14 Relationship Between Tune Freq, Ch Offset, and Channel BW Fields

Ch Offset

Use the channel offset field to enter the frequency difference between the **Tune Freq** setting and the center of the adjacent channels you want to measure. This is an absolute value; only positive values can be entered. See [figure 14](#).

Ext TX key

This field controls a switch at the MIC/ACC connector. Use it to “key” an external transmitter.

See Also

["MIC/ACC" on page 568](#)

Input Atten

Input Attenuation sets the amount of input attenuation for the RF IN/OUT and ANT IN connectors. This function controls two settings:

- The upper field determines if you want the instrument to set the attenuation automatically (**Auto**), or if you want to set the value manually (**Hold**).
- The lower field displays the present attenuation value, and is used to set the desired attenuation level when the upper area is set to **Hold**.

Operating Considerations

Input Attenuator autoranging can interfere with oscilloscope or signaling decoder operation under certain conditions. See ["Input Atten," in chapter 17, on page 475](#) for additional information.

Input Port

This field selects the RF IN/OUT or ANT IN port for making RF measurements. The RF IN/OUT port must be used for making TX Power or ACP Level measurements on this screen.

Operating Considerations

Power levels for each port are printed on the Test Set's front panel. If the RF power at the RF IN/OUT port exceeds allowable limits, a loud warning signal sounds and a message appears at the top of the screen. If this occurs, disconnect the RF power, press the MEAS RESET key, and allow the Test Set to cool off for approximately two minutes before making any other measurements on this port.

The ANT IN (antenna input) connector provides a highly-sensitive input for very low level signals (such as "off the air" measurements). You cannot measure TX (RF) Power or ACP Level on this screen using the ANT IN port.

CAUTION:

Connecting a signal of >200 mW to the ANT IN port can cause instrument damage (although internal protection circuits can typically withstand a short-duration signal of 1 or 2 Watts).

If the overpower circuit is triggered (signified by a warning message at the top of the screen), remove the signal from the ANT IN port, and press the MEAS RESET key or turn the Test Set off and on to reset it.

Lower and Upper ACP [Ratio:Level]

These two measurements display the amount of power in signals above and below the **Tune Freq** signal. The level is displayed as a ratio (referenced to the power around the **Tune Freq**) or as an absolute value.

See Also

[ACP Meas field description, on page 91](#)

Res BW

The resolution bandwidth field selects the IF filter used when measuring the power of the carrier and the adjacent channels.

Operating Considerations

Using a narrower bandwidth filter (300 Hz) slows the measurement, but rejects carrier leakage and out of channel spurs. Using a wider bandwidth filter (1 kHz) speeds measurements, but may allow unwanted spurs and carrier leakage to be integrated into the measurement when measuring at the edges of the selected channel bandwidth.

Tune Freq

This field sets the center frequency for the RF signal to be analyzed.

See Also

[Tune Mode field description \(this page\)](#)

Tune Mode

This field selects Automatic or Manual tuning of the RF Analyzer.

Auto tuning causes the RF Analyzer to find the signal with the greatest amplitude >-36 dBm, and to set the Tune Frequency for that signal.

Manual tuning requires the operator to set the Tune Frequency for the RF signal to be analyzed.

Operating Considerations

Changing the **Tune Mode** also changes the RF frequency display. Automatic tuning enables the **TX Frequency** measurement. Manual tuning enables the **TX Freq Error** measurement.

TX Freq Error/TX Frequency

This measurement displays Transmitter Frequency Error or absolute Transmitter Frequency.

See Also

[Tune Mode field description \(this page\)](#)

TX Power

Transmitter Power measures RF power at the RF IN/OUT port.

Operating Considerations

Only the RF IN/OUT port can be used for measuring TX Power on this screen. When the **Input Port** is set to **Ant**, four dashes (- - -) appear in place of digits for this measurement.

Use the Spectrum Analyzer¹ to measure low-level RF power (≤ 200 mW) at the ANT IN port.

TX Pwr Zero

The transmitter power zero function establishes a 0.0000 W reference for measuring RF power at the RF IN/OUT port.

CAUTION: RF power must not be applied while zeroing. Set the **RF Generator** screen's **Amplitude** field to off to prevent internal cross-coupling into the power detector while zeroing.

Operating Considerations

When power is applied to the RF IN/OUT connector, the temperature of the internal circuitry increases. This can cause changes in the TX Power measurement when low power levels are measured immediately following high power measurements.

When alternately making high and low power measurements, always zero the power meter immediately before making the low power measurements; this provides the best measurement accuracy.

1. Optional on some Test Set models.

AF Analyzer Screen

Block Diagram

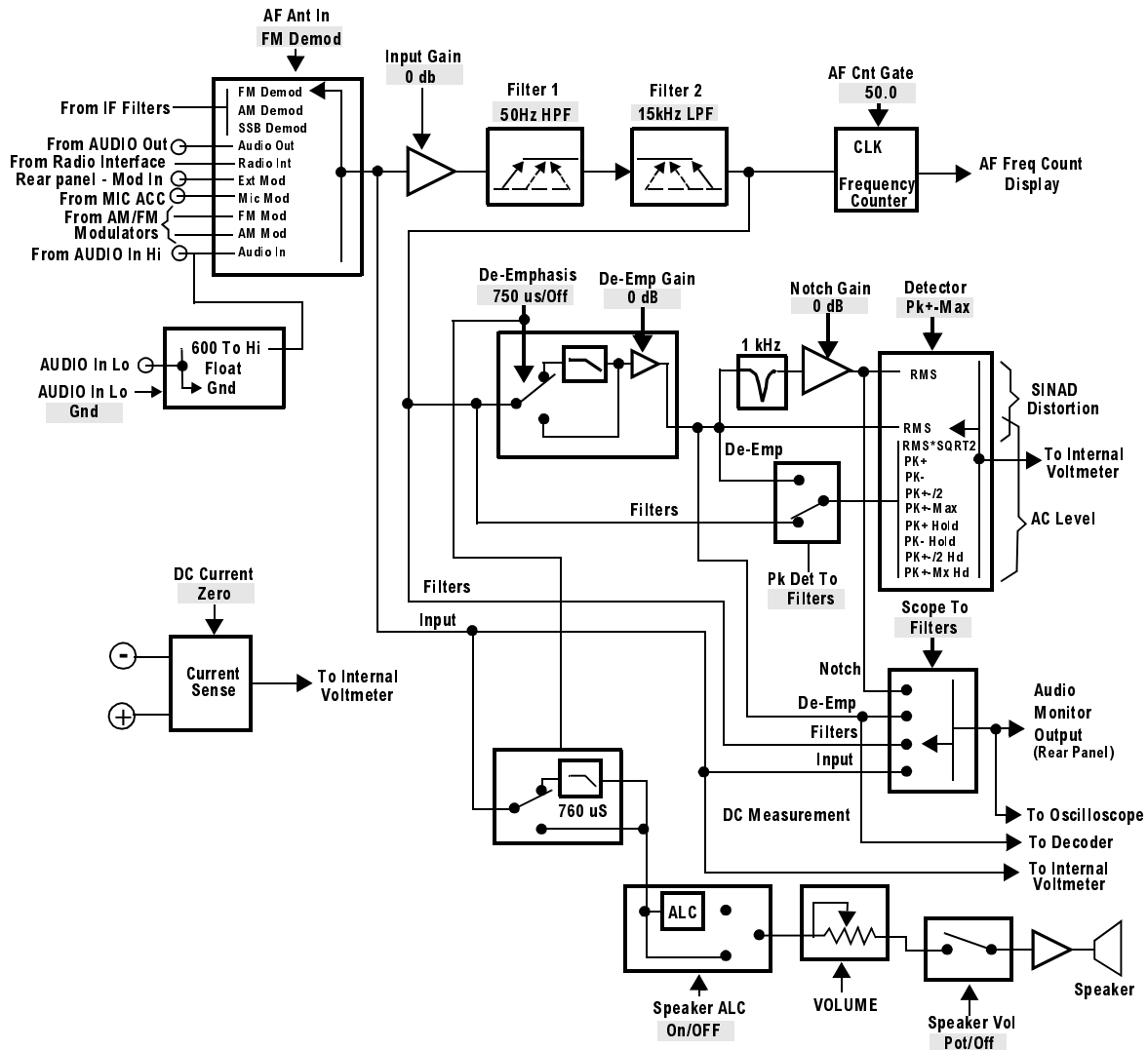

Figure 15 AF ANALYZER Functional Block Diagram

¹The Settling, Gain Cntl, and Ext Load R fields are not shown.

²Variable Frequency Notch if purchased.

Field Descriptions

AC Level

This measurement displays either rms potential (voltage) or audio power (Watts or dBm).

Operating Considerations

When the unit-of-measure is changed to measure AF power, the external load resistance must be specified. Refer to the [Ext Load R field description, on page 106](#).

The input for the ac level measurement on this screen is always the AUDIO IN connectors.

See Also

["Entering and Changing Numbers" on page 63](#)

AF Anl In

The audio frequency analyzer input selects the input for the analyzer. When selected, this field displays a list of choices.

Signals can be analyzed from three different types of inputs:

- The output of the AM, FM, or SSB demodulators.
- The AUDIO IN, RADIO INTERFACE, MODULATION INPUT, MIC/ACC, and AUDIO OUT connectors.
- The signal present at the AM or FM modulators for the RF Generator.

See Also

["Interaction Between Screens" on page 54](#)

["Displaying Measurements" on page 57](#)

AF Cnt Gate

Audio frequency counter gate specifies how long the AF counter samples the signal before displaying the frequency. Specifying a shorter gate time may enable you to see frequency fluctuations that might not be seen using a longer gate time.

AF Freq

This is the default measurement for this measurement field. Selecting this field displays the following measurement choices:

SINAD
Distortion
SNR (Signal to Noise Ratio)
AF Frequency
DC Level

Current - DC only(The HP 8920A requires Current Measurement option) Operating Considerations

This is a priority control field. Accessing the RX TEST or TX TEST screen overrides any changes made to this field in other screens.

SNR Operation

- Selecting SNR turns off the other audio measurement.
- The RF Generator and AFGen1 must be set up to provide the radio's carrier. AFGen1 is automatically turned on and off repeatedly during this measurement.
- AFGen2 must be turned off.
- The radio's receiver's audio output must be connected to the AUDIO IN port (set the **AF An1 In** field to **Audio In**).

See Also

["Interaction Between Screens" on page 54](#)

["Displaying Measurements" on page 57](#)

AM Depth

This field displays the percent depth of modulation of the AM signal. The field is only visible when the **AF ANL In** field is set to **AM MOD** or **AM DEMOD**

Audio In Lo

This field sets the AUDIO IN LO connector's state.

- **Gnd** causes the center pin of the connector to be connected directly to chassis ground.
- **Float** isolates the center pin of the connector from ground, providing a floating input to the AF Analyzer.
- **600 To Hi** establishes a 600-ohm impedance between the center pins of the AUDIO IN LO and AUDIO IN HI connectors. Also, the **Ext Load R** field is removed, since the load is now fixed to 600 ohms.

Current

The **Current** field is found by selecting the SINAD field on the Test Set display of the AF ANALYZER screen. This field only displays the DC current measured at the DC input port on the back of the Test Set. Any offset can be removed by selecting **zero** from the **DC Current** field.

DC Current

DC current measurement zero removes any measurement offset present before making a dc-current measurement¹. The measurement is zeroed by selecting **zero**, and pressing the ENTER key or the Cursor Control knob.

NOTE: The current source must be disconnected before zeroing for accurate operation.

See Also

["DC CURRENT MEASUREMENT" on page 565](#)

["SINAD, Distortion, SNR, AF Frequency, DC Level, DC Current" on page 60 Chapter 24, "Connector, Key, and Knob Descriptions"](#)

1. HP 8920A requires option 103.

DC Level

This field displays the DC voltage entering at the DC input port on the back of the Test Set.

De-Emp Gain

De-emphasis gain displays and selects the desired AF analyzer de-emphasis amplifier gain.

See Also

[Gain Cntl field description, on page 107](#)

De-Emphasis

This setting selects or bypasses the 750 ms de-emphasis networks in the audio analyzer and speaker circuitry.

See Also

["Interaction Between Screens" on page 54](#)

Distn

This field displays the percent of distortion. The Distortion measurement is only for a 1 kHz signaling tone.

Detector

This setting selects the type of detector used when measuring and displaying AF signal levels.

Detector Types

- **RMS** displays the RMS value of signals.
- **√2** displays the RMS value of a signal multiplied by $\sqrt{2}$.
- **Pk+** displays the positive peak value.
- **Pk-** displays the negative peak value.
- **Pk±/2** adds the positive and negative peak values, and divides the sum by 2.
- **Pk±Max** compares the positive and negative peaks and displays the greater value (polarity is not indicated).
- **Pk+ Hold** displays and holds the positive peak value until the measurement is reset. To reset, press the MEAS RESET key, select a different detector, or re-select the same detector.
- **Pk- Hold** displays and holds the negative peak value until the measurement is reset. To reset, press the MEAS RESET key, select a different detector, or re-select the same detector.
- **Pk±/2 Hold** divides the sum of the positive and negative peak values by 2, and displays the value until the measurement is reset. To reset, press the MEAS RESET key, select a different detector, or re-select the same detector.
- **Pk±Max Hold** compares the positive and negative peaks and displays the greater value until the measurement is reset. To reset, press the MEAS RESET key, select a different detector, or re-select the same detector.

See Also

["Interaction Between Screens" on page 54](#)

Ext Load R

External Load Resistance is used to calculate and display AF power. Power is calculated using the voltage measured at the AUDIO IN connections and the resistance value you enter into this field.

Operating Considerations

This field is not displayed when the **Audio In Lo** field is set to **600 To Hi**; the load resistance is internally fixed to 600 ohms.

See Also

[AC Level field description, on page 101](#)

[Audio In Lo field description, on page 103](#)

Filter 1 and Filter 2

Filters 1 and 2 select a variety of standard and optional filters. Selecting either field lists the choices available for that field.

FM Deviation

This is the default measurement for this field. The FM Deviation field displays the frequency deviation between the FM signal and the carrier. The FM Deviation measurement field is only displayed when the **AF An1 In** field is set to **FM Demod** or **FM Mod**.

See Also

[AF An1 In field description, on page 101](#)

["Displaying Measurements" on page 57](#)

Gain Cntl

AF Analyzer Gain Control specifies whether the AF Analyzer's gain settings are controlled automatically by AF autoranging (**Auto**), or by manual control (**Hold**).

The following settings are affected by AF autoranging:

- Input Gain
- De-Emp Gain
- Notch Gain

Operating Considerations

The normal mode of operation for the **Gain Cntl** field is **Auto**, allowing the instrument to adjust the AF gain settings for optimum measurement accuracy.

This field can be set to **Hold** to disable the autoranging routines to increase measurement speed. However, this requires you to select the desired gain settings manually for each measurement.

NOTE:

Decoder and Oscilloscope Interference: The AF autoranging function (**Auto**) takes a small amount of time to determine the attenuation settings for the AF Analyzer. If you are decoding an encoded signal, and your transmitter begins sending encoded information the instant it transmits, the initial encoded information may not be decoded during the autoranging process.

Use the **Auto** setting to establish the initial gain settings while the encoded signal is first being decoded, and then select **Hold** during the decoding process to retain the gain settings. The decoder should capture all encoded information the next time you transmit the signal.

Input Gain

This field displays and selects the gain of the AF Analyzer's input amplifier. Refer to the **Gain Cntl** field information.

Notch Freq

This field sets the center frequency for the variable frequency notch filter.¹ It is typically used for distortion and SINAD measurements at frequencies below or above the standard 1 kHz notch filter.

This field is not displayed if your Test Set does not have this feature.

Operating Considerations

When the **Notch Coupl** field on the CONFIGURE screen is set to **AFGen1**, this filter and the **AFGen1 Freq** field match their settings. A warning message is then displayed if you attempt to set the **AFGen1 Freq** value outside the 300 Hz to 10 kHz range of this filter. When the **Notch Coupl** field is set to **None**, this filter and **AFGen1 Freq** operate independently.

Notch Gain

This field displays and selects the gain of the AF Analyzer's notch filter amplifier. This amplifier is only used for making SINAD and distortion measurements. (Refer to the **Gain Cnt1** field information.)

Pk Det To

Peak Detector To selects the signal source for the peak detectors. This allows you to bypass certain sections of the AF analyzer's circuitry when making ac-level measurements.

See Also

[Figure 15, "AF ANALYZER Functional Block Diagram," on page 100.](#)

1. Optional on some Test Sets

Scope To

Oscilloscope To selects the signal source for the Oscilloscope. This allows you to bypass certain sections of the AF analyzer's circuitry when viewing and measuring a signal. It also allows you to select measurement paths that include additional gain stages, improving the oscilloscope's resolution when measuring low-level signals.

See Also

[Figure 15, "AF ANALYZER Functional Block Diagram," on page 100](#)

Settling

This field selects the settling time for making AF measurements. Lower frequency signals require additional settling time (**s1ow**). Higher frequency measurements require less settling time (**Fast**).

Operating Considerations

Use **s1ow** for ≤ 200 Hz signals. Use **Fast** for > 200 Hz signals.

If the signal being measured is a composite of different frequencies above and below 200 Hz, select the appropriate filtering to analyze the desired signal component.

SINAD

This measurement field is used to select and display any one of the following measurements:

- SINAD
- Distortion
- SNR (Signal to Noise Ratio)
- AF Frequency
- DC Level

Current - DC only ¹ Operating Considerations

This is a priority control field. Accessing the RX TEST or TX TEST screen overrides any changes made to this field in other screens.

SNR Operation

- Selecting SNR turns off the other audio measurement.
- The RF Generator and AFGen1 must be set up to provide the radio's carrier. (AFGen1 is automatically turned on and off repeatedly during this measurement.)
- AFGen2 must be turned off.
- The radio's receiver's audio output must be connected to the AUDIO IN port (set the **AF An1 In** field to **Audio In**).

See Also

["Interaction Between Screens" on page 54](#)

SNR

The **SNR** field is found by selecting the SINAD field on the Test Set display of the AF ANALYZER screen. This field displays the signal to noise ratio of the input audio signal.

1. HP 8920A requires Current Measurement option

Speaker ALC

Speaker Automatic Level Control enables/disables the ALC function for the instrument's internal speaker. When **On** is selected, the speaker volume is independent of the signal level being measured. When **Off** is selected, the speaker volume is dependent on the signal level being measured.

Speaker Vol

Speaker Volume enables/disables the instrument's internal speaker. When **Pot** is selected, the VOLUME control knob operates normally. When **Off** is selected, the speaker is disconnected.

TX Freq Error/ TX Frequency

This measurement area is used to display transmitter frequency error or transmitter frequency. The type of measurement displayed depends on the **Tune Mode** setting in the TX TEST, DUPLEX TEST, or RF ANALYZER screen.

See Also

["Displaying Measurements" on page 57](#)

TX Power

Transmitter Power measures RF power at the RF IN/OUT port.

Operating Considerations

Maximum signal levels at each port are printed on the front panel.

Only the RF IN/OUT port can be used for measuring TX Power on this screen. When the **Input Port** is set to **Ant**, four dashes (- - -) appear in place of digits for this measurement.

Use the Spectrum Analyzer¹ to measure low-level RF power (≤ 200 mW) at the ANT IN port.

CAUTION: Connecting a signal of >200 mW to the ANT IN port can cause instrument damage (although internal protection circuits can typically withstand a short-duration signal of 1 or 2 Watts).

If the overpower circuit is triggered (signified by a warning message at the top of the screen), remove the signal from the ANT IN port, and press the MEAS RESET key or turn the Test Set off and on to reset it.

See Also

[Input Port field description, on page 476](#)

[TX Power field description, on page 480](#)

[TX Pwr Zero field description, on page 480](#)

1. Spectrum Analyzer is optional on some Test Set models.

Call Processing Subsystem

Description of the Call Processing Subsystem

The Call Processing Subsystem, which comprises six call processing screens, allows the Test Set to simulate a cellular base station. The Call Processing Subsystem provides, through host firmware control, the specific signals and protocol messages necessary to automatically establish and maintain a cellular link between the Test Set and a cellular phone (mobile station).

Once the link is established the operator can exercise the call processing functions of the mobile station, such as

- the decoding of orders from the base station, such as orders to retune the transceiver to a new channel, to alert the mobile station user to an incoming call, to adjust the transceiver output power level, or to release the mobile station upon completion of a call.

the encoding of signaling information for transmission to the base station, such as dialed digits for call origination, disconnect signal at the completion of a call, or mobile identification number.

the authentication signaling associated with AMPS (IS-54) call processing such as shared secret data update, unique challenge, origination with authentication, and page with authentication.

In addition, when the link is established the Test Set performs the following functions automatically:

- measures some of the basic RF characteristics of the mobile station's transmitted carrier, such as; transmitter power, frequency accuracy, and modulation deviation
- decodes and displays various reverse control channel and reverse voice channel signaling messages

When sending forward control channel and forward voice channel messages, you can set the bit pattern to an industry standard or to a pattern of your choice. The ability to set the bit patterns gives the operator the opportunity to interject errors into the signaling message, and test the mobile station's ability to find these errors.

Operational Overview

The Test Set simulates a cellular base station by using its hardware and firmware resources to initiate and maintain a link with a mobile station. Unlike a real base station, the Test Set has only one transceiver (its signal generator and RF/AF analyzer) and can support only one mobile station at a time. This means that the Test Set's transceiver can be configured as either a control channel or a voice channel, but not both simultaneously.

To establish a link with a mobile station the Test Set's transceiver is configured as a control channel. Once a link has been established and the user wishes to test the mobile station on a voice channel, the Test Set sends the appropriate information to the mobile station on the control channel and then automatically re-configures its transceiver to the voice channel assigned to the mobile station. Once the voice channel link is terminated, the Test Set automatically re-configures its transceiver back to being a control channel.

Handoffs are accomplished in a similar manner. When a handoff is initiated while on a voice channel, the Test Set sends the necessary information to the mobile station on the current voice channel. At the proper time, the Test Set automatically re-configures its transceiver to the new voice channel.

Figure 16, "Call Processing State Diagram," on page 116 illustrates the primary call processing functions available in the Call Processing Subsystem. Each box represents a call processing state and includes the measurement information available while in that state. Each box also includes the name of the annunciator on the call processing screen that will be lit while in that call processing state. Events which trigger transitions between the various states are shown on the diagram. Events which are initiated from the Test Set are shown in solid lines and events which are initiated from the mobile station are shown in dashed lines.

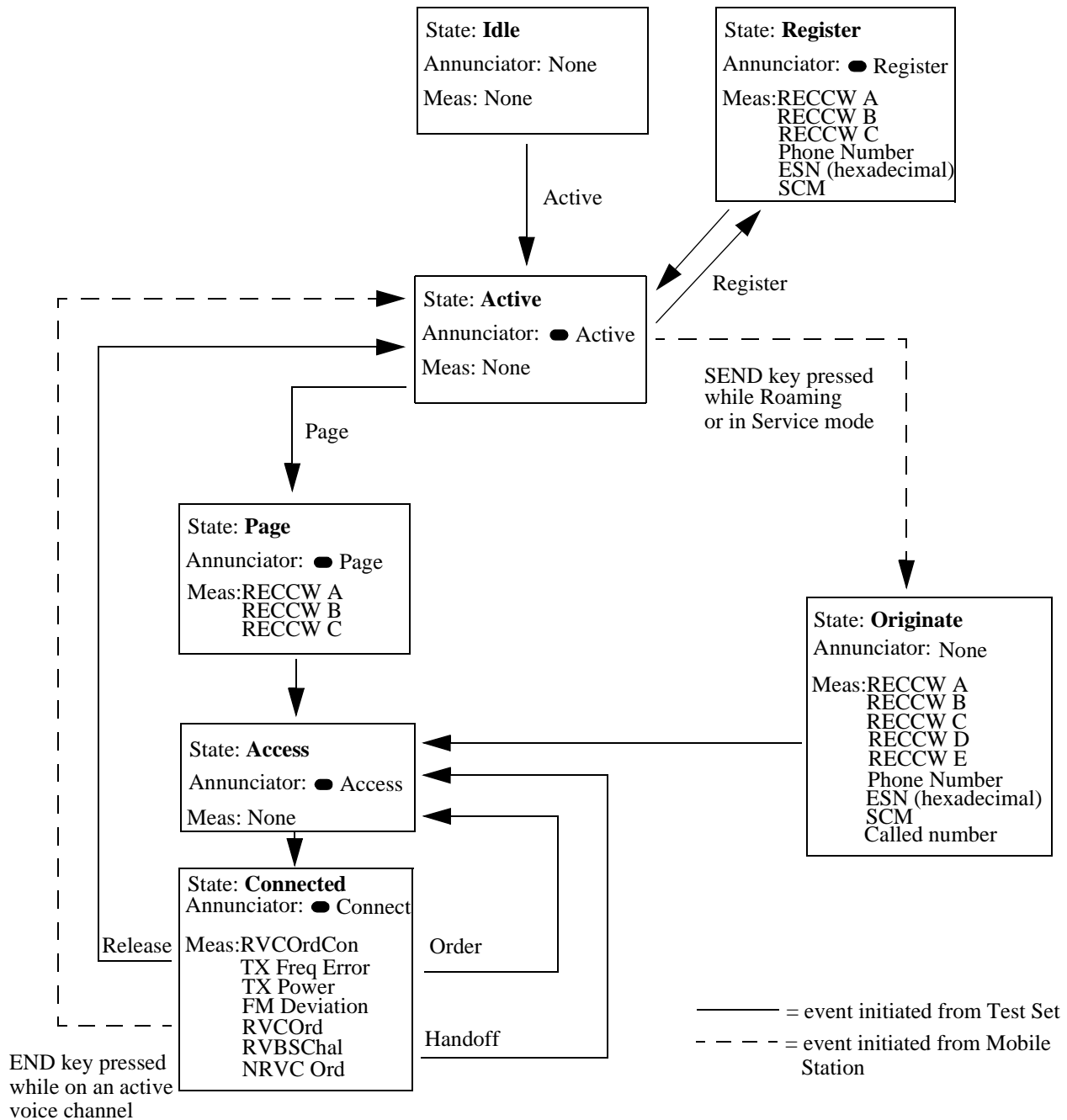

Figure 16 Call Processing State Diagram

Accessing the Call Processing Subsystem's Screens

The Call Processing Subsystem screens are accessed by selecting **CALL CNTL** from the **To screen** menu on the Test Set's CRT (you may have to choose the **More** choice to display the **CALL CNTL** choice).

Option 004:Tone/Digital Signalling is required in an HP 8920A in order to use the Call Processing Subsystem. Attempting to access the Call Processing Subsystem without Option 004 installed will generate an "Option not installed." error.

Call Processing Subsystem's Screens

The Call Processing Subsystem consists of six screens.

five

- The **CALL CONTROL** is the primary Call Processing Subsystem screen. This screen contains the fields used to configure the Test Set's parameters such as SAT Tone frequency, control channel number, and system identification number. Call processing functions such as registration, page, and handoff can be activated from this screen. The transmit power of the mobile station can be set from this screen. Data messages received from the mobile station are displayed on this screen.
- The **CALL DATA** screen displays the decoded signaling messages received from the mobile station on the reverse control channel and the reverse voice channel. Call processing functions such as registration, page, and handoff can also be activated from this screen. The transmit power of the mobile station can be set from this screen.
- The **CALL BIT** screen allows the advanced user to modify the contents of the forward control channel and forward voice channel messages.
- The **CALL CONFIGURE** screen contains the fields used to configure various parameters related to the Call Processing Subsystem, such as **CMAX**, **Detector**, and **Input Att.**

The **ANALOG MEAS** screen is used to make analog RF and audio measurements on the mobile station while a link is active.

AUTHENTICATION screen allows the user to turn on the AMPS authentication process (IS-54) during call processing functions. Various fields contained on this screen allow the advanced user to select new **RAND_A**, **RAND_B**, **RandSSD** and **RAND_U** values for transmission to the mobile station. The user can also select the number of times the system parameter overhead message is sent to the mobile station. **AMPS** Call Processing functions can be tested with or without authentication active.

Call Processing functions with Authentication are only supported for AMPS system types (IS-54).

Using the Call Processing Subsystem

In order to use the Call Processing Subsystem, a mobile station must be powered on, and connected to the Test Set.

Connecting A Mobile Station

Figure 17, "Connecting a Mobile Station to the Test Set," on page 119 shows a typical example of how to connect a mobile station to the Test Set. You may need a special fixture to access the mobile station's antenna, audio in, and audio out signals. These fixtures are available from the mobile station's manufacturer.

If any audio testing is to be done on the mobile station, the audio input (microphone input) to the mobile station and the audio output (speaker output) from the mobile station must be connected to the Test Set. If no audio testing is to be done only the antenna needs to be connected to the Test Set.

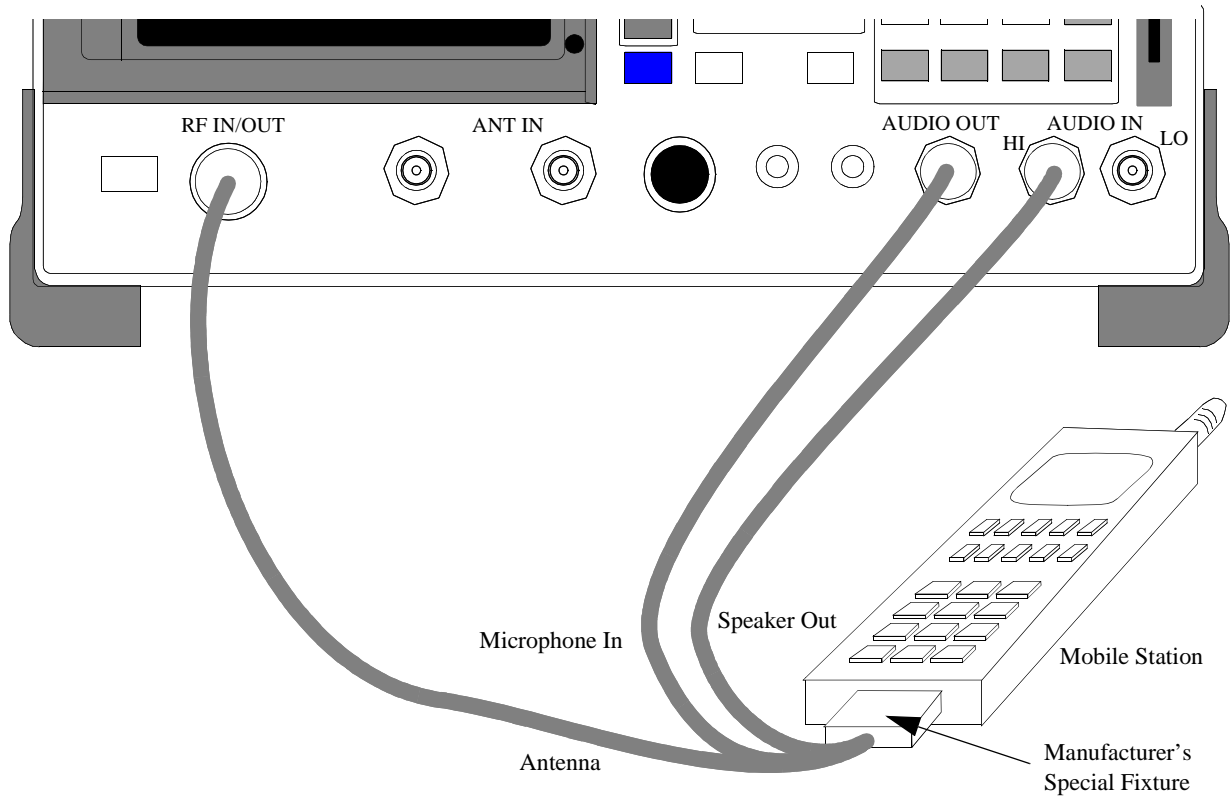

Figure 17 Connecting a Mobile Station to the Test Set

NOTE: Do not connect the antenna of the mobile station to the ANT IN port on the front panel of the Test Set; this will cause the overpower protection circuitry to trip when the mobile station is transmitting. Refer to "**ANT IN**" on page 562 for further information.

Mobile Station Audio Out Impedance

If the mobile station's speaker is disconnected when using the manufacturer's special fixture, the user must ensure that the proper load impedance is applied to the audio output of the mobile station. The special fixtures supplied by the manufacturer of the mobile station may or may not terminate the audio output in its proper load impedance. Refer to the manufacturer's documentation for information on the termination supplied by the special fixture.

If a load impedance must be supplied, then it can be placed across the AUDIO IN connector. Refer to ["AUDIO IN" on page 563](#) and [chapter 5, "AF Analyzer Screen," on page 99](#), for further information.

600 Ohm Impedance

Some industry standards require the audio out of the mobile station to be terminated in 600 ohms for testing purposes. The AUDIO IN connector of the Test Set can be terminated in 600 ohms internally. Refer to ["AUDIO IN" on page 563](#) and [chapter 5, "AF Analyzer Screen," on page 99](#), for further information.

Generalized Procedures Using the Call Processing Subsystem

For general procedures for using the Call Processing Subsystem, see the following sections:

- ["Conditioning the Test Set for Call Processing" on page 141](#)
- ["Configure the Test Set" on page 142](#)
- ["Turn On The Test Set's Control Channel" on page 143](#)
- ["Register a Mobile Station" on page 144](#)
- ["Page a Mobile Station" on page 145](#)
- ["Handoff a Mobile Station to a New Voice Channel" on page 147](#)
- ["Release A Mobile Station" on page 147](#)
- ["Change the Transmit Power Level of a Mobile Station" on page 148](#)
- ["Originate a Call from a Mobile Station" on page 149](#)
- ["Send an Alert Order to a Mobile Station" on page 150](#)
- ["Changing the Content of a Message Field" on page 242](#)
- ["Selecting The Message Content Generation Method" on page 239](#)
- ["To Make an RF Sensitivity Measurement" on page 248](#)
- ["To Make an FM Hum and Noise Measurement" on page 249](#)

The CALL CONTROL Screen

CALL CONTROL			
Display			
Data/Meas			
<input checked="" type="checkbox"/> Active <input type="checkbox"/> Register <input type="checkbox"/> Page <input type="checkbox"/> Access <input type="checkbox"/> Connect		Phone Num: 509-981-2795 ESN (dec): 157-9232940 ESN (hex): 9D8CE22C SCM: Class III, Continuous, 25 MHz	
<input checked="" type="checkbox"/> Active <input type="checkbox"/> Register <input type="checkbox"/> Page <input type="checkbox"/> Handoff <input type="checkbox"/> Release Order <input checked="" type="checkbox"/> Chng PL 0 MS Id <input checked="" type="checkbox"/> Phone Num 5099812795	System Type <input checked="" type="checkbox"/> AMPS Cntrl Chan <input checked="" type="checkbox"/> 321 Amplitude <input checked="" type="checkbox"/> -50.0 dBm SID <input checked="" type="checkbox"/> 231	Voice Channel Assignment Chan: - <input checked="" type="checkbox"/> 212 Pwr Lvl: - <input checked="" type="checkbox"/> 4 SAT: - <input checked="" type="checkbox"/> 5970Hz	To Screen <input checked="" type="checkbox"/> CALL CNTL <input checked="" type="checkbox"/> CALL DATA <input checked="" type="checkbox"/> CALL BIT <input checked="" type="checkbox"/> CALL CNFG <input checked="" type="checkbox"/> ANLG MEAS <input checked="" type="checkbox"/> SPEC ANL <input checked="" type="checkbox"/> AUTHEN <input checked="" type="checkbox"/> More

Figure 18 The CALL CONTROL Screen

The number of fields displayed on the CALL CONTROL screen depends on the selected system type.

The CALL CONTROL screen is the primary Call Processing Subsystem screen. It contains the most often used call processing configuration and command fields.

Figure 18 on page 122 shows the CALL CONTROL screen for NAMPS.

The top right-hand portion of the CALL CONTROL screen is used to display the following information:

- decoded data messages received from the mobile station on the reverse control channel or the reverse voice channel
- modulation quality measurements made on the mobile station's RF carrier while on a voice channel
- raw data message bits, displayed in hexadecimal format, received from the mobile station on the reverse control channel or reverse voice channel when a decoding error occurs

The type of information to be displayed is selected using the **Display** field. Refer to the **Display field description, on page 127** for further information.

Access

When lit, the **Access** annunciator indicates the Test Set is signaling the mobile station with command information on the forward voice channel. This is a transitory state.

The Test Set's speaker is turned off when in the access state. This is done to eliminate any possible audio feedback which may occur if the mobile station's microphone is open.

Active

This field is used to turn on the forward control channel of the Test Set or to force a return to the active state from any other state (register, page, access, connect). If the forward control channel of the Test Set is already active, selecting this field will deactivate and then reactivate the control channel.

Active

When lit, the **Active** annunciator indicates the control channel of the Test Set is turned on.

If this annunciator is lit, the base station is transmitting system parameter overhead messages on the assigned control channel. If the annunciator is not lit, the base station is not active.

NOTE: The Test Set may still be outputting a modulated RF carrier but the Test Set's firmware is not active and no communication can occur between a mobile station and the Test Set.

AF Freq

The **AF Freq** field is displayed only when the **Display** field is set to **Meas**.

This field displays the audio frequency of the demodulated FM signal being transmitted by the mobile station. Four dashes (----) indicate that no audio frequency is present to measure. A numeric value would only be displayed when the Test Set's **Connected** annunciator is lit (connected state).

Amplitude

This field is used to set the output power of the Test Set's transmitter (that is, the output power of the Test Set's RF Generator).

Called Number:

This field displays the called phone number, in decimal form, received from the mobile station on the reverse control channel when the mobile station originates a call. The **Called Number:** field is displayed only when the **Display** field is set to **Data** and a reverse control channel message has been decoded when the mobile originates a call.

CC Order

The CC Order field is only visible when authentication is activated on the AUTHENTICATION screen.

This field is used to send an order on the forward control channel to the mobile station. There are two orders available:

- The SSD Update order ensures that the data contained in the mobile station and the base station is identical. At the completion of the SSD Update process the mobile station and the Test Set will contain identical copies of shared secret data.

The Unique Challenge order challenges the mobile station's shared secret data through a series of algorithm data output comparisons. A successful challenge confirms the validity of a mobile station's shared secret data.

Chan:

Chan: is divided into two fields:

- The left-hand field displays the voice channel number assignment being used by the Test Set and the mobile station. A numeric value would only be displayed when the Test Set's **Connected** annunciator is lit (connected state). A "-" is displayed if a mobile station is not actively connected on a voice channel.
- The right-hand field (highlighted field) is used to enter the voice channel number which will be assigned to the mobile station by the Test Set as either an initial voice channel assignment or as a handoff voice channel assignment.

Ch Loc:

This field is displayed only for NAMPS system type.

CH Loc: is divided into two fields:

- The left-hand field displays the current, narrow-analog-channel location assignment in relation to the standard wide, analog channel. A range of **U**, **M**, **L**, or **W** is only displayed when the Test Set's **Connected** annunciator is lit (connected state). A "-" is displayed if a mobile station is not actively connected on a voice channel.
- The right-hand field (highlighted field) is used to enter the channel location range which will be assigned to the mobile station by the Test Set as either an initial channel-location range assignment or as a handoff channel-location range assignment.

Cntl Channel

This field is used to set the control channel number used by the Test Set.

The **Cntl Channel** field is an immediate action field. That is, whenever the **Cntl Channel** field is changed, the change is reflected immediately in the physical configuration of the Test Set (the control channel is immediately deactivated, reconfigured, and then re-activated to reflect the change) and causes an immediate change to the current state of the Call Processing Subsystem (the state is set to **Active**).

[] Connect

When lit, the **Connect** annunciator indicates that the mobile station is connected to the Test Set on a voice channel.

NOTE:

When the CALL CONTROL screen is displayed and the Call Processing Subsystem is in the connected state (**Connect** annunciator is lit), the Test Set constantly monitors the mobile station's transmitted carrier power. If the power falls below 0.0005 Watts the Test Set will terminate the call and return to the active state (**Active** annunciator is lit). The mobile station's transmitted carrier power is monitored on all Call Processing Subsystem screens except the ANALOG MEAS screen.

If the Test Set is in the connected state (**Connect** annunciator is lit) and a change is made to the **Cntl Channel** field the **connected** state will be lost.

Display

This field is used to select the type of mobile station information to be displayed in the upper right-hand portion of the CALL CONTROL screen:

- Select **Data** to display information received from the mobile station on the reverse control channel or reverse voice channel. If the data message(s) received from the mobile station can be correctly decoded, the decoded message contents are displayed. If the data messages cannot be correctly decoded, the raw data message bits are displayed in hexadecimal format. **Figure 19 on page 128** shows the layout of the CALL CONTROL screen when a decoding error has occurred.

The decoded order confirmation message, origination message, and order message are available from the reverse control channel. The following pieces of information are displayed when these messages are properly decoded: phone number, ESN (dec), ESN (hex), the decoded Station Class Mark (SCM), and the called number. The decoded SCM consists of: the mobile station power class (Class I, II, or III), the transmission type (continuous/discontinuous), and the transmission bandwidth (20 MHz or 25 MHz).

- The decoded Order Confirmation Message is available from the reverse voice channel.
- Select **Meas** to display modulation quality measurements made on the mobile station's RF carrier while on a voice channel.
 - **and**

For system types **AMPS**, **TACS**, **JTACS**, and wide channel **NAMPS** four characteristics of the RF carrier are measured: TX Freq Error, TX Power, FM Deviation, and AF Frequency. When set to the **Meas** display, the AF Analyzer's settings are 300 Hz HPF, 15 kHz LPF, De-Emphasis Off, PK+ detector. The **Meas** information is available only when the Test Set's **Connect** annunciator is lit (connect state). Refer to the individual field descriptions for further information. **Figure 20 on page 129** shows the layout of the CALL CONTROL screen when **Meas** is selected.

For system type **NAMPS** with **Ch Loc**: set to Lower, Middle, or Upper, four characteristics of the RF carrier are measured: TX Freq Error, TX Power, FM Deviation, and DSAT/DST. When set to **NMeas** display, the AF Analyzer's settings are: 300 Hz HPF, 15 kHz LPF, De-Emphasis 750 μ s, PK+ detector. The **NMeas** information is available only when the Test Set's **Connect** annunciator is lit (connect state). Refer to the individual field descriptions for further information. **Figure 21 on page 130** shows the layout of the NAMPS CALL CONTROL screen when **NMeas** is selected.

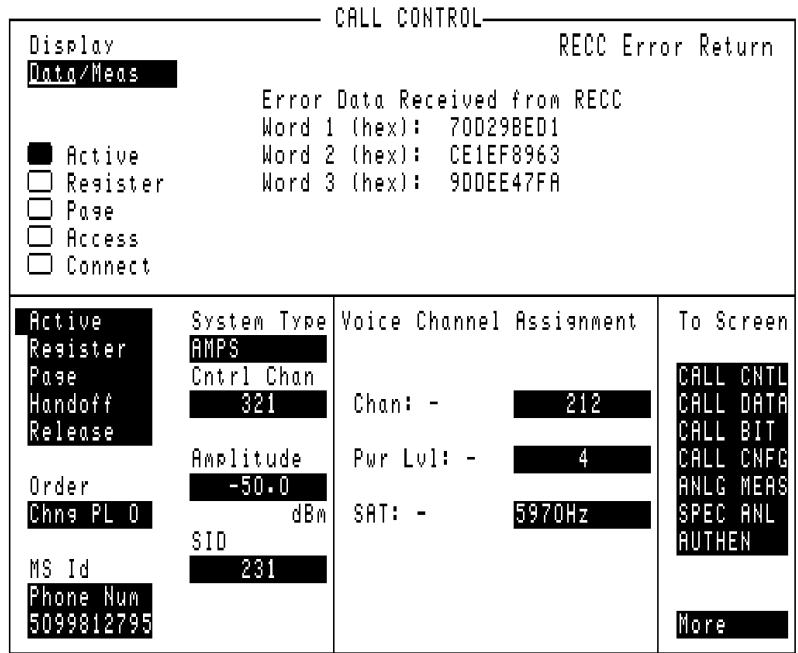

Figure 19 CALL CONTROL Screen with Decoding Error Message Display

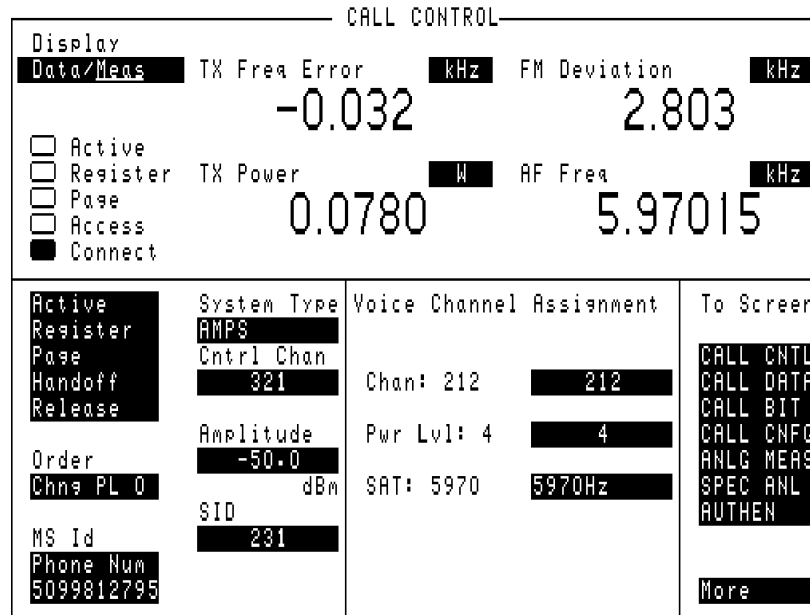

Figure 20

AMPS CALL CONTROL Screen with Meas Selected

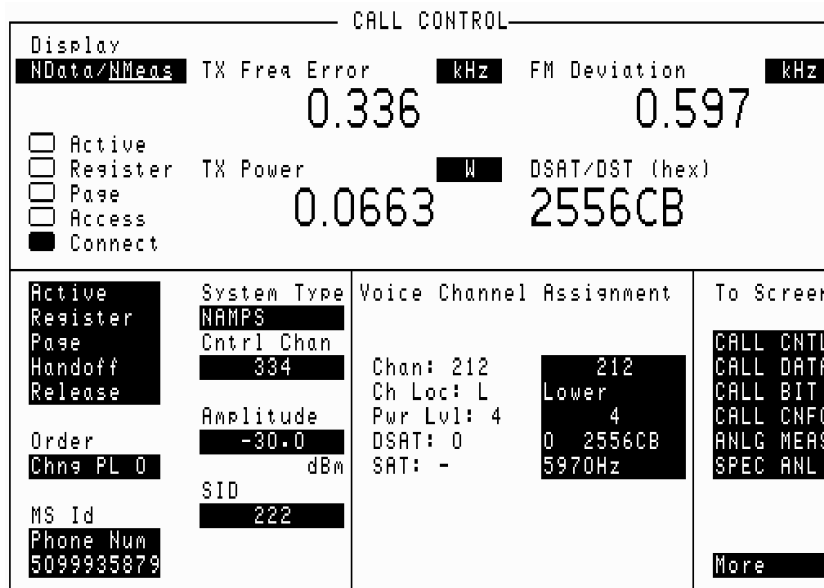

Figure 21 NAMPS CALL CONTROL Screen with Meas Selected

DSAT:

This field is displayed only when the system type is set to **NAMPS**.

DSAT: is divided into two field:

- The left-hand field displays the DSAT control message identifier being broadcast by the Test Set. The DSAT channel number identifier is displayed only when the Test Set's **Connected** annunciator is lit (connected state). A "-" is displayed if a mobile station is not actively connected on a voice channel.
- The right-hand field (highlighted field) is used to select one of the seven valid DSAT sequences to be used on the voice channel (See **Chan: field description, on page 125** for more information about the voice channel.) The DSAT channel number is followed by the corresponding DSAT sequence as defined in IS-88.

DSAT/DST (hex)

The **DSAT/DST** field is displayed only when the **System Type** field is set to **NAMPS** and **Display** field is set to **NMeas**.

The **DSAT/DST** field displays the received **DSAT/DST** sequence from the mobile station on the reverse voice channel. The received sequence is displayed in hexadecimal form and can be checked against the DSAT value displayed in the DSAT right-hand DSAT field. Four dashes (----) indicate no carrier is present to measure. A hexadecimal value would only be displayed when the Test Set's **Connected** annunciator is lit (connected state).

ESN (dec):

This field displays the electronic serial number (ESN), in decimal form, received from the mobile station on the reverse control channel in response to a forward control channel message. The **ESN (dec) :** field is displayed only when the **Display** field is set to **Data** and a reverse control channel message containing this information has been decoded.

ESN (hex):

This field displays the electronic serial number (ESN), in hexadecimal form, received from the mobile station on the reverse control channel in response to a forward control channel message. The **ESN (hex) :** field is displayed only when the **Display** field is set to **Data** and a reverse control channel message containing this information has been decoded.

FM Deviation

This field displays the measured FM deviation of the RF carrier being transmitted by the mobile station on the reverse voice channel. Four dashes (----) indicate no carrier is present to measure. A numeric value would only be displayed when the Test Set's **Connected** annunciator is lit (connected state). The **FM Deviation** field is only displayed when the **Display** field is set to **Meas**.

NOTE: When the CALL CONTROL screen is displayed, the Test Set's instrumentation is configured for optimal performance of the signaling decoder. It is recommended that FM deviation measurements be made using either the ANALOG MEAS screen. Using the CALL CONTROL screen to make FM deviation measurements may result in slightly degraded results.

Handoff

This field is used to initiate a handoff from the current voice channel assignments to a new set of voice channel assignments. The voice channel number to hand the mobile station off to, the channel location (NAMPS system type only), the initial power level to use on the new voice channel, the DSAT sequence (NAMPS system type only) to transpond on the mobile station, and the SAT tone frequency to transpond on the new voice channel are specified using the **Chan:**, **Ch Loc:**, **Pwr Lvl:**, **DSAT:**, and **SAT:** fields in the **Voice Channel Assignment** section of the CALL CONTROL screen.

MS Id

This field is used to enter the identification number of the mobile station. The **MS Id** has two fields. The upper field is a one-of-many selection field and is used to select the format for entering the identification number. The lower field is a numeric entry field and is used to enter the identification number in the format selected using the upper field. The contents of the lower field are automatically updated upon successful completion of a mobile station registration.

There are two formats which can be used to enter the identification number. The identification number can be entered as either the 10-digit phone number in decimal (for example, 5095551212) or as the mobile identification number (MIN) in hexadecimal (for example, AAABBBBBB). The first 3 characters (AAA) in the field represent MIN2 and the last 6 characters (BBBBBB) represent MIN1.

To enter the identification number, select upper field and select the desired format (**Phone Num** or **MIN2 MIN1**). Then select the lower field and enter the information in the selected format. If the desired format is already selected then simply select the lower field and enter the information in the selected format. The formats are coupled, that is, if the **Phone Num** format is selected and the 10-digit phone number is entered, the **MIN2 MIN1** information is automatically updated, and vice versa.

NOTE: The preset values for the **MS Id** fields are:

- **Phone Num** = 111111111
- **MIN2 MIN1** = 00000400

An all zero MIN number (00000000), which does not represent a valid phone number, will be converted to the following phone number: 11111?111.

Order

This field is used to send an order on the forward voice channel to the Mobile Station. A mobile station must be actively connected on a voice channel to the Test Set (that is, the **Connect** annunciator must be lit) before you can send an order to a mobile station.

The **Order** field is a one-of-many selection field. To send an order to the mobile station, select the **Order** field. A list of choices is displayed. Select the desired order from the **Choices:** menu. The following orders are available:

Change Power to Power Level 0 - 7

- Maintenance (put the mobile station in maintenance mode)

Alert (alert the mobile station)

MRI (mobile reported interference) request (**NAMPS** system type only)

Once the selection is made a mobile station control message is sent to the mobile station. The **Access** annunciator will light momentarily while the Test Set is sending the mobile station control message.

Pwr Lvl:

Pwr Lvl: is divided into two fields:

- The left-hand field displays the mobile station's output power level assigned to the voice channel being used by the Test Set and the mobile station. A numeric value is displayed only when a mobile station is actively connected on a voice channel (that is, the **Connect** annunciator must be lit). A "-" is displayed if a mobile station is not actively connected on a voice channel.
- The right-hand field (highlighted field) is used to enter the Voice Mobile Attenuation Code (VMAC). The VMAC determines the mobile station's power level to be used on the voice channel (See [Chan: field description, on page 125](#) for more information about the voice channel).

Page

This field is used to initiate a page to the mobile station that is connected to the Test Set. The Test Set must be in the active state (that is, **Active** annunciator must be lit) and the **MS Id** information must be entered before you can attempt to page the mobile station.

[] Page

When lit, the **Page** annunciator indicates that the mobile station connected to the Test Set is currently being paged on the forward control channel.

Phone Num:

This field displays the decoded MIN number received from the mobile station on the reverse control channel in response to a forward control channel message. The **Phone Num:** field is displayed only when the **Display** field is set to **Data** and a reverse control channel message containing this information has been decoded.

CAUTION: Do not confuse the **Phone Num:** field, which is displayed in the upper right-hand portion of the **CALL CONTROL** screen, with the **Phone Num** selection of the **MS Id** field.

NOTE: An all zero MIN number (000000000), which does not represent a valid phone number, will convert to the following phone number: 111111?111.

Register

This field is used to initiate a registration of the mobile station that is connected to the Test Set. The Test Set must be in the active state (that is, the **Active** annunciator must be lit) before you can attempt to register the mobile station.

[] Register

When lit, the **Register** annunciator indicates that the mobile station connected to the Test Set is being commanded to register with the Test Set.

Release

This field is used to terminate an active voice channel connection with the mobile station. When the **Release** field is selected, a mobile station control message with a release order is sent to the mobile station on the forward voice channel. A mobile station must be actively connected on a voice channel to the Test Set (that is, the **Connect** annunciator must be lit) before you can attempt to send a release order to the mobile station.

SAT:

SAT: is divided into two fields:

The left-hand field displays the SAT frequency assigned to the voice channel being used by the Test Set and the mobile station. A numeric value would only be displayed when the Test Set's **Connected** annunciator is lit (connected state). A "-" is displayed if a mobile station is not actively connected on a voice channel.

The right-hand field (highlighted field) is used to set the SAT Color Code (SCC) to be used on the designated voice channel (**Chan: field description, on page 125** for more information about the voice channel).

SCM:

This field displays the decoded station class mark information received from the mobile station on the reverse control channel in response to a forward control channel message. The **SCM:** field is displayed only when the **Display** field is set to **Data** and a reverse control channel message has been decoded.

SID

This field is used to set the system identification number (SID) of the Test Set. The **SID** field is an immediate action field. If the field is selected and changed, the signaling message(s) being sent on the forward control channel are immediately changed. No change occurs to the current state (that is, active, register, page, access, connect) of the Call Processing Subsystem.

System Type

This field is used to select the type of cellular system (AMPS, NAMPS, TACS, JTACS) which will be simulated.

The **System Type** field is an immediate action field. That is, whenever the **System Type** field is changed, the change is reflected immediately in the physical configuration of the Test Set. The control channel is immediately deactivated, reconfigured, and then re-activated to reflect the change. This change causes the Test Set to enter the active state).

If the Test Set is in the connected state (**Connect** annunciator is lit) and a change is made to the **System Type** field, the connected state will be lost.

TX Freq Error

This field displays the frequency error (frequency error = assigned carrier frequency - measured carrier frequency) of the RF carrier being transmitted by the mobile station. Four dashes (----) indicate that no RF carrier is present to measure. A numeric value would only be displayed in the connected state (that is, the **Connect** annunciator is lit). The **TX Freq Error** field is displayed only when the **Display** field is set to **Meas**.

TX Power

The **TX Power** field is displayed only when the **Display** field is set to **Meas**.

This field displays the measured RF power of the RF carrier being transmitted by the mobile station. A non-zero value would only be displayed when the Test Set's **Connect** annunciator is lit).

When the CALL CONTROL screen is displayed and the Test Set is in the connected state (**Connect** annunciator is lit), the mobile station's transmitted carrier power is constantly monitored. If the power falls below 0.0005 Watts, the error message **RF Power Loss indicates loss of Voice Channel** will be displayed, and the Test Set will terminate the call and return to the active state (**Active** annunciator is lit).

In order to ensure that the Test Set makes the correct decisions regarding the presence of the mobile stations's RF carrier, the Test Set's RF power meter should be zeroed before using the Call Processing Subsystem. Failure to zero the power meter can result in erroneous RF power measurements. See "[Conditioning the Test Set for Call Processing](#)" on [page 141](#) for information on manually zeroing the RF Power meter.

VC Order

This field is used to send an order on the forward voice channel to the Mobile Station with authentication active. The **vc Order** field is only visible when authentication is activated and the mobile is assigned a voice channel.

The orders available are:

- Change Power to Power Level 0 - 7
- Maintenance (put the mobile station in maintenance mode)
- Alert (alert the mobile station)
- SSD Update (shared secret data update)

Uniq Ch (unique challenge)

Using the CALL CONTROL Screen to Test Call Processing Functions

The CALL CONTROL screen provides multiple functions for testing a mobile station. The following sections describe how to:

- [Conditioning the Test Set for Call Processing field description, on page 141](#)
- [Configure the Test Set field description, on page 142](#)
- [Turn On The Test Set's Control Channel field description, on page 143](#)
- [Register a Mobile Station field description, on page 144](#)
- [Page a Mobile Station field description, on page 145](#)
- [Handoff a Mobile Station to a New Voice Channel field description, on page 147](#)
- [Release A Mobile Station field description, on page 147](#)
- [Change the Transmit Power Level of a Mobile Station field description, on page 148](#)
- [Send an Alert Order to a Mobile Station field description, on page 150](#)

Conditioning the Test Set for Call Processing

Perform the following steps when first entering the Call Processing Subsystem (that is, the first time the CALL CONTROL screen is selected during a measurement session).

1. Zero the RF Power Meter.

Select the **RF GEN** from the **To Screen** menu.

- a. Set the **Amplitude** field to off (use the ON/OFF key). This prevent cross-coupling into the power detector while zeroing the power meter.
- b. Select **CALL CNTL** from the **To Screen** menu.
- c. Select **CALL CNFG** from the **To Screen** menu.
- d. Disconnect any cables from the RF IN/OUT port on the front panel of the Test Set.
- e. Select the **TX Pwr Zero** field.
- f. Select the **RF Gen** from the To Screen menu.
- g. Set the **Amplitude** field to On.

There are two reasons for zeroing the RF power meter:

- When any Call Processing Subsystem screen is displayed (except the ANALOG MEAS screen) and the Call Processing Subsystem is in the connected state (**Connect** annunciator is lit), the Test Set constantly monitors the mobile station's transmitted carrier power. If the power falls below 0.0005 Watts, the error message **RF Power Loss indicates loss of Voice Channel** will be displayed and the Test Set will terminate the call and return to the active state. Zeroing the power meter cancels any inherent dc offsets that may be present within the power meter under zero-power conditions. This ensures that the Test Set makes the correct decisions regarding the presence of the mobile stations's RF carrier.
- Zeroing the power meter establishes a 0.0000 W reference for measuring the mobile station's RF power at the RF IN/OUT port. This ensures the most accurate RF power measurements of the mobile station's RF carrier at different power levels.

2. Couple the variable-frequency notch filter to AFGen1.

This step is only required if audio testing is to be done on the mobile station. This step couples the variable-frequency notch filter to the output frequency of AFGen1 (audio frequency generator1). The notch filter is used when making SINAD measurements. AFGen1 is used to generate the audio tone for the SINAD measurement. Coupling the notch filter to the audio source ensures the most accurate measurement.

- a. Press and release the blue SHIFT key and then the DUPLEX key to display the CONFIGURE screen.
- b. Position the cursor on the **Notch Coupl** field and select **AFGen1**.

Configure the Test Set

Select **CALL CNTL** from the **To Screen** menu. The CALL CONTROL screen will be displayed.

3. Verify that the Test Set configuration information is appropriate for the mobile station to be tested. Check the following fields:
 - a. **System Type** - Select the type of cellular system to be simulated (AMPS, NAMPS, TACS, JTACS, DAMPS, DCCH).

If the **System Type** field was modified in step3. a. the control channel will become active since modifying this field automatically activates the control channel. Refer to the [System Type field description, on page 136](#).

- b. **Cntl Channel** - Set the control channel number to be used by the Test Set.

NOTE:

If the **Cntl Channel** field was modified in step 3.b. the control channel will become active since modifying this field automatically activates the control channel. Refer to the [Cntl Channel field description, on page 126](#).

- c. **Amplitude** - Set the output power of the Test Set's transmitter (that is, the output power of the Test Set's RF Generator).
- d. **SID** - Enter the system identification number of the Test Set as a decimal number.
- e. **Chan:** (right-hand field) - Enter the voice channel number which will be assigned to the mobile station by the Test Set as either an initial voice channel assignment or as a handoff voice channel assignment.
- f. **Ch Loc:** (right-hand field, **NAMPS** system type only) - Select the narrow analog channel location which will be assigned to the mobile station by the Test Set as either an initial channel location assignment or as a handoff channel location assignment. The choices are Lower (10 kHz below standard wide analog channels), Middle (centered at the wide analog channel), Upper (10 kHz above the standard analog channel) or Wide Chan.

Pwr Lvl: (right-hand field) - Enter the Voice Mobile Attenuation Code (VMAC). The VMAC determines the mobile station power level to be used on the voice channel (See **Chan: field description, on page 125** for more information about voice channel).

- g. DSAT:** (right-hand field, **NAMPS** system type only) - Select the DSAT Color Code (DSCC) to be used on the voice channel (See **Chan: field description, on page 125** for more information about voice channel)

SAT: (right-hand field) - Enter the SAT frequency to be used on the voice channel (See **Chan: field description, on page 125** for more information about the voice channel).

4. Select **CALL CNFG** from the **To Screen** menu. The CALL CONFIGURATION screen will be displayed.
5. Verify that the Test Set's configuration information is appropriate for the mobile station to be tested. Check the following fields:
 - a. **CMAX** - Set the number of access channels in the system. This will determine how many channels must be scanned by the mobile station when trying to access the Test Set. The value of this field will affect the time required for the mobile station to connect with the Test Set.

Turn On The Test Set's Control Channel

If not already done, condition the Test Set. See "**Conditioning the Test Set for Call Processing**" on page 141 for further information.

1. If not already done, configure the Test Set. See "**Configure the Test Set**" on page 142 for further information.
2. If the CALL CONTROL screen is not displayed, select **CALL CNTL** from the **To Screen** menu. The CALL CONTROL screen will be displayed.
3. Select the **Active** field. The **Active** annunciator will light when the control channel is turned on.

Register a Mobile Station

Ensure that the Test Set is in the active state. See "[Turn On The Test Set's Control Channel](#)" on page 143 for information on how to activate the Test Set.

1. Connect the mobile station to the Test Set as shown in [Figure 17, "Connecting a Mobile Station to the Test Set,"](#) on page 119.
2. Turn on the mobile station.
3. If the CALL CONTROL screen is not displayed, select **CALL CNTL** from the **To Screen** menu. The CALL CONTROL screen will be displayed.
4. Position the cursor on the **Display** field and select **Data**.
5. Select the **Register** field. The **Register** annunciator will light while the registration is in process. If the mobile station responds properly on the reverse control channel, the message **RECC Return** will flash momentarily in the upper right-hand corner of the CALL CONTROL screen and the mobile station phone number, ESN and decoded SCM will be displayed in the upper right-hand portion of the CALL CONTROL screen. The information in the **MS Id** field will be updated. The **Active** annunciator will light when the registration has successfully completed.

Page a Mobile Station

There are two methods that can be used to page a mobile station:

- Page a mobile station that has registered with the Test Set.
- Page a mobile station that has not registered with the Test Set.

Paging a Mobile Station that has Registered with the Test Set

1. Ensure that the Test Set is in the active state. See "[Turn On The Test Set's Control Channel](#)" on page 143 for information on how to activate the Test Set.
2. Connect the mobile station to the Test Set as shown in [Figure 17, "Connecting a Mobile Station to the Test Set,"](#) on page 119.
3. Turn on the mobile station.
4. If the CALL CONTROL screen is not displayed, select **CALL CNTL** from the **To screen** menu. The CALL CONTROL screen will be displayed.
5. Position the cursor on the **Display** field and select **Data**.
6. Ensure that the mobile station has registered with the Test Set. See "[Register a Mobile Station](#)" on page 144 for information on how to register the mobile station.
7. Select the **Page** field. The **Page** annunciator will light while the Test Set pages the mobile on the forward control channel. If the mobile station responds properly on the reverse control channel, the message **RECC Return** will flash momentarily in the upper right-hand corner of the CALL CONTROL screen. The **Access** annunciator will then light while the Test Set sends the mobile station an alert order on the assigned voice channel. The mobile station should ring.
8. Press the SEND key on the mobile station. The **Connect** annunciator will light if the mobile station properly signals the Test Set when the SEND key is pressed. The mobile station is now connected to the Test Set on the assigned voice channel. The voice channel assignment section will be updated: that is, any "-" in the left-hand fields will be replaced with appropriate information.

Paging a Mobile Station That Has Not Registered with the Test Set

1. Ensure that the Test Set is in the active state. See **"Turn On The Test Set's Control Channel" on page 143** for information on how to activate the Test Set.
2. Connect the mobile station to the Test Set as shown in **Figure 17, "Connecting a Mobile Station to the Test Set," on page 119**.
3. Turn on the mobile station.
4. If the CALL CONTROL screen is not displayed, select **CALL CNTL** under the **To Screen** menu. The CALL CONTROL screen will be displayed.
5. Position the cursor on the **Display** field and select **Data**.
6. Select the lower **MS Id** field. Enter the mobile station identification number, either the phone number or the MIN number depending upon what the upper **MS Id** field is set to.
7. Select the **Page** field. The **Page** annunciator will light while the Test Set pages the mobile on the forward control channel. If the mobile station responds properly on the reverse control channel, the message **RECC Return** will flash momentarily in the upper right-hand corner of the CALL CONTROL screen. The **Access** annunciator will then light while the Test Set sends the mobile station an alert order on the assigned voice channel. The mobile station should ring.
8. Press the SEND key on the mobile station. The **Connect** annunciator will light if the mobile station properly signals the Test Set when the SEND key is pressed. The mobile station is now connected to the Test Set on the assigned voice channel. The **Voice Channel Assignment** fields will be updated: that is, any "-" in the left-hand fields will be replaced with appropriate information.

Handoff a Mobile Station to a New Voice Channel

1. Ensure that the Test Set is in the connect state. See "Page a Mobile Station" on page 145 for information on how to bring a mobile station up on a voice channel.
2. If the CALL CONTROL screen is not displayed, select **CALL CNTL** from the **To Screen** menu. The CALL CONTROL screen will be displayed.
3. Position the cursor on the **Display** field and select **Data**.
4. Select the **Chan:** field. Enter a new, valid voice channel number.
5. Select the **Ch Loc:** field (**NAMPS** system type only). Enter a new, valid channel location from the **Choices:** menu.

Select the **Pwr Lvl:** field. Enter a new, valid mobile station power level.

6. Select the **DSAT:** field (**NAMPS** system type only). Enter a new, valid DSAT from the **Choices:** menu.

Select the **SAT:** field. Enter a new, valid SAT frequency.

7. Select the **Handoff** field. The **Access** annunciator will light while the Test Set signals the mobile station with the handoff information. If the mobile responds properly, it will stop transmitting on the current voice channel, switch to the new voice channel, and transpond the newly assigned SAT frequency. When the Test Set detects this has happened the **Connect** annunciator is lit indicating that the handoff was successful. The **Voice Channel Assignment** section will be updated; that is, any “–” in the left-hand fields will be replaced with appropriate information.

Release A Mobile Station

Ensure that the Test Set is in the connected state. See "Page a Mobile Station" on page 145 for information on how to bring a mobile station up on a voice channel.

1. If the CALL CONTROL screen is not displayed, select **CALL CNTL** from the **To Screen** menu. The CALL CONTROL screen will be displayed.
2. Select the **Release** field. The Test Set will signal the mobile station with a release order. The mobile station will respond to the release order and cease transmission. The Test Set will terminate transmission on the forward voice channel, and the **Connect** annunciator will turn off. The Test Set will then reconfigure itself for transmission on the forward control channel, begin to transmit system parameter overhead messages, and the **Active** annunciator will light.

Change the Transmit Power Level of a Mobile Station

Ensure that the Test Set is in the connected state. See "[Page a Mobile Station](#)" on page 145 for information on how to bring a mobile station up on a voice channel.

1. If the CALL CONTROL screen is not displayed, select **CALL CNTL** from the **To Screen** menu. The CALL CONTROL screen will be displayed.
2. Position the cursor on the **Display** field and select **Meas**. The upper right-hand portion of the CALL CONTROL screen will display modulation quality measurements of the mobile station's RF carrier. The Test Set's data functions, such as the average (AVG) function, can be used with any of the measurements. Measurement units can also be changed as desired.
3. Select the **Order** field and select it. A **Choices:** menu is displayed showing the various power levels which the mobile station can be set to. Select the desired power level from the **Choices:** menu. The Test Set will then signal the mobile station with an order to set its power level. If the mobile responds properly, the measured value in the **TX Power** field will change.
4. Position the cursor on the **Display** field and select **Data**.
5. Select the **Order** field. Select the desired power level from the **Choices:** menu. The **Access** annunciator will light while the Test Set signals the mobile station with an order to set its power level. If the mobile responds properly, the message **REVC Return** will flash momentarily in the upper right-hand corner of the CALL CONTROL screen and then the decoded order confirmation message received from the mobile station will be displayed. The left-hand **Pwr Lvl:** field will be updated with the new power level information. The **Connect** annunciator will light when signaling is complete.

Originate a Call from a Mobile Station

Ensure that the Test Set is in the active state. See "[Turn On The Test Set's Control Channel](#)" on page 143 for information on how to activate the Test Set.

1. Connect the mobile station to the Test Set as shown in [Figure 17, "Connecting a Mobile Station to the Test Set,"](#) on page 119.
2. Turn on the mobile station.
3. If the CALL CONTROL screen is not displayed, select **CALL CNTL** from the **To Screen** menu. The CALL CONTROL screen will be displayed.
4. Position the cursor on the **Display** field and select **Data**.
5. Dial the desired phone number on the mobile station and press the SEND key on the mobile station's handset. The mobile station signals the Test Set on the reverse control channel with an origination message which includes the dialed phone number, the mobile station's MIN number and the mobile station's ESN. If the mobile station transmitted properly on the reverse control channel, the message **RECC Return** will flash momentarily in the upper right-hand corner of the CALL CONTROL screen and then the mobile station phone number, ESN, decoded SCM, and the called phone number will be displayed. The Test Set will then reconfigure itself to the voice channel assignments set up in the **Voice Channel Assignment** section of the CALL CONTROL screen. The **Access** annunciator will then light while the Test Set signals the mobile station on the assigned voice channel. The **Connect** annunciator will light if the mobile station properly signals the Test Set on the reverse voice channel. The mobile station is now connected to the Test Set on the assigned voice channel. The left-hand fields will be replaced with appropriate information.

Send an Alert Order to a Mobile Station

Ensure that the Test Set is in the connected state. See "Page a Mobile Station" on page 145 for information on how to bring a mobile station up on a voice channel.

1. If the CALL CONTROL screen is not displayed, select **CALL CNTL** under the **To Screen** menu. The CALL CONTROL screen will be displayed.
2. Select the **Order** field. A **Choices:** menu is displayed showing the various orders which can be sent to the mobile station. Select the **Mainten** order from the list of choices. The Test Set will then go into the **Access** state and signal the mobile station with a maintenance order. If the mobile station is responding properly it will go into its maintenance state as defined by the applicable cellular system standard. The left-hand fields in the **Voice Channel Assignment** section will display a '-' while the Test Set is in the access state.
3. Select the **Order** field. A **Choices:** menu is displayed showing the various orders which can be sent to the mobile station. Position the cursor next to the **Alert** order and select it. The Test Set will then signal the mobile station with an alert order. If the mobile station is responding properly it will alert (that is, it will ring). Press the SEND key on the mobile station to respond to the alert order. The mobile station should exit the maintenance state. The Test Set, upon detecting that the mobile station has exited the maintenance state, will return to the **Connect** state and the left-hand subfields in the **Voice Channel Assignment** section will be updated with the current voice channel assignment information.

NOTE: Applicable cellular system standards may specify a time-out period for the maintenance state. If an Alert order is not received during this time-out period the mobile station may take some action as defined by the standard. One such action might be to terminate the voice channel connection. Refer to the applicable cellular system standard for specific information

Using the CALL CONTROL Screen to test AMPS Authentication

The process of testing AMPS authentication (IS-54) through the Call Processing Subsystem requires the user to synchronize the base station and mobile station. This synchronization requires that the base station and the mobile station possess two pieces of shared secret data (SSD) to confirm a valid call. The first piece is the **ESN** of the mobile station and the second piece is the mobile station's **A-key**. The A-key is a secret 26-digit number stored in the mobile station's semi-permanent memory. The following sections describe how to:

- Condition the Test Set for Call Processing with Authentication
- Configure the Test Set for authentication
- Turn On The Test Set's Control Channel
- Initialize Call Processing with Authentication
- Page a Mobile Station with Authentication
- Originate a Call with Authentication
- Perform an SSD Update
- Perform a Unique Challenge

Condition the Test Set for Call Processing

Perform the following steps when first entering the Call Processing Subsystem (that is, the first time the CALL CONTROL screen is selected during a measurement session).

1. Zero the RF Power Meter.

Select the **RF Gen** from the **To Screen** menu.

- a. Set the **Amplitude** field to off (use the ON/OFF key) This prevents cross-coupling into the power detector while zeroing the power meter.
- b. Select **CALL CNTL** from the **To Screen** menu.
- c. Select **CALL CNFG** from the **To Screen** menu.
- d. Disconnect any cables from the RF IN/OUT port on the front panel of the Test Set.
- e. Select the **TX Pwr Zero** field.

There are two reasons for zeroing the RF power meter:

- When any Call Processing Subsystem screen is displayed (except the ANALOG MEAS screen) and the Call Processing Subsystem is in the connected state (**Connect** annunciator is lit), the Test Set constantly monitors the mobile station's transmitted carrier power. If the power falls below 0.0005 Watts, the error message **RF Power Loss indicates loss of Voice Channel** will be displayed and the Test Set will terminate the call and return to the active state. Zeroing the power meter cancels any inherent dc offsets that may be present within the power meter under zero-power conditions. This ensures that the Test Set makes the correct decisions regarding the presence of the mobile stations's RF carrier.
- Zeroing the power meter establishes a 0.0000 W reference for measuring the mobile station's RF power at the RF IN/OUT port. This ensures the most accurate RF power measurements of the mobile station's RF carrier at different power levels.

2. Couple the variable-frequency notch filter to AFGen1.

This step is only required if audio testing is to be done on the mobile station. This step couples the variable-frequency notch filter to the output frequency of AFGen1 (audio frequency generator 1). The notch filter is used when making SINAD measurements. AFGen1 is used to generate the audio tone for the SINAD measurement. Coupling the notch filter to the audio source ensures the most accurate measurement.

- a. Press and release the blue SHIFT key and then the DUPLEX key to display the CONFIGURE screen.
- b. Position the cursor on the **Notch Coupl** field and select **AFGen1**.

Configure the Test Set

1. Select **CALL CNTL** from the **To Screen** menu. The CALL CONTROL screen will be displayed.
2. Verify that the Test Set configuration information is appropriate for the mobile station to be tested. Check the following fields:
 - a. **System Type** - Select AMPS. At this time, only AMPS is supported for authentication.

NOTE: If the **System Type** field was modified in step 2a- the control channel will become active since modifying this field automatically activates the control channel. Refer to the [System Type field description, on page 136](#).

- b. **Cntl Channel** - Set the control channel number to be used by the Test Set.

NOTE: If the **Cntl Channel** field was modified in step 2b the control channel will become active since modifying this field automatically activates the control channel. Refer to the [Cntl Channel field description, on page 126](#).

- c. **Amplitude** - Set the output power of the Test Sets's transmitter (that is, the output power of the Test Set's RF Generator).
 - d. **SID** - Enter the system identification number of the Test Set as a decimal number.
 - e. **Chan:** (right-hand field) - Enter the voice channel number which will be assigned to the mobile station by the Test Set as either an initial voice channel assignment or as a handoff voice channel assignment.
 - f. **Pwr Lvl:** (right-hand field) - Enter the Voice Mobile Attenuation Code (VMAC). The VMAC determines the mobile station power level to be used on the voice channel (See [Chan: field description, on page 125](#) for more information about the voice channel).
 - g. **SAT:** (right-hand field) - Enter the SAT frequency to be used on the designated voice-channel (See [Chan: field description, on page 125](#) for more information about the voice channel).
3. Select **CALL CNFG** under the **To Screen** menu. The CALL CONFIGURATION screen will be displayed.
4. Verify that the Test Set's configuration information is appropriate for the mobile station to be tested. Check the following field:
 - a. **CMAX** - Set the number of access channels in the system. This will determine how many channels must be scanned by the mobile station when trying to access the Test Set. The value of this field will affect the time required for the mobile station to connect with the Test Set.

Turn on the Test Set's Control Channel

1. If not already done, condition the Test Set. See "[Condition the Test Set for Call Processing](#)" on page 152 for further information.
2. If not already done, configure the Test Set. See "[Configure the Test Set](#)" on page 153 for further information.
3. If the CALL CONTROL screen is not displayed, select **CALL CNTL** from the **To Screen** menu. The CALL CONTROL screen will be displayed.
4. Select **Active** field. The **Active** annunciator will light when the control channel is turned on.

Initialize Call Processing with Authentication

There are two methods to initialize Call Processing with authentication.

- Initializing Call Processing with Authentication through registration with the Test Set.
- Initializing Call Processing with Authentication without registration with the Test Set.

Initialize Call Processing through Registration

1. Ensure that the Test Set is in the active state. See "[Turn on the Test Set's Control Channel](#)" on page 154 for information on how to activate the Test Set.
2. Connect the mobile station to the Test Set as shown in [Figure 17, "Connecting a Mobile Station to the Test Set,"](#) on page 119.
3. Turn on the mobile station.
4. If the CALL CONTROL screen is not displayed, select **CALL CNTL** under the **To Screen** menu. The CALL CONTROL screen will be displayed.
5. Position the cursor on the **Display** field and select **Data**.
6. Select the **Register** field. The **Register** annunciator will light while the registration is in process. If the mobile station responds properly on the reverse control channel, the message **RECC Return** will flash momentarily in the upper right-hand corner of the CALL CONTROL screen and then the mobile station's phone number, ESN and decoded SCM will be displayed in the upper right-hand portion of the CALL CONTROL screen. The information in the **MS Id** field will be updated. The **Active** annunciator will light when the registration has successfully completed.
7. Select **AUTHEN** on the **To Screen** field. The AUTHENTICATION screen will be displayed.
8. Select the **A_KEY** field and enter a valid A_KEY in decimal format.
9. Position the cursor on the **Off/On** field and select **On**.
10. Select **CALL CNTL** from the **To Screen** menu. The CALL CONTROL screen will be displayed.

11. Select **SSD Upd** in the **CC Order** field. The Access annunciator light will light while the SSD Update order is in progress. If the mobile station responds properly on the reverse control-channel, "**SSD Update Order Successful**" will be displayed in the upper right-hand portion of the CALL CONTROL screen. The test set and the mobile station now share common secret data and further call processing functions with authentication can be tested. If the order failed, then "**SSD Update Order Failed**" will appear on the upper right-hand portion of the CALL CONTROL screen.

Initializing Authentication without Registration

1. Ensure that the Test Set is in the active state. See "**Turn on the Test Set's Control Channel**" on page 154 for information on how to activate the Test Set.
2. Connect the mobile station to the Test Set as shown in **Figure 17, "Connecting a Mobile Station to the Test Set,"** on page 119.
3. Turn on the mobile station.
4. If the CALL CONTROL screen is not displayed, select **CALL CNTL** from the **To Screen** menu. The CALL CONTROL screen will be displayed.
5. Position the cursor on the **Display** field and select **Data**.
6. Select the upper **MS ID** field and then select **MIN2 MIN1** from the Choices: menu.
7. Select the lower **MS ID** field and enter the information in hexadecimal format.
8. Select **AUTHEN** from the To Screen menu. The AUTHENTICATION screen will be displayed.
9. Select the **A_KEY** field and enter a valid **A_KEY** in decimal format.
10. Select the **ESN** field and enter the mobile station's electronic serial number in a hexadecimal format.
11. Position the cursor on the **Off/On** field and select **On**.
12. Select **CALL CNTL** from the **To Screen** menu. The CALL CONTROL screen will be displayed.
13. Select **SSD Upd** from the **CC Order** field. The Access annunciator light will light while the SSD Update order is in progress. If the mobile station responds properly on the reverse control-channel, "**SSD Update Order Successful**" will be displayed in the upper right-hand portion of the CALL CONTROL screen. The test set and the mobile station now share common secret data and further call processing functions with authentication can be tested. If the order failed, then "**SSD Update Order Failed**" will appear on the upper right-hand portion of the CALL CONTROL screen.

Page a Mobile Station with Authentication

Paging A Mobile Station That Has Registered With The Test Set

1. Ensure that the Test Set is in the active state. See ["Turn on the Test Set's Control Channel" on page 154](#) for information on how to activate the Test Set.
2. Connect the mobile station to the Test Set as shown in [Figure 17, "Connecting a Mobile Station to the Test Set," on page 119](#).
3. Turn on the mobile station.
4. If the CALL CONTROL screen is not displayed, select **CALL CNTL** from the **To Screen** menu. The CALL CONTROL screen will be displayed.
5. Position the cursor on the **Display** field and select **Data**.
6. Ensure that the mobile station has registered with the Test Set. See ["Initialize Call Processing with Authentication" on page 154](#) for information on how to register the mobile station.
7. Select the **Page** field. The **Page** annunciator will light while the Test Set pages the mobile on the forward control channel. If the mobile station responds properly on the reverse control-channel the message **RECC Return** will flash momentarily in the upper right-hand corner of the CALL CONTROL screen. The **Access** annunciator will then light while the Test Set sends the mobile station an alert order on the assigned voice channel. The mobile station should ring.
8. Press the SEND key on the mobile station. The **Connect** annunciator will light if the mobile station properly signals the Test Set. The mobile station is now connected to the Test Set on the assigned voice channel. The **Voice Channel Assignment** fields will be updated, that is, any "-" in the left-hand fields will be replaced with appropriate information. If page with authentication was successful, **"Page w/Auth successful"** will be displayed in the upper right-hand portion of the CALL CONTROL screen. If page with authentication failed, then **"Page w/Auth failed"** will be displayed in the upper right-hand portion of the CALL CONTROL Screen.

Originate a Call with Authentication

1. Ensure that the Test Set is in the active state. See "[Turn On The Test Set's Control Channel](#)" on page 143 for information on how to activate the Test Set.
2. Connect the mobile station to the Test Set as shown in [Figure 17, "Connecting a Mobile Station to the Test Set,"](#) on page 119.
3. Turn on the mobile station.
4. If the CALL CONTROL screen is not displayed, select **CALL CNTL** under the **To Screen** menu. The CALL CONTROL screen will be displayed.
5. Position the cursor on the **Display** field and select **Data**.
6. Ensure that the mobile station has registered with the Test Set. See "[Initialize Call Processing with Authentication](#)" on page 154 for information on how to register the mobile station.
7. Dial the desired phone number on the mobile station and press the SEND key on the mobile station's handset. The mobile station signals the Test Set on the reverse control channel with an origination message which includes the dialed phone number, the mobile station's MIN number and the mobile station's ESN. If the mobile station transmitted properly on the reverse control channel, the message **RECC Return** will flash momentarily in the upper right-hand corner of the CALL CONTROL screen and then the mobile station's phone number, ESN, decoded SCM, and called phone number will be displayed. The Test Set will then reconfigure itself to the voice channel assignments set up in the **Voice Channel Assignment** section of the CALL CONTROL screen. The **Access** annunciator will then light while the Test Set signals the mobile station on the assigned voice channel. The **Connect** annunciator will light if the mobile station properly signals the Test Set on the reverse voice channel. The mobile station is now connected to the Test Set on the assigned voice channel. The **Voice Channel Assignment** fields will be replaced with appropriate information. If origination with authentication was successful, then "**Origination w/Auth successful**" will be displayed in the upper right-hand portion of the CALL CONTROL screen. If origination with authentication failed, then "**Origination w/Auth failed**" will be displayed in the upper right-hand portion of the CALL CONTROL Screen.

Perform an SSD Update

There are two methods that can be used to perform an SSD Update:

- SSD Update on the Control Channel
- SSD Update on the Voice Channel

Performing an SSD Update on the Control Channel

1. Ensure that the Test Set is in the active state. See ["Turn on the Test Set's Control Channel" on page 154](#) for information on how to activate the Test Set.
2. Connect the mobile station to the Test Set as shown in [Figure 17, "Connecting a Mobile Station to the Test Set," on page 119](#).
3. Turn on the mobile station.
4. If the CALL CONTROL screen is not displayed, select **CALL CNTL** from the **To Screen** menu. The CALL CONTROL screen will be displayed.
5. Position the cursor on the **Display** field and select **Date**.
6. Ensure that the Test Set has Initialized Call Processing with Authentication. See ["Initialize Call Processing with Authentication" on page 154](#) for information on how to register the mobile station and activate Authentication.
7. Select **AUTHEN** on the To Screen menu. The AUTHENTICATION screen will be displayed.
8. Select **RANDSSD_1** field. Enter a new, valid RANDSSD_1 value (6-digit hexadecimal).
9. Select **RANDSSD_2** field. Enter a new, valid RANDSSD_2 value (6-digit hexadecimal).
10. Select **RANDSSD_3** field. Enter a new, valid RANDSSD_3 value (2-digit hexadecimal).
11. Select **CALL CNTL** under the **To Screen** menu. The CALL CONTROL screen will be displayed.
12. Select **SSD Upd** on the **CC Order** field. The **Access** annunciator light will light while the SSD Update order is in progress. If the mobile station responds properly on the reverse control channel, **"SSD Update Order Successful"** will be displayed in the upper right-hand portion of the CALL CONTROL screen. The Test Set and the mobile station are now linked and further call processing functions with authentication can be tested. If the order failed, then **"SSD Update Order Failed"** will appear on the upper right-hand portion of the CALL CONTROL screen.

Performing an SSD Update on the Voice Channel

1. Ensure that the Test Set is in the active state. See ["Turn on the Test Set's Control Channel" on page 154](#) for information on how to activate the Test Set.
2. Connect the mobile station to the Test Set as shown in [Figure 17, "Connecting a Mobile Station to the Test Set," on page 119](#).
3. Turn on the mobile station.
4. If the CALL CONTROL screen is not displayed, select **CALL CNTL** from the **To Screen** menu. The CALL CONTROL screen will be displayed.
5. Position the cursor on the **Display** field and select **Data**.
6. Ensure that the Test Set has Initialized Call Processing with Authentication. See ["Initialize Call Processing with Authentication" on page 154](#) for information on how to register the mobile station and activate Authentication.
7. Ensure that the mobile station is on a voice channel. See ["Page a Mobile Station with Authentication" on page 156](#).
8. Select **AUTHEN** from the **To Screen** menu. The AUTHENTICATION screen will be displayed.
9. Select the **RANDSSD_1** field. Enter a new, valid RANDSSD_1 value (6-digit hexadecimal).
10. Select the **RANDSSD_2** field. Enter a new, valid RANDSSD_2 value (6-digit hexadecimal).
11. Select the **RANDSSD_3** field. Enter a new, valid RANDSSD_3 value (2-digit hexadecimal).
12. Select **CALL CNTL** under the **To Screen** menu. The CALL CONTROL screen will be displayed.
13. Select **SSD Upd** on the **VC Order** field. The **Access** annunciator light will light while the SSD Update order is in progress. If the mobile station responds properly on the reverse control channel, **"SSD Update Order Successful"** will be displayed in the upper right-hand portion of the CALL CONTROL screen. If the order failed then **"SSD Update Order Failed"** will appear on the upper right-hand portion of the CALL CONTROL screen.

Perform a Unique Challenge

There are two methods that can be used to perform a Unique Challenge-Response procedure:

- Unique Challenge on the Control Channel
- Unique Challenge on the Voice Channel

Performing a Unique Challenge on the Control Channel

1. Ensure that the Test Set is in the active state. See "[Turn on the Test Set's Control Channel](#)" on page 154 for information on how to activate the Test Set.
2. Connect the mobile station to the Test Set as shown in [Figure 17, "Connecting a Mobile Station to the Test Set,"](#) on page 119.
3. Turn on the mobile station.
4. If the CALL CONTROL screen is not displayed, select **CALL CNTL** under the **To Screen** menu. The CALL CONTROL screen will be displayed.
5. Position the cursor on the **Display** field and select **Data**.
6. Ensure that the Test Set has Initialized Call Processing with Authentication. See "[Initialize Call Processing with Authentication](#)" on page 154 for information on how to register the mobile station and activate Authentication.
7. Select **AUTHEN** on the **To Screen** menu. The **AUTENTICATION** will be displayed.
8. Select **RAND_U** field. Enter a new, valid **RAND_U** value (6-digit hexadecimal).
9. Select **CALL CNTL** under the **To Screen** menu. The CALL CONTROL screen will be displayed.
10. Select **Uniq Chal** from the **CC Order** field. The **Access** annunciator light will light while the Unique Challenge order is in progress. If the mobile station responds properly on the reverse control channel, "**Unique Challenge Successful**" will be displayed in the upper right-hand portion of the CALL CONTROL screen. If the order failed, then "**Unique Challenge Failed**" will appear on the upper right-hand portion of the CALL CONTROL screen.

Performing a Unique Challenge on the Voice Channel

1. Ensure that the Test Set is in the active state. See ["Turn on the Test Set's Control Channel" on page 154](#) for information on how to activate the Test Set.
2. Connect the mobile station to the Test Set as shown in [Figure 17, "Connecting a Mobile Station to the Test Set," on page 119](#).
3. Turn on the mobile station.
4. If the CALL CONTROL screen is not displayed, select **CALL CNTL** from the **To Screen** menu. The CALL CONTROL screen will be displayed.
5. Position the cursor on the **Display** field and select **Data**.
6. Ensure that the Test Set has Initialized Call Processing with Authentication. See ["Initialize Call Processing with Authentication" on page 154](#) for information on how to register the mobile station and activate Authentication.
7. Ensure that the mobile station is assigned an active voice channel. See ["Page a Mobile Station with Authentication" on page 156](#).
8. Select **AUTHEN** from the To Screen menu. The AUTHENTICATION screen will be displayed.
9. Select the **RAND_U** field. Enter a new, valid RAND_U value (6-digit hexadecimal).
10. Select **CALL CNTL** from the **To Screen** menu. The CALL CONTROL screen will be displayed.
11. Select **Uniq Ch** from the **VC Order** field. The **Access** annunciator light will light while the Unique Challenge order is in progress. If the mobile station responds properly on the reverse control channel, **"Unique Challenge Successful"** will be displayed in the upper right-hand portion of the CALL CONTROL screen. If the order failed, then **"Unique Challenge Failed"** will appear on the upper right-hand portion of the CALL CONTROL screen.

AUTHENTICATION Screen

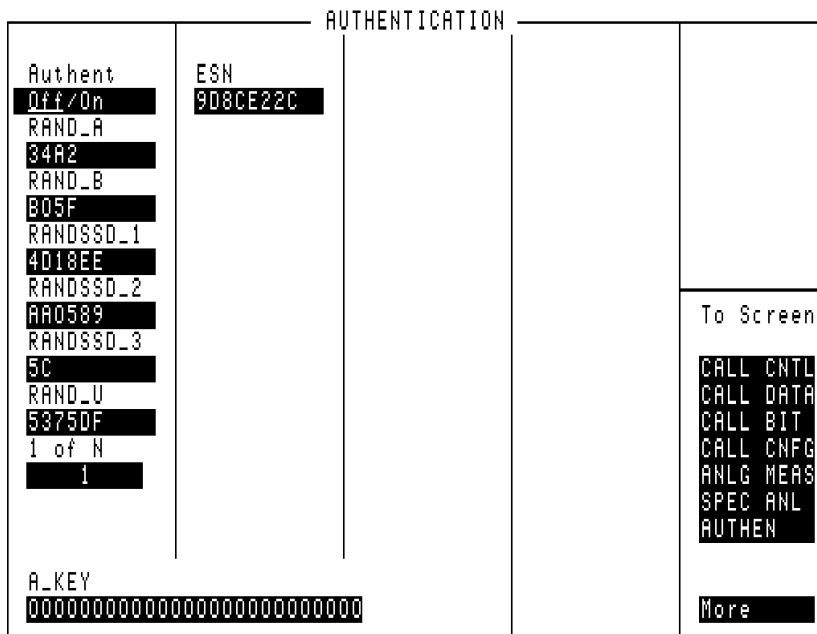

Figure 22 The AUTHENTICATION Screen

The AUTHENTICATION screen allows you to enter parameters for authentication into the Test Set. These parameters are used by the Cave algorithm during Call Processing functions such as registration, page, and originate to verify a valid call.

A_Key

The A_key is a 26-digit decimal number stored in the mobile station's permanent security and identification memory and is not accessible to the user. The user must obtain a valid **A_Key** from the mobile station's manufacturer or from the HLR/AC to test Authentication procedures, otherwise the authentication process will fail. The Test Set reads the first 20-digits and using them during the authentication process. The Test Set does not write data back to the A_key field during manual operation.

NOTE:

A_key generation is not available through the manual user interface. A_key generation is only supported through the remote user interface.

Authent

This field is used to activate the authentication process within the Test Set. With this field set to **On**, the Test Set issues system parameter overhead messages including **SPC WORD1**, **SPC WORD2**, **ACCESS**, **RandChalA**, and **RandChalB** to the mobile station.

ESN

This field is used to enter the electronic serial number (ESN) of the mobile station. There are two methods which can be used to enter the **ESN**. The serial number can be entered as an 8-digit hexadecimal value directly into this field or it can be captured by the Test Set through a registration order.

To enter the electronic serial number directly, select the ESN field and enter the information in hexadecimal format.

RAND_A

RAND_A is the 16 most significant bits of **RAND** and is entered as a 4-digit hexadecimal value. The mobile station stores and uses the most recent version of RAND in the authentication process. RAND_A is user definable.

RAND_B

RAND_B is the 16 least significant bits of **RAND** and is entered as a 4-digit hexadecimal value. The mobile station stores and uses the most recent version of RAND in the authentication process. RAND_B is user definable.

RANDSSD_1

RANDSSD_1 is the 24 most significant bits of the random number issued by the base station in the SSD Update Order. RANDSSD_1 is entered as a 6-digit hexadecimal value. RANDSSD_1 is user definable.

RANDSSD_2

RANDSSD_2 is the 24 subsequent bits (following RANDSSD_1) of the random number issued by the base station in the SSD Update Order. RANDSSD_2 is entered as a 6-digit hexadecimal value. RANDSSD_2 is user definable.

RANDSSD_3

RANDSSD_3 is the 8 least significant bits of the random number issued by the base station in the SSD Update Order. RANDSSD_3 is entered as a 3-digit hexadecimal value.

RAND_U

RAND_U is the 24-bit random number issued by the base station in the Unique Challenge Order. RAND_U is entered as a 6-digit hexadecimal value. RAND_U is user definable.

1 of N

The 1 of N field instructs the Test Set how many times to send a system parameter overhead message. The message contains RAND values, RAND_A and RAND_B. The RAND values are difficult for phones which do not support authentication to parse. This field allows for testing of these phones along with the testing of phones which support authentication by altering the number of times the system parameter message is sent to the mobile station.

CALL DATA Screen

CALL DATA

Active
 Register
 Page
 Access
 Connect

Active
Register
Page
Handoff
Release

Order
Chng PL 0

Display Word RECCW A	Word A														
<table border="1" style="width: 100%; border-collapse: collapse;"> <tr> <td style="width: 10%;">F</td> <td style="width: 20%;">NAWC</td> <td style="width: 10%;">T</td> <td style="width: 10%;">S</td> <td style="width: 10%;">E</td> <td style="width: 15%;">RSVD</td> <td style="width: 35%;">SCM</td> </tr> <tr> <td style="text-align: center;">1</td> <td style="text-align: center;">011</td> <td style="text-align: center;">1</td> <td style="text-align: center;">1</td> <td style="text-align: center;">1</td> <td style="text-align: center;">0</td> <td style="text-align: center;">1010</td> </tr> </table>	F	NAWC	T	S	E	RSVD	SCM	1	011	1	1	1	0	1010	
F	NAWC	T	S	E	RSVD	SCM									
1	011	1	1	1	0	1010									
<table border="1" style="width: 100%; border-collapse: collapse;"> <tr> <td style="width: 50%;">MINI</td> <td style="width: 50%;">Parity</td> </tr> <tr> <td style="text-align: center;">110110011000101010101100</td> <td style="text-align: center;">010111100111</td> </tr> </table>	MINI	Parity	110110011000101010101100	010111100111											
MINI	Parity														
110110011000101010101100	010111100111														

To Screen

CALL CNTL
CALL DATA
CALL BIT
CALL CNFG
ANLG MEAS
SPEC ANL
RUTHEN

More

Figure 23

The CALL DATA Screen

This screen displays the decoded reverse control channel and reverse voice channel signaling messages received by the Test Set from the mobile station. Thirteen different decoded messages can be viewed on this screen. The message to be viewed is selected using the **Display Word** field.

The messages which can be viewed are:

- Reverse Control Channel Messages for Paging, Origination, Orders, and Order Confirmation.
 - RECCW A** - Word A - Abbreviated Address Word
 - RECCW B** - Word B - Extended Address Word
 - RECCW C** - Word C - Serial Number Word
 - RECCW D** - Word D - First Word of the Called-Address
 - RECCW E** - Word E - Second Word of the Called-Address
- Reverse Voice Channel Messages for Order Confirmation.

RVCOrdCon - Reverse Voice Channel Order Confirmation Message

- Reverse Control Channel Authentication Messages.
 - BSChalOrd** - Word C - Base Station Challenge Word
 - AuthWORD** - Word C - Authentication Word
 - UniqChCon** - Word C - Unique Challenge Order Confirmation Word
- Reverse Voice Channel Authentication Messages.
 - RVCOrd** - Word one - Reverse Voice Channel Generic Order
 - RVCBSChal** - Word 2 - Reverse Voice Channel Base Station Challenge Order
- NAMPS Reverse Voice Channel Messages.

NRVC Ord - Narrow Order or Order Confirmation Message

The field descriptions for each of the decoded messages are given in the "[CALL DATA Screen Message Field Descriptions](#)" on page 170.

When the CALL DATA screen is displayed and the Call Processing Subsystem is in the connected state, the Test Set constantly monitors the mobile station's transmitted carrier power. If the power falls below 0.0005Watts, the error message **RF Power Loss indicates loss of Voice Channel** will be displayed and the Test Set will terminate the call and return to the active state.

NOTE:

In order to ensure that the Test Set makes the correct decisions regarding the presence of the mobile stations's RF carrier, the Test Set's RF power meter should be zeroed before using the Call Processing Subsystem. Failure to zero the power meter can result in erroneous RF power measurements. See "[Conditioning the Test Set for Call Processing](#)" on page 141 for information on zeroing the RF Power meter manually.

[] Access

When lit, the **Access** annunciator indicates the Test Set is signaling the mobile station with command information on the forward voice channel. This is a transitory state.

The Test Set's speaker is turned off when in the access state. This is done to eliminate any possible audio feedback which may occur if the mobile station's microphone is open.

Active

This field is used to turn on the forward control channel of the Test Set or to force a return to the active state from any other state (register, page, access, connect). If the forward control channel of the Test Set is already active, selecting this field will deactivate and then reactivate the control channel.

Active

When lit, the **Active** annunciator indicates that the control channel of the Test Set is turned on. If this annunciator is lit, the base station is transmitting system parameter overhead messages on the assigned control channel. If the annunciator is not lit the base station is not active.

NOTE: The Test Set may still be outputting a modulated RF carrier but the Test Set's firmware is not active and no communication can occur between a mobile station and the Test Set.

Connect

When lit, the **Connect** annunciator indicates the mobile station is connected to the Test Set on a voice channel.

Display Word

This field is used to select the desired reverse control channel or reverse voice channel message to be viewed.

Handoff

This field is used to initiate a handoff from the current voice channel assignments to a new set of voice channel assignments. The voice channel number to hand the mobile station off to, the channel location (NAMPS system type only), the initial power level to use on the new voice channel, the DSAT sequence (NAMPS system type only) to transpond on the mobile station, and the SAT tone frequency to transpond on the new voice channel are specified using the **Chan:**, **Ch Loc:**, **Pwr Lvl:**, **DSAT:**, and **SAT:** fields in the **Voice Channel Assignment** section of the CALL CONTROL screen.

This field is used to initiate a handoff from the current voice channel assignments to a new set of voice channel assignments. The voice channel number to hand the mobile station off to, the initial power level to use on the new voice channel, and the SAT tone frequency to transpond on the new voice channel are specified using the **Chan:**, **Pwr Lvl:**, and **SAT:** fields in the **Voice Channel Assignment** section of the CALL CONTROL screen.

Order

This field is used to send an order on the forward voice channel to the mobile station. The orders available are:

- Change Power to Power Level 0 - 7
- MRI (issues a request for mobile reported interference report, NAMPS system type only)

Maintenance (puts the mobile station in maintenance mode)

- Alert (alerts the mobile station)

The **Order** field is a one-of-many selection field. To send an order to the mobile station select the **Order** field. A list of choices is displayed. Select the desired order from the **Choices:** menu. Once the selection is made, a mobile station control message is sent to the mobile station. The **Access** annunciator will light momentarily while the Test Set is sending the mobile station control message.

A mobile station must be actively connected on a voice channel to the Test Set (that is, the **Connect** annunciator must be lit) before you can attempt to send an order to a mobile station.

When the **Authent** is set to **ON**, the **Order** field is not displayed.

Page

This field is used to initiate a page to the mobile station connected to the Test Set. The Test Set must be in the active state (that is, the **Active** annunciator must be lit) and the **MS Id** information field on the CALL CONTROL screen must be correct before you can attempt to page a mobile station.

Page

When lit, the **Page** annunciator indicates that the mobile station connected to the Test Set is currently being paged on the forward control channel.

Register

This field is used to initiate a registration of the mobile station connected to the Test Set. The Test Set must be in the active state (that is, the **Active** annunciator lit) before you can attempt to register a mobile station.

Register

When lit, the **Register** annunciator indicates that the mobile station connected to the Test Set is being commanded to register with the base station.

Release

This field is used to terminate an active voice channel connection to the mobile station. When the **Release** field is selected, a mobile station control message with a release order is sent to the mobile station on the forward voice channel. A mobile station must be actively connected on a voice channel to the Test Set (that is, the **Connect** annunciator must be lit) before you can attempt to send a release order to the mobile station.

CALL DATA Screen Message Field Descriptions

This section describes the individual data fields contained in each of the decoded reverse control channel and reverse voice channel messages.

RECCW A Message Fields

Display Word						
RECCW A Word A						
F	NAWC	T	S	E	RSVD	SCM
1	011	1	1	1	0	1010
MIN1						Parity
110110011000101010101100						010111100111

Figure 24 RECCW A Message Fields

F

This field displays the first word indication received from the mobile station.

- A '1' indicates that this is the first word.
- A '0' is displayed for all subsequent words.

NAWC

This field displays the number of additional words coming from the mobile station.

T

This field displays the message type received from the mobile station.

- Set to '1' to identify the message as an origination or an order.
- Set to '0' to identify the message as an order response or page response.

S

This field displays whether the serial number word is received from the mobile station.

- Set to '1' if the serial number word is sent.
- Set to '0' if the serial number word is not sent.

E

This field displays the extended address word received from the mobile.

- Set to '1' if the extended address word is sent.
- Set to '0' if the extended address word is not sent.

RSVD

This field is reserved for future use.

SCM

This field displays the mobile station's received station class mark.

MIN1

This field displays the first part of the mobile identification number received from the mobile station.

Parity

This field displays the parity of the transmitted data.

RECCW B Message Fields

Display Word					
RECCW B			Word B		
F	NAWC	Local	ORDQ	Order	LT
1	000	00011	000	00000	0
RSVD		MIN2		Parity	
10000000		0111110010		101011101010	

Figure 25 RECCW B Message Fields

F

This field displays the first word indication received from the mobile station.

- A '1' indicates that this is the first word.
- A '0' is displayed for all subsequent words.

NAWC

This field displays the number of additional words coming from the mobile.

LOCAL

This field displays the local control field. This field is specific to each system. The **ORDER** field must be set to local control for this field to be interpreted by the Test Set.

ORDQ

This field displays the received order qualifier. The field qualifies the order confirmation to a specific action.

ORDER

This field displays the **order** field and identifies the order type received by the Test Set.

LT

This field displays the last-try code field.

RSVD

Reserved for future use.

MIN2

This field displays the second part of the mobile identification number received by the Test Set.

Parity

This field displays the parity of the received data.

RECCW C Message Fields

Display Word		Word C
RECCW C		
F	NAWC	
0	111	
Serial		Parity
11000011101001011100000110010011		000110111010

Figure 26 RECCW C Message Fields

F

This field displays the first word indication received from the mobile station.

- A '1' indicates that this is the first word.
- A '0' is displayed for all subsequent words.

NAWC

This field displays the number of additional words coming from the mobile.

Serial

This field displays the serial number of the mobile station.

Parity

This field displays the parity of the received data.

RECCW D Message Fields

Display Word					
RECCW D		Word D			
F	NAWC	Dig 1	Dig 2	Dig 3	Dig 4
0	111	0001	0010	0011	0110
Dig 5		Dig 6	Dig 7	Dig 8	Parity
0101		0100	0111	1000	011011100001

Figure 27 RECCW D Message Fields

F

This field displays the first word indication received from the mobile station.

- A '1' indicates that this is the first word.
- A '0' is displayed for all subsequent words.

NAWC

This field displays the number of additional words coming from the mobile.

Dig 1 through Dig 8

These fields display digits 1 through 8 of the phone number dialed on the mobile station.

Parity

This field displays the parity of the received data.

RECCW E Message Fields

Display Word		Word E			
RECCW E					
F	NAWC	Dig 9	Dig 10	Dig 11	Dig 12
0	011	1001	1010	0000	0000
Dig 13		Dig 14	Dig 15	Dig 16	Parity
0000		0000	0000	0000	010001000100

Figure 28 RECCW E Message Fields

F

This field displays the first word indication received from the mobile station.

- A '1' indicates that this is the first word.
- A '0' is displayed for all subsequent words.

NAWC

This field displays the number of additional words coming from the mobile.

Dig 9 through Dig 16

These fields display digits 9 through 16 of the phone number dialed on the mobile station.

Parity

This field displays the parity of the received data.

RVCOrdCon Message Fields

Display Word					
RVCOrdCon			Order Confirmation Message		
F	NAWC	T	Local	ORDQ	Order
1	00	1	00000	001	01011
RSVD					Parity
00000000000000000000					001010001010

Figure 29 RVCOrdCon Message Fields

F

This field displays the first word indication received from the mobile station.

- A '1' indicates that this is the first word.
- A '0' is displayed for all subsequent words.

NAWC

This field displays the number of additional words coming from the mobile.

T

This field displays the message type received from the mobile station.

- Set to '1' to identify the message as an origination or an order.
- Set to '0' to identify the message as an order response or page response.

Local

This field displays the local control field. This field is specific to each system. The **ORDER** field must be set to local control for this field to be interpreted by the Test Set.

ORDQ

This field displays the received order qualifier. The field qualifies the order confirmation to a specific action.

Order

This field displays the **order** field and identifies the order type received by the Test Set.

RSVD

Reserved for future use.

Parity

This field displays the parity of the received data.

BSChalOrd Message Fields

Display Word		Base Station Challenge Word	
BSChalOrd			
F		NAWC	
0		000	
		RANDBS	Parity
00110100111110111000010011010100		111011111111	

Figure 30 BSChalOrd Message Fields

F

This field displays the first word indication received from the mobile station.

- A '1' indicates that this is the first word.
- A '0' is displayed for all subsequent words.

NAWC

This field displays the number of additional words coming from the mobile.

RANDBS

This field displays the random number used in the SSD update procedure.

Parity

This field displays the parity of the received data.

AuthWORD Message Fields

Display Word		Authentication Word	
AuthWORD			
F	NAWC	COUNT	
0	011	000100	
RANDC		AUTHR	Parity
10001101		000101011001111000	010100011011

Figure 31 AuthWORD Message Fields

F

This field displays the first word indication received from the mobile station.

- A '1' indicates that this is the first word.
- A '0' is displayed for all subsequent words.

NAWC

This field displays the number of additional words coming from the mobile.

COUNT

This field displays the modulo-64 count maintained by the mobile station and used for authentication and anti-fraud purposes.

RANDC

This field displays the 8-bit number used to confirm the last RAND received by the mobile station.

AUTHR

Output of the authentication algorithm when responding to a Unique Challenge Order.

Parity

This field displays the parity of the received data.

UniqChCon Message Fields

Display Word		Unique Challenge Order Confirmation Word	
UniqChCon			
F	NAWC	RSVD	
0	000	0000000000000000	
AUTHU		Parity	
011001000000100000		110000110110	

Figure 32 UniqChCon Message Fields

F

This field displays the first word indication received from the mobile station.

- A '1' indicates that this is the first word.
- A '0' is displayed for all subsequent words.

NAWC

This field displays the number of additional words coming from the mobile.

RSVD

Reserved for future use.

AUTHR

This field displays the output of the authentication algorithm when responding to a unique challenge order.

Parity

This field displays the parity of the received data.

RVCOrd Message Fields

Display Word					
RVCOrd Reverse Voice Channel Generic Order					
F	NAWC	T	Local	ORDQ	Order
1	01	1	00000	000	10011
RSVD 00000000000000000000					Parity 000001110111

Figure 33 RVCOrd Message Fields

RVCOrd is a generic order word. It is utilized to receive an order associated with the specific mobile station under test. This order could be unique to the particular mobile station model or manufacturer.

F

This field displays the first word indication received from the mobile station.

- A '1' indicates that this is the first word.
- A '0' is displayed for all subsequent words.

NAWC

This field displays the number of additional words coming from the mobile.

T

This field displays the message type received from the mobile station.

- Set to '1' to identify the message as an origination or an order.
- Set to '0' to identify the message as an order response or page response.

Local

This field displays the local control field. This field is specific to each system. The **ORDER** field must be set to local control for this field to be interpreted by the Test Set.

ORDQ

This field displays the received order qualifier. The field qualifies the order confirmation to a specific action.

Order

This field displays the **order** field and identifies the order type received by the Test Set.

RSVD

Reserved for future use.

Parity

This field displays the parity of the received data.

RVCBSchal Message Fields

Display Word		Base Station Challenge	
RVCBSchal		Order Word	
F	NAWC	T	
0	00	1	
RANDBS		Parity	
00000111110100001111001001001111		111111010101	

Figure 34 RVCBSchal Message Fields

F

This field displays the first word indication received from the mobile station.

- A '1' indicates that this is the first word.
- A '0' is displayed for all subsequent words.

NAWC

This field displays the number of additional words coming from the mobile.

T

This field displays the message type received from the mobile station.

- Set to '1' to identify the message as an origination or an order.
- Set to '0' to identify the message as an order response or page response.

RANDBS

This field displays the random number use in the SSD update procedure.

Parity

This field displays the parity of the received data.

NRVC Ord Message Fields

Display Word							
NRVC Ord							
Narrow Order or Order Confirmation Message							
T1T2	AWC	Local	ORDQ	Order	DSCC	VMAC	OE
11	0	00000	001	01011	000	000	0
RSVD						Parity	
00000000000000						100000000100	

Figure 35 NRVC Ord Message Fields

T1T2

This field identifies the received message as an order confirmation, an order, or a called address message.

AWC

This field indicates the number of additional words coming.

Local

This field displays the local control field. This field is specific to each system. The **ORDER** field must be set to local control for this field to be interpreted by the Test Set.

ORDQ

This field displays the received order qualifier. The field qualifies the order confirmation to a specific action.

Order

This field displays the **Order** field and identifies the order type received by the Test Set.

DSCC

This field displays the current DSAT Color Code being transmitted by the mobile station.

VMAC

This field displays the voice mobile attenuation code. It shows the mobile station power level associated with the designated voice channel.

OE

The Odd/Even data field is used for adjacent channel protection.

RSVD

Reserved for future use.

Parity

This field displays the parity of the received data.

Using the CALL DATA Screen

To View the Decoded Reverse Channel Words from a Mobile Station Registration

1. If not already done, condition the Test Set. See "[Conditioning the Test Set for Call Processing](#)" on page 141 for further information.
2. If not already done, ensure that the Test Set is properly configured. See "[Configure the Test Set](#)" on page 142 for further information.
3. Connect the mobile station to the Test Set as shown in [Figure 17, "Connecting a Mobile Station to the Test Set,"](#) on page 119.
4. Turn on the mobile station.
5. If the CALL DATA screen is not displayed, select **CALL DATA** from the **To Screen** menu. The CALL DATA screen will be displayed.
6. Select the **Active** field. The **Active** annunciator will light when the control channel is turned on.
7. Select the **Register** field. The **Register** annunciator will light while the registration is in process. If the mobile station responds properly on the reverse control channel, the message **RECC Return** will flash momentarily in the upper right-hand corner of the CALL CONTROL screen. The **Active** annunciator will light when the registration has successfully completed.
8. Select the **Display Word** field. A list of reverse channel words which can be displayed will appear in a **Choices:** menu. Select the desired word from the list of choices. The decoded contents for each of the fields in the selected word will be displayed in the lower portion of the display.
9. If a word is chosen which was not part of the decoded reverse channel message stream, all the fields will be blank when it is displayed.
10. See "[CALL DATA Screen Message Field Descriptions](#)" on page 170 for a description of each of the available reverse channel words.

Step 7. and Step 8. in the above procedure can be reversed, that is, the desired word can be selected first, then the mobile station can be registered. If the registration is successful, the contents of each display word contained in the reverse control channel's message stream will be updated when the decoding is complete.

The registration does not have to happen while you are viewing the CALL DATA screen. When the CALL DATA screen is viewed, the contents of the display words will be the decoded data from the last successful call processing function (registration, origination, page, release, order).

To View the Decoded Reverse Channel Words from a Mobile Station Page

There are two methods that can be used to view the decoded RVCC words from a mobile station page:

- View the decoded RVCC words from a page for a mobile station that has registered with the Test Set
- View the decoded RVCC words from a page for a mobile station that has not registered with the Test Set

Viewing the Decoded Reverse Channel Words from a Page to a Mobile Station that has Registered with the Test Set

1. If not already done, condition the Test Set. See "[Conditioning the Test Set for Call Processing](#)" on page 141 for further information.
2. If not already done, ensure that the Test Set is properly configured. See "[Configure the Test Set](#)" on page 142 for further information.
3. Connect the mobile station to the Test Set as shown in [Figure 17, "Connecting a Mobile Station to the Test Set,"](#) on page 119.
4. Turn on the mobile station.
5. If the CALL DATA screen is not displayed, select **CALL DATA** under the **To Screen** menu. The CALL DATA screen will be displayed.
6. Select the **Active** field. The **Active** annunciator will light when the control channel is turned on.
7. Ensure that the mobile station has registered with the Test Set. See "[Register a Mobile Station](#)" on page 144 for information on how to register the mobile station.
8. Select the **Page** field. The **Page** annunciator will light while the Test Set pages the mobile on the forward control channel. If the mobile station responds properly on the reverse control channel, the message **RECC Return** will flash momentarily in the upper right-hand corner of the CALL CONTROL screen. The **Access** annunciator will then light while the Test Set sends the mobile station an alert order on the assigned voice channel. The mobile station should ring.
9. Press the SEND key on the mobile station. The **Connect** annunciator will light if the mobile station properly signals the Test Set when the SEND key is pressed. The mobile station is now connected to the Test Set on the assigned voice channel.
10. Select the **Display Word** field. A list of reverse channel words appears in a **Choices:** menu. Select the desired word from the list of choices. The decoded contents for each of the fields in the selected word will be displayed in the lower portion of the display.

NOTE:

If a word is chosen which was not part of the decoded reverse channel's message stream, all the fields will be blank when it is displayed.

See "[CALL DATA Screen Message Field Descriptions](#)" on page 170 for a description of each of the available reverse channel words.

Step 8. and Step 10. in the above procedure can be reversed, that is, the desired word can be selected first, then the mobile station can be paged. If the page is successful, the contents of each display word contained in the reverse control channel's message stream will be updated when the decoding is complete.

The page does not have to happen while you are viewing the CALL DATA screen. When the CALL DATA screen is viewed, the contents of the display words will be the decoded data from the last successful call processing function (registration, origination, page, release, order).

Viewing the Decoded Reverse Channel Words from a Page to a Mobile Station That Has Not Registered with the Test Set

1. If not already done, condition the Test Set. See "[Conditioning the Test Set for Call Processing](#)" on page 141 for further information.
2. If not already done, configure the Test Set See "[Configure the Test Set](#)" on page 142 for further information.
3. Connect the mobile station to the Test Set as shown in [Figure 17, "Connecting a Mobile Station to the Test Set,"](#) on page 119.
4. Turn on the mobile station.
5. If the CALL CONTROL screen is not displayed, select **CALL CNTL** under the **To Screen** menu. The CALL CONTROL screen will be displayed.
6. Select the lower **MS Id** field. Enter the mobile station identification number, either the phone number or the MIN number depending upon what the upper **MS Id** field is set to.
7. Select **CALL DATA** from the **To Screen** menu. The CALL DATA screen will be displayed.
8. Select the **Active** field. The **Active** annunciator will light when the control channel is turned on.
9. Select the **Page** field. The **Page** annunciator will light while the Test Set pages the mobile on the forward control channel. If the mobile station responds properly on the reverse control channel, the message **RECC Return** will flash momentarily in the upper right-hand corner of the CALL CONTROL screen. The **Access** annunciator will then light while the Test Set sends the mobile station an alert order on the assigned voice channel. The mobile station should ring.
10. Press the SEND key on the mobile station. The **Connect** annunciator will light if the mobile station properly signals the Test Set when the SEND key is pressed. The mobile station is now connected to the Test Set on the assigned voice channel.
11. Select the **Display Word** field. A list of reverse channel words which can be displayed will appear in a **Choices:** menu. Select the desired word from the list of choices. The decoded contents for each of the fields in the selected word will be displayed in the lower portion of the display.

NOTE: If a word is chosen which was not part of the decoded reverse channel's message stream, all the fields will be blank when it is displayed.

See "[CALL DATA Screen Message Field Descriptions](#)" on page 170 for a description of each of the available reverse channel words.

Step 9. and step 11. in the above procedure can be reversed, that is - the desired word can be selected first, then the mobile station can be paged. If the page is successful, the contents of each display word contained in the reverse control channel's message stream will be updated when the decoding is complete.

The page does not have to happen while you are viewing the CALL DATA screen. When the CALL DATA screen is viewed, the contents of the display words will be the decoded data from the last successful call processing function (registration, origination, page, release, order).

To View the Decoded Reverse Channel Words From a Mobile Station Handoff

1. If not already done, condition the Test Set. See "[Conditioning the Test Set for Call Processing](#)" on page 141 for further information.
2. If not already done, configure the Test Set. See "[Configure the Test Set](#)" on page 142 for further information.
3. Connect the mobile station to the Test Set as shown in [Figure 17, "Connecting a Mobile Station to the Test Set,"](#) on page 119.
4. Turn on the mobile station.
5. Ensure that the Test Set is in the **Connect** state. See "[Page a Mobile Station](#)" on page 145 for information on how to bring a mobile station up on a voice channel.
6. If the CALL CONTROL screen is not displayed, Select **CALL CNTL** from the **To Screen** menu. The CALL CONTROL screen will be displayed.
7. Select the **Chan:** field and enter a new, valid voice channel number from the choices provided.
8. Select the **Ch Loc:** field (**NAMPS System Type** only) and enter a new, valid channel location from the choices provided.

Select the **Pwr Lvl:** field and enter a new, valid mobile station power level.

9. Select the **DSAT:** field (**NAMPS System Type** only) and enter a new, valid DSAT from the choices menu.

Select the **SAT:** field and enter a new, valid SAT frequency.

10. Select **CALL DATA** from the **To Screen** menu. The CALL DATA screen will be displayed.

11. Select the **Handoff** field. The **Access** annunciator will light while the Test Set signals the mobile station with the handoff information. If the mobile responds properly, it will stop transmitting on the current voice channel, switch to the new voice channel assignment, and transpond the new SAT frequency assignment. When the Test Set detects this has happened, the **Connect** annunciator lights indicating the handoff was successful.
12. Select the **Display Word** field. A list of reverse channel words which can be displayed will appear in a **Choices:** menu. Select the desired word from the list of choices. The decoded contents for each of the fields in the selected word will be displayed in the lower portion of the display.
13. If a word is chosen which was not part of the decoded reverse channel's message stream, all the fields will be blank when it is displayed.

See "[CALL DATA Screen Message Field Descriptions](#)" on page 170 for a description of each of the available reverse channel words.

Step 11. and step 12. in the above procedure can be reversed, that is - the desired word can be selected first, then the mobile station can be handed off. If the handoff is successful, the contents of each display word contained in the reverse control channel's message stream will be updated when the decoding is complete.

The handoff does not have to happen while you are viewing the CALL DATA screen. When the CALL DATA screen is viewed, the contents of the display words will contain the decoded data from the last successful call processing function (registration, origination, page, release, order).

To View the Decoded Reverse Channel Words from a Mobile Station Release

1. If not already done, condition the Test Set. See ["Conditioning the Test Set for Call Processing" on page 141](#) for further information.
2. If not already done, configure the Test Set. See ["Configure the Test Set" on page 142](#) for further information.
3. Connect the mobile station to the Test Set as shown in [Figure 17, "Connecting a Mobile Station to the Test Set," on page 119](#).
4. Turn on the mobile station.
5. Ensure that the Test Set is in the **Connect** state. See ["Page a Mobile Station" on page 145](#) for information on how to bring a mobile station up on a voice channel.
6. Select **CALL DATA** under the **To Screen** menu. The CALL DATA screen will be displayed.
7. Select the **Release** field. The Test Set will signal the mobile station with a release order. The mobile station will respond to the release order and cease transmission. The Test Set will terminate transmission on the forward voice channel and the **Connect** annunciator will turn off. The Test Set will then reconfigure itself for transmission on the forward control channel, begin to transmit system parameter overhead messages and the **Active** annunciator will light.
8. Select the **Display Word** field. A list of reverse channel words which can be displayed will appear in a Choices: menu. Select the desired word from the list of choices. The decoded contents for each of the fields in the selected word will be displayed in the lower portion of the display.
9. If a word is chosen which was not part of the decoded reverse channel's message stream, all the fields will be blank when it is displayed.
10. See ["CALL DATA Screen Message Field Descriptions" on page 170](#) for a description of each of the available reverse channel words.

Step 7. and step 8. in the above procedure can be reversed, that is, the desired word can be selected first, then the mobile station can be released. If the release is successful, the contents of each display word contained in the reverse control channel's message stream will be updated when the decoding is complete.

The release does not have to happen while you are viewing the CALL DATA screen. When the CALL DATA screen is viewed, the contents of the display words will contain the decoded data from the last successful call processing function (registration, origination, page, release, order).

To View the Decoded Reverse Channel Words from an Order to Change the Transmit Power Level of a Mobile Station

1. If not already done, condition the Test Set. See "[Conditioning the Test Set for Call Processing](#)" on page 141 for further information.
2. If not already done, configure the Test Set. See "[Configure the Test Set](#)" on page 142 for further information.
3. Connect the mobile station to the Test Set as shown in [Figure 17, "Connecting a Mobile Station to the Test Set,"](#) on page 119.
4. Turn on the mobile station.
5. Ensure that the Test Set is in the **Connect** state. See "[Page a Mobile Station](#)" on page 145 for information on how to bring a mobile station up on a voice channel.
6. If the CALL DATA screen is not displayed, select **CALL DATA** under the **To Screen** menu. The CALL DATA screen will be displayed.
7. Select the **Order** field and select it. A **Choices:** menu is displayed showing the various power levels which the mobile station can be set to. Select the desired power level. The **Access** annunciator will light while the Test Set signals the mobile station with an order to set its power level. If the mobile responds properly, the message **REVC Return** will flash momentarily in the upper right-hand corner of the CALL CONTROL screen. The **Connect** annunciator will light when signaling is complete.
8. Select the **Display Word** field. A list of reverse channel words which can be displayed will be presented. Position the cursor on the desired word and select it. The decoded contents for each of the fields in the selected word will be displayed in the lower portion of the display.
9. If a word is chosen which was not part of the decoded reverse channel's message stream, all the fields will be blank when it is displayed.
10. See "[CALL DATA Screen Message Field Descriptions](#)" on page 170 for a description of each of the available reverse channel words.

Step 7. and Step 8. in the above procedure can be reversed, that is, the desired word can be selected first, then the mobile station can be sent an order to change transmit power level. If the order is successful, the contents of each display word contained in the reverse control channel's message stream will be updated when the decoding is complete.

The ordered to change transmit power does not have to happen while you are viewing the CALL CONTROL screen. When the CALL DATA screen is viewed, the contents of the display words will be the decoded data from the last successful call processing function (registration, origination, page, release, order).

To View The Reverse Channel Words From a Mobile Station Origination

1. If not already done, condition the Test Set. See "[Conditioning the Test Set for Call Processing](#)" on page 141 for further information.
2. If not already done, configure the Test Set. See "[Configure the Test Set](#)" on page 142 for further information.
3. Connect the mobile station to the Test Set as shown in [Figure 17, "Connecting a Mobile Station to the Test Set,"](#) on page 119.
4. Turn on the mobile station.
5. Ensure that the Test Set is in the **Connect** state. See "[Page a Mobile Station](#)" on page 145 for information on how to bring a mobile station up on a voice channel.
6. Select the **Active** field. The **Active** annunciator will light when the control channel is turned on.
7. Dial the desired phone number on the mobile station and press the SEND key on the mobile station's handset. The mobile station signals the Test Set on the reverse control channel with an origination message which includes the dialed phone number, the mobile station's MIN number and the mobile station's ESN. If the mobile station transmitted properly on the reverse control channel, the message **RECC Return** will flash momentarily in the upper right-hand corner of the CALL CONTROL screen. The Test Set will then reconfigure itself to the voice channel assignments set up in the **Voice Channel Assignment** section of the CALL CONTROL screen. The **Access** annunciator will then light while the Test Set signals the mobile station on the assigned voice channel. The **Connect** annunciator will light if the mobile station properly signals the Test Set on the reverse voice channel. The mobile station is now connected to the Test Set on the assigned voice channel.
8. Select the **Display Word** field. A list of reverse channel words which can be displayed will be presented. Position the cursor on the desired word and select it. The decoded contents for each of the fields in the selected word will be displayed in the lower portion of the display.

NOTE:

If a word is chosen which was not part of the decoded reverse channel's message stream, all the fields will be blank when it is displayed.

See "[CALL DATA Screen Message Field Descriptions](#)" on page 170 for a description of each of the available reverse channel words.

Step 7. and Step 8. in the above procedure can be reversed, that is, the desired word can be selected first, then a mobile station origination can be performed. If the origination is successful, the contents of each display word contained in the reverse control channel's message stream will be updated when the decoding is complete.

The origination does not have to happen while you are viewing the CALL DATA screen. When the CALL DATA screen is viewed, the contents of the display words will contain the decoded data from the last successful call processing function (registration, origination, page, release, order).

CALL BIT Screen

CALL BIT			
<input checked="" type="checkbox"/> Active	<input type="checkbox"/> Register	<input type="checkbox"/> Page	<input type="checkbox"/> Access
<input type="checkbox"/> Connect			
Data Spec		Order	
Std/Bits		Chng PL 0	
Set Message			To Screen
SPC WORD1 System Parameter Overhead Message Word 1			CALL CNTL
T1T2	DCC	SID1	RSVD
11	00	00000001110011	100
NAWC		OHD	Parity
0010		110	101001101010
			More

Figure 36 The CALL BIT Screen

The CALL BIT screen is designed to give an advanced user the capability to modify the contents of the forward control channel and forward voice channel signaling messages that are used in all processing messaging protocol. A messaging protocol is defined as the sequence of messages sent from the Test Set to the mobile station to perform a desired action, such as registering a mobile station. Modifying the contents of one or more messages may be required for testing the robustness of a mobile station's call processing algorithms or for new product development.

Using the CALL BIT screen requires expert knowledge of the call processing messaging protocols used in the system selected in the **System Type** field on the CALL CONTROL screen.

The CALL BIT screen should not be used to change any parameter that can be set on any other Call Processing Subsystem screen. The contents of the applicable fields on the CALL CONTROL screen and the CALL CONFIGURE screen are not updated to reflect any changes made while using the CALL BIT screen. There is no coupling between the CALL BIT screen and the Test Set.

For example: changing the value of the SAT color code field (SCC) in the forward control channel mobile station control message (MS IntVCh) does not change the setting of the **SAT:** field on the CALL CONTROL screen.

When using the CALL BIT screen the user is responsible for setting the contents of all messages used in a messaging protocol. When using the CALL BIT screen, the Call Processing Subsystem sends the correct messages at the correct times as defined in the applicable industry standard. Message content is the responsibility of the user.

When the CALL BIT screen is displayed and the Call Processing Subsystem is in the connected state, the Test Set constantly monitors the station's transmitted carrier power. If the Power falls below 0.0005 Watts, the error message **RF Power Loss indicates loss of Voice Channel** will be displayed and the Test Set will terminate the call and return to the active state.

NOTE:

In order to ensure that the Test Set makes the correct decisions regarding the presence of the mobile stations's RF carrier, the Test Set's RF power meter should be zeroed before using the Call Processing Subsystem. Failure to zero the power meter can result in erroneous RF power measurements. See "[Conditioning the Test Set for Call Processing](#)" on page 141 for information on manually zeroing the RF Power meter.

The field descriptions for each of the messages are given in the "[CALL BIT Screen Message Field Descriptions](#)" on page 201.

Message Contents that can be Modified Using the CALL BIT screen

The contents of twenty nine different messages can be modified from this screen. The message to be modified is selected using the **Set Message** field. The eleven messages whose contents can be modified are:

- Forward Control Channel Messages for Paging, Origination, Order Confirmation, and Orders.
 - **SPC WORD1** - System Parameter Overhead Message Word 1
 - **SPC WORD2** - System Parameter Overhead Message Word 2
 - **ACCESS** - Access Type Parameters Global Action Message
 - **REG INC** - Registration Increment Global Action Message
 - **REG ID** - Registration ID Message
 - **C-FILMESS** - Control-Filler Message
 - **MS WORD1** - FCC mobile station control message Word 1- Abbreviated Address Word
 - **MS IntVCh** - FCC mobile station control message Word 2- Extended Address-Word - Voice Channel Assignment
 - **MSMessOrd** - FCC mobile station control message Word 2- Extended Address Word - Order
 - **FVC V Mes** - FVC Mobile Station Control Voice Channel Assignment Message
- FVC O Mes** - FVC Mobile Station Control Order Message
- Forward Control Channel Authentication Messages.
 - **RandChalA** - Random Challenge A Global Action Message
 - **RandChalB** - Random Challenge B Global Action Message
 - **RAND SSD1** - First SSD Update Order Word
 - **RAND SSD2** - Second SSD Update Order Word
 - **RAND SSD3** - Third SSD Update Order Word
 - **BSChalCon** - Base Station Challenge Order Confirmation Word
 - **UniqChOrd** - Unique Challenge Order Word
- Forward Voice Channel Authentication Messages.
 - **FVC SSD1** - First SSD Update Order Word
 - **FVC SSD2** - Second SSD Update Order Word
 - **FVC SSD3** - Third SSD Update Order Word
 - **FVCBSCon** - Base Station Challenge Order Confirmation
 - **FVCUniqCh** - Unique Challenge Order Word

- NAMPS Forward Voice Channel Messages.
 - **EXT PROT** - Extended Protocol mobile station control message
 - **NCH ASN** - Extended Protocol Narrow Channel Assignment Message
 - **NMS FVC** - Narrow Channel mobile station control message
 - **WNHO MES** - Word 1- Narrow Channel Wide to Narrow Handoff Message
 - **NHO MES** - Narrow Handoff Message

Access

When lit, the **Access** annunciator indicates that the Test Set is signaling the mobile station with command information on the forward voice channel. This is a transitory state.

The Test Set's speaker is turned off when in the access state. This is done to eliminate any possible audio feedback which may occur if the mobile station's microphone is open.

Active

This field is used to turn on the forward control channel of the Test Set or to force a return to the active state from any other state (register, page, access, connect). If the forward control channel of the Test Set is already active, selecting this field will deactivate and then reactivate the control channel.

Active

When lit, the **Active** annunciator indicates that the control channel of the Test Set is turned on. If this annunciator is lit the base station is transmitting system parameter overhead messages on the assigned control channel. If the annunciator is not lit the base station is not active (note that the Test Set may still be outputting a modulated RF carrier but the Test Set's firmware is not active and no communication can occur between a mobile station and the Test Set).

Connect

When lit, the **Connect** annunciator indicates that the mobile station is connected to the Test Set on a voice channel.

Data Spec

This field is used to determine how the contents of the signaling messages are built.

- **Std** -Use the signaling formats defined in the applicable industry standard to build the forward control channel and forward voice channel signaling messages. Use the contents of the applicable fields on the CALL CONTROL screen and the CALL CONFIGURE screen to obtain information necessary to build the messages. Whenever a signaling message is used, update the contents of all fields in that message on the CALL BIT screen.
- **Bits** -Use the bit patterns as set on the CALL BIT screen to build all forward control channel and forward voice channel signaling messages. For any call processing function (that is, setting the message stream on the active control channel, registering the mobile station, paging the mobile station, handing off the mobile station or releasing the mobile station) the user is responsible for setting the contents of all signaling messages used in that function. The Call Processing Subsystem uses the messaging protocol as defined in the applicable industry standard.

The contents of the applicable fields on the CALL CONTROL screen and the CALL CONFIGURE screen are not updated to reflect any changes made while in the Bits mode. There is no coupling between the Bits mode and the Test Set. For example: if a mobile station was actively connected to the Test Set on a voice channel and the user changed the **CHAN** field on the forward voice channel mobile station control message (FVC V Mes) and sent that message to the mobile station, the mobile station would change its voice channel assignment. However, the Test Set will stay on the voice channel assignment specified in the **Chan:** field on the CALL CONTROL screen. This situation will result in a dropped call. The Bits mode should not be used to change any parameter that can be set on any other Call Processing Subsystem screen.

Handoff

This field is used to initiate a handoff from the current voice channel assignments to a new set of voice channel assignments. The voice channel number to hand the mobile station off to, the channel location (NAMPS system type only), the initial power level to use on the new voice channel, the DSAT sequence (NAMPS system type only) to transpond on the mobile station, and the SAT tone frequency to transpond on the new voice channel are specified using the **Chan:**, **Ch Loc:**, **Pwr Lvl:**, **DSAT:**, and **SAT:** fields in the **Voice Channel Assignment** section of the CALL CONTROL screen.

Order

This field is used to send an order type mobile station control message on the forward voice channel to the mobile station. The orders available are:

- Change Power to Power Level 0 - 7
- Maintenance (put the mobile station in maintenance mode)

Alert (alert the mobile station)

MRI (mobile reported interference report, NAMPS system type only)

The **Order** field is a one-of-many selection field. To send an order to the mobile station select the **Order** field. A list of choices is displayed. Select the desired order from the **Choices:** menu. Once the selection is made, a Mobile Station Control Message is sent to the mobile station. The **Access** annunciator will light momentarily while the Test Set is sending the mobile station control message.

A mobile station must be actively connected on a voice channel to the Test Set (that is, the **Connect** annunciator lit) before you can attempt to send an order to a mobile station.

When **Authent** is set to **ON**, the **Order** field is not displayed.

Page

This field is used to initiate a page to the mobile station connected to the Test Set. The Test Set must be in the active state (that is, **Active** annunciator must be lit) and the **MS ID** information field on the CALL CONTROL screen must be correct before you can attempt to page a mobile station.

Page

When lit, the **Page** annunciator indicates that the mobile station connected to the Test Set is currently being paged on the forward control channel.

Register

This field is used to initiate a registration of the mobile station connected to the Test Set. The Test Set must be in the active state (that is, the **Active** annunciator must be lit) before you can attempt to register a mobile station.

[] Register

When lit, the **Register** annunciator indicates that the mobile station connected to the Test Set is being commanded to register with the base station.

Release

This field is used to terminate an active voice channel connection to the mobile station. When the **Release** field is selected, a mobile station control message with a release order is sent to the mobile station on the forward voice channel. A mobile station must be actively connected on a voice channel to the Test Set (that is, the **Connect** annunciator must be lit) before you can attempt to send a release order to the mobile station.

Set Message

This field is used to select the desired forward control channel or forward voice channel message to be modified.

CALL BIT Screen Message Field Descriptions

This section describes the individual data fields contained in each of the forward control channel and forward voice channel messages.

SPC WORD1 Message Fields

Set Message			
SPC WORD1 System Parameter Overhead Message			
Word 1			
T1T2	DCC	SID1	RSVD
11	00	00000001110011	100
NAWC		OHD	Parity
0010		110	101001101010

Figure 37 **SPC WORD1 Message Fields**

T1T2

This field identifies the received message as an order confirmation, an order, or a called address message.

DCC

This field sets the digital color code.

SID1

First part of the system identification field. The field contains the decimal equivalent of the 14 most significant bits of the system identification number.

RSVD

Reserved for future use.

NAWC

This field displays the number of additional words coming.

OHD

This field displays the overhead message type.

- A '100' indicates a global action message.
- A '110' indicates that this is the first word of the system overhead parameter message.
- A '111' indicates this is the second word of the system parameter overhead message.

Parity

Parity field. The contents of the Parity field cannot be set by the user. The Test Set calculates the parity bits.

SPC WORD2 Message Fields

Set Message							
SPC WORD2 System Parameter Overhead Message Word 2							
T1T2	DCC	S	E	REGH	REGR	DTX	N-1
11	00	1	1	1	1	00	10110
RCF	CPA	CMAX-1		END	OHD	Parity	
1	1	0010101		0	111	001100111111	

Figure 38 SPC WORD2 Message Fields

T1T2

This field identifies the received message as an order confirmation, an order, or a called address message.

DCC

Digital color code field.

S

This field displays whether the serial number word is sent to the mobile station.

- Set to '1' if the serial number word is sent.
- Set to '0' if the serial number word is not sent.

E

This field displays the extended address word sent to the mobile.

- Set to '1' if the extended address word is sent.
- Set to '0' if the extended address word is not sent.

REGH

Registration field for home stations.

REGR

Registration field for roaming stations.

DTX

Discontinuous transmission field.

N-1

N is the number of paging channels in the system.

RCF

Read-control-filler field.

CPA

Combined paging/access field.

CMAx-1

CMAx is the number of access channels in the system.

END

End indication field.

- Set to 1 to indicate the last word of the overhead message train.
- Set to 0 if not the last word.

OHD

This field displays the overhead message type.

- A '100' indicates a global action message.
- A '110' indicates that this is the first word of the system overhead parameter message.
- A '111' indicates this is the second word of the system parameter overhead message.

Parity

Parity field. The contents of the Parity field cannot be set by the user. The Test Set calculates the parity bits.

ACCESS Message Fields

Set Message			
ACCESS		Access Type Parameters Global Action Message	
T1T2	DCC	ACT	BIS
11	00	1001	0
RSVD		END	OHD
0000000000000000		1	100
Parity 011011111110			

Figure 39 ACCESS Message Fields

T1T2

This field identifies the received message as an order confirmation, an order, or a called address message.

DCC

Digital color code field.

ACT

Global Action Field.

BIS

Busy-Idle status field.

RSVD

Reserved for future use, all bits must be set as indicated.

END

End indication field.

- Set to 1 to indicate the last word of the overhead message train.
- Set to 0 if not the last word.

OHD

This field displays the overhead message type.

- A '100' indicates a global action message.
- A '110' indicates this is the first word of the system parameter overhead parameter message.
- A '111' indicates this is the second word of the system parameter overhead message.

Parity

Parity field. The contents of the Parity field cannot be set by the user. The Test Set calculates the parity bits.

REG INC Message Fields

Set Message			
REG INC		Registration Increment Global Action Message	
T1T2	DCC	ACT	REGINCR
11	00	0010	000001100100
RSVD		END	OHD
0000		0	100
Parity 100110010010			

Figure 40 **REG INC Message Fields**

T1T2

This field identifies the received message as an order confirmation, an order, or a called address message.

DCC

Digital color code field.

ACT

Global Action Field.

REGINCR

Registration increment field.

RSVD

Reserved for future use, all bits must be set as indicated.

END

End indication field.

- Set to 1 to indicate the last word of the overhead message train.
- Set to 0 if not the last word.

OHD

This field displays the overhead message type.

- A '100' indicates a global action message.
- A '110' indicates this is the first word of the system parameter overhead parameter message.
- A '111' indicates this is the second word of the system parameter overhead message.

Parity

Parity field. The contents of the Parity field cannot be set by the user. The Test Set calculates the parity bits.

REG ID Message Fields

Set Message		REG ID		Registration ID Message	
T1T2	DCC	REGID			
11	00	000000000000000000000000			
END		OHD	Parity		
1		000	110100011010		

Figure 41 REG ID Message Fields

T1T2

This field identifies the received message as an order confirmation, an order, or a called address message.

DCC

Digital color code field.

REGID

Registration ID field.

END

End indication field.

- Set to 1 to indicate the last word of the overhead message train.
- Set to 0 if not the last word.

OHD

This field displays the overhead message type.

- A '100' indicates a global action message.
- A '110' indicates this is the first word of the system parameter overhead parameter message.
- A '111' indicates this is the second word of the system parameter overhead message.

Parity

Parity field. The contents of the Parity field cannot be set by the user. The Test Set calculates the parity bits.

C-FILMESS Message Fields

Set Message						
C-FILMESS			Control-filler Message			
T1T2	DCC	F1	CMAC	RSVD1	F2	RSVD2
11	00	010111	000	00	11	00
F3	WFOM	F4	OHD	Parity		
1	1	1111	001	001000000011		

Figure 42 C-FILMESS Message Fields

T1T2

This field identifies the received message as an order confirmation, an order, or a called address message.

DCC

Digital color code field.

F1

Control filler message field 1. All bits must be set as indicated.

CMAC

Control mobile attenuation field. Indicates the mobile station power level associated with reverse control channel.

RSVD1

Reserved for future use, all bits must be set as indicated.

F2

Control filler message field 2. All bits must be set as indicated.

RSVD2

Reserved for future use, all bits must be set as indicated.

F3

Control filler message field 3. All bits must be set as indicated.

WFOM

Wait-for-overhead-message field.

F4

Control filler message field 4. All bits must be set as indicated.

OHD

This field displays the overhead message type.

- A '100' indicates a global action message.
- A '110' indicates this is the first word of the system parameter overhead parameter message.
- A '111' indicates this is the second word of the system parameter overhead message.

Parity

Parity field. The contents of the Parity field cannot be set by the user. The Test Set calculates the parity bits.

MS WORD1 Message Fields

Set Message		
MS WORD1 FCC Mobile Station Control Message Abbreviated Address Word		
T1T2	DCC	MIN1
01	00	110110011000101010101100
Parity 010001101111		

Figure 43 MS WORD1 Message Fields

T1T2

This field identifies the received message as an order confirmation, an order, or a called address message.

DCC

Digital color code field.

MIN1

First part of the mobile identification number field.

Parity

Parity field. The contents of the Parity field cannot be set by the user. The Test Set calculates the parity bits.

MSMessOrd Message Fields

Set Message				
MSMessOrd FCC Mobile Station Control Message Extended Address Word				
T1T2	SCC	MIN2	RSVD	Local
10	11	0111110010	0	00000
ORDQ		Order	Parity	
000		00000	000110100001	

Figure 44 MSMessOrd Message Fields

Send Word

The Send Word field sends the currently defined bits displayed in the MSMessOrd field to the mobile station.

T1T2

This field identifies the received message as an order confirmation, an order, or a called address message.

SCC

SAT color code field.

MIN2

Second part of the mobile identification number field.

RSVD

Reserved for future use, all bits must be set as indicated.

LOCAL

This field is specific to each system. The **ORDER** field must be set to local control for this field to be interpreted.

ORDQ

The order qualifier field qualifies the order confirmation to a specific action.

ORDER

This field identifies the order type.

Parity

Parity field. The contents of the Parity field cannot be set by the user. The Test Set calculates the parity bits.

MS IntVCh Message Fields

Set Message			
MS IntVCh		FCC Mobile Station Control Message Extended Address Word	
T1T2	SCC	MIN2	VMAC
10	00	0111110010	100
CHAN		Parity	
00011010100		101001011101	

Figure 45 MS IntVCh Message Fields

T1T2

This field identifies the received message as an order confirmation, an order, or a called address message.

SCC

SAT color code field.

MIN2

Second part of the mobile identification number field.

VMAC

This field displays the voice mobile attenuation code. It shows the mobile station's power level associated with the designated voice channel.

CHAN

Channel number field. Indicates the designated voice channel.

Parity

Parity field. The contents of the Parity field cannot be set by the user. The Test Set calculates the parity bits.

FVC O Mes Message Fields

Set Message				
FVC O Mes		FVC Mobile Station Control Order Message		
T1T2	SCC	PSCC	RSVD	Local
10	11	00	0000000000	000000
ORDQ	Order	Parity		
000	00001	000101000110		

Figure 46 FVC O Mes Message Fields

T1T2

This field identifies the received message as an order confirmation, an order, or a called address message.

SCC

SAT color code for new channel.

PSCC

Present SAT color code. Indicates the SAT color code associated with the present channel.

RSVD

Reserved for future use, all bits must be set as indicated.

LOCAL

Local control field. This field is specific to each system. The ORDER field must be set to local control for this field to be interpreted.

ORDQ

Order qualifier field. Qualifies the order to a specific action.

ORDER

Order field. Identifies the order type.

Parity

Parity field. The contents of the Parity field cannot be set by the user. The Test Set calculates the parity bits.

FVC V Mes Message Fields

Set Message				
FVC V Mes				
FVC Mobile Station Control Voice Message				
T1T2	SCC	PSCC	RSVD	VMAC
10	01	00	00000000	101
CHAN				Parity
00011010101				100001011000

Figure 47 FVC V Mes Message Fields

T1T2

This field identifies the received message as an order confirmation, an order, or a called address message.

SCC

SAT color code for new channel.

PSCC

Present SAT color code. Indicates the SAT color code associated with the present channel.

RSVD

Reserved for future use, all bits must be set as indicated.

VMAC

This field displays the voice mobile attenuation code. It shows the mobile station power level associated with the designated voice channel.

CHAN

Channel number field. Indicates the designated voice channel.

Parity

Parity field. The contents of the Parity field cannot be set by the user. The Test Set calculates the parity bits.

RandChalA Message Fields

Set Message			
RandChalA		Random Challenge A Global Action Message	
T1T2	DCC	ACT	RANDA
11	00	0111	0011010010100010
END		OHD	Parity
0		100	110011000111

Figure 48 **RandChalA Message Fields**

T1T2

This field identifies the received message as an order confirmation, an order, or a called address message.

DCC

Digital color code for new channel.

ACT

Global action field.

RANDA

The 16 most significant bits of the 32 bit RAND variable stored by a mobile for use in the authentication process.

END

End indication field. Set to '1' to indicate the last word of the overhead message train; set to '0' if not last word.

OHD

Overhead message type field. Set to '100' indicating the global action message.

Parity

Parity field. The contents of the Parity field cannot be set by the user. The Test Set calculates the parity bits.

RandChalB Message Fields

Set Message			
RandChalB Random Challenge B Global Action Message			
T1T2	DCC	ACT	RANDB
11	00	1011	1011000001011111
END		OHD	Parity
1		100	111100101010

Figure 49 **RandChalB Message Fields**

T1T2

This field identifies the received message as an order confirmation, an order, or a called address message.

DCC

Digital color code for new channel.

ACT

Global action field.

RANDB

The 16 least significant bits of the 32 bit RAND variable stored by a mobile for use in the authentication process.

END

End indication field.

- Set to 1 to indicate the last word of the overhead message train.
- Set to 0 if not the last word.

OHD

This field displays the overhead message type.

- A '100' indicates a global action message.
- A '110' indicates this is the first word of the system parameter overhead parameter message.
- A '111' indicates this is the second word of the system parameter overhead message.

Parity

Parity field. The contents of the Parity field cannot be set by the user. The Test Set calculates the parity bits.

RAND SSD1 Message Fields

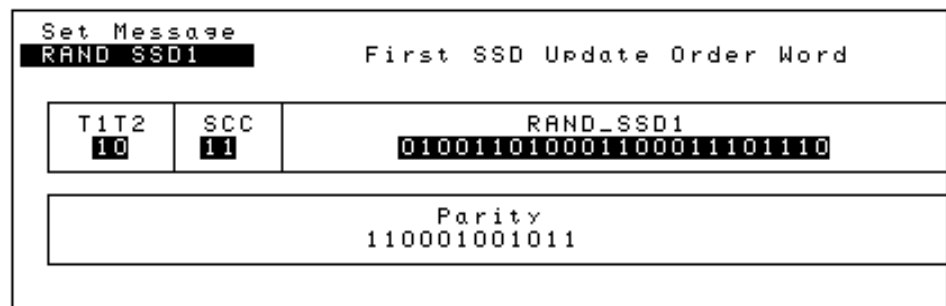

Figure 50 **RAND SSD1 Message Fields**

T1T2

This field identifies the received message as an order confirmation, an order, or a called address message.

SCC

SAT color code for new channel.

RAND_SSD1

The most significant 24-bits of the random number issued by the base station in the SSD Update Order.

Parity

Parity field. The contents of the Parity field cannot be set by the user. The Test Set calculates the parity bits.

RAND SSD2 Message Fields

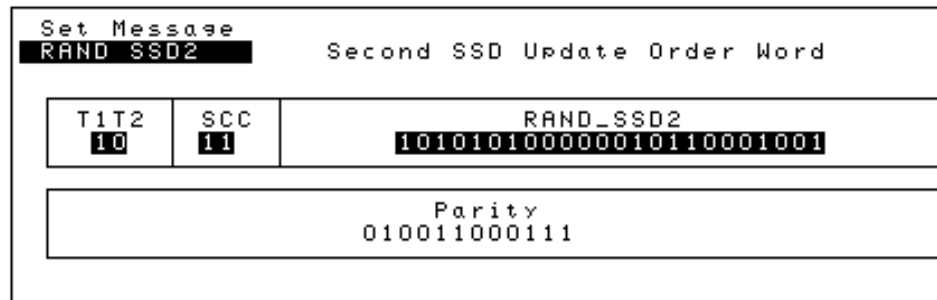

Figure 51 **RAND SSD2 Message Fields**

T1T2

This field identifies the received message as an order confirmation, an order, or a called address message.

SCC

SAT color code for new channel.

RAND_SSD2

The subsequent 24-bits (following RANSSSD_1) of the random number issued by the base station in the SSD Update Order.

Parity

Parity field. The contents of the Parity field cannot be set by the user. The Test Set calculates the parity bits.

RAND SSD3 Message Fields

Set Message		Third SSD Update Order Word	
RAND SSD3			
T1T2	SCC	RSVD1	
10	11	000000000000	
RANDSSD3		RSVD2	Parity
01011100		0000	110010000001

Figure 52 RAND SSD3 Message Fields

T1T2

This field identifies the received message as an order confirmation, an order, or a called address message.

SCC

SAT color code for new channel.

RSVD1

Reserved for future use.

RANDSSD3

The least significant 8-bits of the random number issued by the base station in the SSD Update Order.

RSVD2

Reserved for future use.

Parity

Parity field. The contents of the Parity field cannot be set by the user. The Test Set calculates the parity bits.

BSChalCon Message Fields

Set Message		
BSChalCon Base Station Challenge Order Confirmation Word		
T1T2 10	SCC 11	RSVD1 00
AUTHBS 010110001100110100	RSVD2 0000	Parity 001000101101

Figure 53 **BSChalCon Message Fields**

T1T2

This field identifies the received message as an order confirmation, an order, or a called address message.

SCC

SAT color code for new channel.

RSVD1

Reserved for future use.

AUTHBS

Output response of the authentication algorithm initiated by the Base Station Challenge order.

RSVD2

Reserved for future use.

Parity

Parity field. The contents of the Parity field cannot be set by the user. The Test Set calculates the parity bits.

UniqChOrd Message Fields

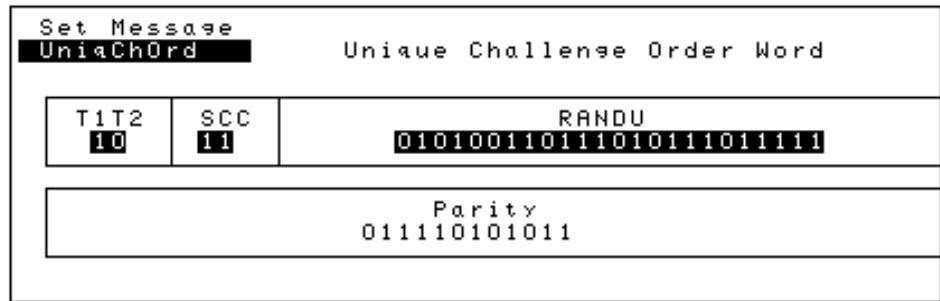

Figure 54 **UniqChOrd Message Fields**

T1T2

This field identifies the received message as an order confirmation, an order, or a called address message.

SCC

SAT color code for new channel.

RANDU

The 24 bit random number issued by the base station in the Unique Challenge Order.

Parity

Parity field. The contents of the Parity field cannot be set by the user. The Test Set calculates the parity bits.

FVC SSD1 Message Fields

Set Message		First SSD Update Order Word	
FVC SSD1			
T1T2	RANDSSD_1		
01	010011010001100011101110		
RSVD		Parity	
00		00111010101	

Figure 55 FVC SSD1 Message Fields

T1T2

This field identifies the received message as an order confirmation, an order, or a called address message.

RANDSSD_1

The most significant 24-bits of the random number issued by the base station in the SSD Update Order.

RSVD

Reserved for future use.

Parity

Parity field. The contents of the Parity field cannot be set by the user. The Test Set calculates the parity bits.

FVC SSD2 Message Fields

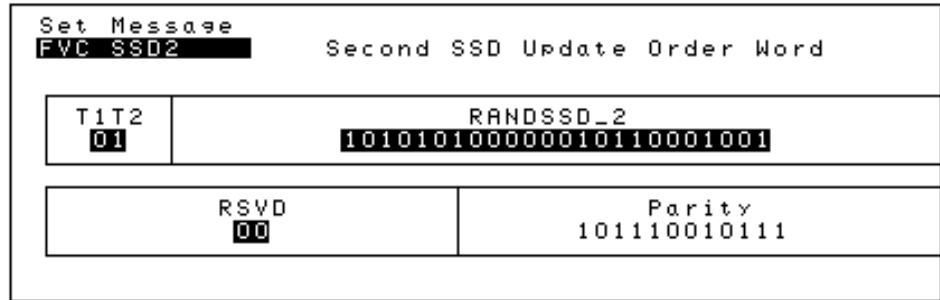

Figure 56 FVC SSD2 Message Fields

T1T2

This field identifies the received message as an order confirmation, an order, or a called address message.

RANDSSD_2

The subsequent 24-bits (following RANSSSD_1) of the random number issued by the base station in the SSD Update Order.

RSVD

Reserved for future use.

Parity

Parity field. The contents of the Parity field cannot be set by the user. The Test Set calculates the parity bits.

FVC SSD3 Message Fields

Set Message FVC SSD3		Third SSD Update Order Word	
T1T2 01	RANDSSD_3 01011100		
RSVD 000000000000000000		Parity 001011101111	

Figure 57 FVC SSD3 Message Fields

T1T2

This field identifies the received message as an order confirmation, an order, or a called address message.

RANDSSD_3

The least significant 8-bits of the random number issued by the base station in the SSD Update Order.

RSVD

Reserved for future use.

Parity

Parity field. The contents of the Parity field cannot be set by the user. The Test Set calculates the parity bits.

FVCBSCon Message Fields

Set Message		Base Station Challenge Order Confirmation	
FVCBSCon			
T1T2	RSVD1	AUTHBS	
01	0000	100111100100110010	
RSVD2		Parity	
0000		100001000000	

Figure 58 FVCBSCon Message Fields

T1T2

This field identifies the received message as an order confirmation, an order, or a called address message.

RSVD1

Reserved for future use.

AUTHBS

Output response of the authentication algorithm initiated by the Base Station Challenge order.

RSVD2

Reserved for future use.

Parity

Parity field. The contents of the Parity field cannot be set by the user. The Test Set calculates the parity bits.

FVCUniqCh Message Fields

Set Message		Uniaue Challenge Order Word
FVCUniqCh		
T1T2	RSVD	RANDU
01	00	010100110111010111011111
Parity		
101010100011		

Figure 59 FVCUniqCh Message Fields

T1T2

This field identifies the received message as an order confirmation, an order, or a called address message.

RSVD

Reserved for future use.

RANDU

The 24 bit random number issued by the base station in the Unique Challenge Order.

Parity

Parity field. The contents of the Parity field cannot be set by the user. The Test Set calculates the parity bits.

EXT PROT Message Fields

Set Message		FCC Mobile Station Control Message	
EXT PROT			
T1T2	SCC	MIN2	EF
10	11	0111110010	1
MSL	MST	Parity	
00001	10000000	111001100011	

Figure 60 EXT PROT Message Fields

T1T2

This field identifies the received message as an order confirmation, an order, or a called address message.

SCC

SAT color code for new channel.

MIN2

Second part of the mobile identification number.

EF

Extended Protocol Forward Channel Indicator.

MSL

Message Length. Extended Protocol Message Length.

MST

Message Type. Extended Protocol Message Type.

Parity

Parity field. The contents of the Parity field cannot be set by the user. The Test Set calculates the parity bits.

NCH ASN Message Fields

Set. Message				
NCH ASN		FCC Narrow Channel Assignment Message		
T1T2	DSCC	RSVD	C13	C12
10	010	0000000	1	0
VMAC		CHAN	Parity	
100		00011011101	111101110011	

Figure 61 NCH ASN Message Fields

T1T2

This field identifies the received message as an order confirmation, an order, or a called address message.

DSCC

DSAT color code for the new channel. Also represents SCC for handoff to a wide analog channel.

RSVD

Reserved for future use.

C13

Channel number bit 13 set - 10 kHz above channel number in CHAN Field.

C12

Channel number bit 12 set - 10 kHz below channel number in CHAN Field.

VMAC

This field displays the voice mobile attenuation code. It shows the mobile station power level associated with the designated voice channel.

CHAN

Channel number field. Indicates the designated RF channel.

Parity

Parity field. The contents of the Parity field cannot be set by the user. The Test Set calculates the parity bits.

NMS FVC Message Fields

Set Message					
NMS FVC Send Word			FVC Mobile Station Control Message		
T1T2 10	DSCC 111	PDSCC 010	EF 0	RSVD 00000	OE 1
LOCAL 00000	ORDQ 000	ORDER 00010	Parity 110001101101		

Figure 62 NMS FVC Message Fields

T1T2

This field identifies the received message as an order confirmation, an order, or a called address message.

DSCC

DSAT color code for the new channel. Also represents SCC for handoff to a wide analog channel.

PDSCC

Present DSAT color code. Indicates the DAST color code associated with the present channel.

EF

Extended protocol order used for multiple word features.

RSVD

Reserved for future use.

OE

The Odd/Even data field is used for adjacent channel protection.

LOCAL

This field is specific to each system. The **Order** field must be set to local control for this field to be interpreted.

ORDQ

The order qualifier field qualifies the order confirmation to a specific action.

ORDER

This field indicates the order type.

Parity

Parity field. The contents of the Parity field cannot be set by the user. The Test Set calculates the parity bits.

WNHO MESS Message Fields

Set Message							
WNHO MES							
Wide to Narrow Handoff Message							
T1T2	SCC	PSCC	CTYP	DSCC	RSVD	C13	C12
10	00	00	1	100	00	0	1
VMAC	CHAN			Parity			
100	00011010100			000011011011			

Figure 63 WNHO MESS Message Fields

T1T2

This field identifies the received message as an order confirmation, an order, or a called address message.

SCC

SAT color code for new channel.

PSCC

Present SAT color code. Indicates the ST color code associated with the present channel.

CTYP

Channel type indicator.

DSCC

DSAT color code for the new channel. Also represents SCC for handoff to a wide analog channel.

RSVD

Reserved for future use.

C13

Channel number bit 13 set - 10 kHz above channel number in CHAN Field.

C12

Channel number bit 12 set - 10 kHz below channel number in CHAN Field.

VMAC

This field displays the voice mobile attenuation code. It shows the mobile station power level associated with the designated voice channel.

CHAN

Channel number field. Indicates the designated RF channel.

Parity

Parity field. The contents of the Parity field cannot be set by the user. The Test Set calculates the parity bits.

NHO MES Message Fields

Set Message							
NHO MES							
Narrow Handoff Message							
T1T2	DSCC	PDSCC	CTYP	OE	RSVD	C13	C12
10	100	010	0	1	00	0	0
VMAC	CHAN		Parity				
100	00011010100		011001100100				

Figure 64 NHO MES Message Fields

T1T2

This field identifies the received message as an order confirmation, an order, or a called address message.

DSCC

DSAT color code for the new channel. Also represents SCC for handoff to a wide analog channel.

PDSCC

Present DSAT color code. Indicates the DAST color code associated with the present channel.

CTYP

Channel type indicator.

OE

The Odd/Even data field is used for adjacent channel protection.

RSVD

Reserved for future use.

C13

Channel number bit 13 set - 10 kHz above channel number in CHAN Field.

C12

Channel number bit 12 set - 10 kHz below channel number in CHAN Field.

VMAC

This field displays the voice mobile attenuation code. It shows the mobile station power level associated with the designated voice channel.

CHAN

Channel number field. Indicates the designated RF channel.

Parity

Parity field. The contents of the Parity field cannot be set by the user. The Test Set calculates the parity bits.

Using the CALL BIT Screen

Selecting The Message Content Generation Method

The contents (i.e. bit patterns) of the signaling messages sent to the mobile station on the forward control channel and the forward voice channel are generated using one of two methods. Method 1 uses the formats defined in the applicable industry standard to build the contents of the signaling messages. Method 2 uses the bit patterns which the user defines on the CALL BIT screen to build the contents of the signaling messages.

The **Data Spec** field on the CALL BIT screen determines which method will be used to build the contents of the signaling messages.

- **Std** -The Test Set will use the signaling formats defined in the applicable industry standard to build the forward control channel and forward voice channel signaling messages. The Test Set will use the contents of the applicable fields on the CALL CONTROL screen and the CALL CONFIGURE screen to obtain information necessary to build the messages. Whenever a signaling message is used, the Test Set will update the contents of all fields in that message on the CALL BIT screen.
- **Bits** -Use the bit patterns as set on the CALL BIT screen to build all forward control channel and forward voice channel signaling messages. For any call processing function (that is, setting the message stream on the active control channel, registering the mobile station, paging the mobile station, handing off the mobile station or releasing the mobile station) the user is responsible for setting the contents of all signaling messages used in that function. The Call Processing Subsystem uses the messaging protocol as defined in the applicable industry standard.

NOTE:

The contents of the applicable fields on the CALL CONTROL screen and the CALL CONFIGURE screen are not updated to reflect any changes made while in the Bits mode. There is no coupling between the Bits mode and the Test Set. For example: if a mobile station was actively connected to the Test Set on a voice channel and the user changed the **CHAN** field on the forward voice channel mobile station control message (FVC V Mes) and sent that message to the mobile station, the mobile station would change its voice channel assignment. However, the Test Set will stay on the voice channel assignment specified in the **Chan:** field on the CALL CONTROL screen. This situation will result in a dropped call. The Bits mode should not be used to change any parameter that can be set on any other Call Processing Subsystem screen.

System Operation When Data Spec Field Set to Std

When the **Data Spec** field is set to **std** the Test Set builds the signaling messages by first examining the fields which contain the information needed to build the messages (i.e. SID, BIS, SAT Tone, VMAC, etc.). After obtaining the necessary information the Test Set builds the bit patterns according to the signaling formats specified in the applicable industry standard.

For example: if the type of cellular system being emulated is AMPS and the **SID** field on the CALL PROC screen was set to 231, the SID1 field in the System Parameter Overhead Message (SPC WORD1) would be set to 00000001110011 (the 14 most significant bits of the system identification number) as defined by the EIA/TIA-553 Mobile Station - Land Station Compatibility Specification.

When the **Data Spec** field is set to **std**, the contents of the applicable message(s) on the CALL BIT screen are updated with the bit patterns generated using the signaling formats defined in the applicable industry standard whenever that signaling message is sent to the mobile station. This feature allows a user to set the **Data Spec** field to **std**, select a message of interest, perform a call processing function, and view the bit patterns generated using the signaling formats defined in the applicable industry standard.

It is important to note individual messages can be used more than once during a messaging protocol. The contents of any message viewed on the CALL BIT screen when the **Data Spec** field is set to **std** will reflect the message contents for the last time the message was used in a messaging protocol.

For example: if the Call Processing Subsystem is in the active state and the user selects the **Register** field, a registration message will be sent to the mobile station. When the registration completes the Call Processing Subsystem returns to the active state. The contents of some messages (such as the System Parameter Overhead Message Word 1) will reflect the correct settings for the active state, not the register state, since the messages are currently being used in the active state.

System Operation When Data Spec Field Set to Bits

When the **Data Spec** field is set to **Bits**, the Test Set builds the signaling messages using only the bit patterns set on the CALL BIT screen whenever a call processing function is executed which uses any of the available messages. The Test Set calculates the contents of the **Parity** field using the coding algorithms specified in the industry standard for the selected system (that is, the system specified in the **System Type** field on the CALL CONTROL screen).

By definition, the Test Set must meet the timing requirements of the industry standard for the selected system. Therefore, depending upon the state of the Call Processing Subsystem (i.e. Active, Register, Page, Access, or Connect) and the frequency with which a particular call processing protocol uses a particular message, it may not be possible to modify the contents of more than one field in a message before it is sent to the mobile station.

For example: in the AMPS system, the system parameter overhead message must be sent every 0.8 +/- 0.3 seconds on the forward control channel. Given this timing requirement it is highly unlikely that, while in the active state, a user could modify more than one field before the message was sent to the mobile station.

There is no functionality in the Test Set to allow an entire message to be modified and then inserted into a messaging protocol at a specific location at a specific time. This functionality requires a protocol analyzer.

When in the **Bits** mode the Test Set provides the messaging protocol for the user (that is, for a desired call processing function the correct message(s) will be sent at the correct time(s) according to the standard). It is the responsibility of the user to generate the contents of all the messages which will be used in a particular call processing function.

For example: if the Call Processing Subsystem was in the active state and the operator wished to register the mobile station from the **Bits** mode, the user would have to set the contents of all the messages used in the registration before selecting the **Register** field to start the registration process.

NOTE:

No error checking is done on the bit patterns. The bit patterns are used but are not checked against any industry standard. It is the responsibility of the user to ensure that the bit patterns set in the CALL BIT screen are correct when the **Data Spec** field is set to **Bits**. Unexpected operation of the mobile station can occur if the contents of the signaling messages are incorrect.

Changing the Content of a Message Field

Perform the following steps to change the contents of a message field:

1. Position the cursor on the **Data Spec** field and select **Bits**.
2. Select the **Set Message** field. A **Choices:** menu is displayed listing the available messages. Select the desired message. The message fields will be displayed on the screen.
3. Select the desired bit field. A **Choices:** menu will be displayed. Using the **Choices:** menu enter the desired bit pattern. Select **Done** from the **Choices:** menu when the desired bit pattern has been entered.

When a message field is being modified the original contents of the field (that is - the contents of the field before modification was started) is sent whenever the message is used in a messaging protocol. The new contents are not used until **Done** is selected from the **Choices:** menu. Use the CANCEL key to abort a modification. If the CANCEL key is selected the original field contents are restored.

NOTE:

If a message field is modified while the **Data Spec** field is set to **Std** the modified contents will be overwritten with the bit patterns generated using the signaling formats defined in the applicable industry standard immediately after **Done** is selected from the **Choices:** menu.

Typical Example

The following example illustrates the use of the CALL BIT screen. In this example an AMPS mobile station is brought up on a voice channel and then handed off to a new voice channel assignment. The contents of the **FVC V Msg** message, which was set when the first handoff occurred, is then modified from the CALL BIT screen. The mobile station is then handed off again by sending the modified message to the mobile station from the CALL BIT screen.

1. Ensure that the Test Set is in the connected state. See "[Page a Mobile Station](#)" on [page 145](#) for information on how to bring a mobile station up on a voice channel.
2. If the CALL CONTROL screen is not displayed, select **CALL CNTL** under the **To Screen** menu. The CALL CONTROL screen will be displayed.
3. Position the cursor on the **Display** field and select **Data**.
4. Select the **Chan:** field and enter a new, valid voice channel number.
5. Select the **Pwr Lvl:** field enter a new, valid mobile station power level.
6. Select the **SAT:** field and enter a new, valid SAT frequency.
7. Select the **Handoff** field. The **Access** annunciator will light while the Test Set signals the mobile station with the handoff information. If the mobile responds properly, it will stop transmitting on the current voice channel, switch to the new voice channel assignment, and transpond the new SAT frequency assignment. When the Test Set detects that this has happened the **Connect** annunciator is lit indicating that the handoff was successful. The left-hand fields in the **Voice Channel Assignment** section will be updated with the new voice channel assignment information.
8. Select **CALL BIT** from the **To Screen** menu. The CALL BIT screen will be displayed.
9. Position the cursor on the **Data Spec** field and select **Bits**.
10. Select the **Set Message** field and select **FVC V Msg**.
11. Select the **VMAC** field in the **FVC V Msg** and set it to 101 (this corresponds to a mobile station power level of 5 - reference EIA/TIA-553 Mobile Station - Land Station Compatibility Specification, September 1989, page 2-2, Table 2.1.2-1).
12. Select the **Handoff** field. The **Access** annunciator will light while the Test Set signals the mobile station with the handoff information. If the mobile responds properly, it will stop transmitting on the current voice channel, and start transmitting on the same channel with a power level of 5 (note that the channel assignment and SAT assignment were not modified in this example, the mobile station simply switched to the same channel with the same SAT assignment). When the Test Set detects that this has happened, the **Connect** annunciator is lit indicating that the handoff was successful. The mobile station power level after the handoff should be power level 5.
13. Position the cursor on the **Data Spec** field and select **Std**.

ANALOG MEAS Screen

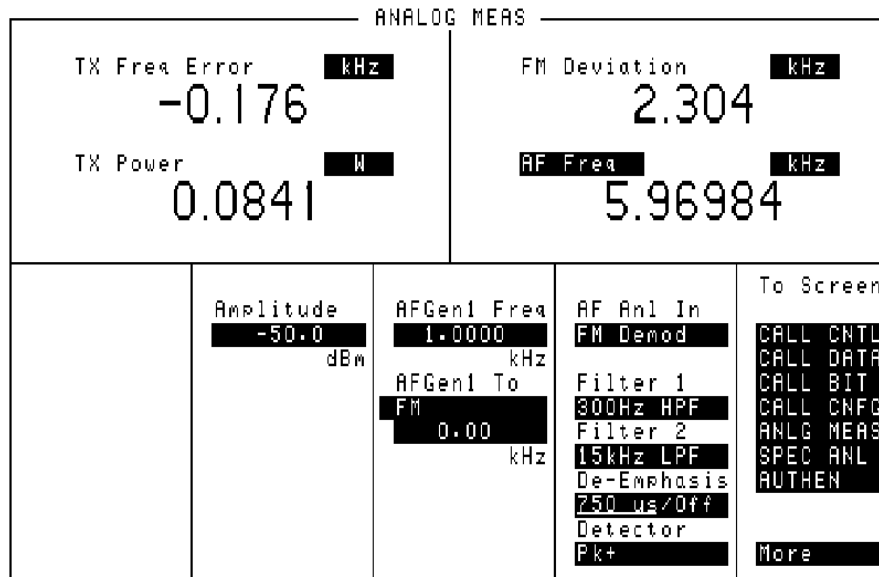

Figure 65 The ANALOG MEAS Screen

This screen is used to make RF and audio measurements on the mobile station connected to the Test Set while on an active voice channel.

The Test Set does not monitor the mobile station’s transmitted carrier power while the ANALOG MEAS screen is displayed. If the power falls below 0.0005 Watts no error message is displayed nor will the Test Set terminate the call while on the ANALOG MEAS screen.

AF Anl In

This field selects the input for the Audio Frequency analyzer. Refer to the [AF Anl In field description, on page 101](#) for further information.

AF Freq

This field is a one-of-many field used to select the type of measurement to be made by the Audio Frequency Analyzer on the audio signal being measured. Refer to the [SINAD field description, on page 110](#) for descriptions of the measurements available.

AFGen1 Freq

This field sets the output frequency of Audio Frequency Generator 1. Refer to the [AFGen1 Freq field description, on page 486](#) for further information.

AFGen1 To

This field has two fields:

- the upper field sets the destination port for Audio Frequency Generator 1
 - **FM** -RF Generator FM modulator
 - **AM** -RF Generator AM modulator
 - **Audio Out** -AUDIO OUT connector on front panel of Test Set
- the lower field sets the:
 - FM modulation deviation if the upper field set to **FM**
 - AM modulation depth if the upper field set to **AM**
 - amplitude of audio signal (volts RMS) at the AUDIO OUT connector if upper field is set to **Audio Out**

For testing mobile stations, the upper field is normally set to **FM**, and the lower field set to the desired FM deviation in kHz. Refer to the [AFGen1 Freq field description, on page 486](#) for further information.

Amplitude

This field sets the output power of the Test Sets's transmitter (that is, the output power of the Test Set's RF Generator). Refer to the [Amplitude field description, on page 487](#) for further information.

De-Emphasis

This field is used to select or bypass the 750 μ s de-emphasis filter network used to condition the audio signal before being analyzed by the Audio Frequency Analyzer. Refer to the [De-Emphasis field description, on page 104](#) for further information.

Detector

This field is used to select the type of detector used to measure the amplitude of the audio signal being measured. Refer to the [Detector field description, on page 105](#) for descriptions of the detectors available.

Filter 1

This field selects one of several standard or optional audio frequency filters which can be used to condition the audio signal before being analyzed by the Audio Frequency Analyzer. Refer to the [Filter 1 and Filter 2 field description, on page 106](#) for further information.

Filter 2

This field selects one of several standard or optional audio frequency filters which can be used to condition the audio signal before being analyzed by the Audio Frequency Analyzer. Refer to the [Filter 1 and Filter 2 field description, on page 106](#) for further information.

FM Deviation

This field displays the measured FM deviation of the carrier being transmitted by the mobile station. Four dashes (----) indicate that no carrier is present to measure.

TX Freq Error

This field displays the frequency error (error = assigned carrier frequency - measured carrier frequency) of the carrier being transmitted by the mobile station. Four dashes (----) indicates that there is no carrier frequency present to measure.

TX Power

This field displays the measured RF power of the carrier being transmitted by the mobile station. Four dashes (----) indicates that there is no carrier present to measure.

Using the ANALOG MEAS Screen

The ANALOG MEAS screen combines some of the Test Set's **Audio Analyzer** fields and some of the Test Set's RF Generator fields onto one screen for the purpose of testing the audio characteristics of the mobile station. Only those fields which are pertinent to testing the mobile stations audio characteristics have been combined onto the ANALOG MEAS screen. The Test Set must be in the connected state (that is, the **Connect** annunciator is lit) in order to use the ANALOG MEAS screen.

The mobile station's speaker output must be connected to the Test Set's AUDIO IN connector and the mobile station's microphone input must be connected to the Test Set's AUDIO OUT connector in order to use the ANALOG MEAS screen. Refer to [figure 17, "Connecting a Mobile Station to the Test Set," on page 119](#) for connection information. If the mobile station does not have audio connections the ANALOG MEAS screen cannot be used.

There are a wide variety of audio measurements which can be made from the ANALOG MEAS screen. The following examples illustrate how to make a typical mobile station receiver measurement (RF Sensitivity) and a typical mobile station transmitter measurement (FM Hum and Noise). Refer to the *HP 8920A RF Communications Test Set Applications Handbook*, section "Testing FM Radios" for further information on using the Test Set's Audio Analyzer to make audio measurements.

To Make an RF Sensitivity Measurement

1. If not already done, condition the Test Set. See "Conditioning the Test Set for Call Processing" on page 141 for further information.
2. If not already done, configure the Test Set. See "Configure the Test Set" on page 142 for further information.
3. Connect the mobile station to the Test Set as shown in Figure 17, "Connecting a Mobile Station to the Test Set," on page 119.

NOTE:

The mobile station's speaker output must be connected to the Test Set's AUDIO IN and the mobile station's microphone input must be connected to the Test Set's AUDIO OUT in order to use the ANALOG MEAS screen.

4. Turn on the mobile station.
5. Ensure that the Test Set is in the connected state. See "Page a Mobile Station" on page 145 for information on how to bring a mobile station up on a voice channel.
6. If the ANALOG MEAS screen is not displayed, select the **ANLG MEAS** field from the **To Screen** menu. The ANALOG MEAS screen will be displayed.
7. The following example illustrates how to make a 12 dB SINAD Receiver Sensitivity measurement:
 - a. Select the **AFGen1 Freq** field and set it to 1 kHz.
 - b. Select the upper **AFGen1 To** field and set it to **FM**.
 - c. Select the lower **AFGen1 To** field and set it to 8 kHz.
 - d. Select the **AF Anl In** field and select **Audio In**.
 - e. Select the **Filter 1** field and select **C MESSAGE**.
 - f. Select the **Filter 2** field and select **>99kHz LP**.
 - g. Position the cursor on the **De-Emphasis** field and select **Off**.
 - h. Select the **Detector** field and select **RMS**.
 - i. Select the **AF Freq** measurement field and select **SINAD**.
 - j. Select the **Amplitude** field and begin to lower the transmitted base station voice channel power until 12 dB SINAD is reached.
 - k. The mobile station might mute or drop off the air before a 12 dB SINAD is reached. The performance of the mobile station at low RF levels is dependent upon the characteristics of the mobile station (that is, what type of system it is designed for). Unlike a real base station, the Test Set does not perform any protocol functions on the voice channel.

To Make an FM Hum and Noise Measurement

1. If not already done, condition the Test Set. See "[Conditioning the Test Set for Call Processing](#)" on page 141 for further information.
2. If not already done, configure the Test Set. See "[Configure the Test Set](#)" on page 142 for further information.
3. Connect the mobile station to the Test Set as shown in [Figure 17, "Connecting a Mobile Station to the Test Set,"](#) on page 119.

NOTE:

The mobile station's speaker output must be connected to the Test Set's AUDIO IN and the mobile station's microphone input must be connected to the Test Set's AUDIO OUT in order to use the ANALOG MEAS screen.

4. Turn on the mobile station.

Ensure that the Test Set is in the connected state. See "[Page a Mobile Station](#)" on page 145 for information on how to bring a mobile station up on a voice channel.

5. If the ANALOG MEAS screen is not displayed, select the **ANLG MEAS** field from the **To Screen** menu. The ANALOG MEAS screen will be displayed.

NOTE:

It is recommended that the mobile station's microphone be muted, if possible, when making measurements on the mobile stations RF carrier. If the microphone is not muted it is possible for extraneous noise to be picked up by the microphone and adversely affect the measurements.

6. The following example illustrates how to make a FM Hum and Noise measurement:
 - a. Select the **Amplitude** field and set it to -47 dBm.
 - b. Select the **AFGen1 Freq** field and set it to 1 kHz.
 - c. Select the upper **AFGen1 To** field and set it to **Audio Out**.
 - d. Select the **AF An1 In** field and select **FM Demod**.
 - e. Select the **Filter 1** field and select **C MESSAGE**.
 - f. Select the **Filter 2** field and select **>99kHz LP**.
 - g. Position the cursor on the **De-Emphasis** field and select **750 us**.
 - h. Select the **Detector** field and select **PK+**.
 - i. Select the measurement field and select **AF Freq**.
 - j. Select the lower **AFGen1 To** field and adjust the signal level until the **FM Deviation** field on the upper portion of the CRT reads 8 kHz.
 - k. Select the **Detector** field and select **RMS**.
 - l. Select the **FM Deviation** field.
 - m. Press the blue SHIFT key, the INCR -10 key, then the ENTER key. This sets a zero reference point.
 - n. Select the lower **AFGen1 To** field and press the ON/OFF key. This turns off the modulating signal to the mobile station transmitter.
 - o. The FM Hum and Noise figure is displayed in the **FM Deviation** field.

CALL CONFIGURE Screen

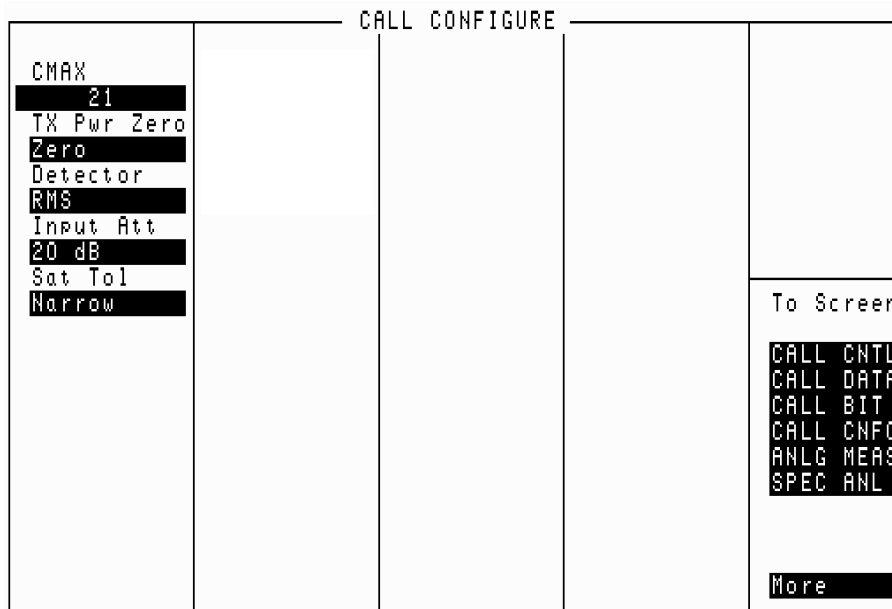

Figure 66 The CALL CONFIGURE Screen

The number of fields displayed on the CALL CONFIGURE screen depends on the selected system type.

This screen is used to set some of the less commonly used Test Set configuration parameters.

When the CALL CONFIGURE screen is displayed and the Call Processing Subsystem is in the connect state, the Test Set constantly monitors the mobile station's transmitted carrier power. If the power falls below 0.0005Watts, the error message **RF Power Loss indicates loss of Voice Channel** will be displayed and the Test Set will terminate the call and return to the active state.

NOTE: In order to ensure that the Test Set makes the correct decisions regarding the presence of the mobile stations's RF carrier, the Test Set's RF power meter should be zeroed before using the Call Processing Subsystem. Failure to zero the power meter can result in erroneous RF power measurements. See "[Conditioning the Test Set for Call Processing](#)" on page 141 for information on zeroing the RF Power meter manually.

CMAX

The **CMAX** field sets the number of access channels in the system. This will determine how many channels must be scanned by the mobile station when trying to access the Test Set. The value of this field will affect the time required for the mobile station to connect with the Test Set.

Detector

This field is used to select the type of detector used to measure the amplitude of the audio signal being measured. Refer to the [Detector field description, on page 105](#) for descriptions of the detectors available.

Input Att

Input Att sets the amount of input attenuation for the RF IN/OUT and ANT IN connectors. The Input Att field displays the present attenuation value, and it is used to set the desired attenuation level.

Sat Tol

This field is used to select the Sat tolerance. When set to Narrow the Sat limit is one of the three valid Sat tones ± 10 Hz. When set to Wide the Sat limit is defined at 0 to 7000 Hz. When operating in noisy environments the narrow Sat limit may not allow for correct measurements and the ability to alter the limit to encompass a wider range provides for testing flexibility.

TX Pwr Zero

The **TX Pwr Zero** function establishes a 0.0000 W reference for measuring RF power at the RF IN/OUT port. See "[TX Pwr Zero](#)" on page 480 for further information.

CAUTION: RF power must not be applied while zeroing. Set the **RF GENERATOR** screen's **Amplitude** field to off to prevent internal cross-coupling into the power detector while zeroing.

Configure Screen

The CONFIGURE screen defines a number of general operating functions, such as date and time, screen intensity, and beeper volume. It is also used to define some RF signal parameters, such as RF Generator/Analyzer offset, channel standards and characteristics, and signal loss/gain compensation.

Field Descriptions

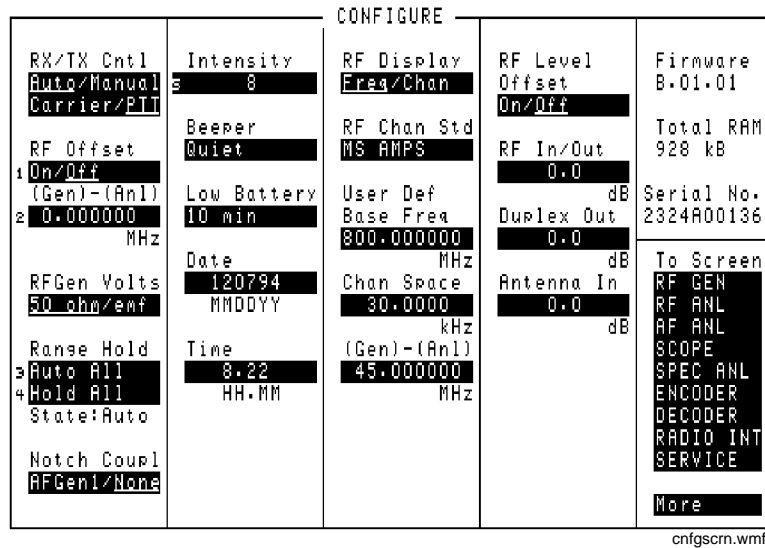

Figure 67 The Configure Screen

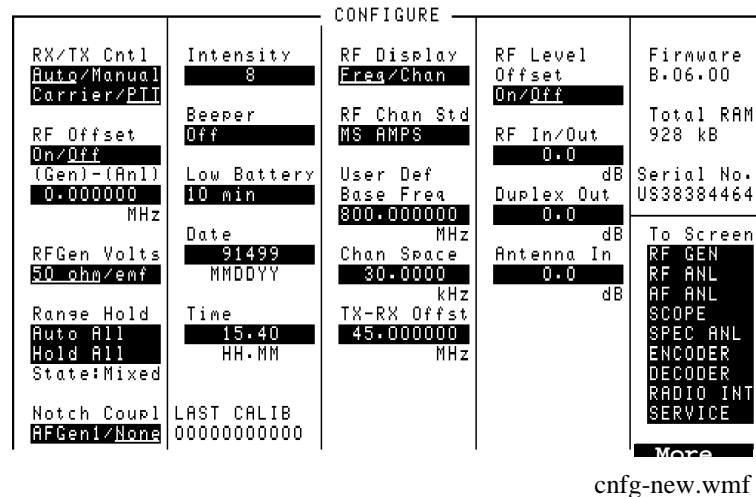

Figure 68 The Configure Screen

Antenna In

This field is used to indicate losses or gains between the ANT IN port and the device-under-test.

Enter a *positive* value to indicate a gain (such as an amplifier). The Spectrum Analyzer's¹ marker level (**Lv1**) measurement is automatically reduced by that amount. The Spectrum Analyzer's **Ref Level** is automatically decreased by the same amount, so the trace position does not appear to change.

Enter a *negative* value to indicate a loss (such as cable loss). The Spectrum Analyzer Marker's Level (**Lv1**) measurement is automatically increased by that amount. The Spectrum Analyzer's **Ref Level** is automatically increased by the same amount, so the trace position does not appear to change.

This field is only used when the **RF Level Offset** field is set to **On**.

See Also

[RF Level Offset field description, on page 265](#)

Base Freq (User Defined)

The Base Frequency field sets the RF Generator reference for channel 0 (zero) when the **RF Chan Std** field is set to **USER-DEF**, and the **RF Display** field is set to **Chan**.

Channel frequencies are calculated using the following formula:

$$\text{Channel N} = \text{Base Frequency} + (\text{N})(\text{Channel Spacing})$$

The Base Frequency is calculated using the following formula:

$$\text{Base Frequency} = \text{Channel 1 Frequency} - \text{Channel Spacing}$$

For example, if your multi-channel radio's lowest *receive* channel frequency is 870.030 MHz and the system channel spacing is 30 KHz, you would enter **870 MHz** in this field. You would also use the **Chan Space** and **(Gen)-(An1)** fields to tell the Test Set where other transmit and receive channel frequencies are in relation to the base frequency, and whether or not the system is duplex.

Operating Considerations

The value of this field is only used if the **RF Display** field is set to **Chan**, and the **RF Chan Std** field is set to **USER-DEF**.

1. Spectrum Analyzer is optional on some Test Set models.

See Also

[Chan Space \(User Defined\) field description, on page 257](#)

[\(Gen\) - \(An1\) field description, on page 259](#)

[RF Chan Std field description, on page 262](#)

[RF Display field description, on page 263](#)

Beeper

This field changes the audio beeper volume by selecting the desired level from a list of choices. The beeper always beeps when the instrument is turned on, regardless of this setting.

Operating Considerations

The beeper alerts you any time a message is displayed. Since a message may be removed from the screen before you notice it, it is better to leave the beeper on to alert you to errors during operation.

The beeper's volume setting is retained when the instrument is turned off.

Chan Space (User Defined)

This field specifies the RF channel spacing when the **RF Display** field is set to **Chan**, and the **RF Chan Std** field is set to **USER-DEF**.

For example, entering **25 kHz** causes a 25 kHz spacing between each channel. If the receive frequency for channel 1 is 150.500 MHz, channel 2's receive frequency would be 150.525 MHz.

Operating Considerations

The value of this field is only used if the **RF Display** field is set to **Chan**, and the **RF Chan Std** field is set to **USER-DEF**.

See Also

[\(Gen\) - \(An1\) field description, on page 259](#)

[RF Chan Std field description, on page 262](#)

[Base Freq \(User Defined\) field description, on page 255](#)

Date

This field specifies the current date for the internal clock. The date can be read by a controller using HP-IB and printed on test results.

The format is MMDDYY (Month Day Year), using two digits for each term. When entering months January through September (01-09), the leading zero is not displayed when entered. Example; May 5, 1993 is entered as 050593, but is displayed as 50593.

The internal clock still functions when the instrument is turned off.

Duplex Out

This field is used to indicate losses or gains between the DUPLEX OUT port and the device-under-test.

- Enter a *positive* value to indicate a gain (such as an amplifier gain). The RF Generator's level is automatically set that amount *below* what is indicated in the RF Generator's **Amplitude** field. (Example; if this value is 10 dB, and the **Amplitude** field shows 0 dBm, the actual level out this port is -10 dBm.) The value at the output of the external amplifier should then be at the level indicated in the **Amplitude** field.
- Enter a *negative* value to indicate a loss (such as cable loss). The RF Generator's level is automatically set that amount *above* what is indicated in the RF Generator's **Amplitude** field to compensate. The value at the opposite end of the cable (loss) should then be at the level indicated in the **Amplitude** field; unless the resulting RF Generator setting exceeds the maximum output level, then an error occurs: **Input value out of range**. In that case, reduce the **Amplitude** setting, or decrease the **Duplex Out** value.

This field is only used when the **RF Level Offset** field is set to **On**.

Firmware

This field displays the current firmware revision for your Test Set. The revision number is automatically changed when updated firmware is installed.

(Gen)-(Anl)

This field is used with the **RF Offset** field to specify the amount of frequency offset between the RF Generator and RF Analyzer.

This field is not displayed when the **RF Display** field is set to **Chan** (the offset is automatically set when using channel tuning).

See Also

["Setting an RF Generator/Analyzer Offset" on page 84](#)

(Gen)-(Anl) (User Defined)

This field defines the receiver-transmitter frequency offset when using User Defined channel operation.

Use a *positive* value when the radio's receive frequency is higher than the transmit frequency (such as 45 MHz)

Use a *negative* value when the radio's receive frequency is lower than the transmit frequency (such as -45 MHz).

Operating Considerations

The value of this field is only used if the **RF Display** field is set to **Chan**, and the **RF Chan Std** field is set to **USER-DEF**.

See Also

[Chan Space \(User Defined\) field description, on page 257](#)

[RF Chan Std field description, on page 262](#)

[RF Display field description, on page 263](#)

Intensity

This field adjusts the screen intensity from a setting of 1 (very dim) to 8 (bright). If the setting is set too low, the screen can no longer be read. If you can't read the screen, and you don't know where the cursor is (or even what screen is displayed), press [PRESET], and re-access the CONFIGURE screen. The cursor automatically goes to this field at that point. Press [8], [ENTER] to set the maximum intensity, and re-adjust if desired.

This setting is retained when the instrument is turned off.

Low Battery

This setting is used during battery (dc) operation to alert you when no front-panel controls are used within the specified amount of time. The setting is changed by selecting this field, then choosing the setting from a list of choices.

This setting is retained when the instrument is turned off.

Notch Coupl

This field selects if the **Notch Freq** setting of the AF ANALYZER screen is coupled to the **AF Gen1 Freq** setting. When set to **None**, the notch filter and AF Generator 1 do not interact. When set to **AFGen1** (coupled), the settings track each other unless the AF Generator's frequency is set outside the 300 Hz to 10 kHz limits of the notch filter¹

Range Hold

These fields enable/disable several autoranging and autotuning routines.

Auto All enables these routines, providing automatic adjustment when making AF or RF measurements.

Hold All disables these routines, requiring you to manually set the affected settings.

1. Optional for the HP 8920A.

The following fields are affected by the **Range Hold** field:

- **RX/TX Cntl** in the CONFIGURE screen.
- **Tune Mode** in the TX TEST, DUPLEX TEST, and RF ANALYZER screens.
- **Input Atten** in the RF ANALYZER and SPECTRUM ANALYZER screens.
- **Gain Cntl** in the AF ANALYZER screen. This field controls three AF gain setting fields:

Input Gain

De-Emp Gain

Notch Gain

Operating Considerations

The **Hold All** setting is primarily used when the instrument is operated by remote control, such as in an automated test system.

Unless you have very specific reasons for disabling the automatic functions, you should set this field to **Auto All** when operating the instrument manually.

See Also

Programmer's Guide

RF Chan Std

Use the RF channel standard field to select the channel standard for the radio-under-test. The RF Generator's and the RF Analyzer's frequencies are automatically set to correspond to the channel number entered in the **RF Channel** field. **RF Channel** replaces the **Amplitude** and **Tune Freq** fields on several screens when channel tuning is used.

Each standard has a prefix code that indicates what type of radio to test; mobile station (MS) or land station (LS). For example, if you are testing an AMPS mobile, select **MS AMPS**.

For the NAMPS standards, a third letter is added indicating which frequency band is used: upper, middle, or lower. For example, when testing a mobile station using the lower band, choose **MSL NAMPS**. Testing a land station using the upper band you would select **LSU NAMPS**.

The **USER-DEF** selection is used to define your own channel assignments. When selected, you enter the **Base Freq**, **Chan Space**, and **(Gen)-(An1)** settings.

See Also

[Base Freq \(User Defined\) field description, on page 255](#)

[Chan Space \(User Defined\) field description, on page 257](#)

[\(Gen\)-\(An1\) field description, on page 259](#)

RF Display

This field selects the format for entering the RF Generator's and RF Analyzer's frequencies:

- When **Freq** is selected, you enter the RF Generator's and the RF Analyzer's frequencies directly using the keypad or knob.
- When **Chan** is selected, the **RF Gen Freq** and **Tune Freq** fields on all screens are replaced by the **RF Channel** field, and only the channel number is entered and displayed.

Channel tuning eliminates the need to enter transmit and receive frequencies directly into the Test Set. Once your radio's RF channel standard is selected, you only have to enter the channel number to automatically set the RF Generator and RF Analyzer to the correct frequencies.

Operating Considerations

When channel tuning is used, the RF Analyzer is set to manual tuning. The **Tune Mode** field on the TX TEST, DUPLEX TEST, and RF ANALYZER screens is no longer displayed. As a result, the **TX Freq Error** measurement is displayed (since the **TX Frequency** measurement is only displayed when the **Tune Mode** field is set to **Auto**).

See Also

[RF Chan Std field description, on page 262](#)

RF Gen Volts

This field specifies whether you want RF voltages expressed as the voltage across a 50 ohm load, or the open circuit voltage (emf).

Operating Considerations

This setting affects the RF Generator's and the Tracking Generator's amplitudes.

RF In/Out

This field is used to indicate losses or gains between the RF IN/OUT port and the device-under-test.

- Enter a *positive* value to indicate a gain (such as an amplifier gain). When the RF IN/OUT port is used as an output, the RF Generator's (or Tracking Generator's) level is automatically set the specified amount *below* what is indicated in the RF Generator's **Amplitude** field. Example; if this value is 10 dB, and the **Amplitude** field shows 0 dBm, the actual level out of this port is -10 dBm.

When this port is used as an input, the **TX Power** measurement and Spectrum Analyzer's Marker Level (**Lvl**) are automatically *reduced* by that amount.

- Enter a *negative* value to indicate a loss (such as cable loss). The RF Generator's (or Tracking Generator's) level out this port is automatically set that amount *above* what is indicated in the RF Generator's **Amplitude** field.

When used as an input, the **TX Power** and the Spectrum Analyzer's marker level (**Lvl**) measurements are *increased* by that amount.

This field is only used when the **RF Level Offset** field is set to **On**.

See Also

[RF Level Offset field description, on page 265](#)

RF Level Offset

This field enables/disables the RF level offsets entered in the **RF In/Out**, **Duplex Out**, and **Antenna In** fields below it.

- When set to **On**, the RF Generator's amplitude and RF Analyzer's power measurement are offset by the values entered in these fields.
- When set to **Off**, the values in these fields are ignored.

See Also

[Antenna In field description, on page 255](#)

[Duplex Out field description, on page 258](#)

[RF Chan Std field description, on page 262](#)

RF Offset

This field is displayed when the RF Display field has Freq selected.

This field enables/disables the RF Generator–RF Analyzer frequency offset specified in the **(Gen) – (An1)** field below it.

Operating Considerations

When an RF offset is used, changing the RF Generator's frequency or RF Analyzer's tune frequency automatically alters the other setting. On screens where both fields are not shown (such as the RX TEST and TX TEST screens), you will not see the corresponding field change.

See Also

["Setting an RF Generator/Analyzer Offset" on page 84](#)

RX/TX Cntl

This function controls automatic screen changes between the RX TEST and TX TEST screens during radio testing. It is divided into two fields:

The **Auto/Manual** field enables/disables automatic switching between the RX TEST and TX TEST screens under certain testing conditions.

- **Auto** allows automatic screen changes between the RX TEST and TX TEST screens while testing radios.
- **Manual** requires you to select the RX TEST or TX TEST screen when performing radio tests.

The **Carrier/PTT** field specifies the condition that will cause automatic screen changes.

- **Carrier** causes the instrument to automatically switch from the RX TEST screen to the TX TEST screen when an RF carrier is detected. The screen returns to RX TEST when the carrier is no longer detected.
- **PTT** (Push-To-Talk) causes the instrument to automatically switch from the TX TEST screen to the RX TEST screen when a microphone connected to the MIC/ACC connector is keyed. The screen changes back to TX TEST when the microphone is no longer keyed.

Operating Considerations

CAUTION: The Test Set can be damaged by connecting a reverse-power signal to the DUPLEX OUT port of >200 mW.

If **Auto** and **Carrier** are used together, the screen may continuously change between RX TEST and TX TEST. This only occurs if the RF IN/OUT port is used with the RF Generator **Amplitude** set ≥ 35 dBm (a much higher level than is typically used for receiver tests). To prevent this problem, set the **Amplitude** ≤ 35 dBm or **Off**, or use the DUPLEX OUT port for the RF Generator's output.

Serial No.

This field displays the serial number of the Test Set.

Time

This field sets the time-of-day for the instrument's 24 hour clock.
(Example, 4:53 PM is entered **16:53**)

Operating Considerations

The internal clock still functions when the instrument is turned off.

Total RAM

This field displays the total amount of RAM available for IBASIC programs and save/recall registers.

Signaling Decoder Screen

Field Descriptions for Decoder Modes

The Signaling Decoder analyzes different data-encoded signaling formats. The format is selected in the **Mode** field in any of the decoder's screens.

A list of standards for each format is displayed by selecting the **Standard** field in any screen.

Separate screen and field descriptions are given for each screen. The descriptions are listed in the following order:

- AMPS-TACS/NAMPS-NTACS
- CDCSS (Continuous Digital Controlled Squelch System)
- Digital Paging
- DTMF (Dual-Tone Multi-Frequency) Sequence
- EDACS (Enhanced Digital Access Communications System)
- Function Generator
- LTR (Logic Trunked Radio: Registered Trademark of EF Johnson Company)
- MPT 1327
- NMT (Nordic Mobile Telephone) encoder and decoder
- Tone Sequence

The Decoder's Signal Source

The decoder *always* gets its signal immediately after the de-emphasis network of the AF Analyzer. De-emphasis can be turned on or off on the AF ANALYZER screen, or can be controlled while using the decoder by assigning a global USER key to the **De-Emphasis** field. Refer to the AF ANALYZER screen's field descriptions and functional block diagram in [chapter 5, "AF Analyzer Screen," on page 99](#).

Decoder Frequency Measurements

The decoder uses a different timebase for frequency counting than the AF Analyzer. Therefore, their measurements may be different when measuring the same signal (by a very small amount).

AMPS-TACS, NAMPS-NTACS Decoder

The AMPS-TACS, NAMPS-NTACS decoder acts like a base station receiver by analyzing Reverse Control Channel (RECC) and Reverse Voice Channel (RVC) message streams for various cellular telephone formats.

The decoder can also be used to analyze Forward Control Channel (FOCC) and Forward Voice Channel (FVC) data from the base station.

Decoder Mode Differences

The AMPS-TACS and NAMPS-NTACS Decoder modes are essentially the same for analyzing Reverse Control Channel (RECC) information. However, the Voice Channel (RVC) information for NAMPS-NTACS is displayed differently than AMPS-TACS information. Fields and decoder measurements that are only used for either mode are noted in their descriptions.

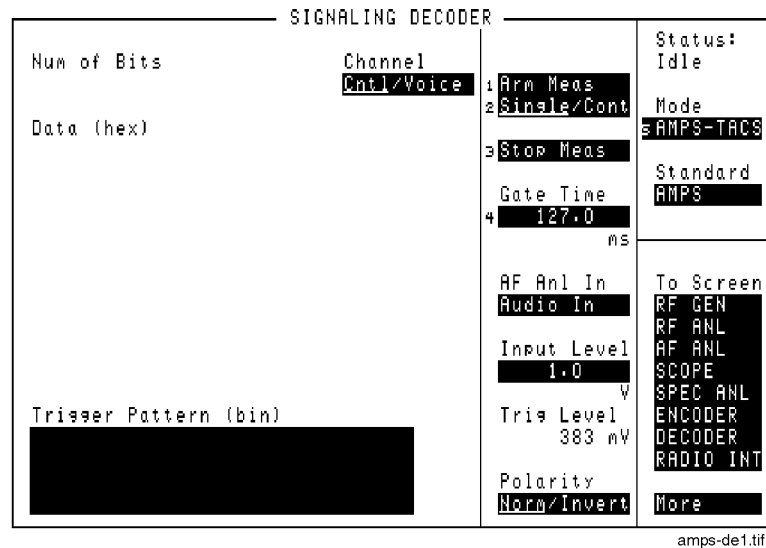

Figure 69

AMPS-TACS Control/Voice and NAMPS/NTACS Control Channel Decoder

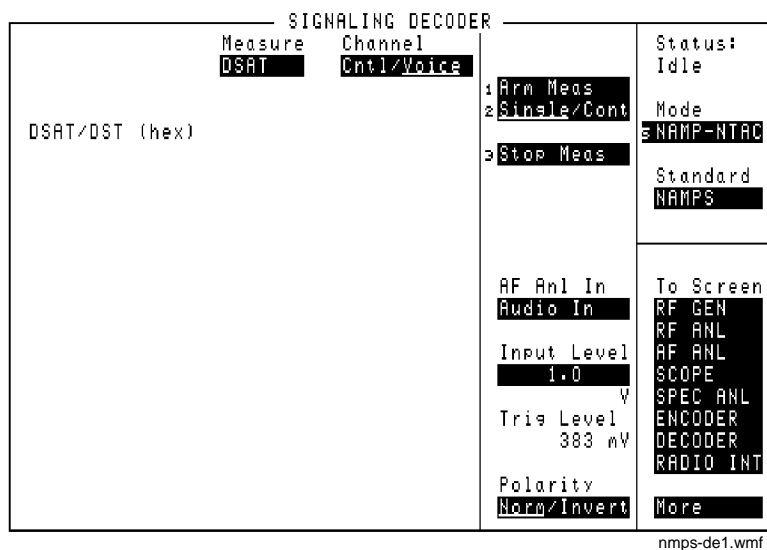

Figure 70 The NAMPS-NTACS Voice Channel Decoder

AF Anl In

Audio frequency analyzer input selects the source of the signal to be analyzed.

Operating Considerations

This is a priority control field. Accessing the RX TEST or TX TEST screen overrides any changes made to this field in this screen.

Arm Meas

Arm measurement prepares the decoder to be triggered by an incoming signal.

Channel

This field selects the type of data to decode: Reverse Control Channel (**Cntl**), or Reverse Voice Channel (**voice**).

Data (hex) (AMPS-TACS)

This display field lists the decoded data serially as it is received. This field is labeled **RECC Data (hex)** for the NAMPS/NTACS mode, but performs the identical function.

Gate Time

This field specifies how long the decoder analyzes a signal after it has been triggered. The longer the gate time, the greater the number of bits analyzed.

Operating Considerations

If the gate time is too long, the decoder's data buffer becomes full. A message is displayed instructing you to decrease the gate time.

This function is not used with the NAMPS/NTACS RVC decoder.

See Also

[Arm Meas field description, on page 272](#)

[Num of Bits field description, on page 274](#)

Input Level

This field specifies the expected data signal level (after de-emphasis if used). The higher the level of signal expected by the analyzer, the higher the trigger level is set.

Operating Considerations

The unit-of-measure is determined by the **AF An1 In** setting.

The input level should be set high enough to prevent false triggering, but low enough to allow triggering for valid signals. *This you to set the input level well below the expected level.*

Also, when using de-emphasis, the **Input Level** setting may need to be reduced significantly to properly decode the incoming signal. De-Emphasis is enabled/disabled using the **De-Emphasis** field on the AF ANALYZER screen.

See Also

[Trig Level field description, on page 275](#)

Measure (NAMPS-NTACS: RVC)

This field selects the type of decoded data to display: DSAT or DST codes, Message data, or DTMF (Dual-Tone Multi-Frequency) tone data.

Num of Bits

This field lists the total number of bits displayed. This number is dependent on Data Rate of the signal being decoded, the **Gate Time** of the decoder, and the size of the decoder's data buffer.

Operating Considerations

The buffer has a maximum capacity of:

- 1584 bits for decoding Reverse Voice Channel (RVC) data streams.
- 1583 bits for decoding Reverse Control Channel (RECC) data streams.

This measurement is not available for NAMPS-NTACS RVC decoding.

See Also

[Gate Time field description, on page 273](#)

Polarity

This setting is used to match the polarity of the encoded signal being analyzed.

Normal Operation. When this field is set to **Norm**, a logical high (1) is displayed when a positive peak in the received signal is detected. A negative peak displays a logical low (0).

Inverted Operation. When this field is set to **Invert**, a logical high (1) is displayed when a negative peak in the received signal is detected. A positive peak displays a logical low (0).

RECC Data (NAMPS-NTACS: RECC)

This display field lists the decoded data serially as it is received. This is the same information that the AMPS-TACS **Data (hex)** measurement displays.

Single/Cont

This field specifies how long you want the analyzer to decode incoming signals:

- **Single** tells the analyzer to display the information received during one **Gate Time** (or after one measurement for NAMPS-NTACS RVC data).
- **Cont** is used to automatically re-arm the analyzer and display the measurements on a continual basis until **Single** is selected.

Stop Meas

Selecting this field stops the analyzer when making single measurements.

Trig Level

The trigger level indicates the minimum signal level required to begin a measurement that has been “armed.” The level is adjusted by changing the **Input Level** field’s setting.

The input level should be set high enough to prevent false triggering, but low enough to allow triggering for valid signals. *This may require you to set the input level well below the expected level.*

Trigger Pattern (bin)

This field allows you to enter a specific bit pattern to filter displayed information. The decoder only displays the received data when this binary pattern is encountered immediately after triggering. This is helpful when you only want to display messages containing very specific information.

The trigger pattern is entered as a sequence of ones, zeros, and dots. A dot will cause the decoder to trigger for either a one or a zero in that bit position in the received data stream.

Operating Considerations

This function is not available for decoding NAMPS-NTACS RVC information.

Using the AMPS/TACS, NAMPS/NTACS Decoder

Interaction With the Encoder

The encoder screen's **Data Rate** field tells the decoder how fast the incoming message is being sent. Set that field's value before using the AMPS-TACS or NAMPS-NTACS Decoder.

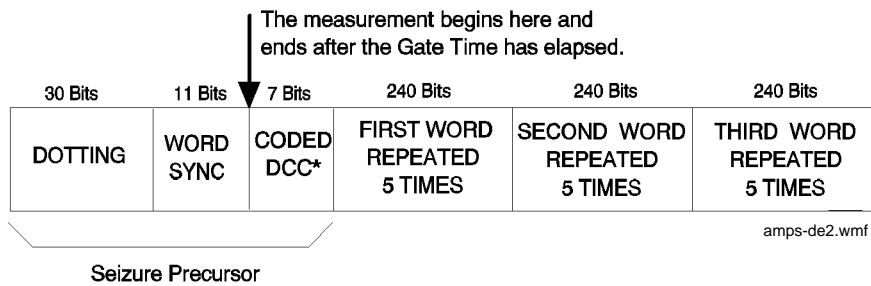

* Digital Color Code

Figure 71 **Decoding the Reverse Control Channel (RECC) Data**

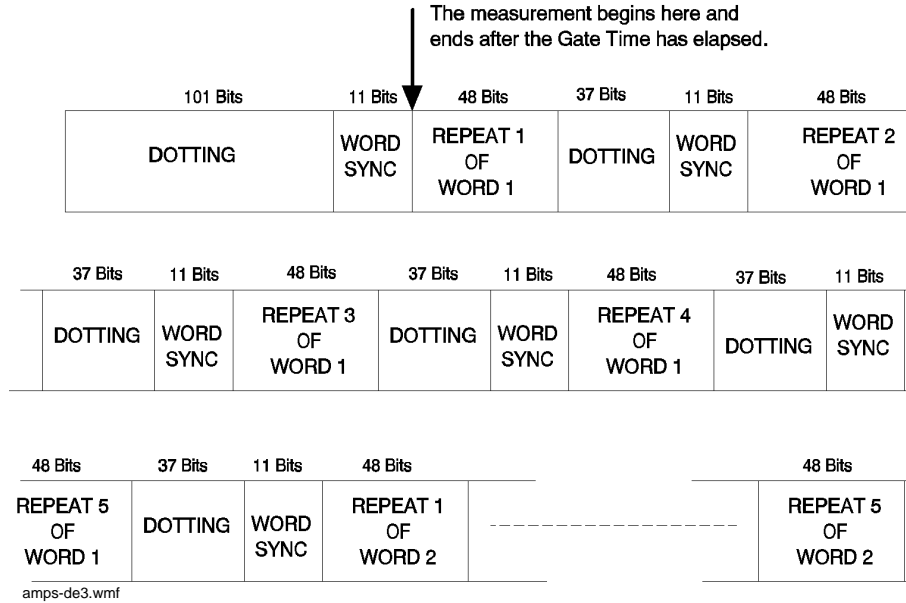

Figure 72 Decoding AMPS-TACS Reverse Voice Channel (RVC) Data

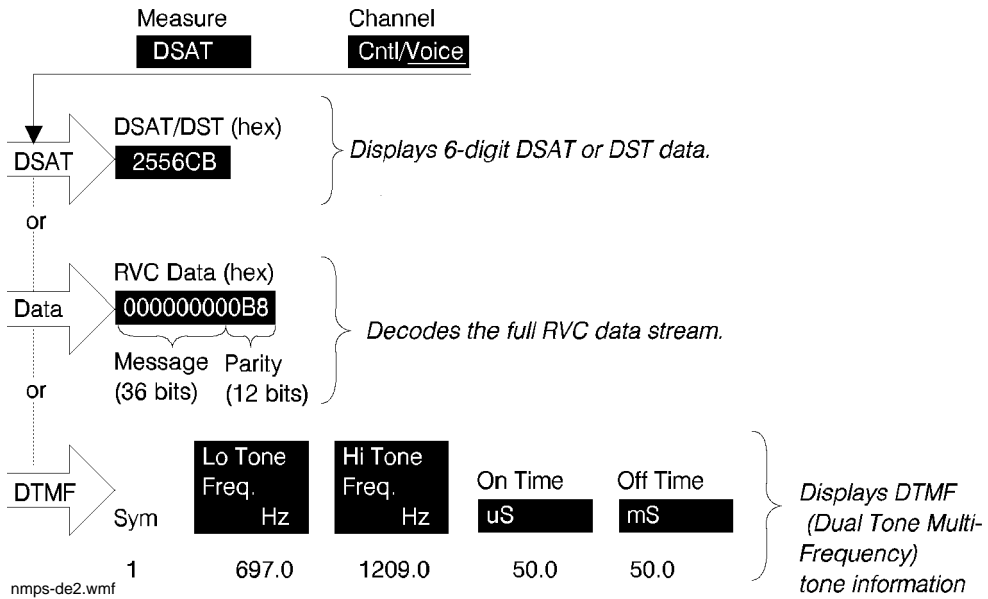

Figure 73 Decoding NAMPS-NTACS Reverse Voice Channel (RVC) Data

Interpreting Decoded Data

The following information refers to all Reverse Control Channel (RECC) measurements, and the AMPS-TACS Reverse Voice Channel (RVC) measurements. See the next section for information about NAMPS-NTACS RVC measurements.

After being armed, the measurement begins when the last bit of Word Sync has been received. All RECC measurements, and the AMPS-TACS RVC measurement, last for the period specified in the **Gate Time** field.

The received bits are displayed as hexadecimal (hex) characters. If the last bits received do not complete the last hex character, the received bits are used as the most significant bits in the character, and the remaining bit positions are filled with zeros.

For example; if the last bits received are “01”, two zeros are added to the right to produce the binary number 0100. The hexadecimal equivalent, **4**, is displayed.

The first two hex characters of the RECC data displayed contain the 7-bit Digital Color Code of the Seizure Precursor. The characters are right-justified so the farthest bit to the left for the first hex character is always 0. The first word of the RECC message begins in the third hex character of the displayed data.

All bits of the RECC and RVC data streams received after the initial Word Sync are displayed, including Parity and additional Dotting and Word Sync sequences.

The decoder does not check for any errors in the received data stream.

NAMPS-NTACS Reverse Voice Channel Measurements

Three types of RVC information can be decoded; selected using the **Measure** field.

- **DSAT** displays the 6-digit DSAT (Digital Supervisory Audio Tone) or DST (Digital Signaling Tone) number, depending on the type of signal being received. If the received number is not one of the 14 standard combinations (7 DSAT or 7 DST), the decoder displays a constantly changing number until one of the standard values is detected.
- **Data** displays the 36 message bits and 12 parity bits of the RVC message. The measurement begins when the last sync word bit is received, and ends after the last parity bit is received. The measurement is re-triggered when the next sync word is received; there is no gate time function for this decoder mode.
- **DTMF** displays Dual-Tone Multi-Frequency tone pair frequencies and on/off times. These are tones that may be used to trigger connected equipment after a mobile-to-base station connection has been made (such as an answering machine or voice-mail system).

Continuous Digital Controlled Squelch System Decoder

The Continuous Digital Controlled Squelch System (CDCSS) Decoder analyzes digital data streams used to turn squelch on and off on digitally-controlled-squelch radios.

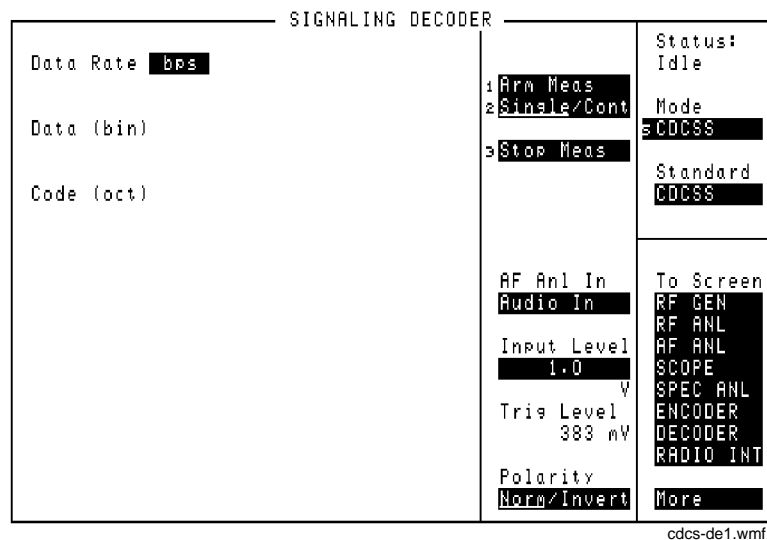

Figure 74 The CDCSS Sequence Decoder Screen

AF Anl In

Audio frequency analyzer input selects the source of the signal to be analyzed.

See Also

["Interaction Between Screens" on page 54](#)

Arm Meas

Arm measurement prepares the decoder to be triggered by an incoming signal when **single** is selected.

Code (oct)

This field displays all of the code word combinations from the received data stream.

The top entry in this column is always 1 of the 83 standard (primary) industry codes or **NPC** (No Primary Code). All other possible code combinations are listed in numerical order after this entry.

If a Turn-Off Code (TOC) is measured for a full sampling period, **TOC** is displayed with no other codes listed.

Data (bin)

This measurement field displays a 23-bit segment of the data stream being received.

After 23 bits have been received, the decoder shifts the bit sequence 23 times until all possible bit patterns have been analyzed. Any possible code words are displayed in the **Codes (oct)** column. Even if no code words are found, this field will still display the bit sequence that was received.

Operating Considerations

This field is blank if the only signal received during the decoder's latest sampling period is a turn-off-code.

The final bit pattern displayed will not necessarily match any of the displayed codes, since the bits are shifted 23 times during decoding.

Data Rate

This measurement field displays the data rate in bits-per-second for the data stream being received.

Operating Considerations

For accurate measurements, the **Data Rate** for the CDCSS encoder should be set to the expected data rate for the signal being analyzed by the CDCSS decoder.

Input Level

This field specifies the signal level that you input (after de-emphasis if used). The higher the level of signal expected by the analyzer, the higher the trigger level is set.

Operating Considerations

The unit-of-measure is determined by the **AF An1 In** setting.

The input level should be set high enough to prevent false triggering, but low enough to detect all valid zero-crossings of the incoming signal.

When using de-emphasis, the **Input Level** setting may need to be reduced significantly to properly decode the incoming signal. De-emphasis is enabled/disabled using the **De-Emphasis** field on the AF ANALYZER screen.

See Also

[Trig Level field description, on page 283](#)

Polarity

This field is used to match the polarity of the encoded signal being analyzed.

Normal Operation. When this field is set to **Norm**, a logical high (1) is displayed when a positive peak in the received signal is detected. A negative peak displays a logical low (0).

Inverted Operation. When this field is set to **Invert**, a logical low (0) is displayed when a positive peak in the received signal is detected. A negative peak displays a logical high (1).

Operating Considerations

Inverting amplifiers used in transmitters, receivers, and repeaters can cause an inversion of the modulating digital data. If the decoded signal does not display the expected results, change this field's setting to see if the signal may be getting inverted before being decoded.

Single/Cont

This field specifies how you want the analyzer to be armed:

- **Single** is used to analyze and display the decoded information once each time **Arm Meas** is selected.
- **Cont** is used to automatically re-arm the analyzer and display the measurements on a continual basis until **Single** is selected.

Stop Meas

Selecting this field stops the analyzer when making a single measurement.

Trig Level

The trigger level indicates the minimum signal level required to begin a measurement that has been “armed”. The level is adjusted by changing the **Input Level** field’s setting.

Using the CDCSS Decoder

AF Analyzer Settings

For proper CDCSS decoder operation, make the following AF ANALYZER screen settings:

- **Filter 1** to **<20Hz HPF** (Required)
- **Filter 2** to **3kHz LPF** (Recommended)
- **Settling** to **Slow** (Recommended)

Interpreting Decoded Data

Because CDCSS uses a continuously-repeating data stream, and there is no framing information to tell the receiver when the code word is going to be sent, the decoded data can result in several possible code combinations. This is why more than one code word may be listed in the **Codes (oct)** column after decoding.

Digital Paging Decoder

This is used to test paging system transmitters using various formats, such as POCSAG and GSC (Golay Sequential Code). The **Tune Freq** field of the TX TEST screen is typically used to tune to the pager channel to be decoded.

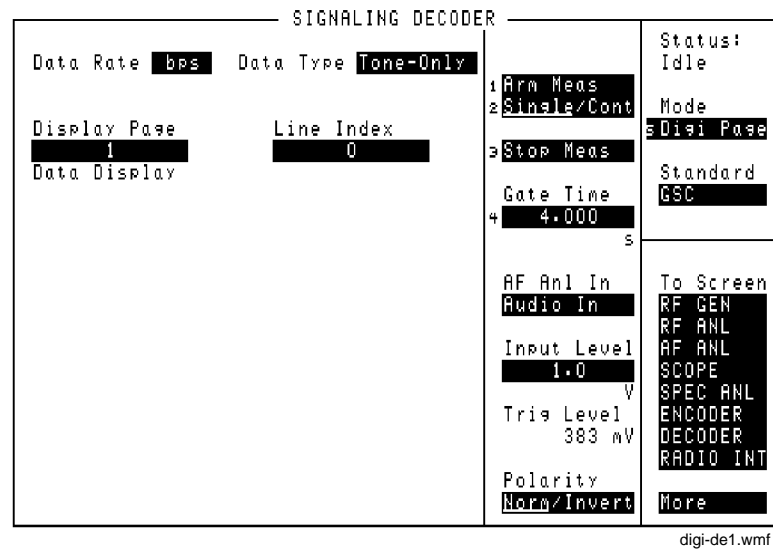

Figure 75 The Digital Paging Decoder Screen

AF Anl In

Audio frequency analyzer input selects the source of the signal to be analyzed. This is typically set to **FM Demod** for off-the air decoding of pager transmitters.

Arm Meas

Arm measurement prepares the decoder to be triggered by an incoming signal.

Data Display

This field displays up to three different decoded parameters after a message has been analyzed:

Pager code - the unique pager code number or address.

Function - number representing one of the four types of signals that can be sent.

Pager data - information sent as a numeric or alpha-numeric message. This parameter is not displayed when tone-only formats are decoded.

Data Rate

This display field lists the data rate of the received signal in bits-per-second (bps).

Operating Considerations

This measurement relies on the digital paging encoder screen's data rate setting. Set the encoder's **Data Rate** field to the expected incoming data rate for accurate measurements.

See Also

[Data Rate field description, on page 374](#)

Display Page

This field is used to select a specific page of decoded data. More than one page of decoded data may be available when a batch of messages is received during the specified gate time. The **Number of Pages** field indicates how many pages were decoded.

Gate Time

This field specifies how long the decoder analyzes a signal after it has been triggered. Up to 65 seconds of gate time can be specified. The minimum gate time should be set long enough to allow the preamble and all necessary data bits to be captured.

If too much data is decoded during the gate time, the decoder buffer will overflow (an error message is displayed when this happens). Decrease the gate time if this error is displayed.

Input Level

Enter the expected data signal level in this field. The higher the level of signal expected by the analyzer, the higher the trigger level is set.

Operating Considerations

The unit-of-measure is determined by the **AF An1 In** setting.

The input level should be set high enough to prevent false triggering, but low enough to allow triggering for valid signals (typically about 3 kHz).

De-emphasis should not be used with this signaling format. Access the AF ANALYZER screen and set the **De-Emphasis** field setting to **Off**.

See Also

[Trig Level field description, on page 288](#)

Number of Pages

See the [Display Page field description, on page 286](#)

Polarity

This setting is used to match the polarity of the encoded signal being analyzed.

Normal Operation. When this field is set to **Norm**, a logical high (1) is displayed when a positive peak in the received signal is detected. A negative peak displays a logical low (0).

Inverted Operation. When this field is set to **Invert**, a logical high (1) is displayed when a negative peak in the received signal is detected. A positive peak displays a logical low (0).

Single/Cont

This field specifies how long you want the analyzer to decode incoming signals:

- **Single** tells the analyzer to display the information received during one gate time. Measurements are displayed until **Arm Meas** is selected again.
- **Cont** is used to automatically re-arm the analyzer and display new measurements on a continual basis until **Single** is selected. Previous measurement results are over-written by subsequent measurements.

Stop Meas

Selecting this field stops the analyzer when making single measurements.

Trig Level

The trigger level indicates the minimum signal level required to begin a measurement that has been “armed.” The level is adjusted by changing the **Input Level** field setting.

Dual-Tone Multi-Frequency (DTMF) Decoder

The DTMF Sequence Decoder analyzes Dual-Tone Multi-Frequency tone sequences and displays the associated parameters.

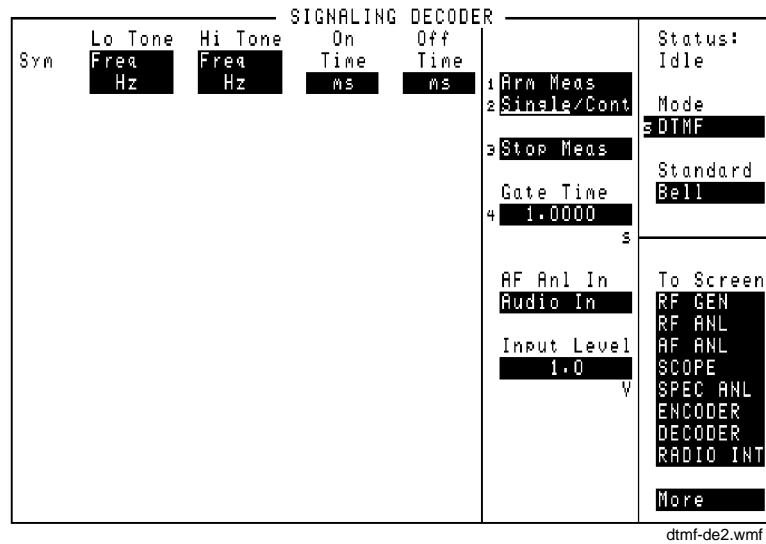

Figure 76 The DTMF Decoder Screen

AF Anl In

Audio frequency analyzer input selects the source of the signal to be analyzed.

Operating Considerations

This is a priority control field. Accessing the RX TEST or TX TEST screen overrides any changes made to this field in this screen.

Arm Meas

Arm measurement prepares the decoder to be triggered by an incoming signal when making single measurements.

Gate Time

This field specifies how long the decoder analyzes a signal after it has been triggered.

Hi Tone

This for the high frequency tone in each tone pair. The measurement type is selected by selecting the **Freq** field to display a list of measurement choices.

Operating Considerations

Frequency error is calculated by comparing the DTMF Encoder's frequency settings for each tone pair with the decoded frequencies.

See Also

["Using the DTMF Decoder" on page 294](#)

Input Level

This field specifies the signal level that you input (after de-emphasis if used). The higher the level of signal expected by the analyzer, the higher the trigger level is set.

Operating Considerations

The unit-of-measure is determined by the **AF An1 In** setting.

The input level should be set high enough to prevent false triggering, but low enough to allow triggering for fluctuating signal levels.

De-emphasis Effects

De-emphasis is a single-pole, low-pass filter with a 212.2 Hz corner frequency. It is enabled/disabled using the **De-Emphasis** field on the AF ANALYZER screen. (Refer to [Figure 15, "AF ANALYZER Functional Block Diagram," on page 100.](#)) The Input Level is the expected level at the output of the de-emphasis network.

Assuming a mean DTMF frequency of approximately 1 kHz, decoding with de-emphasis on (set to 750 μ s) requires the input level to be set to $212/1000 = 0.212$ times the peak deviation, or about 1/5 the incoming level of the tone.

Examples of Input Level Settings

Example 1

Peak deviation 3 kHz, De-emphasis off. Set the input level to 3 kHz.

Example 2

Peak deviation 3 kHz, De-emphasis 750 ms. Set the input level to $3 \times 0.212 = 636$ Hz

Lo Tone

This measurement field lists the frequency or frequency error for the low frequency tone in each tone pair. The measurement type is selected by selecting the **Freq** field to display a list of measurement choices.

Operating Considerations

Frequency error is calculated by comparing the DTMF Encoder's frequency settings for each tone pair with the decoded frequencies.

See Also

["Using the DTMF Decoder" on page 294](#)

Off Time

This measurement column lists the length of time each tone pair was "off" prior to the next tone being received.

On Time

This measurement column lists the length of time each tone pair was "on."

Single/Cont

This field specifies how you want the analyzer to be armed:

- **Single** is used to analyze and display the decoded information once each time **Arm Meas** is selected.
- **Cont** is used to automatically re-arm the analyzer and display the measurements on a continual basis until **Single** is selected.

Stop Meas

Selecting this field stops the analyzer when making single measurements.

Sym

The symbol column corresponds to the DTMF Encoder's symbols assigned for each tone pair. As each tone pair is analyzed, the corresponding symbol is listed in this column.

Operating Considerations

The symbol assigned is based on the closest symbol frequencies to that tone pair.

Using the DTMF Decoder

Measurement Limits

Lo Tone: 680 - 960 Hz

Hi Tone: 1190 - 1660 Hz

Actual limits are typically slightly wider than this. However, the crossover point between Hi and Lo tone decoding is approximately 1.1 kHz. If incoming tones approach this point, unreliable measurements may be displayed (frequency measurement errors and spurious off times).

EDACS Decoder

This screen decodes the digital signaling data from an Ericsson GE EDACS® (Enhanced Digital Access Communications System) transmitter. This function is provided to test mobile radios, but it is not designed to test EDACS base stations.

Before transmitter measurements can be made, the EDACS Encoder must be set up to provide the necessary system information. (Refer to ["Using the EDACS Encoder" on page 388](#) for information on setting up the EDACS Encoder.)

Four types of calls can be decoded: group, individual, emergency, and voice guard.

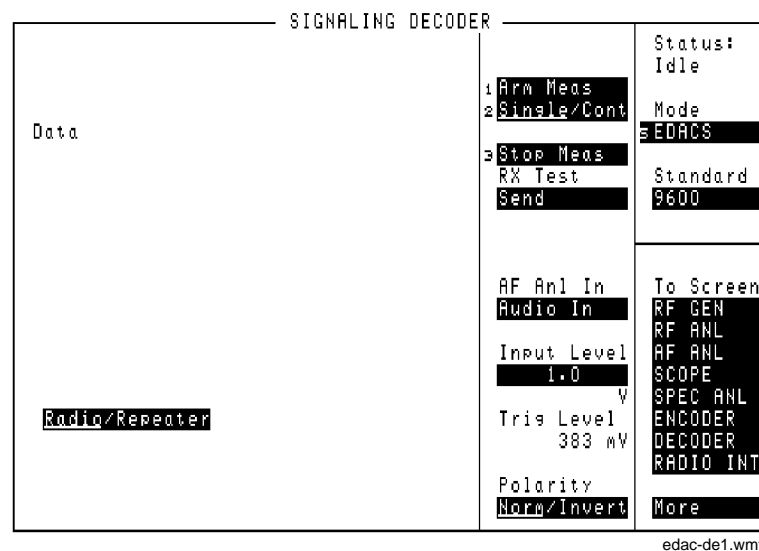

Figure 77 The EDACS Trunked Radio Decoder Screen

AF Anl In

This field selects the source of the signal to be decoded. **FM Demod** is normally used, since the data being decoded is usually the demodulated signaling data from an EDACS transceiver.

Arm Meas

Select this field to prepare the decoder to be triggered by transmitted signaling data. When selected, the **status:** field indicates **Armed**.

Data

This area displays the decoded call request signaling data from your transmitter. The type of data displayed depends on the **Radio/Repeater** setting and the type of message decoded.

Input Level

This field is used to set the trigger level for the decoder. The displayed **Trig Level** changes as the **Input Level** is adjusted. This field is normally set to 1 kHz for EDACS decoding (assuming the **AF An1 In** field is set to **FM Demod**).

Operating Considerations

The units displayed (kHz, %, V) depends on the **AF An1 In** setting.

Polarity

This field is used to match the polarity of the data to be decoded. This field is usually set to **Norm**.

See Also

[Polarity field description, on page 385](#)

Radio/Repeater

This field specifies whether the decoder will trigger on the received sync word of a mobile signal (**Radio**), or on the sync word from a repeater (**Repeater**). It also specifies how the received data will be interpreted.

The repeater function is not fully implemented at this time to provide base station decoding.

RX Test

When **Send** is selected, the Control Channel Site ID message is output at the RX Frequency specified in the **Control Channel** settings on the EDACS Encoder screen.

Single/Cont

This field specifies how you want to arm the decoder.

- **Single** requires you to manually arm the decoder (using the **Arm Meas** field) before each measurement is made.
- **Cont** automatically arms the decoder to make a measurement, and re-arms the decoder after a measurement is made.

Operating Considerations

To dis-arm the decoder in single mode, select the **Stop Meas** field. The Stop Meas function is disabled when **Cont** is selected.

Standard

The encoder's **Data Rate** field must be set to the data rate expected from the radio or the repeater being decoded. This is best done by selecting the corresponding standard on the encoder's screen.

See Also

[standard field description, on page 386](#)

Stop Meas

This field is used to dis-arm the decoder when making single measurements. It is not used when making continuous (**Cont**) measurements.

Using the EDACS Decoder

EDACS Transmitter Testing

When the mobile is turned on, it automatically tunes to its pre-programmed control channel frequency. The Test Set generates the control channel signal using the RF Generator and the **Control Channel** fields of the EDACS Encoder.

When the mobile is receiving the control channel, the transmitter can be keyed to send a call request message to go to a working channel. (The working channel settings are specified in the EDACS Encoder.)

After the mobile starts transmitting, the EDACS Decoder displays the decoded signaling data. You can then access the DUPLEX TEST screen to make modulation and RF carrier measurements.

Transmitter Test Procedure

This procedure establishes a control channel connection between the Test Set and your mobile. After the mobile locks to the control channel, the decoder is armed and the mobile's transmitter is keyed to make measurements.

NOTE:

Each EDACS radio is pre-programmed to access a specific control channel and one or more working channels. Other mobile and system identification information is also programmed into the radio. You cannot test an EDACS mobile without first entering these values into the EDACS Encoder screen.

CAUTION:

Before testing your transmitter, read the MAX PWR limit printed under the Test Set's RF IN/OUT port. Exceeding this limit could damage your Test Set.

Preset the Test Set

Press the PRESET key on the Test Set to set all controls to a known state and display the RX TEST screen.

Connect the Mobile to the Test Set

Connect the antenna port of the mobile to the RF IN/OUT port of the Test Set.

Define the Control Channel Settings

1. Turn AF Generator 1 off by positioning the cursor in front of the **3.00** value of the **AFGen1 To** field and pressing the ON/OFF key.
2. Select **ENCODER** from the **To Screen** menu.
3. Select the EDACS **Mode** to display the EDACS Encoder.
4. Select the **Data Rate** using the **Standard** field. (4800 or 9600 bps)
5. Enter the **Control Channel** settings.
 - The **Number** is your system's control channel number.
 - The **RX Frequency** is the control channel's receive frequency for your mobile.
 - The **TX Frequency** is the control channel's transmit frequency for your mobile.
6. Enter the **Working Channel** settings.
 - The **Number** is the working channel number you want the mobile to be sent to.
 - The **RX Frequency** is the mobile's receive frequency for the selected working channel.
 - The **TX Frequency** is the mobile's transmit frequency for the selected working channel.
7. Enter the **Logical ID** number.
8. Enter the **Group ID** number.
9. Enter the **Site ID** number.

Prepare the Decoder for Transmitter Measurements

1. Turn the **SQUELCH** control on the Test Set fully clockwise.
2. Select **DECODER** from the **To Screen** menu to access the EDACS Decoder.
3. Set the **AF An1 In** field to **FM Demod** to demodulate the signal from your transmitter.
4. Set the **Input Level** field to about one third of the expected deviation. (For example, if your transmitter's deviation is 3 kHz, set the **Input Level** to about 1 kHz.)
5. Select the **Arm Meas** field to prepare the decoder. The **Status:** field should indicate **Armed**.
6. Select the **Send** field (under **RX Test**). This outputs the control channel information specified in the EDACS Encoder.

The mobile should indicate that it is receiving the control channel data.

Make Basic Transmitter Measurements

1. Key the mobile's transmitter and verify that its transmit indicator is on. The call type, Group ID, and Logical ID information transmitted by your mobile is displayed under the **Data** field.
2. With the transmitter still keyed, press the DUPLEX key to access the DUPLEX TEST screen. **TX Frequency** and **TX Power** are displayed.

Making Other Transmitter Measurements

By connecting Audio Frequency Generator 1 (AFGen 1) to your transmitter's microphone input, you can make calibrated modulation measurements; such as microphone sensitivity, modulation limiting, and transmitter frequency response.

1. Connect the AUDIO OUT port of the Test Set to your mobile's microphone input.
2. Access the DUPLEX TEST screen.
3. Set the upper part of the **AFGen1 To** field to **Audio Out**.
4. Use the lower part of the **AFGen1 To** field to adjust the output level into the microphone line.
5. Use the **AFGen1 Freq** field to adjust the audio generator's frequency.

Function Generator Decoder

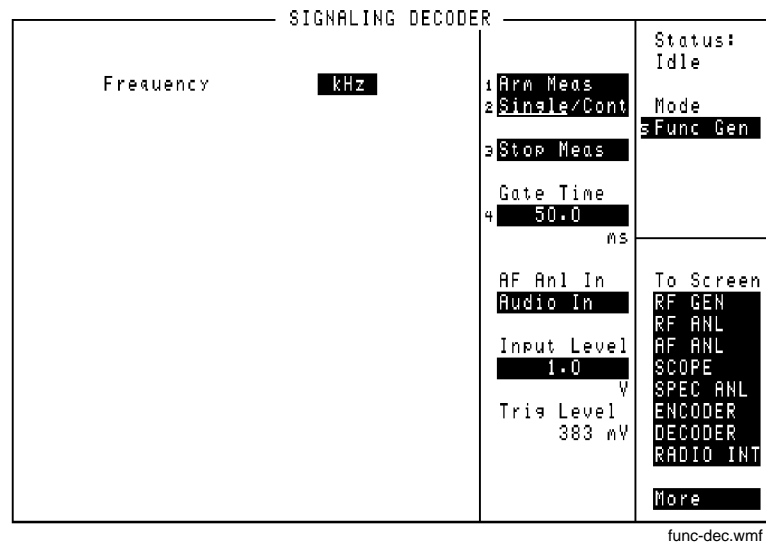

Figure 78 The Function Generator Decoder Screen

AF Anl In

Audio frequency analyzer input selects the source of the signal to be analyzed.

Operating Considerations

This is a priority control field. Accessing the RX TEST or TX TEST screen overrides any changes made to this field in this screen.

See Also

["Interaction Between Screens" on page 54](#)

Arm Meas

Arm measurement prepares the decoder to be triggered by an incoming signal when making single measurements.

Frequency

This measurement displays the decoded signal's frequency.

Gate Time

This field specifies the minimum time the decoder analyzes a signal after it has been triggered.

Input Level

This field specifies the signal level that you input (after de-emphasis if it is turned on). The higher the level of signal expected by the analyzer, the higher the trigger level is set.

Operating Considerations

The unit-of-measure is determined by the **AF An1 In** setting.

The input level should be set high enough to prevent false triggering, but low enough to allow triggering for fluctuating signal levels.

If de-emphasis is used (by setting the AF Analyzer's **De-Emphasis** field to **750 μs**), the **Input Level** should be set to about 1/5 of the measured signal's level. For example, a 1 kHz, 1 V_{peak} sinewave into the AF Analyzer's input requires an **Input Level** of approximately 0.212 V to trigger correctly.

See Also

[Trig Level field description, on page 308](#)

Stop Meas

Selecting this field stops the analyzer when making single measurements.

Single/Cont

This field specifies how you want the analyzer to be armed:

- **Single** is used to analyze and display the decoded information once each time **Arm Meas** is selected.
- **Cont** is used to automatically re-arm the analyzer and display the measurements on a continual basis until **Single** is selected.

Trig Level

The trigger level indicates the minimum signal level required to begin a measurement that has been “armed”. The level is adjusted by changing the **Input Level** field setting.

Using the Function Generator Decoder

Decoding Considerations

Frequency measurements are affected by the **Filter1**, **Filter2**, **Settling**, and **De-Emphasis** settings in the AF ANALYZER screen.

Four dashes (- - - -) are displayed if the incoming signal is out of range, or if the **Gate Time** is too long for the frequency being measured.

LTR Decoder

This decoder mode displays trunked signaling data for mobile radios and repeaters using the EF Johnson LTR® (Logic Trunked Radio) format.

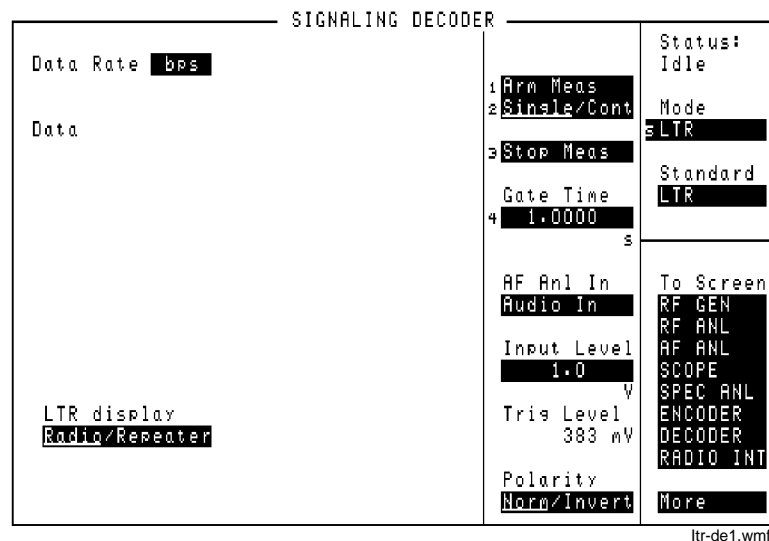

Figure 79 The LTR Trunked Radio Decoder Screen

AF Anl In

Audio frequency analyzer input selects the source of the signal to be analyzed (almost always **FM Demod** for LTR decoding).

Arm Meas

Arm measurement prepares the decoder to be triggered by an incoming signal when set to make a single measurement.

Data

This field displays decoded LTR data. The **LTR display** setting determines what type of data is decoded.

Data Rate

This display field lists the data rate of the received signal.

Operating Considerations

This measurement relies on the LTR Encoder screen's data rate setting. Set the encoder's **Data Rate** field to the expected incoming data rate for accurate measurements (typically 297.6 bps).

Gate Time

This field specifies how long the decoder analyzes a signal after it has been triggered.

Input Level

Enter the expected data signal level in this field (typically 1 kHz for LTR data). The higher the level of signal expected by the analyzer, the higher the Trigger Level is set.

Operating Considerations

The unit-of-measure is determined by the **AF An1 In** setting (**kHz** when the input is **FM Demod**).

The input level should be set high enough to prevent false triggering, but low enough to allow triggering for valid signals.

See Also

[Trig Level field description, on page 308](#)

LTR Display

- **Radio** - displays the mobile's transmitted trunking data. An example display might look like this:

```
Area : 0  
Goto : 2  
Home : 2  
ID : 128  
Free : 31
```

- **Repeater** - lists the 20 possible repeater numbers in an LTR system. The data from the monitored repeater is displayed. If multiple radios try to access the repeater during decoding, the data sent to those radios by that repeater is also displayed.

The data is displayed as a series of digits next to the number of the repeater that sent it. For example, a decoded message with a Goto number of 02 may look like this:

```
01:      02: 0020212806  
03:      04:  
04:      05:  
~        ~
```

This is interpreted as follows:

```
02:  0  02  02  128  06  
Repeater Area Goto Home ID Free
```

Polarity

This setting is used to match the polarity of the encoded signal being analyzed.

Normal Operation. When this field is set to **Norm**, a logical high (1) is displayed when a positive peak in the received signal is detected. A negative peak displays a logical low (0).

Inverted Operation. When this field is set to **Invert**, a logical high (1) is displayed when a negative peak in the received signal is detected. A positive peak displays a logical low (0).

Single/Cont

This field specifies how long you want the analyzer to decode incoming signals:

- **Single** tells the analyzer to display valid LTR information received during one gate time.
- **Cont** is used to automatically re-arm the analyzer and display the measurements on a continual basis until **Single** is selected.

Stop Meas

Selecting this field stops the analyzer when making single measurements.

Trig Level

The trigger level indicates the minimum signal level required to begin a measurement that has been “armed.” The level is adjusted by changing the **Input Level** field setting.

Using the LTR Decoder

Decoding Mobile Radio Signaling Data

A transmit channel must be established before a mobile radio is tested (otherwise the transmitter will attempt to transmit but time-out and de-key automatically). A procedure for establishing a trunked transmit channel is provided in "[Using the LTR Encoder](#)" on page 400.

After establishing a trunked transmit channel, keep the transmitter keyed and perform the following steps.

1. Access the DECODER screen, and select **LTR** for the **Mode**.
2. Set the **LTR display** field to **Radio**.
3. Set the **Single/Cont** field to **Single**.
4. Set the **AF An1 In** field to **FM Demod**.
5. Set the **Input Level** to 1 kHz.
6. Select **Arm Meas** to prepare the decoder for triggering. The transmitted data should be displayed after being computed.

An **End of Data reached during decode.** message may be displayed at the top of the screen during decoding. Four conditions usually cause this message to be displayed:

- The **Gate Time** is too short to decode all the data. Increase this setting.
- The **Input Level** is set too low or too high. Change the level.
- The trunking data is inverted. Select **Invert** in the **Polarity** field.
- The LTR radio is not transmitting. Re-establish a transmit channel.

Decoding Repeater Signaling Data

Press the PRESET key.

1. Access the DUPLEX TEST screen.
2. Set the **Tune Mode** to **Manual**.
3. Enter your repeater's transmit frequency in the **Tune Freq** field.
4. Select the **Input Port** (RF IN/OUT for direct transmitter-to-Test Set connections; **Ant** (ANT IN) for off-the-air measurements).
5. Attach an antenna to the Test Set if you are making off-the-air measurements.
6. Access the DECODER and select the **LTR** mode.
7. Set the **LTR display** field to **Repeater**.
8. Select the triggering mode.
 - Select **Single** to decode and display only the first valid transmitter data received. The decoder must be re-armed before another measurement can be made.
 - Select **Cont** to continuously monitor a repeater and display its transmitted data.
9. Set the **AF An1 In** field to **FM Demod**.
10. Set the **Input Level** to 1 kHz.
11. Select **Arm Meas** if you are using single triggering. The transmitted data is displayed after computing is displayed in the **Status** field.

If no decoded data is displayed

- The repeater may not be transmitting.
- The RF signal may be too low for off-the-air measurements. Use a better antenna, or set the RF ANALYZER screen's **Sensitivity** field to **High**.
- The **Gate Time** may be too short. Increase the value.
- The received data may be inverted. Set the **Polarity** field to **Invert**.
- The trigger level may be too low or too high. Change the **Input Level** setting.

MPT 1327 Decoder

The MPT 1327 Decoder screen is used with the MPT 1327 Encoder screen to decode and display MPT 1327 data streams. Like the MPT 1327 Encoder, the MPT 1327 Decoder is primarily intended to be controlled using IBASIC programs running on the Test Set's IBASIC controller or on an external controller.

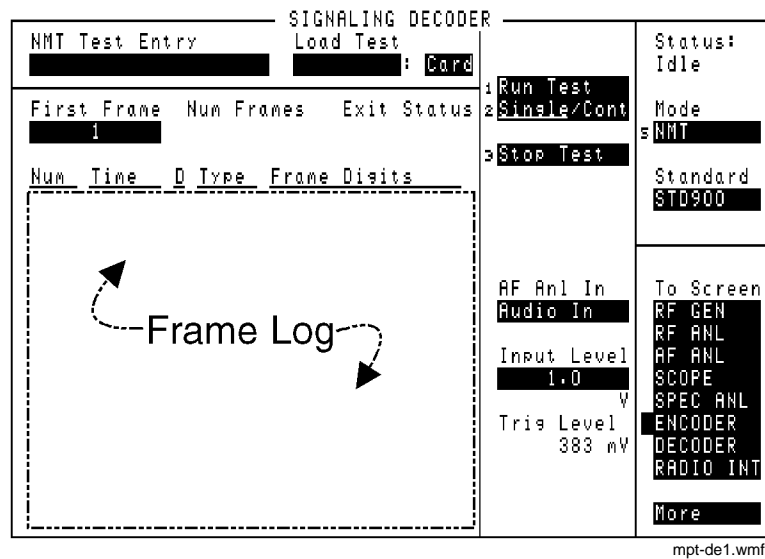

Figure 80 The MPT 1327 Decoder Screen

Manually Decoding MPT 1327 Signals

To manually test MPT 1327 radios using this decoder, you must first set up the MPT 1327 Encoder to provide the necessary protocol to get the radio up on the correct channel. This requires a thorough knowledge of the MPT 1327 Encoder operation, including using the undisplayed controls accessed using IBASIC commands.

For these reasons, the following information generally assumes you are operating the decoder under IBASIC control.

Decoder Triggering

For MPT 1327 signaling detection, the decoder should be configured for repetitive retriggering using the HP-IB command:

```
TRIGger:MODE:RETRigger REPetitive
```

When the decoder is armed it is triggered whenever it receives the synchronization sequence appropriate to the test mode (selected on the MPT 1327 Encoder screen). Refer to [table 7](#).

Table 7 **Triggering the MPT 1327 Decoder**

Test Mode	Decoder Synchronization Sequence
Off	-
Control	SYNC
Traffic	SYNT
1200Hz	1111
1800Hz	0000
Dotting	1010

The SYNC and SYNT patterns are those defined for the MPT 1327 Encoder. (The defaults are $C4D7_{16}$ and $3B28_{16}$ respectively.)

When a synchronization sequence is recognized, the message is placed (timeslot aligned) into the receive buffer. The receive buffer is organized as 16×128 bit timeslots.

Decoder repetitive retriggering is used to minimize the decoder down-time between messages. It is therefore important to extract the messages from the decoder buffer as soon as possible after their arrival. This avoids the messages being overwritten by further signaling.

Detecting and Querying Messages

IBASIC can be informed about the arrival of a message in the decoder buffer. To do this, configure the HP-IB status registers to cause a service request (SRQ) on the negative transition event of bit 12, “Decoder Result Available” in the Hardware Status Register #1.

For further information on the Hardware Status Register refer to the *Programmer’s Guide*.

The message is read from the decoder buffer by the command:

```
MEASure:DECoder:MPT1327:BUFFer?
```

This query returns a quoted string comprising the contents of one or more timeslots. The string is disassembled into mnemonic form. If more than one message is received, the individual messages are separated by semicolons. If a timeslot contains data codewords, it is disassembled into the DCW extension.

Examples of this are:

- Simple RQS from RU. **RQS 0,1,5,0**
- Cleardown from RU sent in three consecutive timeslots.
MAINT 0,1,283,3,0;MAINT 0,1,283,3,0;MAINT 0,1,283,3,0
- SAMIS response to AHYC giving PSTN digits for call.
SAMIS 14391,83782;DCW #H080000000000,#H000000000000

There are two other measurements available on the decoder screen:

- **The Signaling Data Rate.** The signaling data rate measurement is the measured baud rate of the received message. It is most accurately measured on a “dotting” pattern.
- **The Received Message Timing.** This measures the timing of the received message relative to the timeslots in the forward control channel. It has two modes of operation:
 - **Slot timing mode.** This works in the **Control** test mode only, it is disabled in all other modes. This is the default mode.
 - The timing counter is reset at the end of every control channel timeslot. If a message is received, the time from the most recent slot end, to the start of the received message’s preamble, is reported as the timing measurement result.

- In the slot timing mode it is not possible to determine whether the message was returned in the “correct” timeslot. (For example, if it is a response that should return in the timeslot immediately following the requesting forward message.) It is possible to check that the timing offset from the forward channel slot boundaries is within specification.

- This mode is selected with the following HP-IB with the command:

- `DECoder:MPT1327:TIME:MODE 'SLOT`

- works in the Control and Traffic test modes, it is disabled in all other modes.

- In Control mode the timing counter is reset at the end of each message transmitted from the control channel message buffer. It is not affected by the on-going transmission of the control channel filler pattern.

- In the Traffic mode the timing counter is reset at the end of each message transmitted from the traffic channel message buffer. There is no background filler pattern.

- In the response timing mode both next slot and slot offset timing can be checked. The received message must however, be solicited by a forward message so that the timer is reset and the measurement is meaningful.

- This mode is selected via the HP-IB with the command:

- `DECoder:MPT1327:TIME:MODE 'RESPONSE'`

NMT Decoder

The NMT Encoder and Decoder work together to test Nordic Mobile Telephone equipment used in a number of countries using different NMT standards. As each standard is selected, the Test Set configures the encoder and decoder to create and measure the corresponding RF carrier and digital data structure.

The following terms are used throughout the NMT sections of the manual:

DUT - Device-Under-Test: The device being tested (MS, BS, or MTX).

Frames - Groups of digital information that comprise an NMT signal. (This manual assumes you understand the frame structure for the signals you need to create or analyze; any frame information provided is for reference purposes.)

MS - Mobile Station: The equipment used by a mobile subscriber.

BS - Base Station: The unit that provides the radio interface between one or more Mobile Stations and the Mobile Telephone Exchange.

MTX - Mobile Telephone Exchange: The unit that provides the interface between one or more Base Stations and the telephone network.

Standard - The set of frequency and data format standards used by different countries.

The NMT Decoder screen is used to load and run NMT test programs you create. The programs are used to transmit NMT-encoded signals to a device, and to evaluate received NMT signals.

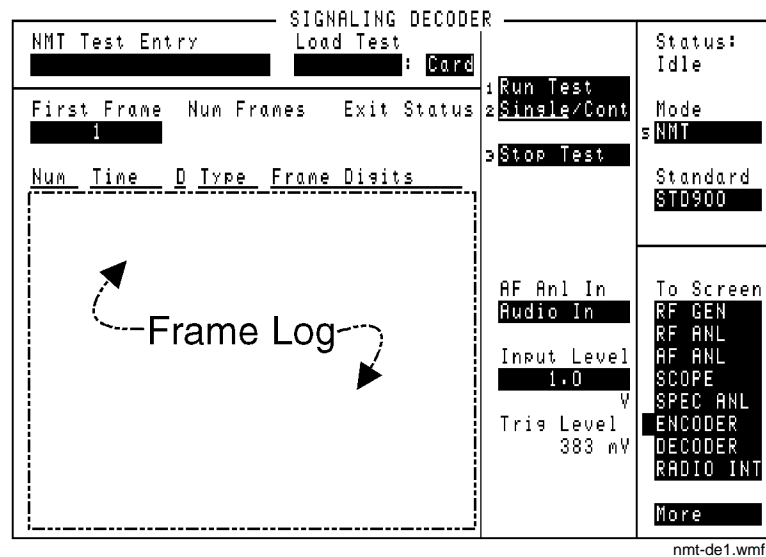

Figure 81 The NMT Decoder Screen

AF Anl In

Audio frequency analyzer input selects the input for the analyzer. When selected, this field displays a list of choices:

- The output of the AM, FM, or SSB demodulators.
- The AUDIO IN, RADIO INTERFACE, MODULATION INPUT, MIC/ACC, and AUDIO OUT connectors.
- The signal present at the AM or FM modulators for the RF Generator.

See Also

["Interaction Between Screens" on page 54](#)

["Displaying Measurements" on page 57](#)

Exit Status

This field indicates which EXIT n command caused the program to stop running.

See Also

EXIT n command in the ["Program Command Syntax" on page 331](#).

Frame Log

The Frame Log area lists the recorded frame information generated by the encoder and received by the decoder. Field descriptions for this area are listed together.

D

The Direction column tells if a frame was *transmitted* by the encoder (**T**), or *received* by the decoder (**R**).

Frame Digits

This column lists the information part of the recorded frames, displayed as hexadecimal digits.

Num

This column lists the reference numbers assigned to the recorded frames in the order they were transmitted and received.

Time

The times in this column indicate when each frame was transmitted or received after **Run Test** was selected. The times are listed in bit intervals that are dependent on the data rate set in the NMT Encoder.

For example, at a data rate of 1200 bps, one bit interval is equivalent to 0.833 ms (1/1200).

Type

This column lists the NMT standards frame type for each frame.

Operating Considerations

The received frame type is determined using the decoder's **Standard** field setting, and the encoder's **DUT** field setting. If these settings do not agree with the actual DUT and its standard, the received (R) frame types may not be correctly identified.

The transmitted frame type is determined by the Send f commands used in the NMT test program being executed.

Input Level

This field specifies the signal level that you input. The higher the level of signal expected by the analyzer, the higher the trigger level is set.

Operating Considerations

The unit-of-measure is determined by the **AF An1 In** setting.

The input level should be set high enough to prevent false triggering, but low enough to allow triggering for fluctuating signal levels.

De-emphasis can greatly affect the input level required for proper decoding. When decoding NMT data streams, you should turn de-emphasis off (controlled by the **De-Emphasis** field on the AF ANALYZER screen.)

See Also

[Trig Level field description, on page 288](#)

Load Test

This double field is used to select and load NMT tests from a variety of mass storage devices. After the appropriate Mass Storage device is selected using the field on the right, the desired NMT test is selected using the field on the left.

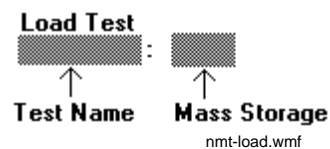

Operating Considerations

Directly entering a command into the **NMT Test Entry** field automatically removes from memory any NMT test previously loaded using the **Load Test** field.

NMT Test Entry

See ["Using Direct Command Entry" on page 328](#).

Run Test

Selecting this function executes (runs) the NMT test specified in the **Load Test** field or entered directly into the **NMT Test Entry** field.

Single/Cont

This field specifies how you want the test to be run:

- **Single** executes the NMT program and displays the decoded information once each time **Run Test** is selected.
- **Cont** continually re-runs the program, and displays the decoded information, until **Single** is selected.

Stop Test

Selecting this field interrupts the NMT test while running. If **Cont** is selected, the program automatically re-runs from the beginning.

Standard

This field specifies the NMT standard for the signal being decoded.

Operating Considerations

This setting alters the decoder's function by specifying the expected frame structure and channel range for the incoming signal.

Trying to run a test with the wrong standard selected will result in incorrect decoded data, or will display an operating error message.

See Also

[Trig Level field description, on page 275](#)
["Standard Equivalents" on page 323](#)

Trig Level

Trigger level indicates the minimum signal level required to begin a measurement. This level is adjusted by changing the **Input Level** field setting.

Using the NMT Decoder/Encoder

General Encoder Operation

The following are fields that are typically used for testing different types of NMT equipment.

Refer to the individual field descriptions for detailed information on each field's function and operating parameters.

Testing Mobile Stations

These fields are typically used to test an MS:

- Calling Channel: Number and Power
- Traffic Channel (Main): Number and Power
- Traffic Channel (Alt): Number and Power
- Traffic Area: Main and Alt
- DUT
- TCI (Tariff Class Information)
- MSN (Mobile Subscriber Number)
- Data Rate
- Access Channel: Number and Power
- Batt Save
- Area #
- Add Info
- SIS Challenge

Testing A BS or MTX

These fields are typically used to test a BS or MTX:

- Mgmt/Maint
- Meas Ch #
- Phi Signal
- Meas Field Strength
- Password
- BS Identity
- Alarm Level High and Low
- SIS Response

Fields Used with Different Standards

Fields in the upper part of the screen are used with all NMT standards. Fields in the lower part of the screen are only used with the STD900 standard.

General Decoder Operation

The NMT Decoder screen has several uses:

- Entering NMT programming commands.
- Loading existing NMT tests from a variety of storage media.
- Running NMT tests.
- Decoding received NMT signals.

Operating Steps

Manual NMT radio tests generally follow four basic steps:

1. Write your test program to send encoded information and evaluate received frames.
2. Enter the necessary information into the various encoder and decoder fields.
3. Make the required Test Set AF Analyzer, RF Analyzer, and RF Generator settings.
4. Load and run your program from the decoder.

Changing Standards: Each NMT standard affects several operating parameters for the encoder and decoder screens; however, there are no visual changes to the contents of either screen when standards are changed. You must be aware of these changes when manually testing radios using these screens.

Refer to the **Standard** and **Calling Channel Number** field descriptions for explanations on the effects of these fields

Standard Equivalents

Only two standards are referred to in this section: STD450 and STD900. All other national standards are based on these two. If a field description says “only used with the STD900 standard”, the field can also be used with other national standards listed under the STD900 equivalents below.

The following list identifies which national standards are based on STD450 and STD900:

STD450 Equivalents

- Austria
- Benelux
- Bulgaria
- Cro-Slav (Croatia-Slovenia)
- Hungary
- Malaysia
- Saudi 1
- Saudi 2
- Spain
- Thailand
- Turkey

STD900 Equivalents

- France (Uses the STD900 protocol at STD450 frequencies)

Manual Testing of NMT Radios

NMT signals contain complex groupings of digital data that vary in format and function, depending on a number of system operating needs.

To be able to test NMT radios using these screens, you must be familiar with the theory, applications, and specifications of the NMT systems. The large volume of information required to explain the NMT system is beyond the scope of this manual.

Documents explaining the structure and specifications for the different NMT standards should be obtained from the radio communications regulatory agency of the appropriate country.

Automated NMT Radio Tests

The HP 11807A Option 006 NMT Cellular Tests software for the HP 8920A provides comprehensive automated tests of NMT mobile stations. All Test Set RF, AF, and encoder/decoder settings are made automatically, requiring minimal operator inputs.

The test type and sequence, measurement specifications, and instrument settings are easily configured for the device being tested. Customized test procedures can be stored on external disks or memory cards for later use.

All HP 11807 Test Software packages include comprehensive documentation explaining hardware connections and software configuration and operation.

Required Test Set Settings

The following Test Set settings should be made before using the NMT Encoder/Decoder screens. These settings assume the Test Set is in its preset state.

RF Generator Settings

AFGen1 To: Audio Out and Off

AFGen2 To: FM and 3.5 kHz

RF Analyzer Settings

Tune Mode: Manual

Input Atten: Hold and 0 dB

Squelch: Fixed

AF Analyzer Settings

AF An1 In: FM Demod

Filter 1: 300Hz HPF

Filter 2: 15kHz LPF

De-Emphasis: Off

Initial NMT Encoder Settings

Mode: NMT

DUT: MS (for testing Mobile Stations)

Initial NMT Decoder Settings

Input Level: 3.0 kHz

Special Frame Suffixes

Some frame designations include a suffix to identify specific encoder screen fields (such as **TC2** for Alternate Traffic Channel) or to indicate special frame values affected (such as the **S** suffix that indicates Battery Save information; example - 1aS).

The following suffixes are appended to some frame designations:

AC = Access Channel

CC = Calling Channel

S = Battery Save

TA1 = Main Traffic Area

TA2 = Alternate Traffic Area

TC1 = Main Traffic Channel

TC2 = Alternate Traffic Channel

Creating NMT Tests

The NMT Encoder outputs signals using programs running in the NMT Decoder. This differs from the Test Set's other signaling encoder functions that have a "send" function to directly output their signals (such as DTMF and Tone Sequence).

To use the NMT Encoder and Decoder functions, you must first understand how tests are written.

Programming Overview

Special program commands are used by the Test Set to test NMT radios. These commands are used to send frames, perform simple branching and looping operations, change RF channels, and test received frame types.

The NMT Decoder has its own RAM to run programs. All NMT program commands must be entered into the decoder's RAM before they can be executed. This can be done directly by entering commands one at a time into the **NMT Test Entry** field, or by loading a test program that has been created and saved on mass storage.

NOTE: **NMT Format:** When storing NMT tests you have created, you *must* save them as ASCII files using the BASIC command SAVE (and use the GET command to retrieve them). Non-ASCII files cannot be retrieved using the NMT Decoder screen's **Load Test** field, and therefore cannot be run.

Creating NMT Tests

Tests can be created and saved using any of these methods:

- Writing programs on a connected external controller, downloading them into the Test Set's IBASIC RAM, and then storing them on mass storage.
- Using the TESTS screen's IBASIC Controller and the cursor-control knob to enter programs line-by-line into IBASIC RAM, and then saving them on mass storage.
- Using the TESTS screen's IBASIC Controller and a connected terminal to enter programs line-by-line into RAM, and then saving them on mass storage.
- Using an IBASIC program that creates a file to output program commands.

Entering Tests Into The Decoder's RAM

NMT commands are entered into the decoder's RAM using any of these methods:

- Using the **Load Test** field to load an existing test from mass storage.
- Using a connected terminal or cursor-control knob to directly enter commands into the decoder's **NMT Test Entry** field.
- Using an IBASIC program that outputs commands to the **NMT Test Entry** field.

The most efficient method is to use a connected computer to write the program, store the program on a memory card, and then select the test from the memory card using the decoder's **Load Test** field.

Using Direct Command Entry

The decoder's **NMT Test Entry** field allows you to directly enter program commands into the decoder's RAM. Program line numbers are not used, and no LIST or EDIT function is available for programs entered this way. This capability is provided to allow direct entry of small programs without the need of external equipment or the need to store the program for future use.

Program Example

This example program can be entered line-by-line into the **NMT Test Entry** field, and then run by selecting **Run Test**:

```
begin  
set 1 5  
10 send 1a  
send 2a  
repeat 1 10  
exit 0  
end
```

NOTE:

Entering commands directly into the **NMT Test Entry** field causes any existing programs you have loaded to be removed from the decoder's memory.

Also, programs entered into the **NMT Test Entry** field cannot be saved on mass storage.

Programming Using an External Computer

Writing programs on an external computer using BASIC allows you to write and edit the NMT program, and then store it on mass media (memory card, RAM disk, external disk).

Since some NMT syntax used are not valid BASIC language commands, a special program structure is required.

Program Structure

The following rules must be followed when writing NMT programs to be stored on mass media:

- All statements in the program must appear as BASIC comments, beginning with an exclamation point (!) following the line number. REM statements *cannot* be substituted for the (!) symbol.
 - All statements desired as comments in the NMT program are indicated by a double exclamation point (!!)
 - The first line of all NMT programs must have !!NMT following the line number.
 - When storing NMT programs, file names must begin with the letter n (either lower or upper case). The n is removed before the filename is shown in the menu for the **Load Test** field. (For example, a file saved as **nNMT1** appears as **NMT1**.)
- Program Example**

The following example can be saved on mass storage, and then retrieved and run using the decoder's **Load Test** field:

```
10  !!NMT
20  !BEGIN
30  !SET 1 5
40  !10 SEND 1A
50  !SEND 2A
60  !REPEAT 1 10
70  !EXIT 0
80  !END
```

Downloading Programs

Once programs are entered into the Test Set's IBASIC Controller's RAM and saved on mass storage, they can be retrieved and run from the NMT Decoder.

Downloading A Program Into IBASIC Controller RAM

To copy a program from your BASIC computer to the Test Set's RAM, follow these steps:

1. Connect an HP-IB cable from your BASIC computer to the Test Set.
2. Load the program into your computer.
3. Set the HP-IB **Mode** field in the I/O CONFIGURE screen to **Talk&Listen**.
4. Enter the following commands on your computer:

```
OUTPUT Addr; "PROG:DEL"  
OUTPUT Addr; "PROG:DEF #0"  
LIST #Addr  
OUTPUT Addr; " "END
```

Addr is the HP-IB address of the Test Set.

The END statement indicates that EOI is asserted with the last byte sent. (Refer to IEEE 488.2 standards for more information.)

NOTE:

Although your NMT program is now in the Test Set's IBASIC program RAM, it cannot be run from the TESTS (IBASIC Controller) screen, since IBASIC does not recognize the NMT commands. You must copy the program to mass storage before it can be run in the decoder.

Copying Programs to Mass Storage

Programs copied to RAM disk, external disk, or memory cards require specific initialization and configuration procedures for proper storage and retrieval. Refer to the *Programmer's Guide*.

Program Command Syntax

The following list describes the NMT command syntax and parameters. Commands can be entered directly into the decoder's **NMT Test Entry** field, or used in test programs saved on mass storage.

All commands can be preceded by an integer as a label for branching purposes. These labels can range from 0 to 255.

BEGIN

Begin description of NMT test. This must always be the first command entered to describe a new NMT test program. It will initialize all internal memory associated with the NMT test and prepare the Test Set to accept the rest of the test program. It has no parameters.

END

End of the NMT test. This must always be the last command entered to describe an NMT test. It causes the program to be checked for valid label references and terminates the test entry process.

EXIT n

Stop the test and report exit status **n**.

Valid entries for the parameter **n** are integers from 0 to 10 and the following words (these may be in upper or lower case): PASSED, FAILED, ACCEPTED, REJECTED, INCOMPLETE.

All NMT test programs must contain an EXIT **n**, EXITX **n**, or GOTO **l** statement immediately before the END statement.

EXITX n

Stop the test and report exit status **n**. Exchange the settings in the main and alternate traffic channel number fields and the power field.

Valid entries for the parameter **n** are integers from 0 to 10 and the following words (these may be in upper or lower case): PASSED, FAILED, ACCEPTED, REJECTED, INCOMPLETE.

All NMT test programs must contain an EXIT **n**, EXITX **n**, or GOTO **l** statement immediately before the END statement.

GOTO l

Unconditionally jump to the label reference **l**.

Valid entries for the parameter **l** are integers from 0 to 255. The label reference must exist within the program or an error will occur after the END statement is entered.

All NMT test programs must contain an EXIT n, EXITX n, or GOTO l statement immediately before the END statement.

RCHAN c

Set the RF Analyzer to the correct frequency for NMT channel **c**.

Valid entries for the parameter **c** are as follows: CC, TC1, TCM, TC2, TCA and AC. TC1 and TCM are synonyms as are TC2 and TCA.

The frequency setting is determined by the channel number in the appropriate encoder field, the selected DUT, and the selected standard.

The parameter CC refers to the calling channel; TC1 and TCM refer to the main traffic channel; TC2 and TCA refer to the alternate traffic channel; AC refers to the access channel.

TCHAN c

Set the RF Generator to the correct frequency for NMT channel **c**.

Valid entries for the parameter **c** are as follows: CC, TC1, TCM, TC2, TCA and AC. TC1 and TCM are synonyms as are TC2 and TCA.

The frequency setting is determined by the channel number in the appropriate encoder field, the selected DUT, and the selected standard.

The parameter CC refers to the calling channel; TC1 and TCM refer to the main traffic channel; TC2 and TCA refer to the alternate traffic channel; AC refers to the access channel.

SEND f

Send the designated frame **f**.

Valid entries for the parameter **f** are as follows: 1A, 1A' or 1AP, 1A" or 1APP, 1AS, 1A'S or 1APS, 1A"S or 1APPS, 1B, 1BS, 1BTA1, 1BTA2, 2A, 2A' or 2AP, 2A" or 2APP, 2B, 2B' or 2BP, 2B" or 2BPP, 2C, 2C' or 2CP, 2C" or 2CPP, 2D, 2D' or 2DP, 2D" or 2DPP, 2E, 2F, 3A, 3A1, 3A2, 3B, 3BTA2, 3BTC2, 3C, 3D, 3DTA2, 4, 4TA2, 4B, 4BTA2, 5B, 6, 7, 10A, 10AAC, 10B, 10C, 10D, 11, 11A, 11B, 12, 13B, 15, 16, 21B, 21C, 22, 26, 27, 28 and 30.

Some of these frame types are only valid for certain NMT Standards. This will be checked when the program is run.

SEND f n

Send the designated frame **f** with the signal **n**. Valid entries for the parameter **f** with parameters **n** are as follows:

Table 8 Valid Channel Assignments

f	n
5a, 13a	Line signal number: 0 to 15, or 0 to F (hex)
14a, 14b	Digit signal value: 0 to 13, A to D(10 to 13), * and #.
20	Channel activation order: 0 to 15, or 0 to F (hex)
25	Channel status information: 0 to 15, or 0 to F (hex)

IF f l

If the received frame register contains the frame **f**, go to label **l**.

Valid entries for the parameter **f** include all the valid entries for **f** in the two SEND statements; however, the special suffixes discussed in "[Special Frame Suffixes](#)" on [page 325](#) are ignored by this instruction.

Valid entries for **l** are integers from 0 to 255. The specified label **l** must appear somewhere before the END statement of the program.

CLEAR

Clear the received frame register. This statement should appear before an IF f l statement in the test program.

SET n m

Set the counter **n** to the value **m**.

Valid entries for the parameter **n** are integers 1 and 2. Valid entries for **m** are integers from 0 to 255.

REPEAT n l

Decrement the counter **n** by one and go to the label **l** if the counter value is still greater than 0.

Valid entries for **n** are 1 and 2. Valid entries for **l** are integers from 0 to 255. The specified counter **n** must have been set with a SET n m statement previously in the test program. The label **l** must appear somewhere in the test program before the END statement.

WAIT n

Wait **n** bits with no data being sent.

Valid entries for the parameter **n** are integers from 0 to 4095. The actual wait time depends on the data rate setting, in bits-per-second, on the NMT ENCODER.

Tone Sequence Decoder

The Tone Sequence Decoder analyzes sequential tone signals and displays the associated parameters.

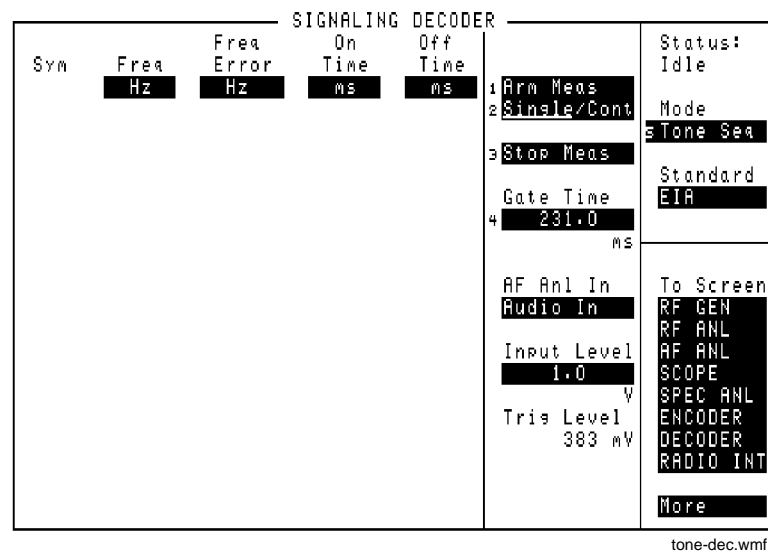

Figure 82 The Tone Sequence Decoder Screen

AF Anl In

Audio frequency analyzer input selects the source of the signal to be analyzed.

Operating Considerations

This is a priority control field. Accessing the RX TEST or TX TEST screen overrides any changes made to this field in this screen.

Arm Meas

Arm measurement prepares the decoder to be triggered by an incoming signal when **Single** is selected.

Freq

This measurement column lists the tone frequency for each symbol received in the tone sequence.

Freq Error

This measurement column lists the frequency difference between the tone frequency specified for each symbol in the Tone Sequence Encoder screen and the frequency measured for each symbol in the Tone Sequence Decoder screen.

Operating Considerations

The decoder and encoder **standard** fields are interactive. The standard you choose in either field is automatically selected for the other.

Gate Time

This field specifies how long the decoder analyzes a signal after it has been triggered.

Input Level

This field specifies a tone's "on" signal level that you input (after de-emphasis if used). The higher the level of signal expected by the analyzer, the higher the trigger level is set.

Operating Considerations

The unit-of-measure is determined by the **AF An1 In** setting.

The input level should be set high enough to prevent false triggering, but low enough to allow triggering for every desired tone received.

If de-emphasis is used (by setting the AF Analyzer's **De-Emphasis** field to **750 μs**), the **Input Level** should be set to about 1/5 of the measured signal's level. For example, a 1 kHz, 1 V_{peak} sinewave into the AF Analyzer input requires an **Input Level** of approximately 0.212 V to trigger correctly.

See Also

[Trig Level field description, on page 337](#)

Off Time

This measurement column lists the length of time each tone was “off” prior to the next tone being received.

On Time

This measurement column lists the length of time each tone was “on.”

Single/Cont

This field specifies how you want the analyzer to be armed:

- **Single** is used to analyze and display the decoded information once each time **Arm Meas** is selected.
- **Cont** is used to automatically re-arm the analyzer and display the measurements on a continual basis until **Single** is selected.

Stop Meas

Selecting this field stops the analyzer when making single measurements.

Sym

The symbol column corresponds to the Tone Sequence Encoder’s symbols assigned for each tone. As each tone is analyzed, the symbol that represents each tone is listed in this column.

Operating Considerations

The symbol assigned to a received tone is based on the closest symbol frequency to that tone. If the frequency of the received tone is exactly half-way between two symbol frequencies, the symbol associated with the higher of the two frequencies is displayed.

Trig Level

Trigger level indicates the minimum signal level required to begin a measurement that has been “armed.” The level is adjusted by changing the **Input Level** field setting.

Duplex Test Screen

Block Diagram

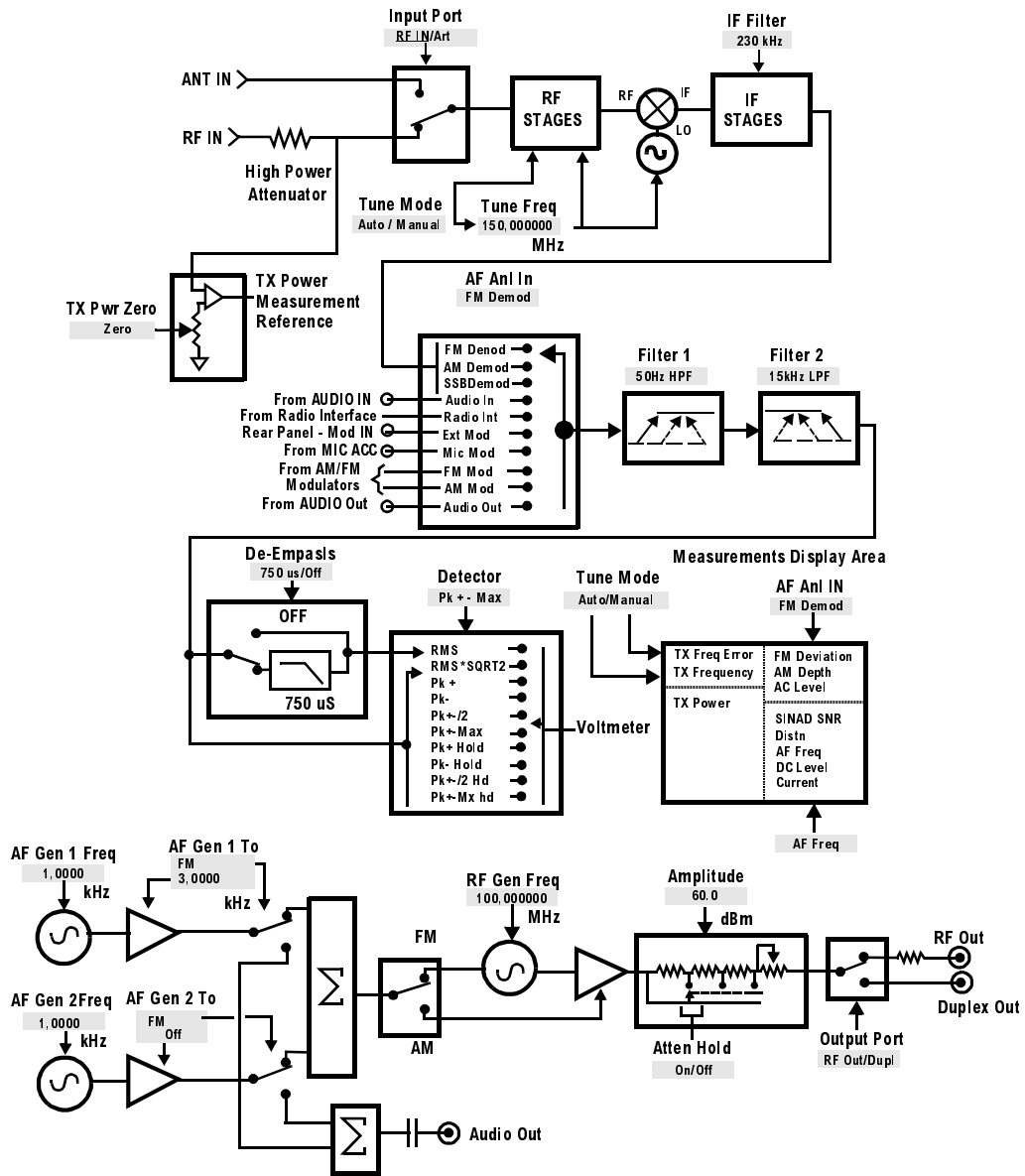

Figure 83 DUPLEX TEST Functional Block Diagram

Field Descriptions

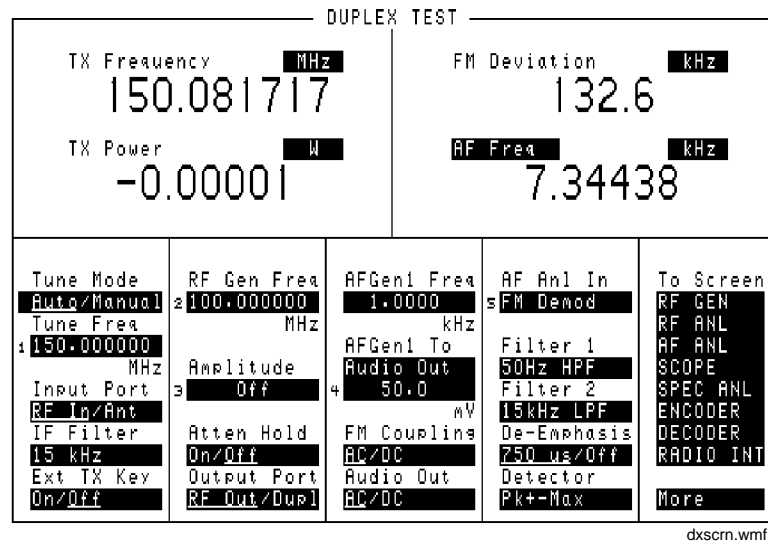

Figure 84 The Duplex Test Screen

AC Level

This is the default measurement for this field. The type of measurement shown is dependent on the **AF An1 In** settings.

See Also

[AF An1 In field description, on page 342](#)

["Displaying Measurements" on page 57](#)

AF Anl In

Audio frequency analyzer input selects the input for the analyzer. When selected, this field displays a list of choices.

Signals can be analyzed from three different types of inputs:

- the output of the AM, FM, or SSB demodulators
- the AUDIO IN, RADIO INTERFACE, MODULATION INPUT, MIC/ACC, and AUDIO OUT connectors
- the signal present at the AM or FM modulators for the RF Generator

Operating Considerations

Changing this field causes the upper AF measurement to change.

This is a priority control field. Accessing the RX TEST or TX TEST screen overrides any changes made to this field in other screens.

See Also

[FM Deviation field description, on page 348](#)
["Interaction Between Screens" on page 54](#)
["Displaying Measurements" on page 57](#)

AF Freq

This is the default measurement for this field. Selecting this field displays the following measurement choices:

- SINAD
- Distortion
- SNR (Signal to Noise Ratio)
- AF Frequency
- DC Level
- Current - DC only

Operating Considerations

This is a priority control field. Accessing the RX TEST or TX TEST screen overrides any changes made to this field in other screens.

SNR Operation

- Selecting SNR turns off the other audio measurement.
- The RF Generator and AF Generator 1 must be set up to provide the radio's carrier. (AFGen1 is automatically turned on and off repeatedly during this measurement.)
- AFGen2 must be turned off.
- The radio's receiver's audio output must be connected to the AUDIO IN port (set the **AF An1 In** field to **Audio In**).

See Also

["Interaction Between Screens" on page 54](#)

["Displaying Measurements" on page 57](#)

AFGen1 Freq

This field sets the frequency for the first audio frequency sinewave generator.

AFGen1 To

This field is used to set two values for the first audio frequency generator:

- The upper field determines whether the AF signal modulates the RF Generator, or is output through the AUDIO OUT connector.
- The lower field sets the amplitude (including **OFF**). The AUDIO OUT level is always in volts RMS.

Operating Considerations

This is a priority control field. Accessing the RX TEST or TX TEST screen overrides any changes made to this field in other screens.

See Also

["Interaction Between Screens" on page 54](#)

Amplitude

This field adjusts the amplitude of the RF Generator.

Operating Considerations

This is a priority control field. Accessing the RX TEST or TX TEST screen overrides any changes made to this field in other screens.

If a microphone is connected, and the amplitude is set to **OFF**, keying the microphone causes the amplitude to turn on to its previous level until the microphone is no longer keyed.

See Also

[Atten Hold field description, on page 345](#)

["Interaction Between Screens" on page 54](#)

["MIC/ACC" on page 568](#)

Atten Hold

Attenuator hold prevents the fixed RF output attenuators from switching in and out, eliminating the loss of the output signal as the level is changed. This function is helpful when making squelch measurements.

Operating Considerations

When this function is set to **On**, the RF output level is restricted to a range of 15 dB around the present **Amplitude** setting. Attempting to set an amplitude outside the allowed range results in an error message and beep (if the beeper is on). RF output level accuracy is greatly degraded outside the allowed range.

Audio Out

This field selects ac or dc coupling to the AUDIO OUT connector.

De-Emphasis

This setting selects or bypasses the 750 ms de-emphasis networks in the audio analyzer and internal speaker circuitry.

Operating Considerations

This is a priority control field. Accessing the RX TEST or TX TEST screen overrides any changes made to this field in other screens.

See Also

["Interaction Between Screens" on page 54](#)

Detector

This setting selects the type of detector used when measuring and displaying AF signal levels.

Detector Types

- **RMS** displays the RMS value of signals.
- **Sqr** displays the RMS value of a signal multiplied by the square-root-of-2.
- **Pk+** displays the positive peak value.
- **Pk-** displays the negative peak value.
- **Pk±/2** adds the positive and negative peak values, and divides the sum by 2.
- **Pk±Max** compares the positive and negative peaks and displays the greater value (polarity is not indicated).
- **Pk+ Hold** displays and holds the positive peak value until the measurement is reset. To reset, press the MEAS RESET key, select a different detector, or re-select the same detector.
- **Pk- Hold** displays and holds the negative peak value until the measurement is reset. To reset, press the MEAS RESET key, select a different detector, or re-select the same detector.
- **Pk±/2 Hold** divides the sum of the positive and negative peak values by 2, and displays the value until the measurement is reset. To reset, press the MEAS RESET key, select a different detector, or re-select the same detector.
- **Pk±Mx Hold** compares the positive and negative peaks and displays the greater value until the measurement is reset. To reset, press the MEAS RESET key, select a different detector, or re-select the same detector.

Operating Considerations

This is a priority control field. Accessing the RX TEST or TX TEST screen overrides any changes made to this field in other screens.

See Also

["Interaction Between Screens" on page 54](#)

Ext TX Key

This field controls a switch at the MIC/ACC connector. Its intended use is to “key” an external transmitter.

See Also

["Interaction Between Screens" on page 54](#)

FM Coupling

This field selects ac or dc coupling between the RF Generator’s frequency modulator and the rear-panel MODULATION INPUT connector. This field also alters the FM modulator to allow DCFM from internal and external modulation sources.

FM Deviation

This is the default measurement for this field. The type of measurement listed here is dependent on the **AF An1 In** settings.

See Also

[AF An1 In field description, on page 342](#)

["Displaying Measurements" on page 57](#)

IF Filter

This field selects the desired IF filter bandwidth for modulated signals being analyzed.

Input Port

This field selects the RF IN/OUT or ANT IN connector for making RF measurements. The RF IN/OUT port must be used for making **TX Power** measurements on this screen.

Operating Considerations

Maximum signal levels at each port are printed on the front panel.

If the RF power at the RF IN/OUT port exceeds allowable limits, a loud warning signal sounds and a message appears at the top of the screen. If this occurs, disconnect the RF power, press the MEAS RESET key, and allow the Test Set to cool off for approximately 2 minutes before making any other measurements on this port.

The ANT IN (antenna input) connector provides a highly-sensitive input for very low-level signals (such as “off-the-air” measurements). You cannot measure TX (RF) Power on this screen using the ANT IN port. However, low-level RF power at the ANT IN port can be measured using the Spectrum Analyzer.

CAUTION:

Connecting a signal of >200 mW to the ANT IN port can cause instrument damage (although internal protection circuits can typically withstand a short-duration signal of 1 or 2 Watts).

If the overpower circuit is triggered (signified by a warning message at the top of the screen), remove the signal from the ANT IN port, and press the MEAS RESET key or turn the Test Set off and on to reset it.

Output Port

This field selects the RF Generator's output port.

Operating Considerations

Maximum signal levels at each port are printed on the front panel.

CAUTION: Applying reverse RF power to the DUPLEX OUT connector can damage the instrument. (A message is displayed when an overpower conditions occurs.) Whenever possible, use the RF IN/OUT connector when testing transceivers to prevent damage from accidental transmitter keying.

If a reverse-power condition triggers the internal protection circuit, remove the reverse-power signal and press the MEAS RESET key or turn the Test Set off and on to reset it.

RF Gen Freq

This field sets the RF Generator's frequency.

Tune Freq

RF analyzer tune frequency sets the center frequency for the RF signal to be analyzed.

Operating Considerations

If the **Tune Mode** field is set to **Auto**, the frequency is set by the instrument.

If the **Tune Mode** is set to **Manual**, the operator must enter the desired frequency.

See Also

[Tune Mode field description, on page 351](#)

Tune Mode

This field selects automatic or manual tuning of the RF Analyzer.

Auto tuning causes the RF Analyzer to find the signal with the greatest amplitude above -36 dBm, and set the tune frequency for that signal.

Manual tuning requires the operator to set the tune frequency for the RF signal to be analyzed.

Operating Considerations

Changing the **Tune Mode** also changes the RF frequency display. Automatic tuning enables the **TX Frequency** measurement. Manual tuning enables the **TX Freq Error** measurement.

After autotuning to the desired signal, select **Manual** tuning to prevent the **Tune Freq** from changing when the signal is no longer applied.

TX Freq Error/TX Frequency

This measurement displays transmitter frequency error or absolute Transmitter Frequency, depending on the **Tune Mode** setting.

See Also

[Tune Mode field description \(this page\)](#)

TX Power

Transmitter power measures RF power at the RF IN/OUT port.

Operating Considerations

Maximum signal levels at each port are printed on the front panel.

Only the RF IN/OUT port can be used for measuring TX Power on this screen. When the **Input Port** is set to **Ant**, four dashes (- - -) appear in place of digits for this measurement.

Use the Spectrum Analyzer¹ to measure low-level RF power (≤ 200 mW) at the ANT IN port.

CAUTION: Connecting a signal of >200 mW to the ANT IN port can cause instrument damage (although internal protection circuits can typically withstand a short-duration signal of 1 or 2 Watts).

If the overpower circuit is triggered (signified by a warning message at the top of the screen), remove the signal from the ANT IN port, and press the MEAS RESET key or turn the Test Set off and on to reset it.

See Also

[Input Port field description, on page 349](#) (Operating Considerations)

[TX Power field description, on page 480](#)

[TX Pwr Zero field description, on page 480.](#)

1. Spectrum Analyzer is optional on some Test Set models.

Signaling Encoder (AF Generator 2)

Field Descriptions for Encoder Modes

The Encoder (AF Generator 2) uses several screens to generate various signaling formats. These screens are accessed by selecting **ENCODER** from the **To Screen** menu, and then selecting the **Mode** field.

The screen and field descriptions for each Encoder screen are listed in the following order:

- AMPS/NAMPS-TACS/NTACS
- CDCSS (Continuous Digital Controlled Squelch System)
- Digital Paging
- DTMF (Dual-Tone-Multi-Frequency Signaling Encoder)
- EDACS (Enhanced Digital Access Communication System)
- Function Generator
- LTR (Logic Trunked Radio: Registered trademark of EF Johnson Company)
- MPT 1327 Trunked Radio
- NMT (Nordic Mobile Telephone)
- Tone Sequence

When the Test Set is turned on, AFGen1 defaults to 3 kHz FM at a 1 kHz rate. This can interfere with many Encoder signaling formats also being used as an FM source. Therefore, we recommend you turn AFGen1 off on the RX TEST, DUPLEX TEST, or RF GENERATOR screen before using the encoder.

AMPS-TACS NAMPS-NTACS Encoder

- AMPS = Advanced Mobile Phone Service.
- NAMPS = Narrowband Advanced Mobile Phone Service.
- TACS = Total Access Communications Systems.
- JTACS = Total Access Communications System for Japan.
- NTACS = Narrowband Total Access Communications Systems (NTACS is an extension of JTACS).

The AMPS/TACS and NAMPS/NTACS Encoder modes use the same Forward Control Channel (FOCC) settings and output format. However, the Forward Voice Channel (FVC) information is different.

Control and Voice Channel Identifiers

The Control and Voice channel fields are available in separate menus. The **Channel** field is used to select the **Cnt1** (FOCC) or **Voice** (FVC) menu.

Fields available only in the Forward Control Channel menu have **(FOCC)** printed in the field title.

Fields available only in the Forward Voice Channel menu have **(FVC)** printed in the field title.

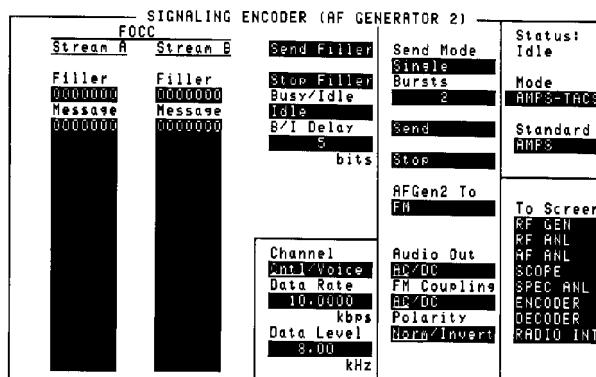

Figure 85

AMPS-TACS/NAMPS-NTACS Mode Forward Control Channel (FOCC)

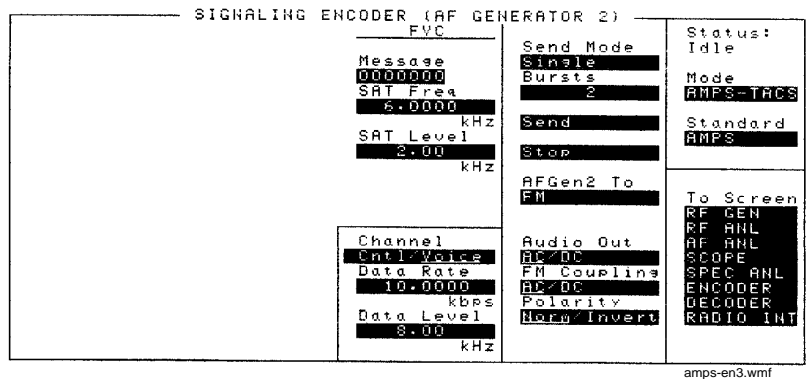

Figure 86 AMPS-TACS Mode Forward Voice Channel (FVC)

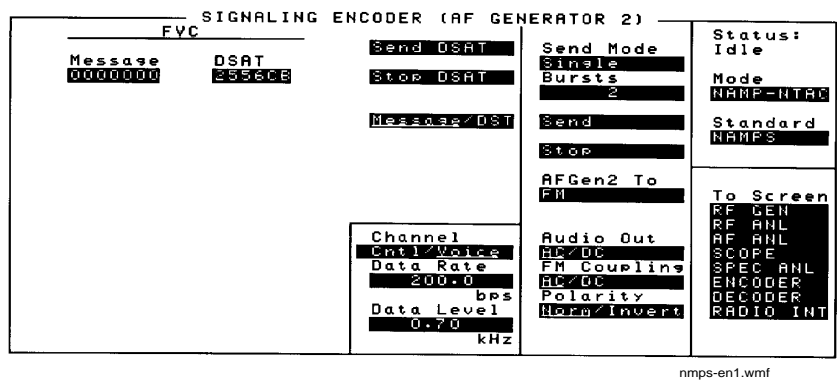

Figure 87 NAMPS-NTACS Mode Forward Voice Channel (FVC)

AFGen2 To

This field determines whether the data stream modulates the RF Generator, or is output through the AUDIO OUT connector.

Audio Out

Audio output coupling selects ac or dc coupling of the AF Generator to the AUDIO OUT connector when **AFGen2 To** is set to **Audio Out**.

Busy/Idle (FOCC)

This field selects the busy/idle status information to be included in the signaling sequence.

- **Idle** sets the busy/idle bits of the forward control channel information to indicate an idle state.
- **Busy** sets the busy/idle bits of the forward control channel information to indicate a busy state.
- **WS Delay**, word sync delay, prevents a busy/idle change until the word sync information has been received and a defined number of delay bits has been counted. The delay bit value is set in the **B/I Delay** field.
- **1stBitDly**, first bit delay causes the busy/idle bit to be set after a bit has been received and a defined number of delay bits has been counted. The delay bit value is set in the **B/I Delay** field.

B/I Delay (FOCC)

Busy/idle delay determines the number of bits that are counted before a busy/idle bit changes from the Idle state to the busy state. This function is used with the **WS Delay** and **1stBitDly** settings in the **Busy/Idle** field.

Bursts

This field defines the number of times the message data is output when **Send** is selected. This function only works when the **Send Mode** field is set to **Burst**.

Channel

This field selects the forward control channel (FOCC) or forward voice control (FVC) menus.

Data Level

This setting determines the signal level change that occurs when a logical high (1) or low (0) is output. The unit-of-measure used depends on the **AFGen2 To** setting. The direction of the output level change depends on the **Polarity** setting.

Data Rate

This setting determines the rate that the FOCC and FVC information are output.

Operating Considerations

This field specifies the data rate for the signal being decoded, and must be set before using the AMPS-TACS/NAMPS-NTACS Decoder.

DSAT (FVC)

This field is available only in NAMP-NTAC mode.

This field is used to specify the 24-bit digital supervisory audio tone (DSAT) sequence. The seven standard sequences are: 2556CB, 255B2B, 256A9B, 25AD4D, 26AB2B, 26B2AD, and 2969AB. (These codes are the inverse of the seven DST codes.)

DSAT is output continuously when **send DSAT** is selected, and is only stopped when **stop DSAT** is selected. If message or DST information is sent using **send**, the DSAT signal is temporarily interrupted until that information has been sent. (The **status:** field in the upper-right corner of the screen indicates what type of data is being sent.)

Filler (FOCC)

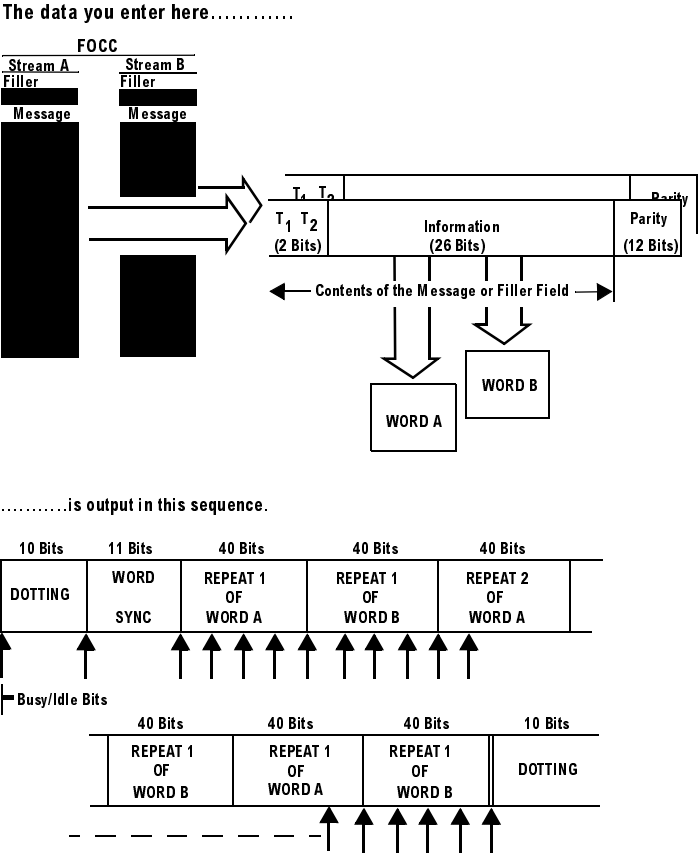

Figure 88 AMPS-TACS/NAMPS-NTACS FOCC Message and Filler Data Format

Each **Filler** field contains 7 hexadecimal characters representing the 2 type bits and 26 information bits of the control filler/message word. The dotting, word sync, and parity bits are generated automatically.

Operating Considerations

The control filler is sent continuously when **Send Filler** is selected, or after a control message has been sent using **Send**. The control message is stopped whenever **Stop Filler**, **Filler**, **Channel**, **Data Rate**, **Polarity**, or **AFGen2 To** is selected.

Both filler fields must be full (seven digits) for the forward control channel information to be structured correctly. Do not leave any blank spaces.

FM Coupling

This field alters the FM modulator to allow DCFM from internal and external modulation sources. This field also selects ac or dc coupling between the RF Generator's frequency modulator and the rear-panel MODULATION INPUT connector.

Message (FOCC)

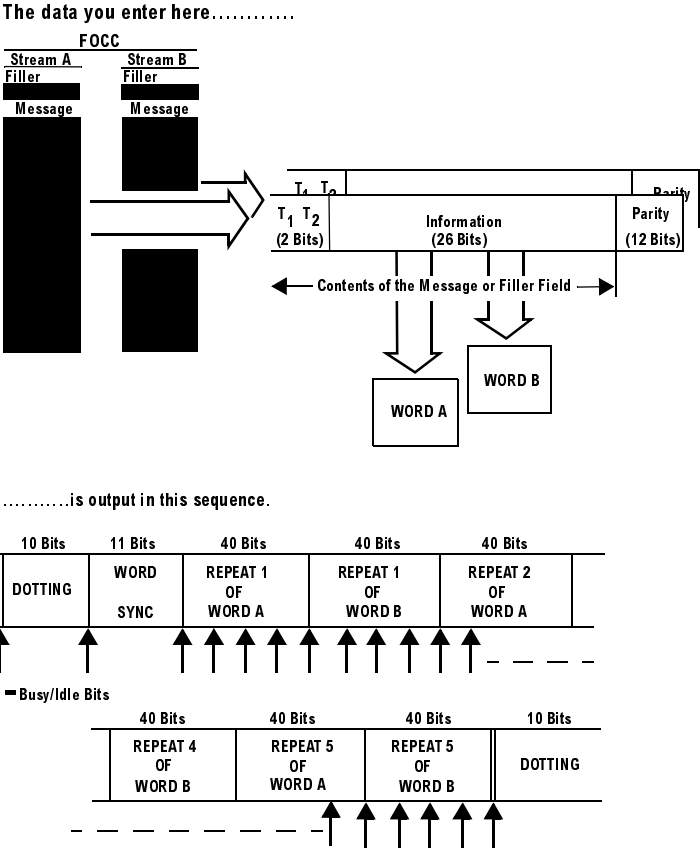

Figure 89 AMPS-TACS/NAMPS-NTACS FOCC Message and Filler Data Format

Message streams A and B specify various forward control channel parameters.

Operating Considerations

Like the filler information, the message information can only be input in full (seven digit) lines. Also, message streams A and B must have the same number of lines in them.

Message (FVC)

The data you enter here.....

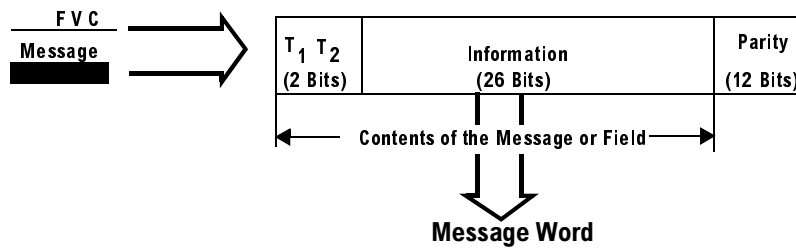

.....is output in this sequence

101 Bits	11 Bits	40 Bits	37 Bits	11 Bits	40 Bits
DOTTING	W.S.	REPEAT 1 OF WORD	DOTTING	W.S.	REPEAT 2 OF WORD

W.S.=Word Sync

37 Bits	11 Bits	40 Bits	37 Bits	11 Bits	40 Bits	37 Bits	11 Bits	40 Bits
DOTTING	W.S.	REPEAT 9 OF WORD	DOTTING	W.S.	REPEAT 10 OF WORD	DOTTING	W.S.	REPEAT 11 OF WORD

Figure 90 AMPS-TACS FVC Message Data Output Format

This description applies to the AMPS-TACS mode.

The 7 hexadecimal characters of the FVC **message** field represent the 2 type bits and 26 information bits in the FVC message word.

The generation of dotting, word sync, parity, and the 11 repetitions of these parameters in the FVC message stream is done automatically.

Operating Considerations

The entire field must contain data, no blank spaces are allowed. SAT is turned off while the FVC message stream is being sent.

Message (FVC)

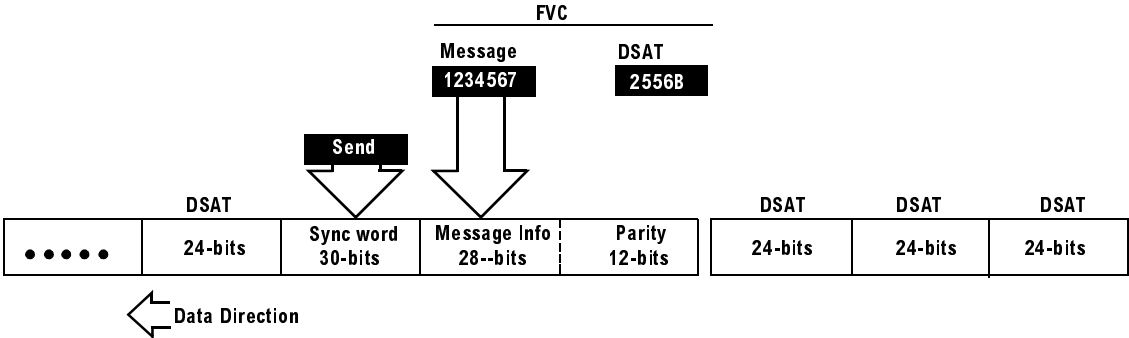

Figure 91 NAMPS-NTACS FVC Message Data output Format

This description applies to the NAMP-NTAC mode.

The 7 hexadecimal characters (28 bits) of this FVC message are combined with 12 parity bits calculated by the encoder to output a 40-character data stream. This information is output when the **Message/DST** field is set to **Message**, and **Send** is selected.

Operating Considerations

The entire field must contain data, no blank spaces are allowed. DSAT is turned off while the FVC Message Stream is being sent.

Message/DST (FVC)

This field is available only in NAMP-NTAC mode.

This field determines what type of data is sent when **send** is selected:

1. Selecting **Message** causes the contents of the **Message** field to be output.
2. Selecting **DST** causes the digital signaling tone sequence to be output. The sequence sent is the inverse of the sequence entered in the **DSAT** field, and is automatically determined by the Encoder.

The DST values are: DAA934, DAA4D4, DA9564, DA52B2, D954D4, D94D52, and D69654.

Polarity

This setting determines the relationship between the signaling logic levels and the effect on the modulated signal.

Normal Operation. When this field is set to **Norm**, a logical high (1) causes the output level of the AF Generator to be more *positive*. The peak level is listed in the **Data Level** field. A logical low (0) causes the level to become negative by the same amount.

Inverted Operation. When this field is set to **Invert**, a logical high (1) causes the output level of the AF Generator to be more *negative*. The peak level is listed in the **Data Level** field. A logical low (0) causes the level to become positive by the same amount.

SAT Freq (FVC)

This field is available only in AMPS-TACS mode.

This field sets the supervisory audio tone's frequency. This signal is sent continuously whenever the FVC is selected, except while the Message is being sent.

SAT Level (FVC: AMPS-TACS)

This field sets the supervisory audio tone's level. The unit-of-measure depends on the **AFGen2 To** setting.

Operating Considerations

SAT is turned off while the FVC message stream is being sent.

Send

Selecting this field causes the FVC or FOCC message to be output.

Operating Considerations

When sending an FOCC message stream, the contents of the **Filler** are continuously output after the message data has been sent. **Stop Filler** is used to stop the output.

Send Filler (FOCC)

Selecting this field causes the contents of the **Filler** fields for Stream A and Stream B to be output. The fillers continue to be output until **Stop Filler** is selected.

Send DSAT (FVC)

This field is available only in NAMPS-NTACS mode.

Selecting this field causes the contents (24 bits) of the **DSAT** field to be continuously output until **stop DSAT** is selected. If a message or DST is sent by selecting **send**, the DSAT data is output continuously *after* the message is output.

Send Mode

This field selects the mode used when **send** is selected to output the message.

- **single** outputs the entire message once.
- **Burst** outputs the Message the number of times specified in the **Bursts** field.
- **Cont** causes the message to be output continuously until **stop** is selected.
- **step** is not used in the AMPS-TACS mode.

Standard

This field selects the signaling standard used for your radio. The standard values used for each signaling format are automatically filled-in when the standard is selected.

Stop

Selecting this field stops the message being output.

Stop DSAT (FVC)

This field is available only in NAMPS-NTACS mode.

Selecting this field stops the digital supervisory audio tone being output.

Stop Filler (FOCC)

Selecting this field stops the **Filler** information from being output after **Send Filler** or **Send** is used.

Using the AMPS-TACS, NAMPS-NTACS Encoder

Using This Information

This screen is used to create various types of cellular telephone data streams. Selecting the **standards** field displays a list of the supported signaling formats.

The theory and applications of cellular telephone systems are beyond the scope of this manual. The field descriptions describe their basic functions, and are not intended to be used as tutorial information.

If additional information is needed, refer to the many technical manuals available on the subject of cellular telephones.

Automated Test Software

Hewlett-Packard offers software packages to test your cellular phone in a fraction of the time normally required for manual testing. You can choose any combination of tests, from full parametric testing, to a single test. The software is shipped on a memory card that inserts directly into your Test Set, and it comes with complete documentation and a blank SRAM memory card for storing your test procedures and test data.

Encoder/Decoder Interaction

The AMPS-TACS/NAMPS-NTACS Encoder acts like a base station transmitter, creating *Forward* Control and Voice channel information (FOCC/FVC). The AMPS-NAMPS-TACS/NTACS Decoder acts like a base station receiver, analyzing *Reverse* Control and Voice channel signals (RECC/RVC).

The decoder uses the encoder's **Data Rate** setting to specify how fast the incoming message is being sent. Therefore, when using the decoder, you must first specify the data rate in the encoder.

CDCSS Encoder

The Continuous Digital Controlled Squelch System (CDCSS) Encoder generates signals to test radios that use a digitally-encoded signal to turn squelch on and off. The encoder can be used to modulate the RF Generator, or it can be output through the front-panel AUDIO OUT connector.

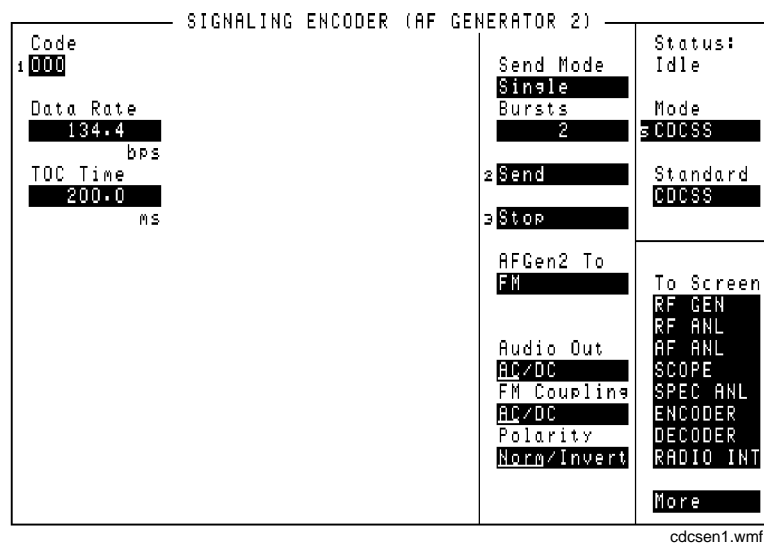

Figure 92 **The CDCSS Encoder Mode Screen**

AFGen2 To

This audio frequency generator control contains two fields:

- The upper field determines whether the CDCSS Encoder modulates the RF Generator, or is output through AUDIO OUT.
- The lower field sets the amplitude (including **Off**).

Audio Out

Audio out coupling selects ac or dc coupling of the encoder to the AUDIO OUT connector when the upper **AFGen2 To** field is set to **Audio Out**.

Operating Considerations

The CDCSS encoder creates data streams using squarewaves. For optimum waveform quality, set this field to **DC** when using the AUDIO OUT connector. This is especially beneficial at low data rates.

Bursts

This field defines the number of data streams output each time **Send** is selected. This function works only when the **Send Mode** field is set to **Burst**.

Code

This field defines the 3-digit octal code used to identify the radio being accessed.

Data Rate

This field specifies how fast the data stream is output in bits-per-second.

This setting is also used to determine the Turn Off Code frequency (TOC frequency Hz = Data Rate in bps). Example: 1000 bps = 1 kHz

Operating Considerations

This field is also used by the CDCSS Signaling Decoder screen to approximate the data rate for the signal being decoded.

FM Coupling

This field alters the FM modulator to allow DCFM from internal and external modulation sources. This field also selects ac or dc coupling between the RF Generator's frequency modulator and the rear-panel MODULATION INPUT connector.

Operating Considerations

This field should be set to **DC** whenever the **AFGen2 To** field is set to **FM**; this provides better modulation response at low data rates.

Polarity

This setting determines the relationship between the data stream's logic levels and the effect on the modulated signal.

This function is helpful to restore the proper data polarity when the transmitter, repeater, or receiver used in your communications system has an odd number of inversions; causing the received data to be inverted when decoded. (This is common when a signal is translated to a lower frequency using an LO whose frequency is higher than the signal's frequency; or when inverting amplifiers are used.)

Normal Operation. When this field is set to **Norm**, a logical high (1) causes the output level of the AF Generator to be more *positive*. A logical low (0) causes the level to become negative by the same amount.

Inverted Operation. When this field is set to **Invert**, a logical high (1) causes the output level of the AF Generator to be more *negative*. A logical low (0) causes the level to become positive by the same amount.

Send

Selecting this field causes the data stream to be output.

Send Mode

This field selects the output format used when **send** is selected to output a sequence.

- **Single** outputs the entire sequence once.
- **Burst** outputs the sequence the number of times specified in the **Bursts** field.
- **Cont** causes the sequence to be output continuously until **Stop** is selected.

Standard

This field selects the digitally-coded squelch standard for your radio.

Stop

Selecting this field stops the data stream being output when the **Send Mode** is set to **Cont** or **Burst**. After this field is selected, the current repetition of the data stream is finished, and the turn-off code is output.

TOC Time

Turn-off code time defines the length of time the turn-off code is output.

Operating Considerations

This code is *always* the last information output before the encoder's **Status** indicator changes from **sending** to **Idle** whether several bursts or only one data stream is sent. If no TOC is desired, set this field to **0.0000**.

Using the CDCSS Encoder

The CDCSS Data Stream

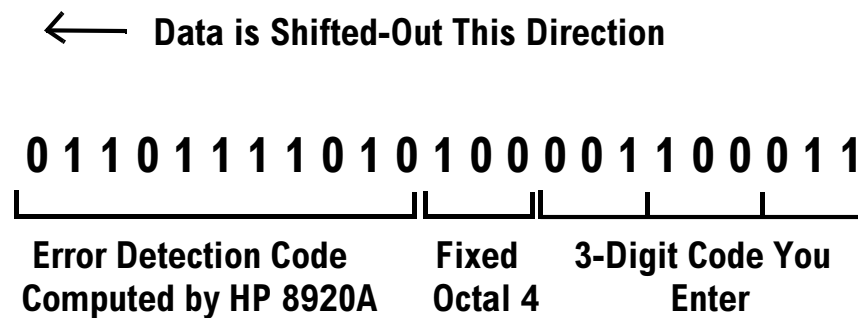

Figure 93 CDCSS Data Stream Bit Assignments

The CDCSS encoder creates a 23-bit digital data stream and Turn Off Code (TOC). The data stream consists of three parts:

- A 3-digit (9 bit) octal code you supply that corresponds to your radios digital squelch code number.
- A fixed octal 4 (coded 100).
- A mathematically-derived 11-bit error detection code.

The data stream is output serially, beginning with the error detection code.

The Turn-Off Code

The turn-off code is a tone burst that is output after the data stream has been output the desired number of times, or after a series of bursts has been interrupted using the **stop** field.

Digital Paging Encoder

The Digital Paging Encoder outputs signals to test pagers using a variety of digital access formats and frequencies. The signal can be used to modulate the RF Generator, or it can be output through the front-panel AUDIO OUT connector. FM is typically selected by using the RX TEST screen to set up the RF Generator to generate the encoded carrier.

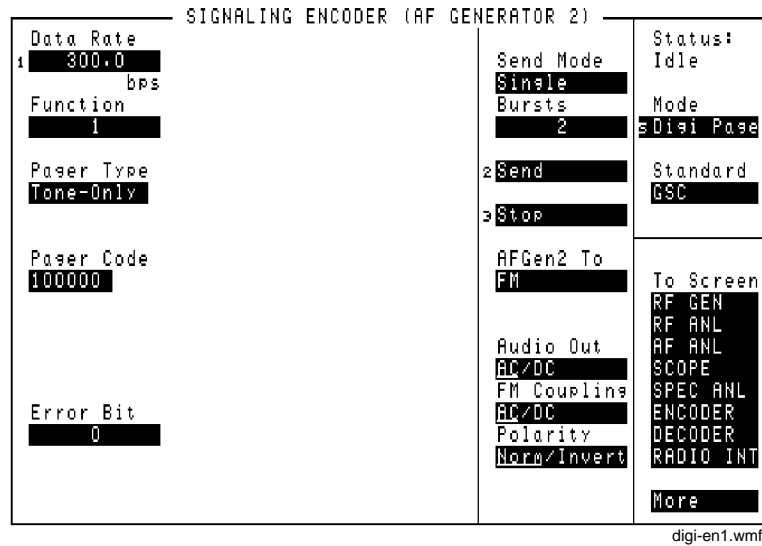

Figure 94 **The Digital Paging Encoder Mode Screen**

AFGen2 To

This field, audio frequency generator 2 to, contains two fields:

- The upper field determines whether the Digital Paging Encoder's signal modulates the RF Generator, or is output through the AUDIO OUT connector.
- The lower field sets the amplitude (including **Off**).

Audio Out

Audio output coupling selects ac or dc coupling of the encoder to the AUDIO OUT connector when the upper **AFGen2 To** field is set to **Audio Out**.

Operating Considerations

This field should be set to **DC** for best results when using the AUDIO OUT connector and low data rates.

Bursts

This field defines the number of digital data streams output each time **Send** is selected. This function works only when the **Send Mode** field is set to **Burst**.

Data Rate

This field specifies how fast the data stream is output in bits-per-second. Common data rates; POCSAG 512, 1200: GSC (GOLAY) 300, 600.

Error Bit

This field enables you to cause an error for a specific bit in the encoded message stream.

FM Coupling

This field alters the FM modulator to allow DCFM from internal and external modulation sources. This field also selects ac or dc coupling between the RF Generator's frequency modulator and the rear-panel MODULATION INPUT connector.

Operating Considerations

This field should be set to **DC** whenever the **AFGen2 To** field is set to **FM**; this provides better modulation response at low data rates.

Function

This setting specifies which of the four types of messages to send. The pager's response is determined by the **Pager Type** field setting and the pager's configuration.

For example, when testing a POCSAG pager set for tone-only operation, functions 00 through 11 typically correspond to the pager beeping one to four times. If the pager is set for Alpha-Numeric operation, the functions correspond to a combination of the number of beeps and the type of message displayed by the pager.

Mssg Length

The **Message Length** field specifies the number of characters output from the **Pager Numeric/Alpha-Numeric** field.

This field is only displayed when the **Pager Type** is set to **Numeric** or **Alpha-Num**.

Pager Alpha-Numeric Message

This field specifies the message you are sending to an alpha-numeric format pager.

This field is only displayed when the **Pager Type** is set to **Numeric** or **Alpha-Num**.

Pager Code

This field is used to identify the individual code number (address) of the pager you are testing.

Pager Numeric Message

This field specifies the message you are sending to a numeric format pager.

This field is only displayed when the **Pager Type** is set to **Numeric** or **Alpha-Num**.

Pager Type

This field specifies the way your pager responds to a received signal: **Tone-Only** (beeps), **Numeric** (displays numbers), or **Alpha-Numeric** (displays numbers and other characters).

Polarity

This setting determines the relationship between the data stream's logic levels and the effect on the modulated signal.

Normal Operation. When this field is set to **Norm**, a logical high (1) causes the output level of the AF Generator to be more *positive* (causing a positive frequency deviation when FM is used). A logical low (0) causes the level to become negative by the same amount (resulting in negative FM deviation).

Inverted Operation. When this field is set to **Invert**, a logical high (1) causes the output level of the AF Generator to be more *negative* (causing a negative FM deviation). A logical low (0) causes the level to become positive by the same amount (resulting in positive FM deviation).

Send

Selecting this field causes the entire data stream to be output (including the preamble, address, and message).

Send Mode

This field selects the output format used when **send** is selected to output a sequence.

- **single** outputs the entire sequence once.
- **Burst** outputs the sequence the number of times specified in the **Bursts** field.
- **Cont** causes the sequence to be output continuously until **stop** is selected.

Standard

This field selects the digital paging standard for the pager being tested, POCSAG or GSC (Golay Sequential Code).

Stop

Selecting this field stops the data stream being output.

DTMF Sequence Encoder

The DTMF Sequence Generator creates Dual-Tone Multi-Frequency tone sequences of variable frequency, amplitude, and duration. It's signal can be used to modulate the RF Generator, or it can be output through the front-panel AUDIO OUT connector.

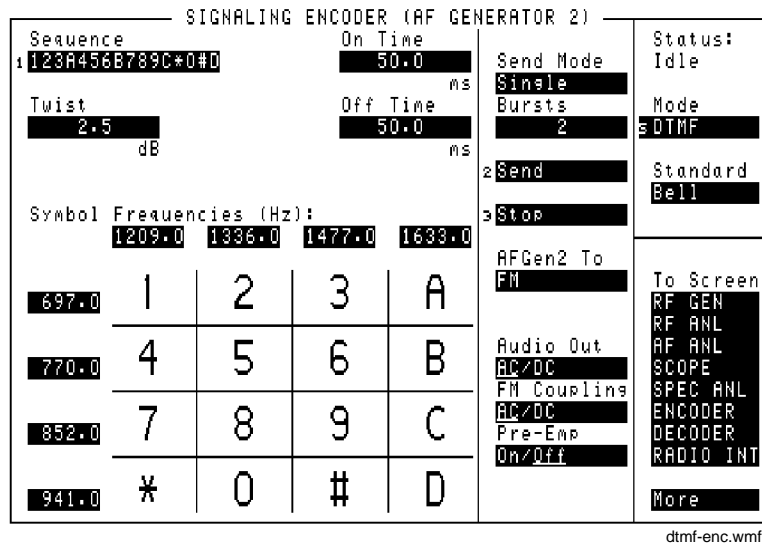

Figure 95 The DTMF Sequence Encoder Mode Screen

AFGen2 To

This audio frequency generator control contains two fields:

- The upper field determines whether the DTMF sequence modulates the RF Generator, or is output through the front-panel AUDIO OUT connector.
- The lower field sets the amplitude (including **Off**).

The output level is the peak value for each tone pair, regardless of the **Twist** and **Pre-Emp** settings.

See Also

[Twist field description, on page 381](#)

Audio Out

Audio output coupling selects ac or dc coupling of the DTMF Sequence Generator to the AUDIO OUT connector when the upper **AFGen2 To** field is set to **Audio Out**.

Bursts

This field defines the number of sequences output each time **Send** is selected. This function only works when the **Send Mode** field is set to **Burst**.

FM Coupling

This field alters the FM modulator to allow DCFM from internal and external modulation sources. This field also selects ac or dc coupling between the RF Generator's frequency modulator and the rear-panel MODULATION INPUT connector.

On Time

This field sets the length of time each DTMF tone is on during the sequence.

Off Time

This field sets the length of time each DTMF tones is off during the sequence.

Pre-Emp

This field determines whether the encoder's signal passes through or bypasses the 750 ms pre-emphasis network. Pre-emphasis may be required when testing some FM receivers.

See Also

[Twist field description, on page 381](#)

Send

Selecting this field causes the DTMF sequence to be output.

Send Mode

This field selects the format used when **Send** is selected to output a sequence.

- **Single** outputs the entire sequence once.
- **Burst** outputs the sequence the number of times specified in the **Bursts** field.
- **Cont** causes the sequence to be output continuously until **Stop** is selected.
- **Step** allows you to output the tones in a sequence one at a time by pressing **Send** for each tone.

Standard

This field selects the DTMF standard used for your radio.

Stop

Selecting this field stops the sequence being output.

Symbol Frequencies (Hz)

The eight column/row frequencies are automatically entered by the **standard** field setting. You can change the frequency values using the DATA keys.

Twist

Twist is the ratio of amplitudes (in dB) between the high frequency and low frequency tone in each DTMF pair. A positive value indicates a higher amplitude for the high frequency tones. A negative value indicates a higher amplitude for the low frequency tones.

The amplitude of the combined tones is set in the **AFGen2 To** field.

Twist and Pre-emphasis Interaction

Twist and Pre-emphasis affect the relative levels of the high and low tones within each symbol (tone pair). If pre-emphasis is off, twist sets the difference in deviation (in dB) between the high and low tones. If twist is off, pre-emphasis places a 6 dB per octave difference in deviation between the high and low tones. If both twist and pre-emphasis are on, the two effects are summed.

For most conditions, set **Twist** to 2.5 dB, **Pre-Emp** on, and 60% rated deviation (3 kHz for a typical 5 kHz deviation rated receiver).

Examples of Twist and Pre-emphasis Interaction

Example 1: 3 kHz deviation, Twist 0 dB, Pre-emphasis off.

The level of each low tone and high tone individually generate 1.5 kHz deviation. The tones are summed to produce 3 kHz deviation.

Example 2: 3 kHz deviation, Twist 2.5 dB, Pre-emphasis off.

The high tone has 2.5 dB (a factor of 1.334) more deviation than the low tone. The two tones are summed to produce 3 kHz peak deviation. Therefore, the low tone's deviation is 1286 Hz and the high tone's deviation is 1714 Hz.

Example 3: 3 kHz deviation, Twist 0 dB, Pre-emphasis on.

There is a 6 dB per octave difference between the high and low tones. For example, if sending a 1, which has a low tone of 697 Hz and a high tone of 1209 Hz, the high tone has a deviation of $1209/697 = 1.735$ times the low tone's deviation. The high tone's deviation is then $20 \times \log(1209/697) = 4.78$ dB higher than the low tone. Since their sum must equal 3 kHz, the low tone's deviation is 1097 Hz, and the high tone's deviation is 1903 Hz.

Example 4: 3 kHz deviation, Twist 2.5 dB, Pre-emphasis on.

If sending a 1 (697 Hz low tone and 1209 Hz high tone), the high tone's deviation is 1.334 (see example 2) \times 1.735 (see example 3) approximately 2.314 times the low tone's deviation. Since the peak deviation of their sum is 3 kHz, the low tone's deviation is 905.5 Hz and the high tone's deviation is 2094.5 Hz.

EDACS Encoder

This encoder simulates an Ericsson/GE EDACS® (Enhanced Digital Access Communications System) repeater site to test trunked mobile radios using that format.

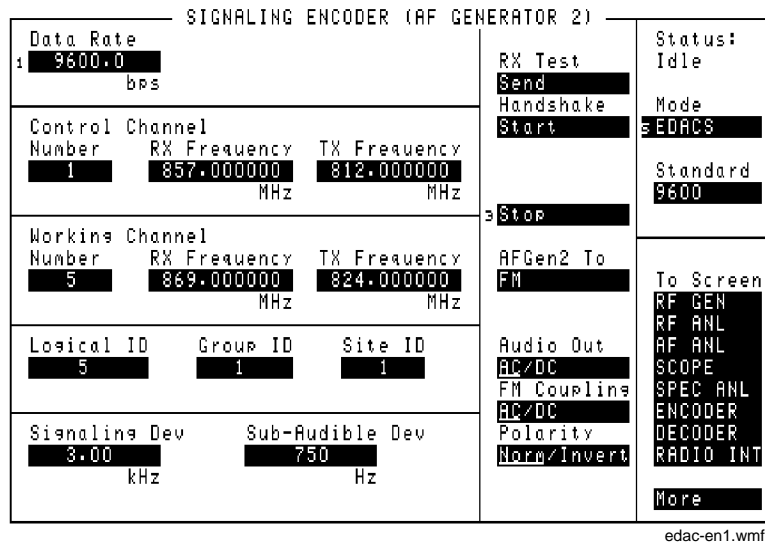

Figure 96 The EDACS Trunked Radio Encoder Mode Screen

AFGen2 To

This audio frequency generator control is used to specify where the encoder's data is sent:

- **FM** is used to frequency modulate the RF Generator. This is the normally-used setting. (Refer to the **FM Coupling** field description.)
- **AM** is used to amplitude modulate the RF Generator (not generally used for EDACS signaling).
- **Audio Out** routes the data to the front-panel AUDIO OUT connector. The signal could then be used as an external modulation source. (Refer to the **Audio Out** field description.)

Operating Considerations

The encoder's digital signal level is adjusted using the **Signaling Dev** and **Sub-Audible Dev** fields. Changing the **AFGen2 To** setting automatically alters the unit-of-measure for both of these fields (kHz, %, or mV).

Audio Out

The audio output coupling field selects ac or dc coupling of the encoder to the AUDIO OUT connector. Because the EDACS Encoder sends low-speed data, this field should be set to **DC** when the AUDIO OUT port is used. The **AFGen2 To** field must be set to **Audio Out** to use this function.

Control Channel, Number

This field is used to specify the Control Channel number for the EDACS system (typically 1 to 25).

Control Channel, RX Frequency

This field is used to specify the Control Channel receive frequency for the mobile.

Control Channel, TX Frequency

This field is used to specify the Control Channel transmit frequency for the mobile.

Data Rate

This field sets the data rate (in bits-per-second) for the high-speed signaling. The value can be changed using the keypad, or by selecting a value from the **standard** field. However, the 9600 bps rate is the EDACS default, and should not be changed under most circumstances. (4800 is used for narrowband 900 MHz systems in the U.S.)

FM Coupling

This field is used to select ac or dc coupling of the encoder to the RF Generator when the **AFGen2 To** field is set to **FM**. Because the EDACS Encoder sends low-speed data, this field should be set to **DC**.

Group ID

This field is used to specify the group identification number for the trunked radio group your radio is set up to access.

Handshake

This field is used to get the mobile up on a working channel after it has accessed the control channel.

When **send** is selected, the control channel message is output at the receive frequency specified in the **Control Channel** settings. The **status:** field changes from **Idle** to **Control**, and the RF Analyzer is tuned to the control channel's transmit frequency.

Operating Considerations

The control channel message must be transmitting before a handshake can be initiated. The **status:** field indicates **Control** when the control channel is transmitting, and changes to **Working** when the working channel is being sent.

Logical ID

This field is used to specify the identification number of the calling radio. It should be set to the Logical ID of the radio being tested when performing transmitter tests. Generally, when performing receiver tests, it must be set to a Logical ID different from that of the radio being tested.

Polarity

This setting determines how the encoder's digital data modulates the RF Generator. This field is usually set to **Norm**. **Invert** is used for narrowband systems. This field is automatically set to the correct polarity by the **standard** field.

When this field is set to **Invert**, a logical high (1) causes the output level of the encoder to be *negative*. A logical low (0) causes the level to become positive. When using FM, the RF Generator would then produce a negative frequency deviation for a positive-going digital transition - the opposite of the normal mode of operation.

This field is automatically set to the correct polarity by the **standard** field.

RX Test

When **start** is selected, the encoder sends a digital message over the control channel to tell the mobile to go to the specified working channel (called a channel assignment). Immediately after the message is sent, the RF Generator's and RF Analyzer's frequencies are automatically changed to match the same working channel settings.

See Also

[Handshake field description, on page 384](#)

Signaling Dev

This field is used to specify the high-speed data level. The unit-of-measure used depends on the **AFGen2 To** setting.

- When **AFGen2 To** is set to **FM**, the displayed units are **kHz** or **Hz**. This is the normally-used setting for testing EDACS radios.
- When **AFGen2 To** is set to **AM**, the displayed unit is **%**.
- When **AFGen2 To** is set to **Audio Out**, the displayed units are μV , **mV**, or **V**.

See Also

[AFGen2 To field description, on page 383](#)

Site ID

This field is used to specify the identification number of the repeater site being simulated by the encoder.

Standard

This field specifies the signaling standard used by the radio: 4800 bps (narrowband) or 9600 bps (wideband). In addition to telling the encoder and decoder which system is being used, this field presets the values of certain fields as shown in the following table.

Field	Standard	
	9600	4800
Data Rate	9600.0	4800.0
Signaling Dev	3.00	1.80
Sub-Audible Dev	750	350
(Encoder) Polarity	Norm	Invert

Status

This field indicates what the encoder is doing.

Idle is displayed when no data is being sent.

Control is displayed when control channel data is being output.

Working is displayed when a handshake has been performed and working channel data is being sent.

Sub-Audible Dev

This field is used to specify the low-speed data level. The unit-of-measure used depends on the **AFGen2 To** setting.

- When **AFGen2 To** is set to **FM**, the displayed units are **kHz** or **Hz**. This is the normally-used setting for testing EDACS radios.
- When **AFGen2 To** is set to **AM**, the displayed unit is **%**.
- When **AFGen2 To** is set to **Audio Out**, the displayed units are **μV**, **mV**, or **V**.

See Also

[AFGen2 To field description, on page 383](#)

Stop

This field is used to stop the control channel or working channel data from being output. The carrier continues to be output, but without the digital modulation.

Working Channel, Number

This field is used to specify the working channel number for the EDACS system (typically 1 to 25).

Working Channel: RX Frequency

This field is used to specify the working's channel receive frequency for the mobile.

Working Channel: TX Frequency

This field is used to specify the working channel's transmit frequency for the mobile.

Using the EDACS Encoder

Automated Test Software

Hewlett-Packard offers software packages to fully test your EDACS radio in a fraction of the time normally required for complete manual testing. Under software control, you can perform receiver and transmitter tests on several channels in succession very quickly.

You can choose any combination of tests, from full transmitter and receiver testing, to a single test. The software is shipped on a memory card that inserts directly into your Test Set, and it comes with complete documentation and a blank SRAM memory card for storing your test procedures and test data.

Testing EDACS Mobiles

When the mobile is turned on, it automatically tunes to its pre-programmed control channel frequency. The Test Set generates the control channel's carrier and site identification data using the RF Generator's and the EDACS Encoder's settings. (The RF carrier level for the control channel and working channel is adjusted using the **Amplitude** field on the DUPLEX TEST screen.) Once the mobile is receiving the Control Channel, the encoder can send a digital message to the mobile to go to a designated Working Channel for making receiver tests (this is called a handshake).

Testing the Mobile's Receiver

If the working channel's RF carrier's level is high enough, the mobile's receiver unscelches to allow the modulating signal (speech or a test tone) to be heard from your mobile's speaker.

If the audio output (speaker) connection of your mobile is connected to the AUDIO IN connectors of the Test Set, you can then make receiver audio-quality measurements such as distortion at 1 kHz, and SINAD.

Testing the Mobile's Transmitter

The EDACS Encoder's information is used to help the EDACS Decoder receive and decode transmitted data from the mobile. After entering all of the information in the EDACS Encoder screen, the EDACS Decoder screen is accessed to get the mobile transmitting and to decode the digital data. With the transmitter keyed, you can access the TX TEST or DUPLEX TEST screen to measure transmitter power, and transmitter frequency or transmitter frequency error. You can also decode and display the transmitted data using the EDACS Decoder. Refer to the "**EDACS Decoder**" on page 295 for more information on *EDACS Transmitter Testing*.

Mobile Receiver Test Procedure

The following procedure establishes a control channel connection between the Test Set and your mobile, and then performs a handshake to pass the mobile to a working channel. Receiver measurements can then be made.

NOTE:

Each EDACS radio is pre-programmed to access a specific control channel and one or more working channels. Other identification information is also pre-programmed into the mobile (such as the Logical ID and Group ID numbers). You cannot test an EDACS mobile without entering these values into the Encoder.

Connect the Mobile to the Test Set

1. Press the PRESET key on the Test Set.
2. Connect the mobile's antenna port to the Test Set's RF IN/OUT port.
3. Connect the mobile's audio output to the AUDIO IN HI port of the Test Set. (The AUDIO IN LO port is typically only used when the mobile's antenna port shield is not at the same potential as the audio output shield. See the AF ANALYZER screen, [Audio In Lo field description, on page 103.](#))
4. Turn the mobile on.

Get the Mobile Up on the Control Channel

1. Turn AF Generator 1 **Off** (to disable the default 3 kHz FM deviation). To do this, position the cursor in front of the **3.00** value in the **AFGen1 To** field on the RF GENERATOR or DUPLEX TEST screen and press the ON/OFF key.
2. Select **ENCODER** from the **To Screen** menu.
3. Select the **Mode** field and choose **EDACS** from the **Choices** menu.
4. Select the standard used by the radio (4800 or 9600 bps).
5. Enter the **Control Channel** settings.
 - The **Number** is the system control channel number programmed into your mobile.
 - The **RX Frequency** is the control channel's receive frequency for your mobile.
 - The **TX Frequency** is the control channel's transmit frequency for your mobile.
6. Enter the **Working Channel** settings.
 - The **Number** is the working channel number (programmed into your mobile) that you want the mobile to be sent to.
 - The **RX Frequency** is the mobile's receive frequency for the selected working channel.
 - The **TX Frequency** is the mobile's transmit frequency for the selected working channel.
7. Enter the **Logical ID** number.
8. Enter the **Group ID** number.
9. Enter the **Site ID** number.
10. Select the **Send** field (under **RX Test**). The **Status:** field should now indicate **Control**.
11. The Test Set should now be sending the control channel's site identification information to the mobile, and the mobile should indicate that it is receiving the control channel data.
12. Select the **Handshake** field. This tells the mobile and RF Generator to go to the working channel frequencies. The mobile should now indicate that it is "busy", and is tuned to a working channel (this is a "receiver handshake"). The **Status:** field should now indicate **Working**.

Make Receiver Measurements

1. Press the RX key to access the RX TEST screen.
2. Turn AF Generator 1 **On**. (Position the cursor in front of the **Off** entry in the lower part of the **AFGen1 To** field, and press the ON/OFF key.) The entry should now read **3.00**. The working channel is now being modulated at a 1 kHz rate (**AFGen1 Freq**) with 3 kHz deviation (**AFGen1 To**) in addition to the subaudible EDACS signaling from the encoder (AFGen2).
3. Set the volume control on your mobile to about half of full scale. (You may or may not hear the 1 kHz tone from your radio's speaker, depending on how the external speaker connection affects the speaker.)
4. Turn up the VOLUME of the Test Set. You should be able to hear the 1 kHz tone.

Your mobile's SINAD is displayed, as well as the **AC Level** of the audio output. You can now change the RF Generator's **Amplitude** setting to check sensitivity, or select the SINAD measurement to list and access other available audio measurements.

Function Generator Encoder

The Function Generator provides single-tone audio frequency signals of various waveforms, amplitudes, and frequencies. Its signal can be used to modulate the RF Generator, or it can be output through the front-panel AUDIO OUT connector.

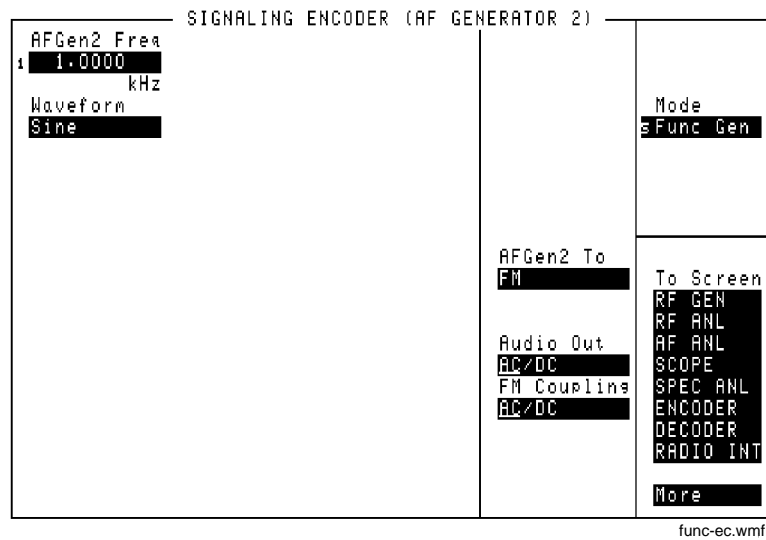

Figure 97 The Function Generator Encoder Screen

AFGen2 Freq

This field sets the tone frequency for the Function Generator.

AFGen2 To

This audio frequency generator control contains two fields:

- The upper field determines whether the Function Generator's signal modulates the RF Generator, or is output through the AUDIO OUT connector.
- The lower field sets the amplitude (including **Off**).

Operating Considerations

When the **Waveform** field is set to **sine** and the signal is output to the AUDIO OUT connector, the amplitude can be set in units of rms or peak voltage. This is done in the **sine Units** field that appears when **Audio Out** is selected. In all other cases, the amplitude is always set in peak voltage.

Audio Out

Audio output coupling selects ac or dc coupling of the Function Generator to the AUDIO OUT connector when the upper **AFGen2 To** field is set to **Audio Out**.

FM Coupling

This field alters the FM modulator to allow DCFM from internal and external modulation sources. This field also selects ac or dc coupling between the RF Generator's frequency modulator and the rear-panel MODULATION INPUT connector.

Sine Units

This field specifies whether the signal's output is in units of rms or peak. This field is only present when the **AFGen2 To** field is set to **Audio Out**.

Waveform

This field selects the desired waveform for AF Generator 2. The available waveforms are as follows:

- Sine wave
- Square wave
- Triangle wave
- Ramp (positive-going and negative-going)
- DC±
- Universal Noise
- Gaussian Noise

LTR Encoder

This Encoder mode is used to test trunked mobile radios that use the EF Johnson LTR® (Logic Trunked Radio) format. Two different trunking messages can be used (Message1 and Message 2) to allow you to change radio operation while the encoder is running.

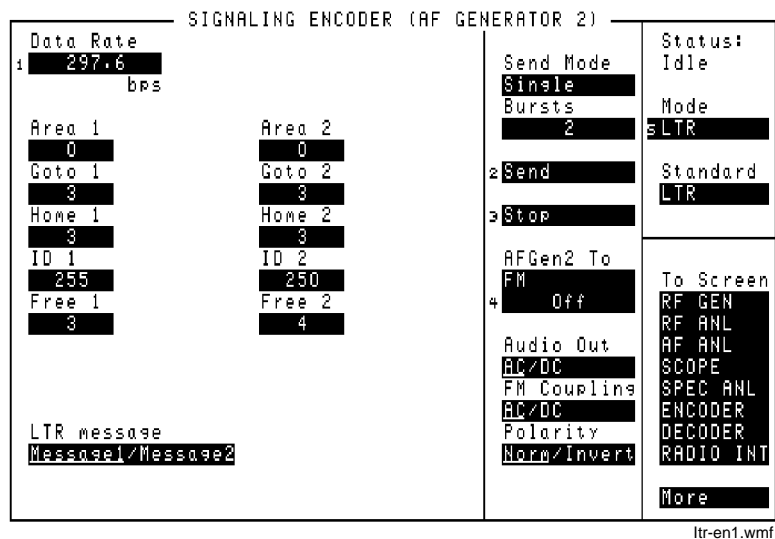

Figure 98 The LTR Trunked Radio Encoder Mode Screen

AFGen2 To

This audio frequency generator control contains two fields:

- The upper field determines whether the LTR Encoder's signal modulates the RF Generator, or is output through AUDIO OUT (normally set to FM for LTR signaling).
- The lower field sets the amplitude, including **Off** (typically set to 1 kHz for LTR signaling).

Area 1, Area 2

Enter the trunked system Area Number (0 or 1) programmed into your radio.

Audio Out

Audio output coupling selects ac or dc coupling of the LTR Encoder to the AUDIO OUT connector when the upper **AFGen2 To** field is set to **Audio Out**.

Bursts

This field defines the number of times Message 1 or Message 2 is output each time **Send** is selected. This function works only when the **Send Mode** field is set to **Burst**.

Data Rate

Enter the LTR signaling data rate used for your radio. The standard and default value is 297.6 bits-per-second.

FM Coupling

This field alters the FM modulator to allow DCFM from the LTR Encoder's modulation source. This field should be set to **DC** when testing trunked radios.

This field also selects ac or dc coupling between the RF Generator's frequency modulator and the rear-panel MODULATION INPUT connector.

Free 1, Free 2

Enter the repeater number to *transmit* to when the radio is keyed. When channel switching is performed, you would specify any of the other repeaters in the system.

Goto 1, Goto 2

Enter the repeater number to *receive* when the message is sent.

Home 1, Home2

Enter the home repeater number programmed into your radio.

ID 1, ID 2

Enter the transmit or receive ID number programmed into your radio.

LTR message

This field selects which message (Message1 or Message2) is output when **send** is selected. The underlined message is output.

Polarity

This setting determines the relationship between the LTR Encoder's data stream logic levels and the effect on the modulated signal.

When this field is set to **Invert**, a logical high (1) causes the output level of the AF Generator to be more *negative*. A logical low (0) causes the level to become positive by the same amount.

Send

Selecting this field causes the LTR Encoder to start modulating the RF Generator.

Send Mode

This field selects the output format used when **Send** is selected to output a sequence. **Cont** is typically used for LTR radio testing.

- **Single** outputs Message 1 or Message 2 once.
- **Burst** outputs the message the number of times specified in the **Bursts** field.
- **Cont** causes the message to be repeated continuously until **Stop** is selected.
- **Step** is not used with this encoder mode.

Standard

This field selects the trunked radio standard for your radio.

Stop

Selecting this field stops the message being output when the **Send Mode** is set to **Cont** or **Burst**. After this field is selected, the current repetition of the message is finished.

Using the LTR Encoder

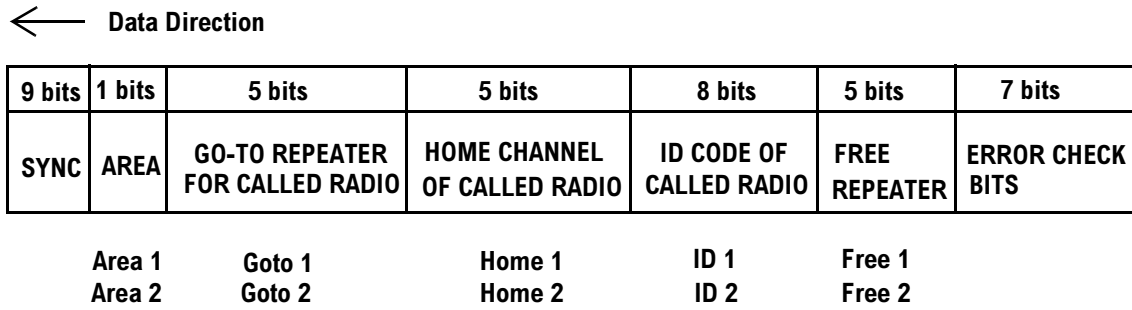

Figure 99 How Message 1 and Message 2 Fields are Used to Create Trunking Data

Radio Test Examples

The following procedures establish a receiver or transmitter trunked channel on the home channel.

To Test Your Receiver

To establish a trunked receiver channel on the home channel,

1. Connect the RF IN/OUT port of the Test Set to your radio's antenna port.
2. If you want to make audio measurements, connect your radio's speaker output to the Test Set's AUDIO IN port(s), and turn the Test Set's VOLUME up about half way.
3. Turn your radio's volume up about half way.
4. Turn your radio on, and select the channel to test.
5. Press the PRESET key (to establish a known instrument state for this procedure).
6. Access the DUPLEX TEST screen.
7. Set the **Tune Mode** field to **Manual**.
8. Set the **RF Gen Freq** field to the *receive* frequency for the selected channel. (Note that the preset function caused the **Amplitude** to be set to -80 dBm, and AFGen1 is set to 1 kHz FM with 3 kHz deviation. These settings should work with your radio to produce the audio tone.)
9. Access the ENCODER screen, and select the LTR mode.
10. Enter your Area Number (0 or 1) in the **Area 1** field.
11. Enter the home channel number in these fields: **Goto 1**, **Home 1**, and **Free 1**. (For example, if your radio's home channel is 2, enter 2 in all three fields.)
12. Enter the Receive ID number for your radio in the **ID 1** field.
13. Set the **Send Mode** field to **Cont**.
14. Set the **AFGen2 To** field to **FM, 1 kHz**.
15. Set the **FM Coupling** field to **DC**.
16. Select **Send** to continuously output the encoded signal.

You should hear the 1 kHz tone from your radio and/or the Test Set's speaker, indicating that the trunked channel has been established.

If you connected the radio's speaker to the AUDIO IN port(s), access the DUPLEX TEST screen to display the **AC Level** and **SINAD** measurements.

To make a 12 dB SINAD measurement

1. Set **Filter 1** to **300Hz HPF** and **Filter 2** to **3kHz LPF**.
2. Decrease the **Amplitude** until approximately 12 dB SINAD is displayed.
3. Use the AVG (average) function to stabilize the measurement by positioning the cursor in front of the SINAD **dB** field and pressing and releasing the SHIFT key, then the INCR $\times 10$ key to access the AVG function, then press the ENTER key.

To Test Your Transmitter

To establish a trunked transmit channel on the home channel:

1. Connect the RF IN/OUT port of the Test Set to your radio's antenna port.
2. Turn your radio on, and select the channel to test.
3. Press the PRESET key (to establish a known instrument state for this procedure).
4. Access the DUPLEX TEST screen.
5. Set the **Tune Mode** field to **Manual**.
6. Enter the home channel's transmit frequency in the **Tune Freq** field.
7. Enter the home channel's receive frequency in the **RF Gen Freq** field.
8. Set **AFGen1 To** to **Off**.
9. Set the **AF An1 In** field to **FM Demod**.
10. Access the ENCODER screen, and select the LTR mode.
11. Set up Message 1 with idle message data:
 - a. Enter your Area Number (0 or 1) in the **Area 1** field.
 - b. Enter the home channel number in these fields: **Goto 1**, **Home 1**, and **Free 1**.
 - c. Enter **255** in the **ID 1** field to establish an idle channel.
12. Set up Message 2 with transmit message data:
 - a. Enter your Area Number (0 or 1) in the **Area 2** field.
 - b. Enter the home channel number in these fields: **Goto 2**, **Home 2**, and **Free 2**.
 - c. Enter the Transmit ID number for your radio in the **ID 2** field.
13. Set the **Send Mode** field to **Cont**.
14. Set the **AFGen2 To** field to **FM, 1 kHz**.
15. Set the **FM Coupling** field to **DC**.
16. Set the **LTR message** field to **Message1**.
17. Select **Send** to continuously output idle message.
18. Key the transmitter.
19. Select **Message2** in the **LTR message** field to tell your radio to transmit. If the transmitter fails to establish a transmit channel before time-out occurs, try again using these steps:
 - a. De-key the transmitter.
 - b. Select Message 1.
 - c. Key the transmitter.
 - d. Select Message 2.

Once a transmit channel is established, turn the Test Set's VOLUME up and speak into your radio's microphone. You should hear your voice out of the Test Set's speaker. Access the DUPLEX TEST screen to display the transmitter's power and frequency error.

Performing Channel Changes

Testing the mobile's ability to change to other receive channels when commanded requires rapid RF Generator frequency changes. After the idle message on the home channel has been established (using Message 1), a message is sent to change channels (Message 2). The mobile must see the LTR-encoded carrier at the new channel frequency within a few seconds to establish the new channel. You can change the RF Generator's frequency using a global USER key after entering an increment value equal to the required channel offset. This procedure must be done *very* quickly to work.

The best way to perform a channel change is to use an HP-IB or IBASIC program to change the RF Generator's frequency to the new channel frequency immediately after the appropriate message has been output.

Automated Test Software

Hewlett-Packard offers software packages to test your LTR-format trunked radio in a fraction of the time normally required for manual testing. You can choose any combination of tests, from full transmitter and receiver testing, to a single test. The software is shipped on a memory card that inserts directly into your Test Set, and it comes with complete documentation and a blank SRAM memory card for storing your test procedures and test data.

MPT 1327 Encoder

This encoder is used to test trunked mobile radios that use the MPT 1327 standard. It is primarily intended to be controlled using IBASIC programs running on the Test Set's IBASIC controller or on an external controller.

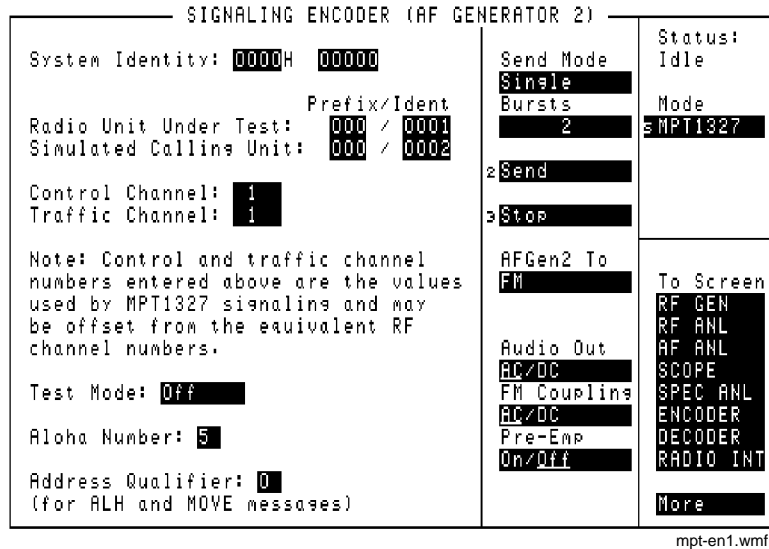

Figure 100 The MPT 1327 Trunked Radio Encoder Mode Screen

Address Qualifier

The **Address Qualifier** field allows you to enter the address qualifier. The address qualifier is a bit mask. It indicates the number of bits in the identity field which have to be compared by a radio unit (RU) when it is deciding whether the ALH or MOVE message is addressed to that RU.

The address qualifier is a two-digit decimal integer without leading zeros. It has the range 0 through 20 and its default value is 0.

- A value of 0 corresponds to no bits being compared (all RUs receive the ALH or MOVE message).
- A value of 20 corresponds to all bits being compared (the ALH or MOVE being addressed to one specific RU).
- For a value of M between 0 and 20, sub-divide the RU population into 2^M subsets.

Aloha Number

The **Aloha Number** field allows you to enter the aloha number. The aloha number defines the number of timeslots in the random access frames on the forward control channel. The value entered in this field is translated to a frame length according to [table 9](#).

The aloha number is a two-digit decimal integer without leading zeros. It has a range 0 through 15, and its default value is 5.

Table 9 Aloha number encoding for 4-bit aloha numbers

Aloha Number	Frame length
0	Not a frame marker
1	1
2	2
3	3
4	4
5	5
6	6
7	7
8	8
9	9
10	10
11	12
12	15
13	19
14	25
15	32

Control Channel

The **Control Channel** field allows you to enter the Control Channel number.

Radio units (RU) are programmed to look for control channel signaling on a restricted set of radio channels, known as the hunt group. It is essential that the channel number on which the Test Set transmits the control channel signaling matches one of the channels in the RU's hunt group. If there is not a match, no communication will be possible.

The control channel is a four-digit decimal integer without leading zeros. It has the range 0 through 1023, and its default value is 1.

Test Mode

The **Test Mode** field is used to select how the encoder is used for tests:

Selection	Description
Off	In this mode the signaling hardware is disabled and does not transmit data.
Control	In this mode the signaling hardware is enabled and is retransmitting a basic control channel structure as defined by the content of the filler buffer. (Refer to " Forward Control Channel Message and Filler Buffers " on page 408 for an explanation of the filler buffer). One or more timeslots in the filler pattern can be overlaid by messages from the control message buffer under control of the Send field.
Traffic	In this mode the signaling hardware is enabled. The filler pattern is not transmitted. Single or multi-timeslot messages can be transmitted from the traffic message buffer under the control of the Send field.
1200Hz	In this mode the signaling hardware is enabled and transmits a continuous 1200 Hz tone (equivalent to an FFSK transmission of continuous ones).
1800Hz	In this mode the signaling hardware is enabled and transmits a continuous 1800 Hz tone (equivalent to an FFSK transmission of continuous zeros).
Dotting	In this mode the signaling hardware is enabled and transmits alternating 1200 Hz and 1800 Hz tones (equivalent to an FFSK transmission of alternating ones and zeros).

Traffic Channel

The **Traffic Channel** field allows you to enter the traffic channel number. The traffic channel is a four-digit decimal integer without leading zeros. It has the range 0 through 1023, and its default value is 1.

Undisplayed Controls

Some MPT 1327 controls are not displayed on the encoder screen; they are only accessed using IBASIC commands over HP-IB. These controls include the delay parameter, the SYNC and SYNT synchronization codewords, and the message and filler buffers.

The controls listed in the remainder of this section are not displayed on the MPT 1327 Encoder screen.

Delay Parameter for Repeat Transmissions

This control is only available using IBASIC commands; it is not displayed on the MPT 1327 Encoder screen.

In the aloha message there is a bit field which indicates to the radio unit (RU) how long it should wait for a response from the TSC. If the RU does not receive a response within this period it should re-issue the request. This is generally set to a fixed value determined by the protocol speed and the responsiveness of IBASIC. In some circumstances it may be useful to change this value.

Table 10 **Delay Parameter to Actual Response Delay**

Delay Parameter	Response delay
0	0
1	1
2	2
3	3
4	4
5	5
6	10
7	15

The delay parameter has a range 0 through 7, with a default value of 7.

This control is listed as **RDELay** in the HP-IB Syntax Diagrams in the *Programmer's Guide*.

Forward Control Channel Message and Filler Buffers

This control is only available using IBASIC commands; it is not displayed on the MPT 1327 Encoder screen.

The encoder screen **Test Mode** field selects the type of signal being transmitted by the signaling hardware (as explained in "**Test Mode**" on page 406). The most important modes are the **Control** and **Traffic** modes.

In the **Control** mode the Test Set continuously generates a slotted aloha forward control channel, as defined and controlled from IBASIC. In **Traffic** mode the Test Set generates individual messages, as defined and controlled from IBASIC.

These modes are central to testing MPT 1327 RUs. An RU must acquire and validate a control channel. It must also be instructed, by control channel signaling, to proceed to a traffic channel before any RF or audio measurements can be performed.

During testing it is necessary to generate the forward control channel continuously; initially, for the RU to acquire and validate the control channel for exchanging the necessary call setup signaling; thereafter, for the RU to remain locked onto the control channel, awaiting exchange of further signaling. This also prevents the RU from re-entering control channel acquisition procedures.

The exception to this is when the RU-under-test is participating in a test call on a traffic channel. It is not necessary to maintain the control channel signaling during test calls as there is only one RU in the test environment and it is on a traffic channel.

As there is only one RU, the control channel signaling comprises a fixed slotted aloha sequence with occasional variations to send specific messages (such as requests for registration (RQR), broadcast messages (BCAST), ahoy messages (AHY)).

The filler buffer contains the repeating pattern of the forward control channel. It also contains a message buffer from which selected timeslots in the filler buffer can be replaced on a one-off or repeating basis.

The control channel filler buffer comprises 32 individual timeslots. It is accessed only through the HP-IB with the following command:

```
ENCoder:MPT1327:FILLer:DATA n,string
```

Where

- *n* is the location selector and has the range 1 through 32.
- *string* is a string containing a signaling language command defining the content of one timeslot. Some signaling language commands also define data codewords and therefore translate to data for two or three timeslots. The signaling language commands take the form of an assembly language.

NOTE:

In MPT 1327 an address codeword can be followed by up to four data codewords. A data codeword occupies half of one timeslot. The signaling language definition restricts the firmware to accept only two or four data codewords. An odd number of data codewords must be added to occupy a whole number of timeslots. For messages with an odd number of data codewords the padding word must be generated by IBASIC.

An example of the format is given in the sequence of commands below. It defines a two timeslot random access frame with a broadcast message, transmitted on channel 212 of system 4901₁₆.

```
ENC:MPT1327:FILL:DATA 1,'ALH 0,ALLI,212,0,0,2'  
ENC:MPT1327:FILL:DATA 2,'ALH 0,ALLI,212,0,0,0'  
ENC:MPT1327:FILL:DATA 3,'BCAST 2,#H4901,0,0'
```

The signaling commands from such strings are assembled into 48-bit address and data codeword message values.

For an address codeword message, the timeslot (128-bits) consists of a 64-bit control channel system codeword (CCSC), followed by the address message, followed by a 16-bit parity word.

Data codeword messages are taken in pairs. Each has its own 16-bit parity word. The firmware is never supplied with an odd number of codewords. The resulting pair of 64-bit words is concatenated to again give 128-bits.

The resulting 128-bits are stored in the addressed location of the filler buffer.

Figure 101 on page 410, shows a signaling instruction being processed, and should clarify this explanation.

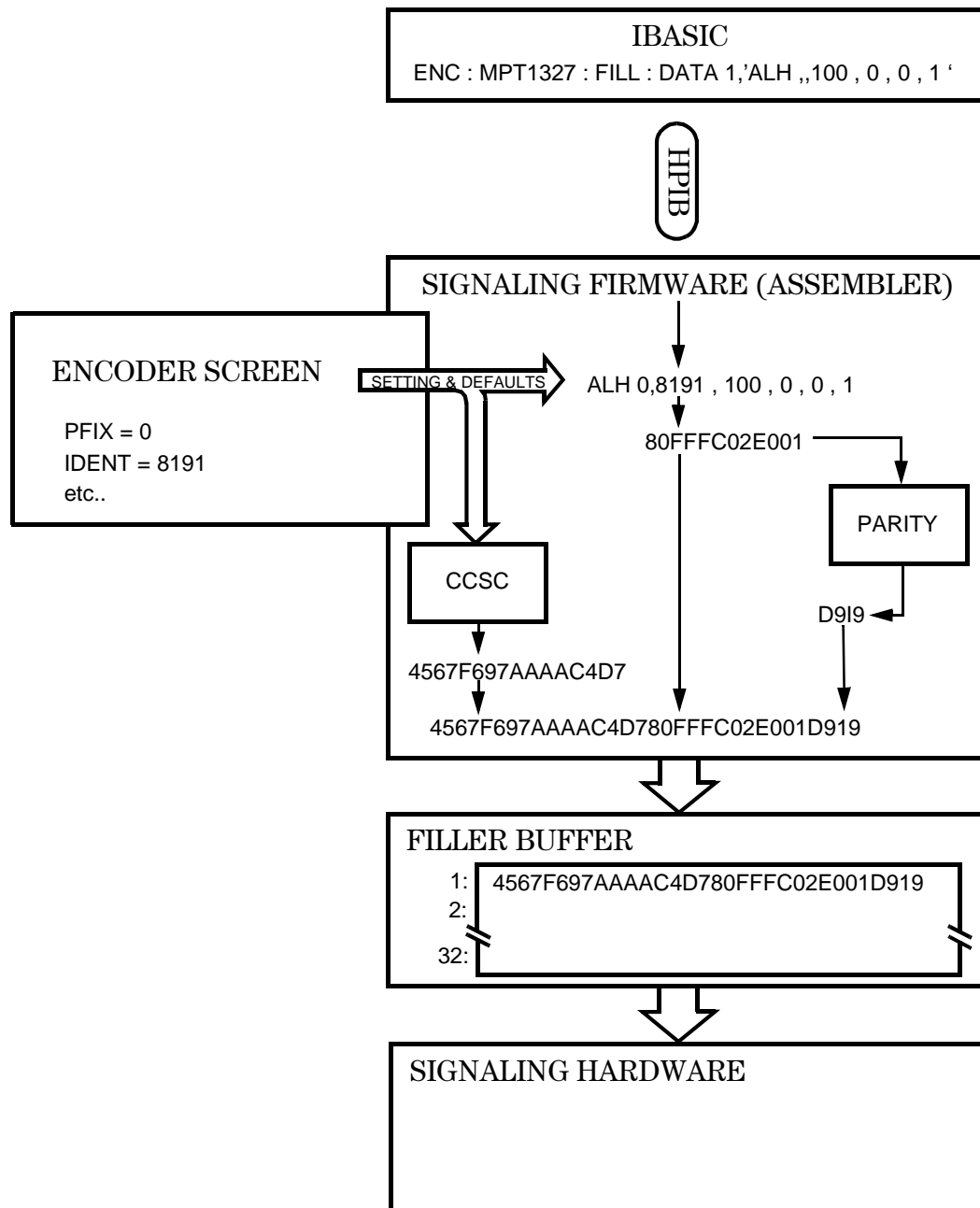

Figure 101 Sequence of Events in Assembling a Signaling Message

If the signaling command has the data codeword extension, **DCW2** or **DCW4**, subsequent timeslot locations are overwritten with the data codewords. If this results in a write to a timeslot greater than 32, the write will wrap back to timeslot one.

A new filler pattern typically comprises several commands to be written. Since each is written individually, the following update command is also needed to transfer data into the working filler buffer:

ENCoder:MPT1327:FILLer:UPDATe

To complete the command set for managing the filler buffer, the individual timeslot locations of the filler buffer are cleared by the following command:

ENCoder:MPT1327:FILLer:CLEAR n

Where *n* selects the timeslot to be cleared and has the range 1 through 32.

The whole buffer is cleared by the command:

ENCoder:MPT1327:FILLer:RESET

When the **Test Mode** field is in **Control** mode, the signaling firmware/hardware will cycle through the defined part of the filler buffer, transmitting each 128-bit timeslot in turn. This is shown in [figure 102 on page 411](#). [Figure 102](#) also shows the control message buffer for comparison with [figure 103 on page 413](#).

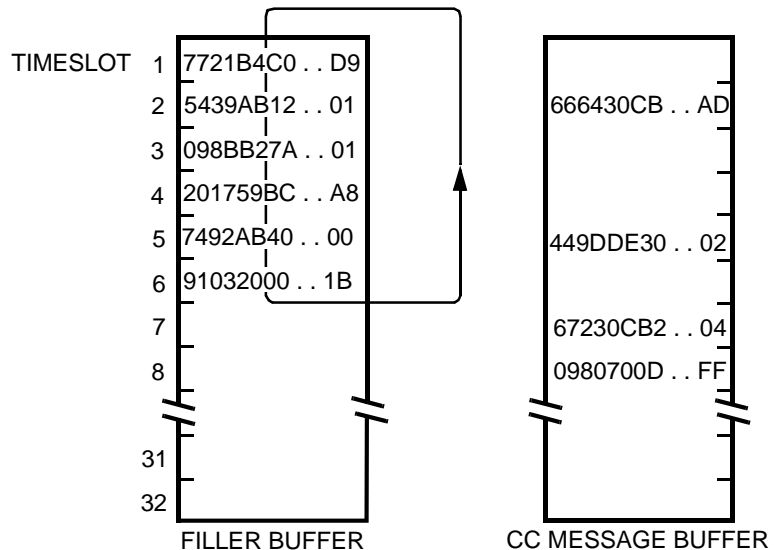

Figure 102

Forward Control Channel in Control Mode and Not Sending

The IBASIC test program occasionally alters the content of the forward control channel temporarily (for example to send an ACKI in response to an RQS). The message buffer enables IBASIC to do this without having to reload the filler buffer.

The control channel message buffer (like the filler buffer), comprises 32 locations, corresponding to the 32 timeslot capacity of the filler buffer. These are accessed through HP-IB with the following command:

```
ENCoder:MPT1327:MESSAge:CONTrol:DATA n,string
```

Where

- *n* is the location selector and has the range 1 through 32.
- *string* is a string containing a signaling command. The signaling command is assembled as for the filler buffer and written into the selected location. If the signaling command has one of the data codeword extensions (DCW2 or DCW4), subsequent timeslot locations are overwritten with the data codewords.

The control channel message buffer is activated by the following HP-IB command:

```
ENCoder:SEND
```

If the encoder is configured for single operation, the message buffer contents will be sent once.

If the encoder is configured for burst or continuous operation, the control channel message buffer can be de-activated by the following HP-IB command:

```
ENCoder:STOP
```

The ENC:STOP/ENC:SEND command sequence is also an UPDATE command. New timeslot contents written using ENC:MPT1327:MESS:CONT:DATA are buffered until the STOP/SEND sequence causes the control message buffer to be updated.

NOTE: The encoder's sending status can be monitored to establish when a message has been sent by looking at the bit-8 "Encoder sending Aux Information" in the Hardware Status Register #1. For further information on the Hardware Status Register refer to the *Programmer's Guide*.

When the **Test Mode** field is in **Control** mode and the control message buffer is activated by ENC:SEND, the signaling firmware/hardware cycles through the defined part of the filler buffer. It transmits each 128-bit filler buffer timeslot in turn. This happens except where there is a message defined in the corresponding timeslot of the control message buffer. In this case the contents of the control message buffer are transmitted as shown in [figure 103 on page 413](#).

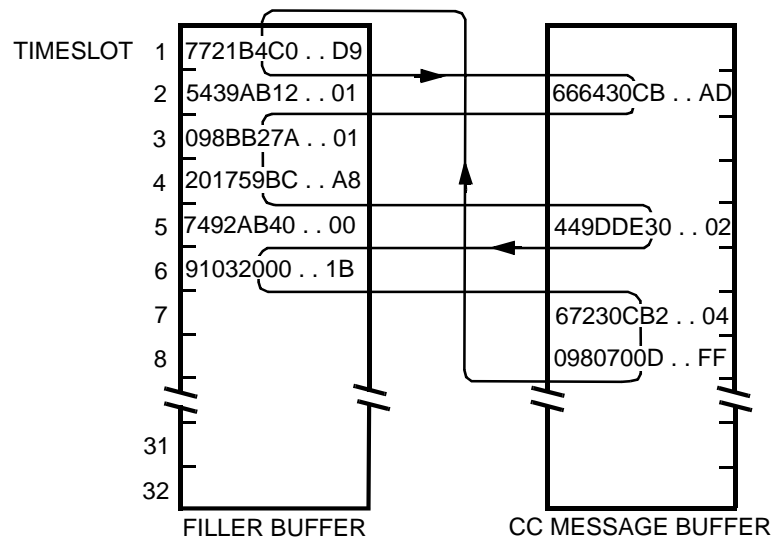

Figure 103 Forward Control Channel in Control Mode and Sending

Figure 103 shows that messages defined in contiguous timeslots, following the last timeslot defined in the filler message, are transmitted between each repeat of the filler pattern.

This can be used, for example, to insert a registration frame (ALHR) between the normal filler frames.

The individual timeslot locations of the message buffer can be cleared by the following command:

```
ENCoder:MPT1327:MESSAge:CONTrol:CLEAR n
```

where *n* is the timeslot to be cleared and has the range 1 through 32.

In addition the whole message buffer can be cleared by the following command:

```
ENCoder:MPT1327:MESSAge:CONTrol:RESET
```

Traffic Channel Message Buffer

This control is only available using IBASIC commands; it is not displayed on the MPT 1327 Encoder screen.

When the RU-under-test moves to a traffic channel, the IBASIC test program needs to stop the transmission of the control channel signaling temporarily but still be able to send individual messages (for example, to send a **CLEAR** message).

When **Test Mode** is set to **Traffic**, the control channel filler and message buffers are disabled, and a traffic channel message buffer is enabled. A message is sent from the traffic channel message buffer on demand by use of ENC:SEND. Only messages in message buffer timeslot 1 and any contiguous timeslots are sent. Refer to [figure 104](#) .

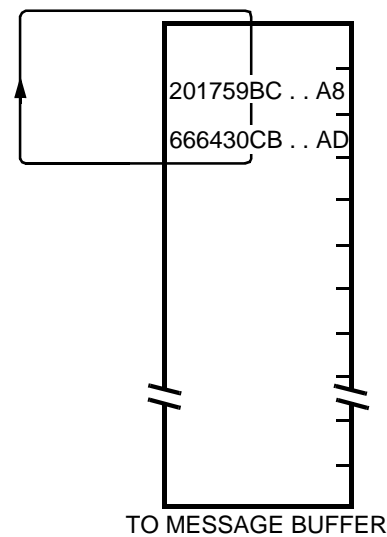

Figure 104 Traffic Channel Message Generation

Control and Traffic Channel Message Structures

This control is only available using IBASIC commands; it is not displayed on the MPT 1327 Encoder screen.

In both control and traffic mode, the signaling transmissions commence with the standard link establishment time (LET), preamble, and SYNC or SYNT pattern, and the transmissions are terminated with a “hang-over” bit as shown in [figure 105](#) and [figure 106](#) .

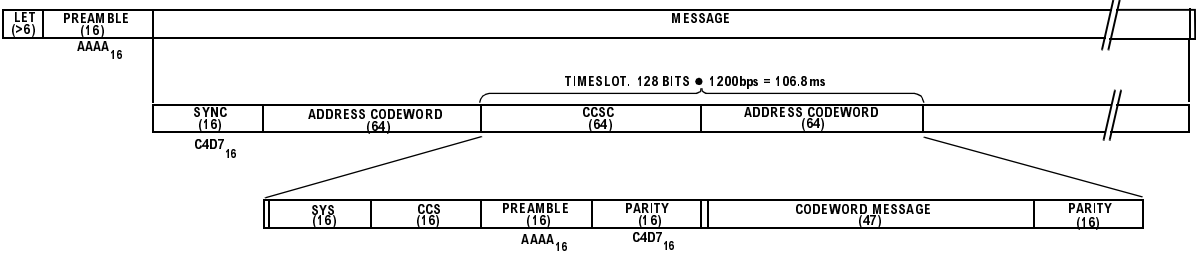

Figure 105 Forward Control Channel Message Structure

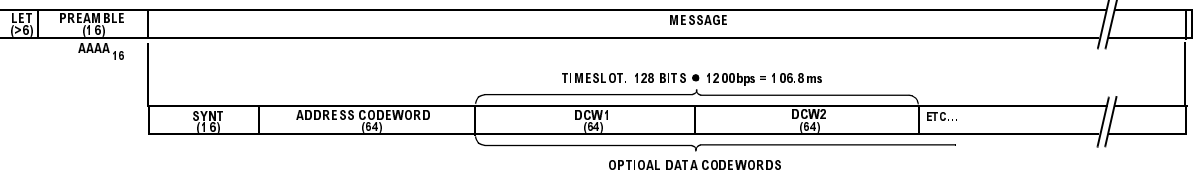

Figure 106 Traffic Channel Message Structure

Table 11 describes the signaling encoder as it is changed between the various test modes. Particular reference is made to how the control and traffic channel message structures are started and stopped.

Table 11 Signaling Mode Transitions Table

To From	Off	Control	Traffic	1200Hz	1800Hz	Dotting
Off	—	A	B	C	D	E
Control	F	—	H then B	F then C	F then D	F then E
Traffic	G	I then A	—	G then C	G then D	G then E
1200Hz	J	J then A	J then B	—	N	O
1800Hz	K	K then A	K then B	M	—	O
Dotting	L	L then A	L then B	M	N	—

- A.** Start the control channel with a 6-bit LET, PREAMBLE, and SYNC. For the first address codeword (before the repeating SYS, CCS, PREAMBLE, PARITY, CODEWORD, PARITY structure), the codeword comes from the second half of the filler (or message) buffer timeslot 1.
- B.** Start the traffic channel with a LET, PREAMBLE, and SYNT. Again the first codeword is taken from the timeslot 1 entry.
- C.** Turn on 1200 Hz sine wave starting at 0° phase.
- D.** Turn on 1800 Hz sine wave starting at 0° phase.
- E.** Turn on “dotting” with a 1 symbol. The starting phase may be 0° or 180°.
- F.** Continue to generate the control channel until the end of the filler buffer (and message buffer if messages are present) then produce a hang-over bit and stop. The hang-over bit repeats the last bit of the transmission.
- G.** Continue to generate the traffic channel until the message is completed then produce a hang-over bit and stop. The hang-over bit is followed by one “off” bit before the next sequence begins.
- H.** Stop control channel generation after the next bit.
- I.** Stop traffic channel generation after the next bit.
- J.** Turn off 1200 Hz sine wave on completion of the next symbol.
- K.** Turn off 1800 Hz sine wave on completion of the next symbol.
- L.** Turn off “dotting” on completion of the next 1010 symbol. Dotting is sent as the sequence 1010 rather than 10. This makes the trace on the internal scope stable when triggered by the encoder since every second 1 starts on the opposite phase.
- M.** Make a phase continuous transition to 1200 Hz on completion of the next symbol.
- N.** Make a phase continuous transition to 1800 Hz on completion of the next symbol.
- O.** Make a phase continuous transition to “dotting” (starting with a 1 symbol) on completion of the next 1010 sequence.

Using the MPT 1327 Encoder

Manually Testing MPT 1327 Radios

MPT 1327 signals contain complex groupings of digital data that vary in format and function, depending on a number of system operating parameters.

To be able to test MPT 1327 radios using this screen, you must be familiar with the theory, applications, and specifications of the MPT 1327 system. You must also be familiar with IBASIC programming, since some of the required signaling commands are not available on the encoder screen; they must be sent using IBASIC commands. (See "[Undisplayed Controls](#)" on page 407.)

The large volume of information required to explain the MPT 1327 system is beyond the scope of this manual. Documents explaining the structure and specifications of this system should be obtained from the radio communications regulatory agency of the appropriate country.

Using Automated Test Software

The HP 11807A Option 012 MPT 1327 Trunked Radio Tests software provides comprehensive automated tests of MPT 1327 radios. All Test Set RF, AF, and Encoder/Decoder controls are automatically set, requiring minimal operator inputs.

You can choose any combination of tests, from full transmitter and receiver testing, to a single test. The software is shipped on a memory card that inserts directly into your Test Set, and comes with complete documentation and a blank SRAM memory card for storing your test procedures and test data.

System Identity

The **System Identity** uses two areas to enter the system identity number as either a decimal or hexadecimal value. When a value is entered in either field, the corresponding value is automatically entered in the other field.

The first field is a four-digit hexadecimal integer with leading zeros (**H** indicates the hexadecimal number base). It has the range 0 through $7FFF_{16}$ and its default is 0000_{16} .

The second field is a five-digit decimal integer with leading zeros. It has the range 0 through 32767 and its default is 00000.

It is essential that the 15-bit system identity transmitted by the Test Set matches the system identity programmed into the radio unit. If there is not a match, the RU will not recognize the forward control channel and no communication will be possible.

Radio Unit Under Test

The **Radio Unit Under Test** function uses two input fields; a 7-bit **Prefix** field and a 13-bit **Ident** field. This allows you to enter the prefix and identity of your radio unit (RU).

Each RU has a unique prefix/ident value that is used to address messages to that RU only. An RU can also have a number of “group” prefix/ident values that it and several other RUs respond to.

The prefix is a three-digit decimal integer with leading zeros. It has the range 0 through 127 and its default is 000.

The ident is a four-digit decimal integer with leading zeros. It has the range 0 through 8191 and its default is 0001.

Simulated Calling Unit

The **simulated Calling Unit** function uses two input fields; a 7-bit **Prefix** field and a 13-bit **Ident** field. This allows you to enter the prefix and identity of the calling unit.

To test an RU the Test Set simulates a Trunking System Controller (TSC). In some tests the Test Set simulates calls from a third party. For this purpose it is necessary to specify the simulated calling unit's number.

The simulated calling party could be any radio or line unit. It could also be one of the special idents indicating, for example, a system wide call or a call from a PABX or PSTN gateway.

The prefix is a three-digit decimal integer with leading zeros. It has the range 0 through 127 and its default value is 000.

The ident is a four-digit decimal integer with leading zeros. It has the range 0 through 8191 and its default value is 0002.

Nordic Mobile Telephone (NMT) Encoder

The NMT Encoder screen is used to create the different signals used to communicate between the Mobile Station (MS), Base Station (BS), and Mobile Telephone Exchange (MTX). The signal is output under program control from the NMT Decoder screen.

The operation of the NMT Encoder is strongly dependent on functions used in the NMT Decoder screen. For information about using the NMT Encoder and Decoder see ["Using the NMT Decoder/Encoder" on page 321](#) and ["Creating NMT Tests" on page 326](#).

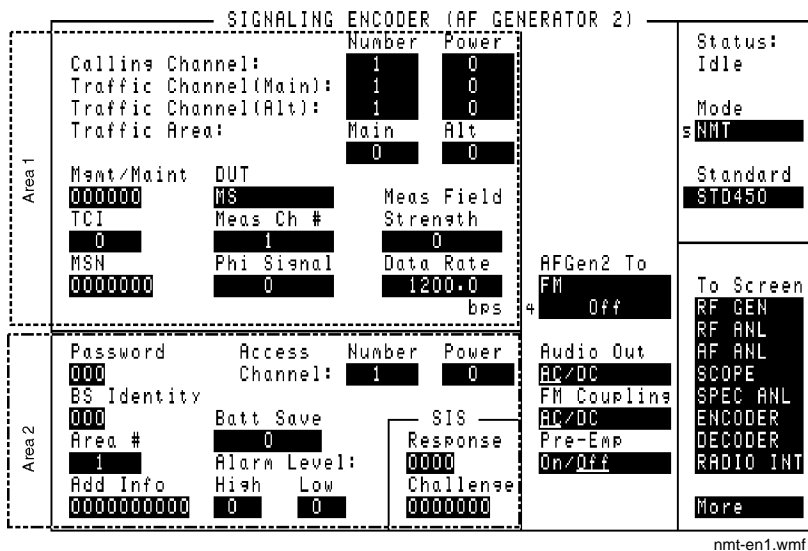

Figure 107 The NMT Encoder Screen

Access Channel Number

This field defines the channel number for the signal that initiates a call from the MS to the MTX.

Valid Entry Range: 1 through 2023

NMT Frames Affected: 3d, 3dTA2, 4b, 4bTA2, 10aAC

Operating Considerations

This field is only used with the STD900 standard.

This setting affects the RF generator and analyzer frequencies used when the TCHAN AC and RCHAN AC commands are used.

See Also

[Calling Channel Number field description, on page 425](#)

Access Channel Power

This channel's power setting. Each power setting represents one of the four available levels allowed by the NMT standards.

Valid Entry Range: 0 through 3

NMT Frames Affected: 3d, 3dTA2, 4b, 4bTA2, 10aAC.

Operating Considerations

This field is only used with the STD900 standard.

Add Info

The additional information field contains various types of information, depending on the frame type. Several frame types contain additional information digits in the form H1 to H10, as outlined in the NMT system standards.

The following table shows the relationship between the **Add Info**, **%**, and **Base save** fields, and how they are used in frame data. (The H1 to H10 designations correspond to the frame digit assignments shown in the *NMT DOC. 900-1, Jan. 1985* standards.)

Table 12 **NMT Additional Information Bits**

Frames	Content of Additional Information Digits
1a, 1a', 1a	H1H2H3H4H5H6H7H8H9H10 All from Add Info field
1aS, 1a'S, 1a"S	H1H2H4H5H6H7H8H9H10 From Add Info field H3 From Bate Save field
1b, 1bTA1,1bTA2	H1H2H3H4H5H6H7 From Add Info field H8H9H10 From Area # field
1bS	H1H2H4H5H6H7 From Add Info field H3 From Bate Save field H8H9H20 From Area # field
2a, 2a', 2a", 2e, 3b, 3bTA2, 3bTC2, 4, 4TA2,4b, 4bTA2, 30	H1H2H3H4H5H6H7 Not Used. H8H9H10 From Area # field
2c, 2c', 2c", 2d, 2d', 2d", 2f	H1H2H3H4H5H6H7 Not used. H8H9H10 Fixed by standard as fictitious channel numbers.

Valid Entry Range: 0000000000 - FFFFFFFF (hex)

NMT Frames Affected: (Refer to the Frames column in the preceding table.)

Operating Considerations

This field is only used with the STD900 standard.

AFGen2 To

Audio frequency generator 2 to contains two fields:

- The upper field determines whether the NMT Encoder modulates the RF Generator, or is output through AUDIO OUT.
- The lower field sets the amplitude (including **Off**).

Alarm Level Low

This field sets the lower trigger level for the signal-strength measurement's alarm for the Phi signal.

Valid Entry Range: 0 through F (hex)

NMT Frames Affected: 20, 25.

Operating Considerations

This field is only used with the STD900 standard.

Alarm Level High

This field sets the upper trigger level for the signal-strength measurement's alarm for the Phi signal.

Valid Entry Range: 0 through F (hex)

NMT Frames Affected: 20, 25.

Operating Considerations

This field is only used with the STD900 standard.

Area

The area number field identifies which MTX is used to call an MS. This identification prevents MS to BS calling problems caused by co-channel interference.

Valid Entry Range: 1 through 4

NMT Frames Affected: 1b, 1bS, 1bTA1, 1bTA2, 2a, 2a', 2a", 2e, 3bTA2, 3b, 3bTC2, 4, 4TA2, 4b, 4bTA2, 10a, 10aAC, 10b, 10c, 10d, 11a, 11b, 12, 30.

Operating Considerations

This information is used to encode the information in the last three digits of the **Add Info** field, rather than taking the information directly from that field.

This field is only used with the STD900 standard.

Audio Out

Audio out coupling selects ac or dc coupling of the encoder to the AUDIO OUT connector when the upper **AFGen2 To** field is set to **Audio Out**.

BS Identity

The base station identity field provides the 3-digit hex code that identifies which BS an MTX is communicating with.

Valid Entry Range: 000 through FFF (hex)

NMT Frames Affected: 20, 21b, 21c, 22.

Operating Considerations

This field is only used with the STD900 standard.

Batt Save

The the length of the battery saving period in 5 second increments. For example, a setting of **5** produces a 25-second period.

Valid Entry Range: 0 through 7

NMT Frames Affected: 1aS, 1a'S, 1a"S, 1bS

Operating Considerations

This field is only used with the STD900 standard.

Calling Channel Number

This number setting when initiating a call from the BS to the MS.

Valid Entry Range: 1 through 2023

NMT Frames Affected: 1a, 1a', 1a", 1aS, 1a'S, 1a"S, 1b, 1bS, 2a, 2a', 2a", 2b, 2b', 2b", 2c, 2c', 2c", 2d, 2d', 2d", 2e, 2f, 10a, 10d, 11b.

Operating Considerations

This setting affects the RF frequencies the RF generator and analyzer tune to when the TCHAN CC and RCHAN CC commands are used.

Each NMT standard has its own range of available channels. **Table 13** lists the valid channel assignments for Calling, Traffic, and Access channels.

Table 13 Valid Channel Assignments

NMT Standard	Valid Channel Numbers
STD450	1 to 180
STD900	1 to 1000, 1025 to 2023

Calling Channel Power

This field specifies the calling channel's power setting. Each Power setting represents one of the four available levels allowed by the NMT standards.

Valid Entry Range: 0 through 3

NMT Frames Affected: 1a, 1a', 1a", 1aS, 1a'S, 1a"S, 1b, 1bS, 2a, 2a', 2a", 2b, 2b', 2b", 2c, 2c', 2c", 2d, 2d', 2d", 2e, 2f, 10a, 10d, 11b.

Data Rate

This field specifies the rate that the frames are output in bits-per-second. This field also sets the data rate expected by the NMT Decoder.

Valid Entry Range: 9.2 through 2400

DUT

The device-under-test field defines *the device you are testing*.

Valid Entries: MS, BS, MTX

NMT Frames Affected: None

Operating Considerations

This field affects the RF generator and analyzer frequencies used for the NMT TCHAN and RCHAN program commands.

This field also affects how frames are interpreted by the decoder when determining the type of frame being received.

FM Coupling

This field alters the FM modulator to allow DCFM from internal and external modulation sources. This field also selects ac or dc coupling between the RF Generator's frequency modulator and the rear-panel MODULATION INPUT connector.

Meas Ch

The measurement channel number field specifies the channel whose signal strength is measured.

Valid Entry Range: 1 through 2023

NMT Frames Affected: 21b, 21c, 26.

See Also

[Calling Channel Number field description, on page 425](#)

Meas Field Strength

This field specifies the Phi Signal strength measurement that is sent from the BS to the MTX.

Valid Entry Range: 0 through 99

NMT Frames Affected: 26

Mgmt/Maint

The management/maintenance field is used to send system status information.

Valid Entry Range: 000000 through FFFFFFFF (hex)

NMT Frames Affected: 22, 27, 28.

MSN

The mobile subscriber number field specifies the unique seven-digit code that identifies an MS.

Valid Entry Range: 0000000 through FFFFFFFF (hex)

NMT Frames Affected: 2a, 2a', 2a", 2b, 2b', 2b", 2c, 2c', 2c", 2d, 2d', 2d", 2e, 2f, 3a1, 3a2, 3b, 3bTA2, 3bTC2, 3c, 3d, 3dTA2, 5a, 5b, 10a, 10aAC, 10b, 10c, 10d, 11, 11a, 11b, 12, 13a, 13b, 14a, 14b.

Phi Signal

This field specifies the F (Phi) signal frequency.

Valid Entry Range: 0 through F (hex)

NMT Frames Affected: 20, 21b, 21c, 25, 26.

Password

This field specifies the 3-digit code added to the end of the MSN to prevent unauthorized use of a subscriber number.

Valid Entry Range: 000 through FFF (hex)

NMT Frames Affected: 10b, 10c, 11a, 12.

Operating Considerations

This field is only used with the STD900 standard.

Pre-Emp

Pre-emphasis, when used, attenuates the lower frequency tone (1200 Hz at 1200 bps) to 2/3 of the field level setting.

SIS Challenge

The subscriber identity security challenge field is used to confirm a subscriber's MS identity.

Valid Entry Range: 0000000 through FFFFFFFF (hex)

NMT Frame Affected: 7

Operating Considerations

This field is only used with the STD900 standard.

SIS Response

The subscriber identity security response field is used to respond to the SIS challenge to confirm a subscriber's MS identity.

Valid Entry Range: 0000 through FFFF (hex)

NMT Frame Affected: 16

Operating Considerations

This field is only used with the STD900 standard.

Standard

This NMT system standard for equipment you are testing. When a standard is chosen, the Test Set automatically alters several corresponding parameters.

Operating Considerations

Each standard affects the following conditions:

- The types of frames that can be sent.
- The range of valid channel numbers.
- The encoding of the frame data.
- The frequencies tuned to for the various channel settings when CHAN programming commands are executed in an NMT program.
- The interpretation of received frames.

The following standards are available:

STD450: Transmit and receive frequencies are in the 453 to 467.5 MHz range.

STD900: Transmit and receive frequencies are in the 890 to 960 MHz range.

See Also

[Calling Channel Number field description, on page 425](#)

TCI

The tariff class information field is used to specify MS billing information to the MTX.

Valid Entry Range: 0 through 99

NMT Frames Affected: 5b, 13b.

Traffic Area - Alt

This field specifies the alternate traffic area code that identifies the base stations used to simultaneously transmit a calling signal to an MS.

Valid Entry Range: 0 through FF (hex)

NMT Frames Affected: 1bTA2, 3bTA2, 3dTA2, 4TA2, 4bTA2.

Traffic Area - Main

This field specifies the main traffic area code that identifies the base stations used to simultaneously transmit a calling signal to an MS.

Valid Entry Range: 0 through FF (hex)

NMT Frames Affected: 1a, 1a', 1a", 1aS, 1a"S, 1a"S, 1b, 1bS, 1bTA1, 2a, 2a', 2a", 2b, 2b', 2b", 2c, 2c', 2c", 2d, 2d', 2d", 2e, 2f, 3a1, 3a2, 3b, 3bTC2, 3c, 3d, 4, 4b, 5a, 5b, 7, 10a, 10aAC, 10b, 10c, 10d, 11a, 11b, 12, 20, 21b, 21c, 22, 30.

Traffic Channel (Alt) Number

This field specifies the alternate traffic channel used for conversation after communications have been established.

Valid Entry Range: 1 through 2023

NMT Frames Affected: 3a2, 3bTC2, 3c.

Operating Considerations

This setting affects the RF generator and analyzer frequencies used when the TCHAN TC2 and RCHAN TC2, or TCHAN TCA and RCHAN TCA, programming commands are used.

See Also

[Calling Channel Number field description, on page 425](#)

Traffic Channel (Alt) Power

This field specifies the power of the alternate traffic channel. Each power setting represents one of the four available levels allowed by the NMT standards.

Valid Entry Range: 0 through 3

NMT Frames Affected: 3a2, 3bTC2, 3c.

Traffic Channel (Main) Number

This field specifies the main traffic channel used for conversation after communications have been established.

Valid Entry Range: 1 through 2023

NMT Frames Affected: 1bTA1, 1bTA2, 2b, 2b', 2b", 3a1, 3a2, 3b, 3bTA2, 3d, 3dTA2, 4, 4TA2, 5a, 5b, 7, 10b, 10c, 11, 11a, 12, 13a, 13b, 14a, 14b, 16, 20, 21b, 21c, 22, 25, 26, 27, 28, 30.

Operating Considerations

This setting affects the RF generator and analyzer frequencies used when the TCHAN TC1 and RCHAN TC1, or TCHAN TCM and RCHAN TCM, programming commands is used.

See Also

[Calling Channel Number field description, on page 425](#)

Traffic Channel (Main) Power

This field specifies the power of the main traffic channel. Each power setting represents one of the four available levels allowed by the NMT standards.

Valid Entry Range: 0 through 3

NMT Frames Affected: 1bTA1, 1bTA2, 2b, 2b', 2b", 3a1, 3a2, 3b, 3bTA2, 3d, 3dTA2, 4, 4TA2, 5a, 5b, 7, 10b, 10c, 11, 11a, 12, 13a, 13b, 14a, 14b, 16, 20, 21b, 21c, 22, 25, 26, 27, 28, 30.

Tone Sequence Encoder

The Tone Sequence Generator outputs sequences of tones of variable frequency, amplitude, and duration. Its signal can be used to modulate the RF Generator, or can be output through the front-panel AUDIO OUT connector.

SIGNALING ENCODER (AF GENERATOR 2)									
Symbol Sequence			Symbol Definition			Send Mode		Status:	
1 12345						Single		Idle	
Sea Num	On Time ms	Off Time ms	Sym	Frea Hz	Amptd %	Bursts		Mode	
1	33.0	0.0	0	600.0	100.0	2		Tone Sea	
2	33.0	0.0	1	741.0	100.0	Send		Standard	
3	33.0	0.0	2	882.0	100.0	Stop		EIA	
4	33.0	0.0	3	1023.0	100.0	AFGen2 To		To Screen	
5	33.0	0.0	4	1164.0	100.0	FM		RF GEN	
6	33.0	0.0	5	1305.0	100.0	Audio Out		RF ANL	
7	33.0	0.0	6	1446.0	100.0	AC/DC		AF ANL	
8	33.0	0.0	7	1587.0	100.0	FM Coupling		SCOPE	
9	33.0	0.0	8	1728.0	100.0	AC/DC		SPEC ANL	
10	33.0	0.0	9	1869.0	100.0	Pre-Emph		ENCODER	
11	33.0	0.0	A	459.0	100.0	On/Off		DECODER	
12	33.0	0.0	B	2010.0	100.0			RADIO INT	
13	33.0	0.0	C	2151.0	100.0			More	
14	33.0	0.0	D	0.0	0.0				
15	33.0	0.0	E	0.0	0.0				
16	33.0	0.0							

tone-ec.wmf

Figure 108 The Tone Sequence Encoder Mode Screen

AFGen2 To

This audio frequency generator control contains two fields:

- The upper field determines whether the tone sequence modulates the RF Generator or is output through the front-panel AUDIO OUT connector.
- The lower field sets the amplitude (including **Off**).

Audio Out

Audio output coupling selects ac or dc coupling of the Tone Sequence Generator to the AUDIO OUT connector when the upper **AFGen2 To** field is set to **Audio Out**.

Bursts

This field defines the number of sequences output each time **Send** is selected. This function works only when the **Send Mode** field is set to **Burst**.

FM Coupling

This field alters the FM modulator to allow DCFM from internal and external modulation sources. This field also selects ac or dc coupling between the RF Generator's frequency modulator and the rear-panel MODULATION INPUT connector.

Pre-Emp

This field determines whether the encoder signal passes through or bypasses 750 ms pre-emphasis.

Send

Selecting this field causes the tone sequence to be output.

Send Mode

This field selects the output format used when **Send** is selected to output a sequence.

- **Single** outputs the entire sequence once.
- **Burst** outputs the sequence the number of times specified in the **Bursts** field.
- **Cont** causes the sequence to be output continuously until **Stop** is selected.
- **Step** allows you to output the sequence one tone at a time by pressing **Send** for each tone.

Standard

This field selects the Tone Sequence standard for your radio.

Stop

Selecting this field stops the sequence being output.

Symbol Definition

This table specifies three types of information:

- **Sym**, symbol numbers, indicate the hexadecimal number that represents each tone when creating a tone sequence. These numbers cannot be changed.
- **Freq Hz** lists the tone frequency associated with each symbol number. The frequency values are preset for the **Standard** you are using. You can change the values using the DATA keys.
- lists the relative amplitude for each tone. Amplitude is based on a percentage of the level shown in the **AFGen2 To** field.

Symbol Sequence

This area performs two functions:

- The **Symbol Sequence** field at the top of the screen is used to enter and edit the tone sequence. The sequence uses the symbol numbers (Sym) listed in the **Symbol Definition** table. A total of 16 symbols can be entered.
- Below the **Symbol Sequence** is the sequence on/off times table. This table contains three entries:

Seq Num identifies which *position* in the **Symbol Sequence** is affected by the On and Off times listed.

On Time specifies the length of time a tone is output during the sequence.

Off Time specifies the length of time a tone is off before the next tone in the sequence is output.

Operating Considerations

The symbol numbers can be entered directly, using the DATA keys, or by using the **Choices** menu that appears when this field is selected. The **Choices** menu is also used to edit an existing sequence.

The on and off times are changed using the DATA keys.

Help Screen

Field Descriptions

The HELP screen is used to access tutorial information for a wide variety of instrument functions.

After this screen is accessed, push the cursor-control knob to display the help Index. The knob is then used to select the desired topic.

Once you have accessed the desired information, you can return to the Help Index by pushing the cursor-control knob.

To exit the HELP screen and return to the previous screen, press the PREV key.

I/O Configure Screen

Field Descriptions

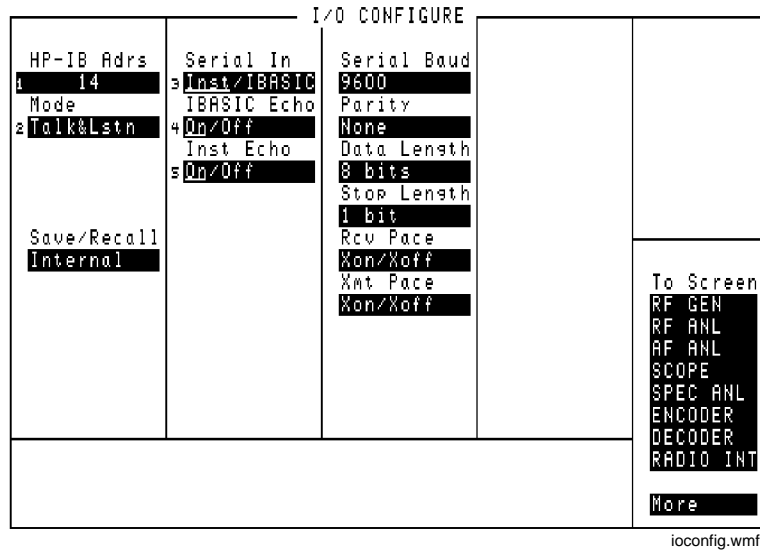

Figure 109 The I/O Configure Screen

The I/O CONFIGURE screen's fields are used to specify HP-IB and serial communications settings. (HP 8920As must be equipped with option 003)

This screen is accessed by selecting the **More** field (directly below the **To Screen** menu), and selecting **IO CONFIG**.

Data Length

This field specifies the number of bits used for each word of serial data when using the rear-panel serial port.

This setting is retained when the instrument is turned off.

HP-IB Adrs

This field is used to display and change the HP-IB address of the Test Set.

Operating Considerations

The address can be set from 0 to 30 by using the DATA keys, or by pushing and then turning the cursor-control knob.

This setting is retained when the instrument is turned off.

IBASIC Echo

This field enables/disables screen and error message echoing from IBASIC.

This setting is retained when the instrument is turned off.

Inst Echo

This field enables/disables character and screen echoing when using an external ASCII RS-232 terminal or computer to enter or edit IBASIC programs.

This setting is retained when the instrument is turned off.

Mode

This field sets the HP-IB operating mode. **Talk&Lstn** is used for “normal” HP-IB operation. **Control** is used to control external instruments using the Test Set.

This setting is retained when the instrument is turned off.

Parity

This field specifies the serial communication parity setting when using the rear-panel serial port.¹

This setting is retained when the instrument is turned off.

Rcv Pace

The receive pace field is used when receiving serial data.

- **Xon/Xoff** lets the Test Set “talk” to the transmitting device to alter the rate of the data being sent.
- **None** disables the Xon/Xoff function.

This setting is retained when the instrument is turned off.

1. Optional on some Test Set models.

Save/Recall

This field specifies which memory device the Test Set accesses when the save and recall functions are used.

- **Internal** is a section of internal RAM. RAM is also used for running IBASIC programs, which may require you to delete the Save/Recall registers if the program is very large.
- **Card** is the front-panel MEMORY CARD slot. A **Save/Recall Device is not Present** message is displayed if you try to save or recall an instrument setup when a write-able memory card is not installed in the Test Set.
- **RAM** refers to RAM disks that you can create on internal RAM. Refer to the *Programmer's Guide* for information on creating RAM Disks. This is part of the same memory used when "internal" is specified, and may have to be erased when loading very large IBASIC programs. A **Save/Recall Device is not initialized** message is displayed if you try to save or recall an instrument setup when a RAM disk has not been created.
- **Disk** is used with external disk drives. The **Mode** field must be set to **Control** to access the drive. Also, the HP-IB address of the drive must be entered in the **External Disk Specification** field of the TESTS (External Devices) screen.

Serial Baud

This field selects the baud rate for serial communications when using the rear-panel serial port¹. Selecting this field displays a list of baud rate choices.

This setting is maintained after the instrument is turned off.

1. Optional on some Test Set models.

Serial In

This field selects the destination of characters received by the Test Set on the serial port.

- **Inst** configures the serial port to connect to an external ASCII terminal or computer to enter IBASIC programs, or to control the Test Set using an external keyboard.
- **IBASIC** is used to allow the IBASIC controller to read the serial port while a program is running.

Operating Considerations

If a serial printer is connected, the PRINT command causes the printer to take control of the serial port until printing is done.

This setting is maintained after the instrument is turned off.

See Also

Programmer's Guide

Stop Length

This field specifies the number of stop bits used for serial communications when using the rear-panel serial port.¹ Selecting this field displays a list of stop bit choices.

This setting is maintained after the instrument is turned off.

Xmt Pace

The transmit pace field is used when transmitting serial data.

- **Xon/Xoff** lets the receiving device “talk” to the Test Set to alter the rate of the data being sent.
- **None** disables the Xon/Xoff function.

This setting is maintained after the instrument is turned off.

1. Optional on some Test Set models.

Message Screen

Field Descriptions

The MESSAGE screen lists any error or operation messages that have occurred since the instrument was turned on.

The type of error and the time it occurred are listed. If one error occurs more than once before a different error is encountered, the number of times it occurred, and when it occurred, are displayed.

All messages are shown until the entire display is filled. If enough errors occur, the MESSAGE screen will scroll the first messages past the top of the screen. These messages cannot be retrieved.

Oscilloscope Screen

Field Descriptions

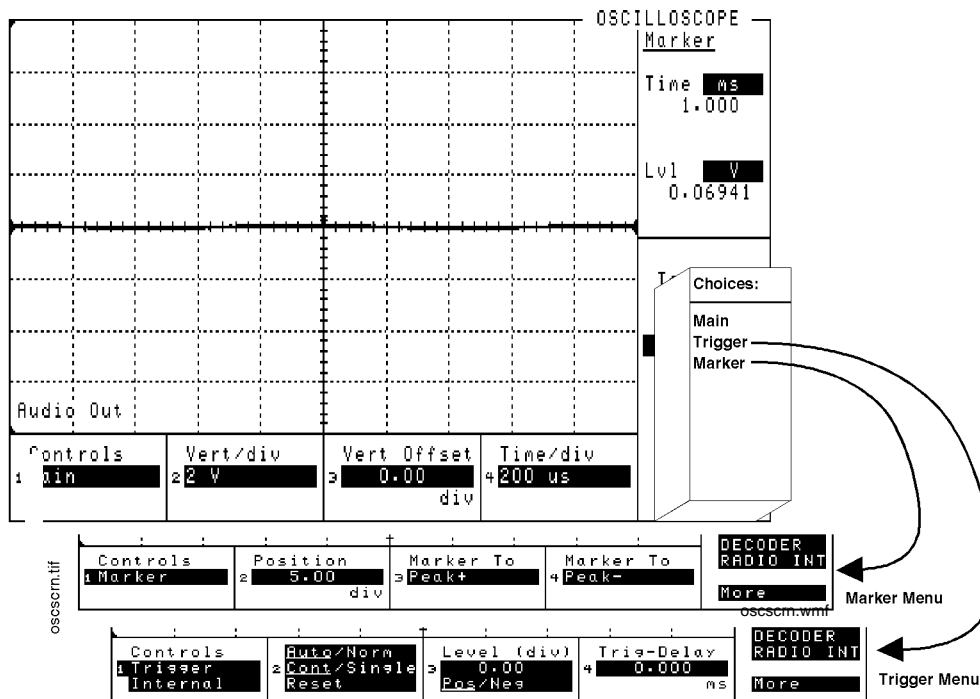

Figure 110 The Oscilloscope Screen and Menus

The OSCILLOSCOPE screen's controls are arranged by menu. The menus are accessed using the **Controls** field. The field descriptions are grouped by menu names.

Assigning global USER keys to the most-used functions on the menus allows you to access the functions without having to change menus during operation.

Oscilloscope Main Menu Fields

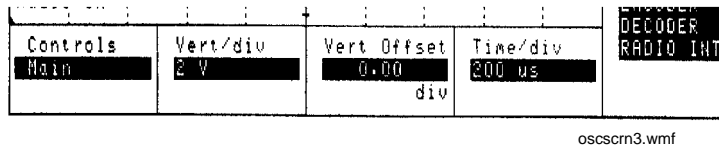

Figure 111 Oscilloscope Main Functions

Time/div

This field selects the horizontal sweep time per division.

Operating Considerations

The time-per-division is selected from a list of choices.

Vert Offset

Vertical offset moves the displayed signal above or below the oscilloscope's fixed centerline.

Operating Considerations

A centerline is displayed for the signal when an offset is used.

When the vertical offset is $\neq 0.00$, the marker level is referenced to the center line generated by the vertical offset feature, not the center line of the screen.

Vert/div

Vertical sensitivity sets the vertical amplitude per division.

Operating Considerations

The value for this field is selected from a list of choices.

Depending on the AF Analyzer's **AF An1 In** setting, the units for this field may be in Volts, kHz, or Percent (AM). For example; if the **AF An1 In** field is set to **FM Demod**, the amplitude is displayed in kHz/div.

Oscilloscope Marker Menu Fields

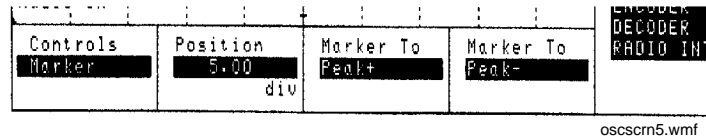

Figure 112 Markers on the Oscilloscope

How the Oscilloscope Displays Measurements

The digital oscilloscope screen is 417 pixels wide. Several measurement samples may be taken for each pixel as a signal is processed (at 100 ns/sample). The number of samples depends on the sweep speed (**Time/div**), and can vary from several thousand to one sample per pixel. The level displayed for each pixel is the average level of the sample or samples taken for each pixel.

Marker To:

Peak+ causes the marker to move to the maximum value of the *average* level measured on the display.

Peak- causes the marker to move to the minimum value of the *average* level measured on the display.

Because these functions look at the average value for each displayed pixel, the marker may not appear directly on the displayed peak of a noisy signal.

Position

This field indicates the number of scale divisions from the left side of the screen to the marker.

Use the DATA keys or cursor-control knob to move the marker to any point on the displayed signal.

Marker Measurements

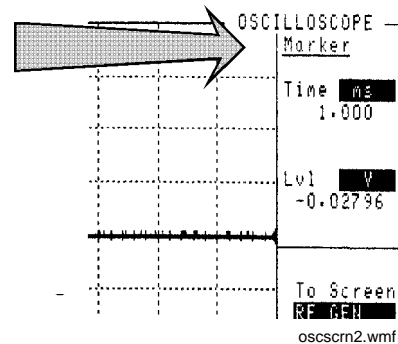

Figure 113 Reading Measurement Results at the Oscilloscope's Markers

Marker: Lvl

This measurement field displays the signal level of the current marker position.

Operating Considerations

The unit-of-measure for this field is dependent on the source of the signal being measured. For instance; when measuring a signal from the AUDIO IN connector, the amplitude is measured in Volts. When looking at a signal from the FM demodulator, the amplitude is given in units of kHz.

When the **vert Offset** field is $\neq 0.00$, the displayed marker level is referenced to the center line generated by the vertical offset feature, not the center line of the screen.

The REF SET function can be used with this measurement to display levels relative to a specific value. (See "[Setting A Measurement Reference](#)" on page 70.)

Marker: Time

This measurement displays the time elapsed from the trigger point to the current marker position.

The REF SET function can be used with this measurement to display time relative to a specific position. (See "[Setting A Measurement Reference](#)" on page 70.)

Oscilloscope Trigger Menu Fields

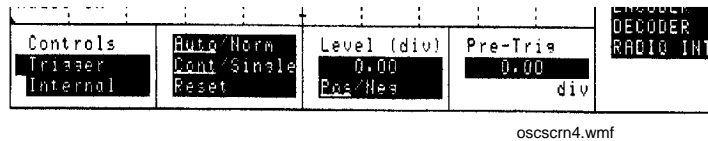

Figure 114 Oscilloscope Triggering

Internal

This field selects the trigger source.

- **Internal** uses the signal being displayed for triggering.
- **External** uses the rear-panel EXT SCOPE TRIGGER INPUT for triggering. This is a TTL level trigger (approximately 2.5 V).
- **ENCODER**¹ uses the signaling encoder for triggering. The encoder must be sending its signal to trigger the oscilloscope.

Auto/Norm

This field specifies how the trigger level is set.

- **Auto** automatically triggers if a triggering signal is not detected within approximately 50 ms of the last trigger.
- **Norm** requires a specific triggering signal before triggering.

Operating Considerations

Automatic triggering should be used for signals >20 Hz. Normal triggering should be used for signals ≤20 Hz.

Also, when measuring ≤1 Hz signals, you should set the **Scope To** field in the AF ANALYZER screen to **Input** to provide dc coupling to the oscilloscope's input.

1. Optional on some Test Set models.

Cont/Single

This field specifies whether the oscilloscope is continuously triggered (**Cont**), or if it is only triggered each time **Reset** is selected (**Single**).

Level (div)

This control is divided into two fields:

The upper field (**0.00**) sets the *internal* trigger level as a function of vertical divisions. The trigger level is indicated by small pointers that appear on each side of the screen (only used for internal triggering).

The lower field (**Pos/Neg**) specifies whether triggering happens when the waveform being measured is positive-going (**Pos**), or negative-going (**Neg**).

Pre-Trig

This field specifies the number of horizontal divisions displayed previous to the trigger point. It allows you to see what the signal looked like before the trigger point.

When pre-triggering is used, the trigger point is indicated by small pointers that appear at the top and bottom of the screen.

Reset

See the [Cont/Single field description, on page 451](#)

Using the Oscilloscope

Selecting the Oscilloscope's Input

The oscilloscope's input is determined by the **AF An1 In** field setting in the AF ANALYZER, TX TEST, or DUPLEX TEST screens.

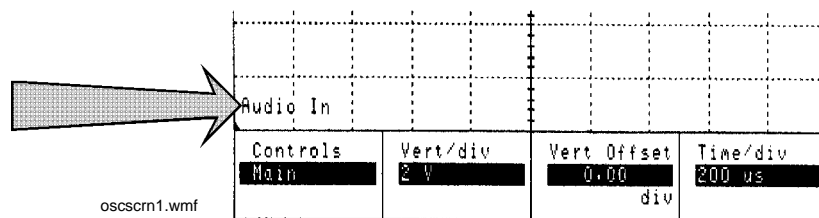

Figure 115 Oscilloscope Input Indicator

Using the Scope To Field

The **scope To** field in the AF ANALYZER screen allows you to look at the signal at different stages in the AF Analyzer's process. (Refer to the AF ANALYZER screen description to understand the different **scope To** choices.)

Except for the **Input** setting, all the choices are capacitively coupled. If the signal to be measured is ≤ 1 Hz, use the **Input** setting to provide the needed dc coupling.

Print Configure Screen

This screen configures the Test Set to print screen images with your printer. Images are printed using either the front-panel PRINT function (see “Printing a Screen” in volume 1) or the **Print All USER** key available on some TESTS environment screens.

Refer to your HP 11807 software manual for information on how to use your printer to print automated test results.

Field Descriptions

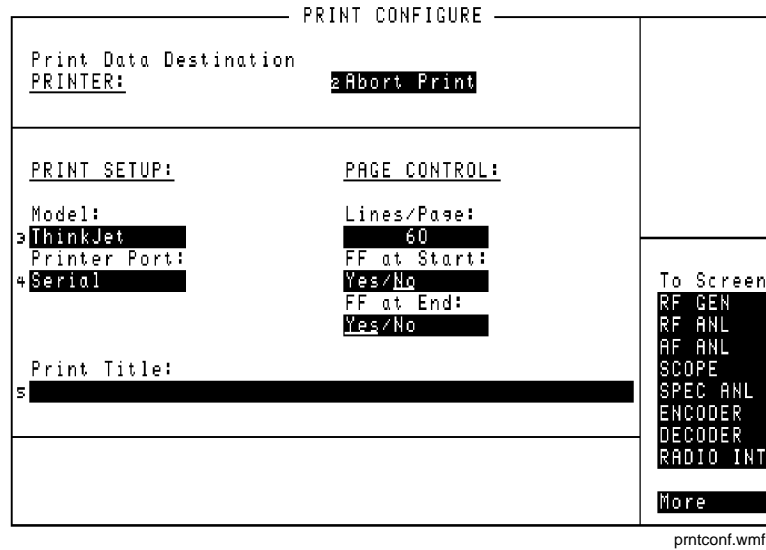

Figure 116 The Printer Configurations Screen

NOTE: This screen is displayed on HP 8920As only if your instrument has Option 103.

Abort Print

Select this field to interrupt the print in progress.

FF at End

This field can only be controlled programmatically. It is used to specify if you want a form feed at the end of printing.

FF at Start

This field can only be controlled programmatically. It is used to specify if you want a form feed at the start of printing.

Lines/Page

This field is used to specify how many lines are printed per page.

Model

This field is used to specify the type of printer used. If your printer is not listed in the **Choices** menu when you select this field, configure your printer to emulate one of those that is listed.

Printer Address

This field is used to specify the address of an HP-IB printer. This field is only displayed if the **Printer Port** field is set to HP-IB.

Print Data Destination

This field will be used in the future to select whether the data is formatted specifically for printers or for some other device (such as a computer). At this time the only selection is **Printer**.

Printer Port

This field is used to select the port your printer is connected to.

Print Title

This field is used to enter up to 50 characters to be displayed at the top of the print.

Radio Interface Screen

The RADIO INTERFACE screen controls the digital functions of the rear-panel RADIO INTERFACE parallel connector. A functional description of the radio interface, followed by field descriptions and operating instructions is included in this chapter. For more information see [chapter 24, "Connector, Key, and Knob Descriptions"](#) and the *Programmer's Guide*.

Radio Interface Functional Description

Data I/O

The rear-panel connector labeled OPTION INTERFACE is present on Test Sets with a Radio Interface board. This connector has 16 pins that are used for parallel data transfer between an external device and the Test Set's internal CPU.

The Radio Interface board includes 32 voltage comparators used for data input/output. Sixteen of the comparators have their outputs connected to the Radio Interface's 16 parallel data pins, and 16 comparators have their inputs connected to the Radio Interface's 16 parallel data pins.

Data transfer is asynchronous, meaning that each block of data is transferred after a key is pressed on the Test Set's front panel, or an HP-IB command is sent. Data transfer is also "half-duplex", meaning that data input and output cannot occur simultaneously.

The parallel output data lines are implemented using 16 LM339M open-collector voltage comparators with pull-up resistors provided on the Radio Interface board. The Radio Interface provides two methods for determining the logic level for data output:

1. Use the default (internal) power supply and internal pull-up resistors.
2. Use an external supply voltage connected to the internal pull-up resistors on the Radio Interface board.

These methods are described in "[Setting the Radio Interface's Logic Level](#)" on page 463.

The parallel input data lines are implemented using another 16, LM339M, open-collector voltage comparators. An external supply voltage can be used to provide the reference voltage to the comparators if the default supply is not compatible with the external device-under-test.

This procedure is also described in "[Setting the Radio Interface's Logic Level](#)" on page 463.

Audio Source

The Test Set has two audio sources, AFGen 1 and AFGen 2. Either or both of these sources can be routed to the OPTION INTERFACE connector. See ["Audio Out" on page 574](#).

Audio Analyzer

The Test Set's audio analyzer can be accessed through the OPTION INTERFACE connector.

See ["Audio Input" on page 574](#).

External Transmitter Key Relay

Two pins on the Radio Interface are connected in parallel with the Key Out 1 and Key Out 2 pins on the front-panel MIC/ACC connector.

The Key Out 1 and Key Out 2 pins allow a radio transmitter to be keyed through a front-panel display field called Ext TX Key. Refer to ["Key Out 1" on page 574](#) and ["Key Out 2" on page 574](#).

Interrupt Capability

Two pins on the Radio Interface are designated as Interrupt lines 1 and 2. If Interrupt 1 or 2 is armed, by selecting Arm on the RADIO INTERFACE screen, and the corresponding pin is grounded, the word **Tripped** is displayed on the RADIO INTERFACE screen, and a status register bit is set.

Refer to ["Interrupt Input 1" on page 575](#) and ["Interrupt Input 2" on page 575](#).

+12.6 V, -12.6 V Supplies

The Radio Interface provides +12.6 V and -12.6 V power supplies capable of powering low-current devices.

Refer to ["-12.6 V" on page 574](#), and ["+12.6 V" on page 574](#).

Refer to ["Using the Radio Interface \(Manual Operation\)" on page 463](#) and ["Using The Radio Interface \(Remote Operation\)" on page 469](#) for more detailed information about using the Radio Interface.

Field Descriptions

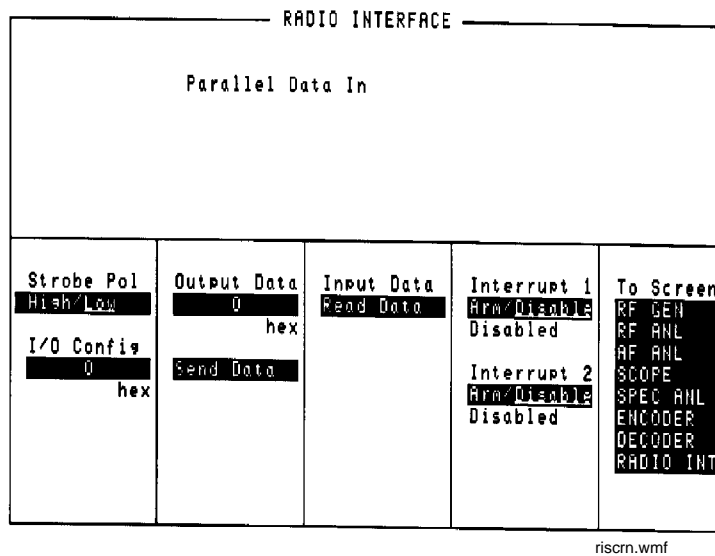

Figure 117 The Radio Interface Screen

Input Data

This field trips the Test Set to latch the data on the parallel data pins that have been designated as inputs.

Interrupt 1

This field arms or disarms the Interrupt 1 pin. When it is armed, and the pin is pulled low by an external device, **Tripped** is displayed below the field until the interrupt is re-armed.

Operating Considerations

The field can be queried directly in an IBASIC or HP-IB program, or it can be monitored with the HP-IB status reporting system. This is done by reading bit 5 of the status byte and then reading bit 13 of the Hardware 1 status register. The Interrupt 1 pin can also be set as the HP-IB SRQ mask.

Once the interrupt has been tripped it must be re-armed. To do this, remove the low on the Interrupt 1 pin and then set the **Interrupt 1** field to **Disable** and then set it to **Arm**.

Interrupts can be disabled and any external signals will have no effect on the interrupt.

Both Interrupt 1 and Interrupt 2 are independent, and they can be used simultaneously.

See also

Programmer' Guide

Interrupt 2

Same as **Interrupt 1** but, it applies to the Interrupt 2 pin on the RADIO INTERFACE connector and bit 14 of the Hardware 1 status register.

I/O Config

This field designates which of the 16 parallel data pins will be used as inputs. Pins designated as inputs are pulled high internally. They can be left high for a logic 1 or pulled low for a logic 0.

Operating Considerations

A hexadecimal number that can range from 0000 to FFFF is entered in this field. Hex 0000 designates no pins as inputs, while hex FFFF designates all 16 pins as inputs.

To determine the number, convert the input pin's binary weight to hexadecimal, then add. Pin 19, D0, is the least significant bit. For example, if D0 through D7 are to be inputs and D8 through D15 are outputs the number to enter would be 00FF.

Output Data

This field sets the data to be output on the parallel data lines.

Operating Considerations

The data is entered as a hexadecimal number that can range from 0000 to FFFF. To determine the number, convert the binary weight of the pins that you want to set high to hexadecimal, then add. Pin 19, D0, is the least significant bit. For example 0008 would set pin 22, D3, high and the rest of the pins low.

The field will show the entered value but the pins don't change until the **Send Data** field is selected.

Parallel Data In

This field displays the value on the parallel data pins when the **Parallel Data In** field is selected. The data appears in bitwise fashion with the 16 bits organized from MSB to LSB.

Send Data

When selected, this field clocks the data in the **Output Data** field to the parallel data pins. It also outputs a pulse on the Strobe pin.

Strobe Pol

The strobe polarity field sets the polarity of the pulse on the Strobe pin. This pulse occurs when the **Send Data** field is selected.

Using the Radio Interface (Manual Operation)

CAUTION: Do not connect a voltage source in excess of -0.3 V (for example, -0.4 V) to any Parallel Data pin. Also, do not connect a voltage source that exceeds 5.7 V, unless the logic voltage has been set to a level other than the default. If the logic voltage has been set to some value other than the default of 5.1 V, the maximum voltage that can be applied is the logic voltage plus 0.6 V. Refer to "[Setting the Radio Interface's Logic Level](#)" on page 463.

Setting the Radio Interface's Logic Level

The logic levels on the parallel data bus are determined by the Logic Voltage. The two choices for the Logic Voltage are 5.1 V from the default (internal) Logic Voltage supply, or 5.1 V to 20 V from an external power supply.

The Logic Voltage affects both the input and output logic levels on the Radio Interface board. When data is output, the logic-high voltage level will be determined by the Logic Voltage applied through internal 3.16 k-ohm pull-up resistors. When data is input, the voltage comparator's reference voltage is determined by the Logic Voltage applied to a resistive divider. The formulas for calculating logic levels are shown below. The default values are calculated in the examples, and if these are not compatible with the device that is sending/receiving data, connect an external power supply to pin 9. At levels above $+5.1$ V, the external power supply will reverse bias a steering diode and "turn off" the default Logic Voltage. See [figure 118 on page 464](#).

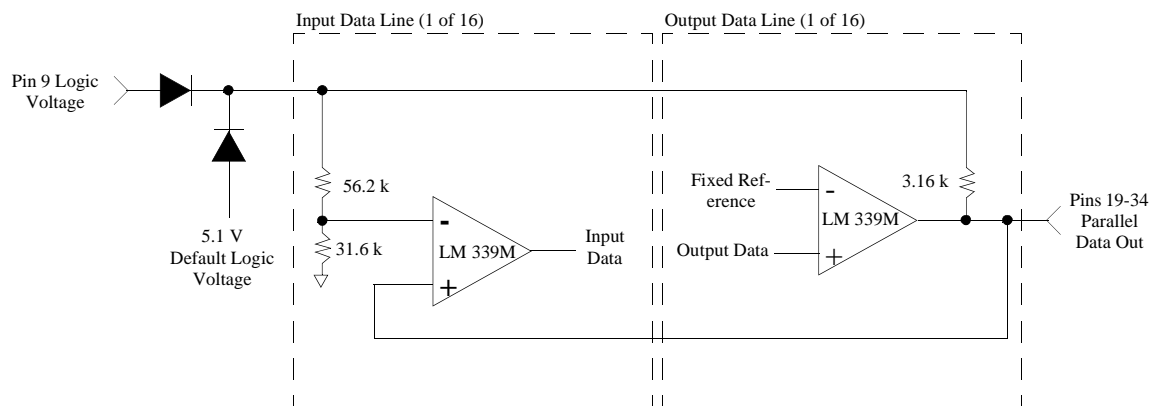

Figure 118

For data input, use the following formula to determine the logic threshold voltage:

$$(\text{Logic Voltage} - 0.7) \times 0.34 = V_{\text{threshold}}$$

For example, the default Logic Voltage of 5.1 V would give:

$$4.4 \times 0.34 = 1.5 \text{ V}$$

A 12.5 V supply connected to the Logic Voltage pin 9 would give:

$$11.8 \times 0.34 = 4 \text{ V}$$

For data output, calculate the logic high level using this formula:

Logic Voltage - 0.7 through a 3.16 k ohm pull-up resistor.

A logic low on the data output will be near 0 V, depending on the amount of current the comparator is sinking. For example, if the output current is 4 mA, the output voltage will be about 250 mV.

Inputting Data

Data can only be input through parallel data bus lines that are configured as inputs. Data bus lines are configured as inputs by setting the output comparators to their logic-high states (positive output level). This is best accomplished by entering a hex value in the **I/O Config** field that will set the corresponding bit(s) to a 1. For example, if you want to use lines 0-7 for input and lines 8-15 for output, enter 00FF (which would be 0000000011111111 in binary) in the **I/O Config** field.

To read data to the Test Set's internal CPU, select the **Read Data** field on the RADIO INTERFACE screen. A 16-bit binary value will be displayed under the **Parallel Data In** field near the top of the screen.

Important: When data is read, the **Parallel Data In** field will display the value for all 16 parallel data bus lines, not just the lines designated as inputs.

See the [I/O Config field description, on page 462](#).

The need for configuring pins as inputs is a result of the “half-duplex” hardware architecture of the bus. The 16 I/O pins on the parallel data bus are connected to both the input data comparators and the output data comparators. Because the output comparators are open-collector, a logic low makes it impossible to input a logic high, since the output transistor is essentially clamped to ground.

NOTE:

A logic “OR” function is implemented in the Radio Interface design between **I/O Config** field and the **Send Data** the. Entering a hex value in the **I/O Config** field writes that value to the output data lines, just as selecting **Send Data** writes the value entered in the **Output Data** field to the output data lines. The effect of this operation is that it will not be possible to use the **Output Data** field to set a parallel data bus line low if that line has been designated as an input by the value entered in the **I/O Config** field.

The fastest rate at which input data can change is about 50 kHz. The practical limits on data transfer, however, are based on the speed of the IBASIC or external controller program since all data transfer is asynchronous.

Outputting Data

Outputting data is accomplished by entering the appropriate hex value in the **Output Data** field, and then selecting the **Send Data** field.

The output data value can be incremented or decremented by turning the cursor control knob with the **Output Data** field highlighted.

The output data lines are implemented by open-collector output voltage comparators. Sending a logic 0 causes active pull-down through a transistor in the voltage comparator. Sending a logic 1 causes passive pull-up through a pull-up resistor.

Variations in the Logic Voltage can be used to provide logic levels compatible with the radio-under-test. See "[Setting the Radio Interface's Logic Level](#)" on page 463.

The data transfer rate for data output is primarily determined by the speed of the IBASIC or external program, not the ability of the Test Set's internal CPU to access and output the data on the parallel lines, or the output loading capacitance. (If loading capacitance is below 158 pF, the Test Set's CPU can send data at about 200 Kb/s. The time for a program line to execute is typically greater than this).

The Parallel Strobe Out, pin 13, can be used to signal when output data has been clocked onto the parallel data bus. The front-panel RADIO INTERFACE screen allows the choice of strobe polarity through the **Strobe Pol** field. As with the parallel data outputs, the Parallel Strobe Out logic threshold is determined by the Logic Voltage. Although the edges of Parallel Strobe Out and data output occur at approximately the same time, an external device should latch on the Strobe Pol trailing edge, or better yet, the Strobe Pol level. This will allow sufficient time for output data to settle. Refer to [figure 119 on page 467](#)

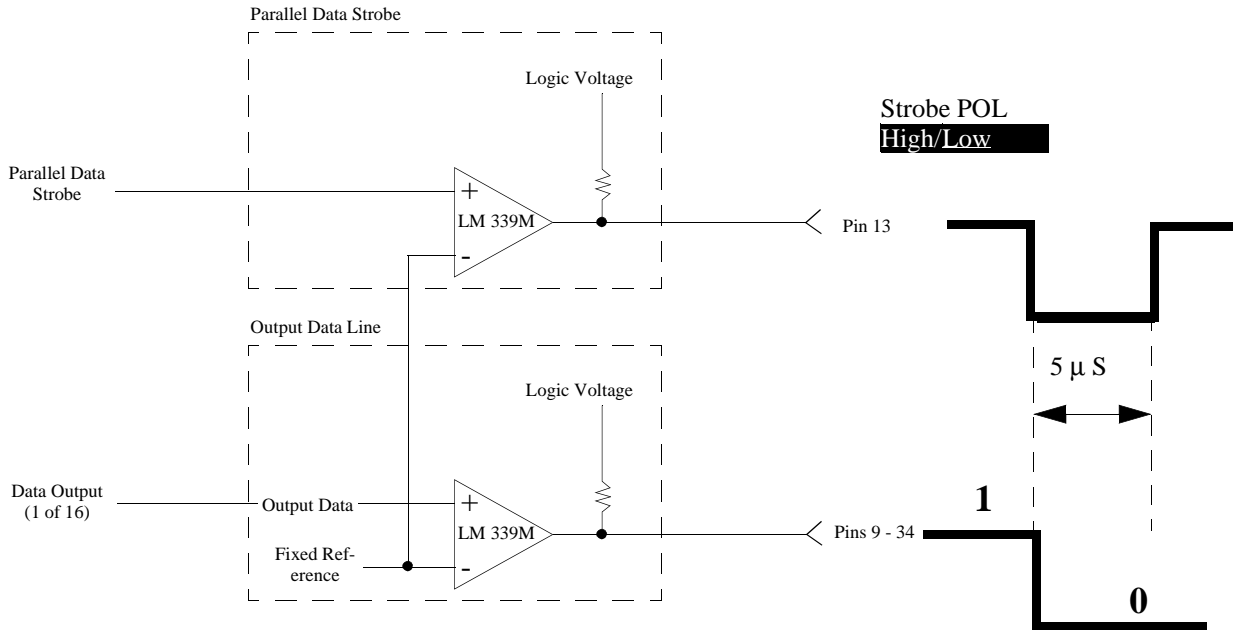

External device should latch data on Strobe POL Level to allow Output Data time to settle.

Figure 119

The **I/O Config** field will also output data to the output data line comparators. The **I/O Config** field, however, is primarily intended to configure parallel data lines as inputs or outputs. See the [Input Data field description, on page 460](#).

Using Interrupts

There are two interrupt lines that, when armed, allow monitoring of interrupt conditions. An interrupt is tripped when a logic low, determined by the same Logic Voltage as described in "[Setting the Radio Interface's Logic Level](#)" on page 463, is detected. When tripped, the field directly below **Arm/Disable** will change from **Armed** to **Tripped**. To re-arm the next interrupt you must first disable the interrupt, then select **Arm**.

Besides displaying the word **Tripped**, an interrupt condition will set a bit in one of the Test Set's status registers. This makes it possible to generate SRQ interrupts or query a condition register to find out if an interrupt has occurred. Refer to "[Using The Radio Interface \(Remote Operation\)](#)" on page 469.

Using The Radio Interface (Remote Operation)

CAUTION: Do not connect a voltage source in excess of -0.3 V (for example, -0.4 V) to any Parallel Data pin. Also, do not connect a voltage source that exceeds 5.7 V, unless the logic voltage has been set to a level other than the default. If the logic voltage has been set to some value other than the default of 5.1 V, the maximum voltage that can be applied is the logic voltage plus 0.6 V. Refer to "[Setting the Radio Interface's Logic Level](#)" on page 463.

HP-IB Command Summary

The HP-IB command mnemonics can be found in the Programmer's Guide, under Radio Interface.

Inputting Data over HP-IB

Use the following commands to configure the eight least significant parallel data bus lines as inputs by writing logic 1's to them.

```
DISP RINT;RINTerface:PARAllel:CONFIgure #HFF (hex)
```

or

```
DISP RINT;RINTerface:PARAllel:CONFIgure 255 (decimal)
```

Use the following command to read the data on the parallel bus to the Test Set's internal CPU.

```
DISP RINT;RINTerface:PARAllel:INPut:READ
```

Use the following command to query the data read by the READ command.

```
DISP RINT;RINTerface:PARAllel:INPut:DATA?
```

If the output data lines are zero, and none of the input data lines are pulled low, the value returned by the previous command will be 255 (decimal). Remember that data lines not configured as inputs will still be displayed, and the value returned will be the previous query will include all 16 data lines, some of which may be configured as outputs.

Outputting Data over HP-IB

Use one of the following commands to output 1's to the 8 most significant bits on the parallel data bus.

```
DISP RINT;RINterface:PARAllel:OUTPut 65280 ;SEND (decimal)
```

or

```
DISP RINT;RINterface:PARAllel:OUTPut #HFF00;SEND (hex)
```

Using Interrupts over HP-IB

Use the following command to arm Interrupt 1.

```
DISP RINT;RINterface:INTerrupt1 'ARM'
```

Use the following command to disarm Interrupt 1.

```
DISP RINT;RINterface:INTerrupt1 'DISARM'
```

Interrupt 1 and Interrupt 2, when armed, will set bits in the Hardware Status Register #1 Group. An SRQ interrupt can be generated when either of these interrupts is tripped, or the Condition register can simply be read to see if a bit was set. Refer to the Programmer's Guide for details and an example program showing how to set up an SRQ interrupt.

RF Analyzer Screen

Block Diagram

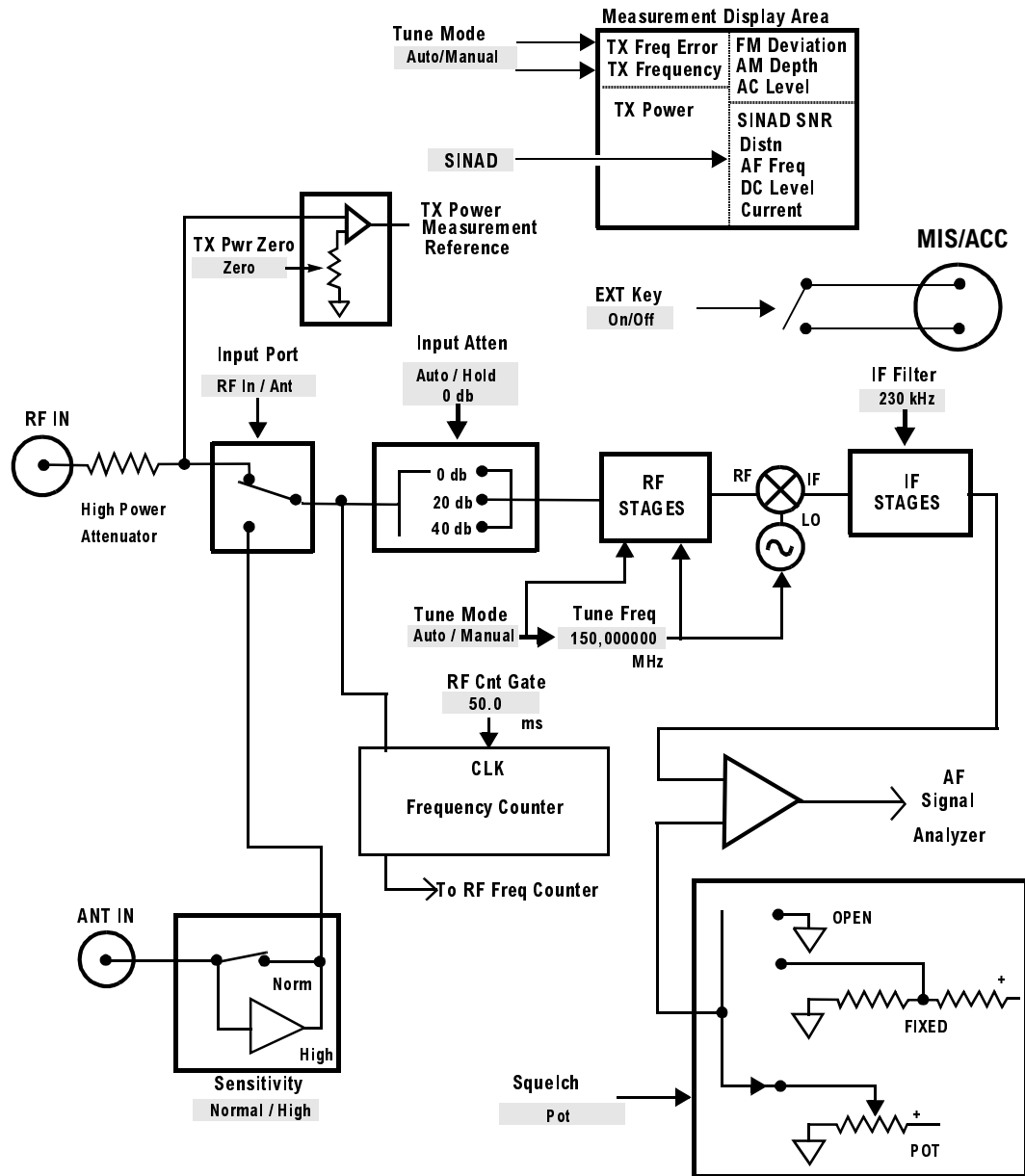

Figure 120 RF ANALYZER Functional Block diagram

Field Descriptions

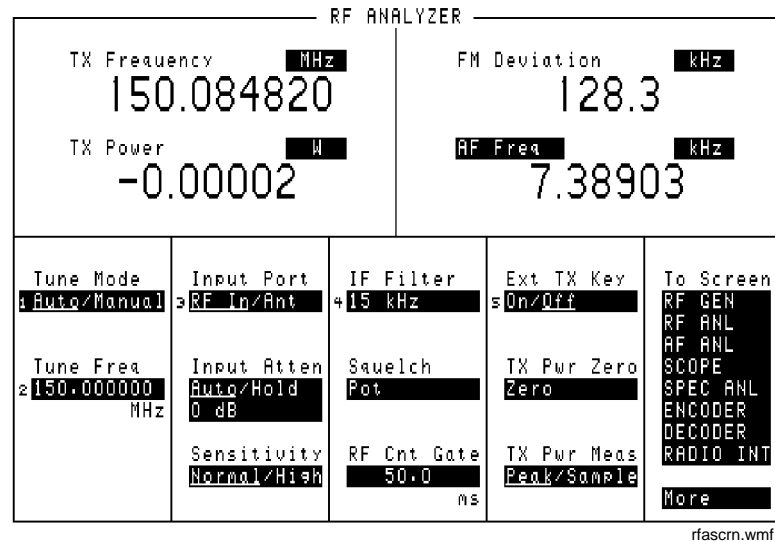

Figure 121 The RF Analyzer Screen

AC Level

This is the default measurement for this field. The type of measurement listed here is dependent on the **AF An1 In** settings.

See Also

- [AC Level1 field description, on page 496](#)
- [AF An1 In field description, on page 101](#)
- ["Displaying Measurements" on page 57](#)

AM Depth

This field displays the percent depth of modulation of the AM signal. The field is only visible when the **AF ANL In** field on the AF ANL screen is set to **AM MOD** or **AM DEMOD**.

Ext TX key

This field controls a switch at the MIC/ACC connector. Its intended use is to “key” an external transmitter.

See Also

["MIC/ACC" on page 568](#)

Distn

This field displays the percent of distortion for a 1 kHz signal tone.

FM Deviation

This measurement field displays the frequency deviation between the FM signal and the carrier. The FM Deviation measurement field is only displayed when the **AF An1 In** field is set to **FM Demod** or **FM Mod**.

See Also

[AF An1 In field description, on page 101](#)
["Displaying Measurements" on page 57](#)

IF Filter

This field selects the desired IF Filter bandwidth for modulated signals being analyzed.

Input Atten

Input attenuation sets the amount of input attenuation for the RF IN/OUT and ANT IN connectors. This function controls two settings:

- The upper field determines if you want the instrument to set the attenuation automatically (**Auto**), or if you want to set the value manually (**Hold**).
- The lower field displays the present attenuation value, and it is used to set the desired attenuation level when the upper area is set to **Hold**.

NOTE:

Oscilloscope and Decoder Interference. After a signal is input, the RF autoranging function (**Auto**) takes a small amount of time to determine the required input attenuator setting. If your transmitter begins sending encoded information the instant it transmits, the initial encoded information may not be decoded during the autoranging process. The same situation can arise when trying to display the first part of the demodulated signal on the Oscilloscope.

When decoding a signaling sequence using the decoder, or when trying to capture the initial modulation waveform of a signal on the Oscilloscope, set the upper field to **Hold** and set the lower field to an appropriate level for the signal being decoded (start with 40 dB).

Input Port

This field selects the RF IN/OUT or ANT IN port for making RF measurements. The RF IN/OUT port must be used for making **TX Power** measurements on this screen.

Operating Considerations

Maximum signal levels at each port are printed on the front panel.

If the RF power at the RF IN/OUT port exceeds allowable limits, a loud warning signal sounds and a message appears at the top of the screen. If this occurs, disconnect the RF power, press [MEAS RESET], and allow the Test Set to cool off for approximately 2 minutes before making any other measurements on this port.

The ANT IN (antenna input) connector provides a highly-sensitive input for very low-level signals (such as “off the air” measurements). You cannot measure TX (RF) Power on this screen using the antenna port. However, low-level RF power at the antenna port can be measured using the Spectrum Analyzer.¹

CAUTION: Connecting a signal of >200 mW to the ANT IN port can cause instrument damage (although internal protection circuits can typically withstand a short-duration signal of 1 or 2 Watts).

If the over-power circuit is triggered (signified by a warning message at the top of the screen), remove the signal from the ANT IN port, and press [MEAS RESET] or turn the Test Set off and on to reset it.

1. Spectrum Analyzer is optional on some Test Set models.

RF Cnt Gate

RF counter gate specifies how long the RF counter samples the signal before displaying the frequency. Specifying a shorter gate time may enable you to see frequency fluctuations that might not be seen using a longer gate time.

Sensitivity

RF Analyzer sensitivity adds about 6 dB of sensitivity for the ANT IN port when **High** is selected.

Operating Considerations

Selecting **High** sensitivity may cause Spectrum Analyzer¹ measurements to be uncalibrated when the ANT IN port is used (a message appears when this occurs).

High-level AM measurements may be distorted when high sensitivity is used with the ANT IN port.

Squelch

This setting determines the squelch operation when demodulating FM, AM or SSB signals. Three settings are available:

- **Pot** uses the front-panel SQUELCH knob for squelch level adjustment.
- **Open** disables squelch operation.
- **Fixed** sets the squelch to a fixed level, disabling the front-panel SQUELCH knob control.

Operating Considerations

Most measurement processes on this screen are not displayed if the incoming signal falls below the squelch level (with the exception of **TX Power**). The measurements are replaced by four dashes (- - -) to indicate they have been 'squelched'.

The decoder and Oscilloscope measurements are also disabled when the signal has been squelched.

Spectrum Analyzer measurements are not affected by the squelch setting (although squelch still affects whether the demodulated signal can be heard while viewing the RF signal).

1. Optional on Test Sets

Trying to read a squelched measurement using HP-IB will cause your program to halt until the squelch is either turned down, a measurement is made, or until a program time-out aborts the measurement process.

SINAD

This is the default measurement for this field. Selecting this field displays the following measurement choices:

SINAD
Distortion
SNR (Signal to Noise Ratio)
AF Frequency
DC Level

Current - DC only ¹Operating Considerations

This is a priority control field. Accessing the RX TEST or TX TEST screen overrides any changes made to this field in other screens.

SNR Operation

- Selecting SNR turns off the other audio measurements.
- The RF Generator and AFGen1 must be set up to provide the radio's carrier. (AFGen1 is automatically turned on and off repeatedly during this measurement.)
- AFGen2 must be turned off.
- The radio's receiver's audio output must be connected to the AUDIO IN port (set the **AF An1 in** field to **Audio In**).

See Also

["Interaction Between Screens" on page 54](#)

["Displaying Measurements" on page 57](#)

1. The Test Set requires Current Measurement option.

Tune Freq

RF Analyzer tune frequency sets the center frequency for the RF signal to be analyzed.

See Also

[Tune Mode field description \(this page\)](#)

Tune Mode

This field selects automatic or manual tuning of the RF Analyzer.

Auto causes the RF Analyzer to find the signal with the greatest amplitude >-36 dBm, and set the tune frequency for that signal.

Manual requires the operator to set the tune frequency for the RF signal to be analyzed.

Operating Considerations

Changing the **Tune Mode** also changes the RF frequency display. Automatic tuning enables the **TX Frequency** measurement. Manual tuning enables the **TX Freq Error** measurement.

After autotuning to the desired signal, select **Manual** to prevent the **Tune Freq** from changing when the signal is no longer applied.

TX Freq Error/TX Frequency

This measurement area is used to display transmitter frequency error or transmitter frequency.

See Also

[Tune Mode field description \(this page\)](#)

TX Power

Transmitter power measures RF power at the RF IN/OUT port.

Operating Considerations

Maximum signal levels at each port are printed on the front panel.

Only the RF IN/OUT port can be used for measuring TX power on this screen. When the **Input Port** is set to **Ant**, four dashes (- - -) appear in place of digits for this measurement.

Use the Spectrum Analyzer¹ to measure low-level RF power (≤ 200 mW) at the ANT IN port.

CAUTION: Connecting a signal of >200 mW to the ANT IN port can cause instrument damage (although internal protection circuits can typically withstand a short-duration signal of 1 or 2 Watts).

If the overpower circuit is triggered (signified by a warning message at the top of the screen), remove the signal from the ANT IN port, and press [MEAS RESET] or turn the Test Set off and on to reset it.

See Also

[Input Port field description, on page 476](#) (Operating Considerations)

[TX Power field description \(this page\)](#)

[TX Pwr Zero field description, on page 480.](#)

TX Pwr Zero

The transmitter power zero function establishes a 0.0000 W reference for measuring RF power at the RF IN/OUT port.

RF power must not be applied while zeroing. Set the **RF GENERATOR** screen **Amplitude** field to off to prevent internal cross-coupling into the power detector while zeroing.

Operating Considerations

When power is applied to the RF IN/OUT connector, the temperature of the internal circuitry increases. This can cause changes in the **TX Power** measurement when low power levels are measured immediately following high power measurements.

1. Spectrum Analyzer is optional on some Test Set models.

When alternately making high and low power measurements, always zero the power meter immediately before making the low power measurements to provide the best measurement accuracy.

Chapter 17, RF Analyzer Screen
Field Descriptions

RF Generator Screen

Block Diagram

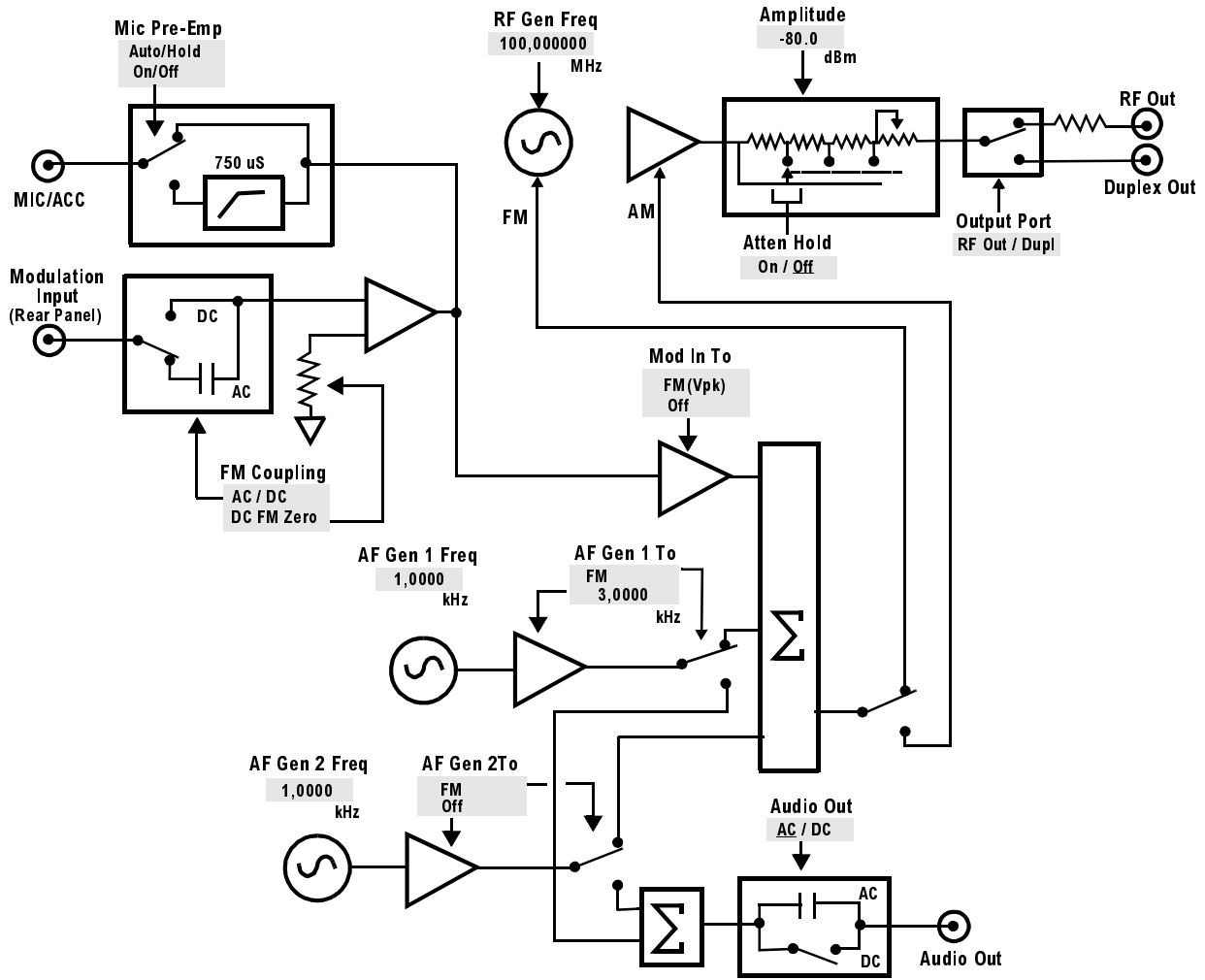

Figure 122 RF GENERATOR Functional Block Diagram

Field Descriptions

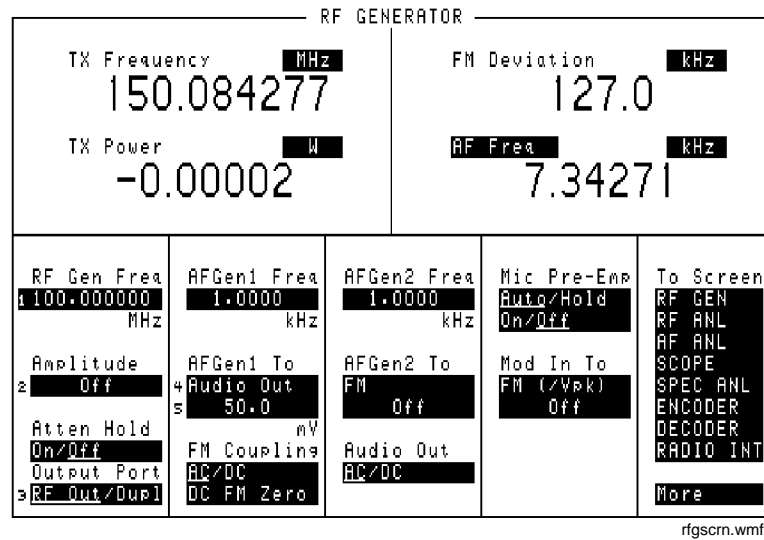

Figure 123 The RF Generator Screen

AC Level

This measurement displays either rms potential (voltage) or audio power (Watts or dBm).

Operating Considerations

When the unit-of-measure is changed to measure AF power, the external load resistance must be specified. (Refer to the [Ext Load R field description, on page 498.](#))

The input for the ac level measurement on this screen is always the AUDIO IN connectors.

See Also

["Entering and Changing Numbers" on page 63](#)

AFGen1 Freq

This Audio Frequency Generator control sets the frequency for the first audio frequency sinewave generator.

AFGen2 Freq

This Audio Frequency Generator control sets the frequency for the second audio frequency sinewave generator. It can also be used to set the Function Generator's frequency when the signaling encoder is used.

This field is also used to control the send/stop functions for some encoder modes. For example, when sending a tone sequence, this field is used to send and stop the sequence. The field's name changes to **AFGen2** when this type of operation is used.

This field is removed from this screen when NMT encoding or decoding is used. (NMT programs can only be run from the NMT Decoder screen.)

See Also

[Chapter 10, "Signaling Encoder \(AF Generator 2\)"](#)

AFGen1 To

This Audio Frequency Generator control is used to set two values:

- The upper field determines whether the AF signal modulates the RF Generator, or is output through the AUDIO OUT connector.
- The lower field sets the amplitude (including **Off**). The level at the AUDIO OUT connector is always in volts rms across a low-impedance output.

Operating Considerations

This is a priority control field. Accessing the RX TEST or TX TEST screen overrides any changes made to this field in other screens.

See Also

["Interaction Between Screens" on page 54](#)

AFGen2 To

This Audio Frequency Generator control is used to set two values:

- The upper field determines whether the AF signal modulates the RF Generator, or is output through the AUDIO OUT connector.
- The lower field sets the amplitude (including **Off**). The level at the AUDIO OUT connector is always in volts rms for standard *sinewave* operation across a low-impedance output.

If the signaling option is installed, the sinewave can be set in units of rms or peak. This is done in the **Sine Units** field for the Function Generator. When non-sinewave waveforms are used, or if the upper field is set to AM or FM, the level is always expressed as a peak value.

See Also

["Function Generator Encoder" on page 393.](#)

Amplitude

RF Generator amplitude adjusts the amplitude of the RF Generator.

Operating Considerations

This is a priority control field. Accessing the RX TEST or TX TEST screen overrides any changes made to this field in other screens.

If a microphone is connected, and the amplitude is off, keying the microphone causes the Amplitude to turn on to its previous level until the microphone is no longer keyed.

See Also

["Interaction Between Screens" on page 54](#)

Atten Hold

Attenuator hold prevents the fixed RF output attenuators from switching in and out, eliminating the loss of the output signal as the level is changed. This function is helpful when making squelch measurements.

Operating Considerations

When this function is set to **On**, the RF output level is restricted to a range above and below the present **Amplitude** setting. Attempting to set an amplitude outside the allowed range results in an error message and beep (if the beeper is on). RF output level accuracy is greatly degraded outside the allowed range.

Audio Out

Audio output coupling selects ac or dc coupling to the AUDIO OUT connector.

FM Coupling

These fields provide two functions:

- The upper field specifies ac or dc coupling between the MODULATION INPUT connector and the RF Generator's FM modulator. This field also alters the FM modulator to allow DCFM from internal and external modulation sources.
- Selecting the lower field causes the instrument to offset any dc bias that may exist when dc coupling is selected.

Mic Pre-Emp

Microphone pre-emphasis determines whether the modulating signal from the MIC/ACC connector goes through or bypasses the 750 ms pre-emphasis network. Two fields are used:

- The upper field is used to specify whether you want the instrument to automatically turn pre-emphasis on during FM operation and off for other modulations (**Auto**), or to leave the pre-emphasis switching to the user's operation (**Hold**).
- The lower field tells you whether pre-emphasis is on or off (when **Auto** operation is selected), or allows you to manually turn pre-emphasis on or off (if **Hold** is selected).

Mod In To

This modulation input field defines how an external modulation source is used with the RF Generator. Two fields are used:

- The upper field determines whether the rear-panel MODULATION INPUT signal is set for AM or FM modulation of the RF GENERATOR.
- The lower field sets the modulation sensitivity. For instance, if **FM (/Vpk)** is selected for the upper field, and you set the lower field to **1.0000 kHz**, the RF Generator will deviate 1 kHz for every 1 Volt peak at the MODULATION INPUT connector.

In addition, the peak deviation produced by MIC signals will be approximately 1 kHz.

Output Port

Output port selects the desired RF Generator output port.

Operating Considerations

Maximum signal levels at each port are printed on the front panel.

CAUTION:

Applying reverse RF power to the DUPLEX OUT connector can damage the instrument. (A message is displayed when an overpower conditions occurs.) Whenever possible when testing transceivers, use the RF IN/OUT connector to prevent damage from accidental transmitter keying.

If a reverse power condition triggers the internal protection circuit, remove the reverse power signal and press the MEAS RESET key, or turn the Test Set off and on to reset it.

RF Gen Freq

This field sets the RF generator's frequency.

SINAD

This is the default measurement for this field. Selecting this field displays the following measurement choices:

SINAD
Distortion
SNR (Signal to Noise Ratio)
AF Frequency
DC Level

Current - DC only¹ Operating Considerations

This is a priority control field. Accessing the RX TEST or TX TEST screen overrides any changes made to this field in other screens.

SNR Operation

- Selecting SNR turns off the other audio measurement.
- The RF Generator and AFGen1 must be set up to provide the radio's carrier. (AFGen1 is automatically turned on and off repeatedly during this measurement.)
- AFGen2 must be turned off.
- The radio's receiver's audio output must be connected to the AUDIO IN port (set the **AF An1 In** field to **Audio In**).

See Also

["Interaction Between Screens" on page 54](#)

["Displaying Measurements" on page 57](#)

1. The Test Set requires Current Measurement option.

TX Freq Error TX Frequency

This measurement displays transmitter frequency error or absolute transmitter frequency.

See Also

[Tune Mode field description, on page 351](#)
["Displaying Measurements" on page 57](#)

TX Power

Transmitter power measures RF power at the RF IN/OUT port.

Operating Considerations

Maximum signal levels at each port are printed on the front panel.

Only the RF IN/OUT port can be used for measuring TX power on this screen. When the **Input Port**¹ is set to **Ant**, four dashes (- - - -) appear in place of digits for this measurement.

Use the Spectrum Analyzer² to measure low-level RF power (≤ 200 mW) at the ANT IN port.

CAUTION:

Connecting a signal of >200 mW to the ANT IN port can cause instrument damage (although internal protection circuits can typically withstand a short-duration signal of 1 or 2 Watts).

If the overpower circuit is triggered (signified by a warning message at the top of the screen), remove the signal from the ANT IN port, and press the MEAS RESET key or turn the Test Set off and on reset it.

See Also

[TX Power field description, on page 480](#)
[TX Pwr Zero field description, on page 480](#)

1. The **Input Port** field is accessed on the TX TEST, DUPLEX TEST, and RF ANALYZER screens.
2. Spectrum Analyzer is optional on some Test Set models.

RX Test Screen

Block Diagram

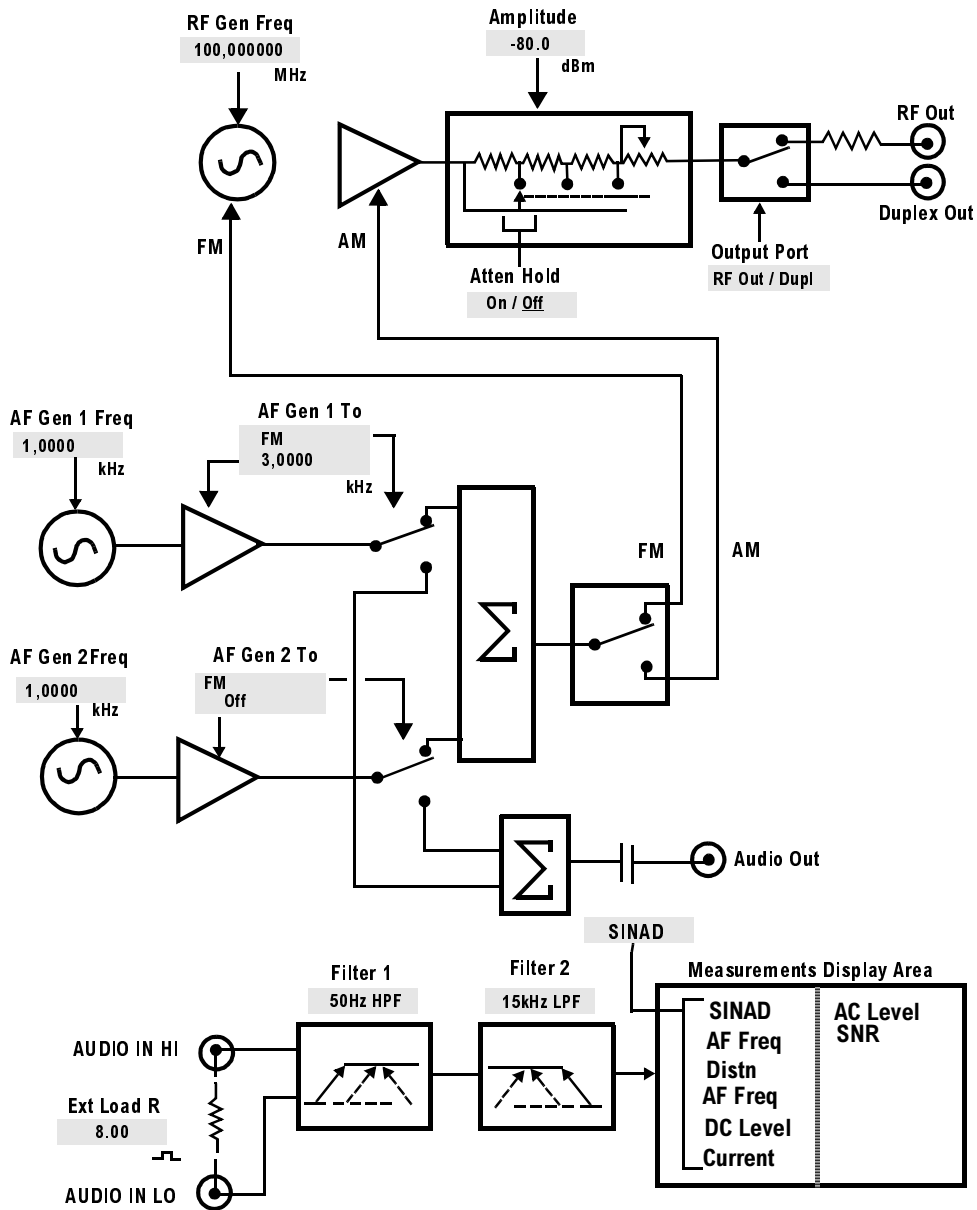

Figure 124 The RX Test Fields and Their Functions

Field Descriptions

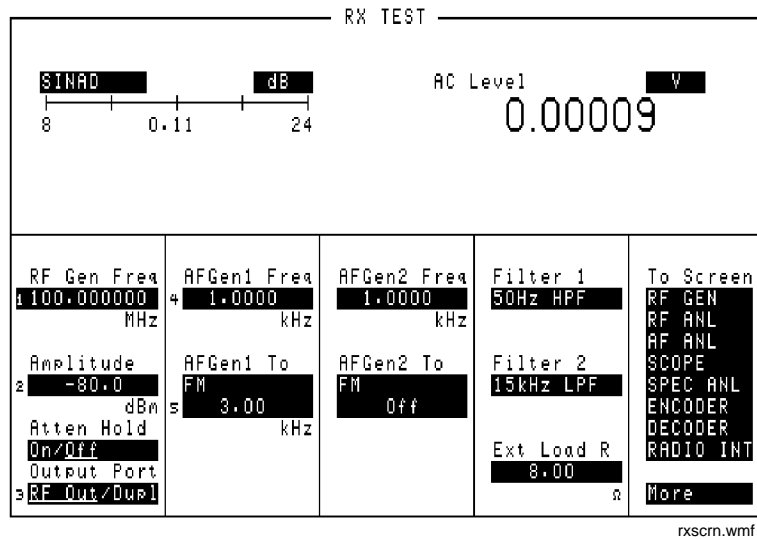

Figure 125 The RX Test Screen

NOTE: Since most of the measurements displayed are dependent on different field settings, the settings and values shown in the diagrams use the Test Set's preset conditions.

AC Level

This measurement displays either rms potential (voltage) or audio power (Watts or dBm).

Operating Considerations

When the unit-of-measure is changed to measure AF power, the external load resistance must be specified. (Refer to the [Ext Load R field description, on page 498.](#))

The input for the ac level measurement on this screen is always the AUDIO IN connectors.

See Also

["Entering and Changing Numbers" on page 63](#)

AFGen1 Freq

This Audio Frequency Generator control sets the frequency for the first audio frequency sinewave generator.

AFGen2 Freq

This Audio Frequency Generator control sets the frequency for the second audio frequency sinewave generator. It can also be used to set the Function Generator's frequency when the signaling encoder is used.

This field is also used to control the send/stop functions for some encoder modes. For example, when sending a tone sequence, this field is used to send and stop the sequence. The field name changes to **AFGen2** when this type of operation is used.

This field is removed from this screen when NMT encoding or decoding is used. (NMT programs can only be run from the NMT Decoder screen.)

See Also

[Chapter 10, "Signaling Encoder \(AF Generator 2\)".](#)

AFGen1 To

This Audio Frequency Generator control is used to set two values:

- The upper field determines whether the AF signal modulates the RF Generator or is output through the AUDIO OUT connector.
- The lower field sets the amplitude (including **OFF**). The AUDIO OUT level is set either in volts rms (across a low-impedance output) or dBm, mW, or W across a 600-ohm load (mW is selected by pressing [SHIFT], [ENTER]).

Operating Considerations

The upper field is a priority control field. Accessing the RX TEST or TX TEST screen overrides any changes made to this field in other screens.

See Also

["Interaction Between Screens" on page 54](#)

AFGen2 To

This Audio Frequency Generator control is used to set two values:

- The upper field determines whether the AF signal modulates the RF Generator, or is output through the AUDIO OUT connector.
- The lower field sets the amplitude (including **OFF**). The AUDIO OUT level is always in volts rms for standard *sinewave* operation across a low-impedance output.

If the signaling option is installed, the sinewave can be set in units of rms or peak. This is done in the **sine units** field for the Function Generator. When non-sinewave waveforms are used, or if the upper field is set to AM or FM, the level is always expressed as a peak value.

See Also

["Function Generator Encoder" on page 393](#)

Amplitude

The amplitude field adjusts the amplitude of the RF Generator.

Operating Considerations

This is a priority control field. Accessing the RX TEST or TX TEST screen overrides any changes made to this field in other screens.

If a microphone is connected, and the amplitude is off, keying the microphone causes the amplitude to turn on to its previous level until the microphone is no longer keyed.

See Also

[Atten Hold field description, on page 498](#)
["Interaction Between Screens" on page 54](#)
["MIC/ACC" on page 568](#)

Atten Hold

Attenuator hold prevents the fixed RF output attenuators from switching in and out, eliminating the brief loss of the output signal as the level is changed. This function is helpful when making squelch measurements.

Operating Considerations

When this function is set to **On**, the RF output level is restricted to a range of 15 dB around the present **Amplitude** setting. Attempting to set an amplitude outside the allowed range results in an error message and beep (if the beeper is on). RF output level accuracy is uncalibrated outside the allowed range.

Ext Load R

External load resistance is used to calculate and display AF power dissipated in an external load resistance. Power is calculated using the voltage measured at the AUDIO IN connections and the resistance value you enter into this field.

See Also

[AC Level field description, on page 496](#)

Filter 1 and Filter 2

Filters 1 and 2 select a variety of standard and optional filters. Selecting either field lists the choices available for that field.

See Also

[Chapter 5, "AF Analyzer Screen"](#)

Output Port

Output port selects the desired RF Generator output port.

Operating Considerations

Maximum signal levels at each port are printed on the front panel.

CAUTION:

Applying reverse RF power to the DUPLEX OUT connector can damage the instrument. (A message is displayed when an over-power conditions occurs.) Whenever possible when testing transceivers, use the RF IN/OUT connector to prevent damage from accidental transmitter keying.

CAUTION:

If a reverse power condition triggers the internal protection circuit, remove the reverse power signal and press the MEAS RESET key or turn the Test Set off and on to reset it.

RF Gen Freq

RF Generator frequency sets the generator's frequency.

SINAD

This measurement field is used to select and display any one of the following measurements:

- SINAD
- Distortion
- SNR (Signal to Noise Ratio)
- AF Frequency
- DC Level

Current - DC only (requires Current Measurement option) Operating Considerations

This is a priority control field. Accessing the RX TEST or TX TEST screen overrides any changes made to this field in other screens.

SNR Operation

- Selecting SNR turns off the other audio measurement.
- The RF Generator and AFGen1 must be set up to provide the radio's carrier. (AFGen1 is automatically turned on and off repeatedly during this measurement.)
- AFGen2 must be turned off.
- The radio's receiver's audio output must be connected to the AUDIO IN port (set the **AF An1 In** field to **Audio In**).

See Also

["Interaction Between Screens" on page 54](#)

["Displaying Measurements" on page 57](#)

Service Screen

NOTE: This screen is used for component-level troubleshooting by the manufacturer. This method of troubleshooting is not currently supported outside of the factory.

This screen allows you to monitor individual circuit node measurements and change various MUX and DAC latch settings for isolating faulty modules. To access the SERVICE screen, you must first access the CONFIGURE screen, then select **Service** from the **To Screen** menu in the bottom-right corner.

Field Descriptions

Counter Connection

This field selects the desired circuit node to connect to the frequency counter.

Frequency

This measurement field displays the frequency measurement for the circuit node shown in the **Counter Connection** field.

Gate Time

This field is used to adjust the frequency counter's gate time. A shorter gate time may enable you to see frequency fluctuations that might not be seen using a longer gate time.

Latch

This field is used to alter the circuit latches that control a variety of operations. The value of the selected latch is displayed and changed in the **Value** field.

RAM Initialize

Selecting this field clears all SAVE registers and test programs that may be in RAM and resets all latches to their factory power-up configuration.

Operating Considerations

If you have saved one or more instrument setups using the SAVE function, using this function will permanently remove them.

Value

This field displays and changes the value for the latch shown in the **Latch** field.

Voltage

This measurement field displays the voltage measurement for the circuit node shown in the **Voltmeter Connection** field.

Voltmeter Connection

This field selects the desired circuit node for voltage measurements. The reading is displayed in the **Voltage** measurement field.

Spectrum Analyzer Screen

The SPECTRUM ANALYZER screen's controls are arranged in four menus. The menus are accessed using the **Controls** field. The field descriptions are grouped by menu names. Assigning global USER keys to the most-used functions on the menus allows you to access the functions without having to change menus.

Field Descriptions

NOTE: The Spectrum Analyzer is optional on some Test Set models.

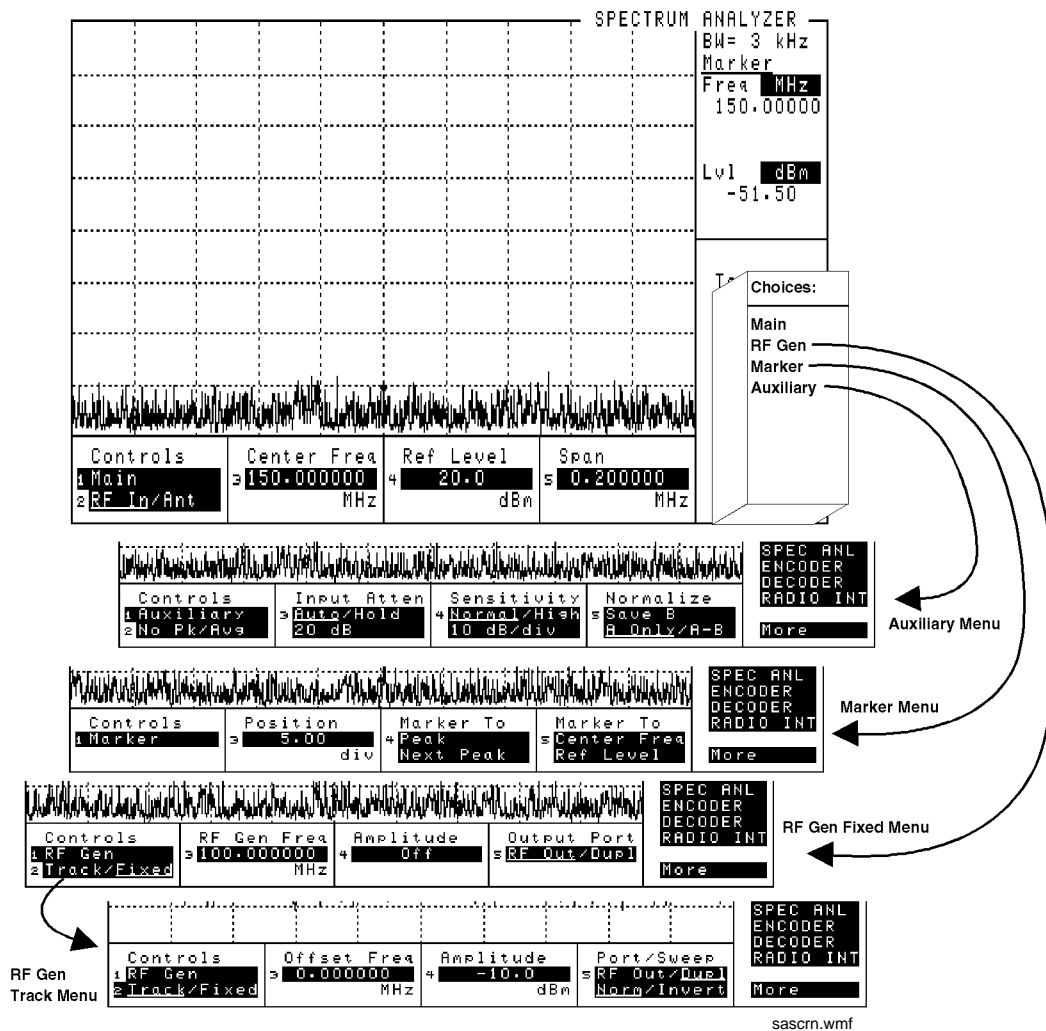

Figure 126 The Spectrum Analyzer Screen and Menus

Spectrum Analyzer Main Menu Fields

Controls	Center Freq	Ref Level	Span
1 Main	3 150.000000	4 20.0	5 0.200000
2 RF In/Ant	MHz	dBm	MHz

sascrn2.wmf

Figure 127 Spectrum Analyzer Main functions

Center Freq

This field sets the tune frequency for the center of the screen.

Operating Considerations

This field also changes the frequency of the Tracking Generator's and the RF Analyzer's center frequency.

Ref Level

Reference level sets the amplitude reference level for the top line of the display. All signals displayed are referenced to this line.

Operating Considerations

The unit-of-measure for the reference can be changed as needed. For instance, 0 dBm, 0.224 V, 107.0 dB mV, and 0.00100 W can all be used to represent the same level.

RF In/Ant

This field selects the input port for the analyzer.

Operating Considerations

Maximum signal levels at each port are printed on the front panel.

CAUTION:

Connecting a signal of >200 mW to the ANT IN port can cause instrument damage (although internal protection circuits can typically withstand a short-duration signal of 1 or 2 Watts).

If the overpower circuit is triggered (signified by a warning message at the top of the screen), remove the signal from the ANT IN port, and press the MEAS RESET key or turn the Test Set off and on to reset it.

Using the ANT IN port with the field set to **High** can result in uncalibrated operation (a message appears on the screen when this happens). The purpose for the high sensitivity setting is to allow you to look and listen to very low level signals when absolute accuracy is not essential.

See Also

[Sensitivity field description, on page 517](#)

Span

Sets the span of frequencies to be displayed on the screen.

Operating Considerations

When the Tracking Generator is used, the span also defines the frequency sweep range.

Spans >1.5 MHz disable the AF Analyzer when the analyzer's **AF An1 In** field is set to FM Demod, AM Demod, or SSB Demod. This disables all the AF Analyzer's measurement and output functions. When the AF Analyzer's **AF An1 In** field is set to any of the other available inputs, such as Audio In or Ext Mod, the speaker and AUDIO MONITOR OUTPUT are not affected when the Spectrum Analyzer's span is changed.

RF Generator Menu Fields, Fixed Operation

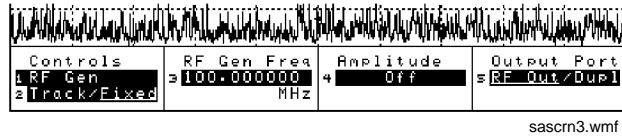

Figure 128 Using the Spectrum Analyzer with the RF Generator

Amplitude

This field sets the amplitude of the RF Generator.

Operating Considerations

This is a priority control field. Accessing the RX TEST screen overrides the Amplitude setting on this screen.

If a microphone is connected, and the amplitude is off, keying the microphone causes the amplitude to turn on to its previous level until the microphone is no longer keyed.

See Also

["Interaction Between Screens" on page 54](#)

Output Port

This field selects the output port for the RF Generator.

Operating Considerations

Maximum signal levels at each port are printed on the front panel.

CAUTION:

Applying reverse RF power to the DUPLEX OUT connector can damage the instrument. (A message is displayed when an overpower conditions occurs.) Whenever possible when testing transceivers, use the RF IN/OUT connector to prevent damage from accidental transmitter keying.

If a reverse power condition triggers the internal protection circuit, remove the reverse power signal and press the MEAS RESET key or turn the Test Set off and on to reset it.

RF Gen Freq

This field sets the RF Generator's frequency.

RF Generator Menu Fields, Tracking Operation

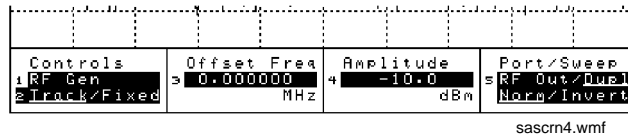

Figure 129 Using the Spectrum Analyzer with the Tracking Generator

The Tracking Generator performs a frequency sweep operation. The start and stop frequencies are determined by the Main Menu **span** setting. This allows you to characterize devices (such as filter networks) over a wide span of frequencies.

An RF offset can be set between the Tracking Generator and the center frequency of the Spectrum Analyzer. This allows you to look at a signal that is related to a source whose frequency is outside of the displayed span.

Amplitude

This field sets the amplitude of the Tracking Generator.

Operating Considerations

This field operates independently of the RF Generator's amplitude settings in other screens.

If a microphone is connected, and the amplitude is off, keying the microphone causes the amplitude to turn on to its previous level until the microphone is no longer keyed.

Offset Freq

Frequency offset (RF Generator) sets the difference between the instantaneous frequencies of the Tracking Generator and the center frequency of the Spectrum Analyzer.

Operating Considerations

The offset can be a positive or negative value. When set to zero, the Tracking Generator produces a sweeping signal that matches the Spectrum Analyzer's tune frequency.

Port/Sweep

This control performs two functions:

- The upper field specifies the output port of the Tracking Generator.
- The lower field specifies whether the Tracking Generator sweeps from low-to-high frequencies (**Norm**), or from high-to-low frequencies (**Invert**). (The Spectrum Analyzer always sweeps from low to high frequencies.) The swept frequency range is determined by the **Span** setting in the Spectrum Analyzer's Main Menu.

Operating Considerations

When using the Tracking Generator, if the output port is set **RF Out**, or the main menu **Input Port** is set to **RF In**, internal instrument coupling can occur. For the best isolation between the Tracking Generator and the Spectrum Analyzer, use **Dup1** for the output, and **Ant** for the input.

For measurements on high-power devices, such as amplifiers, use the RF IN/OUT port for the input.

Spectrum Analyzer Marker Menu Fields

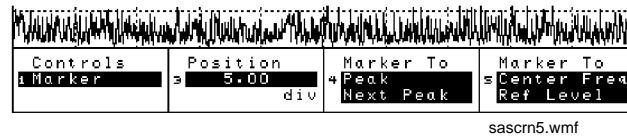

Figure 130 Setting Markers on the Spectrum Analyzer

Marker To:

- **Peak** moves the marker to the highest peak and enters the location in the **Position** field.
- **Next Peak** moves the marker to the next peak to the right and enters the location in the **Position** field.
- **Center Freq** changes the center frequency value to match the current position of the marker.
- **Ref Level** changes the reference level setting to match the current position of the marker.

Position

This field sets the marker position, referenced to the left side of the screen.

Marker Measurements

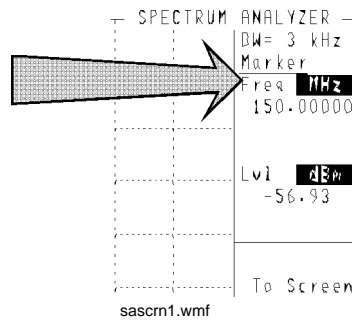

Figure 131 Reading Measurement Results at the Spectrum Analyzer's Markers

Marker: Freq

Marker frequency displays the frequency at the marker's present position.

Marker: Lvl

Marker level displays the amplitude at the marker's present position.

Operating Considerations

The marker's level can be displayed in various units of measure.

See Also

["To Change the Measurement's Unit-of-Measure" on page 61](#)

Spectrum Analyzer Auxiliary Menu Fields

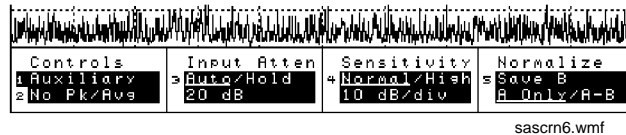

Figure 132 Spectrum Analyzer Auxiliary Functions

Input Atten

Input attenuation sets the amount of input attenuation for the RF IN/OUT and ANT IN ports. This field performs two functions:

- The upper field determines if the instrument sets the attenuation (**Auto**), or if you want to set the value (**Hold**).
- The lower field displays the present attenuation value and is used to set the desired attenuation level when the upper area is set to **Hold**.

Operating Considerations

Maximum signal levels at each port are printed on the front panel.

Setting the upper field to **Hold** prevents the RF autoranging process from interrupting Spectrum Analyzer operation when a signal is first measured. This can be helpful when you need to see the signal the instant the source is input, but requires you to set the needed amount of input attenuation.

Normalize

This area performs three display operations:

- **Save B** saves the currently-displayed trace for the A-B operation.
- **A only** provides a continuously-updated display (the “normal” mode of operation).
- **A-B** displays the difference between the trace saved using **Save B** and the currently displayed trace. The comparison can yield either losses or gains in amplitude.

Operating Considerations

The A-B function works correctly only if the center frequency and span settings are the same for both signals.

The reference level (**Ref Level**) can be changed to move the trace below the top line of the display if the A-B function results in a gain.

The the HOLD key can be used to “freeze” the display at any time. This allows you to view a trace before performing the Save B or A-B functions.

No Pk/Avg

This field performs two functions:

Pk Hold (peak hold) prevents the Spectrum Analyzer from erasing the previous trace each time it sweeps. This causes the traces to ‘build-up’ on the screen until **Off**, **No Pk/Avg** or the MEAS RESET key is selected. This allows the capture of transient signals that are not displayed long enough to view during normal operation.

Avg 1 through (video averaging) enables the Spectrum Analyzer to display a trace representing the average of several measurements. The number of samples used for measurement averaging range from 1 to 100 (see below). **No Pk/Avg** and **Off** function identically. **Off** is provided to maintain backwards compatibility with earlier firmware and software.

- **No Pk/Avg** means that peak hold and video averaging are off.
- **Pk Hold** means that peak hold is on.
- **Avg [n]** enables video averaging over [n] measurements, where n = 1, 2, 3, 4, 5, 10, 20, 50, or 100
- **Off** means that peak hold and video averaging are off.

Operating Considerations

After capturing the desired signal, you can use the HOLD function (press and release the SHIFT key, then the PREV key) to prevent additional signals from building-up on the display.

Sensitivity

This area performs two functions:

- The upper field selects **Normal** or **High** sensitivity for the RF input. The **High** setting adds about 6 dB of sensitivity to the ANT IN port for looking at very low level signals. However, this setting can cause measurements to be uncalibrated (indicated by a message on the screen). **High** sensitivity can also cause high-level AM signals to be distorted.
- The lower field selects the vertical resolution of the display. You can choose from 1 dB, 2 dB, or 10 dB per graticule.

Using the Spectrum Analyzer

Automatic Calibration

During operation, the Spectrum Analyzer pauses for approximately 2 seconds every 5 minutes to recalibrate itself. This does not affect the accuracy of displayed measurements, but does cause a brief interruption of the displayed information during the process.

Setting Resolution Bandwidth and Sweep Rate

The resolution bandwidth and sweep rate are determined by the span setting, and cannot be set independently.

These settings are listed in the following table.

Table 14 Relationship Between Span, Resolution Bandwidth, and Sweep Rate

Span	Resolution BW (kHz)	Sweep Rate
<50 kHz	0.3	28.6 kHz/second
<200 kHz	1.0	329.0 kHz/second
<1.5 MHz	3.0	3.0 MHz/second
<3 MHz	30.0	21.4 MHz/second
<18 MHz	30.0	36.3 MHz/second
<200 MHz	300.0	257.0 MHz/second
1 GHz	300.0	1.0 GHz/second

Tests Screen

Description of the Tests Subsystem

The TESTS screens are also referred to as the Tests Subsystem; a group of screens used to create, edit, and run automated test programs. Using program control, the Test Set can run radio tests by itself and control other instruments using the HP-IB or Serial Port¹. The HP 11807A Radio Test Software is an example of this type of automated testing.

Tests can be run from memory cards, the Test Set's internal ROM or RAM, or from an external disk drive.

Test programs are written in the HP Instrument BASIC (IBASIC) programming language.

For detailed (step-by-step) instructions about using the TESTS screens, see your Radio Test Software's documentation or the Test Set's *Programmer's Guide*.

1. Serial port is optional on some Test Set models.

Tests Subsystem Screens

When you press the TESTS key, you access the main TESTS screen. The other screens of the subsystem are accessed using the **CUSTOMIZE TEST PROCEDURE:** or **SET UP TEST SET:** lists at the bottom of this screen.

TESTS Subsystem Screens

- **Main Menu** is used to load a test procedure from a disk, RAM, ROM, or memory card. It is also used to access the other screens in the Tests Subsystem.
- **Channel Information** is used to specify transmitter and receiver frequency information for the radio being tested and to enter squelch and signaling information.
- **Test Parameters** is used to tell the Test Set the requirements of the test system for testing your radio.
- **Order of Tests** is used to define a test sequence from a list of possible tests.
- **Pass/Fail Limits** is used to specify the upper and lower limits for each test point. If a limit is violated during a test, an **F** appears next to the test value to indicate a failure.
- **Save/Delete Procedure** is used to save and delete test procedures.
- **Execution Conditions** is used to control which test results are output and where the results are printed (CRT/printer). This screen also controls whether tests run continuously or singly, and whether the test continues or stops after a failure is detected.
- **External Devices** is used to specify what types of external equipment are connected to the Test Set and their addresses. It is also used to specify where to store test result data.
- **Printer Setup** is used to control which test results are output and where the results are printed. This screen is also used for basic formatting of the printout (lines per page and form feeds). Printer port and printer model number are also chosen on this screen.
- **IBASIC Cntrl** is used to run IBASIC programs. This screen is also used as a stand-alone IBASIC computer. See the *Instrument BASIC Programmer's Handbook* for information about writing your own tests for the Test Set.

TESTS (Main Menu)

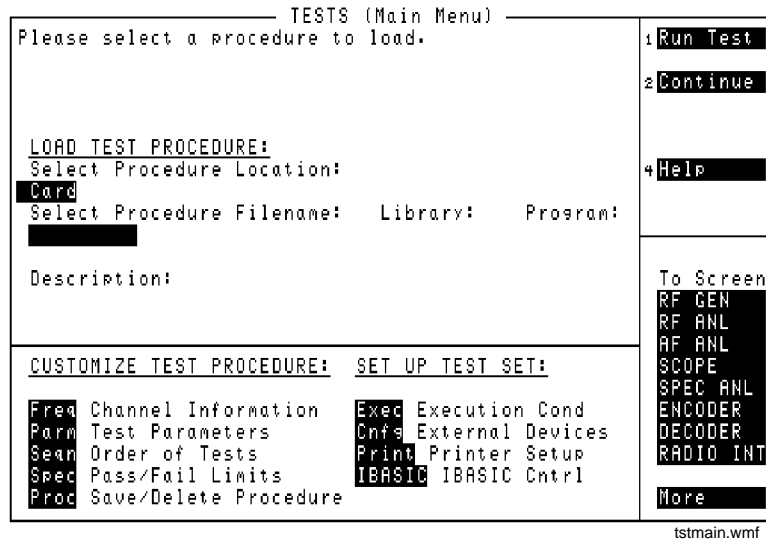

Figure 133 The TESTS (Main Menu) Screen

Cnfg External Devices

Selecting this field displays the TESTS (External Devices) screen.

Continue

This field is used to restart a paused test.

Description

This field displays a description of the file chosen in the **Select Procedure Filename:** field.

Exec Execution Cond

Selecting this field displays the TESTS (Execution Conditions) screen.

Freq Channel Information

Selecting this field displays the TESTS (Channel Information) screen.

IBASIC IBASIC Cntrl

Selecting this field displays the TESTS (IBASIC Controller) screen.

Library

This field displays the library information of the file chosen in the **Select Procedure Filename:** field.

Parm Test Parameters

Selecting this field displays the TESTS (Test Parameters) screen.

Print Printer Setup

Selecting this field displays the TESTS (Printer Setup) screen.

Proc Save/Delete Procedure

Selecting this field displays the TESTS (Save/Delete Procedure) screen.

Program

This field displays program information for the file chosen in the **Select Procedure Filename:** field.

Run Test

Selecting this field loads and runs the test chosen in the **Select Procedure Filename:** field.

Select Procedure Filename

This field is used to select the file you want to load from the location chosen in the **Select Procedure Location:** field.

Select Procedure Location

This field is used to select the location of the procedure to load. Procedures can be loaded from disk, card, ROM, or RAM.

Seqn Order of Tests

Selecting this field displays the TESTS (Order of Tests) screen.

Spec Pass/Fail Limits

Selecting this field displays the TESTS (Pass/Fail Limits) screen.

TESTS (Channel Information)

TESTS (Channel Information)						
Chan#	RX Freq (MHz)	TX Freq (MHz)	Test?	Prime?		
	RX Chan Info	TX Chan Info				
1	0.000000	0.000000	Yes/No	Yes/No	1 Insert CH	
2	0.000000	0.000000	No	No	2 Delete CH	
3	0.000000	0.000000	No	No	3 Print All	
4	0.000000	0.000000	No	No	4 Help	
5	0.000000	0.000000	No	No	5 Main Menu	
6	0.000000	0.000000	No	No	To Screen	
7	0.000000	0.000000	No	No	RF GEN	
8	0.000000	0.000000	No	No	RF ANL	
					RF ANL	
					SCOPE	
					SPEC ANL	
					ENCODER	
					DECODER	
					RADIO INT	
					More	

tstcinfo.wmf

Figure 134 **The TESTS (Channel Information) Screen**

This screen displays the channel frequencies to be tested.

Delete Ch

This field allows you to delete a channel from the frequency table at the bottom of the screen.

Insert Ch

This field allows you to enter a new channel in frequency table at the bottom of the screen.

Operating Considerations

You are required to specify if the test channel is a prime test channel. Prime test channels are the radio channels primarily used by the radio operator; they are the channels you are the most concerned about testing.

Use the **RX Chan Info** or **TX Chan Info** fields if the channel requires a tone code or frequency for testing radios that have CTCSS (Continuous Tone-Controlled Squelch System) squelch.

For example, if your radio uses a CTCSS tone of 91.5 Hz, you could enter the tone frequency in both RX and TX channel information fields as **CT FR91.5** or you could enter the tone code itself as **CT ZZ**. The specific entries are described in your HP 11807A software manual.

When testing cellular radios, the Channel Information is the channel number you are testing (don't confuse this with the **Chan#** field used to list channels on this screen). When the cellular radio channel number is entered, the HP 11807A software automatically sets the channel frequencies when testing. You do not need to enter the RX and TX frequencies because they correspond directly to the channel numbers.

NOTE: Enter -1 in the **RX** and **TX** test frequency fields to have all subsequent channels ignored when testing is started.

Main Menu

Selecting this field returns you to the TESTS (Main Menu) screen.

Print All

This field allows you to print the Test Set's screen image.

TESTS (Test Parameters)

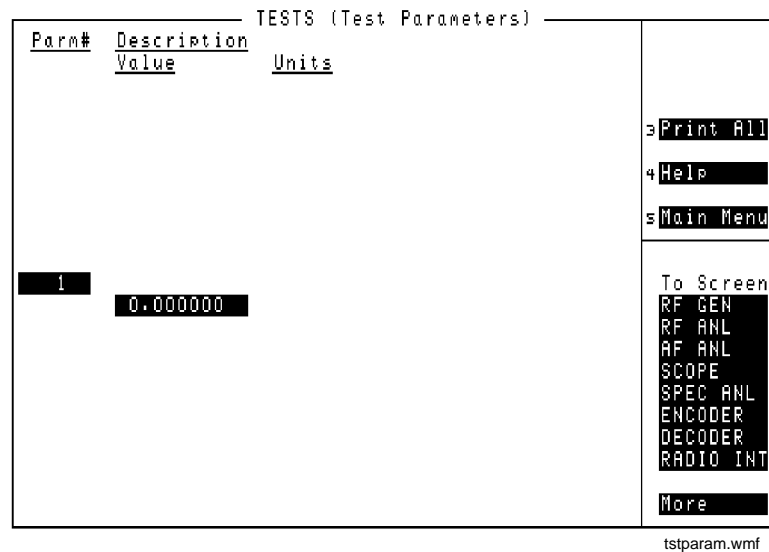

Figure 135 **The TESTS (Test Parameters) Screen**

Test Parameters are used to define operating and testing characteristics to match those of the radio being tested (audio-load impedance, audio power, power-supply voltage, and so forth).

By selecting the **Parm#**, **Value**, or **Units** fields and using the data and units keys, you can modify or enter parameters.

NOTE: The tests you select determine the parameters that are required. Your radio test documentation provides details if you are using HP 11807 software.

Print All

This field allows you to print the Test Set's screen image.

Main Menu

Selecting this field returns you to the TESTS (Main Menu) screen.

TESTS (Order of Tests)

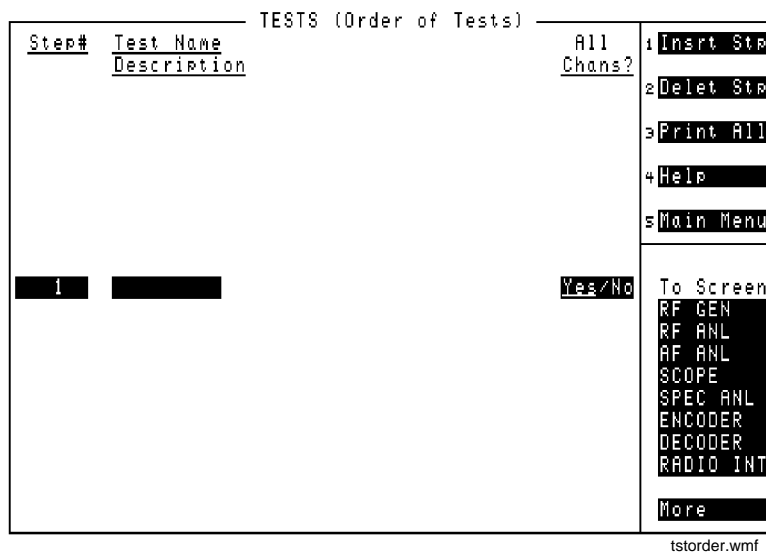

Figure 136 The TESTS (Order of Tests) Screen

The order of tests is set up by selecting one or more tests from the complete list of available tests (such as selecting a subset of an entire HP 11807A package). The TESTS (Order of Tests) menu lets you select the radio tests you want to perform and the order in which the tests are done.

Tests can be selected in any order; but to reduce testing time, you should strategically organize the test sequence. Tests requiring operator intervention (changing volume, channels, and so forth) should be grouped together. If you are using HP 11807 software, see its documentation to see which parameters go with each test.

All Chans?

This field allows you to choose if a new test is to be run on all channels (**Yes**) or only on prime channels (**No**). Prime channels are specified on the TESTS (Channel Information) screen. The underlined entry is the active choice.

Delet Stp

This field allows you to delete a step from the test list at the bottom of the screen.

Insrt Stp

This field allows you to enter a step in the test list at the bottom of the screen.

Operating Considerations

When inserting a new test, you must select the **step#** where you want to insert a new test. When inserted, the new test forces the current test (at that step #) down one step, and a duplicate of the current test is inserted. This duplicate is overwritten when the new test is selected.

See Also

Programmer's Guide

Main Menu

Selecting this field returns you to the TESTS (Main Menu) screen.

Print All

This field allows you to print the Test Set's screen image.

Step#

The **step#** field lists the order of selected tests for the current procedure.

Operating Considerations

Use the knob, up-arrow, or down-arrow key to select the step where you want to delete, replace, or insert a test.

Test Name

This field displays the names of the tests available from the software package or program currently selected. As you turn the knob, the **Test Name** for the corresponding step appears above the test's **Description**.

TESTS (Pass/Fail Limits)

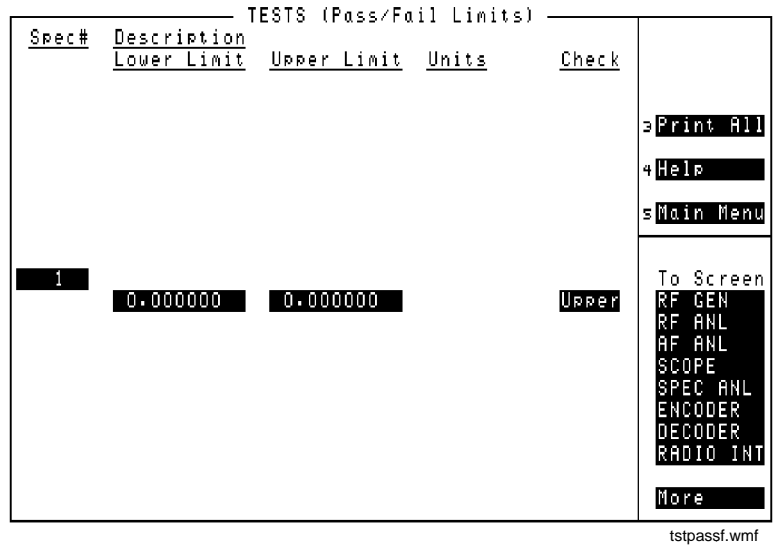

Figure 137 The TESTS (Pass/Fail Limits) Screen

Pass/Fail limits are the radio manufacturer’s upper and lower limits used by the Tests Subsystem. For a radio to pass a test, the measured value must fall within the test’s limits. Tests results can be compared to only the lower limit, only the upper limit, both the upper and lower limits, or no limits (**None**). (Pass/Fail limits are sometimes referred to as specifications.)

NOTE: The tests you select determine the specifications that are required. The HP 11807 documentation provides details if you are using HP 11807 software.

Check

This field is used to select whether the test will verify only upper, only lower, both, or none of the specified limits.

Operating Considerations

Selecting both upper and lower limits increases test time, but may be required for some tests.

Lower Limit

This field is used to set the lower limit to be compared with the measured results. If the measured result is below this limit, the test will fail.

Main Menu

Selecting this field returns you to the TESTS (Main Menu) screen.

Print All

This field allows you to print the Test Set's screen image.

Spec#

The **spec#** field lists the order of selected pass/fail limits for the current procedure.

Units

The **units** column indicates the unit-of-measure used for the limits (% , dBm, kHz, and so forth).

Upper Limit

This field is used to set the upper limit to be compared with the measured results. If the measured result is above this limit, the test will fail.

TESTS (Save/Delete Procedure)

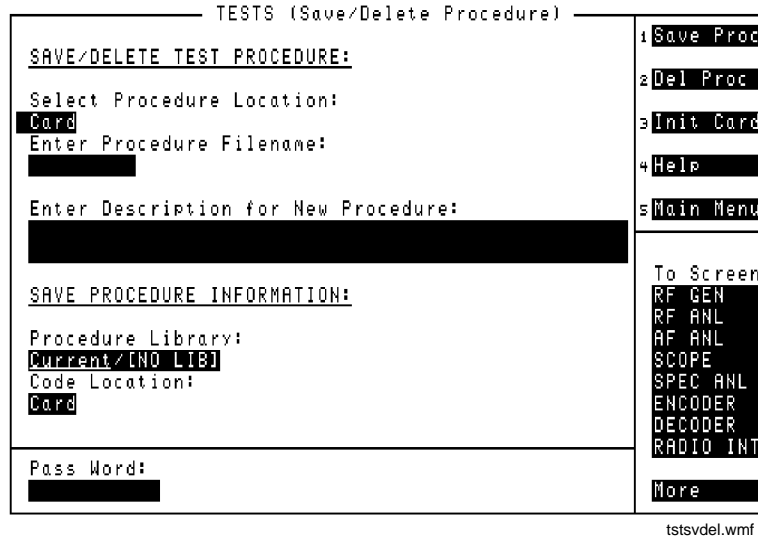

Figure 138 The TESTS (Save/Delete Procedure) Screen

After selecting a test sequence and defining the appropriate specifications, parameters, frequencies, and system configuration, you can save all that information as a procedure file for later use.

This screen is also used to delete procedures.

Code Location

This field is used to select where the program (code file) for the test procedure is stored. Code files are the main program files of the software, containing all of the test subroutines. If an HP 11807 memory card is catalogued, the code file is preceded by a lower-case **c**.

Enter Procedure Filename

This field is used to enter the name of the file you want to save or delete.

Operating Considerations

When you save a procedure file, you can use any name with up to 9 characters.

You can also delete previously-saved files to be able to resave a file using the same file name.

The media must be initialized before a file can be saved. Refer to the *Programmer's Guide*.

Main Menu

Selecting this field returns you to the TESTS (Main Menu) screen.

Pass Word

The **Pass Word** field allows you to access a secured test procedure file. Test procedures are secured using the **SECURE_IT** program in ROM. On the HP 8920A this program is directly accessed from the ROM list of choices.

See Also

["Securing a Test Procedure" on page 547](#)

Procedure Library

This field is used to select whether the new test procedure will use the current test's library or no library. All HP 11807 Test Procedures must be saved with a test library. Other IBASIC programs may not require an associated library file.

Library files contain *all* of the channel, parameter, and test name information used with the code file. If an HP 11807 memory card is catalogued, the library file is preceded by a lower-case **l**.

Select Procedure Location

This field is used to select where a new procedure will be saved, or the location from which a procedure will be deleted. Procedures can be saved to, or deleted from, disk, card, or RAM.

Operating Considerations

Procedure files contain a subset of the library file. This is where you save all of your own frequency, parameter, test sequence, specification, and system configuration information. A procedure file is not a directly-executable file for HP 11807 tests; it requires the code and library files to be present before running.

To save a file to an external disk drive, you must enter the drive's HP-IB address into the **External Disk Specification** field on the TESTS (External Devices) screen.

TESTS (Execution Conditions)

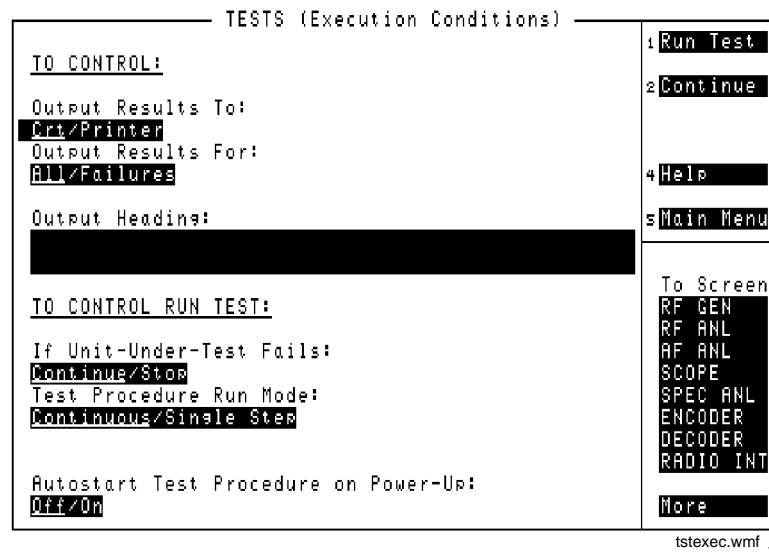

Figure 139 The TESTS (Execution Conditions) Screen

The TESTS (Execution Conditions) screen determines how tests are run.

Autostart Test Procedure on Power-Up

When set to **on**, this field automatically loads and runs the specified procedure whenever the Test Set is turned on. If this field is set to **off** or the specified procedure cannot be loaded for any reason (such as, memory card not inserted, disk drive not connected), the Test Set will default to its normal power-on state.

Continue

This field is used to restart a paused test.

If Unit-Under-Test Fails

This field selects what happens if the measured results do not meet criteria for passing the current test. The underlined entry is the active choice.

- **Continue** continues with testing even though a test in the test sequence fails to meet its test specification limits. When this occurs, an error is listed on the test-results printout, is displayed on the CRT, or both.
- **Stop** stops the test when a failure occurs and requires operator intervention before testing proceeds.

Main Menu

Selecting this field returns you to the TESTS (Main Menu) screen.

Output Heading

This field allow you to enter a heading for the test results printout (or CRT display).

Output Results To

This field selects where test results are output. The underlined entry is the active choice.

- **CRT** displays test results on the Test Set's CRT.
- **Printer** displays test results on the Test Set's CRT and outputs them to a printer. (The printer information must first be entered on the TESTS (Printer Setup) screen.)

Output Results For

This field selects which test results are output. The underlined entry is the active choice.

- **All** outputs all test results on to the location selected in the **Output Results To:** field.
- **Failures** outputs only the results of tests which fail.

Run Test

Selecting this field loads and runs the test chosen in the **Select Procedure Filename:** field on the TESTS (Main Menu) screen.

Test Procedure Run Mode

This field selects how the test will be run. The underlined entry is the active choice.

- **Continuous** runs the tests in the test sequence one after another without stopping. Testing pauses only if the operator is required to interact with the UUT or Test Set. Interactions such as changing UUT channels and setting squelch and audio levels cause testing to pause. Selecting **Stop** in the **If Unit-Under-Test Fails:** field may also stop a test.
- **Single Step** runs the tests in the test sequence one at a time. The operator is prompted to press **Continue** to proceed with testing.

TESTS (External Devices)

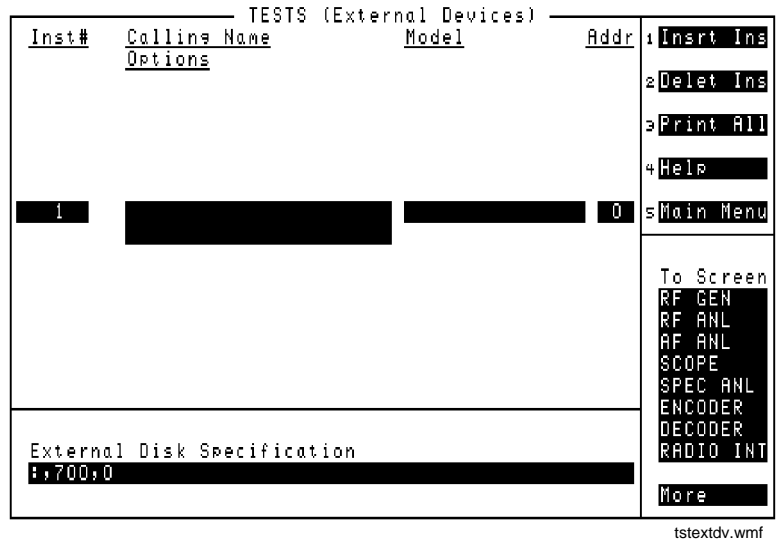

Figure 140 The TESTS (External Devices) Screen

The Tests Subsystem can only access external devices if they have been configured. Most external devices use the HP-IB port for control. A serial printer can be connected to the serial port for printing test results.

NOTE: **HP-IB Mode.** The **mode** field on the I/O CONFIGURE screen must be set to **Control** to access connected HP-IB instruments.

Addr

This field is used to enter the instrument's remote address. For HP-IB instruments, enter the full 3-digit address (such as 704).

Calling Name

The **Calling Name** field is used to enter the instrument's function (in upper-case letters). For example, **PRINTER, POWER SUPPLY, DATA COLLECTION** (disk drive), and so forth.

Delet Ins

This field allows you to delete an instrument from the list at the bottom of the screen.

Use the knob, up-arrow, or down-arrow key to select the step where you want to delete an instrument.

External Disk Specification

This field is used when storing and loading procedures on an external disk.

Operating Considerations

The HP-IB path entered in the **External Disk Specification** field is used by the **Select Procedure Location:** field on the TESTS (Main Menu) screen when **Disk** is selected.

Insrt Ins

This field allows you to enter an instrument in the list at the bottom of the screen.

Use the knob, up-arrow, or down-arrow key to select the step where you want to insert an instrument.

See Also

Programmer's Guide

Inst#

The **Inst#** field lists the number of external devices that are configured for the tests in the current procedure.

Main Menu

Selecting this field returns you to the TESTS (Main Menu) screen.

Model

This field is used to enter the instrument's model number. There is no specific syntax for entering model numbers into this field.

Options

This field is used to enter the instrument's option number or numbers if any.

Operating Considerations

This field may be left blank, or otherwise may include other calling name options, for example:

Printer options – **LN=#, START, END**

Where **#** is the number of lines on each page.

Where **START** causes a form feed at the start of each printout.

Where **END** causes a form feed at the end of each printout.

Data collection options – **NN**

Where **NN** is the number of records (file size) for the mass-storage location where data will be collected on disk or memory card. The default record size is 80.

Print All

This field allows you to print the Test Set's screen image.

TESTS (Printer Setup)

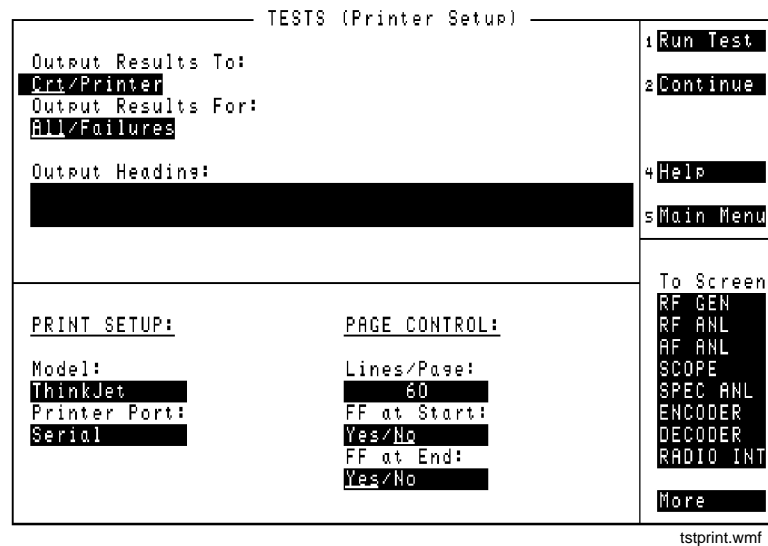

Figure 141 **The TESTS (Printer Setup) Screen**

The TESTS (Printer Setup) screen determines how tests are run.

Continue

This field is used to restart a paused test.

FF at End:

This field can only be controlled programmatically. It is used to specify if you want a form feed at the end of printing. The underlined entry is the active choice.

FF at Start:

This field can only be controlled programmatically. It is used to specify if you want a form feed at the start of printing. The underlined entry is the active choice.

Lines/Page:

This field is used to specify how many lines are printed per page.

Main Menu

Selecting this field returns you to the TESTS (Main Menu) screen.

Model:

This field is used to specify the type of printer used. If your printer is not listed in the **Choices** menu when you select this field, configure your printer to emulate one of those that is listed.

Output Heading:

This field allows you to enter a heading for the test results printout (or CRT display).

Output Results To:

This field selects where test results are output. The underlined entry is the active choice.

- Crt displays test results on the Test Set's CRT.
- **Printer** displays test results on the Test Set's CRT and outputs them to a printer.

Output Results For:

This field selects which test results are output. The underlined entry is the active choice.

- All outputs all test results on to the location selected in the **Output Results To:** field.
- **Failures** outputs only the results of tests which fail.

Printer Address:

This field is used to specify the address of an HP-IB printer. This field is only displayed if the **Printer Port:** field is set to HP-IB.

Printer Port:

This field is used to select the port your printer is connected to.

Run Test

Selecting this field loads and runs the test chosen in the **Select Procedure Filename:** field on the TESTS (Main Menu) screen.

TESTS (IBASIC Controller)

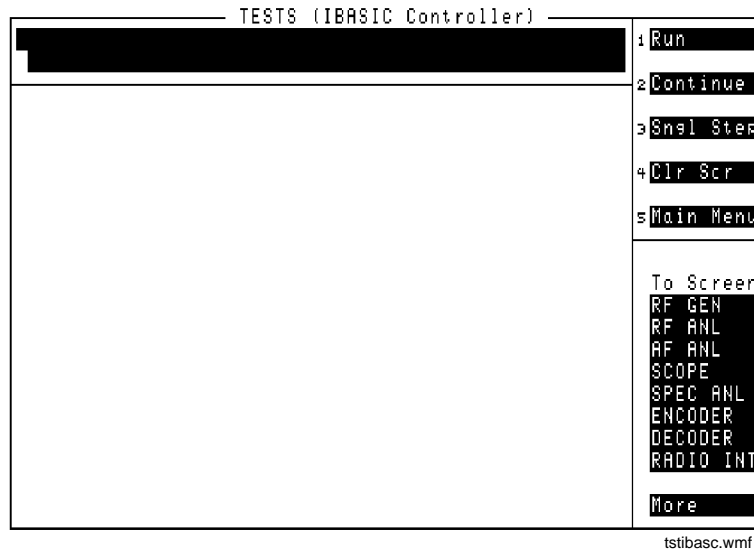

Figure 142 **The TESTS (IBASIC Controller) Screen**

The IBASIC controller is used to run IBASIC programs. This screen is also used as a stand-alone IBASIC computer. See the Instrument BASIC documentation for information about writing your own tests for the Test Set.

If you need to perform a simple IBASIC operation, such as a SAVE or GET function, you can enter commands one at a time. To do this, access the TESTS (IBASIC Controller) screen and use the knob to enter commands.

Refer to the *Programmer's Guide* for information about using the TESTS (IBASIC Controller) screen to write and store your own tests.

Clr Scr

This field is used to clear the IBASIC controller screen.

Continue

This field is used to restart a paused test.

Main Menu

Selecting this field returns you to the TESTS (Main Menu) screen.

Run

Selecting this field runs the IBASIC program.

Sngl Step

This field (single step) allows you to step through an IBASIC program line-by-line.

ROM Programs

Using the Signal Strength Meter

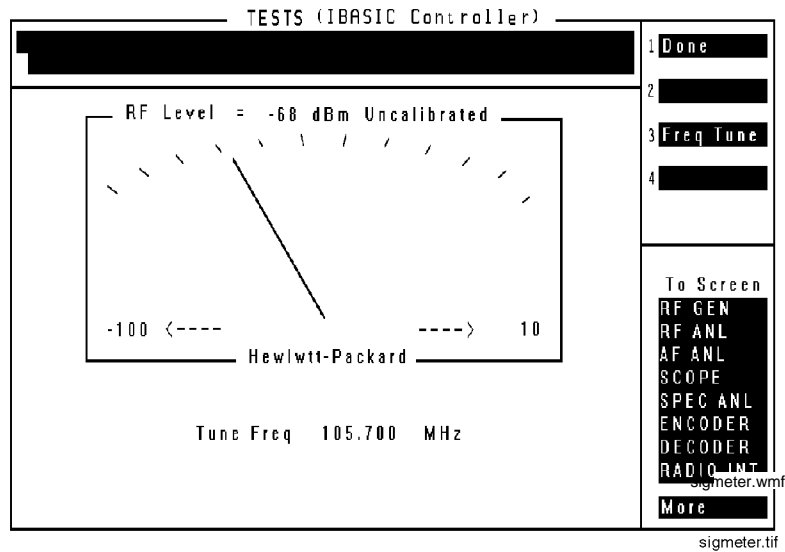

Figure 143 The Signal Strength Meter Screen

The Signal Strength Meter is accessed by loading and running the **LVL_MTR** ROM program.

1. Select the TESTS (Main Menu) screen.
2. Move the cursor to the **Select Procedure Location:** field and choose **ROM**.
3. Move the cursor to the **Select Procedure Filename:** field and select **LVL_MTR**.
4. Press the k3 key and enter the tune frequency (in MHz), then press the ENTER key. Do not press a units (MHz, kHz, Hz) key. MHz is the default unit and cannot be changed.

The ANT IN port is always the signal source.

Securing a Test Procedure

The password option for securing a test procedure is accessed by loading and running the **SECURE_IT** ROM program. This program is accessed by running the **IB_UTIL** program.

The password option for securing a test procedure is accessed by loading and running the **SECURE_IT** ROM program. This program is accessed by directly selecting it from the **Choices** menu.

1. Select the TESTS (Main Menu) screen.
2. Select the **Select Procedure Location:** field and choose **ROM**.
3. Select the **Select Procedure Filename:** field.
 - Select **SECURE_IT** from the list of programs. Press **Run Test** to run the procedure; follow the directions to secure the desired information.
 - Select **IB_UTIL** from the list of programs. Press **Run Test** to display a list of procedures; select **SECURE_IT** and follow directions to secure the desired information.

Clearing RAM

RAM can be cleared using the **RAM_MNG** program in the Test Set's ROM. This program clears *all* RAM, including any SAVE/RECALL registers saved to **Internal** (see the [Save/Recall field description, on page 441](#) in the I/O CONFIGURE screen description).

This program is accessed by running the **IB_UTIL** program.

This program is accessed by directly selecting it from the **Choices** menu.

1. Select the TESTS (Main Menu) screen.
2. Select the **Select Procedure Location:** field and choose **ROM**.
3. Select the **Select Procedure Filename:** field.
 - Select **RAM_MNG** from the list of programs. Press **Run Test** to run the procedure; follow directions to clear RAM.
 - Select **IB_UTIL** from the list of programs. Press **Run Test** to display a list of procedures; select **RAM_MANAGER** and follow directions to clear RAM.

To preserve the SAVE/RECALL registers, don't use the **RAM_MNG** program. Instead, load a different test program to clear the previous test from RAM, and then reload the desired test.

TX Test Screen

Block Diagram

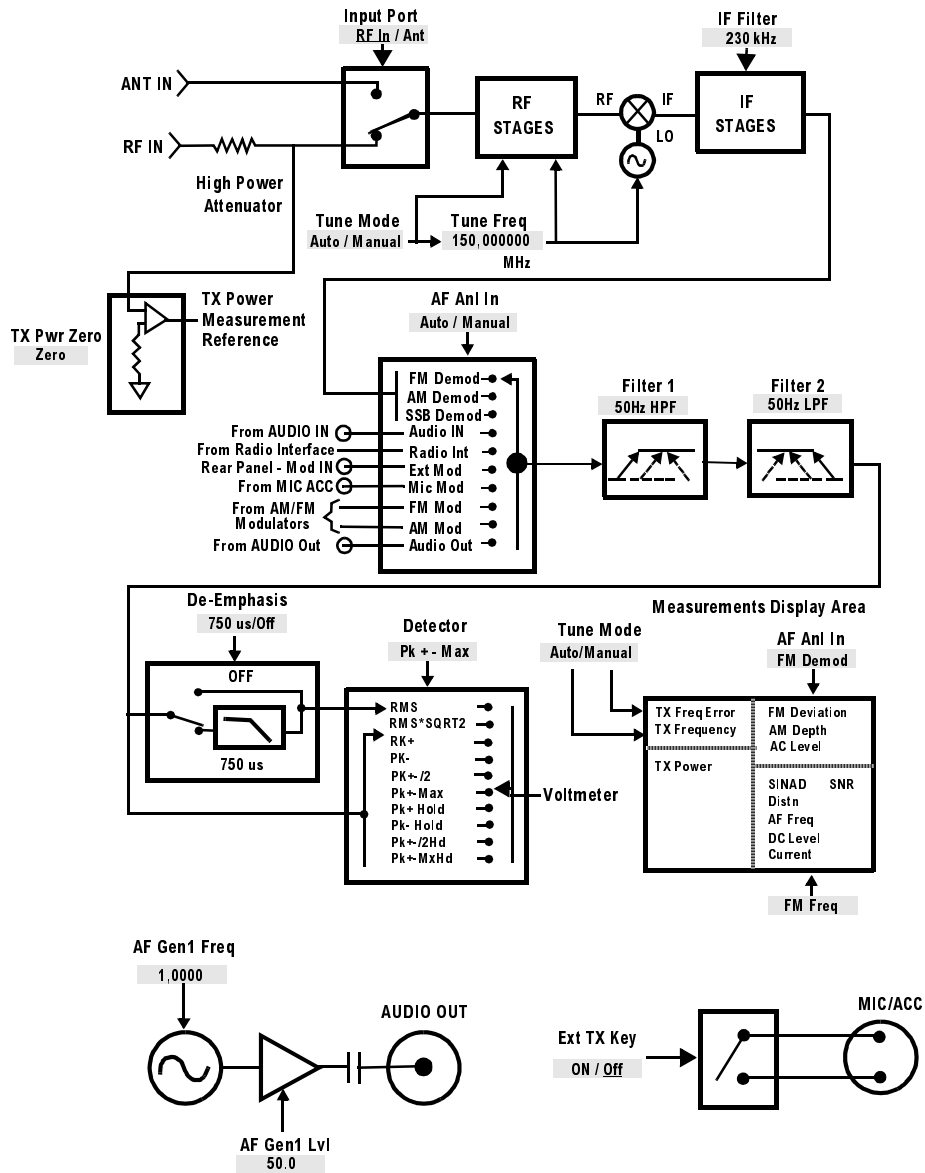

Figure 144 TX TEST Functional Block Diagram

Field Descriptions

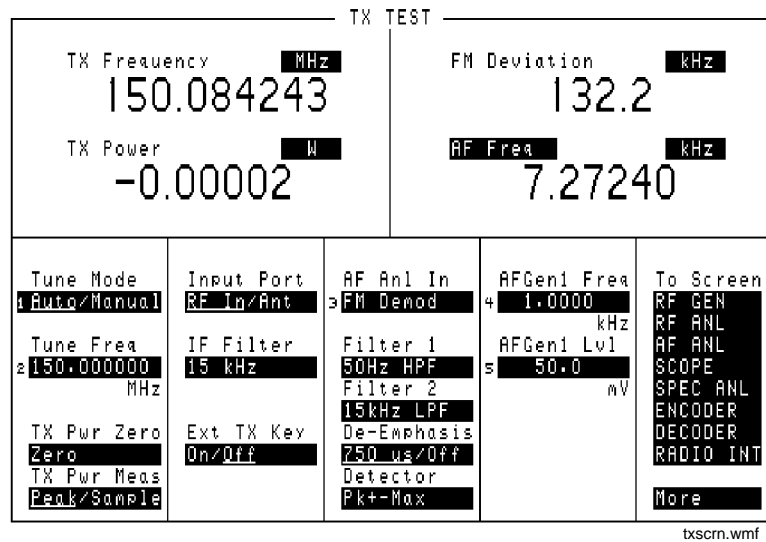

Figure 145 The TX Test Screen

AF Anl In

Audio Frequency Analyzer input selects the input for the analyzer. When selected, this field displays a list of choices.

Signals can be analyzed from three different types of inputs:

- The output of the AM, FM, or SSB demodulators.
- The AUDIO IN, RADIO INTERFACE, MODULATION INPUT, MIC/ACC, and AUDIO OUT connectors.

The signal present at the AM or FM modulators for the RF Generator.

Operating Considerations

Changing this field alters the upper AF measurement to the appropriate measurement type.

This is a priority control field. Accessing the RX TEST or TX TEST screen overrides any changes made to this field in other screens.

See Also

["Interaction Between Screens" on page 54](#)

["Displaying Measurements" on page 57](#)

AF Freq

This is the default measurement for this measurement field. Selecting this field displays the following measurement choices:

- SINAD
- Distortion
- SNR (Signal to Noise Ratio)
- AF Frequency
- DC Level

Current - DC only (HP 8920A requires Current Measurement option)

Operating Considerations

This is a priority control field. Accessing the RX TEST or TX TEST screen overrides any changes made to this field in other screens.

SNR Operation

- Selecting SNR turns off the other audio measurement.
- The RF Generator and AFGen1 must be set up to provide the radio's carrier. (AFGen1 is automatically turned on and off repeatedly during this measurement.)
- AFGen2 must be turned off.
- The radio's receiver's audio output must be connected to the AUDIO IN port (set the **AF An1 In** field to **Audio In**).

See Also

["Interaction Between Screens" on page 54](#)

["Displaying Measurements" on page 57](#)

AFGen1 Freq

This Audio Frequency Generator control sets the frequency for the first audio frequency sinewave generator.

AFGen1 Lvl

This Audio Frequency Generator control sets the level out the AUDIO OUT connector in volts rms (across a low-impedance output), or in mW, W, or dBm across a 600-ohm load (mW is selected by pressing [SHIFT], [ENTER]).

Operating Considerations

In the TX TEST screen, the signal is *always* output through the AUDIO OUT connector.

Current

The **Current** field is found by selecting the SINAD field on the Test Set display of the TX TEST screen. This field only displays the DC current measured at the DC input port on the back of the Test Set. Any offset can be removed by selecting **Zero** from the **DC Current** field.

DC Level

This field displays the DC voltage entering at the DC input port on the back of the Test Set.

De-Emphasis

This setting selects or bypasses the 750 ms de-emphasis networks in the audio analyzer and speaker circuitry.

Operating Considerations

This is a priority control field. Accessing the RX TEST or TX TEST screen overrides any changes made to this field in other screens.

See Also

["Interaction Between Screens" on page 54](#)

Detector

This setting selects the type of detector used when measuring and displaying AF signal levels.

Detector Types

- **RMS** displays the RMS value of signals.
- **RMS*SQRT2** displays the RMS value of a signal multiplied by $\sqrt{2}$.
- **Pk+** displays the positive peak value.
- **Pk-** displays the negative peak value.
- **Pk±/2** adds the positive and negative peak values and divides the sum by 2.
- **Pk±Max** compares the positive and negative peaks and displays the greater value (polarity is not indicated).
- **Pk+ Hold** displays and holds the positive peak value until the measurement is reset. To reset, press the MEAS RESET key, or select a different detector, or reselect the same detector.
- **Pk- Hold** displays and holds the negative peak value until the measurement is reset. To reset, press the MEAS RESET key, select a different detector, or reselect the same detector.
- **Pk±/2 Hold** divides the sum of the positive and negative peak values by 2, and displays the value until the measurement is reset. To reset, press the MEAS RESET key, select a different detector, or reselect the same detector.
- **Pk±Max Hold** compares the positive and negative peaks and displays the greater value until the measurement is reset. To reset, press the MEAS RESET key, select a different detector, or reselect the same detector.

Operating Considerations

This is a priority control field. Accessing the RX TEST or TX TEST screen overrides any changes made to this field in other screens.

See Also

["Interaction Between Screens" on page 54](#)

Distn

This field displays the percent of distortion. The Distortion measurement is only for a 1 kHz signaling tone.

Ext TX Key

This field controls a switch at the MIC/ACC connector. Its intended use is to “key” an external transmitter.

See Also

[Figure 146 on page 570](#)

Filter 1 and Filter 2

Filters 1 and 2 select a variety of standard and optional filters. Selecting either field lists the choices available for that field.

See Also

[Chapter 5, "AF Analyzer Screen"](#)

FM Deviation

This is the default measurement for this field. The type of measurement listed here is dependent on the **AF An1 In** settings.

See Also

[AF An1 In field description, on page 552](#)
["Displaying Measurements" on page 57](#)

IF Filter

This field selects the desired IF filter’s bandwidth for modulated signals being analyzed.

Input Port

This field selects the RF IN/OUT or ANT IN port for making RF measurements. The RF IN/OUT port must be used for making **TX Power** measurements on this screen.

Operating Considerations

Maximum signal levels at each port are printed on the front panel.

If the RF power at the RF IN/OUT port exceeds allowable limits, a loud warning signal sounds and a message appears at the top of the screen. If this occurs, disconnect the RF power, press the MEAS RESET key, and allow the Test Set to cool off for approximately 2 minutes before making any other measurements on this port.

The ANT IN (antenna input) connector provides a highly-sensitive input for very low-level signals (such as “off the air” measurements). You cannot measure TX (RF) Power on this screen using the antenna port. However, low-level RF power at the antenna port can be measured using the Spectrum Analyzer¹.

CAUTION: Connecting a signal of >200 mW to the ANT IN port can cause instrument damage.

If the overpower circuit is triggered (signified by a warning message at the top of the screen), remove the signal from the ANT IN port, and press the MEAS RESET key or turn the Test Set off and on to reset it.

RF Channel

The **RF Channel** field is displayed only when the **RF Display** field is set to **Chan** on the CONFIGURE screen.

This field displays the current channel number. Channel tuning eliminates the need to transmit and receive frequencies directly into the Test Set. Once the radio’s RF channel standard is selected, you only have to enter the channel number to automatically set the **RF Generator** and **RF Analyzer** to the correct frequency.

Operating Considerations

To utilize the correct transmit and receive frequencies select the appropriate channel standard from the **RF Chan Std** field on the CONFIGURE screen.

1. Spectrum Analyzer is optional on some Test Set models.

SINAD

This field is only visible when SINAD is selected from the AF Freq field on the display area of the TX TEST screen. This field displays the measured SINAD of the input signal.

Tune Freq

RF Analyzer tune frequency sets the center frequency for the RF signal to be analyzed.

Operating Considerations

If the **Tune Mode** is set to **Auto**, the frequency is set by the Test Set by finding the strongest RF signal above -36 dBm within the full bandwidth of the RF Analyzer.

If the **Tune Mode** is set to **Manual**, the operator must enter the desired frequency.

See Also

[Tune Mode field description \(this page\)](#)

Tune Mode

This field selects automatic or manual tuning of the RF Analyzer.

Auto causes the RF Analyzer to find the signal with the greatest amplitude >-36 dBm, and set the tune frequency for that signal.

Manual requires the operator to set the tune frequency for the RF signal to be analyzed.

Operating Considerations

Changing the **Tune Mode** also changes the RF frequency display. Automatic tuning enables the **TX Frequency** measurement. Manual tuning enables the **TX Freq Error** measurement.

After autotuning to the desired signal, select **Manual** to prevent the **Tune Freq** from changing when the signal is no longer applied.

TX Freq Error, TX Frequency

This measurement area is used to display transmitter frequency error or transmitter frequency.

See Also

[Tune Mode field description \(this page\)](#)

TX Power

Transmitter power measures RF power at the RF IN/OUT port.

Operating Considerations

Maximum signal levels at each port are printed on the front panel.

Only the RF IN/OUT port can be used for measuring TX Power on this screen. When the **Input Port** is set to **Ant**, four dashes (- - -) appear in place of digits for this measurement.

Use the Spectrum Analyzer¹ to measure low-level RF power (≤ 200 mW) at the ANT IN port.

CAUTION:

Connecting a signal of >200 mW to the ANT IN port can cause instrument damage (although internal protection circuits can typically withstand a short-duration signal of 1 or 2 Watts).

If the overpower circuit is triggered (signified by a warning message at the top of the screen), remove the signal from the ANT IN port, and press the MEAS RESET key or turn the Test Set off and on to reset it.

See Also

[Input Port field description, on page 557](#) (Operating Considerations)

[TX Power field description \(this page\)](#)

[TX Power field description, on page 480](#)

[TX Pwr Zero field description, on page 480](#)

1. Spectrum Analyzer is an option on some Test Set models.

TX Pwr Zero

The transmitter power zero function establishes a 0.0000 W reference for measuring RF power at the RF IN/OUT port.

CAUTION: RF power must not be applied while zeroing. Set the **RF GENERATOR** screen **Amplitude** field to off to prevent internal cross-coupling into the power detector while zeroing

Operating Considerations

When power is applied to the RF IN/OUT connector, the temperature of the internal circuitry increases. This can cause changes in the **TX Power** measurement when low power levels are measured immediately following high power measurements.

When alternately making high and low power measurements, always zero the power meter immediately before making the low-power measurements; this provides the best measurement accuracy.

Connector, Key, and Knob Descriptions

Connector Descriptions

ANT IN

The antenna input is used for analyzing low-power RF signals (≤ 200 mWatts), and is typically used for off-the-air measurements. This port can be selected in the TX TEST, DUPLEX TEST, RF ANALYZER, or SPECTRUM ANALYZER screens.

CAUTION:

Connecting a signal of >200 mW to the ANT IN port can cause instrument damage (although internal protection circuits can typically withstand a short-duration signal of 1 or 2 Watts).

If the overpower circuit is triggered (signified by a warning message at the top of the screen), remove the signal from the ANT IN port, and press [MEAS RESET] or turn the Test Set off and on to reset it.

Operating Considerations

Input impedance = 50Ω

TX Power cannot be measured using this port; use the RF IN/OUT port. However, low power levels can be measured using this port with the Spectrum Analyzer.

Additional sensitivity for this port is available using the **sensitivity** field in the RF ANALYZER and SPECTRUM ANALYZER screens.

AUDIO IN

Two connectors are used to input audio signals to the AF Analyzer:

- HI is the main audio signal input connection.
- LO is used for the audio signal reference. Three choices are available using the AF ANALYZER screen's **Audio In Lo** field:
 - Gnd connects the center pin through approximately 100Ω to chassis ground.
 - Float is a floating input.
 - 600 To Hi provides a 600Ω internal load to match an audio source with an output impedance of 600Ω .

The measured level is the potential between the HI and LO center pins. The shells of both connectors are at chassis ground.

Operating Considerations

Input impedance is switchable between $1\text{ M}\Omega$ in parallel with 95pF , or 600Ω floating.

This port is selected as the AF Analyzer's input using the **AF An1 In** field in the TX TEST screen, DUPLEX TEST screen, AF ANALYZER screen, and various encoder modes. This port is always the AF Analyzer's input when the RX TEST screen is displayed.

Signals input to the AF Analyzer are routed through different filters, amplifiers, and detectors that affect the displayed measurement.

CAUTION: The maximum level between the HI and LO center pins is 42 V peak (approximately 30 Vrms). Exceeding this value can cause permanent instrument damage.

See Also

[Chapter 5, "AF Analyzer Screen"](#)

AUDIO MONITOR OUTPUT

This connector provides an external output from various tap points in the AF Analyzer.

Operating Considerations

The **scope To** field in the AF ANALYZER screen determines the source of this signal.

The level is not affected by the front-panel VOLUME knob.

Output impedance <1 k Ω

See Also

[Chapter 5, "AF Analyzer Screen"](#)

AUDIO OUT

This port is used to output signals from AF Generators 1 and 2, including the encoder functions.

Operating Considerations

The output level is set by the AF Generators and is not affected by the front-panel VOLUME control.

Output impedance <1 Ω

Maximum output current = 20 mA peak

Maximum reverse voltage = 12 V peak

AC/DC coupling is selected using the **Audio Out** field. This field is available in the DUPLEX TEST screen, RF GENERATOR screen, and various encoder modes.

Chassis Ground

The rear-panel chassis ground terminal provides a general chassis connection, as well as providing a safety ground when dc power is used.

WARNING: To prevent a potential shock hazard, always connect the chassis ground terminal to earth ground when operating this instrument from a dc power source.

CRT VIDEO OUTPUT

This connector provides a signal for using an external video monitor. The signal provides a duplicate of the Test Set's screen.

Operating Considerations

A multi-sync monitor must be used to match the video sync rate of 19.2 kHz. Examples of this type of monitor include - Mitsubishi Diamond Scan, NEC 3D, Leading Edge CMC-141M, and Sony CPD-1302.

DC CURRENT MEASUREMENT

This connector is optional on the HP 8920A.

These connectors are used in series with a DC supply and load to provide a 0 to 10 amp DC current meter.

Operating Considerations

The dc current meter is designed to measure *positive* current (the connector's polarity is marked on the rear panel). Negative current of ≤ 10 amps will not damage the instrument, but will cause inaccurate positive current measurements (due to magnetic memory within the current-sensing element).

To recalibrate the current meter after negative current has been applied:

1. Connect a 10 amp positive current.
2. Disconnect the current.
3. Access the AF ANALYZER screen.
4. Select the **DC Current Zero** field to zero the meter.

See Also

["Displaying Measurements" on page 57](#)

DC INPUT

This female connector is used with a dc supply to provide power to the instrument. The male counterpart to this connector is included in the *Connector Kit* accessory. (See "Accessories" on page 589.)

The following HP parts can also be ordered to assemble the male counterpart to this connector:

Connector housing: 1251-4782 (1 required)

Connector contacts: 1252-0385 (2 required)

WARNING: To prevent a potential shock hazard, always connect the chassis ground terminal to earth ground when operating this instrument from a DC power source.

Digital Test Connections

Control I/O, CW RF OUT, DET OUT, IQ RF IN, 114.3 MHz OUT

The following connectors are only used when an HP cellular adapter (such as an HP 83203B) is connected to the Test Set to perform digital modulation tests. These connectors are optional.

1. Control I/O provides control of the cellular adapter.
2. CW RF OUT routes the RF carrier to the cellular adapter. *If a cellular adapter is not present, a jumper must be used to connect this port to the IQ RF IN port.*
3. DET OUT routes the average power detector's signal to the AUX DSP IN of the cellular adapter for making average power measurements. This port may not be used with all models of cellular adapter.
4. IQ RF IN routes the RF carrier from the cellular adapter back into the Test Set. *If a cellular adapter is not present, a jumper must be used to connect this port to the CW RF OUT port.*
5. 114.3 MHz IF OUT provides the down-converted RF signal to the cellular adapter.

DUPLEX OUT

This connection is an output for the RF Generator and Tracking Generator.

Operating Considerations

Output impedance = 50Ω

The RF Generator's output is selected in the **Output Port** field. This field is available in the RX TEST, DUPLEX TEST, RF GENERATOR, and SPECTRUM ANALYZER screens.

CAUTION: Connecting an RF source of >200 mW to this connector can permanently damage the instrument.

EXT SCOPE TRIGGER INPUT

This connector provides an external oscilloscope trigger.

Operating Considerations

Input threshold approximately 2.5 V

Maximum Input level approximately 20 V peak

Input impedance is:

100 k Ω for signals ≤ 5.6 V peak

5 k Ω for signals > 5.6 V peak

When measured with no load on the input, a 5 Volt level is present on the connector due to the internal pull-up resistor design.

See Also

[Chapter 14, "Oscilloscope Screen"](#)

HP-IB

This connector is optional on the HP 8920A.

This connector allows communication between the Test Set and other instruments or computers using the Hewlett-Packard Interface Bus (HP-IB).

See Also

[Chapter 12, "I/O Configure Screen"](#)
HP 8920 Programmer's Guide

MEMORY CARD Slot

This front-panel opening is where memory cards are inserted.

See Also

HP 8920 Programmer's Guide

MIC/ACC

This 8-pin DIN connector (see [figure 146 on page 570](#)) is used for several functions:

- Mic In is used to modulate the RF Generator when the KEY IN line is grounded. This signal is summed with the external MODULATION INPUT signal. The **Mod In To** field of the RF GENERATOR screen sets the type of modulation (AM or FM) and sensitivity (%AM/Vpk or kHz/Vpk) for this connection.
- Key In provides control of the RF Generator's output state (on or off) and automatic switching between the TX TEST and RX TEST screens (if the CONFIGURE screen's **RX/TX Cntl** functions are set to **Auto** and **PTT**). Screen switching occurs when this line is grounded.
- Key Out 1 and Key Out 2 provide a switch path to control external equipment (such as keying a transmitter). Key Out 1 and Key Out 2 are connected when the **Ext TX key** field is set to **On**.

CAUTION: Do not exceed 50 Vdc (open circuit) or 250 mA dc (closed circuit) between Key Out 1 and Key Out 2. Damage to internal components may result.

To Use the Microphone

To modulate the RF Generator using the optional microphone (HP part number 08920-61059):

1. Connect the microphone to the MIC/ACC connector.
2. Access the RF GENERATOR screen.
3. Enter the carrier frequency in the **RF Gen Freq** field.
4. Enter the RF Generator's **Amplitude**.
5. Select the **Output Port** (RF IN/OUT or DUPLEX OUT).
6. Connect the selected output port to your receiver or antenna.
7. Using the **Mod In To** field,
 - select the type of modulation: **FM (/Vpk)**
 - enter the modulation sensitivity to a 1 V_{peak} signal (usually 1 kHz for microphone use). See "**Mod In To**" on page 489.
8. Key the microphone to transmit.

MIC/ACC Operating Considerations

Mic In specifications

Input impedance = 100 k Ω

Maximum input level = 10 V peak

Full scale input = 10 mV

Bandwidth is limited to 3 kHz.

The Mic In signal is filtered and amplified to provide a stable deviation-limited signal to the RF Generator.

750 μ s microphone pre-emphasis is selected in the RF GENERATOR screen.

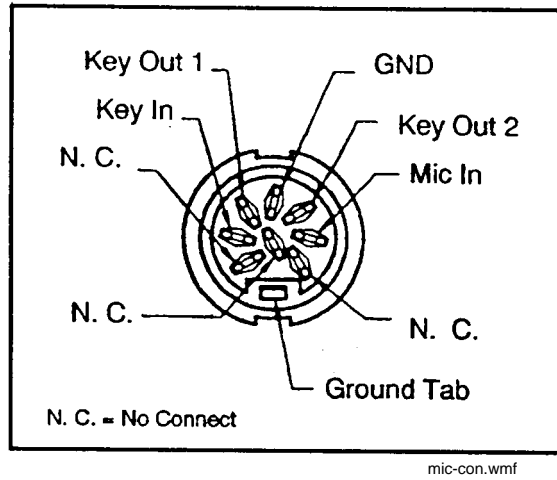

Figure 146 MIC/ACC Connections

See Also

[Chapter 18, "RF Generator Screen"](#)

[Chapter 7, "Configure Screen"](#)

[Chapter 17, "RF Analyzer Screen"](#)

MODULATION INPUT

This connector provides an external modulation connection to the RF Generator.

Operating Considerations

Input impedance = 600Ω

Maximum input level = 12 V peak

Full scale input = 1 V peak

The **Mod In To** field of the RF GENERATOR screen sets the type of modulation (AM or FM) and sensitivity (%AM/Vpk or kHz/Vpk) for this connection.

This signal is summed with the microphone MIC IN signal from the MIC/ACC connector.

The **FM Coupling** field in the RF GENERATOR, DUPLEX TEST, and various encoder modes selects ac or dc coupling of this signal for FM operation.

Parallel Port

This port is optional on the HP 8920A.

This port is used with printers requiring a parallel interface when printing screen images or test results. Set the **Printer Port:** field (on the PRINT CONFIGURE screen or TESTS (Printer Setup) screen) to **Parallel** to print to this port. Use address 15 when sending data to this port from IBASIC programs.

Pin numbers are embossed on the connector. Pin assignments are as follows:

Connector Descriptions

1. nStrobe
2. Data 1 (Least Significant Bit)
3. Data 2
4. Data 3
5. Data 4
6. Data 5
7. Data 6
8. Data 7
9. Data 8 (Most Significant Bit)
10. nAck
11. Busy
12. PError
13. Select
14. nAutoFd
15. nFault
16. nInit
17. nSelectIn
18. Signal Ground (nStrobe)
19. Signal Ground (Data 1 and Data 2)
20. Signal Ground (Data 3 and Data 4)
21. Signal Ground (Data 5 and Data 6)
22. Signal Ground (Data 7 and Data 8)
23. Signal Ground (Busy and nFault)
24. Signal Ground (PError, Select, and nAck)
25. Signal Ground (nAutoFd, nSelectIn, and nInit)

RADIO INTERFACE

This connector is optional on all Test Sets.

This connector provides parallel communications between the Test Set and external radio equipment. The connector provides a 16-line parallel digital interface that you can configure as inputs, outputs, or a combination of inputs and outputs. You can set the logic thresholds and output levels so that the interface will match the levels and thresholds of the device it is connector to. Audio and transmitter control lines are also provided.

Parallel communication parameters are entered in the RADIO INTERFACE screen. This screen is only available if the Radio Interface option is installed.

The audio signal from this connector is input by setting the **AF An1 In** field to **Radio Int.** (The **AF An1 In** field is available in the TX TEST, DUPLEX TEST, and AF ANALYZER screens, as well as various DECODER screens.)

Radio Interface Operating Considerations

Connector type: D-Subminiature, 37 pin.

All pins have 4.6 μ H chokes in series for RFI suppression. Control and data lines have clamp diodes across them for electrostatic discharge protection.

CAUTION: To prevent damage to the diodes, the input voltage must not exceed logic voltage +0.6 V or be less than -0.6 V.

Rise times are affected by capacitive loading. This is because the control and data lines have 3.16 k Ω pull-up resistors.

Fall times are affected by open collector current sink limitations.

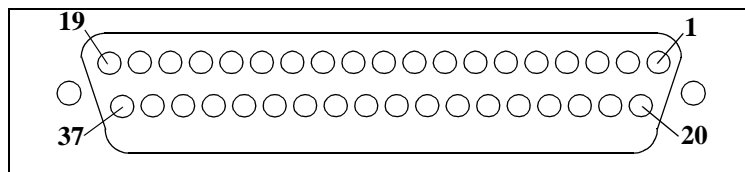

Figure 147 Pin Numbers for the Radio Interface Connector

The pin numbers for the radio interface connector are listed on the connector and in [figure 147 on page 573](#). Pin assignments are as follows:

1. GND
2. No Connection
3. Audio Out
 - This is an output for the audio sources, AF Gen1 and AF Gen2. It is also connected in parallel to the front-panel AUDIO OUT connector.
 - Set the **AFGen1 To** field, the **AFGen2 To** field, or both to **Audio Out** to select this pin and the front-panel AUDIO OUT connector as the audio source output. These fields are found on the RX TEST and DUPLEX TEST screens as well as on the signalling encoder screen.
 - All settings for the audio source affect the signal at this pin.
 - Output specifications are the same as the front-panel AUDIO OUT connector.
4. Key Out 2
 - This pin is a key relay contact.
 - Key Out 1 and Key Out 2 are connected in parallel with the Key Out 1 and Key Out 2 pins of the front-panel MIC/ACC connector. They go to internal relay contacts and can be used to key a transmitter. The relay contacts are closed, which connects the two pins when the **Ext TX Key** field is set to **On**. This field can be found on the TX TEST, DUPLEX TEST, or RF ANALYZER screen. (See "[MIC/ACC](#)" on [page 568](#).)
 - Capacitance is 0.1 μ F per pin (300 pF per pin after approximately 6 μ s). Contact Rating is 0.5 A, 50 V.
5. Audio Input
 - Set the **AF Anl In** field to **Radio Int** to select this pin as the audio analyzer's input. This field is found on the TX TEST, DUPLEX TEST, or AF ANALYZER screen, as well as various signalling decoder screens.
 - Input impedance is 100 k Ω .
6. Key Out 1
 - See pin 4. Also see "[MIC/ACC](#)" on [page 568](#).
7. -12.6 V
 - Pins 7 and 8 can supply power to a low current device. The voltage is always present when the Test Set is powered on and cannot be varied or turned on or off.
 - Output current is limited by an internal 100 Ω , 2 W resistor.
8. +12.6 V
 - See pin 7.

9. Logic Voltage (data level):

- The voltage on this pin determines the high output voltage and input logic thresholds of the parallel data, strobe, and interrupt pins.
- Either +12 volts or +5 volts is supplied by the radio under test to indicate the HI (1) logic level it uses for serial/parallel communications. If no signal is supplied, the logic level defaults to 5 volts.
- The load that this pin presents to an external voltage source depends on how many lines are pulled low.
- Input range is 5.1 to 20 V dc.
Load at maximum current (all lines pulled low) is 145Ω.

10. No connection

11. Parallel Strobe Out

- This pin outputs a digital pulse to indicate when data is output on the parallel data pins.
- The leading edge occurs when the pins change state. But, to allow for settling time, the external device should latch on the level of the pulse or the trailing edge. The strobe can be set to go high or low with the **Strobe Pol** field on the RADIO INTERFACE screen.
- The output level and current sink capability is the same as the parallel data pins. Strobe pulse width is 5 μs (typical).
Logic Sense is programmable high or low.

12. Interrupt Input 1

- The interrupt lines can be used together or independently. The lines must be armed for the Test Set to sense an interrupt. This is done in the **Interrupt 1** or **Interrupt 2** fields on the RADIO INTERFACE screen. When an armed interrupt is pulled low, the **Interrupt 1** or **Interrupt 2** fields will show that the interrupt is **Tripped**. The interrupt can only be cleared when the line returns to the high state and the interrupt is armed again. The status of the interrupt lines can be read from the RADIO INTERFACE screen or by an HP-IB or IBASIC program. Also, one of the interrupts can be designated as the HP-IB service request (SRQ) indicator.
- Logic is active low.
Input impedance is internally pulled-up to the logic voltage through 100 kΩ.
Logic threshold is the same as the parallel data pins.

13. Interrupt Input 2

- See pin 14.

14. No Connection

15. Parallel Data In/Out

- You can designate these pins as outputs or inputs with the **I/O CONFIG** field of the RADIO INTERFACE screen. Pins designated as inputs are pulled high by the Test Set. Output level and input logic thresholds are set by the logic voltage (pin 9).
- Pin 19 is LSB, Pin 34 is MSB.
- High level output is Logic Voltage through a 3.16 k Ω pull-up resistor.
Output current sink (TTL low, voltage ≤ 1.5 V) is 6 mA minimum, 16 mA typical
Input data logic threshold is (Logic Voltage – 0.7 V) \times 0.34
The default Logic Voltage is 5.1 V.
- Read back on the data bus is accomplished by setting all data lines to the high state and then having the user pull appropriate data lines low according to the data to be read back.

16. No Connection.

See Also

[Chapter 16, "Radio Interface Screen"](#).

RF IN/OUT

This Type-N connection is used to output signals from the RF Generator and to input RF signals.

CAUTION:

Overpower Damage — Refer to the Test Set's front panel for maximum input power level. Exceeding this level can cause permanent instrument damage.

If the RF power at the RF IN/OUT port exceeds allowable limits, a loud warning signal sounds and a message appears at the top of the screen. If this occurs, disconnect the RF power, press [MEAS RESET], and allow the Test Set to cool off for approximately 2 minutes before making any other measurements on this port.

Operating Considerations

This port must be used when measuring TX (RF) Power.

Signals ≤ 200 mWatts can be input to the ANT IN connector for all RF measurements except TX Power.

This port can be selected in the TX TEST, DUPLEX TEST, RF ANALYZER, or SPECTRUM ANALYZER screens.

See Also

["Displaying Measurements" on page 57.](#)

SERIAL PORT

This connector is optional on the HP 8920A.

This 6-pin, RJ-11, dual serial port is used to input and output serial data for entering programs, printing tests results and screen images, and sending test results to a connected controller, disk drive, or terminal.

Operating Considerations

The serial communications settings are defined on the I/O CONFIGURE screen.

NOTE:

Using Port B. The second serial port (B) is only used with IBASIC programs to communicate with base stations or other equipment when the primary serial port is used for printing or data collection. Port B cannot be used for printing screens, and its communication settings can only be changed using IBASIC commands (listed in the Programmer's Guide). Unless you are writing IBASIC programs that require serial printing *and* other serial data transfer at the same time, we recommend that you only use the primary port (A).

The IBASIC Controller sends and receives data to the serial ports using address 9 for the primary port, and 10 for Port B. For example, to enter data from the primary serial port into a program variable named `SDATA`, you could use the following command:

```
ENTER 9;SDATA
```

To send data from your program out of the primary serial port, you could use the following command:

```
OUTPUT 9;SDATA
```

Use an RJ-11, 25-pin, RS-232 adapter (HP P/N 98642-66508) and RJ-11 cable (HP P/N 98642-66505) to connect the Test Set to a serial printer, terminal, or computer.

NOTE:

RJ-11 Connectors. RJ-11 cables and adapters can be wired several ways. If you buy a cable or adapter other than the HP parts listed, verify the connections for the pins indicated in the following table before connecting cables to the instruments.

The following table lists connections for the primary serial port (address 9). When using both ports at the same time, you need to locate or fabricate an adapter to provide the necessary connections.

Test Set RJ-11 Serial Port		Terminal/PC 25-Pin RS-232		Terminal/PC 9-Pin RS-232
Pin 2 (RX)	to	pin 2 (TX)	or	pin 3 (TX)
Pin 5 (TX)	to	pin 3 (RX)	or	pin 2 (RX)
Pin 4 (GND)	to	pin 7 (GND)	or	pin 5 (GND)

Serial Port Connections

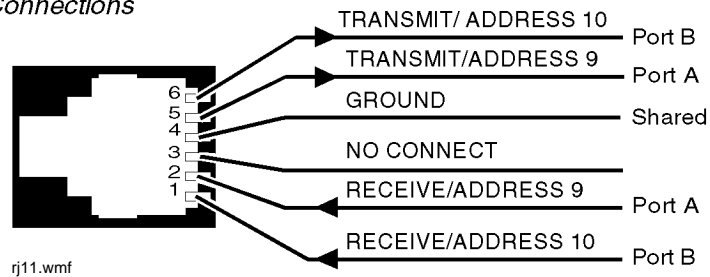

10 MHz REF INPUT

This connection allows you to input an external reference.

Operating Considerations

Input frequency = 1, 2, 5, or 10 MHz

Input level >0.15 V rms

Input impedance approximately 50Ω.

When a valid signal is applied to the 10 MHz REF INPUT, the Test Set automatically switches from internal to external reference.

This signal is used as a reference for, and directly affects, these functions:

- RF Generator Frequency (including the Tracking Generator)

- RF Frequency Counter

- AF Frequency Counter

- RF Analyzer Tune Frequency

- Spectrum Analyzer Center Frequency

AF Generators 1 and 2, and the decoder's frequency counter, are not affected using an external reference; they use their own reference.

NOTE: The reference output frequency is always 10 MHz, independent of the selected input reference frequency.

Electrostatic discharges to the 10 MHz REF INPUT port of 0.5 kV or above may cause degradation of performance requiring operator intervention.

10 MHz REF OUTPUT

This connector furnishes a 10 MHz reference for external instruments.

Operating Considerations

Waveform = sinewave

Output frequency = 10 MHz

Output level >0.5 V rms

Output impedance approximately 50Ω.

NOTE: The reference output frequency is always 10 MHz, independent of the selected input reference frequency.

Key Descriptions

DATA Keys

The DATA keys have four main uses:

- The [0] to [9], [.], [+/-], and A to F keys are for entering and changing values.
- [ENTER] is used to select a field or screen, and to enter numbers when the unit-of-measure is not specified. This function is identical to pressing the cursor-control knob.
- [ON/OFF] is used to enable and disable measurements, and to turn numeric fields (such as **Amplitude**) on and off.
- YES and NO are used to confirm selected operations before they are executed.
- EEX ([SHIFT], [+/-]) is used for entering numbers using scientific notation.
- The remaining keys in this area are for entering and changing the unit-of-measure for measurements or field entries.

See Also

["Entering and Changing Numbers" on page 63.](#)

DATA FUNCTIONS Keys

[INCR ³10], [INCR SET], and [INCR ×10] are used to change the increment or decrement a value when changing field values.

- Up-arrow and down-arrow keys increment or decrement field values. These keys are also used to select alternate field entries without displaying the **Choices** menu used by some fields. They are also used to move the cursor in string entry fields (such as the **Print Title** field on the PRINT CONFIGURE screen).
- LO LIMIT ([SHIFT], down-arrow key) and HI LIMIT ([SHIFT], up-arrow key) and set measurement end points. Exceeding the end points causes screen prompts to blink until they are reset.

REF SET ([SHIFT], [INCR ³10]) is used to enter or remove a measurement reference for relative AF and RF measurements.

METER ([SHIFT], [INCR SET]) enables or disables the analog bar-graph meter function for measurements using large digits (such as the RX TEST and TX TEST screen measurements).

AVG ([SHIFT], [INCR ×10]) enables or disables measurement averaging.

See Also

["Operating Overview" on page 53.](#)

INSTRUMENT STATE Keys

[LOCAL] returns the instrument to manual control after HP-IB control is used.

- [RECALL] lists any instrument setups that were saved.
- [MEAS RESET] clears the measurement “history” for all of the instrument’s measurement algorithms (such as the averaging function) to restart all measurements that are in progress.
- [PRESET] restores most instrument settings to their factory default states, (although most CONFIGURE screen changes are not affected). Instrument self-diagnostics are not run at this time.
- ADRS ([SHIFT], [LOCAL]) displays the HP-IB address of the Test Set.
- SAVE ([SHIFT], [RECALL]) stores instrument setups.

See Also

["Saving and Recalling Instrument Setups" on page 76.](#)

SCREEN CONTROL Keys

[RX], [TX], [DUPLEX], [TESTS], MSSG, HELP, and CONFIG access several instrument control and information screens.

- [PREV] accesses the previous screen.
- HOLD ([SHIFT], [PREV]) stops all measurements. Selecting HOLD again resumes measurements.
- PRINT ([SHIFT], [TESTS]) prints the entire contents of the displayed screen, the time and date, and any **Print Title** defined in the PRINT CONFIGURE screen.

See Also

["Printing A Screen" on page 66.](#)

Miscellaneous Keys and Buttons

- [SHIFT] is used to select the blue-labeled functions listed above some keys (such as PRINT, CONFIG, RELEASE, EEX and so forth).
- [CANCEL] is used to cancel an entry in progress, or to stop a running IBASIC program. For example, if you press [RECALL] to recall an instrument setup, and then decide not to recall a setting, pressing [CANCEL] exits the recall procedure.
- Left-arrow key (backspace) is used to move the cursor to the left when entering numbers in a field, such as **RF Gen Freq**. Each press of this key moves the cursor one place to the left, erasing the previous character.
- The rear-panel AC/DC button setting selects the instrument's power source. The power source must be changed with the Test Set turned off.
- [POWER] turns the instrument power on and off. Several CONFIGURE screen settings, and all SAVE/RECALL registers, are retained by battery back-up when power is disconnected.

USER Keys

These keys are used to instantly access fields without using the cursor-control knob or changing screens.

See Also

["Using USER Keys" on page 80.](#)

Knob Descriptions

- CURSOR CONTROL has three functions:
 1. Moving the cursor.
 2. Selecting fields, screens, and settings from a list of choices.
 3. Changing numeric field values.
- VOLUME controls the speaker volume for monitoring the AF Analyzer's selected input. The volume is also affected by the **Speaker Vol** and **Speaker ALC** fields in the AF ANALYZER screen.
- SQUELCH adjusts the squelch level when demodulating AM, FM, or SSB signals. The squelch level is affected by the **Squelch** field in the RF ANALYZER screen.

See Also

[Chapter 17, "RF Analyzer Screen"](#)

[Chapter 5, "AF Analyzer Screen"](#)

**Modifications, Accessories, Manuals,
Support**

Modifications

This section includes information regarding:

- Hardware Upgrades/Modifications
- Firmware Upgrades
- Accessories
- Manuals (English and non-English)
- Radio Test Software
- Power Cables
- Sales and Service Support

Hardware Upgrades and Modifications

You can install several options in your Test Set or have Hewlett-Packard install them for you. If you want HP to install the options, contact the nearest regional sales office listed at the end of this chapter.

Some options may not be available depending on which model number you have. One or more options may already be installed in your instrument. For more specific information, see table 14 on the following page.

Table 15 **Hardware Retrofits and Modifications**

Description	HP 8920A
Option 001: High Stability Timebase	R01
Option 004: Tone/Digital Signaling	R04
Option 007 ^a : Low-level RF Power Measurement	R07 ^b
Option 008 ^c : Cellular Mobile RF Power Measure Range	R08 ^b
Option 010 ^d : 400 Hz High Pass Filter	R10
Option 011 ^d : CCITT Weighting Filter	R11 ^b
Option 012 ^d : 4 kHz Bandpass Filter	R12
Option 013 ^d : C-Message Weighting Filter	R13

Table 15 Hardware Retrofits and Modifications

Description	HP 8920A
Option 014 ^d : 6 kHz Bandpass Filter	R14
Option 019: Variable Frequency Notch Filter, 300 Hz - 10 kHz	R19
Option 020: Radio Interface Card	R20 ^b
Option 050: Dual-mode Rear Panel Connectors	R50 ^{ef}
Firmware Upgrade Kit	R98
Option 102: Spectrum Analyzer with Tracking Generator	R02 ^g
Option 103: HP-IB/RS-232/Parallel Port/DC Current Measurement	R93

- a. This option reduces the maximum input power of the HP 8920A from 60 watts to 2.4 watts. It cannot be ordered with Option 008 or H08.
- b. Firmware upgrade kit included with option retrofit kit.
- c. This option reduces the maximum input power of the HP 8920A from 60 watts to 6 watts. It cannot be ordered with Option 008 or H08.
- d. A maximum of two filters options can be added to an instrument.
- e. Included high stability timebase and improved residual FM performance.
- f. Retrofit kit can only be installed in instruments with serial prefix 3248A and above.
- g. Retrofit kit does not include firmware. 1, 2, 10 dB resolution requires firmware revision A.06.01 or later. ACP (Adjacent Channel Power) measurement capability requires revision A.12.01, or later.

Firmware Upgrades

Table 16 **Firmware Upgrades**

Description	HP 8920A
Operating System and Signaling ^a ROMs	R40 R98

- a. Option 004 Tone/Digital Signaling.

Accessories

Table 17 **Accessories**

Description	HP 8920A
Telescoping Antenna	08920-61060
Microphone	08920-61059
DC Battery Pack (24V)	08920-80027
Battery Charger	08920-80028
CRT Sun Shade	08920-61051
Connector Kit (one each: dc power, MIC/ACC, RS-232, RJ-11, and radio interface connectors)	08920-61061
DC Power Connector Housing (Qty 1)	1251-4782
DC Power Connector Contacts (Qty 2)	1252-0385
System Rack Mount Flange Kit (Option 908)	5061-4846
Rack mount kit ^a for HP 8920D or HP 8921D	08921-61037
Padded Carrying Case	1540-1130
Hardshell Transit Case	08920-90033
Passive Oscilloscope Probe (1 M Ω /7.5pF 10:1)	HP 10435A
Passive Oscilloscope Probe (High Z/40pF 1:1)	HP 10438A
Passive Oscilloscope Probe (High Z/64pF 1:1)	HP 10439A
RF Detector Probe (100 kHz to 700 MHz)	HP 34301A
Resistor Divider Probe Kit	HP 54006A
Power Splitter (DC to 3 GHz, 50 Ω)	HP 11850C

Table 17 **Accessories (Continued)**

Description	HP 8920A
32 KByte SRAM ^b Memory Card	HP 85700A
128 KByte SRAM Memory Card	HP 85702A
256 KByte SRAM Memory Card	HP 85704A
512 KByte SRAM Memory Card	HP 85705A
128 KByte OTP ^c Memory Card	HP 85701A
256 KByte OTP Memory Card	HP 85703A
512 KByte OTP Memory Card	HP 85706A

- a. Allows rack mounting of Cellular Adapter (example: HP 83201A) to HP 8920A.
- b. SRAM = Static Random Access Memory
- c. OTP = One Time Programmable (PROM).

External Monitor

The CRT's Video Output drives a multisync monitor at 19.2 kHz (analog). Examples of this type of monitor include the Electrohome ECM 1410-DMS 14-inch color monitor and the EVM 1242-P4VID 12-inch monochrome monitor.

Manuals (English and non-English)

Table 18 **Manuals**

Description	Language	Option	HP 8920A
Quick Reference Manual ^a	English	--	08920-90010
Quick Reference Card	English	--	08920-90014
HP 8920 User's Guide	English	--	08920-90203
Instrument BASIC Language Reference	English	--	E2083-90000
Programmer's Guide	English	--	08920-90204
Assembly Level Repair Manual	English	--	08920-90168
Applications Handbook	English	--	08920-90126
Quick Reference Manual ^b	Japanese	ABJ	08920-90016
User's Guide	Japanese	ABJ	08920-90191
Programmer's Guide	Japanese	ABJ	08920-90192
Quick Reference Manual	Spanish	ABE	08920-90017
User's Guide	Spanish	ABE	08920-90097
Quick Reference Manual	French	ABF	08920-90018
Quick Reference Manual	German	ABD	08920-90019
Quick Reference Manual	Italian	ABZ	08920-90020
User's Guide	Italian	ABZ	08920-90123
Quick Reference Manual (Traditional Chinese for Taiwan)	Chinese	AB0	08920-90021
User's Guide (Traditional Chinese for Taiwan)	Chinese	AB0	08920-90098
Applications Handbook (Traditional Chinese for Taiwan)	Chinese	AB0	08920-90146
Quick Reference Manual (Simplified Chinese, PRC)	Chinese	AB2	08920-90022
User's Guide (Simplified Chinese, PRC)	Chinese	AB2	08920-90156
Applications Handbook (Simplified Chinese, PRC)	Chinese	AB2	08920-90147
Quick Reference Manual	Korean	AB1	08920-90023

Table 18 **Manuals (Continued)**

Description	Language	Option	HP 8920A
Applications Handbook	Korean	AB1	08920-90145
Quick Reference Manual	Finnish	ABX	08920-90039

- a. Shipped inside instrument impact cover
- b. Each non-English Quick Reference Manual includes a Quick Reference Card, and a Quick Start Label.

Radio Test Software

The Radio Test Software performs automated tests on radios used in various radio communication systems. Each test package is contained on an individual memory card.

The HP 11807A Radio Test Software performs automated tests on radios used in various radio communication systems. The HP 11807A software is used primarily with the HP 8920A.

Memory Expansion. All HP 11807A software products require the **HP 8920A** to be equipped with instrument option 005, 512-kilobyte RAM expansion.

Table 19 **HP 11807A Software for the HP 8920A**

Option 001	North American FM Tests
Option 002	European PM Tests
Option 003	AM Tests
Option 004	AMPS-EAMPS-NAMPS Cellular Tests ^a
Option 005	TACS-ETACS Cellular Tests ^a
Option 006	NMT Cellular Tests ^a
Option 007	JTACS-NTACS Cellular Tests
Option 008	TDMA Dual-Mode Cellular Tests ^b
Option 009	AMPS-EAMPS-NAMPS-TDMA Dual-Mode ^c
Option 010	LTR Trunked Radio Tests (Includes conventional FM test capability.) ^a
Option 011	EDACS Trunked Radio Tests ^a
Option 012	MPT 1327 Trunked Radio Tests ^a
Option 100	System Support Tests (frequency scanning, cable fault location, field strength, intermodulation products programs).

- a. HP 8920A requires Option 004 Tone/Digital Signaling
- b. Requires an HP 83201A Dual Mode Cellular Adapter
- c. Requires options 1013, 004, 005, 013, 050, and the HP 89201A to perform the TDMA tests.

Power Cables

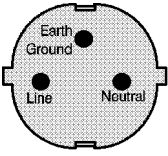
Plug Type	Plug Descriptions male/female	HP Part # (cable & plug)	Cable Descriptions
	Straight/Straight Straight/90°	8120-1689 8120-1692	79 inches, mint gray 79 inches, mint gray
Used in the following locations			
Afghanistan, Albania, Algeria, Angola, Armenia, Austria, Azerbaijan, Azores			
Bangladesh, Belgium, Benin, Bolivia, Bosnia-Herzegovina, Bulgaria, Burkina Faso, Burma, Burundi, Byelarus			
Cameroon, Canary Islands, Central African Republic, Chad, Chile, Comoros, Congo, Croatia, Czech Republic, Czechoslovakia			
Denmark, Djibouti			
East Germany, Egypt, Estonia, Ethiopia			
Finland, France, French Guiana, French Indian Ocean Areas			
Gabon, Gaza Strip, Georgia, Germany, Gozo, Greece			
Hungary			
Iceland, Indonesia, Iran, Iraq, Israel, Italy, Ivory Coast			
Jordan			
Kazakhstan, Korea, Kyrgystan			
Latvia, Lebanon, Libya, Lithuania, Luxembourg			
Macedonia, Madeira Islands, Malagasy Republic, Mali, Malta, Mauritania, Miquelon, Moldova, Mongolia, Morocco, Mozambique			
Nepal, Netherlands, Netherlands Antilles, Niger, Norway			
Oman			
Pakistan, Paraguay, Poland, Portugal			
Rep. South Africa, Romania, Russia, Rwanda			
Saudi Arabia (220V), Senegal, Slovak Republic, Slovenia, Somalia, Spain, Spanish Africa, Sri Lanka, St. Pierre Islands			
Sweden, Syria			
Tajikistan, Thailand, Togo, Tunisia, Turkey, Turkmenistan			
USSR, Ukraine, Uzbekistan			
Western Africa, Western Sahara			
Yugoslavia			
Zaire			

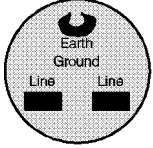
Plug Type	Plug Descriptions male/female	HP Part # (cable & plug)	Cable Descriptions
	Straight/Straight	8120-0698	90 inches, black
Used in the following locations			
Peru			

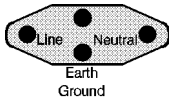
Plug Type	Plug Descriptions male/female	HP Part # (cable & plug)	Cable Descriptions
	Straight/Straight Straight/90°	8120-2104 8120-2296	79 inches, gray 79 inches, gray
Used in the following locations			
Switzerland			

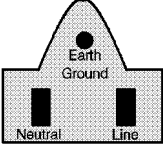
Plug Type	Plug Descriptions male/female	HP Part # (cable & plug)	Cable Descriptions
<p style="text-align: center;">125V</p> 	<p>Straight/Straight Straight/90° Straight/Straight</p>	<p>8120-1378 8120-6177 8120-1751</p>	<p>90 inches, jade gray 90 inches, jade gray 90 inches, jade gray</p>
Used in the following locations			
American Samoa			
Bahamas, Barbados, Belize, Bermuda, Brazil,			
Caicos, Cambodia, Canada, Cayman Islands, Columbia, Costa Rica, Cuba			
Dominican Republic			
Ecuador, El Salvador			
French West Indies			
Guam, Guatemala, Guyana			
Haiti, Honduras			
Jamaica			
Korea			
Laos, Leeward and Windward Is., Liberia			
Mexico, Midway Islands			
Nicaragua			
Other Pacific Islands			
Panama, Philippines, Puerto Rico			
Saudi Arabia (115V,127V), Surname			
Taiwan, Tobago, Trinidad, Trust Territories of Pacific Islands			
Turks Island			
United States			
Venezuela, Vietnam, Virgin Islands of the US			
Wake Island			

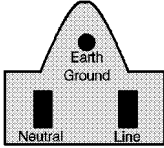
Plug Type	Plug Descriptions male/female	HP Part # (cable & plug)	Cable Descriptions
JIS C 8303, 100 V 	Straight/Straight Straight/90°	8120-4753 8120-4754	90 inches, dark gray 90 inches, dark gray
Used in the following locations			
Japan			

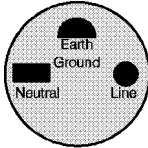
Plug Type	Plug Descriptions male/female	HP Part # (cable & plug)	Cable Descriptions
	90°/Straight 90°/90° Straight/Straight	8120-2956 8120-2957 8120-3997	79 inches, gray 79 inches, gray 79 inches, gray
Used in the following locations			
Denmark			
Greenland			

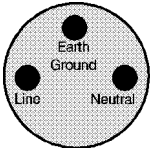
Plug Type	Plug Descriptions male/female	HP Part # (cable & plug)	Cable Descriptions
	Straight/Straight Straight/90°	8120-4211 8120-4600	79 inches, mint gray 79 inches, mint gray
Used in the following locations			
Botswana			
India			
Lesotho			
Malawi			
South-West Africa (Namibia), Swaziland			
Zambia, Zimbabwe			

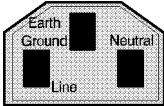
Plug Type	Plug Descriptions male/female	HP Part # (cable & plug)	Cable Descriptions
	Straight/Straight Straight/Straight Straight/90° Straight/90°	8120-1860 8120-1575 8120-2191 8120-4379	60 inches, jade gray 30 inches, jade gray 60 inches, jade gray 15.5 inches, jade gray
Used in the following locations			
System Cabinets			

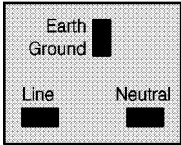
Plug Type (Male)	Plug Descriptions male/female	HP Part # (cable & plug)	Cable Descriptions
	90°/Straight 90°/ 90°	8120-1351 8120-1703	90 inches, mint gray 90 inches, mint gray
Used in the following locations			
Bahrain, British Indian Ocean Territories, Brunei			
Canton, Cyprus			
Enderbury Island, Equatorial Guinea			
Falkland Islands, French Pacific Islands			
Gambia, Ghana, Gibraltar, Guinea			
Hong Kong			
Ireland			
Kenya, Kuwait			
Macao, Malaysia, Mauritius			
Nigeria			
Qatar			
Seychelles, Sierra Leone, Singapore, Southern Asia, Southern Pacific Islands, St. Helena, Sudan			
Tanzania			
Uganda, United Arab Emirates, United Kingdom			
Yeman (Aden & Sana)			

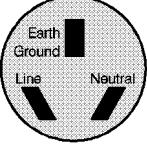
Plug Type	Plug Descriptions male/female	HP Part # (cable & plug)	Cable Descriptions
	Straight/Straight Straight/90°	8120-1369 8120-0696	79 inches, gray 80 inches, gray
Used in the following locations			
Argentina, Australia			
China (People's Republic)			
New Zealand			
Papua New Guinea			
Uruguay			
Western Samoa			

HP Support for Your Instrument

Parts and service for your Test Set can be ordered by contacting the nearest Hewlett-Packard regional sales office listed in **table 20, "Regional Sales Offices"** on **page 602**.

Customer Training

Hewlett-Packard offers customers a variety of training materials and classes that explain the theory and applications of many HP products. Contact your HP regional sales office to arrange training for you or your group.

Table 20 **Regional Sales Offices**

United States of America U.S. Instrument Support Center For Test & Measurement Equip- ment Repair & Calibration. Englewood, Colorado 80112 Telephone: (800) 403-0801 Fax: (888) 857-8161	United States of America Customer Information Center Hewlett-Packard Company Tel: (800) 752-0900 6:00 am to 5:00 pm Pacific Time Parts Direct: 1-800-227-8164	United Kingdom Sales and Service Hewlett-Packard Ltd. Cain Road Amen Corner Bracknell, Berkshire RG12 1HN United Kingdom Telephone: 44 344 360000 Fax: 44 344 363344
South Eastern Europe Sales and Service Hewlett-Packard Ges. m.b.h. Liebigasse 1 P.O. Box 72 A-1222 Vienna, Austria Telephone: 43 222 2500 0 Telex: 13 4425	European Multicountry Region Sales and Service Hewlett-Packard S.A. P.O. Box 95 150, Route dv Nant_dl_AVRIL CH-1217 Meyrin 2 Geneva, Switzerland Telephone: (41/22) 780-8111 Fax: (41/22) 780-8542	Northern Europe Sales and Service Hewlett-Packard Nederland B.V. Startbaan 16 1187 XR Amstelveen, The Netherlands P.O. Box 667 Telephone: 31/20 5476911 X 6631 Fax: 31-20-6471825NL

Table 20 Regional Sales Offices

<p>Asia Sales and Service Hewlett-Packard Asia Ltd. 22-30/F Peregrine Tower Lippo Center 89 Queensway, Central Hong Kong G.P.O. Box 863 Hong Kong Telephone: 852-848-7777 Fax: 852-868-4997</p>	<p>Japan Hewlett-Packard Japan, Ltd. Measurement Assistance Center 9-1, Takakura-Cho, Hachioji-Shi Tokyo 192-8510, Japan Telephone: (81)-426-7832 Fax: (81)-426-56-7840</p>	<p>International Sales Branch Head- quarters Sales and Service Hewlett-Packard S.A. 39 Rue Veyrot P.O. Box 365 1217 Meyrin 1 Geneva, Switzerland Telephone: 41-22-780-4111 Fax: 41-22-780-4770</p>
<p>Australia, New Zealand Sales and Service Hewlett-Packard Ltd. P.O. Box 221 31-41 Joseph Street Blackburn, Victoria 3130 Telephone: (61/3) 895-2895 Fax: (61/3) 898-9257</p>	<p>Canada Sales and Service Hewlett-Packard (Canada) Ltd. 5150 Spectrum Way Mississauga, Ontario L4W 5G1 Canada Telephone: (416) 206-4725 Fax: (416) 206-4739</p>	<p>Canada Service Center Hewlett-Packard Company 17500 Transcanada Highway S. Serv Road Kirkland, Quebec H9J 2X8 Canada Telephone: (416) 206-3295</p>
<p>Canada Service Center Hewlett-Packard Ltd. 11120 178 Street Edmonton, Alberta T5S 1P2 Canada Telephone: (403) 486-6666 Fax: (403) 489-8764</p>	<p>Latin America Hewlett-Packard Company LAHQ Mexico City Col. Lomas de Virreyes 11000 Mexico D.F. Mexico Telephone: (52/5) 326-4000 Fax: (52/5) 202 7718</p>	

Error Messages

General Information About Error Messages

Information concerning error messages displayed by the Test Set may be found in one of the following manuals:

- *HP 8920A, HP 8920B, or HP 8921A User's Guides*
- *HP 8920A, HP 8920B, or HP 8921A Programmer's Guide*
- *HP 8920A, HP 8920B, or HP 8921 Assembly Level Repair Manual*
- *HP Instrument BASIC User's Handbook:*
 - HP 8920A or HP 8921A: *HP Instrument BASIC Users Handbook* (HP P/N E2083-90601)
 - HP 8920B: *HP Instrument BASIC Users Handbook Version 2.0* (HP P/N E2083-90005)

The format of the displayed message determines which manual contains information about the error message. There are four basic error message formats:

- Positive numbered error messages
- IBASIC error messages
- HP-IB error messages
- Text only error messages

The following paragraphs give a brief description of each message format and direct you to the manual to look in for information about error messages displayed in that format.

Positive Numbered Error Messages

Positive numbered error messages are generally associated with IBASIC. Refer to the *HP Instrument BASIC User's Handbook* for information on IBASIC error messages.

Positive numbered error messages take the form: **ERROR XX**

For example:

- **Error 54 Duplicate file name**
- or
- **Error 80 in 632 Medium changed or not in drive**

Negative Numbered Error Messages

Negative numbers preceding the error messages text correspond to the error conditions outlined in the Standard Commands for Programmable Instruments (SCPI). For more information on SCPI, order the following book,

A Beginner's Guide to SCPI Addison-Wesley Publishing Company ISBN 0-201-56350-9
HP P/N 5010-7166

or contact,

Fred Bode, Executive Director SCPI Consortium
8380 Hercules Drive, Suite P3
La Mesa, CA 91942
Phone: (619) 697-8790, FAX: (619) 697-5955 CompuServe Number: 76516,254

Negative numbered error messages take the form: ERROR -XX <error message>

For example:

Error -128 Numeric data not allowed

or

Error -141 Invalid character data

IBASIC Error Messages

IBASIC Error Messages are associated with IBASIC operation. IBASIC error messages can have both positive and negative numbers. Refer to the *HP Instrument BASIC User's Handbook* for information on positive numbered error messages. Refer to the HP-IB Error Messages section of the *Programmer's Guide* for information on negative numbered error messages (the error message associated with a negative number is the same for HP-IB errors and IBASIC errors).

IBASIC error messages take the form: **IBASIC Error: -XX**

For example:

- **IBASIC Error: -286 Program runtime error**

HP-IB Error Messages

HP-IB Error Messages are associated with HP-IB operation. Refer to the Programmers Guide for information on HP-IB error messages.

HP-IB error messages take the form: **HP-IB Error: -XX** or **HP-IB Error**

For example:

HP-IB Error: -410 Query INTERRUPTED.

or

HP-IB Error: Input value out of range.

Text Only Error Messages

Text only error messages are generally associated with manual operation of the Test Set. This manual contains information on text only error messages.

Text only error messages can also be displayed while running the Test Set's built-in diagnostic or calibration utility programs. Refer to the *Assembly Level Repair* manual for information on text only error messages displayed while running the Test Set's built-in diagnostic or calibration utility programs.

Text only error messages take the form: **This is an error message.**

For example:

- **Input value out of range.**

The Message Display

During instrument operation, various messages may appear on the Test Set's display. Prompt-type messages generally appear on the first line of the Test Set's display. General operating and error messages usually appear on the second line of the display. Some messages are persistent; they remain displayed until the error condition no longer exists, or until another persistent message with greater priority occurs. Other messages are only displayed when the error first occurs; they are removed when a key is pressed or the knob is turned, or when an HP-IB command is received. Many of the messages are displayed on the MESSAGE screen until the instrument is turned off.

Messages that are about error conditions may tell you what to do to correct the error (turn something off, reduce a field's value, press a certain key, and so forth). Messages and prompts are sometimes accompanied by a beep or warble.

NOTE:**Warbles and Beeps**

A warble sound indicates that an instrument-damaging event is occurring. Beeps often occur only with the first occurrence of the message. Prompts are generally silent.

Non-Recoverable Firmware Error

The non-recoverable firmware error is very important. It appears when an unanticipated event occurs that the Test Set's firmware cannot handle. The message appears in the center of the Test Set's display and (except for the two lines in the second paragraph) has the form:

```
Non-recoverable firmware error. Please record the 2 lines of
text below and contact Hewlett-Packard through your local
service center or by calling (800) 827-3848 (USA, collect) and
asking to speak to the Service Engineer.
```

```
    'Address error exception'
      at line number 0
```

To continue operation, turn POWER off and back on.

Follow the instructions in the message.

Unfortunately, you will not be able to recover from this condition. You must switch the Test Set off and back on. When you rerun the test where the Error Message occurred, it may not occur again. If it does reappear, it would be helpful to Hewlett-Packard to record exactly what the configuration of the instrument was when the error appeared and contact Hewlett-Packard.

Text Only Error Messages

Operation errors generally occur when you try to do something the Test Set was not designed to do. Most messages tell you what to do to correct the problem, (turn something off, reduce a field's value, press a certain key, ...and so forth).

Some common messages are listed here:

All self tests passed.

The Test Set did not detect any hardware or firmware failures during its initial self-diagnostics. This message should always be displayed immediately after instrument turn on.

Input value out of range.

A number was entered that was too large or small for the selected field, for example, trying to set **AFG1 Freq** to 125 kHz.

Invalid keystroke.

You used a key that has no function relating to the selected field, for example, pressing the [ON/OFF] key while the **Filter 1** field is selected.

Option not installed.

You selected a function that requires optional hardware that is not present for example, selecting **TDMA TEST** from the **To Screen** menu when you do not have an HP 83201A or HP 83201B Cellular Adapter connected to the Test Set.

Table 21 Required Hardware for Additional Test Set Functions

Function	Required Hardware
AD CH PWR (Adjacent Channel Power)	Option 102 - Spectrum Analyzer
SPEC ANL (Spectrum Analyzer)	Option 102 - SpectrumAnalyzer
LVL_MTR (signal strength meter) ROM Program	A16 Receiver Assembly
TDMA TEST	HP 83201A/B Cellular Adapter
PDC TEST, PHP TEST	HP 83201B Cellular Adapter
TDMA	HP 83204 Cellular Adapter
PCS	HP 83236B Interface
CDMA TEST	HP 83203A/B Cellular Adapters
PRNT CNFG (Printer Configure)	Option 103 - Serial/HP-IB/ParallelPorts
RADIO INT	Option 020 - Radio Interface Port
Encoder, Decoder	Option 004 - Tone/ Digital Signaling

Turn off either AM or FM settings.

You tried to create simultaneous AM and FM (using any combination of AFGen1, AFGen2, and the **Mod In To** field). The Test Set does not provide simultaneous AM and FM.

Squelch interrupt overflow. Press MEAS RESET.

The Test Set temporarily interrupts audio measurements when squelch is first broken to prevent internal switching transients from influencing measurements (except when using the OSCILLOSCOPE, SPECTRUM ANALYZER, DECODER, or SERVICE screens). If squelch is repetitively broken in a period of a few seconds, the duration of measurement interruption becomes too great, and the Test Set stops interrupting the signal. Following measurements may be influenced by transient signals.

Pressing [MEAS RESET] clears the data buffer used to generate interrupts, resetting the normal squelch operation to eliminate transients.

This condition may occur when monitoring low-level off-the-air signals.

Cal file checksum incorrect - initializing file.

This error usually occurs after changing the Test Set's firmware ROM's. It is not a problem in that instance, but should not re-appear during subsequent operation of the Test Set.

Decoder buffer full. Decrease gate time.

Too many decoder samples were sent to the decoder's buffer during a measurement gate time causing a data overflow. Reducing the gate time decreases the amount of data sent during each measurement.

One or more self tests failed. Error code: XXXX

An instrument failure was detected when the Test Set was turned on. (For example, having a stuck front-panel key during turn on.) The numbered error message corresponds to a binary-weighted group of errors listed in the *TST Common Command description in the Programmer's Guide.

Change Ref Level, Input Port or Attenuator (if using "Hold").

The RF signal level is either too great or too small for the current input port, attenuator setting, or both. This error often occurs when trying to make a low-level measurement using the RF IN/OUT port with the Spectrum Analyzer. Make the indicated changes until this message is no longer displayed.

Change RF Gen Amplitude, Output Port or Atten Hold (if on).

This message appears when the RF Generator's **Amplitude** field is set too high when using the RF IN/OUT port or when adjusting the amplitude with the **Atten Hold** field set to **On**.

The RF IN/OUT port has a lower maximum output level than the DUPLEX OUT port. Use the DUPLEX OUT port, or reduce the RF Generator's level.

If **Atten Hold** is **On**, you may be adjusting the amplitude outside of the allowed range. Change the amplitude

Direct latch write occurred. Cycle power when done servicing.

The SERVICE screen was accessed and one or more internal latch settings were changed. Turn the instrument off and back on to reset the latches. (This condition can occur during periodic calibration.)

Error Messages

meaning of, ACP level measurement,
 91
meaning of, AF frequency, 124
meaning of, FM deviation, 131
meaning of, squelch, 477
meaning of, TX frequency error, 137
meaning of, TX power measurement,
 58, 91, 97, 112, 352, 480, 491, 559

Symbols

(Gen)-(AnI)
 Configure screen, 259

Numerics

10 MHz REF INPUT connector
 description, 579
10 MHz REF OUTPUT connector
 description, 579
114.3 MHz IF OUT connector
 description, 566
24-hour clock
 setting, 267
600 ohm impedance
 at AUDIO IN, 103

-
- A**
- abbreviated address word
 - forward control channel, 212
 - reverse control channel, 170
 - Abort Print
 - Print Configure screen, 454
 - abort printing, 66
 - ac
 - power source, 583
 - ac coupling
 - input, 348, 360, 370, 375, 379, 384, 394, 397, 426, 433, 488
 - output, 346, 356, 369, 374, 379, 383, 394, 397, 424, 432, 488
 - AC Level
 - AF Analyzer screen, 101
 - Duplex Test screen, 341
 - Radio Frequency Analyzer screen, 473
 - RF Analyzer screen, 473
 - RF Generator screen, 485
 - RX Test screen, 496
 - ac level
 - measurement, 59
 - peak detector, 108
 - AC, access channel, 325
 - AC/DC button, 583
 - Access annunciator
 - Call Bit screen, 197
 - Call Control screen, 123
 - Call Data screen, 166
 - access channel
 - channel number, call processing, 251
 - channel number, NMT, 425
 - Access Channel Number
 - Signaling Encoder screen, NMT mode, 421
 - Access Channel Power
 - Signaling Encoder screen, NMT mode, 421
 - access message, 204
 - accessing screens, 42
 - accessories, 589
 - ACP, 91
 - AM transmitter, 90
 - input port, 91
 - level, 91
 - measurement, 90
 - measurement speed, 96
 - output port, 90
 - ratio, 91
 - ACP Meas
 - Adjacent Channel Power screen, 91
 - Active
 - Call Bit screen, 197
 - Call Control screen, 123
 - Call Data screen, 167
 - Active annunciator
 - Call Bit screen, 197
 - Call Control screen, 123
 - Call Data screen, 167
 - Add Info
 - Signaling Encoder screen, NMT mode, 421
 - add options, 586
 - Addr
 - Tests (External Devices) screen, 539
 - address
 - digital paging, 376
 - HP-IB, external devices, 539
 - HP-IB, printer, 455, 543
 - HP-IB, test set, 439, 582
 - key, 582
 - pager, 286
 - Address Qualifier
 - Signaling Encoder screen, MPT 1327 mode, 404
 - adjacent channel power
 - measurement, 91
 - Adjacent Channel Power screen
 - ACP Meas, 91
 - AFGen1 Freq, 92
 - AFGen1 To, 92
 - Carrier Ref, 92
 - Ch Offset, 94
 - Channel BW, 92
 - Ext TX Key, 94
 - Input Atten, 94
 - Input Port, 95
 - Res BW, 96
 - Tune Freq, 96
 - Tune Mode, 96
 - TX Freq Error, 97
 - TX Frequency, 97
 - TX Power, 97
 - TX Pwr Zero, 97
 - view of, 91
 - ADRS key, 582
 - advanced mobile phone service
 - decoder, 271
 - encoder, 355
 - AF analyzer
 - CDCSS decoder settings, 284
 - input, 101, 272, 280, 285, 289, 295, 301, 305, 317, 335, 342, 552
 - level, 273, 282, 287, 291, 296, 302, 306, 319, 336
 - signal types analyzed, 101, 342, 552
 - AF Analyzer screen
 - AC Level, 101
 - AF Anl In, 101
 - AF Cnt Gate, 102
 - AF Freq, 110
 - Audio In Lo, 103
 - Current, 103, 110
 - DC current, 103
 - DC Level, 104, 110
 - De-Emp Gain, 104
 - De-emphasis, 104
 - Detector, 105
 - Distn, 110
 - Ext Load R, 106
 - Filter 1 and Filter 2, 106
 - FM Deviation, 106
 - functional block diagram, 101
 - Gain Cntl, 107
 - Input Gain, 107
 - Notch Freq, 108
 - Notch Gain, 108
 - Pk Det To, 108
 - Scope To, 109
 - Settling, 109
 - SINAD, 110
 - SNR, 110
 - Speaker ALC, 111
 - Speaker Vol, 111
 - TX Freq Error, 111
 - TX Frequency, 111
 - TX Power, 112
 - view of, 101
 - AF Anl In
 - AF Analyzer screen, 101
 - Analog Meas screen, 244
 - Duplex Test screen, 342
 - Signaling Decoder screen, AMPS-
-

-
- TACS mode, 272
 - Signaling Decoder screen, CDCSS mode, 280
 - Signaling Decoder screen, Digi Page mode, 285
 - Signaling Decoder screen, DTMF mode, 289
 - Signaling Decoder screen, EDACS mode, 295
 - Signaling Decoder screen, Func Gen mode, 301
 - Signaling Decoder screen, LTR mode, 305
 - Signaling Decoder screen, NAMPS-NTACS mode, 272
 - Signaling Decoder screen, NMT mode, 317
 - Signaling Decoder screen, Tone Seq mode, 335
 - TX Test screen, 552
 - AF Cnt Gate
 - AF Analyzer screen, 102
 - AF Freq
 - AF Analyzer screen, 110
 - Analog Meas screen, 245
 - Call Control screen, 124
 - Duplex Test screen, 343
 - RF Generator screen, 490
 - RX Test screen, 500
 - TX Test screen, 102, 553
 - AF frequency
 - modulation quality, 127
 - AF generator 1
 - amplitude, 344, 486, 497
 - frequency, 92, 344, 486, 496, 554
 - level, 554
 - modulation, 92, 344, 486, 497
 - AF generator 2
 - amplitude, 356, 369, 374, 379, 383, 394, 397, 422, 432, 487, 497
 - frequency, 394, 486, 496
 - modulation, 356, 369, 374, 379, 383, 394, 397, 422, 432, 487, 497
 - use of, 354
 - AF power
 - external load resistance, 60, 101, 485, 496
 - measurement, 60
 - AFGen1 Freq
 - Adjacent Channel Power screen, 92
 - Analog Meas screen, 245
 - Duplex Test screen, 344
 - RF Generator screen, 486
 - RX Test screen, 496
 - TX Test screen, 554
 - AFGen1 Lvl
 - TX Test screen, 554
 - AFGen1 To
 - Adjacent Channel Power screen, 92
 - Analog Meas screen, 245
 - Duplex Test screen, 344
 - RF Generator screen, 486
 - RX Test screen, 497
 - AFGen2 Freq
 - RF Generator screen, 486
 - RX Test screen, 496
 - Signaling Encoder screen, Func Gen mode, 394
 - AFGen2 To
 - RF Generator screen, 487
 - RX Test screen, 497
 - Signaling Encoder screen, AMPS-TACS mode, 356, 359
 - Signaling Encoder screen, CDCSS mode, 369
 - Signaling Encoder screen, Digi Page mode, 374
 - Signaling Encoder screen, DTMF mode, 379
 - Signaling Encoder screen, EDACS mode, 383
 - Signaling Encoder screen, Func Gen mode, 394
 - Signaling Encoder screen, LTR mode, 397
 - Signaling Encoder screen, NAMP-NTAC mode, 356, 359
 - Signaling Encoder screen, NMT mode, 422
 - Signaling Encoder screen, Tone Seq mode, 432
 - Alarm Level High
 - Signaling Encoder screen, NMT mode, 423
 - Alarm Level Low
 - Signaling Encoder screen, NMT mode, 423
 - ALC
 - disabling, 111
 - internal speaker, 111
 - alert order, 150
 - All Chans?
 - Tests (Order of Tests) screen, 528
 - Aloha Number
 - Signaling Encoder screen, MPT 1327 mode, 405
 - alpha-numeric operation
 - digital paging, 375
 - alternate traffic area, 429
 - alternate traffic channel
 - number, 430
 - power, 430
 - AM
 - depth, 59
 - input, 489
 - RF generator, 92, 344, 356, 369, 374, 379, 383, 394, 397, 422, 432, 486, 487, 497
 - AM Depth
 - Audio Analyzer Screen, 103, 473
 - amplifier
 - for distortion measurements, 108
 - for SINAD measurements, 108
 - Amplitude
 - Analog Meas screen, 245
 - Call Control screen, 124
 - Duplex Test screen, 345
 - RF Generator screen, 487
 - RX Test screen, 498
 - Spectrum Analyzer screen, 509
 - amplitude
 - AFGen1, 92, 344, 486, 497
 - AFGen2, 356, 369, 374, 379, 383, 394, 397, 422, 432, 487, 497
 - for call control, 124
 - for tone sequence, 434
 - function generator, 394
 - off, 92, 344, 356, 369, 374, 379, 383, 394, 397, 422, 432, 486, 487, 497
 - RF generator, 345, 487, 498, 509
 - tracking generator, 511
 - twist, 381
 - vertical sensitivity, 447
 - AMPS Call Control screen
-

- view of, [122](#)
- AMPS-TACS
 - control channel decoder, [271](#)
 - forward control channel, [355](#)
 - forward voice channel, [355](#)
 - radio standard, [366](#)
 - reverse control channel, [276](#)
 - reverse voice channel, [276](#)
 - simulated system, [136](#)
 - voice channel decoder, [271](#)
- AMPS-TACS decoder mode
 - AF Anl In, [272](#)
 - Arm Meas, [272](#)
 - Channel, [272](#)
 - Data (hex), [273](#)
 - Gate Time, [273](#)
 - Input Level, [273](#)
 - Num of Bits, [274](#)
 - Polarity, [274](#)
 - Single/Cont, [275](#)
 - Stop Meas, [275](#)
 - Trig Level, [275](#)
 - Trigger Pattern (bin), [275](#)
 - view of, [271](#)
- AMPS-TACS encoder mode
 - AFGen2 To, [356](#)
 - Audio Out, [356](#)
 - B/I Delay, [357](#)
 - Bursts, [357](#)
 - Busy/Idle, [357](#)
 - Channel, [357](#)
 - Data Level, [357](#)
 - Data Rate, [358](#)
 - Filler, [359](#)
 - FM Coupling, [360](#)
 - Message, [361](#), [362](#)
 - Polarity, [364](#)
 - SAT Freq, [365](#)
 - SAT Level, [365](#)
 - Send, [365](#)
 - Send Filler, [365](#)
 - Send Mode, [366](#)
 - Standard, [366](#)
 - Stop, [366](#)
 - Stop Filler, [366](#)
 - view of, [355](#)
- Analog Meas screen
 - AF Anl In, [244](#)
 - AF Freq, [245](#)
 - AFGen1 Freq, [245](#)
 - AFGen1 To, [245](#)
 - Amplitude, [245](#)
 - De-Emphasis, [245](#)
 - Detector, [246](#)
 - Filter 1, [246](#)
 - Filter 2, [246](#)
 - FM Deviation, [246](#)
 - TX Freq Error, [246](#)
 - TX Power, [246](#)
 - view of, [244](#)
- analog meter, [62](#)
- analyzer
 - arming measurements, [275](#), [283](#), [288](#), [292](#), [297](#), [303](#), [308](#), [320](#), [337](#)
 - calibration, [518](#)
 - disarming measurements, [297](#)
 - frequency, markers, [514](#)
 - input port, [508](#)
 - level, markers, [514](#)
- analyzer, AF
 - CDCSS decoder settings, [284](#)
 - input, [272](#), [280](#), [285](#), [289](#), [295](#), [301](#), [305](#), [317](#), [335](#)
 - level, [273](#), [282](#), [287](#), [291](#), [296](#), [302](#), [306](#), [319](#), [336](#)
- analyzer, RF
 - frequency, [351](#), [479](#), [558](#)
 - input attenuation, [475](#)
 - input port, [476](#)
 - level, [473](#)
 - measurements, [478](#)
 - sensitivity, [477](#)
 - tuning, [351](#), [479](#), [558](#)
- ANT IN connector
 - avoiding damage, [58](#), [95](#), [112](#), [349](#), [352](#), [476](#), [480](#), [508](#), [557](#), [559](#), [562](#)
 - connecting to, [40](#), [508](#)
 - description, [562](#)
 - for ACP ratio measurements, [91](#), [95](#)
 - for off-the-air measurements, [95](#), [310](#), [349](#), [476](#), [557](#)
 - for RF measurements, [95](#), [349](#), [476](#), [557](#)
 - gain at, [255](#)
 - input attenuation, [94](#), [475](#), [515](#)
 - loss at, [255](#)
 - sensitivity, [477](#), [517](#)
- Antenna In
 - Configure screen, [255](#)
- Area #
 - Signaling Encoder screen, NMT mode, [423](#)
- Area 1
 - Signaling Encoder screen, LTR mode, [397](#)
- Area 2
 - Signaling Encoder screen, LTR mode, [397](#)
- arm
 - measurment, [272](#), [275](#), [281](#), [283](#), [285](#), [288](#), [289](#), [292](#), [296](#), [297](#), [302](#), [303](#), [305](#), [308](#), [320](#), [335](#), [337](#)
 - radio interface interrupt, [461](#)
- Arm Meas
 - Signaling Decoder screen, AMPS-TACS mode, [272](#)
 - Signaling Decoder screen, CDCSS mode, [281](#)
 - Signaling Decoder screen, Digi Page mode, [285](#)
 - Signaling Decoder screen, DTMF mode, [289](#)
 - Signaling Decoder screen, EDACS mode, [296](#)
 - Signaling Decoder screen, Func Gen mode, [302](#)
 - Signaling Decoder screen, LTR mode, [305](#)
 - Signaling Decoder screen, NAMPS-NTACS mode, [272](#)
 - Signaling Decoder screen, Tone Seq mode, [335](#)
- arrow down key, [581](#)
- arrow left key, [583](#)
- arrow up key, [581](#)
- ASCII terminal, [86](#)
 - configuring, [442](#)
- ASSIGN, [82](#), [83](#)
- Atten Hold
 - Duplex Test screen, [345](#)
 - RF Generator screen, [488](#)
 - RX Test screen, [498](#)
- attenuation
 - automatic control, [94](#), [475](#), [515](#)

-
- input, RF analyzer, [94, 475](#)
 - input, spectrum analyzer, [515](#)
 - manual control, [94, 475, 515](#)
 - attenuator
 - decoder interference, [107, 475](#)
 - input, [94, 475, 515](#)
 - oscilloscope interference, [107, 475](#)
 - attenuator hold, [345, 488, 498](#)
 - Audio Analyzer Screen
 - AM Depth, [103, 473](#)
 - Audio Frequency Analyzer screen
 - Distortion, [104](#)
 - audio frequency counter
 - gate time, [102](#)
 - sampling, [102](#)
 - audio frequency generator, [496](#)
 - audio frequency measurements, [59, 102, 110, 343, 478, 490, 500, 553](#)
 - AUDIO IN connector
 - avoiding damage to, [563](#)
 - description, [563](#)
 - for ac level measurement, [101, 485, 496](#)
 - for ac level measurements, [59](#)
 - for call processing, [120](#)
 - for external load resistance measurement, [106, 498](#)
 - for SNR operation, [102, 110, 343, 490, 500, 553](#)
 - AUDIO IN HI connector, [563](#)
 - Audio In Lo
 - AF Analyzer screen, [103](#)
 - AUDIO IN LO connector
 - 600 ohm impedance, [103, 563](#)
 - floating, [103, 563](#)
 - grounded, [103, 563](#)
 - AUDIO MONITOR OUTPUT connector
 - description, [564](#)
 - Audio Out
 - Duplex Test screen, [346](#)
 - RF Generator screen, [488](#)
 - Signaling Encoder screen, AMPS-TACS mode, [356](#)
 - Signaling Encoder screen, CDCSS mode, [369](#)
 - Signaling Encoder screen, Digi Page mode, [374](#)
 - Signaling Encoder screen, DTMF mode, [379](#)
 - Signaling Encoder screen, EDACS mode, [383](#)
 - Signaling Encoder screen, Func Gen mode, [394](#)
 - Signaling Encoder screen, LTR mode, [397](#)
 - Signaling Encoder screen, NAMP-NTAC mode, [356](#)
 - Signaling Encoder screen, NMT mode, [424](#)
 - Signaling Encoder screen, Tone Seq mode, [432](#)
 - AUDIO OUT connector
 - coupling, [346, 356, 369, 374, 379, 383, 394, 397, 424, 432, 488](#)
 - description, [564](#)
 - audio power
 - measurement, [101, 485, 496](#)
 - audio source, [272, 280, 285, 289, 295, 301, 305, 317, 335](#)
 - Authent
 - AUTHENTICATION screen, [163](#)
 - AUTHENTICATION screen
 - Authent, [163](#)
 - Authentication screen
 - view of, [162](#)
 - AuthWORD
 - CALLP, [166](#)
 - Auto All
 - Range Hold, [261](#)
 - Auto/Norm
 - Oscilloscope screen, [450](#)
 - automatic level control, [111](#)
 - autoranging
 - AF/RF measurements, [260](#)
 - gain setting, [107](#)
 - input attenuator, [107, 475](#)
 - Autostart Test Procedure on Power-Up Tests (ExecutionConditions) screen, [536](#)
 - auto-tuning
 - AF/RF measurements, [260](#)
 - RF, [96, 351, 479, 558](#)
 - averaging
 - example, [69](#)
 - measurement results, [69](#)
 - restart averaging, [69](#)
 - AVG, [69, 581](#)
 - Avg 1-100
 - Spectrum Analyzer screen, [517](#)
-

B

- B/I Delay (FOCC)
 - Signaling Encoder screen, AMPS-TACS mode, 357
 - Signaling Encoder screen, NAMP-NTAC mode, 357
- backspace key, 583
- bandwidth
 - adjacent channel power, 92
 - IF filter, 349, 475, 556
 - resolution, ACP measurement, 96
- Base Freq
 - Configure screen, 255
- base settings
 - changing, 79
 - default, 79
- base station receiver
 - simulating, AMPS-TACS/NAMPS-NTACS, 271
- basic operation, 53
- Batt Save
 - Signaling Encoder screen, NMT mode, 424
- Battery
 - memory card, 74
 - part numbers, 74
 - replacing, 74
- battery, 51, 260
 - saving, 424
- baud rate, 441
- beat frequency, 62
- Beeper
 - Configure screen, 51, 257
- beeper
 - error alert, 257
 - volume control, 51, 257
- Bell
 - radio standard, 380
- bias
 - dc, offsetting, 488
- billing information, 429
- bit error, 374
- bits
 - CDCSS data rate, 281
 - CDCSS data stream, 372
 - CDCSS sequence, 281
 - digital paging data rate, 286
 - dotting, 360, 362
 - information, 360, 362
 - LTR data rate, 306
 - message, 279
 - NMT data rate, 425
 - parity, 279, 360, 362, 363
 - serial data word, 439
 - specifying patter to display, 275
 - sync word, 279
 - triggering, 275
 - type, 360, 362
 - word sync, 360, 362
- block diagram
 - AF Analyzer, 101
 - Duplex Test screen, 341
 - RF Analyzer, 473
 - RF Generator, 485
 - RX Test, 495
 - TX Test, 551
- brightness
 - setting, 50, 259
- BS
 - definition, 316
- BS Identity
 - Signaling Encoder screen, NMT mode, 424
- BSChalOrd
 - CALLP, 166
- buffer overflow error, 287
- Bursts
 - Signaling Encoder screen, AMPS-TACS mode, 357
 - Signaling Encoder screen, CDCSS mode, 369
 - Signaling Encoder screen, Digi Page mode, 374
 - Signaling Encoder screen, DTMF mode, 379
 - Signaling Encoder screen, LTR mode, 397
 - Signaling Encoder screen, NAMP-NTAC mode, 357
 - Signaling Encoder screen, Tone Seq mode, 433
- busy state, 357
- Busy/Idle
 - Signaling Encoder screen, AMPS-TACS mode, 357
 - Signaling Encoder screen, NAMP-NTAC mode, 357

C

- cables
 - power, 595
- calibration
 - spectrum analyzer, 518
- Call Bit screen
 - Access annunciator, 197
 - Active, 197
 - Active annunciator, 197
 - Connect annunciator, 197
 - Data Spec, 198
 - Set Message, 200
 - view of, 194
- CALL CONFIGURE
 - Sat Tol, 251
- Call Configure screen
 - CMAX, 251
 - Detector, 251
 - Input Attenuator, 251
 - TX Pwr Zero, 251
 - view of, 250
- Call Control Screen
 - Ch Loc, 125
 - DSAT, 130
 - DSAT/DST, 131
- Call Control screen
 - Access annunciator, 123
 - Active, 123
 - Active annunciator, 123
 - AF Freq, 124
 - Amplitude, 124
 - Called Number, 124
 - Chan, 125
 - Cntl Channel, 126
 - Connect annunciator, 126
 - Display, 127
 - ESN (dec), 131
 - ESN (hex), 131
 - FM Deviation, 131
 - Handoff, 132, 168, 198
 - MS Id, 132
 - Order, 134, 139
 - Page, 134
 - Page annunciator, 135
 - Phone Num, 135
 - Pwr Lvl, 134
 - Register, 135
 - Register annunciator, 135
 - Release, 135
 - SAT, 136
 - SCM, 136
 - SID, 136
 - System Type, 136
 - TX Freq Error, 137
 - TX Power, 138
 - view of, decoding error message, 128
 - view of, measurement display, 129, 130
- Call Data screen
 - Access annunciator, 166
 - Active, 167
 - Active annunciator, 167
 - Connect annunciator, 167
 - Display Word, 167
 - Order, 168, 199
 - Page, 169, 199
 - Page annunciator, 169, 199
 - Register, 169, 199
 - Register annunciator, 169, 200
 - Release, 169, 200
 - view of, 165
- call origination, 149
- Call Processing
 - Ch Loc
 - , 147, 189
- call processing
 - AUDIO IN connector, 120
 - connecting mobile station, 118
 - description, 113
 - general procedure, 121
 - operational overview, 115
 - screen, description of, 117
 - state diagram, 116
- Called Number
 - Call Control screen, 124
- Calling Channel Number
 - Signaling Encoder screen, NMT mode, 425
- Calling Name
 - Tests (External Devices) screen, 539
- CALLP
 - AuthWORD, 166
 - BSChalOrd, 166
 - NRVC Ord, 166
 - RECCW A, 165
 - RECCW B, 165
 - RECCW C, 165
 - RECCW D, 165
 - RECCW E, 165
 - RVCBSChal, 166
 - RVCOrd, 166
 - RVCOrdCon, 166
 - UniqChCon, 166
- CANCEL key, 583
- card
 - procedure location, 524, 533, 534
- Carrier
 - Configure screen, 266
- carrier
 - effect on RX/TX screen, 266
- Carrier Ref
 - Adjacent Channel Power screen, 92
- CC, calling channel, 325
- CCIR1
 - radio standard, 433
- CCIR2
 - radio standard, 433
- CCITT
 - radio standard, 433
- CDCSS decoder mode
 - AF analyzer settings, 284
 - AF Anl In, 280
 - Arm Meas, 281
 - Code (oct), 281
 - Data (bin), 281
 - Data Rate, 281
 - Input Level, 282
 - Polarity, 282
 - Single/Cont, 283
 - Stop Meas, 283
 - Trig Level, 283
 - view of, 280
- CDCSS encoder mode
 - AFGen2 To, 369
 - Audio Out, 369
 - Bursts, 369
 - Code, 369
 - Data Rate, 369
 - FM Coupling, 370
 - Polarity, 370
 - Send, 370
 - Send Mode, 371
 - Standard, 371
 - Stop, 371

- TOC Time, 371
- view of, 368
- cellular adapter
 - connectors, 566
- cellular telephone, 367
- Center Freq
 - Spectrum Analyzer screen, 507
- center frequency
 - for notch filter, 108
 - for spectrum analyzer, 507
 - RF signal, 96, 351, 479, 558
 - spectrum analyzer marker, 513
- Ch Loc
 - Call Control Screen, 125
- Ch Offset
 - Adjacent Channel Power screen, 94
- Chan
 - Call Control screen, 125
- Chan Space
 - Configure screen, 257
- Channel
 - Signaling Decoder screen, AMPS-TACS mode, 272
 - Signaling Decoder screen, NAMPS-NTACS mode, 272
 - Signaling Encoder screen, AMPS-TACS mode, 357
 - Signaling Encoder screen, NAMPS-NTACS mode, 357
- channel
 - access, NMT, 425
 - assignments, NMT, 425
 - bandwidth, ACP measurement, 92
 - calling, NMT, 425
 - changing, 403
 - number, control channel, 126
 - number, NMT encoder, 425
 - offset, ACP measurement, 94
 - spacing, user defined, 257
 - traffic, NMT, 425
 - trunked home, receiver, 401
 - trunked home, transmitter, 402
 - tuning, 263
- Channel BW
 - Adjacent Channel Power screen, 92
- channel power
 - level, 91
 - measurement, 90
 - measuring, 91
 - ratio, 91
- channel standard
 - AMPS (MS, LS), 262
 - ETACS (MS, LS), 262
 - JTACS (MS, LS), 262
 - LTR800/900 (MS, LS), 262
 - NAMPS(MSL, MSM, MSU, LSL, LSM, LSU), 262
 - NTACS (MS, LS), 262
 - TACS (MS, LS), 262
 - USER-DEF, 262
- chassis ground, 565
- Check
 - Tests (Pass/Fail Limits) screen, 531
- clear
 - global user key assignment, 83
 - local user key assignment, 82
 - RAM, 547
 - register contents, 77, 547
- clock
 - time-of-day, 267
- Clr Scr
 - Tests (IBASIC Controller) screen, 545
- CMAX
 - Call Configuration screen, 251
- Cnfg External Devices
 - Tests (Main Menu) screen, 522
- Cntl Channel
 - Call Control screen, 126
- co-channel interference, 423
- Code
 - Signaling Encoder screen, CDCSS mode, 369
- Code (oct)
 - Signaling Decoder screen, CDCSS mode, 281
- Code Location
 - Tests (Save/Delete Procedure) screen, 533
- code word
 - CDCSS decoder, 281
- color code
 - SAT, 136
- CONFIG key, 582
- configuration
 - call control, 250
 - call processing, 142, 153
 - radio interface inputs, 462
 - serial port, 86
 - test set, 49
- Configure screen
 - (Gen)-(Anl), 259
 - Antenna In, 255
 - Base Freq, 255
 - Beeper, 51, 257
 - Carrier, 266
 - Chan Space, 257
 - Date, 50, 258
 - Duplex Out, 258
 - Intensity, 50, 259
 - Low Battery, 51, 260
 - Notch Coupl, 260
 - PTT, 266
 - Range Hold, 260
 - RF Chan Std, 262
 - RF Display, 263
 - RF Gen Volts, 264
 - RF In/Out, 264
 - RF Level Offset, 265
 - RF Offset, 265
 - RFGen Volts, 50
 - RX/TX Cntl, 266
 - Serial No., 267
 - Time, 50, 267
 - Total RAM, 267
 - User Def Base Freq, 255
 - view of, 254
- connect
 - DUT to test set, 40
 - mobile station to test set for call processing, 118
 - radio to test set, 40
- Connect annunciator
 - Call Bit screen, 197
 - Call Control screen, 126
 - Call Data screen, 167
- connectors
 - 10 MHz REF INPUT, 579
 - 10 MHz REF OUTPUT, 579
 - 114.3 MHz IF OUT, 566
 - ANT IN, 562
 - AUDIO IN, 563
 - AUDIO MONITOR OUTPUT, 564
 - AUDIO OUT, 564
 - cellular adapters, 566

-
- Control I/O, [566](#)
 CRT VIDEO OUTPUT, [565](#)
 CW RF OUT, [566](#)
 DC CURRENT MEASUREMENT, [565](#)
 DC INPUT, [566](#)
 DET OUT, [566](#)
 digital testing, [566](#)
 DUPLEX OUT, [567](#)
 EXT SCOPE TRIGGER, [567](#)
 HP-IB, [568](#)
 IQ RF IN, [566](#)
 MIC/ACC, [568](#)
 MODULATION INPUT, [571](#)
 ParallelPort, [571](#)
 parts kit, [566](#)
 RADIO INTERFACE, [573](#)
 RF IN/OUT, [576](#)
 SERIAL PORT, [577](#)
 Cont/Single
 Oscilloscope screen, [451](#)
 Continue
 Tests (Execution Conditions) screen, [536](#)
 Tests (IBASIC Controller) screen, [545](#)
 Tests (Main Menu) screen, [522](#)
 Tests (Printer Setup) screen, [541](#)
 continuous digital controlled squelch system
 decoder, [280](#)
 encoder, [368](#)
 control
 characters, [86](#)
 filler, [360](#)
 filler message, [210](#)
 message, [360](#)
 remote, [85](#)
 status, [387](#)
 Control Channel
 Signaling Encoder screen, MPT 1327 mode, [406](#)
 control channel
 decoder, AMPS-TACS/NAMPS-NTACS, [271](#)
 number, call processing, [126](#)
 turning on, [143](#), [154](#)
 Control Channel, Number
 Signaling Encoder screen, EDACS mode, [383](#)
 Control Channel, RX Frequency
 Signaling Encoder screen, EDACS-mode, [383](#)
 Control Channel, TX Frequency
 Signaling Encoder screen, EDACS-mode, [383](#)
 Control I/O connector
 description, [566](#)
 Controls
 Oscilloscope screen, [446](#)
 Spectrum Analyzer screen, [505](#)
 counter
 AF, [102](#)
 RF, [477](#)
 Counter Connection
 Service screen, [502](#)
 coupling
 ac, [346](#), [348](#), [356](#), [360](#), [369](#), [370](#), [374](#), [375](#), [379](#), [383](#), [384](#), [394](#), [397](#), [424](#), [426](#), [432](#), [433](#), [488](#)
 dc, [346](#), [348](#), [356](#), [360](#), [369](#), [370](#), [374](#), [375](#), [379](#), [383](#), [384](#), [394](#), [397](#), [424](#), [426](#), [432](#), [433](#), [452](#), [488](#)
 notch frequency, [260](#)
 CRT VIDEO OUTPUT connector
 description, [565](#)
 Current
 AF Analyzer screen, [103](#), [110](#)
 Duplex Test screen, [343](#)
 RF Analyzer screen, [478](#)
 RF Generator screen, [490](#)
 RX Test screen, [500](#)
 TX TEST screen, [554](#)
 TX Test screen, [102](#), [553](#)
 current
 measurement, dc, [102](#), [110](#), [343](#), [478](#), [490](#), [500](#), [553](#)
 cursor control, [584](#)
 CW RF OUT connector
 description, [566](#)
- D**
- D (direction)
 Signaling Decoder screen, NMT mode, [318](#)
 dashes
 meaning of, ACP level measurement, [91](#)
 meaning of, squelch, [477](#)
 meaning of, TX power measurement, [58](#), [91](#), [97](#), [112](#), [352](#), [480](#), [491](#), [559](#)
 Data
 Signaling Decoder screen, EDACS mode, [296](#)
 Signaling Decoder screen, LTR mode, [305](#)
 Data (bin)
 Signaling Decoder screen, CDCSS mode, [281](#)
 Data (hex)
 Signaling Decoder screen, AMPS-TACS mode, [273](#)
 data buffer
 capacity, [274](#)
 Data Display
 Signaling Decoder screen, Digi Page mode, [286](#)
 DATA FUNCTIONS keys, [581](#)
 DATA keys
 uses for, [580](#)
 Data Length
 I/O Configure screen, [439](#)
 Data Level
 Signaling Encoder screen, AMPS-TACS mode, [357](#)
 Signaling Encoder screen, NAMPS-NTAC mode, [357](#)
 Data Rate
 Signaling Decoder screen, CDCSS mode, [281](#)
 Signaling Decoder screen, Digi Page mode, [286](#)
 Signaling Decoder screen, LTR mode, [306](#)
 Signaling Decoder screen, MPT 1327 mode, [314](#)
 Signaling Encoder screen, AMPS-TACS mode, [358](#)
 Signaling Encoder screen, CDCSS
-

- mode, 369
- Signaling Encoder screen, Digi Page mode, 374
- Signaling Encoder screen, EDACS mode, 384
- Signaling Encoder screen, LTR mode, 397
- Signaling Encoder screen, NAMP-NTAC mode, 358
- Signaling Encoder screen, NMT mode, 425
- data rate
 - encoder, 367
- Data Spec
 - Call Bit screen, 198
- data stream
 - CDCSS, 372
 - outputting, 370
 - outputting digital paging, 377
 - rate, 369
- data type
 - pager, 286
- Date
 - Configure screen, 50, 258
- date and time, 50
- dBm
 - displaying results in, 61
- dc
 - power, grounding for safety, 565
 - power, source, 583
 - supply, connector, 565
- dc bias
 - offsetting, 488
- dc coupling, 452
 - input, 348, 360, 370, 375, 379, 384, 394, 397, 426, 433, 488
 - offsetting bias, 488
 - output, 346, 356, 369, 374, 379, 383, 394, 397, 424, 432, 488
- DC Current
 - AF Analyzer screen, 103
- dc current
 - zeroing measurement offset, 103
- DC CURRENT MEASUREMENT connector
 - description, 565
- DC FM zero, 488
- DC INPUT connector
 - description, 566
- DC Level
 - AF Analyzer screen, 104, 110
 - Duplex Test screen, 343
 - RF Analyzer screen, 478
 - RF Generator screen, 490
 - RX Test screen, 500
 - TX TEST screen, 554
 - TX Test screen, 102, 553
- dc level
 - measurement, 102, 110, 343, 478, 490, 500, 553
- dc wave
 - function generator, 395
- DCFM, 348, 360, 370, 375, 379, 394, 397, 426, 433, 488
- decimal format, 63
- decoder
 - AMPS-TACS, 271
 - CDCSS, 280
 - digital paging, 285
 - DTMF, 289
 - EDACS, 295
 - function generator, 301
 - input attenuator, 107, 475
 - LTR, 305
 - MPT 1327, 311
 - NAMPS-NTACS, 271
 - narrowband, 297
 - NMT, 316
 - selecting, 270
 - set up for, 270
 - sqelch effects, 477
 - tone sequence, 335
 - wideband, 297
- decrement
 - changing setting, 65
- De-Emp Gain
 - AF Analyzer screen, 104
- De-Emphasis
 - AF Analyzer screen, 104
 - Duplex Test screen, 346
 - TX Test screen, 554
- De-emphasis
 - Analog Meas screen, 245
- de-emphasis
 - bypassing, 104, 346, 554
 - effect on DTMF frequency, 291
 - filter, description, 291
 - gain, 104
 - input level, 273, 282, 291, 302, 336
 - off for digital paging, 287
 - off for NMT decoder, 319
 - selecting, 104, 346, 554
- default settings
 - base, 79
 - changing, 78, 79
 - power-on, 78
- delay
 - busy/idle, 357
 - first bit, 357
 - word sync, 357
- Delet Ins
 - Tests (External Devices) screen, 539
- Delet Stp
 - Tests (Order of Tests) screen, 529
- delete
 - global user key assignment, 83
 - local user key assignment, 82
 - RAM contents, 547
 - register contents, 77, 547
- Delete Ch
 - Tests (Channel Information) screen, 526
- depth
 - AM, 59
- Description
 - Tests (Main Menu) screen, 522
- DET OUT connector
 - description, 566
- Detector
 - AF Analyzer screen, 105
 - Analog Meas screen, 246
 - Call Configuration screen, 251
 - Duplex Test screen, 347
 - TX Test screen, 555
- detector
 - peak, 105, 108, 347, 555
 - rms, 105, 347, 555
 - selecting, 105, 347, 555
- deviation
 - FM, 59, 106, 348, 474, 556
- device-under-test
 - connecting, 40
 - for NMT encoder, 426
- diagram

-
- AF Analyzer functional block, 101
 - Duplex Test functional block, 341
 - RF Analyzer functional block, 473
 - RF Generator functional block, 485
 - RX Test functional block, 495
 - TX Test functional block, 551
 - Digital Paging decoder mode
 - AF Anl In, 285
 - Arm Meas, 285
 - Data Display, 286
 - Data Rate, 286
 - Display Page, 286
 - Gate Time, 287
 - Input Level, 287
 - Number of Pages, 287
 - Polarity, 288
 - Single/Cont, 288
 - Stop Meas, 288
 - Trig Level, 288
 - view of, 285
 - Digital Paging encoder mode
 - AFGen2 To, 374
 - Audio Out, 374
 - Bursts, 374
 - Data Rate, 374
 - Error Bit, 374
 - FM Coupling, 375
 - Function, 375
 - Mssg Length, 375
 - Pager Alpha-Numeric Message, 376
 - Pager Code, 376
 - Pager Numeric Message, 376
 - Pager Type, 376
 - Polarity, 376
 - Send, 377
 - Send Mode, 377
 - Standard, 377
 - Stop, 377
 - view of, 373
 - digital signaling tone, 274, 279
 - digital supervisory audio tone, 130, 274, 279
 - digital test connections, 566
 - disarm
 - measurement, 297
 - radio interface interrupt, 461
 - disk
 - procedure location, 524, 533, 534
 - Display
 - Call Control screen, 127
 - Display Page
 - Signaling Decoder screen, Digi Page mode, 286
 - Display Word
 - Call Data screen, 167
 - Distn
 - AF Analyzer screen, 110
 - Duplex Test screen, 343
 - RF Analyzer screen, 478
 - RF Generator screen, 490
 - RX Test screen, 500
 - TX Test screen, 102, 553
 - Distortion
 - Audio Frequency Analyzer screen, 104
 - RF Analyzer screen, 474
 - TX TEST screen, 556
 - distortion, 60
 - measurement, 102, 110, 343, 478, 490, 500, 553
 - measurement, amplifier, 108
 - measurement, variable notch filter, 108
 - dotting bits, 360, 362
 - down arrow key, 581
 - downloading programs, 330
 - DSAT, 274, 279
 - Call Control Screen, 131
 - Signaling Encoder screen, NAMP-NTAC mode, 358
 - DSAT (hex)
 - Call Control Screen, 130
 - DST, 274, 279
 - DTMF, 274, 279
 - DTMF decoder mode
 - AF Anl In, 289
 - Arm Meas, 289
 - Gate Time, 290
 - Hi Tone, 290
 - Input Level, 291
 - Lo Tone, 292
 - Off Time, 292
 - On Time, 292
 - Single/Cont, 292
 - Stop Meas, 293
 - Sym, 293
 - view of, 289
 - DTMF sequence
 - outputting, 380
 - DTMF Sequence encoder mode
 - AFGen2 To, 379
 - Audio Out, 379
 - Bursts, 379
 - FM Coupling, 379
 - Off Time, 379
 - On Time, 379
 - Pre-Emp, 380
 - Send, 380
 - Send Mode, 380
 - Standard, 380
 - Stop, 380
 - Symbol Frequencies (Hz), 380
 - Twist, 381
 - view of, 378
 - dual-tone
 - frequency pair, 279, 290, 292
 - dual-tone multi-frequency
 - decoder, 289
 - encoder, 378
 - dual-tone multi-frequency tone pair, 279
 - dump graphics, 66, 582
 - DUPLEX key, 582
 - Duplex Out
 - Configure screen, 258
 - DUPLEX OUT connector
 - avoiding damage, 350, 489, 499, 510
 - description, 567
 - gain at, 258
 - loss at, 258
 - Duplex Test screen
 - AC Level, 341
 - AF Anl In, 342
 - AF Freq, 343
 - AFGen1 Freq, 344
 - AFGen1 To, 344
 - Amplitude, 345
 - Atten Hold, 345
 - Audio Out, 346
 - Current, 343
 - DC Level, 343
 - De-emphasis, 346
 - Detector, 347
 - Distn, 343
 - Ext TX key, 348
 - FM Coupling, 348
 - FM Deviation, 348
-

-
- functional block diagram, 341
 - IF Filter, 349
 - Input Port, 349
 - Output Port, 350
 - RF Gen Freq, 350
 - SINAD, 343
 - SNR, 343
 - Tune Freq, 351
 - Tune Mode, 351
 - TX Freq Error, 352
 - TX Frequency, 352
 - TX Power, 352
 - view of, 341
- DUT
- connecting, 40
 - definition for NMT, 316
 - Signaling Encoder screen, NMT mode, 426
- E
- EDACS decoder mode
 - AF Anl In, 295
 - Arm Meas, 296
 - Data, 296
 - Input Level, 296
 - Polarity, 296
 - Radio/Repeater, 297
 - RX Test, 297
 - Single/Cont, 297
 - Standard, 297
 - Stop Meas, 297
 - view of, 295
 - EDACS encoder mode
 - AFGen2 To, 383
 - Audio Out, 383
 - Control Channel, Number, 383
 - Control Channel, RX Frequency, 383
 - Control Channel, TX frequency, 383
 - Data Rate, 384
 - FM Coupling, 384
 - Group ID, 384
 - Handshake, 384
 - Logical ID, 385
 - Polarity, 385
 - RX Test, 385
 - Signaling Dev, 386
 - Site ID, 386
 - Standard, 386
 - Status, 387
 - Stop, 387
 - Sub-Audible Dev, 387
 - view of, 382
 - Working Channel, Number, 387
 - Working Channel, RX frequency, 387
 - Working Channel, TX frequency, 387
 - edit
 - tone sequence, 434
 - EEX key, 580
 - EIA
 - radio standard, 433
 - electronic serial number
 - decimal, 131
 - hexadecimal, 131
 - emergency call, 295
 - emf voltage, 264
 - encoder
 - AMPS-TACS, 355
 - CDCSS, 368
 - data rate, 367
 - digital paging, 373
 - DTMF, 378
 - EDACS, 382
 - function generator, 393
 - LTR, 396
 - MPT 1327, 404
 - NAMPS-NTACS, 355
 - narrowband, 386
 - NMT, 420
 - selecting, 354
 - set up for, 354
 - tone sequence, 432
 - turning off AF Gen 1, 354
 - wideband, 386
 - encoder/decoder
 - interactions, 367
 - enhanced digital access communications system
 - decoder, 295
 - encoder, 382
 - ENTER key, 580
 - Enter Procedure Filename
 - Tests (Save/Delete Procedure) screen, 533
 - EPSON card (see Memory card), 71
 - equivalent front-panel control characters, 86
 - Error Bit
 - Signaling Encoder screen, Digi Page mode, 374
 - error detection code
 - CDCSS encoder, 372
 - error message
 - buffer overflow, 287
 - error messages, 605
 - IBASIC, 439
 - operation, 614
 - ESC characters, 86
 - ESN (dec)
 - Call Control screen, 131
 - ESN (hex)
 - Call Control screen, 131
 - Euro
 - radio standard, 433
 - Exec Execution Cond
 - Tests (Main Menu) screen, 522
-

-
- Exit Status
 Signaling Decoder screen, NMT mode, 317
- exponents
 entering numbers, 580
- Ext Load R, 60
 AF Analyzer screen, 106
 effect of Audio In Lo, 106
 RX Test screen, 101, 485, 496, 498
- EXT SCOPE TRIGGER connector
 description, 567
- Ext TX key
 Adjacent Channel Power screen, 94
 Duplex Test screen, 348
 RF Analyzer screen, 474
 TX Test screen, 556
- extended address word
 order, 213
 reverse control channel, 172
 voice channel assignment, 214
- external AM
 input, 489
- External Disk Specification
 Tests (External Devices) screen, 539
- external FM
 input, 489
- external load resistance, 60, 101, 106, 485, 496, 498
- external modulation
 input, 489
- external monitor, 591
- F**
- FCC mobile station control word 2
 order, 213
 voice channel assignment, 214
- FCC mobile station control, word 1, 212
- FF at End
 Print Configure screen, 454
 Tests (Printer Setup) screen, 541
- FF at Start
 Print Configure screen, 454
 Tests (Printer Setup) screen, 541
- fields
 changing settings, 43
 control channel (FOCC), 355
 interactions, 54
 priority settings, 54
 types of, 43
 voice channel (FVC), 355
- File system
 initializing media, 75
- filename
 procedure to load, 524
 procedure to save, 533
- files
 saving, 533
 securing, 547
 selecting, 524
- filler data
 FOCC, AMPS-TACS/NAMPS-NTACS, 355
- Filter 1
 Analog Meas screen, 246
- Filter 1 and Filter 2
 AF Analyzer screen, 106
 RX Test screen, 499
 TX Test screen, 556
- Filter 2
 Analog Meas screen, 246
- filters
 IF bandwidth, 349, 475, 556
 IF, for ACP measurements, 96
 selecting, 106, 499, 556
 settings for CDCSS decoder, 284
 variable notch, 108
- Firmware
 Configure screen, 258
- firmware
 upgrading, 588
- Firmware revision number
 Configure screen, 258
- First Frame
 Signaling Decoder screen, NMT mode, 316
- first word of called address, 175
- floating input
 at AUDIO IN LO, 103
- FM
 accuracy degradation, 132
 deviation, 59
 deviation measurement, 106, 348, 474, 556
 deviation, modulation quality, 127
 input, 489
 RF generator, 92, 344, 356, 369, 374, 379, 383, 394, 397, 422, 432, 486, 487, 497
- FM Coupling
 Duplex Test screen, 348
 RF Generator screen, 488
 Signaling Encoder screen, AMPS-TACS mode, 360
 Signaling Encoder screen, CDCSS mode, 370
 Signaling Encoder screen, Digi Page mode, 375
 Signaling Encoder screen, DTMF mode, 379
 Signaling Encoder screen, EDACS mode, 384
 Signaling Encoder screen, Func Gen mode, 394
 Signaling Encoder screen, LTR mode, 397
 Signaling Encoder screen, NAMP-NTAC mode, 360
 Signaling Encoder screen, NMT mode, 426
 Signaling Encoder screen, Tone Seq mode, 433
- FM Deviation
 AF Analyzer screen, 106
 Analog Meas screen, 246
 Call Control screen, 131
 Duplex Test screen, 348
 RF Analyzer screen, 474
 TX Test screen, 556
-

-
- FOCC
 AMPS-TACS/NAMPS-NTACS, 355
 data rate, 358
 filler data, AMPS-TACS/NAMPS-NTACS, 355
 menu, 357
 outputting, 365
- FOCC message
 data format, AMPS-TACS/NAMPS-NTACS, 355
- form feed, 454
- forward control channel, 367
 AMPS-TACS/NAMPS-NTACS, 355
 filler data format, AMPS-TACS/NAMPS-NTACS, 355
 message data format, AMPS-TACS/NAMPS-NTACS, 355
 modifying messages, 194
 turning on, 123, 167, 197
- forward voice channel, 367
 AMPS-TACS, 355
 message data format, AMPS-TACS, 355
 message data format, NAMPS-NTACS, 355
 modifying messages, 194
 NAMPS-NTACS, 355
- four dashes
 meaning of, ACP level measurement, 91
 meaning of, AF frequency, 124
 meaning of, FM deviation, 131
 meaning of, squelch, 477
 meaning of, TX frequency error, 137
 meaning of, TX power measurement, 58, 91, 97, 112, 352, 480, 491, 559
- Frame Digits
 Signaling Decoder screen, NMT mode, 318
- frames
 definition for NMT, 316
 NMT information, 318
 suffixes, 325
- Free 1
 Signaling Encoder screen, LTR mode, 398
- Free 2
 Signaling Encoder screen, LTR mode, 398
- Freq
 Signaling Decoder screen, Tone Seq mode, 336
- Freq (marker)
 Spectrum Analyzer screen, 514
- Freq Channel Information
 Tests (Main Menu) screen, 523
- Freq Error
 Signaling Decoder screen, Tone Seq mode, 336
- Frequency
 Service screen, 502
 Signaling Decoder screen, Func Gen mode, 302
- frequency
 AFGen1, 92, 344, 486, 496, 554
 AFGen2, 394, 486, 496
 carrier, ACP measurement, 92
 center, for notch filter, 108
 center, for spectrum analyzer, 507
 center, RF signal, 96, 351, 479, 558
 decoded signal, 302
 effects of RF offset, 265
 for DTMF sequence, 380
 for tonesequene, 434
 measurement, 97, 111, 352, 479, 491, 559
 offset receiver/transmitter, 259
 offset RF generator/analyzer, 259
 range, for DTMF decoder, 294
 RF generator, 499
 RF generator, reference, 255
 setting, 263, 350, 489
 span, 508
 spectrum analyzer, 514
 symbol, 336
 transmitter, 58
 tuning, 96, 351, 479, 558
- frequency error
 measurement, 97, 111, 352, 479, 491, 559
 modulation quality, 127
 symbol, 336
 transmitter, 58
- frequency offset, 84
- tracking generator, 512
- frequency pair
 DTMF, high tone, 290
 DTMF, low, 279, 292
- Function
 Signaling Encoder screen, Digi Page mode, 375
- function generator
 waveform, 395
- Function Generator decoder mode
 AF Anl In, 301
 Arm Meas, 302
 Frequency, 302
 Gate Time, 302
 Input Level, 302
 Single/Cont, 303
 Stop Meas, 303
 Trig Level, 303
 view of, 301
- Function Generator encoder mode
 AFGen2 Freq, 394
 AFGen2 To, 394
 Audio Out, 394
 FM Coupling, 394
 Sine Units, 394
 view of, 393
 Waveform, 395
- functional diagram
 AF Analyzer, 101
 Duplex Test screen, 341
 RF Analyzer, 473
 RF Generator, 485
 RX Test, 495
 TX Test, 551
- functional test
 for verifying operation, 46
- FVC
 AMPS-TACS, 355
 data rate, 358
 menu, 357
 NAMPS-NTACS, 355
 outputting, 365
- FVC message
 data format, AMPS-TACS, 355
 data format, NAMPS-NTACS, 355
- FVC mobile station control message
 order, 215
 voice channel assignment, 217, 219, 220, 221, 222, 223, 224, 225, 226, 227, 228, 229, 230, 231, 232, 233,
-

235, 236

G

- gain
 - automatic control, 107
 - between ANT IN and device-under-test, 255
 - between DUPLEX OUT and device-under-test, 258
 - between RF IN/OUT and device-under-test, 264
 - de-emphasis, 104
 - input, 107
 - manual control, 107
 - notch filter, 108
- Gain Cntl
 - AF Analyzer screen, 107
- Gate Time
 - Service screen, 502
 - Signaling Decoder screen, AMPS-TACS mode, 273
 - Signaling Decoder screen, Digi Page mode, 287
 - Signaling Decoder screen, DTMF mode, 290
 - Signaling Decoder screen, Func Gen mode, 302
 - Signaling Decoder screen, LTR mode, 306
 - Signaling Decoder screen, NAMPS-NTACS mode, 273
 - Signaling Decoder screen, Tone Seq mode, 336
- gate time, 102
 - decoder, 273, 287, 290, 302, 306, 336
 - RF counter, 477
- Gaussian noise
 - function generator, 395
- generator
 - CDCSS, 368
 - DTMF, 378
 - tone sequence, 432
- generator, AF
 - amplitude, 92, 344, 356, 369, 374, 379, 383, 394, 397, 422, 432, 486, 487, 497
 - frequency, 92, 344, 394, 486, 496, 554
 - level, 554
- generator, RF
 - amplitude, 345, 498
 - frequency, 350, 499
 - output port, 350, 499, 510, 512
 - reference frequency, 255
- generator, tracking
 - amplitude, 511
 - frequency, 507
 - frequency offset, 512
 - output port, 512
 - RF offset, 511
 - sweep, 512
 - sweep frequency range, 508
 - use with spectrum analyzer, 511
- Golay sequential code, 377
- Goto 1
 - Signaling Encoder screen, LTR mode, 398
- Goto 2
 - Signaling Encoder screen, LTR mode, 398
- grounded input
 - at AUDIO IN LO, 103
- grounding, 565
- group call, 295
- Group ID
 - Signaling Encoder screen, EDACS mode, 384
- GSC
 - data rates, 374
 - radio standard, 377

H

Handoff
 Call Control screen, [132](#), [168](#), [198](#)
 handoff
 mobile station to new voice channel, [147](#)
 Handshake
 Signaling Encoder screen, EDACS mode, [384](#)
 hardware
 modifications, [586](#)
 heading
 for printout, [455](#), [542](#)
 HELP key, [582](#)
 Help screen
 view of, [436](#)
 hexadecimal format, [64](#)
 hexadecimal numbers
 for tone sequence, [434](#)
 HI indicator, [67](#)
 HI LIMIT key, [581](#)
 Hi Tone
 Signaling Decoder screen, DTMF mode, [290](#)
 high limit
 removing, [68](#)
 setting, [67](#)
 Hold All
 Range Hold, [261](#)
 HOLD key, [582](#)
 Home 1
 Signaling Encoder screen, LTR mode, [398](#)
 Home 2
 Signaling Encoder screen, LTR mode, [398](#)
 horizontal sweep
 oscilloscope, [447](#)
 HP 11807A software, running, [520](#)
 HP 8920A Memory Card Part Numbers, [71](#)
 HP 8920B Memory Card Part Numbers, [71](#)
 HP-IB
 address, external devices, [539](#)
 address, printer, [455](#), [543](#)
 address, test set, [439](#), [582](#)
 HP-IB Address

I/O Configure screen, [439](#)
 HP-IB connector
 description, [568](#)
 HP-IB control, [85](#)
 HP-IB operation
 squelch effects, [478](#)
 hum and noise
 measuring, [249](#)

I

I/O Config
 Radio Interface screen, [462](#)
 I/O Configure screen
 Data Length, [439](#)
 HP-IB Address, [439](#)
 IBASIC Echo, [439](#)
 Inst Echo, [439](#)
 Mode, [440](#)
 Parity, [440](#)
 Rcv Pace, [440](#)
 Save/Recall, [441](#)
 Serial Baud, [441](#)
 Serial In, [442](#)
 Stop Length, [442](#)
 view of, [438](#)
 Xmt Pace, [442](#)
 IB_UTIL, [547](#)
 IBASIC
 INITIALIZE command, [75](#)
 IBASIC controller
 configuring, [442](#)
 IBASIC Echo
 I/O Configure screen, [439](#)
 IBASIC error messages, [439](#)
 IBASIC IBASIC Cntrl
 Tests (Main Menu) screen, [523](#)
 IBASIC programs
 running, [85](#)
 ID 1
 Signaling Encoder screen, LTR mode, [398](#)
 ID 2
 Signaling Encoder screen, LTR mode, [398](#)
 identification
 base station, [424](#)
 mobile station, [132](#)
 mobile station subscriber, [427](#)
 mobile telephone exchange, [423](#)
 octal code for radio, [369](#)
 subscriber identity security challenge, [428](#)
 subscriber identity security response, [428](#)
 idle
 state, [357](#)
 status, [387](#)

-
- IF Filter
 Duplex Test screen, 349
 RF Analyzer screen, 475
 TX Test screen, 556
- IF filter bandwidth
 selecting, 349, 475, 556
- If Unit-Under-Test Fails
 Tests (Execution Conditions) screen, 536
- impedance
 input, 563
 input, for call processing, 120
 output, for call processing, 120
- INCR SET key, 581
- increment
 changing setting, 65
- indicators
 oscilloscope input, 452
 status, 371
- individual call, 295
- information bits, 360, 362
- input
 AF analyzer, 272, 280, 285, 289, 295, 301, 305, 317, 335
 analyzer, 508
 audio, 600 ohm impedance, 103
 audio, floating, 103
 audio, grounded, 103
 configuring, radio interface, 462
 coupling, 348, 360, 370, 375, 379, 384, 394, 397, 426, 433, 488
 gain, 107
 oscilloscope, 452
 RF, 95, 349, 476, 557
 spectrum analyzer, 508
 types of, 101, 342, 552
- Input Atten
 Adjacent Channel Power screen, 94
 RF Analyzer screen, 475
 Spectrum Analyzer screen, 515
- input attenuation, 515
 automatic control, 94, 475, 515
 manual control, 94, 475, 515
 setting, 94, 475
- Input Attenuator
 Call configure screen, 251
- input attenuator
 decoder interference, 107, 475
 oscilloscope interference, 107, 475
- Input Data
 Radio Interface screen, 460
- Input Gain
 AF Analyzer screen, 107
- input impedance
 selecting, 563
- Input Level
 Signaling Decoder screen, AMPS-TACS mode, 273
 Signaling Decoder screen, CDCSS mode, 282
 Signaling Decoder screen, Digi Page mode, 287
 Signaling Decoder screen, DTMF mode, 291
 Signaling Decoder screen, EDACS mode, 296
 Signaling Decoder screen, Func Gen mode, 302
 Signaling Decoder screen, LTR Seq mode, 306
 Signaling Decoder screen, NAMPS-NTACS mode, 273
 Signaling Decoder screen, NMT mode, 319
 Signaling Decoder screen, Tone Seq mode, 336
- Input Port
 Adjacent Channel Power screen, 95
 Duplex Test screen, 349
 RF Analyzer screen, 476
 TX Test screen, 557
- Insert Ch
 Tests (Channel Information) screen, 526
- Insrt Stp
 Tests (External Devices) screen, 539
 Tests (Order of Tests) screen, 529
- Inst Echo
 I/O Configure screen, 439
- Inst#
 Tests (External Devices) screen, 540
- INSTRUMENT STATE Keys, 582
- Intensity
 Configure screen, 50, 259
- intensity
 setting, 50
- interactions
 between fields, 54
 between screens, 54
 encoder/decoder, AMPS-TACS/NAMPS-NTACS, 276, 367
 encoder and decoder radio standards, 336
 high-power/low-power measurements, 97, 560
 Range Hold and other fields, 260
 RF generator/analyzer, RF offset, 265
 RX/TX screen automatic changes, 266
 spectrum analyzer with RF generator, 509
 spectrum analyzer with tracking generator, 511
 twist and pre-emphasis, 381
- interference
 co-channel, 423
- Internal
 Oscilloscope screen, 450
- internal clock
 date, 258
- Interrupt 1
 Radio Interface screen, 461
- inverted data, 274, 282, 288, 307, 364, 370, 376, 385, 398
- IQ RF IN connector
 description, 566
-

J

JTACS

- radio standard, 366
- simulated system, 136

K

k1 through k5, 80

k1' through k3', 80

key sequences

- for front-panel controls, 86, 87

keyboard

- external, 442

keying

- effect on amplitude, 345, 487, 498, 509, 511

- external transmitter, 94, 348, 474, 556

keys

- \$Leftarrow\$, 583
- ADRS, 582
- backspace, 583
- CANCEL, 583
- CONFIG, 582
- DATA, 580
- DATA FUNCTIONS, 581
- DUPLEX, 582
- EEX, 580
- ENTER, 580
- front-panel, 580
- HELP, 582
- HI LIMIT, 581
- HOLD, 582
- INCR SET, 581
- LO LIMIT, 581
- LOCAL, 582
- MEAS RESET, 582
- MSSG, 582
- NO, 580
- ON/OFF, 580
- POWER, 583
- PRESET, 582
- PREV, 582
- PRINT, 582
- RECALL, 582
- REF SET, 581
- RX, 582
- SAVE, 582
- SCREEN CONTROL, 582
- SHIFT, 583
- TESTS, 582
- TX, 582
- unit-of-measure, 580
- YES, 580

knob

CURSOR CONTROL, 584

SQUELCH, 584

VOLUME, 584

-
- L**
- Latch
 - Service screen, 502
 - leakage
 - ACP measurement, 96
 - left arrow key, 583
 - level
 - ac, 59
 - ACP, 91
 - AF analyzer, 273, 282, 287, 291, 296, 302, 306, 319, 336
 - AF generator 1, 554
 - data, 357
 - oscilloscope, 449
 - reference for spectrum analyzer, 507
 - spectrum analyzer, 514
 - supervisory audio tone, 365
 - triggering, 275, 283, 288, 303, 308, 320, 337
 - Level (div)
 - Oscilloscope screen, 451
 - Library
 - Tests (Main Menu) screen, 523
 - limits
 - example, 68
 - indicators, 67
 - pass/fail, 67
 - removing, 68
 - setting, 67
 - Lines/Page
 - Print Configure screen, 455
 - Tests (Printer Setup) screen, 542
 - LO indicator, 67
 - LO LIMIT key, 581
 - Lo Tone
 - Signaling Decoder screen, DTMF mode, 292
 - load
 - external resistance, 60, 101, 106, 485, 496, 498
 - Load Test
 - Signaling Decoder screen, NMT mode, 319
 - LOCAL key, 582
 - logic trunked radio
 - decoder, 305
 - encoder, 396
 - Logical ID
 - Signaling Encoder screen, EDACS mode, 385
 - loss
 - between ANT IN and device-under-test, 255
 - between DUPLEX OUT and device-under-test, 258
 - between RF IN/OUT and device-under-test, 264
 - Low Battery
 - Configure screen, 51, 260
 - low battery setting, 51, 260
 - low limit
 - removing, 68
 - setting, 67
 - Lower Limit
 - Tests (Pass/Fail Limits) screen, 531
 - low-level RF power measurements, 97, 112, 349, 352, 476, 480, 491, 557, 559
 - LTR
 - radio standard, 399
 - LTR decoder mode
 - AF Anl In, 305
 - Arm Meas, 305
 - Data, 305
 - Data Rate, 306
 - Gate Time, 306
 - Input Level, 306
 - Polarity, 307
 - Single/Cont, 308
 - Stop Meas, 308
 - Trig Level, 308
 - view of, 305
 - LTR encoder mode
 - AFGen2 To, 397
 - Area 1, 397
 - Area 2, 397
 - Audio Out, 397
 - Bursts, 397
 - Data Rate, 397
 - FM Coupling, 397
 - Free 1, 398
 - Free 2, 398
 - Goto 1, 398
 - Goto 2, 398
 - Home 1, 398
 - Home 2, 398
 - ID 1, 398
 - ID 2, 398
 - LTR message, 398
 - Polarity, 398
 - Send, 398
 - Send Mode, 399
 - Standard, 399
 - Stop, 399
 - view of, 396
 - LTR message
 - Signaling Encoder screen, LTR mode, 398
 - LTR tests
 - setup, 309
 - Lvl (marker)
 - Oscilloscope screen, 449
 - Spectrum Analyzer, 514
 - LVL_MTR, 546
-

M

- Main Menu
 - Tests (Channel Information) screen, 526, 527
 - Tests (Execution Conditions) screen, 536
 - Tests (External Devices) screen, 540
 - Tests (IBASIC Controller) screen, 545
 - Tests (Order of Tests) screen, 529
 - Tests (Pass/Fail Limits) screen, 531
 - Tests (Printer Setup) screen, 542
 - Tests (Save/Delete Procedure) screen, 533
- main traffic area, 430
- main traffic channel
 - number, 431
 - power, 431
- manual tuning, 96, 351, 479, 558
- manuals, 592
- marker
 - spectrum analyzer, position, 513
- Marker To
 - Oscilloscope screen, 448
 - Spectrum Analyzer screen, 513
- markers
 - frequency, 514
 - level, 449, 514
 - oscilloscope, 448
 - oscilloscope, peak+, 448
 - spectrum analyzer, 513
 - spectrum analyzer, center frequency, 513
 - spectrum analyzer, peak, 513
 - spectrum analyzer, reference level, 513
 - time, 449
 - triggering, 449
- mass storage
 - loading NMT test from, 319
- Mass Storage Devices
 - EPSON cards, 71
 - initializing media for, 75
 - OTP card, 71
 - PCMCIA cards, 71
 - ROM card, 71
 - SRAM card, 71
 - write protecting, 73
- Meas Ch #
 - Signaling Encoder screen, NMT mode, 426
- Meas Field Strength
 - Signaling Encoder screen, NMT mode, 427
- MEAS RESET key, 582
- Measure
 - Signaling Decoder screen, NAMPS-NTACS mode, 274
- measurement
 - accuracy, gain control for, 107
 - accuracy, zeroing for, 103
 - accuracy, zeroing power for, 97, 481, 560
 - arming, analyzer, 275, 283, 288, 292, 297, 303, 308, 320, 337
 - averaging, 69
 - disarming, analyzer, 297
 - limit indicators, 67
 - removing limits, 68
 - saving and recalling setups, 76
 - setting a reference, 70
 - setting limits, 67
 - settling, 109
 - speed, ACP measurement, 96
 - stopping, analyzer, 308
 - units, 61
- measurements
 - ac level, 59, 101, 341, 473, 485, 496
 - ac level, peak detector, 108
 - ACP reference, 92
 - adjacent channel power, 90, 91
 - AF power, 60
 - AM depth, 59
 - arming decoder, 272, 281, 285, 289, 296, 302, 305, 335
 - audio frequency, 59, 102, 110, 343, 478, 490, 500, 553
 - audio power, 101, 485, 496
 - beat frequency, 62
 - CDCSS code word, 281
 - CDCSS data rate, 281
 - CDCSS, 23-bit sequence, 281
 - current, dc, 102, 110, 343, 478, 490, 500, 553
 - dc level, 102, 110, 343, 478, 490, 500, 553
 - decoded frequency, 302
 - digital paging data rate, 286
 - distortion, 60, 102, 110, 343, 478, 490, 500, 553
 - DTMF decoder limits, 294
 - EDACS transmitter, 300
 - FM deviation, 59, 106, 348, 474, 556
 - frequency error, transmitter, 97, 111, 352, 479, 491, 559
 - frequency error, DTMF, 290
 - frequency error, transmitter, 97, 111, 352, 479, 491, 559
 - frequency, DTMF, 290
 - frequency, transmitter, 97, 111, 352, 479, 491, 559
 - hum and noise, 249
 - LTR data rate, 306
 - mobile station receiver, 392
 - NMT data rate, 425
 - RECC, AMPS-TACS/NAMPS-NTACS, 278
 - RF, 58
 - RF power, 97, 112, 352, 480, 491, 559
 - RF sensitivity, 248
 - rms potential, 101, 485, 496
 - RVC, AMPS-TACS, 278
 - RVC, NAMPS-NTACS, 279
 - signal/noise ratio, 60, 102, 110, 343, 478, 490, 500, 553
 - SINAD, 60, 102, 110, 343, 402, 478, 490, 500, 553
 - SNR, 60, 102, 110, 343, 478, 490, 500, 553
 - stopping analyzer, 275, 283, 288, 293, 297, 303, 337
 - transmitter frequency, 58
 - transmitter frequency error, 58
 - transmitter power, 58, 97, 112, 352, 480, 491, 559
 - voltage, 101, 485, 496
- memory
 - cards, 85
 - considerations, 79
 - total RAM, 267
- Memory Cards
 - battery (see Battery), 74
 - initializing, 75
 - inserting, 72
 - part numbers, 71
 - removing, 72
 - using, 71
 - write-protect switch, 73

- memory overflow error, 79
- Message
- Signaling Encoder screen, AMPS-TACS mode, 361, 362
 - Signaling Encoder screen, NAMP-NTAC mode, 361, 363
- message
- abbreviated address word, 212
 - access, 204
 - access type parameters global action, 204
 - beeper alert, 257
 - C-FILMESS, 210
 - changing contents, 242
 - control filler, 210
 - detection, 314
 - digital paging, 375
 - error, 605
 - error, buffer overflow, 287
 - extended address word, order, 213
 - extended address word, voice channel assignment, 214
 - FCC mobile station control, word 1, 212
 - FCC mobile station control, word 2, order, 213
 - FCC mobile station control, word 2, voice channel assignment, 214
 - FOCC, AMPS-TACS/NAMPS-NTACS, 355
 - FVC mobile station control, order, 215
 - FVC mobile station control, voice channel assignment, 217, 219, 220, 221, 222, 223, 224, 225, 226, 227, 228, 229, 230, 231, 232, 233, 235, 236
 - FVC O Mes, 215
 - FVC V Mes, 217, 219, 220, 221, 222, 223, 224, 225, 226, 227, 228, 229, 230, 231, 232, 233, 235, 236
 - FVC, AMPS-TACS, 355
 - FVC, NAMPS-NTACS, 355
 - IBASIC error, 439
 - MS IntVCh, 214
 - MS WORD1, 212
 - MSMessOrd, 213
 - operation, 614
 - output, FOCC, 365
 - output, FVC, 365
 - query, 314
 - RECCW A, 170
 - RECCW B, 172
 - RECCW C, 174
 - RECCW D, 175
 - RECCW E, 176
 - REG ID, 208
 - REG INC, 206
 - registration identification message, 208
 - registration increment global action, 206
 - reverse control channel, 170
 - reverse voice channel, 170
 - RVCOrdCon, 177, 178, 179, 180, 181, 182, 183
 - SPC Word 1, 201
 - SPC Word 2, 202
 - system parameter overhead, word 1, 201
 - system parameter overhead, word 2, 202
 - to view, from mobile station handoff, 189
 - to view, from mobile station origination, 193
 - to view, from mobile station page, 187
 - to view, from mobile station registration, 186
 - to view, from mobile station release, 191
 - to view, from order to change TX power of mobile, 192
 - types of, 605
- Message 1
- LTR encoder, 396
- Message 2
- LTR encoder, 396
- Message screen
- view of, 444
- Message/DST
- Signaling Encoder screen, NAMP-NTAC mode, 364
- METER, 581
- meter
- analog, 62
 - changing display, 62
 - changing settings, 62
 - dc current, 565
 - signal strength, 546
- Mgmt/Maint
- Signaling Encoder screen, NMT mode, 427
- Mic Pre-Emp
- RF Generator screen, 488
- MIC/ACC connector
- description, 568
 - for keying external transmitter, 94, 348, 474, 556
- dB, 61
- pre-emphasis
- 750, 380, 433
- microphone, 345, 487
- keying, 498, 509, 511
 - pre-emphasis, 488
 - push-to-talk, 266
 - use of, 569
- MIN
- MS id, 132, 155, 163
- mobile radio
- decoding LTR data, 309
- mobile station
- connecting to test set, 390
 - control channel, 391
 - receiver test procedure, 390
 - receiver testing, 389
 - transmitter testing, 389
- mobile subscriber number, 427
- Mod In To
- RF Generator screen, 489
- Mode
- I/O Configure screen, 440
 - Signaling Decoder screen, AMPS-TACS, 271
 - Signaling Decoder screen, CDCSS, 280
 - Signaling Decoder screen, Digi Page, 285
 - Signaling Decoder screen, DTMF, 289
 - Signaling Decoder screen, EDACS, 295
 - Signaling Decoder screen, Func Gen, 301
 - Signaling Decoder screen, LTR, 305
 - Signaling Decoder screen, MPT 1327, 311

-
- Signaling Decoder screen, NAMPS-NTACS, 271
 - Signaling Decoder screen, NMT, 316
 - Signaling Decoder screen, Tone Seq, 335
 - Signaling Encoder screen, AMPS-TACS mode, 355
 - Signaling Encoder screen, CDCSS, 368
 - Signaling Encoder screen, Digi Page, 373
 - Signaling Encoder screen, DTMF, 378
 - Signaling Encoder screen, EDACS, 382
 - Signaling Encoder screen, Func Gen, 393
 - Signaling Encoder screen, LTR, 396
 - Signaling Encoder screen, MPT 1327, 404
 - Signaling Encoder screen, NAMPS-NTACS mode, 355
 - Signaling Encoder screen, NMT, 420
 - Signaling Encoder screen, Tone Seq, 432
 - Model
 - Print Configure screen, 66, 455
 - Tests (External Devices) screen, 540
 - Tests (Printer Setup) screen, 542
 - modifications
 - hardware, 586
 - modulation
 - AM, 92, 344, 356, 369, 374, 379, 383, 394, 397, 422, 432, 486, 487, 497
 - carrier, ACP reference measurement, 92
 - external AM, 489
 - external, FM, 489
 - external, input, 489
 - FM, 92, 344, 356, 369, 374, 379, 383, 394, 397, 422, 432, 486, 487, 497
 - input, 489
 - input, coupling, 348, 360, 370, 375, 379, 384, 394, 397, 426, 433, 488
 - LTR encoder, 398
 - sensitivity, input, 489
 - turning off, 387
 - MODULATION INPUT connector
 - coupling, 348, 360, 370, 375, 379, 384, 394, 397, 426, 433, 488
 - description, 571
 - for modulating RF generator, 489
 - modulation quality
 - AF frequency, 127
 - FM deviation, 127
 - transmitter frequency error, 127
 - transmitter power, 127
 - monitor
 - external, 591
 - MPT 1327 decoder mode
 - Data Rate, 314
 - Timing, 314
 - view of, 311
 - MPT 1327 encoder mode
 - Address Qualifier, 404
 - Aloha Number, 405
 - Control Channel, 406
 - Delay Parameter, 407
 - FCC Msg and Buffers, 408
 - Msg Structures, 414
 - Radio Unit Under Test, 418
 - Simulated Calling Unit, 419
 - System Identity, 418
 - Test Mode, 406
 - Traffic Chan. Msg., 413
 - Traffic Channel, 407
 - undisplayed controls, 407
 - view of, 404
 - MPT 1327 tests
 - manual, 312
 - MS
 - definition, 316
 - MS Id
 - Call Control screen, 132
 - MSN
 - Signaling Encoder screen, NMT mode, 427
 - MSSG key, 582
 - Mssg Length
 - Signaling Encoder screen, Digi Page mode, 375
 - MTX
 - definition, 316
 - mW (milliwatt)
 - displaying results in, 61
- N**
- names
 - printout, 455, 542
 - registers, 78
 - NAMPS-NTACS
 - control channel decoder, 271
 - forward control channel, 355
 - forward voice channel, 355
 - radio standard, 366
 - reverse control channel, 276
 - reverse voice channel, 276
 - voice channel decoder, 271
 - NAMPS-NTACS decoder mode
 - AF Anl In, 272
 - Arm Meas, 272
 - Channel, 272
 - Gate Time, 273
 - Input Level, 273
 - Measure, 274
 - Num of Bits, 274
 - Polarity, 274
 - RECC Data, 274
 - Single/Cont, 275
 - Stop Meas, 275
 - Trig Level, 275
 - Trigger Pattern (bin), 275
 - view of, 271
 - NAMPS-NTACS encoder mode
 - AFGen2 To, 356, 359, 365
 - Audio Out, 356
 - B/I Delay, 357
 - Bursts, 357
 - Busy/Idle, 357
 - Channel, 357
 - Data Level, 357
 - Data Rate, 358
 - DSAT, 358
 - FM Coupling, 360
 - Message, 361, 363
 - Message/DST, 364
 - Polarity, 364
 - Send, 365
 - Send DSAT, 365
 - Send Mode, 366
 - Standard, 366
 - Stop, 366
 - Stop DSAT, 366
 - Stop Filler, 366
-

- view of, 355
- narrowband
 - decoder, signaling standard, 297
 - encoder, signaling standard, 386
 - for 900 MHz system, 384
- narrow-band advanced mobile phone service
 - decoder, 271
- narrowband advanced mobile phone service
 - encoder, 355
- narrow-band total access communication system
 - decoder, 271
- narrowband total access communication system
 - encoder, 355
- NATEL
 - radio standard, 433
- NAWC, 184
- negative edge
 - triggering, 451
- newlink ampolarity, 364
- NMT
 - radio standard, 320, 429
- NMT decoder mode
 - AF Anl In, 317
 - basic operation, 322
 - D (direction), 318
 - Exit Status, 317
 - First Frame, 316
 - Frame Digits, 318
 - Input Level, 319
 - Load Test, 319
 - Num, 318
 - Run Test, 320
 - Single/Cont, 320
 - Standard, 320
 - Stop Test, 320
 - Time, 318
 - Trig Level, 320
 - Type, 318
 - view of, 316
- NMT ENCODER
 - Calling Channel Power, 425
- NMT encoder mode
 - Access Channel Number, 421
 - Access Channel Power, 421
 - Add Info, 421
 - AFGen2 To, 422
 - Alarm Level High, 423
 - Alarm Level Low, 423
 - Area #, 423
 - Audio Out, 424
 - basic operation, 322
 - Batt Save, 424
 - BS Identity, 424
 - Calling Channel Number, 425
 - Data Rate, 425
 - DUT, 426
 - FM Coupling, 426
 - Meas Ch #, 426
 - Meas Field Strength, 427
 - Mgmt/Maint, 427
 - MSN, 427
 - Password, 428
 - Phi Signal, 427
 - Pre-Emp, 428
 - SIS Challenge, 428
 - SIS Response, 428
 - Standard, 429
 - TCI, 429
 - Traffic Area, Alt, 429
 - Traffic Area, Main, 430
 - Traffic Channel (Alt), Number, 430
 - Traffic Channel (Alt), Power, 430
 - Traffic Channel (Main), Number, 431
 - Traffic Channel (Main), Power, 431
 - view of, 420
- NMT tests
 - automated with software, 324
 - base station, 321
 - creating, 326
 - manual, 323
 - mobile station, 321
 - mobile telephone exchange, 321
 - programming, 326
 - programming commands, 331
 - programming example, 328, 329
 - programming file format, 326
 - required settings, 324
 - saving, 327
 - stopping, 320
 - terms and abbreviations, 316
 - using external computer, 329
 - using RAM, 327
- NO key, 580
- No Pk/Avg
 - Spectrum Analyzer screen, 517
- Nordic mobile telephone
 - decoder, 316
 - encoder, 420
- Normalize
 - Spectrum Analyzer screen, 516
- Notch Coupl
 - Configure screen, 260
 - used with variable notch, 108
- notch filter
 - gain, 108
 - variable, 108
- Notch Freq
 - AF Analyzer screen, 108
- Notch Gain
 - AF Analyzer screen, 108
- NPC
 - defined, 281
- NRVC Ord
 - CALLP, 166
- Num
 - Signaling Decoder screen, NMT mode, 318
- Num of Bits
 - Signaling Decoder screen, AMPS-TACS mode, 274
 - Signaling Decoder screen, NAMPS-NTACS mode, 274
- Number of Pages
 - Signaling Decoder screen, Digi Page mode, 287
- numbers
 - changing, 63
 - decimal format, 63
 - entering, 63
 - hexadecimal format, 64
 - scientific notation, 580
- numeric entries, 63

-
- O**
- octal code
 - for CDCSS encoder, 369
 - Off Time
 - Signaling Decoder screen, DTMF mode, 292
 - Signaling Decoder screen, Tone Seq mode, 337
 - Signaling Encoder screen, DTMF mode, 379
 - Tone Sequence encoder, 434
 - offset
 - example, 84
 - for dc bias, 488
 - frequency, receiver/transmitter, 259
 - frequency, RF generator/analyzer, 259
 - frequency, tracking generator, 512
 - measurement, zeroing, 103
 - RF generator/analyzer, 265
 - RF level, 265
 - setting, frequency, 84
 - tracking generator, 511
 - vertical, oscilloscope, 447, 449
 - Offset Freq (Tracking Gen)
 - Spectrum Analyzer screen, 512
 - off-the-air measurements, 95, 349, 476, 557, 562
 - On Time
 - Signaling Decoder screen, DTMF mode, 292
 - Signaling Decoder screen, Tone Seq mode, 337
 - Signaling Encoder screen, DTMF mode, 379
 - tone sequence, 434
 - ON/OFF key, 580
 - operating basics, 53
 - operation messages, 614
 - Options
 - Tests (External Devices) screen, 540
 - options
 - adding, 586
 - Order
 - Call Control screen, 134, 139
 - Call Data screen, 168, 199
 - origination, call, 149
 - oscilloscope
 - display, 448
 - input, 452
 - input attenuator, 107, 475
 - level, markers, 449
 - marker types, 448
 - markers, level, 449
 - resolution, 109
 - scale, 448
 - signal source, 109
 - squelch effects, 477
 - triggering display, 451
 - Oscilloscope screen
 - Auto/Norm, 450
 - Cont/Single, 451
 - Controls, 446
 - Internal, 450
 - Level (div), 451
 - Lvl (marker), 449
 - Main menu, 447
 - Marker menu, 448
 - Marker To, 448
 - Position, 448
 - Pre-Trig, 451
 - Time (marker), 449
 - Time/div, 447
 - Trigger menu, 450
 - Vert Offset, 447
 - Vert/div, 447
 - view of, 446
 - output
 - coupling, 346, 356, 369, 374, 379, 383, 394, 397, 424, 432, 488
 - data stream, 370
 - data, radio interface, 462
 - digital paging data stream, 377
 - F0CC, 365
 - FVC, 365
 - RF, 350, 489, 499, 510, 512
 - tone sequence, 380, 433
 - tracking generator, 512
 - Output Data
 - Radio Interface screen, 462
 - Output Heading
 - Tests (Execution Conditions) screen, 536
 - Tests (Printer Setup) screen, 542
 - Output Port
 - Duplex Test screen, 350
 - RF Generator screen, 489
 - RX Test screen, 499
 - Spectrum Analyzer screen, 510
 - Output Results For
 - Tests (Execution Conditions) screen, 537
 - Tests (Printer Setup) screen, 542
 - Output Results To
 - Tests (Execution Conditions) screen, 536
 - Tests (Printer Setup) screen, 542
 - overpower
 - at ANT IN, 58, 562
 - at RF IN/OUT connector, 95, 349, 476, 557
 - damage, 40
 - damage, at ANT IN connector, 95, 112, 349, 352, 476, 480, 508, 557, 559
 - damage, at DUPLEX OUT, 350, 489, 499, 510
 - warning, 95, 349, 476, 557
 - overview of operation, 53
-

P

- Page
 - Call Control screen, 134
 - Call Data screen, 169, 199
- page
 - selecting, 286
- Page annunciator
 - Call Control screen, 135
 - Call Data screen, 169, 199
- pager
 - address, 286
 - alpha-numeric format, 376
 - code (address), 286
 - data type, 286
 - numeric format, 376
 - signal type, 286
 - testing, 285, 373
 - tone-only format, 376
- Pager Alpha-Numeric Message
 - Signaling Encoder screen, DigiPage mode, 376
- Pager Code
 - Signaling Encoder screen, Digi Page mode, 376
- Pager Numeric Message
 - Signaling Encoder screen, Digi Page-mode, 376
- Pager Type
 - Signaling Encoder screen, Digi Page mode, 376
- paging
 - mobile station, 145, 156
- Parallel Data In
 - Radio Interface screen, 462
- Parallel Port connector
 - description, 571
- Parity
 - I/O Configure screen, 440
- parity bits, 360, 362, 363
- Parm Test Parameters
 - Tests (Main Menu) screen, 523
- Pass Word
 - Tests (Save/Delete Procedure) screen, 533
- pass/fail limits, 67
- Password
 - Signaling Encoder screen, NMT mode, 428
- password, 547
- PCMCIA card (see Memory card), 71
- peak
 - hold, spectrum analyzer, 517
 - spectrum analyzer marker, 513
 - units, 394, 487, 497
- peak detector, 105, 108, 347, 555
 - signal source, 108
- peak+
 - oscilloscope marker, 448
- Phi Signal
 - Signaling Encoder screen, NMT mode, 427
- Phone Num
 - Call Control screen, 135
- phone number
 - called by mobile, 124
 - MS Id, 132, 155, 163
- Phone numbers
 - customer support, 10
- Pk Det To
 - AF Analyzer screen, 108
- Pk Hold
 - Spectrum Analyzer screen, 517
- POCSAG
 - data rates, 374
 - radio standard, 377
- Polarity
 - Signaling Decoder screen, AMPS-TACS mode, 274
 - Signaling Decoder screen, CDCSS mode, 282
 - Signaling Decoder screen, Digi Page mode, 288
 - Signaling Decoder screen, EDACS mode, 296
 - Signaling Decoder screen, LTR mode, 307
 - Signaling Decoder screen, NAMP-NTAC mode, 274
 - Signaling Encoder screen, AMPS-TACS mode, 364
 - Signaling Encoder screen, CDCSS mode, 370
 - Signaling Encoder screen, Digi Page mode, 376
 - Signaling Encoder screen, EDACS mode, 385
- Signaling Encoder screen, LTR mode, 398
- Signaling Encoder screen, NAMP-NTAC mode, 364
- polarity
 - radio interface strobe, 462
- Port/Sweep (Tracking Gen)
 - Spectrum Analyzer screen, 512
- Position
 - Oscilloscope screen, 448
 - Spectrum Analyzer screen, 513
- positive edge
 - triggering, 451
- power
 - access channel, NMT encoder, 421
 - AF, 60
 - mobile station output, 134
 - transmitter, 58
 - zero reference, 97, 480, 560
- power cables, 595
- POWER key, 583
- power meter
 - zeroing, 97, 480, 560
- power source
 - ac, 583
 - dc, 583
- power switch, 583
- power-on settings
 - changing, 78
- Pre-Emp
 - Signaling Encoder screen, DTMF mode, 380
 - Signaling Encoder screen, NMT mode, 428
 - Signaling Encoder screen, Tone Seq mode, 433
- pre-emphasis
 - automatic control, 488
 - bypassing, 380, 433, 488
 - manual control, 488
 - microphone, 488
 - NMT encoder, 428
 - tone sequence encoder, 380, 433
- PRESET key, 582
- preset state
 - changing, 79
 - default, 79
- Pre-Trig

-
- Oscilloscope screen, 451
 - PREV key, 582
 - print
 - screens, 66, 582
 - Print All
 - Tests (Channel Information) screen, 526, 527
 - Tests (External Devices) screen, 540
 - Tests (Order of Tests) screen, 529
 - Tests (Pass/Fail Limits) screen, 531
 - Print Configure screen
 - Abort Print, 454
 - FF at End, 454
 - FF at Start, 454
 - Lines/Page, 455
 - Model, 66, 455
 - Print Data Destination, 455
 - Print Title, 66, 455
 - Printer Address, 66, 455
 - Printer Port, 66, 455
 - settings, 66
 - view of, 454
 - Print Data Destination
 - Print Configure screen, 455
 - PRINT key, 582
 - Print Printer Setup
 - Tests (Main Menu) screen, 523
 - Print Title
 - Print Configure screen, 66, 455
 - printer
 - connecting, 455, 543
 - model, 455, 542
 - Printer Address
 - Print Configure screen, 66, 455
 - Tests (Printer Setup) screen, 543
 - Printer Port
 - Print Configure screen, 66, 455
 - Tests (Printer Setup) screen, 543
 - printing
 - aborting, 454
 - form feed, 454, 541
 - lines per page, 455, 542
 - printer address, 455, 543
 - printer model, 455, 542
 - screens, 453
 - selecting printer port, 455
 - title, 455, 542
 - priority fields, 55, 92, 101, 102, 110, 272, 289, 301, 335, 342, 343, 344, 345, 346, 347, 478, 486, 487, 490, 497, 498, 500, 509, 552, 553, 554, 555
 - Proc Save/Delete Procedure
 - Tests (Main Menu) screen, 524
 - Procedure Library
 - Tests (Save/Delete Procedure) screen, 533
 - Program
 - Tests (Main Menu) screen, 524
 - Programmer's Guide, 85
 - programming
 - downloading, 330
 - NMT tests, 326
 - programming example
 - NMT test, external controller, 329
 - NMT test, internal controller, 328
 - programs
 - language, 520
 - running from memory card, 85
 - PTT
 - Configure screen, 266
 - push to talk, 266
 - Pwr Lvl
 - Call Control screen, 134
- R**
- radio
 - connecting, 40
 - LTR trunking data, 307
 - test software, 594
 - Radio Frequency Analyzer screen
 - AC Level, 473
 - RADIO INTERFACE connector
 - description, 573
 - Radio Interface screen
 - I/O Config, 462
 - Input Data, 460
 - Interrupt 1, 461
 - Output Data, 462
 - Parallel Data In, 462
 - Send data, 462
 - Strobe Pol, 462
 - view of, 460
 - Radio Repeater
 - Signaling Decoder screen, EDACS mode, 297
 - radio standard
 - AMPS, 271, 355
 - AMPS-TACS, 366
 - Bell, 380
 - CCIR1, 433
 - CCIR2, 433
 - CCITT, 433
 - CDCSS, 371
 - DTMF, 380
 - EDACS, 4800, 297, 386
 - EDACS, 9600, 297, 386
 - EEA, 433
 - EIA, 433
 - European, 433
 - GSC, 377
 - JTACS, 271, 355, 366
 - LTR, 399
 - NAMPS, 271, 355
 - NAMPS-NTACS, 366
 - NATEL, 433
 - NMT, 320, 429
 - NMT, STD450, 323, 429
 - NMT, STD900, 323, 429
 - NTACS, 271, 355
 - POCSAG, 377
 - TACS, 271, 355
 - tone sequence, 433
-

-
- ZVEI1, 433
 - ZVEI2, 433
 - Radio Unit Under Test
 - Signaling Encoder screen, MPT 1327 mode, 418
 - RAM
 - for NMT decoder tests, 327
 - procedure location, 524, 533, 534
 - total available, 267
 - RAM Initialize
 - Service screen, 503
 - RAM_MNG, 547
 - ramp wave
 - function generator, 395
 - Range Hold
 - Configure screen, 260
 - Rcv Pace
 - I/O Configure screen, 440
 - recall
 - example, 77
 - instrument setups, 76
 - saved register with hardware change, 79
 - settings, 76
 - RECALL key, 582
 - using, 76
 - RECC
 - AMPS-TACS/NAMPS-NTACS, 276
 - measurements, AMPS-TACS/NAMPS-NTACS, 278
 - RECC Data
 - Signaling Decoder screen, NAMPS-NTACS mode, 274
 - RECCW A
 - CALLP, 165
 - messages, 170
 - RECCW B
 - CALLP, 165
 - messages, 172
 - RECCW C
 - CALLP, 165
 - messages, 174
 - RECCW D
 - CALLP, 165
 - messages, 175
 - RECCW E
 - CALLP, 165
 - messages, 176
 - receive pace, 440
 - Ref indicator, 70
 - Ref Level
 - Spectrum Analyzer screen, 507
 - REF SET, 70
 - REF SET key, 581
 - reference
 - carrier, ACP, 92
 - external input, 579
 - external output, 579
 - frequency, ACP measurement, 92
 - level, spectrum analyzer, 507
 - setting, 70, 449
 - transmitter power, zero, 97, 480, 560
 - Register
 - Call Control screen, 135
 - Call Data screen, 169, 199
 - Register annunciator
 - Call Control screen, 135
 - Call Data screen, 169, 200
 - registers
 - clearing, 77
 - naming, 78
 - registration
 - of mobile station, 144
 - registration identification message, 208
 - registration increment global action message, 206
 - RELEASE, 82, 83
 - Release
 - Call Control screen, 135
 - Call Data screen, 169, 200
 - release
 - global user key assignment, 83
 - local user key assignment, 82
 - mobile station, 147
 - remote control, 85
 - remote operation, 85
 - mode, 440
 - squelch effects, 478
 - remove
 - register contents, 77
 - remove high/low limits, 68
 - remove pass/fail limits, 68
 - repeater
 - decoding LTR data, 310
 - LTR system, 307
 - simulating, EDACS, 382
 - Res BW
 - Adjacent Channel Power screen, 96
 - resolution
 - bandwidth, ACP measurement, 96
 - bandwidth, spectrum analyzer, 518
 - oscilloscope, 109
 - response timing
 - MPT 1327 decoder, 315
 - reverse control channel, 367
 - AMPS-TACS/NAMPS-NTACS, 276
 - data, 127
 - decoding, AMPS-TACS/NAMPS-NTACS, 272
 - measurements, AMPS-TACS/NAMPS-NTACS, 278
 - message viewing, 167
 - reverse RF power, 350, 489, 499, 510
 - reverse voice channel, 367
 - AMPS-TACS, 276
 - data, 127
 - decoding, AMPS-TACS/NAMPS-NTACS, 272
 - DSAT, NAMPS-NTACS, 274
 - DST, NAMPS-NTACS, 274
 - DTMF, NAMPS-NTACS, 274
 - measurements, AMPS-TACS, 278
 - measurements, NAMPS-NTACS, 279
 - message viewing, 167
 - NAMPS-NTACS, 276
 - order confirmation message, 177, 178, 179, 180, 181, 182, 183
 - revision number
 - firmware, 258
 - RF Analyzer screen
 - AC Level, 473
 - Current, 478
 - DC Level, 478
 - Distn, 478
 - Distortion, 474
 - Ext TX key, 474
 - FM Deviation, 474
 - functional block diagram, 473
 - IF Filter, 475
 - Input Atten, 475
 - Input Port, 476
 - RF Cnt Gate, 477
 - Sensitivity, 477
 - SINAD, 478
-

-
- SNR, 478
 - Squelch, 477
 - Tune Freq, 479
 - Tune Mode, 479
 - TX Freq Error, 479
 - TX Frequency, 479
 - TX Power, 480
 - TX Pwr Meas (HP 8920B), 480
 - TX Pwr Zero, 480
 - view of, 473
 - RF auto-tuning, 96, 351, 479, 558
 - RF Chan Std
 - Configure screen, 262
 - RF Cnt Gate
 - RF Analyzer screen, 477
 - RF counter
 - sampling, 477
 - RF Display
 - Configure screen, 263
 - RF Gen Freq
 - Duplex Test screen, 350
 - RF Generator screen, 489
 - RX Test screen, 499
 - Spectrum Analyzer screen, 510
 - RF Gen Volts
 - Configure screen, 264
 - RF generator
 - amplitude, 345, 487, 498, 509
 - frequency, 350, 489, 499
 - microphone modulation, 569
 - output, 489, 499, 512
 - output port, 350, 489, 510
 - use with spectrum analyzer, 509
 - RF Generator screen
 - AC Level, 485
 - AF Freq, 490
 - AFGen1 Freq, 486
 - AFGen1 To, 486
 - AFGen2 Freq, 486
 - AFGen2 To, 487
 - Amplitude, 487
 - Atten Hold, 488
 - Audio Out, 488
 - Current, 490
 - DC Level, 490
 - Distn, 490
 - FM Coupling, 488
 - functional block diagram, 485
 - Mic Pre-Emp, 488
 - Mod In To, 489
 - Output Port, 489
 - RF Gen Freq, 489
 - SINAD, 490
 - SNR, 490
 - TX Freq Error, 491
 - TX Frequency, 491
 - TX Power, 491
 - view of, 485
 - RF In/Ant
 - Spectrum Analyzer screen, 508
 - RF In/Out
 - Configure screen, 264
 - RF IN/OUT connector
 - connecting to, 40
 - description, 576
 - for ACP level measurements, 91, 95
 - for RF ratio measurements, 91
 - for measuring high-power devices, 512
 - for measuring transmitter power, 95, 112, 349, 352, 476, 480, 491, 557, 559
 - for RF measurements, 95, 349, 476, 557
 - for testing transceivers, 510
 - for testing transceivers, 350, 489, 499
 - gain at, 264
 - input attenuation, 94, 475, 515
 - loss at, 264
 - power measured at, 97, 112, 352, 480, 491, 559
 - RF input
 - selecting port, 95, 349, 476, 557
 - RF Level Offsert
 - Configure screen, 265
 - RF measurements, 58
 - RF Offset
 - Configure screen, 265
 - RF offset
 - example, 84
 - setting, 84
 - RF output
 - selecting port, 350, 489, 499, 510, 512
 - RF power
 - exceeding limits, 95, 349, 476, 557
 - measurement, 97, 112, 352, 480, 491, 559
 - zero reference, 97, 480, 560
 - RF voltage
 - setting, 50
 - RFGen Volts
 - Configure Screen, 50
 - rms
 - dectector, 105, 347, 555
 - measurement, 101, 485, 496
 - units, 394, 487, 497
 - ROM
 - procedure location, 524, 533, 534
 - ROM program
 - IB_UTIL, 547
 - ROMprogram
 - RAM_MNG, 547
 - Run
 - Tests (Printer Setup) screen, 545
 - Run Test
 - Signaling Decoder screen, NMT mode, 320
 - Tests (Execution Conditions) screen, 537
 - Tests (Main Menu) screen, 524
 - Tests (Printer Setup) screen, 543
 - RVC
 - AMPS-TACS, 276
 - measurements, AMPS-TACS, 278
 - measurements, NAMPS-NTACS, 279
 - NAMPS-NTACS, 276
 - RVCBSchal
 - CALLP, 166
 - RVCOrd
 - CALLP, 166
 - RVCOrdCon
 - CALLP, 166
 - messages, 177, 178, 179, 180, 181, 182, 183
 - RX key, 582
 - RX Test
 - Signaling Decoder screen, EDACS mode, 297
 - Signaling Encoder screen, EDACS mode, 385
 - RX Test screen
 - AC Level, 496
 - AF Freq, 500
 - AFGen1 Freq, 496
 - AFGen1 To, 497
-

-
- AFGen2 Freq, 496
 - AFGen2 To, 497
 - Amplitude, 498
 - Atten Hold, 498
 - Current, 500
 - DC Level, 500
 - Distn, 500
 - Ext Load R, 498
 - Filter 1 and Filter 2, 499
 - functional block diagram, 495
 - Output Port, 499
 - priority settings, 54
 - RF Gen Freq, 499
 - SINAD, 500
 - SNR, 500
 - view of, 495
 - RX/TX Cntl
 - Configure screen, 266
 - RX/TX screen interactions, 266
 - setting intensity, 50, 259
 - using screen control keys, 42
 - second word of called address, 176
 - SECURE_IT, 547
 - securing files, 547
 - Select Procedure Filename
 - Tests (Main Menu) screen, 524
 - Select Procedure Location
 - Tests (Main Menu) screen, 524
 - Tests (Save/Delete Procedure)screen, 534
 - Send
 - Signaling Encoder screen, AMPS-TACS mode, 365
 - Signaling Encoder screen, CDCSS mode, 370
 - Signaling Encoder screen, Digi Page mode, 377
 - Signaling Encoder screen, DTMF mode, 380
 - Signaling Encoder screen, LTR mode, 398
 - Signaling Encoder screen, NAMP-NTAC mode, 365
 - Signaling Encoder screen, Tone Seq mode, 433
 - Send Data
 - Radio Interface screen, 462
 - Send DSAT
 - Signaling Encoder screen, NAMP-NTAC mode, 365
 - Send Filler
 - Signaling Encoder screen, AMPS-TACS mode, 365
 - Signaling Encoder screen, NAMP-NTAC mode, 365
 - Send Mode
 - Signaling Encoder screen, AMPS-TACS mode, 366
 - Signaling Encoder screen, CDCSS mode, 371
 - Signaling Encoder screen, Digi Page mode, 377
 - Signaling Encoder screen, DTMF mode, 380
 - Signaling Encoder screen, LTR mode, 399
 - S
 - s, 380, 433
 - S, battery save, 325
 - sampling
 - AF counter, 102
 - RF counter, 477
 - SAT
 - Call Control screen, 136
 - SAT color code, 136
 - SAT Freq
 - Signaling Encoder screen, AMPS-TACS mode, 365
 - Sat Tol
 - CALL CONFIGURE, 251
 - save
 - example, 77
 - instrument setups, 76
 - settings, 76
 - SAVE key, 582
 - using, 76
 - Save/Recall
 - I/OConfigure screen, 441
 - saving instrument setups, 76
 - saving settings, 76
 - scale
 - for oscilloscope, 448
 - SCC, 136
 - scientific notation
 - entering numbers, 580
 - SCM
 - Call Control screen, 136
 - scope
 - horizontal sweep, 447
 - input, 452
 - level, markers, 449
 - markers, 449
 - triggering display, 451
 - vertical offset, 447
 - Scope To
 - AF Analyzer screen, 109, 452
 - SCREEN CONTROL keys, 582
 - screen control keys, 42
 - screen dump, 66, 453, 582
 - screens
 - accessing, 42
 - go to previous, 582
 - interactions, 54
 - printing, 66, 453, 582
-

-
- Signaling Encoder screen, NAMP-NTAC mode, [366](#)
 - Signaling Encoder screen, Tone Seq mode, [433](#)
 - Sensitivity
 - RF Analyzer screen, [477](#)
 - Spectrum Analyzer screen, [517](#)
 - sensitivity
 - adverse effects on measurements, [477](#), [517](#)
 - ANT IN, [477](#), [517](#)
 - modulation input, [489](#)
 - RF, measuring, [248](#)
 - Seq Num
 - tone sequence, [434](#)
 - Seqn Order Of Tests
 - Tests (Main Menu) screen, [524](#)
 - sequence
 - CDCSS, [368](#)
 - DTMF, [378](#)
 - tone, [432](#)
 - Serial Baud
 - I/O Configure screen, [441](#)
 - serial data word
 - bits, [439](#)
 - Serial In
 - I/O Configure screen, [442](#)
 - Serial No.
 - Configure screen, [267](#)
 - serial number
 - electronic, decimal, [131](#)
 - electronic, hexadecimal, [131](#)
 - serial number word, [174](#)
 - serial port
 - configuring, [86](#)
 - SERIAL PORT connector
 - description, [577](#)
 - Service screen
 - Counter Connection, [502](#)
 - Frequency, [502](#)
 - Gate Time, [502](#)
 - Latch, [502](#)
 - RAM Initialize, [503](#)
 - Value, [503](#)
 - view of, [502](#)
 - Voltage, [503](#)
 - Voltmeter Connection, [503](#)
 - Set Message
 - Call Bit screen, [200](#)
 - settings
 - base, [79](#)
 - beeper volume, [51](#)
 - changing, field, [43](#)
 - date, [50](#)
 - default, [78](#), [79](#)
 - meter, [62](#)
 - power-on, [78](#)
 - recalling, [76](#)
 - RF voltage, [50](#)
 - saving, [76](#)
 - time, [50](#)
 - Settling
 - AF Analyzer screen, [109](#)
 - settling time
 - AF measurements, [109](#)
 - setups
 - recalling, [76](#)
 - saving, [76](#)
 - SHIFT key, [583](#)
 - shock hazard, avoiding, [565](#)
 - SID
 - Call Control screen, [136](#)
 - signal level
 - data, [357](#)
 - signal strength
 - Phi signal, [427](#)
 - signal strength meter, [546](#)
 - signal type
 - pager, [286](#)
 - signal/noise ratio
 - measurement, [60](#)
 - operation, [102](#), [110](#), [343](#), [478](#), [490](#), [500](#), [553](#)
 - signaling decoder
 - selecting, [270](#)
 - Signaling Decoder screen
 - Mode, AMPS-TACS, [271](#)
 - Mode, CDCSS, [280](#)
 - Mode, Digi Page, [285](#)
 - Mode, DTMF, [289](#)
 - Mode, EDACS, [295](#)
 - Mode, Func Gen, [301](#)
 - Mode, LTR, [305](#)
 - Mode, MPT 1327, [311](#)
 - Mode, NAMPS-NTACS, [271](#)
 - Mode, NMT, [316](#)
 - Mode, Tone Seq, [335](#)
 - Signaling Decoder screen, AMPS-TACS mode
 - AF Anl In, [272](#)
 - Arm Meas, [272](#)
 - Channel, [272](#)
 - Data (hex), [273](#)
 - Gate Time, [273](#)
 - Input Level, [273](#)
 - Num of Bits, [274](#)
 - Polarity, [274](#)
 - Single/Cont, [275](#)
 - Stop Meas, [275](#)
 - Trig Level, [275](#)
 - Trigger Pattern(bin), [275](#)
 - Signaling Decoder screen, CDCSS mode
 - AF Anl In, [280](#)
 - Arm Meas, [281](#)
 - Code (oct), [281](#)
 - Data (bin), [281](#)
 - Data Rate, [281](#)
 - Polarity, [282](#)
 - Stop Meas, [283](#)
 - Trig Level, [283](#)
 - Signaling Decoder screen, CSCSS mode
 - Input Level, [282](#)
 - Single/Cont, [283](#)
 - Signaling Decoder screen, Digi Page mode
 - AF Anl In, [285](#)
 - Arm Meas, [285](#)
 - Data Display, [286](#)
 - Data Rate, [286](#)
 - Display Page, [286](#)
 - Gate Time, [287](#)
 - Input Level, [287](#)
 - Number of Pages, [287](#)
 - Polarity, [288](#)
 - Single/Cont, [288](#)
 - Stop Meas, [288](#)
 - Trig Level, [288](#)
 - Signaling Decoder screen, DTMF mode
 - AF Anl In, [289](#)
 - Arm Meas, [289](#)
 - Gate Time, [290](#)
 - Hi Tone, [290](#)
 - Input Level, [291](#)
 - Lo Tone, [292](#)
-

- Off Time, [292](#)
- On Time, [292](#)
- Single/Cont, [292](#)
- Stop Meas, [293](#)
- Sym, [293](#)
- Signaling Decoder screen, EDACS mode
 - AF Anl In, [295](#)
 - Arm Meas, [296](#)
 - Data, [296](#)
 - Input Level, [296](#)
 - Polarity, [296](#)
 - Radio/Repeater, [297](#)
 - RX Test, [297](#)
 - Single/Cont, [297](#)
 - Standard, [297](#)
 - Stop Meas, [297](#)
- Signaling Decoder screen, Func Gen mode
 - AF Anl In, [301](#)
 - Arm Meas, [302](#)
 - Frequency, [302](#)
 - Gate Time, [302](#)
 - Input Level, [302](#)
 - Single/Cont, [303](#)
 - Stop Meas, [303](#)
 - Trig Level, [303](#)
- Signaling Decoder screen, LTR mode
 - AF Anl In, [305](#)
 - Arm Meas, [305](#)
 - Data, [305](#)
 - Data Rate, [306](#)
 - Gate Time, [306](#)
 - Input Level, [306](#)
 - Polarity, [307](#)
 - Single/Cont, [308](#)
 - Stop Meas, [308](#)
 - Trig Level, [308](#)
- Signaling Decoder screen, MPT 1327 mode
 - Data Rate, [314](#)
 - Timing, [314](#)
- Signaling Decoder screen, NAMP-NTAC mode
 - Polarity, [274](#)
- Signaling Decoder screen, NAMPS-NTACS mode
 - AF Anl In, [272](#)
 - Arm Meas, [272](#)
 - Channel, [272](#)
 - Input Level, [273](#)
 - Measure, [274](#)
 - Num of Bits, [274](#)
 - RECC Data, [274](#)
 - Single/Cont, [275](#)
 - Stop Meas, [275](#)
 - Trig Level, [275](#)
 - Trigger Pattern(bin), [275](#)
- Signaling Decoder screen, NAMPS-NTACS Seq mode
 - Gate Time, [273](#)
- Signaling Decoder screen, NMT mode
 - AF Anl In, [317](#)
 - D (direction), [318](#)
 - Exit Status, [317](#)
 - First Frame, [316](#)
 - Frame Digits, [318](#)
 - Input Level, [319](#)
 - Load Test, [319](#)
 - Num, [318](#)
 - Run Test, [320](#)
 - Single/Cont, [320](#)
 - Standard, [320](#)
 - Stop Test, [320](#)
 - Time, [318](#)
 - Trig Level, [320](#)
 - Type, [318](#)
- Signaling Decoder screen, Tone Seq mode
 - AF Anl In, [335](#)
 - Arm Meas, [335](#)
 - Freq, [336](#)
 - Freq Error, [336](#)
 - Gate Time, [336](#)
 - Input Level, [336](#)
 - Off Time, [337](#)
 - On Time, [337](#)
 - Single/Cont, [337](#)
 - Stop Meas, [337](#)
 - Sym, [337](#)
 - Trig Level, [337](#)
- Signaling Dev
 - Signaling Encoder screen, EDACS mode, [386](#)
- signaling encoder
 - selecting, [354](#)
- Signaling Encoder screen
 - Mode, AMPS-TACS, [355](#)
 - Mode, CDCSS, [368](#)
 - Mode, Digi Page, [373](#)
 - Mode, DTMF, [378](#)
 - Mode, EDACS, [382](#)
 - Mode, Func Gen, [393](#)
 - Mode, LTR, [396](#)
 - Mode, MPT 1327, [404](#)
 - Mode, NAMPS-NTACS, [355](#)
 - Mode, NMT, [420](#)
 - Mode, Tone Seq, [432](#)
- Signaling Encoder screen, AMPS-TACS mode
 - AFGen2 To, [356, 359](#)
 - Audio Out, [356](#)
 - B/I Delay (FOCC), [357](#)
 - Bursts, [357](#)
 - Busy/Idle, [357](#)
 - Channel, [357](#)
 - Data Level, [357](#)
 - Data Rate, [358](#)
 - FM Coupling, [360](#)
 - Message, [361, 362](#)
 - Polarity, [364](#)
 - SAT Freq, [365](#)
 - Send, [365](#)
 - Send Filler, [365](#)
 - Send Mode, [366](#)
 - Standard, [366](#)
 - Stop, [366](#)
 - Stop Filler, [366](#)
- Signaling Encoder screen, CDCSS mode
 - AFGen2 To, [369](#)
 - Audio Out, [369](#)
 - Bursts, [369](#)
 - Code, [369](#)
 - Data Rate, [369](#)
 - FM Coupling, [370](#)
 - Polarity, [370](#)
 - Send, [370](#)
 - Send Mode, [371](#)
 - Standard, [371](#)
 - Stop, [371](#)
 - TOC Time, [371](#)
- Signaling Encoder screen, Digi Page mode
 - AFGen2 To, [374](#)
 - Audio Out, [374](#)

- Bursts, 374
- Data Rate, 374
- Error Bit, 374
- FM Coupling, 375
- Function, 375
- Mssg Length, 375
- Pager Alpha-NumericMessage, 376
- Pager Code, 376
- Pager NumericMessage, 376
- Pager Type, 376
- Polarity, 376
- Send, 377
- Send Mode, 377
- Standard, 377
- Stop, 377
- Signaling Encoder screen, DTMF mode
 - AFGen2 To, 379
 - Audio Out, 379
 - Bursts, 379
 - FM Coupling, 379
 - Off Time, 379
 - On Time, 379
 - Pre-Emp, 380
 - Send, 380
 - Send Mode, 380
 - Standard, 380
 - Stop, 380
 - Symbol Frequencies, 380
 - Twist, 381
- Signaling Encoder screen, EDACS mode
 - AFGen2 To, 383
 - Audio Out, 383
 - Control Channel, Number, 383
 - Control Channel, RXFrequency, 383
 - Control Channel, TXFrequency, 383
 - Data Rate, 384
 - FM Coupling, 384
 - Group ID, 384
 - Handshake, 384
 - Logical ID, 385
 - Polarity, 385
 - RX Test, 385
 - Signaling Dev, 386
 - Site ID, 386
 - Standard, 386
 - Status, 387
 - Stop, 387
 - Sub-Audible Dev, 387
 - Working Channel, Number, 387
 - Working Channel, RXFrequency, 387
 - Working Channel, TXFrequency, 387
- Signaling Encoder screen, Func Gen mode
 - AFGen2 Freq, 394
 - AFGen2 To, 394
 - Audio Out, 394
 - FM Coupling, 394
 - Sine Units, 394
 - Waveform, 395
- Signaling Encoder screen, LTR mode
 - AFGen2 To, 397
 - Area 1, 397
 - Area 2, 397
 - Audio Out, 397
 - Bursts, 397
 - Data Rate, 397
 - FM Coupling, 397
 - Free 1, 398
 - Free 2, 398
 - Goto 1, 398
 - Goto 2, 398
 - Home 1, 398
 - Home 2, 398
 - ID 1, 398
 - ID 2, 398
 - LTR message, 398
 - Polarity, 398
 - Send, 398
 - Send Mode, 399
 - Standard, 399
 - Stop, 399
- Signaling Encoder screen, MPT 1327 mode
 - Address Qualifier, 404
 - Aloha Number, 405
 - Control Channel, 406
 - Radio Unit Under Test, 418
 - Simulated CallingUnit, 419
 - System Identity, 418
 - Test Mode, 406
 - Traffic Channel, 407
 - undisplayed controls, 407
- Signaling Encoder screen, NAMP-NTAC mode
 - AFGen2 To, 356, 359
 - Audio Out, 356
 - B/I Delay (FOCC), 357
 - Bursts, 357
 - Busy/Idle, 357
 - Channel, 357
 - Data Level, 357
 - Data Rate, 358
 - DSAT, 358
 - FM Coupling, 360
 - Message, 361, 363
 - Message/DST, 364
 - Polarity, 364
 - Send, 365
 - Send DSAT, 365
 - Send Filler, 365
 - Send Mode, 366
 - Standard, 366
 - Stop, 366
 - Stop DSAT, 366
 - Stop Filler, 366
- Signaling Encoder screen, NMT mode
 - Access Channel Number, 421
 - Access Channel Power, 421
 - Add Info, 421
 - AFGen2 To, 422
 - Alarm Level High, 423
 - Alarm Level Low, 423
 - Area #, 423
 - Audio Out, 424
 - Batt Save, 424
 - BS Identity, 424
 - Calling Channel Number, 425
 - Data Rate, 425
 - DUT, 426
 - FM Coupling, 426
 - Meas Ch #, 426
 - Meas Field Strength, 427
 - Mgmt/Maint, 427
 - MSN, 427
 - Password, 428
 - Phi Signal, 427
 - Pre-Emp, 428
 - SIS Challenge, 428
 - SIS Response, 428
 - Standard, 429
 - TCI, 429
 - Traffic Area, Alt, 429
 - Traffic Area, Main, 430
 - Traffic Channel (Alt),Number, 430

- Traffic Channel (Alt),Power, 430
- Traffic Channel (Main),Number, 431
- Traffic Channel (Main),Power, 431
- Signaling Encoder screen, Tone Seq mode
 - AFGen2 To, 432
 - Audio Out, 432
 - Bursts, 433
 - FM Coupling, 433
 - Pre-Emp, 433
 - Send, 433
 - Send Mode, 433
 - Standard, 433
 - Stop, 433
 - Symbol Definition, 434
 - Symbol Sequence, 434
- signaling format
 - AMPS, 271, 355
 - JTACS, 271, 355
 - NAMPS, 271, 355
 - NTACS, 271, 355
 - TACS, 271, 355
- signaling standard
 - narrowband, 297, 386
 - wideband, 297, 386
- Simulated Calling Unit
 - Signaling Encoder screen, MPT 1327mode, 419
- SINAD
 - AF Analyzer screen, 110
 - Duplex Test screen, 343
 - measurement, 60, 102, 110, 343, 478, 490, 500, 553
 - measurement, amplifier, 108
 - measurement, variable notch filter, 108
 - RF Analyzer screen, 478
 - RF Generator screen, 490
 - RX Test screen, 500
 - TX TEST screen, 558
 - TX Test screen, 102, 553
- Sine Units
 - Signaling Encoder screen, Func Gen mode, 394
- sine wave
 - function generator, 395, 496
- Single/Cont
 - Signaling Decoder screen, AMPS-TACS mode, 275
 - Signaling Decoder screen, CDCSS mode, 283
 - Signaling Decoder screen, Digi Page mode, 288
 - Signaling Decoder screen, DTMF mode, 292
 - Signaling Decoder screen, EDACS mode, 297
 - Signaling Decoder screen, Func Gen mode, 303
 - Signaling Decoder screen, LTR mode, 308
 - Signaling Decoder screen, NAMPS-NTACS mode, 275
 - Signaling Decoder screen, NMT mode, 320
 - Signaling Decoder screen, Tone Seq mode, 337
- SIS Challenge
 - Signaling Encoder screen, NMT mode, 428
- SIS Response
 - Signaling Encoder screen, NMT mode, 428
- Site ID
 - Signaling Encoder screen, EDACS mode, 386
- slot timing
 - MPT 1327 decoder, 314
- Sngl Step
 - Tests (IBASIC Controller) screen, 545
- SNR
 - AF Analyzer screen, 110
 - Duplex Test screen, 343
 - measurement, 60, 102, 110, 343, 478, 490, 500, 553
 - operation, 102, 110, 343, 478, 490, 500, 553
 - RF Analyzer screen, 478
 - RF Generator screen, 490
 - RX Test screen, 500
 - TX Test screen, 102, 553
- software
 - automated testing, 594
 - for automated testing, 367
 - running, 520
- source
 - oscilloscope, 109
 - peak detector, 108
- Span
 - Spectrum Analyzer screen, 508
- span
 - effect on AF analyzer, 508
 - spectrum analyzer, 518
- speaker
 - ALC, 111
 - disabling, 111
 - volume control, 111
- Speaker ALC
 - AF Analyzer screen, 111
- Speaker Vol
 - AF Analyzer screen, 111
- Spec Pass/Fail Limits
 - Tests (Main Menu) screen, 524
- Spec#
 - Tests (Order of Tests) screen, 531
- specifications
 - setting limits, 530
- spectrum analyzer
 - calibration, 518
 - frequency, markers, 514
 - input port, 508
 - level, markers, 514
 - marker position, 513
 - markers, 513
 - markers, frequency, 514
 - markers, level, 514
 - measuring low-level RF power, 97, 112, 349, 352, 476, 480, 491, 557, 559
 - resolution bandwidth, 518
 - span, 518
 - squelch effects, 477
 - sweep rate, 518
 - traces, 516
 - use of, 97, 112, 349, 352, 476, 480, 491, 557, 559
 - use with RF generator, 509
 - use with tracking generator, 511
- Spectrum Analyzer screen
 - Amplitude, 509
 - Amplitude (Tracking Gen), 511
 - Auxiliary menu, 515
 - Avg 1-100, 517
 - Center Freq, 507
 - Controls, 505

-
- Freq (marker), 514
 Input Atten, 515
 Lvl (marker), 514
 Main menu, 507
 Marker menu, 513
 Marker To, 513
 No Pk/Avg, 517
 Normalize, 516
 Offset Freq (Tracking Gen), 512
 Output Port (RF Gen), 510
 Pk Hold, 517
 Port/Sweep (Tracking Gen), 512
 Position, 513
 Ref Level, 507
 RF Gen Freq, 510
 RF In/Ant, 508
 Sensitivity, 517
 Span, 508
 view of, 506
 spurs
 ACP measurement, 96
 square wave
 function generator, 395
 Squelch
 RF Analyzer screen, 477
 squelch
 CDCSS, 368
 digital decoding, 280
 effects on decoder, 477
 effects on HP-IB operation, 478
 effects on oscilloscope, 477
 effects on remote operation, 478
 effects on spectrum analyzer, 477
 fixed level, 477
 manual control, 477
 off, 477
 using attenuator hold, 345, 488, 498
 squelch control, 584
 Standard
 Signaling Decoder screen, EDACS mode, 297
 Signaling Decoder screen, NMT mode, 320
 Signaling Encoder screen, AMPS-TACS mode, 366
 Signaling Encoder screen, CDCSS mode, 371
 Signaling Encoder screen, Digi Page mode, 377
 mode, 377
 Signaling Encoder screen, DTMF mode, 380
 Signaling Encoder screen, EDACS mode, 386
 Signaling Encoder screen, EDACS mode, 386
 Signaling Encoder screen, LTR mode, 399
 Signaling Encoder screen, NAMP-NTAC mode, 366
 Signaling Encoder screen, NMT mode, 429
 Signaling Encoder screen, Tone Seq mode, 433
 station class mark, 136
 Status
 Signaling Encoder screen, EDACS mode, 387
 status
 control, 387
 idle, 387
 indicators, 371
 working, 387
 STD450 NMT radio standard, 323, 429
 STD900 NMT radio standard, 323, 429
 Step#
 Tests (Order of Tests) screen, 529
 Stop
 Signaling Encoder screen, AMPS-TACS mode, 366
 Signaling Encoder screen, CDCSS mode, 371
 Signaling Encoder screen, Digi Page mode, 377
 Signaling Encoder screen, DTMF mode, 380
 Signaling Encoder screen, EDACS mode, 387
 Signaling Encoder screen, LTR mode, 399
 Signaling Encoder screen, NAMP-NTAC mode, 366
 Signaling Encoder screen, Tone Seq mode, 433
 stop bit, 442
 Stop DSAT
 Signaling Encoder screen, NAMP-NTAC mode, 366
 Stop Filler
 Signaling Encoder screen, AMPS-TACS mode, 366
 Signaling Encoder screen, NAMP-NTAC mode, 366
 Stop Length
 I/O Configure screen, 442
 Stop Meas
 Signaling Decoder screen, AMPS-TACS mode, 275
 Signaling Decoder screen, CDCSS mode, 283
 Signaling Decoder screen, Digi Page mode, 288
 Signaling Decoder screen, DTMF mode, 293
 Signaling Decoder screen, EDACS mode, 297
 Signaling Decoder screen, Func Gen mode, 303
 Signaling Decoder screen, LTR mode, 308
 Signaling Decoder screen, NAMP-NTACS mode, 275
 Signaling Decoder screen, Tone Seq mode, 337
 Stop Test
 Signaling Decoder screen, NMT mode, 320
 Strobe Pol
 Radio Interface screen, 462
 Sub-Audible Dev
 Signaling Encoder screen, EDACS mode, 387
 subscriber identity security challenge, 428
 subscriber identity security response, 428
 subscriber number, 427
 support, 602
 Support Contacts
 electronic mail, 10
 HP Desk, 10
 telephone, 10
 sweep
 frequency range, tracking generator, 508
 oscilloscope, 447
 rate, spectrum analyzer, 518
 time per division, 447
-

-
- tracking generator, 512
 - Sym
 - Signaling Decoder screen, DTMF mode, 293
 - Signaling Decoder screen, Tone Seq mode, 337
 - symbol
 - for tone sequence, 293, 337, 434
 - frequency, 293, 336, 337
 - frequency error, 336
 - hexadecimal number, 434
 - Symbol Definition
 - Signaling Encoder screen, Tone Seq mode, 434
 - Symbol Frequencies
 - Signaling Encoder screen, DTMF mode, 380
 - Symbol Sequence
 - Signaling Encoder screen, Tone Seq mode, 434
 - sync delay
 - word, 357
 - synchronization sequence
 - decoder, MPT 1327, 313
 - syntax
 - NMT programming, 331
 - system identification number, 136
 - System Identity
 - Signaling Encoder screen, MPT 1327 mode, 418
 - system parameter overhead word 2 message, 202
 - System Type
 - Call Control screen, 136
- T**
- TA1, main traffic area, 325
 - TA2, alternate traffic area, 325
 - talk & listen, 440
 - tariff class information, 429
 - TC1, main traffic channel, 325
 - TC2, alternate traffic channel, 325
 - TCI
 - Signaling Encoder screen, NMT mode, 429
 - terminal, ASCII, 86
 - Test Mode
 - Signaling Encoder screen, MPT 1327 mode, 406
 - Test Name
 - Tests (Order of Tests) screen, 529
 - Test Procedure Run Mode
 - Tests (Execution Conditions) screen, 537
 - test set
 - configuring, 49
 - test subsystem, 521
 - Tests (Channel Information) screen, 521
 - Delete Ch, 526
 - Insert Ch, 526
 - Main Menu, 526, 527
 - Print All, 526, 527
 - view of, 525
 - Tests (Execution Conditions) screen, 521
 - Autostart Test Procedure on Power-Up, 536
 - Continue, 536
 - If Unit-Under-Test Fails, 536
 - Main Menu, 536
 - Output Heading, 536
 - Output Results For, 537
 - Output Results To, 536
 - Run Test, 537
 - Test Procedure Run Mode, 537
 - view of, 535
 - Tests (External Devices) screen, 521
 - Addr, 539
 - Calling Name, 539
 - Delet Ins, 539
 - External Disk Specification, 539
 - Insrt Ins, 539
 - Inst#, 540
 - Main Menu, 540
 - Model, 540
 - Options, 540
 - Output Heading, 540
 - view of, 538
 - Tests (IBASIC Controller) screen, 521
 - Clr Scr, 545
 - Continue, 545
 - Main Menu, 545
 - Sngl Step, 545
 - view of, 544
 - Tests (Main Menu) screen, 521
 - Cnfg External Devices, 522
 - Continue, 522
 - Description, 522
 - Exec Execution Cond, 522
 - Freq Channel Information, 523
 - IBASIC IBASIC Cntrl, 523
 - Library, 523
 - Parm Test Parameters, 523
 - Pass/Fail Limits, 524
 - Print Printer Setup, 523
 - Proc Save/Delete Procedure, 524
 - Program, 524
 - Run Test, 524
 - Select Procedure Filename, 524
 - Select Procedure Location, 524
 - Seqn Order of Tests, 524
 - view of, 522
 - Tests (Order of Tests) screen, 521
 - All Chans?, 528
 - Delet Stp, 529
 - Insrt Stp, 529
 - Main Menu, 529
 - Output Heading, 529
 - Spec#, 531
 - Step#, 529
 - Test Name, 529
 - view of, 528
 - Tests (Pass/Fail Limits) screen, 521
 - Check, 531
 - Lower Limit, 531
 - Main Menu, 531
 - Output Heading, 531
 - Units, 531
 - Upper Limit, 531
 - view of, 530
 - Tests (Printer Setup) screen, 521
 - Continue, 541
-

-
- FF at End, [541](#)
 - FF at Start, [541](#)
 - Lines/Page, [542](#)
 - Main Menu, [542](#)
 - Model, [542](#)
 - Output Heading, [542](#)
 - Output Results For, [542](#)
 - Output Results To, [542](#)
 - Printer Address, [543](#)
 - Printer Port, [543](#)
 - Run, [545](#)
 - Run Test, [543](#)
 - view of, [541](#)
 - Tests (Save/Delete Procedure) screen, [521](#)
 - Code Location, [533](#)
 - Enter Procedure Filename, [533](#)
 - Main Menu, [533](#)
 - Pass Word, [533](#)
 - Select ProcedureLocation, [533](#), [534](#)
 - view of, [532](#)
 - Tests (Test Parameters) screen, [521](#)
 - view of, [527](#)
 - TESTS key, [582](#)
 - Time
 - Configure screen, [50](#), [267](#)
 - Signaling Decoder screen, NMT mode, [318](#)
 - time
 - markers, [449](#)
 - Time (marker)
 - Oscilloscope screen, [449](#)
 - time and date, [50](#)
 - Time/div
 - Oscilloscope screen, [447](#)
 - timebase
 - decoder, [270](#)
 - external input, [579](#)
 - external output, [579](#)
 - timer
 - low battery, [51](#), [260](#)
 - Timing
 - Signaling Decoder screen, MPT 1327 mode, [314](#)
 - timing
 - response, MPT 1327 decoder, [315](#)
 - slot, MPT 1327 decoder, [314](#)
 - title
 - for printout, [455](#), [542](#)
 - TOC
 - defined, [281](#)
 - TOC Time
 - Signaling Encoder screen, CDCSS mode, [371](#)
 - tone length
 - DTMF encoder, [379](#)
 - tone sequence decoder, [292](#), [337](#)
 - Tone Sequence endcoder, [434](#)
 - tone sequence
 - burst, [366](#), [371](#), [377](#), [380](#), [399](#), [433](#)
 - continuous, [366](#), [377](#), [380](#), [399](#), [433](#)
 - editing, [434](#)
 - entering, [434](#)
 - outputting, [433](#)
 - single, [366](#), [371](#), [377](#), [380](#), [399](#), [433](#)
 - stepped, [366](#), [380](#), [399](#), [433](#)
 - stopping, [366](#), [371](#), [377](#), [380](#), [399](#), [433](#)
 - symbol frequency, [336](#)
 - symbol frequency error, [336](#)
 - using frequencies, [434](#)
 - using hexadecimal numbers, [434](#)
 - using relative amplitude, [434](#)
 - Tone Sequence decoder mode
 - AF Anl In, [335](#)
 - Arm Meas, [335](#)
 - Freq, [336](#)
 - Freq Error, [336](#)
 - Gate Time, [336](#)
 - Input Level, [336](#)
 - Off Time, [337](#)
 - On Time, [337](#)
 - Single/Cont, [337](#)
 - Stop Meas, [337](#)
 - Sym, [337](#)
 - Trig Level, [337](#)
 - view of, [335](#)
 - Tone Sequence encoder mode
 - AFGen2 To, [432](#)
 - Audio Out, [432](#)
 - Bursts, [433](#)
 - FM Coupling, [433](#)
 - Pre-Emp, [433](#)
 - Send, [433](#)
 - Send Mode, [433](#)
 - Standard, [433](#)
 - Stop, [433](#)
 - Symbol Definition, [434](#)
 - Symbol Sequence, [434](#)
 - view of, [432](#)
 - tone-only operation
 - digital paging, [375](#)
 - total access communication system for Japan
 - decoder, [271](#)
 - encoder, [355](#)
 - total access communications systems
 - decoder, [271](#)
 - encoder, [355](#)
 - Total RAM
 - Configure screen, [267](#)
 - trace
 - comparison, spectrum analyzer, [516](#)
 - spectrum analyzer, [516](#)
 - tracking generator
 - amplitude, [511](#)
 - frequency, [507](#)
 - frequency offset, [512](#)
 - offset, [511](#)
 - output, [512](#)
 - output port, [512](#)
 - sweep, [512](#)
 - use with spectrum analyzer, [511](#)
 - Traffic Area, Alt
 - Signaling Encoder screen, NMT mode, [429](#)
 - Traffic Area, Main
 - Signaling Encoder screen, NMT mode, [430](#)
 - Traffic Channel
 - Signaling Encoder screen, MPT 1327 mode, [407](#)
 - traffic channel
 - channel number, NMT, [425](#)
 - Traffic Channel (Alt), Number
 - Signaling Encoder screen, NMTmode, [430](#)
 - Traffic Channel (Alt), Power
 - Signaling Encoder screen, NMTmode, [430](#)
 - Traffic Channel (Main), Number
 - Signaling Encoder screen, NMTmode, [431](#)
 - Traffic Channel (Main), Power
 - Signaling Encoder screen, NMTmode,
-

-
- 431
- training, 602
- transmit pace, 442
- transmitter
- keying, 94, 348, 474, 556
- transmitter frequency, 58
- measurement, 97, 111, 352, 479, 491, 559
- transmitter frequency error, 58
- measurement, 97, 111, 352, 479, 491, 559
- transmitter power, 58
- fast (HP 8920B), 480, 559
 - measurement, 97, 112, 352, 480, 491, 559
 - mobile station, 148
 - modulation quality, 127
 - zero reference, 97, 480, 560
- transmitter testing
- EDACS, 298
- triangle wave
- function generator, 395
- Trig Level
- Signaling Decoder screen, AMPS-TACS mode, 275
 - Signaling Decoder screen, CDCSS mode, 283
 - Signaling Decoder screen, Digi Page mode, 288
 - Signaling Decoder screen, Func Gen mode, 303
 - Signaling Decoder screen, LTR mode, 308
 - Signaling Decoder screen, NAMPS-NTACS mode, 275
 - Signaling Decoder screen, NMT mode, 320
 - Signaling Decoder screen, Tone Seq mode, 337
- Trigger Pattern (bin)
- Signaling Decoder screen, AMPS-TACS mode, 275
 - Signaling Decoder screen, NAMPS-NTACS mode, 275
- triggering
- automatic, 450
 - bit position, 275
 - continuous, 451
- decoder, AMPS-TACS/NAMPS-NTACS, 272, 275
- decoder, CDCSS, 281, 283
- decoder, digital paging, 285, 288
- decoder, DTMF, 289, 292
- decoder, EDACS, 296, 297
- decoder, function generator, 302, 303
- decoder, LTR, 305, 308
- decoder, MPT 1327, 312
- decoder, NMT, 320
- decoder, tone sequence, 335, 337
- display, 451
- encoder, oscilloscope, 450
- external, oscilloscope, 450
- gate time, 273, 287, 290, 302, 306, 336
- input level, 273, 282, 287, 291, 296, 302, 306, 319, 336
- internal, 451
- internal, oscilloscope, 450
- level, 275, 283, 288, 303, 308, 320, 337, 450
- negative edge, 451
- NMT alarm, 423
- positive edge, 451
- radio interface, 460
- signal, 450
- source, oscilloscope, 450
- time, 449
- troubleshooting, 502
- trunked receiver channel
- home channel, 401
- trunked transmit channel
- home channel, 402
- trunking data, 396
- trunking message, 396
- Tune Freq
- Adjacent Channel Power screen, 96
 - Duplex Test screen, 351
 - RF Analyzer screen, 479
 - TX Test screen, 558
- Tune Mode
- Adjacent Channel Power screen, 96
 - Duplex Test screen, 351
 - RF Analyzer screen, 479
 - TX Test screen, 558
- tuning
- automatic, 96, 351, 479, 558
 - channel, automatic, 263
 - manual, 96, 351, 479, 558
- turn off code
- CDCSS encoder, 372
 - frequency, 369
 - output time, 371
- turning off squelch, 477
- Twist
- Signaling Encoder screen, DTMF mode, 381
- twist
- recommended settings, 381
- twist and pre-emphasis interactions, 381
- TX Freq Error
- Adjacent Channel Power screen, 97
 - AF Analyzer screen, 111
 - Analog Meas screen, 246
 - Call Control screen, 137
 - Duplex Test screen, 352
 - RF Analyzer screen, 479
 - RF Generator screen, 491
 - TX Test screen, 559
- TX Frequency
- Adjacent Channel Power screen, 97
 - AF Analyzer screen, 111
 - Duplex Test screen, 352
 - RF Analyzer screen, 479
 - RF Generator screen, 491
 - TX Test screen, 559
- TX key, 582
- TX Power
- Adjacent Channel Power screen, 97
 - AF Analyzer screen, 112
 - Analog Meas screen, 246
 - Call Control screen, 138
 - Duplex Test screen, 352
 - RF Analyzer screen, 480
 - RF Generator screen, 491
 - TX Test screen, 559
- TX Pwr Meas (HP 8920B)
- RF Analyzer screen, 480
 - TX Test screen, 559
- TX Pwr Zero
- Adjacent Channel Power screen, 97
 - Call Configuration screen, 251
 - RF Analyzer screen, 480
 - TX Test screen, 560
- TX TEST screen
-

-
- Current, 554
 - DC Level, 554
 - Distortion, 556
 - SINAD, 558
 - TX Test Screen
 - view of, 551
 - TX Test screen
 - AF Anl In, 552
 - AF Freq, 102, 553
 - AFGen1 Freq, 554
 - AFGen1 Lvl, 554
 - Current, 102, 553
 - DC Level, 102, 553
 - De-emphasis, 554
 - Detector, 555
 - Distn, 102, 553
 - Ext TX key, 556
 - Filter 1 and Filter 2, 556
 - FM Deviation, 556
 - functional block diagram, 551
 - IF Filter, 556
 - Input Port, 557
 - priority settings, 54
 - SINAD, 102, 553
 - SNR, 102, 553
 - Tune Freq, 558
 - Tune Mode, 558
 - TX Freq Error, 559
 - TX Frequency, 559
 - TX Power, 559
 - TX Pwr Meas (HP 8920B), 559
 - TX Pwr Zero, 560
 - Type
 - Signaling Decoder screen, NMT mode, 318
 - type bits, 360, 362
-
- U**
 - undisplayed controls
 - Signaling Encoder screen, MPT 1327 mode, 407
 - UniqChCon
 - CALLP, 166
 - unit-of-measure
 - changing, 61, 64
 - converting, 61, 64
 - keys, 580
 - Units
 - Tests (Pass/Fail Limits) screen, 531
 - units
 - peak, 394
 - rms, 394
 - universal noise
 - function generator, 395
 - up arrow key, 581
 - upgrades
 - firmware, 588
 - hardware, 586
 - Upper Limit
 - Tests (Pass/Fail Limits) screen, 531
 - User Def Base Freq
 - Configure screen, 255
 - user keys
 - assigning global, 83
 - assigning, local, 82
 - clearing, global assignment, 83
 - clearing, local assignment, 82
 - deleting, global assignment, 83
 - deleting, local assignment, 82
 - example, 82
 - explanation, 80
 - global, assignment, 83
 - global, defined, 80
 - local, assignment, 82
 - local, defined, 80
 - preassigned, 81
 - releasing, global assignment, 83
 - releasing, local assignment, 82
 - setting, global, 83
 - setting, local, 82
-
- V**
 - V
 - displaying results in, 61
 - V (volts)
 - displaying results in, 61
 - Value
 - Service screen, 503
 - variable frequency notch filter, 108
 - version number
 - firmware, 258
 - Vert Offset
 - Oscilloscope screen, 447
 - Vert/div
 - Oscilloscope screen, 447
 - vertical offset
 - oscilloscope, 447, 449
 - vertical sensitivity
 - oscilloscope, 447
 - video averaging
 - spectrum analyzer, 517
 - VMAC
 - power level, 134
 - voice channel assignment, 125
 - voice channel decoder
 - AMPS-TACS, 271
 - NAMPS-NTACS, 271
 - voice guard, 295
 - Voltage
 - Service screen, 503
 - voltage
 - measurement, 101, 485, 496
 - RF, across 50 ohm load, 264
 - RF, emf (open circuit), 264
 - setting, 50
 - Voltmeter Connection
 - Service screen, 503
 - volume
 - beeper, 51, 257
 - control, 584
 - internal speaker, 111
-

-
- W**
- W (watts)
 - displaying results in, 61
 - Waveform
 - Signaling Encoder screen, Func Gen mode, 395
 - waveform
 - dc, 395
 - Gaussian noise, 395
 - selecting, 395
 - sine, 395
 - square, 395
 - triangle, 395
 - universal noise, 395
 - wideband
 - decoder, signaling standard, 297
 - encoder, signaling standard, 386
 - word
 - abbreviated address, 170
 - extended address, 172
 - first word of called address, 175
 - number of additional word coming, 184
 - reverse voice channel order confirmation message, 177, 178, 179, 180, 181, 182, 183
 - second word of called address, 176
 - serial number, 174
 - to view, from mobile station handoff, 189
 - to view, from mobile station origination, 193
 - to view, from mobile station page, 187
 - to view, from mobile station registration, 186
 - to view, from mobile station release, 191
 - to view, from order to change TX power of mobile, 192
 - word sync bits, 360, 362
 - word sync delay, 357
 - working
 - status, 387
 - Working Channel, Number
 - Signaling Encoder screen, EDACS mode, 387
 - Working Channel, RX Frequency
 - Signaling Encoder screen, EDACS mode, 387
 - Working Channel, TX Frequency
 - Signaling Encoder screen, EDACS mode, 387
 - Write-protect switch, 73
- X**
- Xmt Pace
 - I/O Configure screen, 442
 - Xon/Xoff, 440, 442
-

Y

YES key, 580

Z

zero crossing
 detecting, 282
zero reference
 transmitter power, 97, 480, 560
zeroing
 DCFM, 488
 measurement offset, 103
 power meter, 97, 141, 152, 480, 560
ZVEI1
 radio standard, 433
ZVEI2
 radio standard, 433