

**North American FM Tests
HP 11807A,E Option 001
Reference Guide
for the HP 8920A,B,D**

**HP Part No. 11807-90116
Printed in U. S. A.
March 1999**

Rev C

Copyright © Hewlett-Packard Company 1995

**RESTRICTED
RIGHTS LEGEND**

Use, duplication or disclosure by the U. S. Government is subject to restrictions as set forth in subparagraph (c) (1) (ii) of the Rights in Technical Data and Computer Software clause in DFARS 252.227-7013.

Hewlett-Packard Company
3000 Hanover Street
Palo Alto, CA 94304. U.S.A.

Rights for non-DOD U.S. Government Departments and Agencies are as set forth in FAR 52.227-19 (c) (1,2).

Contents

1 Product Description

HP 11807A,E Software 16

Finding the Information You Need 20

Additional Services Available 21

Contents

A.14.00	2 Using the Software/HP 8920B or HP 8920A FW Above Rev.
	Testing Overview 26
	Customizing Testing 32

Contents

3 Using the Software/HP 8920A FW Rev. Below A.14.00

Testing Overview 60

Customizing Testing 66

4 Test, Parameter, and Pass/Fail Limit Descriptions

Introduction 90

TEST_01. TX and RX Stand-by Current Drain 91

TEST_02. TX Frequency Error 92

TEST_03. TX Output Power 93

TEST_04. TX Modulation Limiting 94

TEST_05. TX Audio Frequency Response 95

TEST_06. TX Audio Distortion 96

TEST_07. TX Microphone Sensitivity 97

TEST_08. TX FM Hum and Noise 98

TEST_09. TX Residual AM Hum and Noise 99

TEST_10. TX CTCSS/CDCSS Deviation, Freq/Code 100

TEST_11. RX Hum and Noise 101

TEST_12. RX Audio Distortion 102

TEST_13. RX Audio Frequency Response 103

TEST_14. RX Usable Sensitivity 104

TEST_15. RX Audio Squelch Sensitivity 105

TEST_16. RX Squelch Blocking 106

TEST_17. RX CTCSS/CDCSS Opening 107

TEST_18. RX Audio Sensitivity 108

Contents

TEST_19. RX Variation of Sens with Freq	109
TEST_20. RX Quick Test	110
TEST_21. TX Quick Test	111
Test Parameter Descriptions	112
Parameter 1, RT External Pad and Cable Loss	113
Parameter 2, RT Full Rated System Deviation	114
Parameter 3, RT High Supply Voltage	115
Parameter 4, RT Low Supply Voltage	116
Parameter 5, RT Nominal Supply Voltage	117
Parameter 6, RX Audio Freq Response Step Frequency	118
Parameter 7, RX Audio Load Impedance	119
Parameter 8, RX CT/CDCSS Available	120
Parameter 9, RX CT/CDCSS Control	121
Parameter 10, RX CT/CDCSS Deviation	122
Parameter 11, RX Maximum Audio Power	123
Parameter 12, RX Set Radio Volume	124
Parameter 13, RX Squelch Blocking Step Frequency	125
Parameter 14, RX Squelch Control	126
Parameter 15, RX Squelch Preset Only	127
Parameter 16, RX Standard RF Input Level	128

Contents

Parameter 17, RX Tolerance for Setting Volume	129
Parameter 18, RX Usable Sens Set and Measure	130
Parameter 19, RX Usable Sensitivity SINAD Level	131
Parameter 20, TX Audio Distn % Full Rated System Dev	132
Parameters 21-23, TX Audio Freq Response Start, Step, and Stop Frequency	133
Parameter 24, TX CD/CTCSS Available	134
Parameter 25, TX CD/CTCSS Control	135
Parameter 26, TX CD/CTCSS Filter 1 Opt	136
Parameter 27, TX De-emphasis	137
Parameter 28, TX Dekey Between TX Tests	138
Parameter 29, TX Mic Sens Set and Measure	139
Parameter 30, TX Modulation Limiting Sweep Step Freq	140
Parameter 31, TX Output Power @Low Switch	141
Parameter 32, TX User/System Key UUT	142
Parameter 33, XX Secure Frequency Info	143
Pass/Fail Limit Descriptions (specifications)	144
Pass/Fail Limit 1, RX Audio Distn 17 dB Below Rated Power	145
Pass/Fail Limit 2, RX Audio Distortion	146
Pass/Fail Limit 3, RX Audio Freq Resp Delta from 6 dB/Oct	147

Contents

Pass/Fail Limit 4, RX Audio Frequency Response Roll <0.5 kHz	148
Pass/Fail Limit 5, TX Audio Frequency Response Roll >2.5 kHz	149
Pass/Fail Limit 6, RX Audio Output @40% of Full Rated Dev	150
Pass/Fail Limit 7, RX CDCSS SINAD at Opening	151
Pass/Fail Limit 8, RX CT/CDCSS FM Hum and Noise	152
Pass/Fail Limit 9, RX CT/CDCSS Opening Level	153
Pass/Fail Limit 10, RX CTCSS SINAD at Opening	154
Pass/Fail Limit 11, RX Hum and Noise Squelched	155
Pass/Fail Limit 12, RX Hum and Noise Unsquelched	156
Pass/Fail Limit 13, RX Squelch Blocking	157
Pass/Fail Limit 14, RX Stand-by Current Drain	158
Pass/Fail Limit 15, RX Threshold Squelch Sensitivity	159
Pass/Fail Limit 16, RX Tight Squelch Sensitivity	160
Pass/Fail Limit 17, RX Usable Sensitivity	161
Pass/Fail Limit 18, RX Variation of Sens Delta Frequency	162
Pass/Fail Limit 19, TX Audio Distortion	163
Pass/Fail Limit 20, TX Audio Response Delta From 6 dB/oct	164
Pass/Fail Limit 21, TX Audio Frequency Response Roll <0.5 kHz	165

Contents

Pass/Fail Limit 22, TX Audio Frequency Response Roll >2.3 kHz for 896-940M	166
Pass/Fail Limit 23, TX Audio Response Roll >2.5 kHz	167
Pass/Fail Limit 24, TX Audio Frequency Response Roll >2.7 kHz for 896-940M	168
Pass/Fail Limit 25, TX CT/CDCSS Deviation	169
Pass/Fail Limit 26, TX CTCSS Frequency Error	170
Pass/Fail Limit 27, TX Current Drain	171
Pass/Fail Limit 28, TX Deviation If Set and Measure Mic Sens	172
Pass/Fail Limit 29, TX FM Hum and Noise	173
Pass/Fail Limit 30, TX Frequency Error	174
Pass/Fail Limit 31, TX Microphone Sensitivity	175
Pass/Fail Limit 32, TX Modulation Limiting	176
Pass/Fail Limit 33, TX Output Power	177
Pass/Fail Limit 34, TX Output Power at High Supply	178
Pass/Fail Limit 35, TX Output Power at High Supply Low SW	179
Pass/Fail Limit 36, Output Power at Low Supply	180
Pass/Fail Limit 37, TX Output Power at Low Supply Low SW	181
Pass/Fail Limit 38, TX Output Power at Low Switch Setting	182
Pass/Fail Limit 39, TX Residual AM Hum and Noise	183

5 Reference (Alphabetical)

Conventions Used 186

Copying Files 187

Data Collection (Saving and Retrieving Test Results) 189

Disks 198

Exiting a Program 200

HP-IB Control Annunciators 201

Memory Cards 202

Parameters 209

Pass/Fail Limits (specifications) 210

Pausing or Stopping a TEST 211

Printing 212

Procedures 225

RAM 230

Saving Tests Results 232

Serial Port 233

Test Execution Conditions 234

USER Keys 236

6 Problem Solving

If you have a problem testing your radio 240

If the test procedure doesn't run on an test set 241

If the HP 11807A,E program was incorrectly loaded 242

If the printer does not print the test results 243

If the FM radio fails the audio tests 245

If radio volume can't be set on the test set's meter screen 246

If your radio fails CTCSS/CDCSS tests or the tests don't run 247

If you can't get the data-collection function to work 251

Contents

Glossary 253

Contents

Index 257

Product Description

HP 11807A,E Software

The HP 11807A,E Option 001 Software performs fast, accurate, automated tests that determine the RF and audio performance of FM radios. The measurement methods and specifications used for these tests are based on methods and values derived from the following industry standards:

EIA/TIA-603
EIA/TIA-204-D (TEST_19)

Materials Included in This Package

This package contains the following materials. Verify that all the materials are present and inspect them for damage. If a part is missing or appears to be damaged, contact your nearest Hewlett-Packard sales or service office.

- HP 11807A Option 001 Test Software (part number 11807-10001) or HP 11807E Option 001 Test Software (part number 11807-10020)
- SRAM memory card (uninitialized), for saving your own test procedures and results.
 - For 11807A, 32 Kbyte SRAM (part number 85700A).
 - For 11807E, 64 Kbyte SRAM (part number 83230A).
- HP 11807A,E Option 001 Software Reference Guide (part number 11807-90116)
- HP software product license agreement

Additional Equipment Required

- HP 8920A (B or D) RF Communications Test Set
 - HP 8920A Option 005: 512 Kbyte RAM Memory extension

Recommended Equipment

- HP 8920 Option 001: High-Stability Timebase
- HP 8920 Option 004: Tone/Digital Signaling
- HP 8920A Option 010: 400 Hz High-Pass Filter
- HP 8920A Option 013: C MESSAGE Weighting Filter
- External power supply An external power supply for the FM radio can be configured to the HP 8920A in one of three ways:
 1. A power supply or battery can be connected directly to the FM radio.
 2. A power supply can be connected to the rear-panel *DC CURRENT MEASUREMENT* banana-plug connectors. (This requires the HP 8920A Option 003, HP-IB/RS-232/Current Measurement.)
 3. A power supply can be controlled by the HP 8920A when it's connected to the HP-IB connector. (This requires the HP 8920A Option 003, HP-IB/RS-232/DC Current Measurement.)

HP-IB programmable power supplies from the following series are supported for external control:

HP 664xA
HP 665xA
HP 667xA
HP 668xA

NOTE: HP 662xA and HP 663xA series DC power supplies are not supported.

Ordering Upgrades

If your test set does not contain all of the required options you must update your instrument accordingly. Order the necessary upgrade kit(s) from your local Hewlett-Packard sales office. Regional sales offices are listed at the front of this manual.

Required Upgrades

- HP 8920A Option R05: 512 Kbyte RAM expansion retrofit kit

Recommended Upgrades

- HP 8920A,B Option R01: High-Stability Timebase retrofit kit
- HP 8920A,B Option R04: Tone/Digital Signaling retrofit kit
- HP 8920A,B Option R10: 400 Hz High-Pass Filter (HPF) retrofit kit (A maximum of two optional filters can be installed in your test set. If you already have two optional filters installed, one of them must be removed before installing this kit.)
- HP 8920A,B Option R13: C MESSAGE Weighting Filter retrofit kit (A maximum of two optional filters can be installed in your test set. If you already have two optional filters installed, one of them must be removed before installing this kit.)

Available Tests:

The following tests can be performed with this software.

- TX and RX stand-by current drain
- TX frequency error
- TX output power
- TX modulation limiting
- TX audio frequency response
- TX audio distortion
- TX microphone sensitivity
- TX FM hum and noise
- TX residual AM hum and noise
- TX CTCSS/CDCSS deviation, freq/code
- RX hum and noise
- RX audio distortion
- RX frequency response

- RX usable sensitivity
- RX audio squelch sensitivity
- RX squelch blocking
- RX CTCSS/CDCSS opening
- RX audio sensitivity
- RX variation of sensitivity with frequency
- RX quick test
- TX quick test

For test, parameter, and specification descriptions, [see chapter 4, "Test, Parameter, and Pass/Fail Limit Descriptions" on page 89.](#)

Software Features

The following features simplify testing:

- While adjustments are being made, a large meter display and auditory feedback are provided.
- Results of tests and pass/fail indications are displayed on the test set's CRT, and can be printed, or collected in a disk drive, memory card, PC, or HP palmtop computer.
- The software allows the operator to change the order of tests, pass/fail limits, test parameters, and equipment configurations.

Finding the Information You Need

This manual describes the setup and use of the HP 11807A,E Software with the HP 8920A,B,D Test Set. The book is arranged in self-contained chapters to provide the following information:

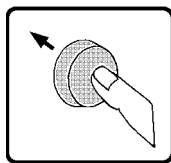

PRODUCT DESCRIPTION CHAPTER 1

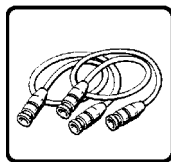

USING THE SOFTWARE-CHAPTER 2

- Instructions for cabling test set.
- How to load
- How to run
- How to customize

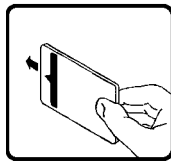

TEST DESCRIPTIONS-CHAPTER 4

Definitions, special conditions and restrictions for:

- Tests
- Pass/fail limits
- Parameters



REFERENCE-CHAPTER 5

- Alphabetically listed
- Detailed descriptions of all the features and functions of the software.
- For the advanced level user.



PROBLEM SOLVING-CHAPTER 6

- Alphabetically listed
- Symptoms and possible corrections to frequent user problems.

MANUAL1

Additional Services Available

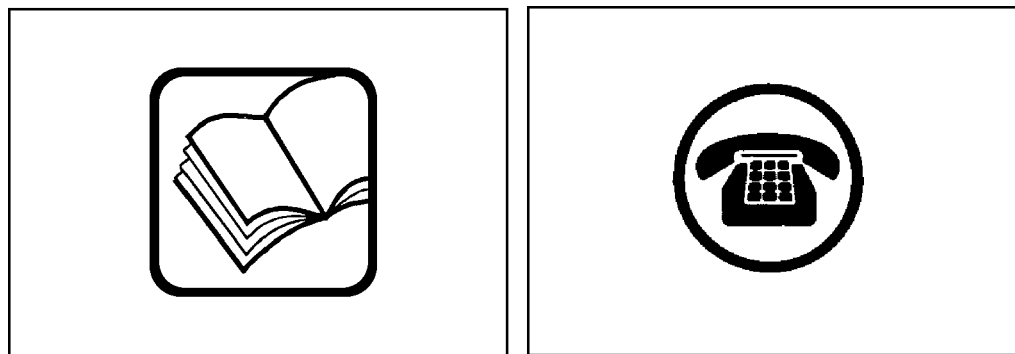

TROUBLE1

Consult the HP 8920 User's Guide or call the HP 8920 Hotline 1-800-922-8920 (in the USA and Canada only) and give your software model number.

Chapter 1, Product Description
Additional Services Available

**Using the Software/HP 8920B or HP
8920A FW Above Rev. A.14.00**

NOTE:

The firmware revision A.14.00 in the HP 8920A,D had several enhancements, which are standard in the HP 8920B. This chapter applies to users with:

- **HP 8920A test sets with firmware revision above A.14.00**
- **All HP 8920B test sets.**

The test set's firmware revision is displayed on the top right corner of the configuration screen.

- Press SHIFT CONFIG to display the configuration screen and read the firmware revision.

If you have an HP 8920A test set with firmware revision below A.14.00, refer to [chapter 3, "Using the Software/HP 8920A FW Rev. Below A.14.00," on page 57](#). Contact Hewlett-Packard at 1-800-922-8920 for details on upgrading your firmware if desired.

The software can be run on the factory default settings or customized to your individual needs and specific requirements. This chapter provides detailed information on how to load, run, and customize the software.

The test set has two methods of accessing on-line help. In each of the screens in the test environment, **k4 (He1p)** accesses specific information about how to set up/use the current screen. **SHIFT HELP** accesses the master help file, with an alphabetical listing of help topics.

Testing Overview

Pressing TESTS will display what is called the TESTS (Main Menu) screen. To begin testing, you must first load the software and make connections. From this screen you have the option to:

Begin running tests:

- The factory default settings are acceptable for your application or
- The software has already been customized and saved to a memory card

Customize the software:

- Decide which tests you desire to run (Order of Tests)
 - you may want to run all, some, or just one of the tests.
- Specify which channels to test (Channel Information)
 - you may want to test one, some, or all of the channels on your radio.
- Change the pass/fail limits for specific measurements (Pass/Fail Limits)
 - you may want the pass/fail limits to have tighter or looser specifications than the default settings.
- Change the test environment and conditions (Test Parameters)
 - decide output format.
 - enter specific information about radio equipment and/or environment.
- Save any or all of the above customized changes to a memory card (Save/Delete Procedure)

Set Up Test Set:

- Print test results or certain screens.
- Decide when and where test results are displayed (**Execution Conditions/Printer Setup**)

To Run Tests

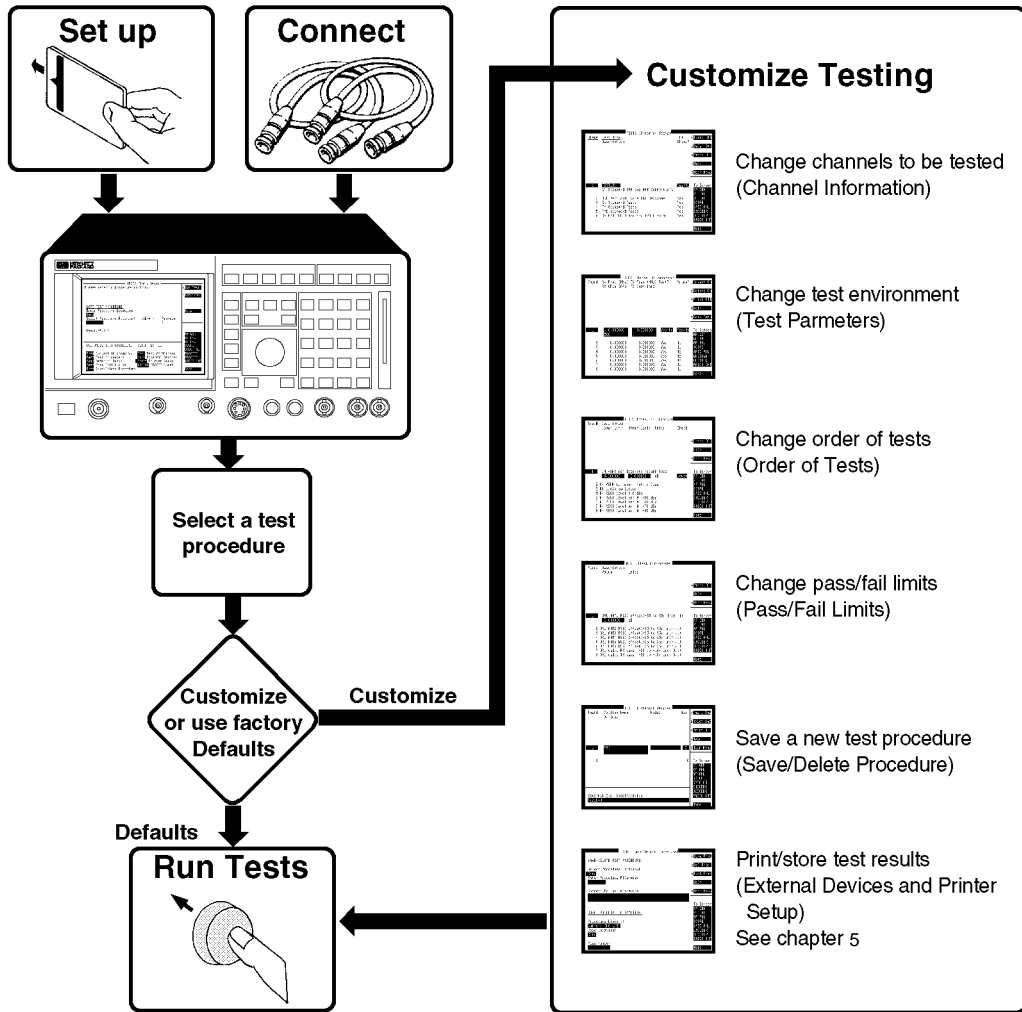

Setting Up the Test Set and Making Connections

Before you begin testing, you must set up the test set and make the appropriate hardware connections.

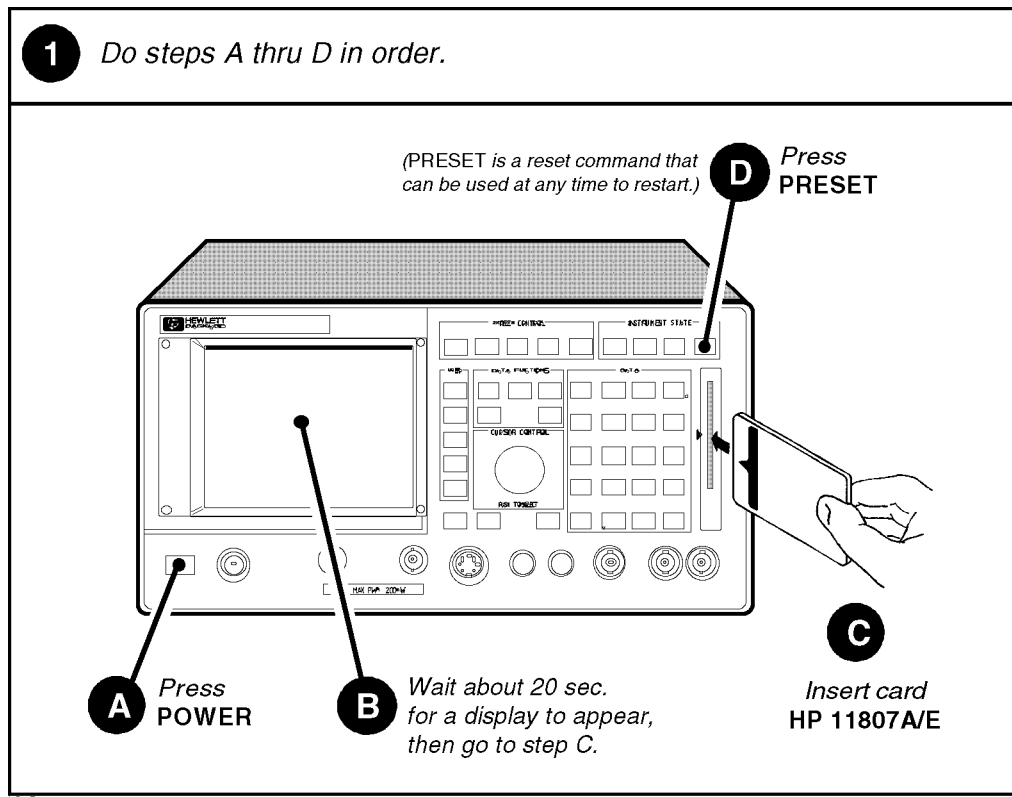

Making a Connection

2 Connect a radio to the test set.

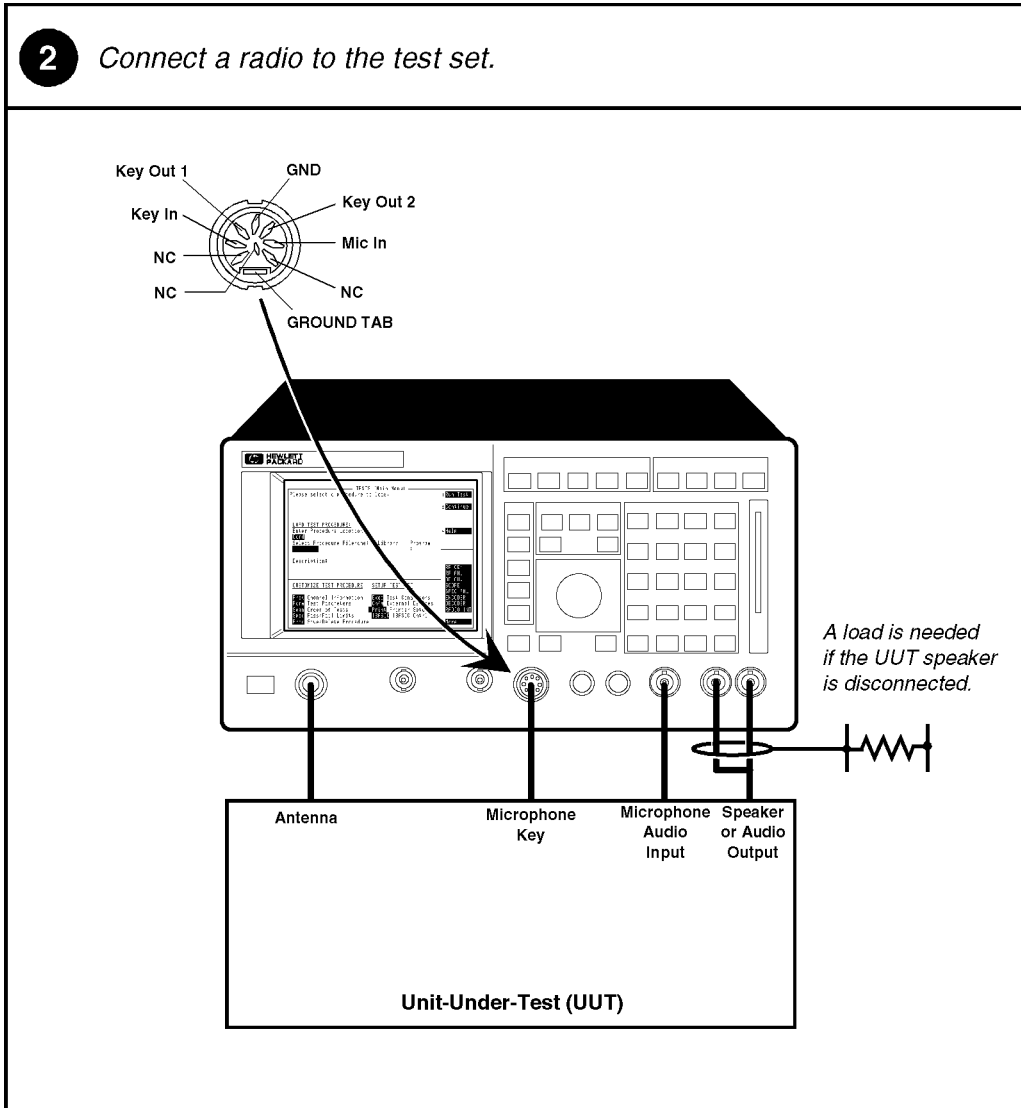

CONNECT1

Selecting a Test Procedure









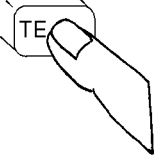

To load the software, you must first select the location to load from (in this case, it will be **Card**) and a procedure filename. Your card comes pre-programmed with at least one procedure. The actual software program does not get loaded into the test set's memory until k1 (**Run Test**) is selected. It will take approximately 15 seconds to load the software in an HP 8920B, and approximately two minutes in an HP 8920A,D.

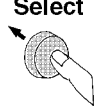
The software memory card can be removed after the program is loaded into the test set's memory. The program will remain in memory after a power-down/power-up cycle, unless it is manually deleted or a new program is loaded.

When tests begin to run, they are executed in the order in which they were entered into the Test Procedure.

Pressing CANCEL will pause the current test (press k2 to continue the test.)

Selecting A Test Procedure

<p>1 Press TESTS to display the TESTS screen.</p> <p><i>If you are in IBASIC, press SHIFT, CANCEL before pressing TESTS.</i></p> 	<p>2 Position cursor and select Select Procedure Location:.</p> <p>Position</p>  <p>Select</p> 
<p>3 Position cursor and select Card.</p> <p>Position</p>  <p>Select</p>  <p>Choices :</p> <ul style="list-style-type: none"> <input checked="" type="checkbox"/> Card ROM RAM Disk 	<p>4 Position cursor and select Select Procedure Filename:.</p> <p>Position</p>  <p>Select</p> 
<p>5 Position cursor and select desired Procedure.</p> <p>Position</p>  <p>Select</p>  <p>Choices :</p> <ul style="list-style-type: none"> <input checked="" type="checkbox"/> XXXXXX XXXXXX XXXXXX XXXXXX 	<p>6 Position cursor and select Run Test.</p> <p>Position</p>  <p>Select</p>  <p>8920A,D ≈ 2 min. 8920B ≈ 15 sec.</p> <ul style="list-style-type: none"> <input checked="" type="checkbox"/> Run Test 2 Continue 4 Help

PROCD1

Customizing Testing

Because of the diversity of individual testing needs, the software has been designed so that changes may be easily made from the test set's front panel. You may store these changes on a memory card so that you may skip these steps in the future. See "[Saving a Test Procedure](#)" on page 50.

Because your needs change, the software allows changes to its default settings whenever you need to make them. For example, tests may be inserted or deleted, and later after running the tests you can change the pass/fail limits or decide to test different channels.

Most testing customization is accomplished through the customization screens. These customization screens are accessed from the main TESTS (Main Menu) screen as shown in the following figure. Customizing procedures is explained later in this chapter.

NOTE:

External Devices, Printer Setup, and IBASIC will not be explained in this customizing section.

- External Devices and Printer Setup are used when setting up printers and external disk drives which is explained in "[Disks](#)" on page 198 and "[Printing](#)" on page 212 in [chapter 5](#).
- IBASIC is used when writing your own programs and is not explained in this manual. If you need to write your own IBASIC programs you may acquire the following manuals:
 - 8920A,D
 - *HP Instrument Basic User's Handbook* HP part number E2083-90000.
 - *HP 8920A Programming Manual* HP part number 08920-90220.
 - 8920B
 - *HP Instrument Basic User's Handbook Version 2.0*
HP part number E2083-90005.
 - *HP 8920B Programming Manual* HP part number 08920-90222.

How to Customize Testing

TESTS Screen

```

TESTS (Main Menu)
Please select a procedure to load.

LOAD TEST PROCEDURE:
Select Procedure Location:
Card
Select Procedure Filename:  Library:  Program:
Description:

CUSTOMIZE TEST PROCEDURE:  SET UP TEST SET:
Freq Channel Information  Exec Execution Cond
Parm Test Parameters      Cnfg External Devices
Seqn Order of Tests       Print Printer Setup
Spec Pass/Fail Limits     IBASIC IBASIC Cntrl
Proc Save/Delete Procedure

To Screen
RF GEN
RF ANL
AF ANL
SCOPE
SPEC ANL
ENCODER
DECODER
RADIO INT
More

1 Run Test
2 Continue
4 Help
    
```

Selecting a Test Function opens a Customization Screen.

CUSTOM1

Changing the Order of Tests











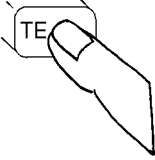













You may define the order of tests to include all, some, or just one of the tests available. When the first test is finished, the next will run. The test sequence will remain in the test set's battery backed-up memory until another test sequence is loaded or set up. For information on saving a customized test sequence, see ["Saving a Test Procedure" on page 50](#).

Defining the order of tests is accomplished by inserting or deleting tests from the list of tests that come with the software package. See [chapter 4, "Test, Parameter, and Pass/Fail Limit Descriptions" on page 89](#), for descriptions of tests included in this package.

The **All Chans?** field allows the user to decide to run the test on all channels entered in the **Channel Information** table, or just the channels which are selected as **Prime** in the **Channel Information** screen. This feature allows the user the flexibility to use channels that are selected as **Prime** in all the tests in the sequence, and those indicated as non-prime in a subset of tests (those tests with a **Yes** response in **All Chans**). For more information, see ["Specifying Channel Information" on page 38](#).













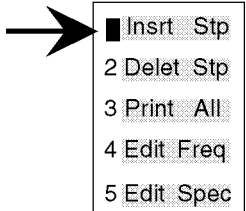

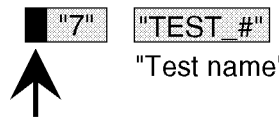
The following describes how to create a new test sequence and enter a response to the **All Chans?** field.

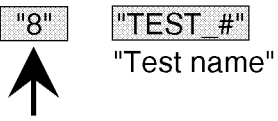
How to Change the Order of Tests

<p>1 Press TESTS to display the TESTS (Main Menu) screen.</p> <p><i>If you are in IBASIC, press SHIFT, CANCEL before pressing TESTS.</i></p> 	<p>2 Position cursor and select Seqn Order of Tests.</p> <table border="1"> <tr> <td>Position</td> <td></td> </tr> <tr> <td></td> <td>Freq Channel Information</td> </tr> <tr> <td></td> <td>Parm Test Parameters</td> </tr> <tr> <td>Select</td> <td>Seqn Order of Tests</td> </tr> <tr> <td></td> <td>Spec Pass Fail Limits</td> </tr> <tr> <td></td> <td>Proc Save/Delete Procedure</td> </tr> </table>	Position			Freq Channel Information		Parm Test Parameters	Select	Seqn Order of Tests		Spec Pass Fail Limits		Proc Save/Delete Procedure					
Position																		
	Freq Channel Information																	
	Parm Test Parameters																	
Select	Seqn Order of Tests																	
	Spec Pass Fail Limits																	
	Proc Save/Delete Procedure																	
<p>The Order of Tests screen is now present on your CRT.</p>	<p>3 Position cursor and select Step # field.</p> <table border="1"> <tr> <td>Position</td> <td></td> </tr> <tr> <td></td> <td>Example</td> </tr> <tr> <td>Select</td> <td> <table border="0"> <tr> <td></td> <td>"1"</td> <td>"TEST_5"</td> </tr> <tr> <td></td> <td></td> <td>"Test name"</td> </tr> </table> </td> </tr> </table>	Position			Example	Select	<table border="0"> <tr> <td></td> <td>"1"</td> <td>"TEST_5"</td> </tr> <tr> <td></td> <td></td> <td>"Test name"</td> </tr> </table>		"1"	"TEST_5"			"Test name"					
Position																		
	Example																	
Select	<table border="0"> <tr> <td></td> <td>"1"</td> <td>"TEST_5"</td> </tr> <tr> <td></td> <td></td> <td>"Test name"</td> </tr> </table>		"1"	"TEST_5"			"Test name"											
	"1"	"TEST_5"																
		"Test name"																
<p>4 Rotate knob until Step # which precedes the insertion point of the new test you are adding is highlighted, then select it.</p> <table border="1"> <tr> <td>Rotate</td> <td></td> </tr> <tr> <td></td> <td></td> </tr> <tr> <td>Select</td> <td></td> </tr> <tr> <td></td> <td></td> </tr> </table> <p><i>For example, select step 7 if you want to insert the new test as step 8.</i></p> <table border="0"> <tr> <td></td> <td>"7"</td> <td>"TEST_#"</td> </tr> <tr> <td></td> <td></td> <td>"Test name"</td> </tr> <tr> <td></td> <td>"8"</td> <td>"New test"</td> </tr> </table>		Rotate				Select					"7"	"TEST_#"			"Test name"		"8"	"New test"
Rotate																		
																		
Select																		
																		
	"7"	"TEST_#"																
		"Test name"																
	"8"	"New test"																

SEQ1

Continue on next page

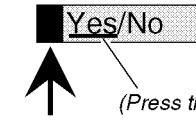
<p>5 <i>Position cursor and select Insrt Stp.</i></p>	<p>6 <i>Position cursor back at Step # field and select it.</i></p>
<p>Position</p>  <p>Select</p>  	<p>Position</p>  <p>Select</p>  
<p>7 <i>Highlight and select Step # field of newly inserted test.</i></p>	<p>8 <i>Position cursor and select Test Name field.</i></p>
<p>Highlight</p>  <p>Select</p>  	<p>Position</p>  <p>Select</p>  
<p>9 <i>Rotate knob and select desired Test Name when it appears.</i></p>	<p>10 <i>Position cursor at All Chans? field and select Yes or No.</i></p>
<p>Rotate</p>  <p>Select</p>  	<p>Position</p>  <p>Select</p>   <p><i>(Press the knob to change the selection.)</i></p>

5EQ2

Continue on next page

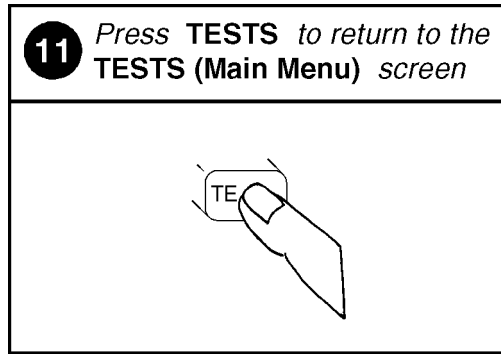

Specifying Channel Information

For each channel that you wish to specify, you must enter the following information into the **Channel Information** screen:

- RX Freq (MHz)
 - Enter the receive frequency of your radio in (MHz).
- TX Freq (MHz)
 - Enter the transmit frequency of your radio in (MHz).

NOTE: Enter a **-1** in the RX or TX test frequency fields to have all subsequent frequencies ignored when testing is started.

- Sq Freq/Code (for RX Freq)
 - If you are testing receiver CTCSS or CDCSS (test parameter 8 is set=1), you must enter the receive squelch frequency or code. Otherwise, leave this field empty.
 1. Enter a CTCSS frequency, for example, 91.5 Hz as **"CT FR91.5"**, or
 2. Enter a CTCSS tone code, for example, **"ZZ"** for 91.5 Hz as **"CT ZZ"**. The tone codes supported by the software are shown in [table 17, "CTCSS Tone Codes" on page 248](#), or
 3. Enter a CDCSS code word, for example **"CD 023"** (octal). The code words supported by the software are shown in [table 18, "CDCSS Code Words" on page 249](#).
- Sq Freq/Code (for TX Freq)
 - If you are testing transmitter CTCSS or CDCSS (test parameter 23 is set=1), you must enter the transmit squelch frequency or code. Otherwise, leave this field empty.
 1. Enter a CTCSS frequency, for example, 91.5 Hz as **"CT FR91.5"**, or
 1. Enter a CTCSS tone code, for example, **"ZZ"** for 91.5 Hz as **"CT ZZ"**. The tone codes supported by the software are shown in [table 17, "CTCSS Tone Codes" on page 248](#), or
 2. Enter a CDCSS code word, for example **"CD 023"** (octal). The code words supported by the software are shown in [table 18, "CDCSS Code Words" on page 249](#).

- **Test?** (yes/no) specifies whether you want to test the UUT at this channel. If set to “No” then the UUT will not be tested at that channel, but you may retain the channel information in the table for later use. If set to “Yes” then the channel will be used as defined by settings of **Prime?** and **All Chans?** fields.
- **Prime?** (yes/no) specifies which channels are “prime”. Select “Yes” if you want to test the UUT at this channel on all the tests in the procedure. Select **No** if you want to test the UUT at this channel on just a subset of tests, which are designated by selecting **Yes** in the **All Chans** field of the **Order of Tests** screen. See **All Chans?** in "[Changing the Order of Tests](#)" on page 34 for more information.

For information on saving the channel information table, see "[Saving a Test Procedure](#)" on page 50.

The **All Chans** field in the **Order of Tests** screen interacts closely with the **Prime?** field on the **Channel Information** screen. When the software runs, it begins by retrieving the first channel entered into the **Channel Information** screen. It then checks the response in the **Test?** field to determine if the UUT should be tested at that channel at this time. If there is a **No** response in the **Test?** field, the software will go to the next channel in the table. If there is a **Yes** response in the **Test?** field, the software will check if the channel is **Prime**.

A **Yes** response in the **Prime?** field indicates to test the UUT at that channel on the entire sequence of tests in the procedure. A **No** response in the **Prime?** field indicates to test the UUT at that channel on a subset of tests in the procedure. The subset of tests is determined by a **Yes** response in the **All Chans?** field. Therefore, tests with a **No** response in the **All Chans?** field will be run on *prime* channels only.

Below is an example of how the software would run if you had a procedure set up as follows:

Table 1

Chan #	Test?	Prime?
Chan 01	Yes	Yes
Chan 02	Yes	No
Chan 03	No	No

Table 2

Test Number	All Chan? Setting
Test 01	No
Test 02	Yes
Test 03	Yes
Test 04	No

The result would be:

- Chan 01 is used in Test 01, Test 02, Test 03, and Test 04.
- Chan 02 is used in Test 02, and Test 03 only.
- Chan 03 is not used.

The following **table 3** shows how to properly configure these settings according to your testing needs.

Table 3

Testing Need	Necessary Field Settings		
	Test?	Prime?	All Chan?
Test channel on all tests in sequence	Yes	Yes	Don't Care
Test channel on a subset of tests in sequence	Yes	No	Yes on tests you want included in the testing subset
Do not test this channel now, but retain information for later use	No	Don't Care	Don't Care

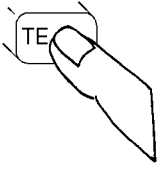

How to Specify Channel Information

<p>1 Press TESTS to display the TESTS (Main Menu) screen.</p> <p><i>IF you are in IBASIC, press SHIFT, CANCEL before pressing TESTS.</i></p> 	<p>2 Position cursor and select Freq Channel Information.</p> <table border="1"> <tr> <td>Position</td> <td></td> <td>Freq Channel Information</td> </tr> <tr> <td>Select</td> <td></td> <td>Parm Test Parameters</td> </tr> <tr> <td></td> <td></td> <td>Seqn Order of Tests</td> </tr> <tr> <td></td> <td></td> <td>Spec Pass Fail Limits</td> </tr> <tr> <td></td> <td></td> <td>Proc Save/Delete Procedure</td> </tr> </table>	Position		Freq Channel Information	Select		Parm Test Parameters			Seqn Order of Tests			Spec Pass Fail Limits			Proc Save/Delete Procedure
Position		Freq Channel Information														
Select		Parm Test Parameters														
		Seqn Order of Tests														
		Spec Pass Fail Limits														
		Proc Save/Delete Procedure														
<p>The Channel Information screen is now present on your CRT.</p>	<p>3 Position cursor and select Chan # field.</p> <table border="1"> <tr> <td>Position</td> <td></td> <td>(Disregard this number.)</td> </tr> <tr> <td>Select</td> <td></td> <td></td> </tr> </table>	Position		(Disregard this number.)	Select											
Position		(Disregard this number.)														
Select																
<p>4 Scroll to and select desired Chan #.</p> <table border="1"> <tr> <td>Scroll</td> <td></td> <td>(This numbers are examples.)</td> </tr> <tr> <td>Select</td> <td></td> <td></td> </tr> </table>	Scroll		(This numbers are examples.)	Select			<p>5 Position cursor and select RX Freq (MHz) field.</p> <table border="1"> <tr> <td>Position</td> <td></td> <td></td> </tr> <tr> <td>Select</td> <td></td> <td></td> </tr> </table>	Position			Select					
Scroll		(This numbers are examples.)														
Select																
Position																
Select																



FREQ1

Continue on next page

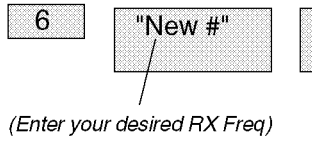

6 Use **DATA** keys to enter new RX Freq, then select it.

<p>Enter</p>  <p>Select</p> 	 <p>(Enter your desired RX Freq)</p>
--	---

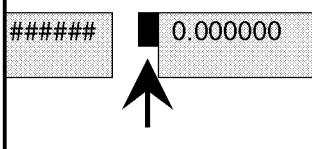
7 Position cursor and select TX Freq (MHz) field.

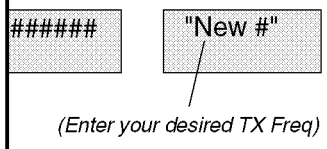

<p>Position</p>  <p>Select</p> 	
---	--

8 Use **DATA** keys to enter new TX Freq, then select it.



<p>Enter</p>  <p>Select</p> 	 <p>(Enter your desired TX Freq)</p>
---	--

If you are testing receiver/transmitter CTCSS or CDCSS do steps 9 - 12 to enter the receive/transmitt squelch frequency or codes, otherwise continue instructions at step 13.

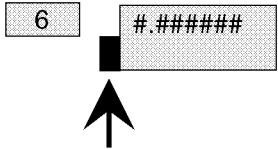
9 Position cursor and select Sq Freq/Code field.





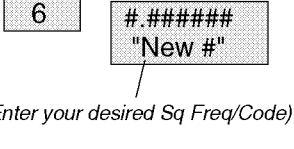

<p>Position</p>  <p>Select</p> 	
---	---

10 Use **DATA** keys to enter new Sq Freq/Code, then select it.

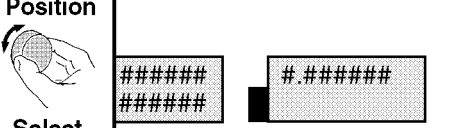
<p>Enter</p>  <p>Select</p> 	 <p>(Enter your desired Sq Freq/Code)</p>
--	--

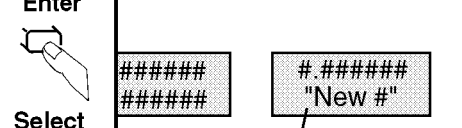
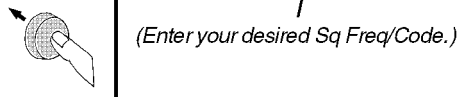
Continue on next page

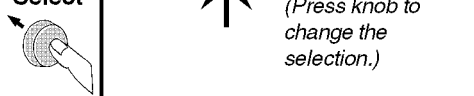
FREQ2

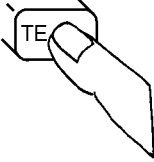
<p>11 Position cursor and select Sq Freq/Code field.</p>	<p>12 Use DATA keys to enter new Sq Freq/Code, then select it.</p>
<p>Position</p>  <p>Select</p> 	<p>Enter</p>  <p>Select</p>  <p>(Enter your desired Sq Freq/Code.)</p>
<p>13 Position cursor at Test? field and select Yes or No.</p>	<p>14 Position cursor at Prime? field and select Yes or No.</p>
<p>Position</p>  <p>Select</p>  <p>(Press knob to change the selection.)</p>	<p>Position</p>  <p>Select</p>  <p>(Press knob to change the selection.)</p>
<p>15 Press TESTS to return to the TESTS (Main Menu) screen.</p>	
	







FREG3

Changing Pass/Fail Limits

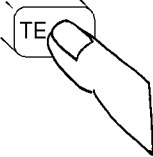
Pass/Fail limits define the values a measurement's result is compared against to determine if the UUT meets its specified standards. Default values are set in the test software. These default values may be changed to suit your particular requirements.





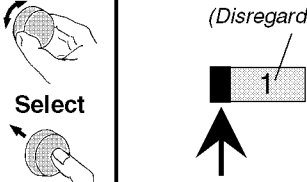











The following describes how to change the pass/fail (upper and lower) limits. See ["Pass/Fail Limit Descriptions \(specifications\)," in chapter 4, on page 144](#) for descriptions of each pass/fail limit. For information on saving customized pass/fail limits, see ["Saving a Test Procedure" on page 50](#).

How to Change Pass/Fail Limits

<p>1 Press TESTS to display the TESTS screen.</p> <p><i>IF you are in IBASIC, press SHIFT, CANCEL before pressing TESTS.</i></p> 	<p>2 Position cursor and select Spec Pass Fail Limits.</p> <table border="1"> <tr> <td>Position</td> <td></td> </tr> <tr> <td></td> <td>Freq Channel Information</td> </tr> <tr> <td></td> <td>Parm Test Parameters</td> </tr> <tr> <td></td> <td>Seqn Order of Tests</td> </tr> <tr> <td>Select</td> <td>Spec Pass Fail Limits</td> </tr> <tr> <td></td> <td>Proc Save/Delete Procedure</td> </tr> </table>	Position			Freq Channel Information		Parm Test Parameters		Seqn Order of Tests	Select	Spec Pass Fail Limits		Proc Save/Delete Procedure
Position													
	Freq Channel Information												
	Parm Test Parameters												
	Seqn Order of Tests												
Select	Spec Pass Fail Limits												
	Proc Save/Delete Procedure												
<p>The Pass Fail Limits screen is now present on your CRT.</p>	<p>3 Position cursor and select Spec # field.</p> <p><i>(Disregard this number.)</i></p> 												





Continue on next page

SPEC1

<p>4 Scroll to and select desired Spec #.</p>	<p>5 Position cursor and select Lower limit field.</p>
<p>Scroll  Select </p> <p>(This Spec # is an example.)</p> <p>6 FCC TX output p -1.000000 1.</p> <p></p>	<p>Position  Select </p> <p>6 FCC TX output p -1.000000 1.</p> <p></p>
<p>6 Use DATA keys to enter new value, then select it.</p>	<p>7 Position cursor and select Upper Limit field.</p>
<p>Enter  Select </p> <p>6 FCC TX output p -0.500000 1.</p> <p>(Enter your desired value.)</p>	<p>Position  Select </p> <p>C TX output power adjustme .500000 1.000000 dB</p> <p></p>
<p>8 Use DATA keys to enter new value, then select it.</p>	<p>9 Position cursor and select Check field.</p>
<p>Enter  Select </p> <p>C TX output power adjustme .500000 0.500000 dB</p> <p>(Enter your desired value.)</p>	<p>Position  Select </p> <p>Both</p> <p></p>

SPEC2

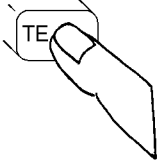
Continue on next page

10 <i>Position cursor and select Both .</i>		11 <i>Press TESTS to return to the TESTS (Main Menu) screen.</i>						
Position 		Select 						
		<table border="1"><tr><td>Choices :</td></tr><tr><td>Upper</td></tr><tr><td>Lower</td></tr><tr><td><input checked="" type="checkbox"/> Both</td></tr><tr><td>None</td></tr></table>	Choices :	Upper	Lower	<input checked="" type="checkbox"/> Both	None	
Choices :								
Upper								
Lower								
<input checked="" type="checkbox"/> Both								
None								







SPEC3

Changing the Test Parameters

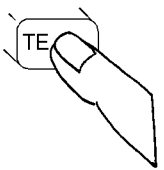
The software uses parameters to optimize the test environment and conditions for your testing situation. Many of the test parameters are determined by examining your test needs. The software comes with default settings for test parameters. Review the defaults for your particular needs. See "Test Parameter Descriptions," in chapter 4, on page 112 for descriptions of each test parameter. For information on saving customized test parameters, see "Saving a Test Procedure" on page 50.

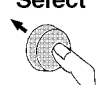
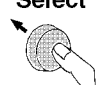

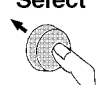
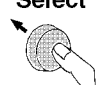

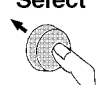
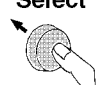







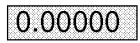





The following describes how you can change test parameters through the Test Parameter screen to optimize your testing conditions.

How to Change the Test Environment and Conditions

<p>1 Press TESTS to display the TESTS (Main Menu) screen.</p> <p><i>If you are in IBASIC, press SHIFT, CANCEL before pressing TESTS.</i></p> 	<p>2 Position cursor and select Parm Test Parameters.</p> <table border="1"><tr><td>Position</td><td></td><td>Freq</td><td>Channel Information</td></tr><tr><td></td><td></td><td>Parm</td><td>Test Parameters</td></tr><tr><td>Select</td><td></td><td>Seqn</td><td>Order of Tests</td></tr><tr><td></td><td></td><td>Spec</td><td>Pass Fail Limits</td></tr><tr><td></td><td></td><td>Proc</td><td>Save/Delete Procedure</td></tr></table>	Position		Freq	Channel Information			Parm	Test Parameters	Select		Seqn	Order of Tests			Spec	Pass Fail Limits			Proc	Save/Delete Procedure
Position		Freq	Channel Information																		
		Parm	Test Parameters																		
Select		Seqn	Order of Tests																		
		Spec	Pass Fail Limits																		
		Proc	Save/Delete Procedure																		

PARM1

Continue on next page

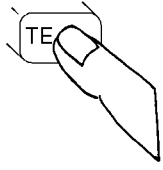
<p>The Tests Parameters screen is now present on your CRT.</p>	<p>3 Position cursor and select Parm # field.</p> <p>Position  Select </p> <p>(Entries on your display may be different.)</p> <p> 1 RT audio test to  0.000000</p> <p></p>
<p>4 Scroll to and select Parm # to be changed.</p> <p>Scroll  Select </p> <p>(This parameter number and description are examples.)</p> <p> 15 TX cable loss </p>	<p>5 Position cursor and select Value field.</p> <p>Position  Select </p> <p> 15 TX cable loss  0.000000 </p>
<p>6 Use DATA keys to enter new value, then select it.</p> <p>Enter  Select </p> <p> 15 TX cable loss  1.000000  (Enter your desired value.)</p>	<p>7 Press TESTS to return to the TESTS (Main Menu) screen.</p> <p></p>

PAPM2

Saving a Test Procedure

A Test Procedure is a collection of channel information, test parameters, testing order, and pass/fail limits saved in a file that customizes the test software to a specific application. You may save the file to a memory card or disk.

When you save a procedure you will be saving channel information, test parameters, pass/fail limits, and testing order, plus a library that contains the names of all test parameters, pass/fail limits, and tests that are resident in the software. The library file comes from the software and cannot be modified. The library file will be automatically saved on the card or disk that is being used to store the new test procedure.





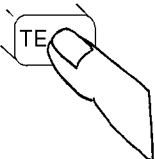
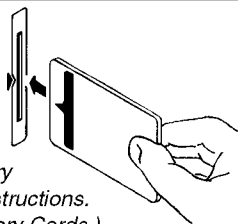

















The following example shows how to save a new procedure to a memory card. For more information concerning procedures, [see "Procedures," in chapter 5, on page 225.](#)

How to Save a Test Procedure

<p>1 Press TESTS to display the TESTS (Main Menu) screen.</p> <p><i>If you are in IBASIC, press SHIFT, CANCEL before pressing TESTS.</i></p> 	<p>2 Position cursor and select Proc Save/Delete Procedure.</p> <table border="1"> <tr> <td>Position</td> <td></td> </tr> <tr> <td></td> <td> <table border="1"> <tr><td>Freq</td><td>Channel Information</td></tr> <tr><td>Parm</td><td>Test Parameters</td></tr> <tr><td>Seqn</td><td>Order of Tests</td></tr> <tr><td>Spec</td><td>Pass Fail Limits</td></tr> <tr><td>Proc</td><td>Save/Delete Procedure</td></tr> </table> </td> </tr> <tr> <td>Select</td> <td></td> </tr> <tr> <td></td> <td></td> </tr> </table>	Position			<table border="1"> <tr><td>Freq</td><td>Channel Information</td></tr> <tr><td>Parm</td><td>Test Parameters</td></tr> <tr><td>Seqn</td><td>Order of Tests</td></tr> <tr><td>Spec</td><td>Pass Fail Limits</td></tr> <tr><td>Proc</td><td>Save/Delete Procedure</td></tr> </table>	Freq	Channel Information	Parm	Test Parameters	Seqn	Order of Tests	Spec	Pass Fail Limits	Proc	Save/Delete Procedure	Select			
Position																			
	<table border="1"> <tr><td>Freq</td><td>Channel Information</td></tr> <tr><td>Parm</td><td>Test Parameters</td></tr> <tr><td>Seqn</td><td>Order of Tests</td></tr> <tr><td>Spec</td><td>Pass Fail Limits</td></tr> <tr><td>Proc</td><td>Save/Delete Procedure</td></tr> </table>	Freq	Channel Information	Parm	Test Parameters	Seqn	Order of Tests	Spec	Pass Fail Limits	Proc	Save/Delete Procedure								
Freq	Channel Information																		
Parm	Test Parameters																		
Seqn	Order of Tests																		
Spec	Pass Fail Limits																		
Proc	Save/Delete Procedure																		
Select																			
<p><i>The Save/Delete Procedure screen is now present on your CRT.</i></p>	<p>3 Position cursor and select Select Procedure Location.</p> <table border="1"> <tr> <td>Position</td> <td></td> </tr> <tr> <td></td> <td>Select Procedure Location:</td> </tr> <tr> <td>Select</td> <td></td> </tr> <tr> <td></td> <td></td> </tr> </table>	Position			Select Procedure Location:	Select													
Position																			
	Select Procedure Location:																		
Select																			
<p>4 Position cursor and select Card.</p> <table border="1"> <tr> <td>Position</td> <td></td> </tr> <tr> <td></td> <td> <table border="1"> <tr><td>Choices :</td></tr> <tr><td>Card</td></tr> <tr><td>RAM</td></tr> <tr><td>Disk</td></tr> </table> </td> </tr> <tr> <td>Select</td> <td></td> </tr> <tr> <td></td> <td></td> </tr> </table> <p><i>(You can also save procedures to an internal RAM disk or external disk drive. See chapter 5-Disks.)</i></p>	Position			<table border="1"> <tr><td>Choices :</td></tr> <tr><td>Card</td></tr> <tr><td>RAM</td></tr> <tr><td>Disk</td></tr> </table>	Choices :	Card	RAM	Disk	Select				<p>5 Insert an initialized SRAM memory card.</p>  <p><i>(For detailed memory card initialization instructions, see chapter 5 -Memory Cards.)</i></p>						
Position																			
	<table border="1"> <tr><td>Choices :</td></tr> <tr><td>Card</td></tr> <tr><td>RAM</td></tr> <tr><td>Disk</td></tr> </table>	Choices :	Card	RAM	Disk														
Choices :																			
Card																			
RAM																			
Disk																			
Select																			



PROCMAN1



Continue on next page

<p>6 <i>Position cursor and select</i> Enter Procedure Filename:.</p> <p>Position  Select </p> <p>Enter Procedure Filename:  </p>	<p>7 <i>Select characters to name the procedure, then select Done.</i></p> <p>Position  Select </p> <p>  <table border="1" data-bbox="1058 541 1198 772"> <tr><td>Choices :</td></tr> <tr><td>Done</td></tr> <tr><td>Position</td></tr> <tr><td>Over/Ins</td></tr> <tr><td>Delete</td></tr> <tr><td>Del End</td></tr> <tr><td>Bk space</td></tr> <tr><td>A</td></tr> <tr><td>B</td></tr> <tr><td>C</td></tr> </table>  </p>	Choices :	Done	Position	Over/Ins	Delete	Del End	Bk space	A	B	C
Choices :											
Done											
Position											
Over/Ins											
Delete											
Del End											
Bk space											
A											
B											
C											
<p>8 <i>Position cursor and select</i> Enter Description for new</p> <p>Position  Select </p> <p>Enter Description for new ...  </p>	<p>9 <i>Select characters for the description, then select Done.</i></p> <p>Position  Select </p> <p>  <table border="1" data-bbox="1058 898 1208 1136"> <tr><td>Choices :</td></tr> <tr><td>Done</td></tr> <tr><td>Position</td></tr> <tr><td>Over/Ins</td></tr> <tr><td>Delete</td></tr> <tr><td>Del End</td></tr> <tr><td>Bk space</td></tr> <tr><td>A</td></tr> <tr><td>B</td></tr> <tr><td>C</td></tr> </table>  </p>	Choices :	Done	Position	Over/Ins	Delete	Del End	Bk space	A	B	C
Choices :											
Done											
Position											
Over/Ins											
Delete											
Del End											
Bk space											
A											
B											
C											
<p>10 <i>Position cursor at Procedure Library: and select Current.</i></p> <p>Position  Select </p> <p>Procedure Library:    <i>(The underline indicates which option is selected. Pressing knob changes the selection.)</i></p>	<p>11 <i>Position cursor and select Code Location:.</i></p> <p>Code Location:  </p>										

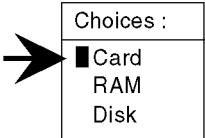
PROCMA12

Continue on next page

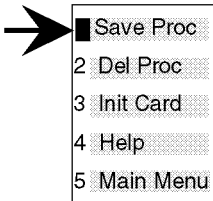
12 Position cursor at Card and select it.	
Position 	
Select 	

13 Position cursor at Save Proc and select it.	
Position 	
Select 	

14 Press **TESTS** to return to the **TESTS (Main Tests)** screen.

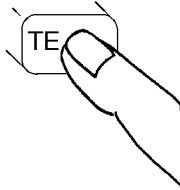

15 To run the saved procedure, follow the instructions below.

- 1) Insert the RAM card with your saved procedure.
- 2) On the **TESTS (Main Menu)** screen, a) position cursor and select **Select Procedure Location:**, then select **Card**, b) position cursor and select **Select Procedure Filename:**, then select your saved file name.
- 3) Remove your RAM card and insert the original HP 11807B ROM memory card.
- 4) Press **Run Test** .

The original card contains the full program needed to run your procedure.

PROCM3a

Changing Test Execution Conditions

Test Execution Conditions define where and when test output occurs. You may decide to:

- Display output on CRT only, or display on CRT and print hardcopy (**Output Results To**).

NOTE:

If printing test results is desired, after selecting **Printer**, additional steps are necessary to connect and configure the printer. See "**Printing**," in chapter 5, on page 212.

- Display (or print) only measurements that fail, or display (or print) all measurements that pass or fail (**Output Results For**).
- Enter a title for an output heading for the displayed or printed results (**Output Heading**).
- Stop testing when a measurement fails or continue through all of the tests without stopping (**If Unit-Under-Test-Fails**).
- Pause between each measurement, or run through entire test (**Test Procedure Run Mode**).
- Start the program automatically when the Test System is powered on. (**Autostart Test Procedure on Power-up**)

Test Execution Conditions is accessed from the **SETUP TEST SET:** list. To change a default setting, position the cursor to the desired field. Pressing the knob ("selecting") will toggle the underlined selection.

Test Execution Conditions settings are not retained after a power-down/power-up cycle, and will return to their default settings.



How to Change Test Execution Conditions

1 Press **TESTS** to display the **TESTS (Main Menu)** screen.

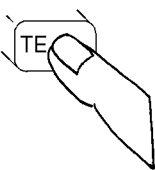
If you are in IBASIC, press SHIFT, CANCEL before pressing TESTS.



2 Position cursor at **Exec Execution Cond** and select it.

Position		Exec Execution Cond	
		Cnfg External Devices	
		Print Printer Setup	
Select		IBASIC IBASIC Cntrl	

3

Select Printer to output test procedure results to the CRT and a printer.

Select Failures to display only the CRT and printer measurements that fail.

Select Stop to stop a Test Procedure when a failure occurs.

Select Single Step to stop a Test Procedure at the end of each measurement.

TESTS (Execution Conditions)

Output Results To:	Crt/Printer
Output Results For:	All/Failures
Output Heading:	[REDACTED]
If Unit-Under-Test Fails:	Continue/Stop
Test Procedure Run Mode:	Continuous/Single Step
Autostart Test Procedure on Power-Up:	Off/On

1 Run Test

2 Continue

4 Help

5 Main Menu

To Screen

RF GEN

RF ANL

RF ANL

SCOPE

SPEC ANL

ENCODER

DECODER

RADIO INT

More

TESTEXEa

Printing and Saving Test Results

Printing and saving test results are features of the software which require additional equipment and configuration. See "Printing," in chapter 5, on page 212 for detailed descriptions and instructions for these features.

**Using the Software/HP 8920A FW Rev.
Below A.14.00**

NOTE:

The firmware revision A.14.00 in the HP 8920A,D had several enhancements, which are standard in the HP 8920B. This chapter applies to users with:

- **HP 8920A test sets with firmware revision below A.14.00**

The test set's firmware revision is displayed on the top right corner of the configuration screen.

- Press SHIFT CONFIG to display the configuration screen and read the firmware revision.

If you have an HP 8920B or an HP 8920A with firmware revision above A.14.00, refer to [chapter 2, "Using the Software/HP 8920B or HP 8920A FW Above Rev. A.14.00," on page 23](#). Contact Hewlett-Packard at 1-800-922-8920 for details on upgrading your firmware if desired.

The HP 11807A software can be run on the factory default settings or customized to your individual needs and the specific requirements. This chapter provides detailed information on how to load, run, and customize the software.

Testing Overview

Pressing TESTS will display what is called the **TESTS** screen. To begin testing, you must first load the software and make connections. From this screen you have the option to:

Begin running tests:

- The factory default settings are acceptable for your application or
- The software has already been customized and saved to a memory card

Customize the software:

- Decide which tests you desire to run (**Edit Seqn**)
 - you may want to run all, some, or just one of the tests.
- Specify which channels to test (**Edit Freq**)
 - you may want to test one, some, or all of the channels on your radio.
- Change the pass/fail limits for specific measurements (**Edit Spec**)
 - you may want the pass/fail limits to have tighter or looser specifications than the default settings.
- Change the test environment and conditions (**Edit Parm**)
 - decide output format.
 - enter specific information about radio equipment and/or environment.
- Save any or all of the above customized changes to a memory card (**Proc Mngr**)

Set Up Test Set:

- Print test results or certain screens.
- Decide when and where test results are displayed (**Edit Cnfg**)

To Run Tests

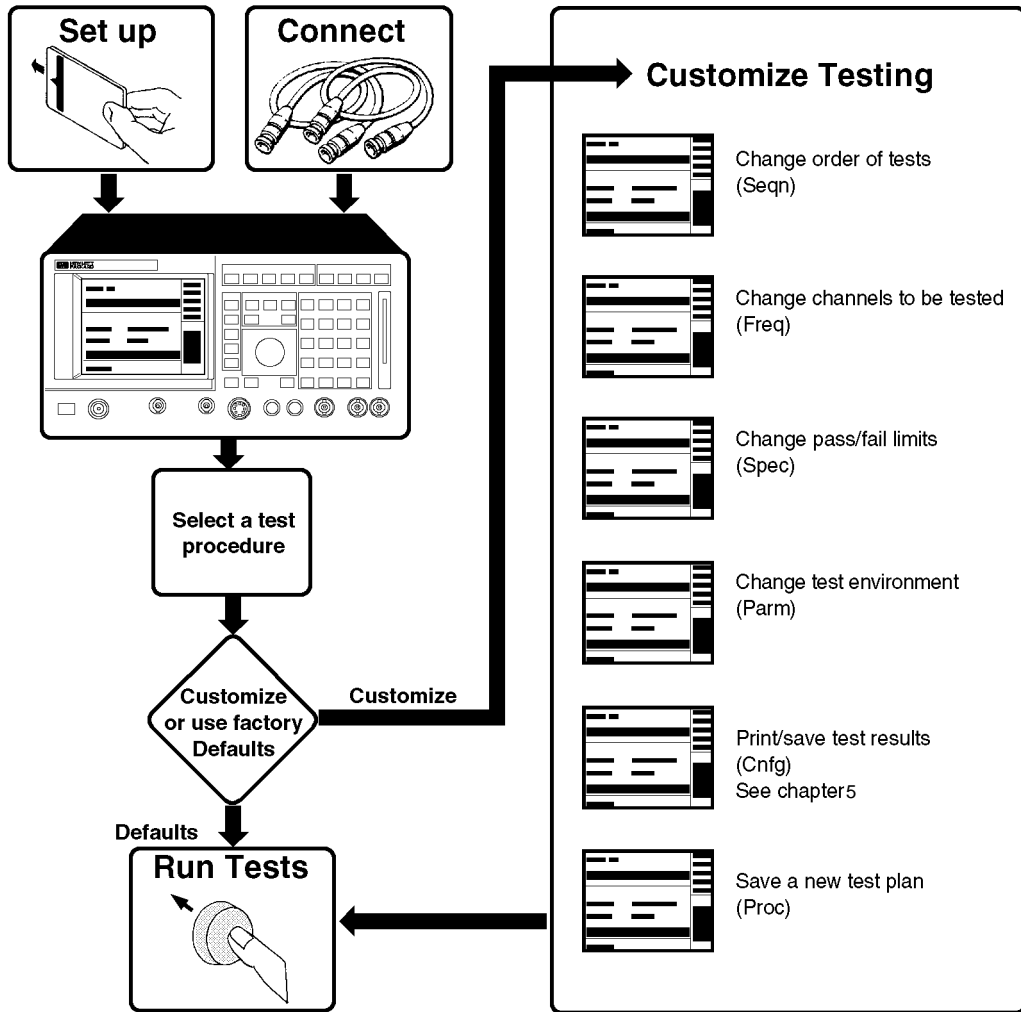

OVVIEWB

Setting Up the Test Set and Making Connections

Before you begin testing, you must set up the test set and make the appropriate hardware connections.

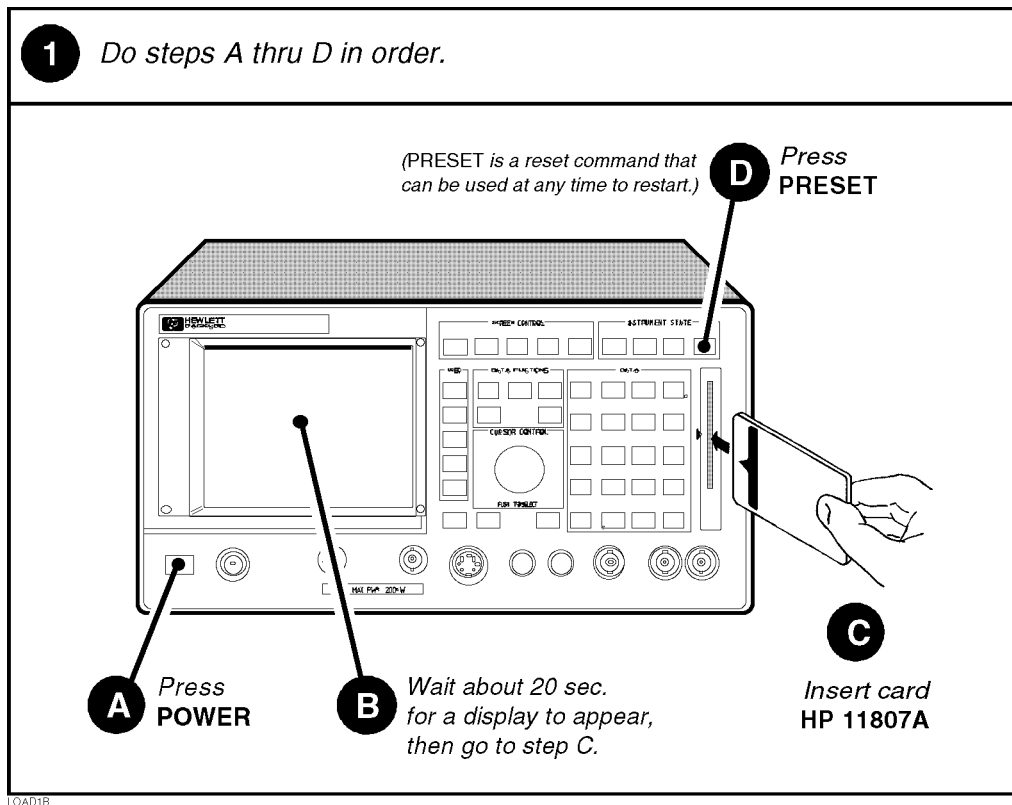

LOAD1B

Making a Connection

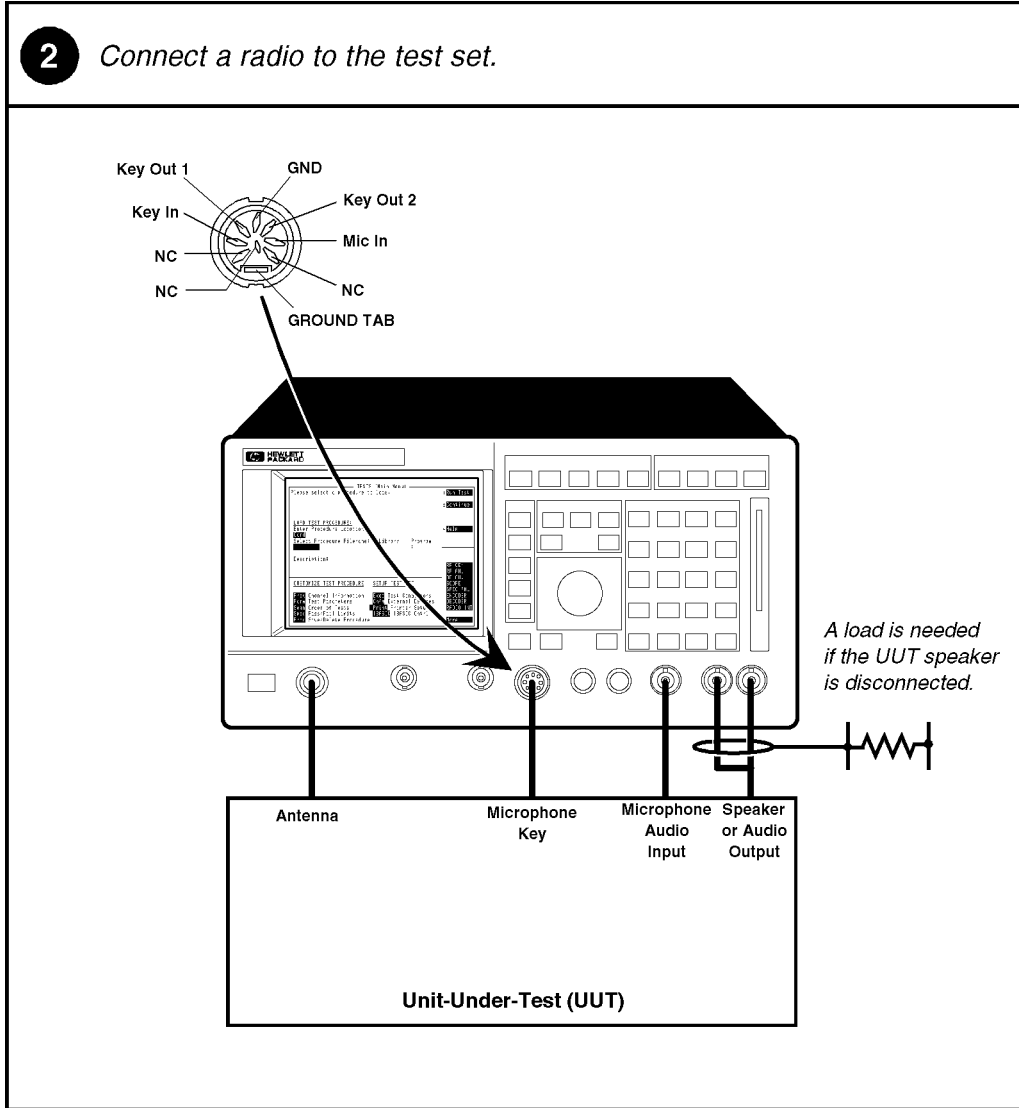

Selecting a Test Procedure











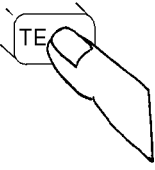

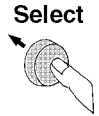
To load the software, you must first select the location to load from (in this case, it will be **Card**) and a procedure filename. Your card comes pre-programmed with at least one procedure. The actual software program does not get loaded into the test set's memory until k1 (**Run Test**) is selected. It will take approximately 2 minutes to load the software in an HP 8920A,D.

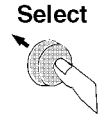
The software memory card can be removed after the program is loaded into the test set's memory. The program will remain in memory after a power-down/power-up cycle, unless it is manually deleted or a new program is loaded.

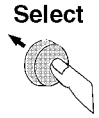
When tests begin to run, they are executed in the order in which they were entered into the Test Procedure.

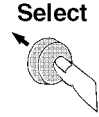
Pressing CANCEL will pause the current test (press k2 to continue the test.)

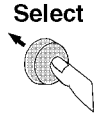
Selecting A Test Procedure

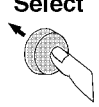
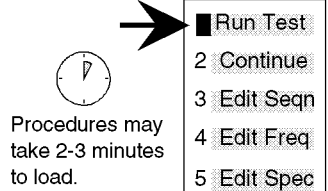
<p>1 Press TESTS to display the TESTS screen.</p>	<p>2 Position cursor at Location and select it.</p>
<p>If you are in IBASIC, press SHIFT, CANCEL before pressing TESTS.</p> 	<p>Position</p>  <p>Select</p>  <p>Procedure: Location</p> 
<p>3 Position cursor at Card and select it.</p>	<p>4 Position cursor at Procedure and select it.</p>
<p>Position</p>  <p>Select</p>  <p>Choices :</p> <ul style="list-style-type: none"> ■ Card ROM RAM Disk 	<p>Position</p>  <p>Select</p>  <p>Procedure: Location</p> 
<p>5 Position cursor at the desired Procedure and select it.</p>	<p>6 Position cursor at Run Test and select it.</p>
<p>Position</p>  <p>Select</p>  <p>Choices :</p> <ul style="list-style-type: none"> ■ XXXXXX YYYYYY ZZZZZZ 	<p>Position</p>  <p>Select</p>  <p>Procedures may take 2-3 minutes to load.</p>  <ul style="list-style-type: none"> ■ Run Test 2 Continue 3 Edit Seqn 4 Edit Freq 5 Edit Spec

PROCED1B

Customizing Testing

Because of the diversity of individual testing needs, the software has been designed so that changes may be easily made from the test set's front panel. You may store these changes on an SRAM card so that you may skip these steps in the future. See "Saving a Test Procedure Using the Procedure Manager," in chapter 3, on page 83.

You may customize your software at any time. Because your needs change, the software allows changes to its default settings when you need to make them and in any order that you choose. For example, tests may be inserted or deleted, and later after running the tests you can change the pass/fail limits or decide to test different channels.

Most testing customization is accomplished through the test set's Test Function screens. These Test Function screens are accessed from the main **TESTS** screen as shown in the following figure. All Test Functions are explained in this chapter by function.

NOTE:

Edit Cnfg and IBASIC will not be explained in this customizing section.

- Edit Cnfg is used when setting up printers and external disk drives which is explained in "Disks" on page 198 and "Printing" on page 212 in chapter 5.
- IBASIC is used when writing your own programs and is not explained in this manual. If you need to write your own IBASIC programs you may acquire the following manuals:
 - HP 8920A,D
 - *HP Instrument Basic User's Handbook* HP part number E2083-90000.
 - *HP 8920A Programming Manual* HP part number 08920-90220.
 - HP 8920B
 - *HP Instrument Basic User's Handbook Version 2.0* HP part number E2083-90005.
 - *HP 8920B Programming Manual* HP part number 08920-90222.

Beginning Software Customization

All software customization begins by accessing the **TESTS** screen first and then selecting the **Test Function** which will open the **Choices** menu. To access the **TESTS** screen, press TESTS on the front panel of the test set.

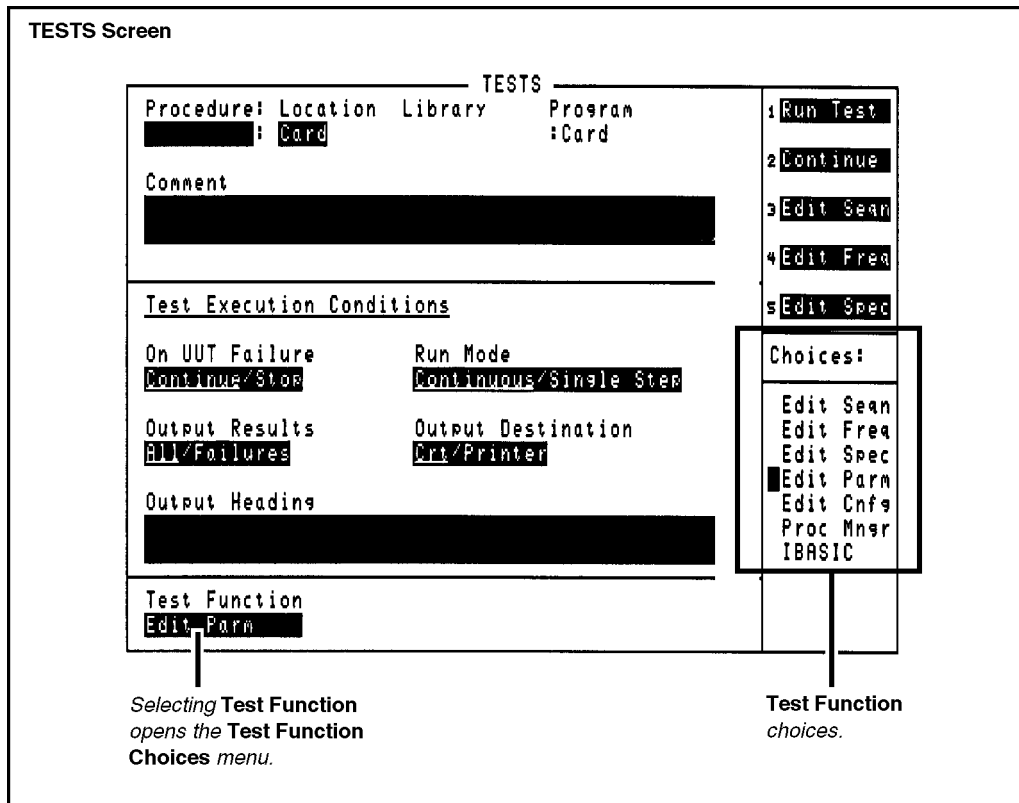

CUSTOM1B

Changing the Order of Tests (Edit Sequence)







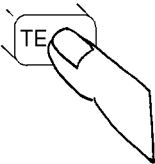

You may define a test sequence to include all, some, or just one of the tests available. When the first test is finished, the next will run. The test sequence will remain in the Test System's battery backed-up memory until another test sequence is loaded or set up. For information on saving a customized test sequence, see "[Changing the Order of Tests \(Edit Sequence\)](#)" on page 68.

Creation of a test sequence is accomplished by inserting or deleting tests from the list of tests that come with the HP 11807A software package. See [chapter 4, "Test, Parameter, and Pass/Fail Limit Descriptions"](#) on page 89, for test descriptions.

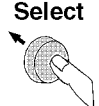
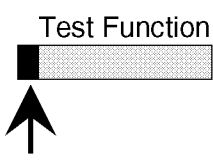
The **All Chans?** field allows the user to decide to run the test on all channels entered in the frequency table, or just the channels which are selected as **Prime** in the **Edit Freq** screen. This feature allows the user the flexibility to use channels that are selected as **Prime** in all the tests in the sequence, and those selected as non-prime in a subset of tests (those with a **Yes** response in **All Chans**). For more information, see "[Specifying Channel Information \(Edit Frequency\)](#)" on page 72.

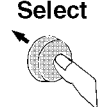
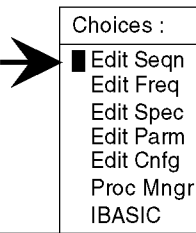

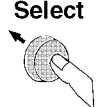
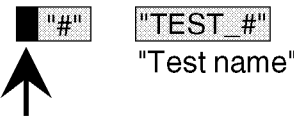

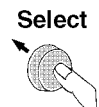
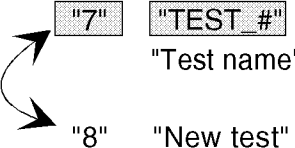
The following describes how to create a new test sequence and enter a response to **All Chans**.

How to Change a Sequence of Tests

<p>1 Press TESTS to display the TESTS screen.</p>	<p>2 Position cursor at Test Function and select it.</p>
<p>If you are in IBASIC, press SHIFT, CANCEL before pressing TESTS.</p> 	<p>Position</p>  <p>Select</p>  
<p>3 Position cursor at Edit Seqn and select it.</p>	<p>4 Position cursor at Step # field and select it.</p>
<p>Position</p>  <p>Select</p>  	<p>Position</p>  <p>Select</p>  <p><i>Example</i></p> 
<p>5 By rotating knob, highlight the Step # which precedes the insertion point of the new test that you are adding, then select it.</p>	
<p>Rotate</p>  <p>Select</p> 	<p><i>For example, select step 7 if you want to insert the new test as step 8.</i></p> 

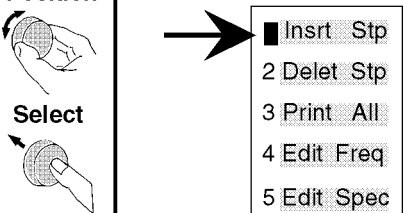
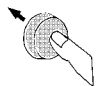
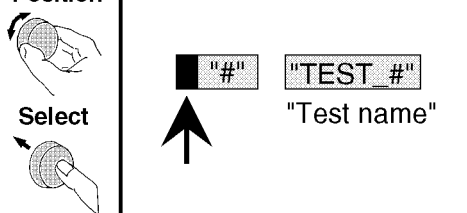
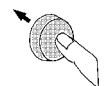
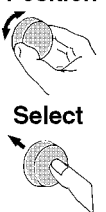
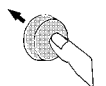
SEQ1B

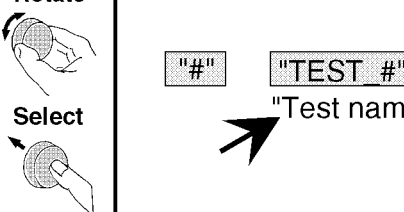
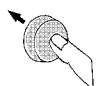
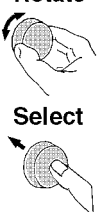
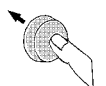
Continue on next page

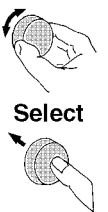
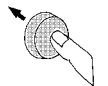
<p>6 Position cursor at Insrt Stp and select it.</p>	<p>7 Position cursor back at Step # field and select it.</p>
<p>Position</p>  <p>Select</p> 	<p>Position</p>  <p>Select</p> 
<p>8 Highlight Step # of the newly inserted test, then select it.</p>	<p>9 Position cursor at Test name field and select it.</p>
<p>Position</p>  <p>Select</p>  <p><i>This is the test that you selected at step 5.</i></p>   <p>"Test name"</p>	<p>Position</p>  <p>Select</p> 
<p>10 Rotate knob until desired Test Name appears, then select it</p>	<p>11 Position cursor at All Chans? field and select Yes or No.</p>
<p>Rotate</p>  <p>Select</p>    <p>"Test name"</p>	<p>Position</p>  <p>Select</p>  <p>Yes/No</p> <p><i>(Press the knob to change the selection.)</i></p>

5EQ2B

Continue on next page

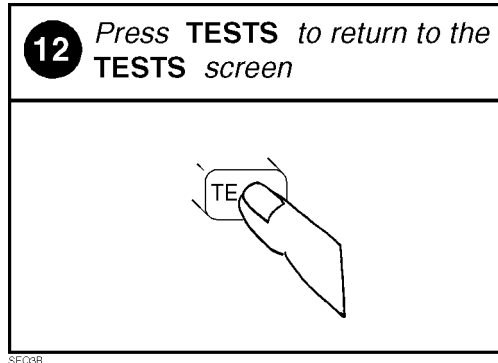

Specifying Channel Information (Edit Frequency)

For each channel that you wish to specify, you must enter the following information into the **Edit Frequency** screen:

- RX Freq (MHz)
 - Enter the receive frequency of your radio in (MHz).
- TX Freq (MHz)
 - Enter the transmit frequency of your radio in (MHz).

NOTE: Enter a **-1** in the RX or TX test frequency fields to have all subsequent frequencies ignored when testing is started.

- RX Chan Info
 - If you are testing receiver CTCSS or CDCSS (test parameter 8 is set=1), you must enter the receive squelch frequency or code. Otherwise, leave this field empty.
- TX Chan Info
 - If you are testing transmitter CTCSS or CDCSS (test parameter 23 is set=1), you must enter the transmit squelch frequency or code. Otherwise, leave this field empty.
- **Test?** (yes/no) specifies whether you want to test the UUT at this channel. If set to "No" then the UUT will not be tested at that channel, but you may retain the channel information in the table for later use. If set to "Yes" then the channel will be used as defined by settings of **Prime?** and **All Chans?** fields.
- **Prime?** (yes/no) specifies which channels are "prime". Select "Yes" if you want to test the UUT at this channel on all the tests in the procedure. Select **No** if you want to test the UUT at this channel on just a subset of tests, which are designated by selecting **Yes** in the **All Chans** field of the **Edit Seqn** screen. See **All Chans?** in "[Changing the Order of Tests \(Edit Sequence\)](#)" on page 68 for more information.

For information on saving the frequency table, see "[Saving a Test Procedure Using the Procedure Manager](#)" on page 83.

The **All Chans** field in the **Edit Seqn** screen interacts closely with the **Prime?** field on the **Edit Freq** screen. When the software runs, it begins by retrieving the first channel entered into the **Edit Freq** screen. It then checks the response in the **Test?** field to determine if the UUT should be tested at that channel at this time. If there is a **No** response in the **Test?** field, the software will go to the next channel in the table. If there is a **Yes** response in the **Test?** field, the software will check if the channel is **Prime**.

A **Yes** response in the **Prime?** field indicates to test the UUT at that channel on the entire sequence of tests in the procedure. A **No** response in the **Prime?** field indicates to test the UUT at that channel on a subset of tests in the procedure. The subset of tests is determined by a **Yes** response in the **All Chans?** field.

Therefore, tests with a **No** response in the **All Chans?** field will be run on *prime* channels only.

Below is an example of how the software would run if you had a procedure set up as follows:

Table 4

Chan #	Test?	Prime?
Chan 01	Yes	Yes
Chan 02	Yes	No
Chan 03	No	No

Table 5

Test Number	All Chan? Setting
Test 01	No
Test 02	Yes
Test 03	Yes
Test 04	No

The result would be:









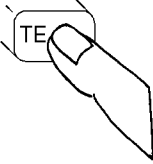

- Chan 01 is used in Test 01, Test 02, Test 03, and Test 04.
- Chan 02 is used in 02, and Test 03 only.
- Chan 03 is not used.

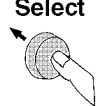
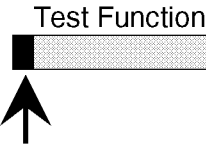
The following table shows how to properly configure these settings according to your testing needs.

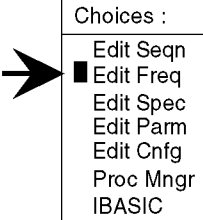
Table 6

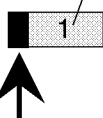
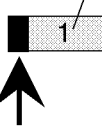

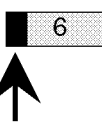
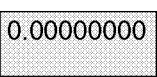
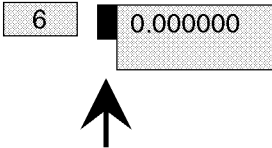

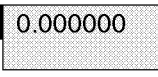

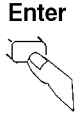

Testing Need	Necessary Field Settings		
	Test?	Prime?	All Chan?
Test channel on all tests in sequence	Yes	Yes	Don't Care
Test channel on a subset of tests in sequence	Yes	No	Yes on tests you want included in the testing subset
Do not test this channel now, but retain information for later use	No	Don't Care	Don't Care

How to Specify Channel Information

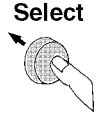

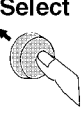
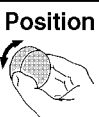
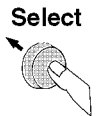

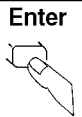





<p>1 Press TESTS to display the TESTS screen.</p> <p><i>IF you are in IBASIC, press SHIFT, CANCEL before pressing TESTS.</i></p> 	<p>2 Position cursor at Test Function and select it.</p> <p>Position</p>  <p>Select</p>  
<p>3 Position cursor at Edit Freq and select it.</p> <p>Position</p>  <p>Select</p>  	<p>4 Position cursor at Chan # field and select it.</p> <p>Position</p>  <p>Select</p>  <p><i>(Disregard this number.)</i></p> 
<p>5 Scroll to the desired Chan # and select it.</p> <p>Scroll</p>  <p>Select</p>  <p><i>(This Chan # is an example.)</i></p>  	<p>6 Position cursor and select RX Freq (MHz) field.</p> <p>Position</p>  <p>Select</p>  

FREQ1B

Continue on next page

<p>7 Use DATA keys to enter new RX Freq, then select it.</p> <p>Enter </p> <p>Select </p> <p>6 "New #" (Enter your desired RX Freq.)</p>	<p>8 Position cursor and select TX Freq (MHz) field.</p> <p>Position </p> <p>Select </p> <p>##### 0.000000 </p>
<p>9 Use DATA keys to enter new TX Freq, then select it.</p> <p>Enter </p> <p>Select </p> <p>##### "New #" (Enter your desired TX Freq.)</p>	<p>If you are testing receiver/transmitter CTCSS or CDCSS do steps 10 - 13 to enter the receive/transmitt squelch frequency or codes, otherwise continue instructions at step 14.</p>
<p>10 Position cursor and select RX Chan Info field.</p> <p>Position </p> <p>Select </p> <p>6 #.##### </p>	<p>11 Use DATA keys to enter new Sq Freq/Code, then select it.</p> <p>Enter </p> <p>Select </p> <p>6 #.##### "New #" (Enter your new info.)</p>

Continue on next page

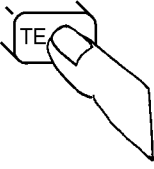
<p>12 Position cursor and select TX Chan Info field.</p>	<p>13 Use DATA keys to enter new Sq Freq/Code, then select it.</p>
<p>Position</p>  <p>Select</p>  <p>##### #.#####</p> 	<p>Enter</p>  <p>Select</p>  <p>##### #.##### ##### "New #"</p> <p>(Enter your New Info.)</p>
<p>14 Position cursor at Test? field and select Yes or No.</p>	<p>15 Position cursor at Prime? field and select Yes or No.</p>
<p>Position</p>  <p>Select</p>  <p>Yes/No</p>  <p>(Press knob to change the selection.)</p>	<p>Position</p>  <p>Select</p>  <p>Yes/No</p>  <p>(Press knob to change the selection.)</p>
<p>16 Press TESTS to return to the TESTS screen.</p> 	



FREQ3B

Changing Pass/Fail Limits (Edit Specifications)

Specifications are values that set pass/fail limits for tests. Default values are available in the test software. These default values may be changed to suit your particular requirements.



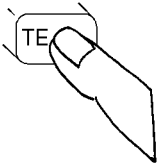
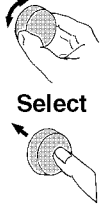
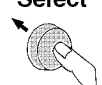
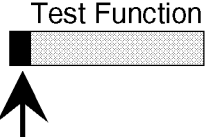

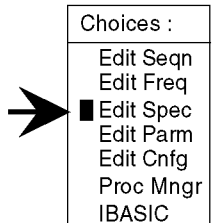
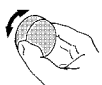
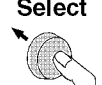



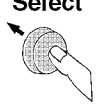

The following describes how to change the pass/fail (upper and lower) limits in the HP 8920A,D **Edit Specification** screen. See "[Pass/Fail Limit Descriptions \(specifications\)](#)," in [chapter 4, on page 144](#) for descriptions for each specification. For information on saving customized specifications, see "[Saving a Test Procedure Using the Procedure Manager](#)" on page 83.

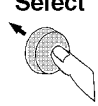
How to Change Pass/Fail Limits

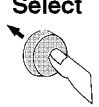
<p>1 Press TESTS to display the TESTS screen.</p>	<p>2 Position cursor at Test Function and select it.</p>
<p>IF you are in IBASIC, press SHIFT, CANCEL before pressing TESTS.</p> 	<p>Position</p>  <p>Select</p>  <p>Test Function</p> 
<p>3 Position cursor at Edit Spec and select it.</p>	<p>4 Position cursor at Spec # field and select it.</p>
<p>Position</p>  <p>Select</p>  <p>Choices :</p> <ul style="list-style-type: none"> Edit Seqn Edit Freq █ Edit Spec Edit Parm Edit Cnfg Proc Mngr IBASIC 	<p>Position</p>  <p>Select</p>  <p>(Disregard this number.)</p> 

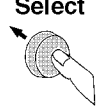

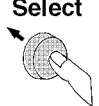

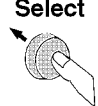
SPEC1B

Continue on next page

<p>5 Scroll to the desired Spec # and select it.</p>	<p>6 Position cursor at Lower limit field and select it.</p>
<p>Position  (This Spec # is an example.)</p> <p>Select </p> <p>6 FCC TX output p -1.000000 1.</p>	<p>Position  6 FCC TX output p</p> <p>Select </p> <p>-1.000000 1.</p>
<p>7 Use DATA keys to enter new value, then select it.</p>	<p>8 Position cursor at Upper Limit field and select it.</p>
<p>Position  6 FCC TX output p</p> <p>Select </p> <p>-0.500000 1.</p> <p>(Enter your desired value.)</p>	<p>Position  C TX output power adjustme</p> <p>Select </p> <p>.500000 1.000000 dB</p>
<p>9 Use DATA keys to enter new value, then select it.</p>	<p>10 Position cursor at Check field and select it.</p>
<p>Position  C TX output power adjustme</p> <p>Select </p> <p>.500000 0.500000 dB</p> <p>(Enter your desired value.)</p>	<p>Position </p> <p>Select </p> <p>Both</p>

SPEC2B

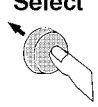
Continue on next page

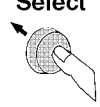
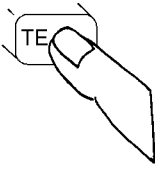
11 <i>Position cursor at Both and select it.</i>		12 <i>Press TESTS to return to the TESTS screen.</i>	
Position 		Position 	
Select 		Select 	









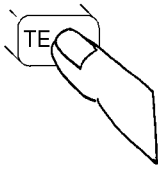

SPEC38

Changing the Test Environment and Conditions (Edit Parameters)

The software uses parameters to optimize the test environment and conditions for your testing situation. Many of the parameters are determined by examining your test needs. Other parameters are determined by performing measurements to calibrate items in your system. Examples of parameters include cable losses, rated system deviation, and the audio test tone frequency your system requires. The HP 11807A software comes with default settings for parameters. The defaults should be reviewed for your particular needs. See **"Test Parameter Descriptions," in chapter 4, on page 112** for descriptions and default values for each parameter. For information on saving customized parameters, see **"Saving a Test Procedure Using the Procedure Manager" on page 83**.









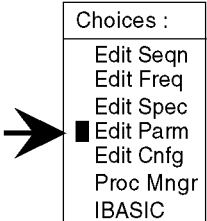

The following describes how you can change parameters through the Edit Parameter screen to optimize your testing conditions.

How to Change the Test Environment and Conditions

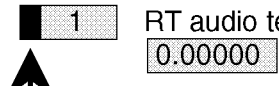
1 Press TESTS to display the TESTS screen.	2 Position cursor at Test Function and select it.				
<p><i>If you are in IBASIC, press SHIFT, CANCEL before pressing TESTS.</i></p> 	<table border="1"><tr><td data-bbox="857 1087 980 1207">Position </td><td data-bbox="980 1087 1346 1207">Test Function </td></tr><tr><td data-bbox="857 1207 980 1331">Select </td><td data-bbox="980 1207 1346 1331"></td></tr></table>	Position 	Test Function 	Select 	
Position 	Test Function 				
Select 					

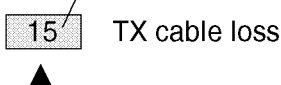
PARM1B

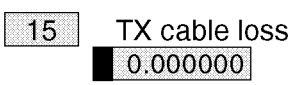
Continue on next page

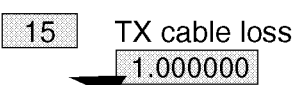
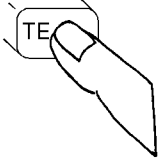
<p>3 Position cursor at Edit Parm and select it.</p>	<p>4 Position cursor at Parm # field and select it.</p>
<p>Position</p>  <p>Select</p>  	<p>Position</p>  <p>Select</p>  <p>(Entries on your display may be different.)</p> 
<p>5 Scroll to Parm # to be changed and select it</p>	<p>6 Position cursor at Value field and select it.</p>
<p>Scroll</p>  <p>Select</p>  <p>(This parameter number and description are examples.)</p> 	<p>Position</p>  <p>Select</p>  
<p>7 Use DATA keys to enter new value, and select it.</p>	<p>8 Press TESTS to return to the TESTS screen.</p>
<p>Enter</p>  <p>Select</p>   <p>(Enter your desired value.)</p>	

PARM2B







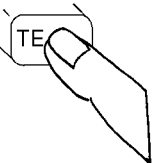

Saving a Test Procedure Using the Procedure Manager

A Test Procedure is a collection of pass/fail limits (specifications), the test environment and conditions (parameters), and a TEST sequence, saved in a file that customizes the test software to a specific application. You may save the file to a memory card or disk.

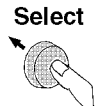
When you save a Procedure you will be saving parameters, specifications, and a test sequence, plus a library that contains the names of all parameters, specifications, and tests that are resident in the HP 11807A software. The library file comes from the HP 11807A software and cannot be modified. The library file will be automatically saved on the card or disk that is being used to store the new test procedure.

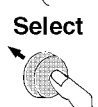
The following example shows how to save a new procedure to a memory card. For more information concerning procedures, [see "Procedures," in chapter 5, on page 225.](#)

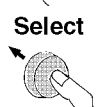
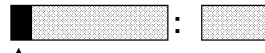
How to Save a Test Procedure

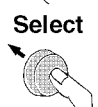
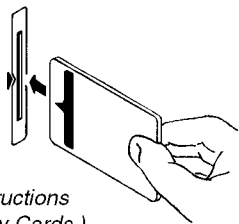
<p>1 Press TESTS to display the TESTS screen.</p> <p><i>If you are in IBASIC, press SHIFT, CANCEL before pressing TESTS.</i></p> 	<p>2 Position cursor at Test Function and select it.</p> <p>Position</p>  <p>Select</p>  <p>Test Function</p> 
<p>3 Position cursor at Proc Mngr and select it.</p> <p>Position</p>  <p>Select</p>  <p>Choices :</p> <ul style="list-style-type: none"> Edit Seqn Edit Freq Edit Spec Edit Parm Edit Cnfg ■ Proc Mngr IBASIC 	<p>4 Position cursor at Procedure field and select it.</p> <p>Position</p>  <p>Select</p>  <p>Procedure: Location</p> 
<p>5 Select characters to name the Procedure, then select Done.</p> <p>Position</p>  <p>Select</p>  <p>Choices :</p> <ul style="list-style-type: none"> Done Position Over/Ins Delete Del End Bk space ■ A B C 	<p>6 Insert an initialized SRAM memory card.</p>  <p><i>(For detailed memory card initialization instructions see chapter 5 -Memory Cards.)</i></p>

Continue on next page

7 Position cursor at **Location** and select it.

Procedure: Location

8 Position cursor at **Card** and select it.

Position

Choices :

- Card
- RAM
- Disk

Select

(You can also save procedures to an internal RAM disk or external disk drive. See Chapter 5-Disks.)

9 Position cursor at **Comment** and select it.

Position

Comment

Select

10 Select characters for the **Comment**, then select **Done**.

Position

Choices :

- Done
- Position
- Over/Ins
- Delete
- Del End
- Bk space
- A
- B
- C

Select

11 Position cursor at **Library** for new p.... , and select **Current**.

Position

Library for new procedur

Current / [NO LIB]

Select

(The underline indicates which option is selected. Pressing knob changes the selection.)











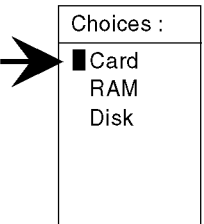

12 Position cursor at **Program** location for and select it.

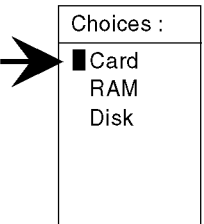
Program location for new procedu

Card

Continue on next page

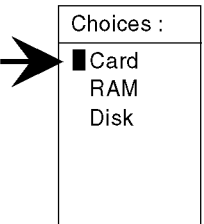
PROCMA2B

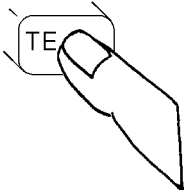
<p>13 Position cursor at Card and select it.</p>	<p>14 Position cursor at Action and select Make Procedure.</p>						
<table border="1"> <tr> <td data-bbox="279 558 399 793"> <p>Position</p>  <p>Select</p>  </td> <td data-bbox="399 558 760 793">  </td> </tr> </table>	<p>Position</p>  <p>Select</p> 		<table border="1"> <tr> <td data-bbox="795 558 915 793"> <p>Position</p>  <p>Select</p>  </td> <td data-bbox="915 558 1274 793"> <p>Action</p> <table border="1"> <tr> <td>Make Procedure</td> </tr> <tr> <td>Delete Procedure</td> </tr> </table> <p>(To make selection, position the cursor in front of Make Procedure, then press the knob.)</p> </td> </tr> </table>	<p>Position</p>  <p>Select</p> 	<p>Action</p> <table border="1"> <tr> <td>Make Procedure</td> </tr> <tr> <td>Delete Procedure</td> </tr> </table> <p>(To make selection, position the cursor in front of Make Procedure, then press the knob.)</p>	Make Procedure	Delete Procedure
<p>Position</p>  <p>Select</p> 							
<p>Position</p>  <p>Select</p> 	<p>Action</p> <table border="1"> <tr> <td>Make Procedure</td> </tr> <tr> <td>Delete Procedure</td> </tr> </table> <p>(To make selection, position the cursor in front of Make Procedure, then press the knob.)</p>	Make Procedure	Delete Procedure				
Make Procedure							
Delete Procedure							
<p>15 Press TESTS to return to the TESTS screen.</p>	<p>To run the saved procedure:</p> <ol style="list-style-type: none"> 1) Load the Procedure. 2) Insert the original HP 11807B memory card. 3) Press Run Test. <p><i>The original card contains the full program needed to run your procedure.</i></p>						
							

PROCMA3B

Changing Test Execution Conditions

Test Execution Conditions define how your testing program starts and where and when test output occurs. You may decide to:

- Start the program automatically when the Test System is powered on. (**Autostart**)
- Stop testing when a measurement fails or continue through all of the tests without stopping. (**On UUT Failure**)
- Display (or print) only measurements that fail, or display (or print) all measurements that pass or fail. (**Output Results**)
- Pause between each measurement, or run through the entire test sequence. (**Run Mode**)
- Display output on CRT only, or display on CRT and print hardcopy. (**Output Destination**)

NOTE:

If printing test results is desired, after selecting **Printer** additional steps are necessary to connect and configure the printer. See "**Printing,**" in chapter 5, on page 212.

- Enter a title for an output heading for the displayed or printed results. (**Output Heading**). Select the field with the knob and enter the output heading by selecting the appropriate letters and the select **Done**.

Test Execution Conditions is located on the **TESTS** screen. Press **TESTS** to display them. To change a default setting, position the cursor to the desired field. Pressing the knob ("selecting") will toggle the underlined selection.

Test Execution Conditions settings (except for **Autostart**) are not retained after a power-down/ power-up cycle, and will return to their default settings. They are not stored on the memory card when a test procedure is saved.

How to Change Test Execution Conditions

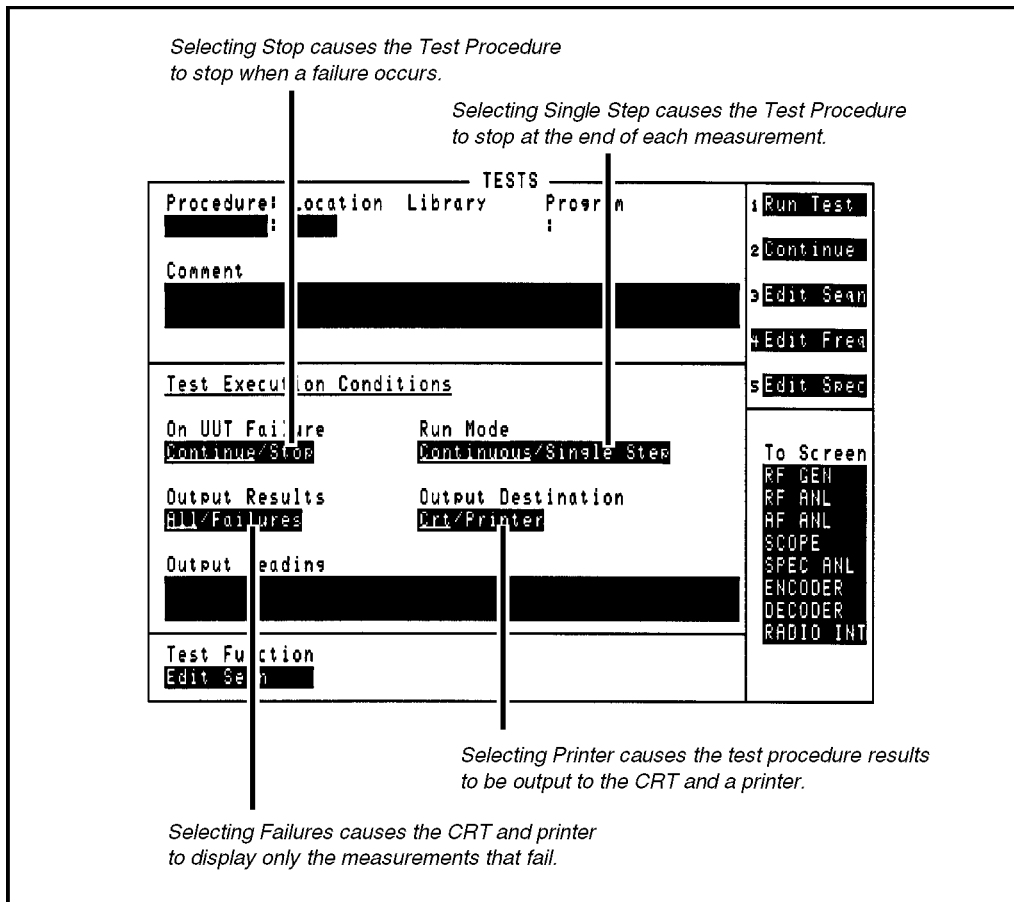

TESTEXB

Printing and Saving Test Results

Printing and saving test results are features of the HP 11807A software which require additional equipment and configuration. [See "Printing," in chapter 5, on page 212](#) for detailed descriptions and instructions for these features.

Test, Parameter, and Pass/Fail Limit Descriptions

Introduction

Tests are a series of measurements, and one or more tests make up a procedure (see [chapter 2, "Using the Software/HP 8920B or HP 8920A FW Above Rev. A.14.00"](#)). While you may change the tests that make up a procedure, you may not change the measurements the test will perform. Generally, the order in which the tests are run is not important.

This chapter describes each test and the associated test parameters, pass/fail limits, and external equipment that are required. When you first load a test procedure or create a new test sequence, refer to this section to understand what test parameters and pass/fail limits are required for each test.

Tests are derived from the following industry standards:

- EIA – Electronic Industry Association, FM test pass/fail limits,
 - EIA/TIA-603
 - EIA/TIA-204-D ([TEST_19. RX Variation of Sens with Freq](#))

NOTE:

Refer to [chapter 2](#) in this manual for details about customizing a Test Procedure for testing your FM radio.

TEST_01. TX and RX Stand-by Current Drain

This test measures the power-supply current required by the FM radio while it's in both the transmit and receive modes. While transmitting, current drain is measured without modulation, and while receiving, stand-by current drain is measured after the squelch control is set to maximum.

This test requires that the test set has the optional current-measuring circuit, Option 003, or that an external power supply is configured to the test set. If an external power supply is configured, this test reads current from the external supply.

NOTE:

The HP 11807A software does not zero the test set's current-measuring circuit. Zeroing this circuit should be done periodically.

The transmitter and receiver stand-by current drain is measured in Amps.

Pass/Fail Limits Used

Pass/Fail Limit 14, RX Stand-by Current Drain

Pass/Fail Limit 27, TX Current Drain

TEST_02. TX Frequency Error

This test measures the difference between the unmodulated carrier frequency and the assigned carrier frequency. The frequency error is measured in parts-per-million (ppm).

Pass/Fail Limits Used

Pass/Fail Limit 30, TX Frequency Error

TEST_03. TX Output Power

This test measures the power available at the output terminals of the transmitter when connected to a 50 Ω load.

Testing is performed at the nominal supply voltage and can also be performed with high and low supply voltages for extreme measurements if a programmable power supply is configured to the test set. Refer to [chapter 1, "Product Description," on page 15](#) for a list of programmable power supplies.

Pass/Fail Limits Used

- Pass/Fail Limit 33, TX Output Power
- Pass/Fail Limit 34, TX Output Power at High Supply ¹
- Pass/Fail Limit 35, TX Output Power at High Supply Low SW ¹
- Pass/Fail Limit 36, Output Power at Low Supply ¹
- Pass/Fail Limit 37, TX Output Power at Low Supply Low SW ¹
- Pass/Fail Limit 38, TX Output Power at Low Switch Setting ²

Test Parameters Used

- Parameter 3, RT High Supply Voltage ¹
- Parameter 4, RT Low Supply Voltage ¹
- Parameter 5, RT Nominal Supply Voltage
- Parameter 31, TX Output Power @Low Switch ²

1. These pass/fail limits and test parameters are used only when an external power supply is configured to the test set.
2. This specification and the test parameter is used only if the power supply has a low switch setting.

TEST_04. TX Modulation Limiting

This test measures the ability of the transmitter's circuits to prevent the transmitter from producing deviations in excess of a rated system deviation. During testing, the audio input is over driven at a constant level while the modulation rate is stepped from 300 Hz to 3 kHz (step size is determined by [Parameter 30, TX Modulation Limiting Sweep Step Freq](#)). The instantaneous peak+ and peak– frequency deviation is measured and reported, along with the steady-state frequency deviation measured at each step.

Modulation limiting is measured in kHz. *Audio connections from the radio to the test set are required for this test.*

If your radio has Continuous Digital-Controlled Squelch System (CDCSS), the added signal can cause this test to fail. In this case, disable the CDCSS circuitry.

Pass/Fail Limits Used

[Pass/Fail Limit 32, TX Modulation Limiting](#)

Test Parameters Used

[Parameter 2, RT Full Rated System Deviation](#)

[Parameter 30, TX Modulation Limiting Sweep Step Freq](#)

Testing Conditions Defined by the Software

- Audio input level is increased 20 dB above the level required to produce 60% of rated system deviation.
- The instantaneous peak+ and peak– frequency deviation is measured at a 1 kHz rate.
- The steady-state for peak+ and peak– deviation is measured with:
 - The start frequency set to 300 Hz.
 - The stop frequency set to 3 kHz.
- If test 29 is set to “0”, then the steady-state deviation is only measured at a 1 kHz rate.

TEST_05. TX Audio Frequency Response

This test compares the audio frequency response of your transmitter to a 6 dB/octave pre-emphasis curve from 0.5 kHz to 2.5 kHz. Variation from that pre-emphasis curve is measured separately for frequencies <0.5 kHz and >2.7 kHz. An additional roll-off is allowed from 2.3 kHz to 2.7 kHz, and from 2.7 kHz to 3 kHz in equipment operating in the 896 MHz to 940 MHz range. *Audio connections from the radio to the test set are required for this test.*

The test results indicate the flatness of the audio output as frequency is varied. Audio frequency response is measured in “dB error” from the 6 dB/octave pre-emphasis slope.

If your radio has Continuous Digital-Controlled Squelch System (CDCSS) or Continuous Tone-Controlled Squelch System (CTCSS), the added signal can cause this test to fail. In this case, disable the CDCSS circuitry.

Pass/Fail Limits Used

Pass/Fail Limit 20, TX Audio Response Delta From 6 dB/oct

Pass/Fail Limit 21, TX Audio Frequency Response Roll <0.5 kHz

Pass/Fail Limit 22, TX Audio Frequency Response Roll >2.3 kHz for 896-940M

Pass/Fail Limit 23, TX Audio Response Roll >2.5 kHz

Pass/Fail Limit 24, TX Audio Frequency Response Roll >2.7 kHz for 896-940M

Test Parameters Used

Parameter 2, RT Full Rated System Deviation

Parameters 21-23, TX Audio Freq Response Start, Step, and Stop Frequency

Testing Conditions Defined by the Software

- Audio frequency response is measured at 20% of the rated system deviation and the reference is taken at 1 kHz rate.
- The rms detector is used when the 20% reference is set.

TEST_06. TX Audio Distortion

This test measures the audio-frequency harmonic distortion, which is the change in harmonic content of the input signal as a result of passing through the audio and RF circuits of the transmitter. *Audio connections from the radio to the test set are required for this test.*

The 400 Hz High-Pass Filter is used by this test if Option 010 is installed in the test set.

Transmitter audio distortion is measured in percent.

If your radio has Continuous Digital-Controlled Squelch System (CDCSS), the added signal can cause this test to fail. In this case, disable the CDCSS circuitry.

If your radio has Continuous Tone-Controlled Squelch System (CTCSS) or Continuous Digital-Controlled Squelch System (CDCSS) available but is not controllable, an alternate filter may be selected, if available, to reduce the effect of the tone or code on the result. A 400 Hz HPF, C MESSAGE, or CCITT filter may be selected.

Pass/Fail Limits Used

Pass/Fail Limit 19, TX Audio Distortion

Test Parameters Used

Parameter 2, RT Full Rated System Deviation

Parameter 20, TX Audio Distn % Full Rated System Dev

Parameter 27, TX De-emphasis

Testing Conditions Defined by the Software

- Audio distortion is measured at 40% of the rated system deviation and at a 1 kHz rate.

TEST_07. TX Microphone Sensitivity

This test measures the level of the audio-input signal required to produce 60% of rated system deviation. The 400 Hz High-Pass Filter is used by this test if Option 010 is installed in the test set.

This test can be run in two different ways:

- The first method is the “iterative” test where **Parameter 29, TX Mic Sens Set and Measure** is set to “0”. In this case, microphone sensitivity is measured by varying the microphone voltage until 60% of rated system deviation is obtained. The required voltage is reported in the test results and compared to **Pass/Fail Limit 24, TX Audio Frequency Response Roll >2.7 kHz for 896-940M** to determine if the test passed or failed.
- The second (and faster) method is the “set and measure” test where test 28 is set to “1”. In this case, microphone sensitivity is measured by setting the microphone voltage half-way between the limits set by **Pass/Fail Limit 24, TX Audio Frequency Response Roll >2.7 kHz for 896-940M**. The measured system deviation is reported in the test results and compared to **Pass/Fail Limit 22, TX Audio Frequency Response Roll >2.3 kHz for 896-940M** to determine if the test passed or failed.

Pass/Fail Limits Used

Pass/Fail Limit 28, TX Deviation If Set and Measure Mic Sens
Pass/Fail Limit 31, TX Microphone Sensitivity

Test Parameters Used

Parameter 2, RT Full Rated System Deviation
Parameter 29, TX Mic Sens Set and Measure

TEST_08. TX FM Hum and Noise

This test measures the ratio of residual frequency modulation to the reference taken at 60% of rated system deviation. *Audio connections from the radio to the test set are required for this test.*

The 400 Hz High-Pass Filter is used if Option 010 is installed in the test set.

FM hum and noise is measured in dB, from the formula:

$$-20 \times \text{Log}(\text{Reference Deviation} \div \text{Present Deviation})$$

If your radio has Continuous Tone-Controlled Squelch System (CTCSS) or Continuous Digital-Controlled Squelch System (CDCSS) available but is not controllable, an alternate filter may be selected, if available, to reduce the effect of the tone or code on the result. A 400 Hz HPF, C MESSAGE, or CCITT filter may be selected.

Pass/Fail Limits Used

[Pass/Fail Limit 29, TX FM Hum and Noise](#)

Test Parameters Used

[Parameter 2, RT Full Rated System Deviation](#)
[Parameter 27, TX De-emphasis](#)

TEST_09. TX Residual AM Hum and Noise

This test measures the AM hum and noise level which is the amount of amplitude modulation present on the carrier at the output of the receiver in the absence of any audio-input signal.

The 400 Hz High-Pass Filter is used if Option 010 is installed in the test set.

Residual AM hum and noise is measured in percent when the transmitter is keyed.

Pass/Fail Limits Used

[Pass/Fail Limit 39, TX Residual AM Hum and Noise](#)

TEST_10. TX CTCSS/CDCSS Deviation, Freq/Code

This test measures the peak+ deviation, and frequency error of the transmitted CTCSS (Continuous Tone-Controlled Squelch System) and the CDCSS (Continuous Digital-Controlled Squelch System).

Pass/Fail Limits Used

Pass/Fail Limit 25, TX CT/CDCSS Deviation
Pass/Fail Limit 26, TX CTCSS Frequency Error

Test Parameters Used

Parameter 24, TX CD/CTCSS Available

TEST_11. RX Hum and Noise

This test measures the receiver's hum and noise ratio (a ratio of the output signal power to the residual output power in the absence of modulation) in decibels. Hum and noise is measured at unsquelched and squelched settings.

Audio connections from the radio to the test set are required for this test.

Pass/Fail Limits Used

[Pass/Fail Limit 8, RX CT/CDCSS FM Hum and Noise](#)
[Pass/Fail Limit 11, RX Hum and Noise Squelched](#)
[Pass/Fail Limit 12, RX Hum and Noise Unsquelched](#)

Test Parameters Used

[Parameter 2, RT Full Rated System Deviation](#)
[Parameter 11, RX Maximum Audio Power](#)
[Parameter 14, RX Squelch Control](#)
[Parameter 16, RX Standard RF Input Level](#)
[Parameter 17, RX Tolerance for Setting Volume](#)

Testing Conditions Defined by the Software

- The receiver's unsquelched FM hum and noise is measured at 60% of rated system deviation ([Parameter 2, RT Full Rated System Deviation](#)) at a 1 kHz rate.
- If the radio has a squelch control, the hum and noise at the squelched position is also measured.

TEST_12. RX Audio Distortion

This test measures audio distortion from the receiver when a standard RF signal (test **Parameter 15, RX Squelch Preset Only**) is applied to the radio. Distortion is the voltage ratio, expressed as a percentage, of:

- the rms value of the sum of the second and higher harmonic components,
- to the rms value of the complete signal at the output.

Audio connections from the radio to the test set are required for this test.

If your radio has Continuous Tone-Controlled Squelch System (CTCSS) or Continuous Digital-Controlled Squelch System (CDCSS) available but is not controllable, an alternate filter may be selected, if available, to reduce the effect of the tone or code on the result. A 400 Hz HPF, C MESSAGE, or CCITT filter may be selected.

Pass/Fail Limits Used

Pass/Fail Limit 1, RX Audio Distn 17 dB Below Rated Power
Pass/Fail Limit 2, RX Audio Distortion

Test Parameters Used

Parameter 11, RX Maximum Audio Power
Parameter 16, RX Standard RF Input Level
Parameter 17, RX Tolerance for Setting Volume

Testing Conditions Defined by the Software

- Receiver distortion is measured at two volume settings and at a 1 kHz rate.

TEST_13. RX Audio Frequency Response

This test compares the audio frequency response of your transmitter to a 6 dB/octave pre-emphasis curve from 0.5 kHz to 2.5 kHz. Variation from that pre-emphasis curve is measured separately from frequencies <0.5 kHz and >2.5 kHz. *Audio connections from the radio to the test set are required for this test.*

Receiver audio-frequency response is measured in “dB error” from a 6 dB/octave curve.

Pass/Fail Limits Used

Pass/Fail Limit 3, RX Audio Freq Resp Delta from 6 dB/Oct
Pass/Fail Limit 4, RX Audio Frequency Response Roll <0.5 kHz
Pass/Fail Limit 5, TX Audio Frequency Response Roll >2.5 kHz

Test Parameters Used

Parameter 2, RT Full Rated System Deviation
Parameter 6, RX Audio Freq Response Step Frequency
Parameter 11, RX Maximum Audio Power
Parameter 16, RX Standard RF Input Level
Parameter 17, RX Tolerance for Setting Volume

Testing conditions Fixed by the Software

- Receiver volume is set to 50% of maximum when the deviation is set to 60% of rated system deviation.
- Deviation is the reduced to 20% of rated system deviation and a reference level is read at a 1 kHz rate.
- The audio frequency is then swept from 300 Hz to 3 kHz (in steps determined by test 6) and the audio frequency response is measured.

TEST_14. RX Usable Sensitivity

This test measures the RF signal level required to produce the standard SINAD ratio (determined by **Parameter 18, RX Usable Sens Set and Measure** the “usable sensitivity SINAD level”) at the output of the receiver. *Audio connections from the radio to the test set are required for this test.*

This test can be run in two different ways:

- The first method is the “iterative” test where **Parameter 17, RX Tolerance for Setting Volume** is set to “0”. In this case, usable sensitivity is measured at 60% of rated system deviation at a 1 kHz rate. The volume is checked to verify that it has not decreased by more than 3 dB. The measured usable sensitivity is reported in the test results and compared to **Pass/Fail Limit 13, RX Squelch Blocking** to determine if the test passed or failed.
- The second (and faster) method is the “set and measure” test where **Parameter 17, RX Tolerance for Setting Volume** is set to “1”. In this case, usable sensitivity is measured by setting the RF level to the upper limit of **Pass/Fail Limit 13, RX Squelch Blocking** and SINAD is measured to determine if the test passed or failed.

Pass/Fail Limits Used

Pass/Fail Limit 17, RX Usable Sensitivity

Test Parameters Used

Parameter 1, RT External Pad and Cable Loss
Parameter 11, RX Maximum Audio Power
Parameter 16, RX Standard RF Input Level
Parameter 17, RX Tolerance for Setting Volume
Parameter 18, RX Usable Sens Set and Measure
Parameter 19, RX Usable Sensitivity SINAD Level

TEST_15. RX Audio Squelch Sensitivity

This test measures the minimum signal level required from a standard input signal, which, when modulated at standard test modulation, will open the receiver squelch.

Both “threshold” and “tight squelch” sensitivity are measured in this test. Threshold sensitivity is measured with the squelch adjusted for ≥ 40 dB noise quieting. Tight squelch sensitivity is measured with the squelch adjusted to the tight (maximum) test position.

Audio connections from the radio to the test set are required for this test. Threshold and tight squelch sensitivity are both measured in μV .

Pass/Fail Limits Used

[Pass/Fail Limit 15, RX Threshold Squelch Sensitivity](#)
[Pass/Fail Limit 16, RX Tight Squelch Sensitivity](#)

Test Parameters Used

[Parameter 1, RT External Pad and Cable Loss](#)
[Parameter 11, RX Maximum Audio Power](#)
[Parameter 15, RX Squelch Preset Only](#)
[Parameter 16, RX Standard RF Input Level](#)
[Parameter 17, RX Tolerance for Setting Volume](#)

Testing Conditions Defined by the Software

- If [Parameter 14, RX Squelch Control](#) is set to indicate that the radio only has a preset squelch, the section of the test measuring “tight squelch” sensitivity is skipped.
- During testing, volume is adjusted to be at 60% rated system deviation at a 1 kHz rate.

TEST_16. RX Squelch Blocking

This test measures the tendency of the receiver's squelch circuit to close in the presence of modulation on the RF signal. *Audio connections from the radio to the test set are required for this test.*

Squelch blocking is measured in dB.

Pass/Fail Limits Used

Pass/Fail Limit 13, RX Squelch Blocking
Pass/Fail Limit 16, RX Tight Squelch Sensitivity

Test Parameters Used

Parameter 2, RT Full Rated System Deviation
Parameter 11, RX Maximum Audio Power
Parameter 13, RX Squelch Blocking Step Frequency
Parameter 16, RX Standard RF Input Level
Parameter 17, RX Tolerance for Setting Volume

Testing Conditions Defined by the Software

- RF level is set to 12 dB above tight squelch and volume is set to 10% of maximum rated volume (**Parameter 10, RX CT/CDCSS Deviation**).
- Audio frequency is then swept from 300 Hz to 3 kHz with deviation at the rated system deviation (**Parameter 2, RT Full Rated System Deviation**).
- The receiver's output is monitored for blocking of the audio signal at each step of the sweep (**Parameter 12, RX Set Radio Volume**, has a minimum step size of 0.07 kHz).

TEST_17. RX CTCSS/CDCSS Opening

This test measures the level of the RF signal (with the squelch tone) required to open the squelch circuit of the radio with an applied CTCSS (Continuous Tone-Controlled Squelch System) tone or CDCSS (Continuous Digital-Controlled Squelch System) code word. The SINAD at the measured opening level is also measured.

Audio connections from the radio to the test set are required for this test.

Pass/Fail Limits Used

[Pass/Fail Limit 7, RX CDCSS SINAD at Opening](#)
[Pass/Fail Limit 9, RX CT/CDCSS Opening Level](#)
[Pass/Fail Limit 10, RX CTCSS SINAD at Opening](#)

Test Parameters Used

[Parameter 1, RT External Pad and Cable Loss](#)
[Parameter 8, RX CT/CDCSS Available](#)
[Parameter 11, RX Maximum Audio Power](#)
[Parameter 16, RX Standard RF Input Level](#)
[Parameter 17, RX Tolerance for Setting Volume](#)

TEST_18. RX Audio Sensitivity

This test measures the receiver's audio output after setting the signal level to 40% of rated system deviation. *Audio connections from the radio to the test set are required for this test.*

Pass/Fail Limits Used

Pass/Fail Limit 6, RX Audio Output @40% of Full Rated Dev

Test Parameters Used

Parameter 2, RT Full Rated System Deviation

Parameter 7, RX Audio Load Impedance

Parameter 11, RX Maximum Audio Power

Parameter 16, RX Standard RF Input Level

TEST_19. RX Variation of Sens with Freq

This test sets the RF level to 6 dB above the usable sensitivity and then varies the RF frequency until usable sensitivity is re-obtained. *Audio connections from the radio to the test set are required for this test.*

The variation of sensitivity with frequency is measured in kHz.

Pass/Fail Limits Used

Pass/Fail Limit 17, RX Usable Sensitivity

Pass/Fail Limit 18, RX Variation of Sens Delta Frequency

Test Parameters Used

Parameter 11, RX Maximum Audio Power

Parameter 16, RX Standard RF Input Level

Parameter 17, RX Tolerance for Setting Volume

Parameter 19, RX Usable Sensitivity SINAD Level

TEST_20. RX Quick Test

This test contains a subset of the complete test list for receivers. It is designed to do a quick evaluation of the receiver using the following tests:

- **TEST_18. RX Audio Sensitivity**
- **TEST_12. RX Audio Distortion**
- **TEST_14. RX Usable Sensitivity**
- **TEST_11. RX Hum and Noise**
- **TEST_15. RX Audio Squelch Sensitivity** (if CTCSS/CDCSS is not available)
- **TEST_17. RX CTCSS/CDCSS Opening** (if CTCSS/CDCSS is available and controllable)
- **TEST_16. RX Squelch Blocking**
- **TEST_13. RX Audio Frequency Response**

Pass/Fail Limits Used

Refer to each test shown above for the pass/fail limits that are used.

Test Parameters Used

Refer to each test shown above for the test parameters that are used.

TEST_21. TX Quick Test

This test contains a subset of the complete test list for transmitters. It is designed to enable you to do a quick evaluation of the transmitter using the following tests:

- **TEST_02. TX Frequency Error**
- **TEST_03. TX Output Power**
- **TEST_07. TX Microphone Sensitivity**
- **TEST_04. TX Modulation Limiting**
- **TEST_08. TX FM Hum and Noise**
- **TEST_06. TX Audio Distortion**
- **TEST_05. TX Audio Frequency Response**
- **TEST_09. TX Residual AM Hum and Noise**

Pass/Fail Limits Used

Refer to each test shown above for the pass/fail limits that are used.

Test Parameters Used

Refer to each test shown above for the test parameters that are used.

Test Parameter Descriptions

Test parameters are used to define the conditions under which a test will run. You may edit the test parameters to change the default values to meet your specific testing needs and conditions. Test parameters may be used in one or more tests.

For information on editing test parameters, see ["Customizing Testing," in chapter 2, on page 32.](#)

Test parameters remain in battery-backed-up memory until you select a procedure to run. If you wish to prevent them from being lost when a new procedure is selected, you will have to save them in a procedure. see ["Saving a Test Procedure," in chapter 2, on page 50.](#)

To print the list of test parameters, see ["To print TESTS screens;," in chapter 5, on page 219.](#)

There are several different types of test parameters:

- Receiver/Transmitter Test Parameters (RT)
- Receiver Test Parameters (RX)
- Transmitter Test Parameters (TX)
- Extra Test Parameters (XX)

NOTE:

Refer to [chapter 2](#) in this manual for details about selecting test parameters for your FM radio.

Parameter 1, RT External Pad and Cable Loss

This test parameter allows you to set the amount of loss for any external cables or pads (attenuators) that may be connected to the test set.

Besides being used in the tests shown below, pad and cable loss is compensated for in power measurements and in signal generator level settings by subroutines in the software whenever:

- a reading in Watts is converted to dBm.
- finding the radio's squelch sensitivity.
- setting the test set's RF level to the desired level in dBm.

For Example:

If a 30 dB attenuator is connected in line with the radio's antenna, enter **30** in the value column. The value is entered in dB.

It's Used in the Following Tests:

- [TEST_14. RX Usable Sensitivity](#)
- [TEST_15. RX Audio Squelch Sensitivity](#)
- [TEST_17. RX CTCSS/CDCSS Opening](#)

Parameter 2, RT Full Rated System Deviation

This test parameter sets the full-rated (maximum) deviation used by the test set during receiver and transmitter tests.

Besides being used in the tests shown below, full-rated system deviation is set on the test set by subroutines in the software whenever:

- the test set is set to the standard receiver mode.
- transmitter deviation is set on the test set.

For Example:

If your industry standard specifies the full-rated system deviation to be 5 kHz, enter 5 in the value column. The value is entered in kHz.

It's Used in the Following Tests:

- TEST_04. TX Modulation Limiting**
- TEST_05. TX Audio Frequency Response**
- TEST_06. TX Audio Distortion**
- TEST_07. TX Microphone Sensitivity**
- TEST_08. TX FM Hum and Noise**
- TEST_11. RX Hum and Noise**
- TEST_13. RX Audio Frequency Response**
- TEST_16. RX Squelch Blocking**
- TEST_18. RX Audio Sensitivity**

Parameter 3, RT High Supply Voltage

This test parameter sets the high-power setting on the radio's external power supply (if one is used) when testing extreme voltages during the output power test.

For Example:

If your industry standard specifies the high-supply voltage required for extreme measurements as +20% of the normal (nominal) supply voltage, which is +13.2V for the radio's power supply, you would enter **15.8** in the value column. The value is entered in Vdc.

It's Used in the Following Tests:

TEST_03. TX Output Power
TEST_21. TX Quick Test

Parameter 4, RT Low Supply Voltage

This test parameter sets the low-power setting on the radio's external power supply (if one is used) when testing extreme voltages during the output power test.

For Example:

If your industry standard specifies the low-supply voltage required for extreme measurements as -20% of the normal (nominal) supply voltage, which is +13.2V for the radio's power supply, enter **10.6** in the value column. The value is entered in Vdc.

It's Used in the Following Tests:

TEST_03. TX Output Power
TEST_21. TX Quick Test

Parameter 5, RT Nominal Supply Voltage

This test parameter sets the nominal (that is, normal) power-supply voltage required by the radio. Besides being used in the tests shown below, this test parameter is used whenever the test set is initialized prior to starting a Test Procedure.

For Example:

If your radio specification lists the nominal supply voltage to be +13.2V, enter **13.2** in the value column. The value is entered in Vdc.

It's Used in the Following Tests:

TEST_03. TX Output Power
TEST_21. TX Quick Test

Parameter 6, RX Audio Freq Response Step Frequency

This test parameter sets the step size used to vary the modulation frequency when testing the receiver's audio-frequency response.

For Example:

If your industry standard requires that receiver audio-frequency response is to be tested from 300 Hz to 3 kHz and you want vary the modulation frequency in 500 Hz steps, enter 0.5 in the value column. The value is entered in kHz.

It's Used in the Following Tests:

[TEST_13. RX Audio Frequency Response](#)

[TEST_20. RX Quick Test](#)

Parameter 7, RX Audio Load Impedance

This test parameter refers to the output impedance of the radio's receiver circuitry. The value of this test parameter affects the calculation of audio sensitivity as it is measured and reported in the test results.

Besides being used in the tests shown below, audio-load impedance is used by subroutines in the software whenever:

- radio volume or squelch control is adjusted during testing.
- finding the radio's squelch sensitivity.

For Example:

If the output impedance of your receiver is 8 ohms, enter **8** in the value column. The value is entered in ohms.

It's Used in the Following Tests:

- [TEST_18. RX Audio Sensitivity](#)
- [TEST_20. RX Quick Test](#)

Parameter 8, RX CT/CDCSS Available

This test parameter lets the test set know whether the receiver's audio-squelch circuitry uses Continuous Tone-Controlled Squelch System (CTCSS) or Continuous Digital-Controlled Squelch System (CDCSS).

Besides being used in the test shown below, this test parameter affects all receiver tests by prompting the test operator to disable the RX tone squelch before continuing with testing.

For Example:

Enter a **0** in the value column to indicate that the radio does not use CTCSS or CDCSS.

Enter a **1** in the value column to indicate that the radio has CTCSS or CDCSS.

It's Used in the Following Test:

[TEST_17. RX CTCSS/CDCSS Opening](#)

Parameter 9, RX CT/CDCSS Control

This test parameter allows the receiver's audio-squelch circuitry for Continuous Tone-Controlled Squelch System (CTCSS) or Continuous Digital-Controlled Squelch System (CDCSS) to be controlled by the test operator.

This test parameter affects all receiver tests in that if the radio uses CTCSS or CDCSS squelch and you indicate that no control is available, then the software does not prompt the test operator to disable the RX tone squelch during testing but continues testing by enabling the test set's tone or code which un-squelches the receiver.

For Example:

If you want to prompt the test operator to disable the tone squelch during testing, enter **1** in the value column, otherwise, enter **0** in the value column.

It's Used in the Following Tests:

All receiver tests when CTCSS or CDCSS is available (as indicated by [TEST_08. TX FM Hum and Noise](#)).

Parameter 10, RX CT/CDCSS Deviation

This test parameter sets the amount of deviation on the signal modulating the CTCSS tone which is input to the receiver's antenna during the CTCSS opening test. With CDCSS, the code word produces the necessary deviation.

For Example:

If you want the CTCSS tone to deviate 750 Hz during the CTCSS opening test, enter **0.75** in the value column. The value is entered in kHz.

It's Used in the Following Test:

[TEST_17. RX CTCSS/CDCSS Opening](#)

Parameter 11, RX Maximum Audio Power

This test parameter sets the rated audio-output power for the receiver so the software can determine the full-scale volume level of the meter screen displayed on the test set during testing.

Besides being used in the tests shown below, the maximum audio power test parameter is used by subroutines in the software whenever:

- radio volume or squelch is adjusted during testing.
- finding the radio's squelch sensitivity.

For Example:

If the audio-output power for your receiver is rated at 12 Watts, you would enter **12** in the value column. The value is entered in Watts. The meter screen will show a full-scale volume level of 18 Watts since the level is scaled up by 50%.

It's Used in the Following Tests:

- [TEST_11. RX Hum and Noise](#)
- [TEST_12. RX Audio Distortion](#)
- [TEST_13. RX Audio Frequency Response](#)
- [TEST_14. RX Usable Sensitivity](#)
- [TEST_15. RX Audio Squelch Sensitivity](#)
- [TEST_16. RX Squelch Blocking](#)
- [TEST_17. RX CTCSS/CDCSS Opening](#)
- [TEST_18. RX Audio Sensitivity](#)
- [TEST_19. RX Variation of Sens with Freq](#)
- [TEST_20. RX Quick Test](#)

Parameter 12, RX Set Radio Volume

This test parameter prompts the test operator to adjust volume on the radio during testing or allows the software to take the volume setting as it is.

You can decrease testing time by setting this test parameter to **0=no** if you are willing to let the tests run at the same volume (audio) level. The industry standard often requires adjusting volume to specific volume levels.

For example:

If you want the test operator to adjust the radio's volume during testing, enter **1** in the value column. If you want the test set to take the volume setting as it is, enter **0** in the value column.

It's Used in the Following Tests:

All receiver tests where adjusting volume is required.

Parameter 13, RX Squelch Blocking Step Frequency

This test parameter sets the step-size to vary the audio frequency while testing receiver squelch blocking.

For Example:

If you want the audio frequency to be varied in 500 Hz steps during the receiver squelch-blocking test, enter **0.5** in the value column. The value is entered in kHz.

It's Used in the Following Test:

[TEST_16. RX Squelch Blocking](#)

Parameter 14, RX Squelch Control

Depending upon how you set this test parameter, the test operator is either prompted to adjust the squelch control on the radio during testing, or the software is allowed to take the squelch setting where it is at.

Besides being used in the test shown below, a subroutine in the software uses this test parameter whenever the test operator is prompted to adjust the radio squelch control.

For example:

If you want the test operator to be able to adjust radio squelch during testing, enter **1** in the value column. If you want the test set to take the squelch setting as it is, enter **0** in the value column.

It's Used in the Following Test:

[TEST_11. RX Hum and Noise](#)

Parameter 15, RX Squelch Preset Only

This test parameter allows you to use the preset squelch setting on the radio, in which case, the test operator is not prompted to adjust the squelch setting. For radios without an adjustable squelch knob, you'll want to set this test parameter to 1.

For Example:

If you want to use the receiver's preset setting for squelch, enter 1 in the value column. If you want to allow the test operator to adjust squelch during testing, enter 0 in the value column.

It's Used in the Following Test:

[TEST_15. RX Audio Squelch Sensitivity](#)

Parameter 16, RX Standard RF Input Level

This test parameter sets the standard RF input level (which is the test set's RF generator's output level) that is used in receiver testing.

For Example:

The EIA standard specifies the standard input-signal level as 60 dB above the reference (usable) sensitivity. The reference sensitivity is specified for each RF band.

If your radio was specified for 1 μ V sensitivity, then the input level should be 60 dB above that or 1000 μ V. In this case, enter **1000** in the value column. The value is entered in μ V.

It's Used in the Following Tests:

- TEST_11. RX Hum and Noise
- TEST_12. RX Audio Distortion
- TEST_13. RX Audio Frequency Response
- TEST_14. RX Usable Sensitivity
- TEST_15. RX Audio Squelch Sensitivity
- TEST_16. RX Squelch Blocking
- TEST_17. RX CTCSS/CDCSS Opening
- TEST_18. RX Audio Sensitivity
- TEST_19. RX Variation of Sens with Freq
- TEST_20. RX Quick Test

Parameter 17, RX Tolerance for Setting Volume

This test parameter sets a tolerance window for the maximum percentage of error allowed on the meter screen. The meter screen is displayed on the test set during testing for manually setting the radio's volume. The tolerance for setting volume should be as accurate as the radio's volume control will allow.

For Example:

If maximum audio power is 10 watts (set up in [Parameter 11, RX Maximum Audio Power](#)) the meter screen on the test set will display a full-scale reading of 15 Watts since the software scales the meter screen by 50%. The tolerance window displayed on the meter screen will be a percentage of the 10 Watts. In this example, test [Parameter 17, RX Tolerance for Setting Volume](#) set to "10%" would create a tolerance window of 1 Watt, "5%" would create a tolerance window of 0.5 Watts, and so forth.

The value should be based on the highest accuracy the radio volume control allows. Enter a number equal to the accuracy you want and then run a test to see if the radio's volume control allows you to make the setting. If you cannot adjust the volume within the tolerance window, enter a larger number. The value is entered in % error.

It's Used in the Following Tests:

- [TEST_11. RX Hum and Noise](#)
- [TEST_12. RX Audio Distortion](#)
- [TEST_13. RX Audio Frequency Response](#)
- [TEST_14. RX Usable Sensitivity](#)
- [TEST_15. RX Audio Squelch Sensitivity](#)
- [TEST_16. RX Squelch Blocking](#)
- [TEST_17. RX CTCSS/CDCSS Opening](#)
- [TEST_19. RX Variation of Sens with Freq](#)
- [TEST_20. RX Quick Test](#)

Parameter 18, RX Usable Sens Set and Measure

This test parameter allows you to choose how the test for usable sensitivity will be performed.

For Example:

Setting this test parameter to “1” causes the software to perform a pass/fail measurement of the receiver’s usable sensitivity. In this case, the test set RF generator’s output level is set to the upper limit of [Pass/Fail Limit 13, RX Squelch Blocking](#) for “RX usable sensitivity” and the measured SINAD level at the radio’s output is checked against test [Parameter 18, RX Usable Sens Set and Measure](#) for “RX usable sensitivity SINAD level”. If the SINAD level is within the specified limits the test passes and the specified usable sensitivity from [Pass/Fail Limit 13, RX Squelch Blocking](#) is displayed in the “**Measured value**” column.

Setting this test parameter to “0” causes the software to perform a faster, iterative measurement of usable sensitivity. In this case, the test set’s RF generator’s output level is set to the “RX Standard RF Input Level” (determined by the value in test [Parameter 15, RX Squelch Preset Only](#)). The RF generator’s output level is varied until the SINAD level measured at the radio’s output. The SINAD level measured is displayed in the “**Measured value**” column as the usable sensitivity SINAD level.

It’s Used in the Following Tests:

- [TEST_14. RX Usable Sensitivity](#)
- [TEST_20. RX Quick Test](#)

Parameter 19, RX Usable Sensitivity SINAD Level

This test parameter sets the test set RF generator's output level to the standard signal-to-noise ratio (SINAD) which is used in receiver sensitivity testing.

For Example:

If your industry standard specifies the standard SINAD ratio as 12 dB, enter **12** in the value column. The value is entered in dB.

It's Used in the Following Tests:

- [TEST_14. RX Usable Sensitivity](#)
- [TEST_19. RX Variation of Sens with Freq](#)
- [TEST_20. RX Quick Test](#)

Parameter 20, TX Audio Distn % Full Rated System Dev

This parameter specifies the maximum percent of full rated frequency deviation to use when testing audio distortion.

For Example:

If your industry standard specifies that Audio Distortion is measured at 60% of the maximum rated frequency deviation, enter **60** in the value column. The value is entered in percent.

It's Used in the Following Tests:

[TEST_06. TX Audio Distortion](#)

Parameters 21-23, TX Audio Freq Response Start, Step, and Stop Frequency

The start frequency test parameter sets the lowest modulation frequency used for testing the transmitter's audio frequency response.

The step frequency test parameter sets the step size used to vary the modulation frequency for testing the transmitter's audio frequency response.

The stop frequency test parameter sets the highest modulation frequency used for testing the transmitter's audio frequency response.

For Example:

If your industry standard determines that the modulation frequency used for testing the transmitter's audio frequency response should start at 300 Hz and stop at 3 kHz in 500 Hz steps, enter:

- 0.3 in the value column for test parameter 20.
- 0.5 in the value column for test parameter 21.
- 3 in the value column for test parameter 22.

The values are entered in kHz.

It's Used in the Following Tests:

TEST_05. TX Audio Frequency Response

TEST_21. TX Quick Test

Parameter 24, TX CD/CTCSS Available

This test parameter lets the test set know that the radio transmits a carrier modulated with a CTCSS tone code or CDCSS code word.

Besides being used in the test shown below, this test parameter affects all transmitter tests by prompting the test operator to disable the TX tone squelch before continuing with testing.

For Example:

If you want the transmitted CTCSS tone code tested for deviation and frequency accuracy, enter **1** in the value column, otherwise, enter **0** in the value column.

It's Used in the Following Tests:

All transmitter tests when CTCSS or CDCSS is available (when this test parameter is set to **1**).

Parameter 25, TX CD/CTCSS Control

This test parameter allows the transmitted CTCSS tone code or CDCSS code word to be controlled by the test operator.

This test parameter affects all transmitter tests in that if the radio uses CTCSS or CDCSS squelch and you indicate that no control is available, then the software does not prompt the test operator to disable the TX tone squelch during testing but continues testing whether the tone is on or off.

For Example:

If you want to prompt the test operator to disable the tone squelch during testing, enter **1** in the value column, otherwise, enter **0** in the value column.

It's Used in the Following Tests:

All transmitter tests when CTCSS or CDCSS is available (as indicated by [Parameter 24, TX CD/CTCSS Available](#)).

Parameter 26, TX CD/CTCSS Filter 1 Opt

This test parameter allows the CD/CTCSS filter (test set Option 010, 400 Hz High-Pass Filter) to be used by the test set *if one is installed*. If the CD/CTCSS filter is installed, “**400 Hz HPF**” appears in the AF Analyzer’s **Filter 1** field.

For Example:

If you want the installed CD/CTCSS filter to be used during receiver and transmitter testing, enter **1** in the value column, otherwise, enter **0** in the value column.

It’s Used in the Following Tests:

All tests when the CD/CTCSS filter is installed in the test set.

Parameter 27, TX De-emphasis

De-emphasis refers to the network at the input of the test set's AF Analyzer which is designed to restore the received, pre-emphasized FM signal. If this test parameter is turned on, a 750 μ sec de-emphasis filter is activated.

For Example:

If your industry standard requires the "standard test receiver" to use a 750 μ sec de-emphasis filter, enter **1** in the value column, otherwise, enter **0** to have de-emphasis off.

It's Used in the Following Tests:

TEST_06. TX Audio Distortion
TEST_08. TX FM Hum and Noise
TEST_21. TX Quick Test

Parameter 28, TX Dekey Between TX Tests

This test parameter forces the test operator to de-key the radio between each transmitter (TX) test or allows the radio to transmit continuously.

For Example:

If you want the Test Procedure sequence to proceed as quickly as possible and are not concerned that the radio transmits continuously between tests or if your radio has a transmitter timeout feature, enter **0** in the value column, otherwise, enter **1** in the value column.

It's Used in the Following Tests:

All transmitter tests if this test parameter is turned on (that is, set to **1**).

Parameter 29, TX Mic Sens Set and Measure

This test parameter allows you to choose how the test for microphone sensitivity will be performed.

For Example:

Setting this test parameter to “0” causes the software to perform a pass/fail measurement of the microphone’s sensitivity. In this case, the test set’s AF generator’s output level is set half-way between the lower and upper limits of [Pass/Fail Limit 24, TX Audio Frequency Response Roll >2.7 kHz for 896-940M](#) for “TX microphone sensitivity” and the measured deviation is checked against the half-way limits of [Pass/Fail Limit 21, TX Audio Frequency Response Roll <0.5 kHz](#) for “TX deviation if set and measure mic sens” to see if the test passes or fails. The measured microphone sensitivity in mVrms is displayed in the “**Measured value**” column.

Setting this test parameter to “1” causes the software to perform a faster, iterative measurement of microphone sensitivity. In this case, the test set AF generator’s output level is set to the half-way value of [Pass/Fail Limit 24, TX Audio Frequency Response Roll >2.7 kHz for 896-940M](#) “TX microphone sensitivity” and the deviation measured at the microphone input. The measured results in kHz are displayed in the “**Measured value**” column.

It’s Used in the Following Test:

[TEST_07. TX Microphone Sensitivity](#)

Parameter 30, TX Modulation Limiting Sweep Step Freq

This test parameter sets the step-size used to vary the modulation frequency for testing transmitter modulation limiting.

For Example:

If your industry standard determines that the modulation frequency in the modulation limiting test should be varied from 300 Hz to 3000 Hz and you want to measure only one step, enter **2.7** in the value column. The value is entered in kHz.

It's Used in the Following Test:

[TEST_04. TX Modulation Limiting](#)

Parameter 31, TX Output Power @Low Switch

This test parameter allows you to test for transmitter output power with the power supply voltage set to its low-switch setting.

For Example:

If your radio has a high/low-switch setting and you want to test the transmitter for output power at the low switch setting, you would enter **1** in the value column, otherwise, enter **0** in the value column.

It's Used in the Following Tests:

[TEST_03. TX Output Power](#)

[TEST_21. TX Quick Test](#)

Parameter 32, TX User/System Key UUT

This test parameter allows you to determine if the test operator (user) keys the transmitter or if the test set (system) keys the transmitter during testing. Having the test set key the transmitter requires connections from the radio to the test set's MIC/ACC connector (refer to [chapter 2, "Using the Software/HP 8920B or HP 8920A FW Above Rev. A.14.00," on page 23](#)).

For Example:

If you want the test set to automatically key the transmitter, enter **1** in the value column, otherwise, enter **0** in the value column.

It's Used in the Following Tests:

All transmitter tests if this test parameter is turned on (that is, set to **1**).

Parameter 33, XX Secure Frequency Info

This test parameter allows you to secure the radio's channels .

This test parameter provides security for the radio by preventing the channel's frequency from being seen on the test set's display and from being printed in the test results. Instead, the receive frequency is shown as "**RX=FXXX MHz**" and the transmit frequency is shown as "**TX=FXXX MHz**" where "**FXXX**" is the secured frequency.

For Example:

If you want to prevent the radio channel's receive and transmit frequencies from being viewed or printed with the test results, enter **1** in the value column, otherwise, enter **0** in the value column.

It's Used in the Following Tests:

All tests if this test parameter is turned on (that is, set to **1**).

Pass/Fail Limit Descriptions (specifications)

Pass/Fail Limits define the values a measurement's result is compared against to determine if the UUT meets its specified standards.

For information on editing Pass/Fail Limits, see ["Customizing Testing," in chapter 2, on page 32.](#)

The list of pass/fail limits is arranged alphabetically. The first few capital letters in the title of each pass/fail limit indicate what the pass/fail limit refers to.

Pass/Fail Limits remain in battery-backed-up memory until you select a procedure to run. If you wish to prevent them from being lost when a new procedure is selected you will have to save them in a procedure. See ["Saving a Test Procedure," in chapter 2, on page 50.](#) To print the list of Pass/Fail Limits, see ["To print TESTS screens;," in chapter 5, on page 219.](#)

There are two types of pass/fail limits:

- Receiver Test Pass/Fail Limits (RX)
- Transmitter Test Pass/Fail Limits (TX)

NOTE:

Refer to [chapter 2](#) in this manual for details about selecting pass/fail limits for your FM radio.

Pass/Fail Limit 1, RX Audio Distn 17 dB Below Rated Power

This sets the pass/fail limits for testing a receiver's audio distortion when the radio's volume is set 17 dB below the rated output power.

Pass/Fail limits are determined from an applicable radio specification or industry standard, such as:

- Radio specification: Audio Distortion
- Industry standard: EIA/TIA-603, Section 2.1.12, *Audio Distortion*.

For Example:

If your industry standard defines the maximum harmonic distortion as 5% at 17 dB below the rated output power and you want to test the radio's upper limits only, enter **0** in the lower-limit column and **5** in the upper-limit column. Limits are entered in %.

It's Used in the Following Tests:

- [TEST_12. RX Audio Distortion](#)
- [TEST_20. RX Quick Test](#)

Pass/Fail Limit 2, RX Audio Distortion

This defines pass/fail limit values for testing a receiver's audio distortion when the radio's volume is set to the standard input-signal level.

Pass/Fail limits are determined from an applicable radio specification or industry standard, such as:

- Radio specification: Audio Distortion
- Industry standard: EIA/TIA-603, Section 2.1.12, *Audio Distortion*.

For Example:

If your industry standard defines the maximum harmonic distortion as 10% at the rated output power and you want to test the radio's upper limits only, enter **0** in the lower-limit column and **10** in the upper-limit column. Limits are entered in %.

It's Used in the Following Tests:

- [TEST_12. RX Audio Distortion](#)
- [TEST_20. RX Quick Test](#)

Pass/Fail Limit 3, RX Audio Freq Resp Delta from 6 dB/Oct

This defines pass/fail limits for testing a receiver's audio-frequency response, with squelch set to minimum and volume set to 50% of rated audio-output power.

Pass/Fail limits are determined from an applicable radio specification or industry standard, such as:

- Radio specification: Audio Response
- Industry standard: EIA/TIA-603, Section 2.1.10, *Audio Frequency Response*.

For Example:

If your radio specification defines receiver audio response to be within +1 and -3 dB of a 6 dB/octave de-emphasis curve and you want to test both limits on the radio, enter -3 in the lower-limit column and 1 in the upper-limit column. Limits are entered in dB.

It's Used in the Following Tests:

- [TEST_13. RX Audio Frequency Response](#)
- [TEST_20. RX Quick Test](#)

Pass/Fail Limit 4, RX Audio Frequency Response Roll <0.5 kHz

This sets the pass/fail limits for testing a receiver's audio-frequency-response roll off for measurements less than 0.5 kHz.

Pass/Fail limits are determined from an application radio specification or industry standard, such as:

- Radio standard: Audio Response
- Industry standard: EIA/TIA-603, Section 2.1.10, *Audio Frequency Response*

For Example:

If your radio specification defines audio response roll off for frequencies less than 500 Hz to be a maximum of 6 dB/octave and you want to test the radio's upper limits, enter **0** in the lower-limit column and **6** in the upper-limit column. Limits are entered in dB.

It's Used in the Following Tests:

- [TEST_13. RX Audio Frequency Response](#)
- [TEST_20. RX Quick Test](#)

Pass/Fail Limit 5, TX Audio Frequency Response Roll >2.5 kHz

This sets the pass/fail limits for testing a transmitter's audio-frequency-response roll off for measurements greater than 2.5 kHz.

Pass/Fail limits are determined from an application radio specification or industry standard, such as:

- Radio standard: Audio Response
- Industry standard: EIA/TIA-603, Section 2.1.10, *Audio Frequency Response*.

For Example:

If your radio specification defines audio response roll off for frequencies greater than 2.5 kHz to be a maximum of 12 dB/octave and you want to test the radio's upper limits, enter 0 in the lower-limit column and 12 in the upper-limit column. Limits are entered in dB.

It's Used in the Following Tests:

- [TEST_13. RX Audio Frequency Response](#)
- [TEST_20. RX Quick Test](#)

Pass/Fail Limit 6, RX Audio Output @40% of Full Rated Dev

This sets the pass/fail limits for testing a receiver's audio sensitivity at 40% of full-rated deviation, with squelch set to minimum and volume set to maximum.

Pass/Fail limits are determined from an applicable radio specification or industry standard, such as:

- Radio specification: Audio Sensitivity
- Industry standard: EIA/TIA-603, Section 2.2.7, *Audio Distortion*.

For Example:

If your radio specification defines audio sensitivity to be not more than 40% of the rated system deviation and the audio output power needed to meet this specification should not be less than 5 Watts, enter 5 in the lower-limit column and 0 in the upper-limit column. Limits are entered in Watts.

It's Used in the Following Tests:

- [TEST_18. RX Audio Sensitivity](#)
- [TEST_20. RX Quick Test](#)

Pass/Fail Limit 7, RX CDCSS SINAD at Opening

“CDCSS SINAD at opening” refers to the SINAD measured at the opening level of the squelch tone.

This is used with [Pass/Fail Limit 9, RX CT/CDCSS Opening Level](#) to set the pass/fail limits for testing a receiver’s CDCSS opening.

Pass/Fail limits are determined from an applicable radio specification or industry standard, such as:

- Radio specification: Threshold Squelch Sensitivity
- Industry standard: EIA/TIA-603, Section 2.4.1, *Squelch Opening SINAD*.

For Example:

If your industry standard defines the tone-squelch opening SINAD as less than 10 dB and you want to test the radio’s upper limits only, enter **0** in the lower-limit column and **10** in the upper-limit column. Limits are entered in dB.

It’s Used in the Following Test:

[TEST_17. RX CTCSS/CDCSS Opening](#)

Pass/Fail Limit 8, RX CT/CDCSS FM Hum and Noise

This sets the pass/fail limits for receiver hum-and-noise testing with CT/CDCSS present and the receiver un-squelched.

Pass/Fail limits are determined from an applicable radio specification or industry standard, such as:

- Radio specification: Hum and Noise
- Industry standard: EIA/TIA-603, Section 2.1.11, Hum and Noise Ratio

For Example:

If your radio standard defines hum and noise, un-squelched, as 30 dB minimum and you want to test the radio's lower limits only, you would enter **30** in the lower-limit column and **0** in the upper-limit column. Limits are entered in dB.

It's Used in the Following Test:

TEST_11. RX Hum and Noise

Pass/Fail Limit 9, RX CT/CDCSS Opening Level

The Continuous Tone-Controlled Squelch System (CTCSS) and Continuous Digital-Controlled Squelch System (CDCSS) opening level is the level of the RF signal applied to the receiver's input (with the squelch tone on for CTCSS, or the code word input for CDCSS) that causes the radio to de-squelch.

This is used with [Pass/Fail Limit 7, RX CDCSS SINAD at Opening](#) to set the pass/fail limits for testing receiver CTCSS and CDCSS opening.

Pass/Fail limits are determined from an applicable radio specification or industry standard, such as:

- Radio specification: Threshold Squelch Sensitivity
- Industry standard: EIA/TIA-603, Section 2.4.1, *Squelch Opening SINAD*

For Example:

If your radio specification defines the Threshold Sensitivity as 0.5 μV and you want to test the radio's upper limits, you would enter 0 in the lower-limit column and 0.5 in the upper-limit column. Limits are entered in μV .

It's Used in the Following Test:

[TEST_17. RX CTCSS/CDCSS Opening](#)

Pass/Fail Limit 10, RX CTCSS SINAD at Opening

“CTCSS SINAD at opening” refers to the SINAD measured at the opening level of the squelch tone.

This is used with [Pass/Fail Limit 9, RX CT/CDCSS Opening Level](#) to set the pass/fail limits for testing a receiver’s CTCSS opening.

Pass/Fail limits are determined from an applicable radio specification or industry standard, such as:

- Radio specification: Threshold Squelch Sensitivity
- Industry standard: EIA/TIA-603, Section 2.4.1, *Squelch Opening SINAD*

For Example:

If your industry standard defines the tone-squelch opening SINAD as less than 8 dB and you want to test the radio’s upper limits only, enter **0** in the lower-limit column and **8** in the upper-limit column. Limits are entered in dB.

It’s Used in the Following Test:

[TEST_17. RX CTCSS/CDCSS Opening](#)

Pass/Fail Limit 11, RX Hum and Noise Squelched

This sets the pass/fail limits for receiver hum-and-noise testing, with squelch set to maximum.

Pass/Fail limits are determined from an applicable radio specification or industry standard, such as:

- Radio specification: Hum and Noise
- Industry standard: EIA/TIA-603, Section 2.1.11, *Hum and Noise Ratio*.

For Example:

If your radio standard defines hum and noise, squelched, as 57 dB minimum and you want to test the radio's lower limits only, you would enter **57** in the lower-limit column and **0** in the upper-limit column. Limits are entered in dB.

It's Used in the Following Test:

[TEST_11. RX Hum and Noise](#)

Pass/Fail Limit 12, RX Hum and Noise Unsilenced

This sets the pass/fail limits for receiver hum-and-noise testing with squelch set to minimum.

Pass/Fail limits are determined from an applicable radio specification or industry standard, such as:

- Radio specification: Hum and Noise
- Industry standard: EIA/TIA-603, Section 2.1.11, *Hum and Noise Ratio*

For Example:

If your radio standard defines hum and noise, unsilenced, as 37 dB minimum and you want to test the radio's lower limits only, you would enter **37** in the lower-limit column and **0** in the upper-limit column. Limits are entered in dB.

It's Used in the Following Test:

TEST_11. RX Hum and Noise

Pass/Fail Limit 13, RX Squelch Blocking

This is used with **Pass/Fail Limit 16, RX Tight Squelch Sensitivity** to set the pass/fail limits for testing a receiver's squelch blocking. The limits you set determine how much the receiver's output is allowed to drop as a continuous signal level is applied and the modulation frequency is varied from 300 Hz to 3 kHz.

Pass/Fail limits are determined from an applicable industry standard, such as:

- Industry standard: EIA/TIA-603, Section 2.1.14, *Squelch Blocking*

For Example:

If your industry standard states that the receiver's output should not drop more than 10 dB and you want to test the radio's upper limit only, enter 0 in the lower-limit column and 10 in the upper-limit column. Limits are entered in dB.

It's Used in the Following Test:

TEST_16. RX Squelch Blocking

Pass/Fail Limit 14, RX Stand-by Current Drain

This sets the pass/fail limits for testing a receiver's stand-by current drain (with squelch set to maximum).

Pass/Fail limits are determined from an applicable radio specification, such as:

- Radio specification: Maximum Battery Drain

For Example:

If your radio specification defines the maximum battery drain, while the radio is receiving, as 0.5 amps and you want to test the radio's upper limits only, enter 0 in the lower-limit column and 0.5 in the upper-limit column. Limits are entered in Amps.

It's Used in the Following Test:

TEST_01. TX and RX Stand-by Current Drain

Pass/Fail Limit 15, RX Threshold Squelch Sensitivity

This sets the pass/fail limits for testing audio-squelch sensitivity, with squelch and volume adjusted for the “threshold squelch” setting.

Pass/Fail limits are determined from an applicable industry standard, such as:

- Industry standard: EIA/TIA-603, Section 2.1.13, *Audio Squelch Sensitivity*

For Example:

From the EIA standard, if your radio operates in the 400 MHz frequency range, threshold squelch sensitivity for the radio should be 0.5 μV . In this case, enter 0 in the lower-limit column and 5 in the upper-limit column. Limits are entered in μV .

It's Used in the Following Tests:

- [TEST_15. RX Audio Squelch Sensitivity](#)
- [TEST_20. RX Quick Test](#)

Pass/Fail Limit 16, RX Tight Squelch Sensitivity

This sets the pass/fail limits for testing a receiver's audio-squelch sensitivity (in [TEST_15. RX Audio Squelch Sensitivity](#) and [TEST_20. RX Quick Test](#)), with squelch set to maximum and volume adjusted for the “threshold squelch” setting, and for testing squelch blocking (in [TEST_16. RX Squelch Blocking](#)).

Pass/Fail limits are determined from an applicable industry standard, such as:

- Industry standard: EIA/TIA-603, Section 2.1.13, *Audio Squelch Sensitivity*,
- and Section 2.1.14, *Squelch Blocking*

For Example:

If your industry standard specifies that the RF signal required for tight audio-squelch sensitivity shall be no more than 20 dB greater than the measured reference sensitivity value, and the radio's specification for usable sensitivity is 1 μV , you would calculate the upper limit for tight-squelch sensitivity to be:

$$20 \log \left(\frac{V_2}{V_1} \right) = 20$$

$$V_2 = V_1 (10)^{\frac{20}{20}}$$

$$V_2 = (1 \mu\text{V})(10)^1 = 10 \mu\text{V}$$

Therefore, enter **0** in the lower-limit column and **10** in the upper-limit column. Limits are entered in μV .

It's Used in the Following Tests:

[TEST_15. RX Audio Squelch Sensitivity](#)
[TEST_16. RX Squelch Blocking](#)
[TEST_20. RX Quick Test](#)

Pass/Fail Limit 17, RX Usable Sensitivity

This sets the pass/fail limits for testing usable sensitivity (in [TEST_14. RX Usable Sensitivity](#) and [TEST_20. RX Quick Test](#)) and for testing the variation of sensitivity with signal frequency changes (in [TEST_19. RX Variation of Sens with Freq](#)).

Pass/Fail limits are determined from an applicable radio specification or industry standard, such as:

- Radio specification: Sensitivity
- Industry standard: EIA/TIA-603, Section 2.1.4 *Reference (Usable) Sensitivity*,
- and EIA/TIA-204-D, Section 8.0, *Variation of Sensitivity with Signal Frequency*

For Example:

If your radio specification defined sensitivity to be 1 μV and you want to test the radio's upper limits, you would enter **0** in the lower-limit column and **1** in the upper-limit column. Limits are entered in μV .

It's Used in the Following Tests:

[TEST_14. RX Usable Sensitivity](#)
[TEST_19. RX Variation of Sens with Freq](#)
[TEST_20. RX Quick Test](#)

Pass/Fail Limit 18, RX Variation of Sens Delta Frequency

This sets the pass/fail limits for testing the variation of sensitivity with signal frequency, which is the change of input signal level required to maintain the standard signal-to-noise ratio (the usable sensitivity SINAD level) as a function of the signal frequency.

Pass/Fail limits are determined from an applicable industry standard, such as:

- Industry standard: EIA/TIA-204-D, Section 8.0, *Variation of Sensitivity with Signal Frequency*

For Example:

If your specified receiver frequency stability should not be greater than 1.5 kHz to maintain the standard SINAD level, enter **1.5** in the lower-limit column and **0** in the upper-limit column. Limits are entered in kHz.

It's Used in the Following Test:

[TEST_19. RX Variation of Sens with Freq](#)

Pass/Fail Limit 19, TX Audio Distortion

This sets the pass/fail limits for testing a transmitter's audio distortion.

Pass/Fail limits are determined from an applicable radio specification or industry standard, such as:

- Radio specification: Audio Distortion
- Industry standard: EIA/TIA-603, Section 2.2.7, *Audio Distortion*

For Example:

If your industry standard defines audio-frequency harmonic distortion to be not more than 10% and you want to test the radio's upper limits, enter 0 in the lower-limit column and 10 in the upper-limit column. Limits are entered in %.

It's Used in the Following Tests:

- [TEST_06. TX Audio Distortion](#)
- [TEST_21. TX Quick Test](#)

Pass/Fail Limit 20, TX Audio Response Delta From 6 dB/oct

This sets the pass/fail limits for testing a transmitter's audio-frequency-response variation from a true 6 dB/octave pre-emphasis slope.

Pass/Fail limits are determined from an applicable radio specification or industry standard, such as:

- Radio standard: Audio Response
- Industry standard: EIA/TIA-603, Section 2.2.6, *Audio Frequency Response*

For Example:

If your radio specification defines audio response to be within +1 and –3 dB of 6 dB/octave pre-emphasis characteristic and you want to test both limits on the radio, enter –3 in the lower-limit column and 1 in the upper-limit column. Limits are entered in dB.

It's Used in the Following Tests:

- [TEST_05. TX Audio Frequency Response](#)
- [TEST_21. TX Quick Test](#)

Pass/Fail Limit 21, TX Audio Frequency Response Roll <0.5 kHz

This sets the pass/fail limits for testing a transmitter's audio-frequency-response roll off for measurements less than 0.5 kHz.

Pass/Fail limits are determined from an application radio specification or industry standard, such as:

- Radio standard: Audio Response
- Industry standard: EIA/TIA-603, Section 2.2.6 *Audio Frequency Response*

For Example:

If your radio specification defines audio response roll off for frequencies less than 500 Hz to be a maximum of 6 dB/octave and you want to test the radio's upper limits, enter **0** in the lower-limit column and **6** in the upper-limit column. Limits are entered in dB.

It's Used in the Following Tests:

- [TEST_05. TX Audio Frequency Response](#)
- [TEST_21. TX Quick Test](#)

Pass/Fail Limit 22, TX Audio Frequency Response Roll >2.3 kHz for 896-940M

This sets the pass/fail limits for testing a transmitter's audio-frequency-response roll off for measurements greater than 2.3 kHz but less than 2.7 kHz for radio's in the frequency range of 896-940 MHz.

Pass/Fail limits are determined from an application radio specification or industry standard, such as:

- Radio standard: Audio Response
- Industry standard: EIA/TIA-603, Section 2.2.6, *Audio Frequency Response*

For Example:

If your radio specification defines audio response roll off for frequencies greater than 2.3 kHz but less than 2.7 kHz to be a maximum of 6 dB/octave and you want to test the radio's upper limits, enter **0** in the lower-limit column and **6** in the upper-limit column. Limits are entered in dB.

It's Used in the Following Tests:

[TEST_05. TX Audio Frequency Response](#)

[TEST_21. TX Quick Test](#)

Pass/Fail Limit 23, TX Audio Response Roll >2.5 kHz

This sets the pass/fail limits for testing a transmitter's audio-frequency-response roll off for measurements greater than 2.5 kHz.

Pass/Fail limits are determined from an applicable radio specification or industry standard, such as:

- Radio standard: Audio Response
- Industry standard: EIA/TIA-603, Section 2.2.6, *Audio Frequency Response*

For Example:

If your radio specification defines audio response roll off for frequencies greater than 2.5 kHz to be at a maximum of 6 dB/per octave and you want to test the radio's upper limits, enter **0** in the lower-limit column and **6** in the upper-limit column. Limits are entered in dB.

It's Used in the Following Tests:

- [TEST_05. TX Audio Frequency Response](#)
- [TEST_21. TX Quick Test](#)

Pass/Fail Limit 24, TX Audio Frequency Response Roll >2.7 kHz for 896-940M

This sets the pass/fail limits for testing a transmitter's audio-frequency-response roll off for measurements greater than 2.7 kHz for radio's in the frequency range of 896-940 MHz.

Pass/Fail limits are determined from an application radio specification or industry standard, such as:

- Radio standard: Audio Response
- Industry standard: EIA/TIA-603, Section 2.2.6, *Audio Frequency Response*

For Example:

If your radio specification defines audio response roll off for frequencies greater than 2.7 kHz to be a maximum of 12 dB/octave and you want to test the radio's upper limits, enter 0 in the lower-limit column and 6 in the upper-limit column. The additional 6 dB/octave which totals the maximum of 12 dB/octave is accounted for by the software with test specification 22. Limits are entered in dB.

It's Used in the Following Tests:

- [TEST_05. TX Audio Frequency Response](#)
- [TEST_21. TX Quick Test](#)

Pass/Fail Limit 25, TX CT/CDCSS Deviation

This sets the pass/fail limits for testing a transmitter's Continuous Tone-Controlled Squelch System (CTCSS) and Continuous Digital-Controlled Squelch System (CDCSS) deviation and is used as a reference value in the receiver CT/CDCSS opening test ([TEST_17. RX CTCSS/CDCSS Opening](#)).

Pass/Fail limits are determined from an applicable industry standard, such as:

- Industry standard: EIA/TIA-603, Section 2.4.17, *Transmitter Subaudible Deviation*

For Example:

If your industry standard defines CTCSS deviation as 0.9 to 2.0 kHz for a radio with ± 15 kHz deviation and you want to test both limits for the radio, enter **0.5** in the lower-limit column and **1** in the upper-limit column. Limits are entered in kHz.

It's Used in the Following Test:

[TEST_10. TX CTCSS/CDCSS Deviation, Freq/Code](#)

Pass/Fail Limit 26, TX CTCSS Frequency Error

This sets the pass/fail limits for testing transmitter's Continuous-Tone-Controlled Squelch System (CTCSS) frequency error.

Pass/Fail limits are determined from an applicable industry standard, such as:

- Industry standard: EIA/TIA-603, Section 2.4.12, *CTCSS Encoder Frequency*

For Example:

If your industry standard defines the acceptable CTCSS frequency error as $\pm 3\%$ and you want to test both limits on the radio, enter -3 in the lower-limit column and 3 in the upper-limit column. Limits are entered in %.

It's Used in the Following Test:

TEST_10. TX CTCSS/CDCSS Deviation, Freq/Code

Pass/Fail Limit 27, TX Current Drain

This sets the pass/fail limits for testing a transmitter's current drain.

Pass/Fail limits are determined from an applicable radio specification, such as:

- Radio pass/fail limits; Maximum Battery Drain, Transmit at Rated Power

For Example:

If your radio specification defines the maximum battery drain while transmitting as 5 Amps and you want to test the radio's upper limits, enter 0 in the lower-limit column and 5 in the upper-limit column. Limits are entered in Amps.

It's Used in the Following Tests:

ALL TESTS. Whenever a system initialization is done.

TEST_01. TX and RX Stand-by Current Drain

Pass/Fail Limit 28, TX Deviation If Set and Measure Mic Sens

If test **Parameter 29, TX Mic Sens Set and Measure** is set to “1”, this pass/fail limit sets the deviation for testing a microphone’s sensitivity.

Pass/Fail limits are determined from an applicable radio specification or industry standard, such as:

- Radio specification: Audio Sensitivity
- Industry standard: EIA/TIA-603, Section 2.2.10, *Acoustic Microphone Sensitivity*

For Example:

Suppose your industry standard specifies that for a modulation frequency of 1 kHz, the resulting frequency deviation should be 60% of the maximum permissible frequency deviation. So, if your transmitter’s maximum deviation is 5 kHz, 60% would be 3 kHz. To set the radio’s limits within ± 0.5 kHz of 3 kHz, enter **2.5** in the lower-limit column and **3.5** in the upper-limit column. Limits are entered in kHz.

It’s Used in the Following Tests:

- TEST_07. TX Microphone Sensitivity**
- TEST_21. TX Quick Test**

Pass/Fail Limit 29, TX FM Hum and Noise

This sets the pass/fail limits for testing a transmitter's FM hum and noise.

Pass/Fail limits are determined from an applicable radio specification or industry standard, such as:

- Radio specification: FM Noise
- Industry standard: EIA/TIA, Section 2.2.8, *FM Hum and Noise Ratio*

For Example:

If your radio specification defines the FM noise as -35 dB and you want to test the radio's upper limits, enter 0 in the lower-limit column and -35 in the upper-limit column. Limits are entered in dB.

It's Used in the Following Tests:

- [TEST_08. TX FM Hum and Noise](#)
- [TEST_21. TX Quick Test](#)

Pass/Fail Limit 30, TX Frequency Error

This sets the pass/fail limits for testing a transmitter's frequency error.

Pass/Fail limits are determined from an applicable radio specification or industry standard, such as:

- Radio specification: Frequency Stability
- Industry standard: EIA/TIA-603, Section 2.2.2, *Carrier Frequency Stability*

For Example:

If your radio specification defines the frequency stability as ± 2.5 ppm and you want to test both limits on the radio, you would enter **-2.5** in the lower-limit column and **2.5** in the upper-limit column. Limits are entered in parts-per-million (ppm).

It's Used in the Following Tests:

- [TEST_02. TX Frequency Error](#)
- [TEST_21. TX Quick Test](#)

Pass/Fail Limit 31, TX Microphone Sensitivity

This sets the pass/fail limits for testing a transmitter's microphone sensitivity. Microphone sensitivity is the nominal voltage measured at the input of the microphone which will cause full-rated system deviation of the transmitter. The value for full-rated system deviation is set by **Parameter 2, RT Full Rated System Deviation**.

Pass/Fail limits are determined from an applicable radio specification or industry standard, such as:

- Radio specification: Transmitter Audio Sensitivity
- Industry standard: EIA/TIA-603, Section 2.2.10, *Acoustic Microphone Sensitivity*

For Example:

If your radio specification defined the microphone sensitivity to be 100 mVrms $\pm 10\%$, enter **90** in the lower-limit column and **110** in the upper-limit column. Limits are entered in mVrms.

It's Used in the Following Tests:

- TEST_07. TX Microphone Sensitivity**
- TEST_21. TX Quick Test**

This pass/fail limit is used as a reference value whenever transmitter deviation is set during testing.

Pass/Fail Limit 32, TX Modulation Limiting

This sets the pass/fail limits for testing a transmitter's modulation limiting.

Pass/Fail limits are determined from an applicable radio specification or industry standard, such as:

- Radio specification: Modulation Deviation
- Industry standard: EIA/TIA-603, Section 2.2.3, *Modulation Limiting*

For Example:

If your industry standard defines the maximum modulation limiting to be not more than the full-rated system deviation (for example, 5 kHz), enter 0 in the lower-limit column and 5 in the upper-limit column. Limits are entered in kHz.

It's Used in the Following Tests:

- [TEST_04. TX Modulation Limiting](#)
- [TEST_21. TX Quick Test](#)

Pass/Fail Limit 33, TX Output Power

This sets the pass/fail limits for testing a transmitter's output power at its normal-power setting.

Pass/Fail limits are determined from an applicable radio specification or industry standard, such as:

- Radio specification: RF Power
- Industry standard: EIA/TIA-603, Section 2.2.1 *Carrier Output Power Rating*

For Example:

If your radio specification defines the RF output power as 8 Watts and you want to test both limits on your radio, you could enter **8** in the lower-limit column and choose an appropriate upper-limit, for example **12** Watts. Limits are entered in Watts.

It's Used in the Following Tests:

- [TEST_03. TX Output Power](#)
- [TEST_21. TX Quick Test](#)

Pass/Fail Limit 34, TX Output Power at High Supply

This sets the pass/fail limits for testing the high-power setting for the radio's external power supply (if one is used).

Pass/Fail limits are determined from an applicable radio specification, such as:

- Radio specification: Power Requirements

For example:

If your radio's power supply is rated to output 10 Watts at its high-supply setting, you might enter **9** in the lower-limit column and **11** in the upper-limit column and test both limits. Limits are entered in Watts.

It's Used in the Following Tests:

- [TEST_03. TX Output Power](#)
- [TEST_21. TX Quick Test](#)

Pass/Fail Limit 35, TX Output Power at High Supply Low SW

This sets the pass/fail limits for testing the transmitter at its low-switch setting with the power supply set to its high-power setting.

Pass/Fail limits are determined from an applicable radio specification or industry standard, such as:

- Radio specification: RF Power
- Industry standard: EIA/TIA-603, Section 2.2.1, *Carrier Output Power Rating*

For Example:

If your radio specification defines the RF output power as 5 Watts at its low-switch setting, the power supply is set to its high-power setting, and you want to test both limits on your radio, you might enter **4** in the lower-limit column and choose an appropriate upper-limit, for example **6** Watts. Limits are entered in Watts.

It's Used in the Following Tests:

- [TEST_03. TX Output Power](#)
- [TEST_21. TX Quick Test](#)

Pass/Fail Limit 36, Output Power at Low Supply

This sets the pass/fail limits for testing the low-power setting for the radio's external power supply (if one is used).

Pass/Fail limits are determined from an applicable radio specification, such as:

- Radio specification: Power Requirements

For example:

If your radio's power supply is rated to output 7 Watts at its low-supply setting, you might enter **6** in the lower-limit column and **8** in the upper-limit column and test both limits. Limits are entered in Watts.

It's Used in the Following Tests:

- TEST_03. TX Output Power**
- TEST_21. TX Quick Test**

Pass/Fail Limit 37, TX Output Power at Low Supply Low SW

This sets the pass/fail limits for testing the transmitter at its low-switch setting with the power supply set to its low-power setting.

Pass/Fail limits are determined from an applicable radio specification or industry standard, such as:

- Radio specification: RF Power
- Industry standard: EIA/TIA-603, Section 2.2.1, *Carrier Power Output Rating*

For Example:

If your radio specification defines the RF output power as 2 Watts at its low-switch setting with the power supply at its low-power setting and you want to test both limits on your radio, you might enter **1** in the lower-limit column and choose an appropriate upper-limit, for example **3** Watts. Limits are entered in Watts.

It's Used in the Following Tests:

- [TEST_03. TX Output Power](#)
- [TEST_21. TX Quick Test](#)

Pass/Fail Limit 38, TX Output Power at Low Switch Setting

This sets the pass/fail limits for testing a transmitter's output power at its low-power setting.

Pass/Fail limits are determined from an applicable radio specification or industry standard, such as:

- Radio specification: RF Power
- Industry standard: EIA/TIA-603, Section 2.2.1, *Carrier Output Power Rating*

For Example:

If your radio specification defines the RF output power as 3 Watts and you want to test both limits on your radio, you could enter **2** in the lower-limit column and choose an appropriate upper-limit, for example **4** Watts. Limits are entered in Watts.

It's Used in the Following Tests:

- [TEST_03. TX Output Power](#)
- [TEST_21. TX Quick Test](#)

Pass/Fail Limit 39, TX Residual AM Hum and Noise

This sets the pass/fail limits for testing the transmitter's residual AM hum and noise.

Pass/Fail limits are determined from an applicable radio specification or industry standard, such as:

- Radio specification: Residual AM Hum and Noise
- Industry standard: EIA/TIA-603, Section 2.2.9, *AM Hum and Noise Ratio*

For Example:

If your radio specification defines residual AM hum and noise as 2% AM and you want to test the radio's upper limits, enter **0** in the lower-limit column and **2** in the upper-limit column. Limits are entered in % AM.

It's Used in the Following Tests:

- [TEST_09. TX Residual AM Hum and Noise](#)
- [TEST_21. TX Quick Test](#)

Chapter 4, Test, Parameter, and Pass/Fail Limit Descriptions
Pass/Fail Limit 39, TX Residual AM Hum and Noise

5

Reference (Alphabetical)

This chapter provides detailed descriptions of the features and functions of the HP 11807A,E software. Topics are arranged alphabetically for quick, easy reference.

Conventions Used

Special presentations of text in this manual reflect the appearance of the item being referred to.

Examples of these special presentations are:

TESTS

A key on the test set.

Procedure:

Characters displayed on the CRT display.

k1 (**Run Test**)

*A USER key, in the key column next to the CRT. **Run Test** is displayed on the CRT.*

0.000000

A field on the CRT where entries can be made.

Titles of documentation are printed in italics.

The term test set refers to the HP 8920A,B. In the steps in this manual the following words are used to describe cursor and entry actions:

- **select** refers to pressing the knob after positioning the cursor in front of the appropriate field (**inverse video** area).
- **choose** means to position the cursor in front of an item in the **Choices:** or **To Screen** menu in the lower right corner of the CRT display, and then press the knob.
- **enter** means to use the numeric keypad, and the ENTER key or measurement units keys to make entries to fields. In some procedures, *enter* is used to describe the action of entering characters into a field.

Copying Files

Files can be copied from one mass-storage device to another using IBASIC COPY commands. For example, to copy a file from an inserted memory card to the left drive of an external dual-disk drive with HP-IB address 700, press TESTS. Select **IBASIC Cntrl** from the **SET UP TEST SET** list (or **IBASIC** from the **Test Function** field). Position the cursor to the IBASIC command line and select it. Using the character list that appears in the **Choices** menu, enter the following command:

```
COPY "MY_TEST:INTERNAL" TO "MYFILE:,700,0"
```

You can copy a file from a memory card to an SRAM memory card by loading the program from the memory card into the test set, inserting an initialized SRAM memory card, and then using the IBASIC SAVE command. Enter the following:

```
SAVE "MY_TEST:INTERNAL"
```

You can list the names of the files stored in a memory card or disk catalog by using the IBASIC CAT command. To display a list of file names on a memory card, enter the following:

```
CAT ":INTERNAL" or CAT
```

The mass storage powers-up to memory card as a default. If you did not change this setting, then **":INTERNAL"** is optional. If you are entering many characters into the IBASIC command line, you may want to connect a terminal to the test set. See ["Configuring the Test Set for Printing" on page 215](#). You will also want to use a terminal if you have many files to list because file names displayed with the **CAT** IBASIC command scroll past the top of the test set's CRT display and cannot be scrolled down.

IBASIC is used when writing your own programs and is not explained in this manual. If you need to write your own IBASIC programs you may acquire the following manuals:

- HP 8920A
 - *HP Instrument Basic User's Handbook* HP part number E2083-90000.
 - *HP 8920A Programming Manual* HP part number 08920-90220.
- HP 8920B
 - *HP Instrument Basic User's Handbook Version 2.0* HP part number E2083-90005.
 - *HP 8920B Programming Manual* HP part number 08920-90222.

See also: "[Data Collection \(Saving and Retrieving Test Results\)](#)" on page 189 and "[Initializing a Memory Card](#)" on page 205.

Data Collection (Saving and Retrieving Test Results)

The software has the capability to save test results to an SRAM memory card, to a disk drive, or to a PC.

Collection to a Memory Card or Disk

You will have to make entries into the **External Devices** (Edit Config) screen to describe the type of data collection you are using.

To configure External Devices entries:

1. Press TESTS
2. Select **External Devices** from the **SET UP TEST SET** list (or **Edit Cnfg** from the **Test Function** field).
3. Position the cursor to the **Calling Name** field and select it.
4. Using the list of characters in the **Choices** menu, enter **DATA C** into the **Calling Name** next to **Inst# 1**. The entry will look like:

```
1 DATA C
```

Note: For some SW revisions, DATA C will appear in the **Choices** menu. In this case, you may select DATA C, then Done instead of typing each character individually.

5. Position cursor to the **Addr** field and select it.
6. Using the DATA keypad, enter a number into **Addr**, depending on the type of storage media you will be using (press ENTER when complete):

If you are using a memory card, enter **1** into the **Addr**:

```
1 DATA C 1
```

If you are using a disk drive, enter the HP-IB disk address. For example, if the drive you are using is set to 700, then the display needs to look like:

```
1 DATA C 700
```

Calling names can be entered in any order.

The test software supports data storage on Logical Interchange Format (LIF) and Disk Operating System (DOS) disk formats. Storage can be to any of the following file types:

- ASCII files under LIF
- BDAT files under LIF
- HP-UX files under LIF
- DOS files under DOS

You will be specifying the file type with the entry you make into the **Options** field immediately below **DATA C**. If no file type is entered, and the disk format is LIF, the software will select an HP-UX file type. If no file type is entered, and the disk format is DOS, the software will select a DOS file type. For example, if you are using a DOS file and you are not using an extension on the file name, the entry on this screen will look like:

```
1  DATA C    700
```

If you are using an ASCII, BDAT or HP-UX file, you can specify the number of records allocated to the file. The DOS file is automatically updated as data is stored, so record allocation is not required. If you are using HP-UX files, you will have to enter **REC=** to establish a usable number of records. **REC=20480** sets the size to be the same as the default number of 256 byte records used for ASCII files (80 × 256). You can enter the **REC=** after the file type. For example, to use an ASCII file with 200 records of 256 bytes each, you will enter **ASCII REC=200** into the **Options** field.

NOTE:

For some software revisions, **REC=** and **ASCII REC=** will appear in the **Choices** menu. In this case, you may select **REC=** or **ASCII REC=**, enter the number of records using the **DATA** keypad, then select **Done**, instead of typing in each character individually.

The display will appear as follows:

```
1  DATA C    700
   ASCII REC=200
```

The default number of records, used when no **REC=** entry is made, is 80.

Items in the **Options** field can be separated by a comma or a space.

See **"Initializing a Disk" on page 198** if using a new disk. See **"Initializing a Memory Card" on page 205** if using a new memory card. The file types under LIF can be used by the test set's IBASIC controller and some HP workstations. The DOS format is required if you wish to use the disk with a PC.

Table 7 Data Collection (Saving/Retrieving Tests) Configuration Summary

Inst#	Calling Name Options	Model	Addr	Description
1	DATA Collection	don't care	7xx ¹	To HP-IB disk drive
1	DATA Collection	don't care	1	To memory card
Options: ²	File types of ASCII, or BDAT, or (EXT) ³ or blank, ⁴ REC=xxxxx, (number of records)	don't care	7xx ¹	LIF format LIF format DOS file type DOS or HP-UX file type ⁴ Number of records
1	DATA Collection	don't care	9	Serial to external computer (laptop)

1. xx = Last two digits of HP-IB address.
2. These options apply to disk drive and memory card data collection. They do not apply when collecting data with Addr=9.
3. A DOS file name extension. For example, the file name may be CELL1.EXT.
4. DOS is used if the disk format isDOS.HP-UX is used if the disk format is LIF.

Retrieving Data from a Memory Card

To retrieve the test results after they have been saved on an SRAM memory card, you will have to run an IBASIC program. The following is a program to transfer data from a memory card to a terminal emulator. You can type the program lines into the IBASIC command line from a terminal emulator. See "[Configuration for Terminal or PC Operation](#)" on page 195.

To enter the data retrieval program:

1. Press TESTS.
2. Select **IBASIC Cntrl** from the **SET UP TEST SET** list (or **IBASIC** from the **Test Function** field).
3. Position the cursor to the IBASIC command field (large field in the upper part of the display) and select it. From the list of characters in the **Choices** field, enter the following IBASIC program statements and commands.
4. Enter **SCRATCH** to delete the previous IBASIC program. Be sure it's saved first.
5. Enter the following program:

```
10 DIM A$(120)
```

Sets the string length to 120.

```
20 ASSIGN @File TO "RES:INTERNAL";FORMAT ON
```

Opens a path to the memory card file called "RES" (for results).

```
30 ON ERROR GOTO 80
```

Exits at end of file if an error is encountered.

```
40 LOOP
```

Extracts file contents.

```
50 ENTER @File;A$
```

Transfers part of the file to the string.

```
60 OUTPUT 9;A$
```

The string is output at the Serial port.

```
70 END LOOP
```

Goes back to get more of the file.

```
80 END
```

End of the program.

6. Press k1 (**Run**) to run the entered IBASIC program.

NOTE:

Difference between Run and Run Test

The USER (**Run**) key, assigned as a default key on the TESTS (**IBASIC Controller**) screen, will start an IBASIC program that is resident in the test set's memory. The USER (**Run Test**) key, assigned as a default key on the TESTS screens, will load and run the program that is called from the **Select Procedure Filename:** and **Select Procedure Location:** entries on the TESTS (Main Menu) screen.

Collection to a PC

Test results can be output through the serial port. A variety of devices can receive the data. An HP Palmtop computer, PC, laptop, or terminal can be used. A terminal emulator can log the test results to a file. Examples of terminal emulator programs are HP AdvanceLink and ProComm, a product of DataStorm Technologies, Inc.

For example: Configuring an IBM-Compatible PC with HP AdvanceLink for DOS

1. Load and run HP AdvanceLink on your PC.
2. Use the following [table 8](#), [table 9](#), and [table 10](#) to set the *Global Configuration*, *Terminal Configuration*, and *Remote Configuration* settings.

Table 8 Global Configuration Settings

FIELD	SETTING	FIELD	SETTING
Keyboard	USASCII	Memory Size	32K
Personality	HP	Plotter I/F	None
Language	English	HP Mode	Yes
Terminal Mode	Alphanumeric	Video Type	<i>Select your display type</i>
Remote to	<i>enter PC's serial port #</i>	Forms Path	<i>Enter path if used</i>
Printer I/F	None	Screen Size	<i>Enter the size</i>

Table 9 Terminal Configuration Settings

FIELD	SETTING	FIELD	SETTING
Terminal ID	2392A	Esc Xfer(N)	YES
Local Echo	OFF	ASCII 8 Bits	YES
CapsLock	OFF	FldSeparator	US
Start Col	01	BlkTerminator	RS
Bell	ON	ReturnDef	CR
XmitFnctn(A)	NO	Copy	Fields
SPOW(B)	NO	Type Ahead	NO
InhEolWrp(C)	NO	ROW Size	80
Line/Page(D)	LINE	Host Prmpt Char	D1
InhHndShk(G)	NO	Horiz. Scroll. Incr.	08
Inh DC2(H)	NO	Large [+] Key	+

Table 10 Remote Configuration Settings

FIELD	SETTING	FIELD	SETTING
Baud Rate	4800	SR(CH)	LO
Parity/Data Bits	None/8	Recv Pace	None
Eng Ack	No	Xmit Pace	None
Asterisk	OFF	CS(CB)Xmit	NO
Chk Parity	NO		

To set up for data collection to a PC:

1. Press TESTS.
2. Select **External Devices** from the **SET UP TEST SET** list (or **Edit Cnfg** from the **Test Function** field).
3. Position the cursor to the **Calling Name** field and select it.
4. Using the list of characters in the **Choices** menu, enter **DATA C** (next to **Inst# 1**):

```
1 DATA C
```
5. Position the cursor to the **Addr** field and select it.
6. Using DATA keypad, enter **9** and press ENTER :

```
1 DATA C 9
```

Calling names can be entered in any order.

Configuration for Terminal or PC Operation

It is preferable to enter long strings of characters into fields using a terminal. The characteristics of the serial port, when used for instrument control from a terminal or terminal emulator, are determined by settings on the test set's I/O CONFIGURE screen.

Set the following:

- **Serial In** to **Inst**
- **IBASIC Echo** to **On**
- **Inst Echo** to **On**

Set the remaining configuration entries to match the settings of your terminal or PC program.

Equivalent Front-Panel Control Characters

The following [table 11](#) lists the terminal/computer keystrokes that equate to front-panel controls. *Each equivalent character must be preceded by the Escape key.*

For example, to remotely access the CONFIGURE screen, you type Esc, C on your terminal/computer. (Be sure to use upper-case C for this example.)

Alternate sequences for 5 commonly-used functions are also available. Hold down the Ctrl (control) key and select the corresponding key for the desired function. (Example: Ctrl/H moves the cursor to the left one space.)

ENTER - ^J or ^M
CANCEL - ^C
BACKSPACE - ^H
KNOB_TURN_CW - ^R
KNOB_TURN_CCW - ^L

Table 11 **Equivalent Front-Panel Control Characters**

Function	Equiv. ESC Char.	Function	Equiv. ESC Char.	Function	Equiv. ESC Char.
CANCEL	!	REF_SET	J	INCR_SET	k
PERCENT MHZ_V	(METER	K	INCR_TIMES_10	l
S_KHZ_MV)	AVG	L	DOWN	m
BACKSPACE	-	LO_LIMIT	M	UP	n
ENTER	.	HI_LIMIT	N	SEVEN	o
RELEASE	0	E	R	EIGHT	p
K1	1	F	S	NINE	q
K2	2	B	U	FOUR	r
K3	3	C	V	FIVE	s
K4	4	D	W	SIX	t
K5	5	A	X	ONE	u
K1_PRIME	6	EEX	Z	TWO	v
K2_PRIME	7	YES_ON_OFF	[THREE	w
K3_PRIME	8	NO_PPM_W]	ZERO	x
ASSIGN	9	RX	a	POINT	y
KNOB_TURN_CCW	<	TX	b	PLUS_MINUS	z
KNOB_TURN_CW	>	DUPLEX	c	OHM_PCT_DEL_DBUV	{
MSSG	A	PREV	d	DB_GHZ_DBM	
HELP	B	TESTS_MAIN	e	MS_HZ_UV	}
CONFIG	C	LOCAL	f		
HOLD	D	RECALL	g		
PRINT	E	MEAS_RESET	h		
ADRS	F	PRESET	i		
SAVE	G	INCR_DIV_10	j		

Disks

Initializing a Disk

If you are starting with a blank disk, you will have to initialize it to the format you have chosen. Disk drives require specific commands to perform initialization. The test set's IBASIC commands to initialize some disks are described here. You should verify that the drive you are using can be controlled by the test set and that you are initializing a disk using a drive or PC that has a compatible format.

To initialize a disk to LIF in an HP-IB disk drive:

1. Verify that the test set **Mode** on the I/O CONFIGURE screen is set to **Control**:
 - a. Press TESTS.
 - b. Select **IBASIC Cntrl** from the **SET UP TEST SET** list (or **IBASIC** from the **Test Function** field).
 - c. Position the cursor to the IBASIC command field and select it.
 - d. With the list of characters in the **Choices** menu, enter the following:

```
INITIALIZE ":,7xx,y"
```

where:

xx = the HP-IB address of the disk drive, and

y = the unit number of the drive.

To initialize a disk to DOS in an HP-IB drive:

Follow the procedure for the LIF format, replacing the INITIALIZE statement with **INITIALIZE "DOS: ,7xx,y"**.

Retrieving Data from a Disk

One way to retrieve the test results from a disk is to run an IBASIC program. A program to transfer data from a disk to a terminal emulator is given below. You can type it into the IBASIC command line from the terminal emulator.

Be sure your program is saved, because it will be deleted from programmable memory. The file name for this example is "RES". The disk address is 700, and the drive number is 0. The entire file name is **RES: ,700,0**.

**To enter the data
retrieval program:**

1. Press TESTS.
2. Select **IBASIC Cntrl** from the **SET UP TEST SET** list (or **IBASIC** from the **Test Function** field).
3. Position the cursor to the IBASIC command field (large field in the upper part of the display) and select it. From the list of characters in the **Choices** field, enter the following IBASIC program statements and commands.
4. Enter **SCRATCH** to delete the previous IBASIC program. Be sure it's saved first.
5. Enter the following program:

```
10 DIM A$(120)
```

Sets the string length to 120.

```
20 ASSIGN @File TO "RES:,700,0"
```

Opens a path to the file called "RES" (for results).

```
30 ON ERROR GOTO 80
```

Exits at end of file if an error is encountered.

```
40 LOOP
```

Extracts file contents.

```
50 ENTER @File;A$
```

Transfers part of the file to the string.

```
60 OUTPUT 9;A$
```

The string is output at the serial port.

```
70 END LOOP
```

Goes back to get more of the file.

```
80 END
```

End of the program.

6. Press k1 (**Run**) to run the entered IBASIC program.

Exiting a Program

Do not press RX or TX to exit the program. Selecting the RX TEST or TX TEST screen causes signal paths internal to the test set to be modified. If you exit the program to a screen other than RX TEST or TX TEST, the settings necessary to resume testing will be retained.

After you have made the manual settings you want, press the DUPLEX key as a last step before continuing the software. This will cause the test set to be properly set up.

Another way to safely exit is to:

1. Press CANCEL.
2. Press DUPLEX.
3. Press SHIFT SAVE.
4. Using list of characters in the **Choices** menu, enter a register name or number.
5. Select **Done**.
- 6 Operate the test set manually.
7. Press RECALL.
- 8 Choose the name of the saved setup.
9. Press TESTS.
10. Press k2 (**Continue**).

HP-IB Control Annunciators

The words, letters, and symbols at the top right corner of the CRT display indicate these conditions:

- **R** indicates remote operation from an external controller or IBASIC program in the test set. This letter will be displayed while the software is running.
- **L** indicates that the test set is listening, and is ready to receive a manual or remote command.
- **T** indicates that the test set is talking to another HP-IB device.
- **S** indicates that a service request has been generated.
- **C** indicates that the test set is currently an active controller. Control mode is set on the I/O CONFIGURE screen. The test set must be a controller if HP-IB peripherals are to be controlled.
- ***** indicates that an IBASIC program is running, or that the IBASIC controller is executing a command.
- **?** indicates that an IBASIC program is waiting for a user response.
- **-** indicates that the IBASIC program is paused.
- **SHIFT** indicates that the SHIFT key was pressed, and that the next key entry will be shifted. (Press SHIFT again to clear).

Memory Cards

Memory cards are inserted into the slot on the test set's front panel. The memory card is powered by the test set while it is inserted. Arrows printed on the memory card and the test set's front panel indicate the direction and orientation of card insertion.

Memory cards are used to store or retrieve the following:

- Software code
- An HP-supplied Procedure, containing:
 - A default TEST sequence
 - Default test parameter values
 - Default pass/fail limit values
- A Library file
- Procedures you make, optimized for your application
- Data collection files
- Channel Information
- User defined keys

Three types of memory cards are available:

- Static Random Access Memory (SRAM)
 - SRAM cards have read and write capability. SRAM cards can be programmed and read with the test set.
- One-Time Programmable (OTP)
 - Once programmed with a suitable card programmer, OTP cards have read-only capability. OTP cards can be read with the test set, but cannot be programmed with the test set.
- Flash Memory
 - Flash cards have read and write capability. They can only be written to, or programmed with a suitable card reader/programmer. Flash memory cards cannot be written to, or programmed with a test set. Flash memory cards can be read by the test set.

NOTE:

Hewlett-Packard-supplied software code and Hewlett-Packard procedure and library files are typically supplied on either OTP cards or flash cards. Flash cards can be distinguished from OTP cards by a small write protect (WP) switch in the end of the flash cards. SRAM cards also have a write protect or safe switch in the end of the card, but they also use a battery. Software and procedure/library files stored on a flash card cannot be overwritten by a test set regardless of the position of the write protect (WP) switch.

The software memory card can be removed after the program is loaded into the test set memory. The program will remain in memory after a power-down/power-up cycle, until a new program is loaded. Loading a new program will replace the existing program.

SRAM Memory Cards

A Static Random Access Memory (SRAM) Card can be used to store test results and procedures you make. The following parts can be used.

Table 12 SRAM Memory Card Products for HP 8920A,D

Memory	Product
32 kilobytes	HP 85700A
128 kilobytes	HP 85702A
256 kilobytes	HP 85704A
512 kilobytes	HP 85705A

Table 13 PCMCIA SRAM Memory Card Products for the HP 8920B

Memory	Product
64 kilobytes	HP 83230A
256 kilobytes	HP 83233A
1 megabyte	HP 83231A

SRAM memory cards use a lithium battery (For 11807A: part number CR 2016 or HP part number 1420-0383. For 11807E: part number CR 2025 or HP part number 1420-0509). Programs and data will be retained for over one year if the memory card is stored at 25° C. The memory card is powered by the test set while it is inserted. Replace the battery while the memory card is inserted into a powered-up test set. To retain data and programs, it should be replaced annually. See the *HP 8920A User's Guide*. The write-protect switch on an SRAM memory card will write protect the card when it is set toward the outside of the card.

Memory Card Storage Space

Procedures use 12-16 records each. A Library uses 20-35 records. A single library must be included on the card. A record is 256 bytes. Approximately 11 kilobytes of overhead is required on each card.

Use the following formula to estimate the storage space needed:

$$\text{Storage Space (in kilobytes)} = (\text{Number of Procedures} \times 4.1) + 20$$

For example, if you want to save ten different procedures, you will need 61 kilobytes of memory. The 64 kilobyte or 128 kilobyte card is sufficient.

The storage space you need for data collection depends on the number of test results that are saved. You will need approximately 4 kilobytes per page of test results that you save. A page of test results is about 57 lines of CRT or printer output.

The storage space of smaller SRAM cards can be quickly used. If you are collecting large quantities of data, data collection using a PC or printer may be preferable.

Initializing a Memory Card

Initializing HP 11807A cards (Smart Cards) using the TESTS **Save/Delete Procedure** screen automatically defaults to LIF format. Initializing HP 11807E cards (PCMCIA) using the TESTS **Save/Delete Procedure** screen automatically defaults to DOS format. However, initializing cards from the **Save/Delete Procedure** screen is only available on HP 8920B or HP 8920A,D test sets with firmware above revision A.14.00. If these settings do not match your needs, or you have firmware below revision A.14.00, there is another method described below in which you may select the format.

- Press TESTS.
- Select **Save/Delete Procedure** from the **CUSTOMIZE TEST PROCEDURE** list.
- Insert the SRAM card in the slot on the front panel. (Make sure the switch on the card is not in the write-protected position).
- Press k3 (**Init Card**).
- Press Yes if you want to continue.

There are two ways to initialize a memory card to select the format. If you have a terminal emulator attached to the test set, you can type a command into the IBASIC command line. A second way to initialize a card is to run the ROM program RAM_MNG.

To initialize an SRAM card using IBASIC

1. Press TESTS.
2. Select **IBASIC Cntrl** from the **SET UP TEST SET** list (or **IBASIC** from the **Test Function** field).
3. Position the cursor to the IBASIC command line and select it.
4. Using the list of characters under the **Choices** menu, enter the following IBASIC command:

For LIF format: **INITIALIZE ":INTERNAL"**

For DOS format: **INITIALIZE "DOS:INTERNAL"**

To initialize an SRAM card using RAM_MNG

1. Press TESTS.
2. Position the cursor to the **Select Procedure Location** (or **Location**) field and select it.
3. From the **Choices** menu, select **ROM**.
4. Position the cursor to the **Select Procedure Filename** (or **Procedure**) field and select it.
5. From the **Choices** menu, select **IB_UTIL** (or **RAM_MNG**).
6. Press k1 (**Run Test**).
7. Follow the displayed instructions.

NOTE: Loading RAM_MNG will delete any procedure or program in memory.

Retrieving Data from a Memory Card

To retrieve the test results after they have been saved on an SRAM memory card, you will have to run an IBASIC program. The following is program to transfer data from a memory card to a terminal emulator. You can type the program lines into the IBASIC command line from a terminal emulator. See "[Configuration for Terminal or PC Operation](#)" on page 195.

To enter the data retrieval program:

1. Press TESTS.
2. Select **IBASIC Cntrl** from the **SET UP TEST SET** list (or **IBASIC** from the **Test Function** field).
3. Position the cursor to the IBASIC command field (large field in the upper part of the display) and select it. From the list of characters in the **Choices** field, enter the following IBASIC program statements and commands.
4. Enter **SCRATCH** to delete the previous IBASIC program. Be sure it's saved first.
5. Enter the following program:

```
10 DIM A$(120)
```

Sets the string length to 120.

```
20 ASSIGN @File TO "RES:INTERNAL";FORMAT ON
```

Opens a path to the memory card file called "RES" (for results).

```
30 ON ERROR GOTO 80
```

Exits at end of file if an error is encountered.

```
40 LOOP
```

Extracts file contents.

```
50 ENTER @File;A$
```

Transfers part of the file to the string.

```
60 OUTPUT 9;A$
```

The string is output at the serial port.

```
70 END LOOP
```

Goes back to get more of the file.

```
80 END
```

End of the program.

6. Press k1 (**Run**) to run the entered IBASIC program.

NOTE:

Difference between Run and Run Test

The USER (**Run**) key, assigned as a default key on the TESTS (IBASIC Controller) screen, will start an IBASIC program that is resident in the test set's memory. The USER (**Run Test**) key, assigned as a default key on the other TESTS screens, will load and run the program that is called from the **Select Procedure Filename** and **Select Procedure Location** entries on the TESTS (Main Menu) screen.

Parameters

Parameters are values you enter that optimize your use of the test software. Many of the parameters are determined by examining your test needs.

Default values are set into the software. Some of these values are derived from standard methods of measurement and some are derived from the industry standard requirements. Load a Procedure and select the **Test Parameters** screen from the **CUSTOMIZE TEST PROCEDURE** list, to see the default values.

You should verify that parameters are properly set after you select the tests to be placed in your procedure.

Parameters remain in battery-backed-up memory until you select a procedure to run. If you wish to prevent them from being lost when a new procedure is selected, you will have to save them in a procedure. See "[Saving a Procedure](#)" on page 225.

To print the parameters list, see "[To print TESTS screens:](#)" on page 219.

To edit a parameter value:

1. Press TESTS.
2. Select **Test Parameters** from the **CUSTOMIZE TEST PROCEDURE** list (or **Edit Parm** from the **Test Function** field).
3. Position the cursor to the **Parm#** field and select it.
4. Rotate the knob to the desired parameter number and select it.
5. Position the cursor to the **Value** field and select it.
6. Enter the desired value using the DATA keypad and press ENTER.
 - Use the ← key to backspace.
 - Press CANCEL to cancel entries and retain the old value.
7. Press k5 (**Main Menu**) (or TESTS) to return to the TESTS screen.

Pass/Fail Limits (specifications)

Pass/Fail Limits are values you enter that set passing limits for tests. Default values are available in the test software. They have been derived from standard methods of measurement.

Pass/Fail Limits do not have to be changed when you select a test or change the tests in your procedure. Each test has pass/fail limits that apply to it.

You should verify that pass/fail limits are properly set after you select the tests to be placed in your procedure. Lists of the pass/fail limits used by each of the tests are contained in the test descriptions in [chapter 4](#) of this manual. A lock is provided to prevent access to the pass/fail limits. See "[Securing a Procedure](#)" on [page 228](#).

Pass/fail limits remain in the test set's battery-backed-up memory until you select a procedure to run. If you wish to prevent pass/fail limits from being lost when a new procedure is selected, you will have to save them in a procedure. See "[Saving a Procedure](#)" on [page 225](#).

To print the pass/fail limits list, see "[To print TESTS screens:](#)" on [page 219](#).

To edit a pass/fail limit value:

1. Press TESTS.
2. Select **Pass/Fail Limits** from the **CUSTOMIZE TEST SET** list (or **Edit Spec** from the **Test Function** field).
3. Position the cursor to the **Spec#** field and select it.
4. Rotate the knob to the desired pass/fail limit number and select it.
5. Position the cursor to the **Lower Limit** or the **Upper Limit** field and select it.
6. Enter desired value using the DATA keypad and press ENTER.
 - Use the ← key to backspace.
 - Press CANCEL to cancel entries and retain the old value.
7. Position the cursor to the **Check** field and select it.
8. From the **Choices** menu, select the combination of upper and lower limits to be checked.

Pausing or Stopping a TEST

To pause the program, press CANCEL.

To stop the program, press SHIFT then CANCEL. This performs an IBASIC RESET operation.

NOTE:

Changing Settings while Paused

If you make changes to instrument settings while the program is paused, subsequent operation may be unpredictable. Error messages may or may not be displayed. See "[Exiting a Program](#)" on page 200.

To continue a paused program:

1. Press TESTS.
2. Press k1 (**C**ontinue).

The test time is displayed when the test is completed. This time includes the time that the program is paused and the time that it is waiting for connection and inputs to be made. If you are testing through midnight, the test time will not display properly.

Printing

You can print any of the following:

- Test results
- TESTS screens
 - "External Devices" (Edit Cnfg)
 - "Order of Tests" (Edit Seqn)
 - "Channel Information" (Edit Freq)
 - "Pass/Fail Limits" (Edit Spec)
 - "Test Parameters" (Edit Parm)

How to Print (task list)

There are five basic steps to printing listed below. A detailed description of each of these steps is at the end of this section.

1. Check to see if your printer is supported by the test set (see ["Supported Printers" on page 212](#)).
2. Determine if your printer requires serial, parallel, or HP-IB connection. Connect the printer to the appropriate port on the test set (see ["Printer Connection" on page 213](#)).
3. Configure the test set for your printer and its interface (see ["Configuring the Test Set for Printing" on page 215](#)).
4. Instruct the test set what to print (see ["To print test results:" on page 216](#)).

Supported Printers

- HP ThinkJet printer
- HP QuietJet printer
- HP PaintJet printer
- HP DeskJet printer
- HP LaserJet printer
- Epson FX-80 printer
- Epson LQ-850 printer

If you do not have one of these printers, consult your printer's manual for the correct printer settings to emulate one of the supported printers.

Printer Connection

HP-IB Connection

An HP-IB printer can be connected to the test set's rear-panel HP-IB connector with an HP-IB cable.

Serial Connection

A serial printer can be attached to the serial port. See [figure 1](#). Use the following RJ-11 pins for this connection.

- RJ-11 Pin 2 - test set Receive Data
- RJ-11 Pin 4 - Ground
- RJ-11 Pin 5 - test set Transmit Data

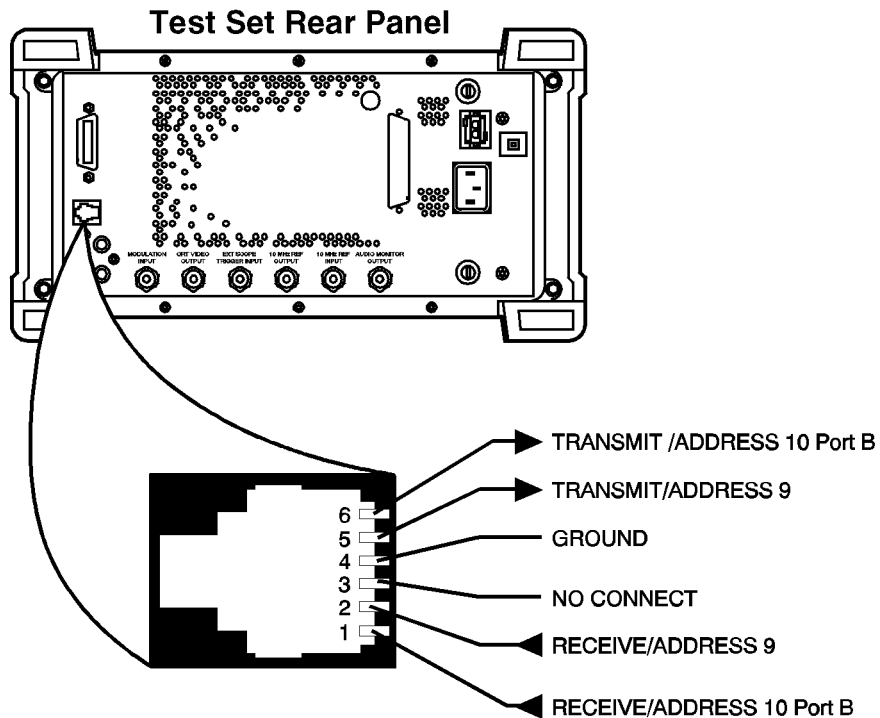

Figure 1 Test Set RJ-11 Serial Port Connections

Parallel Connection

A parallel printer can be attached to the parallel port. Use the following **figure 2** for pin information.

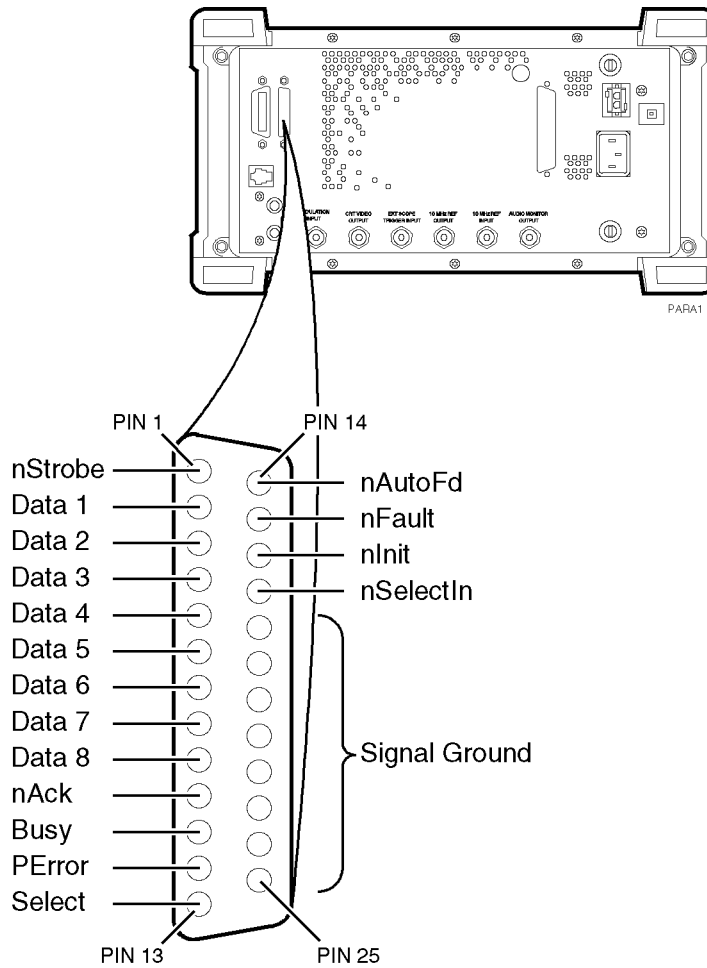

Figure 2 Test Set Parallel Port Connections

Configuring the Test Set for Printing

If using a serial printer, you cannot use the serial port for other connections at the same time, such as Data Collection (saving test results). Serial port connections are shown earlier in this section.

NOTE:

Printer Setup Differences

The HP 8920A,D had several firmware enhancements, which are standard in the HP 8920B. The following **Setup Printer** section applies to users with:

- HP 8920A,D test sets with firmware above revision A.14.00.
- All HP 8920B test sets.

The test set's firmware revision is displayed on the top right corner of the configuration screen.

- Press SHIFT CONFIG to display the configuration screen and read the firmware revision.

If you have an HP 8920A with firmware revision below A.14.00, refer to the next section titled "[To Setup Printer Using HP 8920A FW Below Rev A.14.00](#)" on [page 220](#). Contact Hewlett-Packard at 1-800-922-8920 for details on upgrading your firmware if desired.

NOTE:

EXCEPTION: If you are using A.xx.xx revision software, you can not use the **Printer Setup** screen regardless of your firmware revision. Refer to the instructions for firmware below A.14.00.

To Setup Printer Using Any HP 8920B Or HP 8920A FW Above Rev A.14.00

1. Press TESTS
2. Select **Printer Setup** from the **SET UP TEST SET** list.
3. Position the cursor to **Model** and select the desired printer.
4. Position the cursor to **Print Port** and select the desired port.
5. (If HP-IB only) Position the cursor to **Printer Adrs** and enter the HP-IB address for your printer (0-30).
6. Set the following options if desired:
 - Lines/Page (controls the number of lines, 20-120, printed on a page before a form feed is sent to the printer)
 - FF at Start (to cause a form feed at the start of a test sequence)
 - FF at End (to cause a form feed at the end of a test sequence)
7. From the **To Screen** menu, select **More**.
8. From the **Choices** menu, select **IO CONFIG**.
 - For Serial Printing, set the **Serial Baud** field and other serial communications fields listed under it to correspond to your printer's configuration.
 - For HP-IB Printing, set the **Mode** field to **Control**.
9. Press TESTS to return to the TESTS (Main Menu) screen.

To print test results:

1. Press TESTS
2. Select **Printer Setup** from the **SET UP TEST SET** list.
3. Position the cursor to **Output Results To** and select **Printer**.
4. Position the cursor to **Output Results For** and select **All** if you want all results printed, or **Failures** if you want failures only printed.
5. (Optional) Position the cursor to **Output Heading** and enter your desired heading.

To send Escape Sequences to the printer

If you have revision B.xx.xx software, you may use the test set to send escape sequences to control printer options such as pitch, margins, paper size, and so forth. The software comes with some pre-defined escape sequences compatible with HP printers, listed below, or you have the option to enter others which are compatible with your printer (use your printer's user's manual for the available print features and corresponding escape sequences). This function is not available with revision A.xx.xx software.

The software already has an implied escape character for the first sequence, you need only to enter the escape sequence following the escape character. However, if you are linking two or more sequences together, you must use the ~ to indicate the escape character between each sequence. If the sequence exceeds the space allotted in the options field, you may continue with additional escape sequences in the next available **Options** field. You must however, still enter **Escape Seq** in the **Calling Name** field and the appropriate address in the **Addr** field for all subsequent entries.

How to send an Escape Sequence:

1. Press TESTS.
2. Select **External Devices** from the **SET UP TEST SET** list.
3. Position the cursor to the **Inst#** field and select it.
4. Rotate the knob until an empty **Calling Name** field appears, and select it.
5. Position the cursor to the **Calling Name** field and select it.
6. Select **Escape Seq** from the **Choices** menu.
7. Position the cursor to the **Addr** (address) field and select it.
8. Using the DATA keypad, enter **9** for serial printers, **15** for parallel printers, or **70X** for HP-IB printers, then press ENTER. .
9. Position the cursor to the **Options** field (directly under **Calling Name**) and select it.
10. Select the desired escape sequence from the **Choices** menu if applicable, or enter an appropriate sequence using the list of characters below the choices.

Table 14 **Escape Sequence Definitions for HP Printers**

Escape Sequence	Print Feature
&l66P	Sets page length to 66 lines
&l72P	Sets page length to 72 lines
&l6D	Sets lines per inch to 6 lines
&l8D	Sets lines to inch to 8 lines
(s12h12v6T	Selects 12 characters per inch 12/72 inch character height gothic typeface
&a9L~&l6E	Sets left margin to 9 characters top margin to 6 lines
(s12h12v6T~&a9L~&l6E	Selects 12 characters per inch 12/72 inch character height gothic typeface left margin to 9 characters top margin to 6 lines
&l8d88P	Selects 8 lines per inch 88 lines per page
&l8d96P	Selects 8 lines per inch 96 lines per page
(s16.67h12V~&a17L~&l6E	Selects 16.67 characters per inch 12/72 inch character height left margin to 17 characters top margin to 6 lines

To print TESTS screens:

TESTS screens include:

- "External Devices"
- "Order of Tests"
- "Channel Information"
- "Pass/Fail Limits"
- "Test Parameters"

The same general process is used to print the information for all of the above TESTS screens.

1. Make sure that your printer is properly connected and configured as explained earlier in this section.
2. Press TESTS.
3. Select the **CUSTOMIZE TEST PROCEDURE** screen of your choice.
4. Press k3 (**Print All**) and select it.
5. Press TESTS to return to the TESTS (Main Menu) screen.

To Setup Printer Using HP 8920A FW Below Rev A.14.00

1. Press TESTS
2. Select **Edit Cnfg** from the **Test Function** field.
3. Position the cursor to the **Inst#** field and select it.
4. Rotate the knob until an empty **Calling Name** field appears, and select it.
5. Position the cursor to the **Calling Name** field and select it.
6. Using the list of characters in the **Choices** menu, enter the word **Printer**. Select **Done** when complete.
7. Position the cursor to the **Model** field and select it (optional).
8. Using the DATA keypad, enter the Model # and press ENTER.
9. Position the cursor to the **Addr** (address) field and select it.
10. Using the DATA keypad, enter **9** for serial printers, **15** for parallel printers, or **70X** for HP-IB printers, then press ENTER. .
11. Position the cursor to the **Options** field (directly under **Calling Name**) and select it.
12. Using the list of characters from the **Choices** menu, the following commands may be entered. Separate the commands with commas (example; **LN=60 , START , END**)
 - **LN** equals the number of printed lines per page.
 - **START** causes a form feed at the start of each printout.
 - **END** causes a form feed at the end of each printout.
13. From the **To Screen** menu, select **More**.
14. From the **Choices** menu, select **IO CONFIG**.
15. For Serial Printers:
 - a. Set the **Serial Baud** field and other serial communications fields listed under it to correspond to your printer's configuration.
16. For HP-IB Printers:
 - a. Position the cursor to the **Mode** field and select it.
 - b. From the **Choices** menu, select **Control**.
 - c. Position the cursor to the **Print Adrs** field and select it.
 - d. Rotate the knob and select the HP-IB address of your printer.
 - e. Position the cursor to the **Print To** field. Pressing knob will toggle the underlined selection. Select to underline **HP-IB**.
17. Press TESTS to return to the TESTS screen.

To print test results

1. Make sure that your printer is properly connected and configured as explained earlier in this section.
2. Press TESTS.
3. Position the cursor to the **Output Results To:** field (or the **Output Destination** field). Pressing knob will toggle the underlined selection. Select to underline **Printer**.
4. Position the cursor to the **Output Heading** field and select it.
5. Using the list of characters in the **Choices** menu, enter a printout heading (optional). Select **Done** when the heading is complete.

To send Escape Sequences to the printer

If you have revision B.xx.xx software, you may use the test set to send escape sequences to control printer options such as pitch, margins, paper size, and so forth. You may enter sequences which are compatible with your printer (use your printer's user's manual for the available print features and corresponding escape sequences). This function is not available with revision A.xx.xx software.

The software already has an implied escape character for the first sequence, you need only to enter the escape sequence following the escape character. However, if you are linking two or more sequences together, you must use the ~ to indicate the escape character between each sequence. If the sequence exceeds the space allotted in the options field, you may continue with additional escape sequences in the next available **Options** field. You must however, still enter **Escape Seq** in the **Calling Name** field and the appropriate address in the **Addr** field for all subsequent entries.

**How to send an
Escape
Sequence:**

1. Press TESTS.
2. Select **Edit Cnfg** from the **Test Function** field.
3. Position the cursor to the **Inst#** field and select it.
4. Rotate the knob until an empty **Calling Name** field appears, and select it.
5. Position the cursor to the **Calling Name** field and select it.
6. Enter **ESCAPE SEQ** using the characters in the **Choices** menu. Select **Done** when you are finished.
7. Position the cursor to the **Addr** (address) field and select it.
8. Using the DATA keypad, enter **9** for serial printers, **15** for parallel printers, or **70X** for HP-IB printers, then press ENTER. .
9. Position the cursor to the **Options** field (directly under **Calling Name**) and select it.
- 10 Select the desired sequence using the list of characters below the choices.

Table 15 **Examples of Common Escape Sequences**

Escape Sequence	Print Feature
&l66P	Sets page length to 66 lines
&l72P	Sets page length to 72 lines
&l6D	Sets lines per inch to 6 lines
&l8D	Sets lines to inch to 8 lines
(s12h12v6T	Selects 12 characters per inch 12/72 inch character height gothic typeface
&a9L~&l6E	Sets left margin to 9 characters top margin to 6 lines
(s12h12v6T~&a9L~&l6E	Selects 12 characters per inch 12/72 inch character height gothic typeface left margin to 9 characters top margin to 6 lines
&l8d88P	Selects 8 lines per inch 88 lines per page
&l8d96P	Selects 8 lines per inch 96 lines per page
(s16.67h12V~&a17L~&l6E	Selects 16.67 characters per inch 12/72 inch character height left margin to 17 characters top margin to 6 lines

To print TESTS screens

TESTS screens include:

- "Edit Cnfg"
- "Edit Seqn"
- "Edit Freq"
- "Edit Spec"
- "Edit Parm"

The same general process is used to print the information for all of the above TESTS screens.

1. Make sure that your printer is properly connected and configured as explained earlier in this section.
2. Press TESTS.
- 3 Select the TESTS screen you desire.
4. Press k3 (**Print All**) and select it.
5. Press TESTS to return to the TESTS screen.

Procedures

A procedure is a collection of test parameters, pass/fail limits and a testing order, saved in a file that customizes the test software to a specific application. You may save the file on a memory card or disk.

You do not have to save a test sequence in a procedure. Each test can be stand-alone if desired. After you choose a procedure, you can choose which of the tests you want to run.

When you save a procedure you will only be saving test parameters, pass/fail limits and a testing order. The memory card or disk must also contain a library file. A library file contains the names of all of the test parameters, pass/fail limits and tests that are in the test software. The library you use will be the library that is supplied with your software. When you save your procedure, the library will be automatically saved on the same card or disk.

The procedure(s) supplied with your software will be listed in the **Choices:** column when you select the **Select Procedure Filename:** (or **Procedure**) field. Procedures will be displayed if your software memory card is plugged in.

Saving a Procedure

After you have set up the test software you can save the setup to an SRAM memory card, disk, or internal RAM memory by doing the following.

The memory card or disk you use must be initialized before its first use. See ["Initializing a Memory Card" on page 205](#) or ["Initializing RAM Disks" on page 231](#). If you are using a disk drive, you may have to enter the **External Disk Specification** into the **TESTS External Devices** screen (or **Edit Cnfg** screen). It will be used when the **Select Procedure Location:** field on the **TESTS** screen is **Disk**.

To save a procedure:

1. Press TESTS.
2. Select **Save/Delete Procedure** from the **CUSTOMIZE TEST PROCEDURE** list (or **Proc Mngr** from the **Test Function** field).
3. Position the cursor to the **Select Procedure Location** (or **Location**) field and select it.
4. From the **Choices** menu, select the desired location. The media must be initialized before a file can be saved. To initialize an SRAM card (HP 8920B or HP 8920A,D firmware above revision A.14.00 only, otherwise see [I"Initializing a Memory Card" on page 205](#)):
 - a. Insert card in the slot on the test set's front panel.
 - b. Press k3 (**Init Card**)
 - c. Press **Yes**. Note: this will delete any procedures or programs from memory.

To initialize a RAM disk, see "Memory Cards/Mass Storage" in the *HP 8920A Programmer's Guide* .

5. Position the cursor to the **Enter Procedure Filename** (or **Procedure**) field and select it.
6. From the list of characters in the **Choices** menu, enter a filename. Filename must be nine characters or less. When filename is complete, position cursor to **Done** and select it. Procedure filenames that already exist on the card will appear at the top of the list of characters.
7. If you selected **Card**, insert an initialized memory card into the slot on the test set's front-panel.
8. Verify that the card or other media is not write-protected. See ["Memory Cards" on page 202](#).
9. Position the cursor to the **Enter Description for New Procedure** (or **Comment for new procedure**) field and select it. From the list of characters in the **Choices** menu, enter comments. When the comments are complete, position the cursor to **Done** and select it.
10. Position the cursor to the **Procedure Library** (or **Library for new procedure**) field and select **Current** (Current underlined). The name of the Library is displayed on the TESTS screen.
11. Position the cursor to the **Code Location** (or **Program location for new procedure**) field and select it.

From the **Choices** menu, choose memory **Card**, **ROM**, **RAM** or **Disk**. When a procedure is run, the test system will look in this location for a code file if it is not resident in the Test Set's battery-backed-up memory. This location will usually be the software memory card.
12. Press k1 (**Save Proc**) (or position the cursor to the **Action** field and select **Make Procedure**). A procedure will be saved at the location you chose.

Loading a Procedure

A procedure can be loaded from storage media into the test set's battery-backed-up memory by doing the following.

To load a procedure:

1. Press TESTS.
2. Position the cursor to the **Select Procedure Location** (or **Location**) field and select it.
3. From the **Choices** menu, choose the desired location where the procedure is stored and select: **Card**, **ROM**, **RAM** or **Disk**.
4. Position the cursor to the **Select Procedure Filename** (or **Procedure**) field and select it.
5. From the **Choices** menu, choose the procedure file that you want to load.
6. Read the **Description** (or **Comment**) field to ensure that the loaded procedure file is the one you want.

Deleting a Procedure

Procedures can be removed from an SRAM memory card, disk or RAM by doing the following.

To delete a Procedure:

1. Press TESTS.
2. Select **Save/Delete Procedure** from the **CUSTOMIZE TEST PROCEDURE** list (or **Proc Mngr** from the **Test Function** field).
3. Position the cursor to the **Select Procedure Location** (or **Location**) field and select it.
4. From the **Choices** menu, select the desired location.
5. Position the cursor to the **Enter Procedure Filename** (or **Procedure**) field and select it.
6. From the **Choices** menu, select the name of the procedure you wish to delete.
7. Press k2 (**Del Proc**) (or position the cursor to the **Action** field and select **Delete Procedure**).
8. Press Yes if you wish to continue.

Securing a Procedure

After you have set up your test software with a testing order, channel information, test parameters, and pass/fail limits, you may wish to secure it. This operation will prevent the viewing and changing of those functions. You can select the items you wish to secure or un-secure. An IBASIC ROM program is stored in the Test Set's firmware to do this.

You can secure the procedure that is supplied with the test software. It is shipped un-secured.

After you make a procedure, you can secure it.

To secure a Procedure:

1. Press TESTS.
2. Position the cursor to the **Select Procedure Location** (or **Location**) field and select it.
3. From the **Choices** menu, select **ROM**.
4. Position the cursor to the **Select Procedure Filename** (or **Procedure**) field and select it.
5. From the **Choices** menu, select **IB_UTIL** (or **SECURE_IT**).
6. Press k1 (**Run Test**).
7. Select the location of the procedure you want to secure: k1 memory (**Card**) or k2 (**RAM**).

NOTE:

RAM refers to the RAM Disk memory within the test set. Before selecting RAM, you must initialize the RAM as a disk. See "[Initializing RAM Disks](#)" on page 231.

8. Proceed with the on-line instructions. You may wish to secure only one of the items, such as pass/fail limits.
9. When you are prompted to enter the **pass number**, enter any sequence of numerals 0 through 9 using the DATA keypad. Enter 9 digits or less.

To un-secure a procedure:

To un-secure a procedure, you must know the **pass number**.

1. Press TESTS.
2. Position the cursor to the **Select Procedure Location** (or **Location**) field and select it.
3. From the **Choices** menu, select **ROM**.
4. Position the cursor to the **Select Procedure Filename** (or **Procedure**) field and select it.
5. From the **Choices** menu, select **IB_UTIL** (or **SECURE_IT**).
6. Press k1 (**Run Test**).
7. Select the location of the procedure you want to un-secure: k1 memory (**Card**) or k2 (**RAM**).
8. Enter the name of the procedure you wish to un-secure.
9. If the procedure has any item secured, you will be asked for the **pass number**.
10. Proceed with the on-line instructions. Select the items you wish to un-secure.
11. When you are prompted, enter the **pass number** using the DATA keypad.

RAM

RAM disk is a section of internal memory that acts much like a flexible disk. Programs can be stored, re-stored, erased, and retrieved.

The RAM disk is partitioned into four separate volumes; 0-3. Each volume is treated as a separate 'disk'. You can also specify the size of each disk in 256-byte increments.

The four RAM disk volumes are designated **:MEMORY, 0, 0** to **:MEMORY, 0, 3**. For example, to catalogue the contents of RAM disk volume '0' from the **IBASIC Cntrl** screen, enter

```
CAT " :MEMORY, 0, 0"
```

Volume 0's contents can be viewed and loaded from the three screens mentioned at the beginning of this section. Volumes 1, 2, and 3 can *only* be accessed from the IBASIC Controller.

NOTE:

RAM Disk Erasure

Any existing programs or formatting on RAM is erased if you use the **RAM_MNG** or **COPY_PL** ROM programs, or the SERVICE screen's **RAM Initialize** function.

Therefore, you should only use RAM disks for short-term storage of files.

Initializing RAM Disks

Each RAM disk volume must be initialized before it can be used. Volume 0 can be initialized using the RAM_MNG procedure stored on the internal ROM's **IB_UTIL** menu. Volumes 1, 2, and 3 must be initialized from the **IBASIC Cntrl** screen.

The optional 'volume size' in the following procedure lets you specify the memory area set aside for each disk in 256 byte blocks.

Follow these steps to initialize volumes 1, 2, or 3:

1. Press TESTS.
2. Select **IBASIC Cntrl** from the **SET UP TEST SET** list.
3. Position the cursor to the data entry field and select it.
4. Using the list of characters from the **Choices** menu, enter the following command:

```
INITIALIZE ":MEMORY,0,<volume number 1-3>",<volume size>  
or  
INITIALIZE ":MEMORY,0,1",50
```

Saving Tests Results

See "[Data Collection \(Saving and Retrieving Test Results\)](#)" on page 189.

Serial Port

This 6-pin, RJ-11 serial port is used to input and output serial data. Serial data is used for entering programs, printing, and for sending test results to a connected controller, disk drive, or terminal.

Operating Considerations

The serial communications settings are defined on the I/O CONFIGURE screen. Ground is used with both IBASIC and all other serial connections. Transmit B and Receive B are exclusively used with IBASIC programs. Transmit and Receive are used with all other serial connections (see [figure 1](#)).

The IBASIC Controller sends data to and receives data from the serial ports using address 9 for the primary port, and address 10 for Port B.

Use an RJ-11/25-pin RS-232 adapter (HP P/N 98642-66508) and RJ-11 cable (HP P/N 98642-66505) to connect the HP 8920A,B,D to a serial printer or terminal/computer.

NOTE:

RJ-11 Connectors

RJ-11 cables and adapters can be wired several ways. If you buy a cable or adapter other than the HP parts listed, verify the connections for the pins indicated in the following [table 16](#) before connecting cables to the instruments.

The following [table 16](#) lists connections for Transmit, Receive, and Ground pins (address 9).

Table 16 Examples of Common Escape Sequences

HP 8920A RJ-11 Serial Port		Terminal/PC 25-Pin RS-232		Terminal/PC 9-Pin RS-232
Pin 2 (RX)	to	pin 2 (TX)	or	pin 3 (TX)
Pin 5 (TX)	to	pin 3 (RX)	or	pin 2 (RX)
Pin 4 (GND)	to	pin 7 (GND)	or	pin 5 (GND)

Test Execution Conditions

In some situations, you may wish to change the way the software works when a test result is obtained. **Test Execution Conditions** allow you to do this.

Test Execution Conditions are accessed from the **SET UP TEST SET** list on the TESTS (Main Menu) screen. Press TESTS, then select **Execution Cond** to display them. (They are displayed directly on the main TESTS screen in firmware below revision A.14.00).

Test Execution Conditions are not retained after a power-down/power-up cycle.

The following **Test Execution Conditions** can be set as needed:

Output Results To: (Output Destination)

You can select either: **Crt** or **Printer** Default:**Crt**

You can specify where test results are to be placed. If you select **Crt**, results will be displayed on the test set's CRT. If you select **Printer**, test results will be sent to the CRT and to a printer. You must connect and configure a printer if you select **Printer**. See "[Printing](#)" on page 212.

Output Results For: (Output Results)

You can select either: **All** or **Failures** Default:**All**

You can specify if you want only the failed results to be displayed or printed. This will be useful if you generally do not print test results, and want to ensure that failed results are displayed or printed.

Output Heading

You can use this field to enter a heading that will be printed or displayed.

Select the **Output Heading** field. Use the knob to choose and enter the characters that you want to appear in the heading.

Choose **Done** when you are finished.

If Unit-Under-Test Fails (If UUT Fails)

You can select either: **Continue** or **Stop** Default: **Continue**

If you set this to **Stop**, and a pass/fail result is **F**, the program will stop.

Test Procedure Run Mode (Run Mode)

You can select either: **Continuous** or **Single Step** Default: **Continuous**

You can make tests pause at certain times. If you set this to **Single Step**, the program will pause after a comparison is made between a test determination and the expected result. For example, tests will pause after the program compares the results to a specification. You can continue from the paused state by pressing **k2** (**Continue**).

Autostart Test Procedure on Power-Up

You can select either: **On** or **Off** Default: **Off**

You can set up the test set so that if the procedure was previously loaded, the procedure will be immediately executed when the test set is powered on.

USER Keys

When you are using the test set, you will see the following USER keys assigned appear at times in the top right corner of the display. These keys are assigned to the hard keys k1 through k5. In many cases, these keys can be used as “shortcuts” instead of positioning the cursor and selecting. USER keys are sometimes referred to as softkeys.

Clr Scr clears the test set’s CRT display.

Continue continues the program after it has been paused.

Delete Stp is used to edit items in a test sequence. When you press this key, the test in the displayed sequence that has its **Step #** highlighted (inverse video) will be deleted. The tests that follow in the sequence will be scrolled up by one step.

Del Proc is used to delete the selected procedure. When you press this key, you will be prompted to verify the command by pressing Yes.

Press **Done** when you want to exit a test or have completed a task. The program will continue if there is a next test in the sequence or if there are additional program steps in the test being run.

Help provides information on how to use the current TEST screen.

Init Card is used to initialize a memory card. Before you press this key, verify that the card is inserted correctly and not in the write-protected position.

Insrt Stp is used to enter items into a test sequence. When you press this key, the test in the displayed sequence that has its **Step #** highlighted (inverse video) will be copied into a new sequence location, immediately after the highlighted one. The tests that follow in the sequence will be scrolled down by one step. This key does nothing if there are no items in the sequence. Choose a test before using this key to insert another.

Main Menu is used to return to the main TESTS screen. The same result is achieved by pressing TESTS.

Page Up\Page Down are used to quickly display items in the list when some of the items won’t fit on the screen.

Run starts an IBASIC program that has been loaded into the test set’s memory.

Run Test loads and runs the program that is called from the procedure that has been entered into the TESTS screen **Select Procedure Filename:** entry. If the program is already loaded into the test set's memory, it will be started.

Save Proc is used to save the specified procedure.

Sngl Step steps the IBASIC program one line at a time. This is different from **Continuous/Single Step** run mode. See "**Test Execution Conditions**" on page 234.

Stop Test pauses the test software.

Take It causes the program to accept the setting of an adjustment, and proceed with the program. The test, determining if the adjustment is within limits, is ceased.

Yes\No are pressed when answering questions displayed on the test set's CRT display.

Problem Solving

If you have a problem testing your radio

This section contains information for solving some of the most common problems related to using the HP 11807A,E radio-test software. All problems in this section have a single obvious symptom (shown in bold typeface at the top of each page), but many possible causes (listed in order from the most probable cause to the least probable cause).

NOTE:

If the test set displays an error that states “*One or more self-tests failed*”, you have a hardware problem. In this case, refer to the test set’s *Assembly Level Repair* manual.

If the problem has to do with operating the test set, you’ll want to refer to the MESSAGE screen to list errors or operating messages that have occurred since the instrument was turned on. To do this, press the SHIFT and then the MSSG key.

Also, the *HP Instrument BASIC* manual describes any errors that happen as a result of running IBASIC programs.

If the test procedure doesn't run on an test set

- Check to see that the memory card is correctly inserted into the test set.
- Check to see that a test procedure file has been loaded into the test set.

In the upper left corner of the TESTS (Main Menu) screen, a file name should be seen in the **Select Procedure** field. If the field is blank, then a test procedure file has not been loaded.

To load a test procedure file:

1. Press TESTS.
2. Position the cursor to the **Select Procedure Location** (or **Location**) field and choose **Card** from the **Choices** menu.
3. Position the cursor to the **Select Procedure Filename** (or **Procedure**) field and choose the test procedure file you want from the **Choices** menu.

- Check that you have selected k1 (**Run Test**) to start testing.
- Check the MESSAGE screen to see if an error is causing the test procedure to not run.

If you see the error message “Structures improperly matched” or “Improper context terminator”, the software program was incorrectly loaded into the test set. In this case, refer to the directions on the next page.

NOTE:

Test procedure files are not the actual code or program needed to run the tests. You'll need to load the test procedure file, then run the selected tests with the memory card containing the program code inserted in the memory card slot. The program code remains loaded in the test set until another program is loaded.

If the HP 11807A,E program was incorrectly loaded

An error message like “Structures improperly matched” or “Improper context terminator” appears. It takes 2-4 minutes to load an HP 11807A program when k1 (**Run Test**) is first pressed. It takes approximately 15 seconds to load an HP 11807E program. Thereafter, it takes only a few seconds to run.

- Were the SHIFT CANCEL keys pressed or the memory card removed while the program was loading? If this was done, you will need to clear the RAM, or load another program and then re-load the HP 11807A,E program.

To clear RAM in the test set: (*All SAVE registers are lost.*)

1. Press TESTS.
 2. Position the cursor to **Select Procedure Location** and choose **ROM** from the **Choices** menu.
 3. Position the cursor to **Select Procedure Filename** and choose **IB_UTIL** (or **COPY_PL**) from the **Choices** menu.
 4. Press k1 (**Run test**).
 5. Press k5 (**CLEAR RAM**).
 6. Press TESTS, and re-load and run the test procedure you want.
- Check to see that the test set has enough RAM memory. To see if there's enough RAM memory:
 1. Press TESTS.
 2. Position the cursor to **Select Procedure Location** and choose **ROM** from the **Choices** menu.
 3. Position the cursor to **Select Procedure Filename** and choose **LIST_OPTS** from the **Choices** menu.
 4. Press k1 (**Run Test**).
 5. If the screen displays **OPTIONAL RAM**, your test set has enough RAM memory. If **OPTIONAL RAM** is not displayed, refer to "[Ordering Upgrades](#)" on page 18 in [chapter 1](#).

If the printer does not print the test results

- Check that the printer is turned on.
- Check that the HP-IB, parallel, or serial cable from the test set to the printer is connected.

If have firmware below revision A.14.00 OR you are using software with Revision A.xx.xx

1. Press TESTS.
2. Check that **Printer** was selected as the **Output Destination** in the **Test Execution Conditions**.
3. Check that the test set is correctly configured for HP-IB, parallel, or serial printing:

For a HP-IB printer:

- a. Check that the printer's **Calling Name** is "PRINTER" and its address is correctly set up in the **External Devices** (or **Edit Cnfg**) screen.
- b. Check that the I/O CONFIGURE screen has been set up correctly:
 - i. Mode=Control
 - ii. Print To=HP-IB
 - iii. Print Adrs=address of your printer

For a parallel printer:

- a. Check that the printer's **Calling Name** is **PRINTER** and its address is set to **15** in the **External Devices** (or **Edit Cnfg**) screen.

For a serial printer:

- a. Check that the printer's **Calling Name** is **PRINTER** and its address is set to **9** in the **External Devices** (or **Edit Cnfg**) screen.
- b. Check that the I/O CONFIGURE screen has been set up correctly for the printer's baud rate, parity, and so forth.

Refer to the test set's *User's Guide* for details about configuring the printer.

**If you have an HP 8920B or HP 8920A,D with firmware above revision A.14.00
AND you are using software with Revision B.xx.xx**

1. Press **TESTS**.
2. Select **Printer Setup** from the **SET UP TEST SET** list.
3. Check that **Printer** was selected in the **Output Results To:**.
4. Check that the test set is correctly configured for HP-IB or serial printing:
 - a. Select **Model** and choose the most compatible printer model from the **Choices** menu.
 - b. Select **Printer Port** and choose which printer port you are using.
 - c. If the HP-IB port was selected, check that the correct **Printer Adrs** was entered.
 - d. If the Serial port was selected, check that the **I/O CONFIGURE** screen has been set up correctly for the printer's baud rate, parity, and so forth.

Refer to the test set's *User's Guide* for details about configuring the printer.

If the FM radio fails the audio tests

- Check the specifications for the FM radio to make sure they match with those entered in the software Pass/Fail Limits.
- Check the audio connections from the FM radio to the test set. Refer to "**Making a Connection**" in chapter 2 on page 29 for a diagram showing the correct connections.
- Check the FM radio to make sure the microphone is not active and picking up ambient noise.
- Check the FM radio to see if the audio lines carry other signals.

For example, if the audio lines carry other dc signals, a blocking capacitor in series with the test set is required.

If radio volume can't be set on the test set's meter screen

- Check that the meter needle on the test set's meter screen moves when you turn the radio's volume knob. If the meter needle doesn't move make sure the radio is powered on.
- Check that the radio is correctly connected to the test set. Refer to "**Making a Connection**" in chapter 2 on page 29 for a diagram showing the correct connections.
- If the meter needle moves but cannot be set high enough, check to see if the parameters for setting radio volume are correctly set up. Incorrect settings for any one of these parameters will affect how the test runs.
 1. **Parameter 7, RX Audio Load Impedance** is used by the software whenever radio volume or squelch control is adjusted during testing.
 2. **Parameter 11, RX Maximum Audio Power** sets the full-scale volume level of the meter displayed on the test set. The value you enter for this parameter is scaled up by 50%.
 3. **Parameter 17, RX Tolerance for Setting Volume** sets the tolerance window displayed on the meter screen.

If your radio fails CTCSS/CDCSS tests or the tests don't run

- Check the test parameters for setting CTCSS/CDCSS squelch to be sure they are correctly set up. Incorrect settings for any one of these test parameters will affect how the test runs.
 1. **Parameter 8, RX CT/CDCSS Available** lets the test set know whether the receiver's audio-squelch circuitry uses Continuous-Tone-Controlled Squelch System (CTCSS) or Continuous Digital-Controlled-Squelch-System (CDCSS).
 2. **Parameter 9, RX CT/CDCSS Control** allows the receiver's audio-squelch circuitry for CTCSS or CSCSS to be controlled by the test operator.
 3. **Parameter 10, RX CT/CDCSS Deviation** sets the amount of deviation on the signal modulating the CTCSS tone or CDCSS code word which is input to the receiver's antenna during the CT/CDCSS opening test.
 4. **Parameter 24, TX CD/CTCSS Available** lets the test set know that the radio transmits a carrier modulated with a CTCSS tone or CDCSS code word.
 5. **Parameter 25, TX CD/CTCSS Control** allows the transmitted CTCSS tone code or CDCSS code word to be controlled by the test operator (that is, turned on and off).
 6. **Parameter 26, TX CD/CTCSS Filter 1 Opt** allows the CD/CTCSS filter (test set Option 010 400 Hz High-Pass Filter) to be used by the test set if one is installed.

Chapter 6, Problem Solving
If your radio fails CTCSS/CDCSS tests or the tests don't run

- ❑ Check the **Channel Information** menu to see if the CTCSS frequency or tone code, or CDCSS code word is set up in the appropriate columns.
 1. Enter a CTCSS frequency, for example, 91.5 Hz as “**CT FR91.5**”, in both RX and TX channel information columns, or
 2. Enter a CTCSS tone code, for example, “ZZ” for 91.5 Hz as “**CT ZZ**” in both RX and TX channel information columns. The tone codes supported by the software are shown in [table 17, "CTCSS Tone Codes" on page 248](#), or
 3. Enter a CDCSS code word, for example “023” (octal) in both RX and TX channel information columns. The code words supported by the software are shown in [table 18, "CDCSS Code Words" on page 249](#).

Table 17 **CTCSS Tone Codes**

Tone Code	Frequency (Hz)	Tone Code	Frequency (Hz)
XZ	67	3B	131.8
—	69.3	4Z	136.5
XA	71.9	4A	141.3
WA	74.4	4B	146.2
XB	77	5Z	151.4
SP	79.7	5A	156.7
YZ	82.5	5B	162.2
YA	85.4	6Z	167.9
UB	88.5	6A	173.8
ZZ	91.5	6B	179.9
ZA	94.8	7Z	186.2
ZB	97.4	7A	192.8
1Z	100	M1	203.5
1A	103.5	M2	210.7
1B	107.2	M3	218.1
2Z	110.9	M4	225.7

Table 17 **CTCSS Tone Codes**

Tone Code	Frequency (Hz)	Tone Code	Frequency (Hz)
2A	114.8	—	233.6
2B	118.8	—	241.8
3Z	123	—	250.3
3A	127.3		

Table 18 **CDCSS Code Words**

Octal Code	Octal Code	Octal Code	Octal Code
023	315	143	532
025	331	152	546
026	343	155	565
031	346	156	606
032	351	162	612
043	364	165	624
047	365	172	627
051	371	174	631
054	411	205	632
065	412	223	654
071	413	226	662
072	423	243	664
073	431	244	703
074	432	245	712
114	445	251	723
115	464	261	731
116	465	263	732

Table 18 **CDCSS Code Words**

Octal Code	Octal Code	Octal Code	Octal Code
125	466	265	734
131	503	271	743
132	506	306	754
134	516	311	

If you can't get the data-collection function to work

- Check that you have **DATA C** entered in the TESTS (**External Devices**) (or **Edit Config**) menu.
 1. Press TESTS.
 2. Select the **External Devices** screen, from the **SET UP TEST SET** list (or **Edit Config** from the **Test Function** field).
 3. Position the cursor to the **Calling Name** field, push the knob and enter:
DATA C.
- Check the **Model** field, it should be kept empty since it is not used.
- Check the **Addr** (address) field to make sure the correct address is entered for where the data is to be stored.
 1. If data is to be stored on an SRAM memory card, enter "1" into the **Addr** field.
 2. If data is to be stored on an external computer through the test set's RS-232 serial port (if available), enter "9" into the **Addr** field.
 3. If data is to be stored on an external disk drive over HP-IB, enter an address of "700" or greater into the **Addr** field.
- Check the **Options** field to make sure it is correctly set up:
 1. **For an external disk drive (LIF format) or an SRAM memory card:**
 - a. Enter **ASCII** for saving data as an ASCII file.
 - b. Enter **BDAT** for saving data as a Binary-Data file.
 - c. As an option, you may enter **REC=xxx**, where "xxx" is the number of records for each file. *(The software defaults to 80 records. However, if too small a record size is used, you'll get an "End of file error" when the test is run.)*
 2. **For a DOS disk drive, you may keep the Options field empty, or you may enter any of the following key words:**
 - a. Enter **ASCII** for saving data as an ASCII file.
 - b. Enter **BDAT** for saving data as a Binary-Data file.
 - c. Enter **REC=xxx** for the file's record size, where "xxx" is the number of records for each file. *(The software defaults to 80 records. However, DOS systems automatically change record size if it's too small.)*
 - d. Enter a (**dot extension**) of 3 characters or less for the file name. For example, all model ABCD radio's tested may be organized to have a ".ABC" file extension.

Chapter 6, Problem Solving
If you can't get the data-collection function to work

- Check the test set to make sure it's in the controller mode *if you are using an external disk drive*.
 1. Access the I/O CONFIGURE screen from the **More** field in the **To Screen** menu.
 2. Position the cursor to the **Mode** field and select **Control**.

NOTE:

When the test operator is prompted to enter a file name where data is to be stored, the protocol for the mass-storage device being used must be followed.

Hierarchical directory paths are not allowed, and all files are created with "FORMAT ON".

Also, when initializing a disk, use the following format ("7xx" is the disk address, "y" is the device selector):

DOS disk: INITIALIZE "DOS:CS80,7xx,y"

LIF disk: INITIALIZE ":,7xx,y"

Glossary

CANCEL A key used to pause (stop) the IBASIC program running in the test set.

card Refers to the memory card containing the procedures for testing the unit-under-test.

Choices Refers to a field in the lower right of the screen that displays several possible functions for selection.

Continue Proceed with the IBASIC software program if it has been stopped (paused).

CS Carrier Squelch

CTCSS Continuous Tone Controlled Squelch System

cursor Refers to the brightened region of the screen used to indicate the field/function currently being accessed.

Del Step A function to delete a step in the procedure.

Disp Loc A menu function which presents an assembly diagram that displays location of the adjustable component.

ESD ElectroStatic Discharge - A transfer of electric charge from one place to another. Devices can be damaged by the energy transferred during the discharge.

field An area on the CRT with an inverse video display (**example**) where entries can be made.

function Refers to a particular field, feature, or operation of the test set.

Help A feature providing specific information about how to use the current screen in the TESTS environment. This feature is accessed by pressing k4 (**Help**) from any TEST screen. Note: this feature is only available in the HP 8920B or HP 8920A,D firmware above revision A.14.00.

HELP A feature providing additional test set information accessed by pressing SHIFT, then TX (HELP) keys. Help topics are listed in alphabetical order.

highlight Refers to the brightened region (cursor) of the screen used to indicate the field/function currently being accessed.

HPF High- Pass-Filter. A filter that increasingly passes signals as their frequency increases towards, and then is greater than, a certain cutoff frequency. In the test set, audio high pass filters are used to reduce the level of low frequency signals during certain measurements.

IBASIC Instrument BASIC is the computer language (code or software) used by the test set's built-in controller. The IBASIC software is downloaded from the OTP CARD into the test set's RAM. This software is then used to control the test set during autotesting the unit-under-test.

initialize A card or disk must be formatted prior to storing data. This may be done by pressing k3 (**Init Card**) on the TESTS (**Save/Delete Procedure**) screen. The default for PCMCIA cards (HP 11807E) is DOS format, and for Epson Cards (HP 11807A/B) is LIF format. [See "Memory Cards," in chapter 5, on page 202](#) for information on changing these default settings.

Glossary

key (USER keys) Keys refer to any of the push buttons on the front panel of the test set. The USER keys are a specific grouping of keys labeled k1 tok5 which perform the associated numbered function in the action field located in the upper right of the screen. The USER keys are user programmable.

knob The large tuning dial for cursor control located in the center of the test set front panel. This knob is rotated to position the cursor on the screen and then pressed to select the particular field or function.

library A collection of the names of all of the parameters, pass/fail limits, and tests in the test software. The test software and the test set's firmware use the library, test software program code file, and a procedure to run a customized application program. A library is stored as a file on a memory card or other mass storage with its associated procedure files.

Location Where to retrieve or save a particular testing procedure, for example, to a disk, card, RAM, or PC.

LPF Low-Pass Filter. A filter that increasingly rejects signals as their frequency increases towards, and then is greater than, a certain cutoff frequency. In the test set, audio low-pass filters are used to reduce the level of high frequency signals during certain measurements.

measurement A series of calculations on data measured by the test set. These calculations provide a value to be compared against pass/fail limit values that verify the performance of the unit-under-test.

Main Menu The screen accessed by

pressing the TESTS key, or k5 (**Main Menu**). It is used to customize and execute (run) automated testing.

Also referred to as the "TESTS" screen.

menu The test set's screen displays various tasks to be selected with the cursor control knob or the USER keys ; this display is the menu.

message The upper portion of the test set's screen is reserved for messages and prompts. Messages give an indication of the status of the test set, for example, **System initialization**.

OTP One Time Programmable (OTP) refers to a CARD on which code or data may only be stored once; similar to ROM. The HP 11807A/E software is shipped on an OTP memory card.

parameters Entries you make for calibration data, radio characteristics, or test customization. They give you flexibility in the way you use the software. Default values for parameters are present in the software.

pass/fail limits Pass/fail limits are the names of criteria verifying the performance of the unit-under-test. Usually, the associated measurement value must fall within the HI/LO limits of pass/fail values to verify performance of the unit-under-test. Default values in the test software have been derived from standard methods of measurement or from the unit-under-test requirements.

Glossary

pause Using the CANCEL key pauses the running of IBASIC software in the test set and allows access to the keyboard functions. CONTINUE allows the software to proceed.

peak+/- max A detector in the test set that measures and computes the maximum of the absolute value of the positive and negative excursions of the measurement. For example, when an FM waveform with a +10 kHz and -9 kHz deviation is applied, 10 kHz will be displayed.

PRESET Sets the test set to its initial power-up state.

procedure A shortened label for test procedure. A procedure is a collection of channels, parameters, pass/fail limits, and testing order, saved in a file, that customizes the test software to a specific application. Procedures are made by editing existing channels, parameters, pass/fail limits, and testing order, and saving the resulting files to a memory card, disk or internal test set RAM.

prompts The upper portion of the test set (inverse video field) is reserved for prompts and messages. The prompt directs the user to take some action. Messages give an indication of the status of the test set.

RAM Random Access Memory - The memory in the test set that is used to store program code and data. The test set's RAM is battery-backed-up, retaining data and program codes when the power is turned off.

ROM Read Only Memory

Run Test Directs the test set to load the program from the current procedure and begin testing (may take up to two minutes).

save Save and store are used synonymously and refer to putting data or software on some memory device, such as, card or RAM.

screen Refers to the video display of the test set.

select To choose a particular field or function. Rotate the CURSOR CONTROL knob and position the highlighted cursor on the chosen field or function, then press the knob. An alternative method is to press the numbered USER key having the same number as displayed alongside the desired function.

SINAD Signal plus noise and distortion divided by noise and distortion. A measurement result that determines the quality of an audio tone in the presence of noise and distortion. A 12 dB SINAD value is often used when measuring a receiver's sensitivity.

softkey The name of the set of keys next to the CRT display that can be assigned to certain special actions or fields. The keys are also called USER keys.

SRAM Static Random Access Memory - A data storage device. SRAM memory cards can be used with the test set to save programs and test results.

Step# Orders the sequence of tests, e.g. Step #1 may be Test_5, and Step #2 may be Test_26 and so on.

Glossary

store Store and save are used synonymously and refer to putting data or software on some memory device, such as card, RAM.

tests Tests are a collection of measurements (or a series of other tests) which verify a particular specification value or operation of the UUT. A sequence of tests are contained in a test procedure.

TESTS screen The screen accessed by pressing the TESTS key. It is used to customize and execute (run) all automated testing. Also referred to as the “Main Menu”.

USER keys A group of keys located immediately to the right of the test set’s screen that allow the user to more rapidly select certain functions without rotating and pressing the knob. These key assignments are displayed in the upper right portion of the test set’s screen. The number on the left of the function corresponds to the number on the user key k1 to k5.

values The scalar quantities or numbers inserted in the inverse video fields of the pass/fail limits or parameters. Units of measure (dB, inches, volts, watts, etc.) are contained in the pass/fail limits and test parameters.

Numerics

1-800 help line, 21

A

additional services available, 21

adjust volume, 124

AdvanceLink, 193

AF analyzer

400 Hz HPF filter option, 136

de-emphasis, 137

AM hum and noise, 99

residual, 183

ASCII file type, 190

at opening

SINAD, 151

audio distortion

for the transmitter, 163

audio distortion pass/fail limit

for the receiver, 146

audio distortion test

for the receiver, 102

for the transmitter, 96

audio frequency, 149

set the step size to vary, 125

audio input

is over-driven, 94

audio lines

carry other signals, 245

audio load impedance

for the receiver, 119

audio output

flatness, 95

audio output

at 40% of full-rated deviation, 150

measured, 108

audio power

maximum, 129

audio power, maximum

for the receiver, 123

audio response, 147

audio sensitivity, 150, 172

calculation of, 119

for the receiver, 108

audio squelch sensitivity test

for the receiver, 105

audio testing fails, 245

audio-bandpass response, 103

audio-frequency harmonic distortion,

163

audio-frequency response, 103, 167

delta from 6 dB/octave, 147, 164

for the receiver, 118

for the transmitter, 133

pre-emphasis, 164

step size, 118, 133

audio-frequency response test

for the transmitter, 95

audio-output power, 147

set the rated, 123

audio-response roll >2.5 kHz, 167

audio-squelch circuitry

uses CT/CDCSS, 120

audio-squelch sensitivity, 159, 160

Autostart, 87

Autostart Test Procedure on Power-Up,

235

B

battery drain, 158, 171
BDAT file type, 190
blocking capacitor
 for dc signals, 245

C

CANCEL, 211, 253
card
 how to insert, 28, 62
carrier
 modulated with a CTCSS tone or CDC-
 SS code word, 134
carrier frequency, 92
carrier power
 output rating, 177, 179, 181, 182
carrier-frequency stability, 174
CAT IBASIC command, 187
CDCSS available
 for the transmitter, 134
CDCSS available/control
 for the receiver, 120
CDCSS code word, 121
 carrier modulated with a, 134
 to be controlled by, 135
CDCSS code-word table, 249
CDCSS control
 for the transmitter, 135
CDCSS deviation
 for the receiver, 121
 for the transmitter, 169
CDCSS deviation and frequency test
 for the transmitter, 100
CDCSS filter
 for the transmitter, 136
CDCSS modulation, 169
CDCSS opening, 169
CDCSS opening level, 153
CDCSS opening test
 for the receiver, 107
CDCSS parameters, 247
CDCSS SINAD at opening, 154
CDCSS squelch
 if the radio uses, 135
CDCSS tests fail, 247
Changing the Order of Tests, 34
channel information
 general description, 38
 securing, 228
channel numbers
 specifying information, 38, 72
Choices, 186, 253
choose, 186
Clr Scr, 236

code word
 for CDCSS, 247
codes, tone
 for CTCSS, 247
code-word table
 for CDCSS octal codes, 249
configuration
 for data collection, 189
 for terminal or PC operation, 195
CONFIGURE screen
 for printer, 243
configuring an IBM-compatible PC with
 HP AdvanceLink, 193
connecting
 a printer, 213
 the radio, 28, 62
connections
 parallel printer, 214
 RJ-11 connector, 213
 serial printer, 213
Continue, 236, 253
Continue USER key, 211
continuing a paused program, 211
conventions used, 186
COPY IBASIC command, 187
COPY_PL program, 242
copying files, 187
CT/CDCSS, 152
CTCSS, 253
CTCSS available
 for the transmitter, 134
CTCSS available/control
 for the receiver, 120
CTCSS code frequency, 170
CTCSS control
 for the transmitter, 135
CTCSS deviation
 for the receiver, 121
 for the transmitter, 169
CTCSS deviation and frequency test
 for the transmitter, 100
CTCSS filter
 for the transmitter, 136
 HP 8920A Option 010, 400 Hz HPF,
 247
CTCSS frequency, 247
CTCSS frequency-error
 for the transmitter, 170

CTCSS modulation, 169
CTCSS opening, 169
CTCSS opening level, 153
CTCSS opening test
 for the receiver, 107
CTCSS parameters, 247
CTCSS SINAD at opening, 154
CTCSS squelch
 if the radio uses, 135
CTCSS tests fail, 247
CTCSS tone code
 carrier modulated with a, 134
 to be controlled by, 135
CTCSS tone-code table, 248
current
 required by FM radio, 91
current drain
 stand-by, 91
current-drain
 for the transmitter, 171
current-measuring circuit, 91
cursor, 253
customizing testing, 32, 66

D
data collection
 description, 189
 entering the configuration for, 189
 example configuration, 190
 memory card part numbers, 204
 retrieving data, 192, 198, 207
 saving to a memory card or disk, 189
 to a PC, 193
 to a PC, setting up, 195
dc signals
 require a blocking capacitor, 245
de-emphasis
 750 mu sec filter, 137
 for the receiver, 103
 for the transmitter, 137
dekey between TX tests
 for the transmitter, 138
Del Proc, 236
Delet Stp, 236, 253
deleting a procedure, 227
deviation
 CDCSS, 100
 CTCSS, 100
 for CT/CDCSS, 121
 full-rated system deviation, 114
 in excess of, 94
 measured at the microphone input, 139
deviation if set and measure
 for the transmitter, 172
disk
 initializing, 198
 retrieving data from, 198
disk drive
 External Disk Specification, 225
disk formats, LIF and DOS, 190
distortion
 audio, 96
 harmonic, 96
 harmonic, audio frequency, 163
Done, 236
DOS disk format, 190
DOS file type, 190

E
Edit Configuration
 data collection to a PC, 195
Edit Frequency, 38, 72
Edit Parameter, 48, 81
Edit Seqn field, 90
Edit Sequence, 68
Edit Spec, 210
Edit Specifications, 45, 78
EIA standards
 for FM tests, 90
ENTER key, 186
equipment
 additional requirements, 16
 included, 16
 recommended, 17
errors
 from hardware problems, 240
 from IBASIC, 240
 from operating HP 8920A, 240
 improper context terminator, 241, 242
 on MESSAGE screen, 240
 structures improperly matched, 241,
 242
escape sequences, 216
 rev B software with fw below A.14.00,
 221
exiting a program, 200

F

Factory Hot Line, 21
field, 253
 selecting a, 186
file name
 disk example, 198
 DOS with extensions, 191
file types
 ASCII, 190
 BDAT, 190
 DOS, 190
 HP-UX, 190
files
 copying, 187
filter
 400 Hz HPF, 136
 750 μ sec de-emphasis, 137
 for CDCSS tests, 247
 for CTCSS or CDCSS, 136
 for CTCSS tests, 247
filter, HPF
 for TX audio distortion, 96
 for TX FM hum and noise, 98
 for TX microphone sensitivity, 97
 for TX residual AM hum and noise, 99
flash
 memory cards, 203
FM current
 from power supply, 91
FM hum and noise, 152
 for the transmitter, 173
FM hum and noise test
 for the transmitter, 98
FM radio
 fails audio tests, 245
 fails CDCSS tests, 247
 fails CTCSS tests, 247
 parameters for setting volume, 246
FM signal
 pre-emphasized, 137
frequency
 editing values, 38, 72
 general description, 72
frequency deviation
 is measured, 94
frequency error
 for the transmitter, 174
frequency error test

 for the transmitter, 92
frequency error, CTCSS, 100
frequency information, secured, 143
frequency modulation
 residual measured, 98
frequency response test
 for the receiver, 103
frequency stability, 174
frequency table
 of CTCSS tone codes, 249
front-panel control characters, 195
full-rated deviation
 for audio output, 150
full-rated system deviation, 175

H

hardware errors, 240
harmonic components
 in audio distortion, 102
harmonic distortion, 96
harmonic distortion factor, 146
harmonic distortion, audio frequency,
 163
Help, 236
high-pass filter
 for CDCSS tests, 247
 for CTCSS tests, 247
 for TX audio distortion, 96
 for TX FM hum and noise, 98
 for TX microphone sensitivity, 97
 for TX residual AM hum and noise, 99
 Option 010, 136
high-power voltage setting
 test parameter, 115
HP 8920A, Option 010, 400 Hz HPF, 247
HP-IB control annunciators, 201
HP-IB printer, 215, 243
HP-IB printer connections, 213
HP-UX file type, 190
hum and noise, 152
 AM, 99, 183
 FM, 173
 squelched, 155
 unsquelched, 156
hum and noise squelched
 for the receiver, 155
hum and noise test
 for the receiver, 101

I

IBASIC, 253
 copying files, 187
 errors, 240
 initializing a disk, 198
 initializing RAM, 231
 retrieving data from a card, 192, 207
 retrieving data from a disk, 198
 TESTS screen, 32, 66
IBASIC commands
 entering from a terminal, 187
If Unit-Under-Test Fails, 54, 235
If UUT Fails, 235
improper context terminator
 error, 241, 242
Init Card, 236
initialized
 when the test set is, 117
initializing, 253
initializing a disk, 198
initializing an SRAM memory card, 205
initializing RAM disks, 231
Insrt Stp, 236

L

library, 254
 definition, 50, 83
 saving, 50, 83, 225
LIF disk format, 190
loading a procedure, 227
loading software, 28, 62
Location, 31, 65, 254
low-power voltage setting
 test parameter, 116

M

Main Menu, 236, 254
maximum battery drain, 158, 171
measurement, 254
measurements, 90
memory cards, 253
 are used for, 202
 determining whether it is OTP, flash, or
 SRAM, 203
 flash, 203
 how they're powered, 202
 initializing, 205
 inserting, 202
 OTP, 203
 removing, 203
 retrieving data from, 192, 207
 saving data to, 189
 software, 28, 62
 SRAM, 203
 SRAM battery part number, 204
 Static Random Access Memory
 (SRAM), 204
 storage space needed, 205
 write protect switch, 204
MESSAGE screen errors, 240
meter needle
 for setting radio volume, 246
meter screen
 for setting radio volume, 246
 full-scale reading, 129
 percentage of error, 129
 volume level, 123
MIC/ACC connector, 142
microphone
 not active, 245
 microphone and accessory connector,
 142
 microphone input, 139
 microphone sensitivity, 172
 for the transmitter, 139, 175
 iterative measurement of, 139
 microphone sensitivity test
 for the transmitter, 97
modulation frequency
 should be varied, 140
modulation limiting
 for the transmitter, 140, 176
 sweep step frequency, 140

modulation limiting test
for the transmitter, [94](#)

N

No, [236](#)
noise level, AM Hum, [183](#)
nominal (normal) power-supply voltage,
[117](#)
nominal supply voltage, [93](#)

O

octal code table
of CDCSS code words, [249](#)
On UUT Failure, [87](#)
operating errors, [240](#)
option 010
400 Hz HPF, [136](#)
Optional RAM message, [242](#)
order of tests
printing, [212](#)
saving, [226](#)
ordering upgrades, [18](#)
OTP
memory cards, [203](#)
OTP card, [254](#)
Output Destination, [87](#), [234](#)
Output Heading, [54](#), [87](#), [234](#)
output power
at high supply, [178](#)
at low supply, [180](#)
at the low-switch setting, [179](#), [181](#), [182](#)
for the transmitter, [177](#)
with the power supply set to low, [141](#)
output power at low switch
for the transmitter, [141](#)
output power test
for the transmitter, [93](#)
output power, audio
set the rated, [123](#)
output results, [87](#), [234](#)
for, [54](#), [234](#)
to, [54](#), [234](#)
output signal power, [101](#)

P

Page Down, 236
 Page Up, 236
 parallel printer connections, 214
 parameters, 254

- editing values, 48, 81, 209
- for CDCSS squelch, 247
- for CTCSS squelch, 247
- for setting radio volume, 246
- general description, 48, 81, 209
- printing, 212
- saving, 50, 83, 209, 226
- securing, 228

 part numbers

- memory card battery, 204
- software memory cards, 16
- SRAM Memory Cards, 204

 pass number, 228
 pass/fail limits, 254

- default values, 144
- descriptions, 144
- editing values, 45, 78, 210
- general description, 45, 78, 210
- printing, 212
- saving, 210, 226
- securing, 228

 pause, 255
 pausing a test, 211
 PC

- collecting data to, 193

 peak+ deviation

- for CDCSS, 100
- for CTCSS, 100

 power requirements

- for the transmitter, 178, 180

 power supply

- current, 91
- external, 178, 180
- low-switch setting, 179, 181, 182
- measurements, 93
- the radio's external, 115, 116

 power-supply voltage

- nominal (normal) value, 117
- set to its low setting, 141

 pre-emphasis

- for audio-frequency response, 164
- for the transmitter, 95

 pre-emphasized FM signal, 137

PRESET, 28, 62, 255

print options

- margins, 221
- paper size, 221
- pitch, 221
- typeface, 221

 printer

- does not print, 243
- HP-IB, 215
- HP-IB or serial, 243
- output heading, 234
- serial, 215

 printers supported, 212
 printing, 212

- test results, 234
- test results using firmware above revision A.14.00, 216
- test results using firmware below revision A.14.00, 221
- TESTS Screens, 219, 224
- using A.xx.xx revision software, 215

 procedure, 31, 65, 90, 255

- deleting, 227
- general description, 50, 83, 225
- loading into test set memory, 227
- names, 225
- saving, 50, 83, 225
- securing, 228
- un-securing, 229
- what is saved, 225

 product description, 16
 program

- exiting a program, 200
- incorrectly loaded, 242
- stored in test set memory, 203

 programmable power supply, 93

Q

quick test

- for the receiver, 110
- for the transmitter, 111

R

- radio
 - adjust the squelch control, 126
 - channel security, 143
 - connecting, 28, 62
 - dekey between TX tests, 138
 - keying, 142
 - microphone sensitivity, 139
 - operator to de-key, 138
 - security, 143
 - squelch setting, 127
 - transmit continuously, 138
- radio power-supply voltage
 - normal value, 117
- radio sensitivity
 - for squelch, 123
- radio squelch
 - is adjusted, 119
 - is adjusted during testing, 123
- radio standards
 - for FM, 90
- radio volume
 - can't be set, 246
 - control, 129
 - for the receiver is set, 124
 - is adjusted, 119
 - is adjusted during testing, 123
 - manually setting, 129
 - parameters, 246
- RAM, 255
 - disk, 230
 - initializing, 230
- RAM memory
 - enough for the test set, 242
- rated audio-output power, 123
- rated system deviation, 94
- REC=
 - default entry, 190
 - entering record number, 190
 - to set record size, 190
- receiver
 - audio distortion, 102
 - audio distortion pass/fail limit, 146
 - audio frequency response roll %, 148
 - audio sensitivity, 108
 - audio-frequency response, 118
 - audio-frequency response specification, 147
 - audio-load impedance, 119
 - audio-output specification, 150
 - audio-squelch sensitivity, 105
 - CDCSS opening, 107
 - CT/CDCSS available/control, 120
 - CT/CDCSS deviation, 121
 - CT/CDCSS opening level specification, 153
 - CT/CDCSS SINAD at opening specification, 154
 - CTCSS opening, 107
 - current drain, 91
 - de-emphasis, 103
 - frequency response, 103
 - frequency security, 143
 - hum and noise, 101
 - hum and noise specification, 156
 - hum and noise squelched specification, 155
 - maximum audio power, 123
 - quick test, 110
 - radio volume is set, 124
 - sensitivity testing, 131
 - squelch, 105
 - squelch blocking, 106
 - squelch blocking step frequency, 125
 - squelch control, 126
 - squelch preset only, 127
 - squelch sensitivity specification, 159
 - squelch-blocking specification, 157
 - standard RF input level, 128
 - stand-by current drain, 158
 - tight-squelch sensitivity specification, 160
 - tolerance for setting volume, 129
 - usable sensitivity, 104
 - usable sensitivity set and measure, 130
 - usable sensitivity SINAD level, 131
 - usable sensitivity specification, 161
 - variation of sensitivity specification, 162
 - variation of sensitivity with frequency, 109
- reference (usable) sensitivity, 128
- reference sensitivity, 161
- residual AM hum and noise
 - for the transmitter, 183
- Residual AM hum and noise test
 - for the transmitter, 99
- residual frequency modulation, 98
- retrieving data from a memory card, 192
- RF carrier
 - modulated with a CTCSS tone or CDCSS code word, 134
- RF generator's
 - output level, 128, 130
- RF input level
 - for the receiver, 128
- RF power, 177, 179, 181, 182
- RF signal level
 - for usable sensitivity, 104
- RJ-11 connectors, 233
- ROM, 255
- Run, 236
- Run Mode, 87, 235
- Run Test, 236, 255
 - difference between Run and, 192, 207
- running tests, 24
 - overview, 26, 60
- RX Audio frequency response roll %, 148
- RX CDCSS SINAD at Opening, 151
- RX CT/CDCSS FM Hum and Noise, 152

S

- save, 255
- SAVE IBASIC command, 187
- Save Proc, 236
- SAVE registers lost, 242
- saving
 - procedure, 50, 83
 - test procedure, 50
 - test results, 189
- saving a procedure, 225
- secure frequency information, 143
- SECURE IT ROM program, 228
- securing a procedure, 228
- security
 - for the radio, 143
- select, 186, 255
- sensitivity
 - audio, 119
 - audio squelch, 160
 - for the microphone, 172
 - microphone, 97
 - microphone, set and measure, 139
 - reference, 128
 - testing, 131
 - threshold squelch, 154
 - usable set and measure, 130
- sequence
 - changing, 34
 - editing, 68
 - general description, 34, 68
 - saving, 50, 83
- serial port connections
 - figure, 233
- serial printer, 215, 243
- serial printer connections, 213
- Signal-to-Residual Output Power Ratio, 155, 156
- SINAD, 255
 - at opening, 151
 - at the CDCSS opening, 107
 - at the CTCSS opening, 107
 - measured in usable sensitivity test, 104
- SINAD level
 - is within specified limits, 130
 - receiver usable sensitivity, 131
- Sngl Step, 236
- softkeys, 236, 255
- software
 - features, 19
 - how to load, 31, 65
 - loading, 28, 62
 - overview, 26, 60
 - stopping the, 211
 - software revision A.xx.xx
 - printer setup, 215
 - special display conventions used, 186
 - specifications
 - editing values, 45, 78
 - general description, 45, 78, 210
 - saving, 50, 83
 - specifying channel information
 - general description, 38, 72
 - squelch
 - CDCSS, 247
 - CTCSS, 247
 - squelch blocking, 160
 - for the receiver, 125, 157
 - while testing receiver, 125
 - squelch blocking test
 - for the receiver, 106
 - squelch control
 - for the receiver, 126
 - is adjusted during testing, 119
 - squelch knob, 127
 - squelch preset only
 - for the receiver, 127
 - squelch sensitivity
 - finding the, 123
 - squelch tone
 - opening level, 154
 - SRAM, 255
 - memory cards, 203, 204
 - standard RF input level
 - for the receiver, 128
 - standard RF signal
 - for audio distortion, 102
 - standards
 - for FM tests, 90
 - stand-by current drain
 - for the receiver, 158
 - stand-by current drain test, 91
 - steady-state deviation, 94
 - step size
 - for audio-frequency response, 133
 - Stop Test, 236
 - stopping a test, 211
 - stopping the program
 - using Test Execution Conditions, 54, 87, 234
 - structures improperly matched
 - error, 241, 242
 - supply voltage
 - the test parameter for normal value, 117
 - sweep step frequency
 - for modulation limiting, 140
 - system deviation, 114

T

- Take It, 236
- terminal emulator, 198
 - configuration, 195
 - DataStorm Technologies, Inc. Pro-Comm, 193
 - HP AdvanceLink, 193
- Test Execution Conditions, 54, 87, 234
- Test Functions, 32, 66
 - Edit Frequency, 72
 - Edit Parameter, 48, 81
 - Edit Sequence, 68
 - Edit Specifications, 45, 78
 - Procedure Manager, 50, 83
- test parameters
 - default values, 112
 - descriptions, 112
 - editing values, 209
 - general description, 209
- Test Procedure Run Mode, 54, 235
- test procedures, 50
 - don't run, 241
 - saving, 225
 - to load, 241
- test results
 - output failures, 234
 - printing using firmware above revision A.14.00, 216
 - printing using firmware below revision A.14.00, 221
 - retrieving from a disk, 198
 - retrieving from a memory card, 192, 207
 - saving, 189
 - security, 143
 - where sent, 234
- test set
 - keying the UUT, 142
- test system
 - overall description, 16
- test time, 211
- testing order
 - securing, 228
- tests, 256
 - entering a sequence of, 34, 68
 - environment and conditions, 48, 81
 - list of available, 18
 - pausing or stopping, 211
 - reference information, 90
 - required order, 90
 - running, 24
- TESTS (Pass/Fail Limits) screen
 - entering into, 210
- TESTS screen, 256
- threshold sensitivity, 105
 - adjust for, 160
- threshold squelch sensitivity, 153, 154
 - for the receiver, 159
- tight-squelch sensitivity, 105
 - for the receiver, 160
 - formula to calculate, 160
- tolerance for setting volume
 - for the receiver, 129
- tolerance window
 - for setting volume, 129, 246
- tone codes
 - for CTCSS, 247
- tone-code table
 - for CTCSS frequencies, 248
- tone-squelch opening SINAD, 153, 154
- transceiver
 - full-rated system deviation, 114
- transmit
 - at rated power, 171
 - continuously, 138
- transmitter
 - audio distortion, 96
 - audio sensitivity, 175
 - audio-distortion specification, 163
 - audio-frequency response, 95, 133
 - audio-frequency response specification, 164
 - audio-response roll-off specification, 167
 - CD/CTCSS available, 134
 - CD/CTCSS control, 135
 - CD/CTCSS filter 1 option, 136
 - CDCSS deviation and frequency, 100
 - CT/CDCSS deviation specification, 169
 - CTCSS deviation and frequency, 100
 - CTCSS frequency-error specification, 170
 - current drain, 91
 - current-drain specification, 171
 - de-emphasis, 137
 - dekey between TX tests, 138
 - deviation, 94
 - deviation set and measure specification, 172
 - FM hum and noise, 98
 - FM hum and noise specification, 173
 - frequency deviation, 95
 - frequency error, 92
 - frequency security, 143
 - frequency-error specification, 174
 - keying, 142
 - microphone connections for, 142
 - microphone sensitivity, 97
 - microphone sensitivity set and measure, 139
 - microphone-sensitivity specification, 175
 - modulation limiting, 94, 140
 - modulation-limiting specification, 176
 - output power, 93
 - output power at high supply specification, 178
 - output power at high-supply low-switch, 179
 - output power at low supply specification, 180
 - output power at low switch, 141
 - output power at low-supply low-switch, 181
 - output power at low-switch, 182
 - output-power specification, 177
 - pre-emphasis, 95
 - quick test, 111
 - residual AM hum and noise, 99, 183
 - user/system key the UUT, 142
 - TX Audio Frequency Response Roll %, 165
 - TX Audio Frequency Response Roll >2.5 kHz, 149

U

upgrades,ordering, 18
usable sensitivity, 109, 128
 for the receiver, 130, 131, 161
 iterative measurement of, 130
 SINAD level, 130
usable sensitivity test
 for the receiver, 104
USER keys, 186, 236, 256
user/system key the UUT
 for the transmitter, 142
UUT keyed
 by user or the test set, 142

V

variation of sensitivity
 with signal frequency, 161
 with signal frequency change, 162
variation of sensitivity test
 for the receiver, 109
voltage
 for extreme measurements, 93
 high supply, 115
 low supply, 116
 when testing extreme, 115, 116
volume
 can't be set, 246
 control, 129
 full-scale level, 246
 manually setting, 129
 tolerance for setting, 129
volume level
 of the meter screen, 123
volume, adjust, 124

Y

Yes, 236