

HP 8924C CDMA Mobile Station Test Set

Reference Guide

Firmware Version A.07.04 and above

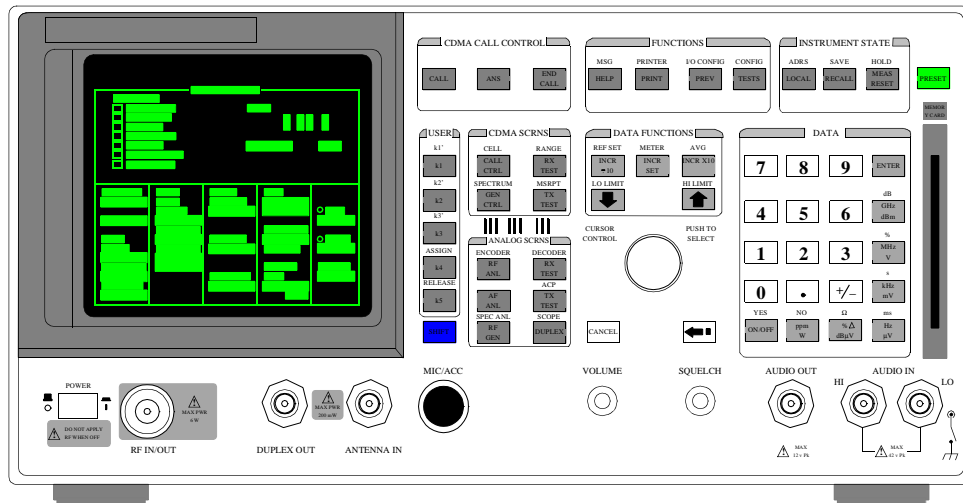

HP Part No. 08924-90053
Printed in U. S. A.
November 1999

Rev. F

Copyright © Hewlett-Packard Company 1997

Notice

Information contained in this document is subject to change without notice.

All Rights Reserved. Reproduction, adaptation, or translation without prior written permission is prohibited, except as allowed under the copyright laws.

This material may be reproduced by or for the U.S. Government pursuant to the Copyright License under the clause at DFARS 52.227-7013 (APR 1988).

Hewlett-Packard Company
Learning Products Department
24001 E. Mission
Liberty Lake, WA 99019-9599
U.S.A.

Manufacturer's Declaration

This statement is provided to comply with the requirements of the German Sound Emission Directive, from 18 January 1991.

This product has a sound pressure emission (at the operator position) < 70 dB(A).

- Sound Pressure $L_p < 70$ dB(A).
- At Operator Position.
- Normal Operation.
- According to ISO 7779:1988/EN 27779:1991 (Type Test).

Herstellerbescheinigung

Diese Information steht im Zusammenhang mit den Anforderungen der Maschinenlärminformationsverordnung vom 18 Januar 1991.

- Schalldruckpegel $L_p < 70$ dB(A).
- Am Arbeitsplatz.
- Normaler Betrieb.
- Nach ISO 7779:1988/EN 27779:1991 (Typprüfung).

Safety Considerations

GENERAL

This product and related documentation must be reviewed for familiarization with safety markings and instructions before operation.

This product has been designed and tested in accordance with *IEC Publication 1010*, "Safety Requirements for Electronic Measuring Apparatus," and has been supplied in a safe condition. This instruction documentation contains information and warnings which must be followed by the user to ensure safe operation and to maintain the product in a safe condition.

SAFETY EARTH GROUND

A uninterruptible safety earth ground must be provided from the main power source to the product input wiring terminals, power cord, or supplied power cord set.

CHASSIS GROUND TERMINAL

To prevent a potential shock hazard, always connect the rear-panel chassis ground terminal to earth ground when operating this instrument from a dc power source.

SAFETY SYMBOLS



Indicates instrument damage can occur if indicated operating limits are exceeded.



Indicates hazardous voltages.



Indicates earth (ground) terminal

WARNING

A WARNING note denotes a hazard. It calls attention to a procedure, practice, or the like, which, if not correctly performed or adhered to, could result in personal injury. Do not proceed beyond a WARNING sign until the indicated conditions are fully understood and met.

CAUTION

A CAUTION note denotes a hazard. It calls attention to an operation procedure, practice, or the like, which, if not correctly performed or adhered to, could result in damage to or destruction of part or all of the product. Do not proceed beyond an CAUTION note until the indicated conditions are fully understood and met.

Safety Considerations for this Instrument

WARNING

This product is a Safety Class I instrument (provided with a protective earthing ground incorporated in the power cord). The mains plug shall only be inserted in a socket outlet provided with a protective earth contact. Any interruption of the protective conductor inside or outside of the product is likely to make the product dangerous. Intentional interruption is prohibited.

Whenever it is likely that the protection has been impaired, the instrument must be made inoperative and be secured against any unintended operation.

If this instrument is to be energized via an autotransformer (for voltage reduction), make sure the common terminal is connected to the earth terminal of the power source.

If this product is not used as specified, the protection provided by the equipment could be impaired. This product must be used in a normal condition (in which all means for protection are intact) only.

No operator serviceable parts in this product. Refer servicing to qualified personnel. To prevent electrical shock, do not remove covers.

Servicing instructions are for use by qualified personnel only. To avoid electrical shock, do not perform any servicing unless you are qualified to do so.

The opening of covers or removal of parts is likely to expose dangerous voltages. Disconnect the product from all voltage sources while it is being opened.

Adjustments described in the manual are performed with power supplied to the instrument while protective covers are removed. Energy available at many points may, if contacted, result in personal injury.

The power cord is connected to internal capacitors that may remain live for 5 seconds after disconnecting the plug from its power supply.

For Continued protection against fire hazard, replace the line fuse(s) only with 250 V fuse(s) or the same current rating and type (for example, normal blow or time delay). Do not use repaired fuses or short circuited fuseholders.

CAUTION:

Always use the three-prong ac power cord supplied with this product. Failure to ensure adequate earth grounding by not using this cord may cause product damage.

This product is designed for use in Installation Category II and Pollution Degree 2 per *IEC 1010* and *IEC 664* respectively.

This product has autoranging line voltage input, be sure the supply voltage is within the specified range.

Ventilation Requirements: When installing the product in a cabinet, the convection into and out of the product must not be restricted. The ambient temperature (outside the cabinet) must be less than the maximum operating temperature of the product by 4° C for every 100 watts dissipated in the cabinet. If the total power dissipated in the cabinet is greater than 800 watts, then forced convection must be used.

Product Markings

CE - the CE mark is a registered trademark of the European Community. A CE mark accompanied by a year indicated the year the design was proven.

CSA - the CSA mark is a registered trademark of the Canadian Standards Association.

CERTIFICATION *Hewlett-Packard Company certifies that this product met its published specifications at the time of shipment from the factory. Hewlett-Packard further certifies that its calibration measurements are traceable to the United States National Institute of Standards and Technology, to the extent allowed by the Institute's calibration facility, and to the calibration facilities of other International Standards Organization members*

WARRANTY This Hewlett-Packard instrument product is warranted against defects in material and workmanship for a period of one year from date of shipment. During the warranty period, Hewlett-Packard Company will at its option, either repair or replace products which prove to be defective.

For warranty service or repair, this product must be returned to a service facility designated by HP. Buyer shall prepay shipping charges to HP and HP shall pay shipping charges, duties, and taxes for products returned to HP from another country.

HP warrants that its software and firmware designated by HP for use with an instrument will execute its programming instructions when properly installed on that instrument. HP does not warrant that the operation of the instrument, or software, or firmware will be uninterrupted or error free.

LIMITATION OF WARRANTY The foregoing warranty shall not apply to defects resulting from improper or inadequate maintenance by Buyer, Buyer-supplied software or interfacing, unauthorized modification or misuse, operation outside of the environmental specifications for the product, or improper site preparation or maintenance.

NO OTHER WARRANTY IS EXPRESSED OR IMPLIED. HP SPECIFICALLY DISCLAIMS THE IMPLIED WARRANTIES OF MERCHANTABILITY AND FITNESS FOR A PARTICULAR PURPOSE.

EXCLUSIVE REMEDIES THE REMEDIES PROVIDED HEREIN ARE BUYER'S SOLE AND EXCLUSIVE REMEDIES. HP SHALL NOT BE LIABLE FOR ANY DIRECT, INDIRECT, SPECIAL, INCIDENTAL, OR CONSEQUENTIAL DAMAGES, WHETHER BASE ON CONTRACT, TORT, OR ANY OTHER LEGAL THEORY.

ASSISTANCE *Product maintenance agreements and other customer assistance agreements are available for Hewlett-Packard products. For any assistance, contact your nearest Hewlett-Packard Sales and Service Office.*

DECLARATION OF CONFORMITY

according to ISO/IEC Guide 22 and EN 45014

Manufacturer's Name: **Hewlett-Packard Co.**

Manufacturer's Address: **Spokane Division
24001 E. Mission Avenue
Liberty Lake, Washington 99019-9599
USA**

declares that the product

Product Name: **CDMA Mobile Station Test Set**

Model Number: **HP 8924C**

Product Options: **This declaration covers all options of the above product.**

conforms to the following Product specifications:

Safety: **IEC 1010-1:1990+A1 / EN 61010-1:1993**

EMC: **CISPR 11:1990/EN 55011:1991- Group 1, Class A
EN 50082-1 : 1992
IEC 801-2:1991 - 4kV CD,8kV AD
IEC 801-3:1984 3V/m
IEC 801-4:1988 0.5 kV Sig. Lines, 1 kV Power Lines**

Supplementary Information:

This product herewith complies with the requirements of the Low Voltage Directive 73/23/EEC and the EMC Directive 89/336/EEC and carries the CE-marking accordingly.

Spokane, Washington USA October 17, 1996



Vince Roland
Reliability & Regulatory
Engineering Manager

European Contact: Your local Hewlett-Packard Sales and Service Office or Hewlett-Packard GmbH
Department ZQ/Standards Europe, Herrenberger Strasse 130, D-71034 Böblingen, Germany (FAX+49-7031-14-3143)

HP 8924C Support Contacts

The documentation supplied with your test set is an excellent source of reference, applications, and service information. Please use these manuals if you are experiencing technical problems:

- Applications information is included in the HP 8924C CDMA Mobile Station Test Set Application Guide (HP P/N 08924-90021)
- Calibration and repair information are in the HP 8924C CDMA Mobile Station Test Set Assembly Level Repair Manual - this manual (HP P/N 08924-90001).

If you have used the manuals and still have *application* questions, contact your local HP Sales Representative.

Repair assistance is available for the HP 8924C CDMA Mobile Test Set from the factory by phone and e-mail. Internal Hewlett-Packard users can contact the factory through HP Desk or cc:Mail© (Lotus Corporation). Parts information is also available from Hewlett-Packard.

When calling or writing for repair assistance, please have the following information ready:

- Instrument model number (HP 8924C)
- Instrument Serial Number (tag located on the rear panel).
- Installed options - if any (tag located on the rear panel).
- Instrument firmware revision (displayed at the top of the screen when the Test Set is powered up, and is also displayed on the CONFIGURE screen).

Support Telephone Numbers:

- 1 800 827 3848 (Spokane Division Service Assistance, U.S. only)
- 1 509 921 3848 (Spokane Division Service Assistance, International)
- 1 800 227 8164 (HP Direct Parts Ordering, U.S. only)
- 1 916 783 0804 (HP Service Parts Identification, U.S. & Intl.)

Electronic mail (Internet): Spokane_Service@spk.hp.com

cc:Mail: SERVICE, SPOKANE /HP-Spokane,desk1

Table 1 Regional Sales and Service Offices

<p>United States of America U.S. Instrument Support Center For Test & Measurement Equipment Repair & Calibration. Hewlett-Packard Company Englewood, Colorado 80112</p> <p>Telephone: (800) 403-0801 Fax: (888) 857-8161</p>	<p>United States of America Customer Information Center For Assistance On All HP Products. Hewlett-Packard Company Tel: (800) 752-0900</p> <p>6:00 am to 5:00 pm Pacific Time Parts Direct: 1-800-227-8164</p>	<p>United Kingdom Sales and Service Hewlett-Packard Ltd. Cain Road Amen Corner Bracknell, Berkshire RG12 1HN United Kingdom</p> <p>Telephone: 44 344 360000 Fax: 44 344 363344</p>
<p>South Eastern Europe Sales and Service Hewlett-Packard Ges. m.b.h. Liebigasse 1 P.O. Box 72 A-1222 Vienna, Austria</p> <p>Telephone: 43 222 2500 0 Telex: 13 4425</p>	<p>European Multicountry Region Sales and Service Hewlett-Packard S.A. P.O. Box 95 150, Route dv Nant_dl_AVRIL CH-1217 Meyrin 2 Geneva, Switzerland</p> <p>Telephone: (41/22) 780-8111 Fax: (41/22) 780-8542</p>	<p>Northern Europe Sales and Service Hewlett-Packard Nederland B.V. Startbaan 16 1187 XR Amstelveen, The Netherlands P.O. Box 667</p> <p>Telephone: 31/20 5476911 X 6631 Fax: 31-20-6471825NL</p>
<p>Asia Sales and Service Hewlett-Packard Asia Ltd. 22-30/F Peregrine Tower Lippo Center 89 Queensway, Central Hong Kong G.P.O. Box 863 Hong Kong</p> <p>Telephone: 852-848-7777 Fax: 852-868-4997</p>	<p>Japan Hewlett-Packard Japan, Ltd. Measurement Assistance Center 9-1, Takakura-Cho Hachioji-Shi Tokyo 192-8510, Japan</p> <p>Telephone: (81)-426-56-7832 Fax: (81)-426-56-7840</p>	<p>International Sales Branch Headquarters Sales and Service Hewlett-Packard S.A. 39 Rue Veyrot P.O. Box 365 1217 Meyrin 1 Geneva, Switzerland</p> <p>Telephone: 41-22-780-4111 Fax: 41-22-780-4770</p>
<p>Australia, New Zealand Sales and Service Hewlett-Packard Ltd. P.O. Box 221 31-41 Joseph Street Blackburn, Victoria 3130</p> <p>Telephone: (61/3) 895-2895 Fax: (61/3) 898-9257</p>	<p>Canada Sales and Service Hewlett-Packard (Canada) Ltd. 5150 Spectrum Way Mississauga, Ontario L4W 5G1 Canada</p> <p>Telephone: (416) 206-4725 Fax: (416) 206-4739</p>	<p>Canada Service Center Hewlett-Packard Company 17500 Transcanada Highway S. Serv Road Kirkland, Quebec H9J 2X8 Canada</p> <p>Telephone: (416) 206-3295</p>

Table 1 **Regional Sales and Service Offices (Continued)**

Canada
Service Center
Hewlett-Packard Ltd.
11120 178 Street
Edmonton, Alberta T5S 1P2
Canada

Telephone: (403) 486-6666
Fax: (403) 489-8764

Latin America
Hewlett-Packard Company
LAHQ Mexico City
Col. Lomas de Virreyes
11000 Mexico D.F.
Mexico

Telephone: (52/5) 326-4000
Fax: (52/5) 202 7718

In this Book

Throughout this manual the term "Test Set" is used to denote the HP 8924C.

Test Set screens shown in this manual may not match those displayed on the Test Set in every detail.

Chapter 1, Key and Miscellaneous Knob Descriptions

This chapter describes functions of the Test Set's keys.

Chapter 2, Connector Descriptions

This chapter describes the Test Set's connectors.

Chapters 3 Screen Descriptions

This chapters describe the Test Set's screens for CDMA testing and for analog testing..

Chapters 4 Field Descriptions

This chapters describe the fields found on the Test Set's screens for CDMA testing and for analog testing.

Contents

1 Description of Keys

Keys That Begin with the Letter A	23
Keys That Begin with the Letter C	27
Keys That Begin with the Letter E	28
Keys That Begin with the Letter H	29
Keys That Begin with the Letter I	30
Keys That Begin with the Letter K	34
Keys That Begin with the Letter L	35
Keys That Begin with the Letter M	40
Keys That Begin with the Letter O	44
Keys That Begin with the Letter P	45
Keys That Begin with the Letter R	47
Keys That Begin with the Letter S	51
Keys That Begin with the Letter Y	53
Keys That Begin with a Number	54
Symbol Keys	55
Miscellaneous Hardware	56
Programmable Front-Panel Keys for Screens	57
Non-Programmable Front-Panel Keys and Functions	58
DATA FUNCTIONS Keys	59

Contents

USER Keys 61

2 Description of Connectors

Connectors That Begin with the Letter A	65
Connectors That Begin with the Letter C	69
Connectors That Begin with the Letter D	72
Connectors That Begin with the Letter E	74
Connectors That Begin with the Letter H	75
Connectors That Begin with the Letter M	76
Connectors That Begin with the Letter P	79
Connectors That Begin with the Letter R	81
Connectors That Begin with the Letter S	83
Connectors That Begin with a Number	85

3 Description of Screens

Adjacent Channel Power Screen	88
AF Analyzer Screen	90
Call Control Screens	92
CDMA Authentication Screen	105
CDMA Call Control Screen	106
CDMA Cell Site Configuration Screen	107
CDMA Cellular Mobile Receiver Test Screen	108
CDMA Cellular Mobile Transmitter Test Screen	110
CDMA Generator Control Screen	111
CDMA Mobile Reported FER Screen	113
CDMA Mobile Reported Pilot Strength Screen	114
CDMA Short Message Service Screen	115
CDMA Transmitter Power Range Test Screen	116
CDMA Reverse Channel Spectrum Screen	117
Configure Screen	118
Duplex Test Screen	119
Help Screens	121
I/O Configure Screen	122
Message Screen	123

Contents

Oscilloscope Screens	124
Print Configure Screen	126
RF Analyzer Screen	127
RF Generator Screen	129
RX Test Screen	131
Service Screen	133
Spectrum Analyzer Screens	134
TESTS Screens	136
TX TEST Screen	147

4 Description of Fields

Fields That Begin with the Letter A	150
Fields That Begin with the Letter B	181
Fields That Begin with the Letter C	187
Fields That Begin with the Letter D	213
Fields That Begin with the Letter E	243
Fields That Begin with the Letter F	261
Fields That Begin with the Letter G	269
Fields That Begin with the Letter H	270
Fields That Begin with the Letter I	273
Fields That Begin with the Letter K	281
Fields That Begin with the Letter L	283
Fields That Begin with the Letter M	285
Fields That Begin with the Letter N	310
Fields That Begin with the Letter O	316
Fields That Begin with the Letter P	326
Fields That Begin with the Letter R	348
Fields That Begin with the Letter S	373
Fields That Begin with the Letter T	417
Fields That Begin with the Letter U	441

Contents

Fields That Begin with the Letter V 444

Fields That Begin with the Letter W 446

Fields That Begin with the Letter X 447

Fields That Begin with a Number 448

Contents

1 Description of Keys

The keys are listed in alphabetical order.

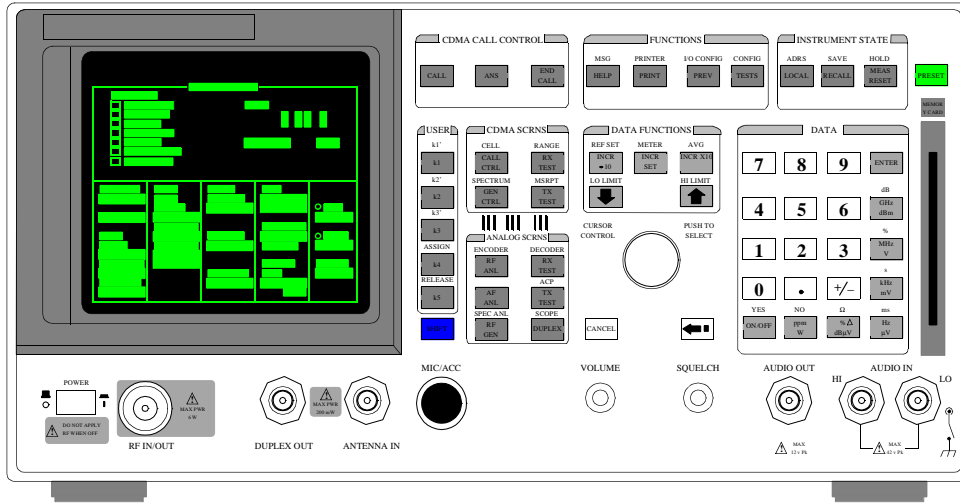

Figure 1 HP 8924C Front Panel

Keys That Begin with the Letter A

ADRS

Press and release the SHIFT key, then the LOCAL key to display the HP-IB address of the Test Set. There is no equivalent HP-IB command for the ADRS key

Programming ADRS

The Test Set's HP-IB address can be changed through HP-IB by using the :CONFigure:BADdress commands. If the Test Set's HP-IB address is changed programmatically, all future HP-IB commands must use the new address.

Example

```
OUTPUT 714;"CONF:BADD 15"
```

This sets the Test Set's HP-IB address to 15.

The Test Set's HP-IB address can be queried through HP-IB by using the :CONFigure:BADdress? commands.

Example

```
OUTPUT 714;"CONF:BADD?"  
ENTER 714;Address
```

This queries the Test Set's HP-IB address.

See Also

["I/O Configure Screen" on page 122](#)

ANS

This key functions only when **Answer Mode** is set to **Manual**.

Pressing this key answers CDMA-mode mobile-station-originated calls by removing the ring back tone from the mobile station's audio path and allowing user conversation or other traffic to be exchanged.

The Test Set will automatically answer calls if **Answer Mode** is set to **Auto**.

HP-IB Example

```
"DISP CCNT;CDMA:CALL:ANSW"
```

AVG

Press and release the SHIFT key, then the INCR x10 key to access the average function. This enables or disables measurement averaging.

Programming AVG

The HP-IB command :AVERage is used to select this data function programmatically.

NOTE: Measurement averaging works the same way programmatically as it does manually.

If the AVG data function is enabled manually and the number of averages is set to ten (N=10), the first value displayed is the average of 1 measurement, the second value displayed is the average of two measurements, the third value displayed is the average of three measurements... the tenth value displayed is the average of 10 measurements. For readings greater than N the data function approximates a hardware single-pole, RC low-pass filter.

If the AVG data function is enabled programmatically and the number of averages is set to ten (N=10) the first value returned through HP-IB is the average of 1 measurement, the second value returned through HP-IB is the average of two measurements, the third value returned through HP-IB is the average of three measurements...the tenth value returned through HP-IB is the average of 10 measurements. Each successive reading would mimic the output of a single-pole, RC low-pass filter that had been initially charged to the value of the tenth reading.

If a “true average” value is desired, that is $V_{avg} = (V_1+V_2+V_3...V_N)/N$, the recommended procedure through HP-IB is to take N sequential readings and calculate the average within the program context.

To Turn Measurement Averaging ON and OFF. Use the :AVERage:STATe commands to turn the averaging data function ON and OFF.

Syntax

```
:AVERage:STATe ON  
:AVERage:STATe OFF
```

Example

```
OUTPUT 714; "MEAS:AFR:DISTN:AVER:STAT ON"
```

This turns the AVG data function ON for the AF Analyzer distortion measurement.

To Query the Measurement Averaging State. Use the :AVERage:STAT? commands to query the current state of the averaging data function. The returned value is either: 0 (OFF) or 1 (ON).

Syntax

:AVERage:STAT?

Example

```
OUTPUT 714;"MEAS:AFR:DISTN:AVER:STAT?"  
ENTER 714;State_on_off ! 1 = ON, 0 = OFF
```

This queries the state of the AVG data function for the AF Analyzer distortion measurement.

To Reset Averaging. Use the :AVERage:RESet commands to restart the averaging algorithm used to calculate an averaged measurement.

Syntax

:AVERage:RESet

Example

```
OUTPUT 714;"MEAS:AFR:DISTN:AVER:RES"
```

This resets the AVG Data Function for the AF Analyzer distortion measurement.

To Set the Number of Averages. Use the :AVERage:VALue commands to set the number of averages used by the averaging algorithm.

Syntax

:AVERage:VALue

Example

```
OUTPUT 714;"MEAS:AFR:DISTN:AVER:VAL 25"
```

This sets the number of averages to 25 for the AVG data function for the AF Analyzer distortion measurement.

To Query the Number of Averages. Use the :AVERage:VALue? commands to query the number of averages used by the averaging algorithm.

Syntax

:AVERage:VALue?

Example

```
OUTPUT 714;"MEAS:AFR:DISTN:AVER:VAL?"  
ENTER 714;Num_of_avgs
```

This queries the number of averages for the AVG data function for the AF Analyzer distortion measurement.

See Also

[“To Use Measurement Averaging”](#) in the Operating Overview chapter of the *HP 8924C User’s Guide*.

ASSIGN

This key is used to assign the User Keys, K1 through K5, and K1' through K3'. Press and release the SHIFT key, then the K4 key to select the ASSIGN function.

HP-IB Example

No equivalent HP-IB command

See Also

“Using USER Keys” in the Operating Overview chapter of the *HP 8924C User's Guide*

IBASIC User's Handbook to assign IBASIC commands to user keys

Keys That Begin with the Letter C

CALL

When this key is pressed, the Test Set attempts a CDMA-mode page to a mobile station. The Call Status annunciators on the CDMA CALL CONTROL screen indicate call flow.

Refer to “[Setting Up a Call](#)” chapter in the *HP 8924C Application Guide*.

HP-IB Example

```
"DISP CCNT;CDMA:CALL:MAKE"
```

CANCEL

CANCEL is used to cancel an entry in progress, or to stop a running IBASIC program. For example, if you press RECALL to recall an instrument setup, and then decide not to recall a setting, pressing CANCEL exits the recall procedure.

HP-IB Example

No equivalent HP-IB command

Keys That Begin with the Letter E

END CALL

When this key is pressed, the Test Set disconnects any CDMA-mode call that is currently connected.

HP-IB Example

"DISP CCNT;CDMA:CALL:END"

ENTER

ENTER is used to select a field or screen, and to enter numbers when the unit-of-measure is not specified. This function is identical to pressing the cursor-control knob.

HP-IB Example

No equivalent HP-IB command

EEX

Press and release the SHIFT key, then the +/- key to access the exponent function. This function is used for entering numbers using scientific notation.

See Also

[“To Enter Values with Exponents”](#) in the Operating Overview chapter of the *HP 8924C User's Guide*

Keys That Begin with the Letter H

HOLD

Press and release the SHIFT key, then the MEAS RESET key. This stops all measurements. Selecting HOLD again resumes measurements.

The HOLD key is used to hold/resume all active measurements. There is no equivalent HP-IB command for the HOLD key. However, the functionality of the HOLD key can be implemented remotely by using Single Triggering of measurements.

HP-IB Example

No equivalent HP-IB command

See Also

[“Measurement Triggering Process”](#) in the Operating Overview chapter of the *HP 8924C User’s Guide*

Keys That Begin with the Letter I

INCR ÷10, INCR SET, INCR x10

These keys are used to change the increment/decrement value when changing field values.

The increment divide-by-10 function reduces the increment setting by a factor of 10 (new increment setting = current setting ÷ 10).

The increment setting function sets the increment value for real-number numeric entry fields.

The increment multiply-by-10 function increases the increment setting by a factor of 10 (new increment setting = current setting × 10).

Programming INCR SET

The HP-IB command :INCRement is used to select this data function programmatically.

To Set the Increment Value. Use the :INCRement command to set the increment value.

Syntax

:INCRement

Example

```
OUTPUT 714; "RFQ:FREQ:INCR 2.5 MHZ"
```

*This sets the increment value for the **RF Gen Freq** field to 2.5 MHz.*

NOTE:

When setting the value of a numeric field (such as **RF Gen Freq**), any non-HP-IB unit's unit-of-measure must be specified in the command string, otherwise the current HP-IB unit is assumed by the Test Set. Integer-only fields (such as **Intensity** and **Print Adrs**) have a fixed increment of 1, and they cannot be changed.

To Query the Increment Value. Use the :INCRement? command to query the increment value.

Syntax

```
:INCRement?
```

Example

```
OUTPUT 714;"RFG:FREQ:INCR?"  
ENTER 714;Incr_value
```

This queries the increment value for the RF Gen Freq field.

NOTE:

When querying a field setting or measurement result through HP-IB, the Test Set always returns numeric values in HP-IB units or attribute units, regardless of the field's current display units setting. Refer to ["To Specify Units-of-Measure for HP-IB Data Transfer"](#) in the Operating Overview chapter of the *HP 8924C User's Guide*.

To Set the Increment Mode. Use the :INCRement:MODE commands to set the increment mode to line24ar or logarithmic.

Syntax

```
:INCRement:MODE <LOGarithm or LINear>
```

Example

```
OUTPUT 714;"RFG:FREQ:INCR:MODE LOG"
```

This sets the increment mode for the RF Generator's frequency to logarithmic.

To Query the Increment Mode. Use the :INCRement:MODE? commands to query the increment mode.

Syntax

```
:INCRement:MODE?
```

Example

```
OUTPUT 714;"RFG:FREQ:INCR:MODE?"  
ENTER 714;Mode$ ! returns LIN or LOG
```

This queries the increment mode of the RF Generator's frequency.

To Set the Increment Value Display Units. Use the :INCRement:DUNits commands to set the units-of-measure used to display the increment value. Refer to ["To Specify Units-of-Measure for CRT Display"](#) in the Operating Overview chapter of the *HP 8924C User's Guide* for description of display units.

Syntax

```
:INCRement:DUNits <disp_units>
```

Example

```
OUTPUT 714;"RFG:FREQ:INCR:DUN KHZ"
```

This sets the increment value's display units to kHz for the RF Generator's frequency.

NOTE: When querying a field setting through HP-IB, the Test Set always returns numeric values in HP-IB units or attribute units, regardless of the field's current display units setting. Numeric values are expressed in scientific notation. Refer to "To Specify Units-of-Measure for HP-IB Data Transfer" in the Operating Overview chapter of the *HP 8924C User's Guide*.

To Query the Increment Value Display Units. Use the :INCRement:DUNits? commands to query the units-of-measure used to display the increment value. Refer to "To Specify Units-of-Measure for CRT Display" in the Operating Overview chapter of the *HP 8924C User's Guide* for description of display units.

Syntax

:INCRement:DUNits?

Example

```
OUTPUT 714;"RFG:FREQ:INCR:DUN?"  
ENTER 714;Disp_unit$
```

This queries the increment value's display units for the RF Generator's frequency.

Programming INCR÷10

Syntax

:INCRement:DIVide

NOTE: Integer-only fields (such as **Intensity** and **Print Adrs**) have a fixed increment of 1, and cannot be changed.

Example

```
OUTPUT 714;"RFG:FREQ:INCR:DIV"
```

If the RF Generator's frequency increment is 10 MHz, this command reduces the increment value from 10 MHz to 1 MHz.

Programming INCR×10

NOTE: Integer-only fields (such as **Intensity** and **Print Adrs**) have a fixed increment of 1, and cannot be changed.

Syntax

:INCRement:MULTiply

Example

OUTPUT 714; "RFG:FREQ:INCR:MULT"

If the RF Generator's frequency increment is 1 MHz, this command increases increment value from 1 MHz to 10 MHz.

See Also

[“To Increment/Decrement Values”](#) in the Operating Overview chapter of the *HP 8924C User's Guide*

Keys That Begin with the Letter K

K1 - K5, & K1' - K3'

These keys are used to display fields from another screen, or access fields without using the CURSOR CONTROL knob or changing screens.

HP-IB Example

No equivalent HP-IB command

See Also

[“Using USER Keys”](#) in the Operating Overview chapter of the *HP 8924C User's Guide*

Keys That Begin with the Letter L

LOCAL

LOCAL returns the instrument to manual control after HP-IB control is used, except when the Test Set is in local-lockout mode. The Test Set returns to Local operation (full front-panel control) when either the Go To Local (GTL) bus command is received, the front-panel LOCAL key is pressed or the REN line goes false. When the Test Set returns to local mode the output signals and internal settings remain unchanged, except that triggering is reset to “repetitive” and settling is reset to “full”. The LOCAL key will not function if the Test Set is in the local lockout mode.

Programming LOCAL

Using HP BASIC, the statement LOCAL returns all specified devices to their local state.

Example

```
LOCAL 714
```

puts the device at address 14 in local mode.

LO LIMIT, HI LIMIT

Press and release the SHIFT key, then the down-arrow key to access the low limit function. Press and release the SHIFT key, then the up-arrow key to access the high limit function. These functions are used to set measurement endpoints. Exceeding the end points causes screen prompts to blink until they are reset.

Programming HI LIMIT and LO LIMIT

The HI LIMIT and LO LIMIT data functions are used to define a measurement “window” which can be used to detect measured values which are outside the defined limits. The HP-IB commands :HLIMit (high limit) and :LLIMit (low limit) are used to set these data functions programmatically.

To Turn High and Low Measurement Limit Checking ON and OFF. Use the :HLIMit:STATe and :LLIMit:STATe commands to turn high and low measurement limit checking ON and OFF.

Syntax

```
:HLIMit:STATe ON  
:HLIMit:STATe OFF  
:LLIMit:STATe ON  
:LLIMit:STATe OFF
```

Example

```
OUTPUT 714;"MEAS:AFR:DISTN:HLIM:STAT ON"  
OUTPUT 714;"MEAS:AFR:DISTN:LLIM:STAT ON"
```

This turns high and low measurement limit checking ON for the AF Analyzer distortion measurement.

To Query the State of High and Low Measurement Limit Checking. Use the :HLIMit:STATe? and :LLIMit:STATe? commands to query the current state of the high and low measurement limit checking. The returned value is either: 0 (OFF) or 1 (ON).

Syntax

```
:HLIMit:STATe?  
:LLIMit:STATe?
```

Example

```
OUTPUT 714;"MEAS:AFR:DISTN:HLIM:STAT?"  
ENTER 714;Hi_state ! 1 = ON, 0 = OFF  
OUTPUT 714;"MEAS:AFR:DISTN:LLIM:STAT?"  
ENTER 714;Lo_state ! 1 = ON, 0 = OFF
```

This queries the state of high and low measurement limit checking for the AF Analyzer distortion measurement.

To Set High and Low Measurement Limits. Use the :HLIMit:VALue and :LLIMit:VALue commands to set the high and low measurement limit values.

Syntax

```
:HLIMit:VALue  
:LLIMit:VALue
```

Example

```
OUTPUT 714;"MEAS:AFR:FM:HLIM 7.5 KHZ"  
OUTPUT 714;"MEAS:AFR:FM:LLIM 2.5 KHZ"
```

This sets a high measurement limit of 7.5 kHz and a low measurement limit of 2.5 kHz for the AF Analyzer FM deviation measurement.

NOTE:

When setting high and low limit values, a non-Attribute Unit unit-of-measure must be specified in the command string, otherwise the current Attribute Unit is assumed by the Test Set. Refer to [“To Specify Units-of-Measure for HP-IB Data Transfer”](#) in the Operating Overview chapter of the *HP 8924C User’s Guide*.

To Set the Display Units for High and Low Measurement Limits. Use the :HLIMit:DUNits and :LLIMit:DUNits commands to set the units-of-measure used to display the high and low measurement limit values.

Refer to [“To Specify Units-of-Measure for CRT Display”](#) in the Operating Overview chapter of the *HP 8924C User’s Guide* for description of display units.

Syntax

```
:HLIMit:DUNits <disp_units>  
:LLIMit:DUNits <disp_units>
```

Example

```
OUTPUT 714;"MEAS:AFR:FM:HLIM:DUN KHZ"  
OUTPUT 714;"MEAS:AFR:FM:LLIM:DUN KHZ"
```

This sets the high and low measurement limit display units to kHz for the AF analyzer FM deviation measurement.

NOTE:

When querying measurement limits through HP-IB, the Test Set always returns numeric values in attribute units, regardless of the current display units or HP-IB units settings. Numeric values are expressed in scientific notation. Refer to [“To Specify Units-of-Measure for HP-IB Data Transfer”](#) in the Operating Overview chapter of the *HP 8924C User’s Guide*.

To Query the Display Units for High and Low Measurement Limits. Use the :HLIMit:DUNits? and :LLIMit:DUNits? commands to query the units-of-measure used to display the high and low measurement limit values.

Refer to “[To Specify Units-of-Measure for CRT Display](#)” in the Operating Overview chapter of the *HP 8924C User’s Guide* for description of display units.

Syntax

```
:HLIMit:DUNits?  
:LLIMit:DUNits?
```

Example

```
OUTPUT 714;"MEAS:AFR:FM:HLIM:DUN?"  
ENTER 714;Hi_disp_unit$  
OUTPUT 714;"MEAS:AFR:FM:LLIM:DUN?"  
ENTER 714;Lo_disp_unit$
```

This queries the high measurement limit display units for the AF Analyzer FM deviation measurement.

NOTE: When querying measurement limits through HP-IB, the Test Set always returns numeric values in attribute units, regardless of the current display units or HP-IB units settings. Numeric values are expressed in scientific notation. Refer to “[To Specify Units-of-Measure for HP-IB Data Transfer](#)” in the Operating Overview chapter of the *HP 8924C User’s Guide*.

To Query the High and Low Measurement Limit Settings. Use the :HLIMit:VALue? and :LLIMit:VALue? commands to query the high and low measurement limit settings.

Syntax

```
:HLIMit:VALue?  
:LLIMit:VALue?
```

Example

```
OUTPUT 714;"MEAS:AFR:FM:HLIM:VAL?"  
ENTER 714;High_limit  
OUTPUT 714;"MEAS:AFR:FM:LLIM:VAL?"  
ENTER 714;Low_limit
```

This queries the high and low measurement limits for the AF Analyzer FM deviation measurement.

NOTE: When querying measurement limits through HP-IB, the Test Set always returns numeric values in attribute units, regardless of the current display units or HP-IB units settings. Numeric values are expressed in scientific notation. Refer to “[To Specify Units-of-Measure for HP-IB Data Transfer](#)” in the Operating Overview chapter of the *HP 8924C User’s Guide*.

To Detect If a Measurement Limit Has Been Exceeded. Use the :HLIMit:EXCeeded? and :LLIMit:EXCeeded? commands to detect if a measurement limit has been exceeded. The returned value is either: 0 (NO) or 1 (YES).

Syntax

```
:HLIMit:EXCeeded?  
:LLIMit:EXCeeded?
```

Example

```
OUTPUT 714;"MEAS:AFR:FM:HLIM:EXC?"  
ENTER 714;Hi_limit_exced ! 1= YES, 0 = NO  
OUTPUT 714;"MEAS:AFR:FM:LLIM:EXC?"  
ENTER 714;Lo_limit_exced ! 1= YES, 0 = NO
```

This determines if the high or low measurement limits for the AF Analyzer FM deviation measurement have been exceeded.

To Reset Measurement Limit Detection. Use the :HLIMit:RESet and :LLIMit:RESet commands to reset measurement limit detection. Once a high or low measurement limit has been exceeded (:HLIMit:EXCeeded? returns a 1 or :LLIMit:EXCeeded? returns a 1), measurement limit detection is disabled until reset by the :RESet command.

Syntax

```
:HLIMit:RESet  
:LLIMit:RESet
```

Example

```
OUTPUT 714;"MEAS:AFR:FM:HLIM:RES"  
OUTPUT 714;"MEAS:AFR:FM:LLIM:RES"
```

This resets high and low measurement limit detection for the AF Analyzer FM deviation measurement.

See Also

“Setting Measurement Limits” in the Operating Overview chapter of the *HP 8924C User’s Guide*.

Keys That Begin with the Letter M

MEAS RESET

MEAS RESET clears the measurement history for all of the instrument's measurement algorithms (such as the averaging and peak hold functions) to restart all measurements that are in progress.

Programming MEAS RESET

The HP-IB commands :MEASure:RESet are used to select this function programmatically.

Example

```
OUTPUT 714; ":MEAS:RES"
```

This resets all of the active measurements in the Test Set.

METER

The METER function displays measurements graphically. The METER format is available for most measurements. To determine if the METER format is provided for a measurement, position the cursor in front of the measurement's units field and press the knob. If the message "Press ON/OFF, LIMITs, REF, AVG, METER, or units" is displayed, the METER format is provided.

Programming METER

The HP-IB command :METer is used to select this data function programmatically.

To Turn the Meter ON and OFF.

Use the :METer:STATe commands to turn the meter ON and OFF. The parameter can be a 1 or ON to turn the meter on and a 0 or OFF to turn the meter off.

Syntax

```
:METer:STATe <ON> or <1>  
:METer:STATe <OFF> or <0>
```

Example

```
OUTPUT 714; "MEAS:RFR:POW:MET ON"
```

This turns the analog bar-graph meter ON for the TX power measurement.

To Query the State of the Meter.

Use the :METer:STATe? commands to query the state of the analog bar-graph meter. The query returns a 1 if the meter is ON, and a 0 if the meter is OFF.

Syntax

```
:METer:STATe?
```

Example

```
OUTPUT 714;"MEAS:RFR:POW:MET:STAT?"  
ENTER 714;Meter_on_off ! returns a 1 (ON) or 0 (OFF)
```

This queries the state of the analog bar-graph meter for the TX power measurement.

To Set the Number of Intervals on the Meter.

Use the :METer:INTerval commands to set the number of intervals displayed on the analog bar-graph meter.

Syntax

```
:METer:INTerval <integer valve>
```

Example

```
OUTPUT 714;"MEAS:RFR:POW:MET:INT 5"
```

This sets the number of intervals displayed on the analog bar-graph meter for the TX power measurement.

To Query the Number of Intervals on the Meter.

Use the :METer:INTerval? commands to query the number of intervals displayed on the analog bar-graph meter.

Syntax

```
:METer:INTerval?
```

Example

```
OUTPUT 714;"MEAS:RFR:POW:MET:INT?"  
ENTER 714;Num_intervals
```

This queries the number of intervals displayed on the analog bar-graph meter for the TX power measurement.

To Set the Meter High End and Low End Points.

Use the :METER:HEND and :METER:LEND commands to set the analog bar-graph meter's high endpoint and low endpoint.

Syntax

```
:METER:HEND <real number>  
:METER:LEND <real number>
```

Example

```
OUTPUT 714;"MEAS:RFR:POW:MET:HEND 20"  
OUTPUT 714;"MEAS:RFR:POW:MET:LEND 10"
```

This sets the analog bar-graph meter's high endpoint to 20 watts and the low endpoint to 10 watts for the TX power measurement.

NOTE:

When setting the value of the METER Data Function through HP-IB, a non-Attribute Unit unit-of-measure must be specified in the command string, otherwise the current Attribute Unit is assumed by the Test Set. Refer to ["To Specify Units-of-Measure for HP-IB Data Transfer"](#) in the Operating Overview chapter of the *HP 8924C User's Guide*.

To Query the Meter High End and Low End Points.

Use the :METER:HEND? and :METER:LEND? commands to query the analog bar-graph meter high endpoint and low endpoint.

Syntax

```
:METER:HEND?  
:METER:LEND?
```

```
OUTPUT 714;"MEAS:RFR:POW:MET:HEND?"  
ENTER 714;Meter_hi_end  
OUTPUT 714;"MEAS:RFR:POW:MET:LEND?"  
ENTER 714;Meter_lo_end
```

This queries the high end point and low end point of the analog bar-graph meter for the TX power measurement.

NOTE:

When querying the value of the METER data function through HP-IB, the Test Set always returns numeric values in attribute units, regardless of the current display units or HP-IB units settings. Numeric values are expressed in scientific notation. Refer to ["To Specify Units-of-Measure for HP-IB Data Transfer"](#) in the Operating Overview chapter of the *HP 8924C User's Guide*.

To Set the Meter High End and Low End Point Display Units.

Use the :METER:HEND:DUNits and :METER:LEND:DUNits commands to set the analog bar-graph meter high end point and low end point display units. Refer to “[To Specify Units-of-Measure for CRT Display](#)” in the Operating Overview chapter of the *HP 8924C User’s Guide* for description of display units.

Syntax

```
:METER:HEND:DUNits <disp_units>  
:METER:LEND:DUNits <disp_units>
```

Example

```
OUTPUT 714;"MEAS:RFR:POW:MET:HEND:DUN DBM"  
OUTPUT 714;"MEAS:RFR:POW:MET:LEND:DUN DBM"
```

This sets the high end point and low end point display units of the analog bar-graph meter for the TX power measurement to dBm.

NOTE:

When querying the METER data function through HP-IB, the Test Set always returns numeric values in attribute units, regardless of the current display units or HP-IB units settings. Numeric values are expressed in scientific notation.

To Query the Meter High End and Low End Point Display Units.

Use the :METER:HEND:DUNits? and :METER:LEND:DUNits? commands to query the analog bar-graph meter high end point and low end point display units. Refer to “[To Specify Units-of-Measure for CRT Display](#)” in the Operating Overview chapter of the *HP 8924C User’s Guide* for description of display units.

Syntax

```
:METER:HEND:DUNits?  
:METER:LEND:DUNits?
```

Example

```
OUTPUT 714;"MEAS:RFR:POW:MET:HEND:DUN?"  
ENTER 714;Met_hidisp_unit$  
OUTPUT 714;"MEAS:RFR:POW:MET:LEND:DUN?"  
ENTER 714;Met_lodisp_unit$
```

This queries the high end point and low end point display units of the analog bar-graph meter for the TX power measurement.

NOTE:

When querying the METER data function through HP-IB, the Test Set always returns numeric values in attribute units, regardless of the current display units or HP-IB units settings. Numeric values are expressed in scientific notation.

See Also

“[To Use the Analog METER Format](#)” in the Operating Overview chapter of the *HP 8924C User’s Guide*

Keys That Begin with the Letter O

ON/OFF

ON/OFF is used to enable and disable measurements, and to turn numeric fields (such as **Amplitude**) on and off.

See Also

[“Using the On/Off Functions”](#) in the Operating Overview chapter of the *HP 8924C User’s Guide*

Keys That Begin with the Letter P

PRESET

PRESET restores most of the instrument's settings to their factory default states, although most CONFIGURE screen changes are not affected. Instrument self-diagnostics are not run when PRESET is pressed.

Programming PRESET

The IEEE 488.2 Common Command *RST is used to select this function programmatically.

Syntax

```
*RST
```

Example

```
OUTPUT 714; "*RST"
```

This resets the Test Set to its power-up state.

PREV

PREV accesses the previous screen.

HP-IB Example

No equivalent HP-IB command

PRINT

Pressing PRINT outputs the entire contents of the displayed screen, the time and date, and any print title defined in the PRINT CONFIGURE screen. To print measurement results through HP-IB, the program must query the measurement and print the result in a format determined by the programmer.

HP-IB Example

No equivalent HP-IB command

See Also

["Print Configure Screen" on page 126](#)

["Printing a Screen"](#) in the Operating Overview chapter of the *HP 8924C User's Guide*

POWER

POWER turns the instrument's power on and off.

HP-IB Example

No equivalent HP-IB command

Keys That Begin with the Letter R

RECALL

RECALL is used to recall instrument setups saved in SAVE/RECALL registers.

Programming RECALL

The HP-IB commands :REGister:RECall are used to select this function programmatically. The SAVE/RECALL mass storage device is selected using the **SAVE/RECALL** field on the I/O CONFIGURE screen.

Example

```
OUTPUT 714;":REG:REC 'SETUP1' "
```

This recalls the instrument state saved in the file SETUP1.

See Also

[“Saving and Recalling Instrument Setups”](#) in the Operating Overview chapter of the *HP 8924C User’s Guide*

[“*SAV \(Save Instrument State\)”](#) in the HP-IB Common Commands chapter of the *HP 8924C Condensed Programming Reference Guide*

[“*RCL \(Recall Instrument State\)”](#) in the HP-IB Common Commands chapter of the *HP 8924C Condensed Programming Reference Guide*

REF SET

Press and release the SHIFT key, then the INCR+10 key to access the reference set function. This function is used to enter or remove a measurement reference for relative AF and RF measurements.

Programming REF SET

The HP-IB command :REFerence is used to select this data function programmatically.

To Turn Measurement Reference Points ON and OFF. Use the :REFerence:STATe <boolean> commands to turn measurement reference points ON and OFF. The <boolean> parameter can be a 1 or ON to turn measurement reference points on, and a 0 or OFF to turn measurement reference points off.

Syntax

```
:REfERENCE:STATe <ON> or <1>  
:REfERENCE:STATe <OFF> or <0>
```

Example

```
OUTPUT 714;"MEAS:RFR:POW:REF:STAT ON"
```

This turns the measurement reference point for the TX power measurement ON.

To Query the State of Measurement Reference Points. Use the :REfERENCE:STATe? commands to query the state of a measurement reference point. The query returns a 1 if a measurement reference points is ON, and a 0 if a measurement reference points is OFF.

Syntax

```
:REfERENCE:STATe?
```

Example

```
OUTPUT 714;"MEAS:RFR:POW:REF:STAT?"  
ENTER 714;Meter_on_off ! returns a 1 (ON) or 0 (OFF)
```

This queries the state of the measurement reference point for the TX power measurement.

To Set A Measurement Reference Point. Use the :REfERENCE:VALue commands to set a measurement reference point.

Syntax

```
:REfERENCE:VALue <real number>
```

Example

```
OUTPUT 714;"MEAS:RFR:POW:REF:VAL 20"
```

This sets the measurement reference point for the TX power measurement to 20 watts.

NOTE:

When setting a measurement reference point, any non-attribute unit's unit-of-measure must be specified in the command string, otherwise the current attribute unit is assumed by the Test Set. Refer to ["To Specify Units-of-Measure for HP-IB Data Transfer"](#) in the Operating Overview chapter of the *HP 8924C User's Guide*.

To Query A Measurement Reference Point. Use the :REfERENCE:VALue? commands to query a measurement reference point.

Syntax

```
:REfERENCE:VALue?
```

Example

```
OUTPUT 714;"MEAS:RFR:POW:REF:VAL?"  
ENTER 714;Ref_val
```

This queries the measurement reference point for the TX power measurement.

NOTE: When querying a measurement reference point through HP-IB, the Test Set always returns numeric values in attribute units, regardless of the current display units or HP-IB units settings. Numeric values are expressed in scientific notation. Refer to [“To Specify Units-of-Measure for HP-IB Data Transfer”](#) in the Operating Overview chapter of the *HP 8924C User’s Guide*.

To Set Measurement Reference Point Display Units. Use the :REfERENCE:DUNits commands to set a measurement reference point’s display units.

Refer to [“To Specify Units-of-Measure for CRT Display”](#) in the Operating Overview chapter of the *HP 8924C User’s Guide* for description of display units.

Syntax

:REfERENCE:DUNits <disp_units>

Example

```
OUTPUT 714;"MEAS:RFR:POW:REF:DUN DBM"
```

This sets the measurement reference point’s display units for the TX power measurement to dBm.

NOTE: When querying a measurement reference point through HP-IB, the Test Set always returns numeric values in Attribute Units, regardless of the current Display Units or HP-IB Units settings. Numeric values are expressed in scientific notation.

To Query Measurement Reference Point Display Units. Use the :REfERENCE:DUNits? commands to query a measurement reference point’s Display Units. Refer to [“To Specify Units-of-Measure for CRT Display”](#) in the Operating Overview chapter of the *HP 8924C User’s Guide* for description of Display Units.

Syntax

:REfERENCE:DUNits?

Example

```
OUTPUT 714;"MEAS:RFR:POW:REF:DUN?"  
ENTER 714;Disp_unit$
```

This queries the measurement reference point’s Display Units for the TX Power measurement.

NOTE: When querying a measurement reference point through HP-IB, the Test Set always returns numeric values in Attribute Units, regardless of the current Display Units or HP-IB Units settings. Numeric values are expressed in scientific notation.

See Also

[“To Set a Measurement Reference”](#) in the Operating Overview chapter of the *HP 8924C User’s Guide*.

RELEASE

This key is used to delete the assignment of the User Keys, K1 through K5, and K1' through K3'. Press and release the SHIFT key, then the K5 key to select the RELEASE function.

HP-IB Example

No equivalent HP-IB command

See Also

[“Using USER Keys”](#) in the Operating Overview chapter of the *HP 8924C User's Guide*

IBASIC User's Handbook to assign IBASIC commands to User Keys

Keys That Begin with the Letter S

SAVE

Press and release the SHIFT key, then the RECALL key to access the save function. This stores instrument setups.

Programming SAVE

The HP-IB commands :REGister:SAVE are used to select this function programmatically. The SAVE/RECALL mass storage device is selected using the **SAVE/RECALL** field on the I/O CONFIGURE screen.

Example

```
OUTPUT 714;"REG:SAVE 'SETUP1' "
```

This saves the instrument state to a file named SETUP1:

Removing Saved Instrument States. One or all of the saved instrument states can be removed from the selected SAVE/RECALL mass storage device. The SAVE/RECALL mass storage device is selected using the **SAVE/RECALL** field on the I/O CONFIGURE screen. The HP-IB commands :REGister:CLEar are used to perform this function programmatically.

NOTE:

The :REGister:CLEar:ALL command is only valid for the *internal* SAVE/RECALL mass storage device. To clear all saved instrument states from the Card, RAM, or Disk SAVE/RECALL mass storage devices, each file must be removed individually using the :REGister:CLEar '<file name>' command.

Example

```
OUTPUT 714;"REG:CLE 'SETUP2' "
```

This clears the instrument state SETUP2 from the selected SAVE/RECALL mass storage device.

Example

```
OUTPUT 714;"REG:CLE:ALL"
```

This clears all saved instrument states from the internal SAVE/RECALL mass storage device.

See Also

“[Saving and Recalling Instrument Setups](#)” in the Operating Overview chapter of the *HP 8924C User’s Guide*

“[Measurement Triggering Process](#)” in the Operating Overview chapter of the *HP 8924C User’s Guide*

“[*SAV \(Save Instrument State\)](#)” in the HP-IB Common Commands chapter of the *HP 8924C Condensed Programming Reference Guide*

“[*RCL \(Recall Instrument State\)](#)” in the HP-IB Common Commands chapter of the *HP 8924C Condensed Programming Reference Guide*

SHIFT

SHIFT is used to selected the blue-labeled functions listed above some keys (such as PRINTER, CONFIG, RELEASE, EEX, and so forth).

HP-IB Example

No equivalent HP-IB command

Keys That Begin with the Letter Y

YES, NO

YES and NO are used to confirm selected operations before they are executed. Press and release the SHIFT key, then the ON/OFF key to access the YES function. Press and release the SHIFT key, then the RATIO W key to access the NO function.

HP-IB Example

No equivalent HP-IB command

Keys That Begin with a Number

0 to 9, decimal point (.), +/-, and A to F

These keys are for entering and changing values. A through F are shifted functions. Press and release the SHIFT key, then the appropriate key (0 through 5) to select the letter A through F.

See Also

[“To Enter and Change Values”](#) in the Operating Overview chapter of the *HP 8924C User's Guide*

Symbol Keys

BACKSPACE

The backspace key is used to move the cursor to the left when entering numbers in a field, such as **RF Gen Freq**. Each press of this key moves the cursor one place to the left, erasing the previous character.

HP-IB Example

No equivalent HP-IB command

Down-Arrow, Up-Arrow

These keys increment (up-arrow) or decrement (down-arrow) field values. The increment value is determined by the INCR SET (:INCRement) data function. These keys are also used to select alternate field entries without displaying the **Choices** menu used by some fields. They are also used to move the cursor in string entry fields (such as the **Print Title** field on the PRINT CONFIGURE screen).

Programming Increment Up/Down (Arrow Keys)

Syntax

```
:INCRement <UP or DOWN>
```

Example

```
OUTPUT 714; "RFG:FREQ:INCR UP"
```

This increases the RF Generator's frequency by one increment value.

See Also

[“To Increment/Decrement Values”](#) in the Operating Overview chapter of the *HP 8924C User's Guide*

Units-of-Measure Keys

The units keys are for entering and changing the unit-of-measure (such as GHz, V, dBm, %, mW, and so forth) for measurements or field entries. Milliwatts (mW) is a shifted function. Press and release the SHIFT key, then the ENTER key to select mW.

See Also

[“To Specify Units-of-Measure”](#) in the Operating Overview chapter of the *HP 8924C User's Guide*

Miscellaneous Hardware

Knobs

CURSOR CONTROL

CURSOR CONTROL has three functions:

- Moving the cursor.
- Selecting fields, screens, and settings from a list of choices.
- Changing numeric field values.

VOLUME

VOLUME controls the speaker volume for monitoring the AF Analyzer's selected input. The volume is also affected by the **Speaker Vol** and **Speaker ALC** fields in the analog AF ANALYZER screen.

SQUELCH

SQUELCH adjusts the squelch level when demodulating AM, FM, or SSB signals. The squelch level is affected by the **Squelch** field in the analog RF ANALYZER screen.

Programmable Front-Panel Keys for Screens

Table 2

Key Name	Screen Displayed	HP-IB Example
ACP	ADJACENT CHANNEL POWER	"DISP ACP"
AF ANL	AF ANALYZER	"DISP AFAN"
CALL CTRL (CDMA)	CDMA CALL CONTROL	"DISP CCNT"
CALL CTRL (ANALOG)	CALL CONTROL	"DISP ACNT"
CELL	CDMA CELL SITE CONFIGURATION	"DISP CCON"
DUPLEX	DUPLEX TEST	"DISP DUPL"
ENCODER	SIGNALING ENCODER (AF GENERATOR 2)	"DISP ENC"
DECODER	SIGNALING DECODER	"DISP DEC"
GEN CTRL	CDMA GENERATOR CONTROL	"DISP CGEN"
MS RPT	CDMA MOBILE STATION REPORTING	"DISP CMOB"
RANGE	CDMA TRANSMITTER POWER RANGE TEST	"DISP CTRX"
RF ANL	RF ANALYZER	"DISP RFAN"
RF GEN	RF GENERATOR	"DISP RFG"
RX TEST (CDMA)	CDMA CELLULAR MOBILE RECEIVER TEST	"DISP CTRX"
RX TEST (ANALOG)	RX TEST	"DISP RX"
SPECTRUM	CDMA REVERSE CHANNEL SPECTRUM	"DISP CSP"
SPEC ANL	SPECTRUM ANALYZER	"DISP SAN"
SCOPE	OSCILLOSCOPE	"DISP OSC"
TX TEST (CDMA)	CDMA CELLULAR MOBILE TRANSMITTER TEST	"DISP CTXT"
TX TEST (ANALOG)	TX TEST	"DISP TX"

Non-Programmable Front-Panel Keys and Functions

ON/OFF Power Switch
Volume Control Knob
Squelch Control Knob
CURSOR CONTROL Knob
SHIFT Key
CANCEL Key
YES Key
NO Key
ENTER Key
BACKSPACE (left-arrow) Key
PREV Key
HOLD Key
HELP Key
PRINT Key
ADRS Key
k1, k2, k3, k4, k5, k1', k2', k3', Assign, Release (USER KEYS)

NOTE: The squelch control knob cannot be programmed. However squelch can be programmed to either the open or fixed position. Refer to “RF Analyzer” in the HP-IB Command Syntax chapter of the *HP 8924C Condensed Programming Reference Guide* and to the [squelch field description, on page 401](#).

DATA FUNCTIONS Keys

The DATA FUNCTIONS keys can be divided into two groups; those which affect measurements (REF SET, METER, AVG, HI LIMIT and LO LIMIT), and those which affect numeric entry fields (INCR÷10, INCR SET, INCR×10, up-arrow, down-arrow). For measurements, the data functions enable the programmer to change the way measurements are calculated and displayed, and provide measurement limit detection. For numeric entry fields, the data functions enable the programmer to set, scale, and change the field's increment value.

Refer to the “[Number Measurement Syntax](#)” in the HP-IB Command Syntax chapter of the *HP 8924C Condensed Programming Reference Guide* for full command syntax.

Guidelines for Using Measurement Data Functions

- Data functions are turned ON and OFF for individual measurements. The HP-IB Data Function commands must immediately follow the HP-IB command for the individual measurement. For example, to turn the AVG data function ON for the AF Analyzer distortion measurement, the following command string would be sent to the Test Set:
OUTPUT 714 ; "MEAS:AFR:DISTN:AVER:STAT ON"
- Attribute Units (AUNits) are used with the data functions to specify the units-of-measure for numeric data which is read or set through HP-IB.
Refer to “[To Specify Units-of-Measure for HP-IB Data Transfer](#)” in the Operating Overview chapter of the *HP 8924C User's Guide*.
- Data function settings, such as number of averages or reference value, are retained if the function is turned off. The setting values are initialized or changed under the following conditions:
 - The Test Set is turned off.
 - The Test Set is PRESET.
 - A saved register is recalled.

Guidelines for Using Numeric Entry Field Data Functions

- Increment values are set, scaled, and changed for individual numeric entry fields. The HP-IB data function commands must immediately follow the HP-IB command for the individual field. For example, to set the increment value for the RF Generator frequency to 2.5 MHZ, the following command string would be sent to the Test Set:
OUTPUT 714; "RFG:FREQ:INCR 2.5 MHZ"
- HP-IB Units (UNITS) are used with the data functions to specify the units-of-measure for numeric data which is read or set through HP-IB.
Refer to [“To Specify Units-of-Measure for HP-IB Data Transfer”](#) in the Operating Overview chapter of the *HP 8924C User's Guide*.
- Data function settings are not retained. The setting values are initialized or changed under the following conditions:
 - The Test Set is turned off (values initialized on power up).
 - The Test Set is PRESET (values initialized).
 - A saved register is recalled (values changed to those in the recalled register).

USER Keys

User keys instantly access instrument settings without using the knob. You can use user keys to move quickly between fields on the same screen, and to access field settings that are not normally available on the screen you are using.

Local user keys are used to move between settings on the screen that is displayed. When the user key is pressed, the cursor instantly moves to, and selects, the assigned field; eliminating the need to turn and push the knob. Five local user keys are available for each screen: k1, k2, k3, k4, and k5.

Five factory-assigned local user keys are available in each screen; however, using these keys removes any other local user keys you may have already set up.

Global user keys are used to access settings that are not available on the current screen. Three global user keys are available: k1', k2', and k3'. (These are shifted functions of the local user keys.)

When defining user keys, the *ASSIGN* function is used to create key definitions; the *RELEASE* function removes the definitions. Re-assigning a user key to a different field setting automatically releases it from the setting it was previously associated with.

2 **Description of Connectors**

The connectors are listed in alphabetical order.

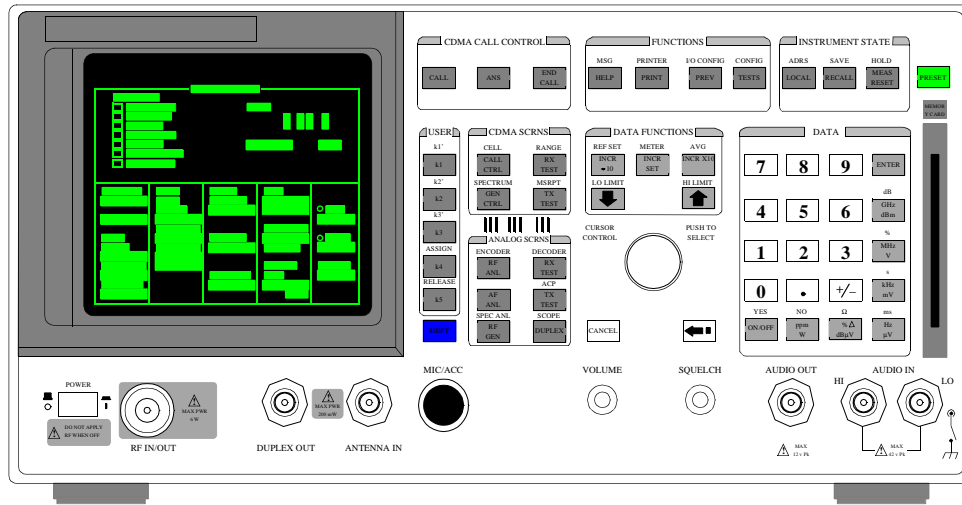

Figure 2 HP 8924C Front Panel

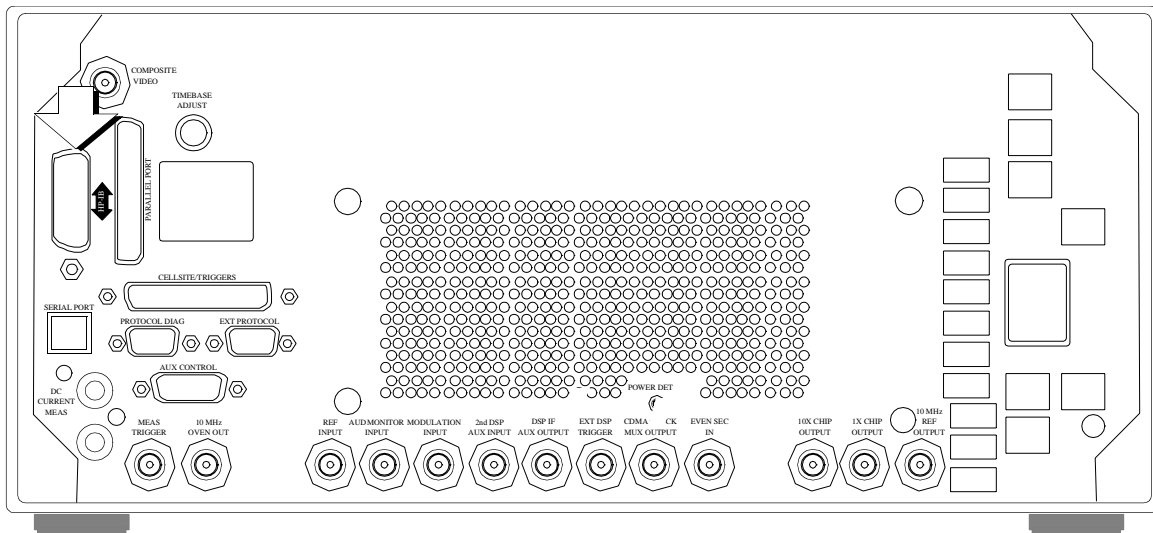

Figure 3 HP 8924C Rear Panel

Connectors That Begin with the Letter A

ANTENNA IN

The antenna input is used to analyze low-power RF signals (≤ 200 mW), and is typically used for off-the-air measurements. This port can be selected in the analog TX TEST, DUPLEX TEST, RF ANALYZER, or SPECTRUM ANALYZER screens.

Operating Considerations

- BNC
- Input impedance = 50Ω
- TX Power cannot be measured using this port; use the RF IN/OUT port. However, low power levels can be measured using this port with the spectrum analyzer.
- Additional sensitivity for this port is available using the **Sensitivity** field in the analog RF ANALYZER and SPECTRUM ANALYZER screens.

CAUTION: Connecting a signal of >200 mW to the ANT IN port can cause instrument damage (although internal protection circuits can typically withstand a short-duration signal of 1 or 2 Watts).

If the over-power circuit is triggered (signified by a warning message at the top of the screen), remove the signal from the ANT IN port, and press the MEAS RESET key, or turn the Test Set off and on to reset it.

AUDIO IN LO, HI

The audio inputs are used to input audio signals to the AF Analyzer.

- AUDIO IN HI is the main audio signal input connection.
- AUDIO IN LO is used for the audio signal reference. Three choices are available using the AF ANALYZER screen's **Audio In Lo** field:
 - Gnd - connects the center pin through approximately 100 Ω to chassis ground
 - Float - provides a floating input.
 - 600 To Hi - provides a 600 internal load to match an audio source with an output.

The measured level is the potential between the HI and LO center pins. The shells of both connectors are at chassis ground.

Operating Considerations

- BNC
- Input impedance switchable between
 - 1 M Ω in parallel with 95 pF,
 - 600 Ω floating.
- This port is selected as the AF Analyzer's input using the **AF An1 In** field in the analog TX TEST screen, DUPLEX TEST screen, and AF ANALYZER screen. This port is always the AF Analyzer's input when the analog RX TEST screen is displayed.
- Signals input to the AF Analyzer are routed through different filters, amplifiers, and detectors that affect the displayed measurement.

CAUTION: The maximum level between the HI and LO center pins is 42 V peak (approximately 30 Vrms). Exceeding this value can cause permanent instrument damage.

See Also

[AF An1 In field description, on page 157](#)

[Audio In Lo field description, on page 169](#)

AUDIO OUT

The audio output is used to output signals from AF Generators 1 and 2.

Operating Considerations

- BNC
- Output impedance <1 Ω
- Maximum output current = 20 mA peak
- Maximum reverse voltage = 12 V peak
- The output level is set by the AF Generators, and it is not affected by the front-panel VOLUME control.
- AC/DC coupling is selected using the **Audio Out** field. This field is available in the DUPLEX TEST screen, RF GENERATOR screen.

AUD MONITOR OUTPUT

The audio monitor output provides an external output from various tap points in the AF Analyzer.

Operating Considerations

- BNC
- Output impedance is $< 1 \text{ k}\Omega$
- The **scope To** field in the analog AF ANALYZER screen determines the source of this signal.
- The level is not affected by the front-panel VOLUME knob.

See Also

[Scope To field description, on page 377](#)

AUX CONTROL

This connector provides two trigger signals for measuring a mobile station's time response to open loop power control.

Operating Considerations

DB-15

About 18 mS before output level changes occur on the HP 8924C, there is a rising edge on AUX CONTROL, pin 6. This line, called M_ENA, is pulled high through resistors, so rise time will vary depending on the nature of external equipment. Typical values for rise time will be approximately 600 nS to rise to 3.5 V.

The trigger signal on pin 6 is an enable line. When pin 6 goes low, pin 13 (M_DATA) also goes low. The initial trigger for level changes will be when pin 13 goes high with pin 6 pulled low.

Chapter 2, Description of Connectors
Connectors That Begin with the Letter A

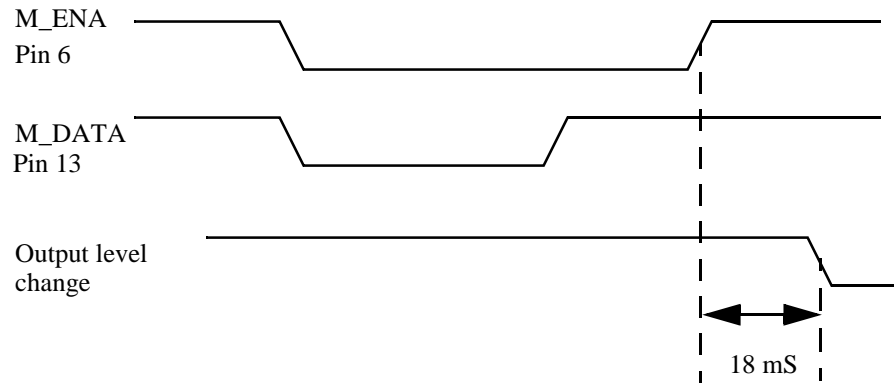

Connectors That Begin with the Letter C

CELL SITE/TRIGGERS

This is a 37-pin connector. It provides CDMA triggers and digital cell diagnostics. Four pins are not used.

A cable adapter is provided for protocol logging. Refer to “[Protocol Logging](#)” chapter in the *HP 8924C Application Guide*, for a description of using this feature. The adapter consists of a ribbon cable with 1 sub-miniature type-D, female, 15-pin connector and 2 male, 9-pin connectors.

Operating Considerations

- Pin 1 - GND
- Pin 2 - GND
- Pin 3 - 1.25 ms Frame Clock
The 1.25 ms Frame Clock provides a clock output that is aligned with power control group timeslots. See also - "[CDMA CLOCK MUX OUTPUT](#)" on page 71.
- Pin 4 - 26.667 ms Frame Clock
The 26.667 ms Frame Clock provides a clock that is aligned with the short (Pilot PN) spreading sequence and the Sync Channel frame structure. See also - "[CDMA CLOCK MUX OUTPUT](#)" on page 71.
- Pin 5 - EVEN_SEC_OUT
The Even Second Clock provides a clock that is aligned with the timing reference for CDMA frame clocks. The even second reference is input on the rear-panel connector, EVEN SEC IN.
- Pin 6 - SAT0
- Pin 7 - SAT2
- Pin 8 - PROTO_TRIG2
- Pin 9 - A_RI_2
Part of cell site #2 diagnostic port.
- Pin 10 - A_CTS_2
Part of cell site #2 diagnostic port.
- Pin 11 - A_RTS_2
Part of cell site #2 diagnostic port.
- Pin 12 - A_DSR_2
Part of cell site #2 diagnostic port.
- Pin 13 - Ground
- Pin 14 - A_DTR_1
Part of cell site #1 diagnostic port.
- Pin 15 - A_TXD_1
Part of cell site #1 diagnostic port.

Chapter 2, Description of Connectors

Connectors That Begin with the Letter C

- Pin 16 - A_RXD_1
Part of cell site #1 diagnostic port.
- Pin 17 - A_SD_1
Part of cell site #1 diagnostic port.
- Pins 18, 19 - Not connected
- Pins 20, 21 - Ground
- Pin 22 - 20 ms Frame Clock
The 20 ms Frame Clock provides a clock output that is aligned with Traffic and Access Channel frames. See also - **"CDMA CLOCK MUX OUTPUT" on page 71.**
- Pin 23 - 80 ms Frame Clock

The 80 ms Frame Clock provides a clock that is aligned with the Paging Channel Slots (referring to mobile station slotted mode operation) and the Sync Channel Superframe. See also - **"CDMA CLOCK MUX OUTPUT" on page 71.**
- Pin 24 - DSP_TRIG_OUT
A true condition on this connector indicates the DSP Analyzer was triggered. The DSP analyzer can be triggered by a signal on the EXT DSP TRIGGER rear-panel BNC connector, or by the user arming a measurement. See Also - **Meas Cnt1 field description, on page 292** and **"EXT DSP TRIGGER" on page 74**
- Pin 25 - SAT1
- Pin 26 - PROTO_TRIG1
- Pin 27 - Ground
- Pin 28- A_DTR_2
Part of cell site #2 diagnostic port.
- Pin 29- A_TXD_2
Part of cell site #2 diagnostic port.
- Pin 30- A_RXD_2
Part of cell site #2 diagnostic port.
- Pin 31- A_SD_2
Part of cell site #2 diagnostic port.
- Pin 32- A_RI_1
Part of cell site #1 diagnostic port.
- Pin 33- A_CTS_1
Part of cell site #1 diagnostic port.
- Pin 34- A_RTS_1
Part of cell site #1 diagnostic port.
- Pin 35- A_DSR_1
Part of cell site #1 diagnostic port.
- Pins 36, 37 - Not Connected

CDMA CLOCK MUX OUTPUT

The CDMA frame clocks provide the CDMA timing references for generating and demodulating CDMA signals. The CDMA clock MUX output provides the following CDMA frame clocks on a multiplexed output.

- 1.25 ms
- 20.00 ms
- 26.67 ms
- 80.00 ms
- 2.00 s

Each of these CDMA frame clocks is available by selecting from the list of choices displayed on the CONFIGURE screen.

The CELLSITE/TRIGGERS connector, a rear-panel miniature D-type 15-pin connector provides all of the above frame clock outputs simultaneously. The timing of these frame clocks may be offset slightly from the timing of the CDMA CLOCK MUX OUTPUT's frame clocks due to propagation delays.

Operating Considerations

- BNC
- Select which frame clock will be output on the CDMA CLOCK MUX OUTPUT connector by pressing and releasing the SHIFT key, then the TESTS key to select the CONFIGURE screen, then selecting the **Frame Clock** field to display the list of choices.
- Nominal output level is $>+5$ dBm
- Output impedance is 50Ω
- All frame clocks are locked to the Test Set's internal 10 MHz reference. Frequency stability is the same as the signal applied to the REF INPUT connector.

See Also

[Frame Clock field description, on page 266](#)

COMPOSITE VIDEO

The composite video output provides a signal for using an external video monitor. The signal provides a duplicate of the Test Set's screen.

Operating Considerations

- BNC
- A multi-sync monitor must be used to match the video sync rate of 19.2 kHz. Example monitors include - Electrohome ECM 1410-DMS 14-inch color monitor and the EVM 1242-P4VID 12-inch monochrome monitor.

Connectors That Begin with the Letter D

DC CURRENT MEAS

The current sense input is used in series with a dc supply and load to provide a 0 to 10 amp dc current meter.

Operating Considerations

- Dual-Banana Jack
- The dc-current meter is designed to measure *positive* current (the connector's polarity is marked on the rear panel). Negative current of ≤ 10 amps will not damage the instrument, but will cause inaccurate positive current measurements (due to magnetic memory within the current-sensing element).
- To re-calibrate the current meter after negative current has been applied
 1. Connect a 10-amp positive current.
 2. Disconnect the current
 3. Access the analog AF ANALYZER screen.
 4. Select the **DC Current Zero** field to zero the meter.

DSP IF AUX OUTPUT

This connector provides an output of the 3.6864 MHz IF signal sent to the Auxiliary DSP Analyzer.

Operating Considerations

- Frequency = 3.6864 MHz ± 2.5 MHz
- Level
 - -61 dBm to -1 dBm (CDMA mode)
 - -91 dBm to -2 dBm (analog mode)
 - 9 dBm ± 3 dBm (test mode)
- RF input to IF output conversion gain = 9 dB ± 2 dB into 50 Ω
- Return Loss = < -5.5 dB into 50 Ω
- Output impedance = 100 Ω
- If the Auxiliary DSP Analyzer is present in the instrument, do not connect any device with < 100 k Ω input impedance.

See Also

["2nd DSP AUX INPUT" on page 85](#)

DUPLEX OUT

The duplex output is an output for the RF Generator and Tracking Generator.

When testing CDMA mobile stations, it is important to enter an RF Level Offset for the selected input and output ports. Refer to “[Calibrating the Test Set](#)” chapter in the *HP 8924C Application Guide*.

Operating Considerations

- BNC
- Output impedance = 50Ω
- The RF Generator's output is selected in the **Output Port** field. This field is available on the CONFIGURE, RX TEST, DUPLEX TEST, RF GENERATOR, and SPECTRUM ANALYZER screens.

CAUTION: Connecting an RF source of >200 mW to this connector can permanently damage the instrument.

Connectors That Begin with the Letter E

EVEN SEC INPUT

This connector is not functioning.

EXT DSP TRIGGER

The DSP trigger input is used to trigger DSP Analyzer measurements when a call is not established, or to override the internal triggers (frame clocks) when on a call.

Operating Considerations

- BNC
- The DSP Analyzer is normally triggered on the first CDMA clock after being put in the Arm state.

See Also

[Meas Cnt.1 field description, on page 292](#)

EXT PROTOCOL

The protocol logging, cell site 2, RS-232 port is not implemented at this time.

Operating Considerations

- 9-pin sub-miniature D

Connectors That Begin with the Letter H

HP-IB

The main HP-IB port allows communication between the Test Set and other instruments or computers using the Hewlett-Packard Interface Bus (HP-IB).

Operating Considerations

- 36-pin GPIB

See Also

[HP-IB Adrs field description, on page 272](#)

Connectors That Begin with the Letter M

MEAS TRIGGER

This connector provides an external oscilloscope trigger.

Operating Considerations

- BNC
- Input threshold ≈ 2.5 V
- Maximum Input level ≈ 20 V peak
- Input impedance:
 - $100\text{ k}\Omega$ for signals ≤ 5.6 V peak
 - $5\text{ k}\Omega$ for signals >5.6 V peak
- When measured with no load on the input, a 5 Volt level is present on the connector due to the internal pull-up resistor design.

See Also

["Oscilloscope Screens" on page 124](#)

MIC/ACC

The microphone/accessory connector is used for several functions:

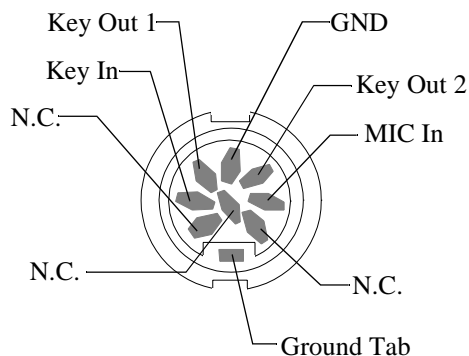

- Mic In is used to modulate the RF Generator when the Key In line is grounded. This signal is summed with the external modulation input signal. The **Mod In To** field of the RF GENERATOR screen sets the type of modulation (AM or FM) and sensitivity (%AM/Vpk or kHz/Vpk) for this connection.
- Key In provides control of the RF Generator's output state (on or off) and automatic switching between the TX TEST and RX TEST screens (if the CONFIGURE screen's **RX/TX Cntl** functions are set to **Auto** and **PTT**). Screen switching occurs when this line is grounded.
- Key Out 1 and Key Out 2 provide a switch path to control external equipment (such as keying a transmitter). Key Out 1 and Key Out 2 are connected when the **Ext TX key** field is set to **On**.

To Use the Microphone

1. Connect the microphone to the MIC/ACC connector.
2. Access the analog RF GENERATOR screen.
3. Enter the carrier frequency in the **RF Gen Freq** field.
4. Enter the RF Generator **Amplitude**.
5. Select the **Output Port** (**RF OUT** or **DUPL**).
6. Connect the selected output port to your receiver or antenna.
7. Using the **Mod In To** field
 - a. Select the type of modulation: **FM** (/Vpk)
 - b. Enter the modulation sensitivity to a 1 V peak signal (usually 1 kHz for microphone use). (See the **Mod In To field description, on page 300**).

Operating Considerations

- 8-pin DIN
- Input impedance = 100 k Ω
- Maximum input level = 10 V peak
- Full scale input = 10 mV
- Bandwidth is limited to 3 kHz.
- The MIC IN signal is filtered and amplified to provide a stable deviation-limited signal to the RF Generator.
- 750 μ s microphone pre-emphasis is selected in the analog RF GENERATOR screen.

See Also

"RF Generator Screen" on page 129

"RF Analyzer Screen" on page 127

"Configure Screen" on page 118

MODULATION INPUT

This connector provides an external modulation connection to the RF Generator.

Operating Considerations

Input impedance = 600Ω

Maximum input level = 12 V peak

Full scale input = 1 V peak

The **Mod In To** field of the RF GENERATOR screen sets the type of modulation (AM or FM) and sensitivity (%AM/Vpk or kHz/Vpk) for this connection.

This signal is summed with the microphone MIC IN signal from the MIC/ACC connector.

The **FM Coupling** field in the RF GENERATOR, DUPLEX TEST, and various encoder modes selects ac or dc coupling of this signal for FM operation.

Connectors That Begin with the Letter P

PARALLEL PORT

This port is used with printers requiring a parallel interface when printing screen images or test results. Set the **Printer Port:** field (on the PRINT CONFIGURE screen or TESTS (Printer Setup) screen) to **Parallel** to print to this port. Use address 15 when sending data to this port from IBASIC programs.

Pin numbers are embossed on the connector.

1. nStrobe
2. Data 1 (Least Significant Bit)
3. Data 2
4. Data 3
5. Data 4
6. Data 5
7. Data 6
8. Data 7
9. Data 8 (Most Significant Bit)
10. nAck
11. Busy
12. PError
13. Select
14. nAutoFd
15. nFault
16. nInit
17. nSelectIn
18. Signal Ground (nStrobe)
19. Signal Ground (Data 1 and Data 2)
20. Signal Ground (Data 3 and Data 4)
21. Signal Ground (Data 5 and Data 6)
22. Signal Ground (Data 7 and Data 8)
23. Signal Ground (Busy and nFault)
24. Signal Ground (PError, Select, and nAck)
25. Signal Ground (nAutoFd, nSelectIn, and nInit)

Operating Considerations

- 25-pin Centronics

POWER DET

The POWER DET input routes a dc-coupled signal from the average power detector on the HP 83236 PCS Interface to the DSP Analyzer in the Test Set. This signal, which is multiplexed with other power measurements, cannot be selected by the user.

Operating Considerations

- SMA
- If a frequency translator is connected to the Test Set, the POWER DET input must be connected to the POWER DET output from the frequency translator to make average power measurements.

See Also

[TX Power field description, on page 437](#)

PROTOCOL DIAG

The protocol logging, cell site 1, RS-232 port is not implemented at this time.

Operating Considerations

- 9-pin sub-miniature D

Connectors That Begin with the Letter R

REF INPUT

This input is normally connected to the 10 MHz oven output. A BNC-to-BNC semi-rigid coaxial cable is provided with the Test Set to make this connection.

This input is routed to a reference phase-locked-loop that generates 10 MHz reference signals for all digital and analog phase-locked-loops. This reference phase-locked-loop will lock to many frequencies other than 10 MHz, including selected multiples of the CDMA chip clock.

A 10 MHz REF OUTPUT from the reference phase-locked-loop is provided on a rear-panel BNC connector.

Operating Considerations

- BNC
- A high-stability REF INPUT is a requirement for testing cellular phones. REF INPUT is normally brought in from the 10 MHz OVEN OUT, a high-stability ovenized oscillator. A BNC-to-BNC semi-rigid connector is provided with the Test Set for this purpose.
- The entry in the **External Reference** field located on the CONFIGURE screen must be the same as the REF INPUT. (The default setting for **External Reference** is 10.0000 MHz.) The Configure screen is accessed by pressing and releasing the SHIFT key, then the TESTS key to select the CONFIG function, or by selecting CONFIG from the **To Screen** menu.
- The following frequencies can be selected from the **External Reference** field:
1.0000 MHz, 1.2288 MHz, 2.0000 MHz, 2.4576 MHz, 4.9152 MHz, 5.0000 MHz, 9.8304 MHz, 10.0000 MHz, 15.0000 MHz
- Input level must be >0.15 Vrms.
- Input impedance $\approx 50\Omega$.
- Duty Cycle must be $\approx 10\%$

See Also

- ["10 MHz OVEN OUT" on page 85](#)
- ["10 MHz REF OUTPUT" on page 86](#)
- ["Configure Screen" on page 118](#)
- ["REF SET" on page 47](#)

RF IN/OUT

The RF IN/OUT port allows full-duplex interaction, or the RF IN portion can be used with DUPLEX OUT, providing more output power.

Operating Considerations

When testing CDMA mobile stations, it is important to enter an RF Level Offset for the selected input and output ports. Refer to “[Calibrating the Test Set](#)” chapter in the *HP 8924C Application Guide*.

- Type-N
- This port must be used when measuring transmitter (RF) power.
- This port can be selected in the CONFIGURE screen, or the analog TX TEST, DUPLEX TEST, RF ANALYZER, or SPECTRUM ANALYZER screens.
- Signals ≤ 200 mW can be input to the ANT IN connector for all RF measurements except transmitter power.

Over-Power Damage. Refer to the Test Set's front panel for maximum input power level. Exceeding this level can cause permanent instrument damage.

CAUTION: If the RF power at the RF IN/OUT port exceeds allowable limits, a loud warning signal sounds and a message appears at the top of the screen.

If this occurs, disconnect the RF power, press the MEAS RESET key, and allow the Test Set to cool off for approximately 2 minutes before making any other measurements on this port.

Connectors That Begin with the Letter S

SERIAL PORT

This connector is used for serial control of an HP 83236 PCS Interface, or for serial data exchange with some other device. A serial cable is provided with the HP 83236 to connect the SERIAL PORT to a DB-15 connector on the HP 83236. Other applications for the SERIAL PORT might include; entering IBASIC programs, printing tests results and screen images, or sending test results from the IBASIC controller to a connected controller, disk drive, or terminal.

If you are using this connector to enter programs, or you would like to see a diagram of the connectors and pin-outs to the serial port, refer to [“Interfacing to the IBASIC Controller using Serial Ports”](#) in IBASIC Controller chapter of the *HP 8924C Application Guide*.

Operating Considerations

- RJ-11 (see [figure 4 on page 84](#))
- The serial communications settings are defined on the I/O CONFIGURE screen.
- The IBASIC controller sends and receives data to the serial ports using address **9** for the primary port (A), and address **10** for the secondary port (B). For example, to enter data from the primary serial port (A) into a program variable named SDATA, you could use the command: ENTER 9;SDATA
- Using Port B: The secondary serial port (B) is only used with IBASIC programs to communicate with other equipment when the primary serial port is used for printing or data collection. Port B cannot be used for printing screens, and its communication settings can only be changed using IBASIC commands.

Unless you are writing IBASIC programs that require serial printing *and* other serial data transfer at the same time, we recommend that you only use the primary serial port (A).

- To send data from your program out of the primary serial port (A), you could use the command: OUTPUT 9;SDATA
- Use an RJ-11/25-pin RS-232 adapter (HP P/N 98642-66508) and RJ-11 cable (HP P/N 98642-66505) to connect the Test Set to a serial printer or terminal/computer.

NOTE:

RJ-11 Connectors: RJ-11 cables and adapters can be wired several ways by the cable manufacturer. If you buy a cable or adapter other than the HP parts listed, verify the connections for the pins indicated in [table 3 on page 84](#) before connecting cables to the instruments.

- [Table 3 on page 84](#) lists connections for the primary serial port (address 9). When using both ports at the same time, you need to locate or fabricate an adapter to provide the necessary connections.

Table 3 Serial Port Connections

Test Set RJ-11 Serial Port		Terminal/PC 25-pin RS-232		Terminal/PC 9-pin RS-232
Pin 2 (RX)	to	pin 2 (TX)	or	pin 3 (TX)
Pin 5 (TX)	to	pin 3 (TX)	or	pin 2 (TX)
Pin 4 (GND)	to	pin 7 (GND)	or	pin 5 (GND)

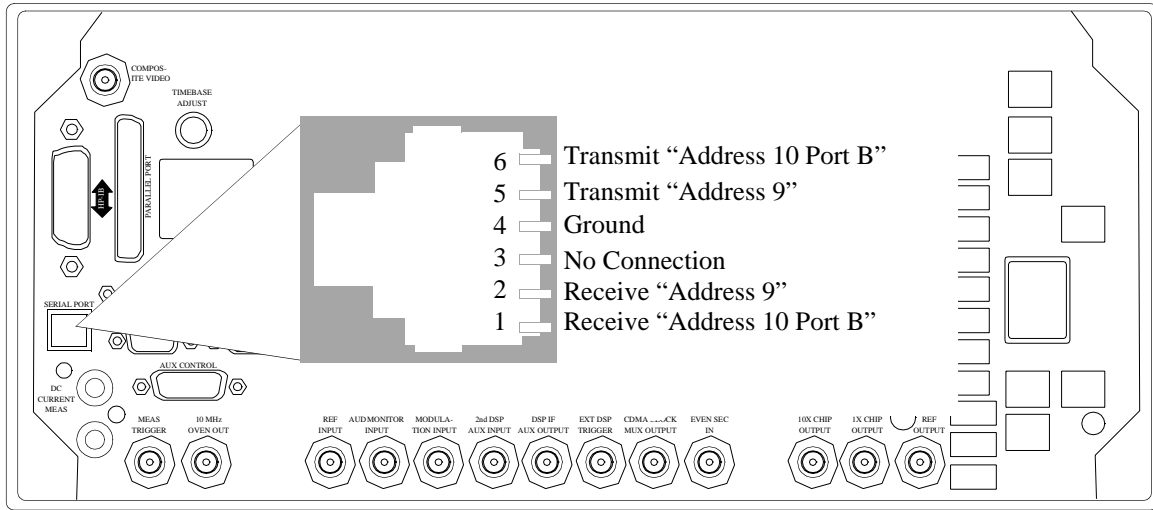

Figure 4 Serial Port Pinout

Connectors That Begin with a Number

1X CHIP OUTPUT

The 1X CHIP OUTPUT provides a 1.2288 MHz chip clock which is synchronized with the short (pilot PN) spreading sequence signal, operating at a fixed rate of 1.2288 Mcps.

The 1X CHIP OUTPUT is phase-locked to the Test Set's internal 10 MHz reference.

Operating Considerations

- BNC
- Nominal output level is $>+5$ dBm
- Output impedance = 50Ω
- All frame clocks are locked to the Test Set's internal 10 MHz reference frequency stability is the same as the signal applied to the REF INPUT connector.

See Also

["16X CHIP OUTPUT" on page 86](#)

["CELL SITE/TRIGGERS" on page 69](#)

2nd DSP AUX INPUT

The auxiliary DSP baseband input provides access to the DSP Analyzer for measuring CDMA IF or baseband I/Q signals.

This input is not implemented at this time.

10 MHz OVEN OUT

The 10 MHz oven output is normally connected to the reference input. A BNC to BNC semi-rigid coaxial cable is provided with the Test Set to make this connection.

Operating Considerations

- BNC

10 MHz REF OUTPUT

The 10 MHz reference output is one output of a reference phase-locked-loop that generates 10 MHz reference signals for all of the digital and analog phase-locked-loops in the Test Set. This reference phase-locked-loop has a fractional divider, enabling it to lock to many frequencies, which are listed in the description of the REF INPUT connector.

Operating Considerations

- BNC
- This reference signal will be phase-locked to the reference input if the operating conditions specified in the REF INPUT connector description are met.
- Nominal output level is $>+5$ dBm
- Output impedance is 50Ω
- Frequency stability is the same as the signal applied to the REF INPUT connector.

See Also

[External Reference field description, on page 259](#)
["REF INPUT" on page 81](#)

16X CHIP OUTPUT

The 16X CHIP OUTPUT is a 19.6608 MHz clock output synchronized with the 1.2288 MHz chipping rate that spreads the CDMA signal. The 16X CHIP OUTPUT is phase-locked to the Test Set's internal 10 MHz reference.

Operating Considerations

- BNC
- The EVEN SEC INPUT
- Nominal output level is $>+5$ dBm
- Output impedance is 50Ω
- All frame clocks are locked to the Test Set's internal 10 MHz reference frequency stability is the same as the signal applied to the REF INPUT connector.

See Also

["1X CHIP OUTPUT" on page 85](#)
["CELL SITE/TRIGGERS" on page 69](#)

3 **Description of Screens**

These screens are listed in alphabetical order.

Adjacent Channel Power Screen

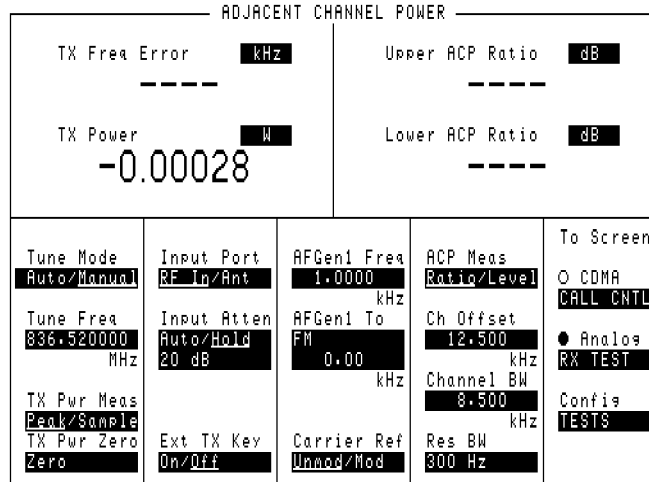

Figure 5 The Adjacent Channel Power Screen

This screen is used to measure Adjacent Channel Power. This is a measurement of the power of signals at a specific channel spacing above and below the RF Analyzer's center frequency. This screen is accessed by selecting **AD CH PWR** from the **Analog To Screen** menu.

How the Test Set Measures Adjacent Channel Power (ACP)

When you access this screen, the Test Set automatically starts a multi-step process for measuring ACP:

1. AF Generator 1 is turned off if the **Carrier Ref** field is set to **Unmod**.
2. The amplitude of the center frequency (**Tune Freq**) is measured to establish a reference.
3. AF Generator 1 is turned back on if it was previously turned off.
4. The power in each of the adjacent channels is analyzed.
5. Adjacent Channel Power is calculated and displayed. This value can be displayed as an absolute power level or as a ratio referenced to the center frequency's level.

NOTE:

Which Input Port to Use. The TX Power measurement is used to calculate absolute Adjacent Channel Power. Since TX Power can only be measured using the RF IN/OUT port, you must use this port to measure ACP Level. ACP Ratio can be measured using either the RF IN/OUT or the ANT IN port.

Measuring ACP on AM Transmitters. When measuring AM signals, the reference level must be measured on an *unmodulated* carrier; so the **Carrier Ref** field must be set to **Unmod**. After the reference is measured, the power in the adjacent channels must be measured *with modulation*. This requires the modulating signal to be turned off and on repeatedly as measurements are being calculated and displayed. Since the Test Set automatically turns AFGen1 on and off when the **Carrier Ref** field is set to **Unmod**, you must use AFGen1 and the AUDIO OUT port as the modulation source for making AM ACP measurements.

AF Analyzer Screen

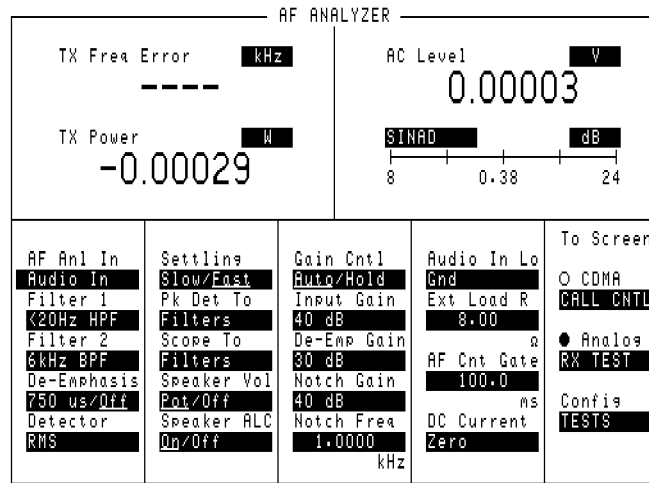

Figure 6 The AF Analyzer Screen

AF Analyzer Block Diagram

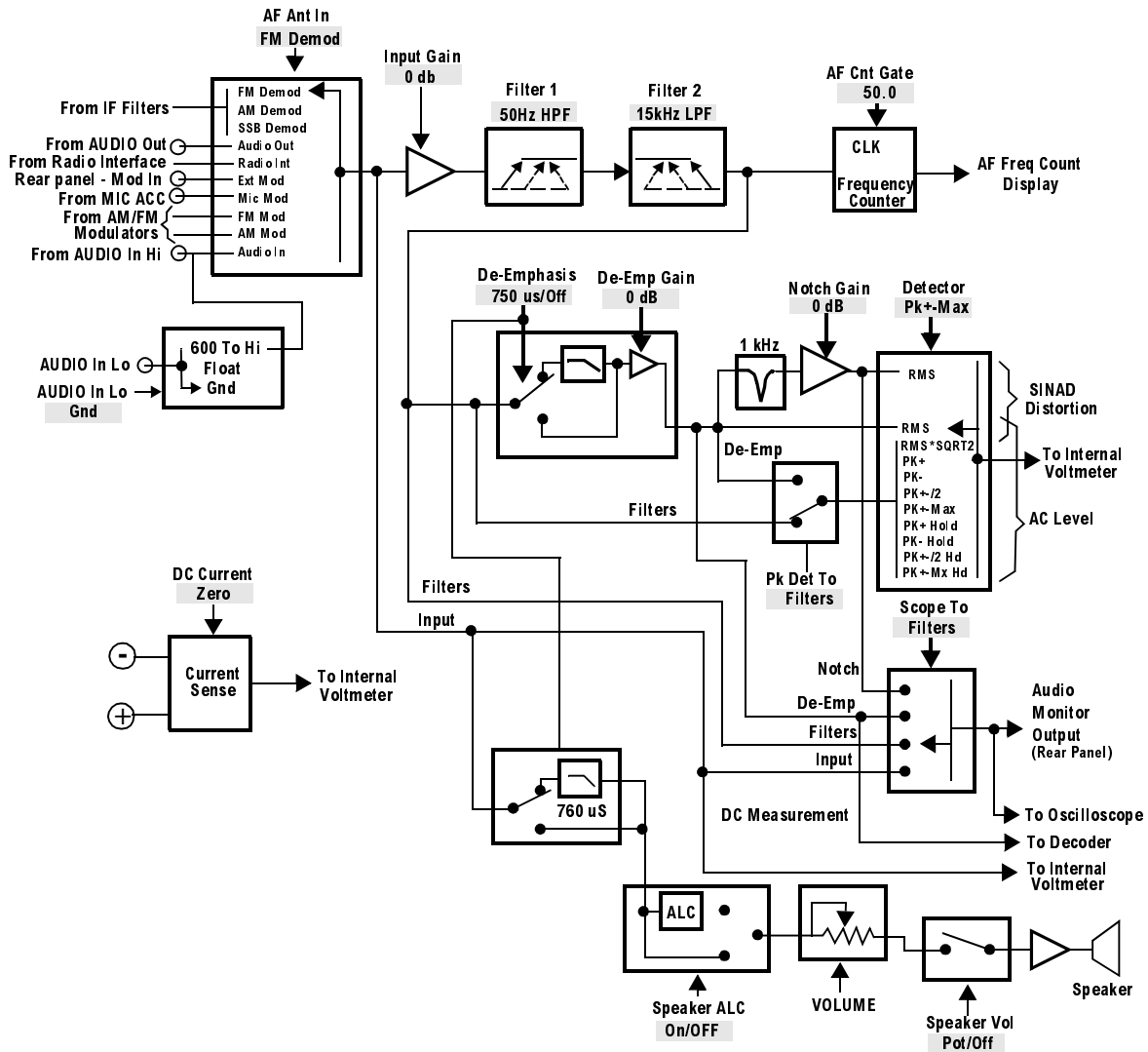

Figure 7 AF ANALYZER Functional Block Diagram

¹The Settling, Gain Cntl, and Ext Load R fields are not shown.
²Variable Frequency Notch if purchased.

Call Control Screens

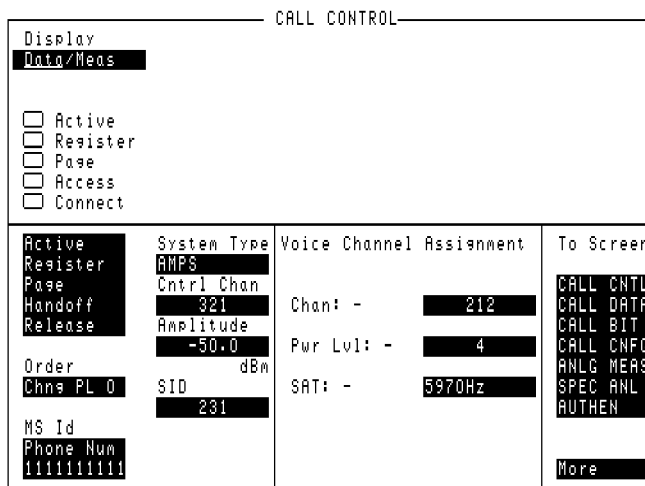

Figure 8 The CALL CONTROL Screen

NOTE: The number and type of fields displayed on the CALL CONTROL screen depends on the selected system type.

The CALL CONTROL screen is the primary analog call processing screen. It contains the most often used call processing configuration and command fields. **Figure 8** shows the CALL CONTROL screen for AMPS.

The top right-hand portion of the CALL CONTROL screen is used to display the following information:

- decoded data messages received from the mobile station on the reverse control channel or the reverse voice channel
- modulation quality measurements made on the mobile station's RF carrier while on a voice channel
- raw data message bits, displayed in hexadecimal format, received from the mobile station on the reverse control channel or reverse voice channel when a decoding error occurs

The type of information to be displayed is selected using the **Display** field. Refer to the **Display field description, on page 223** for further information.

Call Control Screens - ANALOG MEAS

ANALOG MEAS				
TX Freq Error		kHz		

TX Power		W		
-0.00030				
		FM Deviation		
		kHz		

		AF Freq		
		kHz		

	Amplitude	AFGen1 Freq	AF An1 In	To Screen
	-50.0	1.0000	FM Demod	CALL CNTL
	dBm	kHz	Filter 1	CALL DATA
		AFGen1 To	<20Hz HPF	CALL BIT
		FM	Filter 2	CALL CNFG
		kHz	6kHz BPF	ANLG MEAS
			De-Emphasis	SPEC ANL
			750 us/Off	AUTHEN
			Detector	
			Pk+-Max	More

Figure 9 The ANALOG MEAS Screen

This screen is used to make RF and audio measurements on the mobile station connected to the Test Set while on an active voice channel.

The Test Set does not monitor the mobile station's transmitted carrier power while the ANALOG MEAS screen is displayed. If the power falls below 0.0005 Watts no error message is displayed nor will the Test Set terminate the call while on the ANALOG MEAS screen.

Requirements for Using The ANALOG MEAS Screen

The Test Set must be in the connected state (that is, the **Connect** annunciator is lit) in order to use the ANALOG MEAS screen.

The mobile station's speaker output must be connected to the Test Set's AUDIO IN connector and the mobile station's microphone input must be connected to the Test Set's AUDIO OUT connector in order to use the ANALOG MEAS screen. If the mobile station does not have audio connections the ANALOG MEAS screen cannot be used.

CAUTION: The host firmware does not monitor the mobile station's transmitted carrier power while the ANALOG MEAS screen is displayed. If the power falls below 0.0005 Watts no error message is displayed nor will the Test Set terminate the call while on the ANALOG MEAS screen.

How To Program The ANALOG MEAS Screen

The ANALOG MEAS screen combines some of the Test Set's **Audio Analyzer** fields and some of the Test Set's **RF Generator** fields onto one screen for the purpose of testing the audio characteristics of the mobile station.

Only those fields which are pertinent to testing the mobile station's audio characteristics have been combined onto the **ANALOG MEAS** screen.

Since the fields on the **ANALOG MEAS** screen are imported from other screens those fields are programmed exactly as they would be on their home screen. To set up the fields, program the appropriate instrument. To make measurements use the MEASure subsystem.

Call Control Screens - AUTHENTICATION

AUTHENTICATION	
Authent	ESN
Off/On	00000000
RAND_A	
34A2	
RAND_B	
805F	
RANDSSD_1	
4D18EE	
RANDSSD_2	
AAD589	
RANDSSD_3	
5C	
RAND_U	
53750F	
1 of N	
1	
A_KEY	
00000000000000000000000000000000	
	To Screen
	CALL CNTL
	CALL DATA
	CALL BIT
	CALL CNFG
	ANLG MEAS
	SPEC ANL
	AUTHEN
	More

Figure 10 The AUTHENTICATION Screen

The AUTHENTICATION screen allows you to enter parameters for authentication into the Test Set. These parameters are used by the Cave algorithm during Call Processing functions such as registration, page, and originate to verify a valid call.

Call Control Screens - CALL BIT

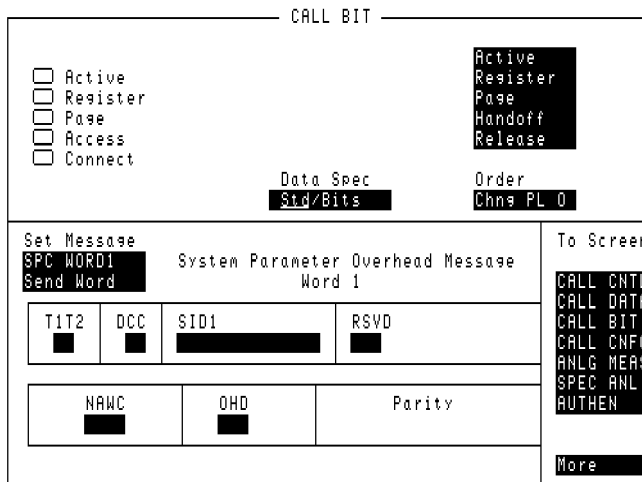

Figure 11 The CALL BIT Screen

The CALL BIT screen is designed to give an advanced user the capability to modify the contents of the forward control channel and forward voice channel signaling messages that are used in all processing messaging protocol.

A messaging protocol is defined as the sequence of messages sent from the Test Set to the mobile station to perform a desired action, such as registering a mobile station. Modifying the contents of one or more messages may be required for testing the robustness of a mobile station’s call processing algorithms or for new product development.

Using the CALL BIT Screen

Using the CALL BIT screen requires expert knowledge of the call processing messaging protocols used in the system selected in the **system Type** field on the CALL CONTROL screen.

The CALL BIT screen should not be used to change any parameter that can be set on any other Call Processing Subsystem screen. The contents of the applicable fields on the CALL CONTROL screen and the CALL CONFIGURE screen are not updated to reflect any changes made while using the CALL BIT screen. There is no coupling between the CALL BIT screen and the Test Set.

For example: changing the value of the SAT color code field (SCC) in the forward control channel mobile station control message (MS IntVCh) does not change the setting of the **SAT:** field on the CALL CONTROL screen.

When using the CALL BIT screen the user is responsible for setting the contents of all messages used in a messaging protocol. When using the CALL BIT screen, the Call Processing Subsystem sends the correct messages at the correct times as defined in the applicable industry standard. Message content is the responsibility of the user.

When the CALL BIT screen is displayed and the Call Processing Subsystem is in the connected state, the Test Set constantly monitors the station's transmitted carrier power. If the Power falls below 0.0005 Watts, the error message **RF Power Loss indicates loss of Voice Channel** will be displayed and the Test Set will terminate the call and return to the active state.

NOTE:

In order to ensure that the Test Set makes the correct decisions regarding the presence of the mobile stations's RF carrier, the Test Set's RF power meter should be zeroed before using the Call Processing Subsystem. Failure to zero the power meter can result in erroneous RF power measurements.

The field descriptions for each of the messages are given in the "**Display Word**" on page 231.

Reading the CALL BIT Screen Message Fields This section provides programming information on how to read the contents of individual fields in the signaling messages available on the **CALL BIT** screen.

The syntactical structure for reading the contents of one or more fields from an individual message is as follows:

General Syntax

CALLP:<message name>:<field name><?>[<?><additional field><?>]

Table 4 lists the message names used to access each of the signaling messages available on the **CALL BIT** screen.

Table 4 CALL BIT Screen Signaling Message Names

Message	Message Name	Message	Message Name
SPC WORD1	SPOM1/SPOMESSAGE1	BSChalCon	BSCConfirmation
SPC WORD2	SPOM2/SPOMESSAGE2	UniqChOrd	UCORder
ACCESS	ACCess	FVC SSD1	FVCSSD1
REG INC	RINCrement	FVC SSD2	FVCSSD2
REG ID	RIDentify	FVC SSD3	FVCSSD3
C-FILMESS	CFMessage	FVCBSCon	FVCBSConfirmation
MS WORD1	MSWord	FVCUniqCh	FVCUChallenge
MSMessOrd	MSORder	EXT PROT	EPFControl EXTP
MS IntvcH	MSVoice	NCH ASN	NCAMessage NCHA
FVC O Mes	FVORder	NMS FVC	NFVMessage NFVC
FVC C Mes	FVVoice	MRI MES	MRIMessage NRMI
RandChalA	RCA	WNHO MES	WNHMessage
RandChalB	RCB	NHO MES	NHOMessage
RAND SSD1	RSSD1		
RAND SSD2	RSSD2		
RAND SSD3	RSSD3		

Example of Querying A Single Field

```
OUTPUT 714;"CALLP:MESS 'SPC WORD1'"
OUTPUT 714;"CALLP:SPOM1:SID?"
ENTER 714;Sid$
PRINT Sid$
```

Example Printout

```
"00000001110011"
```

Querying Multiple Fields With Single OUTPUT/ENTER When multiple queries are combined into one command string the Test Set responds by sending one response message containing individual response message units separated by a response message unit separator (;).

Example of Multiple Queries Combined Into One Command String

```
OUTPUT 714;"CALLP:MESS 'SPC WORD1' "  
OUTPUT 714;"CALLP:SPOM1:DCC?;SID?;OHD? "  
ENTER 714;Message$  
PRINT Message$
```

Printed Test Set Response Message

```
"01";"00000001110011";"110"
```

In order to read individual response message units into individual string variables combined into one ENTER statement the programming language used must recognize the response message unit separator (;) as an entry terminator for each string in the input list. If the programming language used cannot recognize the response message unit separator (;) as an entry terminator then the response message must be read into one string and individual responses parsed out.

Modifying the CALL BIT Screen Message Fields This section provides programming information on how to set the contents of individual fields in the signaling messages available on the **CALL BITS** screen.

The syntactical structure for setting the contents of a field in an individual message is as follows:

General Syntax'

```
CALLP:<message name>:<field name><space><'><data string><'>
```

Table 4, "CALL BIT Screen Signaling Message Names" on page 98 lists the message names used to access each of the signaling messages available on the **CALL BIT** screen.

Example of Modifying A Single Field

```
OUTPUT 714;"CALLP:SPOM1:SID '00000001110011' "
```

Example of Modifying Multiple Fields With One OUTPUT

```
OUTPUT 714;"CALLP:SPOM1:DCC '01';SID '00000001110011';OHD '110' "
```

Call Control Screens - CALL CONFIGURE

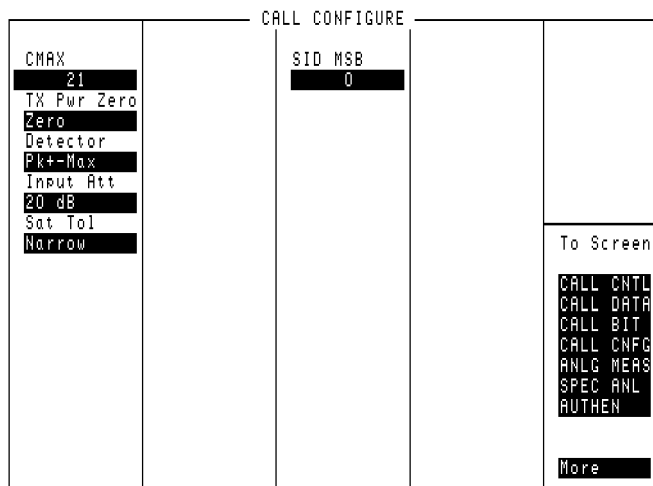

Figure 12 The CALL CONFIGURE Screen

NOTE: The number of fields displayed on the CALL CONFIGURE screen depends on the selected system type.

This screen is used to set some of the less commonly used Test Set configuration parameters.

When the CALL CONFIGURE screen is displayed and the Call Processing Subsystem is in the connect state, the Test Set constantly monitors the mobile station's transmitted carrier power. If the power falls below 0.0005Watts, the error message **RF Power Loss indicates loss of Voice Channel** will be displayed and the Test Set will terminate the call and return to the active state.

NOTE: In order to ensure that the Test Set makes the correct decisions regarding the presence of the mobile stations's RF carrier, the Test Set's RF power meter should be zeroed before using the Call Processing Subsystem. Failure to zero the power meter can result in erroneous RF power measurements.

Call Control Screens - CALL DATA

CALL DATA						
<input type="checkbox"/> Active						Active
<input type="checkbox"/> Register						Register
<input type="checkbox"/> Page						Page
<input type="checkbox"/> Access						Handoff
<input type="checkbox"/> Connect						Release
Order						
Chng PL 0						
Display Word					To Screen	
RECCW A					Word A	
F	NAWC	T	S	E	RSVD	SCM
MINI					Parity	
						More

Figure 13 **The CALL DATA Screen**

This screen displays the decoded reverse control channel and reverse voice channel signaling messages received by the Test Set from the mobile station. Thirteen different decoded messages can be viewed on this screen. The message to be viewed is selected using the **Display Word** field.

The messages which can be viewed are:

- Reverse Control Channel Messages for Paging, Origination, Orders, and Order

Confirmation.

- **RECCW A** - Word A - Abbreviated Address Word
- **RECCW B** - Word B - Extended Address Word
- **RECCW C** - Word C - Serial Number Word
- **RECCW D** - Word D - First Word of the Called-Address
- **RECCW E** - Word E - Second Word of the Called-Address
- Reverse Voice Channel Messages for Order Confirmation.
 - **RVCOrdCon** - Reverse Voice Channel Order Confirmation Message
- Reverse Control Channel Authentication Messages.
 - **BSChalOrd** - Word C - Base Station Challenge Word
 - **AuthWORD** - Word C - Authentication Word
 - **UniqChCon** - Word C - Unique Challenge Order Confirmation Word
- Reverse Voice Channel Authentication Messages.
 - **RVCOrd** - Word one - Reverse Voice Channel Generic Order
 - **RVCBSChal** - Word 2 - Reverse Voice Channel Base Station Challenge Order
- NAMPS Reverse Voice Channel Messages.
 - **NRVC Ord** - Narrow Order or Order Confirmation Message
 - **MRI Ord** - MRI Order message

The field descriptions for each of the decoded messages are given in the [Display Word field description, on page 231](#).

When the CALL DATA screen is displayed and the Call Processing Subsystem is in the connected state, the Test Set constantly monitors the mobile station's transmitted carrier power. If the power falls below 0.0005Watts, the error message **RF Power Loss indicates loss of Voice Channel** will be displayed and the Test Set will terminate the call and return to the active state.

NOTE:

In order to ensure that the Test Set makes the correct decisions regarding the presence of the mobile stations's RF carrier, the Test Set's RF power meter should be zeroed before using the Call Processing Subsystem. Failure to zero the power meter can result in erroneous RF power measurements.

Reading the CALL DATA Screen Message Fields

This section provides programming information on how to read the individual fields from the decoded reverse control channel and reverse voice channel signaling messages available on the **CALL DATA** screen.

The syntactical structure for reading one or more fields from an individual message is as follows:

General Syntax CALLP:<message name>:<field name><?>[<;><additional field><?>]

Call Data Screen Message and Field Names [Table 5](#) lists the message names used to access each of the signaling messages available on the **CALL DATA** screen.

Table 5 CALL DATA Screen Signaling Message Names

Message	Message Name
RECCW A	RECA
RECCW B	RECB
RECCW C	RECC
RECCW D	RECD
RECCW E	RECE
RVCOrdCon	RCOConfirm
BSChalOrd	BSCOrder
AuthWORD	AWORD
UniqChCon	UCConfirmation
RVCOrd	RVCOrder
RVCBSChal	RVCBSChallenge
NRVC Ord	NOConfirm
MRI Ord	MRIOrder

Querying a Single Field

Example of Querying A Single Field

```
OUTPUT 714;"CALLP:DATA 'RECCW A' "  
OUTPUT 714;"CALLP:RECA:SCM? "  
ENTER 714;Scm$  
PRINT Scm$
```

Example Printout

```
"1110"
```

Querying Multiple Fields With Single OUTPUT/ENTER

When multiple queries are combined into one command string the Test Set responds by sending one response message containing individual response message units separated by a response message unit separator (;).

Example of Multiple Queries Combined Into One Command String

```
OUTPUT 714;"CALLP:RECA:NAWC?;SER?;EXT?;SCM?;MIN? "  
OUTPUT 714;"CALLP:DATA 'RECCW A' "  
ENTER 714;Message$  
PRINT Message$
```

Printed Test Set Response Message

```
"010";"1";"1";"1110";"110111100101101111010101"
```

In order to read individual response message units into individual string variables combined into one ENTER statement the programming language used must recognize the response message unit separator (;) as an entry terminator for each string in the input list. If the programming language used cannot recognize the response message unit separator (;) as an entry terminator then the response message must be read into one string and individual responses parsed out.

CDMA Authentication Screen



Figure 14 The CDMA Authentication Screen

The CDMA Authentication screen, available in Test Sets with firmware revision A.06.00 and above, provides the necessary features for testing a CDMA mobile station's ability to perform call-processing functions with authentication. Once a mobile station is registered, valid A-Key Check Digits can be generated, and a table displays the authentication parameters sent by the mobile station, along with the expected value and a passed/failed indication.

CDMA Call Control Screen

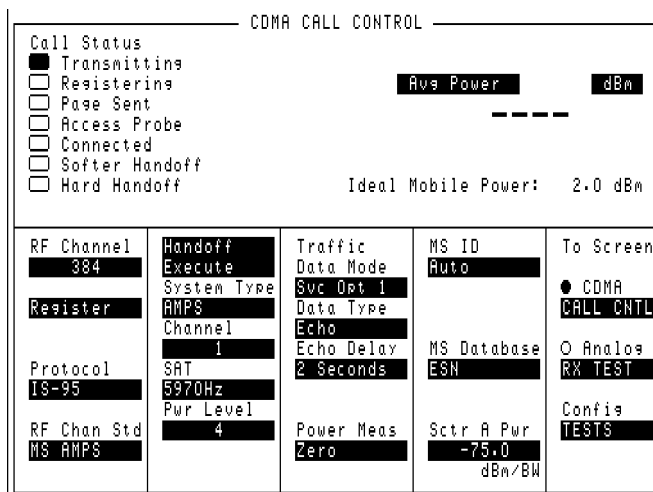

Figure 15 The CDMA Call Control Screen

This screen allows you to establish a call, terminate a call, and perform handoffs.

CDMA Cell Site Configuration Screen

CDMA CELL SITE CONFIGURATION				
Protocol IS-95	Non Power 0 dB	Pwr Up Res On/Off	Answer Mode Auto/Manual	Page Rate Half
Network ID 1		Timer Res On/Off	Call Limit None/Page	Num Pages 1
System ID 7	Init Power 0	Res Period 29	Pilot Inc 12	
Base ID 39	Power Step 3 dB		Srch Win A 8	
	Pan Size 10		Srch Win N 8	To Screen
	Num Step 5	Authen On/Off	Srch Win R 8	<input checked="" type="radio"/> CDMA
	Max Req Sea Max Rsp Sea	RAND 34A2B05F RANDSSD		<input type="radio"/> Analog
Restr NID 12	Max Slot Cycle Index	4D18EEAA05895C RANDU 5375DF		CALL CNTL SMS AUTHEN
Restr SID 12				RX TEST Config TESTS

Figure 16 The CDMA Cell Site Configuration Screen

This screen provides fields for setting up CDMA cell site system parameters and fields for setting up an analog cell site voice channel for digital to analog handoffs.

CDMA Cellular Mobile Receiver Test Screen

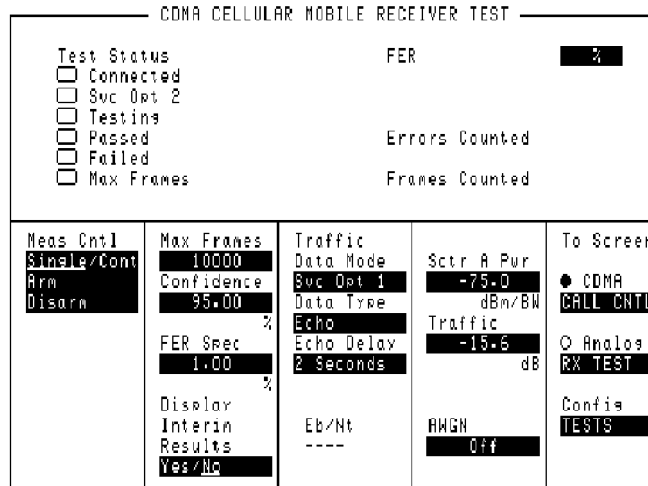
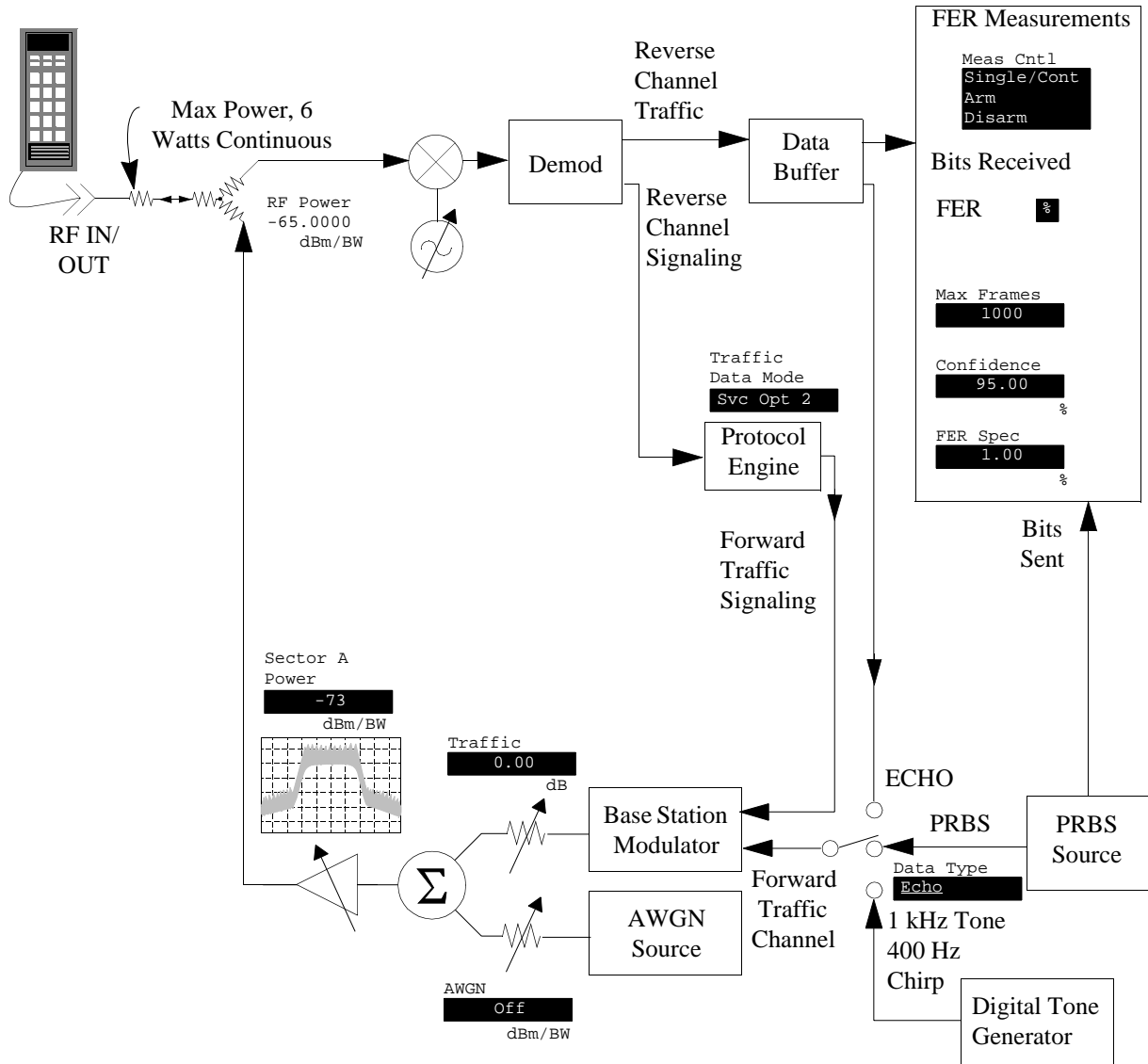

Figure 17 The CDMA Cellular Mobile Receiver Test Screen

This screen allows receiver (FER) test setup, controls start and stop of receiver tests, and displays call status and FER results.

CDMA Cellular Mobile Receiver Block Diagram



CDMA Cellular Mobile Transmitter Test Screen

CDMA CELLULAR MOBILE TRANSMITTER TEST				
Traffic Rho		Phs Error		des
Frea Error		Hz	Avg Power	dBm

Meas Cntl		Traffic	Scrr A Pwr	To Screen
Single/Cont		Data Mode	-75.0	CDMA
Arr		Svc Opt 1	dBm/BW	CALL CNTL
Disarr		Data Type		
		Echo	RF Power	Analog
		Echo Delay	-75.00	RX TEST
		2 Seconds	dBm/BW	
		Power Meas		Confia
		Zero		TESTS

Figure 18 The CDMA Cellular Mobile Transmitter Test Screen

This screen reports measurements of the mobile's transmitter.

CDMA Generator Control Screen

CDMA GENERATOR CONTROL					
Sctr A Pwr -75.0 dBm/BW		Sctr B Pwr Off		AMGN Off	
Pilot -7.0 dB	Walsh 0	Pilot -7.0 dB	Walsh 0	RF Power -75.00 dBm/BW	Eb/Nt ----
Sync -16.0 dB	32			To Screen <input checked="" type="radio"/> CDMA <input type="radio"/> CALL CNTL <input type="radio"/> Analoe <input type="radio"/> RX TEST Confie <input type="radio"/> TESTS	
Paging -12.0 dB	1				
Traffic -15.6 dB	8	Traffic -16.0 dB	12		
OCNS -1.7049 dB	17	OCNS -1.1532 dB	42		
PN Offset 12		PN Offset 36			

Figure 19 The CDMA Generator Control Screen

This screen controls the output power of the Test Set.

CDMA Generator Control Block Diagram

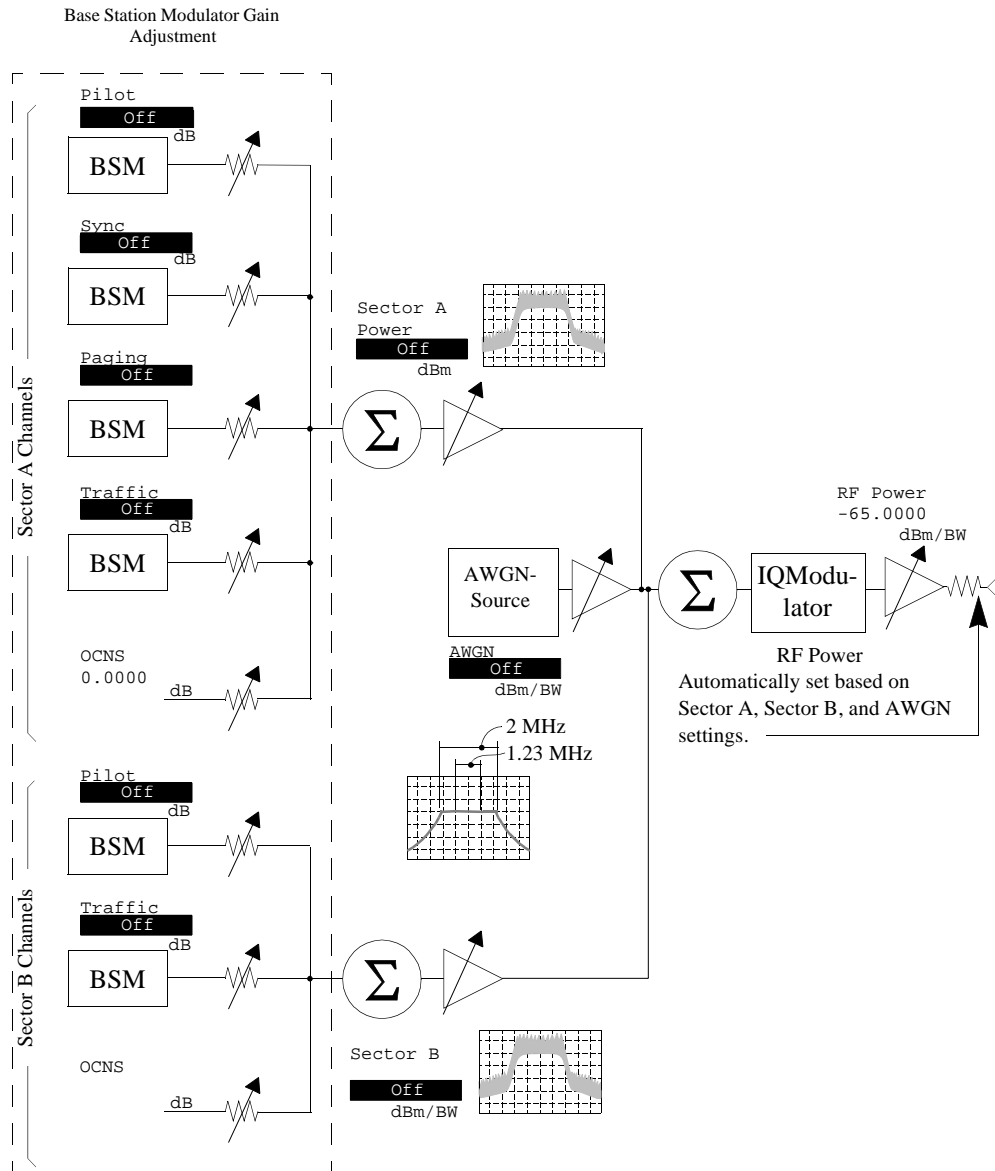

CDMA Mobile Reported FER Screen

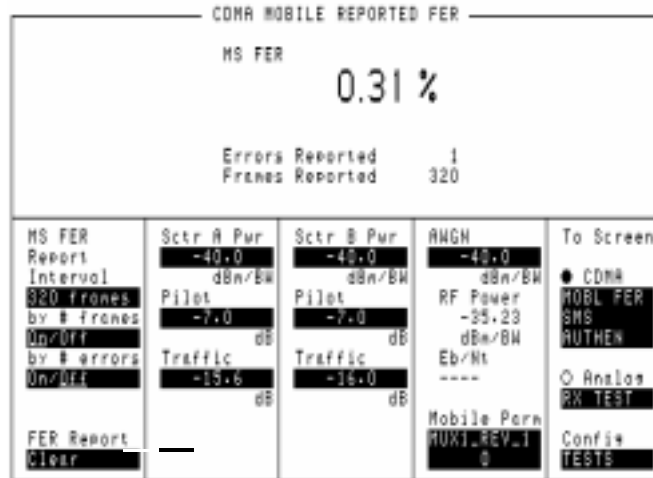

Figure 20 The CDMA Mobile Reporting Screen

This screen displays FER (Frame Error Rate) data as it is reported from the mobile station. The mobile station can be signaled to report FER at time intervals based on the number of frames received or at time intervals based on the number of frame errors counted, or both.

CDMA Mobile Reported Pilot Strength Screen

CDMA MOBILE REPORTED PILOT STRENGTH				
Status (Traffic)	PN Offset	Strength	Keep	
Active	12	17	1	
Candidate	36	22	1	
	Expected PN Offset	Expected Strength	Expected T.Drop	
{Sector A}	12	20	32	
{Sector B}	36	20	32	
Soft Handoff	Expected T.Add	Sctr A Pur	Sctr B Pur	To Screen
On/Off	20	-40.0	-40.0	● CDMA
Soft/Softest		dBm/BW	dBm/BW	MOBL RPT
T.Add		Pilot	Pilot	SMS
28		-7.0	-7.0	AUTHEN
T.Drop	Soft Slope			○ Analog
32	16			RX TEST
T.Comp	Add Intcal	RF Power		Confis
5	6	-36.99	Pilot Meas	TESTS
T.TDrop	Drop Intcal	dBm/BW	Clear	
3	4			

Figure 21 The CDMA Mobile Reporting Screen

This screen displays pilot strength data as reported from the mobile station. You can perform softer handoffs and change pilot measurement thresholds which affect when the mobile station will send Pilot Strength Measurement Report Messages.

CDMA Short Message Service Screen



Figure 22 The CDMA Short Message Service Screen

The CDMA Short Message Service screen, available in Test Sets with firmware revision A.06.00 and above, provides fields for entering and sending messages to the mobile station over both the Traffic and Paging channels. The Test Set also indicates whether the mobile station acknowledged reception of the message.

CDMA Transmitter Power Range Test Screen

CDMA TRANSMITTER POWER RANGE TEST				
Max Power ----- dBm		Ave Power dBm -----		
Min Power ----- dBm		Ideal Mobile Power: 2.0 dBm		
Min/Max Pwr Execute	Closed Loop Pwr Cntl Closed Loop Change n down Steps 50 Execute Droo Tiner On/Off	Traffic Data Mode Svc Opt 1 Data Type Echo Echo Delay 2 Seconds Power Meas Zero	Sctr A Pwr -75.0 dBm/BW Traffic -15.6 dB	To Screen <input checked="" type="radio"/> CDMA CALL CNTL <input type="radio"/> Analog RX TEST Config TESTS

Figure 23 The CDMA Transmitter Power Range Screen

CDMA Reverse Channel Spectrum Screen

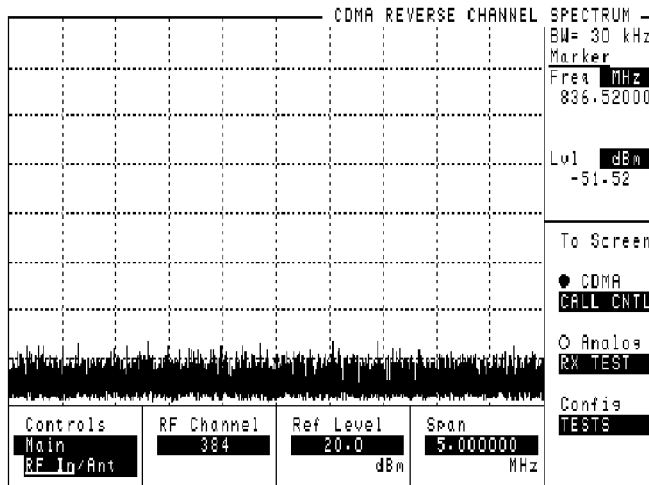

Figure 24

The CDMA Reverse Channel Spectrum Screen

Configure Screen

CONFIGURE				
Range Hold Auto All Hold All State: Mixed	Intensity 7	RF Display Freq/Chan	RF Level Offset On/Off	Firmware A.06.25
RX/TX Cntl Auto/Manual Carrier/PTT	Beeper Quiet	RF Chan Std MS AMPS	RF In/Out 0.0 dB	Total RAM 928 kB
Notch Coupl AFGen1/None	Date 120298 MMDDYY		Duplex Out 0.0 dB	Serial No. US35210014
Input Atten Auto/Hold 0 dB	Time 7.30 HH.MM		Antenna In 0.0 dB	To Screen ● CDMA CALL CNTL SMS AUTHEN
RFGen Volts 50 ohm/enf	External Reference 10.0000 MHz	Alt Pwr Ms Cal Bands	Output Port RF Out/Dupl	O Analog RX TEST
	Time Offset Normal	None	Input Port RF In/Ant	Config TESTS
	Frame Clock 2.00 s	PCS Intrfc Control On/Off		SERVICE

Figure 25 The Configure Screen

The CONFIGURE screen defines a number of general operating functions, such as date and time, screen intensity, and beeper volume. It is also used to define some RF signal parameters, such as RF Generator/Analyzer offset, channel standards and characteristics, and signal loss/gain compensation.

Duplex Test Screen

DUPLX TEST				
TX Freq Error kHz -----		FM Deviation kHz -----		
TX Power W -0.00029		AF Freq kHz -----		
Tune Mode Auto/Manual	RF Gen Freq 881.520000 MHz	AFGen1 Freq 1.0000 kHz	AF An1 In FM Demod	To Screen
Tune Freq 836.520000 MHz	Amplitude Off	AFGen1 To Audio Out 50.0 nV	Filter 1 <20Hz HPF	<input type="radio"/> CDMA
Input Port RF_In/Ant	Atten Hold On/Off	FM Coupling AC/DC	Filter 2 6kHz BPF	<input checked="" type="radio"/> Analog
IF Filter 230 kHz	Output Port RF_Out/Dupl	Audio Out AC/DC	De-Emphasis 750 us/Off	<input type="radio"/> RX TEST
Ext. TX Key On/Off			Detector Pk+-Max	Config TESTS

Figure 26 The Duplex Test Screen

Duplex Test Block Diagram

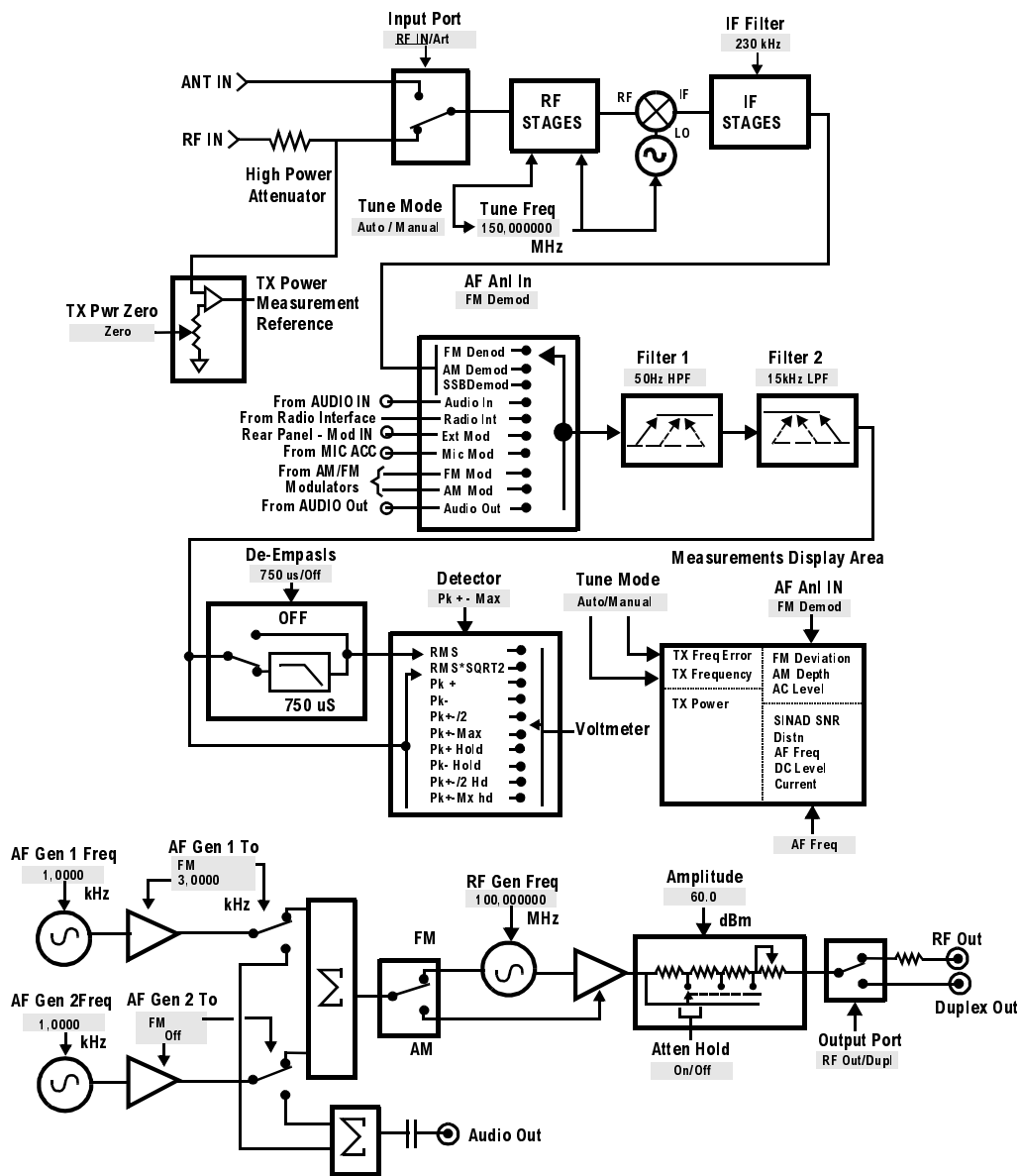

Figure 27 DUPLEX TEST Functional Block Diagram

Help Screens

The HELP screen is used to access tutorial information for a wide variety of instrument functions.

After this screen is accessed, push the cursor-control knob to display the help Index. The knob is then used to select the desired topic.

Once you have accessed the desired information, you can return to the Help Index by pushing the cursor-control knob.

To exit the HELP screen and return to the previous screen, press the PREV key.

I/O Configure Screen

I/O CONFIGURE			
HP-IB Adrs	Serial In	Serial Baud	
14	Inst/IBASIC	9600	
Mode	IBASIC Echo	Parity	
Control	On/Off	None	
	Inst Echo	Data Length	
	On/Off	8 bits	
		Stop Length	
		1 bit	
Save/Recall		Rcv Pace	
Internal		Non/Off	
		Xnt Pace	
		Non/Off	
			To Screen
			<input type="radio"/> CDMA
			<input checked="" type="radio"/> CALL CNTL
			<input checked="" type="radio"/> Analog
			<input checked="" type="radio"/> RX TEST
			Config
			TESTS

Figure 28 **The I/O Configure Screen**

The I/O CONFIGURE screen's fields are used to specify HP-IB and serial communications settings.

Message Screen

The MESSAGE screen lists any error or operation messages that have occurred since the instrument was turned on.

The type of error and the time it occurred are listed. If one error occurs more than once before a different error is encountered, the number of times it occurred, and when it occurred, are displayed.

All messages are shown until the entire display is filled. If enough errors occur, the MESSAGE screen will scroll the first messages past the top of the screen. These messages cannot be retrieved.

Oscilloscope Screens

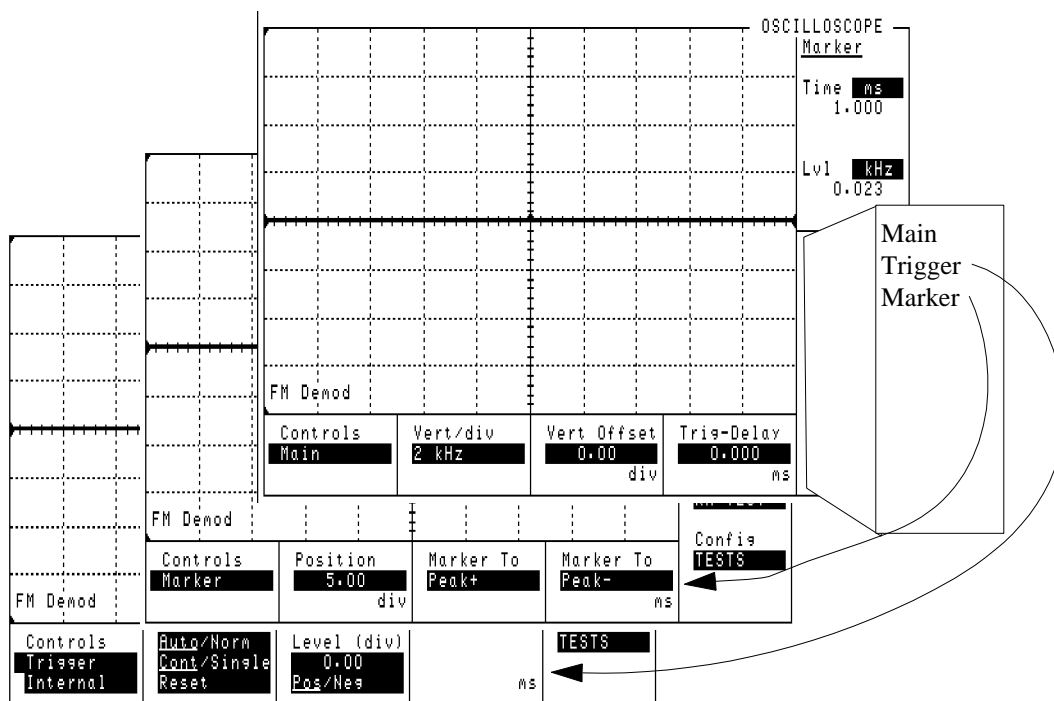

Figure 29 The Oscilloscope Screen and Menus

The OSCILLOSCOPE screen's controls are arranged by menu. The menus are accessed using the **Controls** field.

Assigning global USER keys to the most-used functions on the menus allows you to access the functions without having to change menus during operation.

Selecting the Oscilloscope's Input

The oscilloscope's input is determined by the **AF An1 In** field setting in the AF ANALYZER, TX TEST, or DUPLEX TEST screens.

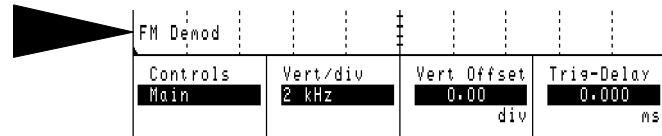

Figure 30 Oscilloscope Input Indicator

Using the Scope To Field

The **Scope To** field in the AF ANALYZER screen allows you to look at the signal at different stages in the AF Analyzer's process. (Refer to the [Scope To field description, on page 377](#) to understand the different choices.)

Except for the **Input** setting, all the choices are capacitively coupled. If the signal to be measured is ≤ 1 Hz, use the **Input** setting to provide the needed dc coupling.

Print Configure Screen

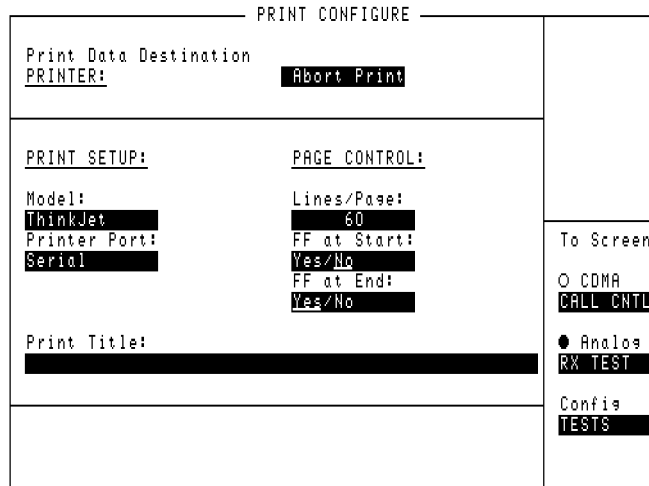

Figure 31 **The Printer Configurations Screen**

This screen configures the Test Set to print screen images with your printer. Images are printed using either the front-panel PRINT function (see [“Printing a Screen”](#) in the Operating Overview chapter of the *HP 8924C User’s Guide*) or the **Print ALL USER** key available on some TESTS environment screens.

RF Analyzer Screen

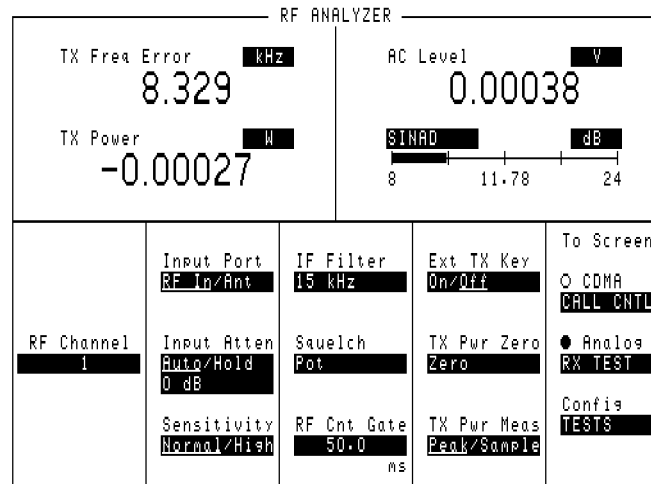

Figure 32 The RF Analyzer Screen

RF Analyzer Block Diagram

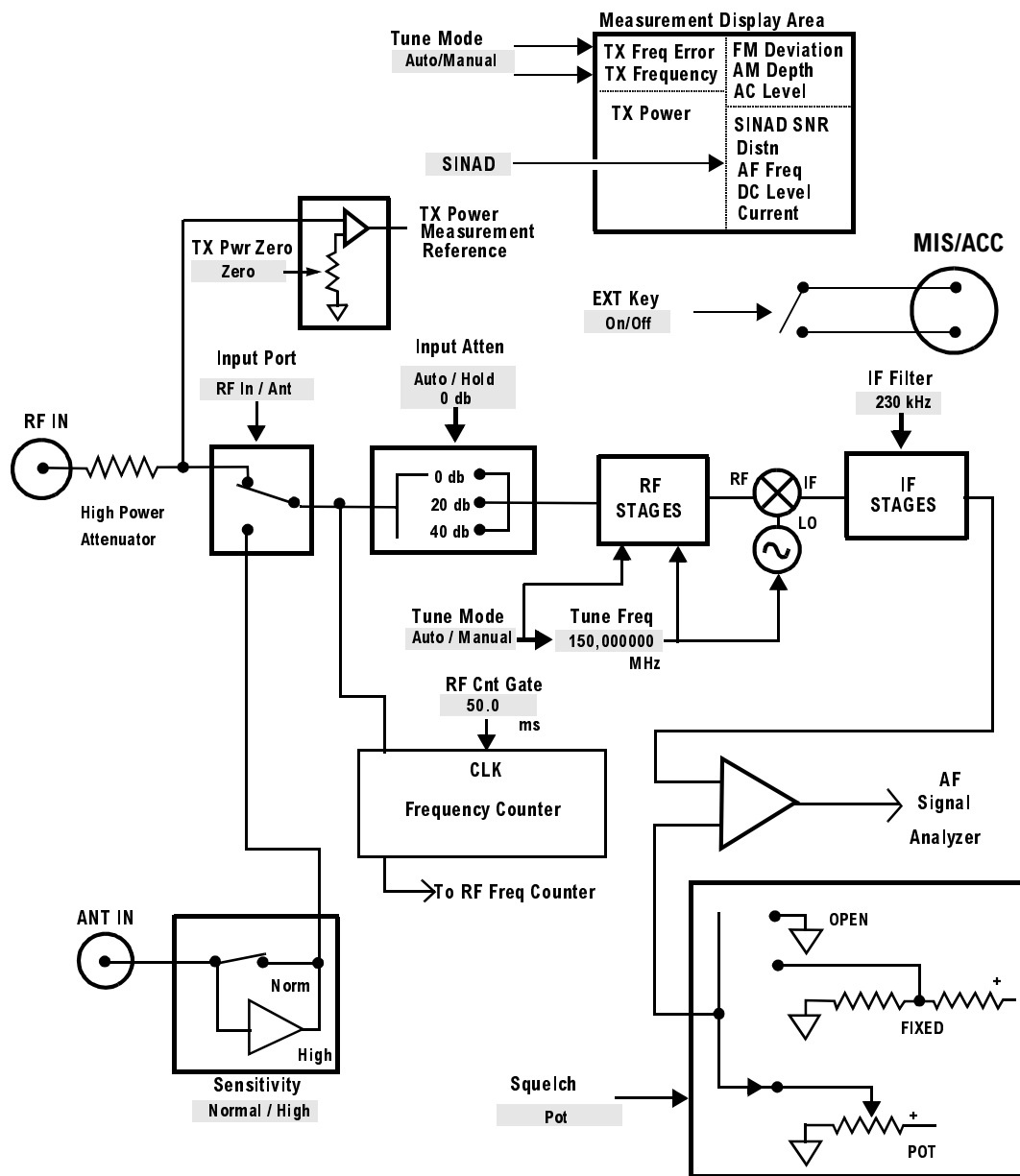

Figure 33 RF ANALYZER Functional Block diagram

RF Generator Screen

RF GENERATOR				
TX Freq Error kHz -----		FM Deviation kHz -----		
TX Power W -0.00029		RF Freq kHz -----		
RF Gen Freq 881.520000 MHz	AFGen1 Freq 1.0000 kHz	AFGen2 Send Stop	Mic Pre-Emph Auto/Hold On/Off	To Screen O CDMA CALL CNTL
Amplitude Off	AFGen1 To Audio Out 50.0	AFGen2 To FM	Mod In To FM (/Vpk) Off	• Analog RX TEST
Atten Hold On/Off	FM Coupling mV AC/DC	Audio Out AC/DC		Confis TESTS
Output Port RF Out/Dupl	DC FM Zero			

Figure 34 The RF Generator Screen

RF Generator Block Diagram

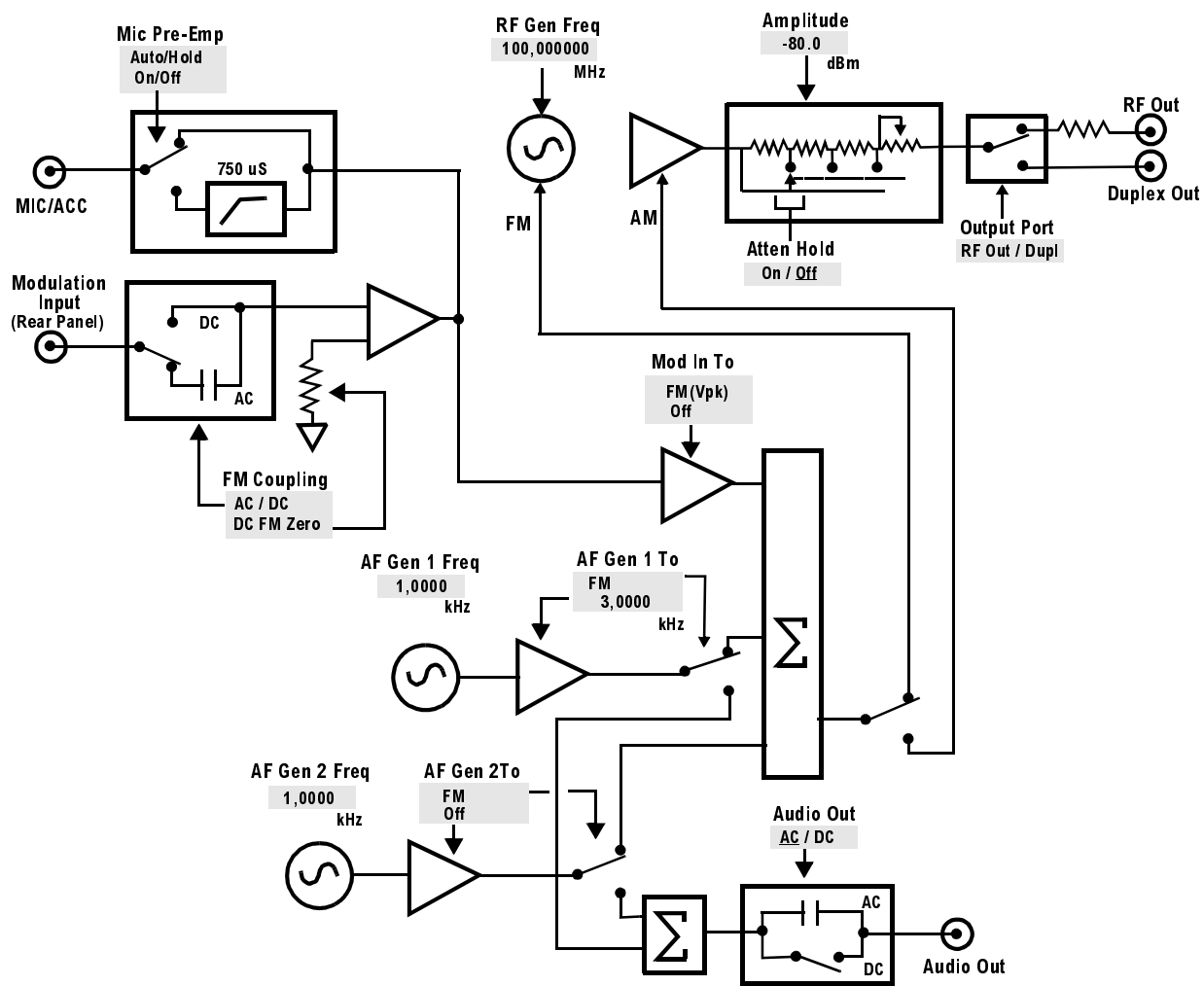

Figure 35 RF GENERATOR Functional Block Diagram

RX Test Screen

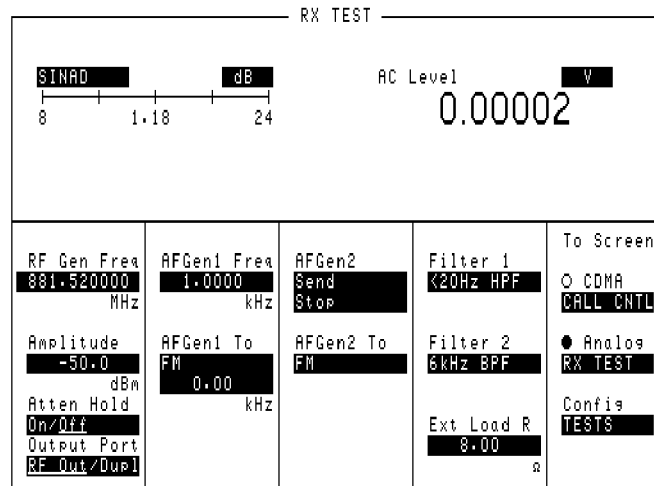

Figure 36 The RX Test Screen

RX Test Block Diagram

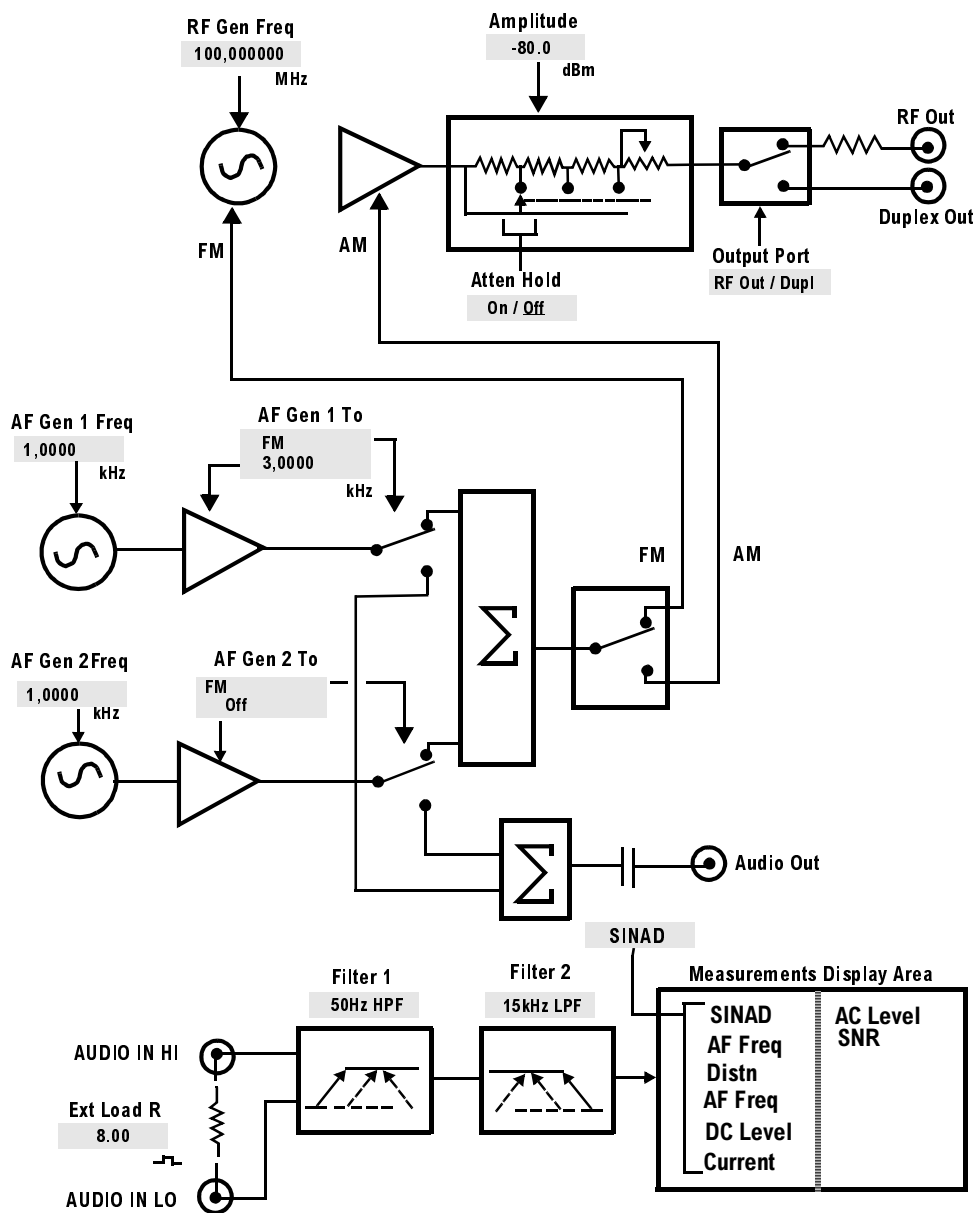

Figure 37 The RX Test Fields and Their Functions

NOTE: Since most of the measurements displayed are dependent on different field settings, the settings and values shown in the diagrams use the Test Set's preset conditions.

Service Screen

NOTE: This screen is used for component-level troubleshooting by the manufacturer. This method of troubleshooting is not currently supported outside of the factory.

This screen allows you to monitor individual circuit node measurements and change various MUX and DAC latch settings for isolating faulty modules. To access the **Service** screen, you must first access the **CONFIGURE** screen, then select **Service** from the **To Screen** menu.

Spectrum Analyzer Screens

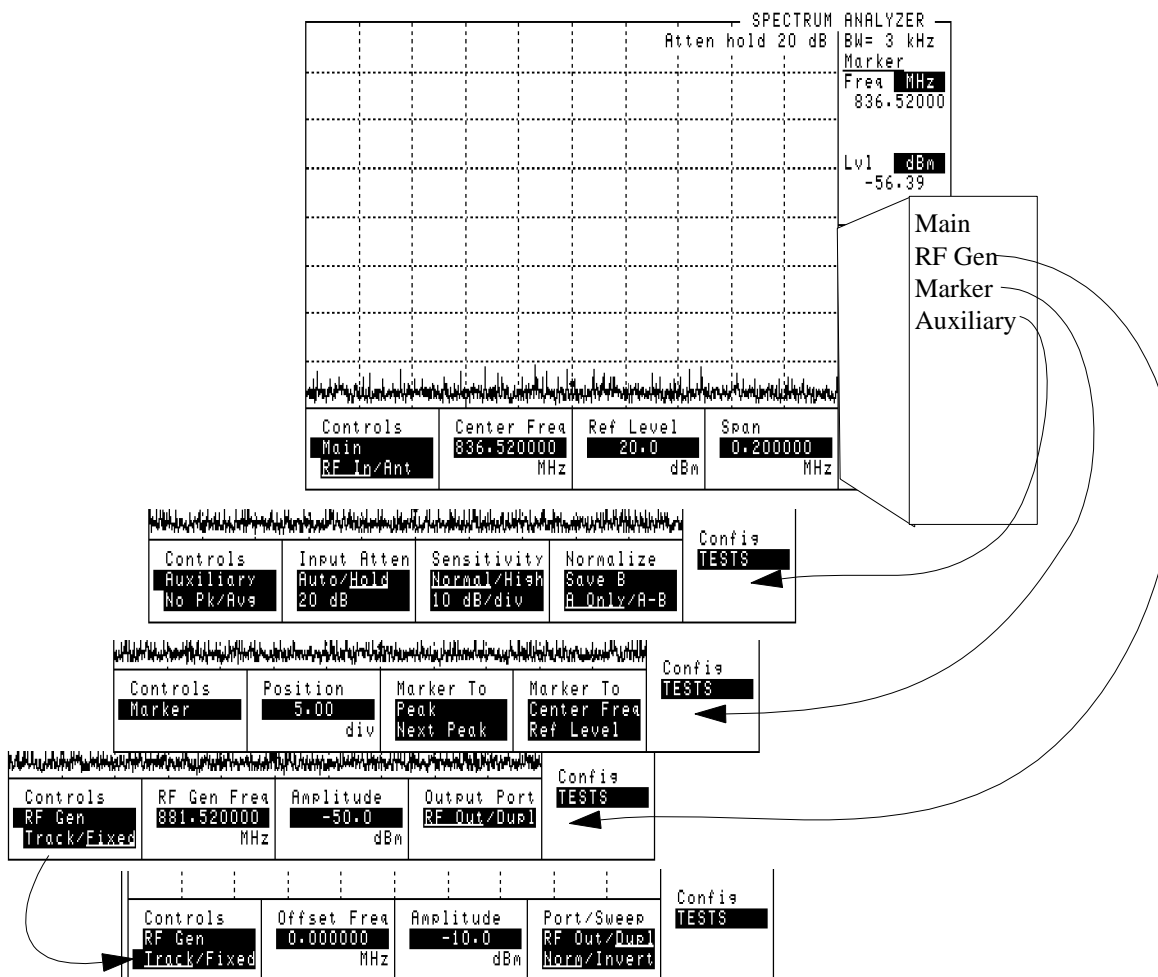

Figure 38 The Spectrum Analyzer Screen and Menus

The SPECTRUM ANALYZER screen's controls are arranged in four menus. The menus are accessed using the **Controls** field.

Assigning global USER keys to the most-used functions on the menus allows you to access the functions without having to change menus.

Using the Spectrum Analyzer

Automatic Calibration

During operation, the Spectrum Analyzer pauses for approximately 2 seconds every 5 minutes to recalibrate itself. This does not affect the accuracy of displayed measurements, but does cause a brief interruption of the displayed information during the process.

Setting Resolution Bandwidth and Sweep Rate

The resolution bandwidth and sweep rate are determined by the span setting, and cannot be set independently.

These settings are listed in the following table.

Table 6 Relationship Between Span, Resolution Bandwidth, and Sweep Rate

Span	Resolution BW (kHz)	Sweep Rate
<50 kHz	0.3	28.6 kHz/second
<200 kHz	1.0	329.0 kHz/second
<1.5 MHz	3.0	3.0 MHz/second
<3 MHz	30.0	21.4 MHz/second
<18 MHz	30.0	36.3 MHz/second
<200 MHz	300.0	257.0 MHz/second
1 GHz	300.0	1.0 GHz/second

TESTS Screens

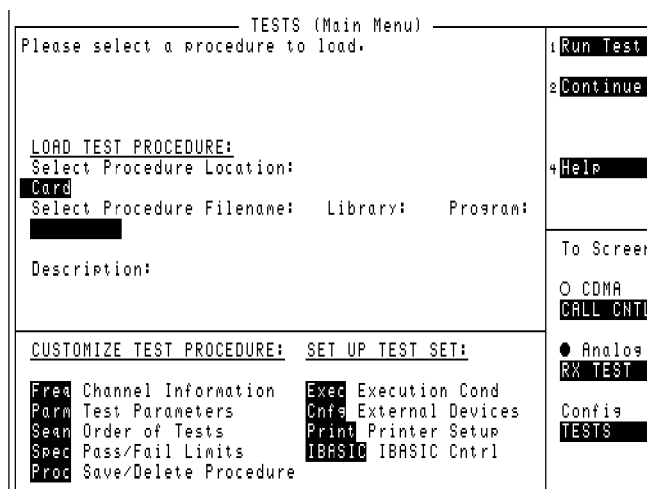

Figure 39 The TESTS (Main Menu) Screen

Description of the Tests Subsystem

The TESTS screens are also referred to as the Tests Subsystem; a group of screens used to create, edit, and run automated test programs. Using program control, the Test Set can run radio tests by itself and control other instruments using the HP-IB or Serial Port. The HP 83217A Mobile Station Test Software is an example of this type of operation.

Tests can be run from memory cards, the Test Set's internal ROM or RAM, or from an external disk drive.

Test programs are written in the HP Instrument BASIC (IBASIC) programming language.

TESTS (Main Menu)

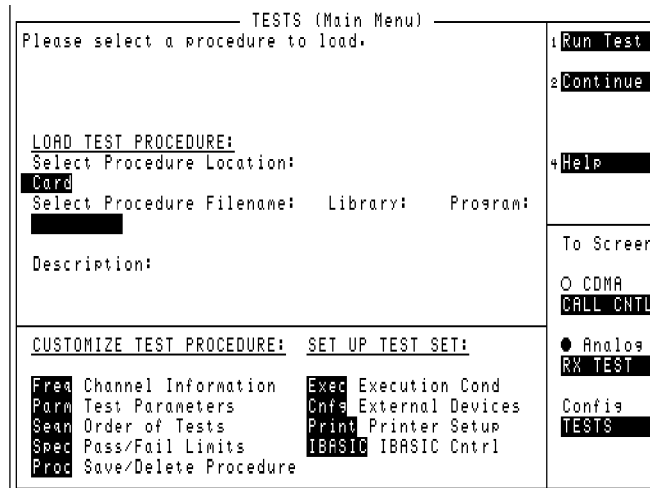

Figure 40 The TESTS (Main Menu) Screen

When you press the TESTS key, you access the main TESTS screen. The other screens of the subsystem are accessed using the **CUSTOMIZE TEST PROCEDURE:** or **SET UP TEST SET:** lists.

- **Main Menu** is used to load a test procedure from a disk, RAM, ROM, or memory card. It is also used to access the other screens in the Tests Subsystem.
- **Channel Information** is used to specify transmitter and receiver frequency information for the radio being tested and to enter squelch and signaling information.
- **Test Parameters** is used to tell the Test Set the requirements of the test system for testing your radio.
- **Order of Tests** is used to define a test sequence from a list of possible tests.
- **Pass/Fail Limits** is used to specify the upper and lower limits for each test point. If a limit is violated during a test, an **F** appears next to the test value to indicate a failure.
- **Save/Delete Procedure** is used to save and delete test procedures.
- **Execution Conditions** is used to control which test results are output and where the results are printed (CRT/printer). This screen also controls whether tests run continuously or singly, and whether the test continues or stops after a failure is detected.
- **External Devices** is used to specify what types of external equipment are connected to the Test Set and their addresses. It is also used to specify where to store test result data.
- **Printer Setup** is used to control which test results are output and where the results are printed. This screen is also used for basic formatting of the printout (lines per page and form feeds). Printer port and printer model number are also chosen on this screen.
- **IBASIC Cntrl** is used to run IBASIC programs. This screen is also used as a stand-alone IBASIC computer. See the *Instrument BASIC Programmer's Handbook* for information about writing your own tests for the Test Set.

TESTS (Channel Information)

TESTS (Channel Information)				
Chan#	RX Freq (MHz)	TX Freq (MHz)	Test?	Prime?
	RX Chan Info	TX Chan Info		
1	0.000000	0.000000	Yes/No	Yes/No
2	0.000000	0.000000	No	No
3	0.000000	0.000000	No	No
4	0.000000	0.000000	No	No
5	0.000000	0.000000	No	No
6	0.000000	0.000000	No	No
7	0.000000	0.000000	No	No
8	0.000000	0.000000	No	No

1 Insert Ch

2 Delete Ch

3 Print All

4 Help

5 Main Menu

To Screen

CDMA

CALL CNTL

Analog

RX TEST

Config

TESTS

Figure 41 The TESTS (Channel Information) Screen

This screen displays the channel frequencies to be tested.

TESTS (Test Parameters)

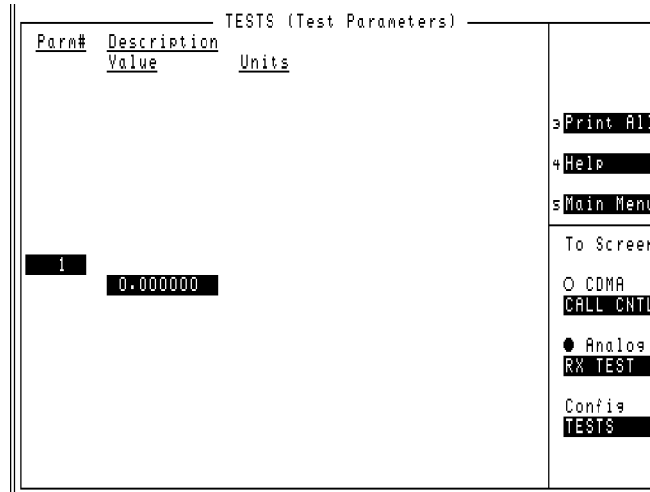

Figure 42 The TESTS (Test Parameters) Screen

Test Parameters are used to define operating and testing characteristics to match those of the radio being tested (audio-load impedance, audio power, power-supply voltage, and so forth).

By selecting the **Parm#**, **Value**, or **Units** fields and using the data and units keys, you can modify or enter parameters.

TESTS (Order of Tests)

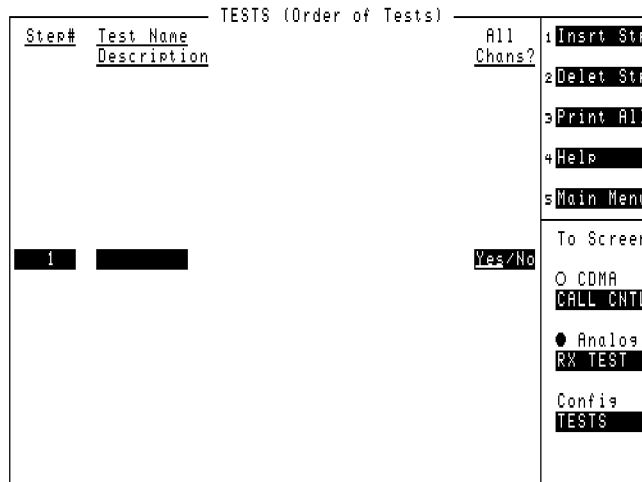

Figure 43 The TESTS (Order of Tests) Screen

This screen is used to decided what sequence the test should be executed.

TESTS (Pass/Fail Limits)

TESTS (Pass/Fail Limits)					
Spec#	Description	Lower Limit	Upper Limit	Units	Check
1		0.000000	0.000000		Upper

3 Print All

4 Help

5 Main Menu

To Screen

CDMA

CALL CNTL

Analog

RX TEST

Config

TESTS

Figure 44 **The TESTS (Pass/Fail Limits) Screen**

Pass/Fail limits are the radio manufacturer’s upper and lower limits used by the Tests Subsystem. For a radio to pass a test, the measured value must fall within the test’s limits. Tests results can be compared to only the lower limit, only the upper limit, both the upper and lower limits, or no limits (**None**). (Pass/Fail limits are sometimes referred to as specifications.)

TESTS (Save/Delete Procedure)

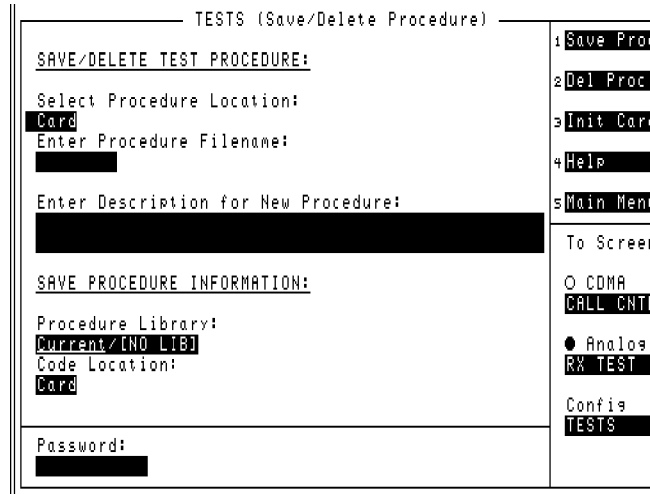

Figure 45 The TESTS (Save/Delete Procedure) Screen

After selecting a test sequence and defining the appropriate specifications, parameters, frequencies, and system configuration, you can save all that information as a procedure file for later use.

This screen is also used to delete procedures.

TESTS (Executions Conditions)

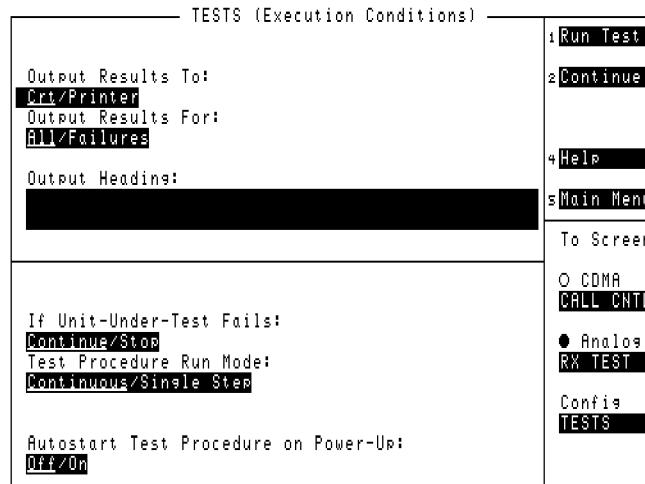

Figure 46 The TESTS (Execution Conditions) Screen

The TESTS (Execution Conditions) screen determines how tests are run.

TESTS (External Devices)

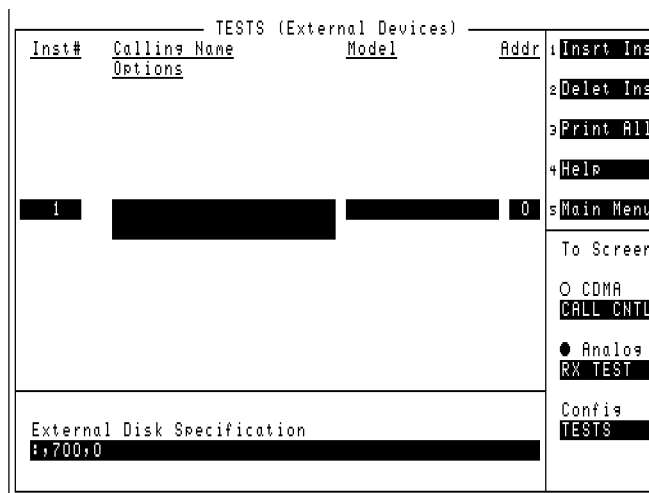

Figure 47 The TESTS (External Devices) Screen

The Tests Subsystem can only access external devices if they have been configured. Most external devices use the HP-IB port for control. A serial printer can be connected to the serial port for printing test results.

NOTE: **HP-IB Mode.** The **mode** field on the I/O CONFIGURE screen must be set to **Control** to access connected HP-IB instruments.

TESTS (Printer Setup)

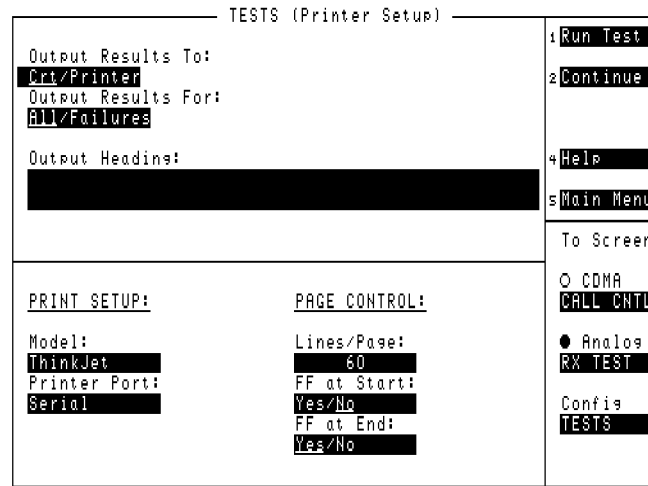

Figure 48 The TESTS (Printer Setup) Screen

The TESTS (Printer Setup) screen determines how tests are run.

TESTS (IBASIC Controller)

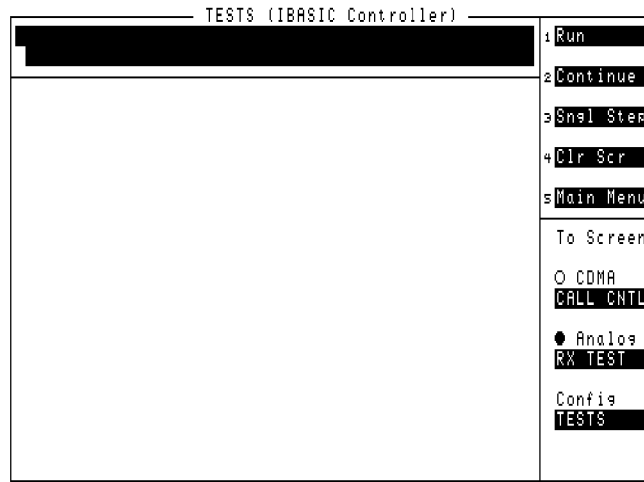

Figure 49 The TESTS (IBASIC Controller) Screen

The IBASIC controller is used to run IBASIC programs. This screen is also used as a stand-alone IBASIC computer. See the Instrument BASIC documentation for information about writing your own tests for the Test Set.

If you need to perform a simple IBASIC operation, such as a SAVE or GET function, you can enter commands one at a time. To do this, access the TESTS (IBASIC Controller) screen and use the knob to enter commands.

TX TEST Screen

TX TEST				
TX Freq Error kHz -----		FM Deviation kHz -----		
TX Power W -0.00029		AF Freq kHz -----		
Tune Mode Auto/Manual	Input Port RF In/Ant	AF Anl In FM Demod	AFGen1 Freq 1.0000	To Screen O CDMA
Tune Freq 836.520000 MHz	IF Filter 230 kHz	Filter 1 420Hz HPF	AFGen1 Lvl 50.0	CALL CNTL
TX Pur Zero Zero	Ext TX Key On/Off	Filter 2 6kHz BPF		Analog RX TEST
TX Pur Meas Peak/Sample		De-Emphasis 250 us/Off		Confis TESTS
		Detector		
		Pkt+Max		

Figure 50 The TX Test Screen

TX Test Block Diagram

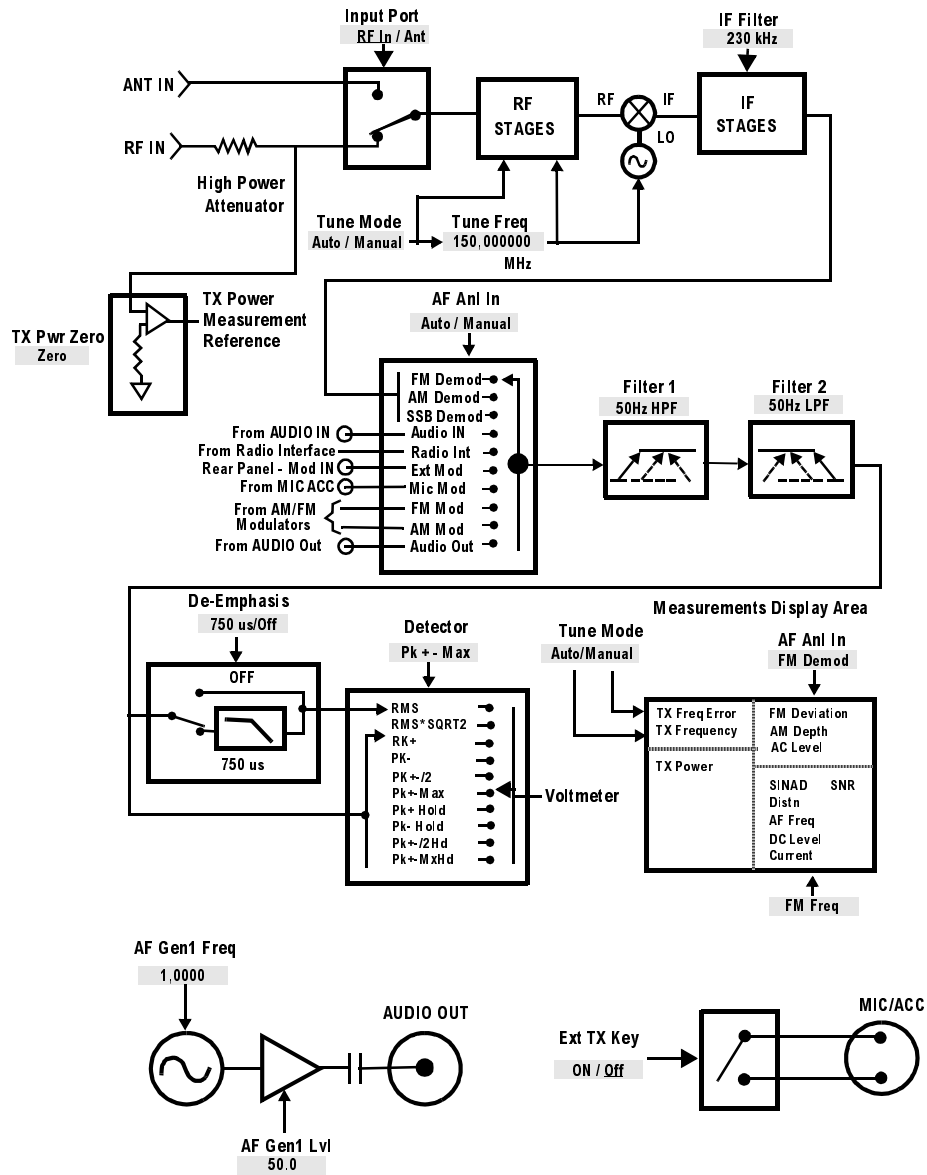

Figure 51 TX TEST Functional Block Diagram

4 **Description of Fields**

Field descriptions are listed in alphabetical order.

Fields That Begin with the Letter A

Abort Print

Select this field to interrupt the print in progress.

HP-IB Example

Abort Print is not directly programmable over the HP-IB."

Screens Where Field is Present

PRINT CONFIGURE

Access (annunciator)

When lit, the **Access** annunciator indicates the Test Set is signaling the mobile station with command information on the forward voice channel. This is a transitory state.

The state of the **Access** annunciator is reflected in the Call Processing Status Register Group Condition Register bit 4.

See "[Call Processing Status Register Group](#)" in the Status Reporting chapter of the *HP 8924C User's Guide* for further information.

The Test Set's speaker is turned off when in the access state. This is done to eliminate any possible audio feedback which may occur if the mobile station's microphone is open.

HP-IB Example

```
"DISP CCNT;STATUS:CDMA:CALLP:COND?"
```

queries the analog Call Processing event register. Bit four will be true (1) when an analog call is in the Access state. Also, the Access annunciator on the CALL CONTROL screen is lit when an analog call is in the Access state.

Screens Where Field is Present

CALL CONTROL
CALL DATA
CALL BIT

Acc Prb Pwr

This power measurement displays mobile station access probe power. This field is accessed by highlighting the currently displayed power measurement (listed below) and selecting Acc Prb Pwr from the list of choices.

This measurement must be cross-calibrated just as the Channel Power measurements. An **Uncal** annunciator will flash below this field when the Access Probe Power measurement has not been calibrated for the frequency band selected in the RF Chan Std field. See “[Calibrating Channel Power Measurements](#)” in the “Calibrating the Test Set” chapter of the *HP 8924C Application Guide*.

The following list describes the purpose for each HP 8924C power measurement. For more detail, refer to the field description for the power measurement you choose.

- Chan Power

Chan Power (Channel Power) displays lower level RF power by analyzing the downconverted IF at the Test Set’s DSP analyzer’s input. The amplitude range of this measurement is from -50 dBm to +35 dBm. This measurement is limited to a 1.23 MHz bandwidth.

- Avg Power

Avg Power (Average Power) displays the average power measured from all demodulated “on” power control groups transmitted by the mobile station under test. The specified amplitude range of this measurement is from -10 dBm to +40 dBm, and the input frequency range is from 30 MHz to 1000 MHz. This measurement is more accurate than the Chan Power measurement.

- Acc Prb Pwr

Acc Prb Pwr (Access Probe Power) displays access probes from the mobile station by automatically triggering a power measurement each time the mobile station registers, performs a mobile station originated call, or performs a mobile station terminated call. (Access Probe Power will also be displayed when SMS (Short Message Service) or Authentication procedures are attempted on the Paging channel.

HP-IB Example

```
"CDMA:TX:POW:MEAS `Acc Prb Pwr`"
```

selects the Access Probe Power measurement.

Operating Considerations

A sequence of access probes is transmitted as part of the mobile station's attempt to gain access to a CDMA system. To determine a mobile station's access probe power, select Acc Prb Pwr from the list of power measurement choices. Press then release the blue SHIFT key, then press the CALL CTRL key to access the CDMA CELL SITE CONFIGURATION screen. Select Page in the Call limit field. This will prevent a call from going to the Connected state, resulting in the mobile station transmitting all access probes in its pre-defined sequence. Several field settings affect the number of access probes and power levels of each access probe. These fields are listed below.

See also

["RF Power" field on page 369](#)

["Sctr A Pwr" field on page 377](#)

["Sctr B Pwr" field on page 378](#)

["Nom Power" field on page 310](#)

["Nom Pwr Ext" field on page 311](#)

["Init Power" field on page 274](#)

["Power Step" field on page 340](#)

["Num Step" field on page 315](#)

["Max Req Seq, Max Rsp Seq" field on page 291](#)

Screens Where Field is Present

CDMA CALL CONTROL

CDMA CELLULAR MOBILE TRANSMITTER TEST

CDMA TRANSMITTER POWER RANGE TEST

Access Probe (annunciator)

This annunciator lights when the mobile station transmits an access probe. This annunciator will remain lit until the call has been terminated.

A sequence of access probes is transmitted as part of the mobile station's attempt to gain access to a CDMA system. A mobile station originated call or a mobile station terminated call each require the mobile station to transmit access probes.

HP-IB Example

```
"DISP CCNT;STATus:CDMA:COND?"
```

queries the CDMA condition register. Bit 0 will be set when the Access Probe annunciator is lit.

Screens Where Field is Present

CDMA CALL CONTROL
CDMA AUTHENTICATION
CDMA SHORT MESSAGE SERVICE
CDMA AUTHENTICATION

AC Level

This is the default measurement for this field. The type of measurement shown is dependent on the **AF An1 In** settings.

This measurement displays either rms potential (voltage) or audio power (Watts or dBm).

HP-IB Example

```
"DISP AFAN;AFAN:INPUT `SSB Demod`;:MEAS:AFR:ACLevel?"
```

selects the AF ANALYZER screen, selects single-sideband demod from the AF An1 In field, then queries the AC Level field.

Operating Considerations

When the unit-of-measure is changed to measure AF power, the external load resistance must be specified. Refer to the [Ext Load R field description, on page 260](#).

The input for the ac level measurement on this screen is always the AUDIO IN connectors.

Screens Where Field is Present

AF ANALYZER
DUPLEX
RF ANALYZER
RX TEST

Active

This field is used to turn on the forward control channel of the Test Set or to force a return to the **Active** state from any other state (Register, Page, Access, Connect).

If the forward control channel of the Test Set is already active, sending the :ACTive command will deactivate and then reactivate the control channel.

The :ACTive command is used to control this field.

There is no query form of the :ACTive command.

Syntax

```
:ACTive
```

Example

```
OUTPUT 714;"CALLP:ACT"
```

Screens Where Field is Present

CALL CONTROL

Active (annunciator)

When lit, the **Active** annunciator indicates the control channel of the Test Set is turned on.

If this annunciator is lit, the base station is transmitting system parameter overhead messages on the assigned control channel. If the annunciator is not lit, the base station is not active.

NOTE: The Test Set may still be outputting a modulated RF carrier but the Test Set's firmware is not active and no communication can occur between a mobile station and the Test Set.

The **Active** annunciator is not programmable.

Screens Where Field is Present

CALL CONTROL
CALL BIT
CALL DATA

ACP Meas

This field selects the format for displaying upper and lower adjacent channel power levels.

- **Ratio** displays the power levels relative to the power around the center frequency (**Tune Freq**). Levels can be displayed in dB or as a percentage (%).
- **Level** displays the absolute power levels in mW, W, dBm, V, mV, and dBmV.

Operating Considerations

TX Power and **ACP Level** can only be measured through the RF IN/OUT port. Four dashes are displayed for these measurements when the **Input Port** is set to **Ant** (ANT IN).

ACP Ratio can be measured on either the ANT IN port or RF IN/OUT port.

For more information, refer to "[How the Test Set Measures Adjacent Channel Power \(ACP\)](#)" on page 89.

Screens Where Field is Present

ADJACENT CHANNEL POWER

Add Intcpt

This field is used to enter the parameter ADD_INTERCEPT. Refer to ANSI TIA/EIA-95-B for additional details.

This field is displayed only when TIA/EIA-95B is selected in the "[Protocol](#)" field on page 344.

HP-IB Example

```
"DISP CMOB;CDMA:MOB:PARM:IADD 8"
```

enters 8 in the Add Intcpt field.

Operating Considerations

This field setting, along with the "[Soft Slope](#)" field on page 396, modifies the way that the mobile station manages pilot sets. Refer to the [formula](#) found in the field description for "[Expected T_Add](#)" field on page 256. These fields also affect the conditions which require the mobile station to send a Pilot Strength Measurement Message.

See Also

[Expected T_Add field description, on page 256](#)

[Expected T_Drop field description, on page 258](#)

[Add Intcpt field description, on page 156](#)

[Drop Intcpt field description, on page 237](#)

Addr

This field is used to enter the instrument's remote address. For HP-IB instruments, enter the full 3-digit address (such as 704).

Screens Where Field is Present

TESTS (External Devices)

AF Anl In

The audio frequency analyzer input selects the input for the analyzer. When selected, this field displays a list of choices.

Signals can be analyzed from three different types of inputs:

- The output of the AM, FM, or SSB demodulators.
- The AUDIO IN, MODULATION INPUT, MIC/ACC, and AUDIO OUT connectors.
- The signal present at the AM or FM modulators for the RF Generator.

See “[AF Analyzer](#)” in the HP-IB Command Syntax chapter of the *HP 8924C Condensed Programming Reference Guide* for programming command syntax.

Operating Considerations

This is a priority control field. Accessing the RX TEST or TX TEST screen overrides any changes made to this field in this screen.

Screens Where Field is Present

AF ANALYZER
ANALOG MEAS
DUPLEX TEST
TX TEST

AF Cnt Gate

Audio frequency counter gate specifies how long the AF counter samples the signal before displaying the frequency. Specifying a shorter gate time may enable you to see frequency fluctuations that might not be seen using a longer gate time.

Screens Where Field is Present

AF ANALYZER

AF Freq

This field is a one-of-many field used to select the type of measurement to be made by the Audio Frequency Analyzer on the audio signal being measured. See “[Measure](#)” in the HP-IB Command Syntax chapter of the *HP 8924C Condensed Programming Reference Guide* for programming command syntax.

Selecting this field displays the following measurement choices:

- SINAD
- Distn (Distortion)
- SNR (Signal to Noise Ratio)
- AF Freq
- DC Level
- Current (DC only)

Operating Considerations

This is a priority control field. Accessing the RX TEST or TX TEST screen overrides any changes made to this field in other screens.

For more information about SNR operation, see the [SNR field description, on page 395](#).

Screens Where Field is Present

- AF ANALYZER
- ANALOG MEAS
- DUPLEX TEST
- RX TEST
- TX TEST
- RF GENERATOR
- RF ANALYZER

AF Freq

The **AF Freq** field is displayed only when the **Display** field is set to **Meas**.

This field displays the audio frequency of the demodulated FM signal being transmitted by the mobile station. Four dashes (----) indicate that no audio frequency is present to measure. A numeric value would only be displayed when the Test Set's **Connected** annunciator is lit.

Refer to the "**Display**" field on page 223 for information on how to read measurement results from this field.

Screens Where Field is Present

CALL CONTROL

AFGen1 Freq

This field sets the output frequency of Audio Frequency Generator #1. See "**AF Generator 1**" in the HP-IB Command Syntax chapter of the *HP 8924C Condensed Programming Reference Guide* for programming command syntax.

Screens Where Field is Present

ADJACENT CHANNEL POWER

ANALOG MEAS

DUPLEX TEST

RF GENERATOR

RX TEST

TX TEST

AFGen1 Lvl

This Audio Frequency Generator control sets the level out of the AUDIO OUT connector in volts rms (across a low-impedance output), or in mW, W, or dBm across a 600-ohm load (mW is selected by pressing SHIFT, ENTER).

Operating Considerations

In the TX TEST screen, the signal is *always* output through the AUDIO OUT connector.

Screens Where Field is Present

TX TEST

AFGen1 To

This field has two fields:

- the upper field sets the destination port for Audio Frequency Generator 1
 - **FM** -RF Generator FM modulator
 - **AM** -RF Generator AM modulator
 - **Audio Out** -AUDIO OUT connector on front panel of Test Set
- the lower field sets the:
 - FM modulation deviation if the upper field set to **FM**
 - AM modulation depth if the upper field set to **AM**
 - amplitude of audio signal (volts RMS) at the AUDIO OUT connector if upper field is set to **Audio Out**

For testing mobile stations, the upper field is normally set to **FM**, and the lower field set to the desired FM deviation in kHz. See “[AF Generator 1](#)” in the HP-IB Command Syntax chapter of the *HP 8924C Condensed Programming Reference Guide* for programming command syntax.

Operating Considerations

This is a priority control field. Accessing the RX TEST or TX TEST screen overrides any changes made to this field in other screens.

Screens Where Field is Present

ADJACENT CHANNEL POWER
ANALOG MEAS
DUPLEX TEST
RX TEST
RF GENERATOR

AFGen2 Freq

This Audio Frequency Generator control sets the frequency for the second audio frequency sinewave generator.

Screens Where Field is Present

RF GENERATOR
RX TEST

AFGen2 To

This field has two fields:

- the upper field sets the destination port for Audio Frequency Generator 2
 - **FM** -RF Generator FM modulator
 - **AM** -RF Generator AM modulator
 - **Audio Out** -AUDIO OUT connector on front panel of Test Set
- the lower field sets the:
 - FM modulation deviation if the upper field set to **FM**
 - AM modulation depth if the upper field set to **AM**
 - amplitude of audio signal (volts RMS) at the AUDIO OUT connector if upper field is set to **Audio Out**

For testing mobile stations, the upper field is normally set to **FM**, and the lower field set to the desired FM deviation in kHz.

The output level is the peak value for each tone pair, regardless of the **Twist** and **Pre-Emp** settings.

Operating Considerations

This is a priority control field. Accessing the RX TEST or TX TEST screen overrides any changes made to this field in other screens.

Screens Where Field is Present

RF GENERATOR
RX TEST

A_Key

Manually, this field is used to enter the mobile station's A_key into the Test Set. The user must obtain a valid **A_Key** from the mobile station's manufacturer, service provider or must generate a valid A_key to test authentication procedures, otherwise the authentication process will fail.

Entering an A_key Directly into the Test Set.

The :AKEY command is used to enter an A_key into the Test Set.

The query form of the command (that is, :AKEY?) can be used to determine the Test Set's current A_key value. The length of the returned value requires declaring the variable length at 26. This command does not return the mobile station's current A_key.

Syntax

```
:AKEY <'><26 CHARACTER A_key><'>  
:AKEY?
```

Example

```
DIM Akey_set$[27]  
OUTPUT 714;"CALLP:AMPS:AUTH:AKEY '12345678901234567890123456' "  
OUTPUT 714;"CALLP:AMPS:AUTH:AKEY?"  
ENTER 714;Akey_set$
```

Generating a New A_key.

The :Generate command is only available through the remote users interface. No field is displayed for this function on the test set.

The :GENerate command is used to generate a new A_key for use in the mobile station. This is an immediate action command. The resultant check sum value will be displayed on the AUTHENTICATION screen in the last six digits of the **A_key** field.

There is no query form of the GENerate command. Use the query form of "**A_Key**" on page 162 to determine the value of the A_key which was generated.

Syntax

```
:GENerate
```

Example

```
OUTPUT 714;"CALLP:AMPS:AUTH:AKEY:GEN"  
OUTPUT 714;"CALLP:AMPS:AUTH:AKEY?"  
ENTER 714;Akey_val$
```

Screens Where Field is Present

AUTHENTICATION

A-Key Digits

This field is used to enter the decimal digits used to generate the A_Key. When a number is entered, the Test Set will add leading zeroes if necessary to fill the field with 20 digits. The default setting is all zeroes.

HP-IB Example

```
"CDMA:AUTH:AKEY `1`"
```

enters a 1 preceded by 19 0's in the A-Key field.

Operating Considerations

When a new value for A_Key is entered into the **A_key** field, the Test Set's Shared Secret Data (SSD_A) is initialized to zero.

Check Digits are computed and displayed if a valid ESN is present in the **MS Database** when a number is entered in the **A_Key** field.

NOTE:

Check Digits are not affected by ESN when Kor PCS is selected in the **Protocol** field.

See also

["SSD Update \(annunciator\)" field on page 408](#)

["Check Digits" field on page 200](#)

Screens Where Field is Present

CDMA AUTHENTICATION

Alert

This field sets the Alert parameter in SMS messages.

HP-IB Example

```
"CDMA:SMS:TERM:ALERT `On`"
```

sets the Alert parameter to "On".

Operating Considerations

Some mobile stations require this field to be set to On for the mobile station to alert the user (through audio tones or vibration for example) that a message has been received.

Screen(s) Where Field is Present

CDMA SHORT MESSAGE SERVICE

All Chans?

This field allows you to choose if a new test is to be run on all channels (**Yes**) or only on prime channels (**No**). Prime channels are specified on the TESTS (Channel Information) screen. The underlined entry is the active choice.

Screens Where Field is Present

TESTS (Order of Tests)

Alt Pwr Ms Cal Bands

The frequency band occupied by the RF channel standard entered in this field will be included in the frequency coverage of the channel power calibration routine.

- None
- All Bands
- MS AMPS
- Japan CDMA
- MSL NAMPS
- MSM NAMPS
- MSU NAMPS
- MS TACS
- MS ETACS
- MS NTACS
- MS JTACS

HP-IB Example

```
"CONF:ACST 'All Bands' "
```

selects "All Bands" in the Alt Pwr Ms Cal Bands field.

See Also

["Calibrating the Test Set"](#) chapter in the *HP 8924C Application Guide*

Screens Where Field is Present

CONFIGURE

AM Depth

This field displays the percent depth of modulation of the AM signal. The field is only visible when the **AF ANL In** field is set to **AM MOD** or **AM DEMOD**.

Screens Where Field is Present

AF ANALYZER
RF ANALYZER
RF GENERATOR

Ampl Error

This field is displayed when Ampl Error is selected from the list of choices available when the unnamed field displaying one of the following choices is displayed:

- frequency error
- amplitude error
- time offset measurement

Amplitude error is an indication of the quality of the amplitude component in the reverse link OQPSK (offset quadrature phase shift keyed) signal. It is expressed as a percent difference between the magnitude of the ideal amplitude vector and the magnitude of the amplitude vector transmitted from the mobile station.

HP-IB Example

```
"DISP CTXT;MEASure:CDManalyzer:AMPL:ERROR?"
```

queries the CDMA amplitude error measurement result.

Operating Considerations

These measurements, along with rho, phase error, and carrier feedthrough are made by DSP analysis techniques. The **Meas Cnt1** field controls these measurements.

See Also

[Freq Error field description, on page 268](#)

[Meas Cnt1 field description, on page 292](#)

[Time Offset field description, on page 424](#)

Screens Where Field is Present

CDMA CELLULAR MOBILE TRANSMITTER TEST

Amplitude

This field sets the output power of the Test Sets's transmitter (that is, the output power of the Test Set's RF Generator). See "RF Generator" in the HP-IB Command Syntax chapter of the *HP 8924C Condensed Programming Reference Guide* for programming command syntax.

The :AMPLitude command is used to control this field.

To query the current setting of the amplitude field use the :AMPLitude? command.

Syntax

```
:AMPLitude <real number> <units>  
:AMPLitude?
```

Example

```
OUTPUT 714;"CALLP:AMPL -50 DBM"  
OUTPUT 714;"CALLP:AMPL?"  
ENTER 714;Ampl_val$
```

Operating Considerations

This is a priority control field. Accessing the RX TEST or TX TEST screen overrides any changes made to this field in other screens.

If a microphone is connected, and the amplitude is set to **OFF**, keying the microphone causes the amplitude to turn on to its previous level until the microphone is no longer keyed.

See Also

["Atten Hold" on page 168](#)

["MIC/ACC" on page 76](#)

Screens Where Field is Present

DUPLEX TEST
RF ANALYZER
RF GENERATOR
RX TEST
SPECTRUM ANALYZER
CALL CONTROL
ANALOG MEAS

Answer Mode

This field determines whether the Test Set will require answering before conversation or exchange of other traffic can begin. Use of this field applies only to mobile station originated calls

- **Auto** - a mobile station originated call will automatically progress to the connected state. No ringback tone will be heard on the mobile station's handset.
- **Manual** - the ANS key must be pressed to remove the ringback tone from the mobile station's audio path and allow user conversation, or other traffic, to be sent.

HP-IB Example

```
"DISP CCON;CDMA:CALL:ANSWER:MODE 'MANUAL' "
```

selects manual mode.

```
"DISP CCON;CDMA:CALL:ANSWER"
```

answers a mobile station originated call.

Operating Considerations

Calls will connect faster when **Answer Mode** is set to **Auto**.

Screens Where Field is Present

CDMA CELL SITE CONFIGURATION

Antenna In

This field is used to indicate losses or gains between the ANT IN port and the device-under-test.

Enter a *positive* value to indicate a gain (such as an amplifier). The Spectrum Analyzer's marker level (**Lvl**) measurement is automatically reduced by that amount. The Spectrum Analyzer's **Ref Level** is automatically decreased by the same amount, so the trace position does not appear to change.

Enter a *negative* value to indicate a loss (such as cable loss). The Spectrum Analyzer Marker's Level (**Lvl**) measurement is automatically increased by that amount. The Spectrum Analyzer's **Ref Level** is automatically increased by the same amount, so the trace position does not appear to change.

This field is only used when the **RF Level Offset** field is set to **On**.

See Also

["RF Level Offset" on page 367](#)

Screens Where Field is Present

CONFIGURE

Arm

This field triggers a single measurement. It is only displayed when the **Meas Cntl** field is set to **Single**. *This field is not updated to show the Meas Cntl mode when the Test Set is in remote operating mode.*

HP-IB Examples

```
"DISP CRXT;TRIG:MODE:RETR SINGLE"
```

sets the remote operation trigger mode to "Single".

```
"TRIGger:IMMediate"
```

triggers all active measurements.

Operating Considerations

Sending a command to trigger a measurement will re-start a measurement if there is one in progress.

When any of the CDMA screens are selected, all measurements are active. This eliminates the need to display specific screens to get measurement results.

See Also

["Measurement Triggering Process"](#) in the Operating Overview chapter of the *HP 8924C User's Guide*

[Disarm field description, on page 222](#)

Screens Where Field is Present

CDMA CELLULAR MOBILE RECEIVER TEST
CDMA CELLULAR MOBILE TRANSMITTER TEST

Atten Hold

Attenuator hold prevents the fixed RF output attenuators from switching in and out, eliminating the loss of the output signal as the level is changed. This function is helpful when making squelch measurements.

Operating Considerations

When this function is set to **On**, the RF output level is restricted to a range of 15 dB around the present **Amplitude** setting. Attempting to set an amplitude outside the allowed range results in an error message and beep (if the beeper is on). RF output level accuracy is greatly degraded outside the allowed range.

Screens Where Field is Present

DUPLEX TEST
RF GENERATOR
RX TEST

Audio In Lo

This field sets the AUDIO IN LO connector's state.

Gnd causes the center pin of the connector to be connected directly to chassis ground.

Float isolates the center pin of the connector from ground, providing a floating input to the AF Analyzer.

600 To Hi establishes a 600-ohm impedance between the center pins of the AUDIO IN LO and AUDIO IN HI connectors. Also, the **Ext Load R** field is removed, since the load is now fixed to 600 ohms.

Screens Where Field is Present

AF ANALYZER

Audio Out

Audio output coupling selects ac or dc coupling of the AF Generator to the AUDIO OUT connector.

Operating Considerations

This field should be set to **DC** for best results when using the AUDIO OUT connector and low data rates.

Screens Where Field is Present

DUPLEX TEST
RF GENERATOR

Authen

This field turns CDMA authentication **On** or **Off**.

When CDMA authentication is **On**, the Test Set signals the mobile station to go into authentication mode (AUTH_s is set to '01') when registrations, call originations, pages, or data bursts are performed.

The results of authentication procedures will be displayed in the Authentication Data Table. See "[Authentication Data Table](#)" on page 171.

Operating Considerations

When **Authen** is **On**, the Test Set will display the authentication parameters which the mobile station is required to send to a base station as part of the protocol's authentication procedures.

When **Authen** is **Off**, the expected AUTH_MODE parameter will be '0', and any other authentication parameters displayed in the **Authentication Data Table** will be dashes (-).

HP-IB Example

```
CDMA:CELL:CONF:AUTH:MODE 'ON'
```

turns Authentication "On"

See Also

Authentication Tests, HP 8924C Application Guide

Screens Where Field is Present

CDMA AUTHENTICATION

Authen Data Clear

Selecting **Clear** removes any data present in the Authentication Data Table.

HP-IB Example

CDMA:AUTH:DATA:CLE?"

clears the Authentication Data Table.

See Also

["Authentication Data Table" field on page 171](#)

Screens Where Field is Present

CDMA AUTHENTICATION

Authentication Data Table

The Authentication Data Table, located on the CDMA AUTHENTICATION screen, displays pass/fail results and authentication parameters associated with the last authentication procedure performed.

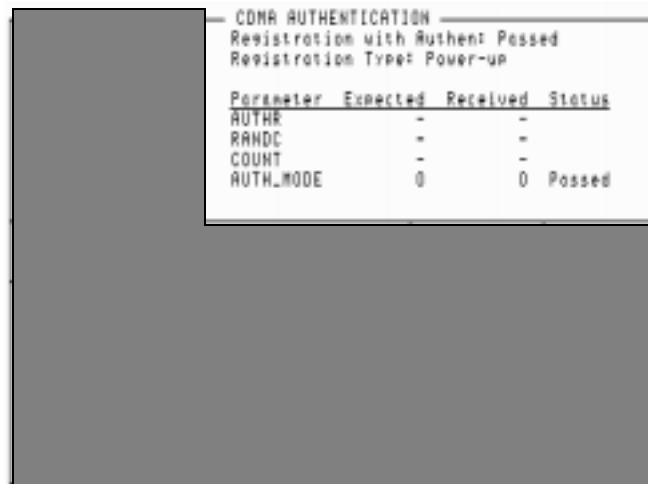

The screenshot shows a terminal window titled "CDMA AUTHENTICATION". The text displayed is as follows:

```
CDMA AUTHENTICATION
Registration with Authen Passed
Registration Type: Power-up

Parameter Expected Received Status
-----
AUTH          -          -
RANDC         -          -
COUNT        -          -
AUTH_MODE     0          0 Passed
```

A dash indicates that no valid table entry is currently available.

HP-IB Example

CDMA:AUTHenticate:DATA?"

queries the CDMA Authentication Data Table.

Operating Considerations

If the **Authen** field is **off**, all Parameters displayed will be dashes (-), except for AUTH_MODE, which will be “0”.

When the data that is currently displayed in the Authentication Data Table is queried, the returned string consists of 18 numeric values separated by commas. Each numeric value occupies a Data Position, and the format is shown in the table below.

NOTE: If no data is available in a Data Position, -1 is returned

Reading the Authentication Data Table over HP-IB

Table 7

Data Position	Data	Numeric Value
1	Authentication Type	1= Registration with Authen 2=Page with Authen 3=Origination with Authen 4=Unique Challenge on Paging or Traffic channels 5=SSD Update on Paging or Traffic channels 6=Mobile Data Burst with Authen
2	Overall Test Status	0=Passed 1=Failed
3	Registration Type	0=Timer Based 1=Zone Based (Power-up or Register field) 2=Implicit
4	Expected AUTH_MODE	0 or 1
5	Received AUTH_MODE	0 or 1
6	AUTH_MODE status	0=Passed 1=Failed
7	Expected AUTHR	Decimal value
8	Received AUTHR	Decimal value
9	AUTHR Status	0=Passed 1=Failed

Table 7 (Continued)

Data Position	Data	Numeric Value
10	Expected RANDC	Decimal
11	Received RANDC	Decimal
12	RANDC Status	0=Passed 1=Failed
13	Expected COUNT	Decimal If “Unknown”, the value 255 is returned
14	Received COUNT	Decimal
15	COUNT Status	0=Passed 1=Failed
16	Expected AUTHU	Decimal
17	Received AUTHU	Decimal
18	AUTHU Status	0=Passed 1=Failed

Programming Example for Authentication Data Table

```
10 RE-SAVE "c:\8924c\auth.txt"
20 ON TIMEOUT 7,14 GOTO 500
30 CLEAR 714
40 !Enter Authentication Data Table into a string variable
50 DIM Data$[100]
60 OUTPUT 714;"cdma:auth:data?"
70 ENTER 714;Data$
80 !Determine position values for each comma
90 Comma1=POS(Data$[1],",")
100 Comma2=POS(Data$[Comma1+1],",")+Comma1
110 Comma3=POS(Data$[Comma2+1],",")+Comma2
120 !Evaluate the first data position, Authentication Type
130 Type$=Data$[Comma1-1,Comma1-1]
140 SELECT Type$
150 CASE "1"
160 PRINT "Registration with Authen: "
170 CASE "2"
180 PRINT "Page with Authen: "
190 CASE "3"
200 PRINT "Origination with Authen: "
210 CASE "4"
220 PRINT "Unique Challenge: "
230 CASE "5"
240 PRINT "SSD Update: "
250 CASE "-1"
260 PRINT "No ""Authentication Type"" returned"
270 END SELECT
280 !Evaluate the second data position, Overall Test Status
290 Status$=Data$[Comma1+1,Comma2-1]
300 SELECT Status$
310 CASE "0"
320 PRINT "Passed"
330 CASE "1"
340 PRINT "Failed"
350 CASE "-1"
360 PRINT "No ""Status"" returned"
370 END SELECT
380 !Evaluate the third data position, Registration Type
```

```
390 Reg_type$=Data$[Comma2+1,Comma3-1]
400 SELECT Reg_type$
410 CASE "0"
420     PRINT "Registration Type: Timer"
430 CASE "1"
440     PRINT "Registration Type:Power-up"
450 CASE "2"
460     PRINT "Registration Type: Implicit"
470 CASE "-1"
480     PRINT "No " "Registration Type" " returned"
490 END SELECT
500 STOP
510 END
```

See Also

["Authen" field on page 170](#)

["Authen Data Clear" field on page 171](#)

Screens Where Field is Present

CDMA AUTHENTICATION

Authent

This field is used to activate the authentication process within the Test Set. With this field set to **on**, the Test Set issues system parameter overhead messages including **SPC WORD1**, **SPC WORD2**, **ACCESS**, **RandChal1A**, and **RandChal1B** to the mobile station.

The **:AUTHenticate** command instructs the Test Set to issue system parameter overhead messages with the AUTH bit set to one.

The query form of the command (that is, **:AUTHenticate?**) can be used to determine the current setting of the test set.

Syntax

```
:AUTHenticate <'><ON/OFF><'>
```

```
:AUTHenticate?
```

Example

```
OUTPUT 714;"CALLP:AMPS:AUTH:ONOFF 'ON' "
```

```
OUTPUT 714;"CALLP:AMPS:AUTH:ONOFF?"
```

```
ENTER 714;Auth_state$
```

Screens Where Field is Present

AUTHENTICATION

Auto/Norm

This field specifies how the trigger level is set.

- **Auto** automatically triggers if a triggering signal is not detected within approximately 50 ms of the last trigger.
- **Norm** requires a specific triggering signal before triggering.

Operating Considerations

Automatic triggering should be used for signals >20 Hz. Normal triggering should be used for signals ≤20 Hz.

Also, when measuring ≤1 Hz signals, you should set the **Scope To** field in the AF ANALYZER screen to **Input** to provide dc coupling to the oscilloscope's input.

Screens Where Field is Present

OSCILLOSCOPE

Autostart Test Procedure on Power-Up

When set to **On**, this field automatically loads and runs the specified procedure whenever the Test Set is turned on. If this field is set to **Off** or the specified procedure cannot be loaded for any reason (such as, memory card not inserted, disk drive not connected), the Test Set will default to its normal power-on state.

Screens Where Field is Present

TESTS (Execution Conditions)

Avg Power

This field allows you to choose the CDMA Average Power Measurement, the CDMA Channel Power Measurement, or the Access Probe Power Measurement.

The Avg Power measurement can only be made on a signal from the RF IN/OUT connector on the Test Set or an HP 83236 PCS Interface. The power meter must be zeroed to correct for internal amplitude offsets. See [Power Meas field description, on page 339](#).

NOTE: *Under certain conditions, the Average Power measurement will display a power level measurement when low (or no) signal power is applied to the RF Input! This measurement is a result of the power detector sensing the Test Set's RF Power (source) when the RF generator's output port selection is **RF Out**. Always use the Channel Power measurement when the RF Power is at a level that will power-control the mobile station to levels below -10 dBm to avoid this condition.*

The following list describes the purpose for each HP 8924C power measurement. For more detail, refer to the field description for the power measurement you choose.

- **Avg Power**
Avg Power (Average Power) displays the average power measured from all demodulated "on" power control groups transmitted by the mobile station under test. The specified amplitude range of this measurement is from -10 dBm to +40 dBm. This measurement is more accurate than the Chan Power measurement.
- **Chan Power**
Chan Power (Channel Power) displays lower level RF power by analyzing the downconverted IF at the Test Set's DSP analyzer's input. The amplitude range of this measurement is from -50 dBm to +35 dBm. This measurement is limited to a 1.23 MHz bandwidth.
- **Acc Prb Pwr**
Acc Prb Pwr (Access Probe Power) displays access probes from the mobile station by automatically triggering a power measurement each time the mobile station registers, performs a mobile station originated call, or performs a mobile station terminated call. (Access Probe Power will also be displayed when SMS (Short Message Service) or Authentication procedures are attempted on the Paging channel.

HP-IB Examples

```
"DISP CTXT;CDMA:TX:POW:MEAS `Avg Power`"
```

selects the average power measurement.

```
"DISP CTXT;MEAS:CDM:AVGP?"
```

queries the average power measurement.

```
"DISP CTXT;MEAS:CDM:AVGP:ZERO"
```

zeroes the average power measurement.

Operating Considerations for the Average Power Measurement

The Test Set compensates for internal amplitude offsets by zeroing the power meter when the **zero** field is selected. Average power measurements should be zeroed *at least* as often as the following conditions arise:

- 5 °C change in operating temperature
- Power cycle
- Daily

Average Power measurements are made using a factory-calibrated power detector. If the Test Set is configured for PCS band operation, the detector is located in the HP 83236 PCS Interface. Otherwise, the detector is located in the Test Set.

The detector measures power during the time that power control groups are gated on. Each Average Power measurement is computed from data taken during a 10 ms (one-half of one traffic frame) sampling period, ensuring that at least one out of the eight available power control groups in the half-frame will be gated on, even if the transmit data rate is 1200 bps.

For example, if the data rate is 9600 bps (full-rate) average power will be measured during all eight available power control groups. If the data rate is 1200 bps, Average Power will be measured during only one power control group. (The Test Set is able to determine the pseudo-random positioning of the power control groups that are gated on). The benefit of this measurement process is that measurement results will be consistent across all possible transmit data rates.

Use the “TRIG” command to trigger Average Power measurements when using single trigger mode. (The command “TRIG:AST ‘Arm’” will not trigger Average Power measurements).

See Also

["Chan Power" on page 197](#)

[“Zeroing Average Power Measurements”](#) in the Calibrating the Test Set chapter of the *HP 8924C Application Guide*

Screens Where Field is Present

CDMA CALL CONTROL

CDMA TRANSMITTER POWER RANGE TEST

CDMA CELLULAR MOBILE TRANSMITTER TEST

AWGN

This field controls the Additive White Gaussian Noise (AWGN) generator's level.

HP-IB Examples

```
"CDMA:AWGN:BWPowEr -75dBm"  
"CDMA:AWGN:STATe ON"
```

sets the AWGN generator's level to -75 dBm.

Operating Considerations

AWGN is summed with Sector A power and Sector B power. The total power is displayed in the **RF Power** field. When AWGN is turned on, E_b/N_t will be displayed unless the **Data Type** field is set to Echo.

This field is duplicated on the CDMA CELLULAR MOBILE RECEIVER TEST.

Screens Where Field is Present

CDMA GENERATOR CONTROL
CDMA CELLULAR MOBILE RECEIVER TEST

Fields That Begin with the Letter B

Band Class

The Band Class field is displayed on the CDMA CALL CONTROL screen when the **"Protocol" field on page 344** is set to TIA/EIA-95B and the **"RF Chan Std" field on page 361** is set to USER-DEF. This field allows entry of the BAND_CLASS parameter.

The range of values that can be entered in this field is 0 to 4.

HP-IB Example

```
"DISP CCNT;CDMA:CELL:BCL 0"
```

sets the BAND_CLASS parameter to 0.

Operating Considerations

The value entered in the Band Class field affects Test Set operation only when the field is displayed.

The BAND_CLASS parameter, which affects forward channel messages, is a function of Protocol and RF Chan Std field settings.

When the RF Chan Std field is set to USER-DEF (user defined) the user is expected to select one of the five available values.

If BAND_CLASS 0, 2, or 3 is selected:

- The **"Nom Pwr Ext" field on page 311** field is removed from the CDMA CELL SITE CONFIGURATION screen, and
- The offset power used to calculate **"Ideal Mobile Power" field on page 273** is set to -73, and
- the Neighbor List Message is sent on the Paging channel (not the Extended Neighbor List Message), and
- the BASE_CLASS field in the System Parameters message on the Paging channel is set to 0 (Public Macrocellular System)

If BAND_CLASS 1 or 4 is selected:

- The **"Nom Pwr Ext" field on page 311** field is displayed on the CDMA CELL SITE CONFIGURATION screen, and
- The offset power used to calculate **"Ideal Mobile Power" field on page 273** is set to -76, and
- The Extended Neighbor List Message is sent on the Paging channel (not the Neighbor List Message), and
- the BASE_CLASS field in the System Parameters message on the Paging channel is set to 1 (Public PCS System)

Base Freq (User Defined)

The Base Frequency field sets the RF Generator reference for channel 0 (zero) when the **RF Chan Std** field is set to **USER-DEF**, and the **RF Display** field is set to **Chan**.

Channel frequencies are calculated using the following formula:

$$\text{Channel N} = \text{Base Frequency} + (\text{N})(\text{Channel Spacing})$$

The Base Frequency is calculated using the following formula:

$$\text{Base Frequency} = \text{Channel 1 Frequency} - \text{Channel Spacing}$$

For example, if your multi-channel radio's lowest *receive* channel frequency is 870.030 MHz and the system channel spacing is 30 KHz, you would enter **870 MHz** in this field. You would also use the **Chan Space** and **(Gen)-(An1)** fields to tell the Test Set where other transmit and receive channel frequencies are in relation to the base frequency, and whether or not the system is duplex.

Operating Considerations

The value of this field is only used if the **RF Display** field is set to **Chan**, and the **RF Chan Std** field is set to **USER-DEF**.

See Also

[Chan Space \(User Defined\) field description, on page 203](#)

[\(Gen\)-\(An1\) field description, on page 269](#)

[RF Chan Std field description, on page 361](#)

[RF Display field description, on page 363](#)

Screens Where Field is Present

CONFIGURE

Base ID

This field allows entry of the base station identification (BASE_ID).

HP-IB Example

```
"DISP CCON;CDMA:CELL:CONFigure:BiD 0"
```

sets the base identification of the simulated CDMA cell site to 0.

Operating Considerations

The mobile station acquires the BASE_ID when it receives the *System Parameters Message* from the Test Set.

Screens Where Field is Present

CDMA CELL SITE CONFIGURATION

Beeper

This field changes the audio beeper volume by selecting the desired level from a list of choices. The beeper always beeps when the instrument is turned on, regardless of this setting.

Operating Considerations

The beeper alerts you any time a message is displayed. Since a message may be removed from the screen before you notice it, it is better to leave the beeper on to alert you to errors during operation.

The beeper's volume setting is retained when the instrument is turned off.

Screens Where Field is Present

CONFIGURE

BER Thresh

The :BSETting command is used to control this field.

The query form of the command (that is, :BSETting?) can be used to determine the current control channel setting.

Syntax

```
:BSETting <integer number>
```

```
:BSETting?
```

Example

```
OUTPUT 714;"CALLP:NAMPS:MRI:BSET 20"
```

```
OUTPUT 714;"CALLP:NAMPS:MRI:BSET?"
```

```
ENTER 714;Bset_val$
```

Screens Where Field is Present

CALL CONFIGURE

BW=

This field displays the resolution bandwidth of the CDMA spectrum analyzer.

Operating Considerations

This field is coupled to the **span** field's setting.

Range of Values

- 1 kHz
- 3 kHz
- 30 kHz

Screens Where Field is Present

CDMA REVERSE CHANNEL SPECTRUM

by # errors

When this field is **On**, the mobile station reports FER at least as often as the number of errors entered in the numeric entry portion below **On/Off**.

The numeric entry portion of the by # errors field is not displayed when this selection is **Off**.

HP-IB Example

```
"DISP CMOB;CDMA:MOBILE:FERASURE:REPORT:BY:ERRORS:STATE: 'ON' "
```

causes the mobile station to report FER whenever the number of errors counted by the mobile station reaches the value entered by the command below.

```
"DISP CMOB;CDMA:MOBILE:FERASURE:REPORT::BY:ERRORS 5"
```

causes the mobile station to report FER if the FER count reaches 5 within the number of frames specified in the MS FER Report Interval.

Operating Considerations

If **by # frames** is **On**, it is possible that mobile station reported FER will occur more frequently than the error count specified in **by # errors**.

Range of values: 1 through 15

See Also

[by # frames field description, on page 186](#)

Screens Where Field is Present

CDMA MOBILE REPORTING

by # frames

When this field is **On**, the mobile station will report FER at least as often as the mobile station's frame counter cycles through the number of frames entered in the **MS FER Report Interval** field.

HP-IB Example

```
"DISP CMOB;CDMA:MOBILE:FERasure:REPort:BY:FRAMES:STATE 'ON'"
```

causes the mobile station to report FER based on frame count.

Operating Considerations

If **by # errors** is **On**, FER reporting can occur more frequently than the frame count specified by **MS FER Report Interval**.

See Also

[by # errors field description, on page 185](#)

Screens Where Field is Present

CDMA MOBILE REPORTING

Fields That Begin with the Letter C

Called Number:

This field displays the called phone number, in decimal form, received from the mobile station on the reverse control channel when the mobile station originates a call. The **Called Number:** field is displayed only when the **Display** field is set to **Data** and a reverse control channel message has been decoded when the mobile originates a call.

Refer to the "**Display**" field on page 223 for information on how to read measurement results from this field.

See Also

For CDMA calls see the "**MS Database**" field on page 303

Screens Where Field is Present

CALL CONTROL

Calling Name

The **Calling Name** field is used to enter the instrument's function (in upper-case letters). For example, **PRINTER**, **POWER SUPPLY**, **DATA COLLECTION** (disk drive), and so forth.

Screens Where Field is Present

TESTS (External Devices)

Call Limit

This field is used for measuring access probe power levels.

- **Page**, a mobile or base originated call is attempted, the Test Set will not respond to access probes. In this state, a call cannot be connected. This causes the mobile station to continue with an access attempt until it has completed its prescribed number of access probe sequences.
- **None**, - the Test Set will respond to access probes and acquire the reverse traffic channel.

HP-IB Syntax

```
"DISP CCON;CDMA:CALL:LIMit 'PAGE' "
```

limits call progress to the paging channel.

See Also

[“Measuring Access Probe Output Power”](#) in the CDMA Transmitter Tests chapter in the *HP 8924C Application Guide*

[Pilot Inc field description, on page 332](#)

[Max Req Seq, Max Rsp Seq field description, on page 291](#)

Screens Where Field is Present

CDMA CELL SITE CONFIGURATION

Call Status

The labels under **Call Status** are highlighted by annunciators. When lit, these annunciators indicate that an event took place or that a condition exists. The CDMA Status Condition Register bits that correspond with **Call Status** annunciators are shown in [table 8](#).

All call status annunciators can be queried over HP-IB.

Table 8 CDMA Status Register Bit Definitions

Status LED	CDMA Status Condition Register Bit
Transmitting	2
Registering	No Condition Register Bit available. See "Registering (annunciator)" on page 358 .
Page Sent	1
Access Probe	0
Connected	3
Softer Handoff	5
Hard Handoff	6
SMS Sent ^a	
SMS Ack Received ^a	
SSD Update ^b	
Uniq Chall ^b	

a. CDMA Short Message Service Screen Only

b. CDMA Authentication Screen Only

See Also

[RF Channel \(CDMA\) field description, on page 360](#)

[PN Offset \(Sector A Power\) field description, on page 336](#)

[Traffic \(Sector A Power\) field description, on page 428](#)

Screens Where Field is Present

CDMA CALL CONTROL

CDMA AUTHENTICATION

CDMA SHORT MESSAGE SERVICE

Carrier

This field is displayed when Carrier is selected from the list of choices available when the unnamed field displaying one of the following choices is displayed:

- phase error measurement
- carrier feedthrough measurement

HP-IB Example

```
"DISP CTXT;MEASure:CDManalyzer:CARrier:FEEDthrough?"
```

queries the carrier feedthrough measurement result.

Operating Considerations

These measurements, along with rho, frequency error, amplitude error, and time offset are made by DSP analysis techniques. The **Meas Cnt1** field triggers these measurements.

See Also

[Meas Cnt1 field description, on page 292](#)

[Phs Error field description, on page 331](#)

Screens Where Field is Present

CDMA CELLULAR MOBILE TRANSMITTER TEST

Carrier Ref

Use the carrier reference field to indicate whether the carrier (**Tune Freq**) being measured should be unmodulated or modulated when making the ACP reference measurement. (For more information, refer to "[How the Test Set Measures Adjacent Channel Power \(ACP\)](#)" on page 89.)

Operating Considerations

- FM transmitters can be measured with the carrier modulated or unmodulated.
- For AM transmitters, the carrier must be measured while *unmodulated*. AFGen1 and the AUDIO OUT port must be used as the modulation source whenever **Unmod** is selected.

Screens Where Field is Present

ADJACENT CHANNEL POWER

CC Order

The CC Order field is only visible when authentication is set to **ON** on the AUTHENTICATION screen and the Test Set is in the Active state.

This field is used to send an order on the forward overhead control channel to the mobile station when authentication is turned on. There are two orders available:

- The SSD Update ensures that the data contained in the mobile station and the base station is identical. At the completion of the SSD Update process the mobile station and the Test Set will contain identical copies of shared secret data.
- The Unique Challenge order challenges the mobile station's shared secret data through a series of algorithm data output comparisons. A successful challenge confirms the validity of a mobile station's shared secret data.

The :CCORder command is used to send an order type mobile station control message to the mobile station. The **Access** annunciator will light momentarily while the Test Set is sending the mobile station control message.

The query form of the command (that is, :CCORder?) can be used to determine the last order sent to the mobile station using the :CCORder command.

Syntax

```
:CCORder <'><SSD Upd/Uniq Ch><'>  
:CCORder?
```

Example

```
OUTPUT 714;"CALLP:AMPS:AUTH:CCOR 'SSD Upd' "  
OUTPUT 714;"CALLP:AMPS:AUTH:CCOR? "  
ENTER 714;Last_ord_sent$
```

Screens Where Field is Present

CALL CONTROL

Center Freq

This field sets the tune frequency for the center of the screen.

Operating Considerations

This field also changes the frequency of the Tracking Generator's and the RF Analyzer's center frequency.

Screens Where Field is Present

SPECTRUM ANALYZER

Center Freq

This field sets the center frequency of the CDMA spectrum analyzer. This field is displayed when the **Controls** field is set to **Main** and the **RF Display** field on the **CONFIGURE** screen is set to **Freq**.

HP-IB Example

```
"RFAN:FREQ 850MHZ"
```

sets the center frequency to 850 MHz.

See Also

[RF Display field description, on page 363](#)

Screens Where Field is Present

CDMA REVERSE CHANNEL SPECTRUM

Change

This field defines the type of power control bits that will be sent to the mobile station when **Execute** is selected. The range over which the mobile station will be commanded to change its power level is determined in the **Steps** field.

- **n Up** sends a series of "0" power-control bits, causing the MSUT to increase its power, then returns to the "normal" sequence.
- sends a series of "1" power-control bits, causing the MSUT to decrease its power, then returns to the "normal" sequence.
- **Ramp** sends a series of "n up" followed by a series of "n down" bits.

HP-IB Example

```
"DISP CTXR;CDMA:PCONtrol:CHANge 'n up'"
```

selects "n up" power control steps.

Operating Considerations

[See "Closed Loop Pwr Cntl" on page 204.](#)

Screens Where Field is Present

CDMA TRANSMITTER POWER RANGE TEST

Chan Std

This field is used during CDMA-to-CDMA hard (intersystem) handoffs when TIA/EIA-95B is selected in the Protocol field. The selection made in this field will specify the destination cell's channel standard.

Range of Values

- MS AMPS
- US PCS
- Kor PCS P0
- Kor PCS P1
- MS TACS
- MS JTACS
- Japan CDMA

HP-IB Example

```
"CDMA:CALL:AHAN:CSTandard 'MS AMPS'"
```

selects MS AMPS for a CDMA-to-CDMA hard handoff.

Screens Where Field is Present

CDMA CALL CONTROL

See Also

[Handoff field description, on page 271](#)

Chan: -

Chan: is divided into two fields:

- The left-hand field displays the voice channel number assignment being used by the Test Set and the mobile station.

A numeric value is only displayed when the Test Set's **Connected** annunciator is lit (connected state). A "-" is displayed if a mobile station is not actively connected on a voice channel.

This is a read only field.

The :AVCNumber? query command is used to query the contents of the left-hand field.

There is no command form of the :AVCNumber? query.

Syntax

:AVCNumber?

Example

```
OUTPUT 714;"CALLP:AVCN?"
```

```
ENTER 714;Active_vc_number$
```

- The right-hand field (highlighted field) is used to set the voice channel number which will be assigned to the mobile station by the Test Set as either an initial voice channel assignment or as a handoff voice channel assignment.

The :VCHannel command is used to control the right-hand subfield.

The query form of the command (that is, :VCHannel?) can be used to determine the current voice channel setting.

Syntax

:VCHannel <real number>

:VCHannel?

Example

```
OUTPUT 714;"CALLP:VCH 215"
```

```
OUTPUT 714;"CALLP:VCH?"
```

```
ENTER 714;Vch_number$
```

Screens Where Field is Present

CALL CONTROL

Channel

This field allows entry of an analog voice channel for digital-to-analog handoffs.

HP-IB Example

```
"CDMA:CALL:AHAN:CHAN 1"
```

sets the Channel field to 1.

Operating Considerations

During a CDMA-to-analog handoff, the Test Set commands the mobile station to re-tune to this analog voice channel. A CDMA-to-analog handoff attempt will occur when the Execute field on the CDMA Call Control screen is selected.

Range of values: 1 through 1023

Screens Where Field is Present

CDMA CALL CONTROL

Channel BW

Use the channel bandwidth field to specify the bandwidth of the carrier and adjacent channels to be measured. (See [figure 52](#).)

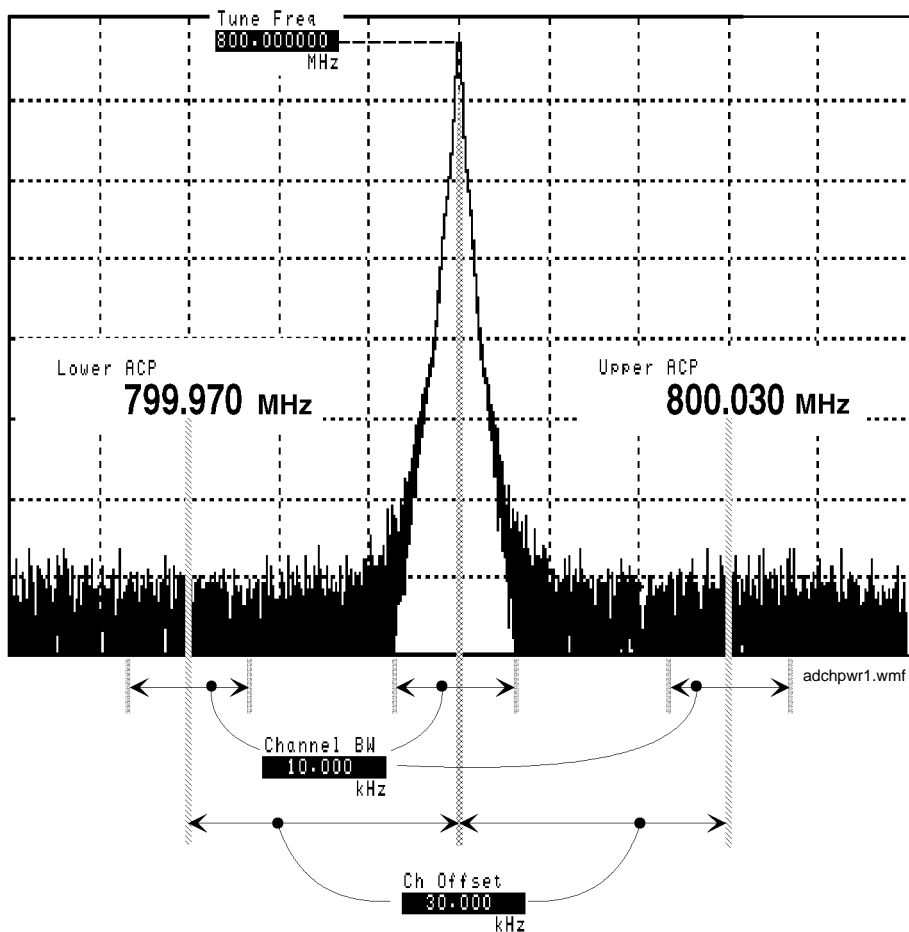

Figure 52

Relationship Between Tune Freq, Ch Offset, and Channel BW Fields

Screens Where Field is Present

ADJACENT CHANNEL POWER

Chan Power

This field allows you to choose the CDMA Channel Power, Average Power, or Access Probe Power measurements.

The CDMA Channel Power Measurement can be made on a signal connected to the Test Set's RF IN/OUT or ANTENNA IN connector, or to a signal connected to the HP 83236 PCS Interface RF IN/OUT connector.

This measurement must be cross-calibrated to the Average Power Meter. See [“Calibrating Channel Power Measurements”](#) in the Calibrating the Test Set chapter of the *HP 8924C Application Guide*.

An **Unca1** annunciator will flash below this field when the Channel Power measurement has not been calibrated for the frequency band selected in the RF Chan Std field.

- Avg Power

Avg Power (Average Power) displays the average power measured from all demodulated “on” power control groups transmitted by the mobile station under test. The specified amplitude range of this measurement is from -10 dBm to +40 dBm, and the input frequency range is from 30 MHz to 1000 MHz. This measurement is more accurate than the Chan Power.

- Chan Power

Chan Power (Channel Power) displays lower level RF power by analyzing the downconverted IF at the Test Set's DSP analyzer's input. The amplitude range of this measurement is from -50 dBm to +35 dBm. This measurement is limited to a 1.23 MHz bandwidth.

- Acc Prb Pwr

Acc Prb Pwr (Access Probe Power) displays access probes from the mobile station by automatically triggering a power measurement each time the mobile station registers, performs a mobile station originated call, or performs a mobile station terminated call. (Access Probe Power will also be displayed when SMS (Short Message Service) or Authentication procedures are attempted on the Paging channel.

HP-IB Examples

```
"DISP CTXT;CDMA:TX:POW:MEAS `Chan Power`"
```

selects Channel Power measurements.

```
"DISP CTXT;MEAS:CDM:CHAN?"
```

queries the channel power measurement.

```
"DISP CTXT;MEAS:CDM:CHAN:CAL"
```

calibrates channel power measurements (connect the DUPLEX OUT and RF IN/OUT ports before sending this command).

Operating Considerations for the Channel Power Measurement

The cross-calibration process is performed by connecting a cable between the DUPLEX OUT port and the RF IN/OUT port, then selecting the **Power Meas, Calibrate** field. Refer to ["Calibrating the Test Set"](#) in the Calibrating the Test Set chapter of the *HP 8924C Application Guide*. Channel power measurements must be calibrated whenever any of the following conditions occur:

- **Uncal** annunciator is flashing
- 5 °C change in operating temperature
- Test Set power cycle
- Daily

The Average Power measurement, which is used during cross-calibration, is automatically zeroed during the calibration procedure.

No special measurement triggers are required for Channel Power measurements.

See Also

[Avg Power field description, on page 178](#)

Screens Where Field is Present

CDMA CALL CONTROL

CDMA TRANSMITTER POWER RANGE TEST

CDMA CELLULAR MOBILE TRANSMITER TEST

Chan Power Meas Intrvl

This field allows you to set the interval for the Channel Power measurement. This setting is only valid with Service Option 2 or Service Option 9, and during Full Rate.

HP-IB Examples

```
"CDManalyzer:CHANpower:INTerval 1"
```

sets the measurement interval to 1 ms.

Screens Where Field is Present

CDMA TX

Check

This field is used to select whether the test will verify only upper, only lower, both, or none of the specified limits.

Operating Considerations

Selecting both upper and lower limits increases test time, but may be required for some tests.

Screens Where Field is Present

TESTS (Pass/Fail Limits)

Check Digits

This field displays the six A_Key check digits. Check digits are calculated when a valid ESN is entered in the **MS Database** field (usually through Registration). Check digits provide a method for checking the validity of A-Key numbers.

See the [A-Key Digits field description, on page 163](#) for more information.

NOTE: Check digits are not affected by ESN when Kor PCS is selected in the **Protocol** field.

HP-IB Example

"CDMA:AUTH:CDIG?"

queries the Check Digits field

See also

["MS Database" field on page 303](#)

["Register \(CDMA\)" field on page 357](#)

["Timer Reg" field on page 425](#)

["Pwr Up Reg" field on page 347](#)

Screens Where Field is Present

CDMA AUTHENTICATION

Ch Loc:

The **Ch Loc:** field (NAMPS and NTACS system types only) sets the analog channel location that will be assigned to the mobile station by the Test Set as either an initial voice channel location or as a handoff channel location assignment.

For NAMPS systems, the choices are:

- Lower - 10 kHz below standard wide analog channel
- Middle - centered at the wide analog channel
- Upper - 10 kHz above the standard wide analog channel
- Wide - standard 25 kHz AMPS channel width

For NTACS systems, the choices are:

- Narrow - standard narrow band NTACS channel, the default value
- Wide - the JTACS channel

The `:CEXT:SETT` command is used to set the new channel location.

The query form of the command (that is, `:CEXT:SETT?`), can be used to determine the current setting of the Ch Loc right-hand field and `CEXT:ACT?` can be used to determine the actual setting of the **Ch Loc:** left-hand field.

The syntax and an example for NAMPS systems are as follows:

Syntax

```
:CEXTension:ACT?  
:CEXTension:SETTing <`><LOWER/MIDDLE/UPPER/WIDE><`>  
:CEXTension:SETTing?
```

Example

```
OUTPUT 714;"CALLP:NAMPS:CEXT:ACT?"  
OUTPUT 714;"CALLP:NAMPS:CEXT:SETT `LOWER` "  
OUTPUT 714;"CALLP:NAMPS:CEXT:SETT?"  
ENTER 714;Last_ord_sent$
```

The syntax and an example for NTACS systems are as follows:

Syntax

```
:CEXTension:ACT?  
:CEXTension:SETTing <`><NARROW, WIDE CHAN><`>  
:CEXTension:SETTing?
```

Example

```
OUTPUT 714;"CALLP:NTACS:CEXT:ACT?"  
OUTPUT 714;"CALLP:NTACS:CEXT:SETT `NARROW` "  
OUTPUT 714;"CALLP:NTACS:CEXT:SETT?"  
ENTER 714;Last_ord_sent$
```

Screens Where Field is Present

CALL CONTROL

Ch Offset

Use the channel offset field to enter the frequency difference between the **Tune Freq** setting and the center of the adjacent channels you want to measure. This is an absolute value; only positive values can be entered. See [figure 52](#).

Screens Where Field is Present

ADJACENT CHANNEL POWER

Chan Space (User Defined)

This field specifies the RF channel spacing when the **RF Display** field is set to **Chan**, and the **RF Chan Std** field is set to **USER-DEF**.

For example, entering **25 kHz** causes a 25 kHz spacing between each channel. If the receive frequency for channel 1 is 150.500 MHz, channel 2's receive frequency would be 150.525 MHz.

Operating Considerations

The value of this field is only used if the **RF Display** field is set to **Chan**, and the **RF Chan Std** field is set to **USER-DEF**.

See Also

[\(Gen\) - \(An1\) field description, on page 269](#)

[RF Chan Std field description, on page 361](#)

[Base Freq \(User Defined\) field description, on page 182](#)

Screens Where Field is Present

CONFIGURE

Closed Loop Pwr Cntl

This field sets the power control mode.

- **Open Loop** mode causes the Test Set to send an alternating sequence of up/down power-control bits to the mobile station during periods when no other power-control operation is being performed. For example, if the **Execute** field is selected while the Test Set is in **Open Loop** mode, the mobile station will adjust its power according to the sequence of power control bits entered in the **Change** and **Steps** field. As soon as the number of power control bits entered in the **Steps** field have been sent, an alternating sequence of up/down power-control bits resumes, attempting to hold the mobile station's power level at the value the mobile station was driven to by the **Change** and **Steps** fields.

NOTE:

Make sure that the Test Set power level is not reduced to a level where the mobile station receives bad frames when using Open Loop power control mode. If the mobile station receives a bad frame, it will assume the power control bit was a down bit and reduce its power by 1 dB. When the power control mode is Open Loop, the alternating sequence of power control bits will attempt to hold the mobile station's power level at the reduced power level. As more bad frames are received, the mobile station can continue to lower its power level until the call is eventually dropped. See "[Drop Timer](#)" on page 238.

-
- **Off** disables the power control subchannel.
 - **Closed Loop** sends power control bits to the mobile station in an attempt to drive the mobile station's power level to a set-point based on the power transmitted from the Test Set and the open loop estimate.
 - **Always Up** forces the power control subchannel to send continuous "up" power control bits (0's).
 - **Always Down** forces the power control subchannel to send continuous "down" bits. (1's).

HP-IB Example

```
"DISP CTXR;CDMA:PCONtrol:MODE 'Open Loop' "
```

selects "Open Loop" power control mode.

Operating Considerations for Closed Loop Pwr Cntl

The power control operations performed when the **Execute** field is selected, such as "n up" or "ramp" take precedence over the power control bit sequence expected when a mode, such as "always up" is selected. For example, if the choice in the **Change** field is "n down" and the power control mode is "Always Up", the number of "down" power control bits entered in the **Steps** field will be sent when the **Execute** field is selected. The Test Set will then resume sending continuous "up" power control bits.

Screens Where Field is Present

CDMA TRANSMITTER POWER RANGE TEST

Clr Scr

This field is used to clear the IBASIC controller screen.

Screens Where Field is Present

TESTS (IBASIC Controller)

CMAX

The **C****M****A****X** field sets the number of access channels in the system. This will determine how many channels must be scanned by the mobile station when trying to access the Test Set. The value of this field will affect the time required for the mobile station to connect with the Test Set.

The :C**M****A****X**imum command is used to control this field.

The **C****M****A****X** field is an immediate action field. That is, whenever the :C**M****A****X**imum command is sent, the change is reflected immediately in the appropriate signaling message(s) being sent on the forward control channel. No change occurs to the current state (i.e. Active, Register, Page, Access, Connect) of the Call Processing Subsystem.

The query form of the command (that is, :C**M****A****X**imum?) can be used to determine the current control channel setting.

Syntax

```
:CMAXimum <integer number>
```

```
:CMAXimum?
```

Example

```
OUTPUT 714;"CALLP:CMAX 21"
```

```
OUTPUT 714;"CALLP:CMAX?"
```

```
ENTER 714;Num_acc_chans
```

Screens Where Field is Present

CALL CONFIGURE

Cntl Chan

The **Cntl Channel** field is an immediate action field. That is, whenever the :CCHannel command is sent, the change is reflected immediately in the physical configuration of the Test Set (the control channel is immediately deactivated, reconfigured, and then reactivated to reflect the change) and causes an immediate change to the current state of the Call Processing Subsystem (the state is set to **Active**).

NOTE: If the Test Set is in the **Connect** state and a change is made to the **Cntl Channel** field the **Connect** state will be lost.

This field is used to set the control channel number used by the Test Set.

The :CCHannel command is used to control this field.

The query form of the command (that is, :CCHannel?) can be used to determine the current control channel setting.

Syntax

```
:CCHannel <integer number>  
:CCHannel?
```

Example

```
OUTPUT 714;"CALLP:CCH 333"  
OUTPUT 714;"CALLP:CCH?"  
ENTER 714;Control_chan
```

Screens Where Field is Present

CALL CONTROL

Cnfg (External Devices)

Selecting this field displays the TESTS (External Devices) screen.

Screens Where Field is Present

TESTS (Main Menu)

Cntry Code

This field sets the base station's country code. This field is displayed when the field "**Protocol**" on page 344 has IS-95A, TSB-74, or J-STD-008 selected and the Esc Mode field is set to Off.

HP-IB Syntax

```
"CDMA:CELL:CONF:BCC 2"
```

sets the base station's country code to 2.

Operating Considerations

The Test Set sends the base station country code in the MCC field of the Extended System Parameters Message.

See Also

[Protocol field description, on page 344](#)

Screens Where Field is Present

CDMA CELL SITE CONFIGURATION

Code Location

This field is used to select where the program (code file) for the test procedure is stored. Code files are the main program files of the software, containing all of the test subroutines. If an HP 83217 memory card is catalogued, the code file is preceded by a lower-case **c**.

Screens Where Field is Present

TEST (Save/Delete Procedure)

Confidence

This field sets the confidence interval for the **FER Spec** field.

HP-IB Example

```
"DISP CRXT;MEASure:CDManalyzer:FERasure:CONFidence:INTerval 95"
```

sets a confidence interval of 95%.

Operating Considerations

The confidence interval provides the Test Set operator with a feature to decrease test cycle time by forcing an FER test to complete before the number of frames entered in the **Max Frames** field are tested. Each frame error rate test will halt as soon as it becomes probable that a specified frame error rate will be achieved, assuming a Poisson statistical distribution of errors.

The Test Set provides the **FER Spec** field to enter the targeted FER percentage that is specified for a particular test. Testing can end (with a Pass or Fail indication) when the Confidence level entered in this field is achieved.

Range of values: floating point number 80 through 100

See Also

[FER Spec field description, on page 262](#)

[Test Status field description, on page 421](#)

Screens Where Field is Present

CDMA CELLULAR MOBILE RECEIVER TEST

Connect (annunciator)

When lit, the **Connect** annunciator indicates that the mobile station is connected to the Test Set on a voice channel.

NOTE:

When the CALL CONTROL screen is displayed and the Call Processing Subsystem is in the connected state (**Connect** annunciator is lit), the Test Set constantly monitors the mobile station's transmitted carrier power. If the power falls below 0.0005 Watts the Test Set will terminate the call and return to the active state (**Active** annunciator is lit). The mobile station's transmitted carrier power is monitored on all Call Processing Subsystem screens except the ANALOG MEAS screen.

If the Test Set is in the connected state (**Connect** annunciator is lit) and a change is made to the **Cnt1 Channel** field the **connected** state will be lost.

The state of the **Connect** annunciator is reflected in the Call Processing Status Register Group Condition Register bit 5.

See "[Call Processing Status Register Group](#)" in the Status Reporting chapter of the *HP 8924C User's Guide* for further information.

The **Connect** annunciator is not programmable.

Screens Where Field is Present

CALL CONTROL
CALL BIT
CALL DATA

Connected (annunciator)

This annunciator indicates that the Test Set and a mobile station have completed the signaling steps required to establish a CDMA call, and the Test Set has not had any indication that the call has ended or should end.

- For a Service Option 1 or Service Option 9 call to the mobile station (initiated by the Test Set), the mobile station must be answered before this annunciator will light. When using Service Option 2 or Service Option 32768, the mobile station will automatically answer a call and the **Connected** annunciator will light.
- For a call to the Test Set (initiated by the mobile station), the Test Set will automatically answer the call (if the Answer Mode field on the CDMA CELL SITE CONFIGURATION screen is set to Auto), and the **Connected** annunciator will light. If the Answer Mode field is set to Manual, a message will appear prompting you to press the ANS key. After pressing the ANS key, the **Connected** annunciator will light.

When a call is terminated, this annunciator will go out.

NOTE:

When a Service Option 1 or Service Option 9 call is initiated from the Test Set, and the mobile station has acquired the traffic channel, the mobile station will start ringing. During this time, bit 4 (Alerting) in the CDMA condition register will be set. When a Service Option 1 or Service Option 9 call is initiated from the mobile station, and Manual is selected in the Answer Mode field on the CDMA CELL SITE CONFIGURATION screen, a message on the display will prompt you to press the ANS key. Until the mobile station is answered, bit 4 (Alerting) in the CDMA condition register will be set.

HP-IB Example

```
"DISP CRXT;STATus:CDMA:CONDition?"
```

queries the CDMA condition register. Bit 4 will be set when the mobile station is ringing, and Bit 3 will be set when the Connected annunciator is lit (call was answered).

Screens Where Field is Present

CDMA CALL CONTROL
CDMA SHORT MESSAGE SERVICE
CDMA AUTHENTICATION

Controls

This field is used to choose which of the spectrum analyzer's menus is displayed.

- **Main** controls RF channel, input port, span, and RF level.
- **CDMA Gen** controls RF power, RF channel, and output port.
- **Marker** controls the position of the markers on the display.
- **Auxiliary** controls input attenuation, peak hold, video averaging, trace comparison (normalize), and sensitivity.

Screens Where Field is Present

CDMA REVERSE CHANNEL SPECTRUM

Controls

This field is used to choose which of the spectrum analyzer's menus is displayed.

- **Main**
- **RF Gen**
- **Marker**

Screens Where Field is Present

SPECTRUM ANALYZER

Controls

This field is used to choose which of the oscilloscope's menus is displayed.

- **Main**
- **Trigger**
- **Marker**

Screens Where Field is Present

OSCILLOSCOPE

Continue

This field is used to restart a paused test.

Screens Where Field is Present

TESTS (Main Menu, Execution Conditions, Printer Setup, IBASIC Controller)

Cont/Single

This field specifies whether the oscilloscope is continuously triggered (**Cont**), or if it is only triggered each time **Reset** is selected (**Single**).

Screens Where Field is Present

OSCILLOSCOPE

Current

When set to **Current**, this field displays the DC current measured at the DC CURRENT MEAS port on the back of the Test Set. Any offset can be removed by selecting **Zero** in the **DC Current** field.

This field is a one-of-many field used to select the type of measurement to be made by the Audio Frequency Analyzer on the audio signal being measured. See “**Measure**” in the HP-IB Command Syntax chapter of the *HP 8924C Condensed Programming Reference Guide* for programming command syntax.

Selecting this field displays the following measurement choices:

- SINAD
- Distn (Distortion)
- SNR (Signal to Noise Ratio)
- AF Freq
- DC Level
- Current (DC only)

Operating Considerations

This is a priority control field. Accessing the RX TEST or TX TEST screen overrides any changes made to this field in other screens.

For more information about SNR operation, see the [SNR field description, on page 395](#).

Screens Where Field is Present

AF ANALYZER
ANALOG MEAS
DUPLEX TEST
RX TEST
TX TEST
RF GENERATOR
RF ANALYZER

Fields That Begin with the Letter D

Data Length

This field specifies the number of bits used for each word of serial data when using the rear-panel serial port.

This setting is retained when the instrument is turned off.

Screens Where Field is Present

I/O CONFIGURE

Data Mode

This field allows you to select the data format for the User Data field.

- **ASCII** selects ASCII character entry.
- **Hex** selects hexadecimal character entry. This choice is available for sending messages that require non-English language character sets.

When the **User Data** field is selected, the front-panel knob is used to enter characters.

HP-IB Example

```
"CDMA : SMS : MDM `Hex` "
```

sets the **User Data** field data format to hexadecimal.

Operating Considerations

If you select Hex the Test Set expects an even number of hex characters to be entered in the **User Data** field. Each pair of hex characters represents a byte of data. If an odd number of hex characters is entered in the User Data field, the least significant four bits of the last byte will consist of zeroes.

See Also

[Encoding field description, on page 245](#)

[User Data \(ASCII or Hex\) field description, on page 443](#)

Screen(s) Where Field is Present

CDMA SHORT MESSAGE SERVICE

Data Rate

This field is displayed only when the **Traffic Data Mode** field is set to **Svc Opt 2** or **Svc Opt 9**, or when the **Traffic Data Mode** field is set to **Svc Opt 1**, **Svc Opt 3**, or **SO 32768** and the **Data Type** field is set to **PRBS**. It allows the selection of various traffic channel data-transmission rates from the Test Set.

When the **Traffic Data Mode** field is set to **Svc Opt 1**, **Svc Opt 2**, or **Svc Opt 3** the following data rates are available:

- **Full** - 9600 bps data rate
- **Half** - 4800 bps data rate
- **Quarter** - 2400 bps data rate
- **Eighth** - 1200 bps data rate
- **Random** - The Test Set will pseudorandomly choose a data rate on a frame-by-frame basis.

When the **Traffic Data Mode** field is set to **Svc Opt 9** or **Svc Opt 32768** (and the **Data Type** field is set to **PRBS**) the following data rates are available:

- **Full** - 14400 bps data rate
- **Half** - 7200 bps data rate
- **Quarter** - 3600 bps data rate
- **Eighth** - 1800 bps data rate
- **Random** - The Test Set will pseudorandomly choose a data rate on a frame-by-frame basis.

HP-IB Example

```
"CDMA:CALL:TRAFfIC:DATA:RATE `FULL`"
```

selects full-rate data transmission.

Screens Where Field is Present

CDMA CALL CONTROL
CDMA TRANSMITTER RANGE TEST
CDMA CELLULAR MOBILE RECEIVER TEST
CDMA CELLULAR MOBILE TRANSMITTER TEST

Data Spec

This field is used to determine how the contents of the signaling messages are built.

- **std** = Use the signaling formats defined in the applicable industry standard to build the forward control channel and forward voice channel signaling messages. Use the contents of the applicable fields on the CALL CONTROL screen and the CALL CONFIGURE screen to obtain information necessary to build the messages. Whenever a signaling message is used, update the contents of all fields in that message on the CALL BIT screen.
- **Bits** = Use the bit patterns as set on the CALL BIT screen to build all forward control channel and forward voice channel signaling messages. For any call processing function (that is, setting the message stream on the active control channel, registering the mobile station, paging the mobile station, handing off the mobile station or releasing the mobile station) the user is responsible for setting the contents of all signaling messages used in that function. The Call Processing Subsystem host firmware uses the messaging protocol as defined in the applicable industry standard.

NOTE:

The contents of the applicable fields on the CALL CONTROL screen and the CALL CONFIGURE screen are not updated to reflect any changes made while in the Bits mode. There is no coupling between the Bits mode and the Test Set. For example: if a mobile station was actively connected to the Test Set on a voice channel and the user changed the **CHAN** field on the forward voice channel mobile station control message (FVC V Mes) and sent that message to the mobile station, the mobile station would change its voice channel assignment. However, the Test Set will stay on the voice channel assignment specified in the **Chan :** field on the CALL CONTROL screen. This situation will result in a dropped call. The Bits mode should not be used to change any parameter that can be set on any other Call Processing Subsystem screen.

The :DSPecifier command is used to control this field.

The query form of the command (that is, :DSPecifier?) can be used to determine which method is currently being used to build the contents of the signaling messages.

See "[Reading the CALL BIT Screen Message Fields](#)" on page 97 for information on how to read the contents of the individual messages.

Syntax

:DSpecifier <'><STD/BITS><'>
:DSpecifier?

Example

```
OUTPUT 714;"CALLP:DSP?"  
OUTPUT 714;"CALLP:DSP 'STD' "  
ENTER 714;Build_method$
```

Screens Where Field is Present

CALL BIT

Data Type

This field selects the data type. This field appears only when **Traffic Data Mode** is set to **Svc Opt 1**, **Svc Opt 3**, or **32768**.

- **PRBS** - a pseudorandom bit sequence
- **Echo** - a reformatted and returned traffic packet (originated by the MSUT, received and reformatted by the Test Set, then returned to the MSUT).
- **1 kHz Tone** - a mathematically generated 1 kHz sine wave fed through a voice coder by simulation software.
- **400Hz** - a vocoded 400 Hz tone sent as the forward traffic data.
- **Chirp** - a vocoded chirp, with a duration of approximately 3 seconds, sent on the forward traffic channel. The Chirp repeats after about 0.5 seconds delay.

HP-IB Example

```
"CDMA:CALL:TRAFFIC:DATA:TYPE 'PRBS' "  
selects PRBS.
```

Operating Considerations

The 1 kHz Tone, 400 Hz, and audio Chirp require the mobile station to have an IS-96-A vocoder. Some mobile stations will distort the 1 kHz tone after a few seconds.

Screens Where Field is Present

CDMA CALL CONTROL
CDMA TRANSMITTER POWER RANGE TEST
CDMA CELLULAR MOBILE RECEIVER TEST
CDMA CELLULAR MOBILE TRANSMITTER TEST
CDMA AUTHENTICATION

Date

This field specifies the current date for the internal clock. The date can be read by a controller using HP-IB and printed on test results.

The format is MMDDYY (Month Day Year), using two digits for each term. When entering months January through September (01-09), the leading zero is not displayed when entered. Example; May 5, 1993 is entered as 050593, but is displayed as 50593.

The internal clock still functions when the instrument is turned off.

Screens Where Field is Present

CONFIGURE

DC Current

DC current measurement zero removes any measurement offset present before making a dc-current measurement. The measurement is zeroed by selecting **zero**, and pressing the ENTER key or the Cursor Control knob.

NOTE: The current source must be disconnected before zeroing for accurate operation.

Screens Where Field is Present

AF ANALYZER

DC Level

When set to **DC Level1**, this field displays the DC voltage entering at the DC input port on the back of the Test Set.

This field is a one-of-many field used to select the type of measurement to be made by the Audio Frequency Analyzer on the audio signal being measured. See “Measure” in the HP-IB Command Syntax chapter of the HP 8924C Condensed Programming Reference Guide for programming command syntax.

Selecting this field displays the following measurement choices:

- SINAD
- Distn (Distortion)
- SNR (Signal to Noise Ratio)
- AF Freq
- DC Level
- Current (DC only)

Operating Considerations

This is a priority control field. Accessing the RX TEST or TX TEST screen overrides any changes made to this field in other screens.

For more information about SNR operation, see the [SNR field description, on page 395](#).

Screens Where Field is Present

- AF ANALYZER
- ANALOG MEAS
- DUPLEX TEST
- RX TEST
- TX TEST
- RF GENERATOR
- RF ANALYZER

De-Emp Gain

De-emphasis gain displays and selects the desired AF analyzer de-emphasis amplifier gain.

See Also

[Gain Cntl field description, on page 269](#)

Screens Where Field is Present

AF ANALYZER

De-Emphasis

This field is used to select or bypass the 750 uSec de-emphasis filter network used to condition the audio signal before being analyzed by the Audio Frequency Analyzer. See “[AF Analyzer](#)” in the HP-IB Command Syntax chapter of the *HP 8924C Condensed Programming Reference Guide* for programming command syntax.

Operating Considerations

This is a priority control field. Accessing the RX TEST or TX TEST screen overrides any changes made to this field in other screens.

Screens Where Field is Present

AF ANALYZER
ANALOG MEAS
DUPLEX TEST
TX TEST

Delete Ch

This field allows you to delete a channel from the frequency table at the bottom of the screen.

Screens Where Field is Present

TESTS (Channel Information)

Delet Ins

This field allows you to delete an instrument from the list at the bottom of the screen.

Use the knob, up-arrow, or down-arrow key to select the step where you want to delete an instrument.

Screens Where Field is Present

TESTS (External Devices)

Delet Stp

This field allows you to delete a step from the test list at the bottom of the screen.

Screens Where Field is Present

TESTS (Order of Tests, External Devices)

Description

This field displays a description of the file chosen in the **Select Procedure** **Filename:** field.

Screens Where Field is Present

TESTS (Main Menu)

Detector

This field is used to select the type of detector used to measure the amplitude of the audio signal being analyzed by the Audio Frequency Analyzer.

See “[AF Analyzer](#)” in the HP-IB Command Syntax chapter of the *HP 8924C Condensed Programming Reference Guide* for programming command syntax.

Detector Types

- **RMS** displays the RMS value of signals.
- **RMS*SQRT2** displays the RMS value of a signal multiplied by $\sqrt{2}$.
- **Pk+** displays the positive peak value.
- **Pk-** displays the negative peak value.
- **Pk±/2** adds the positive and negative peak values, and divides the sum by 2.
- **Pk±Max** compares the positive and negative peaks and displays the greater value (polarity is not indicated).
- **Pk+ Hold** displays and holds the positive peak value until the measurement is reset. To reset, press the MEAS RESET key, select a different detector, or re-select the same detector.
- **Pk- Hold** displays and holds the negative peak value until the measurement is reset. To reset, press the MEAS RESET key, select a different detector, or re-select the same detector.
- **Pk±/2 Hold** divides the sum of the positive and negative peak values by 2, and displays the value until the measurement is reset. To reset, press the MEAS RESET key, select a different detector, or re-select the same detector.
- **Pk±Max Hold** compares the positive and negative peaks and displays the greater value until the measurement is reset. To reset, press the MEAS RESET key, select a different detector, or re-select the same detector.

Operating Considerations

This is a priority control field. Accessing the RX TEST or TX TEST screen overrides any changes made to this field in other screens.

Screens Where Field is Present

AF ANALYZER
ANALOG MEAS
CALL CONFIGURE
DUPLEX TEST
TX TEST

Disarm

This field stops a measurement in progress. It is only displayed when the **Meas Cntl** field is set to **single**. *This field is not updated to show the Meas Cntl mode when the Test Set is operated remotely.*

HP-IB Example

```
"DISP CRXT;TRIGger:AState 'DISARM' "
```

stops a measurement in progress.

Operating Considerations

The 'DISARM' command *does not prevent subsequent measurements from being triggered when the Test Set is in REPetitive triggering mode.*

If **Disarm** is selected with no measurement in progress, it will have no effect on the display.

Screens Where Field is Present

CDMA CELLULAR MOBILE RECEIVER TEST
CDMA CELLULAR MOBILE TRANSMITTER TEST

Display

The top right-hand portion of the **CALL CONTROL** screen is used to display:

- Decoded data messages received from the mobile station on the reverse control channel or the reverse voice channel. If a decoding error occurs the raw data message bits received from the mobile station are displayed in hexadecimal format.
- Modulation quality measurements made on the mobile station's RF carrier while on a voice channel.

The **Display** field is used to select the type of mobile station information to be displayed. **Data/Meas** is displayed for AMPS measurements. **NData/NMeas** is displayed for NAMPS measurements.

- The **:MODE** command is used to Control the **Display** field for AMPS, TACS, and JTACS system types.
- The **:NDMMode** command is used to control the **Display** field for NAMPS system type.
- The **:MODE?** query is used to determine the current **Display** field setting for AMPS, TACS, and JTACS system types.
- The **:NDMMode?** query is used to determine the current **Display** field setting for NAMPS system type.

Syntax

```
:MODE <'><DATA/MEAS><'>  
:MODE?  
:NDMMode <'><NDATA/NMEAS><'>  
:NDMMode?
```

Example

```
OUTPUT 714;"CALLP:MODE 'DATA' "  
OUTPUT 714;"CALLP:MODE? "  
ENTER 714;Screen$  
OUTPUT 714;"CALLP:NAMP:NDMMode 'NDATA' "  
OUTPUT 714;"CALLP:NAMP:NDMMode? "  
ENTER 714;Screen$
```

Setting the Display field to Data

When the **Display** field is set to **Data** the top right-hand portion of the **CALL CONTROL** screen is used to display decoded data message(s) received from the mobile station on the reverse control channel or the reverse voice channel.

Chapter 4, Description of Fields
Fields That Begin with the Letter D

If the data message(s) received from the mobile station can be correctly decoded, the decoded message contents are displayed. **Figure 53** shows an example of a correctly decoded reverse control channel data message being displayed in the top right-hand portion of the screen.

If the data message(s) cannot be correctly decoded, the raw data message bits are displayed in hexadecimal format.

See “Using the Analog Call Processing Subsystem” chapter in the *HP 8924C Application Guide* for more information.

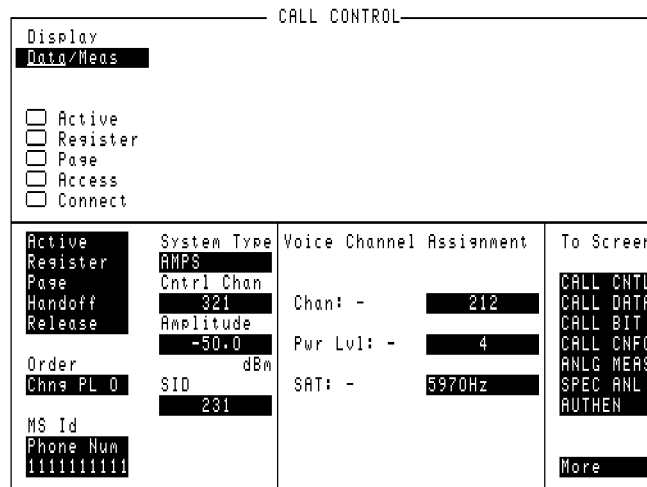

Figure 53 The CALL CONTROL Screen

The messages are displayed in six non-labeled received data fields (that is, there is no field label on the display screen). The fields are named RCDD1 through RCDD6. The first and topmost field is RCDD1. The last and lowermost field is RCDD6. **Figure 54** shows the position of the received data fields on the **CALL CONTROL** screen.

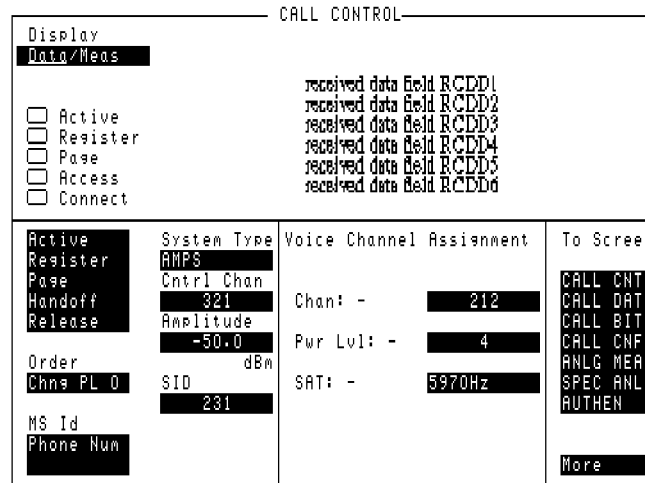

Figure 54 CALL CONTROL Screen Received Data Fields

The control program queries these received data fields to obtain the displayed information strings.

Information Strings Available From The Received Data Fields

Table 9 lists the information strings available from the reverse control channel data messages received from the mobile station. The control program would query the appropriate received data field to obtain the displayed information string.

Table 10 lists the information strings available from the reverse voice channel data messages received from the mobile station. The control program would query the appropriate received data field to obtain the displayed information string.

Table 11 lists the information strings available when a decoding error occurs. The control program would query the appropriate received data field to obtain the displayed information string.

Table 9 Information Strings Available From Reverse Control Channel

Reverse Control Channel Message	Information Strings Displayed	Displayed in Received Data Field
Order Confirmation Message	Phone Number ESN(dec) ESN(hex) Station Class Mark Authentication messages	RCDD1 RCDD2 RCDD3 RCDD4 RCDD6
Origination Message	Phone Number ESN(dec) ESN(hex) Station Class Mark Called Number Authentication messages	RCDD1 RCDD2 RCDD3 RCDD4 RCDD5 RCDD6
Order Message	Phone Number ESN(dec) ESN(hex) Station Class Mark Authentication Messages	RCDD1 RCDD2 RCDD3 RCDD4 RCDD6

Table 10 Information Strings Available from Reverse Voice Channel

Reverse Voice Channel Message	Information Strings Displayed	Displayed in Received Data Field
Order Confirmation Message	Change Power Level Confirmation Authentication Messages Order Type	RCDD1 RCDD1 RCDD2

Table 11 Information Strings Available When A Decoding Error Occurs

Information Strings Displayed	Displayed in Received Data Field	Length of Received Data Field
error data received from <channel type> word 1 word 2 word 3 word 4 word 5 word 6	RCDD1 RCDD2 RCDD3 RCDD4 RCDD5 RCDD6	30 characters max 40 characters max 30 characters max 40 characters max 40 characters max 40 characters max

Reading The Received Data Fields To read the decoded data messages received from the mobile station on the reverse control channel or reverse voice channel or the raw data message bits displayed when a decoding error occurs, the control program queries one, some, or all of the six received data fields. The information in each field is returned exactly as displayed on the CRT. The information is returned to the control program as a quoted string (“This is an example.”).

The received data fields are read only data fields.

The :RCDD1? through :RCDD6? query commands are used to read the contents of the six received data fields.

Syntax

:RCDD<1-6>?

Example

```
OUTPUT 714;"CALLP:RCDD1?"  
ENTER 714;Rcv_data$
```

Setting the Display Field to Meas

When the **Display** field is set to **Meas** the top right-hand portion of the **CALL CONTROL** screen is used to display modulation quality measurements made on the mobile station’s RF carrier while on a voice channel.

- For system type AMPS, TACS, AND JTACS the following parameters are measured when the Test Set is in the connect state. See [Figure 55](#) .
 - TX Freq Error
 - TX Power
 - FM Deviation
 - AF Frequency

Chapter 4, Description of Fields
 Fields That Begin with the Letter D

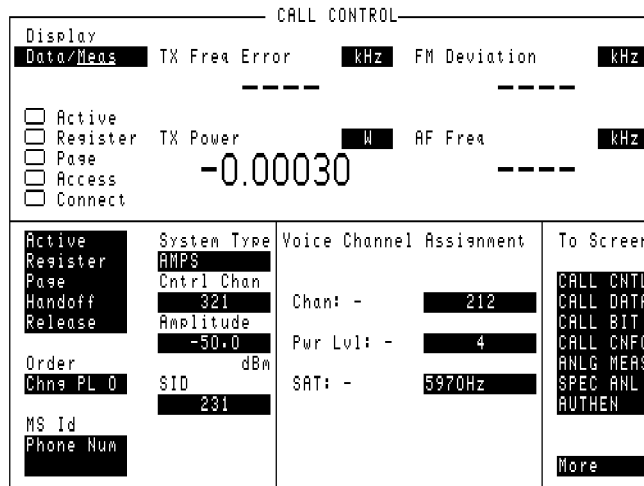

Figure 55 CALL CONTROL Screen with Meas Selected

- For system type NAMPS the following parameters are measured when the Test Set is in the connect state. See [Figure 56](#) .
 - TX Freq Error
 - TX Power
 - FM Deviation
 - DSAT/DST

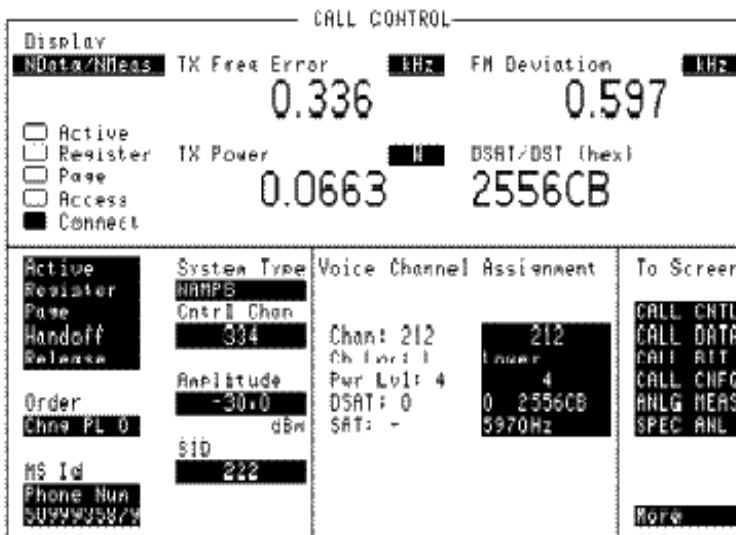

Figure 56 CALL CONTROL Screen with NMeas Selected

Reading The Modulation Quality Measurement Fields The **MEAS** selection brings some of the Test Set's Audio Analyzer fields and some of the Test Set's RF Analyzer fields onto the **CALL CONTROL** screen for the purpose of making modulation quality measurements on the mobile station's RF carrier while on a voice channel.

Example

```
OUTPUT 714;"MEAS:RFR:POW?"
ENTER 714;Tx_power
OUTPUT 714;"MEAS:RFR:FREQ:ERR?"
ENTER 714;Tx_freq_error
OUTPUT 714;"MEAS:AFR:FREQ?"
ENTER 714;Af_freq
OUTPUT 714;"MEAS:AFR:FM?"
ENTER 714;Fm_deviation
```

Screens Where Field is Present

ANALOG MEAS
CALL CONTORL

Display Interim Results

This field allows the display of the current FER, errors, and number of frames counted while a measurement is in progress.

- **Yes** displays periodic updates from the cell site's processor.
- **No** display one measurement result at the end of the test.

HP-IB Example

```
"DISP CRXT;DISPlay:FERasure:INTerim:RESults 'YES'"
displays interim FER results.
```

Operating Considerations

This field must have **Yes** selected to display interim results.

If **Display Interim Results** is **Yes**, and a measurement result is queried over HP-IB during a measurement, an interim measurement will be returned.

Screens Where Field is Present

CDMA CELLULAR MOBILE RECEIVER TEST

Display Word

This field is used to select the desired reverse control channel or reverse voice channel message to be displayed.

The :DATA command is used to control this field.

The query form of the command (that is, :DATA?) can be used to determine which reverse control channel or reverse voice channel message is currently being displayed.

See "[Reading the CALL DATA Screen Message Fields](#)" on page 103 for information on how to read the contents of the individual messages.

Syntax

```
:DATA <'><Reverse Control or Voice Channel message word><'>  
:DATA?
```

Example

```
OUTPUT 714;"CALLP:DATA 'RECCW A' "  
OUTPUT 714;"CALLP:DATA? "  
ENTER 714;Message$
```

Screens Where Field is Present

CALL DATA

Display Word Choices

AuthWORD

Standard Equivalent: Word C - Authentication Word

Message Fields: AUTHR, COUNT, F, NAWC, Parity, RANDC

BSChalOrd

Standard Equivalent: Word C - Base Station Challenge Word

Message Fields: F, NAWC, Parity, RANDBS

MRI Ord

Standard Equivalent: MRI Order message

Message Fields: AWC, DSCC, OE, Order, ORDQ, Parity, RSSI, RSVD, VMAC, T1T2

NRVC Ord

Standard Equivalent: Narrow Order or Order Confirmation Message

Message Fields: AWC, DSCC, Local, OE, ORDQ, Parity, RSVD, VMAC, T1T2

RECCW A

Standard Equivalent: Word A - Abbreviated Address Word

Message Fields: E, F, MIN1, NAWC, Parity, RSVD, S, SCM, T

RECCW B

Standard Equivalent: Word B - Extended Address Word

Message Fields: F, LOCAL, LT, MIN2, NAWC, ORDER, ORDQ, Parity, RSVD

RECCW C

Standard Equivalent: Word C - Serial Number Word

Message Fields: F, NAWC, Parity, SERIAL

RECCW D

Standard Equivalent: Word D - First Word of the Called-Address

Message Fields: F, Dig 1 through Dig 8, NAWC, Parity

RECCW E

Standard Equivalent: Word E - Second Word of the Called-Address

Message Fields: F, Dig 9 through Dig 16, NAWC, Parity

RVCBSChal

Standard Equivalent: Word 2 - Reverse Voice Channel Base Station Challenge Order

Message Fields: F, NAWC, Parity, RANDBS, T

RVC Ord

Standard Equivalent: Word one - Reverse Voice Channel Generic Order

Message Fields: F, Local, NAWC, Order, ORDQ, Parity, RSVD, T

RVCOrdCon

Standard Equivalent: Reverse Voice Channel Order Confirmation Message

Message Fields: F, LOCAL, NAWC, ORDER, ORDQ, Parity, RSVD, T

UniqChCon

Standard Equivalent: Word C - Unique Challenge Order Confirmation Word

Message Fields: AUTHR, F, NAWC, Parity, RSVD

Call Data - Display Word Message Field Descriptions

AUTHR Output of the authentication algorithm when responding to a Unique Challenge Order.

AWC This field indicates the number of additional words coming.

COUNT This field displays the modulo-64 count maintained by the mobile station and used for authentication and anti-fraud purposes.

Dig 1 through Dig 8 These fields display digits 1 through 8 of the phone number dialed on the mobile station.

Dig 9 through Dig 16 These fields display digits 9 through 16 of the phone number dialed on the mobile station.

DSCC This field displays the current DSAT Color Code being transmitted by the mobile station.

E This field displays the extended address word received from the mobile.

- Set to '1' if the extended address word is sent.
- Set to '0' if the extended address word is not sent.

F This field displays the first word indication received from the mobile station.

- A '1' indicates that this is the first word.
- A '0' is displayed for all subsequent words.

LOCAL This field displays the local control field. This field is specific to each system. The **ORDER** field must be set to local control for this field to be interpreted by the Test Set.

LT This field displays the last-try code field.

MIN1 This field displays the first part of the mobile identification number received from the mobile station.

MIN2 This field displays the second part of the mobile identification number received by the Test Set.

NAWC This field displays the number of additional words coming from the mobile station.

OE The Odd/Even data field is used for adjacent channel protection.

ORDER This field displays the **Order** field and identifies the order type received by the Test Set.

ORDQ This field displays the received order qualifier. The field qualifies the order confirmation to a specific action.

Parity This field displays the parity of the transmitted data.

RANDBS This field displays the random number used in the SSD update procedure.

RANDC This field displays the 8-bit number used to confirm the last RAND received by the mobile station.

RSSI This field displays the received signal strength over the last reporting period.

RSVD This field is reserved for future use.

S This field displays whether the serial number word is received from the mobile station.

- Set to '1' if the serial number word is sent.
- Set to '0' if the serial number word is not sent.

SCM This field displays the mobile station's received station class mark.

Serial This field displays the serial number of the mobile station.

T This field displays the message type received from the mobile station.

- Set to '1' to identify the message as an origination or an order.
- Set to '0' to identify the message as an order response or page response.

T1T2 This field identifies the received message as an order confirmation, an order, or a called address message.

VMAC This field displays the voice mobile attenuation code. It shows the mobile station power level associated with the designated voice channel.

Distn

When this field is set to **Distn** it displays the percent of distortion for a 1 kHz signal tone.

This field is a one-of-many field used to select the type of measurement to be made by the Audio Frequency Analyzer on the audio signal being measured. See “Measure” in the HP-IB Command Syntax chapter of the HP 8924C Condensed Programming Reference Guide for programming command syntax.

Selecting this field displays the following measurement choices:

- SINAD
- Distn (Distortion)
- SNR (Signal to Noise Ratio)
- AF Frequency
- DC Level
- Current (DC only)

Operating Considerations

This is a priority control field. Accessing the RX TEST or TX TEST screen overrides any changes made to this field in other screens.

For more information about SNR operation, see the [SNR field description, on page 395](#).

Screens Where Field is Present

- AF ANALYZER
- ANALOG MEAS
- DUPLEX TEST
- RX TEST
- TX TEST
- RF GENERATOR
- RF ANALYZER

Drop Intcpt

This field is used to enter the parameter DROP_INTERCEPT. Refer to ANSI TIA/EIA-95-B for additional details.

This field is displayed only when TIA/EIA-95B is selected in the **"Protocol" field on page 344**.

HP-IB Example

```
"DISP CMOB;CDMA:MOB:PARM:IDROP 4"
```

enters 4 in the Drop Intcpt field.

Operating Considerations

This field setting, along with the **"Soft Slope" field on page 396**, modifies the way that the mobile station manages pilot sets. Refer to the [formulas](#) found in the field description for **"Expected T_Drop" field on page 258**. These fields also affect the conditions which require the mobile station to send a Pilot Strength Measurement Message.

See Also

[T_Drop field description, on page 418](#)

Drop Timer

This field turns the call drop timer on or off.

- **On** - the call drop timer is activated. If, during a call, the Test Set does not receive a signal from the MSUT for a period of 256 frames, the call is dropped
- **Off**-the call drop timer is de-activated.

HP-IB Example

```
"DISP CTRX;CDMA:CALL:DTIMER `OFF`" "
```

turns off the call drop timer.

Operating Considerations

When a call is connected and the Test Set fails to decode a traffic frame, the Test Set begins a counter that will increment with each bad frame. This counter is referred to as the "call drop" timer. When the Call Drop field is **On**, the call drop timer allows 256 bad frames in sequence before dropping the call. If you want to disable the Test Set's call drop timer, set this field to **Off**.

With the Call Drop timer off and a call connected, the Test Set will continue to transmit the CDMA forward channel even in the absence of a reverse link. For example, if a mobile station has been power-controlled to a level that is too low for the Test Set to decode (and therefore acknowledge) signaling messages, the mobile station could drop the call but the **Connected** annunciator will still be lit.

With the Call Drop timer off, the **Connected** annunciator can still go out:

- if a procedure that requires signaling, such as Hard Handoff, was initiated but could not be completed, or
- if the END CALL key is pressed, or
- if the CDMA:CALL:END command is sent via HP-IB, or
- if the mobile station sends a *Release Order* message and the Test Set is able to decode it.

Screens Where Field is Present

CDMA TRANSMITTER POWER RANGE TEST

DSAT

On the analog CALL CONTROL screen, the **DSAT:** field is displayed only when the **System Type** field is set to **NAMPS** or **NTACS**. The **DSAT:** field is located in the **Voice Channel Assignment** field, and it is divided into subfields. The left-hand subfield displays the current DSAT control message being broadcast by the base station.

- A “-” is displayed if a mobile station is not actively connected on a voice channel or the **Ch Loc:** is set to Wide. When the **Ch Loc:** is set to Wide the **SAT** field displays the current SAT frequency being broadcast by the Test Set.
- A numeric value is displayed when the **Ch Loc:** is set to Lower, Middle or Upper and a mobile station is actively connected on a voice channel (that is, the **Connect** annunciator is lit).

The `:DSAT:ACTual?` query command is used to query the contents of the left-hand field.

There is no command form of the query `:DSAT:ACTual?`.

Syntax

```
:DSAT:ACTual?
```

Example

```
OUTPUT 714;"CALLP:NAMP:DSAT:ACTual?"  
ENTER 714;Active_dsat$
```

- The right-hand field (highlighted field) is used to set one of the 7 valid DSAT sequences to be used on the designated voice channel entered into the **Chan:** field.

The `:DSAT` command is used to control the right-hand field.

The query form of the command (that is, `:DSAT:SETTing?`) can be used to determine the current Test Set DSAT setting.

Syntax

```
:DSAT:SETTing <'><0 2556CB/1 255B2B/2 256A9B/3 25AD4D/4 26AB2B/5  
26B2AD/6 2969AB><'>  
:DSAT:SETTing?
```

Example

```
OUTPUT 714;"CALLP:NAMP:DSAT '0 2556CB' "  
OUTPUT 714;"CALLP:NAMP:DSAT:SETT?"  
ENTER 714;DSat_sequence$
```

Screens Where Field is Present

CALL CONTROL
CDMA CALL CONTROL

DSAT/DST (hex)

The **DSAT/DST (hex)** field is displayed only when the **System Type** field is set to **NAMPS** and the **Display** field is set to **NMeas**.

The DSAT/DST field displays the received **DSAT/DST** sequence from the mobile station on the reverse voice channel. The received sequence is displayed in hexadecimal and can be checked against the DSAT value displayed in the DSAT right-hand DSAT field. Four dashes (----) indicate no carrier is present to measure. A numeric value would only be displayed when the Test Set's **Connected** annunciator is lit (connected state).

The :DSAT:MEASurement? query command is used to query the contents of the left-hand subfield.

There is no command form of the :MEASurement? query.

Syntax

:DSAT:MEASurement?

Example

```
OUTPUT 714;"CALLP:NAMP:DSAT:MEASurement?"  
ENTER 714;MEASured_dsat$
```

Screens Where Field is Present

CALL CONTROL

DSAT Meas

This field is displayed only when the **System Type** field is set to **NAMPS** or **NTACS** .

This field is used to select what the signaling decoder will decode. The choices are:

- **DSAT**
- **Data**

When **DSAT** is selected, the signaling decoder decodes DSAT (Digital Supervisory Audio Tone) transponded from the mobile station currently connected on a call.

When **Data** is selected, the signaling decoder decodes and displays reverse voice channel data and acts upon messages from the mobile station currently connected on a call.

Operating Considerations

To verify that the mobile station is transponding the correct DSAT, make sure DSAT is selected in this field, and select “NMeas” in the Display field. The decoded DSAT will be displayed in the DSAT/DST (hex) field. .

To set up the signaling decoder to decode and display signaling messages that are transmitted on the reverse voice channel, make sure that “Data” is selected in this field, then select “NData” in the Display field. Messages generated by signaling events, such as when a call is ended by the mobile station, will now be decoded and displayed. If this field is not set to “Data”, and a call is ended by the mobile station, the Test Set will drop the call when it detects that the mobile station is no longer on the call.

HP-IB Example

```
"CPRocess:NAMPS:DSAT:MEASure:SElect 'Data' "
```

commands the analog signaling decoder to decode reverse traffic channel data.

Screens Where Field is Present

CALL CONTROL (when NAMPS is selected in the System Type field)

Duplex Out

This field is used to indicate losses or gains between the DUPLEX OUT port and the device-under-test.

- Enter a *positive* value to indicate a gain (such as an amplifier gain). The RF Generator's level is automatically set that amount *below* what is indicated in the RF Generator's **Amplitude** field. (Example; if this value is 10 dB, and the **Amplitude** field shows 0 dBm, the actual level out this port is –10 dBm.) The value at the output of the external amplifier should then be at the level indicated in the **Amplitude** field.
- Enter a *negative* value to indicate a loss (such as cable loss). The RF Generator's level is automatically set that amount *above* what is indicated in the RF Generator's **Amplitude** field to compensate. The value at the opposite end of the cable (loss) should then be at the level indicated in the **Amplitude** field; unless the resulting RF Generator setting exceeds the maximum output level, then an error occurs: **Input value out of range**. In that case, reduce the **Amplitude** setting, or decrease the **Duplex Out** value.

HP-IB Example

```
"CONF:OFL:DUPL -1"
```

enters a path loss of 1 dB between the DUPLEX OUT port and the mobile station.

This field is only used when the **RF Level Offset** field is set to **On**.

Screens Where Field is Present

CONFIGURE

Duplicate User Data

This field is used to determine the maximum number of copies of user data that will be sent in an SMS message.

HP-IB Example

```
"CDMA:SMS:TERM:DUPL 2"
```

enters 2 (times) in the Duplicate Entered Data field.

Screens Where Field is Present

CDMA SHORT MESSAGE SERVICE

Fields That Begin with the Letter E

Eb/Nt

This field is displayed when AWGN is “On” and the **Data Type** field on the CDMA CALL CONTROL screen or the CDMA CELLULAR MOBILE RECEIVER TEST screen to **PRBS, 1 kHz Tone, 400 Hz, or Chirp**.

HP-IB Example

```
"DISP CGEN;CDMA:STN?"
```

queries the E_b/N_t field.

Operating Considerations

To display a value for E_b/N_t , turn on **AWGN** and set the **Data Type** field on the CDMA CALL CONTROL screen or the CDMA CELLULAR MOBILE RECEIVER TEST screen to **PRBS, 1 kHz Tone, 400 Hz, or Chirp**.

Screens Where Field is Present

CDMA GENERATOR CONTROL
CDMA CELLULAR MOBILE RECEIVER TEST

Echo Delay

This field is displayed only when the **Data Type** field is set to **Echo**. This field allows selection of the time period between when you talk into the mobile station and when you hear your voice echoed back.

- 0 Seconds
- 2 Seconds
- 5 Seconds

HP-IB Example

```
"DISP CCNT;CDMA:CALL:TRAFfic:ECHO:DElay `2 SECONDS`"
```

delays your voice 2 seconds.

Screens Where Field is Present

CDMA CALL CONTROL

CDMA TRANSMITTER POWER RANGE TEST

CDMA CELLULAR MOBILE RECEIVER TEST

CDMA CELLULAR MOBILE TRANSMITTER TEST

Encoding

This field determines how the characters in the User Data field will be encoded in the SMS message. The choices currently available are:

- **Octet** causes each character to be encoded as a byte (8-bits).
- **7-bit ASCII** causes each character to be encoded in 7-bit lengths.

HP-IB Example

```
"CDMA:SMS:ENC `Octet`"
```

selects the "Octet" format.

Operating Considerations

If you select Octet and the **Data Mode** field is set to Hex, the Test Set will put each byte of data from the **User Data** field in the SMS message without translation.

If you select 7-bit ASCII and the **Data Mode** field is set to Hex, the Test Set will truncate the most significant bit of each byte of data from the **User Data** field, then put the resulting 7-bit data in the SMS message without translation.

If the **Data Mode** field set to ASCII, the Test Set will translate the data from the **User Data** field using the ASCII code chart, then put the resulting data in the SMS message in 7-bit or byte format depending on the selection you make in this field.

The data that comes from characters entered in the **User Data** field are put in the CHARi fields of the User Data subparameter of the SMS message as described in Section 4.5.2 of IS-637 and TSB79. This field affects this subparameter as shown in [table 12](#).

Table 12

Encoding field selection	MSG_ENCODING field value	CHARi field length (bits)
Octet	0	8
7-bit ASCII	2	7

The encoding to be used by mobile stations for the Octet encoding type is unspecified in the IS-637 and TSB79 standards. While some mobile stations use ASCII encoding, others may use a different encoding or may not implement the Octet encoding type at all. Consequently, using 'Octet' encoding to send ASCII User Data to a mobile station may cause the mobile station to display the message using a different character set or the mobile station may not display a message at all.

See Also

[User Data \(ASCII or Hex\) field description, on page 443](#)

Screens Where Field is Present

CDMA SHORT MESSAGE SERVICE

Enter ASCII Data

This field is displayed when the **Message Data Mode** is set to **ASCII**. It is used to enter the message to be sent on the paging channel. You can use the default message or enter your own message.

Operating Considerations

A maximum of 64 ASCII characters can be entered.

The default ASCII message is as follows:

```
ABCDEFGHIJKLMNOPQRSTUVWXYZ_01234  
abcdefghijklmnopqrstuvwxyz#56789
```

Screens Where Field is Present

CDMA SHORT MESSAGE SERVICE

Enter Hex Data

This field is displayed when the **Message Data Mode** is set to **Hex**. It is used to enter the message to be sent on the paging channel. You can use the default message or enter your own message.

Operating Considerations

A maximum of 128 hex characters can be entered.

The default hex message is as follows:

```
4142434445464748494A4B4C4D4E4F50  
5152535455565758595A5F3031323334  
61626364656666768696A6B6C6D6E6F70  
7172737475767778797A233536373839
```

Screens Where Field is Present

CDMA SHORT MESSAGE SERVICE

Enter Procedure Filename

This field is used to enter the name of the file you want to save or delete.

Operating Considerations

When you save a procedure file, you can use any name with up to 9 characters.

You can also delete previously-saved files to be able to resave a file using the same file name.

Screens Where Field is Present

TESTS (Save/Delete Procedure)

Errors

Indicates the number of errors detected during an FER report interval.

HP-IB Example

```
"DISP CMOB;CDMA:MOBILE:FERasure:ERRors?"
```

queries the number of errors counted by the mobile station during an FER report interval.

Operating Considerations

The report interval is specified in terms of error count or frame count.

See Also

[by # errors field description, on page 185](#)

[by # frames field description, on page 186](#)

[MS FER Report Interval field description, on page 305](#)

Screens Where Field is Present

CDMA MOBILE REPORTING

Errors Counted

This field displays the number of frame errors counted during or after an FER test. A Service Option 2 (mobile station data loopback) call must be connected before running an FER test.

HP-IB Example

```
"DISP CRXT;MEASure:CDManalyzer:FERasure:ERRORs?"
```

queries the FER errors measurement result.

Operating Considerations

A measurement result will be displayed at the end of a test if Display Interim Results is **No**. Measurement results will be displayed continuously if Display Interim Results is **Yes**.

Screens Where Field is Present

CDMA CELLULAR MOBILE RECEIVER TEST

Esc Mode

This field is displayed when the field called "**Protocol**" on page 344 has IS-95A, TSB-74, or J-STD-008 selected.

This field, when set to "On", configures the Test Set as a base station that is compatible with any Country Code/Network Code combination that a mobile station is programmed with.

- **On** (enables escape mode)
- **Off** (disables escape mode)

HP-IB Syntax

```
"CDMA:CELL:CONF:EMOD `On`"
```

enables escape mode.

Operating Considerations

When Escape Mode is "On", the **Cntry Code** and **Netwrk Code** fields are no longer needed and are removed from the Cell Site Configuration screen. The mobile station may still require a specific **Network ID** and **System ID** setting to find service from the Test Set.

See Also

[Protocol field description, on page 344](#)

Screens Where Field is Present

CDMA CELL SITE CONFIGURATION

ESN (dec):

This field displays the electronic serial number (ESN), in decimal form, received from the mobile station on the reverse control channel in response to a forward control channel message. The **ESN (dec) :** field is displayed only when the **Display** field is set to **Data** and a reverse control channel message containing this information has been decoded.

Refer to the "**Display**" field on page 223 for information on how to read measurement results from this field.

Screens Where Field is Present

CALL CONTROL

ESN (hex):

This field displays the electronic serial number (ESN), in hexadecimal form, received from the mobile station on the reverse control channel in response to a forward control channel message. The **ESN (hex) :** field is displayed only when the **Display** field is set to **Data** and a reverse control channel message containing this information has been decoded.

Refer to the "**Display**" field on page 223 for information on how to read measurement results from this field.

Screens Where Field is Present

CALL CONTROL

ESN

This field is used to enter the electronic serial number (ESN) of the mobile station into the Test Set. There are two methods which can be used to enter the **ESN**. The serial number can be captured by the Test Set through a registration order, or the serial number can be entered as an 8-digit hexadecimal value directly into this field.

To capture the electronic serial number through a registration , see [Register field description, on page 356](#) for further information.

To enter the serial number directly use the :ESNumber command.

The query form of the command (that is, :ESNumber?) can be used to determine the current setting of the ESN field.

Syntax

```
:ESNumber <'><8 character hex value><'>
```

```
:ESNumber?
```

Example

```
OUTPUT 714;"CALLP:AMPS:AUTH:ESN '12D4E678' "
```

```
OUTPUT 714:"CALLP:AMPS:AUTH:ESN?"
```

```
ENTER 714;Esn_val$
```

Screens Where Field is Present

AUTHENTICATION

Execute

This field executes the signaling event displayed in the field directly above it. At the time of this printing, the only choice was Handoff (CDMA to Analog).

HP-IB Example

```
"DISP CCNT;CDMA:CALL:AHAN:[EXEC]"
```

executes a CDMA to Analog handoff.

Operating Considerations

A CDMA to Analog handoff to the voice channel selected in the Channel field is performed when the Execute field is selected. A CDMA call must be in progress to execute a CDMA to Analog handoff.

Screens Where Field is Present

CDMA CALL CONTROL

Execute (Closed Loop Power Control Change)

This field allows execution of n-up, n-down, or ramp power-control steps.

HP-IB Example

```
"DISP CTRX;CDMA:PCONTrol:EXECute"
```

*causes the Test Set to output the selected number of steps in the direction selected in the **Change** field over the power control sub-channel.*

Operating Considerations

When **Execute** is selected, the Test Set will begin sending power-control bits to the mobile station. Each power-control bit attempts to adjust the mobile station's power level by 1 dB.

See Also

[Change field description, on page 193](#)

[Steps field description, on page 411](#)

Screens Where Field is Present

CDMA TRANSMITTER POWER RANGE TEST

Exec (Execution Cond)

Selecting this field displays the TESTS (Execution Conditions) screen.

Screens Where Field is Present

TESTS (Main Menu)

Expected

This column in the authentication results table lists Test Set's computed authentication data for the parameters that are returned from the mobile in the Access Channel Registration, Page Response Message, or Origination Message. The data in the **Expected** column is compared to the data in the **Received** column to verify if authentication passes or fails.

See Also

[Authen field description, on page 170](#)

Screens Where Field is Present

CDMA AUTHENTICATION

Expected PN Offset

The values displayed in this column are the current Sector A and Sector B pilot PN Offsets. The mobile station should report pilot PN Offset values for each of its Active or Candidate set pilots whenever level thresholds are crossed that might indicate a change in pilot status. The mobile reported PN Offset values should exactly match one of the Expected PN Offset values, depending on the reported pilot (Sector A or Sector B).

HP-IB Example

```
"DISP CGEN;CDMA:CELL:ASEctor:PNOFFset?"
```

queries the expected PN Offset value for Sector A.

Operating Considerations

A Pilot Strength Message, which includes each detected pilot's PN Offset, is sent from the mobile station when a Softer Handoff is executed, ended, or when the mobile station detects a change in pilot levels that could affect the assignment of pilots to the mobile station's Active, Candidate, or Neighbor sets (refer to the CDMA Mobile Reporting table at the top of the display). The actual mobile-reported values for PN Offset in the CDMA Mobile Reporting table at the top of the display should exactly match the values for Expected PN Offset.

See Also

[Expected Strength field description, on page 255](#)

[PN Offset \(Sector A Power\) field description, on page 336](#)

[PN Offset \(Sector B Power\) field description, on page 336](#)

Screens Where Field is Present

CDMA MOBILE REPORTING

Expected Strength

The values displayed in this column are the expected pilot strength numbers the mobile station should be sending to the Test Set, based on the current ratio of pilot energy to RF power. Changes to the following fields could cause changes to the Expected Strength numbers:

- Sector A Pilot
- Sector B Pilot
- Sector A Power
- Sector B Power
- AWGN

Example:

With Sector A Power on, Sector B Power off, and AWGN off, changes to Sector A Power will not affect expected strength numbers. This is because the relative level of the Sector A Pilot channel to RF Power has not changed. However, changes to the Sector A Pilot field *will* affect expected strength numbers. Similarly, turning on Sector B or AWGN will change the ratio of Sector A pilot signal strength to overall RF power, changing the expected strength number for Sector A.

HP-IB Example

```
"CDMA:CELL ASECTOR:STrength?"
```

queries the expected pilot strength value for Sector A.

Operating Considerations

A Pilot Strength Message is sent from the mobile station when a Softer Handoff is executed, ended, or when the mobile station detects a change in pilot levels that could affect the assignment of pilots to the mobile station's Active, Candidate, Access HO, or Neighbor sets (refer to the CDMA Mobile Reporting table at the top of the display). The actual mobile-reported values in the CDMA Mobile Reporting table should closely match the values for Expected Strength.

See Also

[Expected PN Offset field description, on page 254](#)

Screens Where Field is Present

CDMA MOBILE REPORTING

Expected T_Add

This field is displayed only when TIA/EIA-95B is selected in the **"Protocol" field on page 344**. Refer to *ANSI/TIA/EIA-95-B*, 6.6.6.2.6, Set Maintenance, for additional information.

This field displays an integer value representing a power level threshold. The Test Set calculates this threshold based on several field settings, described in the formula below. The purpose of this calculation is to determine the approximate power level threshold that will cause the mobile station to send a pilot strength message reporting that a non-Active pilot has sufficient signal strength to be added to the Active pilot set.

To compare the integer value in the Expected T_Add field with the expected pilot strength the mobile station is currently receiving from the Test Set, refer to the **"Expected Strength" field on page 255**.

The Test Set will update the status of each pilot strength report in the Status column on the CDMA MOBILE REPORTED PILOT STRENGTH screen.

HP-IB Example

```
"CDMA:MOBILE:PARM:ETADD?"
```

queries the Expected T_Add value calculated by the Test Set.

Operating Considerations

If the mobile station detects that a non-active pilot's signal strength has crossed the Expected T_Add threshold while on the traffic channel (call connected), it should report (in the Status field):

- *Candidate*, if the Soft Handoff field is Off, and the detected strength is less than T_Comp above the Active set (Sector A) pilot , or
- *To Add*, if the Soft Handoff field is Off, and the detected strength is greater than T_Comp above the Active set (Sector A) pilot , or
- *Active*, if the Soft Handoff field is On.

The value displayed in this field is calculated by the Test Set using the following formula (unless the Soft Slope field is set to 0):

$$\text{ExpectedTAdd} = 2 \times \max \left(\frac{\text{SoftSlope}}{8} \times 10 \times \log \sum_{i \in A} \text{PS}_i + \frac{\text{AddIntercept}_s}{2}, \frac{-\text{TAdd}_s}{2} \right)$$

where PS_i is defined as E_c/I_o for the pilot in question.

The calculations used in determining Expected T_Add do not account for any interfering signals the mobile station may be receiving in addition to the forward CDMA channels from the Test Set.

If the Soft Slope field is 0, the Expected T_Add field will display the same value as that currently entered in the T_Add field.

The table at the top of the CDMA MOBILE REPORTED PILOT STRENGTH screen can be cleared by selecting the "[Pilot Meas \(Clear\)](#)" field on page 333

See Also

[T_Add field description, on page 417](#)

[Add Intcpt field description, on page 156](#)

[Soft Slope field description, on page 396](#)

[Status field description, on page 408](#)

[Expected Strength field description, on page 255](#)

[Softer Handoff field description, on page 397](#)

Screens Where Field is Present

CDMA MOBILE REPORTED PILOT STRENGTH

Expected T_Drop

This field is displayed only when TIS/EIA-95B is selected in the **"Protocol" field on page 344**. Refer to *ANSI/TIA/EIA-95-B*, 6.6.6.2.6, Set Maintenance, for additional information.

This field displays an integer value representing an expected power level threshold. The purpose of this calculation is to determine the approximate power level threshold that will cause the mobile station to send a pilot strength message reporting that an Active pilot signal strength has lowered to a point where it should be dropped from the Active set.

To compare the integer value in the Expected T_Add field with the pilot strength the mobile station is currently receiving from the Test Set, refer to the **"Expected Strength" field on page 255**.

The Test Set will update the status of each pilot strength report in the Status column on the CDMA MOBILE REPORTED PILOT STRENGTH screen.

HP-IB Example

"CDMA:MOBILE:PARM:ETDRop?"

queries the Expected T_Drop value calculated by the Test Set.

Operating Considerations

If there is a call connected with the Soft Handoff field **On** and the status of both pilot signals is Active, the mobile station should report *To Drop* (in the Status field) if it detects that one of pilot's signal strength has decreased to less than Expected T_Drop.

The value displayed in this field is calculated from the current T_Drop field and, if Soft Slope is not 0, the Drop Intcpt field. .

$$\text{ExpectedT}(\text{Drop}_A) = 2 \times \max \left(\frac{\text{SoftSlope}}{8} \times 10 \times \log \sum_{(j \in A) \cap (PS_j > PS_A)} PS_j + \frac{\text{DropIntercept}_s}{2}, \frac{-\text{TDrop}_s}{2} \right)$$

$$\text{ExpectedT}(\text{Drop}_B) = 2 \times \max \left(\frac{\text{SoftSlope}}{8} \times 10 \times \log \sum_{(j \in A) \cap (PS_j > PS_B)} PS_j + \frac{\text{DropIntercept}_s}{2}, \frac{-\text{TDrop}_s}{2} \right)$$

The table at the top of the CDMA MOBILE REPORTED PILOT STRENGTH screen can be cleared by selecting the **"Pilot Meas (Clear)" field on page 333**

See Also

[T_Add field description, on page 417](#)

[Drop Intcpt field description, on page 237](#)

[Soft Slope field description, on page 396](#)

[Softer Handoff field description, on page 397](#)

Screens Where Field is Present

CDMA MOBILE REPORTED PILOT STRENGTH

External Disk Specification

This field is used when storing and loading procedures on an external disk.

Operating Considerations

The HP-IB path entered in the **External Disk Specification** field is used by the **Select Procedure Location:** field on the TESTS (Main Menu) screen when **Disk** is selected.

Screens Where Field is Present

TESTS (External Devices)

External Reference

This field is used to select the reference frequency for the REF INPUT rear-panel connector. The CDMA Reference section of the Test Set will lock to this frequency, and all CDMA frame clocks will be derived from it.

Operating Considerations

The 10 MHz OVEN OUT is connected to the REF INPUT rear-panel connector when the Test Set is shipped from the factory.

If the entry in this field does not match the frequency of the reference frequency on the REF INPUT connector, the message “Reference unlocked, check reference connection and frequency” will be displayed.

See Also

["REF INPUT" on page 81](#)

["10 MHz OVEN OUT" on page 85](#)

Screens Where Field is Present

CONFIGURE

Ext Load R

External Load Resistance is used to calculate and display AF power. Power is calculated using the voltage measured at the AUDIO IN connections and the resistance value you enter into this field.

Operating Considerations

This field is not displayed when the **Audio In Lo** field is set to **600 To Hi**; the load resistance is internally fixed to 600 ohms.

See Also

[AC Level field description, on page 154](#)

[Audio In Lo field description, on page 169](#)

Screens Where Field is Present

AF ANALYZER
RX TEST

Ext TX Key

This field controls a switch at the MIC/ACC connector. Its intended use is to “key” an external transmitter.

See Also

["MIC/ACC" on page 76](#)

Screens Where Field is Present

ADJACENT CHANNEL POWER
DUPLEX TEST
RF ANALYZER
TX TEST

Fields That Begin with the Letter F

FER

This field displays the current frame error rate (FER) measured by the Test Set. A Service Option 2 (mobile station data loopback) call must be connected before running an FER test.

A measurement result will be displayed at the end of a test if Display Interim Results is **No**. (The **Passed**, **Failed**, or **Max Frames** annunciator will light when a test is done.) Measurement results will be displayed continuously, and queries will be returned based on interim results if Display Interim Results is **Yes**.

HP-IB Example

```
"DISP CRXT;MEASure:CDManalyzer:FERasure?"
```

queries the currently displayed FER measurement result.

Operating Considerations

To measure FER, the mobile station must be on a traffic channel and looping data back. The **Connected** and **Svc Opt 2** annunciators are lit when the mobile station is looping data back.

The CDMA Status Register provides status bits for the Passed, Failed, and Max Frames Test Status indicators.

See Also

[Meas Cnt1 field description, on page 292](#)

Screens Where Field is Present

CDMA CELLULAR MOBILE RECEIVER TEST

FER Report (Clear)

This field allows the user to clear the Errors Reported and Frames Reported fields on the CDMA MOBILE REPORTED FER screen.

HP-IB Example

```
"DISP CFER;CDMA:MOBILE:REPORT:CLEAR"
```

displays the CDMA MOBILE REPORTED FER screen and clears the Errors Reported and Frames Reported fields.

Screens Where Field is Present

CDMA MOBILE REPORTED FER

FER Spec

This field allows entry of the specified frame error rate (FER) the Test Set will apply Confidence interval testing to.

HP-IB Example

```
"DISP CRXT;MEASURE:CDMANALYZER:FERASURE:CONFIDENCE:LIMIT 0.5"
```

sets the confidence limit to 0.5% (0.005).

Operating Considerations

This field is only displayed when the **Confidence** field is on.

See Also

[Confidence field description, on page 208](#)

Screens Where Field is Present

CDMA CELLULAR MOBILE RECEIVER TEST

FF at End

This field can only be controlled programmatically. It is used to specify if you want a form feed at the end of printing.

Screens Where Field is Present

TESTS (Printer Setup)
PRINT CONFIGURE

FF at Start

This field can only be controlled programmatically. It is used to specify if you want a form feed at the start of printing.

Screens Where Field is Present

TESTS (Printer Setup)
PRINT CONFIGURE

Filter 1

This field selects one of several standard or optional audio frequency filters which can be used to condition the audio signal before being analyzed by the Audio Frequency Analyzer. See “[AF Analyzer](#)” in the HP-IB Command Syntax chapter of the *HP 8924C Condensed Programming Reference Guide* for programming command syntax.

Screens Where Field is Present

AF ANALYZER
ANALOG MEAS
DUPLEX TEST
RX TEST
TX TEST

Filter 2

This field selects one of several standard or optional audio frequency filters which can be used to condition the audio signal before being analyzed by the Audio Frequency Analyzer. See “[AF Analyzer](#)” in the HP-IB Command Syntax chapter of the *HP 8924C Condensed Programming Reference Guide* for programming command syntax.

Screens Where Field is Present

AF ANALYZER
ANALOG MEAS
DUPLEX TEST
RX TEST
TX TEST

Firmware

This field displays the current firmware revision for your Test Set. The revision number is automatically changed when updated firmware is installed.

Screens Where Field is Present

CONFIGURE

FM Coupling

This field alters the FM modulator to allow DCFM from internal and external modulation sources. This field also selects ac or dc coupling between the RF Generator's frequency modulator and the rear-panel MODULATION INPUT connector.

Operating Considerations

This field should be set to **DC** whenever the **AFGen2 To** field is set to **FM**; this provides better modulation response at low data rates.

Screens Where Field is Present

RX TEST
RF GENERATOR
DUPLEX TEST

FM Deviation

This is the default measurement for this field. The FM Deviation field displays the frequency deviation between the FM signal and the carrier. The FM Deviation measurement field is only displayed when the **AF An1 In** field is set to **FM Demod** or **FM Mod**.

See Also

[Atten Hold field description, on page 168](#)

[AF An1 In field description, on page 157](#)

Screens Where Field is Present

DUPLEX TEST
ANALOG MEAS
AF ANALYZER
RF ANALYZER
RF GENERATOR
TX TEST

FM Deviation

This field displays the measured FM deviation of the carrier being transmitted by the mobile station. Four dashes (----) indicate that no carrier is present to measure. See “[Measure](#)” in the HP-IB Command Syntax chapter of the *HP 8924C Condensed Programming Reference Guide* for programming command syntax.

A numeric value would only be displayed in the connected state (that is, the **Connected** annunciator is lit). The **FM Deviation** field is only displayed when the **Display** field is set to **Meas**.

Refer to the “[Display](#)” field on page 223 for information on how to read measurement results from this field.

When the **CALL CONTROL** screen is displayed, the Test Set’s instrumentation is configured for optimal performance of the signaling decoder. Two characteristics of the instrumentation which have a significant affect on the performance of the signaling decoder are: 1) audio frequency gain and 2) post detection filtering.

While the **CALL CONTROL** screen is displayed the audio frequency gain stages are fixed (that is, autoranging is tuned off). This is necessary to ensure that no signaling bursts are missed as a result of the audio gain stages autoranging in response to a burst of signaling data. Fixing the audio gain stages may result in a slight accuracy degradation for FM deviation measurements less than 7 kHz.

In addition, the post detection bandwidth is set at <20 Hz and >99 kHz in the Active, Register and Page states, and 300 Hz to 15 kHz when in the Connected state. This is done to ensure that no signaling tones are filtered off. This wide post detection bandwidth allows more noise to be introduced into the measurement process which affects the measured deviation.

Given these conditions it is recommended that FM deviation measurements requiring full Test Set FM deviation accuracy be made on the **ANALOG MEAS** screen or the **AF ANALYZER** screen. The audio frequency gains stages are set to autorange while on these screens and post detection filters can be selected to optimize deviation measurements.

Screens Where Field is Present

CALL CONTROL
ANALOG MEAS

Frame Clock

This field is used to select the CDMA frame clock output frequency on the rear-panel CDMA CLOCK MUX OUTPUT.

Operating Considerations

The CDMA frame clocks provide the CDMA timing references for generating and demodulating CDMA signals.

The CELLSITE/TRIGGERS connector, a rear-panel miniature D-type 15-pin connector provides all of the above frame clock outputs simultaneously. The timing of these frame clocks may be offset slightly from the timing of the CDMA CLOCK MUX OUTPUT's frame clocks due to propagation delays.

See Also

["CELL SITE/TRIGGERS" on page 69](#)

["CDMA CLOCK MUX OUTPUT" on page 71](#)

Screens Where Field is Present

CONFIGURE

Frames

This field indicates the number of frames counted during the reporting interval.

HP-IB Example

```
"DISP CMOB;CDMA:MOBILE:FERasure:ERRORS?"
```

queries the number of frames counted by the mobile station during an FER report interval.

Operating Considerations

The reporting interval is specified in terms of error count or frame count.

See Also

[by # errors field description, on page 185](#)

[by # frames field description, on page 186](#)

[MS FER Report Interval field description, on page 305](#)

Screens Where Field is Present

CDMA MOBILE REPORTING

Frames Counted

This field displays the number of frames tested during a FER measurement.

HP-IB Example

```
"DISP CRXT;MEASure:CDManalyzer:FERasure:FRAMES?"
```

queries the FER frames measurement result.

Operating Considerations

A measurement result will be displayed at the end of a test if **Display Interim Results** is **No**. Measurement results will be displayed continuously if **Display Interim Results** is **Yes**.

Screens Where Field is Present

CDMA CELLULAR MOBILE RECEIVER TEST

Freq (Channel Information)

Selecting this field displays the TESTS (Channel Information) screen.

Screens Where Field is Present

TESTS (Main Menu)

Freq Error

This field is displayed when Freq Error is selected from the list of choices available when the unnamed field displaying one of the following choices is displayed:

- frequency error
- amplitude error
- time offset measurement

HP-IB Example

```
"DISP CTXT;CDMA:RHO:MEAS:FERR `Freq Error`"
```

selects frequency error from the list of choices.

```
"DISP CTXT;MEASure:CDManalyzer:FREQ:ERRor?"
```

queries the CDMA frequency error measurement result.

Operating Considerations

These measurements, along with rho, phase error, and carrier feedthrough are made by DSP analysis techniques. The **Meas Cnt1** field controls these measurements.

Frequency error is referred to as ΔF .

See Also

[Meas Cnt1 field description, on page 292](#)

[Ampl Error field description, on page 165](#)

[Time Offset field description, on page 424](#)

Screens Where Field is Present

CDMA CELLULAR MOBILE TRANSMITTER TEST

Fields That Begin with the Letter G

Gain Cntl

AF Analyzer Gain Control specifies whether the AF Analyzer's gain settings are controlled automatically by AF autoranging (**Auto**), or by manual control (**Hold**).

The following settings are affected by AF autoranging:

- Input Gain
- De-Emp Gain
- Notch Gain

Operating Considerations

The normal mode of operation for the **Gain Cntl** field is **Auto**, allowing the instrument to adjust the AF gain settings for optimum measurement accuracy.

This field can be set to **Hold** to disable the autoranging routines to increase measurement speed. However, this requires you to select the desired gain settings manually for each measurement.

NOTE:

Decoder and Oscilloscope Interference: The AF autoranging function (**Auto**) takes a small amount of time to determine the attenuation settings for the AF Analyzer. If you are decoding an encoded signal, and your transmitter begins sending encoded information the instant it transmits, the initial encoded information may not be decoded during the autoranging process.

Use the **Auto** setting to establish the initial gain settings while the encoded signal is first being decoded, and then select **Hold** during the decoding process to retain the gain settings. The decoder should capture all encoded information the next time you transmit the signal.

Screens Where Field is Present

AF ANALYZER

(Gen)-(Anl)

This field is used with the **RF Offset** field to specify the amount of frequency offset between the RF Generator and RF Analyzer.

This field is not displayed when the **RF Display** field is set to **Chan** (the offset is automatically set when using channel tuning).

Screens Where Field is Present

CONFIGURE

Fields That Begin with the Letter H

Handoff

This field is used to initiate a handoff.

The voice channel number to hand the mobile station off to, the initial power level to use on the new voice channel and the SAT tone frequency to transpond on the new voice channel are specified using the **Chan:**, **Ch Loc:**, **Pwr Lvl:**, **DSAT:**, and **SAT:** fields under the **Voice Channel Assignment** section of the **CALL CONTROL** screen.

The :HANDoff command is used to control this field.

There is no query form of the :HANDoff command.

Syntax

:HANDoff

Example

```
OUTPUT 714; "CALLP:HAND"
```

Screens Where Field is Present

CALL CONTROL

Handoff

This field displays the choice of signaling events that will occur when the Execute field is selected.

- **Handoff** (CDMA to Analog Call Control or IS-95B hard handoff)

HP-IB Example

```
"DISP CCNT;CDMA:CALL:AHAN:[EXEC]"
```

executes a handoff.

Operating Considerations

When a protocol stack other than TIA/EIA-95B is selected in the System Type field, a CDMA to Analog handoff to the voice channel entered in the Channel field is performed when the Execute field is selected. A CDMA call must be connected to execute a CDMA to Analog handoff.

When TIA/EIA-95B is selected in the System Type field, a CDMA-to-CDMA (intersystem) handoff to the traffic channel entered in the Channel field is performed when the Execute field is selected. The traffic channel entered in the Channel field will use the channel standard selected from the Chan Std field. A CDMA call must be connected to execute a hard handoff.

Screens Where Field is Present

CDMA CALL CONTROL

Hard Handoff (annunciator)

This annunciator is lit when a change is made to the RF channel number while a call is connected. It remains lit until the Test Set acquires the new reverse traffic channel, or the call is terminated

HP-IB Example

```
"DISP CCNT;STATUS:CDMA:CONDition?"
```

queries the CDMA condition register. Bit 6 will be set when the Hard Handoff annunciator is lit.

Screens Where Field is Present

CDMA CALL CONTROL

HP-IB Adrs

This field is used to display and change the HP-IB address of the Test Set.

Operating Considerations

The address can be set from 0 to 30 by using the DATA keys, or by pushing and then turning the cursor-control knob.

This setting is retained when the instrument is turned off.

Screens Where Field is Present

I/O CONFIGURE

Fields That Begin with the Letter I

IBASIC Echo

This field enables/disables screen and error message echoing from IBASIC.

This setting is retained when the instrument is turned off.

Screens Where Field is Present

I/O CONFIGURE

IBASIC (IBASIC Cntrl)

Selecting this field displays the TESTS (IBASIC Controller) screen.

Screens Where Field is Present

TESTS (Main Menu)

Ideal Mobile Power

This field displays the power level that a mobile station on a call should be transmitting to the Test Set. The value displayed for Ideal Mobile Power should closely match the value for Average or Channel Power, providing the following conditions are met:

- The Average Power measurement is zeroed, if you are making an Average Power measurement.
- The Channel Power measurement is calibrated, if you are making a Channel Power measurement.
- The Power Control mode is Closed Loop.
- Path loss has been accounted for by turning on the RF Level Offset field.
- No additional signals, such as external interference, are being received by the mobile station.
- The noise figure of the mobile station receiver is 10 dB or greater.

Ideal Mobile Power is a calculated value based on equations found in the EIA/TIA standards, under "Estimated Open Loop Output Power".

HP-IB Example

```
"DISP CCNT;CDMA:MOB:POW:IDEA?"
```

queries the Ideal Mobile Power field.

Screens Where Field is Present

CDMA CALL CONTROL
CDMA TRANSMITTER POWER RANGE TEST

IF Filter

This field selects the desired IF filter bandwidth for modulated signals being analyzed.

Screens Where Field is Present

TX TEST
DUPLEX TEST
RF ANALYZER

If Unit-Under-Test Fails

This field selects what happens if the measured results do not meet criteria for passing the current test. The underlined entry is the active choice.

- **Continue** continues with testing even though a test in the test sequence fails to meet its test specification limits. When this occurs, an error is listed on the test-results print-out, is displayed on the CRT, or both.
- **Stop** stops the test when a failure occurs and requires operator intervention before testing proceeds.

Screens Where Field is Present

TESTS (Execution Conditions)

Init Power

This field allows entry of the initial power offset for system access (INIT_PWR).

HP-IB Example

```
"DISP CCON;CDMA:CELL:CONFigure:INITial:POWer 0"  
sets INIT_PWR to 0.
```

Operating Considerations

This field specifies a correction factor the mobile station adds to the estimated open-loop output power for setting the power level of the first (initial) access probe in an access probe sequence.

Screens Where Field is Present

CDMA CELL SITE CONFIGURATION

Input Att

Input Att sets the amount of input attenuation for the RF IN/OUT and ANT IN connectors. The Input Att field displays the present attenuation value, and it is used to set the desired attenuation level.

The :CRFAttenuator command is used to control this field.

The query form (that is, :CRFAttenuator?) can be used to query the current field value.

Syntax

```
:CRFAttenuator <'><0 dB/20 dB/40 dB><'>
```

```
:CRFAttenuator?
```

Example

```
OUTPUT 714;"CALLP:AMPS:CRFA `40 dB`"
```

```
OUTPUT 714;"CALLP:AMPS:CRFA?"
```

```
ENTER 714;Attenuator_set$
```

Operating Considerations

This is a priority control field. Accessing the CALL CONFIGURE screen overrides any changes made to this field in other screens. The other screens affected include the RF ANALYZER screen and the SPECTRUM ANALYZER screen.

Screens Where Field is Present

CALL CONTROL

CALL CONFIGURE

Input Atten

Input Attenuation sets the amount of input attenuation for the RF IN/OUT and ANT IN connectors. This function controls two settings:

- The upper field determines if you want the instrument to set the attenuation automatically (**Auto**), or if you want to set the value manually (**Hold**).
- The lower field displays the present attenuation value, and is used to set the desired attenuation level when the upper area is set to **Hold**.

NOTE: **Oscilloscope and Decoder Interference.** After a signal is input, the RF autoranging function (**Auto**) takes a small amount of time to determine the required input attenuator setting. If your transmitter begins sending encoded information the instant it transmits, the initial encoded information may not be decoded during the autoranging process. The same situation can arise when trying to display the first part of the demodulated signal on the Oscilloscope.

NOTE: When decoding a signaling sequence using the decoder, or when trying to capture the initial modulation waveform of a signal on the Oscilloscope, set the upper field to **Hold** and set the lower field to an appropriate level for the signal being decoded (start with 40 dB).

HP-IB Example

```
"DISP CSP;CSP:ATT:MODE 'HOLD' "
```

displays the CDMA REVERSE CHANNEL SPECTRUM screen and selects attenuator hold mode.

Operating Considerations

Input Attenuator autoranging can interfere with oscilloscope or signaling decoder operation under certain conditions. See ["Input Atten" on page 276](#) for additional information.

Maximum signal levels at each port are printed on the front panel.

This field is displayed on the spectrum analyzer when the **Controls** field is set to **Auxiliary**.

Setting the upper field to **Hold** prevents the RF autoranging process from interrupting Spectrum Analyzer operation when a signal is first measured. This can be helpful when you need to see the signal the instant the source is input, but requires you to set the needed amount of input attenuation.

Range of Values for Hold

- 0 dB
- 20 dB
- 40 dB

Screens Where Field is Present

ADJACENT CHANNEL POWER
CONFIGURE
RF ANALYZER
SPECTRUM ANALYZER
CDMA REVERSE CHANNEL SPECTRUM

Input Gain

This field displays and selects the gain of the AF Analyzer's input amplifier. Refer to the "[Gain Cntl](#)" field on page 269.

Screens Where Field is Present

AF ANALZYER

Input Port

This field is not displayed when the Test Set is configured to operate with an HP 83236B PCS Interface.

This field selects the RF IN/OUT or ANT IN port for making RF measurements.

Operating Considerations

Maximum power levels for each port are printed on the Test Set's front panel. If the RF power at the RF IN/OUT port exceeds allowable limits, a warning signal sounds and a message appears at the top of the screen. If this occurs, disconnect the RF power, press the MEAS RESET key, and allow the Test Set to cool off for approximately two minutes before making any other measurements on this port.

The ANT IN (antenna input) connector provides a highly-sensitive input for very low level signals (such as "off the air" measurements). You cannot measure TX (RF) Power, Average Power, Channel Power, or ACP Level on this screen using the ANT IN port.

CAUTION: Connecting a signal of >200 mW to the ANT IN port can cause instrument damage (although internal protection circuits can typically withstand a short-duration signal of 1 or 2 Watts).

If the overpower circuit is triggered (signified by a warning message at the top of the screen), remove the signal from the ANT IN port, and press the MEAS RESET key or turn the Test Set off and on to reset it.

See Also

[Sensitivity field description, on page 380](#)

RF In/Ant field description, on page 365

Screens Where Field is Present

ADJACENT CHANNEL POWER
CONFIGURE
DUPLEX TEST
RF ANALYZER
TX TEST

Insert Ch

This field allows you to enter a new channel in frequency table at the bottom of the screen.

Operating Considerations

You are required to specify if the test channel is a prime test channel. Prime test channels are the radio channels primarily used by the radio operator; they are the channels you are the most concerned about testing.

Use the **RX Chan Info** or **TX Chan Info** fields if the channel requires a tone code or frequency for testing radios that have CTCSS (Continuous Tone-Controlled Squelch System) squelch.

For example, if your radio uses a CTCSS tone of 91.5 Hz, you could enter the tone frequency in both RX and TX channel information fields as **CT FR91.5** or you could enter the tone code itself as **CT ZZ**.

When testing cellular radios, the Channel Information is the channel number you are testing (don't confuse this with the **Chan#** field used to list channels on this screen).

NOTE: Enter -1 in the **RX** and **TX** test frequency fields to have all subsequent channels ignored when testing is started.

Screens Where Field is Present

TESTS (Channel Information)

Insrt Ins

This field allows you to enter an instrument in the list at the bottom of the screen.

Use the knob, up-arrow, or down-arrow key to select the step where you want to insert an instrument.

Screens Where Field is Present

TESTS (External Devices)

Insrt Stp

This field allows you to enter a step in the test list at the bottom of the screen.

Operating Considerations

When inserting a new test, you must select the **step#** where you want to insert a new test. When inserted, the new test forces the current test (at that step #) down one step, and a duplicate of the current test is inserted. This duplicate is overwritten when the new test is selected.

Screens Where Field is Present

TESTS (Order of Tests, External Devices)

Inst Echo

This field enables/disables character and screen echoing when using an external ASCII RS-232 terminal or computer to enter or edit IBASIC programs.

This setting is retained when the instrument is turned off.

Screens Where Field is Present

I/O CONFIGURE

Inst#

The **Inst#** field lists the number of external devices that are configured for the tests in the current procedure.

Screens Where Field is Present

TESTS (Order of Tests)

Intensity

This field adjusts the screen intensity from a setting of 1 (very dim) to 8 (bright). If the setting is set too low, the screen can no longer be read. If you can't read the screen, and you don't know where the cursor is (or even what screen is displayed), press **PRESET**, and re-access the **CONFIGURE** screen. The cursor automatically goes to this field at that point. Press 8, **ENTER** to set the maximum intensity, and re-adjust if desired.

This setting is retained when the instrument is turned off.

Screens Where Field is Present

CONFIGURE

Internal

This field selects the trigger source.

- **Internal** uses the signal being displayed for triggering.
- **External** uses the rear-panel EXT SCOPE TRIGGER INPUT for triggering. This is a TTL level trigger (approximately 2.5 V).
- **ENCODER** uses the signaling encoder for triggering. The encoder must be sending its signal to trigger the oscilloscope.

Screens Where Field is Present

OSCILLOSCOPE

Fields That Begin with the Letter K

Keep

This column in the CDMA Mobile Reporting table lists the “Keep” pilot indicator bit from the Pilot Strength Message.

All numbers displayed in the CDMA Mobile Reporting table reflect the last pilot strength message received from a mobile station. A Pilot Strength Message is sent from the mobile station when a Softer Handoff is executed, ended, or when the mobile station detects a change in pilot levels that affects the assignment of pilots to the mobile station’s Active, Candidate, or Neighbor sets.

The CDMA Mobile Reporting table can be cleared by selecting the MS Report (Clear) field.

Operating Considerations

If the “Keep” bit is zero, the mobile station’s handoff drop timer for that pilot has expired. Otherwise, this bit will be a one.

HP-IB Example

```
"DISP CMOB;CDMA:MOB:PIL:STR?"
```

queries the results displayed in the CDMA Mobile Reporting table.

The value returned by the Test Set includes Status, PN Offset, Strength, and Keep for each pilot currently being tracked by the mobile station. These values are sent as a comma-separated list of IEEE floating point numbers, 16 characters each, ending with a line feed character.

NOTE:

If no values are displayed in the CDMA Mobile Reporting table, the query example shown above will return only the line feed character.

Programming Example for Keep Field

```
10 ! RE-STORE "C:\HPBASIC\READ_MRT"
20 CLEAR SCREEN
30 DIM Pil_str$(500)
40 OUTPUT 714;"CDMA:MOB:PIL:STR?"
50 ENTER 714;Pil_str$
60 Length=LEN(Pil_str$)
70 Num_pn=(Length+1) DIV 68 !Determine number of Pilots in the
table
80 FOR I=1 TO Num_pn
90 Stat(I)=VAL(Pil_str$[1;16])
100 PRINT "Pilot";I;"status is ";Stat(I)
110 Pnofst(I)=VAL(Pil_str$[18;16])
120 PRINT "Pilot";I;"PN Offset is";Pnofst(I)
130 Str(I)=VAL(Pil_str$[35;16])
140 PRINT "Pilot";I;"pilot strength is ";Str(I)
150 Keep(I)=VAL(Pil_str$[52;16])
160 PRINT "Pilot";I;"keep bit is ";Keep(I)
170 IF I<>Num_pn THEN
180 Pil_str$=Pil_str$[69,LEN(Pil_str$)] !Move to next Pilot in
the string
190 PRINT
200 END IF
210 NEXT I
220 END
```

Screens Where Field is Present

CDMA MOBILE REPORTING

Fields That Begin with the Letter L

Length

This field displays the total message length, in characters, of a SMS message multiplied by the number entered in the **Duplicate User Data** field.

HP-IB Example

"CDMA : SMS : TERM : DATA : LENG? "

queries the length of the current SMS message length.

Screens Where Field is Present

CDMA SHORT MESSAGE SERVICE

Level (div)

This control is divided into two fields:

The upper field (**0.00**) sets the *internal* trigger level as a function of vertical divisions. The trigger level is indicated by small pointers that appear on each side of the screen (only used for internal triggering).

The lower field (**Pos/Neg**) specifies whether triggering happens when the waveform being measured is positive-going (**Pos**), or negative-going (**Neg**).

Screens Where Field is Present

OSCILLOSCOPE

Library

This field displays the library information of the file chosen in the **Select Procedure Filename:** field.

Screens Where Field is Present

TESTS (Main Menu)

Lines/Page

This field is used to specify how many lines are printed per page.

Screens Where Field is Present

TESTS (Printer Setup)
PRINT CONFIGURE

Lower and Upper ACP [Ratio:Level]

These two measurements display the amount of power in signals above and below the **Tune Freq** signal. The level is displayed as a ratio (referenced to the power around the **Tune Freq**) or as an absolute value.

See Also

[ACP Meas field description, on page 155](#)

Screens Where Field is Present

ADJACENT CHANNEL POWER

Lower Limit

This field is used to set the lower limit to be compared with the measured results. If the measured result is below this limit, the test will fail.

Screens Where Field is Present

TESTS (Pass/Fail Limits)

Fields That Begin with the Letter M

Main Menu

Selecting this field returns you to the TESTS (Main Menu) screen.

Screens Where Field is Present

TESTS (Channel Information)
TESTS (Test Parameters)
TESTS (Order of Tests)
TESTS (Pass/Fail Limits)
TESTS (Save/Delete Procedures)
TESTS (Execution Conditions)
TESTS (External Devices)
TESTS (Printer Setup)
TESTS (IBASIC Controller)

Marker: Freq

Marker frequency displays the frequency at the marker's present position.

HP-IB Example

```
"DISP CSP;MEAS:CSP:MARK:FREQ?
```

queries the frequency at the marker's present position.

Operating Considerations

The marker can be positioned using the **Marker Pos** field.

Screens Where Field is Present

SPECTRUM ANALYZER
CDMA REVERSE CHANNEL SPECTRUM

Marker: Lvl

This measurement field displays the signal level of the current marker position.

HP-IB Example

```
"DISP CSP;MEAS:CSP:MARK:LEV?
```

queries the amplitude at the marker's present position.

Operating Considerations

The unit-of-measure for this field is dependent on the source of the signal being measured. For instance; when measuring a signal from the AUDIO IN connector, the amplitude is measured in Volts. When looking at a signal from the FM demodulator, the amplitude is given in units of kHz.

When the **vert Offset** field is $\neq 0.00$, the displayed marker level is referenced to the center line generated by the vertical offset feature, not the center line of the screen.

The REF SET function can be used with this measurement to display levels relative to a specific value.

The marker position can be adjusted using the **Marker Pos** field.

Screens Where Field is Present

OSCILLOSCOPE

SPECTRUM ANALYZER

CDMA REVERSE CHANNEL SPECTRUM

Marker Pos

This field is displayed when the **Controls** field is set to **Marker**. This field sets the marker's position, referenced to the left side of the display.

HP-IB Example

```
"DISP CSP;CSP:MARKer:POSition 5.0"
```

positions the marker in the center of the display.

Operating Considerations

The position is settable in units of divisions.

Screens Where Field is Present

CDMA REVERSE CHANNEL SPECTRUM

Marker: Time

This measurement displays the time elapsed from the trigger point to the current marker position.

The REF SET function can be used with this measurement to display time relative to a specific position.

Screens Where Field is Present

OSCILLOSCOPE

Marker To:

Peak+ causes the marker to move to the maximum value of the *average* level measured on the display.

Peak- causes the marker to move to the minimum value of the *average* level measured on the display.

Because these functions look at the average value for each displayed pixel, the marker may not appear directly on the displayed peak of a noisy signal.

Screens Where Field is Present

OSCILLOSCOPE

Marker To:

This field is displayed when the **Controls** field is set to **Marker**.

- **Peak** moves the marker to the highest peak and enters the location in the **Position** field.

HP-IB Example

```
"DISP CSP;CSP:MARKer:PEAK"
```

- **Next Peak** moves the marker to the next peak to the right and enters the location in the **Position** field.

HP-IB Example

```
"DISP CSP;CSP:MARKer:NPEAK"
```

- **Center Freq** changes the center frequency value to match the current position of the marker. (Center Freq is not available in the CDMA reverse channel spectrum.)
- **Ref Level** changes the reference level setting to match the current position of the marker.

HP-IB Example

```
"DISP CSP;CSP:MARKer:RLEV"
```

Screens Where Field is Present

SPECTRUM ANALYZER
CDMA REVERSE CHANNEL SPECTRUM

Max Frames

This field sets the maximum frame count for each FER test.

HP-IB Example

```
"DISP CRXT;MEASure:CDManalyzer:FERasure:MAXimum:FRAMES 1000"
```

sets the maximum number of frames for FER measurements to 1000.

Operating Considerations

FER measurements will be made on the number of frames entered in this field unless the test terminates because a confidence limit is reached.

Range of values: 25 through 10000000

See Also

[Confidence field description, on page 208](#)

Screens Where Field is Present

CDMA CELLULAR MOBILE RECEIVER TEST

Max Power

The value shown under the Max Power label in the upper left portion of the display is the maximum power measurement result obtained the last time a Min/Max Power measurement was executed.

HP-IB Example

```
"DISP CTRX;MEASure:CDManalyzer:MMPower:[EXECute]"
```

executes a Min/Max Power measurement.

```
"DISP CCNT;CDMA:MOBILE:POWER:MAXimum?"
```

queries the Max Power measurement value.

Operating Considerations

While a mobile station is on a call, the mobile station's range of power levels can be obtained by selecting the Execute field under the Min/Max Pwr label. Before Min/Max Power is executed, make sure that the Average Power measurement is zeroed, and the Channel Power measurement is calibrated. (Refer to "Calibrating the Test Set" chapter in the *HP 8924C Application Guide*, if you do not know how to zero Average Power measurements and calibrate Channel Power measurements).

The Test Set will measure the mobile station's minimum power first. Using a procedure that closely follows the EIA/TIA IS-98 test "Minimum Controlled Output Power", the Test Set sets Sector A power to -3535 dBm/BW and Traffic E_c/I_{or} to -7.4, then sends "Always Down" power control bits to drive the mobile station to its minimum power level. A Channel Power measurement is made, and the Test Set is returned to closed loop power control mode.

Then, to measure maximum power, the Test Set sets Sector A power to -104 dBm/BW, turns the Call Drop Timer "Off", and sends "Always Up" power control bits to the mobile station, using a procedure similar to the EIA/TIA IS-98 test "Maximum RF Output Power". An Average Power measurement is made, and the Test Set is returned to closed loop power control mode.

See Also

[Min/Max Pwr field description, on page 296](#)

[Min Power field description, on page 294](#)

Screens Where Field is Present

CDMA TRANSMITTER POWER RANGE TEST

Max Req Seq, Max Rsp Seq

This field allows simultaneous entry of the maximum number of access probe sequences for an access channel request and the maximum number of access probe sequences for an access channel response (MAX_REQ_SEQ or MAX_RSP_SEQ). These are separate parameters in the CDMA specification but the Test Set sets both parameters to a single value.

HP-IB Example

```
"DISP CCON;CDMA:CELL:CONFigure:MAXReqrspseq 3"
```

sets both parameters to 3.

Operating Considerations

This field indicates the maximum number of access probe sequences sent by the mobile when the mobile is requesting service (Max Req Seq) or when the mobile has been paged (Max Rsp Seq). If the **Call Limit** field on the CDMA Call Site Configuration screen is set to "Page", the mobile station will transmit the number of access probe sequences entered in this field.

Screens Where Field is Present

CDMA CELL SITE CONFIGURATION

Max Slot Cycle Index

Max Slot Cycle Index allows you to set the slot cycle used by the HP 8924 to page a mobile station. It is set by integer values, which correspond to time using the following formula: $T = 1.28 \times 2^i$ seconds, where i has integer values from 0 to 7 (0 is default).

NOTE: When $i = 7$, the value is quite large at 163.84 seconds. You may not want to wait this long during normal testing.

HP-IB Example

```
"CDMA:CELL:CONFigure:MSCindex 1"
```

sets the cycle to 2.56 seconds.

Screens Where Field is Present

CDMA CELL CONFIGURE

Meas Cntl

This field allows the selection of either single or continuous measurements.

- **Single** causes a measurement to be made each time the **Arm** field is selected.
- **Cont** causes measurements to re-arm automatically until **Single** is selected or the call is terminated.

HP-IB Example

```
"DISP CRXT;TRIGger:MODE:RETRigger SINGle"
```

sets the measurement mode to single.

Operating Considerations

During remote operation, the default measurement-control setting is continuous. The displayed mode (Single or Cont) only applies to local (front-panel) operation. This field does not update when the Test Set is operated remotely.

During manual operation, the default measurement-control setting is single.

See Also

["Measurement Triggering Process"](#) in the Operating Overview chapter of the *HP 8924C User's Guide*

Screens Where Field is Present

CDMA CELLULAR MOBILE RECEIVER TEST
CDMA CELLULAR MOBILE TRANSMITTER TEST

Message Data Mode

This field is selects either ASCII or Hex data for the SMS message.

See Also

["Enter ASCII Data" field on page 246](#)

["Enter Hex Data" field on page 246](#)

Screens Where Field is Present

CDMA SHORT MESSAGE SERVICE

Mic Pre-Emp

Microphone pre-emphasis determines whether the modulating signal from the MIC/ACC connector goes through or bypasses the 750 ms pre-emphasis network. Two fields are used:

- The upper field is used to specify whether you want the instrument to automatically turn pre-emphasis on during FM operation and off for other modulations (**Auto**), or to leave the pre-emphasis switching to the user's operation (**Hold**).
- The lower field tells you whether pre-emphasis is on or off (when **Auto** operation is selected), or allows you to manually turn pre-emphasis on or off (if **Hold** is selected).

Screens Where Field is Present

RF GENERATOR

Min Power

The value shown under the Min Power label in the upper left portion of the display is the minimum power measurement result obtained the last time a Min/Max Power measurement was executed.

HP-IB Example

```
"DISP CTXR;MEASure:CDManalyzer:MMPower:[EXECute]"
```

executes a Min/Max Power measurement.

```
"DISP CCNT;CDMA:MOBile:POWer:MINimum?"
```

queries the Min Power measurement value.

Operating Considerations

While a mobile station is on a call, the mobile station's range of power levels can be obtained by selecting the Execute field under the Min/Max Pwr label. Before Min/Max Power is executed, make sure that the Average Power measurement is zeroed, and the Channel Power measurement is calibrated. (Refer to ["Calibrating the Test Set"](#) chapter in the *HP 8924C Application Guide*, if you do not know how to zero Average Power measurements and calibrate Channel Power measurements).

The Test Set will measure the mobile station's minimum power first. Using a procedure that closely follows the EIA/TIA IS-98 test "Minimum Controlled Output Power", the Test Set sets Sector A power to -3535 dBm/BW and Traffic E_c/I_{or} to -7.4, then sends "Always Down" power control bits to drive the mobile station to its minimum power level. A Channel Power measurement is made, and the Test Set is returned to closed loop power control mode.

Then, to measure maximum power, the Test Set sets Sector A power to -104 dBm/BW, turns the Call Drop Timer "Off", and sends "Always Up" power control bits to the mobile station, using a procedure similar to the EIA/TIA IS-98 test "Maximum RF Output Power". An Average Power measurement is made, and the Test Set is returned to closed loop power control mode.

See Also

[Min/Max Pwr field description, on page 296](#)

[Max Power field description, on page 290](#)

Screens Where Field is Present

CDMA TRANSMITTER POWER RANGE TEST

Min Inp Lvl

This field provides faster analog TX power measurements when -5.0 dBm or 0.0 dBm is selected from the list of choices. To use this field, determine the lowest (minimum) power level that you expect at the RF Input to the Test Set or PCS Interface. Then, choose the highest value from the list of choices that your signal input is expected to stay above.

- **-10 dBm** - This is the default value. When this choice is selected, the signal at the RF Input is not expected to drop below -10 dBm.
- **-5 dBm** - When this choice is selected, the RF Input is not expected to drop below -5 dBm.
- **0.0 dBm** - When this choice is selected, the RF Input is not expected to drop below 0 dBm.

HP-IB Example

```
"DISP RFAN;RFAN:PMEasurement:MIlevel `0.0 dBm`"
```

selects 0.0 dBm as the Minimum Input Level.

Operating Considerations

When Minimum Input Level is adjusted to accommodate a higher power signal, the Test Set reduces the number of samples taken to calculate average power. The time savings are approximately half for each corresponding increase in Minimum Input Level.

If the signal drops below the specified Minimum Input Level, the Test Set will make the measurement without displaying any error message or error code. During these measurements, however, the accuracy and repeatability of the power measurement may be adversely affected.

Screens Where Field is Present

RF ANALYZER
TX TEST
ANALOG MEAS

Min/Max Pwr

This field allows execution of mobile station minimum and maximum power measurements.

HP-IB Example

```
"DISP CTXR;MEASure:CDManalyzer:MMPower:[EXECute]"
```

causes the Test Set to execute a Min/Max Power measurement.

Operating Considerations

While a mobile station is on a call, the mobile station's range of power levels can be obtained by selecting the Execute field under the Min/Max Pwr label. Before Min/Max Power is executed, make sure that the Average Power measurement is zeroed, and the Channel Power measurement is calibrated. (Refer to ["Calibrating the Test Set"](#) chapter in the *HP 8924C Application Guide*, if you do not know how to zero Average Power measurements and calibrate Channel Power measurements).

The Test Set will measure the mobile station's minimum power first. Using a procedure that closely follows the EIA/TIA IS-98 test "Minimum Controlled Output Power", the Test Set sets Sector A power to -35 dBm/BW and Traffic E_c/I_{or} to -7.4, then sends "Always Down" power control bits to drive the mobile station to its minimum power level. A Channel Power measurement is made, and the Test Set is returned to closed loop power control mode.

Then, to measure maximum power, the Test Set sets Sector A power to -104 dBm/BW, turns the Call Drop Timer "Off", and sends "Always Up" power control bits to the mobile station, using a procedure similar to the EIA/TIA IS-98 test "Maximum RF Output Power". An Average Power measurement is made, and the Test Set is returned to closed loop power control mode.

See Also

[Max Power field description, on page 290](#)

[Min Power field description, on page 294](#)

Screens Where Field is Present

CDMA TRANSMITTER POWER RANGE TEST

Mobile Parm

These fields allow entry or display of a mobile station parameter's identifier or a parameter's value.

- MUX1_REV_1 through MUX1_REV_14
- MUX2_REV_1 through MUX2_REV_25 (TSB-74 and J-STD-008 only)
- MUX1_FOR_1 through MUX1_FOR_14
- MUX2_FOR_1 through MUX2_FOR_26 (TSB-74 and J-STD-008 only)
- PAG_1 through PAG_7
- ACC_1 through ACC_8
- LAYER2_RTC1 through LAYER2_RTC5
- SYS_TIME

HP-IB Example

```
"DISP CMOB;CDMA:MOBILE:PARAM 'MUX1_REV_1' "
```

identifies the mobile station parameter MUX1_REV_1.

```
"DISP CMOB;CDMA:MOBILE:PARAM:VALUE 0"
```

sets the mobile station's MUX1_REV_1 parameter value to 0.

Operating Considerations

This field allows selection of a mobile station Parameter Identifier, and displays the value of the selected parameter. If a call is connected and a value is entered, an attempt will be made to write this value into the corresponding register in the mobile station. This field is only valid for mobile stations that conform to the EIA/TIA IS-95-A standard.

Screens Where Field is Present

CDMA MOBILE REPORTING

Mobile Power Mode

This field allows selection between two CDMA Channel Power measurement modes, providing for Channel Power measurements without a call connected. The choices available are:

- Normal (call connected)
- User (requires user to enter mobile power into Mobile Pwr field)

When “User” is selected, the Mobile Pwr field is displayed below it. When the Mobile Pwr field is displayed, the Test Set requires the expected mobile power level to be entered in the Mobile Pwr field for Channel Power measurements.

HP-IB Example

```
"DISP CTXR;CDMA:MOBile:POWer:MODE `User`;MPOWer 0"
```

selects CDMA power measurements without a call connected, and enters an estimated mobile power level of 0 dBm.

Operating Considerations

When this field is set to “User”, the Test Set’s normal autoranging capabilities are disabled. If a call is connected, the Test Set will attempt to drive the mobile station’s power level to the value entered in the Mobile Pwr field, instead of using the open loop law (mobile station power = -73 dBm + forward channel power).

If a call is not connected, the Test Set relies on the entry in the Mobile Pwr field matching the actual mobile station power level to set up analyzer path attenuation correctly. The value entered must be within 3 dB of the actual power level.

See Also

[Mobile Pwr field description, on page 299](#)

Screens Where Field is Present

CDMA TRANSMITTER POWER RANGE TEST

Mobile Pwr

This field is displayed when the Mobile Power Mode field is set to “User”. When this field is displayed, the Test Set requires an estimated mobile station power level to make CDMA Channel Power measurements.

HP-IB Example

```
"DISP CTR;CDMA:MOBILE:POWER:MODE 'User';MPOWER 0"
```

selects CDMA power measurements without a call connected, and enters an estimated mobile power level of 0 dBm.

Operating Considerations

The Test Set uses the value entered in this field to set up analyzer path attenuation.

See Also

[Mobile Power Mode field description, on page 298](#)

Screens Where Field is Present

CDMA TRANSMITTER POWER RANGE TEST

Mode

This field sets the HP-IB operating mode. **Talk&Lstn** is used for “normal” HP-IB operation. **Control** is used to control external instruments using the Test Set.

This setting is retained when the instrument is turned off.

Screens Where Field is Present

I/O CONFIGURE

Model

This field is used to enter the instrument’s model number. There is no specific syntax for entering model numbers into this field.

Screens Where Field is Present

TESTS (External Devices)

Model:

This field is used to specify the type of printer used. If your printer is not listed in the **Choices** menu when you select this field, configure your printer to emulate one of those that is listed.

Screens Where Field is Present

TESTS (Printer Setup)
PRINT CONFIGURE

Mod In To

This modulation input field defines how an external modulation source is used with the RF Generator. Two fields are used:

- The upper field determines whether the rear-panel MODULATION INPUT signal is set for AM or FM modulation of the RF GENERATOR.
- The lower field sets the modulation sensitivity. For instance, if **FM (/Vpk)** is selected for the upper field, and you set the lower field to **1.0000 kHz**, the RF Generator will deviate 1 kHz for every 1 Volt peak at the MODULATION INPUT connector.

In addition, the peak deviation produced by MIC signals will be approximately 1 kHz.

Screens Where Field is Present

RF GENERATOR

MS Ack Cause Code:

This field displays the value of the cause code if the mobile station sent one.

HP-IB Example

```
"CDMA : SMS : TERM : DATA : CCOD : VAL? "
```

queries the MS Ack Cause Code field. An integer value is returned, or an integer value of -1 is returned if no value is present.

```
"CDMA : SMS : TERM : DATA : CCOD : DESC? "
```

queries the MS Ack Cause Code field. A text string description of the MS Ack Cause Code is returned.

Operating Considerations

The MS Ack Cause Code field displays an integer, and the integer represents one of the following text messages.

Table 13

Integer Value Displayed in MS Ack Cause Code Field	Text Message
no value displayed	blank field
32	No page response
33	Destination busy
34	No acknowledgment
35	Destination resource shortage
36	SMS delivery postponed
37	Destination out of service
38	Destination not at this address
39	Other terminal problem
96	Encoding problem
97	SMS origination denied
98	SMS termination denied
99	Service not supported
100	SMS not supported
102	Missing expected parameter
103	Missing mandatory parameter
104	Unrecognized parameter value
15	Unexpected parameter value
106	User Data size error
107	Other general problems

Screens Where Field is Present

CDMA SHORT MESSAGE SERVICE

MS Ack Received (annunciator)

If the mobile station successfully receives the SMS message, it sends an SMS received acknowledgment to the Test Set, lighting the **MS Ack Received** annunciator.

HP-IB Example

```
"STAT:CSMS:EVEN?"
```

queries the CDMA SMS Status Register Event Register. A BCD value of 2 is assigned to the MS Ack Received status bit.

Operating Considerations

When the SMS message acknowledgment is received by the Test Set, the **SMS In Progress** annunciator will go out. See "[SMS In Progress \(annunciator\)" field on page 394](#)

See Also

CDMA SMS Status Register Group Bit Assignments in the *HP 8924C Users Guide*, *Status Reporting* section.

Screens Where Annunciator is Present

CDMA SHORT MESSAGE SERVICE

MS Database

This field displays information obtained from the mobile station during registration. Depending on the settings of the **Protocol** field and the **RF Channel std** field, some combination of the following modes are available, with **ESN** as the default.

- **ESN** - Electronic Serial Number, a permanent, physical attribute of the mobile station.
- **MCC** - Mobile Country Code - displayed when IS-95A or J-STD-008 is selected in the "**Protocol**" field on page 344.
- **MNC** - Mobile Network Code - displayed when IS-95A or J-STD-008 is selected in the "**Protocol**" field on page 344.
- **MSIN** - Mobile Station Identification Number - displayed when IS-95A or J-STD-008 is selected in the "**Protocol**" field on page 344.
- **MIN1** - Part of the Mobile Identification number, a permanent NAM value - displayed when IS-95 is selected in the "**Protocol**" field on page 344.
- **MIN2** - Part of the Mobile Identification number, a permanent NAM value - displayed when IS-95 is selected in the "**Protocol**" field on page 344.
- **Dual Mode** - Returns status of - displayed when IS-95 is selected in the "**Protocol**" field on page 344.
- **Phone Num** - The 10-digit directory telephone number.
- **Dual Mode** - Part of the mobile stations' SCM, a permanent, physical attribute of the mobile station.
- **Pwr Class** - Part of the mobile stations' SCM, a permanent, physical attribute of the mobile station
- **Band Class** - When TIA/EIA-95 B is selected in the Protocol field, this field displays BAND_CLASS_INFO. Bits that are set are displayed in MS Database as comma-separated numeric character string (e.g. If BAND_CLASS_0 and If BAND_CLASS_1 are set, the displayed string will be 0,1).
- **Tx Mode** - Part of the mobile stations' SCM, a permanent, physical attribute of the mobile station
- **C Max EIRP** - Cellular (band class 0, 2, or 3) MAX_EIRP expressed in dBW (MAX_EIRP -60). Values range from 0 to 255. Displayed when TIA/EIA-95B is selected in the "**Protocol**" field on page 344.
- **P Max EIRP** - PCS (band class 1 or 4) MAX_EIRP expressed in dBW (MAX_EIRP -60). Displayed when TIA/EIA-95B is selected in the "**Protocol**" field on page 344.
- **C Op Modes**- Cellular (band class 0, 2, or 3) OP_MODE_INFO. Bits that are set are displayed in MS Database as comma-separated numeric character string (e.g. If OP_MODE0 and OP_MODE1 are set, the displayed string will be 0,1). Displayed when TIA/EIA-95B is selected in the "**Protocol**" field on page 344.
- **P Op Modes**- PCS (band class 1 or 4) OP_MODE_INFO. Bits that are set are displayed in MS Database as comma-separated numeric character string (e.g. If OP_MODE0 and OP_MODE1 are set, the displayed string will be 0,1). Displayed when TIA/EIA-95B is selected in the "**Protocol**" field on page 344.

- **Pwr Step** - MIN_PWR_CNTL_STEP. Minimum closed loop power control step size supported by mobile station. Possible values are: 1 dB, 0.5 dB, or 0.25 dB (message parameters 0, 1, 2 respectively). Displayed when TIA/EIA-95B is selected in the **"Protocol" field on page 344**
- **Called Num** - The number dialed on the mobile station handset during the last mobile station originated call.
- ***Clr All*** - Selecting this Choice clears all MSDatabase values, allowing verification that information currently displayed is not from a previous registration.

HP-IB Example

```
"DISP CCNT;CDMA:MOBILE:DAT `ESN`;:CDMA:MOBILE:DAT:VALue?"
```

sets the desired indicator to "ESN" and returns the 4-digit value for ESN.

Operating Considerations

These indicators are updated each time a mobile registration occurs.

The database is cleared whenever the protocol is changed. (See **"Protocol" field on page 344** for more information about changing protocol.)

Screens Where Field is Present

CDMA CALL CONTROL
CDMA SHORT MESSAGE SERVICE
CDMA AUTHENTICATION

MS FER

This field displays the mobile station's reported FER (frame error rate). The number displayed is a ratio of bad frames to total frames.

The mobile station can be commanded through the Test Set to change its periodic FER reporting intervals through the **MS FER Report Interval** field.

HP-IB Example

```
"DISP CMOB;CDMA:MOBILE:FER?"
```

returns integer value of mobile station reported FER percentage.

See Also

MS FER Report Interval field description, on page 305
by # **errors** field description, on page 185
by # **frames** field description, on page 186

Screens Where Field is Present

CDMA MOBILE REPORTING

MS FER Report Interval

This field sets the number of frames the mobile station will count before reporting frame error rate (FER) when the **by # frames** field is **On**.

HP-IB Example

```
"DISP CCNT;CDMA:MOBILE:FERasure:REPort:INTerval '160 FRAMES'"
```

sets the mobile station's FER report interval to 160 frames.

Operating Considerations

This setting may affect FER measurement speed and will affect the display rate of the **MS FER Report** field.

Screens Where Field is Present

CDMA MOBILE REPORTING

MS Id

This field is used to enter the identification number of the mobile station. The **MS Id** field has two fields. The content of the lower field is automatically updated upon successful completion of a mobile station registration.

The upper field is a one-of-many selection field and is used to select the format for entering the identification number. The **:NMODE** command is used to set the upper field. Two formats are available: **Phone Num** for entering a 10 digit phone number or **MIN2 MIN1** for entering the mobile identification number.

The lower field is a numeric entry field and is used to enter the identification number in the format selected using the upper field.

There are two formats which can be used to enter the identification number in the lower field.

- The identification number can be entered as the 10 digit phone number in decimal (i.e. 5095551212). The **:PNUMBER** command is used to enter the 10 digit phone number.
- The identification number can be entered as the mobile identification number (MIN) in hexadecimal (i.e. AAABBBBB). The MIN number is entered as the 3 character MIN2 (AAA) followed by the 6 character MIN1 (BBBBBB). The **:MINumber** command is used to enter the MIN number.

The formats are coupled, that is, if the **Phone Num** format is selected and the 10 digit phone number is entered, the **MIN2 MIN1** information is automatically updated, and vice versa.

NOTE: The preset values for the **MS Id** fields are:

- **Phone Num** = 1111111111
- **MIN2 MIN1** = 000000400

An all zero MIN number (000000000), which does not represent a valid phone number, will convert to the following phone number: 111111?111.

The query form of the programming commands (that is, the ? form) can be used to interrogate the contents of each field.

Syntax for MS Id Field

```
:NMODE <'><PHONE NUM/MIN2 MIN1><'>
:NMODE?
:PNUMBER <'><10 character phone number><'>
:PNUMBER?
:MINUMBER <'><3 character MIN2 + 6 character MIN1><'>
:MINUMBER?
```

Example

```
OUTPUT 714;"CALLP:NMOD 'PHONE NUM' "
OUTPUT 714;"CALLP:PNUM '5099906092' "
OUTPUT 714;"CALLP:NMOD 'MIN' "
OUTPUT 714;"CALLP:MIN '1F2DE5BD5' "
OUTPUT 714;"CALLP:NMOD?"
ENTER 714;Number_mode$
```

Screens Where Field is Present

CALL CONTROL

MS ID

The **MS ID** field determines how the Test Set identifies a mobile station for paging. Depending on the Protocol field choice, some combination of the following modes are available, with **Auto** as the default.

- **Auto** - The Test Set will obtain the mobile station's identification through mobile station registration, either at mobile station power-on or when the Register field is selected.
- **Phone Num** - Allows entry of a 10-digit phone number that identifies the mobile station, overriding any value for phone number that the test set may have obtained during mobile station power-on registration. *The mobile station must be NON-SLOTTED to use this MS ID mode.* This choice is displayed when IS-95 is selected in the "**Protocol**" field on page 344.
- **MIN** - Allows entry of MIN, a 9-digit hexadecimal string normally derived from the phone number, overriding any value for MIN that the test set may have obtained during mobile station power-up registration. *The mobile station must be NON-SLOTTED to use this MS ID mode.* This choice is displayed when IS-95 is selected in the "**Protocol**" field on page 344.
- **IMSI** - Allows entry of IMSI, consisting of MCC, MNC, and MSIN. This choice is displayed when IS-95A, TSB-74, KorPCS, ARIB T53, or J-STD-008 is selected in the "**Protocol**" field on page 344.

HP-IB Examples

```
"DISP CCNT;CDMA:MOBILE:MSID 'AUTO' "
```

selects "automatic" entry of the mobile station's MIN and Phone Number through registration.

```
"DISP CCNT;CDMA:MOBILE:MSID 'Phone Num' "
```

enters a mode whereby the Test Set uses the Phone Number number entered by the user, and ignores phone numbers obtained during registration.

```
"DISP CCNT;CDMA:MOBILE:MSID 'MIN' "
```

enters a mode whereby the Test Set uses the MIN number entered by the user, and ignores MIN numbers obtained during registration.

```
"DISP CCNT;CDMA:MOBILE:MIN '56789ABCD' "
```

enters the mobile station's MIN number.

```
"DISP CCNT;CDMA:MOBILE:PHONE:NUMBER '1509922075' "
```

enters the mobile station's phone number.

Operating Considerations for MS ID Field

When a registration occurs, the **MS Database** field is updated with values from the mobile station that is currently under test. The **MS Database** field provides a feature at the end of its list of choices called *Clr All*. This feature clears the contents of this data base. If you are using MS ID Auto mode, clear the **MS Database** before connecting the mobile station to the Test Set. Then, when the **MS Database** gets updated you will know that the MS ID Auto mode has the identification of the mobile station currently under test, and you can make a call.

If the **Phone Num**, **MIN**, or **IMSI** field is selected, the Test Set will use the number currently entered in the selected field for page attempts. *This mode disallows use of a mobile station under test's identification obtained through registration. If an incorrect Phone Num or MIN is entered in these fields, and Auto mode is not selected, attempts to make a call will be unsuccessful. MSIN, MCC, MNC and Max Slot Cycle Index are required to bring up a call.*

See Also

[Register \(CDMA\) field description, on page 357](#)
[MS Database field description, on page 303](#)

Screens Where Field is Present

CDMA CALL CONTROL

MS Report (Clear)

The **MS Report (Clear)** field clears the contents of the CDMA Mobile Reporting table.

HP-IB Examples

```
"DISP CMOB;CDMA:MOBILE:REPORT:CLEAR"
```

clears the contents of the CDMA Mobile Reporting table.

Operating Considerations

All numbers displayed in the CDMA Mobile Reporting table reflect the last pilot strength message received from a mobile station. A Pilot Strength Message is sent from the mobile station when a Softer Handoff is executed, ended, or when the mobile station detects a change in pilot levels that affects the assignment of pilots to the mobile station's Active, Candidate, or Neighbor sets. Use MS Report (Clear) to ensure that the currently displayed CDMA Mobile Reporting table

See Also

[Keep field description, on page 281](#)

[PN Offset field description, on page 334](#)

[Status field description, on page 408](#)

[Strength field description, on page 412](#)

Screens Where Field is Present

CDMA MOBILE REPORTING

Fields That Begin with the Letter N

Network ID

This field allows entry of the cell site's network identification (NID).

HP-IB Example

```
"DISP CCON;CDMA:CELL:CONFigure:NID 0"
```

sets the network identification of the simulated CDMA cell site to 0.

Operating Considerations

The mobile station stores the NID number it receives from the cell site and compares it with its home NID to determine if it is roaming.

Screens Where Field is Present

CDMA CELL SITE CONFIGURATION

Network Code

This field is displayed when the field called "**Protocol**" on page 344 has IS-95A, TSB-74, or J-STD-008 selected, and the Esc Mode field is set to Off.

This field sets the base station's network code.

HP-IB Syntax

```
"CDMA:CELL:CONF:BNC 2"
```

sets the base station's network code to 2.

Operating Considerations

The Test Set sends the base station network code in the IMSI_11_12 field of the Extended System Parameters Message.

See Also

[Protocol field description, on page 344](#)

Screens Where Field is Present

CDMA CELL SITE CONFIGURATION

Nom Power

This field allows entry of the nominal transmit power offset (NOM_PWR).

HP-IB Example

```
"DISP CCON;CDMA:CELL:CONFigure:NOMinal:POWer 0"  
sets NOM_PWR to 0.
```

Operating Considerations

Nom Power is an adjustment to the mobile station's open loop power level. The mobile station obtains this value prior to transmitting, as part of the *Access Parameters Message*.

Screens Where Field is Present

CDMA CELL SITE CONFIGURATION

Nom Pwr Ext

This field allows entry of the extended nominal transmit power (NOM_PWR_EXT). This field is displayed only when the field "**Protocol**" on [page 344](#) is set to **J-STD-008** or **TIA/EIA-95B**.

HP-IB Example

```
"CDMA:CELL:CONFigure:NOMinal:POWer:EXT 0"  
sets NOM_PWR_EXT to 0.
```

Operating Considerations

Entering a 0 in this field sets the range of the open loop power control correction factor from -8 dB to 7 dB inclusive. Entering a 1 extends the correction factor from -24 to -9 dB inclusive. The mobile station obtains this value prior to transmitting, as part of the *Access Parameters Message*.

Screens Where Field is Present

CDMA CELL SITE CONFIGURATION

No Pk/Avg

This field is displayed when the **Controls** field is set to **Auxiliary**. This field performs two functions: peak hold, and video averaging.

Pk Hold (peak hold) prevents the Spectrum Analyzer from erasing the previous trace each time it sweeps. This causes the traces to ‘build-up’ on the screen until **Off**, **No Pk/Avg** or the MEAS RESET key is selected. This allows the capture of transient signals that are not displayed long enough to view during normal operation.

Avg 1 through **Avg 100** (video averaging) enables the Spectrum Analyzer to display a trace representing the average of several measurements. The number of samples used for measurement averaging range from 1 to 100 (see below). **No Pk/Avg** and **Off** function identically. **Off** is provided to maintain backwards compatibility with earlier firmware and software.

- **No Pk/Avg** means that peak hold and video averaging are off.

HP-IB Example

```
"DISP CSP;CSP:TRACE:MHOLD 'No Pk/Avg' "
```

- **Pk Hold** means that peak hold is on.

HP-IB Example

```
"DISP CSP;CSP:TRACE:MHOLD 'Pk Hold' "
```

- **Avg [n]** enables video averaging over [n] measurements, where n = 1, 2, 3, 4, 5, 10, 20, 50, or 100

HP-IB Example

```
"DISP CSP;CSP:TRACE:MHOLD 'Avg 1' "
```

- **Off** means that peak hold and video averaging are off.

HP-IB Example

```
"DISP CSP;CSP:TRACE:MHOLD 'Off' "
```

Operating Considerations

After capturing the desired signal, you can use the HOLD function (press and release the SHIFT key, then the MEAS RESET key) to prevent additional signals from building-up on the display.

Screens Where Field is Present

CDMA REVERSE CHANNEL SPECTRUM
SPECTRUM ANALYZER

Normalize

This field is displayed when the **Controls** field is set to **Auxiliary**. This area performs three display operations:

- **Save B** saves the currently-displayed trace for the A-B operation.
- **A only** provides a continuously-updated display (the “normal” mode of operation).
- **A-B** displays the difference between the trace saved using **Save B** and the currently-displayed trace. The comparison can yield either losses or gains in amplitude.

HP-IB Example

```
"DISP CSP;CSP:TRACE:NORM `A only`"
```

Operating Considerations

The A-B function works correctly only if the Center Frequency and Span settings are the same for both signals.

The reference level (**Ref Level1**) can be changed to move the trace below the top line of the display if the A-B function results in a gain.

The HOLD key can be used to “freeze” the display at any time. This allows you to view a trace before performing the Save or A-B functions.

Screens Where Field is Present

CDMA REVERSE CHANNEL SPECTRUM
SPECTRUM ANALYZER

Notch Freq

This field sets the center frequency for the variable frequency notch filter. It is typically used for distortion and SINAD measurements at frequencies below or above the standard 1 kHz notch filter.

This field is not displayed if your Test Set does not have this feature.

Operating Considerations

When the **Notch Coupl** field on the CONFIGURE screen is set to **AFGen1**, this filter and the **AFGen1 Freq** field match their settings. A warning message is then displayed if you attempt to set the **AFGen1 Freq** value outside the 300 Hz to 10 kHz range of this filter. When the **Notch Coupl** field is set to **None**, this filter and **AFGen1 Freq** operate independently.

Screens Where Field is Present

AF ANALYZER

Notch Gain

This field displays and selects the gain of the AF Analyzer's notch filter amplifier. This amplifier is only used for making SINAD and distortion measurements. (Refer to the "[Gain Cntl](#)" field on page 269.)

Screens Where Field is Present

AF ANALYZER

Notch Coupl

This field selects if the **Notch Freq** setting of the AF ANALYZER screen is coupled to the **AF Gen1 Freq** setting. When set to **None**, the notch filter and AF Generator 1 do not interact. When set to **AFGen1** (coupled), the settings track each other unless the AF Generator's frequency is set outside the 300 Hz to 10 kHz limits of the notch filter

Screens Where Field is Present

CONFIGURE

Num Pages

This field allows entry of the number of page attempts the Test Set will perform when a call is made from the Test Set. The power-up or preset default value is one page attempt.

HP-IB Example

```
"CDMA:CELL:CONF:NPAG 2"
```

sets the Num Pages field to two.

Operating Considerations

Multiple pages (two or three) should only be selected when testing non-slotted-mode mobile stations. If multiple pages are selected when testing a slotted-mode mobile station, connect time could take minutes.

Screens Where Field is Present

CDMA CELL SITE CONFIGURATION

Num Step

This field allows entry of the number of power steps in an access probe sequence (NUM_STEP).

HP-IB Example

```
"DISP CCON;CDMA:CELL:CONFigure:NUMStep 0"
```

sets NUM_STEP to 0.

Operating Considerations

This field allows the Test Set to set the maximum number of access probes the mobile-station-under-test will transmit in each access probe sequence. The number of probes transmitted will be $1 + NUM_STEP$.

Screens Where Field is Present

CDMA CELL SITE CONFIGURATION

Fields That Begin with the Letter O

OCNS (Sector A Power)

This field displays OCNS (Orthogonal Channel Noise Simulator). The Walsh code can be specified for OCNS, but OCNS power is not settable.

HP-IB Example

```
"DISP CGEN;CDMA:CELL:ASEctor:ORTHOgonal:POwer?"
```

queries the relative power level of the Sector A OCNS source.

```
"DISP CGEN;CDMA:CELL:ASEctor:ORTHOgonal:WALSh 17"
```

sets the OCNS Walsh code to 17.

Operating Considerations

OCNS is automatically adjusted so that the total power levels of pilot, sync, paging, traffic, and OCNS add up to Sector A power, I_{or} .

Allowable values for OCNS include Walsh codes 8 through 63. If a Walsh value is entered that matches the Traffic or Sync channel setting, an error message will be displayed.

Screens Where Field is Present

CDMA GENERATOR CONTROL

OCNS (Sector B Power)

This field displays Orthogonal Channel Noise Simulator (OCNS). The Walsh Code can also be specified for OCNS, but OCNS power is not settable.

HP-IB Example

```
"DISP CGEN;CDMA:CELL:BSECTOR:ORTHOGONAL:POWER?"
```

queries the relative power level of the Sector B OCNS source.

```
"DISP CGEN;CDMA:CELL:BSECTOR:ORTHOGONAL:WALSH 17"
```

sets the Walsh code for the OCNS to 17.

Operating Considerations

OCNS is automatically adjusted so that the total power levels of pilot, traffic, and OCNS add up to Sector B power, I_{or} .

Allowable values for OCNS include Walsh codes 8 through 63. If a Walsh value is entered that matches the Traffic or Sync channel setting, an error message will be displayed.

Screens Where Field is Present

CDMA GENERATOR CONTROL

Offset Freq

Frequency offset (RF Generator) sets the difference between the instantaneous frequencies of the Tracking Generator and the center frequency of the Spectrum Analyzer.

Operating Considerations

The offset can be a positive or negative value. When set to zero, the Tracking Generator produces a sweeping signal that matches the Spectrum Analyzer's tune frequency.

Screens Where Field is Present

SPECTRUM ANALYZER

Options

This field is used to enter the instrument's option number or numbers if any.

Operating Considerations

This field may be left blank, or otherwise may include other calling name options, for example:

Printer options – **LN=#, START, END**

Where **#** is the number of lines on each page.

Where **START** causes a form feed at the start of each printout.

Where **END** causes a form feed at the end of each printout.

Data collection options – **NN**

Where **NN** is the number of records (file size) for the mass-storage location where data will be collected on disk or memory card. The default record size is 80.

Screens Where Field is Present

TESTS (External Devices)

Order

This field is used to send an order type mobile station control message on the forward voice channel to the mobile station. The orders available are:

- Change Power to Power Level 0 - 7
- Maintenance (put the mobile station in maintenance mode)
- Alert (alert the mobile station)
- MRI (mobile reported interference) request (**NAMPS** system type only)

The ORDER field is updated with two separate HP-IB commands depending on the selected system type. The commands are:

- :ORDER for system types AMPS, TACS, AND JTACS. This command is used to send an order type mobile station control message to the mobile station. The **Access** annunciator will light momentarily while the Test Set is sending the mobile station control message.

A mobile station must be actively connected on a voice channel to the Test Set (that is, the **Connect** annunciator lit) before attempting to send an order to a mobile station.

The query form of the command (that is, :ORDer?) can be used to determine the last order sent to the mobile station using the :ORDer command.

Syntax

```
:ORDer <'><order message><'>  
:ORDer?
```

Example

```
OUTPUT 714;"CALLP:ORD 'CHNG PL 0' "  
OUTPUT 714;"CALLP:ORD?"  
ENTER 714;Last_ord_sent$  
OUTPUT 714;"CALLP:ORD?"
```

- :NORDER for system types NAMPS. This command is used to send an order type mobile station control message to the mobile station. The **Access** annunciator will light momentarily while the Test Set is sending the mobile station control message
- The :NORDER command is used to send an order type mobile station control message to the mobile station. The **Access** annunciator will light momentarily while the Test Set is sending the mobile station control message.
- A mobile station must be actively connected on a voice channel to the Test Set (that is, the **Connect** annunciator lit) before attempting to send an order to a mobile station.
- The query form of the command (that is, :NORDER?) can be used to determine the last order sent to the mobile station using the :NORDER command.

Syntax

```
:NORDER <'><NAMPS order message><'>  
:NORDER?
```

Example

```
OUTPUT 714;"CALLP:NAMPS:NORD 'MRI' "  
OUTPUT 714;"CALLP:NAMPS:NORD 'Chng PL0' "  
OUTPUT 714;"CALLP:NAMPS:NORD?"  
ENTER 714;Last_ord_sent$
```

Screens Where Field is Present

CALL CONTROL

Orig Addr

This field allows entry of an originating phone's address, identified by its phone number, which the mobile station will use when acknowledging reception of a SMS message.

HP-IB Example

```
"CDMA:SMS:TERM:OADD `1111111`"
```

enters "111111" in the Orig Addr field.

Operating Considerations

Refer to TIA/EIA IS-637 for detailed information about the Originating Address parameter in SMS point-to-point messages.

Screens Where Field is Present

CDMA SHORT MESSAGE SERVICE

Output Atten Hold

This field, when set to **On**, prevents the output attenuators in the Test Set (when not configured with a PCS INTERFACE) or the PCS INTERFACE (if present) from switching in and out, avoiding temporary loss of the output signal as the RF Power level is changed.

- **On**
- **Off**

HP-IB Example

```
"RFG:ATT `On`"
```

holds the output attenuators.

Operating Considerations

Always adjust the RF Power level (the sum of **Sctr A Pwr**, **Sctr B Pwr**, and **AWGN**) to the highest power level in the range of values you will be testing before turning **Output Atten Hold** "On".

When the Test Set is configured for PCS mobile station testing, and the Output Atten Hold field is set to "On", the HP 83236 PCS INTERFACE's attenuators are not allowed to switch. The Test Set's attenuators, however, *are* allowed to switch to provide an adequate range of power for testing the range of open loop power control.

When the Test Set is not configured for PCS mobile station test, and the Output **Atten Hold** field is set to "On", the Test Set's attenuators are not allowed to switch.

If the RF Power is raised (or lowered) beyond the limits imposed by attenuator settings being held, the Test Set will beep and the error message "*Change RF Gen Amplitude, Output Port or Atten Hold (if on)*" will be displayed. The range varies between analog and CDMA modes, and between Test Set's configured with a PCS INTERFACE and those that aren't.

This field is coupled to the **Atten Hold** field on the analog RX TEST, RF GEN, and DUPLEX TEST screens.

Screens Where Field is Present

CDMA TRANSMITTER POWER RANGE TEST

Output Heading:

This field allows you to enter a heading for the test results printout (or CRT display).

Screens Where Field is Present

TESTS (Printer Setup, Execution Conditions)

Output Port

This field selects the RF output port on the Test Set or the HP 83236 PCS Interface, depending on the PCS Mode setting.

- **RF Out** selects the RF IN/OUT port on the Test Set's front panel when the **PCS Intrfc Control** field is set to **Off**.
- **RF Out** selects the RF IN/OUT port on the PCS Interface when the **PCS Intrfc Control** field is set to **On**, and power has been cycled to configure the Test Set for PCS band testing.
- **Dupl** selects the DUPLEX OUT port on the HP 8924C front panel. This selection is available when the **PCS Intrfc Control** field is set to **Off**.
- **only** selects the RF OUT Only port on the HP 83236 PCS Interface. This choice is displayed only when the **PCS Intrfc Control** field is set to **On**, an HP 83236 PCS Interface is installed, and power has been cycled to configure the Test Set for PCS band testing.

HP-IB Example

```
"CONF:OUTP `Rf Out`"
```

selects the RF Output port.

Operating Considerations

When the PCS Mode field on the CONFIGURE screen is "On", and the Test Set has been configured for PCS band testing by cycling power, Output Port settings are in reference to the PCS Interface front panel. There is no separate analyzer path available on the PCS Interface, so the RF Out choice, by default, also selects the RF IN/OUT port on the PCS Interface as the RF output *and* RF input.

Maximum signal levels at each port are printed on the front panel. The Duplex Out port provides higher power.

CAUTION:

Applying reverse RF power to the DUPLEX OUT connector can damage the instrument. (A message is displayed when an overpower conditions occurs.) Whenever possible, use the RF IN/OUT connector when testing transceivers to prevent damage from accidental transmitter keying.

If a reverse-power condition triggers the internal protection circuit, remove the reverse-power signal and press the MEAS RESET key or turn the Test Set off and on to reset it.

Screens Where Field is Present

CONFIGURE
CDMA REVERSE CHANNEL SPECTRUM

Output Results For

This field selects which test results are output. The underlined entry is the active choice.

- **All** outputs all test results on to the location selected in the **Output Results To:** field.
- **Failures** outputs only the results of tests which fail.

Screens Where Field is Present

TESTS (Execution Conditions, Printer Setup)

Output Results To

This field selects where test results are output. The underlined entry is the active choice.

- **CRT** displays test results on the Test Set's CRT.
- **Printer** displays test results on the Test Set's CRT and outputs them to a printer. (The printer information must first be entered on the TESTS (Printer Setup) screen.)

Screens Where Field is Present

TESTS (Execution Conditions, Printer Setup)

Fields That Begin with the Letter P

Page

This field is used to initiate a page to the mobile station connected to the Test Set.

The Test Set must be in the active state (that is, **Active** annunciator lit) and the **MS Id** information must be correct before attempting to page a mobile station.

The :PAGE command is used to control this field.

There is no query form of the :PAGE command.

Syntax

:PAGE

Example

```
OUTPUT 714; "CALLP:PAGE"
```

Screens Where Field is Present

CALL CONTROL

Page (annunciator)

When lit, the **Page** annunciator indicates that the mobile station connected to the Test Set is currently being paged on the forward control channel.

The **Page** annunciator is not programmable.

The state of the **Page** annunciator is reflected in the Call Processing Status Register Group Condition Register bit 3.

See [“Call Processing Status Register Group”](#) in the Status Reporting chapter of the *HP 8924C User's Guide* for further information.

Screens Where Field is Present

CALL CONTROL

CALL DATA

Page Rate

This field sets the modulation data rate for the forward paging channel. The quarter (2400) and eighth (1200) rates are not allowed on the paging channel.

- **Full** - 9600 bps
- **Half** - 4800 bps

HP-IB Example

```
"DISP CCON;CDMA:CELL:CONFigure:PAGE:RATE 'FULL' "
```

sets the Page Rate field to full.

Screens Where Field is Present

CDMA CELL SITE CONFIGURATION

Page Sent (annunciator)

This annunciator lights when the CALL key is pressed. If the call proceeds to connected, the **Page Sent** annunciator remains lit until the call is terminated. This annunciator will not remain lit if an attempted call is unsuccessful.

HP-IB Example

```
"DISP CCNT;STATus:CDMA:COND?"
```

queries the CDMA condition register. Bit 1 will be set when the Page Sent annunciator is lit.

See Also

["CALL" on page 27](#)

Screens Where Field is Present

CDMA CALL CONTROL
CDMA SHORT MESSAGE SERVICE
CDMA AUTHENTICATION

Paging (Sector A Power)

This field allows the entry of paging E_c , the paging channel energy per PN chip relative to the total Sector A power.

HP-IB Example

```
"DISP CGEN;CDMA:CELL:ASEctor:PAGing:POWer -16dB"
```

sets Sector A pilot power to -16 dB.

Operating Considerations

As the paging level is varied, OCNS is automatically adjusted so that the total power levels of pilot, sync, paging, traffic, and OCNS add up to Sector A power, I_{or} .

Screens Where Field is Present

CDMA GENERATOR CONTROL

Pam Size

This field allows entry of the access channel preamble length (PAM_SZ).

HP-IB Example

```
"DISP CCON;CDMA:CELL:CONFigure:PAMSize 10"
```

sets PAM_SZ to 10.

Operating Considerations

This field sets the length of the access probe preamble. An access probe is composed of the access channel preamble followed by the access channel message capsule. The access channel preamble length is expressed in units of 20 millisecond frames.

Screens Where Field is Present

CDMA CELL SITE CONFIGURATION

Parameter

This column in the authentication results table lists the parameters that are used to authenticate a registration, page, or origination. These parameters are returned from the mobile in the Access Channel Registration, Page Response Message, or Origination Message.

See Also

[Authen field description, on page 170](#)

Screens Where Field is Present

CDMA AUTHENTICATION

Parm (Test Parameters)

Selecting this field displays the TESTS (Test Parameters) screen.

Screens Where Field is Present

TESTS (Main Menu)

Parity

This field specifies the serial communication parity setting when using the rear-panel serial port.

This setting is retained when the instrument is turned off.

Screens Where Field is Present

I/O CONFIGURE

Pass Word

The **Pass Word** field allows you to access a secured test procedure file. Test procedures are secured using the **SECURE_IT** program in ROM. Load and run the ROM **IB_UTIL** program to access the **SECURE_IT** program.

Screens Where Field is Present

TESTS (Save/Delete Procedure)

PCS Intrfc Control

This field allows you to establish serial communication between the Test Set and an HP 83236B PCS Interface.

HP-IB Example

"CONF:PCSMODE `On`"
configures the Test Set to establish serial communication with a PCS Interface.

Operating Considerations

Power to the Test Set must be cycled after changes to this field. The HP 83236B PCS Interface must be configured correctly, connected to the Test Set as shown in the HP 83236B User's Guide, and power must be turned on.

NOTE: Settings to this field cannot be saved to or recalled from a Save/Recall register.

Screens Where Field is Present

CONFIGURE

Phone Num:

This field displays the decoded MIN number received from the mobile station on the reverse control channel in response to a forward control channel message. The **Phone Num:** field is displayed only when the **Display** field is set to **Data** and a reverse control channel message containing this information has been decoded.

CAUTION: Do not confuse the **Phone Num:** field, which is displayed in the upper right-hand portion of the **CALL CONTROL** screen, with the **Phone Num** selection of the **MS Id** field.

NOTE: An all zero MIN number (00000000), which does not represent a valid phone number, will convert to the following phone number: 11111?111.

Refer to the "**Display**" field on page 223 for information on how to read measurement results from this field.

Screens Where Field is Present

CALL CONTROL

Phs Error

This field is displayed when Freq Error is selected from the list of choices available when the unnamed field displaying one of the following choices is displayed:

- phase error measurement
- carrier feedthrough measurement

HP-IB Example

"DISP CTXT;CDMA:RHO:MEAS:PERR `Phs Error`"
selects phase error from the list of choices.

"DISP CTXT;MEASure:CDManalyzer:PHASe:ERRor?"
queries the phase error measurement result.

Operating Considerations

These measurements, along with Rho, frequency error, amplitude error, and time offset are made by DSP analysis techniques. The **Meas Cnt1** field controls these measurements.

See Also

[Meas Cnt1 field description, on page 292](#)

[Carrier field description, on page 190](#)

Screens Where Field is Present

CDMA CELLULAR MOBILE TRANSMITTER TEST

Pilot (Sector A Power)

This field allows the entry of pilot E_c , the pilot channel energy per PN chip relative to the Sector A power.

HP-IB Example

"DISP CGEN;CDMA:CELL:ASEctor:PILot:POWer -7dB"

sets Sector A pilot power to -7 dB.

Operating Considerations

As the pilot level is varied, OCNS is automatically adjusted so that the total power levels of pilot, sync, paging, traffic, and OCNS add up to Sector A power, I_{or} .

Screens Where Field is Present

CDMA GENERATOR CONTROL

CDMA MOBILE REPORTING

Pilot (Sector B Power)

This field allows the entry of pilot E_c , the pilot channel energy per PN chip relative to the Sector B power.

HP-IB Example

```
"DISP CGEN;CDMA:CELL:BSECTOR:PILOT:POWER -7dB"
```

sets Sector B pilot power to -7 dB.

Operating Considerations

As the pilot level is varied, OCNS is automatically adjusted so that the total power levels of pilot, traffic, and OCNS add up to Sector B power, I_{or} .

Screens Where Field is Present

CDMA GENERATOR CONTROL
CDMA MOBILE REPORTING

Pilot Inc

This field allows entry of the increment between the pilot PN offsets of the Neighbor Set pilots.

When a mobile station finds CDMA service from the Test Set it is assigned seven Neighbor Set pilots in the *Neighbor List Message*. The Test Set assigns the first Neighbor Set pilot to the same PN offset as Sector B (this value is displayed on the CDMA Generator Control screen).

To complete the list, six additional Neighbor Set pilots are assigned equally-spaced PN Offsets, beginning with 15 times the **Pilot Inc** field setting. For example, if **Pilot Inc** is set to 10, the entire Neighbor Set would consist of the following pilots: 150, 160, 170, 180, 190, and 200. All values will be congruent to modulo 512, which is the number of unique values allowed for the pilot offset index.

HP-IB Example

```
"DISP CCON;CDMA:CELL:CONFIGURE:PINCREMENT 12"
```

sets the Pilot Inc field to 12.

Operating Considerations

This field affects the range of PN Offsets over which the mobile station has to search to monitor power levels of pilots in the Neighbor list

Range of values: 1 through 15

Screens Where Field is Present

CDMA CELL SITE CONFIGURATION

Pilot Meas (Clear)

This field allows the user to clear the contents of the CDMA Mobile Reporting table found on the CDMA MOBILE REPORTED PILOT STRENGTH screen.

HP-IB Example

"DISP CMOB;CDMA:MOBILE:PILOT:CLEAR"

displays the CDMA MOBILE REPORTED PILOT STRENGTH screen and clears the contents of the CDMA Mobile Reporting table.

Operating Considerations

All numbers displayed in the CDMA Mobile Reporting table reflect the last pilot strength message received from a mobile station. A Pilot Strength Message is sent from the mobile station when a Softer Handoff is executed, ended, or when the mobile station detects a change in pilot levels that affects the assignment of pilots to the mobile station's Active, Candidate, or Neighbor sets.

Screens Where Field is Present

CDMA MOBILE REPORTED PILOT STRENGTH

See Also

[Keep field description, on page 281](#)

[PN Offset field description, on page 334](#)

[Status field description, on page 408](#)

[Strength field description, on page 412](#)

Pk Det To

Peak Detector To selects the signal source for the peak detectors. This allows you to bypass certain sections of the AF analyzer's circuitry when making ac-level measurements.

See Also

["AF Analyzer Block Diagram" on page 91](#)

Screens Where Field is Present

AF ANALYZER

PN Offset

This column in the CDMA Mobile Reporting table lists the PN Offsets for all pilots being tracked by the mobile station.

All numbers displayed in the CDMA Mobile Reporting table reflect the last pilot strength message received from a mobile station. A Pilot Strength Message is sent from the mobile station when a Softer Handoff is executed, ended, or when the mobile station detects a change in pilot levels that affects the assignment of pilots to the mobile station's Active, Candidate, or Neighbor sets.

The CDMA Mobile Reporting table can be cleared by selecting the MS Report (Clear) field.

Operating Considerations

PN Offsets can be changed for Sector A and Sector B on the CDMA GENERATOR CONTROL screen.

HP-IB Example

```
"DISP CMOB;CDMA:MOB:PIL:STR?"
```

queries the results displayed in the CDMA Mobile Reporting table.

The value returned by the Test Set includes Status, PN Offset, Strength, and Keep for each pilot currently being tracked by the mobile station. These values are sent as a comma-separated list of IEEE floating point numbers, 16 characters each, ending with a line feed character.

NOTE:

If no values are displayed in the CDMA Mobile Reporting table, the query example shown above will return only the line feed character.

Programming Example

```

10 ! RE-STORE "C:\HPBASIC\READ_MRT"
20 CLEAR SCREEN
30 DIM Pil_str$(500)
40 OUTPUT 714;"CDMA:MOB:PIL:STR?"
50 ENTER 714;Pil_str$
60 Length=LEN(Pil_str$)
70 Num_pn=(Length+1) DIV 68 !Determine number of Pilots in the
table
80 FOR I=1 TO Num_pn
100 PRINT "Pilot";I;"status is ";Stat(I)
110 Pnofst(I)=VAL(Pil_str$[18;16])
120 PRINT "Pilot";I;"PN Offset is";Pnofst(I)
130 Str(I)=VAL(Pil_str$[35;16])
140 PRINT "Pilot";I;"pilot strength is ";Str(I)
150 Keep(I)=VAL(Pil_str$[52;16])
160 PRINT "Pilot";I;"keep bit is ";Keep(I)
170 IF I<>Num_pn THEN
180 Pil_str$=Pil_str$[69,LEN(Pil_str$)] !Move to next Pilot in
the string
190 PRINT
200 END IF
210 NEXT I
220 END

```

Table 14 documents the decimal numbers assigned to the Status column states. In the previous programming example, the variable Stat(I) will have one of the decimal values from **Table 14** written into it for each pilot reported.

Table 14 Status States

Decimal	Pilot Strength Level is above	Status
0	None of the settable reference levels	Candidate
1	None of the settable reference levels	To Drop
2	T_Drop	Candidate
3	T_Drop	Active
4	T_Add	Candidate
5	T_Add	To Drop
6	T_Add and T_Drop	Candidate
7	T_Add and T_Drop	Active
14	T_Add and T_Drop and T_Comp	Candidate
15	T_Add and T_Drop and T_Comp	Active

Screens Where Field is Present

CDMA MOBILE REPORTING

PN Offset (Sector A Power)

This field allows entry of the PN sequence offset for all Sector A code channels.

HP-IB Example

```
"DISP CGEN;CDMA:CELL:ASEctor:PNOffset 0"
```

sets the pilot PN offset index to 0.

Operating Considerations

The PN offset is relative to the Test Set's even-second clock.

Allowable values include 0 through 511, excluding the PN Offset for Sector B.

Screens Where Field is Present

CDMA GENERATOR CONTROL

PN Offset (Sector B Power)

This field allows entry of the PN sequence offset for all Sector B code channels.

HP-IB Example

```
"DISP CGEN;CDMA:CELL:BSEctor:PNOffset 0"
```

sets the pilot PN offset index to 0.

Operating Considerations

The PN Offset is relative to the Test Set's even-second clock.

Allowable values include 0 through 511, excluding the PN Offset for Sector A.

Screens Where Field is Present

CDMA GENERATOR CONTROL

Port/Sweep

This control performs two functions:

- The upper field specifies the output port of the Tracking Generator.
- The lower field specifies whether the Tracking Generator sweeps from low-to-high frequencies (**Norm**), or from high-to-low frequencies (**Invert**). (The Spectrum Analyzer always sweeps from low to high frequencies.) The swept frequency range is determined by the **Span** setting in the Spectrum Analyzer's Main Menu.

Operating Considerations

When using the Tracking Generator, if the output port is set **RF Out**, or the main menu **Input Port** is set to **RF In**, internal instrument coupling can occur. For the best isolation between the Tracking Generator and the Spectrum Analyzer, use **Dup1** for the output, and **Ant** for the input.

For measurements on high-power devices, such as amplifiers, use the RF IN/OUT port for the input.

Screens Where Field is Present

SPECTRUM ANALYZER

Position

This field indicates the number of scale divisions from the left side of the screen to the marker.

Use the DATA keys or cursor-control knob to move the marker to any point on the displayed signal.

Screens Where Field is Present

OSCILLOSCOPE
SPECTRUM ANALYZER

Power Cntl Step Size

This field is displayed only when the "**Protocol**" [field on page 344](#) is set to TIA/EIA-95B.

This field allows entry of the following closed loop power control step sizes:

- 1 dB
- 0.5 dB
- 0.25 dB

Operating Considerations,

The power control step size entered in this field must not be less than the minimum step size supported by the mobile station under test.

The value entered in this field will be sent to the mobile station in the Power Control Message PWR_CNTL_STEP field during call setup or while on a traffic channel (call connected). The mobile station should respond with a Mobile Station Acknowledgment Order.

The mobile station's minimum step size, MIN_PWR_CNTL_STEP, is retrieved by the Test Set during registration and displayed in the "**MS Database**" [field on page 303](#) under Pwr Step.

The message "Mobile's minimum power step > selected Power Cntl Step Size" will be displayed if a value is entered into the Power Cntl Step Size field that the Test Set determines is unacceptable

Screens Where Field is Present

CDMA TRANSMITTER POWER RANGE TEST

See Also

[Protocol field description, on page 344](#)
["MS Database" field on page 303](#)

Power Meas

This field provides Average Power zeroing (when **Average Power** is selected) and Channel Power calibration (when **Channel Power** is selected).

- **Calibrate**

Refer to the [Chan Power field description, on page 197](#).

- **Zero**

Refer to the [Avg Power field description, on page 178](#).

HP-IB Example

```
"CDMA:TX:POW:MEAS `Chan Power` ; :MEAS:CDM:CHAN:CAL"
```

selects and calibrates the Channel Power measurement.

```
"CDMA:TX:POW:MEAS `Avg Power` ; :MEAS:CDM:AVGP:ZERO"
```

selects and calibrates the Average Power measurement.

Operating Considerations, Power Zero

The **Power Zero** field is displayed when **Avg Power** is selected in the **Avg Power/Chan Power** field. To zero Average Power measurements, select **Power Zero**. If the message "Zero degraded. Reduce generator level for best results" appears, reduce or use the ON/OFF key to reduce RF Power, which is the sum of the Sector A, Sector B, and AWGN sources.

See Also

["Zeroing Average Power Measurements"](#) in the Calibrating the Test Set chapter of the *HP 8924C Application Guide*

["Calibrating Channel Power Measurements"](#) in the Calibrating the Test Set chapter of the *HP 8924C Application Guide*

Operating Consideration, Calibrate

The **Calibrate** field is displayed when **Chan Power** is selected in the **Avg Power/Chan Power** field. To calibrate Channel Power measurements, connect the DUPLEX OUT connector to the RF IN/OUT connector and select **Calibrate**.

A flashing **Unca1** annunciator will be displayed below the Chan Power field when the Channel Power measurement has not been calibrated for the frequency band selected in the RF Chan Std field.

Screens Where Field is Present

CDMA CALL CONTROL

CDMA TRANSMITTER POWER RANGE TEST

CDMA CELLULAR MOBILE TRANSMITTER TEST

Power Step

This field allows entry of the power increment (PWR_STEP).

HP-IB Example

```
"DISP CCON;CDMA:CELL:CONFigure:STEP:POWer 0"
```

sets PWR_STEP to 0.

Operating Considerations

This field specifies the step increase in transmit power between each access probe within an access probe sequence from a mobile station.

To make power level measurements during an access attempt, set the **Call Limit** field on the CDMA CALL CONTROL screen to **Page**. With **Call Limit** set to **Page**, the base station's response to access probes is inhibited, and the mobile station will continue with an access attempt until its maximum number of access probe sequences has been transmitted.

See Also

[Call Limit field description, on page 188](#)

Screens Where Field is Present

CDMA CELL SITE CONFIGURATION

Print All

This field allows you to print the Test Set's screen image.

Screens Where Field is Present

TESTS (Channel Information, Test Parameters, Order of Tests, Pass/Fail Limits, External Devices)

Print Data Destination

This field will be used in the future to select whether the data is formatted specifically for printers or for some other device (such as a computer). At this time the only selection is **Printer**.

Screens Where Field is Present

PRINT CONFIGURE

Printer Address

This field is used to specify the address of an HP-IB printer. This field is only displayed if the **Printer Port** field is set to HP-IB.

Screens Where Field is Present

TESTS (Printer Setup)

Printer Port:

This field is used to select the port your printer is connected to.

Screens Where Field is Present

TESTS (Printer Setup)
PRINT CONFIGURE

Print (Printer Setup)

Selecting this field displays the TESTS (Printer Setup) screen.

Screens Where Field is Present

TESTS (Main Menu)

Print Title

This field is used to enter up to 50 characters to be displayed at the top of the print.

Screens Where Field is Present

PRINT CONFIGURE

Priority

This field sets the Priority Indicator parameter in SMS messages.

- None
- Normal
- Interactive
- Urgent
- Emergency

HP-IB Example

```
"CDMA:SMS:TERM:PRI `Urgent`"
```

sets the Priority parameter to “Urgent”.

Operating Considerations

Each of these choices represent different levels of call priority. Refer to TIA/EIA IS-637 for detailed information about the Priority Indicator and its effect on the operation of the MSUT.

Screen(s) Where Field is Present

CDMA SHORT MESSAGE SERVICE

Privacy

This field sets the Privacy Indicator parameter in SMS messages. The choices available are:

- None
- No Restrict
- Restricted
- Confidential
- Secret

HP-IB Example

```
"CDMA:SMS:TERM:PRIV `Restricted`"
```

sets the Privacy parameter to “Restricted”.

Operating Considerations

Each of these choices represent different levels of privacy. Refer to TIA/EIA IS-637 for detailed information about the Privacy Indicator and its effect on the operation of the MSUT.

Screen(s) Where Field is Present

CDMA SHORT MESSAGE SERVICE

Procedure Library

This field is used to select whether the new test procedure will use the current test's library or no library.

Library files contain *all* of the channel, parameter, and test name information used with the code file.

Screens Where Field is Present

TESTS (Save/Delete Procedure)

Proc (Save/Delete Procedure)

Selecting this field displays the TESTS (Save/Delete Procedure) screen.

Screens Where Field is Present

TESTS (Main Menu)

Program

This field displays program information for the file chosen in the **Select Procedure Filename:** field.

Screens Where Field is Present

TESTS (Main Menu)

Protocol

This field provides a choice of these protocol selections.

- IS-95
- IS-95A
- TSB-74
- J-STD-008
- KOR PCS
- ARIB T53
- TIA/EIA-95B

HP-IB Example

```
"CDMA:CELL:PROT'IS-95A' "
```

selects the IS-95A protocol.

Operating Considerations

The protocol selection must be made before the mobile station is powered on. The list of choices under "[MS ID](#)" on page 307 and "[MS Database](#)" on page 303 is based on the selected protocol, as are some of the fields available for configuring the cell site found on the "[CDMA Cell Site Configuration Screen](#)" on page 107. For example, selecting IS-95A provides fields for entering the mobile station's IMSI in the MS ID field, and provides fields for entering the country code and network code on the CDMA Cell Site Configuration screen.

See Also

["Setting up a Call"](#) chapter in the *HP 8924C Application Guide*

Screens Where Field is Present

CDMA CALL CONTROL

Pwr Level

This field allows entry of the voice mobile station attenuation code (VMAC).

HP-IB Example

```
"CDMA:CALL:AHANdoff:PLEVel 4"
```

sets the Pwr Level (VMAC) field to 4.

Operating Considerations

During a CDMA-to-analog handoff, the Test Set sends a message to the mobile station telling it to adjust its power to the level that corresponds to the value in this field. A CDMA-to-analog handoff attempt will occur when the Execute field on the CDMA Call Control screen is selected. The value entered in this field is referred to as the VMAC (voice mobile attenuation code).

Screens Where Field is Present

CDMA CALL CONTROL

Pwr Lvl: -

The **Pwr Lvl:** field is divided into two fields:

- The left-hand field displays the mobile station's output power level assignment for the voice channel currently being used by the Test Set and the mobile station.

A numeric value is only displayed when a mobile station is actively connected on a voice channel (that is, the **Connect** annunciator is lit). A "-" is displayed if a mobile station is not actively connected on a voice channel.

This is a read only field.

The :AVCPower? command is used to query the contents of the left-hand subfield.

There is no command form of the :AVCPower? command.

Syntax

```
:AVCPower?
```

Example

```
OUTPUT 714;"CALLP:AVCP?"  
ENTER 714;Active_vc_pwr$
```

- The right-hand subfield (highlighted field) is used to enter the Voice Mobile Attenuation Code (VMAC). The VMAC determines the mobile station power level to be used on the designated voice channel (the channel number entered into the **Chan:** right-hand subfield).

The :VMACCode command is used to control the right-hand subfield.

The query form of the command (that is, :VMACCode?) can be used to determine the current VMAC setting.

Syntax

```
:VMACCode?  
:VMACCode <integer number 0 to 7>
```

Example

```
OUTPUT 714;"CALLP:VMAC 3"  
OUTPUT 714;"CALLP:VMAC?"  
ENTER 714;Vmac_setting
```

Screens Where Field is Present

CALL CONTROL

Pwr Up Reg

This field determines if, at power-up, the mobile station will attempt to register with the Test Set.

- **On** - the mobile station will perform a power-up registration
- **Off** - the mobile station will not perform a power-up registration

HP-IB Example

```
"CDMA:CELL:CONF:PUR `On`"
```

causes the mobile station to attempt to register at power-up

Operating Considerations

This field provides the option of performing a zone-based registration when a mobile station finds service ([Register \(CDMA\) field description, on page 357](#)) instead of waiting for the power-up registration.

This field should be set to the desired mode before a mobile station finds CDMA service.

When this field is "On" the Test Set instructs the mobile station to attempt a registration upon power-up. This instruction is sent as part of the paging channel overhead message *System Parameters*, and is received by the mobile station soon after the mobile station finds service.

See Also

["Setting up a Call"](#) chapter in the *HP 8924C Application Guide*

Screens Where Field is Present

CDMA CELL SITE CONFIGURATION

Fields That Begin with the Letter R

RAND

The 32-bit value entered in this field, Random Challenge Value, will be used by the mobile station during authentication procedures. RAND is sent to the mobile station on the Paging Channel Access Parameters Message.

HP-IB Example

```
"CDMA:CELL:CONF:AUTH:RAND?"
```

queries the RAND field.

See also

Screens Where Field is Present

CDMA AUTHENTICATION

RAND_A

RAND_A is the 16 most significant bits of **RAND** and is entered as a 4-digit hexadecimal value. The mobile station stores and uses the most recent version of RAND_A in the authentication process. RAND_A is user definable.

The :RAND:A command is used to control this field.

The query form (that is, :RAND:A?) can be used to query the current field value.

Syntax

```
:RANDA
```

```
:RANDA?
```

Example

```
OUTPUT 714;"CALLP:AMPS:AUTH:RAND:A `4F5A`"
```

```
OUTPUT 714;"CALLP:AMPS:AUTH:RAND:A?"
```

```
ENTER 714;Rand_val$
```

Screens Where Field is Present

AUTHENTICATION

RAND_B

RAND_B is the 16 least significant bits of **RAND** and is entered as a 4-digit hexadecimal value. The mobile station stores and uses the most recent version of RAND in the authentication process. RAND_B is user definable.

The :RAND:B command is used to control this field.

The query form (that is, :RAND:B?) can be used to query the current field value.

Syntax

:RAND:B

:RAND:B?

Example

```
OUTPUT 714;"CALLP:AMPS:AUTH:RAND:B `4F5A` "
```

```
OUTPUT 714;"CALLP:AMPS:AUTH:RAND:B?"
```

```
ENTER 714;Rand_val$
```

Screens Where Field is Present

AUTHENTICATION

RANDSSD

This field contains random data for computation of SSD (Shared Secret Data). RANDSSD is sent to the mobile station when an SSD Update is executed.

HP-IB Example

```
"CDMA:CELL:CONF:AUTH:RANDS?"
```

queries the RANDSSD field.

See also

["SSD Update" field on page 407](#)

Screens Where Field is Present

CDMA AUTHENTICATION

RANDSSD_1

RANDSSD_1 is the 24 most significant bits of the random number issued by the base station in the SSD Update Order. RANDSSD_1 is entered as a 6-digit hexadecimal value. RANDSSD_1 is user definable.

The :RAND:SSD1 command is used to control this field.

The query form (that is, :RAND:SSD1?) can be used to query the current field value.

Syntax

:RAND:SSD1

:RAND:SSD1?

Example

```
OUTPUT 714;"CALLP:AMPS:AUTH:RAND:SSD1 `4F5A26`"
```

```
OUTPUT 714;"CALLP:AMPS:AUTH:RAND:SSD1?"
```

```
ENTER 714;Rand_val$
```

Screens Where Field is Present

AUTHENTICATION

RANDSSD_2

The :RAND:SSD2 command is used to control this field.

The query form (that is, :RAND:SSD2?) can be used to query the current field value.

Syntax

:RAND:SSD2

:RAND:SSD2?

Example

```
OUTPUT 714;"CALLP:AMPS:AUTH:RAND:SSD2 `4F5A55`"
```

```
OUTPUT 714;"CALLP:AMPS:AUTH:RAND:SSD2?"
```

```
ENTER 714;Rand_val$
```

Screens Where Field is Present

AUTHENTICATION

RANDSSD_3

RANDSSD_3 is the 8 least significant bits of the random number issued by the base station in the SSD Update Order. RANDSSD_3 is entered as a 2-digit hexadecimal value.

The :RAND:SSD3 command is used to control this field.

The query form (that is, :RAND:SSD3?) can be used to query the current field value.

Syntax

```
:RAND:SSD3
```

```
:RAND:SSD3?
```

Example

```
OUTPUT 714;"CALLP:AMPS:AUTH:RAND:SSD3 `4F`"
```

```
OUTPUT 714;"CALLP:AMPS:AUTH:RAND:SSD3?"
```

```
ENTER 714;Rand_val$
```

Screens Where Field is Present

AUTHENTICATION

RAND_U

RAND_U is the 24-bit random number issued by the base station in the Unique Challenge Order. RAND_U is entered as a 6-digit hexadecimal value. RAND__U is user definable.

The :RAND:U command is used to control this field.

The query form (that is, :RAND:U?) can be used to query the current field value.

Syntax

```
:RAND:U <`><6 character hex value><`>
```

```
:RAND:U?
```

Example

```
OUTPUT 714;"CALLP:AMPS:AUTH:RAND:U `4F5A55`"
```

```
OUTPUT 714;"CALLP:AMPS:AUTH:RAND:U?"
```

```
ENTER 714;Rand_val$
```

Screens Where Field is Present

AUTHENTICATION

RANDU

RANDU is the 24-bit random number issued by the base station in the Unique Challenge Order. RANDU is entered as a 6-digit hexadecimal value. RANDU is user definable.

HP-IB Example

```
"CDMA:CELL:CONF:AUTH:RANDU?"
```

queries the RANDU field

See also

["Uniq Chall" field on page 441](#)

Screens Where Field is Present

CDMA AUTHENTICATION

Range Hold

These fields enable/disable several autoranging and autotuning routines.

Auto All enables these routines, providing automatic adjustment when making AF or RF measurements.

Hold All disables these routines, requiring you to manually set the affected settings.

The following fields are affected by the **Range Hold** field:

- **RX/TX Cntl** in the CONFIGURE screen.
- **Tune Mode** in the TX TEST, DUPLEX TEST, and RF ANALYZER screens.
- **Input Atten** in the RF ANALYZER and SPECTRUM ANALYZER screens.
- **Gain Cntl** in the AF ANALYZER screen. This field controls three AF gain setting fields:

Input Gain

De-Emp Gain

Notch Gain

Operating Considerations

The **Hold All** setting is primarily used when the instrument is operated by remote control, such as in an automated test system.

Unless you have very specific reasons for disabling the automatic functions, you should set this field to **Auto All** when operating the instrument manually.

Screens Where Field is Present

CONFIGURE

Rcv Pace

The receive pace field is used when receiving serial data.

- **Xon/Xoff** lets the Test Set “talk” to the transmitting device to alter the rate of the data being sent.
- **None** disables the Xon/Xoff function.

This setting is retained when the instrument is turned off.

Screens Where Field is Present

I/O CONFIGURE

Received

This column in the authentication results table lists authentication data for the parameters that are returned from the mobile in the Access Channel Registration, Page Response Message, or Origination Message. The data in the **Received** column is compared to the data in the **Expected** column to verify if authentication passes or fails.

See Also

[Authen field description, on page 170](#)

Screens Where Field is Present

CDMA AUTHENTICATION

Ref Level

Reference level sets the amplitude reference level for the top line of the display. All signals displayed are referenced to this line. This field is displayed when the **Controls** field is set to **Main**.

HP-IB Example

```
"CSP:RLEV 0"
```

sets the reference level to 0 dBm.

Operating Considerations

The unit-of-measure for the reference can be changed as needed. For instance, 0 dBm, 0.224 V, 107.0 dBmV, and 0.00100 W can all be used to represent the same level.

Screens Where Field is Present

SPECTRUM ANALYZER
CDMA REVERSE CHANNEL SPECTRUM

Reg Period

This field sets the interval for timer-based registrations. The default value for this field, 29, provides registration intervals of approximately 12 seconds. Selecting higher numbers increases this interval.

Table 15 Timer-based registration time periods

Reg Period field setting	Registration Period
29	12.16
30	14.48
331	17.2
32	20.48
38	57.92
62	3707.2
84	167772.16

HP-IB Example

```
OUTPUT 714; "CDMA:CELL:CONF:TREG:PER 29"
```

sets the timer-based registration period to 29.

Operating Considerations

The range of values that can be entered in this field is 29 through 85.

See Also

[Timer Reg field description, on page 425](#)

Screens Where Field is Present

CDMA CELL SITE CONFIGURATION

Register

This field is used to initiate a registration of the mobile station that is connected to the Test Set. The Test Set must be in the active state (that is, the **Active** annunciator must be lit) before you can attempt to register the mobile station.

The :REGister command is used to control this field.

There is no query form of the :REGister command.

Syntax

:REGister

Example

```
OUTPUT 714; "CALLP:REG"
```

Screens Where Field is Present

CALL CONTROL

Register (CDMA)

Selecting this field causes the mobile station to perform a zone-based registration.

The Test Set first transmits an alternate SID/NID pair that causes the mobile station to respond by registering, as if the mobile station were moving into a new zone. This SID/NID pair, used in the System Parameters Overhead Message, settable (see [Rgstr NID field description, on page 369](#) and [Rgstr SID field description, on page 370](#)).

After the mobile station has registered the first time, the Test Set sends another SID/NID pair, this time using the values set in Network ID and System ID fields (see the ["CDMA Cell Site Configuration Screen" on page 107](#)). These are the main SID and NID, and the mobile station will register again and set its roam status according to these values.

HP-IB Example

```
"DISP CCNT;CDMA:MOBILE:REGISTER"
```

causes the mobile to register.

Operating Considerations

Mobile station registration can occur as a result of the following events:

- The mobile station power is cycled
- The "Register" feature is selected by selecting this field or sending the HP-IB command shown above.
- A call is made by pressing the CALL key with the MS ID mode Auto.
- A mobile-station initiated call is made. This event causes an implicit registration to be performed.

When the **Register** field is selected, the **Registering** annunciator will light until the registration is successful, or the registration attempt times-out.

See Also

["Setting up a Call" chapter in the HP 8924C Application Guide MS ID field description, on page 307](#)

Screens Where Field is Present

CDMA CALL CONTROL

Register (annunciator)

When lit, the **Register** annunciator indicates that the mobile station connected to the Test Set is being commanded to register with the Test Set.

The **Register** annunciator is not programmable.

The state of the **Register** annunciator is reflected in the Call Processing Status Register Group Condition Register bit 1.

See “[Call Processing Status Register Group](#)” in the Status Reporting chapter of the *HP 8924C User's Guide* for further information.

Screens Where Field is Present

CALL CONTROL
CDMA AUTHENTICATION

Registering (annunciator)

This annunciator lights when the Register field is selected. The annunciator goes out when the registration is successful, when the registration attempt times out, or when the END CALL key is pressed.

HP-IB Example

```
"DISP CCNT;STATus:CDMA:EVENT?"
```

queries the CDMA event register. Bit 11 in the CDMA Status Event Register will be set upon completion of a successful Registration attempt. (No Condition Register is implemented for this bit).

See Also

[Register \(CDMA\) field description, on page 357](#)

Screens Where Field is Present

CDMA CALL CONTROL

Release

This field is used to terminate an active voice channel connection with the mobile station. When the **Release** field is selected, a mobile station control message with a release order is sent to the mobile station on the forward voice channel. A mobile station must be actively connected on a voice channel to the Test Set (that is, the **Connect** annunciator must be lit) before you can attempt to send a release order to the mobile station.

The :RELease command is used to control this field.

There is no query form of the :RELease command.

Syntax

:RELease

Example

```
OUTPUT 714; "CALLP:REL"
```

Screens Where Field is Present

CALL CONTROL

Res BW

The resolution bandwidth field selects the IF filter used when measuring the power of the carrier and the adjacent channels.

Operating Considerations

Using a narrower bandwidth filter (300 Hz) slows the measurement, but rejects carrier leakage and out of channel spurs. Using a wider bandwidth filter (1 kHz) speeds measurements, but may allow unwanted spurs and carrier leakage to be integrated into the measurement when measuring at the edges of the selected channel bandwidth.

Screens Where Field is Present

ADJACENT CHANNEL POWER

Reset

See the [Cont/Single field description, on page 212](#)

Screens Where Field is Present

OSCILLOSCOPE

RF Channel (analog)

The **RF Channel** field is displayed on the screens listed below when the **RF Display** field on the CONFIGURE screen is set to **Chan**.

This field displays the current channel number. Channel tuning eliminates the need to transmit and receive frequencies directly into the Test Set. Once the radio's RF channel standard is selected, you only have to enter the channel number to automatically set the **RF Generator** and **RF Analyzer** to the correct frequency.

Operating Considerations

To utilize the correct transmit and receive frequencies select the appropriate channel standard from the **RF Chan Std** field on the CONFIGURE screen.

Screens Where Field is Present

TX TEST
RF ANALYZER
SPECTRUM ANALYZER (When the **Controls** field is set to **RF Gen**)

RF Channel (CDMA)

This field is displayed on the screens listed below when the **RF Display** field on the CONFIGURE screen is set to **Chan**.

This field re-tunes the Test Set to the selected channel number. If a call is currently connected, this field initiates a CDMA-to-CDMA hard handoff.

HP-IB Example

```
"DISP CCNT;CDMA:RFChannel 283"
```

selects channel 283.

Operating Considerations

The mobile station must be programmed for the serving system of the RF Channel selected. For example, if the mobile station is programmed to "B only", and channel 283 (which is an "A" system channel) is selected, the handoff will not be successful.

Screens Where Field is Present

CDMA CALL CONTROL
CDMA REVERSE CHANNEL SPECTRUM (When the **Controls** field is set to "RF Gen")

RF Chan Std

This field is displayed when Chan is selected in the RF Display field on the CONFIGURE screen.

Use the RF channel standard field to select the channel standard for the radio-under-test. The RF Generator's and the RF Analyzer's frequencies are automatically set to correspond to the channel number entered in the **RF Channel** field.

Some of the RF Chan Std choices require that the Test Set is configured to operate with a specific HP 83236 model ([table 16 on page 362](#)). The choices displayed will be limited to the RF channel standard's your hardware is capable of providing. If you do not know if your HP 83236B is equipped with Option 007, one way to find out is to query the Test Set using the HP-IB Common Command, ***IDN?** (refer to the *HP-IB Quick Reference Guide* for a detailed description of this command). If you have Option 007, the word "WIDEBAND" will be included in the string returned by the Test Set.

HP-IB Example

```
"DISP CCNT;CONF:RFCS'USER-DEF'
```

selects a user-defined RF Channel Standard, The base frequency, channel spacing, and offset between generator and analyzer frequencies are settable on the Configure screen when USER-DEF is selected. "

Operating Considerations

For the NAMPS standards, a third letter is added indicating which frequency band is used: upper, middle, or lower. For example, when testing a mobile station using the lower band, choose **MSL NAMPS**.

The **USER-DEF** selection is used to define your own channel assignments. When **USER-DEF** is selected, you enter the **Base Freq**, **Chan Space**, and **(Gen) - (An1)** settings, found on the Configure screen.

See Also

[Base Freq \(User Defined\) field description, on page 182](#)

[Chan Space \(User Defined\) field description, on page 203](#)

Screens Where Field is Present

CDMA CALL CONTROL
CONFIGURE

Chapter 4, Description of Fields
Fields That Begin with the Letter R

Table 16 Mobile Test Channel

Standard	Valid Channel Numbers	Offset Freq (MHz)	Channel Spacing (MHz)	Base Transmit Freq Range (MHz) (HP 8924C Generate)	Mobile Transmit Freq Range (MHz) (HP 8924C Receive)
MS- AMPS	1 to 799, 990 to 1023	45.0	0.03	869.01 to 893.97	824.01 to 848.97
MS-NAMPS	1 to 799, 990 to 1023	45.0	0.03	869.01 to 893.97	824.01 to 848.97
MSL- NAMPS	1 to799, 990 to1023	45.0	0.03	869.00 to 893.96	824.00 to 848.96
MSU-NAMPS	1 to 799, 999 to 1023	45.0	0.03	869.02 to 893.98	824.02 to 848.98
MS-TACS ^a	1 to 1000	45.0	0.025	935.0125 to 959.9875	890.0125 to 914.9875
MS-ETACS ^a	1 to 1000, 1329 to 2047	45.0	0.025	917.0125 to 959.9857	872.0125 to 914.9875
MS-NTACS ^a	1 to 798, 801 to 2141	-55.0	0.0125	843.0125 to 869.975	898.0125 to 924.975
MS-JTACS ^a	1 to 798	-55.0	0.0125	860.0125 to 869.972	915.0125 to 924.9725
Japan CDMA ^a	1 to 799, 801 to 1039, 1041 to 1199	-55.0	0.0125	832.0125 to 869.9875	887.0125 to 924.9875
KOR PCS P0 ^b	0 to 1300	90.0	0.05	1805.0 to 1870.0	1715.0 to 1780.0
KOR PCS P1 ^b	1 to 1300	90.0	0.05	1805.05 to 1870.0	1715.05 to 1780.0
US PCS	0 to 1199	80.0	0.05	1930.00 to 1989.95	1850.00 to 1909.95
User Def	0 to 4095	-1000.0 to 1000.0	-1.000 to 1.000	790.0 to 969.999999* 1700.0 to 1999.999999*	790.0 to 969.999999* 1700.0 to 1999.999999*

a. Requires HP 83236B Opt. 007 (Wideband)

b. Requires HP 83236B

RF Cnt Gate

RF counter gate specifies how long the RF counter samples the signal before displaying the frequency. Specifying a shorter gate time may enable you to see frequency fluctuations that might not be seen using a longer gate time.

Screens Where Field is Present

RF ANALYZER

RF Display

This field selects the format for entering the RF Generator's and RF Analyzer's frequencies:

- When **Freq** is selected, you enter the RF Generator's and the RF Analyzer's frequencies directly using the keypad or knob.
- When **Chan** is selected, the **RF Gen Freq** and **Tune Freq** fields on all screens are replaced by the **RF Channel** field, and only the channel number is entered and displayed.

Channel tuning eliminates the need to enter transmit and receive frequencies directly into the Test Set. Once your radio's RF channel standard is selected, you only have to enter the channel number to automatically set the RF Generator and RF Analyzer to the correct frequencies.

Operating Considerations

When channel tuning is used, the RF Analyzer is set to manual tuning. The **Tune Mode** field on the TX TEST, DUPLEX TEST, and RF ANALYZER screens is no longer displayed. As a result, the **TX Freq Error** measurement is displayed (since the **TX Frequency** measurement is only displayed when the **Tune Mode** field is set to **Auto**).

See Also

[RF Chan Std field description, on page 361](#)

Screens Where Field is Present

CONFIGURE

RF Gen Freq

This field is displayed on the screens listed below when the RF Display field on the CONFIGURE screen is set to **Freq**.

This field sets the RF Generator's (or CDMA generator's) frequency.

HP-IB Example

```
"RFG:FREQ 815MHZ"
```

sets the RF generator to 815 MHz.

See Also

[RF Display field description, on page 363](#)

Screens Where Field is Present

DUPLEX TEST

SPECTRUM ANALYZER (When the Controls field is set to "RF Gen")

RX TEST

RF GENERATOR

CDMA CALL CONTROL

CDMA REVERSE CHANNEL SPECTRUM (When Controls is set to "CDMA Gen")

RF Gen Lvl

This field is displayed only when the PCS Mode field is set to "On", an HP 83236 PCS Interface is installed, and power has been cycled to configure the Test Set for PCS band testing. When this field is selected, the RF generator amplitude levels are calibrated across the frequency bands made available by the HP 83236 PCS Interface.

Operating Considerations

RF generator level calibration should be performed whenever operating temperature changes more the 5 deg C, or when power is cycled to the HP 83236 PCS Interface, and before a call is set up. This calibration process takes approximately 15 seconds.

HP-IB Syntax

```
"CONFigure:RFSource:CALibrate"
```

Screens Where Field is Present

CONFIGURE

RF Gen Volts

This field specifies whether you want RF voltages expressed as the voltage across a 50 ohm load, or the open circuit voltage (emf).

Operating Considerations

This setting affects the RF Generator's and the Tracking Generator's amplitudes.

Screens Where Field is Present

CONFIGURE

RF In/Ant

This field is not displayed when the Test Set is configured to operate with an HP 83236B PCS Interface.

This field selects the RF IN/OUT or ANT IN port for making RF measurements.

Operating Considerations

Maximum power levels for each port are printed on the Test Set's front panel. If the RF power at the RF IN/OUT port exceeds allowable limits, a warning signal sounds and a message appears at the top of the screen. If this occurs, disconnect the RF power, press the MEAS RESET key, and allow the Test Set to cool off for approximately two minutes before making any other measurements on this port.

The ANT IN (antenna input) connector provides a highly-sensitive input for very low level signals (such as "off the air" measurements). You cannot measure TX (RF) Power or ACP Level on this screen using the ANT IN port.

CAUTION: Connecting a signal of >200 mW to the ANT IN port can cause instrument damage (although internal protection circuits can typically withstand a short-duration signal of 1 or 2 Watts).

If the overpower circuit is triggered (signified by a warning message at the top of the screen), remove the signal from the ANT IN port, and press the MEAS RESET key or turn the Test Set off and on to reset it.

See Also

[Sensitivity field description, on page 380](#)

[Input Port field description, on page 277](#)

Screens Where Field is Present

SPECTRUM ANALYZER

CDMA REVERSE CHANNEL SPECTRUM

RF In/Out

This field is used to indicate losses or gains between the RF IN/OUT port and the device-under-test. If an HP 83236 PCS Interface is installed on the Test Set, the loss or gain is applied to the PCS Interface RF IN/OUT port.

- Enter a *positive* value to indicate a gain (such as an amplifier gain). When the RF IN/OUT port is used as an output, the RF Generator's (or Tracking Generator's) level is automatically set the specified amount *below* what is indicated in the RF Generator's **Amplitude** field. Example; if this value is 10 dB, and the **Amplitude** field shows 0 dBm, the actual level out of this port is -10 dBm.

When this port is used as an input, the **TX Power** measurement and Spectrum Analyzer's Marker Level (**Lvl**) are automatically *reduced* by that amount.

- Enter a *negative* value to indicate a loss (such as cable loss). The RF Generator's (or Tracking Generator's) level out this port is automatically set that amount *above* what is indicated in the RF Generator's **Amplitude** field.

When used as an input, the **TX Power** and the Spectrum Analyzer's marker level (**Lvl**) measurements are *increased* by that amount.

HP-IB Example

```
"CONF:OFL:RFIN -1"
```

enters a path loss of 1 dB between the RF IN/OUT port and the mobile station.

This field is only used when the **RF Level Offset** field is set to **On**.

See Also

[RF Level Offset field description, on page 367](#)

Screens Where Field is Present

CONFIGURE

RF Level Offset

This field enables/disables the RF level offsets entered in the **RF In/Out**, **Duplex Out**, and **Antenna In** fields below it.

- When set to **On**, the RF Generator's amplitude and RF Analyzer's power measurement are offset by the values entered in these fields.
- When set to **Off**, the values in these fields are ignored.

See Also

[Antenna In field description, on page 167](#)

[Duplex Out field description, on page 242](#)

[RF In/Out field description, on page 366](#)

Screens Where Field is Present

CONFIGURE

RF Offset

This field is displayed when the RF Display field has Freq selected.

This field enables/disables the RF Generator–RF Analyzer frequency offset specified in the **(Gen)–(An1)** field below it.

Operating Considerations

When an RF offset is used, changing the RF Generator's frequency or RF Analyzer's tune frequency automatically alters the other setting. On screens where both fields are not shown (such as the RX TEST and TX TEST screens), you will not see the corresponding field change.

Screens Where Field is Present

CONFIGURE

RF Out only

This field is displayed only when the PCS Mode field is set to “On”, an HP 83236 PCS Interface is installed, and power has been cycled to configure the Test Set for PCS band testing. This field is used to indicate losses or gains between the RF OUT Only port and the device-under-test.

- Enter a *positive* value to indicate a gain (such as an amplifier gain). When the RF IN/OUT port is used as an output, the RF Generator’s (or Tracking Generator’s) level is automatically set the specified amount *below* what is indicated in the RF Generator’s **Amplitude** field. Example; if this value is 10 dB, and the **Amplitude** field shows 0 dBm, the actual level out of this port is –10 dBm.

When this port is used as an input, the **TX Power** measurement and Spectrum Analyzer’s Marker Level (**Lvl**) are automatically *reduced* by that amount.

- Enter a *negative* value to indicate a loss (such as cable loss). The RF Generator’s (or Tracking Generator’s) level out this port is automatically set that amount *above* what is indicated in the RF Generator’s **Amplitude** field.

When used as an input, the **TX Power** and the Spectrum Analyzer’s marker level (**Lvl**) measurements are *increased* by that amount.

HP-IB Example

```
"CONF:OFL:DUPL -1"
```

enters a path loss of 1 dB between the RF Out only port and the mobile station.

This field is only used when the **RF Level Offset** field is set to **On**.

See Also

[RF Level Offset field description, on page 367](#)

Screens Where Field is Present

CONFIGURE

RF Power

This field displays I_0 , the total power spectral density of Sector A power, Sector B power and AWGN.

HP-IB Example

```
"CDMA:RFP?"
```

queries the RF Power level.

Operating Considerations

RF Power is controlled by settings in the **Sector A Power**, **Sector B Power**, and **AWGN** fields. It is not directly settable.

Screens Where Field is Present

CDMA GENERATOR CONTROL
CDMA MOBILE REPORTING
CDMA REVERSE CHANNEL SPECTRUM
CDMA CELLULAR MOBILE TRANSMITTER TEST

Rgstr NID

This field allows entry of the cell site's alternate network identification (NID), used only for registration.

HP-IB Example

```
"DISP CCON;CDMA:CELL:CONFigure:RNID 0"
```

sets the register network identification of the simulated CDMA cell site to 0.

Operating Considerations

The Test Set will send the Rgstr NID and Rgstr SID during the registration process (when the **Register** field is selected) in an attempt to cause a zone-based registration to occur. Immediately following the zone-based registration, another registration is performed using the NID and SID in the **Network ID** and **System ID** fields. The latter values will determine if the mobile station is roaming.

Screens Where Field is Present

CDMA CELL SITE CONFIGURATION

Rgstr SID

This field allows entry of the cell site's alternate system identification (SID), used only for registration.

HP-IB Example

```
"DISP CCON;CDMA:CELL:CONFigure:RSID 0"
```

sets the register network identification of the simulated CDMA cell site to 0.

Operating Considerations

The Test Set will send the Rgstr NID and Rgstr SID during the registration process (when the **Register** field is selected) in an attempt to cause a zone-based registration to occur. Immediately following the zone-based registration, another registration is performed using the NID and SID in the **Network ID** and **System ID** fields. The latter values will determine if the mobile station is roaming.

Screens Where Field is Present

CDMA CELL SITE CONFIGURATION

RSSI Thresh

This field is displayed only for NAMPS system type.

This field is used to set the received signal strength threshold of the mobile station. Exceeding the **RSSI** threshold and **BER** threshold causes the mobile station to send an **MRI** message to the base station reporting its current **RSSI** and **BER**.

The :RSETting command is used to control this field.

The query form (that is, :RSETting?) can be used to query the current field value.

Syntax

```
:RSETting <'><choice><'>
```

```
:RSETting?
```

Example

```
OUTPUT 714;"CALLP:AMPS:RSET `Imm Resp`"
```

```
OUTPUT 714;"CALLP:AMPS:RSET?"
```

```
ENTER 714;Stol_set$
```

Screens Where Field is Present

CALL CONTROL

RX/TX Cntl

This function controls automatic screen changes between the RX TEST and TX TEST screens during radio testing. It is divided into two fields:

The **Auto/Manual** field enables/disables automatic switching between the RX TEST and TX TEST screens under certain testing conditions.

- **Auto** allows automatic screen changes between the RX TEST and TX TEST screens while testing radios.
- **Manual** requires you to select the RX TEST or TX TEST screen when performing radio tests.

The **Carrier/PTT** field specifies the condition that will cause automatic screen changes.

- **Carrier** causes the instrument to automatically switch from the RX TEST screen to the TX TEST screen when an RF carrier is detected. The screen returns to RX TEST when the carrier is no longer detected.
- **PTT** (Push-To-Talk) causes the instrument to automatically switch from the TX TEST screen to the RX TEST screen when a microphone connected to the MIC/ACC connector is keyed. The screen changes back to TX TEST when the microphone is no longer keyed.

Operating Considerations

CAUTION: The Test Set can be damaged by connecting a reverse-power signal to the DUPLEX OUT port of >200 mW.

If **Auto** and **Carrier** are used together, the screen may continuously change between RX TEST and TX TEST. This only occurs if the RF IN/OUT port is used with the RF Generator **Amplitude** set ≥ 35 dBm (a much higher level than is typically used for receiver tests). To prevent this problem, set the **Amplitude** ≤ 35 dBm or **off**, or use the DUPLEX OUT port for the RF Generator's output.

Screens Where Field is Present

CONFIGURE

Run

Selecting this field runs the IBASIC program.

Screens Where Field is Present

TESTS (IBASIC Controller)

Run Test

Selecting this field loads and runs the test chosen in the **Select Procedure Filename:** field.

Screens Where Field is Present

TESTS (Main Menu, Execution Conditions, Printer Setup)

Fields That Begin with the Letter S

SAT

This field allows entry of the SAT color code for CDMA to analog handoffs.

- 5970Hz
- 6000Hz
- 6030Hz

HP-IB Example

```
"CDMA:CALL:AHAN:SAT'6000Hz'"
```

sets the SAT field to 6000 Hz.

Operating Considerations

During a CDMA-to-analog handoff, the Test Set sends a message to the mobile station assigning this supervisory audio tone to the analog call.

A CDMA-to-analog handoff attempt will occur when the Execute field on the CDMA Call Control screen is selected.

Range of values: 0 through 2

Screens Where Field is Present

CDMA CALL CONTROL

SAT:

The **SAT:** field is divided into two fields:

- The left-hand field displays the current SAT tone frequency assignment for the current voice channel being used by the Test Set and the mobile station.

The Sat field only displays a value when the system type is set to AMPS, TACS, JTACS or when NAMPS Ch Loc: is set to Wide. The Test Set must also be actively connected on a voice channel (that is, the **Connect** annunciator is lit). A “-” is displayed if a mobile station is not actively connected on a voice channel or the system type is NAMPS and Ch Loc: is set to Lower, Middle, or Upper.

This is a read only field.

The :AVCSat? query command is used to query the contents of the left-hand subfield.

There is no command form of the :AVCSat? command.

Syntax

```
:AVCSat?
```

Example

```
OUTPUT 714;"CALLP:AVCS?"  
ENTER 714;Active_vc_sat$
```

- The right-hand field (highlighted field) is used to set the SAT Color Code (SCC) to be used on the designated voice channel (the channel number entered into the **Chan:** right-hand subfield).

The :SATone command is used to control the right-hand subfield.

The query form of the command (that is, :SATone?) can be used to determine the current SAT Color Code (SCC) setting.

Syntax

```
:SATone?  
:SATone <'><5970HZ/6000HZ/6030HZ><'>
```

Example

```
OUTPUT 714;"CALLP:SAT?"  
OUTPUT 714;"CALLP:SAT '5970HZ' "  
ENTER 714;Sat_color_code$
```

Screens Where Field is Present

CALL CONTROL

Sat Tol

This field is displayed only for NAMPS system type.

This field is used to select the Sat tolerance. When set to Narrow the Sat limit is one of the three valid Sat tones ± 10 Hz. When set to Wide the Sat limit is defined at 0 to 7000 Hz. When operating in noisy environments the narrow Sat limit may not allow for correct measurements and the ability to alter the limit to encompass a wider range provides for testing flexibility.

The :STOLerance command is used to control this field.

The query form (that is, :STOLerance?) can be used to query the current field value.

Syntax

```
:STOLerance <'><NARROW/WIDE><'>  
:STOLerance?
```

Example

```
OUTPUT 714;"CALLP:AMPS:STOL `NARROW` "  
OUTPUT 714;"CALLP:AMPS:STOL?"  
ENTER 714;Stol_set$
```

Screens Where Field is Present

CALL CONTROL
CALL CONFIGURE

Save/Recall

This field specifies which memory device the Test Set accesses when the save and recall functions are used.

- **Internal** is a section of internal RAM. RAM is also used for running IBASIC programs, which may require you to delete the Save/Recall registers if the program is very large.
- **Card** is the front-panel MEMORY CARD slot. A **Save/Recall Device is not Present** message is displayed if you try to save or recall an instrument setup when a write-able memory card is not installed in the Test Set.
- **RAM** refers to RAM disks that you can create on internal RAM. For information on creating **RAM disks**, see “Memory Cards/Mass Storage” chapter of the This is part of the same memory used when “internal” is specified, and may have to be erased when loading very large IBASIC programs. A **Save/Recall Device is not initialized** message is displayed if you try to save or recall an instrument setup when a RAM disk has not been created.
- **Disk** is used with external disk drives. The **Mode** field must be set to **Control** to access the drive. Also, the HP-IB address of the drive must be entered in the **External Disk Specification** field of the TESTS (External Devices) screen.

Screens Where Field is Present

I/O CONFIGURE

SCM:

This field displays the decoded station class mark information received from the mobile station on the reverse control channel in response to a forward control channel message. The decoded SCM consists of: the mobile station power class (Class I, II, or III), the transmission type (continuous/discontinuous), and the transmission bandwidth (20 MHz or 25 MHz).

The **SCM:** field is only displayed when the **Display** field is set to **Data** and a reverse control channel message has been decoded.

Refer to the "**Display**" field on page 223 for information on how to read measurement results from this field.

Screens Where Field is Present

CALL CONTROL

Scope To

Oscilloscope To selects the signal source for the Oscilloscope. This allows you to bypass certain sections of the AF analyzer's circuitry when viewing and measuring a signal. It also allows you to select measurement paths that include additional gain stages, improving the oscilloscope's resolution when measuring low-level signals.

See Also

["AF Analyzer Block Diagram" on page 91](#)

Screens Where Field is Present

AF ANALYZER

Sctr A Pwr

This field provides control of the Sector A forward CDMA channel generator output level. Forward CDMA channel power is expressed in units of dBm in a 1.23 MHz bandwidth.

HP-IB Example

```
"CDMA:CELL:ASEctor:STATe ON"
```

turns on Sector A.

```
"CDMA:CELL:ASEctor -100 dBm"
```

sets Sector A's power to -100 dBm.

Operating Considerations

Sector A power, Sector B power and AWGN are summed together and output on the selected output connector. The total power in a 1.23 MHz bandwidth centered at the RF channel setting is displayed in the **RF Power** field.

This field is duplicated on the CDMA GENERATOR CONTROL screen.

Screens Where Field is Present

CDMA CALL CONTROL

CDMA GENERATOR CONTROL

CDMA TRANSMITTER POWER RANGE TEST

CDMA MOBILE REPORTING

CDMA CELLULAR MOBILE RECEIVER TEST

CDMA CELLULAR MOBILE TRANSMITTER TEST

Sctr B Pwr

This field provides control of the Sector B forward CDMA channel generator power level (Also referred to as I_{or}). Forward CDMA channel power is expressed in units of dBm/ 1.23 MHz bandwidth.

HP-IB Example

```
"DISP CGEN;CDMA:CELL:BSEctor:BWPower -100 dBm"
```

sets Sector B's power to -100 dBm. BWPower is an optional command, therefore the following program line would also be valid:

```
"DISP CGEN;CDMA:CELL:BSEctor -100 dBm"
```

Operating Considerations

Sector A power, Sector B power and AWGN are summed together and output on the RF IN/OUT connector. The total power in a 1.23 MHz bandwidth centered at the RF channel setting is displayed in the **RF Power** field.

Screens Where Field is Present

CDMA GENERATOR CONTROL
CDMA MOBILE REPORTING

Select Procedure Filename

This field is used to select the file you want to load from the location chosen in the **Select Procedure Location:** field.

Screens Where Field is Present

TESTS (Main Menu)

Select Procedure Location

This field is used to select the location of the procedure to load. Procedures can be loaded from disk, card, ROM, or RAM.

This field is used to select where a new procedure will be saved, or the location from which a procedure will be deleted. Procedures can be saved to, or deleted from, disk, card, or RAM.

Operating Considerations

Procedure files contain a subset of the library file. This is where you save all of your own frequency, parameter, test sequence, specification, and system configuration information.

To save a file to an external disk drive, you must enter the drive's HP-IB address into the **External Disk Specification** field on the TESTS (External Devices) screen.

Screens Where Field is Present

TESTS (Save/Delete Procedure)
TESTS (Main Menu)

Send Msg

When **Execute** is selected, this field sends the message entered in the **User Data (ASCII)** or **User Data (Hex)** fields.

HP-IB Example

"CDMA : SMS : TERM : SEND"

sends the message currently displayed in the User Data field

Operating Considerations

After **Execute** has been selected, the **SMS Sent** annunciator will light while the Test Set waits for an SMS message acknowledgment from the mobile station. See ["MS Ack Received \(annunciator\)" field on page 302](#).

Screens Where Field is Present

CDMA SHORT MESSAGE SERVICE

Send Word

The Send Word field is an immediate action field. The current word in the **Set Message** field is immediately sent to the mobile station. The **Send Word** command is only intended for use with MSMessOrd and does not provide any method for controlling the timing of the word sent to the mobile station.

Screens Where Field is Present

CALL BIT

Sensitivity

RF Analyzer sensitivity adds about 6 dB of sensitivity for the ANT IN port when **High** is selected.

Operating Considerations

Selecting **High** sensitivity may cause Spectrum Analyzer measurements to be uncalibrated when the ANT IN port is used (a message appears when this occurs).

High-level AM measurements may be distorted when high sensitivity is used with the ANT IN port.

Screens Where Field is Present

RF ANALYZER

Sensitivity

This area performs two functions:

- The upper field selects **Normal** or **High** sensitivity for the RF input. The **High** setting adds about 6 dB of sensitivity to the ANT IN port for looking at very low level signals. However, this setting can cause measurements to be uncalibrated (indicated by a message on the screen). **High** sensitivity can also cause high-level AM signals to be distorted.
- The lower field selects the vertical resolution of the display. You can choose from 1 dB, 2 dB, or 10 dB per graticule.

Screens Where Field is Present

SPECTRUM ANALYZER
CDMA REVERSE CHANNEL SPECTRUM

Serial Baud

This field selects the baud rate for serial communications when using the rear-panel serial port. Selecting this field displays a list of baud rate choices.

This setting is maintained after the instrument is turned off.

Screens Where Field is Present

I/O CONFIGURE

Serial In

This field selects the destination of characters received by the Test Set on the serial port.

Inst configures the serial port to connect to an external ASCII terminal or computer to enter IBASIC programs, or to control the Test Set using an external keyboard.

- **IBASIC** is used to allow the IBASIC controller to read the serial port while a program is running.

Operating Considerations

If a serial printer is connected, the PRINT command causes the printer to take control of the serial port until printing is done.

This setting is maintained after the instrument is turned off.

Screens Where Field is Present

I/O CONFIGURE

Serial No.

This field displays the serial number of the Test Set.

Screens Where Field is Present

CONFIGURE

Send Msg

When **Send Msg Execute** is selected, the contents of the **User Data** field is sent, the **MS Ack Rcvd** annunciator is cleared, and the **MS Ack Cause Code** field is cleared.

HP-IB Example

```
"CDMA : SMS : TERM : SEND"
```

sends the message contained in the **User Data** field.

Operating Considerations

After a message is sent, the Test Set waits for an acknowledgment from the mobile station that the message was received. The **MS Ack Rcvd** will light when the mobile station acknowledges reception of the message. If the mobile station does not acknowledge, a time-out will occur.

Screen(s) Where Field is Present

CDMA SHORT MESSAGE SERVICE

Set Message

This field is used to select the desired forward control channel or forward voice channel message to be displayed.

The **:MESSAge** command is used to control this field.

The query form of the command (that is, **:MESSAge?**) can be used to determine which forward control channel or forward voice channel message is currently being displayed.

See "[Reading the CALL BIT Screen Message Fields](#)" on page 97 for information on how to read the contents of the individual messages.

Syntax

```
:MESSAge <'><Forward Control or Voice Channel Message Word><'>  
:MESSAge?
```

Example

```
OUTPUT 714;"CALLP:MESS 'SPC WORD1' "  
OUTPUT 714;"CALLP:MESS?"  
ENTER 714;Message$
```

Screens Where Field is Present

CALL BIT

Set Message Choices:

ACCESS

Standard Equivalent: Access Type Parameters Global Action Message

Message Fields: ACT, BIS, DCC, END, OHD, Parity, RSVD, T1T2

BSChalCon

Standard Equivalent: Base Station Challenge Order Confirmation Word

Message Fields: AUTHBS, Parity, RSVD1, RSVD2, SCC, T1T2

C-FILMESS

Standard Equivalent: Control-filler Message

Message Fields: CMAC, DCC, F1, F2, F3, F4, OHD, Parity, RSVD1, RSVD2, T1T2, WFOM

EXT PROT

Standard Equivalent: FCC Mobile Station Control Message

Message Fields: EF, MIN2, MSL, MST, Parity, SCC, T1T2

FVCBSCon

Standard Equivalent: Base Station Challenge Order Confirmation

Message Fields: AUTHBS, Parity, RSVD1, RSVD2, T1T2

FVC O Mes

Standard Equivalent: FVC Mobile Station Control Order Message

Message Fields: Local, Order, ORDQ, Parity, PSCC, RSVD, SCC, T1T2

FVC SSD1

Standard Equivalent: First SSD Update Order Word
Message Fields: Parity, RANDSSD_1, RSVD, T1T2

FVC SSD2

Standard Equivalent: Second SSD Update Order Word
Message Fields: Parity, RANDSSD_2, RSVD, T1T2

FVC SSD3

Standard Equivalent: Third SSD Update Order Word
Message Fields: Parity, RANDSSD_3, RSVD, T1T2

FVCUniqCh

Standard Equivalent: Unique Challenge Order Word
Message Fields: Parity, RANDU, RSVD, T1T2

FVC V Mes

Standard Equivalent: FVC Mobile Station Control Voice Message
Message Fields: CHAN, Parity, PSCC, RSVD, SCC, T1T2, VMAC

MRI MES

Standard Equivalent: MRI Parameter Message
Message Fields: BER, BER LSB, DSCC, EF, OE, ORDER, ORDQ, Parity, PDSCC, RSSI, T1T2

MS InVCh

Standard Equivalent: FCC Mobile Station Control Message Extended Address Word
Message Fields: CHAN, MIN2, Parity, SCC, T1T2, VMAC

MSMessOrd

Standard Equivalent: FCC Mobile Station Control Message Extended Address Word
Message Fields: Local, MIN2, ORDER, ORDQ, Parity, RSVD, SCC, T1T2,

MS WORD1

Standard Equivalent: FCC Mobile Station Control Message Abbreviated Address Word
Message Fields: DCC, MIN1, Parity, T1T2

NCH ASN

Standard Equivalent: FCC Narrow Channel Assignment Message

Message Fields: CHAN, C12, C13, DSCC, Parity, RSVD, T1T2, VMAC

NHO MES

Standard Equivalent: Narrow Handoff Message

Message Fields: CHAN, CTYP, C12, C13, DSCC, OE, Parity, PDSCC, RSVD, T1T2, VMAC

NMS FVC

Standard Equivalent: FVC Mobile Station Control Message

Message Fields: DSCC, EF, LOCAL, ORDER, ORDQ, Parity, PDSCC, RSVD, T1T2

RandChalA

Standard Equivalent: Random Challenge A Global Action Message

Message Fields: ACT, DCC, END, OHD, Parity, RANDA, T1T2

RandChalB

Standard Equivalent: Random Challenge B Global Action Message

Message Fields: ACT, DCC, END, OHD, Parity, RANDB, T1T2

RAND SSD1

Standard Equivalent: First SSD Update Order Word

Message Fields: Parity, RAND_SSD1, SCC, T1T2

RAND SSD2

Standard Equivalent: Second SSD Update Order Word

Message Fields: Parity, RAND_SSD2, SCC, T1T2

RAND SSD3

Standard Equivalent: Third SSD Update Order Word

Message Fields: Parity, RANDSSD3, RSVD1, RSVD2, SCC, T1T2

REG ID

Standard Equivalent: Registration ID Message

Message Fields: DCC, END, OHD, Parity, REGID, T1T2,

REG INC

Standard Equivalent: Registration Increment Global Action Message

Message Fields: ACT, DCC, END, OHD, Parity, REGINCR, RSVD, T1T2,

SPC WORD1

Standard Equivalent: System Parameter Overhead Message Word 1

Message Fields: DCC, NAWC, OHD, Parity, RSVD, S1D1, T1T2

SPC WORD2

Standard Equivalent: System Parameter Overhead Message Word 2

Message Fields: CPA, CMAX-1, DCC, DTX, E, END, N-1, OHD, Parity, RCF, REGH, REGR, S, T1T2

UniqChOrd

Standard Equivalent: Unique Challenge Order Word

Message Fields: Parity, RANDU, SCC, T1T2

WNHO MESS

Standard Equivalent: Wide To Narrow Handoff Message

Message Fields: CHAN, CTYP, C12, C13, DSCC, Parity, PSCC, RSVD, SCC, T1T2, VMAC

Call Bit - Set Message Field Descriptions

ACT Global Action Field.

AUTHBS Output response of the authentication algorithm initiated by the Base Station Challenge order.

BER Most significant bits of number of allowable bit errors.

BER LSB Least significant bits of number of allowable bit errors.

BIS Busy-Idle status field.

C12 Channel number bit 12 set - 10 kHz below channel number in CHAN Field.

C13 Channel number bit 13 set - 10 kHz above channel number in CHAN Field.

CHAN Channel number field. Indicates the designated voice channel.

CMAC Control mobile attenuation field. Indicates the mobile station power level associated with reverse control channel.

CMAX-1 CMAX is the number of access channels in the system.

CPA Combined paging/access field.

CTYP Channel type indicator.

DCC This field sets the digital color code.

DSCC DSAT color code for the new channel. Also represents SCC for handoff to a wide analog channel.

DTX Discontinuous transmission field.

E This field displays the extended address word sent to the mobile.

- Set to '1' if the extended address word is sent.
- Set to '0' if the extended address word is not sent.

EF Extended Protocol Forward Channel Indicator.

END End indication field.

- Set to 1 to indicate the last word of the overhead message train.
- Set to 0 if not the last word.

F1 Control filler message field 1. All bits must be set as indicated.

F2 Control filler message field 2. All bits must be set as indicated.

F3 Control filler message field 3. All bits must be set as indicated.

F4 Control filler message field 4. All bits must be set as indicated.

LOCAL This field is specific to each system. The **ORDER** field must be set to local control for this field to be interpreted.

MIN1 First part of the mobile identification number field.

MIN2 Second part of the mobile identification number field.

MSL Message Length. Extended Protocol Message Length.

MST Message Type. Extended Protocol Message Type.

N-1 N is the number of paging channels in the system.

OE The Odd/Even data field is used for adjacent channel protection.

OHD This field displays the overhead message type.

- A '100' indicates a global action message.
- A '110' indicates that this is the first word of the system overhead parameter message.
- A '111' indicates this is the second word of the system parameter overhead message.

NAWC This field displays the number of additional words coming.

ORDER This field identifies the order type.

ORDQ The order qualifier field qualifies the order confirmation to a specific action.

Parity Parity field. The contents of the Parity field cannot be set by the user. The Test Set calculates the parity bits.

PDSCC Present DSAT color code. Indicates the DAST color code associated with the present channel.

PSCC Present SAT color code. Indicates the SAT color code associated with the present channel.

RANDA The 16 most significant bits of the 32 bit RAND variable stored by a mobile for use in the authentication process.

RANDB The 16 least significant bits of the 32 bit RAND variable stored by a mobile for use in the authentication process.

RAND_SSD1 The most significant 24-bits of the random number issued by the base station in the SSD Update Order.

RANDSSD_1 The most significant 24-bits of the random number issued by the base station in the SSD Update Order.

RAND_SSD2 The subsequent 24-bits (following RANDSSD_1) of the random number issued by the base station in the SSD Update Order.

RANDSSD_2 The subsequent 24-bits (following RANDSSD_1) of the random number issued by the base station in the SSD Update Order.

RANDSSD3 The least significant 8-bits of the random number issued by the base station in the SSD Update Order.

RANDSSD_3 The least significant 8-bits of the random number issued by the base station in the SSD Update Order.

RANDU The 24 bit random number issued by the base station in the Unique Challenge Order.

RCF Read-control-filler field.

REGH Registration field for home stations.

REGID Registration ID field.

REGINCR Registration increment field.

REGR Registration field for roaming stations.

RSVD Reserved for future use.

RSVD1 Reserved for future use, all bits must be set as indicated.

RSVD2 Reserved for future use, all bits must be set as indicated.

RSSI Received Signal strength.

S This field displays whether the serial number word is sent to the mobile station.

- Set to '1' if the serial number word is sent.
- Set to '0' if the serial number word is not sent.

SCC SAT color code field.

Send Word The Send Word field sends the currently defined bits displayed in the MSMessOrd field to the mobile station.

SID1 First part of the system identification field. The field contains the decimal equivalent of the 14 most significant bits of the system identification number.

T1T2 This field identifies the received message as an order confirmation, an order, or a called address message.

VMAC This field displays the voice mobile attenuation code. It shows the mobile station's power level associated with the designated voice channel.

WFOM Wait-for-overhead-message field.

Settling

This field selects the settling time for making AF measurements. Lower frequency signals require additional settling time (**s1ow**). Higher frequency measurements require less settling time (**Fast**).

Operating Considerations

Use **s1ow** for ≤ 200 Hz signals. Use **Fast** for > 200 Hz signals.

If the signal being measured is a composite of different frequencies above and below 200 Hz, select the appropriate filtering to analyze the desired signal component.

Screens Where Field is Present

AF ANALZYER

Seqn (Order of Tests)

Selecting this field displays the TESTS (Order of Tests) screen.

Screens Where Field is Present

TESTS (Main Menu)

SID MSB

This field is used to set the system identification number (SID) of the Test Set. The **SID** field is an immediate action field. If the field is selected and changed, the signaling message(s) being sent on the forward control channel are immediately changed. No change occurs to the current state (that is, active, register, page, access, connect) of the Call Processing Subsystem.

This field is used to set the system identification number (SID) of the Test Set.

The :SIDentify command is used to control this field.

The query form of the command (that is, :SIDentify?) can be used to determine the current system identification number (SID) setting.

Syntax

```
:SIDentify <integer number>  
:SIDentify?
```

Example

```
OUTPUT 714;"CALLP:SID 231"  
OUTPUT 714;"CALLP:SID?"  
ENTER 714;Sid_number
```

Screens Where Field is Present

CALL CONTROL

SINAD

This is the default measurement for this field. Selecting this field displays the following measurement choices:

- SINAD
- Distn (Distortion)
- SNR (Signal to Noise Ratio)
- AF Freq
- DC Level
- Current (DC only)

Operating Considerations

This is a priority control field. Accessing the RX TEST or TX TEST screen overrides any changes made to this field in other screens.

For more information about SNR operation, see the [SNR field description, on page 395](#).

Screens Where Field is Present

- RX TEST
- AF ANALYZER
- TX TEST
- DUPLEX TEST
- RF GENERATOR
- RF ANALYZER

MS Ack Received (annunciator)

If the mobile telephone successfully receives the SMS message, it sends an SMS received acknowledgment to the Test Set. If the Test Set receives the acknowledgment from the mobile within a 2 second timeout period, this annunciator is lit. (The **SMS Sent** annunciator will turn off.)

If the mobile does not receive the acknowledgment within the 2 second timeout period, the Test Set will beep and the message, **Time-out occurred while waiting for SMS Ack from mobile**, will be displayed. (The **SMS Sent** annunciator will turn off in this case also.) If the acknowledgment is received after the 2 second timeout period, it will be ignored.

See Also

["Call Status" field on page 189](#)

Screens Where Field is Present

- CDMA SHORT MESSAGE SERVICE

SMS Sent (annunciator)

This annunciator indicates that the SMS message has been sent. The annunciator should light when the **Execute** is selected in the **Send Message** field.

See Also

["Call Status" field on page 189](#)

Screens Where Field is Present

CDMA SHORT MESSAGE SERVICE

SMS In Progress (annunciator)

This annunciator indicates that the mobile station has been sent an SMS Data Burst Message, and the Test Set is waiting for an SMS message acknowledgement.t.

HP-IB Example

```
"STAT:CSMS:COND?"
```

queries the CDMA SMS Status Register Condition Register. A BCD value of 1 is assigned to the SMS In Progress status bit.

See Also

CDMA SMS Status Register Group Bit Assignments in the *HP 8924C Users Guide, Status Reporting*

Screens Where Annunciator is Present

CDMA SHORT MESSAGE SERVICE

Sngl Step

This field (single step) allows you to step through an IBASIC program line-by-line.

Screens Where Field is Present

TESTS (IBASIC Controller)

SNR

When set to **SNR**, this field displays the signal to noise ratio of the input audio signal.

This field is a one-of-many field used to select the type of measurement to be made by the Audio Frequency Analyzer on the audio signal being measured. See “Measure” in the HP-IB Command Syntax chapter of the HP 8924C Condensed Programming Reference Guide for programming command syntax.

Selecting this field displays the following measurement choices:

- SINAD
- Distn (Distortion)
- SNR (Signal to Noise Ratio)
- AF Freq
- DC Level
- Current (DC only)

Operating Considerations

This is a priority control field. Accessing the RX TEST or TX TEST screen overrides any changes made to this field in other screens.

SNR Operation

- Selecting SNR turns off the other audio measurements.
- The RF Generator and AFGen1 must be set up to provide the radio’s carrier. (AFGen1 is automatically turned on and off repeatedly during this measurement.)
- AFGen2 must be turned off.
- The radio’s receiver’s audio output must be connected to the AUDIO IN port (set the **AF An1 in** field to **Audio In**).

Screens Where Field is Present

- AF ANALYZER
- RX TEST
- TX TEST
- DUPLEX TEST
- RF GENERATOR
- RF ANALYZER

Soft Slope

This field is used to enter the parameter SOFT_SLOPE.

This field is displayed only when TIA/EIA-95B is selected in the **"Protocol" field on page 344**.

HP-IB Example

```
"DISP CMOB;CDMA:MOB:PARM:SSLope 3"
```

enters 3 in the Soft Slope field.

Operating Considerations

This field setting, along with Add Intcpt and Drop Intcp control the way that the mobile station manages pilot sets during soft handoffs. These fields also affect the conditions which prompt the mobile station to send a Pilot Strength Measurement Message. Refer to ANSI TIA/EIA-95-B for additional details.

See Also

[Expected T_Add field description, on page 256](#)

[Expected T_Drop field description, on page 258](#)

[Add Intcpt field description, on page 156](#)

[Drop Intcpt field description, on page 237](#)

Softer Handoff

This field controls softer handoffs.

HP-IB Example

"CDMA : CALL : SHAN `ON` "

begins a softer handoff.

Operating Considerations

The **Connected** annunciator in the **Call Status** field must be lit before a softer handoff can be performed. Also, Sector B power must be turned on and at a power level that will allow diversity combining (the default power levels that are set when the PRESET key is pressed are acceptable). When **On** is selected, a handoff direction message is sent to the mobile station to add Sector B to its active set. The **Softer Handoff** annunciator lights until **Off** is selected or the call is terminated.

Also, a Pilot Strength Message is sent from the mobile station when a Softer Handoff is turned On or Off. The Pilot Strength Message updates the CDMA Mobile Reporting table displayed at the top of the CDMA MOBILE REPORTING screen.

See Also

[Sctr A Pwr field description, on page 377](#)

[Sctr B Pwr field description, on page 378](#)

[Keep field description, on page 281](#)

[Status field description, on page 408](#)

[PN Offset field description, on page 334](#)

[Strength field description, on page 412](#)

Screens Where Field is Present

CDMA MOBILE REPORTING

Softer Handoff (annunciator)

This annunciator is lit when **On** is selected in the **Softer Handoff** field. When the handoff is ended, the **Softer Handoff** annunciator goes out.

HP-IB Example

```
"DISP CCNT;STATus:CDMA:CONDition?"
```

queries the CDMA condition register.

Operating Considerations

During a softer handoff, a handoff direction message is sent to the mobile station to add Sector B to its active set.

See Also

[Softer Handoff field description, on page 397](#)

Screens Where Field is Present

CDMA CALL CONTROL

Span

This field is displayed when the **Controls** field is set to **Main**. This field sets the span of frequencies to be displayed on the screen.

HP-IB Example

```
"DISP CSP;CSP:SPAN 3 MHZ"
```

sets the frequency span to 3 MHz.

Operating Considerations

When the Tracking Generator is used, the span also defines the frequency sweep range.

Spans >1.5 MHz disable the AF Analyzer when the analyzer's **AF An1 In** field is set to FM Demod, AM Demod, or SSB Demod. This disables all the AF Analyzer's measurement and output functions. When the AF Analyzer's **AF An1 In** field is set to any of the other available inputs, such as Audio In or Ext Mod, the speaker and AUDIO MONITOR OUTPUT are not affected when the Spectrum Analyzer's span is changed.

The span setting is coupled to the **BW=** field.

Range of values: 10 kHz to 5 MHz

Screens Where Field is Present

SPECTRUM ANALYZER
CDMA REVERSE CHANNEL SPECTRUM

Speaker ALC

Speaker Automatic Level Control enables/disables the ALC function for the instrument's internal speaker. When **On** is selected, the speaker volume is independent of the signal level being measured. When **Off** is selected, the speaker volume is dependent on the signal level being measured.

Screens Where Field is Present

AF ANALYZER

Speaker Vol

Speaker Volume enables/disables the instrument's internal speaker. When **On** is selected, the VOLUME control knob operates normally. When **Off** is selected, the speaker is disconnected.

Screens Where Field is Present

AF ANALYZER

Spec (Pass/Fail Limits)

Selecting this field displays the TESTS (Pass/Fail Limits) screen.

Screens Where Field is Present

TESTS (Main Menu)

Spec#

The **spec#** field lists the order of selected pass/fail limits for the current procedure.

Screens Where Field is Present

TESTS (Pass/Fail Limits)

Squelch

This setting determines the squelch operation when demodulating FM, AM or SSB signals. Three settings are available:

- **Pot** uses the front-panel SQUELCH knob for squelch level adjustment.
- **Open** disables squelch operation.
- **Fixed** sets the squelch to a fixed level, disabling the front-panel SQUELCH knob control.

Operating Considerations

Most measurement processes on this screen are not displayed if the incoming signal falls below the squelch level (with the exception of **TX Power**). The measurements are replaced by four dashes (- - -) to indicate they have been 'squelched'.

The decoder and Oscilloscope measurements are also disabled when the signal has been squelched.

Spectrum Analyzer measurements are not affected by the squelch setting (although squelch still affects whether the demodulated signal can be heard while viewing the RF signal).

Trying to read a squelched measurement using HP-IB will cause your program to halt until the squelch is either turned down, a measurement is made, or until a program time-out aborts the measurement process.

Screens Where Field is Present

RF ANALYZER

Srch Win A

This field allows entry of the search-window size for the active set and candidate set.

HP-IB Example

```
"DISP CCON;CDMA:CELL:CONFigure:AWIN 5"
```

sets search-window A to 5.

Operating Considerations

The mobile station searches for the strongest pilot channel signal and usable multipath components of the pilot channel signals included in the active and candidate sets. The search-window limits the range of PN sequence offsets that the mobile station searches.

The range of values for the searcher window size is 0 to 15.

- 0 = 4 PN chips (minimum)
- 5 = 20 PN chips (default)
- 15 = 452 PN chips (maximum)

Screens Where Field is Present

CDMA CELL SITE CONFIGURATION

Srch Win N

This field allows entry of the search-window size for the neighbor set.

HP-IB Example

```
"DISP CCON;CDMA:CELL:CONFiGure:NWIN 5"
```

sets search-window N to 5.

Operating Considerations

The mobile station searches for the strongest pilot channel signal and usable multipath components of the pilot channel signals included in the neighbor set. The search-window limits the range of PN sequence offsets that the mobile station searches.

The range of values for the searcher window size is 0 to 15.

- 0 = 4 PN chips (minimum)
- 5 = 20 PN chips (default)
- 15 = 452 PN chips (maximum)

Screens Where Field is Present

CDMA CELL SITE CONFIGURATION

Srch Win R

This field allows entry of search-window size for the remaining set.

HP-IB Example

```
"DISP CCON;CDMA:CELL:CONFigure:RWIN 5"
```

sets search-window R to 5.

Operating Considerations

The mobile station searches for the strongest pilot channel signal and usable multipath components of the pilot channel signals included in the remaining set. The search-window limits the range of PN sequence offsets that the mobile station searches.

The range of values for the searcher window size is 0 to 15.

- 0 = 4 PN chips (minimum)
- 5 = 20 PN chips (default)
- 15 = 452 PN chips (maximum)

Screens Where Field is Present

CDMA CELL SITE CONFIGURATION

SSD_A=0 (annunciator)

This annunciator, when lit, indicates that SSD (Shared Secret Data) in the Test Set is 0. SSD_A=0 is the default value for SSD_A. Entering a new A-Key initializes SSD_A to 0. Performing a successful SSD Update causes this annunciator to be turned off.

See Also

[Call Status field description, on page 189](#)

[SSD Update field description, on page 407](#)

Screens Where Field is Present

CDMA AUTHENTICATION

SSDA

The :SSDA command is only available through the remote users interface. No field is displayed for this function on the test set. The user can enter a valid value into the Test Set along with other necessary shared secret data to avoid the SSD Upd process at the start of testing to reduce testing time.

SSDA is the most significant 64-bits of the SSD value stored in the mobile station. SSDA is entered as a 16-digit hexadecimal value.

The query form (that is, :SSDA?) can be used to query the current Test Set value.

Syntax

```
:SSDA <`><16 character hex value><`>  
:SSDA?
```

Example

```
OUTPUT 714;"CALLP:AMPS:AUTH:SSDA `1234567890ABCDEF`"  
OUTPUT 714;"CALLP:AMPS:AUTH:SSDA?"  
ENTER 714;Ssda_val$
```

The :SSDA:NEW command is only available through the remote users interface. No field is displayed for this function on the test set. This value can be used during authentication to replace or query the SSD-A_NEW value in the Test Set.

The :SSDA:NEW value is the most significant 64-bits of the SSD value stored in the mobile station. SSDA:NEW is entered as a 16-digit hexadecimal value.

The query form (that is, :NEW?) can be used to query the current Test Set value.

Syntax

```
:NEW <`><16 character hex value><`>  
:NEW?
```

Example

```
OUTPUT 714;"CALLP:AMPS:AUTH:SSDA:NEW `1234567890ABCDEF`"  
OUTPUT 714;"CALLP:AMPS:AUTH:SSDA:NEW?"  
ENTER 714;Ssda_new_val$
```

SSDB

The :SSDB command is only available through the remote users interface. No field is displayed for this function on the test set. The user can enter a valid value into the Test Set along with other necessary shared secret data to avoid the SSD Upd process at the start of testing to reduce testing time.

SSDB is the least significant 64-bits of the SSD value stored in the mobile station. SSDB is entered as a 16-digit hexadecimal value.

The :SSDB command is used to control this field.

The query form (that is, :SSDB?) can be used to query the current Test Set value.

Syntax

```
:SSDB <`><16 character hex value><`>
```

```
:SSDB?
```

Example

```
OUTPUT 714;"CALLP:AMPS:AUTH:SSDB `1234567890ABCDEF` "
```

```
OUTPUT 714;"CALLP:AMPS:AUTH:SSDB?"
```

```
ENTER 714;Ssdb_val$
```

The :SSDB:NEW command is only available through the remote users interface. No field is displayed for this function on the test set. This value can be used during authentication to replace or query the SSD-A_NEW value in the Test Set.

The :SSDB:NEW value is the least significant 64-bits of the SSD value stored in the mobile station. SSDB:NEW is entered as a 16-digit hexadecimal value.

The query form (that is, :NEW?) can be used to query the current Test Set value.

Syntax

```
:NEW <`><16 character hex value><`>
```

```
:NEW?
```

Example

```
OUTPUT 714;"CALLP:AMPS:AUTH:SSDB:NEW `1234567890ABCDEF` "
```

```
OUTPUT 714;"CALLP:AMPS:AUTH:SSDB:NEW?"
```

```
ENTER 714;Ssdb_new_val$
```

SSD Update

NOTE: An SSD update can be performed on the paging/access channels or on the traffic channel.

When **SSD Update Execute** is selected, an SSD Update Message is sent to the mobile station, and the **SSD Update** annunciator is lit. In response to the SSD Update Message, the mobile sends back a Base Station Challenge Order.

If the Test Set does not receive the Base Station Challenge Order from the mobile within 20 seconds, the Test Set will beep and the following message will be displayed: **No response from mobile to SSD Update request**, and the **SSD Update** annunciator will be turned off.

If the Test Set receives the Base Station Challenge Order, it sends a Base Station Challenge Confirmation Order to the mobile station. This order includes the 18-bit parameter, AUTHBS. After determining whether AUTHBS sent from the Test Set matches its computed value, the mobile station sends an SSD Update Confirmation (or Rejection) Order to the Test Set, and a message indicating the Pass/Fail status is displayed. The **SSD Update** annunciator will then be turned off.

If the SSD_A=0 annunciator was lit before the SSD Update was executed, it will be turned off.

HP-IB Example

"CDMA : AUTH : SSD"

initiates the SSD Update procedure.

Operating Considerations

A successful SSD Update requires the mobile station's A-Key to be entered in the A-Key field. The mobile station's ESN must also be entered in the **MS Database** field. If a valid ESN is not found, the Test Set will beep and display the following message: **Cannot perform SSD Update until the phone has registered.**

See Also

Authentication Tests, *HP 8924C Application Guide*

Screens Where Field is Present

CDMA AUTHENTICATION

SSD Update (annunciator)

When lit, this annunciator indicates that an SSD Update is in progress. A successful completion of SSD Update results in a **Passed** indication in the Authentication Data Table (no authentication parameters are displayed from SSD Update).

See Also

[Call Status field description, on page 189](#)

[SSD Update field description, on page 407](#)

Screens Where Field is Present

CDMA AUTHENTICATION

Status

This column in the CDMA Mobile Reporting table lists the received pilots' status.

- **Active** - pilot is a member of the Active Set
- **Candidate** - pilot is a member of the Candidate Set
- **To Drop** - pilot's signal strength has dropped below T_Drop
- **To Add** - pilot's signal strength has exceeded T_dropped below T_Drop

All numbers displayed in the CDMA Mobile Reporting table reflect the last pilot strength message received from a mobile station. A Pilot Strength Message is sent from the mobile station when a Softer Handoff is executed, ended, or when the mobile station detects a change in pilot levels that affects the assignment of pilots to the mobile station's Active, Candidate, or Neighbor sets.

The CDMA Mobile Reporting table can be cleared by selecting the **MS Report (Clear)** field.

HP-IB Example

```
"DISP CMOB;CDMA:MOB:PIL:STR?"
```

queries the results displayed in the CDMA Mobile Reporting table.

The value returned by the Test Set includes Status, PN Offset, Strength, and Keep for each pilot currently being tracked by the mobile station. These values are sent as a comma-separated list of IEEE floating point numbers, 16 characters each, ending with a line feed character.

NOTE:

If no values are displayed in the CDMA Mobile Reporting table, the query example shown above will return only the line feed character.

Programming example for Status Field

```

10 ! RE-STORE "C:\HPBASIC\READ_MRT"
20 CLEAR SCREEN
30 DIM Pil_str$(500)
40 OUTPUT 714;"CDMA:MOB:PIL:STR?"
50 ENTER 714;Pil_str$
60 Length=LEN(Pil_str$)
70 Num_pn=(Length+1) DIV 68 !Determine number of Pilots in the
table
80 FOR I=1 TO Num_pn
90 Stat(I)=VAL(Pil_str$[1;16])
100 PRINT "Pilot";I;"status is ";Stat(I)
110 Pnofst(I)=VAL(Pil_str$[18;16])
120 PRINT "Pilot";I;"PN Offset is";Pnofst(I)
130 Str(I)=VAL(Pil_str$[35;16])
140 PRINT "Pilot";I;"pilot strength is ";Str(I)
150 Keep(I)=VAL(Pil_str$[52;16])
160 PRINT "Pilot";I;"keep bit is ";Keep(I)
170 IF I<>Num_pn THEN
180 Pil_str$=Pil_str$[69,LEN(Pil_str$)] !Move to next Pilot in
the string
190 PRINT
200 END IF
210 NEXT I
220 END

```

Table 17 Status States

Decimal	Pilot Strength Level is above	Status
0	None of the settable reference levels	Candidate
1	None of the settable reference levels	To Drop
2	T_Drop	Candidate
3	T_Drop	Active
4	T_Add	Candidate
5	T_Add	To Drop
6	T_Add and T_Drop	Candidate
7	T_Add and T_Drop	Active
14	T_Add and T_Drop and T_Comp	Candidate
15	T_Add and T_Drop and T_Comp	Active

Table 17 documents the decimal numbers assigned to the Status column states. In the previous programming example, the variable Stat(I) will have one of the decimal values from **Table 17** written into it for each pilot reported.

Operating Considerations for Status Field

When a call is made, the mobile station's Active list is initialized to contain only Sector A. When Sector B's signal strength exceeds the threshold determined by the entry in the **T_Add** field, the mobile station will send a *Pilot Strength*

Measurement Message to the Test Set. The Test Set will then display “Candidate” under the **Status** column for Sector B (Sector A and Sector B are identified by their PN Offsets).

If the power level of Sector B exceeds Sector A power by more than **T_Comp*0.5 dB**, the mobile station will send another *Pilot Strength Measurement Message*, and the Sector B status will change to “To Add”, meaning that Sector B has sufficient signal strength to be added to the mobile station’s Active List.

When a softer handoff has begun, the Test Set will send a *Handoff Direction Message* to the mobile station, adding Sector B to the mobile station’s active set. The mobile station will then perform diversity combining of Sector A and Sector B. When the next *Pilot Strength Measurement Message* is sent from the mobile station, Sector A and Sector B **Status** will either be “Active” or “To Drop”. If an “Active” pilot’s signal strength is decreased to a level determined by the other Sector power and the entry in the **T_Drop** field, the status column will change to indicate “To Drop” status. Conversely, if a “To Drop” pilot’s signal strength is increased to a level determined by the other Sector power and the entry in the **T_Comp** field, the status column will change to indicate “Active” status

See Also

[Srch Win A field description, on page 402](#)

[Srch Win N field description, on page 403](#)

[Srch Win R field description, on page 404](#)

Screens Where Field is Present

CDMA MOBILE REPORTING

Status

This column in the authentication results table lists the status (pass or fail) of the parameters that are used to authenticate a registration, page, or origination. These parameters are returned from the mobile in the Access Channel Registration, Page Response Message, or Origination Message.

See Also

[Authen field description, on page 170](#)

Screens Where Field is Present

CDMA AUTHENTICATION

Steps

This field allows entry of the number of power control bits that the Test Set will send to the mobile station through the power control subchannel when the **Execute** field is selected.

HP-IB Example

```
"DISP CTXR;CDMA:PCONTrol:STEPS 100"
```

selects 100 power control bits to be sent on the power control subchannel.

Operating Considerations

Range of values: 1 through 150

See Also

[Closed Loop Pwr Cntl field description, on page 204,](#)

[Change field description, on page 193](#)

[Execute \(Closed Loop Power Control Change\) field description, on page 252](#)

Screens Where Field is Present

CDMA TRANSMITTER POWER RANGE TEST

Step#

The **Step#** field lists the order of selected tests for the current procedure.

Operating Considerations

Use the knob, up-arrow, or down-arrow key to select the step where you want to delete, replace, or insert a test.

Screens Where Field is Present

TESTS (Order of Tests)

Stop Length

This field specifies the number of stop bits used for serial communications when using the rear-panel serial port. Selecting this field displays a list of stop bit choices.

This setting is maintained after the instrument is turned off.

Screens Where Field is Present

I/O CONFIGURE

Strength

This column in the CDMA Mobile Reporting table lists the power level most recently measured and reported by the mobile station for each pilot the mobile station is currently tracking.

All numbers displayed in the CDMA Mobile Reporting table reflect the last pilot strength message received from a mobile station. Before any numbers are displayed, a call must be connected and Sector B must be transmitting at a high enough power level to cross either of two thresholds set up by the **T_Add** and **T_Comp** fields.

The CDMA Mobile Reporting table can be cleared by selecting the MS Report (Clear) field.

HP-IB Example

```
"DISP CMOB;CDMA:MOB:PIL:STR?"
```

queries the results displayed in the CDMA Mobile Reporting table.

The value returned by the Test Set includes Status, PN Offset, Strength, and Keep for each pilot currently being tracked by the mobile station. These values are sent as a comma-separated list of IEEE floating point numbers, 16 characters each, ending with a line feed character.

NOTE: If no values are displayed in the CDMA Mobile Reporting table, the query example shown above will return only the line feed character.

Programming Example for Strength Field

```
10 ! RE-STORE "C:\HPBASIC\READ_MRT"
20 CLEAR SCREEN
30 DIM Pil_str$(500)
40 OUTPUT 714;"CDMA:MOB:PIL:STR?"
50 ENTER 714;Pil_str$
60 Length=LEN(Pil_str$)
70 Num_pn=(Length+1) DIV 68 !Determine number of Pilots in the
table
80 FOR I=1 TO Num_pn
90 Stat(I)=VAL(Pil_str$[1;16])
100 PRINT "Pilot";I;"status is ";Stat(I)
110 Pnofst(I)=VAL(Pil_str$[18;16])
120 PRINT "Pilot";I;"PN Offset is";Pnofst(I)
130 Str(I)=VAL(Pil_str$[35;16])
140 PRINT "Pilot";I;"pilot strength is ";Str(I)

150 Keep(I)=VAL(Pil_str$[52;16])
160 PRINT "Pilot";I;"keep bit is ";Keep(I)
170 IF I<>Num_pn THEN
180 Pil_str$=Pil_str$[69,LEN(Pil_str$)] !Move to next Pilot in
the string
190 PRINT
200 END IF
210 NEXT I
220 END
```

Screens Where Field is Present

CDMA MOBILE REPORTING

Sync (Sector A Power)

This field allows the entry of Sync E_c , the sync channel energy per PN chip relative to the total sector power.

HP-IB Example

```
"DISP CGEN;CDMA:CELL:ASEctor:SYNC:POWer -16dB"
```

sets Sector A pilot power to -16 dB.

Operating Considerations

As the sync level is varied, OCNS is automatically adjusted so that the total power levels of pilot, sync, paging, traffic, and OCNS add up to Sector A power, I_{or} .

Screens Where Field is Present

CDMA GENERATOR CONTROL

System ID

This field allows entry of the system identification (SID).

HP-IB Example

```
"DISP CCON;CDMA:CELL:CONFigure:SID 0"
```

sets the system identification of the simulated CDMA cell site to 0.

Operating Considerations

The mobile station stores the SID number it receives from the cell site and compares it with its home SID/NID to determine if it is roaming.

Screens Where Field is Present

CDMA CELL SITE CONFIGURATION

System Type

This field is used to select the type of cellular system (AMPS, NAMPS, TACS, JTACS, NTACS, DAMPS, DCCH) to be simulated.

The **System Type** field is an immediate action field. That is, whenever the **System Type** field is changed, the change is reflected immediately in the physical configuration of the Test Set. The analog control channel is immediately de-activated, reconfigured, and then re-activated to reflect the change. This change causes the Test Set to enter the ACTIVE state.

NOTE: If the Test Set is in the connected state (**Connect** annunciator is lit) and a change is made to the **System Type** field, the connected state will be lost.

The :CSYSem command is used to control this field.

Syntax

```
:CSYSem <'><AMPS/NAMPS/TACS/JTACS/DCCH><'>  
:CSYSem?
```

Example

```
OUTPUT 714;"CALLP:CSYS 'AMPS' "  
OUTPUT 714;"CALLP:CSYS? "  
ENTER 714;System_type$
```

Screens Where Field is Present

CALL CONTROL

System Type

This field selects the type of analog system that the Test Set will attempt to handoff the mobile station to when the field titled "**Execute**" on page 252 is selected.

- **AMPS**
- **TACS**
- **JTACS** (displayed only when the **Protocol** field is set to ARIB T53)

HP-IB Example

```
"CDMA:CALL:AHANdoff:CHANnel:STYPe `AMPS`"
```

selects the AMPS system type for a CDMA to analog handoff.

Screens Where Field is Present

CDMA CALL CONTROL

Fields That Begin with the Letter T

T_Add

This field allows entry of the pilot detection threshold T_ADD.

HP-IB Example

```
"DISP CMOB;CDMA:MOBILE:TADD 32"
```

sets T_ADD to 32.

Operating Considerations

If the mobile station finds that the Sector B pilot's signal strength has exceeded T_ADD, the mobile station will send a *Pilot Strength Measurement* message to the Test Set. The Test Set will display "Candidate" in the Status column of the CDMA Mobile Reporting table for Sector B (identified by the PN Offset).

Screens Where Field is Present

CDMA MOBILE REPORTING

T_Comp

This field allows entry of the pilot detection threshold T_Comp.

HP-IB Example

```
"DISP CMOB;CDMA:MOBILE:TCOMP 3"
```

sets T_COMP to 3.

Operating Considerations

If the mobile station finds that the Sector B pilot's signal strength has exceeded Sector A by $T_COMP \times 0.5$, the mobile station will send a *Pilot Strength Measurement* message to the Test Set. The Test Set will display "To Add" in the Status column of the CDMA Mobile Reporting table for Sector B (identified by the PN Offset).

Screens Where Field is Present

CDMA MOBILE REPORTING

T_Drop

This field allows entry of the pilot drop threshold (T_DROP).

HP-IB Example

```
"DISP CMOB;CDMA:MOBILE:TDR 40"
```

sets T_DROP to 40.

Operating Considerations

When the **softer Handoff** annunciator is lit, Sector A and Sector B are added to the mobile station's Active list. If either of these pilot's signal strength falls below **T_DROP**, the mobile station starts its handoff drop timer, **T_TDROF**. If the weaker pilot's signal strength remains below **T_DROP** and the timer expires, the mobile station will send a *Pilot Strength Measurement* message to the Test Set. The Test Set will display "To Drop" in the Status column of the CDMA Mobile Reporting table for the Sector A or Sector B pilot that fell below **T_Drop** (identified by PN Offsets).

See Also

[T_TDrop field description, on page 419](#)

Screens Where Field is Present

CDMA MOBILE REPORTING

T_TDrop

This field allows entry of the handoff drop timer's value (T_DROP).

HP-IB Example

```
"DISP CMOB;CDMA:MOBILE:TDRop 2"
sets T_TDROP to 2.
```

Operating Considerations

When the **softer Handoff** annunciator is lit, Sector A and Sector B are added to the mobile station's Active list. If either of these pilot's signal strength falls below **T_DROP**, the mobile station starts its handoff drop timer, **T_TDROP**. If the weaker pilot's signal strength remains below **T_DROP** and the timer expires, the mobile station will send a *Pilot Strength Measurement* message to the Test Set. The Test Set will display "To Drop" in the Status column of the CDMA Mobile Reporting table for the Sector A or Sector B pilot that fell below **T_Drop** (identified by PN Offsets). Refer to [table 18](#).

Table 18 Handoff Drop Timer Expiration Values

T_TDROP	Timer Expiration (seconds)	T_TDROP	Timer Expiration (seconds)

See Also

[T_Drop field description, on page 418](#)

Screens Where Field is Present

CDMA MOBILE REPORTING

Test Name

This field displays the names of the tests available from the software package or program currently selected. As you turn the knob, the **Test Name** for the corresponding step appears above the test's **Description**.

Screens Where Field is Present

TESTS (Order of Tests)

Test Procedure Run Mode

This field selects how the test will be run. The underlined entry is the active choice.

- **Continuous** runs the tests in the test sequence one after another without stopping. Testing pauses only if the operator is required to interact with the UUT or Test Set. Interactions such as changing UUT channels and setting squelch and audio levels cause testing to pause. Selecting **Stop** in the **If Unit-Under-Test Fails:** field may also stop a test.
- **Single Step** runs the tests in the test sequence one at a time. The operator is prompted to press **Continue** to proceed with testing.

Screens Where Field is Present

TESTS (Execution Conditions)

Test Status

The labels under **Test Status** are highlighted by annunciators. When lit, these annunciators indicate that an event took place or that a condition exists. All status annunciators can be queried over HP-IB.

- "Connected (annunciator)" on page 421
- "Svc Opt 2/9 (annunciator)" on page 421
- "Testing (annunciator)" on page 422
- "Passed (annunciator)" on page 422
- "Failed (annunciator)" on page 422
- "Max Frames (annunciator)" on page 423

Connected (annunciator)

This annunciator indicates that the Test Set and a mobile station have completed the signaling steps required to establish a CDMA call, and the Test Set has not had any indication that the call has ended or should end.

- For a call to the mobile station (initiated by the Test Set), the mobile station must ring and then be answered before this annunciator will light. When using Service Option 2, the mobile station will automatically answer a call and go to the Connected state.
- For a call to the Test Set (initiated by the mobile station), the Test Set will automatically answer the call (if the **Answer Mode** field is set to Auto), and the **Connected** annunciator will light. If the **Answer Mode** field is set to Manual, a message will appear prompting you to press the ANS key.

When a call is terminated, this annunciator will go out.

This field is duplicated on the CDMA CALL CONTROL screen.

HP-IB Example

```
"DISP CRXT;STATus:CDMA:CONDition?"
```

queries the CDMA condition register.

Svc Opt 2/9 (annunciator)

This annunciator is lit when the Test Set is on a service option 2 (mobile station data loopback) call.

HP-IB Example

```
"DISP CRXT;STATus:CDMA:CONDition?"
```

queries the CDMA condition register.

See Also

[Traffic Data Mode field description, on page 430](#)

Testing (annunciator)

This annunciator is lit when a FER test is in progress

HP-IB Example

```
"DISP CRXT;STATUs:CDMA:CONDition?"  
queries the CDMA condition register.
```

Passed (annunciator)

This annunciator is lit when an FER test has passed. An FER test passes when the measured FER is less than the target FER (as set in the FER Spec field) with the specified confidence level (as set in the Confidence field).

Example "Passed" FER measurement

FER Spec set to 1%
Confidence set to 95%
Measured **FER** is displayed as 0.6%

With the parameters specified above, **Passed** means that the measured value of 0.6% indicates a true FER of less than 1% with a confidence level of 95%.

HP-IB Example

```
"DISP CRXT;STATUs:CDMA:CONDition?"  
queries the CDMA condition register. If bit 10 is set (a decimal value of 1024), the  
passed condition is true.
```

Failed (annunciator)

This annunciator is lit when an FER test has failed. An FER test fails when the measured FER is greater than the target FER with the specified confidence level, according to the criteria established by the confidence level and FER specification.

Example "Failed" FER measurement

FER Spec set to 1%
Confidence set to 95%
Measured **FER** is displayed as 1.4%

With the parameters specified above, **Failed** means that the measured value of 1.4% indicates a true FER of greater than 1% with a confidence level of 95%.

HP-IB Example

"DISP CRXT;STATus:CDMA:CONDition?"

queries the CDMA condition register. If bit 9 is set (a decimal value of 512), the failed condition is true.

Max Frames (annunciator)

This annunciator is lit when an FER test terminates by reaching the number of frames entered for maximum frames to test. In this case, the measured FER neither passed nor failed the FER specification with the specified confidence level within the number of frames entered into the **Max Frames** field.

HP-IB Example

"DISP CRXT;STATus:CDMA:CONDition?"

queries the CDMA condition register. If bit 8 is set (a decimal value of 256), the maximum frames condition is true.

Screens Where Field is Present

CDMA CELLULAR MOBILE RECEIVER TEST

Time

This field sets the time-of-day for the instrument's 24 hour clock.
(Example, 4:53 PM is entered **16:53**)

Operating Considerations

The internal clock still functions when the instrument is turned off.

Screens Where Field is Present

CONFIGURE

Time/div

This field selects the horizontal sweep time per division.

Operating Considerations

The time-per-division is selected from a list of choices.

Screens Where Field is Present

OSCILLOSCOPE

Time Offset

This field is displayed when Freq Error is selected from the list of choices available when the unnamed field displaying one of the following choices is displayed:

- frequency error
- amplitude error
- time offset measurement

The time offset measurement is the timing difference between the beginning of a Test Set generated frame, as measured at the Test Set's front panel connector, and the beginning of the same frame received on the reverse link.

HP-IB Example

```
"DISP CTXT;MEASure:CDManalyzer:TIME:OFFS?"
```

queries the CDMA time offset measurement result.

Operating Considerations

These measurements, along with rho, phase error, and carrier feedthrough are made by DSP analysis techniques. The **Meas Cnt1** field controls these measurements.

Time offset is referred to as time alignment in the *Waveform Quality and Frequency Accuracy Definition* (IS-98).

See Also

[Meas Cnt1 field description, on page 292](#)

[Ampl Error field description, on page 165](#)

[Freq Error field description, on page 268](#)

Screens Where Field is Present

CDMA CELLULAR MOBILE TRANSMITTER TEST

Time Offset (Negative)

This field allows setting of a negative time offset for measuring CDMA signals.

HP-IB Example

```
"CONFigure:MMToffset 'Normal'"
```

Screens Where Field is Present

CONFIGURE

Timer Reg

When **Timer Reg** is **On**, the MSUT will perform periodic timer-based registrations, with the time period settable in the **Reg Period** field.

See Also

[Reg Period field description, on page 355](#)

Screens Where Field is Present

CDMA AUTHENTICATION

TM Rho

This field displays the mobile station's measured waveform quality factor, Rho.

Rho can be measured in either of two available modes.

- Traffic Rho

Traffic Rho measures Rho when the mobile station is transmitting a reverse traffic channel. The **Connected** annunciator on the CDMA CALL CONTROL screen must be lit.

- TM (Test Mode) Rho

TM (Test Mode) Rho measures Rho when the CDMA mobile station is transmitting an unmodulated RF signal (short-spreading PN sequence only). This measurement can only be made on mobile stations with a non-industry-standard test mode provided by some mobile station manufacturers. Refer to the mobile station's service documentation for key sequences or bus commands used to put the mobile station in this mode.

The only code channel output by the Test Set during TM Rho measurements is the pilot channel. The pilot channel provides a time reference for the mobile station, and once the mobile station acquires (synchronizes to) the pilot channel, Rho measurements can be made.

HP-IB Example

```
"DISP CTXT;CDMA:MEAS:RHO `Traffic Rho`"
```

selects Traffic Rho as the current Rho measurement.

```
"DISP CTXT;MEASure:CDManalyzer:RHO?"
```

queries the current Rho measurement result.

HP-IB commands for selecting rho measurement modes are not available yet.

Operating Considerations

Rho is defined as the percentage of the mobile station's signal waveform that cross-correlates with an ideal signal waveform carrying the same data.

The default Rho measurement, Traffic Rho, should be used whenever a mobile station is capable of making a call. A Rho of 0.9444 or greater is required for the mobile station to meet EIA/TIA IS-98 standards.

Screens Where Field is Present

CDMA CELLULAR MOBILE TRANSMITTER TEST

To Screen

These fields are used to choose which of the Test Set's screens to display.

CDMA

- CALL CNTL
- CELL CONF
- CDMA GEN
- RX TEST
- TX TEST
- MOBL RPT
- RNG TEST
- REV SPEC
- SMS
- AUTHEN

Analog

- RX TEST
- TX TEST
- DUPLEX
- RF GEN
- RF ANL
- AF ANL
- AD CH PWR
- SPEC ANL
- SCOPE
- CALL CNTL

Config

- TESTS
- CONFIG
- IO CONFIG
- PRNT CNFG
- CELL CONF

Total RAM

This field displays the total amount of RAM available for IBASIC programs and save/recall registers.

Screens Where Field is Present

CONFIGURE

Traffic (Sector A Power)

This field allows the entry of Sector A traffic E_c/I_{or} , the energy per PN chip for the forward traffic channel level relative to the total sector power. The Walsh code can also be specified for the traffic channel.

HP-IB Example

```
"CDMA:CELL:ASEctor:TRAFfic:STATe ON"
```

```
"DISP CGEN;CDMA:CELL:ASEctor:TRAFfic:POWer -16dB"
```

sets Sector A pilot power to -16 dB.

```
"DISP CGEN;CDMA:CELL:ASEctor:TRAFfic:WALSh 8"
```

sets the Walsh cover for Sector A's traffic channel to 8.

Operating Considerations

As the traffic level is varied, OCNS is automatically adjusted so that the total power levels of pilot, sync, paging, traffic, and OCNS add up to Sector A power, I_{or} .

Screens Where Field is Present

CDMA GENERATOR CONTROL

CDMA CELLULAR MOBILE RECEIVER TEST

Traffic (Sector B Power)

This field allows the entry of Sector B traffic E_c/I_{or} , the energy per PN chip for the forward traffic channel level relative to the total sector power. The Walsh code can also be specified for the traffic channel.

HP-IB Example

```
"DISP CGEN;CDMA:CELL:BSECTOR:TRAFFIC:POWER -16dB"
```

sets Sector B's pilot power to -16 dB.

```
"DISP CGEN;CDMA:CELL:BSECTOR:TRAFFIC:WALSH 8"
```

sets the Walsh cover for Sector B's traffic channel to 8.

Operating Considerations

As the traffic level is varied, OCNS is automatically adjusted so that the total power levels of pilot, traffic, and OCNS add up to Sector B power, I_{or} .

Screens Where Field is Present

CDMA GENERATOR CONTROL

Traffic Data Mode

This field selects the desired service option. "Rate set 2" refers to vocoders that operate at 14.4 kips full rate.

- **Svc Opt 1** - normal traffic
- **Svc Opt 2** - data loopback
- **Svc Opt 3** - service redirection
- **Svc Opt 6** - short message service (for rate set 1)
- **Svc Opt 9** - data loopback (for rate set 2 vocoders, displayed when the **Protocol** field is set to TSB-74 or J-STD-008)
- **Svc Opt 14** - short message service (for rate set 2)
- **Svc Opt 32768** - normal traffic (for rate set 2 vocoders, displayed when the **Protocol** field is set to TSB-74 or J-STD-008)

HP-IB Example

```
"DISP CCNT;CDMA:CALL:TRAFfic:DATA:MODE `SVC OPT 1`"
```

selects service option 1.

Operating Considerations

Data loopback is used during most mobile station tests.

The desired service option can be selected at any time. If a service option change is attempted while a call is connected, and the mobile station does not respond to the message, a beep will sound and the service option will not change.

This field is duplicated on the CDMA CELLULAR MOBILE TRANSMITTER TEST, CDMA CALL CONTROL, CDMA CELLULAR MOBILE RECEIVER TEST, CDMA AUTHENTICATION, and CDMA SHORT MESSAGE SERVICE screens.

Screens Where Field is Present

CDMA CALL CONTROL
CDMA TRANSMITTER POWER RANGE TEST
CDMA CELLULAR MOBILE RECEIVER TEST
CDMA CELLULAR MOBILE TRANSMITTER TEST
CDMA SHORT MESSAGE SERVICE
CDMA AUTHENTICATION

Traffic Rho

See the [TM Rho field description, on page 426](#).

Screens Where Field is Present

CDMA CELLULAR MOBILE TRANSMITTER TEST

Transmitting (annunciator)

This annunciator lights when the Test Set is transmitting a forward CDMA channel.

When an analog screen is selected the status of the **Transmitting** annunciator when queried over HP-IB is "Off."

HP-IB Example

```
"DISP CCNT;STATUS:CDMA:COND?"
```

queries the CDMA condition register. Bit 2 will be set whenever the Transmitting annunciator is lit.

Screens Where Field is Present

CDMA CALL CONTROL
CDMA SHORT MESSAGE SERVICE
CDMA AUTHENTICATION

Trig-Delay

The trigger delay is used to specify the time relationship between the trigger and displayed signal.

- **Positive** values delay the measurement trigger by a specific period. The delayed trigger point is the left edge of the screen.
- **Negative** values perform a pre-trigger function, displaying a section of the waveform before the trigger point. The trigger point is indicated by small pointers that appear at the top and bottom of the screen.

Operating Considerations

Negative Values. The maximum negative delay cannot exceed ten divisions of the current **Time/Div** setting. For example; if the **Time/Div** field is set to 1 ms, the maximum allowed negative delay is -10 ms. Larger negative numbers cause an **Excessive negative Trig-Delay will be truncated.** message.

Positive Values. For **Time/Div** settings of 50 ms/Div and smaller, the maximum delay is 400 ms.

For **Time/Div** settings of 100 ms/Div and larger, the maximum delay is 3200 ms.

Resolution. For delays of 400 ms and less, the resolution is 6.4 ms. For delays greater than 400 ms, the resolution is 51.2 ms. All entries are rounded to the nearest multiple of 6.4 ms or 51.2 ms (depending on the delay value).

Screens Where Field is Present

OSCILLOSCOPE

Tune Freq

This field is displayed on the screens listed below when the RF Display field on the CONFIGURE screen is set to "Freq".

RF analyzer tune frequency sets the center frequency for the RF signal to be analyzed.

Operating Considerations

If the **Tune Mode** field is set to **Auto**, the frequency is set by the Test Set by finding the strongest RF signal above -36 dBm within the full bandwidth of the RF Analyzer.

If the **Tune Mode** is set to **Manual**, the operator must enter the desired frequency.

See Also

[Tune Mode field description, on page 434](#)

Screens Where Field is Present

ADJACENT CHANNEL POWER

DUPLEX TEST

RF ANALYZER

TX TEST

Tune Mode

This field is displayed on the screens listed below when the RF Display field on the CONFIGURE screen is set to "Freq".

This field selects Automatic or Manual tuning of the RF Analyzer.

Auto tuning causes the RF Analyzer to find the signal with the greatest amplitude >-36 dBm, and to set the Tune Frequency for that signal.

Manual tuning requires the operator to set the Tune Frequency for the RF signal to be analyzed.

Operating Considerations

Changing the **Tune Mode** also changes the RF frequency display. Automatic tuning enables the **TX Frequency** measurement. Manual tuning enables the **TX Freq Error** measurement.

After autotuning to the desired signal, select **Manual** tuning to prevent the **Tune Freq** from changing when the signal is no longer applied.

Screens Where Field is Present

ADJACENT CHANNEL POWER
DUPLEX TEST
RF ANALYZER
TX TEST

TX Freq Error

The **TX Freq Error** field is displayed only when the **Display** field is set to **Meas**. A numeric value would only be displayed in the connected state (that is, the **Connect** annunciator is lit).

This field displays the frequency error (error = assigned carrier frequency - measured carrier frequency) of the carrier being transmitted by the mobile station. Four dashes (----) indicates that there is no carrier frequency present to measure. See “[Measure](#)” in the HP-IB Command Syntax chapter of the *HP 8924C Condensed Programming Reference Guide* for programming command syntax.

Refer to the “[Display](#)” field on page 223 for information on how to read measurement results from this field.

Screens Where Field is Present

CALL CONTROL

TX Freq Error

This measurement area is used to display transmitter frequency error . This type of measurement displayed depends on the **Tune Mode** setting in the TX TEST, DUPLEX TEST, or RF ANALYZER screen being set to **Manual** .

See Also

[Tune Mode field description, on page 434](#)

Screens Where Field is Present

ADJACENT CHANNEL POWER
ANALOG MEAS
DUPLEX TEST
RF GENERATOR
AF ANALYZER
RF ANALYZER
TX TEST

TX Frequency

This measurement area is used to display transmitter frequency. The type of measurement displayed depends on the **Tune Mode** setting in the TX TEST, DUPLEX TEST, or RF ANALYZER screen being set to **Auto**.

See Also

[Tune Mode field description, on page 434](#)

Screens Where Field is Present

ADJACENT CHANNEL POWER
DUPLEX TEST
RF ANALYZER
TX TEST

TX Power

Transmitter Power measures RF power at the RF IN/OUT port.

Operating Considerations

Only the RF IN/OUT port can be used for measuring TX Power. When the **Input Port** is set to **Ant**, four dashes (- - - -) appear in place of digits for this measurement.

Use the Spectrum Analyzer to measure low-level RF power (≤ 200 mW) at the ANT IN port.

CAUTION: Connecting a signal of >200 mW to the ANT IN port can cause instrument damage (although internal protection circuits can typically withstand a short-duration signal of 1 or 2 Watts). If the overpower circuit is triggered (signified by a warning message at the top of the screen), remove the signal from the ANT IN port, and press the MEAS RESET key or turn the Test Set off and on to reset it.

See Also

[Input Port field description, on page 277](#)

[TX Power field description, on page 437](#)

[TX Pwr Zero field description, on page 440](#)

Screens Where Field is Present

ADJACENT CHANNEL POWER

ANALOG MEAS

DUPLEX TEST

AF ANALYZER

RF ANALYZER

RF GENERATOR

TX TEST

TX Power

This field displays the measured RF power of the carrier being transmitted by the mobile station. Four dashes (----) indicates that there is no carrier present to measure. See “[Measure](#)” in the HP-IB Command Syntax chapter of the *HP 8924C Condensed Programming Reference Guide* for programming command syntax.

A nonzero value would only be displayed in the connected state (that is, the **Connect** annunciator is lit). The **TX Power** field is only displayed when the **Display** field is set to **Meas**.

When the CALL CONTROL screen is displayed and the Test Set is in the connected state (**Connect** annunciator is lit), the mobile station’s transmitted carrier power is constantly monitored. If the power falls below 0.0005 Watts, the error message **RF Power Loss indicates loss of Voice Channel** will be displayed, and the Test Set will terminate the call and return to the active state (**Active** annunciator is lit).

NOTE:

In order to ensure that the Test Set makes the correct decisions regarding the presence of the mobile stations’s RF carrier, the Test Set’s RF power meter should be zeroed before using the Call Processing Subsystem. Failure to zero the power meter can result in erroneous RF power measurements.

Refer to the "[Display](#)" field on page 223 for information on how to read measurement results from this field.

Screens Where Field is Present

CALL CONTROL

TX Pwr Meas

This field is displayed on the screens listed below when the PCS Intrfc Control field on the CONFIGURE screen is set to “On”.

The transmitter power measurement field specifies how transmitter power measurements are made:

- **Peak** can be used to measure AM, FM, and un-modulated (CW) signals.
- **Sample** can be used to measure FM or CW signals with increased measurement speed. This method can only be used with signals having no amplitude modulation component.

Operating Considerations

If you change this field, zero the power measurement (using the **TX Pwr Zero** field) before measuring power.

Screens Where Field is Present

ADJACENT CHANNEL POWER
RF ANALYZER
TX TEST

TX Pwr Zero

The **TX Pwr Zero** function establishes a 0.0000 W reference for measuring RF power at the RF IN/OUT port. The **TX Pwr Zero** field is imported from the **RF ANALYZER** screen and is programmed exactly as it is on its home screen.

See “[RF Analyzer](#)” in the HP-IB Command Syntax chapter of the *HP 8924C Condensed Programming Reference Guide* for programming command syntax.

CAUTION: RF power must not be applied while zeroing. Set the **RF Generator** screen’s **Amplitude** field to off to prevent internal cross-coupling into the power detector while zeroing.

Operating Considerations

When power is applied to the RF IN/OUT connector, the temperature of the internal circuitry increases. This can cause changes in the TX Power measurement when low power levels are measured immediately following high power measurements.

When alternately making high and low power measurements, always zero the power meter immediately before making the low power measurements; this provides the best measurement accuracy.

Screens Where Field is Present

ADJACENT CHANNEL POWER
CALL CONTROL
CALL CONFIGURE
AF ANALYZER
RF ANALYZER
TX TEST

Type

The Type field allows you to set the FOR_TRAFFIC and REV_TRAFFIC parameters in the base station to ‘0’ (None), or ‘1’ (Primary). It appears only when Service Option 6 or Service Option 14 are selected in the Traffic Data Mode field.

HP-IB Example

```
"CDMA:CALL:TRAFfic:TYPE 'None' "
```

Screens Where Field is Present

CDMA CALL CONTROL
CDMA RX TEST
CDMA TX TEST
CDMA RANGE TEST

Fields That Begin with the Letter U

Uniq Chall

NOTE: A Unique Challenge can be performed on the paging/access channels or on the traffic channel.

When **Uniq Chall Execute** is selected, this field sends an Authentication Challenge Message to the mobile station, and the **SSD Update** annunciator is lit. In response, the mobile station sends back an Authentication Challenge Response Message (including the parameter AUTHU).

If the Test Set does not receive the Authentication Challenge Response from the mobile within 20 seconds, the Test Set will beep and the following message will be displayed: **No mobile response to Unique Challenge**. The **SSD Update** annunciator will be turned off.

If the Test Set receives the Authentication Challenge Response, it compares the **Received** parameter AUTHU to its **Expected** (computed) AUTHU value. If the values match, the **Status** column is set to **Passed** and the message , **Unique Challenge on Paging [Traffic]: Passed**. is displayed in the Authentication Data Table. The **Uniq Chall** annunciator will be turned off.

HP-IB Example

```
"CDMA : AUTH : UCH"
```

initiates a Unique Challenge-Response procedure.

Operating Considerations

A Unique Challenge verifies that the mobile station and Test Set possess the same sets of Shared Secret Data (SSD). Refer to the *HP 8924C Application Guide*, Authentication Tests, for a description of performing Unique Challenge-Response.

If a valid ESN is not found in the **MS Database** field, the Test Set will beep and display the following message: **Cannot perform SSD Update until the phone has registered**.

Screens Where Field is Present

CDMA AUTHENTICATION

Uniq Chall (annunciator)

This annunciator, when lit, indicates that a Unique Challenge has been sent to the mobile, and the Test Set is waiting for a response.

See Also

[Call Status field description, on page 189](#)

[Uniq Chall field description, on page 441](#)

Screens Where Field is Present

CDMA AUTHENTICATION

Units

The **units** column indicates the unit-of-measure used for the limits (% , dBm, kHz, and so forth).

Screens Where Field is Present

TESTS (Pass/Fail Limits)

Upper Limit

This field is used to set the upper limit to be compared with the measured results. If the measured result is above this limit, the test will fail.

Screens Where Field is Present

TESTS (Pass/Fail Limits)

User Data (ASCII or Hex)

This field accepts up to 64 ASCII or up to 128 Hex characters to be sent in an SMS Data Burst Message.

HP-IB Example

```
"CDMA:SMS:MDM `ASCII`"
```

selects "ASCII" data entry mode for the User Data field.

```
"CDMA:SMS:TERM:DATA:ASC `Call Home`"
```

enters the ASCII string "Call Home" in the User Data field.

Operating Considerations

The **Data Mode** field determines which data format, ASCII or Hex, is selected for the **User Data** field.

Screens Where Field is Present

CDMA SHORT MESSAGE SERVICE

Fields That Begin with the Letter V

VC Order

This field is used to send an order on the forward voice channel to the Mobile Station with authentication active. The **VC Order** field is only visible when authentication is activated and the mobile is assigned a voice channel.

The orders available are:

- Change Power to Power Level 0 - 7
- Maintenance (put the mobile station in maintenance mode)
- Alert (alert the mobile station)
- SSD Update (shared secret data update)
- Uniq Ch (unique challenge)

The :VCORDer command is used to send an order type mobile station control message to the mobile station. The **Access** annunciator will light momentarily while the Test Set is sending the mobile station control message.

A mobile station must be actively connected on a voice channel to the Test Set (that is, the **Connect** annunciator is lit) before attempting to send a voice channel order to a mobile station.

The query form of the command (that is, :VCORDer?) can be used to determine the last order sent to the mobile station using the :VCORDer command.

Syntax

```
:VCORDer <'><order message><'>
```

```
:VCORDer?
```

Example

```
OUTPUT 714;"CALLP:AMPS:VCORD 'CHNG PL 0' "
```

```
OUTPUT 714;"CALLP:AMPS:VCORD?"
```

```
ENTER 714;Last_ord_sent$
```

Screens Where Field is Present

CALL CONTROL

Vert/div

Vertical sensitivity sets the vertical amplitude per division.

Operating Considerations

The value for this field is selected from a list of choices.

Depending on the AF Analyzer's **AF An1 In** setting, the units for this field may be in Volts, kHz, or Percent (AM). For example; if the **AF An1 In** field is set to **FM Demod**, the amplitude is displayed in kHz/div.

Screens Where Field is Present

OSCILLOSCOPE

Vert Offset

Vertical offset moves the displayed signal above or below the oscilloscope's fixed centerline.

Operating Considerations

A centerline is displayed for the signal when an offset is used.

When the vertical offset is $\neq 0.00$, the marker level is referenced to the center line generated by the vertical offset feature, not the center line of the screen.

Screens Where Field is Present

OSCILLOSCOPE

Fields That Begin with the Letter W

Walsh (Sector A)

This column of fields displays the Walsh code for the Pilot, Sync, and Paging channels, and provides an entry field for Traffic and OCNS Walsh codes.

HP-IB Example

```
"DISP CGEN;CDMA:CELL:ASEC:TRAF:WALS 8"
```

sets Sector A's traffic channel to Walsh code 8.

Operating Considerations

The Test Set will display a warning if duplicate Walsh codes are set. The range of Walsh codes is limited to those allowed by TIA IS-95.

Screens Where Field is Present

CDMA GENERATOR CONTROL

Walsh (Sector B)

This column of fields displays the Walsh code for the Sector B Pilot channel, and provides an entry field for Sector B Traffic and OCNS Walsh codes.

HP-IB Example

```
"DISP CGEN;CDMA:CELL:BSEC:TRAF:WALS 12"
```

sets Sector B's traffic channel to Walsh code 12.

Operating Considerations

The Test Set will display a warning if duplicate Walsh codes are set. The range of Walsh codes is limited to those allowed by TIA IS-95.

Screens Where Field is Present

CDMA GENERATOR CONTROL

Fields That Begin with the Letter X

Xmt Pace

The transmit pace field is used when transmitting serial data.

- **Xon/Xoff** lets the receiving device “talk” to the Test Set to alter the rate of the data being sent.
- **None** disables the Xon/Xoff function.

This setting is maintained after the instrument is turned off.

Screens Where Field is Present

I/O CONFIGURE

Fields That Begin with a Number

1 of N

The 1 of N field instructs the Test Set how many times to send a system parameter overhead message. The message contains RAND values, RAND_A and RAND_B. The RAND values are difficult for phones which do not support authentication to parse. This field allows for testing of these phones along with the testing of phones which support authentication by altering the number of times the system parameter message is sent to the mobile station.

Syntax

:OON <integer>

:OON?

Example

```
OUTPUT 714;"CALLP:AMPS:AUTH:OON 2"
```

```
OUTPUT 714;"CALLP:AMPS:AUTH:OON?"
```

```
ENTER 714;Oon_set$
```

Screens Where Field is Present

AUTHENTICATION

meaning of, ACP level
 measurement, [155](#)
meaning of, squelch, [401](#)
meaning of, TX frequency error,
 [435](#)
meaning of, TX power
 measurement, [155](#), [437](#)

Symbols

Clr All, [303](#)
*RST, [45](#)

Numerics

1 kHz Tone
 Data Type, [216](#)
10 MHz OVEN OUT connector, [85](#)
10 MHz REF OUTPUT connector,
 [86](#)
16X CHIP OUTPUT connector, [86](#)
1X CHIP OUTPUT connector, [85](#)
24-hour clock
 setting, [423](#)
2nd DSP AUX INPUT connector,
 [85](#)
400Hz
 Data Type, [216](#)
600 ohm impedance
 at AUDIO IN, [169](#)

A

- A_Key Digits field, 163
- A_Key field, 162
- abbreviated address word
 - reverse control channel, 232
- Abort Print field, 150
- ac coupling
 - input, 264
 - output, 169
- AC Level field, 154
- ac level, peak detector, 333
- Access annunciator, 150
- access channel number, 205
- Access Prb Pwr, 151
- Access Probe annunciator, 153
- ACP, 88
 - AM transmitter, 89
 - input port, 155
 - level, 155
 - measurement, 89
 - measurement speed, 359
 - output port, 89
 - ratio, 155
- ACP key, 57
- ACP Meas field, 155
- Active annunciator, 155
- Active field, 154
- Active pilot status, 408
- Add Intcpt field
 - CDMA Mobile Reported Pilot Strength, 156
- Addr field, 156
- address
 - ADRS key, 23
 - HP-IB, external devices, 156
 - HP-IB, printer, 341
 - HP-IB, test set, 272
- Adjacent Channel Power screen
 - ACP Meas, 155
 - AFGen1 Freq, 159
 - AFGen1 To, 160
 - Carrier Ref, 190
 - Ch Offset, 203
 - Channel BW, 196
 - Ext TX key, 260
 - Input Atten, 276
 - Input Port, 277
 - Lower ACP Level, 284
 - Lower ACP Ratio, 284
 - Res BW, 359
 - Tune Freq, 433
 - Tune Mode, 434
 - TX Freq Error, 435
 - TX Frequency, 436
 - TX Power, 437
 - TX Pwr Meas, 439
 - TX Pwr Zero, 440
 - Upper ACP Level, 284
 - Upper ACP Ratio, 284
 - view of, 88
- adjacent channel power. *See* ACP
- ADRS key, 23
- AF analyzer
 - input, 157
 - signal types analyzed, 157
- AF Analyzer screen
 - AC Level, 154
 - AF Anl In, 157
 - AF Cnt Gate, 157
 - AF Freq, 158
 - AM Depth, 165
 - Audio In Lo, 169
 - Current, 212
 - DC current, 217
 - DC Level, 218
 - De-Emp Gain, 219
 - De-Emphasis, 219
 - Detector, 221
 - Distn, 236
 - Ext Load R, 260
 - Filter 1, 263
 - Filter 2, 263
 - FM Deviation, 264
 - functional block diagram, 90
 - Gain Cntl, 269
 - Input Gain, 277
 - Notch Freq, 314
 - Notch Gain, 314
 - Pk Det To, 333
 - Scope To, 377
 - Settling, 391
 - SNR, 395
 - Speaker ALC, 399
 - Speaker Vol, 400
 - TX Freq Error, 435
 - TX Power, 437
 - TX Pwr Zero, 440
 - view of, 90
- AF Anl In field, 157
- AF ANL key, 57
- AF Cnt Gate field, 157
- AF Freq field, 158, 159
- AF generator 1, level, 160
- AF generator 2, frequency, 161
- AF power, external load
 - resistance, 154
- AFGen1 Freq field, 159
- AFGen1 Lvl field, 160
- AFGen1 To field, 160
- AFGen2 Freq field, 161
- AFGen2 To field, 161
- ALC
 - disabling, 399
 - internal speaker, 399
- Alert
 - CDMA Short Message Service screen, 163
- All Chans? field, 164
- Alt Pwr Ms Cal Bands field, 164
- alternate power measurement
 - calibration band field, 164
- Always Down
 - power control, 204
- Always Up
 - power control, 204
- AM Demod, AF analyzer input, 157
- AM Depth field, 165
- AM input, 300
- AM Mod, AF analyzer input, 157
- Ampl Error field, 165, 268, 424
- amplifier
 - for distortion measurements, 314
 - for SINAD measurements, 314
- amplitude
 - effects of keying microphone, 166
 - RF generator, 166
 - vertical sensitivity, 445
- Amplitude field, 166
- AMPS
 - channel standard, 361
- AMPS Call Control screen
 - view of, 92
- AMPS Call Control screen. *See* *Also* Call Control screen
- AMPS system type, 416
- AMPS-TACS
 - simulated system, 415
- Analog Meas screen
 - AF Anl In, 157
 - AF Freq, 158
 - AF Gen1 Freq, 159
 - AFGen1 To, 160
 - Amplitude, 166
 - Current, 212
 - DC Level, 218
 - De-Emphasis, 219
 - Detector, 221
 - Distn, 236
 - Filter 1, 263
 - Filter 2, 263
 - FM Deviation, 265
 - Min Inp Lvl, 295
 - SINAD, 393
 - SNR, 395
 - TX Freq Error, 435
 - TX Power, 438
 - view of, 93
- analyzer

- calibration, 135
 - frequency, markers, 285
 - input port, 365
 - level, markers, 287
 - analyzer, RF
 - frequency, 433
 - measurements, 393
 - sensitivity, 380
 - ANS key, 23
 - answer call, 23
 - Answer Mode field, 167
 - Auto, 23, 167
 - Manual, 23, 167
 - ANT IN connector
 - avoiding damage, 277, 365, 437
 - connecting to, 365
 - for ACP ratio measurements, 155
 - for off-the-air measurements, 277, 365
 - for RF measurements, 277
 - gain at, 167
 - input attenuation, 276
 - loss at, 167
 - sensitivity, 380
 - ANTENNA IN connector
 - description, 65
 - Antenna In field, 167
 - ARIB T-53 protocol, 344
 - Arm field, 168
 - ASCII terminal, configuring, 381
 - ASSIGN key, 26
 - Atten Hold field, 168
 - Atten Hold, Output field, 322
 - attenuation
 - automatic control, 276
 - input, RF analyzer, 276
 - manual control, 276
 - attenuator
 - decoder interference, 269, 276
 - hold, 168
 - input, 276
 - oscilloscope interference, 269, 276
 - audio frequency counter
 - gate time, 157
 - sampling, 157
 - audio frequency measurements, 158, 212, 218, 236, 393, 395
 - AUDIO IN connector
 - for ac level measurement, 152, 154
 - for external load resistance measurement, 260
 - selecting, 157
 - AUDIO IN HI connector, 66
 - AUDIO IN LO connector
 - 600 ohm impedance, 169
 - description, 66
 - floating, 169
 - grounded, 169
 - Audio In Lo field, 169
 - AUDIO MONITOR OUTPUT
 - connector, 67
 - AUDIO OUT connector
 - coupling, 169
 - description, 66
 - selecting, 157
 - Audio Out field, 169
 - audio power measurement, 154
 - Authen Data Clear field, 171
 - Authen field, 170
 - Authent field, 176
 - Authentication Data Table, 171
 - CDMA Authentication screen, 171
 - Authentication screen
 - 1 of n, 448
 - A_Key, 162
 - Authent, 176
 - ESN, 251
 - RAND_A, 348
 - RAND_B, 349
 - RAND_U, 351
 - RANDSSD_1, 350
 - RANDSSD_2, 350
 - RANDSSD_3, 351
 - SSDA, 405
 - SSDB, 406
 - view of, 95
 - AuthWORD, 102, 232
 - Auto All, Range Hold, 353
 - automatic level control, 399
 - Auto/Norm field, 177
 - autoranging
 - AF/RF measurements, 352
 - gain setting, 269
 - input attenuator, 269, 276
 - Autostart Test Procedure on Power-Up field, 177
 - auto-tuning
 - AF/RF measurements, 352
 - RF, 434
 - AUX CONTROL connector, 67
 - Auxiliary
 - spectrum analyzer controls, 211
 - averaging measurements, 24
 - Avg 1-100 field, 312
 - AVG key, 24
 - Avg Power field, 178
 - AWGN field, 180
- ## B
- backspace key, 55
 - Band Class
 - CDMA Call Control, 181
 - Band Class field, 181
 - bandwidth
 - adjacent channel power, 196
 - IF filter, 274
 - resolution, ACP measurement, 359
 - Base Freq field, 182
 - Base ID field, 183
 - baud rate, 381
 - beeper
 - error alert, 183
 - volume control, 183
 - Beeper field, 183
 - BER Thresh field, 184
 - bits, serial data word, 213
 - block diagram
 - AF Analyzer, 90
 - Duplex Test screen, 119
 - RF Analyzer, 127
 - RF Generator, 129
 - RX Test, 131
 - TX Test, 147
 - brightness, display, 280
 - BSChalOrd, 102, 232
 - BW= field, 184
 - by # errors field, 185
 - by # frames field, 186

C

- C Max EIRP, 303
- C Op Modes, 303
- Calibrate field (Power Meas), 339
- calibration
 - channel power measurement, 198, 339
 - spectrum analyzer, 135
- call
 - answer, 23
 - disconnect, 28
 - paging, 27
- Call Bit screen
 - Access annunciator, 150
 - Active annunciator, 155
 - Connect annunciator, 209
 - Data Spec, 215
 - modifying the call bit screen
 - message fields, 99
 - reading the call bit screen
 - message fields, 97
 - Send Word, 380
 - Set Message, 382
 - view of, 96
- Call Configure screen
 - BER Thresh, 184
 - CMAX, 205
 - Detector, 221
 - Input Att, 275
 - Sat Tol, 375
 - TX Pwr Zero, 440
 - view of, 100
- Call Control screen
 - Access annunciator, 150
 - Active, 154
 - Active annunciator, 155
 - AF Freq, 159
 - Amplitude, 166
 - Called Number, 187
 - CC Order, 191
 - Ch Loc, 201
 - Chan, 194
 - Cntl Channel, 206
 - Connect annunciator, 209
 - Display, 223
 - Data/Meas, 223
 - DSAT, 239
 - DSAT Meas, 241
 - DSAT/DST (hex), 240
 - ESN (dec), 250
 - ESN (hex), 250
 - FM Deviation, 265
 - Handoff, 270
 - Input Att, 275
 - MS Id, 305
 - Order, 319
 - Page, 326
 - Page annunciator, 326
 - Phone Num, 330
 - Pwr Lvl, 346
 - Register, 356
 - Register annunciator, 358
 - Release, 359
 - RSSI Thresh, 370
 - SAT, 374
 - Sat Tol, 375
 - SCM, 376
 - SID, 392
 - System Type, 415
 - TX Freq Error, 435
 - TX Power, 438
 - TX Pwr Zero, 440
 - VC Order, 444
- CALL CTRL key (analog), 57
- CALL CTRL key (CDMA), 57
- Call Data screen
 - Access annunciator, 150
 - Active annunciator, 155
 - Connect annunciator, 209
 - Display Word, 231
 - Page annunciator, 326
 - reading the call data screen
 - message fields, 103
 - view of, 101
- CALL key, 27
- Call Limit field, 188
- call processing
 - description, 89
- Call Status
 - Connected, 210
 - Hard Handoff, 271
 - Page Sent, 327
 - Registering, 358
 - SMS Ack Received, 393
 - SMS Sent, 394
 - Softer Handoff, 398
 - SSD_A=0, 404
 - Transmitting, 431
 - Uniq Chall, 442
- Call Status field, 189
- called number, 303
- Called Number field, 187
- Calling Name field, 187
- CANCEL key, 27
- Candidate pilot status, 408
- card
 - procedure location, 343, 379
- carrier
 - effect on RX/TX screen, 371
- Carrier field, 190, 331
- Carrier Ref field, 190
- Carrier, RX/TX Cntl, 371
- CC Order field, 191
- CDMA Authentication screen
 - A_Key Digits, 163
 - Authen, 170
 - Authen Data Clear, 171
 - Call Status, 189
 - Check Digits, 200
 - Data Type, 216
 - Expected, 253
 - MSDatabase, 303
 - Parameter, 329
 - RAND, 348, 349
 - RANDU, 352
 - Received, 353
 - SSD Update, 407
 - SSD Update annunciator, 408
 - Status, 411
 - Timer Reg, 425
 - Traffic Data Mode, 430
 - Uniq Chall, 441
- CDMA Call Control screen
 - Access Prb Pwr, 151
 - Access Probe annunciator, 153
 - AvgPower, 178
 - Band Class, 181
 - Calibrate (Power Meas), 198, 339
 - Call Status, 189
 - Chan Power, 197
 - Chan Power Meas Intrvl, 199
 - Channel, 195
 - Data Rate, 214
 - Data Type, 216
 - Echo Delay, 244
 - Execute, 252
 - Handoff, 271
 - Ideal Mobile Power, 273
 - MS ID, 307
 - MSDatabase, 303
 - Power Meas, 339
 - Protocol, 344
 - Pwr Level, 345
 - Register, 357
 - RF Chan Std, 361
 - RF Channel, 360
 - SAT, 373
 - Sector A Power, 377
 - System Type, 416
 - Type, 440
 - VMAC (Power Level), 345
 - Zero (Power Meas), 179, 339
- CDMA Cell Configure screen
 - Max Slot Cycle Index, 291
- CDMA Cell Site Configuration screen
 - Answer Mode, 167
 - Base ID, 183
 - Call Limit, 188

- Cntry Code, 207
- Esc Mode, 249
- Init Power, 274
- Max Req Seq, 291
- Max Rsp Seq, 291
- Network ID, 310
- Netwrk Code, 310
- Nom Power, 310
- Nom Pwr Ext, 311
- Num Pages, 315
- Num Step, 315
- Page Rate, 327
- Pam Size, 328
- Power Inc, 332
- Power Step, 340
- Pwr Up Reg, 347
- Reg Period, 355
- Rgstr NIID, 369
- Rgstr SID, 370
- Srch Win A, 402
- Srch Win N, 403
- Srch Win R, 404
- System ID, 414
- CDMA Cellular Mobile Receiver
 - Test screen
 - Arm, 168
 - AWGN, 180
 - Confidence, 208
 - Data Rate, 214
 - Data Type, 216
 - Disarm, 222
 - Display Interim Results, 230
 - Eb/Nt, 243
 - Echo Delay, 244
 - Errors Counted, 248
 - FER, 261
 - FER Spec, 262
 - Frames Counted, 267
 - Max Frames, 289
 - Meas Cntl, 292
 - Sector A Power, 377
 - Test Status, 421
 - Traffic Data Mode, 430
- CDMA Cellular Mobile
 - Transmitter Test screen
 - Ampl Error, 165, 268, 424, 425
 - Arm, 168
 - Avg Power, 178
 - Calibrate (Power Meas), 339
 - Carrier, 190, 331
 - Data Rate, 214
 - Data Type, 216
 - Disarm, 222
 - Echo Delay, 244
 - Freq Error, 165, 268, 424, 425
 - Meas Cntl, 292
 - Phase Error, 190
 - Phs Error, 331
 - Power Meas, 339
 - RF Power, 369
 - Sector A Power, 377
 - Time Offset, 165, 268, 424, 425
 - TM Rho, 426
 - Traffic Data Mode, 430
 - Traffic Rho, 431
- CDMA CLOCK MUX INPUT
 - connector, 71
- CDMA CLOCK MUX OUTPUT
 - connector, 266
- CDMA Gen
 - spectrum analyzer controls, 211
- CDMA Generator Control screen
 - AWGN, 180
 - Eb/Nt, 243
 - OCNS (Sector A Power), 316
 - OCNS (Sector B Power), 317
 - Paging (Sector A Power), 328
 - Pilot (Sector A Power), 331
 - Pilot (Sector B Power), 332
 - PN Offset (Sector A Power), 336
 - PN Offset (Sector B Power), 336
 - RF Power, 369
 - Sector A Power, 377
 - Sector B Power, 378
 - Sync (Sector A Power), 414
 - Traffic (Sector A Power), 428
 - Traffic (Sector B Power), 429
 - view of, 111
 - Walsh (Sector A), 446
 - Walsh (Sector B), 446
- CDMA Mobile Reported FER
 - FER Report Clear field, 262
- CDMA Mobile Reported Pilot
 - Strength
 - Add Intcpt field, 156
 - Expected T_Add, 256
 - Expected T_Drop, 258
 - Pilot Meas Clear field, 333
 - Soft Slope, 396
- CDMA Mobile Reporting screen
 - by # errors, 185
 - by # frames, 186
 - Errors, 247
 - Expected PN Offset, 254
 - Expected Strength, 255
 - Frames, 266
 - Keep, 281
 - Mobile Parm, 297
 - MS FER, 304
 - MS FER Report Interval, 305
 - MS Report, 309
 - Pilot (Sector B Power), 332
 - PN Offset, 334
 - RF Power, 369
 - Sector A Power, 377
 - Sector B Power, 378
 - Softer Handoff, 397
 - Status, 408
 - Strength, 412
 - T_Add, 417
 - T_Comp, 417
 - T_Drop, 418
 - T_Tdrop, 419
- CDMA Reverse Channel
 - Spectrum screen
 - Avg 1-100, 312
 - BW=, 184
 - Center Freq, 192
 - Controls, 211
 - Freq (marker), 285
 - Input Atten, 276
 - Lvl (marker), 286
 - Marker Pos, 287
 - Marker To, 288
 - No Pk/Avg, 312
 - Normalize, 313
 - Output Port (RF Gen), 324
 - Pk Hold, 312
 - Ref Level, 354
 - RF Channel, 360, 364
 - RF In/Ant, 365
 - RF Power, 369
 - Sensitivity, 380
 - Span, 399
- CDMA Short Message Service
 - screen
 - SMS Ack Received, 302
- CDMA Short Message Service
 - screen
 - Alert, 163
 - Call Status, 189
 - Data Mode, 213
 - Duplicate User Data, 242
 - Encoding field, 245
 - Enter ASCII Data, 246
 - Enter Hex Data, 246
 - Length, 283
 - Message Data Mode, 292
 - MS Ack Cause Code, 300
 - MS Database, 303
 - Orig Addr, 321
 - Priority, 342
 - Privacy, 342
 - Send Msg, 379, 382
 - SMS In Progress, 394
 - Svc Opt 14, Traffic Data Mode, 430
 - Svc Opt 6, Traffic Data Mode, 430
 - Traffic Data Mode, 430

- CDMA Transmitter Closed Loop
 - Range Test screen
 - Closed Loop Pwr Cntl, 204
 - Drop Timer, 238
 - Execute, 252
 - Max Power, 290
- CDMA Transmitter Power Range
 - Test screen
 - Avg Power, 178
 - Change, 193
 - Data Type, 216
 - Echo Delay, 244
 - Ideal Mobile Power, 273
 - Min Power, 294
 - Min/Max Pwr, 296
 - Mobile Power Mode, 298
 - Output Atten Hold, 322
 - Power Meas, 339
 - Sector A Power, 377
 - Steps, 411
 - Svc Opt 1, Traffic Data Mode, 430
 - Svc Opt 2, Traffic Data Mode, 430
 - Svc Opt 32768, Traffic Data Mode, 430
 - Svc Opt 9, Traffic Data Mode, 430
 - Traffic Data Mode, 430
 - Zero (Power Meas), 339
- CDMA-to-analog handoff, 252
- CELL key, 57
- CELL SITE/TRIGGERS
 - connector, 69
- Center Freq field (analog), 192
- Center Freq field (CDMA), 192
- center frequency
 - for notch filter, 314
 - for spectrum analyzer, 192
 - RF signal, 433
 - spectrum analyzer marker, 288
- Ch Loc field, 201
- Ch Offset field, 203
- Chan: - field, 194
- Chan Power field, 197
- Chan Power Meas Intrvl field, 199
- Chan Space field, 203
- Chan Std field, 193
 - CDMA CALL CONTROL screen, 193
- Change field, 193
- channel bandwidth, ACP
 - measurement, 196
- Channel BW field, 196
- Channel field, 195
- Channel Information field, 267
- channel number
 - CDMA generator, 364
 - control channel, 206
 - channel offset, ACP
 - measurement, 203
 - channel power
 - level, 155
 - measurement, 89
 - measuring, 88
 - ratio, 155
 - channel power measurement
 - calibration
 - band selection, 164
 - channel spacing, user defined, 203
 - channel standard
 - AMPS (MS, LS), 361
 - ETACS (MS, LS), 361
 - JTACS (MS, LS), 361
 - LTR800/900 (MS, LS), 361
 - NAMPS(MSL, MSM, MSU, LSL, LSM, LSU), 361
 - NTACS (MS, LS), 361
 - TACS (MS, LS), 361
 - USER-DEF, 361
 - channel tuning, 363
 - Check Digits field, 200
 - Check field, 199
 - Chirp
 - Data Type, 216
 - Clear
 - FER Report field, 262
 - mobile reported FER, 262, 333
 - Pilot Meas field, 333
 - clear MSDatabase, 303
 - clock
 - time-of-day, 423
 - Closed Loop Pwr Cntl field, 204
 - Clr Scr field, 205
 - CMAX field, 205
 - Cnfg External Devices field, 206
 - Cntl Channel field, 206
 - Cntry Code field, 207
 - Code Location field, 207
 - COMPOSITE VIDEO connector, 71
 - Confidence field, 208
 - configuration
 - call control, 100
 - Configure screen
 - Alt Pwr Ms Cal Bands, 164
 - Antenna In, 167
 - Base Freq, 182
 - Beeper, 183
 - Chan Space, 203
 - Date, 217
 - Duplex Out, 242
 - External Reference, 259
 - Firmware, 264
 - Frame Clock, 266
 - (Gen)-(Anl), 269
 - Input Atten, 276
 - Intensity, 280
 - Notch Coupl, 314
 - Output Port, 324
 - PCS Intrfc Control, 330
 - Range Hold, 352
 - RF Display, 363
 - RF Gen Lvl, 364
 - RF Gen Volts, 365
 - RF In/Out, 366, 368
 - RF Level Offset, 367
 - RF Offset, 367
 - RX/TX Cntl, 371
 - Serial No., 381
 - Time, 423
 - Total RAM, 428
 - User Def Base Freq, 182
 - view of, 118
 - Connect annunciator, 209
 - Connected annunciator
 - Call Status, 210
 - Test Status, 421
 - connectors
 - MODULATION INPUT, 78
 - Cont/Single field, 212
 - Continue field, 211
 - control channel
 - number, call processing, 206
 - Controls field (oscilloscope), 211
 - Controls field (spectrum analyzer), 211
 - counter
 - AF, 157
 - RF, 363
 - country code, 207
 - coupling
 - ac, 169, 264
 - dc, 125, 169, 264
 - notch frequency, 314
 - current
 - measurement, dc, 158, 212, 218, 236, 393, 395
 - Current field, 212
 - customer support, HP, 9

D

- dashes
 - meaning of, ACP level measurement, 155
 - meaning of, squelch, 401
 - meaning of, TX power measurement, 155, 437
- Data Length field, 213
- data loopback
 - Service Option 2, 430
 - Service Option 32768, 430
- Data Mode
 - CDMA Short Message Service screen, 213
- Data Rate field, 214
 - Eighth, 214
 - Full, 214
 - Half, 214
 - Quarter, 214
 - Random, 214
- Data Spec field, 215
- Data Type field, 216
 - 1 kHz Tone, 216
 - 400Hz, 216
 - Chirp, 216
 - Echo, 216
 - PRBS, 216
- Data/Meas field (Display), 223
- Date field, 217
- dc coupling, 125
 - input, 264
 - output, 169
- dc current
 - zeroing measurement offset, 217
- DC Current field, 217
- DC CURRENT MEAS connector, 72
- dc level
 - measurement, 158, 212, 218, 236, 393, 395
- DC Level field, 218
- DCFM, 264
- decoder
 - input attenuator, 269, 276
 - squelch effects, 401
- DECODER key, 57
- De-Emp Gain field, 219
- de-emphasis
 - bypassing, 219
 - gain, 219
 - selecting, 219
- De-Emphasis field, 219
- Delet Ins field, 220
- Delet Stp field, 220
- Delete Ch field, 219
- Description field, 220
- detector
 - peak, 221, 333
 - rms, 221
 - selecting, 221
- Detector field, 221
- deviation
 - FM, 264
- digital supervisory audio tone, 239
- digital-to-analog handoff, 252
- Disarm field, 222
- disconnect call, 28
- disk
 - procedure location, 343, 379
- Display field, 223
 - Data/Meas, 223
 - NData/NMeas, 223
- Display Interim Results field, 230
- Display Word field, 231
- Distn field, 236
- distortion
 - measurement, 158, 212, 218, 236, 393, 395
 - measurement, amplifier, 314
 - measurement, variable notch filter, 314
- down-arrow key, 55
- Drop Timer field, 238
- DSAT Meas field, 241
- DSAT/DST (hex) field, 240
- DSP IF AUX OUTPUT connector, 72
- Dual Mode, 303
- DUPLEX key, 57
- DUPLEX OUT connector
 - avoiding damage, 324
 - description, 73
 - gain at, 242
 - loss at, 242
- Duplex Out field, 242
- Duplex Test screen
 - AC Level, 154
 - AF Anl In, 157
 - AF Freq, 158
 - AFGen1 Freq, 159
 - Amplitude, 166
 - Atten Hold, 168
 - Audio Out, 169
 - Current, 212
 - DC Current, 217
 - DC Level, 218
 - De-emphasis, 219
 - Detector, 221
 - Distn, 236
 - Ext TX key, 260
 - Filter 1, 263
 - Filter 2, 263
 - FM Coupling, 264
 - FM Deviation, 264
 - functional block diagram, 119
 - IF Filter, 274
 - Input Port, 277
 - Output Port, 324
 - RF Gen Freq, 364
 - SINAD, 393
 - SNR, 395
 - Tune Freq, 433
 - Tune Mode, 434
 - TX Freq Error, 435
 - TX Frequency, 436
 - TX Power, 437
 - view of, 119
- Duplicate User Data field, 242

E

Eb/Nt field, 243
Echo
 Data Type, 216
Echo Delay field, 244
EEX key, 28
electronic serial number
 decimal, 250
 hexadecimal, 250
electronic serial number (ESN),
 251
emf voltage, 364, 365
ENCODER key, 57
Encoding field, 245
END CALL key, 28
Enter ASCII Data field, 246
Enter Hex Data field, 246
ENTER key, 28
Enter Procedure Filename field,
 247
error messages
 IBASIC, 273
Errors Counted field, 248
Errors field, 247
Esc Mode field, 249
escape mode, 249
ESN, 303
ESN (dec) field, 250
ESN (hex) field, 250
ESN field, 251
ETACS channel standard, 361
EVEN SEC INPUT connector, 74
Exec Execution Cond field, 253
Execute
 SSD Update, 407
Execute field (CDMA-to-Analog
 handoff), 252
Execute field (power control), 252
Execute field (power
 measurement), 296
Expected field, 253
Expected PN Offset field, 254
Expected Strength field, 255
Expected T_Add field
 CDMA Mobile Reported Pilot
 Strength, 256
Expected T_Drop field
 CDMA Mobile Reported Pilot
 Strength, 258
exponents, 28
Ext Load R field, 260
Ext TX Key field, 260
extended address word
 reverse control channel, 232
external AM input, 300
External Devices field, 206

External Disk Specification field,
 259
external FM input, 300
external load resistance, 154, 260
external modulation input, 300
External Reference field, 259

F

Failed annunciator
 Test Status, 422
FER field, 261
FER Report Clear field, 262, 333
Fer Spec field, 262
FF at End field, 262
FF at Start field, 263
filename
 procedure to load, 378
 procedure to save, 247
files
 saving, 247
 selecting, 378
Filter 1 field, 263
Filter 2 field, 263
filters
 IF bandwidth, 274
 IF, for ACP measurements, 359
 variable notch, 314
Firmware field, 264
firmware revision number, 264
first word of called address, 232
floating input at AUDIO IN LO,
 169
FM
 deviation measurement, 264
 input, 300
FM Coupling field, 264
FM Demod, AF analyzer input,
 157
FM Deviation field, 264
FM Deviation field (call control),
 265
FM Mod, AF analyzer input, 157
form feed, 262
forward control channel
 modifying messages, 96
 turning on, 154
forward voice channel
 modifying messages, 96
four dashes
 meaning of, ACP level
 measurement, 155
 meaning of, squelch, 401
 meaning of, TX frequency error,
 435
 meaning of, TX power
 measurement, 155, 437
Frame Clock field, 266
Frames Counted field, 267
Frames field, 266
Freq Channel Information field,
 267
Freq Error field, 165, 424
Freq Error field (CDMA), 268
Freq field (marker), 285

frequency
 AFGen1, 159
 AFGen2, 161
 carrier, ACP measurement, 190
 center, for notch filter, 314
 center, for spectrum analyzer, 192
 center, RF signal, 433
 effects of RF offset, 367
 measurement, 436
 offset RF generator/analyzer, 269
 RF generator, reference, 182
 setting, 363, 364
 span, 399
 spectrum analyzer, 285
 tuning, 434
frequency error
 measurement, 435
frequency offset
 tracking generator, 317

G
gain
 automatic control, 269
 between ANT IN and device-under-test, 167
 between DUPLEX OUT and device-under-test, 242
 between RF IN/OUT and device-under-test, 366, 368
 de-emphasis, 219
 input, 277
 manual control, 269
 notch filter, 314
Gain Cntl field, 269
gate time, 157
 RF counter, 363
GEN CTRL key, 57
(Gen)-(Anl) field, 269
generator, AF
 frequency, 159, 161
 level, 160
generator, RF
 amplitude, 166
 frequency, 364
 output port, 324, 337
 reference frequency, 182
generator, tracking
 frequency, 192
 frequency offset, 317
 output port, 337
 sweep, 337
 sweep frequency range, 399
grounded input
 at AUDIO IN LO, 169

H
Handoff field, 270
Hard Handoff annunciator, 271
heading for printout, 323, 341
Help screen
 view of, 121
HI LIMIT key, 36
Hold All
 Range Hold, 353
HOLD key, 29
horizontal sweep, oscilloscope, 423
HP-IB
 address, displaying, 23
 address, external devices, 156
 address, printer, 341
 address, test set, 272
 non-programmable front-panel functions, 58
HP-IB Address field, 272
HP-IB connector, 75
HP-IB operation, squelch effects, 401

I

I/O Configure screen
 Data Length, 213
 HP-IB Address, 272
 IBASIC Echo, 273
 Inst Echo, 279
 Mobile Pwr, 299
 Mode, 299
 Parity, 329
 Rcv Pace, 353
 Save/Recall, 376
 Serial Baud, 381
 Serial In, 381
 Stop Length, 412
 view of, 122
 Xmt Pace, 447
IBASIC controller
 configuring, 381
IBASIC Echo field, 273
IBASIC error messages, 273
IBASIC IBASIC Cntrl field, 273
Ideal Mobile Power field, 273
IF filter bandwidth, selecting, 274
IF Filter field, 274
If Unit-Under-Test Fails field,
 274
INCR ³10 key, 30
INCR SET key, 30
INCR x10 key, 30
indicators, oscilloscope input, 125
Init Power field, 274
input
 analyzer, 365
 audio, 600 ohm impedance, 169
 audio, floating, 169
 audio, grounded, 169
 coupling, 264
 gain, 277
 oscilloscope, 125
 RF, 277
 spectrum analyzer, 365
Input Att field, 275
Input Atten field, 276
input attenuation
 automatic control, 276
 manual control, 276
 setting, 276
input attenuator
 decoder interference, 269, 276
 oscilloscope interference, 269,
 276
Input Gain field, 277
Input Port field, 277
Insert Ch field, 278
Insrt Stp field, 279
Inst Echo field, 279
Inst# field, 279

Intensity field, 280
interactions
 high-power/low-power
 measurements, 440
 Range Hold and other fields,
 352
 RF generator/analyzer, RF
 offset, 367
 RX/TX screen automatic
 changes, 371
internal clock, date, 217
Internal field, 280
IS-95 protocol, 344
IS-95A protocol, 344
IS-95B protocol, 344

J

J-Std-008 protocol, 344
JTACS channel standard, 361
JTACS simulated system, 415
JTACS system type, 416

K

k1' through k3', 61
Keep field, 281
keyboard
 external, 381
keying
 effect on amplitude, 166
 external transmitter, 260
keys
 ACP, 57
 ADRS, 23
 AF ANL, 57
 ANS, 23
 ASSIGN, 26
 AVG, 24
 backspace, 55
 CALL, 27
 CALL CTRL, 57
 CALL CTRL, analog, 57
 CANCEL, 27
 CELL, 57
 DATA FUNCTIONS, 59
 DECODER, 57
 down-arrow, 55
 DUPLEX, 57
 EEX, 28
 ENCODER, 57
 END CALL, 28
 ENTER, 28
 GEN CTRL, 57
 HI LIMIT, 36
 HOLD, 29
 INCR (div)10, 30
 INCR SET, 30
 INCR x10, 30
 K1 - K5, 34
 K1' - K3', 34
 LO LIMIT, 36
 LOCAL, 35
 MEAS RESET, 40
 METER, 40
 MS RPT, 57
 NO, 53
 ON/OFF, 44
 POWER, 46
 PRESET, 45
 PREV, 45
 PRINT, 45
 RANGE, 57
 RECALL, 47
 REF SET, 47
 RELEASE, 50
 RF ANL, 57
 RF GEN, 57
 RX TEST, analog, 57
 RX TEST, CDMA, 57
 SAVE, 51

SCOPE, 57
SHIFT, 52
SPEC ANL, 57
SPECTRUM, 57
TX TEST, analog, 57
TX TEST, CDMA, 57
 unit-of-measure, 55
 up-arrow, 55
USER, 61
YES, 53
KOR PCS protocol, 344

L

leakage
 ACP measurement, 359
Length field, 283
level
 ACP, 155
 AF generator 1, 160
 oscilloscope, 286
 reference for spectrum analyzer,
 354
 spectrum analyzer, 287
Level (div) field, 283
Library field, 283
Lines/Page field, 284
LO LIMIT key, 36
load, external resistance, 154, 260
LOCAL key, 35
loss
 between ANT IN and
 device-under-test, 167
 between DUPLEX OUT and
 device-under-test, 242
 between RF IN/OUT and
 device-under-test, 366, 368
Lower ACP Level field, 284
Lower ACP Ratio field, 284
Lower Limit field, 284
low-level RF power
 measurements, 437
LTR800/900 channel standard,
 361
Lvl (marker) field, 286

M

- Main
 - spectrum analyzer controls, 211
- Main Menu field, 285
- manual operation, 35
- manual tuning, 434
- Marker
 - spectrum analyzer controls, 211
- Marker Pos field, 287
- Marker To field (scope), 287
- Marker To field (spectrum analyzer), 288
- markers
 - frequency, 285
 - level, 286
 - oscilloscope, 287
 - oscilloscope, peak+, 287
 - position, 287
 - spectrum analyzer, 288
 - spectrum analyzer, center frequency, 288
 - spectrum analyzer, peak, 288
 - spectrum analyzer, reference level, 288
 - time, 287
 - triggering, 287
- Max EIRP, 303
- Max Frames annunciator
 - Test Status, 423
- Max Frames field, 289
- Max Power field, 290
- Max Req Seq field, 291
- Max Rsp Seq field, 291
- Max Slot Cycle Index field, 291
- Meas Cntl field, 292
- MEAS RESET key, 40
- MEAS TRIGGER connector, 76
- measurement accuracy, gain control for, 269
- measurement accuracy, zeroing for, 217
- measurement accuracy, zeroing power for, 440
- measurement averaging, 24
- measurement settling, 391
- measurement speed, ACP measurement, 359
- measurements
 - ac level, 154
 - ac level, peak detector, 333
 - ACP reference, 190
 - adjacent channel power, 88, 89
 - audio frequency, 158, 212, 218, 236, 393, 395
 - audio power, 154
 - current, dc, 158, 212, 218, 236, 393, 395
 - dc level, 158, 212, 218, 236, 393, 395
 - distortion, 158, 212, 218, 236, 393, 395
 - FM deviation, 264
 - frequency error, transmitter, 435
 - frequency, transmitter, 436
 - RF power, 437
 - rms potential, 154
 - signal/noise ratio, 158, 212, 218, 236, 393, 395
 - SINAD, 158, 212, 218, 236, 393, 395
 - SNR, 158, 212, 218, 236, 393, 395
 - Test Mode (TM) Rho, 426
 - Traffic Rho, 426
 - transmitter power, 437
 - voltage, 154
- memory, total RAM, 428
- message
 - beeper alert, 183
 - IBASIC error, 273
- Message Data Mode field, 292
- Message screen
 - view of, 123
 - See Also* error messages
- METER key, 40
- Mic Pre-Emp field, 293
- MIC/ACC connector
 - description, 76
 - for keying external transmitter, 260
 - selecting, 157
- microphone, 166
 - pre-emphasis, 293
 - push-to-talk, 371
- MIN, 303, 307
- Min Inp Lvl field, 295
- Min Power field, 294
- Min/Max Pwr field, 296
- Mobile Data Burst with
 - Authen:Failed message, 170
- Mobile Data Burst with
 - Authen:Passed message, 170
- Mobile Parm field, 297
- Mobile Power Mode field, 298
- Mobile Pwr field, 299
- Mod In To field, 300
- Mode field, 299
- Model field (instrument), 299
- Model: field (printer), 300
- modulation
 - carrier, ACP reference measurement, 190
 - external AM, 300
 - external, FM, 300
 - external, input, 300
 - input, 300
 - input, coupling, 264
 - sensitivity, input, 300
- MODULATION INPUT connector
 - coupling, 264
 - description, 78
 - for modulating RF generator, 300
- MRI Ord, 102, 232
- MS Ack Cause Code, 300
- MS Ack Received annunciator, 302
- MS FER field, 304
- MS FER Report Interval field, 305
- MS ID field, 307
- MS Id field, 305
- MS Report field, 309
- MS RPT key, 57
- MSDatabase field, 303

N

n Down
 power control bits, 193
n Up
 power control bits, 193
names, for printouts, 323, 341
NAMPS channel standard, 361
NAWC, 234
NData/NMeas field (Display), 223
negative edge triggering, 283
Network ID field, 310
Netwrk Code field, 310
NO key, 53
No Pk/Avg field, 312
Nom Power field, 310
Nom Pwr Ext field, 311
non-programmable front-panel
 functions, 58
Normalize field, 313
Notch Coupl
 used with variable notch, 314
Notch Coupl field, 314
notch filter
 gain, 314
 variable, 314
Notch Freq field, 314
Notch Gain field, 314
NRVC Ord, 102, 232
NTACS channel standard, 361
Num Pages field, 315
Num Step field, 315

O

OCNS (Sector A Power) field, 316
OCNS (Sector B Power) field, 317
offset
 frequency, RF
 generator/analyzer, 269
 frequency, tracking generator,
 317
 measurement, zeroing, 217
 RF generator/analyzer, 367
 RF level, 367
 vertical, oscilloscope, 286, 445
Offset Freq field (Tracking Gen),
 317
off-the-air measurements, 277,
 365
ON/OFF key, 44
Open Loop
 power control, 204
Options field, 318
Order field, 319, 321
Order Of Tests field, 391
Origination with Authen:Failed
 message, 170
Origination with Authen:Passed
 message, 170
oscilloscope
 input, 125
 input attenuator, 269, 276
 level, markers, 286
 marker types, 287
 markers, level, 286
 resolution, 377
 scale, 337
 signal source, 377
 squelch effects, 401
Oscilloscope screen
 Auto/Norm, 177
 Cont/Single, 212
 Controls, 124, 211
 Internal, 280
 Level (div), 283
 Lvl (marker), 286
 Marker To, 287
 Output Port, 324
 Position, 337
 Reset, 359
 Time (marker), 287
 Time/div, 423
 Trig-Delay, 432
 Vert Offset, 445
 Vert/div, 445
 view of, 124
output
 coupling, 169
 RF, 324, 337
 tracking generator, 337

Output Atten Hold field, 322
Output Heading field, 323
Output Port field, 324
Output Results For field, 325
Output Results To field, 325
overpower
 at RF IN/OUT connector, 277,
 365
 damage, at ANT IN connector,
 437
 damage, at DUPLEX OUT, 324
 warning, 277, 365

P

- P Max EIRP, 303
- P Op Modes, 303
- Page annunciator, 326
- Page field, 326
- Page Rate field, 327
 - Full, 327
 - Half, 327
- Page Sent annunciator, 327
- Page with Authen:Failed message, 170
- Page with Authen:Passed message, 170
- Paging field (Sector A Power), 328
- paging mobile station, 27
- Pam Size field, 328
- PARALLEL PORT connector, 79
- Parameter field, 329
- Parity field, 329
- Parm Test Parameters field, 329
- Pass Word field, 329
- Pass/Fail Limits field, 400
- Passed annunciator
 - Test Status, 422
- PCS Intrfc Control field, 330
- peak
 - hold, spectrum analyzer, 312
 - spectrum analyzer marker, 288
- peak detector, 221, 333
 - signal source, 333
- peak+
 - oscilloscope marker, 287
- Phase Error field, 190
- Phone Num field, 330
- phone number
 - called by mobile, 187
 - mobile station, entering, 307
 - mobile station, reading, 303
- phone numbers, HP customer support, 9
- Phs Error field, 331
- Pilot field (Sector A Power), 331
- Pilot field (Sector B Power), 332
- pilot status
 - Active, 408
 - Candidate, 408
 - To Add, 408
 - To Drop, 408
- Pk Det To field, 333
- Pk Hold field, 312
- PN Offset field, 334
- PN Offset field (Sector A Power), 336
- PN Offset field (Sector B Power), 336
- Port/Sweep field (Tracking Gen), 337
- Position field, 337
- positive edge triggering, 283
- power control
 - Always Down, 204
 - Always Up, 204
 - closed loop, 204
 - off, 204
 - open loop, 204
- POWER DET connector, 80
- Power Inc field, 332
- POWER key, 46
- Power Meas field, 339
- power meter zeroing, 440
- Power Step field, 340
- power, zero reference, 440
- PRBS
 - Data Type, 216
- pre-emphasis
 - automatic control, 293
 - bypassing, 293
 - manual control, 293
 - microphone, 293
- PRESET key, 45
- PREV key, 45
- Print All field, 340
- Print Configure screen
 - Abort Print, 150
 - FF at End, 262
 - FF at Start, 263
 - Model:, 300
 - Print Data Destination, 340
 - Print Title, 341
 - Printer Address, 341
 - view of, 126
- Print Data Destination field, 340
- PRINT key, 45
- Print Printer Setup field, 341
- Print Title field, 341
- printer
 - connecting, 341
 - model, 300
- Printer Address field, 341
- Printer Port field, 341
- Printer Setup field, 341
- printing
 - aborting, 150
 - form feed, 262
 - lines per page, 284
 - printer address, 341
 - printer model, 300
 - screens, 126
 - selecting printer port, 341
 - title, 323, 341
- Priority
 - CDMA Short Message Service screen, 342
- priority fields, 157, 158, 160, 161, 166, 212, 218, 219, 221, 236, 393, 395
- Privacy
 - CDMA Short Message Service screen, 342
- Proc Save/Delete Procedure field, 343
- Procedure Library field, 343
- Program field, 343
- programming language, 136
- PROTOCOL DIAG connector, 80
- Protocol field, 344
- PTT
 - RX/TX Cntl, 371
- push to talk, 371
- Pwr Class, 303
- Pwr Level field (VMAC), 345
- Pwr Lv field, 346
- Pwr Step, 303
- Pwr Up Reg field, 347

R

- RAM
 - procedure location, 343, 379
 - total available, 428
- Ramp
 - power control bits, 193
- RAND field
 - CDMA Authentication, 348, 349
- RAND_A field, 348
- RAND_B field, 349
- RAND_U field, 351
- RANDSSD_1 field, 350
- RANDSSD_2 field, 350
- RANDSSD_3 field, 351
- RANDU field, 352
- Range Hold field, 352
- RANGE key, 57
- rate set 2
 - Service Option 32768, 430
 - Service Option 9, 430
 - Traffic Data Mode, 430
- Rcv Pace field, 353
- RECALL key, 47
- RECCW A, 102, 232
- RECCW B, 102, 232
- RECCW C, 102, 232
- RECCW D, 102, 232
- RECCW E, 102, 233
- receive pace, 353
- Received field, 353
- REF INPUT connector
 - description, 81
 - setting an external reference, 259
- Ref Level field, 354
- REF SET key, 47
- reference
 - carrier, ACP, 190
 - frequency, ACP measurement, 190
 - level, spectrum analyzer, 354
 - setting, 287
 - transmitter power, zero, 440
- Reg Period
 - CDMA Cell Site Configuration screen, 355
- Register annunciator, 358
- Register field (analog), 356
- Register field (CDMA), 357
- Registering annunciator
 - Call Status, 358
- Registration Type: field, 170
- Registration with Authen:Failed message, 170
- Registration with Authen:Passed message, 170
- Release field, 359
- RELEASE key, 50
- remote operation
 - mode, 299
 - squelch effects, 401
- Res BW field, 359
- reset
 - measurement, 40
- Reset field, 359
- resolution
 - bandwidth, ACP measurement, 359
 - bandwidth, spectrum analyzer, 135
 - oscilloscope, 377
- reverse control channel
 - message viewing, 231
- reverse RF power, 324
- reverse voice channel
 - message viewing, 231
 - order confirmation message, 233
- revision number
 - firmware, 264
- RF Analyzer screen
 - AC Level, 154
 - AF Freq, 158
 - AM Depth, 165
 - Amplitude, 166
 - Current, 212
 - DC Current, 217
 - DC Level, 218
 - Distn, 236
 - Ext TX key, 260
 - FM Deviation, 264
 - functional block diagram, 127
 - IF Filter, 274
 - Input Atten, 276
 - Input Port, 277
 - Min Inp Lvl, 295
 - Output Port, 324
 - RF Channel, 360
 - RF Cnt Gate, 363
 - Sensitivity, 380
 - SINAD, 393
 - SNR, 395
 - Squelch, 401
 - Tune Freq, 433
 - Tune Mode, 434
 - TX Freq Error, 435
 - TX Frequency, 436
 - TX Power, 437
 - TX Pwr Zero, 440
 - view of, 127
- RF ANL key, 57
- RF auto-tuning, 434
- RF Chan Std field, 361
- RF Channel field (analog), 360
- RF Channel field (CDMA), 360
- RF Cnt Gate field, 363
- RF counter
 - sampling, 363
- RF Display field, 363
- RF Gen Freq field, 364
- RF GEN key, 57
- RF Gen Lvl field, 364
- RF Gen Volts field, 365
- RF generator
 - amplitude, 166
 - frequency, 364
 - output, 337
 - output port, 324
- RF Generator screen
 - AF Freq, 158
 - AFGen1 Freq, 159
 - AFGen1 To, 160
 - AFGen2 Freq, 161
 - AFGen2 To, 161
 - AM Depth, 165
 - Amplitude, 166
 - Atten Hold, 168
 - Audio Out, 169
 - Current, 212
 - DC Current, 217
 - DC Level, 218
 - Distn, 236
 - FM Coupling, 264
 - FM Deviation, 264
 - functional block diagram, 129
 - Mic Pre-Emp, 293
 - Mod In To, 300
 - Output Port, 324
 - RF Gen Freq, 364
 - SINAD, 393
 - SNR, 395
 - TX Freq Error, 435
 - TX Frequency, 436
 - view of, 129
- RF In/Ant field, 365
- RF IN/OUT connector
 - description, 82
 - for ACP level measurements, 155, 277, 365
 - for ACP ratio measurements, 155
 - for measuring high-power devices, 337
 - for measuring transmitter power, 277, 365
 - for RF measurements, 277, 365
 - for testing transceivers, 324
 - gain at, 366, 368
 - input attenuation, 276
 - loss at, 366, 368
 - power measured at, 437

- RF In/Out field, 366, 368
- RF input
 - selecting port, 277
- RF Level Offset field, 367
- RF Offset field, 367
- RF output
 - selecting port, 324, 337
- RF power
 - exceeding limits, 277, 365
 - measurement, 437
 - zero reference, 440
- RF Power field, 369
- Rgstr NID field, 369
- Rgstr SID field, 370
- rho
 - test mode measurement, 426
 - traffic measurement, 426
- rms
 - detector, 221
 - measurement, 154
- ROM
 - procedure location, 343, 379
- RSSI Thresh field, 370
- *RST, 45
- Run field, 372
- Run Test field, 372
- RVCBSChal, 102, 233
- RVCOrd, 102, 233
- RVCOrdCon, 102, 233
- RX TEST key (analog), 57
- RX TEST key (CDMA), 57
- RX Test screen
 - AC Level, 154
 - AF Freq, 158
 - AFGen1 To, 160
 - AFGen2 Freq, 161
 - AFGen2 To, 161
 - Amplitude, 166
 - Atten Hold, 168
 - Current, 212
 - DC Current, 217
 - DC Level, 218
 - Distn, 236
 - Ext Load R, 260
 - Filter 1, 263
 - Filter 2, 263
 - FM Coupling, 264
 - functional block diagram, 131
 - Output Port, 324
 - RF Gen Freq, 364
 - RX Test screen, 159
 - SINAD, 393
 - SNR, 395
 - Tune Mode, 434
 - view of, 131
- RX/TX Cntl field, 371
 - Auto, 371
- Carrier, 371
 - Manual, 371
 - PTT, 371
- S**
- sampling
 - AF counter, 157
 - RF counter, 363
- SAT color code, 373
- SAT field (analog), 374
- SAT field (CDMA), 373
- Sat Tol field, 375
- SAVE key, 51
- Save/Delete Procedure field, 343
- Save/Recall field, 376
- scale for oscilloscope, 337
- SCC (SAT color code), 373
- schematic diagrams. *See* block diagram
- scientific notation, 28
- SCM
 - Dual Mode, 303
 - Pwr Class, 303
 - Slot Class, 303
 - Tx Mode, 303
- SCM field, 376
- scope
 - horizontal sweep, 423
 - input, 125
 - level, markers, 286
 - markers, 286
 - vertical offset, 445
- SCOPE key, 57
- Scope To
 - AF Analyzer screen, 125
- Scope To field, 377
- screen dump, 126
- screens
 - printing, 126
 - RX/TX screen interactions, 371
 - setting intensity, 280
- second word of called address, 233
- Sector A Power field, 377
- Sector B Power field, 378
- Select Procedure Filename field, 378
- Select Procedure Location field, 379
- Send Msg
 - CDMA Short Message Service screen, 382
- Send Msg field, 379
- Send Word field, 380
- sensitivity
 - adverse effects on measurements, 380
 - ANT IN, 380
 - modulation input, 300
- Sensitivity field, 380
- Seqn Order Of Tests field, 391
- Serial Baud field, 381

- serial data word
 - bits, 213
- Serial In field, 381
- Serial No. field, 381
- serial number, 381
 - electronic (ESN), 251
 - electronic, decimal, 250
 - electronic, hexadecimal, 250
- serial number word, 232
- SERIAL PORT connector, 83
- Service Option 14, 430
- Service Option 2, 421
- Service Option 32768, 430
- Service Option 6, 430
- Service Option 9, 421
- Set Message field, 382
- Settling field, 391
- settling time
 - AF measurements, 391
- SHIFT key, 52
- SID field, 392
- signal/noise ratio
 - operation, 395
- SINAD
 - measurement, 158, 212, 218, 236, 393, 395
 - measurement, amplifier, 314
 - measurement, variable notch filter, 314
- SINAD field, 393
- Slot Class, 303
- SMS Ack Received annunciator
 - Call Status, 393
- SMS In Progress annunciator, 394
- SMS Sent annunciator
 - Call Status, 394
- Sngl Step field, 394
- SNR
 - AF Analyzer screen, 395
 - measurement, 158, 212, 218, 236, 393, 395
 - operation, 395
- Soft Slope field, 396
- Softer Handoff annunciator
 - Call Status, 398
- Softer Handoff field, 397
- software, running, 136
- source
 - oscilloscope, 377
 - peak detector, 333
- span
 - effect on AF analyzer, 399
 - spectrum analyzer, 135
- Span field, 399
- speaker
 - ALC, 399
 - disabling, 400
 - volume control, 400
- Speaker ALC field, 399
- Speaker Vol field, 400
- SPEC ANL key, 57
- Spec Pass/Fail Limits field, 400
- Spec# field, 400
- specifications, setting limits, 141
- spectrum analyzer
 - calibration, 135
 - frequency, markers, 285
 - input port, 365
 - level, markers, 287
 - markers, 288
 - markers, frequency, 285
 - markers, level, 287
 - measuring low-level RF power, 437
 - resolution bandwidth, 135
 - span, 135
 - squelch effects, 401
 - sweep rate, 135
 - traces, 313
 - use of, 437
- Spectrum Analyzer screen
 - Center Freq, 192
 - Controls, 211
 - Freq (marker), 285
 - Input Atten, 276
 - Lvl (marker), 286
 - Marker To, 288
 - No Pk/Avg, 312
 - Normalize, 313
 - Offset Freq (Tracking Gen), 317
 - Output Port, 324
 - Port/Sweep (Tracking Gen), 337
 - Ref Level, 354
 - RF Channel, 360
 - RF Gen Freq, 364
 - RF In/Ant, 365
 - Sensitivity, 380
 - Span, 399
 - view of, 134
- SPECTRUM key, 57
- spurs, ACP measurement, 359
- squelch
 - effects on decoder, 401
 - effects on HP-IB operation, 401
 - effects on oscilloscope, 401
 - effects on remote operation, 401
 - effects on spectrum analyzer, 401
 - fixed level, 401
 - manual control, 401
 - off, 401
 - using attenuator hold, 168
- Squelch field, 401
- Srch Win A field, 402
- Srch Win N field, 403
- Srch Win R field, 404
- SSB Demod, AF analyzer input, 157
- SSD Update
 - Execute, 407
- SSD Update annunciator, 408
- SSD Update field, 407
- SSD Update on Paging: Failed message, 407
- SSD Update on Paging: Passed message, 407
- SSD Update on Traffic: Failed message, 407
- SSD Update on Traffic: Passed message, 407
- SSD_A=0 annunciator, 404
- SSDA field, 405
- SSDB field, 406
- station class mark, 376
- Status field (CDMA authentication), 411
- Status field (CDMA mobile reporting), 408
- Step# field, 412
- Steps field, 411
- stop bit, 412
- Stop Length field, 412
- Strength field, 412
- support contacts, HP
 - electronic mail, 9
 - telephone, 9
- Svc Opt 1 Traffic Data Mode, 430
- Svc Opt 14 Traffic Data Mode, 430
- Svc Opt 2 Traffic Data Mode, 430
- Svc Opt 2/9 annunciator
 - Test Status, 421
- Svc Opt 32768 Traffic Data Mode, 430
- Svc Opt 6 Traffic Data Mode, 430
- Svc Opt 9 Traffic Data Mode, 430
- sweep
 - frequency range, tracking generator, 399
 - oscilloscope, 423
 - rate, spectrum analyzer, 135
 - time per division, 423
 - tracking generator, 337
- Sync (Sector A Power) field, 414
- System ID field, 414
- system identification number, 392
- System Type field (for handoff), 416
- System Type field (to simulate), 415

T

- T_Add field, 417
- T_Comp field, 417
- T_Drop field, 418
- T_Tdrop field, 419
- TACS channel standard, 361
- TACS system type, 416
- talk & listen, 299
- Test Name field, 420
- Test Parameters field, 329
- Test Procedure Run Mode field, 420
- Test Status
 - Connected, 421
 - Failed, 422
 - Max Frames, 423
 - Passed, 422
 - Svc Opt 2/9, 421
 - Testing, 422
- Test Status field, 421
- Testing annunciator
 - Test Status, 422
- Tests (Channel Information)
 - screen, 137
 - Delete Ch, 219
 - Insert Ch, 278
 - Main Menu, 285
 - Print All, 340
 - view of, 138
- Tests (Execution Conditions)
 - screen, 137
 - Autostart Test Procedure on Power-Up, 177
 - Continue, 211
 - If Unit-Under-Test Fails, 274
 - Main Menu, 285
 - Output Results For, 325
 - Output Results To, 325
 - Run Test, 372
 - Test Procedure Run Mode, 420
 - view of, 143
- Tests (External Devices) screen, 137
 - Addr, 156
 - Calling Name, 187
 - Delet Ins, 220
 - External Disk Specification, 259
 - Insrt Ins, 279
 - Main Menu, 285
 - Model, 299
 - Options, 318
 - view of, 144
- Tests (IBASIC Controller) screen, 137
 - Clr Scr, 205
 - Continue, 211
 - Main Menu, 285
 - Sngl Step, 394
 - view of, 146
- Tests (Main Menu) screen, 137
 - Channel Information, 267
 - Cnfg External Devices, 206
 - Continue, 211
 - Description, 220
 - Exec Execution Cond, 253
 - Freq Channel Information, 267
 - IBASIC IBASIC Cntrl, 273
 - Library, 283
 - Order of Tests, 391
 - Parm Test Parameters, 329
 - Pass/Fail Limits, 400
 - Print Printer Setup, 341
 - Proc Save/Delete Procedure, 343
 - Program, 343
 - Run Test, 372
 - Save/Delete Procedure, 343
 - Select Procedure Filename, 378
 - Select Procedure Location, 379
 - Seqn Order of Tests, 391
 - Spec Pass/Fail Limits, 400
 - Test Parameters, 329
 - view of, 137
- Tests (Order of Tests) screen, 137
 - All Chans?, 164
 - Delet Stp, 220
 - Insrt Stp, 279
 - Inst#, 279
 - Main Menu, 285
 - Spec#, 400
 - Step#, 412
 - Test Name, 420
 - view of, 140
- Tests (Pass/Fail Limits) screen, 137
 - Check, 199
 - Lower Limit, 284
 - Main Menu, 285
 - Units, 442
 - Upper Limit, 442
 - view of, 141
- Tests (Printer Setup) screen, 137
 - Continue, 211
 - FF at End, 262
 - Lines/Page, 284
 - Main Menu, 285
 - Model:, 300
 - Output Heading, 323
 - Print Data Destination, 340
 - Print Title, 341
 - Printer Address, 341
 - Printer Port, 341
 - Run, 372
 - Run Test, 372
 - view of, 145
- Tests (Save/Delete Procedure) screen, 137
 - Code Location, 207
 - Enter Procedure Filename, 247
 - Main Menu, 285
 - Pass Word, 329
 - Procedure Library, 343
 - Select ProcedureLocation, 379
 - view of, 142
- Tests (Test Parameters) screen, 137
 - Main Menu, 285
 - view of, 139
- This, 303
- Time field, 423
- Time field (marker), 287
- time markers, 287
- Time Offset field, 165, 268, 424, 425
- Time/div field, 423
- Timer Reg field, 425
- title for printout, 323, 341
- TM Rho field, 426
- To Add pilot status, 408
- To Drop pilot status, 408
- Total RAM field, 428
- trace
 - comparison, spectrum analyzer, 313
 - spectrum analyzer, 313
- tracking generator
 - frequency, 192
 - frequency offset, 317
 - output, 337
 - output port, 337
 - sweep, 337
- Traffic Data Mode field, 430
- Traffic field (Sector A Power), 428
- Traffic field (Sector B Power), 429
- Traffic Rho field, 431
- transmit pace, 447
- transmitter frequency error measurement, 435
- transmitter frequency measurement, 436
- transmitter keying, 260
- transmitter power
 - fast, 439
 - measurement, 437
 - zero reference, 440
- Transmitting annunciator
 - Call Status, 431
- Trig-Delay field, 432
- triggering
 - automatic, 177
 - continuous, 212

encoder, oscilloscope, 280
external, oscilloscope, 280
internal, 283
internal, oscilloscope, 280
level, 177
negative edge, 283
positive edge, 283
signal, 177
source, oscilloscope, 280
time, 287
Tune Freq field, 433
Tune Mode field, 434
tuning
 automatic, 434
 channel, automatic, 363
 manual, 434
turning off squelch, 401
TX Freq Error field, 435
TX Frequency field, 436
Tx Mode, 303
TX Power field, 437, 438
TX Pwr Meas field, 439
TX Pwr Zero field, 440
TX TEST key (analog), 57
TX TEST key (CDMA), 57
TX Test screen
 AF Anl In, 157
 AF Freq, 158
 AFGen1 Freq, 159
 AFGen1 Lvl, 160
 Current, 212
 DC Current, 217
 DC Level, 218
 De-Emphasis, 219
 Detector, 221
 Distn, 236
 Ext TX key, 260
 Filter 1, 263
 Filter 2, 263
 FM Deviation, 264
 functional block diagram, 147
 IF Filter, 274
 Input Port, 277
 Min Inp Lvl, 295
 RF Channel, 360
 SINAD, 393
 SNR, 395
 Tune Freq, 433
 TX Freq Error, 435
 TX Frequency, 436
 TX Power, 437
 TX Pwr Zero, 440
 view of, 147
Type, 440

U
Uncal annunciator
 channel power measurement,
 339
Uniq Chall annunciator
 Call Status, 442
Uniq Chall field
 CDMA Authentication screen,
 441
UniqChCon, 102, 233
Unique challenge, 441
Unique Challenge on Paging:
 Failed message, 441
Unique Challenge on Paging:
 Passed message, 441
Unique Challenge on Traffic
 Passed message, 441
Unique Challenge on Traffic:
 Failed message, 441
unit-of-measure, 55
Units field, 442
up-arrow key, 55
Upper ACP Level field, 284
Upper ACP Ratio field, 284
Upper Limit field, 442
User Data (ASCII), 443
User Data (Hex), 443
User Def Base Freq field, 182
user keys
 global, defined, 61
 local, defined, 61
USER-DEF channel standard,
 361

V
variable frequency notch filter,
 314
VC Order field, 444
version number, firmware, 264
Vert Offset field, 445
Vert/div field, 445
vertical offset, oscilloscope, 286,
 445
vertical sensitivity, oscilloscope,
 445
video averaging, spectrum
 analyzer, 312
VMAC (voice mobile attenuation
 code), 345
voice channel assignment, 194
voltage
 measurement, 154
 RF, across 50 ohm load, 364,
 365
 RF, emf (open circuit), 364, 365
volume
 beeper, 183
 internal speaker, 400

W

Walsh field (Sector A), [446](#)

Walsh field (Sector B), [446](#)

word

abbreviated address, [232](#)

extended address, [232](#)

first word of called address, [232](#)

number of additional word

coming, [234](#)

reverse voice channel order

confirmation message, [233](#)

second word of called address,

[233](#)

serial number, [232](#)

X

Xmt Pace field, [447](#)

Xon/Xoff, [353](#), [447](#)

Y

YES key, [53](#)

Z

- Zero field (Power Meas), [339](#)
- zero reference, transmitter power, [440](#)
- zeroing
 - average power measurements, [179](#)
 - measurement offset, [217](#)
 - power meter, [440](#)