

HEWLETT  PACKARD

1970 **ELECTRONICS FOR**

**MEASUREMENT
ANALYSIS
COMPUTATION**

*Acoustical Instruments
Automatic Test Systems
Calculators and Peripherals
Communications Test Equipment
Computers and Peripherals
Data Acquisition Systems
DC Power Supplies
Digital Analyzers
Electronic Counters
Frequency and Time Standards
Graphic Recorders
Magnetic Recorders
Meters, Multifunction
Microwave Test Equipment
Network Analyzers
Oscilloscope Systems
Signal Analyzers
Signal Generators
Signal Sources
Spectrum Analyzers*



About this reference catalog.

This catalog is presented to you to simplify selection of quality equipment and accessories for solving your measurement, analysis, and computation tasks.

In addition to the pages outlining the capabilities, features, and specifications of HP products, there is applications material, technical information, and selection charts.

As indicated by the categories to the right, Hewlett-Packard provides a wide variety of equipment for many technical phases of Science, Industry, and Education.

How to use this reference . . .

First, refer to the **Alphabetical Index** on pages 2 through 15 to find the product of interest, and turn to the page(s) indicated. Or, if you know the Model Number turn to the index commencing on page 640.

For assistance, call your Sales and Service Office; see pages 18 through 24 for addresses and telephone numbers.

GENERAL PURPOSE

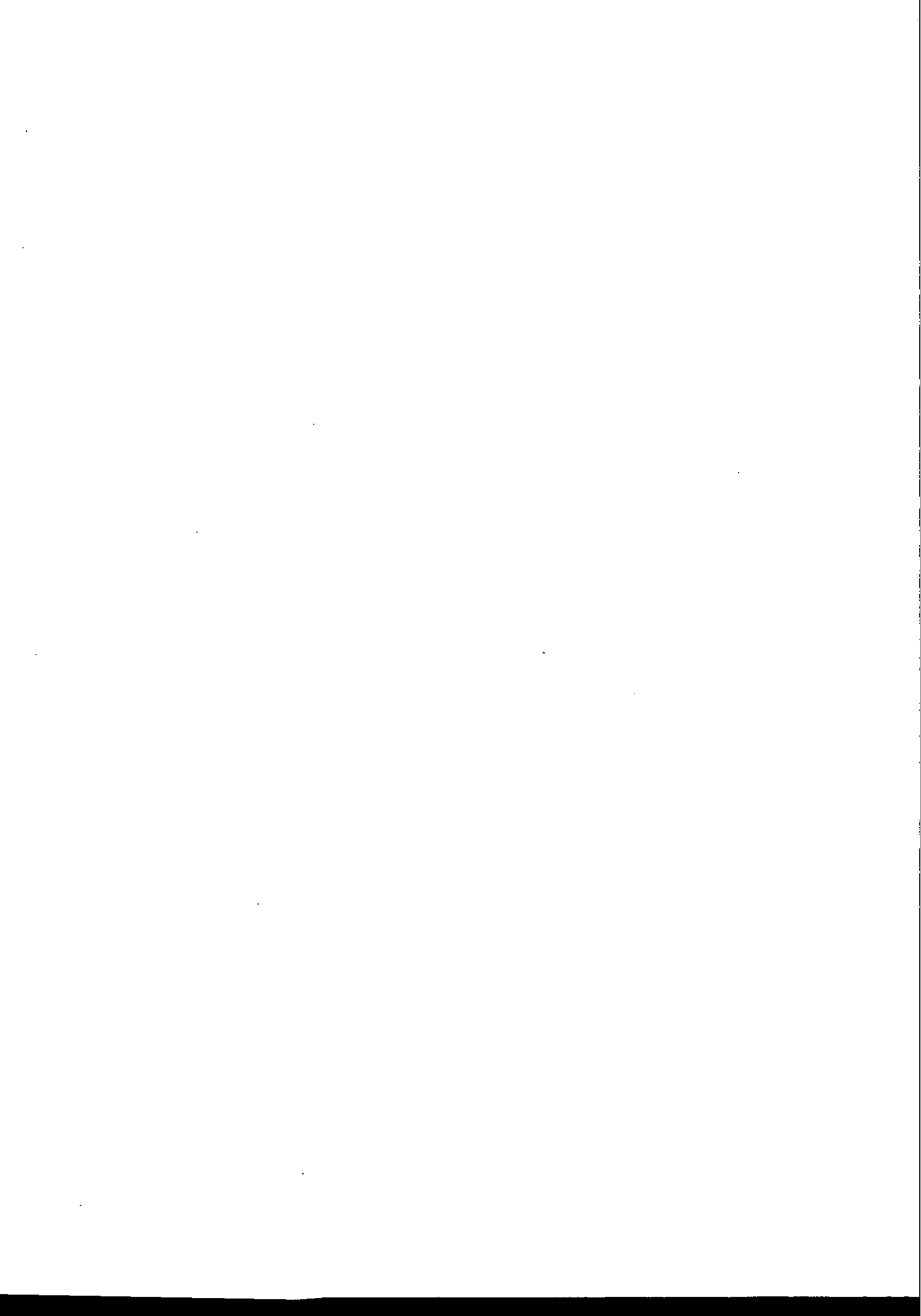
SCIENTIFIC

COMPUTATION

SYSTEMS

MICROWAVE

COMMUNICATIONS



HP Computer Museum
www.hpmuseum.net

For research and education purposes only.

Amplifiers
Ammeters
Attenuators
Bridges
Calibrators
DC Power Supplies
Diodes
Distortion Analyzers

Electronic Counters
Filters
Frequency Standards
Loudness Analyzer
Mixers
Modulators
Multifunction Meters
Network Analyzers

Ohmmeters
Oscilloscopes
Pseudorandom Noise Generator
Q-Meters
Recorders
Signal Sources
Solid State Devices

Spectrum Analyzers
Sweepers
Time Standards
Transducers
Ultrasonic Detectors
Voltmeters
Wave Analyzers

ACOUSTIC

Acoustic Systems
Impulse Sound Level Meters
Loudness Analyzers
Spectrum Analyzer

NUCLEAR

Multichannel Pulse Height Analyzer
Nuclear Instrument Modules
Scalers and Timers

STATISTICAL/ DIGITAL

Correlator
Multichannel Analyzer
Random Noise Generator
Signal Analyzer/Averager



COMPUTING CALCULATOR

COMPUTING COUNTER

DIGITAL COMPUTERS

TIME SHARE COMPUTING SYSTEM

COMPUTER PERIPHERALS

Analog-to-Digital Converter
Disc Memory
Magnetic Tape Units
Mark Sense Readers

Multiplexers
Power Supply Programmer
Punched Tape Reader
Tape Punch
Teleprinters

CUSTOM-BUILT SYSTEMS

Automatic Test and Calibration
Stimulus/Response Testing

STANDARD SYSTEMS

Acoustic
Automatic Network Analyzer

Data Acquisition and Manipulation

Frequency Measuring

Frequency Standard

Logic Module Testing
Recording

Amplifiers
Attenuators
Coaxial Instrumentation
Detectors
Directional Couplers
Frequency Meters

Impedance Meters
Microcircuits
Microwave Link Tester
Mixers
Network Analyzers
Noise Figure Meters

Noise Sources
Phase Shifters
Power Meters
Power Supplies
Signal Generators
Solid State Devices

Spectrum Analyzers
Sweepers
SWR Indicators
Transistor Chips
Vector Voltmeter
Waveguide Instrumentation

Cable Fault Locators
Cable Testing
Distortion Analyzers

Leak Detectors
Microwave Link Analyzer
Spectrum Analyzers

Telemetry Instrumentation
Telephone Test Sets
Test Instrumentation

TV Monitors
TV Waveform Monitors
Wave Analyzers

ABOUT HEWLETT-PACKARD

CATALOGS


To better serve its many customers' broad spectrum of technological needs, Hewlett-Packard annually publishes three catalogs and several brochures. Among these are:

- **Electronics for Measurement, Analysis, and Computation.** This, the primary HP catalog, includes detailed descriptions of all HP electronic instruments for generating, measuring, and analyzing quantities like voltage, current, power, impedance, gain, phase, frequency, noise, and waveform—from dc to microwaves. In addition, it has information on HP computers, calculators, peripherals, automatic test systems, recorders, and sound analyzing instruments.

- **Analytical Instruments for Chemistry.** Detailed descriptions from the chemists' point of view of Hewlett-Packard's analytical equipment, including gas chromatographs, data handling devices, columns and accessories, microwave spec-

trometers (for analysis by molecular rotational resonance), osmometers and viscometers.

- **Solid-state Devices.** Specifications of hot-carrier, step recovery, and PIN diodes (for detectors, switches, mixers, attenuators, harmonic generators and pulse sharpeners), microwave transistors, hybrid circuits, solid-state light sensors, light-emitting diodes, and solid-state numeric displays.

- **Brochures describing Medical Electronics** for diagnosis, monitoring, and research. Descriptions of instruments used by physicians and research scientists in hospitals and clinics for patient monitoring, ultrasound diagnosis, electromyography, electrocardiography, and physiological data acquisition.

Engineers, scientists, and educators may obtain any of these publications free of charge. Ask your nearest Hewlett-Packard field office, or write on company letterhead to Hewlett-Packard, 1501 Page Mill Road, Palo Alto, California 94304.



GENERAL INFORMATION

The fastest and easiest way for you to get information about Hewlett-Packard products, or about prices, ordering procedures, parts, service, and applications, is to call or write the Hewlett-Packard field office or distributor in your area. Although Hewlett-Packard products are manufactured in factories scattered throughout the United States and other parts of the world, the Hewlett-Packard field office or distributor in your area is best equipped to handle all your needs concerning products described in this catalog, and for parts and service on Hewlett-Packard products you already own.

A worldwide listing of field offices, representatives, and distributors is found on pages 18 through 24. Hewlett-Packard field offices, 50 of them, are near all major metropolitan areas in the United States and, in addition, there are 7 in Canada, 17 in Central and South America, 30 in Europe and 40 distributed throughout Africa, Asia, and Australia.

Order by model number

Technical assistance in selecting equipment and preparing orders is available, without charge, from field engineers at all sales offices. When you place your order, please specify the catalog model number as well as the name of the product

desired. For example, "Model 180A Oscilloscope." Whenever you want special options or features, such as special color or non-standard power line voltage, ask your Hewlett-Packard field engineer about availability of these options, then, to prevent misunderstanding, include significant specifications and specific instructions in your order.

Many Hewlett-Packard instruments are supplied in cabinets along with easily attached hardware for direct mounting in standard 19-inch equipment racks. Others are available in two configurations: one a cabinet for bench use and the other with a 19-inch panel for rack mounting. Catalog listings indicate the availability of cabinet or rack mounting arrangements. Please be sure your order indicates which one you want.

Price and delivery information

Prices listed are F.O.B. USA factory or warehouse, except as indicated. Please consult your nearest field sales office to confirm prices at your location and to obtain current delivery information. Although the illustrations and product information in this catalog were current at the time the catalog was approved for printing, Hewlett-Packard, in a continuing effort to offer the finest equipment available, reserves the right to change specification, designs, models or prices without notice and without liability for such changes.

FOR CUSTOMERS IN USA

Where to send your order

Your order should be made out to the Hewlett-Packard Company and sent to the Hewlett-Packard office nearest you (see pages 18 and 19). Each field office has special communication channels to the Hewlett-Packard factories to assure prompt and efficient handling of your order. (For Delcon products, please see pages 423 and 424).

Shipping methods

Shipments to destinations in the USA are made directly from local factories or warehouses. Unless specifically requested otherwise, express or truck transportation is used, whichever is less expensive and most serviceable to you. Small items are sent parcel post. If fast delivery is needed, we gladly ship by air freight, air express, or air parcel post, when speci-

fied on your order, at prevailing rates. In many parts of the USA; a consolidated air freight service provides the speed of air transport at surface rates. Ask your field engineer for details.

Terms in the USA

Terms are net 30 days from invoice date. Extended payment terms to a maximum of 120 days are available on approved credit for a service charge. Your local Hewlett-Packard sales office has the details. Unless credit with Hewlett-Packard has already been established, shipments will be made C.O.D. or on receipt of cash in advance.

Quotations

Upon request, quotations including destination prices, will be furnished to you by your local Hewlett-Packard sales office.

FOR CUSTOMERS OUTSIDE THE USA

Where to send your order

In many countries, your order can be placed directly with your local Hewlett-Packard distributor or representative. If there is none as yet in your area, your order should be placed directly with the office indicated on pages 18 through 24 for your part of the world.

Shipping methods

Shipments to customers outside the USA or Western Europe are made from the appropriate Hewlett-Packard facility by either surface or air, as requested. Sea shipments usually require commercial export packaging at a nominal extra charge.

Terms

Terms for orders from countries outside the United States of America which are placed with the Hewlett-Packard Company, Hewlett-Packard S.A., or Hewlett-Packard Inter-Americas, are irrevocable letter of credit or cash in advance, unless other terms have been arranged previously. Terms for orders placed with authorized Hewlett-Packard distributors are mutually determined between customer and distributor.

Quotations and pro forma invoices

FAS, CIF, C&F, etc. quotations or pro forma invoices, as well as exportation and importation assistance, are available on request from local authorized Hewlett-Packard sales offices or representatives.

ALPHABETICAL INDEX



ABSORPTIVE MODULATORS TO CLIP-ON PROBE

A

- Absorptive Modulators 235, 210, 311
- A to D Converter 98, 99, 103
- AC Amplifiers 467-470
- AC Amplifier/DC Power Supply 468
- AC Calibrator 160, 161, 167, 169
- AC Converter for 3450A 208
- AC Current Probe 195
- AC Meter Calibrator 169
- AC Microvoltmeter 175
- AC Power Pack for 204C/D 276
- AC Power Supply 171
- AC Probe for 410C VM 184
- AC Voltmeters
 - Analog 175-181, 184-187
 - Battery Operated 180
 - Differential 164, 165
 - Digital 207-209, 212-214, 217
 - True rms 181, 209
 - Vacuum Tube 179, 185, 187, 188
- AC/Ohms Converter 98
- AC/Ohms Converter DC Preamplifier 217
- AC to DC Converter 220
- AC-DC Differential Voltmeter/DC Standard 164
- AC/DC Meter Calibrator 168
- AC/DC Range Unit for 3439A/3440A DVM 203, 207
- AC/DC Remote Unit for 3439A/3440A DVM 207
- AC/DC Voltmeter Calibrator 167, 168
- Accessories
 - Acoustics 60-62
 - Adapters, BNC for 3406A RF VM 187
 - Adapters, BNC to Binding Post 283
 - Attenuator 283
 - Cable for 3462A and 3460B DVM's 216
 - Cables and Test Leads 196
 - Cable Ass'y for 740B Stan/ Δ VM 163
 - Carrying Cases 639
 - Current Divider for 456A Probe 195
 - DC Power Supplies 571
 - Detectors for 675A Sweeper 317
 - For 400 series VM's 176, 195
 - For 410B/C VM's 185
 - For 3450A DVM's 211
 - For 3461A AC/ Ω Converter, Preamp 217
 - Instrument and Combining Cases 636-639
 - Kit for 411A 187
 - Oscillator 283
 - Probes for 428B VTVM 194
 - Probe, AC Current 195
 - Probe, High Frequency 195
 - Probe Kit for 3406A 186
 - Probe, Voltage Divider 176, 185, 187, 191, 195
- Accessory Kits
 - For 8405A Vector Voltmeter 378
 - For 8410A Network Analyzer 384
- Acoustic
 - Accessories 60-62
 - Technical Information 47, 48
 - Transducers 60-62
- Active Probes 534
- Adapters, 50 to 75 ohms 516
- Adapter, Binding Post to BNC 283
- Adapters, Oscilloscope Cables 508, 535
- Adapters, Slides 536
- Adapters
 - Adjustable Short, Waveguide 335-337, 338-340
 - Coaxial to Coaxial 355
 - Insert Voltage 60-62
 - For 410 series Probes 184
 - Sweep, for Swept Slotted Line 353
 - Swivel, Coaxial 347
 - Waveguide to Coaxial 355
 - Waveguide to Waveguide 355, 414
- Amplifiers
 - AC Amplifier/Power Supply 468
 - Battery Operated 467
 - DC Preamplifier 217
 - Data 466
 - Differential 465, 466
 - Direct Record (1.5 MHz) 142-148
 - Direct Record (DC-20 kHz) 142-148
 - Direct Reproduce (300 kHz) 142-148
 - FM Record (DC-20 kHz) 142-148
 - FM Reproduce (DC-20 kHz) 142-148
 - Fast Pulse 470
 - General Purpose 467-468, 470
 - Indicator, Transducer 153-154
 - Logarithmic 182
 - Microwave 472
 - Power 468, 471
 - Precision AC 469
 - Wideband 465, 466, 470
 - Wideband Differential 464
 - Technical Information 462, 463
 - Traveling Wave 472
- Analog-to-Digital Converter 35
- Analog Magnetic Tape Recorders 142-152
- Analog Module Test Systems 90, 91
- Analog Voltmeters 162-165, 175-194
- Analog Voltmeter, Technical Information 170-174
- Analysis, Signal, Digital 35-46

Analyzer	
Automatic network	386
Distortion	448-450
Loudness	440-443
Low Frequency Spectrum	399
Microwave Link	445-447
Module Real-Time	51-54
Network	372, 374, 377, 379
Real-Time Audio Spectrum	51-54
Signal	399-422
Signal Averaging	42
Signal, Fourier	40
Signal, Multichannel	35
Signal, Multiparameter	38
Signal, Statistical	35-44
Spectrum	403-414
Systems	60-62
Waveform	451-461
Antenna, VLF Broadcast Receiver	625
APC-7 Short	356
Assemblies, Microphone	60-62
Atomic Frequency Standards	620, 622
Attenuator	283
Accessories	283, 444
75 ohm	444
Coaxial	341, 343
Coaxial Step	343
Coaxial Variable	341
Fixed	333
Step	283, 343
Variable	333, 335, 341, 343
Variable Coaxial	341
Audio Analyzers (See Distortion and Waveguide)	
Audio Data Processor	63-65
Audio Oscillator	443, 444
Audio Range Voltmeters (see Voltmeters)	49
Audio Signal Generator	443, 444
Audio Spectrum Analyzer	51-54, 399
Auto Frequency Divider	598
Auto Range Selector for 3439A/3440A	205
Auto Ranging DVM's	203, 216, 218
Auto Volt-Ohmmeter	188
Automatic Capacitance Bridge	227
Automatic Capacitance Measurement	225
Automatic Counter	602, 603
Automatic Tape Degausser	152
Automatic Test Systems	90, 91-93
Auxiliary Plug-in for 3300A Function Generator	274
Auxiliary Plug-in for 3590, 3591A Wave Analyzer	455-457
Auxiliary Power Supply	384
Averager, Signal, Digital; (see also "Digital Signal Analysis")	42

B

Balanced Mixers	235
Banana Post to BNC Adapter	283
Balanced Probe for 312A Selective VM	460, 461
Bandpass Filters	348, 414
Battery Operated Oscillators	276, 277, 431
Battery Operated Voltmeters	166, 180, 189
Bench Stand for 297A Sweep Drive	458
Bezel Adapters, Camera	542
Bias Network	385
Bias Tee	334
BNC Male-to-Binding Post Adapter	283
Bridge Measurements	224
Bridge, RF	228
Broadband Amplifier	456, 466, 470
Broadband Oscillator	273, 278, 281, 435
Broadband RF Voltmeter	186

C

C Measurements	224
Cabinets, Modular	636, 637
Cable Amplifier	60-62
Cable Accessory for 3460B and 3462A DVM	216, 219
Cable Assemblies, Test Leads	195
Calculator	82-85
Display	85
Marked Card Reader	85
Plotter	84
Printer	83, 84
Calibration Resistor for 4800A	222, 223
Calibrators	
AC	160, 167, 169
AC/DC Meter	168
AC/DC Voltmeter	167, 168
Peak Power	391
Power Meter	394, 395
Sound Level	61, 62
Voltmeter	160, 167, 168
Calorimetric Power Meter	398
Camera accessories	542
Cameras, oscilloscope	539, 540, 541
Capacitance Measurements	224
Capacitive Termination	61, 62
Card Reader for Calculator	85
Card Readers	78, 79
Carriages for slotted lines	354
Carrying Cases	638, 639
Cesium Beam Standards	620, 621
Clip-on AC Current Probe	195

ALPHABETICAL INDEX *continued***Chip Transistors to Digital Analyzers**

- Chip Transistors 232
 Clamps, Waveguide 355
 Clip-on DC Milliammeter 194
 Clocks, Digital 108
 Coaxial
 Adapter kit 228
 Attenuators 341-343
 Crystal Detectors 345
 Directional Couplers 341, 359-361
 Filters 348
 Instrumentation Tables 333, 334
 Loads, fixed and sliding 356
 N-Connector for 410 B&C VM's 184
 Rotary Air Lines 347
 Shorts 356
 Sliding Loads 356
 Slotted Lines 352-354
 Switches 234-347
 T-Connector for 410 B&C VM's 184
 Terminations 356
 Thermistor Mounts 396, 397
 Thermocouple Mount 392, 393
 Comb Generator 409-414
 Combining Cases 636-639
 Communications Technical Information 425-427
 Communications Test Equipment 425-447
 Tutorial 439
 T.V. Scope 438
 Spectrum Analyzer 434
 Comparator, Hi, Go, Lo 211
 Comparator, VLF Time Standard 625
 Component Mtg. Adapter for 4815A 223
 Computers
 Computation 66, 67
 Controlled Test Systems 90, 91
 Data Acquisition Systems 102, 103
 Digital 67-72
 Educational Computer System 74, 77
 General Purpose Digital: Technical Information 66
 Peripheral Graphic 80, 81
 Time-Shared BASIC System 74, 75
 Computing Calculator 82-85
 Computing Counter
 Fixed Program Shell 578, 579
 Input Module 579
 Keyboard 577, 578, 581
 Plug-in Adapter 579
 Constant Current DC Power Supply 550
 Control Unit 327
 Controllers, Preset, Electronic Counter 608, 614
 Controller, Preset, Counter Plug-in Unit 594
 Converter, Analog-to-Digital 35
 Converter, Digital-to-Analog 111
 Converters, Frequency Extender, Counter Plug-in . 591-597
 Converters
 A to D 98, 99
 AC/Ohms to DC 98, 217
 AC/Ohms to DC Preamplifier 217
 AC to DC 217, 220
 Battery 128
 D to A 87, 111
 Logarithmic 182
 Microwave Frequency 600
 Module, AC to DC 139
 Ohms 98
 Thermal 165
 Voltage-to-Frequency 215
 Correlator 415-420
 Counter, 12.5 MHz IC 612
 Counters, Counter/Timers, Electronic 572-616
 Automatic 599, 602
 Computing 577
 Frequency, Tutorial Article 572
 High Frequency Plug-in (50 MHz and
 higher) 583-590, 601
 Medium Frequency (below 50 MHz) 602-616
 Preset, Normalizing 608, 614
 Reversible 613
 Ruggedized, MIL 601
 Timer, Built-in Digital Voltmeter 606
 Universal 602-606
 Counter Assemblies, O.E.M. 610
 Counter Accessories, Plug-in; Frequency Conversion,
 Video Amplifying, Digital Voltmeter, Preset
 Limits 591-598
 Counter Summary, 50 and 150 MHz 583
 Coupling Transformer 231
 Coupler Module, Signal 139
 Couplers
 DC Module 118
 Digital 98
 Digital Instrument 98, 105, 106
 Directional 341, 359-362
 Magnetic Tape 98
 Output 98, 105, 106
 Punched Card 98
 Punched Tape 98
 Recorder Output 98
 Teleprinter 98
 Typewriter 98
 Crossbar Scanner 97
 CRT Filters, colored and contrast 536

CRT phosphors/Glossary	543
CRT viewing hoods	536
Crystal Detector	345
Current Divider, 100:1, for 456A	195
Current Probe and Amplifier	534
Current Meter	184, 191, 194, 206
Current Probe	195
Custom Test Systems	91

D

D/A Converter	87, 111
D Measurements	224
Data Acquisition Systems	100, 101
Computerized	102, 103
Tutorial	94-96
Data Amplifier	464, 465, 466
Data Processor, Audio	63-65
DC/AC Differential Voltmeter/DC Standard	164
DC Attenuator Module	119
DC Coupler Module	118
DC Digital Voltmeter	202
DC Differential Voltmeter/Ratiometer	166
DC Differential Voltmeter/DC Standard	162
DC Microvolt-Ammeter	191
DC Multifunction Meter (Analog)	183-185, 188-191
DC Multifunction Meter (Digital)	203-214, 216, 217
DC Null Volt-Ammeter	189
DC Null Voltmeter	188, 189
DC Offset Module	119
DC Power Supplies	
10 kW	565
Accessories	571
Bench	554
Condensed Listing	545-547
Constant Current	550
Digitally Programmable	86-89
DPB	553
Dual Power Bench	553
Dual Slot	567
High Stability	548
High Voltage	570
IC Test	569
Laboratory	556
Low Voltage Rack	560, 561
LVR-B	560, 561
Medium Power, Dual Range	558, 559
Medium Power Module	552
MPM	552
Medium Voltage	562
Options	571

SCR Regulated	564
Selection Guide	544-547
Slot	566, 567
Transfer Standard	159
Transistor Bias	385
DC Power Supplies/Amplifier	568
DC Power Supplies/Calibrators	548
DC Preamplifier Module	118
DC Range Selector for 3439A/3440A DVM	203
DC Standard/Differential Voltmeter	162
DC Transfer Standard	159
DC Voltage Divider, 100:1, for 410 B/C	185
DC Voltmeters	
Analog	183-185, 188-191
Differential	162-166
Digital	202-214, 216-220
DC/AC Inverter (for 3960 series)	151
Decade Capacitor	192
Delay Generator, Digital	249
Demodulator Module, Phase Sensitive	136-139
Detector, Crystal	345
Detector, Directional	360-361
Detector Mount	345, 353, 364
Detector Probes for slotted lines	354
Detectors for 675A Sweeper	317
Differential Amplifier	464, 465, 466
Digital-to-Analog Converters	111
Digital	
Ammeter	206
Clocks	108
Computers	67-72
Coupler	98, 105, 106
Delay Generator	249
Frequency Meter	598
Logic Module Test System	93
Magnetic Tape Units	79
Module Test Systems	90, 91
Multimeter	208
Ohmmeter	206, 210, 217
Oscillator	280
Recorder	107, 108, 110
Voltage Source	88
Voltmeters, AC	207, 209, 212-214
Voltmeters, DC	202-214, 218-219
Voltmeter, Plug-in	203
Voltmeter, Technical Information	197-201
Digital Frequency Meter, 12.4 GHz	599
Digital Frequency Synthesizers	627-631
Digital Logic Tester	92
Digital Recorders	107-110
Digital Signal Analyzers, Statistical	35-46

Digital Voltmeters to Loudness Analyzers

- Digital Voltmeter, Counter Plug-in Unit 591
- Diodes (Step Recovery, Hot Carrier, Pin, Light Emitting) 236
- Direct Record Amplifier (1.5 MHz) 144-148
- Direct Record Amplifier (300 kHz) 144-148
- Direct Reproduce Amplifier (300 kHz) 144-148
- Directional Couplers 341, 359, 360, 362
- Directional Detectors 360, 361
- Displacement Transducers 153, 154
- Display, Network Analyzer 376, 383
- Display, Precision Raster 436, 437
- Display Sections, Spectrum Analyzer 408, 412
- Display, Solid State Numeric 236
- Display, X-Y 488-489
- Distortion Analyzer 449, 450
- Distortion Analyzer, Technical Information 448
- Divider, Frequency Automatic 598
- Divider for 425A V-AM 191
- Divider Probe for 400 Series VM's 195
- Divider Tip 10:1 for 3406A RF VM 187
- Dividers, Probe, Active, Resistive 534, 536
- DME/ATC Test Set 308
- Double Balanced Mixers 235
- Doubler Probe for 3200B 289
- Doublers, Frequency 296, 306
- DPR Power Supply 558, 559
- Driver, Frequency Synthesizer 635
- Dual Directional Couplers 359, 360, 361
- Dual Slot Power Supplies 567
- DVM Technical Information 197-201
- E**
- Educational Computer System 77
- Electronic Counters; see "Counters" 587, 588
- Electronic Counters, 50 MHz Economical 590
- Electronic Counters, Tutorial 572-576
- Enclosures, Modular 636-639
- EPUT meters see "counters"
- F**
- Feed through terminations 50 & 100Ω 535
- Field Cases 639
- Filters for Spectrum Analyzers 414
- Filters, Coaxial & Waveguide 348
- Filter Module 119
- Filter Sets 58, 59
- Fixed and Pivot slides 536
- Fixture, Transistor 334
- Flutter and Wow Discriminator 616
- FM Discriminator 616
- FM Frequency Source 152
- FM Record Amplifier (DC-20 kHz) 144-148
- FM Reproduce Amplifier (DC-20 kHz) 144-148
- FM Signal Generator 307
- FM-AM Signal Generator 288, 290, 291
- Fourier Analyzer 40, 41
- Frequency
- Comb Generators 235, 296, 414
 - Converter, Microwave 600
 - Converter Plug-in .15-3 GHz 595, 596
 - Converter Plug-in 3-12.4 GHz 595, 596
 - Converter Plug-in 8-18 GHz 595, 596
 - Converter Plug-in 20-100 MHz 595, 596
 - Converter Plug-in 50-512 MHz 595, 596
 - Doubler Probe 289
 - Doubler Sets 306
 - Doubler 296
 - Meters, Electronic 616
 - Meters, Waveguide and Coax 346
 - Multipliers 235, 592
 - Standards, Tutorial 617
 - Synthesizers 630, 632-634
 - Synthesizers, Tutorial 628, 629
- Frequency Comparator, VLF Broadcast 625
- Frequency and Time Measurement; Tutorial Article .. 572
- Frequency Counters; see "Counters"
- Frequency Divider, Automatic, Counter 598
- Frequency Measurement System, Wideband to 40 GHz 601
- Frequency Meter, Digital 599
- Frequency Meter/FM Discriminator 616
- Frequency and Time Standards; Tutorial Article 617
- Frequency Standards 617-634
- Cesium 620
 - Quartz Crystal 624
 - Rubidium 622
- Frequency Standards, Standby Power Unit 627
- Frequency Synthesis, Tutorial Article 628
- Frequency Synthesizers, Direct, Digital 630-634
- Frequency Synthesizers, Driver Unit 635
- Function Generators
- All Instruments 272-275, 316
 - Analog Programmed 273-275, 316
 - Plug-ins 275, 316
 - Sweeper 275, 316
 - Technical Information 267-271
 - Variable Phase 272
 - Voltage Controlled 273-275, 316
- Function Generator and Oscillator
- Technical Information 267-271
- Fuseholder, RF 295

G

G-Band (3.95-5.85 GHz) Waveguide Instrumentation	335
General Purpose Amplifier	467, 468, 470
General Purpose Digital Computers	66
Generators	
Frequency Comb	235, 296, 414
Function	272-275
Function, Technical Information	267-271
Noise, Coax and Waveguide	350, 351
Noise, Pseudo Random	262-266
Precision Noise	57
Pulse	240-245
Signal, Aircraft Test	309
Signal, FM	307
Signal, FM-AM	288, 290, 291
Signal, HF	286, 287
Signal, SHF	302-305
Signal, Sources (also see Signal Sources, Oscillators, Sweepers)	237, 328
Signal, Telemetry	291, 307
Signal, UHF	297-300
Signal, VHF	292, 293
Sweep	312-328
Sweep, Technical Information	312-314
Word	239
Glide Slope Signal Generator	309
Glossary/CRT phosphors	543
GO-NO GO Comparator	211
GR Type Connector	187, 283

H

Harmonic Mixers	355
H-Band (7.05-10.0 GHz) Waveguide Instrumentation	337
HF Signal Generator	286, 287, 294, 295
HF-VHF Signal Generator Accessories	294, 295
High Frequency Probe for VM's	195
High Gain/Auto Range Unit for 3440A DVM	205
High Pass Filters for sampling applications	513
High Power Sweep Oscillators Systems	328
High Power Termination, X-band Waveguide	357
High Resistance Meter	193
High Voltage Amplifier for 745A AC Calibrator	160, 161
Hi-Go-Lo Comparator	211
Hum Filter, 60 and 400 Hz	516
HVB Power Supply	570
HVR Power Supply	570

I

ICS Power Supply	569
IF Noise Source	350, 351

Impedance Adapter for 675A, 676A Network

Analyzer	372-373
Impedance Meter	222, 223
Impedance and Phase	
Measurements	221, 329, 330, 366-371
Impulse Sound Level Meters	49
Inductance Measurements	221
Inductance Meter	222, 228, 229, 230
Inductors	229, 231
Inductors, Reference	229
Input Cable Assembly for 740B DC	
Standard/ Δ VM	162, 163
Input, Scanner	119
Insert Voltage Adapter	60-62
Instrument Cabinets	636, 637
Instrument Cases	638, 639
Instrument Enclosures	636-639
Instrumentation Magnetic Tape Recorders	144-148
Instrumentation Recorder	149-151
Instrumentation Tape Recording System	142-152
Integrating Digital Voltmeter	212-214
Integrating/Dual Slope DVM	208-211
Integrating Potentiometric DVM	216, 218, 219
Interface Logic Cable, 3460B/3461A	217
IRIG-Instrumentation Recording	142-148
Isolation Probe Tip for 3406A	186

J-K

J-Band (5.3-8.2 GHz) Waveguide Instrumentation	336
K-Band (18-26.5 GHz) Waveguide Instrumentation	340
Kits, Probe for 3406A RF VM	187
Kits, Probe for 411A RF VM	187
Klystron Power Supplies	349

L

L Measurements	224
Large Aperture Current Probe for 428B AM	194
Leveling Detector for 675A	317
Limit Selector for 3450A op. 003 DVM	211
Limit Test Plug-in for 3450A DVM	211
Limiter, Coaxial	234
Line Matching Transformer	283
Linear Displacement Transducer	153, 154
Linear Syn Transducers	153, 154
Logarithmic AC VM's	176-179
Logarithmic Converter/Voltmeter	182
Logic Module Test System	93
Logic Probe; Logic Clip	92
Logic Tester, Digital, Probe	92
Loudness Analyzer	55, 56

ALPHABETICAL INDEX *continued***Low Frequency to Green Contrast Filters**

- Low Frequency Function Generators 272-275
 Low Frequency Oscillator 443, 444
 Low Frequency Voltmeters 180
 Low Level Multiplexer 98, 104
 Low Pass Filter 333, 334, 338-340, 348
 LV Syn 153, 154
- M**
- Magnetic Tape Coupler 98
 Magnetic Tape Units
 Analog 142-152
 Digital 79
 Magnetometer Probe for 428B clip-on 194
 Measurement, Frequency; see "Counters" and
 "Frequency" Listings
 Measurement System, Wideband, Microwave,
 to 40 GHz 601
 Mercury Power Pack for 204C/D 276
 Meters
 Ammeters, Analog 185-195
 Ammeter, Clip-on 194
 Ammeter, Digital 206
 Calibrator, AC 160, 161, 169
 Calibrator, AC/DC 167, 168
 Calibrator, Precision AC 160, 161
 Digital VM's 202-214, 216-220
 Frequency, Analog 616
 Frequency, Digital 599
 Frequency, Electronic 333
 Frequency, Waveguide and Coax 346
 High Resistance 193
 Impulse Sound Level 49
 Inductance 228-230
 Logarithmic 182
 Kilovoltmeter 162-166, 177, 183, 184,
 188-190, 203-214, 216-219
 Microvoltmeter 175, 189, 191
 Milliammeter 184, 190-194, 206
 Millivoltmeter 162-166, 175-190, 202-214, 216-219
 Milliohmmeter 192
 Multifunction Analog 183-185, 188-191
 Multifunction Differential 164-166
 Multifunction Digital 203-214, 216, 217
 Noise Figure 350, 351
 Ohmmeters 183-185, 188, 190, 192, 206-214, 215-217
 Phase/Magnitude 372-385
 Portable Multifunction 183
 Power 389-398
 Q 229, 230
 Ratio 365
 RF Vector Impedance 223
- RX 228
 SWR 363, 364
 Vacuum Tube Multifunction 185, 191
 Vector Impedance 222
 Voltmeters, AC Analog 175-181, 184-187
 Voltmeters, AC Differential 164, 165
 Voltmeters, AC Digital 207, 209, 212-214, 217
 Voltmeters, DC Analog 183-185, 188-191
 Voltmeters, DC Differential 162-166
 Voltmeters, DC Digital 202-216, 218, 219
- Microwave Test Equipment (Technical
 Information) 329-332**
 Microdot Connector 186
 Microphone
 Assemblies 60
 Power Supply 60-62
 Preamplifier 60, 62
Microwave
 Amplifiers 233, 472
 Mixers 235, 355, 414
 Modulators 235, 310, 311
 Network Analyzers 379-388
 Oscillators 233
 Power Meters 392-398
 Signal Generators 298-306
 Solid State Devices 232-235
 Spectrum Analyzers 409-414
 Sweepers 320-328
 Switches 234-347
 Test Equipment 329-365
 Transistors 232
 Milliammeter 184, 190-194, 206
 Milliammeter, Clip-on DC 194
 Milliammeter, Clip-on Probe, AC 195
 Milliohmmeter 192
 Mixers 235, 355, 414
 Modular Enclosure Systems 638, 639
 Modular Enclosure Accessories 638, 639
 Modulators 235, 310, 311
Module
 DC Attenuator 119
 DC Coupler 118
 Filter 119
 DC Offset 119
 DC Preamplifier 118
 Multiple-Span Input 125
 Null Detector 118
 Scanner 119
 Single-Span Input 125
 Temperature Input 125
 Testers 90, 91, 93

Time Base	118
Monitor, TV Picture	436, 437
Motion Transducers	153, 154
Mount, Detector	345, 353, 364
Mount, Thermistor, Waveguide and Coax	396, 397
Mount, Thermocouple	392, 393
MPB-3 Power Supply	558, 559
MPB-5 Power Supply	558, 559
Multiband, Sweep Systems	327
Multichannel Analyzer	35, 37
Multifunction Meters	
Analog	183-185, 188-191
Differential	162-166
Digital	203-214, 216, 217
Multifunction Unit for 3439A/3440A	206
Multiparameter Analyzer	38
Multiplexer, RF Signal	327
Multiplexer, Low Level	98, 104
Multiplexer, Scanner	97, 98

N

Network Analyzer	372-388
Network Analyzer, Low Frequency	372-373
Network Analyzer Technical Information	366-371
N.I.M. (Nuclear Instrumentation Modules)	44-47
Nuclear Instrumentation	
N.I.M. Power Supplies	44
Preamplifier Unit	44
Scaler/Timer	45, 46
Noise Generator, Pseudo Random	262-266
Noise Generator, Precision	57
Noise Figure Meter	350, 351
Noise Sources, Waveguide and Coax	350, 351
Normalizing Preset Counters	608, 609
Null Detector	188-189
Null Detector Module	118
Null Voltmeters, dc	188, 189

O

Ohm/AC Converter for 3460B DVM	217
Ohmmeters	183-185, 188, 190, 206-217
Ohms Converter	98
Ohms Converter for 3450A	208
Operating Cases	639
Optical Mark Readers	79
Optoelectronic Devices	236
Oscillators, Sweep	312-328
Oscillators, YIG-tuned	233
Oscillators (also see: Generators, Function Generators, Signal Sources, Sweepers, Signal Generators)	

Audio and Ultrasonic	272-282, 431, 435
Battery Operated	276, 277, 431
Communications	431, 435
Crystal Controlled	272
Low Frequency	272-275, 279
Low Distortion	272, 276, 278
Portable	276, 277, 431
Pushbutton	277
Sinusoidal	272-282, 431, 435
Sweep	275, 316, 317
Technical Information	267-271
Telephone Test	431
Test	281, 282, 435
Tracking for 312A Wave Analyzer	433, 460
Ultra-low Frequency	272-275
Wide Range	273, 278, 281, 435
Oscilloscope Accessories	534-538
Accessories for 191A	537
Active Probe	534
Adapters, BNC to Banana	535
Adapters, BNC to Probe	535
Adapters, (1415A) 50 to 75 Ohms	516
Amber Contrast Filter, CRT	536
Bandwidth Limiter, 1120A	534
Blank-Plug-ins, 140 System	536
Camera	539, 540, 541
Bezel Adapter	542
Backs	542
Carrying Case	542
4-Channel Vertical Amplifier Plug-in	504, 524
Coaxial Cables	537
CRT Amber Filter	536
CRT Blue Filter	536
CRT Contrast Filters	536
CRT Filters	536
CRT Green Filter	536
CRT Viewing Hoods	536
Current Probe	534
Current Probe Amplifier	534
Differential Amplifier Vertical Plug-in	500
Differential/DC Offset Amplifier Plug-in	526
Divider, 1120A 10:1	534
Divider, 1120A 100:1	534
Double Blank Plug, 180 System	536
Drawer (3-inch) for 1117B	538
Drawer (8-inch) for 1117B	538
Dual Trace Vertical Amplifier Plug-in	502
Feed Through Term, 100Ω	534
Fixed and Pivot Slides and Adapter	536
Glossary/CRT Phosphors	543
Green Contrast Filter, CRT	536

ALPHABETICAL INDEX *continued***Hook Tip to Graphic Recorders**

- Hook Tip, 1120A 534
 Horizontal Blank Plug-in, 180 System 536
 Hum Filter, 1415A 516
 Mainframe 521, 522, 530, 531
 Panel Cover, 180A and 181A 537
 Panel Cover & Accessories, 180A and 181A 537
 Panel Cover, Front, 1200A 537
 Passive Probe, 1:1 536
 Plug-in Extender, 140 System 537
 Plug-in Sampling Amplifier & Sampler 509
 Plug-in Vertical Amplifier 523
 Probe for 191A 537
 Probe Power Supply 534
 Probe Tip Kit 535
 Probe Tip Kit, 1410A Sampling 508
 Product and Selection Charts, 180 System 518
 Resistive Dividers 534
 Risetime Converters, TDR Assys 516
 Sampling Accessories, 1410A 508, 513
 Sampling Accessories, 50-ohm Adapter 513
 Sampling Accessories, High Pass Filters 513
 Sampling Accessories, Line Extension 513
 Sampling Accessories, Sync Probe 513
 Sampling RF Voltmeter 186, 187
 Sampling Time Base 512
 Sampling Time Base Plug-in 511
 Sampling Vertical Plug-in 507
 Spectrum Analyzer Plug-ins 517
 Storage Cabinet for 1119A 538
 Storage Cabinet for 1119C 538
 TDR Sampling Plug-in 528, 529
 Terminations, 50 and 100 ohms 535
 Terminations, Feed-thru 283
 Testmobiles 538
 Tilt Tray for 1119A/B 538
 Tilt Tray for 1119C/D 538
 Time Base Plug-ins 527, 505
 Time Base and Delay Generator Plug-in 506
 Vertical Amplifier Plug-in 501, 503
 Vertical Blank Plug-in, 180 System 536
 Vertical & Time Base Plug-ins 530, 531
 Vinyl Cover, 180A and 181A 537
 Voltage Divider Probe, 10:1 536
 Voltage Divider Probe, 50:1 536
- Oscilloscopes 473
 Oscilloscope Selection Chart 476
 Oscilloscope, Low Frequency 477-488
 Oscilloscope, Plug-in 491-533
 Oscilloscope, Plug-ins Selection Charts 496-520
 Oscilloscope, Ruggedized (AN/USM-281-A) 533
 Oscilloscope, Sampling 507, 509, 510, 528
- Oscilloscope, Swept Frequency 514
 Oscilloscope, Time Domain Reflectometry 515, 528
 Oscilloscope, TV Waveform 438
- Output
 Coupler 98
 Parallel Reader 79
 Recorder Coupler 98
- P**
- P-Band (12.4-18 GHz) Waveguide Instrumentation . 339
 Pack Sensor 152
 Pads, Coax 342, 343
 Parallel Output Reader 79
 Patch Panel for 3550B Telephone Test Set 283, 429
 PC Board Testing 90, 91, 93
 Peak Power Calibrator 391
 Pen Type Probe for 3406A 186
 Phase/Amplitude Tracking Detector 372, 373
 Phase-Gain Indicator, Network Analyzer 383
 Phase and Impedance
 Measurements 221, 329, 330, 366-371
 Phase-lock Function Generator 273-275
 Phase-Lock Synchronizer 294, 295, 327
 Phase-Magnitude Display, Network Analyzer 376
 Phase Shifter 358
 Piezo-Electric Accelerometer 60-62
 PIN Modulator 235, 310, 311
 Plotter, Calculator 84
 Plug-in Digital Voltmeter 203
 Plug-in Function Generator 274, 316
 Plug-in Selective Voltmeter 432
 Plug-in Wave Analyzers 455-457
 Plug-in RF Units 322-326
 Plug-in Selective Voltmeter 432
 Point Plotter Accessory 119, 120
 Point Plotting System 121
 Polar Display, Network Analyzer 376, 383
 Portable AC Voltmeter 180
 Portable Instrumentation Tape Recorder 149-151
 Portable Multifunction Meter 183
 Portable Oscillators 277, 432
 Portable Test Set 428, 429
 Portable Transmission, Noise Measuring Set 430
 Power Amplifier 471, 468
 Power Meters 389-398
- Power Supply
 AC 171
 Amplifier 568
 Condensed Listing 545-547
 DC, Constant Current 550

DC Regulated	544-571
Digitally-Programmable	86-89
Microphone	60-62
Regulated DC	548, 552, 553, 560-562, 568, 569
SCR Regulated	563
Selection Guide	544-547
Transistor Bias	385
Power and Voltage Amplifier/Supply	468
Power Supplies, Frequency Standard	627
Power Supplies, Nuclear	44
Preamplifier	44, 217
Preamplifier, Eight-Channel, Low Gain	141
Preamplifier, Eight-Channel, Medium Gain	141
Preamplifier, High Freq.	233
Preamplifier, Microphone	60-62
Preamplifier Module, Carrier	136-139
Preamplifier Module, Low Gain DC	136-139
Preamplifier Module, Low Level	136-139
Preamplifier Module, Medium Gain DC	136-139
Precision AC Amplifier	469
Precision AC Calibrator	160-161
Precision Analog Voltmeters	162-168
Precision Analog Voltmeters & Sources, Tech. Info.	155-158
Precision Noise Generator	57
Precision Raster Display	436, 437
Precision Transfer Standard	159
Prescaler and DVM Counter Plug-ins	591
Preselector for Spectrum Analyzer	413
Preset Counter-Controllers	608, 614, 615
Preset Counter, Plug-in Unit	594
Printer Output Plug-in for 3450A DVM	208
Printers, Digital, Line	107-110
Probe accessories	535
Probe, active	534
Probe, current	534-535
Probe, Digital Logic Test	92
Probe power supply	534
Probe, resistive	534
Probe Tip Kit	535
Probe Tip Kit Sampling	508
Probe, Voltage divider	536
Probes	
AC Current	195
Accessory Kit for 4815A	223
Divider 10:1 for 3406A RF VM	187
Frequency Doubler	289
High Frequency	195
Kit for 411A RF mVM	186
Kit for 3406A RF VM	187
Magnetometer for 428B Clip-on mAM	194
Slotted Line	352-354
Tip to 500 MHz, 411A RF mVM	187
Tip 100:1 Divider to 500 MHz, 411A, RF mVM ..	187
Tip, Pen Type to 50 MHz, 411A RF mVM	187
Tip, Type N Tee to 1 GHz, 411A RF mVM	187
Tip, VHF to 250 MHz, 411A RF mVM	187
Voltage Divider	185, 187, 191, 195
Processor, Audio Data	63-65
Programmable Test Systems	90, 91, 93, 386-388
Programmer, Scanner	97, 98
Pulse Generator	237-245, 248-261
Pulse Generator selection chart	238
Pulse Generators, Signal Sources	237-245, 248-261
Pulse Generator systems (plug-in)	254-261
Pulse Generator, tunnel diode	248, 513
Pulse Height Analyzer	35
Punched Card Coupler	98
Punched Tape Coupler	98
Push Button Oscillator	277
Q	
Q Measurements	224
Q Meter	229, 230
Q Standards	231
Quartz Oscillator	624
R	
R-Band (26.5-40 GHz) Waveguide Instrumentation ..	340
R Measurements	224
Rack Mount Kit (for 3960 Series)	151
Raster Display, Precision	436, 437
Ratio Meter	166, 208-211, 365
Readers, Optical Mark	78
Readers, Parallel Output	79
Real-Time Analyzer Module	51-54
Real-Time Audio Spectrum Analyzer	51-54
Real-Time Executive System	76
Rear Input Cable for 3450A DVM	211
Rear Input Cable for 3461A Ohms Converter	217
Rear Output Cable, 3460 B/3461A DVM	217
Receiver Test Systems	90, 91
Rechargeable Battery Pack for 204C/D	276
Record Amplifiers, Magnetic Tape	142-152
Recorders	
Accessories	120
Digital	105, 106
Dual-Channel Thermal	131
Eight-Channel Ink	134, 135, 141
Eight-Channel Thermal	133, 140
Four-Channel Thermal	132
Graphic	80, 81

ALPHABETICAL INDEX *continued***Ink, Recorders to Receiver**

- Ink, See Recorders, Strip Chart 122, 123
 Low Pressure Ink, See "Recorders, Strip Chart" 122, 123
 Output Coupler 98
 Portable Thermal 127-129
 Single-Channel Thermal 130
 Six-Channel Thermal 133, 140
 Sixteen-Channel Thermal 140
 Sound Level 49
 Strip Chart 122, 123
 Strip Chart, 5-inch 126
 Strip Chart, 1-pen, 10-inch 124
 Strip Chart, 2-pen, 10-inch 124
 Trend 121
 Thermal Tutorial 122, 123
 X-Y, 8½ by 11 inches 113-117, 114
 X-Y, 11 by 17 inches 113-117
 X-Y, 30 by 30 inches 114
 X-Y, with Plug-in Modules 117
 X-Y Tutorial 112
 Recording Systems 121, 124, 134, 135
 Magnetic Tape 142-152
 Reed Scanner 97
 Reflection Measurement
 Equipment 359-362, 365, 372-388
 Reflection/Transmission Test Units 374-376, 379-384
 Reflectometer Equipment 359-362, 365, 383, 384
 Reflectometer Technical Information 330, 368-371
 Regulated Power Supplies 544-571
 Remote Control (for 3960 Series) 151
 Remote Control Cable for 3460B 216
 Remote Control Cable for 3461A 217
 Remote Control Plug-in for 3450A 208
 Reproduce Track Selector 152
 Resistance Measurements 224
 Resistive Dividers 534
 Resistivity Cell 193
 Reversible Counter and 2-Channel Plug-in 613
RF
 Amplifiers 233
 Detector for 675A Sweeper 317
 Millivoltmeter 186, 187, 175
 Network Analyzers 372-388
 Power Meters 391-398
 Signal Generators 286-309
 Spectrum Analyzers 403-408
 Sweeper 312-315, 317-328
 Testing 90, 91, 317, 328
 Vector Impedance Meter 223
 Vector Voltmeter 378
 Risetime Converters for TDR 516
 RMS, True Voltmeter 181, 209
 Rotary Air Lines and Joints, Coax 347
 Rubidium Frequency Standard 622, 623
 RX Meter 228
- S**
- S-Parameters (Technical Information) 371
 Sampler for 140 System Oscilloscope 510
 Sampling RF Voltmeter 186
 Sampling Accessories 508, 513
 Scanner
 Crossbar 97
 Input 97
 Module 119
 Multiplexer 97, 98, 104
 Programmer 97
 Reed 97
 S-Parameter Test Set 384-385
 SCR-1P Power Supply 563
 SCR-3 Power Supply 564
 SCR-10 Power Supplies 565
 Selective Voltmeter 432, 433, 460
 SHF Signal Generators 302-305
 Short, Coax and Waveguide 356, 357
 Shorting Switch, X-band 357
 Signal Analysis, Digital; see "Analyzers" and "Digital"
 Signal Analyzers 42, 43, 399-422
 Signal Generators 284-311
 FM 307
 FM-AM 288, 290, 291
 HF 286, 287
 SHF 302-305
 Technical Information 284-285
 Telemetry 291-307
 UHF 297-300
 VHF 292, 293
 Signal Sources 237-283
 Audio Frequency 267-282
 Delay Gen. Plug-ins 258
 Fixed TR and Word Gen. 261
 Low Frequency 272-275, 278
 Pulse Generator Selection 238
 Pulse Generator Tutorial 237
 Rate Gen. Plug-ins 257
 Square Wave Generator 247
 Sweepers 312-328
 1900 System Mainframe 259
 1900 System Product 254
 Var. Trans. Output 259, 260
 Wideband 273, 278, 281, 282
 Sine/Square Oscillator 276
 Single Frequency Marker for 675A Sweeper 317

- Slide-Screw Tuners, Waveguide 358
Sliding Load, Waveguide and Coax 356-357
Slot Power Supplies 566, 567
Slotted Line Equipment 352-354
Solid State
 Amplifiers 233
 Limiters 234
 Oscillators 233
 Switches 234
Solid State Sweepers 316-328
Sound Level Calibrator 60-62
Sound Level Recorder 49
Source, Microwave Sweep Generator 312-328
Source, Signal 237-328
Source, Sweep Generator 312-328
Sources, Swept 312-328
Sources, Signal Generators 284-311
Spectrum Analyzers 399-414
Spectrum Analyzer Preselector 409-414
Spectrum Generator 296
Square Wave Generator 237, 238, 247, 248
Stabilized Amplifier 467
Stabilized Sweep Oscillator Systems 327
Standards, Inductance 231
Standards, Q 231
Standby Power Supply 627
Statistical Analysis, Signal; see "Analyzers" and "Digital"
STB Power Supplies 548
Subsystems, High Speed Data Acquisition 103
Sweep Drive for 302A, 310A, 312A Wave Analyzers . 458
Sweep, Generators 312-328
Sweep/Network Analysis Systems 328, 372
Sweep Local Osc. Plug-in 3590A, 3591A
 Wave Analyzers 432, 455-457
Sweep/Network Analysis Systems 328, 372
Sweep/Offset Plug-in for 3300A Function
 Generator 275, 316
Sweep Oscillators 312-328
Sweep Oscillator, 8690B Series 320-328
Sweep Plug-in for 3300A Function Generator 316
Sweeper 312-328
Sweepers, Technical Information 312-315
Sweeping Signal Generator 317-319
Swept Frequency Indicator P/I 140-System 514
Swept-Frequency Measurements, Technical
 Information 312-315
Swept Slotted Line 352
Switch, Coaxial 234, 347
Swivel Adapter, Coax 347
SWR Meters 363, 364
Synchronizer, Phase-lock 294, 295, 327
Synthesizer Driver 635
 Controllers 98
 Computer Data Amplifier 102, 103
 Custom 90, 91
 Data Acquisition 100, 101
 Data Amplifier 464, 466
Systems
 Automatic Network Analyzer 386-388
 Frequency Measurement 601
 Multichannel Analyzer 38, 39
 Network Analyzer 374-376, 379-385
 Sweeper 327-328
- ## T
- Tape Recorders, Analog 142-152
Tape Servo 152
TRD-1415A Plug-in for 140 System 515
Tee, 50-Ohms, for 8405A 378
Tee, 50-Ohms, for 3406A RF VM 187
Tee, Bias (Coax) 385
Telephone Test Oscillator 431
Telephone Test Set 428
Teleprinter Coupler 98
Terminal Shield for 4800A 222
Terminations 335-339, 356, 357
 50-Ohm Feed-Thru 283
 75-Ohm Feed-Thru 283
 600-Ohm Feed-Thru 283
 Capacitive 60-62
 Coaxial, Fixed and Sliding 356
 Waveguide, Fixed and Sliding 357
Test Leads 196
Testmobiles 538
Test Oscillator 277, 281, 282, 435
Test Set, DME/ATC 308
Test Set, H-Band 301
Test Set, Microwave 301
Test Set, SHF 301
Test Set, X-Band 301
Test Systems
 Analog Module 90, 91
 Automatic 90, 91, 93
 Computer Controlled 90, 91, 386-388
 Custom Module 90, 91
 Digital Logic Module 93
 Digital Module 90, 91
 Logic Module 93
 Network Analysis 374-376, 379-385
 Programmable 90, 91, 93
 Receiver 90, 91

ALPHABETICAL INDEX *continued***Tester to X-Y Recorders**

Tester, Digital Logic, Probe	92
Testing	
Component	93
RF	90, 91
Thermal Converters, AC to DC	165
Thermistor Mounts, Waveguide and Coax	396, 397
Thermistor Power Meter	394, 395
Thermocouple Mount	392, 393
Thermocouple Power Meter	392, 393
Time and Frequency Measurements: see "Frequency"	
Listings	
Time Base	120
Time Base Module	118
Time Domain Reflectometry	439, 515, 528
Time Interval Measurement; see Frequency Tutorial	
Article	572
Time Interval Counters, Precise	577, 584, 604, 606
Time Interval Units, Counter Plug-in	580, 592, 593
Time Interval Plug-in	592
Time Interval Plug-in for 5360A	580
Time-Shared BASIC System	74-75
Time-Shared System, Computer	74, 75
Tracking Oscillator for 312A	433
Transducer, Acoustics	60-62
Transducer, Linear Displacement, AC	153, 154
Transducer, Linear Displacement, DC	153, 154
Transducer, Linear Velocity	153, 154
Transfer Oscillator Plug-in	597
Transistor Bias Supply	385
Transistor Fixture	385, 333, 334
Transistor Noise Analysis	421
Transistor Noise Analyzer	422
Transistor Test Jig	228
Transit Case (for 3960 Series)	151
Transit Cases, Field	638, 639
Transmission Kit	375, 376
Transmission & Noise Measuring Set	430
Transmission/Reflection Test Units	374-376, 379-384
Transmission Measurements (Tech. Info.) ..	331, 366-371
Trend Recorder	121
Trigger/Phase Lock Plug-in for 3300A	
Function Generator	275
Tripod	60-62
True RMS AC Voltmeter	181, 209
Tuner, Slide Screw, Waveguide	358
TV Monitors	436, 437
Typewriter Coupler	97, 98
TWT Amplifiers	472

U

UHF Noise Source	350, 351
------------------------	----------

UHF Signal Generators	297-300
Universal Bridge	226
Universal Counter	606, 607
Universal Counter, 20 MHz	604, 605
Univerter	291

V

Vacuum Tube Multifunction Meter ...	184, 185, 190, 191
Vacuum Tube Voltmeter	179, 187, 188
Variable Attenuator	283, 333, 341-344
Variable Attenuator, Coax and Waveguide	341-344
Variable Phase Generator	272
Vector Impedance Meter	222
Vector Voltmeter	377, 378
Velocity Transducers	153, 154
VHF Noise Source	350, 351
VHF Oscillator	289
VHF Signal Generators	292, 293
Video Amplifier Plug-in	592
VLF Comparator	625
ULF Receiver, Frequency Comparator	625
Voice Channel (for 3950, 3955 Series)	152
Voice Channel (for 3960 Series)	151
Voltage Divider, 410 B&C	184
Voltage Divider, 100:1 DC, for 410 B/C	185
Voltage Divider 1000:1, for 425A VM	191
Voltage Divider, 1000:1 Capacity, for 400 Series	
VM's	195
Voltage Divider Probe, 10:1 for 400 Series	195
Voltage-to-Frequency Converter	215
Voltmeters	
AC Analog	175-181, 184-187
AC Calibrator	160, 161, 169
AC Differential	164, 165
AC Digital	207, 209, 212-214, 217
AC True RMS	181, 209
AC/DC Calibrator	167, 168
Amplifier, DC Log	182
Analog Technical Information	170-174
Audio-Range	49
Calibrator	160, 168, 169
Converter, AC/DC Log	182
DC Analog	183-185, 188-191
DC Differential	162-166
DC Digital	202-214, 216, 218, 219
Digital, Technical Information	197-201
Logarithmic	182
Multifunction Analog	183-185, 188-191
Multifunction Differential	164-166
Multifunction Digital	203-214, 216, 217

Precision VM's and Sources, Technical Information	155-158
Vector	377, 378

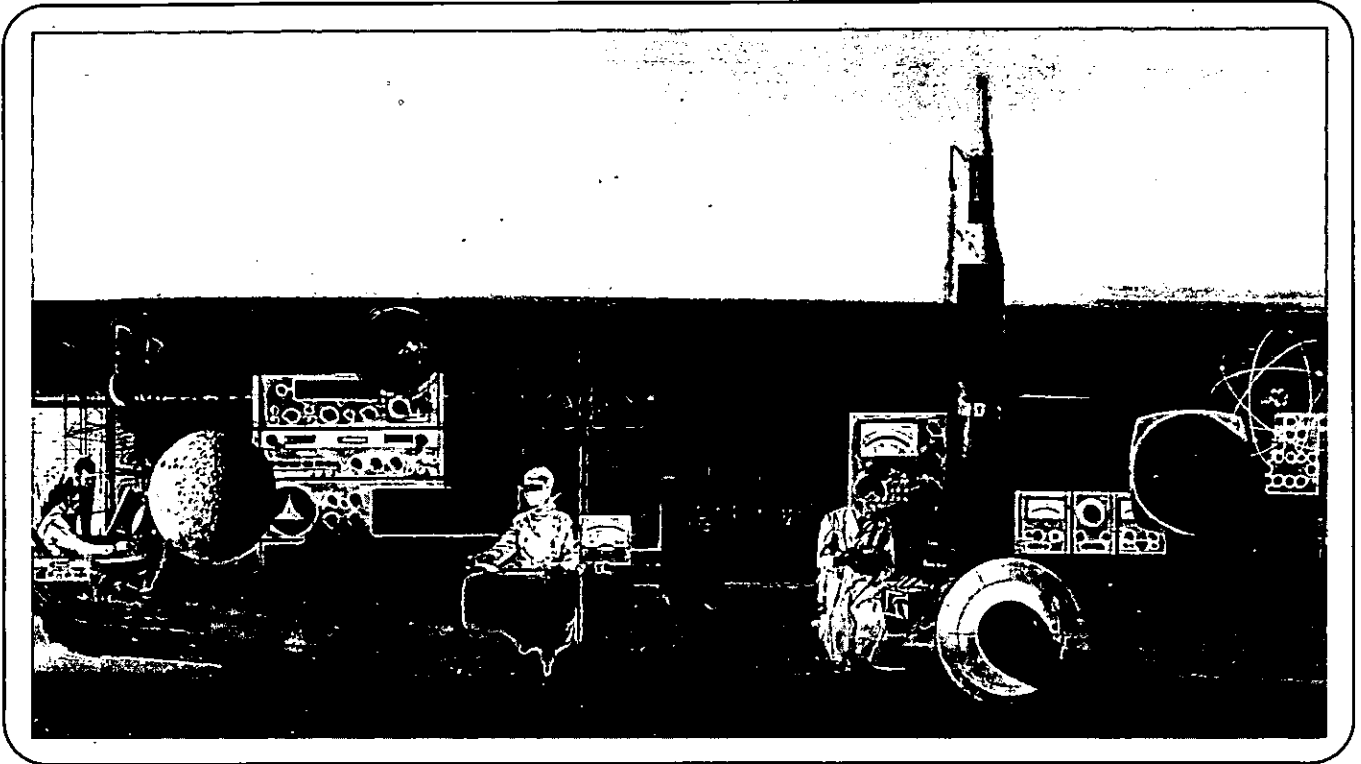
W

Wave Analyzer	455-461
Wave Analyzer, Technical Information	451-454
Waveguide	
Adapters	355, 414
Attenuators	344
Crystal Detectors	345
Directional Couplers	362
Filters	348
Instrumentation Tables	335-340
Loads, Sliding and Fixed	357
Mixers	355, 414
Noise Sources	350, 351
Phase Shifters	358

Shorts	357
Slide-Screw Tuners	358
Slotted Line Equipment	352-354
Stands and Clamps	355
Terminations, Sliding and Fixed	357
Thermistor Mounts	396, 397
Wideband Amplifier	465, 466, 470
Wide Range Oscillator	273, 276-279, 281, 282, 435
Word Generator	239

X-Y

X-Band (8.2-12.4 GHz) Waveguide Instrumentation .	338
X-Y Recorder	117
X-Y Recorder, 8½ by 11 inches	113-117
X-Y Recorder, 11 by 17 inches	113, 115, 116, 117
X-Y Recorder, 30 by 30 inches	114
X-Y Recorder with Plug-in Modules	117
X-Y Recorders, Tutorial	112



What HP Is

Hewlett-Packard is a major designer and manufacturer of electronic instruments for measurement, analysis, and computation. The company was founded in 1939, its first product an economically-priced audio oscillator that was far more stable and easier to use than any such instrument commercially available at the time. From the beginning, the company's basic philosophy has been that each instrument should provide the highest possible return on the customer's investment by offering the maximum accuracy, appropriate to the measurements to be made, along with convenience, dependability, and all-around usefulness. This is still true today.

What HP Makes

Hewlett-Packard now makes more than 2000 products. These include the widely-used electronic laboratory "workhorse" instruments—oscillators, voltmeters, oscilloscopes, counters, and microwave equipment, for example—as well as a variety of instruments for specialized applications, such as a transistor noise analyzer, a microwave communications link analyzer, and cable fault locators. The ever-broadening product list now includes gas chromatographs, osmometers, and other instruments for chemical analysis, a quartz thermometer for precision thermometry, instruments for acoustical measurements, medical instruments for patient monitoring and physiological measurements, and nuclear instruments. These instruments are used by engineers, scientists, doctors, chemists, and technicians to measure and record a wide variety of physical and physiological phenomena.

Hewlett-Packard, offering both instruments that include

computational capability and computers that control measurement systems, is among the leaders in computer-aided measurements. The company's computers and calculators are also widely used as free-standing computational aids.

The company is also a major manufacturer of light-emitting diodes and solid-state alpha-numeric displays. In addition, it offers a variety of semiconductor components including microwave transistors, PIN diodes, step-recovery diodes, and hot-carrier diodes.

Where HP Is

Hewlett-Packard is as close to its customers as the nearest telephone. More than 100 field offices located in North America and the rest of the world are ready to help select new equipment or with any help needed to keep equipment already in service in first-class operating condition. The offices, in constant touch with all Hewlett-Packard factories, are staffed by trained engineers whose primary responsibility is to provide technical data and assistance to customers.

Hewlett-Packard is a world-wide enterprise, with manufacturing facilities in Scotland, West Germany, and Japan, and field offices all over the world. In the United States, the company has seven plants in California, two in Colorado, one in Pennsylvania, two in New Jersey and one in Massachusetts. The company employs over 15,000 people.

To make it possible to develop specialized expertise in all its various capabilities, the company is organized into 17 divisions, each with its own manufacturing facilities, product development laboratories, and marketing support functions for a related group of products. Virtually all Hewlett-Packard products, however, are sold and serviced by the

GENERAL INFORMATION



ABOUT HEWLETT-PACKARD

same field offices so customer needs can be accommodated through a single contact with the company.

Where HP Is Going

To maintain leadership in instruments for measurement, analysis, and computation, the company invests heavily in new product development—research and development expenditures traditionally have averaged about 10 percent of sales revenue. As a result, about half the company's current business now is represented by products that were not in existence six years ago. Virtually all R & D programs are company-funded, giving the company a free hand in committing its resources where the largest contributions to measurement and computation science can be made. More than 1500 graduate engineers and scientists are engaged in the company's aggressive research and development programs.

Formed as a partnership in 1939, and incorporated in 1947, Hewlett-Packard is a well-established company that has controlled its growth so expansion can be financed generally from income on a pay-as-you-go basis. Management has successfully avoided the volatile ups-and-downs often encountered by science-based companies, and has planned for continuing orderly growth with strength (Hewlett-Packard was accepted for listing on both the New York

and Pacific Coast Stock Exchanges in 1961). Although the company has experienced substantial growth, it has never altered its original objective: to make significant contributions to the art and science of measurement.

How HP Does It

Complementing the development of products based on technological contribution, Hewlett-Packard has developed advanced manufacturing techniques that make it possible to offer high quality at moderate cost. This has meant creation of specialized facilities for manufacturing important components where an extra measure of control is desired. Among these are quartz resonators, cathode-ray tubes, transformers, panel meters, and integrated circuits and other semiconductor components.

Of the many factors contributing to the Company's success, one of the most significant is the belief that well-trained, intelligent people can perform far more effectively if they understand the company's objectives and work towards them in an atmosphere of freedom without rigid direction from the top. A feeling of personal involvement and individual responsibility for product quality is infused at each step of the design and manufacturing processes. The result is equipment produced with the high quality that customers have come to expect from Hewlett-Packard.



SALES & SERVICE OFFICES



UNITED STATES AND CANADA

1 ALABAMA
P.O. Box 4207
2003 Byrd Spring Road S.W.
Huntsville 35802
Tel: (205) 881-4591
TWX: 810-726-2204

2 ARIZONA
3009 North Scottsdale Road
Scottsdale 85251
Tel: (602) 945-7601
TWX: 910-950-1282

3 5737 East Broadway
Tucson 85716
Tel: (602) 298-2313
TWX: 910-952-1162

4 CALIFORNIA
1430 East Orangethorpe Ave.
Fullerton 92631
Tel: (714) 870-1000

5 CALIFORNIA
3939 Lankershim Boulevard
North Hollywood 91604
Tel: (213) 877-1282
TWX: 910-499-2170

6 1101 Embarcadero Road
Palo Alto 94303
Tel: (415) 327-6500
TWX: 910-373-1280

7 2591 Carlsbad Avenue
Sacramento 95821
Tel: (916) 482-1463
TWX: 910-367-2092

8 1055 Shafter Street
San Diego 92106
Tel: (714) 223-8103
TWX: 910-335-2000

9 COLORADO
7965 East Prentice
Englewood 80110
Tel: (303) 771-3455
TWX: 910-935-0705

10 CONNECTICUT
508 Tolland Street
East Hartford 06108
Tel: (203) 289-9394
TWX: 710-425-3416

11 111 East Avenue
Norwalk 06851
Tel: (203) 853-1251
TWX: 710-468-3750

12 DELAWARE
3941 Kennett Pike
Wilmington 19807
Tel: (302) 655-6161
TWX: 510-666-2214

13 FLORIDA
P.O. Box 545
Suite 106
9999 N.E. 2nd Avenue
Miami Shores 33153
Tel: (305) 754-4565
TWX: 810-848-7262

14 P.O. Box 20007
Herndon Station 32814
621 Commonwealth Avenue
Orlando
Tel: (305) 841-3970
TWX: 810-850-0113

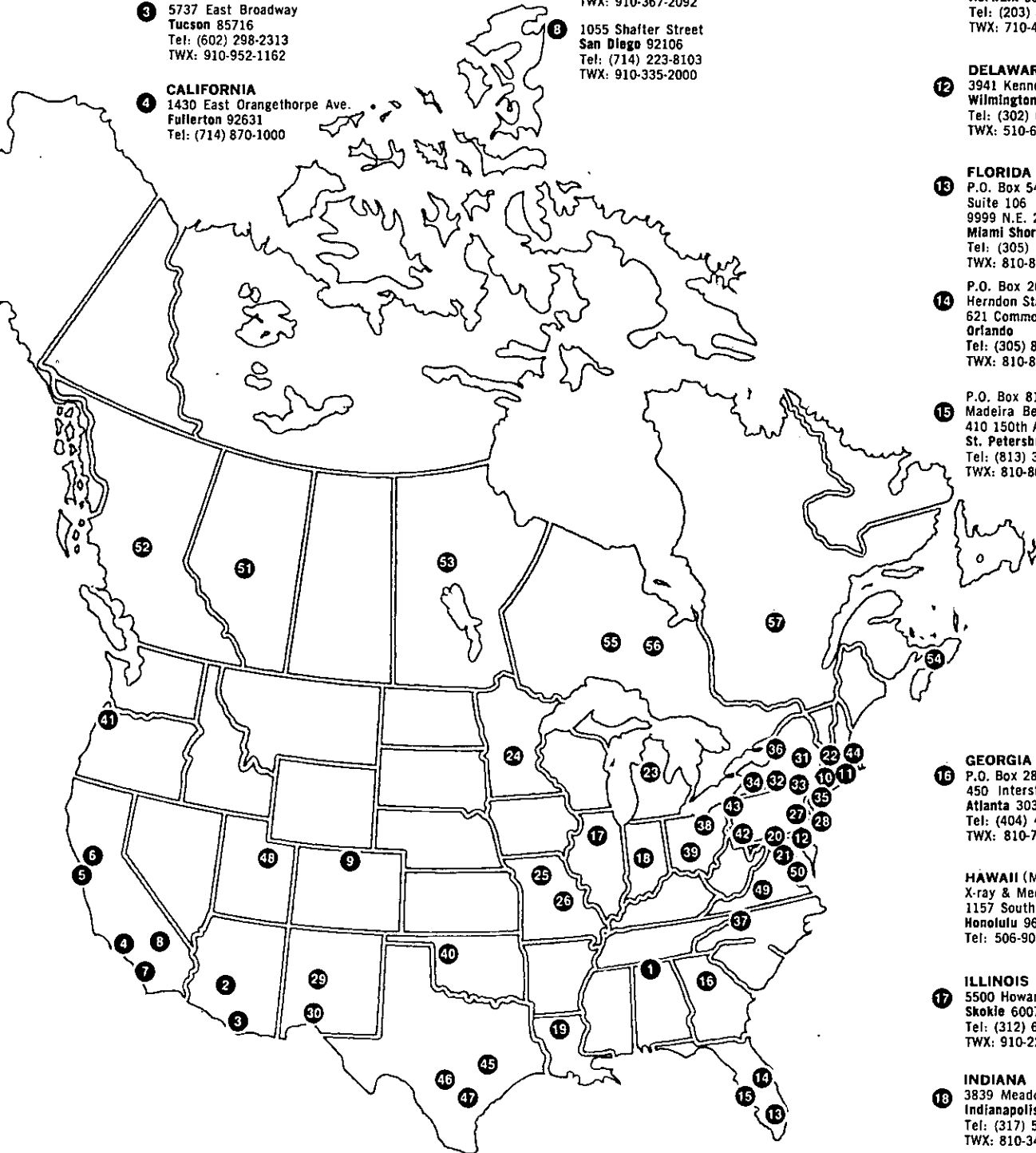
15 P.O. Box 8128
Madeira Beach 33708
410 150th Avenue
St. Petersburg
Tel: (813) 391-0211
TWX: 810-863-0366

16 GEORGIA
P.O. Box 28234
450 Interstate North
Atlanta 30328
Tel: (404) 436-6181
TWX: 810-766-4890

HAWAII (Medical Only)
X-ray & Medical Equipment Co.
1157 South King St.
Honolulu 96814
Tel: 506-900

17 ILLINOIS
5500 Howard Street
Skokie 60076
Tel: (312) 677-0400
TWX: 910-223-3613

18 INDIANA
3839 Meadows Drive
Indianapolis 46205
Tel: (317) 546-4891
TWX: 810-341-3263



19 LOUISIANA
P.O. Box 856
1942 Williams Boulevard
Kenner 70062
Tel: (504) 721-6201
TWX: 810-955-5524

20 MARYLAND
6707 Whitestone Road
Baltimore 21207
Tel: (301) 944-5400
TWX: 710-862-0850

P.O. Box 1648
21 2 Choke Cherry Road
Rockville 20850
Tel: (301) 948-6370
TWX: 710-828-9684

22 MASSACHUSETTS
32 Hartwell Ave.
Lexington 02173
Tel: (617) 861-8960
TWX: 710-326-6904

23 MICHIGAN
24315 Northwestern Highway
Southfield 48075
Tel: (313) 353-9100
TWX: 810-232-1532

24 MINNESOTA
2459 University Avenue
St. Paul 55114
Tel: (612) 645-9461
TWX: 910-563-3734

25 MISSOURI
9208 Wyoming Place
Kansas City 64114
Tel: (816) 333-2445
TWX: 910-771-2087

26 2812 South Brentwood Blvd.
St. Louis 63144
Tel: (314) 962-5000
TWX: 910-760-1670

27 NEW JERSEY
W. 120 Century Road
Paramus 07652
Tel: (201) 265-5000
TWX: 710-990-4951

28 1060 N. Kings Highway
Cherry Hill 08034
Tel: (609) 667-4000
TWX: 710-892-4945

29 NEW MEXICO
P.O. Box 8366
Station C
6501 Lomas Boulevard N.E.
Albuquerque 87108
Tel: (505) 255-5586
TWX: 910-989-1665

30 156 Wyatt Drive
Las Cruces 88001
Tel: (505) 526-2485
TWX: 910-983-0550

31 NEW YORK
1702 Central Avenue
Albany 12205
Tel: (518) 869-8462
TWX: 710-441-8270

32 1219 Campville Road
Endicott 13760
Tel: (607) 754-0050
TWX: 510-252-0890

33 82 Washington Street
Poughkeepsie 12601
Tel: (914) 454-7330
TWX: 510-248-0012

34 39 Saginaw Drive
Rochester 14623
Tel: (716) 473-9500
TWX: 510-253-5981

35 1025 Northern Boulevard
Roslyn, Long Island 11576
Tel: (516) 869-8400
TWX: 510-223-0811

36 5858 East Molloy Road
Syracuse 13211
Tel: (315) 454-2486
TWX: 710-541-0482

37 NORTH CAROLINA
P.O. Box 5188
1923 North Main Street
High Point 27262
Tel: (919) 885-8101
TWX: 510-926-1516

38 OHIO
25575 Center Ridge Road
Cleveland 44145
Tel: (216) 835-0300
TWX: 810-427-9129

39 3460 South Dixie Drive
Dayton 45439
Tel: (513) 298-0351
TWX: 810-459-1925

40 OKLAHOMA
2919 United Founders Boulevard
Oklahoma City 73112
Tel: (405) 848-2801
TWX: 910-830-6862

41 OREGON
Westhills Mall, Suite 158
4475 S.W. Scholls Ferry Road
Portland 97225
Tel: (503) 292-9171
TWX: 910-464-6103

42 PENNSYLVANIA
2500 Moss Side Boulevard
Monroeville 15146
Tel: (412) 271-0724
TWX: 710-797-3650

43 1021 8th Avenue
King of Prussia Industrial Park
King of Prussia 19406
Tel: (215) 265-7000
TWX: 510-660-2670

44 RHODE ISLAND
873 Waterman Ave.
East Providence 02914
Tel: (401) 434-5535
TWX: 710-381-7573

45 TEXAS
P.O. Box 22813
4242 Richmond Avenue
Houston 77027
Tel: (713) 667-2407
TWX: 910-881-2645

46 P.O. Box 1270
201 East Arapahoe Road
Richardson 75080
Tel: (214) 231-6101
TWX: 910-867-4723

47 225 Billy Mitchell Road
San Antonio 78226
Tel: (512) 434-4171
TWX: 910-871-1170

48 UTAH
2890 South Main Street
Salt Lake City 84115
Tel: (801) 487-0715
TWX: 910-925-5681

49 VIRGINIA
P.O. Box 6514
2111 Spencer Road
Richmond 23230
Tel: (703) 282-5451
TWX: 710-956-0157

50 WASHINGTON
433-108th N.E.
Bellevue 98004
Tel: (206) 454-3971
TWX: 910-443-2303

FOR U.S. AREAS NOT LISTED:

Contact the regional office nearest you: Atlanta, Georgia... North Hollywood, California... Paramus, New Jersey... Skokie, Illinois. Their complete addresses are listed above.

CANADA

ALBERTA
Hewlett-Packard (Canada) Ltd.
51 11745 Jasper Ave.
Edmonton
Tel: (403) 482-5561
TWX: 610-831-2431

BRITISH COLUMBIA
Hewlett-Packard (Canada) Ltd.
52 3284 East 1st Ave.
Vancouver 12
Tel: (604) 255-7781
TWX: 610-922-5059

MANITOBA
Hewlett-Packard (Canada) Ltd.
53 511 Bradford Ct.
St. James
Tel: (204) 786-7581
TWX: 610-671-3531

NOVA SCOTIA
Hewlett-Packard (Canada) Ltd.
54 2745 Dutch Village Rd.
Suite 203
Halifax
Tel: (902) 455-0511
TWX: 610-271-4482

ONTARIO
Hewlett-Packard (Canada) Ltd.
55 880 Lady Ellen Place
Ottawa 3
Tel: (613) 722-4223
TWX: 610-562-1952

Hewlett-Packard (Canada) Ltd.
56 50 Galaxy Blvd.
Rexdale
Tel: (416) 677-9611
TWX: 610-492-4246

QUEBEC
Hewlett-Packard (Canada) Ltd.
57 275 Hymus Boulevard
Pointe Claire
Tel: (514) 697-4232
TWX: 610-422-3022
Telex: 01-20607

FOR CANADIAN AREAS NOT LISTED:

Contact Hewlett-Packard (Canada) Ltd. in Pointe Claire, at the complete address listed above.

SALES & SERVICE OFFICES



EUROPE

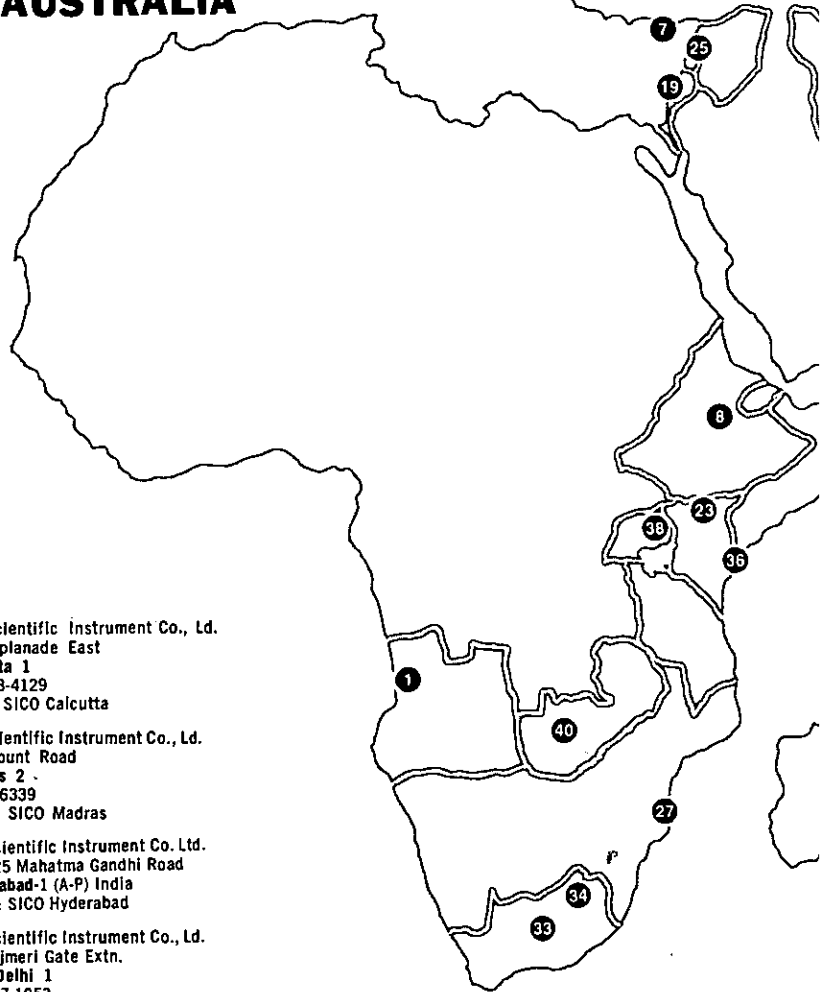
- 1 AUSTRIA**
Unilabor GmbH
Wissenschaftliche Instrumente
Rummelhardtgasse 6/3
P.O. Box 33
Vienna A-1095
Tel: 42 61 81
Cable: LABORINSTRUMENT
Vienna
Telex: 75 762
- 2 BELGIUM**
Hewlett-Packard Benelux S.A.
348 Boulevard du Souverain
Brussels 16
Tel: 72 22 40
Cable: PALOBEN Brussels
Telex: 23 494
- 3 DENMARK**
Hewlett-Packard A/S
Langebjerg 6
2850 Naerum
Tel: (01) 80 40 40
Cable: HEWPACK AS
Telex: 66 40
- 4 FINLAND**
Hewlett-Packard Oy
Gyldenintie 3
Helsinki 20
Tel: 67 35 38
Cable: HEWPACKOY-Helsinki
Telex: 12-1563
- 5 FRANCE**
Hewlett-Packard France
Quartier de Courtaboeuf
Boite Postale No. 6
91 Orsay
Tel: 920 88 01
Cable: HEWPACK Orsay
Telex: 60048
- 6 Hewlett-Packard France**
4 Quai des Etroits
69 Lyon 5ème
Tel: 42 63 45
Cable: HEWPACK Lyon
Telex: 31617
- 7 GERMANY**
Hewlett-Packard Vertriebs-GmbH
Lietzenburgerstrasse 30
1 Berlin W 30
Tel: 24 60 65/66
Telex: 18 34 05
- 8 Hewlett-Packard Vertriebs-GmbH**
Herrenbergerstrasse 110
703 Böblingen, Württemberg
Tel: 07031-6671
Cable: HEPAG Böblingen
- 9 Telex: 72 65 739**
Hewlett-Packard Vertriebs-GmbH
Achenbachstrasse 15
4 Düsseldorf 1
Tel: 68 52 58/59
Telex: 85 86 533
- 10 Hewlett-Packard Vertriebs-GmbH**
Berliner Strasse 117
6 Frankfurt Nieder-Eschbach
Tel: 50 10 64
Cable: HEWPACKSA Frankfurt
Telex: 41 32 49
- 11 Hewlett-Packard Vertriebs-GmbH**
Beim Strohhaus 26
2 Hamburg 1
Tel: 24 05 51/52
Cable: HEWPACKSA Hamburg
Telex: 21 53 32
- 12 Hewlett-Packard Vertriebs-GmbH**
Reginriedstrasse 13
8 München 9
Tel: 0811 69 59 71/75
Cable: HEWPACKSA München
Telex: 52 49 85
- 13 GREECE**
Kostas Karayannis
18, Ermou Street
Athens 126
Tel: 230303 232947
Cable: RAKAR Athens
Telex: 21 59 62 RKAR GR
- 14 IRELAND**
Hewlett-Packard Ltd.
224 Bath Road
Slough, Bucks, England
Tel: Slough 753-33341
Cable: HEWPIE Slough
Telex: 84413
- 15 ITALY**
Hewlett-Packard Italiana S.p.A.
Via Amerigo Vespucci 2
20124 Milano
Tel: 6251 (10 lines)
Cable: HEWPACKIT Milan
Telex: 32046
- 16 Hewlett-Packard Italiana S.p.A.**
Palazzo Italia
Piazza Marconi 25
00144 Rome - Eur
Tel: 591 2544
Cable: HEWPACKIT Rome
Telex: 61514
- 17 NETHERLANDS**
Hewlett-Packard Benelux, N.V.
Weerdestein 117
Amsterdam, Z 11
Tel: 42 77 77
Cable: PALOBEN Amsterdam
Telex: 13 216
- 18 NORWAY**
Hewlett-Packard Norge A/S
Box 149
Nesveien 13
Haslum
Tel: 53 83 60
Cable: HEWPACK Oslo
Telex: 6621
- 19 PORTUGAL**
Telectra
Rua Rodrigo da Fonseca 103
P.O. Box 2531
Lisbon 1
Tel: 68 60 72
Cable: TELECTRA Lisbon
Telex: 1598
- 20 SPAIN**
Ataio Ingenieros
Ganduxer 76
Barcelona 6
Tel: 211-44-66
Ataio Ingenieros
Enrique Larreta 12
Madrid, 16
Tel: 235 43 44
Cable: TELEATAIO Madrid
Telex: 2 72 49
- 21 SWEDEN**
Hewlett-Packard (Sverige) AB
Hagakersgatan 9C
S 431 04 Mölndal 4
Tel: 031 - 27 68 00
- 22 Hewlett-Packard (Sverige) AB**
Svetsarvägen 7
S171 20 Solna 1
Tel: (08) 98 12 50
Cable: MEASUREMENTS
Stockholm
Telex: 10721
- 23 SWITZERLAND**
Hewlett Packard (Schweiz) AG
Zurcherstrasse 20
8952 Schlieren
Zurich
Tel: (051) 98 18 21/24
Cable: HEWPACKAG Zurich
Telex: 53933
- 24 Hewlett Packard (Schweiz) A.G.**
Rue du Bois-du-Lan 7
1217 Meyrin-Geneva
Tel: (022) 41 54 00
Cable: HEWPACKSA Geneva
Telex: 2 24 86
- 25 TURKEY**
Telekom Engineering Bureau
P.O. Box 376 - Galata
Istanbul
Tel: 49 40 40
Cable: TELEMATION Istanbul
- 26 UNITED KINGDOM**
Hewlett-Packard Ltd.
224 Bath Road
Slough, Bucks
Tel: Slough 33341
Cable: HEWPIE Slough
Telex: 84413
- 27 YUGOSLAVIA**
Belram S.A.
83 avenue des Mimosas
Brussels 15, Belgium
Tel: 34 33 32, 34 26 19
Cable: BELRAMEL Brussels
Telex: 21790
- FOR AREAS NOT LISTED, CONTACT:**
Hewlett-Packard S.A.
Rue du Bois-du-Lan 7
1217 Meyrin-Geneva
Tel: (022) 41 54 00
Cable: HEWPACKSA Geneva
Telex: 2.24.86



SALES & SERVICE OFFICES



AFRICA, ASIA, AUSTRALIA



1 ANGOLA
Telectra Empresa Técnica
de Equipamentos Eléctricos SAR
Rua de Barbosa Rodrigues
42-1º
Box 6487
Luanda
Cable: TELECTRA Luanda

2 AUSTRALIA
Hewlett-Packard Australia Pty. Ltd.
22-26 Welr Street
Glen Iris, 3146
Victoria
Tel: 20.1371 (4 lines)
Cable: HEWPARD Melbourne
Telex: 31024

3 Hewlett-Packard Australia Pty. Ltd.
61 Alexander Street
Crows Nest 2065
New South Wales
Tel: 43.7866
Cable: HEWPARD Sydney
Telex: 21561

4 Hewlett-Packard Australia Pty. Ltd.
97 Churchill Road
Prospect 5082
South Australia
Tel: 65.2366
Cable: HEWPARD Adelaide

5 Hewlett Packard Australia Pty. Ltd.
2nd Floor, Suite 13
Casablanca Buildings
196 Adelaide Terrace
Perth, W.A. 6000
Tel: 21-3330

6 CEYLON
United Electricals Ltd.
P.O. Box 681
Yahala Building
Staples Street
Colombo 2
Tel: 5496
Cable: HOTPOINT Colombo

7 CYPRUS
Kypronic
19-19D Hommer Avenue
P.O. Box 752
Nicosia
Tel: 6282-75628
Cable: HE-I-NAMI

8 ETHIOPIA
African Salespower & Agency Private Ltd., Co.
P. O. Box 718
58/59 Cunningham St.
Addis Ababa
Tel: 12285
Cable: ASACO Addisababa

9 HONG KONG
Schmidt & Co. (Hong Kong) Ltd.
P.O. Box 297
1511, Prince's Building
10, Chater Road
Hong Kong
Tel: 240168, 232735
Cable: SCHMIDTCO Hong Kong

10 INDIA
The Scientific Instrument
Co., Ltd.
6, Tej Bahadur Sapru Road
Allahabad 1
Tel: 2451
Cable: SICO Allahbad

11 The Scientific Instrument Co., Ltd.
12/5 Dickenson Road
Bangalore -1
Cable: SICO Bangalore

12 The Scientific Instrument Co., Ltd.
240, Dr. Dadabhai Naoroji Road
Bombay 1
Tel: 26-2642
Cable: SICO Bombay

13 The Scientific Instrument Co., Ltd.
11, Esplanade East
Calcutta 1
Tel: 23-4129
Cable: SICO Calcutta

14 The Scientific Instrument Co., Ltd.
30, Mount Road
Madras 2
Tel: 86339
Cable: SICO Madras

15 The Scientific Instrument Co. Ltd.
5-8-525 Mahatma Gandhi Road
Hyderabad-1 (A-P) India
Cable: SICO Hyderabad

16 The Scientific Instrument Co., Ltd.
B-7, Ajmeri Gate Extn.
New Delhi 1
Tel: 27-1053
Cable: SICO New Delhi

17 INDONESIA
Bah Bolan Trading Coy. N.V.
Djalah Merdeka 29
Bandung

18 IRAN
Telecom, Ltd.
P. O. Box 1812
240 Kh. Saba Shomali
Teheran
Tel: 43850, 48111
Cable: BASCOM Teheran

19 ISRAEL
Electronics & Engineering
Division of Motorola Israel Ltd.
17 Aminadav Street
Tel-Aviv
Tel: 36941 (3 lines)
Cable: BASTEL Tel-Aviv
Telex: Bastel Tv 033-569

20 JAPAN
Yokogawa-Hewlett-Packard Ltd.
Nisei Ibaragi Bldg.
2-2-8 Kasuga
Ibaragi-Shi
Osaka
Tel: 23-1641

21 Yokogawa-Hewlett-Packard Ltd.
Ito Building
No. 59, Kotori-cho
Nakamura-ku, Nagoya City
Tel: 551-0215

22 Yokogawa-Hewlett-Packard Ltd.
Ohashi Building
59 Yoyogi 1-chrome
Shibuya-ku, Tokyo
Tel: 370-2281/7
Telex: 232-2024YHP
Cable: YHPMARKET TOK 23-724

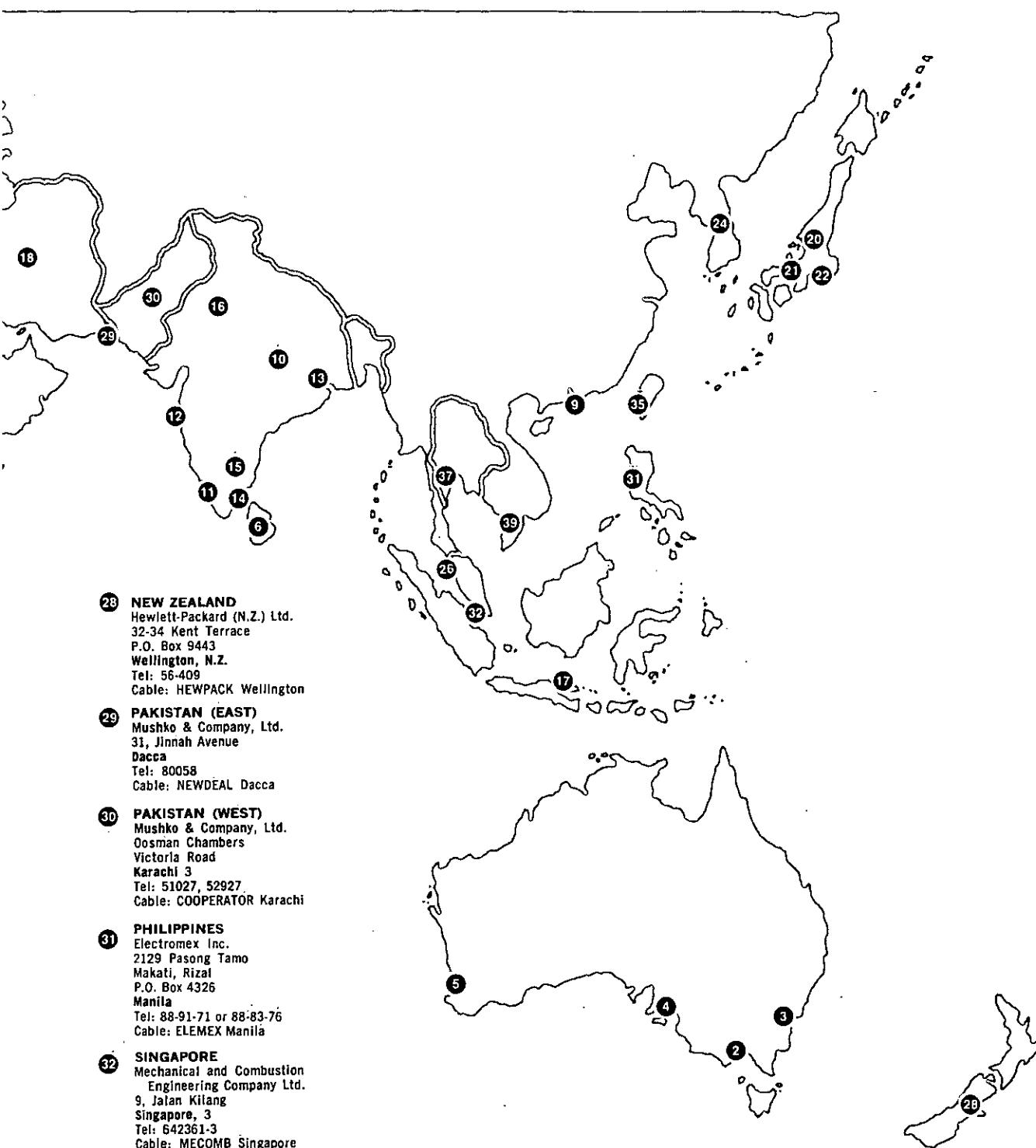
23 KENYA
R. J. Tilbury Ltd.
P. O. Box 2754
Suite 517/518
Hotel Ambassadeur
Nairobi
Tel: 25670, 26803, 68206, 58196
Cable: ARJAYTEE Nairobi

24 KOREA
American Trading Co., Korea, Ltd.
P.O. Box 1103
Dae Kyung Bldg.
107 Sejong Ro
Chongro Ku
Seoul
Tel: 75-5841 (4 lines)
Cable: AMTRACO Seoul

25 LEBANON
Constantin E. Macridis
Clemenceau Street
P.O. Box 7213
Beirut
Tel: 220846
Cable: ELECTRONUCLEAR Beirut

26 MALAYSIA
MECOMB Malaysia Ltd.
2 Lorong 13/6A
Section 13
Petaling Jaya, Selangor
Cable: MECOMB Kuala Lumpur

27 MOZAMBIQUE
A. N. Goncalves, LDA.
4.1 Apt. 14 Av. D. Luis
P.O. Box 107
Louranco Marques
Cable: NEGON



28 NEW ZEALAND
Hewlett-Packard (N.Z.) Ltd.
32-34 Kent Terrace
P.O. Box 9443
Wellington, N.Z.
Tel: 56-409
Cable: HEWPACK Wellington

29 PAKISTAN (EAST)
Mushko & Company, Ltd.
31, Jinnah Avenue
Dacca
Tel: 80058
Cable: NEWDEAL Dacca

30 PAKISTAN (WEST)
Mushko & Company, Ltd.
Oosman Chambers
Victoria Road
Karachi 3
Tel: 51027, 52927
Cable: COOPERATOR Karachi

31 PHILIPPINES
Electromex Inc.
2129 Pasong Tamo
Makati, Rizal
P.O. Box 4326
Manila
Tel: 88-91-71 or 88-83-76
Cable: ELEMEX Manila

32 SINGAPORE
Mechanical and Combustion
Engineering Company Ltd.
9, Jalan Kilang
Singapore, 3
Tel: 642361-3
Cable: MECOMB Singapore

33 SOUTH AFRICA
Hewlett Packard South Africa
(Pty.), Ltd.
Hill House
43 Somerset Rd.
Cape Town
Tel: 3-6019
Cable: HEWPACK Cape Town
Telex: 7038CT

34 Hewlett Packard South Africa
(Pty.), Ltd.
P.O. Box 31716
30 De Beer Street
Braamfontein, Johannesburg
Tel: 724-4172 724-4195
Telex: 0226 JH
Cable: HEWPACK Johannesburg

35 TAIWAN
Hwa Sheng Electronic Co., Ltd.
P. O. Box 1558
Room 404
Chia Hsin Building
No. 96 Chung Shan
North Road, Sec. 2
Taipei
Tel: 555211 Ext. 532-539
Cable: VICTRONIX Taipei

36 TANZANIA
R. J. Tilbury Ltd.
P.O. Box 2754
Suite 517/518
Hotel Ambassadeur
Nairobi
Tel: 25670, 26803, 68206, 58196
Cable: ARJAYTEE Nairobi

37 THAILAND
The International
Engineering Co., Ltd.
P. O. Box 39
614 Sukhumvit Road
Bangkok
Tel: 910722 (7 lines)
Telex: INTENCO BK 226
Cable: GYSOM BANGKOK

38 UGANDA
R. J. Tilbury Ltd.
P.O. Box 2754
Suite 517/518
Hotel Ambassadeur
Nairobi
Tel: 25670, 26803, 68206, 58196
Cable: ARJAYTEE Nairobi

39 VIETNAM
Peninsular Trading Inc.
P.O. Box H-3
216 Hien-Vuong
Saigon
Tel: 20.805
Cable: PENINSULA Saigon

40 ZAMBIA
R. J. Tilbury (Zambia) Ltd.
P.O. Box 2792
Lusaka
Zambia, Central Africa

**FOR AREAS NOT LISTED,
CONTACT:**
Hewlett-Packard
INTERCONTINENTAL
3200 Hillview Ave.
Palo Alto, California 94304
Tel: (415) 326-7000
TWX: 910-373-1267
Cable: HEWPACK Palo Alto
Telex: 034-8461

SALES & SERVICE OFFICES



CENTRAL AND SOUTH AMERICA

1 ARGENTINA
Hewlett-Packard Argentina
S.A.C.e.I
Lavalle 1171 - 3°
Buenos Aires
Tel: 35-0436, 35-0627, 35-0431
Telex: 012-1009
Cable: HEWPACKARG

2 BRAZIL
Hewlett-Packard Do Brasil
I.e.C Ltda.
Rua Coronel: Oscar Porto, 691
Sao Paulo - 8, SP
Tel: 71-1503
Cable: HEWPACK Sao Paulo

3
Hewlett-Packard Do Brasil
I.e.C. Ltda.
Avenida Franklin Roosevelt 84-
grupo 203
Rio de Janeiro, ZC-39, GB
Tel: 32-9733
Cable: HEWPACK Rio de Janeiro

4 CHILE
Hector Calcagni P.
Bustos, 1932-3er Piso
Casilla 13942
Santiago
Tel: 4-2396

5 COLOMBIA
Instrumentacion
Henrik A. Langebaek & Kler
Ltda.
Carrera 7 #48-59
Apartado Aereo 6287
Bogota, 1 D.E.
Tel: 45-78-06, 45-55-46
Cable: AARIS Bogota

6 COSTA RICA
Lic. Alfredo Gallegos Gurdian
Apartado 3243
San José
Tel: 21-86-13
Cable: GALGUR San José

7 ECUADOR
Laboratorios de Radio-Ingenieria
Calle Guayaquil 1246
Post Office Box 3199
Quito
Tel: 12496
Cable: HORVATH Quito

8 EL SALVADOR
Electrónica
Apartado Postal 1589
27 Avenida Norte 1133
San Salvador
Tel: 25-74-50
Cable: ELECTRONICA
San Salvador

9 GUATEMALA
Olander Associates Latin America
Apartado 1226
7a. Calle, 0-22, Zona 1
Guatemala City
Tel: 22812
Cable: GLALA Guatemala City

10 JAMAICA
General Engineering Services,
Ltd.
27 Dunrobin Ave.
Kingston
Tel: 42657
Cable: GENSERV

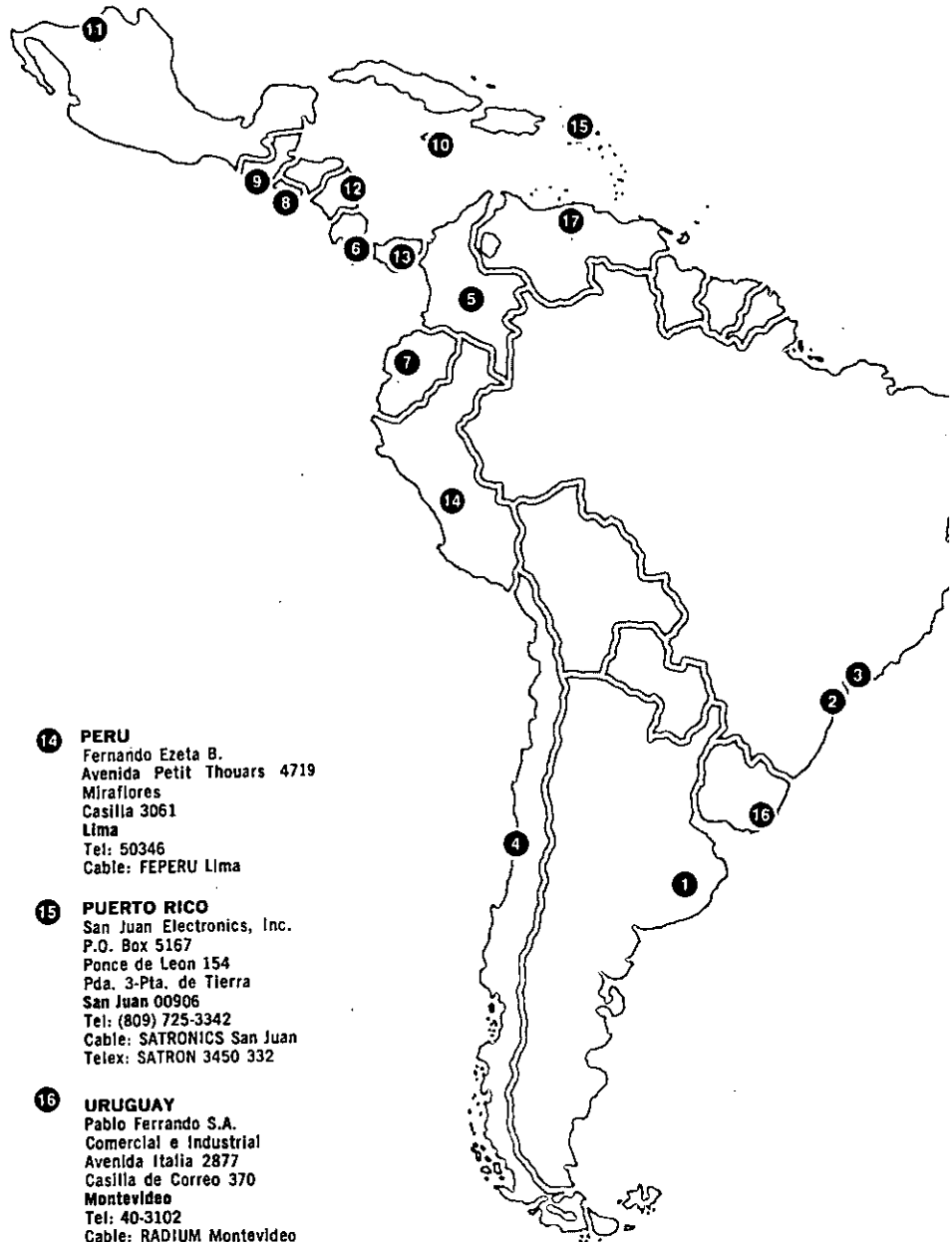
11 MEXICO
Hewlett-Packard Mexicana, S.A.
de C.V.
Moras 439
Col. del Valle
Mexico 12, D.F.
Tel: 5-75-46-49

12 NICARAGUA
Roberto Terán G.
Apartado Postal 689
Edificio Terán
Managua
Tel: 3451, 3452
Cable: ROTERAN Managua

13 PANAMA
Electrónica Balboa, S.A.
P.O. Box 4929
Ave. Manuel Espinosa No. 13-50
Bldg. Alina
Panama City
Tel: 30833
Cable: ELECTRON Panama City

17 VENEZUELA
Hewlett-Packard De Venezuela
C.A.
Apartado del Este 10934
Chacaito
Caracas
Tel: 71.88.05, 71.88.69, 71.88.76
Cable: HEWPACK Caracas

**FOR AREAS NOT LISTED,
CONTACT:**
Hewlett-Packard
INTERCONTINENTAL
3200 Hillview Avenue
Palo Alto, California 94304
Tel: (415) 326-7000
TWX: 910-373-1267
Cable: HEWPACK Palo Alto
Telex: 034-8461



14 PERU
Fernando Ezeta B.
Avenida Petit Thouars 4719
Miraflores
Casilla 3061
Lima
Tel: 50346
Cable: FEPPER Lima

15 PUERTO RICO
San Juan Electronics, Inc.
P.O. Box 5167
Ponce de Leon 154
Pda. 3-Pta. de Tierra
San Juan 00906
Tel: (809) 725-3342
Cable: SATRONICS San Juan
Telex: SATRON 3450 332

16 URUGUAY
Pablo Ferrando S.A.
Comercial e Industrial
Avenida Italia 2877
Casilla de Correo 370
Montevideo
Tel: 40-3102
Cable: RADIUM Montevideo

HOW TO FIND OUT IF HEWLETT-PACKARD OFFERS WHAT YOU NEED



SERVICES

Ask the nearest HP field office

If you have need for an instrument and are not sure whether Hewlett-Packard can supply your need, call the Hewlett-Packard office nearest you. Experienced staff engineers will be able to tell you if one of the more than 2000 Hewlett-Packard products can do the job for you.

Look in your catalog

Equipment made by Hewlett-Packard for measurement, analysis, and computation in science, industry, and education is described in this catalog. To help you find what you need, the index at the very front cross references all this equipment by function and purpose. For those familiar with product model numbers, a numerical index is at the back of the catalog.

Because of the continuing development of new products, new catalogs are prepared every year and supplements are produced twice yearly. Solid-state components, analytical instruments, and medical instruments are described in the other Hewlett-Packard publications discussed on page 1.

Visit technical exhibits

Look for the Hewlett-Packard exhibit when you attend a trade show or convention. The newest Hewlett-Packard products are demonstrated in exhibit booths at major scientific and engineering conventions in the United States, Europe, and other parts of the world. Often, the very engineers who develop the equipment are on hand to discuss uses and capabilities. Space limitations prevent display of the entire Hewlett-Packard line, but latest developments are always found at Hewlett-Packard exhibits.

Visit the Travelabs

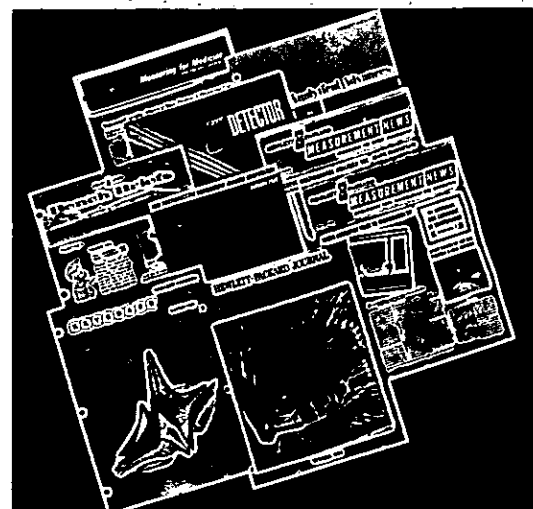
New product capabilities are demonstrated in the Hewlett-Packard mobile laboratories that travel over much of the United States, Canada, and Europe. These make it possible for you to see the equipment in action right at your place of business. Visits are scheduled by your nearest Hewlett-Packard field office, which can tell you when a traveling lab will be in your vicinity and whether or not it will have equipment of interest to you. Hewlett-Packard has used buses, boats, and airplanes to bring such demonstrations to all parts of the world.

Read the ads

Scanning the Hewlett-Packard advertisements that are in all major scientific and engineering publications will keep you abreast of new capabilities being offered. Many of these publications also have New Product departments that carry announcements about many of the latest Hewlett-Packard developments.

Get HP Publications

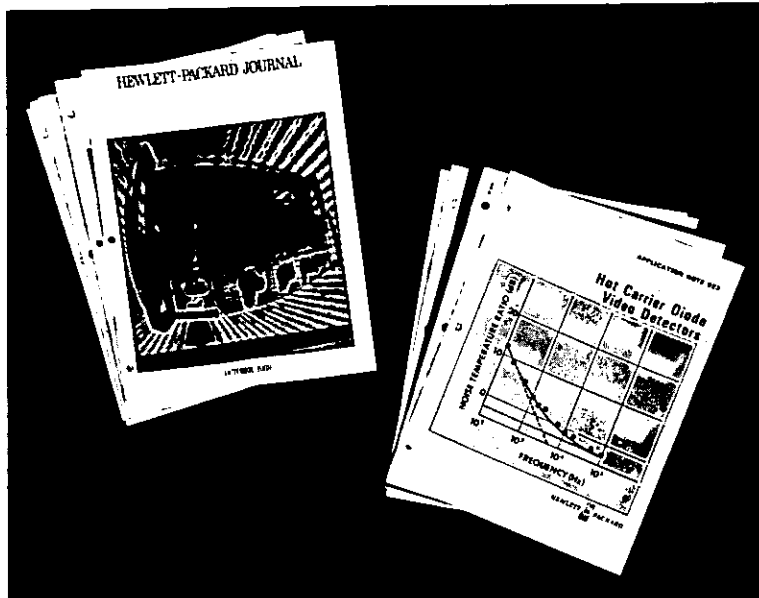
In addition to the channels of communication described above, Hewlett-Packard has several publications which regularly carry information about new equipment and important applications of Hewlett-Packard products. These are described on the next page.



SERVICES



TECHNICAL PUBLICATIONS AND PERIODICALS



The endless expansion of technology requires continual development of new measurement tools. This, in turn, requires continuing education of those who use them. Hewlett-Packard recognizes the importance of keeping its customers informed about new techniques and new instruments and towards this end, Hewlett-Packard publishes periodicals and application notes about new developments in the practice of measurement, analysis, and computation. If you are concerned with these subjects, you may receive any of the company-produced periodicals on a regular basis, or get any of the application notes, by asking your Hewlett-Packard field engineer or by writing Hewlett-Packard, 1501 Page Mill Road, Palo Alto, Calif. 94304. Available publications are:

Hewlett-Packard Journal

In-depth discussions of important new Hewlett-Packard products, written by the engineers who developed them, are published in the Hewlett-Packard Journal. This monthly publication is devoted to detailed academic discussions of new approaches to measurement and computation, of the most productive methods of using instruments and com-

ponents, and of the latest equipment for both complex and routine measurements.

Application Notes

Application Notes that describe a wide variety of uses for electronic instruments and components are prepared by the Hewlett-Packard engineering laboratories. Because of the specialized nature of these publications, they are distributed by individual request only, rather than by general mailings. Brief summaries of all available Application Notes are contained in an Application Note Index, yours for the asking.

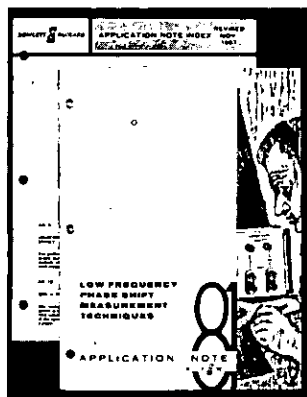
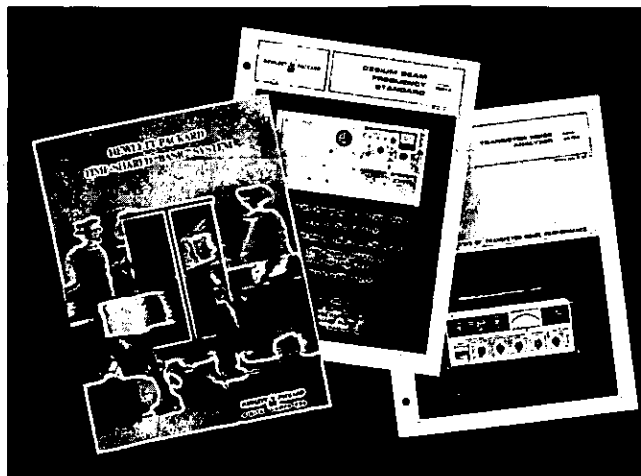
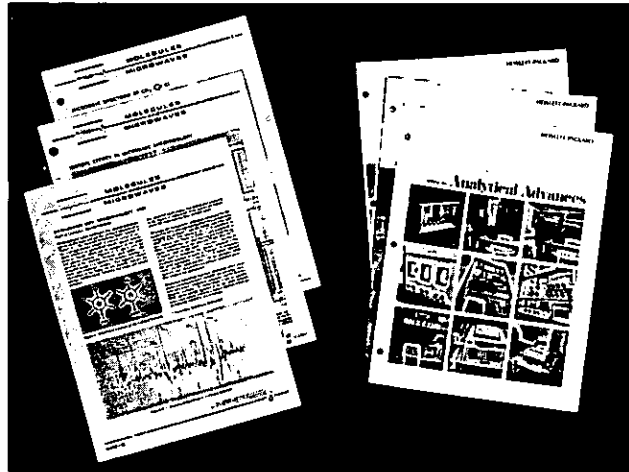
Measurement News

New Hewlett-Packard products are described concisely in Measurement News, a bimonthly publication that has five foreign language versions as well as an English version. This publication carries announcements about newly available products, about new Application Notes, and, very often, it has announcements of local interest from your nearby Hewlett-Packard field office. A convenient postpaid Reader's Service Card accompanying each issue brings you any of the described Application Notes or detailed specifications of the new products outlined in Measurement News.

TECHNICAL PUBLICATIONS AND PERIODICALS



SERVICES



Analytical Advances

Analytical measurement techniques for the chemist are described in *Analytical Advances*, a quarterly journal. This publication, besides discussing new engineering developments, reports new findings from the Hewlett-Packard chemical applications laboratories.

Molecules and Microwaves

New developments and findings in microwave spectrometry (molecular rotational resonance) are described in *Molecules and Microwaves*. This publication is issued periodically as new findings in this new and potentially useful field emerge.

Measuring for Medicine and the Life Sciences

Techniques and results of applying new measurement methods in the life sciences are described in *Measuring for Medicine and the Life Sciences*. This is a quarterly publication produced by the biomedical technical staff at Hewlett-Packard's Medical Electronics Division.

Data Sheets

Technical data sheets are prepared for each Hewlett-Packard product or family of related products. These list performance specifications, capabilities, power consumption, dimensions, prices, and the various options and accessories that may be available, essentially the same information given in this catalog. If you want separate copies of complete technical description of any Hewlett-Packard product, ask for the data sheet by number.

SERVICES



WHAT YOU CAN EXPECT WITH YOUR HP EQUIPMENT

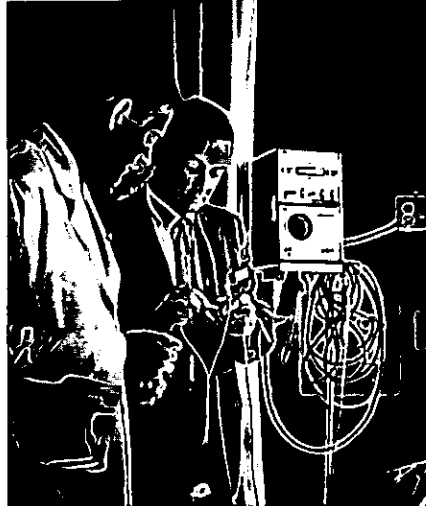
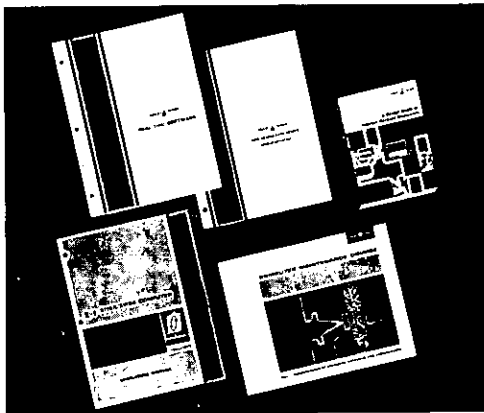
When you purchase equipment from Hewlett-Packard, you get more than a piece of hardware—you get long-term measurement, analysis, or computation capability far more valuable than the worth of the knobs, connectors, wire, and electronic components that make up the product. First of all, Hewlett-Packard certifies traceability at specified accuracy levels to the U.S. National Bureau of Standards. You may be sure that your equipment will meet its published specifications when you get it. Furthermore, you have a warranty on materials and workmanship.

Your purchase also includes applications assistance that helps you get maximum value from your equipment, first by means of the instruction manuals supplied with each Hewlett-Packard product, and then with the many available Hewlett-Packard Application Notes and other user-oriented publications. Also, there are application-oriented training seminars that give hands-on experience with many types of equipment.

Assurance that your equipment will continue to perform as expected for years to come is provided by Hewlett-Packard's world-wide Customer Service organization. There is a Hewlett-Packard field office not far from you—you don't have to correspond with a factory several thousand miles away to get information, replacements parts, or service assistance when you need it. This customer service program is one of the major factors in Hewlett-Packard's reputation for integrity and responsibility towards its customers.

Service information is included in the operating manual supplied with each product. Also available are service-oriented seminars for giving your own service technicians first-hand experience and training in the maintenance of Hewlett-Packard products.

The various support services that Hewlett-Packard makes available to you are described on the following pages.



WARRANTY



SERVICES

All Hewlett-Packard products are warranted against defects in materials and workmanship. The period of coverage is specified in the Operating and Service Manuals provided with each product. We will repair or replace, at our option, products which prove to be defective during the warranty period.

This statement is an expression of confidence in the ability of Hewlett-Packard products to continue meeting the high standards of reliability and performance that engineers and scientists have learned to expect from Hewlett-Packard.

To be attained, high quality requires more than stringent test procedures—quality must be designed into a product from its very inception. Hewlett-Packard engineers make every effort to arrive at a design that achieves quality and long-term reliability. Component engineers help the designers select components that can be relied upon, and make sure that components are not subject to undue electrical, thermal, or mechanical stress. Product engineers on the design team develop a rugged, easily produced mechanical design, and industrial designers, besides contributing to a pleasing appearance, make sure that human factors are considered. Packaging engineers are consulted to anticipate any difficulties that the product otherwise might experience during its trip from factory to customer. Environmental engineers subject prototype products to vibration, shock, humidity, and temperature extremes to assure that they can function in expected environments. Manufacturing know-how developed over the years gets the products assembled right. This statement can then accompany each order:

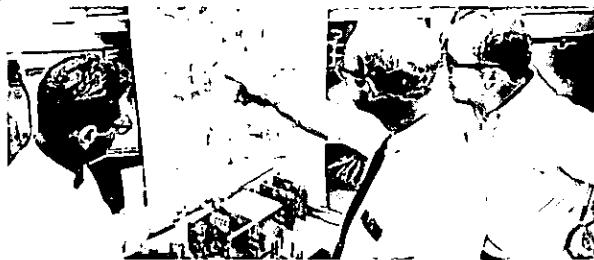
Certification

Products, materials, parts, and services furnished on this order have been provided in accordance with all applicable Hewlett-Packard specifications. Actual inspection and test data pertaining to this order is on file and available for examination.

Hewlett-Packard's calibration measurements are traceable to the National Bureau of Standards to the extent allowed by the Bureau's calibration facilities.

The Hewlett-Packard Quality Program satisfies the requirements of MIL-Q-9858, MIL-I-45208, and MIL-C-45662.

As a further check, products are picked at random off the assembly line and subjected to a quality audit by a "third party" quality assurance group. The result of all these efforts is that users of measuring instruments have found that they can rely on Hewlett-Packard products. This customer confidence has helped build Hewlett-Packard into one of the world's foremost manufacturers of instruments for measurement, analysis, and computation.



Ease of service is an important consideration during the various instrument design stages.



Production lines are designed to provide optimum worker accuracy and efficiency.



Every instrument manufactured is subjected to a thorough mechanical test.



A complete electrical test is also made to ensure that each instrument meets its published specifications.

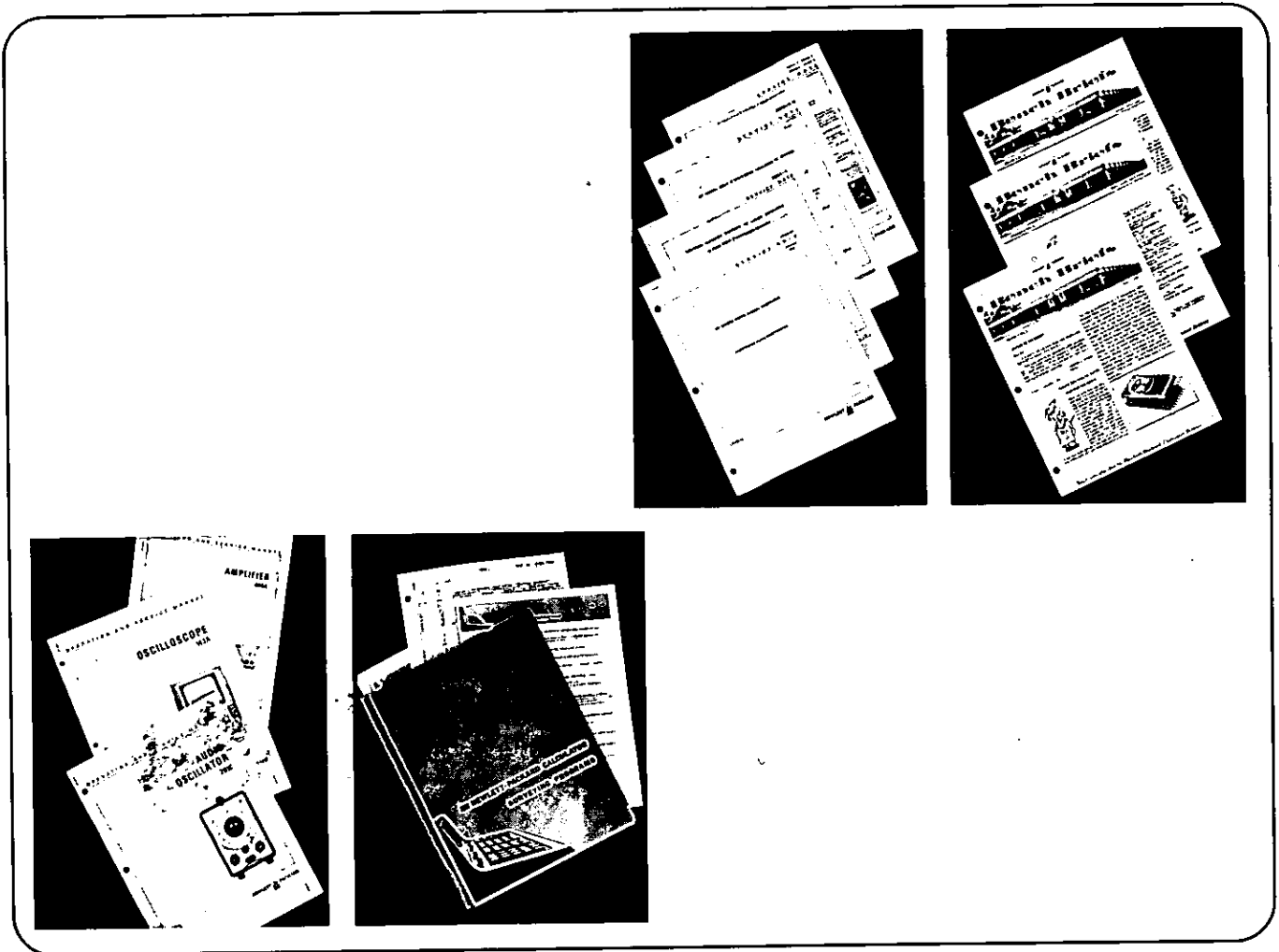


Modern packing procedures minimize damage in transit.

SERVICES



SERVICE PUBLICATIONS



Operating and Service Manuals

Step-by-step instructions explaining how to place the product in service are included in the Operating and Service Manual that accompanies each Hewlett-Packard product. These procedures are complete enough that any technically qualified person should be able to operate the equipment the first time without additional instruction. In addition, the Manual describes the various tasks the equipment can perform, how to use the equipment, and what precautions, if any, should be observed.

The manual also discusses how the equipment works, usually with the help of simplified diagrams, and describes maintenance and calibration procedures. Diagnostics and repair procedures are also included, many with troubleshooting charts as well as complete circuit diagrams. All replaceable parts are listed.

One manual (or set of manuals) is supplied with each product. Extra manuals, for many older instruments as well as for all currently-produced products, are available at reasonable cost from your nearby Hewlett-Packard field office.

Service Notes

New or special calibration procedures, instrument modifications, and special repair procedures are described in detail in the Hewlett-Packard Service Notes. This series of publications, intended primarily to disseminate repair and maintenance information on Hewlett-Packard instruments, serves as a convenient means for updating customers' Operating and Service Manuals. Ask your local Hewlett-Packard field office for a copy of the Service Note Index so you can order the Service Notes that pertain to your instruments.

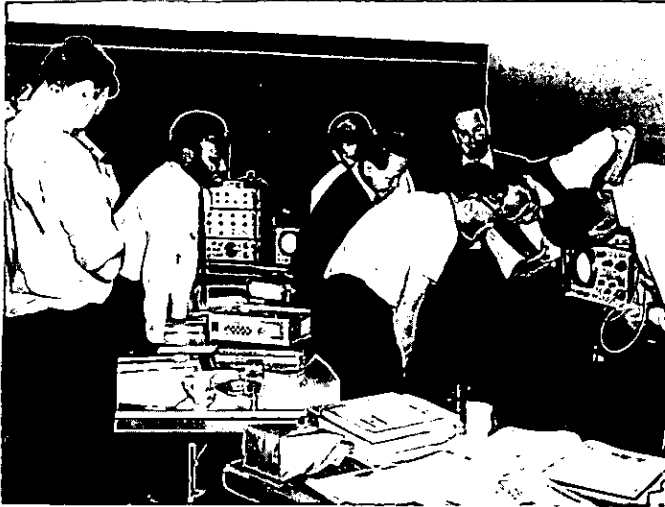
Bench Briefs

This periodic newsletter has servicing tips, new modifications, and other suggestions to help repair and maintenance personnel get maximum performance from the Hewlett-Packard instruments for which they are responsible. It also describes new Service Notes and other company publications as they become available. To become a regular subscriber, merely ask your local Hewlett-Packard field office to place your name on the mailing list.

TECHNICAL TRAINING PROGRAMS



SERVICES



How to use HP products and how to maintain them—you can learn first hand about either in one of the many technical seminar programs offered by Hewlett-Packard. These seminars, held both in the field and in the factory, are conducted by experienced engineers from Hewlett-Packard's Corporate Training Group.

Applications oriented seminars cover such topics as basic microwave measurement techniques, spectrum analyzer applications, frequency counter applications, and the like. These seminars instruct engineers and technicians in the use of Hewlett-Packard products.

Service oriented seminars are on topics like power supply maintenance, oscilloscope maintenance, and many others. These seminars train service personnel in the maintenance, calibration, and repair of Hewlett-Packard products making it possible for you to have factory-trained maintenance technicians in your own service department.

Seminars in the field are held in Hewlett-Packard offices or nearby meeting halls. These seminars generally last one or two days. If circumstances warrant, arrangements can be made to present seminars in a customer's plant.

Factory seminars are given at Hewlett-Packard headquarters in Palo Alto, California. These generally cover the same topics as the field seminars but usually last four or five days, going into the subject in more depth.

Your local Hewlett-Packard office has a schedule of seminars to be presented and can arrange for attendance by your personnel. Except for certain seminars in gas chromatography and in computer programming and maintenance, no charge is made for class time. Seminar attendees need provide only their own travel and living expenses.

Hewlett-Packard's training department also prepares video tapes for sale to any organization that has a need for continuing in-plant training. Most are about maintenance of particular instruments and are usually one or two reels long. Others discuss general electronics theory. One of these, a 15-part series, is a training tape on servicing solid-state equipment. It discusses elementary transistor principles and basic circuits and includes discussions about newer devices such as step recovery diodes and hot carrier diodes, not often found in conventional training materials. This series also describes techniques for logical troubleshooting on electronic equipment.

SERVICES



REPAIR SERVICE

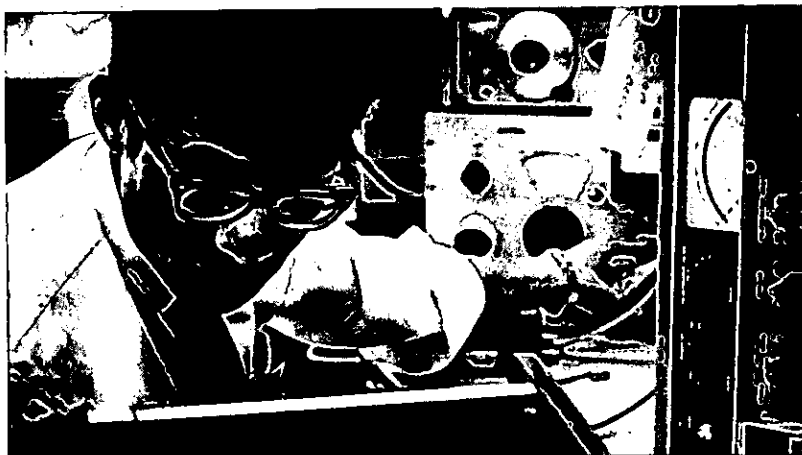
Help in maintaining your Hewlett-Packard equipment in first-rate operating condition is as close as a phone call to the nearest Hewlett-Packard field office. Whether you want to repair an instrument yourself, or send it to a Hewlett-Packard facility for repair, recalibration, or overhaul, your local Hewlett-Packard field office can offer a complete range of technical assistance.

Hewlett-Packard believes that as a manufacturer of measuring instruments it has an obligation to help each user get maximum usefulness from his Hewlett-Packard products. To this end, most Hewlett-Packard field offices have customer service facilities for providing repair and maintenance at a fair price. These are staffed by factory-trained technicians equipped with the needed test instruments and replacement parts. Local repair facilities are backed up by Regional Repair Centers, located in major industrial areas around the world. The Regional Repair Centers have more sophisticated test equipment, factory-trained specialists, and a full line of replacement parts.

Customer services range from simple calibrations to complete restoration of a product to good-as-new condition. Older products can also be modified to match the performance of current production models of the same product, if the product is still in production.

If your equipment installation is fixed, and if justified by the type of service required, Hewlett-Packard can perform service at your facility. Bringing your equipment to the Hewlett-Packard field office is preferred, however, because replacement parts and the needed test equipment are more readily available.

All service facilities have direct access to service engineers within each of Hewlett-Packard's manufacturing divisions. You have access to all of Hewlett-Packard's extensive service network through your local Hewlett-Packard field office. The field office can obtain spare parts for you and will supply you with answers to any questions about special calibration techniques, equipment modifications, and repair procedures.



CUSTOMER SERVICE AGREEMENTS



SERVICES

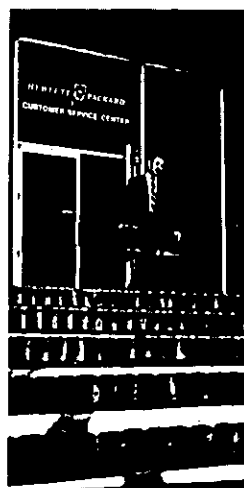
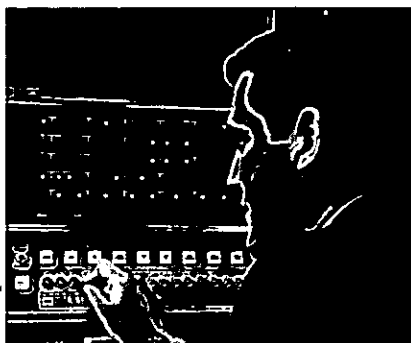
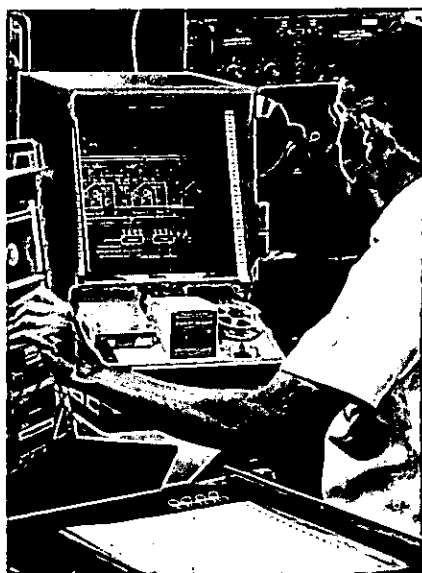
Your instrument maintenance needs in many cases may be handled most economically by entering into a Hewlett-Packard Customer Service Agreement. When you have a customer service agreement, Hewlett-Packard assumes your maintenance responsibilities for a basic annual charge, relieving you of the need for hiring your own trained specialists, for maintaining replacement parts inventories, and for doing the paperwork needed for maintenance scheduling.

Each agreement is shaped to fit individual customer requirements. Depending on the services chosen, Hewlett-Packard performs regularly scheduled and fully documented maintenance and calibration, makes emergency repair service calls, and replaces worn or defective parts. Other options include operator training, standby instruments, exchange

parts or modules, and 24-hour availability of service or an agreed-upon response time.

Work can be performed on your premises or arrangements can be made for delivery of equipment to and from Hewlett-Packard facilities. If you have a large equipment inventory, you may include in your service agreement provisions for a resident Hewlett-Packard service technician stationed on your premises.

The cost of an agreement is derived from analysis of the service and repair history that Hewlett-Packard has collected on each product. By taking advantage of this information, Hewlett-Packard can assure you of continued accuracy and reliability of your equipment at a fair price, with minimum interruption for repair. Contact your nearby Hewlett-Packard field office for details.





Ready availability of replacement parts is essential for prompt equipment maintenance—time spent waiting for parts is wasted time. Hewlett-Packard makes every effort to shorten spare parts delivery time and as a result, over 90% of the replacement parts orders are filled the same day they are received. If the field office does not have the needed part, the order is relayed to a regional center. No time is lost since a computerized data communication system links all field offices to the regional centers. Shipment of a relayed order is made directly from the regional center to the customer.

Spare Parts Kits

To sustain equipment operation in remote areas, or where equipment down-time is extremely critical, spare parts kits are available. The kits are supplied in varying degrees of completeness, allowing you a selection for a better match to your requirements. For information, contact your nearby Hewlett-Packard office.

Modification Kits

Modification kits, for updating the performance of older products, may be ordered from your nearby Hewlett-Packard field office. These include the necessary parts and full instructions for installation, if you want to do the work yourself. If you prefer, your Hewlett-Packard field office can do the work for you at a reasonable price. Newly available modification kits are announced in Bench Briefs (page 30).

Parts Identification

The table of replacement parts in each Operating and Service manual make it easy for you to identify parts you wish to replace. When ordering a replacement part, please specify the Hewlett-Packard stock number listed in the table and give the complete name. If you have trouble identifying a part, be sure to call your local Hewlett-Packard field office. Each field office maintains extensive technical files on all Hewlett-Packard products.

If circumstances require your ordering a part without specifying the stock number, please include in your order the instrument model number, its serial number, a complete description of the part, its function, and its location in the equipment.

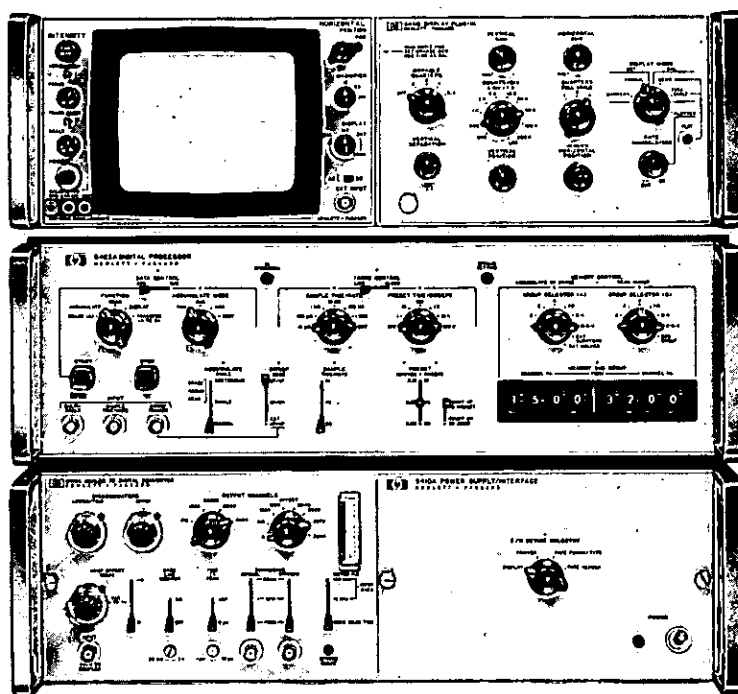


MULTICHANNEL ANALYZER

8192 channel, 200 MHz clock rate ADC
Model 5401B



DIGITAL ANALYZERS



H51-180A Oscilloscope
with 5431B Display
Plug-in

5422A Digital
Processor

5416B Analog to
Digital Converter
in 5410A Power
Supply/Interface

5401B Multichannel Analyzer

Features

- 8192 Channel Analog-to-Digital Converter
- 200 MHz ADC Clock Rate
- DC Coupled ADC
- 2 Coincidence Gating Circuits
- Three Analysis Modes
- 2.25 μ s Memory Cycle Time
- Memory Expandable to 8192 Channels
- 10 MHz Multichannel Scaling
- Interfaces to the HP 9100A Calculator

The Hewlett-Packard 5401B Multichannel Analyzer will perform Pulse Height Analysis, Sampled Voltage Analysis, and Multichannel Scaling with outstanding speed and versatility.

The Analog-to-Digital Converter (ADC) has a dc coupled input circuit which can be adjusted by the Time-to-Peak control to accept input pulse risetimes (zero to peak) of up to 15 μ s. Precision Upper and Lower Discriminators operate over the full input range. Ten output ranges are provided; the minimum 16 channels, the maximum 8192 channels. Fifteen values of digital offset are possible. There are two modes of Coincidence and Anticoincidence gating in the ADC; the Normal Mode has an adjustable resolving time of 1 μ s to 15 μ s and the Strobed Mode a fixed resolving time of 200 ns with a 1 μ s to 15 μ s adjustable delay.

Buffer storage in the Digital Processor permits the ADC to begin another conversion while the previous data is being placed in memory. The 2.25 μ s memory cycle time assures completion of the memory operation before completion of a second conversion. In Multichannel Scaling (MCS) the 2.25 μ s memory cycle time minimizes dead time between channels.

The Digital Processor has a protected memory. Changing the position of a control associated with the memory automatically stops the analyzer and protects the memory contents. Annunciator lights tell which controls on the Digital Processor are involved in a particular operation.

For displaying data the 5401B has a 50 MHz Hewlett-Packard Oscilloscope mainframe interfaced to the Digital Processor memory through a digital-to-analog converter. All the required signals for operation with an HP 7004A or 7591A X-Y Plotter are provided by the Oscilloscope Mainframe.

The 5401B Interfaces to digital input/output devices through an interface card cage. Data can be output to paper tape, incremental magnetic tape, or to a Teleprinter; or data input from paper tape or the Teleprinter.

Interfaces to the Hewlett-Packard 9100A Calculator and the 2114A, 2115A, and 2116B Computers are also available. Several magnetic card programs for data reduction are written for use with the 9100A Calculator interfaced to the 5401B. With these options on-line data reduction is possible.

8192 channel, 200 MHz clock rate ADC
Model 5401B

Specifications

Accumulation modes

Pulse Height Analysis (PHA)

In this mode, the analyzer accumulates a pulse amplitude histogram. Automatic termination of data accumulation may be employed. Amplitude discrimination and coincidence logic circuits are provided.

Input pulse requirements

Amplitude: 10 V; positive.

Pulse shape: >200 ns to peak above baseline.

Input impedance: 1 k Ω , <60 pF shunt; dc coupled.

Trigger level: 0 to 10 V, adjustable (establishes timing).

Time to peak: 1 to 15 μ s adjustable, or 3 μ s fixed.

ADC clock rate: 200 MHz.

Output range: 16 to 8192 channels in binary steps.

Conversion gain (channels out/volts in)

Range: 8192 to 16 channels/10 volts.

Temperature stability: < \pm 0.005%/°C.

Time drift: < \pm 0.01%/24 hours.

Trigger distortion: linearity perturbed within 50 mV of trigger when trigger is set to minimum.

Baseline (input offset)

Analog: \pm 1 V adjustable, 0 or -5 V fixed.

Count rate shift: <0.05% full scale to 50,000 counts per second.

Temperature stability: < \pm 0.1 mV/°C.

Time drift: <0.3 mV/24 hours at fixed temperature.

Digital: 0 to 7680 in steps of 512 channels.

Linearity

Integral: < \pm 0.075% over full range.

Differential: < \pm 1% over full range except in PHA mode, see trigger distortion.

Pulse analysis time

Pulse Analysis Time depends on the output range setting (fixed mode) or on the channel addressed by each accepted pulse (variable mode).

Output Range Channels	Analysis time	
	Fixed Mode Timing	Variable Mode Timing
1024	9.5 μ s	3.7 + (0.005 n) μ s
2048	16.5 μ s	4.3 + (0.005 n) μ s
4096	30.5 μ s	5.8 + (0.005 n) μ s
8192	54.0 μ s	8.4 + (0.005 n) μ s

Where n = number of channel addressed

System dead time: analysis time plus time to peak.

Elapsed time: first channel of selected memory group records elapsed time in increments of 0.01 min.

System noise: less than 1 mV rms referred to the ADC input.

Coincidence inputs (normal and strobed)

Amplitude: 4-12 V positive.

Pulse shape: dc or level with specified timing. For timing-normal, input must be high for >100 ns after pulse crosses trigger level and prior to the coincidence strobe. For timing-strobed, input must be high for a >200 ns interval which includes the coincidence strobe. Coincidence strobe is a 100 ns pulse generated at the end of the time-to-peak setting. Strobe monitor jack provided.

Timing jitter-strobe: \pm 50 ns from average.

Discriminators (upper and lower level) range: 0 to +10 V. Lower level discriminator sets trigger level.

Meter: three ranges display reading of dead time 100% full scale, or counting rate at either 100 kHz or 10 kHz full scale.

Data control: add or subtract, switched.

Timing: count up to preset, or down to zero.

Preset time range: live or clock time, switch selectable; 0.01 min to 5000 min (decade steps x multiplier in 1, 2, 5 steps).

Live timer accuracy: \pm 0.5%.

Memory grouping: any quarter, any half or whole memory. Pulses exceeding selected memory range are rejected. No pulses are stored in 1st channel of group selected.

External routing: external control of memory grouping.

Pulse requirements: positive 4-12 V for >100 ns during time-to-peak period.

Memory: 10⁶ counts per channel; 1024 channels standard, 4096 or 8192 optional. Address is binary; 24-bit data word is BCD coded.

Multichannel scaling (MCS)

In this mode, the analyzer sequentially addresses each channel of the selected portion of memory. Data for the memory channel is the number of input pulses counted during a Sample Time. The address information is converted to an analog voltage available for such applications as driving a Mossbauer apparatus.

Input pulse requirements: (AEC standard compatible).

Amplitude: 4-12 positive.

Input impedance: 1 k Ω (dc coupled).

Minimum pulse width: 25 ns; separation 65 ns.

Pulse pair resolution: 100 ns (10 MHz).

Sample time per channel: 10 μ s to 5 s (decade steps x multiplier in 1,2,5, steps), or external.

Preset sweeping: 1 sweep to 500,000 sweeps (decade steps x multiplied in 1,2,5, steps).

Sweep modes

Single: internal or external triggering.

Continuous: internal or external triggering with sawtooth sweep drive (increasing channel number). Also, internal triggering with triangle waveform drive (increasing then decreasing channel number). Number of sweeps performed is recorded in the first channel of the selected memory group.

Dead time between channels: 2.25 μ s.

Sampled voltage analysis (SVA)

(Probability density functions.) Operation in this mode is identical to pulse height analysis except that the ADC continuously monitors an analog voltage, samples it upon receipt of a pulse, and processes the sampled voltage as though it were a pulse.

Input signal requirements

Amplitude: 10 V.

Polarity: positive or bipolar.

Slewing rate: maximum positive slewing rate, 50 V/ μ s; maximum negative, see table.

Output Range (Channels)	Slewing Rate
1024	2 V/ μ s
2048	1 V/ μ s
4096	0.5 V/ μ s
8192	0.25 V/ μ s

Input impedance: 1 k Ω , <60 pF shunt, dc coupled.

ADC clock rate: 200 MHz.

System dead time: analysis time plus time to peak.

DIGITAL ANALYZERS *continued***8192 channel, 200 MHz clock rate ADC
Model 5401B**

Elapsed time: first channel of selected memory group records elapsed time in increments of 0.01 min.

Digital processor functions

Erase: the entire memory or the contents of any selected quarter or half may be erased.

Accumulate: memory accepts data in one of four modes: PHA, SVA, MCS, or TEST. Manual control or automatic sequencing of accumulate, readout, and erase are possible.

Read: memory data in the channels selected by group selector (B) are output to the device selected by the I/O device selector switch.

Display: full memory is output to the oscilloscope. For greater than 1024 channels of memory the display is interlaced.

Transfer (A to B): transfer the data in Memory Group A to Memory Group (B).

Read-in/read-out modes**CRT Display (Linear) Modes**

During the PHA and SVA accumulation, each channel addressed by the ADC is displayed live for about 12 μ s. Prior to start, address is displayed at baseline. After start, the vertical displacement of the displayed point shows channel content. During MCS and TEST accumulation the CRT is statically unblanked. During display function the entire memory is displayed in an interlaced sequence which sweeps from first to last channel at line frequency. Every channel is displayed at least six times per second. Simultaneous display and accumulation. The H51-180AR Oscilloscope Mainframe used for display is a high quality 50 MHz unit. Standard oscilloscope plug-ins are available.

Channel identification

Decades: intense dot for channels numbered 10 n.

Sub group: 1/2 cm tail on data point.

Horizontal gain: x1 to x20 continuous. Expand about center screen.

Horizontal quarters full screen: 1,2,4 selectable.

Overlap: halves or quarters may be overlapped. 2nd, 3rd, 4th quarters and 2nd half are movable vertically to fully off screen up or down.

Vertical gain: x1 through x3 continuous.

Vertical calibration: 200 through 200k counts/cm in 1,2,5 sequence, selectable. Analog output (plotter connector and BNC's for X, Y and unblank).

Analog output signals (X and Y)

Amplitude: +5 V full scale into open circuit.

Impedance: 100 Ω .

Resolution: $\pm 0.012\%$ of full scale.

Zero drift: $\pm 0.01\%/^{\circ}\text{C}$, $\pm 0.1\%$ /day at fixed temp.

Gain drift: $\pm 0.05\%/^{\circ}\text{C}$, $\pm 0.1\%$ /day at fixed temp, full scale.

Plotter output rate: external timing, 500 channels per sec, max; internal, 1-20 channels per second, variable.

Digital input/output

Code: parallel, 8421 BCD.

Serial: IBM compatible or ASCII as selected by I/O cards. Levels, polarity, and control logic are determined by I/O cards provided with the various I/O options.

Maximum transfer rate: 60,000 characters or channels/sec.

Format:

Parallel: 10 digits simultaneously, four address, six data.

Serial: 76 character line sequence (one address, 10 data channels) is determined by serializer cards of processor and adapted by I/O cards to match requirements of specific device.

Input/Output Options

Peripheral devices for readin or readout of digital data are specified by option number according to column headings A, B and C in the table below. Under column C are listed options which provide cards and cables only; no peripheral device. A number in parentheses indicates the time in minutes for transfer of 1024 channels of memory. Computer transfer takes less than 1 second.

Name	Capability	A	B	C
		60 Hz device cards & cable	50 Hz device cards & cable	Cards & cable only
		Option	Option	Option
Printer H18-5050B	Parallel readout 20 chan/s (0.87)	002	052	012
Teleprinter HP 2752A	Serial readout 10 char/s (13)	003	053	011
Teleprinter HP 2752A	Serial input 10 char/s (13)	004	054	011
Tape Punch HP 2753A	Paper tape output 120 char/s (1.1)	005	055	013
Tape reader HP 2737A	Paper tape input 300 char/s (0.4)	006	056	014
Mag tape Kennedy 1600, etc.	Mag tape readout 200 to 800 bpi (0.3 to 1)	007	057	*
Calculator HP 9100A	Serial output	009	059	019
Computer** HP 2114/5/6	DM interface between memories	*	*	008
Teleprinter HP 2752A	Serial input & output 10 char/s	010	050	011

Option 011 cards and cable provide interface for both readout and readin.

*Consult Factory. **Requires a Computer I/O Card.

Other options

Log Display
4096 Channel Memory
8192 Channel Memory
Signal Averaging Capability

Equipment List

The standard HP 5401B Multichannel Analyzer consists of one each of the following. Total net weight is 111 lb (50 kg). Shipping weight is 148 lb (67 kg).

5410A Power Supply/Interface 45 lb (20 kg).

5416B Analog-to-Digital Converter (plug-in) 6 lb (2,8 kg).

5422A Digital Processor 27 lb (12 kg).

5431B Display (D to A converter plug-in) 6 lb (2,8 kg).

H51-180AR Oscilloscope 26 lb (11,5 kg).

05421-6030 Display cable (dual 36-pin).

05421-6033 Power cable (50-pin).

05421-6034 Data cable (50-pin).

05421-6035 ADC Decimal Data cable (dual 50-pin).

Rack mounting kits, power cords, extender cards and card puller are provided.

Dimensions: typical for H51-180AR, 5422A, and 5410A, 16 3/4" wide x 5 1/4" long x 21 3/8" deep (425 x 133 x 543 mm).

Power input for full capacity operation: 425 W, 50-60 Hz, 115 or 230 V.

Price and ordering information: contact the local sales engineer.

Accessories

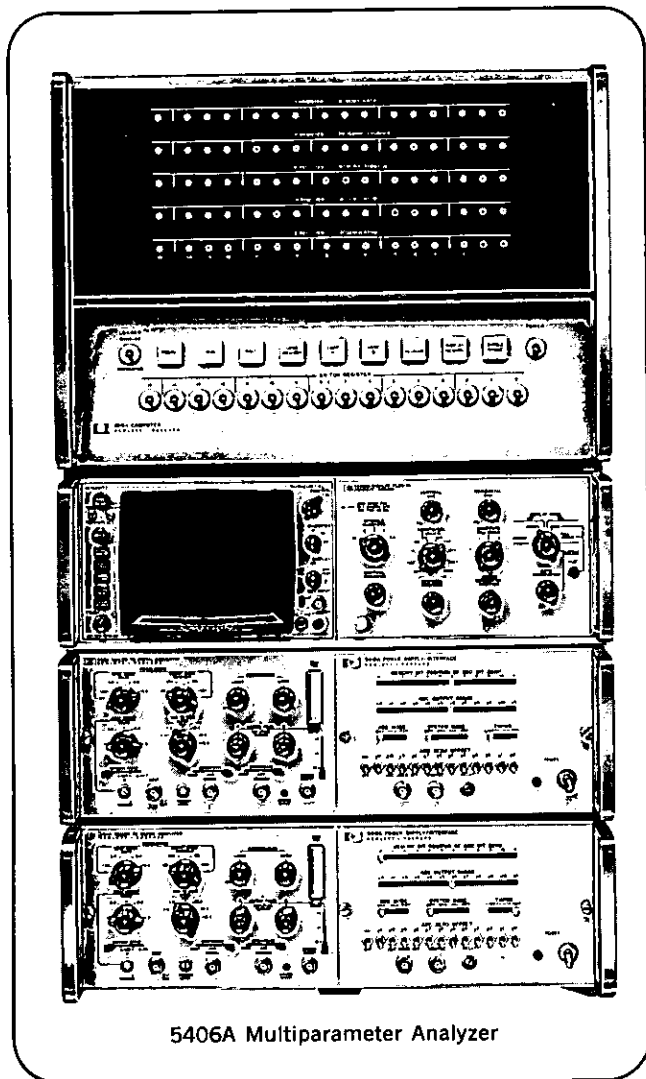
A convenient method of preserving the visual display available on the scope is to plot the analog of memory contents on an X-Y recorder. The HP 7004A provides an ideal combination of accuracy and speed and may be interfaced directly with the 5401B through a connector on the rear of the H51-180AR mainframe. It plots an analog record of any selected portion of the memory at the rate of 50 channels per second. Required are: HP 7004A, \$1395, two H01-17170A DC Coupler plug-ins, \$40 each; 17173A Option 001 Null Detector plug-in, \$225; 17012B Plotter, \$95; and 10640B Cable, \$100. An extended plot for high resolution of individual channels on continuous or fan-fold paper may be obtained using the HP 7591 Option 005 Point Plotting System, \$2660 with the 1064B and (2 each) H01-17170A DC Couplers.

The three mainframes of the 5401B may be conveniently joined to make a single unit with the use of the Joining Bracket kit, HP 5060-0243, \$30.



ANALYZER SYSTEMS

Single parameter, Multiparameter
Model 5405A (Single), Model 5406A (Multi-)



5406A Multiparameter Analyzer

Features

- 8192 Channel Analog-to-Digital Converter
- 200 MHz ADC Clock Rate
- Up to 32,768 Words of Memory
- 2.5 μ s Memory Increment using Hardware Accumulation
- Modular Construction
- Flexibility of Software Control
- Convenience of Hardware
- Modular Software System

The Hewlett-Packard 5405A and 5406A are modular, computerized multichannel analyzer systems which are based on the 5401A Multichannel Analyzer and the Hewlett-Packard line of computers. Two items were added to these modules: a flexible hardware interface between the Analog-to-Digital Converter and the Computer, and a flexible, modular software package. The results—two highly versatile systems which can be operated with the ease and speed of a hardwired analyzer.

Single Parameter Analysis, Multiparameter Analysis, and Multiplex Operation are possible with a 5406A System. Only Single Parameter Analysis is possible with a 5405A System, but expansion from a 5405A to a 5406A requires just the addi-

tion of an ADC and its Interface. The slow coincidence gating required for Multiparameter Analysis is provided by the ADC and its Interface. If fast coincidence timing is necessary, the Hewlett-Packard 5584A Dual Timing Pickoff and 5585A Fast Coincidence NIM nodules will provide this function.

The 5416B Analog-to-Digital Converter adds considerable flexibility to the 5405A/5406A Systems. Its maximum output range is 8192 channels, but there are nine more ranges extending down to 16 channels. Fifteen values of digital off-set are provided; the analog input to the ADC is dc coupled; and two slow coincidence circuits are built into the 5416B. The time between the recognition of an analog input pulse and the beginning of its conversion (the Time-to-Peak) is adjustable; this means the ADC can "wait" for slow rising pulses. The 5416B has a 200 MHz clock rate.

Digital Processing in the 5405A/5406A Systems is performed by one of the three Hewlett-Packard Digital Computers, the 2114A, 2115A, or 2116B. Data storage, analysis control, and peripheral interfacing are handled by the Digital Processor. Five memory sizes ranging from 4096 to 32,768 16-bit words are available. Up to 16,384 memory channels of 16, 20, or 24 bits each can be directly addressed by ADC's when the 32,768 word processor is used. All processors have a hardware interrupt system which allows data accumulation to momentarily interrupt all other processor functions.

A system operating program is supplied with each 5405A/5406A System. Other programs may be prepared using the Subroutine Library and Prepare Executive software provided, or special subroutine can be written using the Processor as a general purpose digital computer. All the necessary software for programming is provided.

The 5405A/5406A Systems are designed for all forms of Pulse Height and Sampled Voltage Analysis. As requirements change, additional ADC/Interface modules can be added, the memory size can be increased, or new subroutines can be added. The computer can perform on-line or off-line data reduction in three programming languages: FORTRAN, ALGOL, and Assembler Language (ALGOL requires an 8192 word memory). The data processing capability of these systems is practically unlimited.

Software flexibility means that one system can be used for different purposes with hardly any time lost to change over.

For high resolution gamma-ray analysis work the 5416B ADC provides 8192 channel resolution and a dc coupled input that accepts a wide variety of input pulse shapes. For high count rate work the 200 MHz Clock Rate and dc coupling minimize analysis time and baseline shift due to count rate. Using the 2115A and 2116B Digital Processors and the Hardware Accumulation Option less than 2.5 μ s is required for the memory increment operation.

The 5406A System offers a way to multiplex up to sixteen analyses into one digital processor with a minimum incremental cost—only an ADC/Interface combination must be added for each additional analysis.

Statistical Analyses of analog waveforms including amplitude correlation studies are possible with the 5405A/5406A Systems operating in the Sampled Voltage Analysis mode.

All or part of a Single Parameter spectrum can be displayed with movable markers on any group of consecutive channels. Two parameter data can be displayed in an isometric or contour pattern. An X and a Y-slice may be intensified on these displays. The intensified slices can be displayed as Single Parameter spectra.

Specifications

Hardware System

Standard 5405A System Components

5416B Analog-to-Digital Converter
 H03-5410A Power Supply/Interface
 10627A Interface Kit
 H51-180AR Oscilloscope Mainframe
 5430A Display Plug-in
 2114A Digital Processor (4096 word memory)
 2752A/12531B Teleprinter and Interface
 12554A 16-Bit Duplex Register Cards (3 required)
 Software Package

Standard 5406A System Components, same as the 5405A System Components except:

Substitute the 10624A Interface Kit for the 10627A
 Add: 1 each 5416B Analog-to-Digital Converter
 1 each H03-5410A Power Supply/Interface

Optional Components for the 5405A/5406A

8192 word memory for the 2114A
 2115A Digital Processor with a 4096 or 8192 word memory
 2116B Digital Processor with 8192 or larger memory
 Hardware Accumulation Option (requires a 2115A-or-2116B)
 Software Accumulate Option (requires one 12554A per ADC)
 H51-181AR Variable Persistence Oscilloscope Mainframe (replaces the H51-180AR)
 2737A/12532A Punched Tape Reader and Interface
 2753A/12597A-03 High Speed Paper Tape Punch and Interface
 Additional ADC Option (required for adding an ADC to a System) includes one 5416B ADC, one H03-5410A, and one 10608A Interface Kit.

Software System

Standard computer software is provided with the Digital Processor of the 5405A/5406A Systems. The following special processor is provided for multichannel analyzer operation.

Prepare Executive Tape
 System Operating Tape
 Subroutine Library Tape
 Basic Control System Tape
 System Test Tape

System Modes

Single Parameter—one ADC interfaced to the Digital Processor.
 Multiparameter—2-4 ADC's performing coincidence analysis, interfaced to the Digital Processor
 Multiplex—2-16 ADC's interfaced to the Digital Processor. ADC's are scanned at a 200 kHz rate. Each ADC has up to a 4-bit code assigned.

5416B Analog-to-Digital Converter

Input pulse requirements, pulse height analysis

Amplitude range: 10 V; positive.
 Pulse shape: >200 ns to peak above the baseline.
 Input impedance: 1 k Ω , <60 pF shunt; dc coupled.
 Time to peak: 1 to 15 μ s adjustable, or 3 μ s fixed.

ADC clock rate: 200 MHz.

Output range: 16 to 8192 channels in binary steps.

Conversion gain (channels out/volts in)

Range: 8192 to 16 channels/10 V.
 Temperature stability: $<\pm 0.005\%$ /°C. Range, 0° to 55°C.
 Time drift: $<\pm 0.01\%$ /24 hours.

Trigger: set by lower level discriminator.

Trigger distortion: with trigger set to minimum, linearity may be perturbed within 50 mV of trigger.

Baseline offset:

Analog: ± 1 V adjustable, 0 V or -5 V fixed.
 Count rate shift: $<0.05\%$ F.S. to 50,000 counts/s.

Temperature stability: $<\pm 0.1$ mV/°C. Range 0° to 55°C.

Time drift: $<\pm 1$ mV/24 hours at fixed temperature.

Digital: 0 to 7680 in steps of 512 channels.

Linearity

Integral: $<0.075\%$ over full range.

Differential: $<\pm 1\%$ over full range. Conversion is linear over 100% of range; for PHA, see trigger.

Pulse analysis time: pulse analysis time depends on the output range setting (fixed mode) or on channel address for each accepted pulse (variable mode).

Analysis Time

Output range, channels	Fixed mode Timing	Variable mode timing
1024	9.5 μ s	3.7 + (0.005 n) μ s
2048	16.5 μ s	4.3 + (0.005 n) μ s
4096	30.5 μ s	5.8 + (0.005 n) μ s
8192	54.0 μ s	8.4 + (0.005 n) μ s

Where n = number of channel addressed

System dead time: analysis time plus time to peak.

System noise: less than 1 mV rms referred to the ADC input.

Input signal requirements, sampled voltage analysis

Amplitude range: 10 V; $+10$ V with offset at 0 V, -5 V to $+5$ V with offset at -5 V.

Polarity: positive or bipolar.

Slewing rate: maximum positive, 50 V/ μ s; maximum negative, 0.25 V/ μ s (8192 channel range) to 2 V/ μ s (1024 channel range).

Coincidence inputs (normal and strobed)

Amplitude: 4-12 V positive, dc or pulse.

Discriminators (upper and lower level): range: 0 to $+10$ V.

Lower level discriminator sets trigger level.

Temperature range: 0° to 55°C.

ADC Interface

Inputs: 4-13 bit addresses from ADC, Ready for Data signal from the Processor, Sample Pulse for Sampled Voltage Analysis Operation (>200 ns, $+4$ to $+12$ V).

Outputs: 0-14 bit addresses from buffer storage to Processor, Data Ready signal to Processor, ADC Holdoff signal (200 ns to 3 μ s wide, 4.5 V pulse for slow coincidence gating of the ADC).

Controls

Timer: LIVE, CLOCK, or OFF; counts stored in channel zero of spectrum (10 counts per second).

ADC mode: Pulse Height Analysis (PHA), Sampled Voltage Analysis (SVA), or External selection of PHA or SVA (EXT).

System mode: Single Parameter (SGL), Multiparameter (MPR), or Multiplex (MPX) Analysis.

Functions

Selects the number of address bits output from the buffer storage.

Selects digital offset to be applied to Interface output.

Provides digital formatting to allow one address to be formed from several ADC outputs in MPR operation. Provides up to a 4-bit code for each ADC in MPX operation.

Digital Processor

See the specifications for the Hewlett-Packard 2114A, 2115A, and 2116B Computers.

H51-180AR/5430A Display Unit

Function: converts from digital data to X and Y analog signals for oscilloscope and X-Y recorder display.

Resolution

Horizontal: 13 bits maximum.

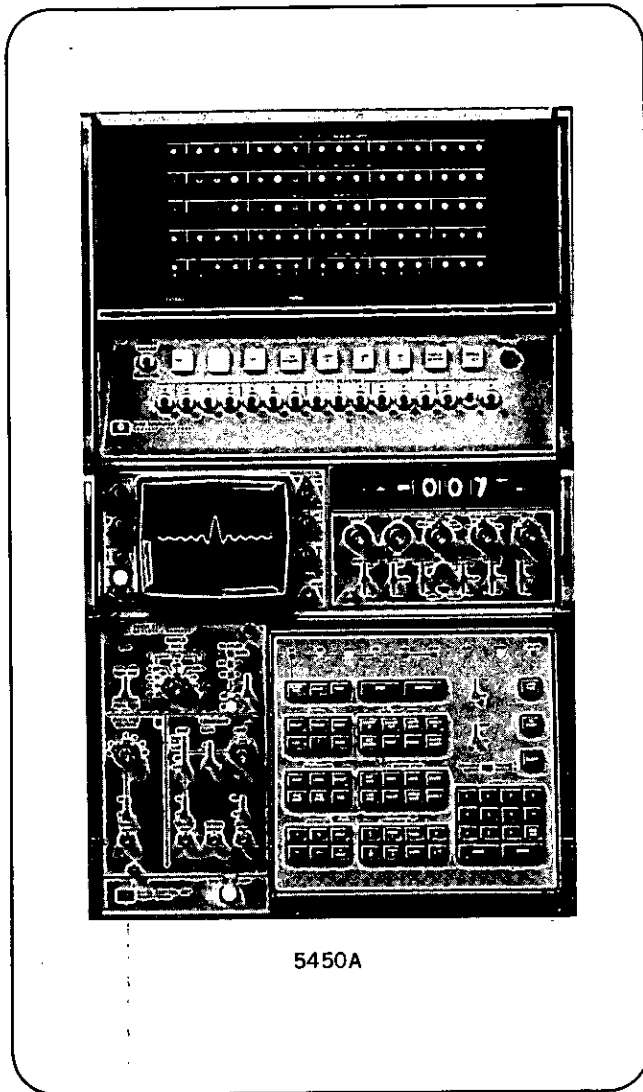
Vertical: 10 bits maximum.

Price and ordering information: contact the local sales engineer.



FOURIER ANALYZER

For Acoustics, Sonar, Geophysics, Vibration Analysis
Model 5450A



5450A

Features

- Keyboard controlled operation
- Keyboard instructable for . . .
- Automatic operation as a
 - Correlator
 - Power spectrum analyzer
 - Digital filter
 - Many others
- Automatically calibrated display

The HP 5450A Fourier Analyzer is a digital instrument designed to perform statistical analysis using Fourier analysis techniques.

Analysis control can be on an operation-by-operation basis or, using the six programming keys provided, measurement

routines may be automatically executed. Keyboard programming allows the 5450A to perform the following operations automatically without special software:

- Forward and inverse Fourier transform
- Power spectrum
- Magnitude and phase spectrum
- Auto and cross correlation
- Cepstrum
- Digital filtering
- Convolution
- Histogram
- Scaling
- Hanning and other Weighting Functions
- Ensemble averaging (time and frequency)

Six editing keys provide on-line editing so that automatically controlled measurement procedures may be changed on-line without the need for off-line compiling or testing.

The 5450A is a completely calibrated instrument; all displays and data outputs are accompanied by a scale factor relating them to physical units. This calibration results from digital techniques being used in all computations. The 5450A uses the Hewlett-Packard 2115A Digital Processor with an 8192 word memory (or optionally the 2116B with an 8192 or 16384 word memory) for these computations. The 2115A can also be used as a stand-alone digital computer by setting a switch on the 5475A Control Unit. In spite of this flexibility, no computer programming knowledge is required for operation of the 5450A—all operations are controlled through the keyboard of the 5475A Control Unit.

The keyboard contains keys for thirty-one input-output and basic analysis operations. Additional numeric address keys control data flow in and out of data blocks and permit entry of numeric values into memory. All control and data entry operations by the operator use decimal numbers for data values and data identification.

Data may be input to the 5450A as analog signals through the two channel 10-bit 5465A Analog-to-Digital Converter or as digital or binary information through the digital processor input channels. The 5465A Analog-to-Digital Converter plug-in can operate as a single or dual channel unit. It has a calibrated input attenuator. Two modes of internal sampling allow equal spacing or samples in either the time domain or the frequency domain.

Data may be output from the 5450A to the oscilloscope display or the teleprinter, or optionally to a paper tape punch, X-Y recorder or other recording device. The 5460A Display Plug-in and H51-180AR Oscilloscope Mainframe provide a linear or logarithmic display of the stored data and signals for driving an X-Y Recorder or X-Y Display.

General

Standard System Components

5460A	Display Plug-in
5465A	Analog-to-Digital Converter
5475A	Control Unit (keyboard console)
H51-180AR	Oscilloscope Mainframe
2115A	Digital Processor with 8192 word memory and Extended Arithmetic Unit
12566A	16-Bit Microcircuit Interface (two provided)
2752A	Teleprinter and Interface Card
2737A	Paper Tape Reader and Interface Card
2940A	Cabinet

Optional Components

2753A	High Speed Paper Tape Punch and Interface
7591A	Point Plotting System (requires option 005 and two each 17178A DC Attenuators)
2116B	Digital Processor with 8192 or 16,384 word memory (replaces 2115A Digital Processor in standard system)
12554A	Interface for binary data channel. One or two as required. (12556A may also be used)
Time Interval Option	(includes a 5235A Electronic Counter and necessary interfacing to the 5450A)

Analog input

The 5465A Analog-to-Digital Converter accepts one or two inputs. In two channel operation both inputs are sampled simultaneously. Resolution of the ADC is 10 bits.

Amplitude range: 0.1 V to 10 V maximum in steps of 1,2,4,10.

Input impedance: 1 M Ω \pm 1% shunted by 45 pF max.

Sensitivity: 30 μ V rms (sine wave).

Conversion gain (Channel A):

Accuracy (as function of frequency): \pm 0.1% \pm 3 \times 10⁻⁴%/Hz.

Temperature stability: 0.005%/°C.

Linearity: integral, \pm 0.05%; differential, \pm 3%.

Gain and phase Channel A to B:

Conversion gain A/B: \pm 0.2% \pm 2 \times 10⁻⁴%/Hz.

Temperature stability: 0.01%/°C.

Phase and delay A to B: \pm 0.2° \pm 0.5 μ s.

Trigger modes: slope and level controls are provided. The trigger input can be ac or dc coupled.

Internal: ADC triggers on signal to Channel A.

External: ADC triggers on signal applied to external input.

Line: ADC triggers on power line frequency.

Free run: ADC triggers on data request from processor.

Digital accuracy and resolution

All calculations use floating point arithmetic on a block basis. Data overflow does not occur. Amplitude resolution is 1 part in 16,000 worst case.

Data memory size: 3072 words (8192 for a 16,384 word memory).

Data block size: any power of 2 from 64 to 1024 (to 4096 with a 16,384 word memory).

Data word size: 16 bit real and 16 bit imaginary or 16 bit magnitude and 16 bit phase.

Computational range: \pm 150 decades.

Transform accuracy: 0.1% worst case error during the forward or inverse calculation.

Computational speed

The following are typical operations and their analysis times. These times are reduced by 20% if the 2116B Digital Processor is used.

Fourier transform:

Block size 1024: 3.4 s for one data block or two independent data blocks simultaneously.

Block size 64: 130 ms for one data block or two independent data blocks simultaneously.

Power spectrum ensemble average:

Block size 1024: 2.4 s per spectral estimate (2 degrees of freedom).

Block size 64: 120 ms per spectral estimate (2 degrees of freedom).

Cross power spectrum ensemble average:

Block size 1024: 4.2 s per spectral estimate.

Block size 64: 220 ms per spectral estimate.

Spectral resolution

The element of spectral resolution is the frequency channel width, the maximum frequency divided by 1/2 the data block size.

Maximum frequency: 25 kHz single channel; 10 kHz dual channel. Adjustable in steps of 1,2,5 down to 0.2 Hz.

Frequency channel width: $<$ 3.2% down to $<$ 0.2% of the maximum frequency in steps of 2 (down to $<$ 0.05% for 16,384 word processor).

Spectral resolution of two equal amplitude sine waves: if separated by 3 frequency channel widths, there will be a null of at least 3 dB between them; if separated by 7 frequency channel widths the relative magnitudes will be correct to within 0.1%. The power spectrum for two equal amplitude sine waves separated by 5 frequency channels will have the correct relative magnitude to within 0.1%.

Dynamic range: 4 decades over \pm 150 decades.

Frequency accuracy: \pm 0.01%.

Time domain resolution

The element of time resolution is the time channel width, the time sample record length divided by the block size.

Maximum sample record length: product of data block size and time channel width. (In ensemble averaging up to 32,767 sample record lengths may be used for a statistical estimate.)

Time channel width: 20 μ s, single channel; 50 μ s, dual channel, up to 5 s in steps of 1,2,5. Accuracy 0.01%.

Display unit

Data may be displayed on the 8 x 10 cm oscilloscope or output to a plotter or remote oscilloscope in the following forms.

Y AXIS	X AXIS
Real Part Amplitude	Time
Real Part Amplitude	Frequency (Linear or Log)
Imaginary Part Amplitude	" " " "
Magnitude (Linear or Log)	" " " "
Phase	" " " "
Imaginary Part Amplitude	Real Part Amplitude
(Nyquist Plot)	

Analog display accuracy: \pm 1%.

Amplitude scale: data in memory is automatically scaled to give a maximum on-screen calibrated display. A scale factor is given in volts/division or volts²/division.

Linear display range: \pm 4 divisions with scale factor ranging from 1 \times 10⁻¹⁵⁰ to 5 \times 10⁺¹⁵⁰ in steps of 1,2,5.

Log display range: 4 decades with a scale factor ranging from 0 to -99.9 decades.

Time and frequency scale:

Linear sweep length: 10, 10.24, or 12.8 division.

Log horizontal: 0.5 decade/division.

Markers: intensity markers every 8th or every 32nd point.

Analog plotter output:

Amplitude: 0.5 V per oscilloscope display division.

Output range: 1-20 pts/s (500 pts/s external timing).

Linearity: 0.1% of full scale.

Power source: 115/230 V \pm 10%, 50/60 Hz.

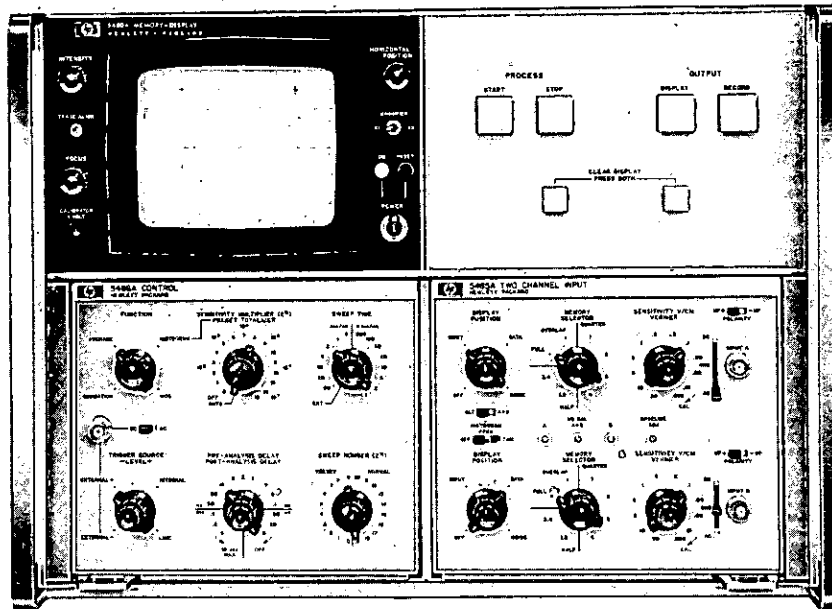
Environmental conditions: +10°C to +40°C (0°C to 55°C using the 2116B Processor).

Price for the above referenced configuration using the 2115A Digital Processor is approximately \$49,000.



SIGNAL ANALYZER

For averaging, variance, histograms, correlation
Model 5480A



5480A Signal Averager

The Model 5480A Signal Analyzer applies statistical principles for real time analysis of data and signal-to-noise improvement. Accurate, detailed information is made available through signal averaging; an example of the results of this technique applied to nerve response is shown in Figure 1. Figure 2 shows the output of the HP 8553/8552 Spectrum Analyzer; the same spectrum enhanced by signal averaging is shown in Figure 3. Many other applications exist for the 5480A in the fields of medicine, bio-medicine, chemistry, physics, electronics, astronomy**, vibration, turbulence, and others.

The plug-in design of the 5480A provides a more versatile instrument and guards against obsolescence. The 5480A Mainframe contains a 1024 word, 24-bit magnetic core memory with related circuits and a CRT display while the two plug-ins chosen (5486A, and either the 5485A, 5487A or 5488A) depend upon the specific application.

Averaging

There are three methods of averaging that provide from 0 to 57 dB signal-to-noise ratio improvement.

Stable averaging: continuous calibrated on-line display. Signal amplitude remains constant as noise is attenuated.

Weighted averaging: permits signal enhancement of slowly varying waveforms by exponential weighting of previous information with respect to new information. SWEEP NUMBER setting determines speed at which the average signal follows input.

Summation averaging: algebraic summation process. Signal will grow from stable base line. If placed in AUTO mode, display will be automatically calibrated at the end of the preset number of sweeps.

Variance (Option 001): the variance of channel A is displayed by averaging the square of the noise in channel B.

Multichannel Scaling (MCS)

The analyzer sweeps through memory remaining at each channel for a preset time. A plot of the number of input pulses versus time is displayed.

Correlation

The frequency of a noisy signal can be obtained by auto-correlation, while the common frequency and relative phase difference of two noisy signals can be obtained by cross-correlation. The 5488A Plug-in is required for correlation.

Histograms

Probability density generation with respect to time interval and frequency.

Time interval: time between synchronization pulses. Horizontal calibration by time base.

Frequency: Start and stop determined by time base. Horizontal calibration by time base.

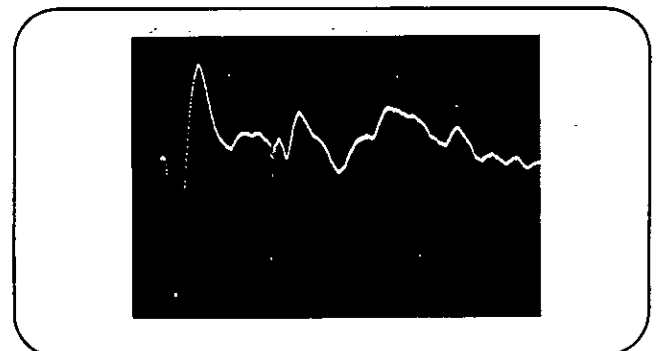


Figure 1. Evoked response, vestibular cortex of rhesus monkey.

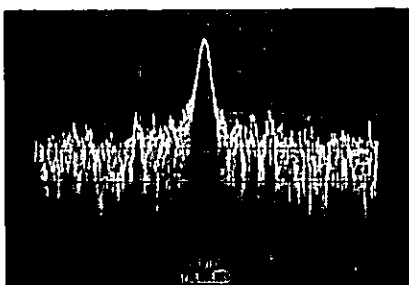


Figure 2. Spectrum analysis using HP 8553/8552.

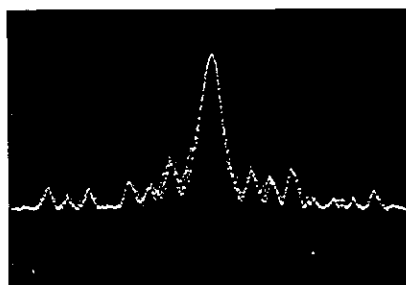


Figure 3. Enhanced spectrum analysis with the HP 5480A*.

*See Microwave Journal, October 1969.

Specifications

5486A Control Unit

S/N ratio improvement: up to 60 dB can be achieved.

Sweep number: manually selected. Dial is arranged in binary sequence (2^N) from single sweep (0 dial position) to 2^{19} (524,288) sweeps.

Sweep time (horizontal sweep): internally generated sweep time is calibrated in s/cm. Adjustable in 15 steps, in a 1, 2, 5 sequence, from 1 ms/cm to 50 s/cm. External sweep capability is provided.

Triggering and synchronization

Internal: sweep is triggered by internally generated pulse occurring at end of each sweep. Pulse available at back panel to control experiment; can be delayed by Post-Analysis Delay.

External: requires 100 mV rms signal (+ or - slope) with rise time less than 10 μ s.

Line: synchronized to power line frequency.

Pre-analysis delay: variable in 15 steps (1,2,5) from 20 μ s to 0.5 s.

Post-analysis delay: continuously variable from 0.01 to 10 s.

Sensitivity multiplier: expands vertical to 64 counts/cm in power of two increments.

Input characteristics: (Histogram Mode).

Bandwidth: dc to 1 MHz.

Sensitivity: 100 mV.

Input impedance: 1 M Ω shunted by 30 pF.

5480A Outputs

Digital: two 50-pin connectors with binary data output. Direct interface with Hewlett-Packard computers is available with the 10625A Interface (5481A System).

Sweep voltage: 0 to +1 V sweep ramp; conveniently adjusted by changing resistors to give output ramp going from 0 V to any value between 0 to +10 V.

Sync: "Pos" provides +12 V, >0.5 μ s pulse at start of each sweep (before pre-analysis delay); "Neg" provides same except -12 V.

Sampling pulses: pulses (100 ns pulse width) go from +5 V to ground and return to +5 V once each time the input is sampled.

Analog: X and Y outputs for Recorder, Point Plotter, Scopes, NMR Systems.

General

Power: 115 or 230 V \pm 10%, 50-400 Hz, 175 watts.

Dimensions: 16 $\frac{3}{4}$ " wide, 12 $\frac{1}{2}$ " high, 24 $\frac{3}{8}$ " deep over-all (425 x 311 x 593 mm).

Weight: 76 lb (34.5 kg) net with plug-ins.

5485A Two Channel Input

Input characteristics: two channels with polarity switch for each channel. Channels can be used individually or their inputs can be summed.

Coupling: ac or dc.

Input impedance: exceeds 1 M Ω shunted by 25 pF.

Bandwidth: from dc (2 Hz ac coupled) to 50 kHz.

Sampling rate: 2 Hz to 100 kHz, in 1,2,5 steps.

Input sensitivity: adjustable from 5 mV/cm to 20 V/cm in 12 steps (1,2,5 sequence) with \pm 3% accuracy. HP amplifiers, Models 2470A or 8875A, may be used to increase sensitivity.

Analog-to-digital converter: ramp type with variable resolution 1 ms/cm sweep time has 5 bit resolution. 2 ms/cm sweep time has 7 bit resolution. 5 ms/cm or slower sweep time has 9 bit resolution. ADC clock rate 10 MHz.

Pulse requirements: (Multichannel Scaling Mode)

Amplitude: >2 V (20 V max).

Maximum repetition rate: 1 MHz.

Minimum pulse width: 500 ns.

Pulse pair resolution: 500 ns.

Input impedance: 3 k Ω minimum.

Dwell time per channel: 10 μ s through 0.5 s in 1,2,5 steps (external time base: 50 μ s to ∞).

Sweep modes: sawtooth. External time base input allows any desired sweep shape.

Triggering: external or internal.

5487A Four Channel Input

Same as 5485A except four inputs. deletes summing of inputs and polarity inversion.

Bandwidth: dc (2 Hz dc coupled) to 25 kHz.

Sensitivity: 50 mV/cm to 20 V/cm.

5488A Correlator Input

Same as 5485A except adds correlation, deletes summing of two inputs, and polarity inversion.

Bandwidth: dc (2 Hz ac coupled) to 25 kHz.

Sensitivity: 50 mV/cm to 20 V/cm.

Price:

5480A Mainframe, \$6950.

5485A Two-Channel Input, \$1500.

5486A Control Unit, \$1500.

5487A Four-Channel Input, \$1800.

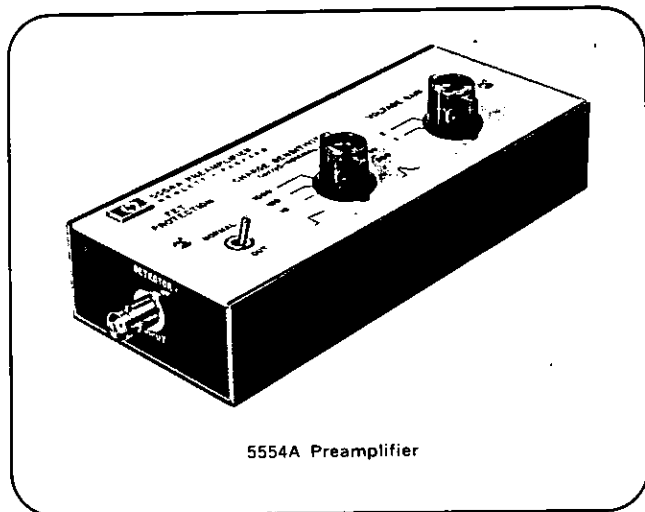
5488A Correlator Input, \$2500.

Option 001 Variance, add \$300.



PREAMPLIFIER, NIM POWER SUPPLY

General purpose
Models 5554A, 5580B



5554A Pre-amplifier

Features

- FET Input Stage
- Selectable Charge Sensitivity and Voltage Gain
- Combination Preamp and Amplifier
- FET Protection

The Hewlett-Packard 5554A ends the need for a variety of special-purpose preamplifiers by providing the ability to operate with semiconductor, gas proportional, Geiger, and scintillation detectors.

The 5554A accepts a burst of charge (current pulse) from a detector and produces an output pulse of voltage proportional to the amount of input charge. There are two stages of amplification, a charge-sensitive stage and a voltage amplification stage. The two are coupled by either a pole-zero cancellation network or a pulse shaping network. Pole-zero cancellation produces an output pulse ideal for use with a Linear Amplifier such as the HP 5582A.

A field-effect transistor (FET) is used in the charge-sensitive stage for low noise performance. Diode protection of the FET against high voltage transients is switch selectable. With no external input capacitance the typical preamp noise is 2.2 keV FWHM (GeLi).

Specifications

Charge sensitive preamplifier

Signal input polarity either.

High voltage: 2.5 kV max, either + or - as required for detector.

HV decoupling: 3 stages, $R = 1 \text{ M}\Omega$, $C = 0.0047 \mu\text{F}$, $\tau = 4.7 \text{ ms}$.

Charge sensitivity (millivolts/picocoulomb): 10, 100, or 1000 mV/pC or 3, 30, 300 mV/pC (shaped pulse).

Voltage amplifier

Gain: with $R_L = 50\Omega$: 1, 2, 4, or 8; with $R_L \geq 500\Omega$: 2, 4, 8, or 16.

Loss as a function of input capacitance: $< 3\%$ at 100 pF.

Output

Polarity: inverted from input.

Positive output: into a 50Ω load, dynamic range is 5 V; into $\geq 500\Omega$, 10 V (with voltage gain X2, X4, or X8).

Negative output: into a 50Ω load, dynamic range is 3.5 V; into $\geq 500\Omega$, 7 V (with voltage gain X2, X4, or X8).

Impedance: 50Ω .

Tail pulse:

Rise time: 50 ns at zero external capacitance.

Tail time constant: 100 ms. Pole-zero cancellation.

Shaped pulse:

RC differentiation, integration time constants: both 1 μs .

Noise: 2.5 keV FWHM (GeLi) plus 0.038 keV/pF max.

Temperature stability: 0.01%/°C (nonshaped pulse).

Integral nonlinearity: 0.05%.

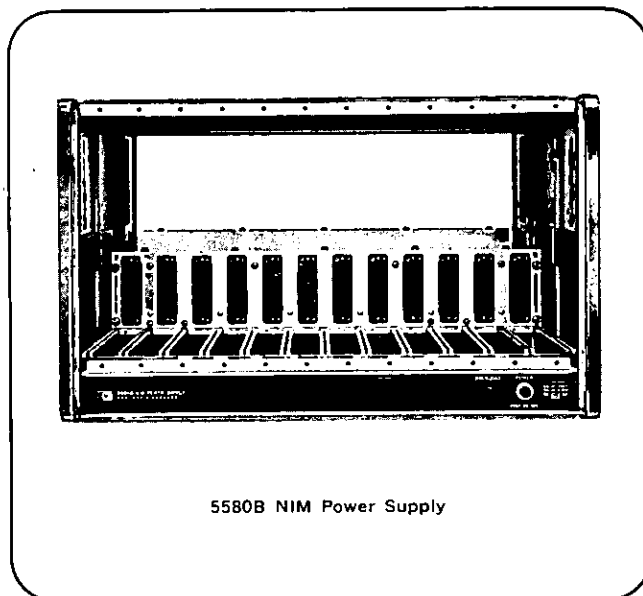
Power required: +20 to +24 V dc, 80 mA max.

Note: specifications valid for +24 V dc input and $R_L \geq 500\Omega$.

Accessories furnished: power input cable, TNC connectors, 6 ft long (HP 10517A).

Accessories available: high voltage cable, 6 ft long, HV-type BNC connectors, (HP 10516A, \$10).

Price: \$325.



5580B NIM Power Supply

Features

- Blower Cooling
- Protection Circuits

The Hewlett-Packard 5580B NIM Power Supply provides the output voltages required by the AEC-NBS Standards (TID-20893). It accepts 12 single width modules. Three protection features are included: overload warning, blower cooling, and automatic protections from short circuits.

Specifications

Outputs, dc: $\pm 24 \text{ V}$ to 0 at 2A; $\pm 12 \text{ V}$ at 0 to 4A; $\pm 6 \text{ V}$ at 0 to 5A. Maximum output power, 120 W.

Outputs, ac: 115 V at line frequency.

Regulation: line, less than 0.05% for a 10% change. Load, output impedance $< 0.040\Omega$ dc; $< 0.3\Omega$ at 100 kHz.

Temperature coefficient: 0.02%/°C.

Ambient operating temperature: 0 to 55°C.

Noise and ripple: 3 mV, peak to peak.

Recovery time: returns to within 0.1% of specified output within 50 μs for a 1A load current change.

Input line voltage: 105 to 125 V or 210 to 250 V, 50 to 60 Hz.

Price: \$995.

NIM INSTRUMENTS, SCALER-TIMER General Purpose

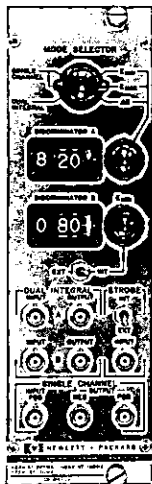
Models 5582A, 5583A, 5584A, 5585A, 5590A, 5201L



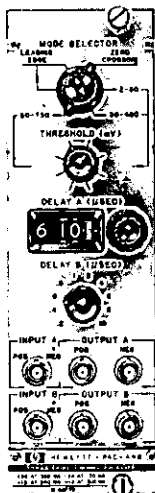
DIGITAL ANALYZERS



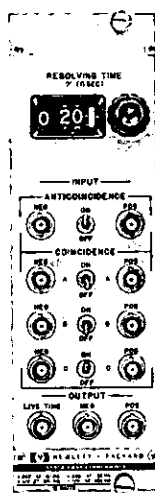
5582A



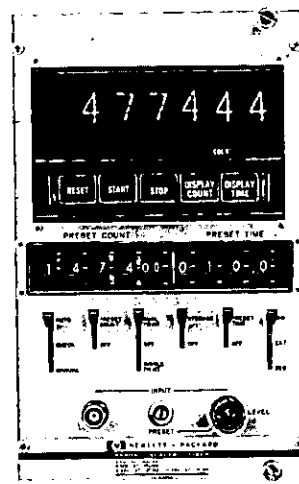
5583A



5584A



5585A



5590A

General

These Hewlett-Packard modular instruments provide signal processing to complement the 5401B Multichannel Analyzer and 5405A/5406A Multichannel Analyzer Systems. Each module requires a NIM power supply such as the HP 5580B. The 5582A, 5583A, 5584A, and 5585A are standard double width modules; the 5590A is a standard four-width module. The 5201L is rack mountable. Temperature operating range is 0-55°C.

Model 5582A

The Hewlett-Packard 5582A Linear Amplifier provides maximum flexibility for nuclear pulse counting with all types of detectors and a wide range of counting rates.

Front panel switches give the user a choice of: integration and single or double RC differentiation, or single or double delay line shaping. Remote gain control is provided.

Specifications

- Input polarity:** positive or negative.
- Input impedance:** 1.5 k Ω , dc coupled.
- Maximum input voltage:** 15 V peak, 15 V dc.
- Gain range:** 2 to 1280.
- Time constants:** to 5 μ s in 1,2,5 sequence. 1 μ s delay lines.
- Amplifier**
 - Rise time:** <40 ns, typically 25 ns.
 - Stability:** gain shift <0.05%/°C, typically 0.02%/°C.
- Output amplitude:** \pm 10 V except \pm 5 V at 0.02 and 0.05 μ s differentiation time constants.
- Output impedance:** <5 Ω ; minimum load 90 Ω .
- Output delay:** 65 ns, relative to input, typical.
- Linearity:** integral, <0.3%; differential, <1%.
- Count rate shift:** <0.05% with inputs to 10⁵ cps, typical.
- Power required:** +24 V, 260 mA; -24 V, 325 mA.
- Price:** \$695.

Model 5583A

The Hewlett-Packard 5583A Single Channel Analyzer is an extremely versatile instrument that can operate in the Single Channel Mode for pulse height analysis or the Dual Integral Mode when two independent integral discriminators are needed.

In the Single Channel ΔE Mode, Discriminator A operates as narrow window (ΔE) adjustable from 0 to 1 volt. Discriminator B selects the window position (E_{min}). In the Single Channel E_{max} Mode, Discriminator A operates as E_{max} and Discriminator B as E_{min} .

Specifications

- Multiple pulse resolution:** 200 ns.
- Input circuit:** ac coupled, 1 ms time constant. Impedance is 500 Ω , single channel; 1 k Ω , dual integral.
- Input signal:** 50 mV to 10 V. Unipolar positive or bipolar with positive portion leading.
- Discriminator ranges**
 - E_{min} and E_{max} :** adjustable from 0.005 V to 10.05 V.
 - ΔE :** adjustable from 0.005 V to 1.005 V.
- E_{min} bias input:** 5 V to scan complete range.
- Integral linearity:** \pm 0.25% of full scale.
- Stability:** <0.01%/°C, E_{max} and E_{min} ; <0.1%/°C, ΔE .
- Strobe input:** 0.6 V negative, 15 ns wide (min), ac coupled.
- Gate input:** >+3 V inhibits single channel outputs (dc coupled).

Outputs

Output	Pulse		Triggered form
	Amplitude	Width	
Dual integral A and B	+5 V into 100 Ω	100 ns	Leading edge of input pulse.
Single channel Positive	+6 V open circuit		Trailing edge of input pulse or from strobe input.
Negative	-0.8 V into 50 Ω	20 ns (5 ns rise time)	

- Power required:** +24 V, 225 mA; -24 V, 190 mA; +12 V, 10 mA.
- Price:** \$595.

Model 5584A

The Hewlett-Packard 5584A Dual Timing Pickoff has two independent channels which can accept analog pulse inputs and produce timing pulses based on either the leading edge or zero crossing of the input pulse. Each channel has a delay circuit. The delay of Channel A can be externally swept.

Specifications

Operating modes: leading edge or zero crossing timing with adjustable modes.

Multiple pulse resolution: 100 ns + delay time.

Crossover walk: 5 ns over range 50 mV to 10 V.

Stability: resolving time, <0.2 ns/ $^{\circ}$ C over nanosecond delay ranges.

Delay

Channel A: 0.1-1.1 μ s or 1-11 μ s.

Channel B: 200 ns to 1 μ s in 200 ns steps and 2 μ s to 10 μ s in 2 μ s steps.

Inputs, Channels A and B: accept pulses between adjustable threshold and 10 V; 1 k Ω . For LE mode, either polarity, ac coupled, 100 ns time constant; for ZC, pos bipolar, dc coupled.

Input, sweep: 0 to 5 V sweeps "A" delay from setting to setting plus 100 ns (low range), plus 1 μ s (high range); 4.75 k Ω , dc coupled.

Outputs: +5 V into 100 Ω , 100 ns width, or -0.8 V into 50 Ω , 15 ns width, 5 ns risetime; dc coupled.

Power required: +24, 350 mA; -24 V, 170 mA; +12 V, 300 mA.

Price: \$900.

Model 5585A

The Hewlett-Packard 5585A Fast Coincidence Module accepts signals from up to four logic circuits. Three inputs are for coincidence signals and one for anticoincidence.

Specifications

Multiple pulse resolution: <200 ns plus resolving time, τ .

Resolving time temp stability: <0.2 ns/ $^{\circ}$ C.

Inputs: coincidence, 3 switchable pairs, separate pos and neg; anticoincidence neg accepts -0.6 to -10 V pulse >15 ns; pos, 2 to 12 V.

Outputs: positive, negative, live time. Positive is +5 V into 100 Ω , width factory set to 100 ns (80 ns to 500 ns); negative is -0.8 V into 50 Ω , 20 ns width, 5 ns rise. All dc coupled.

Resolving time control: 10-turn pot, in-line display, 1 ns to 100 ns continuous; <0.2 ns jitter, typically.

Power required: +24 V, 60 mA; -24 V, 50 mA; ± 12 V, 400 mA.

Price: \$900.

Model 5590A

The Hewlett-Packard 5590A Scaler-Timer Module contains two separate registers for scaling and timing. When both count and time are preset; the first to reach preset value terminates the operation.

Six digital readout tubes are provided (7 optionally) and operation is by pushbuttons. An input integral discriminator is provided.

Specifications

Resolving time, signal input: 100 ns.

Count input sensitivity: 100 mV peak 20 ns min width at half max.

Accuracy: ± 1 count, \pm time base accuracy.

Crystal time base accuracy: $<\pm 5$ parts in 10^8 with temp stability better than ± 5 parts in 10^8 over range.

Preset count: range (1 to 1999) x (10, 100, or 1000).

Preset time: range 0.1 to 999.9 s or min or 1 to 9999 external units.

Discriminator level: 0.1 V to 10 V or PRESET (-1 V to +10 V).

Digital readout: 6 decades.

Condition indicator: OVERFLOW, ARMED, GATE ON, COUNT, and TIME.

Count input: between discriminator and +20 V when LEVEL/PRESET is pos (disc and -20 V when LEVEL/PRESET neg) BNC, 1 k Ω , ac coupled.

External clock: +4 to +12 V, >30 ns, 3 k Ω , dc coupled.

Accessories input

Start, stop: +4 V to +12 V pulse, >200 ns (3 k Ω , dc coupled).

Reset: +4 V to +12 V pulse, >200 ns (510 Ω , dc coupled).

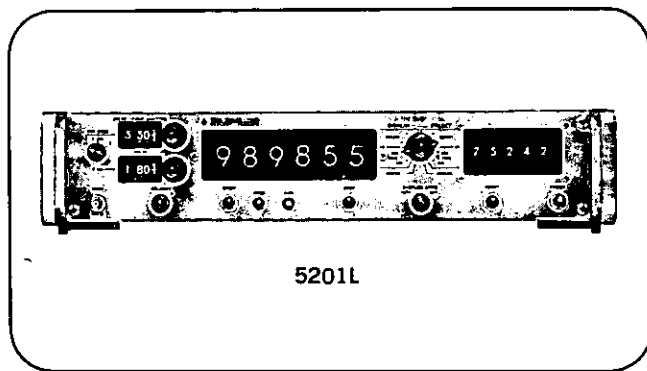
Recycle inhibit: +4 V to +12 V (3 k Ω).

Gate output: open, +5 V (120 Ω source); closed, 0 V (2.2 k Ω source).

Printer output: 8421 BCD "1" state positive.

Power required: 117 V ac, 35 mA; +24 V, 45 mA; -24 V, 30 mA; +12 V, 150 mA; +6 V, 1.4 A.

Price: \$1795.



Model 5201L

The Hewlett-Packard 5201L Scaler-Timer is a 19 inch rack mountable unit which combines a single channel analyzer with a preset pulse counter. Counting can be preset for a certain period or the register can be used to accumulate the time required for a preset number of counts.

Specifications

Functions

Preset time: displays number of counts during preset time interval of 0.1 s or 0.1 min, x preset number N.

Preset count: displays a number of 0.1 s or 0.1 min intervals required for N counts to occur.

Manual: START-STOP pushbuttons or a dc level applied at rear connector.

Single channel analysis

Modes of operation: (a) integral; (b) differential with narrow window; and (c) differential with wide window.

Input circuit: ac coupled. Impedance 500 ohms.

Polarity: positive or negative.

Output: nominal 0.5 V pulse into 50 ohms.

Discriminator ranges: E_{min} and E_{max} are adjustable from 0.05 V to 10.0 V.

ΔE range: adjustable up to 1.0 V.

Discriminator stability: $\pm 0.01\%$ / $^{\circ}$ C full scale change in E_{min} and E_{max} ; and less than $\pm 0.1\%$ / $^{\circ}$ C of full scale change in ΔE .

Integral linearity: $\pm 0.25\%$ of full scale.

General

Resolving time: preset time, 200 ns; preset count, 10 μ s.

Maximum count rate: preset time, 5×10^6 counts/s; preset count, 1×10^5 counts/s.

Preset count times: 0.1 s to 9,999.9 s in 0.1 s steps; 0.1 min to 9,999.9 min in 0.1 min steps.

Minimum pulse for counting: 40 ns minimum width, 0.1 V peak minimum.

Accuracy: ± 1 count \pm time base accuracy.

Time base: line frequency or optional 100 kHz crystal.

Gate in: gate open, $> +5$ V; gate closed, $< +2$ V.

Gate out: $> +15$ V when gate open, $< +2$ V when gate closed.

Printer output: 4-line BCD (1-2-4-8) code, "1" state neg.

Power: 115 V or 230 V $\pm 10\%$, 60 Hz, 60 W.

Temperature range: -0° C to $+55^{\circ}$ C.

Price: \$1995.



Unfortunately for those trying to measure and evaluate sound objectively in terms of the sensation experienced by humans, this sensation seems to involve complicated physiological and psychological mechanisms. Indeed, loudness evaluation is several orders of magnitude more complex than measuring the purely physical quantities of sound pressure and sound pressure level.

Since loudness is a subjective quantity the primary instrument for measuring it can only be a human observer.

To determine whether one sound is louder, equally loud, or less loud than another, we would have to let a statistically significant number of people compare the sounds and then average their opinions. Similarly, to determine how loud a sound is, we should have to choose a standard sound and have a significant number of people compare the unknown with the standard.

In acoustics the accepted standard is a pure 1 kHz tone or narrow-band noise centered at 1 kHz. The loudness level of any sound is defined as the sound pressure level of a standard sound which appears to a significant number of observers to be as loud as the unknown. Loudness level is measured in phons, the loudness level of any sound in phons being equal to the sound pressure level in dB of an equally loud standard sound. Thus a sound which is judged to be as loud as a 40 dB 1 kHz tone has a loudness level $L = 40$ phons.

Although the logarithmic phon scale covers the large dynamic range of the ear (120 dB) conveniently, it does not fit a linear loudness scale. A factor of two in loudness does not correspond to double the number of phons.

It is also difficult to add loudnesses in phons. If, for instance, we produce one tone at 200 Hz with a loudness level of 70 phons, and another at 4 kHz with the same loudness level, it would be convenient if both tones together would yield a loudness level of 140 phons. Unfortunately, this doesn't happen. The two tones actually are perceived as a loudness level of 80 phons.

In an effort to obtain a quantity proportional to the intensity of the loudness sensation, a loudness scale was defined in which the unit of loudness is called a sone. One sone corresponds to a loudness level of 40 phons. For loudness levels of 40 phons or greater, the relationship between the numerical values of loudness level L (in phons) and loudness S (in sones) is given by

Loudness Level (phons)		Loudness (sones)
140	Threshold of pain	1024
120	Jet aircraft	256
100	Truck	64
80	Orator	16
60	Low conversation	4
40	Quiet room	1
20	Rustling of leaves	
3	Hearing threshold	

Table 1

$$S = 2^{(L - 40)/10}$$

(ISO Recommendation R 131). Table 1 compares loudnesses (sones) and loudness levels (phons) of several common sounds.

The loudness level of a 1 kHz tone is the same as its sound pressure level. This would also be true of pure tones of other frequencies if perception were constant with frequency. However, it is not. The loudness level of any other sound (in phons) is not, in general, equal to its sound pressure level (in dB).

Equal loudness contours were first published in 1933 by Fletcher and Munson. Slightly modified curves are now universally accepted as reference data (ISO Recommendation 226). These curves are for pure tones in a frontal sound field (sound traveling in only one direction and approaching the observer from the front).

To human ears, broadband sounds, like those of jet aircraft, seem much louder than pure tones or narrow-band noise having the same sound pressure level. Figure 1 shows what increasing bandwidth does to the loudness of noise having a center frequency of 1 kHz and a constant sound pressure level of 60 dB. Up to a critical bandwidth of 160 Hz, the loudness is constant. Beyond that point, however, there is a marked increase in loudness. At a bandwidth of 2 kHz the loudness level L has increased from 60

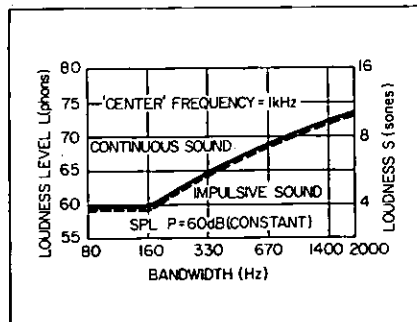


Figure 1. Effect of bandwidth on loudness.

phons to 74 phons. Loudness S has increased by a factor of 2.5. Similar investigations using different center frequencies yield different critical bandwidths. At a center frequency of 200 Hz the critical bandwidth is approximately 100 Hz; at 5 kHz, about 1 kHz.

The human ear's critical bands seem to be related to another property of the ear: subjective pitch. Subjective pitch tells us how our ears compare the frequencies of different sounds. Needless to say, subjective pitch is not linear, i.e. a unit interval is not the same at 100 Hz and 5 kHz. The unit of subjective pitch is the mel. Remarkable enough, an interval of 100 mel approximates the width of a critical band at any point in the audio range. However, the mel is not used. Instead, the width of a critical band is defined as one Bark. Accordingly, the audio range comprises 24 Barks.

Two sounds presented to the ear simultaneously produce a sensation of loudness which is larger than that produced by either of them alone. However, a simple summation of partial loudnesses can only be carried out if the individual sounds are separated widely in frequency. The closer they are in frequency the more they influence each other, and total loudness may not be quite so large as the sum of the partial loudnesses. This effect is called partial masking. In the extreme case, it becomes total masking, wherein a strong sound renders a lower-level sound completely inaudible. When total masking occurs, low-level sound components cannot be heard at all and do not contribute to loudness.

The sounds heard in everyday life are not all uniform. Many, like bangs and rattling sounds, change rapidly with time. Loudness is independent of duration for large pulse widths. Only when the pulse width drops below about 100 ms does the level of a pulse have to be increased to yield the same loudness. The test method has some effect on the results; however, regardless of the method the time constant of the ear appears to be between 35 and 100 ms. It also turns out that the laws describing loudness in terms of critical bands are valid for impulsive sound as well as continuous sound. In practical terms this means that sound should be measured with rms detectors with a time constant between 35 and 100 ms. While this seems to be a loose tolerance in light of the achievable accuracies in purely electronic measurements, we must remember that we are dealing with a subjective field in which there is yet much

work to be done. Even so, the outputs of detectors with 35- and 100-ms time constants differ by only 4 dB in response to a single 5-ms tone burst, and the outputs of both are predictable and thus can be compared.

Acoustic measurements start with the transducer (microphone) which converts audio sound pressure into an electrical signal. The choice of a microphone is based on many parameters such as size, frequency response, sensitivity, and directional characteristics. Fortunately, the quality of present-day microphones simplifies the selection. The HP 15119A ½-in. Microphone (page 60) is particularly well suited for measurements in both diffuse and free (unidirectional) fields. Its size insures a minimum disturbance of the sound field, it covers a wide frequency and pressure range, it has an essentially flat frequency response, and it is omnidirectional. Where sensitivity is the prime parameter, the HP 15109B, a full 10 dB more sensitive, should be the choice.

Good measurement practice dictates the removal of the observer and other interfering objects, including the indicating instrument, from the sound field. To this end, HP microphones are equipped with 10-ft cables. Longer cables can be used, especially with the HP 15127A Cable Amplifier (page 61).

With the sound signal in electrical form, we need to process and display it in a meaningful way. The simplest and most widely used device is the sound level meter, basically an audio rms voltmeter. The frequency response of the sound level meter is shaped to account, in a first-order approximation, for the frequency response of the ear. Three response curves, A, B, and C, (Figure 2) have been standardized, e.g. in IEC Publications 123 and 179 and USA Standard S1.4-1961. (The recently proposed D curve is primarily for the measurement of jet aircraft noise.)

None of the three standards specifies detector time constant directly; instead, they specify overall response to a single 200-ms tone burst. This response, designat-

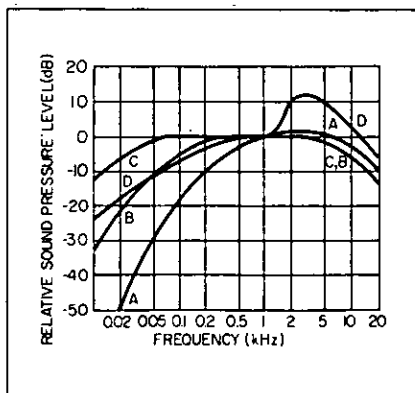


Figure 2. Frequency response curves.

ated Fast, implies a nominal detector time constant of 127 ms (a Slow mode with a 1-s time constant is also allowed). Unfortunately, this does not enable us to predict response to shorter bursts (which are commonly found in practice). A German standard, DIN 45 633, Part 2, specifies an Impulse response in which the corresponding detector time constant is 35 ms, permitting predictable results for tone bursts as short as 5 ms. HP 8052A and 8062A Impulse Sound Level Meters (page 49) incorporate all three response modes.

The biggest problem in overall instrument response, even for a 200-ms tone burst, is the mechanical inertia of the meter. Per DIN 45 633, the 8052A/8062A include a peak detector and stretching circuit between the rms detector and the meter. The rise time of the peak detector is short compared to the 35-ms time constant of the rms detector; the discharge time, long compared to the response time of the meter. Thus the meter or an external dc level recorder has ample time to indicate the maximum rms value of impulsive sounds.

With the sound level meter, then, we measure the frequency- and time-weighted rms value of sound pressure. The frequency weighting (A, B, or C) cannot account for masking, and it's impossible to select the right weighting for all spectral components at once. Thus the sound level meter by itself can only be used to compare sounds from similar sources. We cannot, however, use it to compare autos and typewriters.

For sounds having no significant time structure, selection of time weighting is immaterial; all three give the same reading. In all other cases—and they are the rule rather than the exception—the Impulse mode is mandatory. This is the only one which provides an accurate measurement of sound level maxima and physiologically significant results.

For all its faults, the sound level meter is an extremely useful tool. It is inexpensive, easy to use, and highly portable. Properly used, it can indeed give meaningful data.

Including filters in the measurement system enables us to analyze the individual spectral components of a sound. A simple octave-band analysis system includes the 8052A or 8062A and 8055A Filter Set (page 58). Such a system is well suited for a variety of measurements including the determination of noise rating numbers. For greater resolution of spectral components the 8056A Filter Set, which uses third-octave filters, can be used (page 58). (HP octave and third-octave filters meet the requirements of US Standard S1.11-1966 for Class II and Class III respectively, as well as IEC Recommendation 225).

For many applications, faster processing of data is necessary or at least desirable. The HP 8051A Loudness Analyzer (page 55) and 8054A Real Time Audio Spectrum Analyzer (page 51) provide rapid, completely automatic analysis. The 8051A determines loudness in objective terms according to the Zwicker method (ISO Recommendation 532, Method B). Comprising two octave filters, one 2/3-octave filter, and 17 third-octave filters, each approximating a critical bandwidth, the 8051A displays a new loudness spectrum on a crt (Figure 3) every 25 ms. The analyzer accounts for masking (the curved slopes in the figure) and the frequency response of the ear. In addition, the 8051A computes the area under the spectrum and displays it as total loudness in sones₀ on a front-panel meter. The crt display can be frozen for recording on a X-Y recorder, and pre-printed paper permits Zwicker diagrams to be recorded directly. These diagrams can be used for detailed analysis or filed for reference purposes.

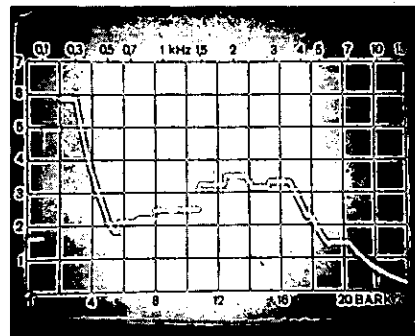


Figure 3. Loudness spectrum.

With 24 third-octave filters, the 8054A provides an unweighted, uncompensated audio spectrum (Figure 4). It is indeed a real-time analyzer, displaying a new spectrum every 28 ms. With both analog and digital outputs, the 8054A is well suited to a variety of automated systems and can be interfaced directly with HP computers.

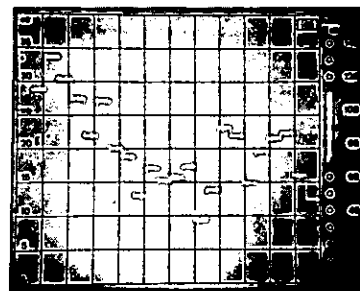


Figure 4. Third-octave spectrum.

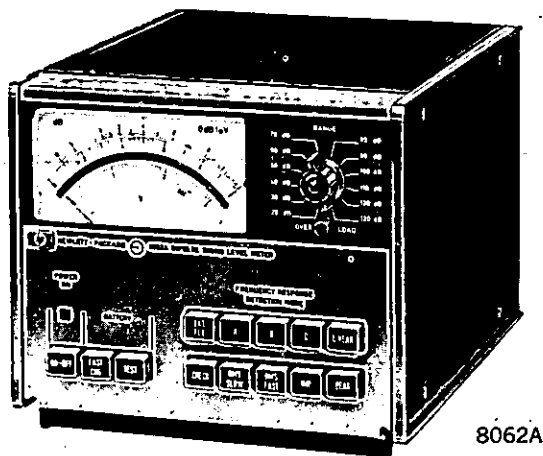
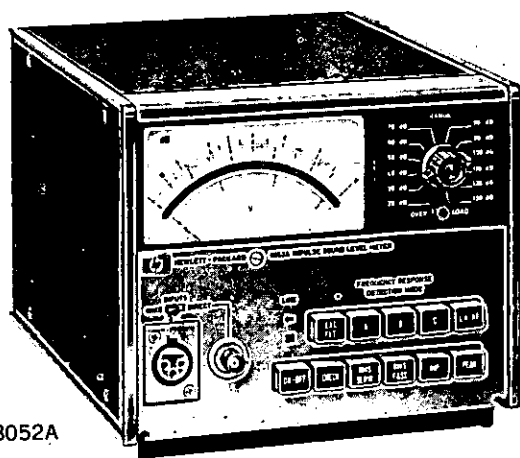
Acoustic measurements and instrumentation are discussed in detail in Application Note 100. This Note is available from your local HP Field Office.

IMPULSE SOUND LEVEL METERS

Precision Measurements, Recordings
Models 8052A, 8062A, 80511P



ACOUSTICS



The Models 8052A and 8062A Impulse Sound Level Meters are suitable for any kind of broadband audio-range sound level measurements. Basically audio-range voltmeters, these instruments incorporate selectable weighting factors and detection modes. The two models are identical in operation, but the 8052A is powered from standard power lines while the 8062A can be powered from internal batteries as well.

Both rms and peak signal values may be measured. Either of two time constants (about 1 s "slow" and 100 ms "fast") can be selected for rms measurements of continuous or quasi-continuous signals with crest factors up to 5. The "impulse" mode is available for impulsive as well as continuous signals (35 ms integrating time constant). In the "peak" mode, peak values of single impulses as short as 100 μ s can be accurately measured.

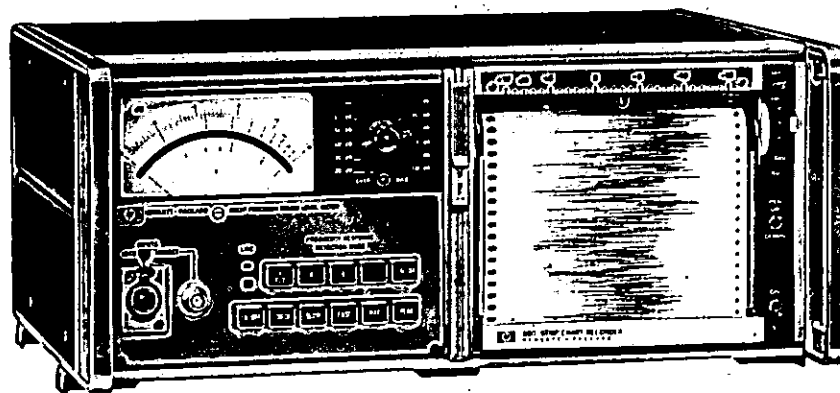
The frequency response of these instruments is also selectable. In addition to the "linear" mode, in which the response is flat from 5 Hz to 20 kHz, three weighted responses (A,B,C) or (A,D,C) are available. The response curves of these weighted modes meet the requirements specified in IEC Recommendation 179 for precision sound level meters.

When used with a Hewlett-Packard Microphone Preamplifier such as the Model 15108B (with BNC adapter) both models become high-quality audio-range voltmeters with an input impedance greater than 1000 M Ω shunted by less than 5 pF. Full-scale sensitivity ranges from 30 μ V to 10 V. As with sound measurements, both peak and rms measurements may be made, for easy determination of crest factors.

A special version of the 8052A, the Option 004, has a 25 dB dynamic range and scale graduated linearly in dB. Both log and linear electrical outputs are available. Price on request.

The Model 80511P Sound Level Recorder is designed for continuous evaluation of sounds and vibrations on both a short- and long-term basis. The system generates permanent records of level variations on electrosensitive paper (no messy ink to deal with). This fact makes the unit highly suitable for unattended operation. Eight chart speeds are available, together with a local or remote pen-lift feature. The unit is extremely easy to set up and to use, and is ideal for occupational noise exposure measurements.

Price and detailed information on request.



80511P

Impulse Sound Level Meters

Specifications, 8052A, 8062A

Frequency range: 5 Hz to 20 kHz.

Amplitude range:

Using direct input or HP preamplifier: 30 μ V to 10 V full scale.

Using HP 15109B 1-in. condenser microphone:

Sound pressure level: 35 to 140 dB (0 dB = 2×10^{-1} μ bar).

Sound level (A-weighted): 22 to 140 dB.

Octave level: 22 to 140 dB.

One-third octave level: 15 to 140 dB.

Using HP 15119A 1/2-in. condenser microphone:

Sound pressure level: 55 to 150 dB.

Sound level (A-weighted): 40 to 150 dB.

Octave level: 40 to 150 dB.

One-third octave level: 30 to 150 dB.

Overall accuracy:*

2 Hz	5 Hz	20 kHz	40 kHz
± 1 dB	± 0.5 dB	+0.5	dB
		-1.0	

Weighting networks: three weighting networks modify frequency response in accordance with A, B, or C, specified in IEC Recommendation 179 for precision sound level meters (Also see Option 01).

Detection mode:

Rms slow and rms fast: indication proportional to rms value of applied signal. Signals with crest factors up to 5 affect accuracy less than ± 0.5 dB (± 0.75 dB above 40°C, for crest factors above 3). Dynamic characteristics per IEC Recommendation 179.

Impulse: indication proportional to the maximum rms value of applied signals, weighted with a 35 ms time constant per the proposed standard for impulse sound level meters.

Peak: indication proportional to the absolute peak value of applied signal with an accuracy of ± 1 dB; rise time < 100 μ s, discharging rate < 0.1 dB/s.

Noise: approximately 5 μ V referred to the input with the input terminated in 600 Ω .**

Absolute maximum input: ac, 50 V peak; dc, 200 V.

Overload recovery time: < 5 s for 80 dB overload in FAST meter response.

Overload indicator: front panel indicator lights when input signal crest factor exceeds five at full scale, or when the input signal is excessive.

Self check: internal signal permits verification of over-all operation.

Input impedance: 100 k Ω shunted by approximately 100 pF; about 1000 M Ω shunted by approximately 5 pF when an HP Microphone Preamplifier such as 15108B with BNC adapter is used.

Microphone input: accepts input signals from one of the HP Condenser Microphones or Preamplifiers and supplies +200 V $\pm 2\%$ as polarization voltage for the microphone cartridge and operating voltage for the microphone preamplifier.***

Microphone sensitivity: range switch calibrated in dB SPL for microphones with a nominal sensitivity factor of 5 mV/ μ bar

(See Option 02); deviation up to +1 and -4.5 dB can be compensated for in 0.5 dB steps.

External filter: external filters can be used to limit the frequency range of the 8052A and 8062A. These filters are electrically inserted into the 8052A and 8062A circuits using the appropriate connectors on the rear panel of the 8052A and 8062A.

External filter input: provides output signal to filter; 100 mV peak or rms for full scale meter indication with 0 dB gain through the filter. Output impedance < 20 Ω , BNC female connector.

Maximum output: 9 V pp.

Load resistance: ≥ 600 Ω , 1 nF.

External filter output: receives output signal from filter. Input Impedance > 100 k Ω shunted by approximately 100 pF, BNC female connector.

Meter: taut-band meter movement with scales individually calibrated to the movement; three meter scales, -10 to +10 dB, 0.1 to 1, and 0.3 to 3 V.

Recorder output: 0 to +5 V proportional to meter deflection. Output impedance < 20 Ω , BNC female connector. Load resistance ≥ 600 Ω , 1 nF.

Operating environment:

8052A: 14° to 122°F (-10° to 50°C), relative humidity up to 95% at 104°F (40°C).

8062A: 14° to 113°F (-10° to +45°C), relative humidity up to 95% at 104°F (40°C).

Power requirements:

8052A: 110 or 220 V, -10%, +15%, 50 to 400 Hz, approximately 5 W.

8062A: two internal rechargeable batteries or external 110 or 220 V, -10%, +15%, 50 to 400 Hz, approximately 5 W. Battery operating time 8 hrs. Batteries are trickle-charged when instrument is operated from external power line; fast charge can be selected, but instrument cannot be operated in this mode. Battery condition can be read on the meter.

Weight:

8052A: net 9 lb (4 kg); shipping 11 lb (5 kg).

8062A: net 12 lb (5.5 kg); shipping 14 lb (6.3 kg).

Accessories furnished: two 15-pin extender boards, one cable ac power, one adapter BNC to binding post.

Dimensions: 6-3/32" high, 7-25/32" wide, 11" deep (155 x 190 x 279 mm).

Options:

01: A, D, and C weighting networks in lieu of A, B, and C networks. The D-weighted network meets the requirements of the draft secretariat revision (Nov. 67) of ISO Recommendation 507 with a tolerance of ± 1 dB. Price: Add \$25.00.

02: range switch calibrated in dB SPL for microphones with a nominal sensitivity factor of 1.58 mV/ μ bar. No additional charge.

Price: Model 8052A, \$740 (\$650 at factory in West Germany). Model 8062A, \$795 (\$700 at factory in West Germany).

*The overall accuracy is the sum of the errors introduced by a change of range (± 0.1 dB), the deviation from linearity of the rms detector with meter reading in the upper 10 dB of the scale (± 0.2 dB), and the deviation from LINEAR frequency response in the RMS SLOW detection mode referred to a steady sine wave of 1 kHz. Deviation from linearity in the lower 10 dB of the scale which overlaps the adjacent range setting is 0.5 dB. These specifications are valid for the whole operating environment range.

**Noise adds to the signal approximately by the relation: Reading = $\sqrt{(\text{signal})^2 + (\text{noise})^2}$.

***The combination of HP 8052A or 8062A and one of the HP Condenser Microphones fulfills the requirements of IEC Recommendation 179 and the German Standard DIN 45633 for precision sound level meters and impulse sound level meters.

REAL-TIME AUDIO ANALYZER

Spectrum analysis in real time
Models 8054A, 8060A



ACOUSTICS

In a real-time measurement, data must be presented in usable form at essentially the same time the event occurs, and the delay in presenting the data must be small enough to allow a corrective action to be taken if required. An advantage of measuring in real time is that the effects of external adjustments or changes in measurement parameter can be seen immediately and acted upon if necessary.

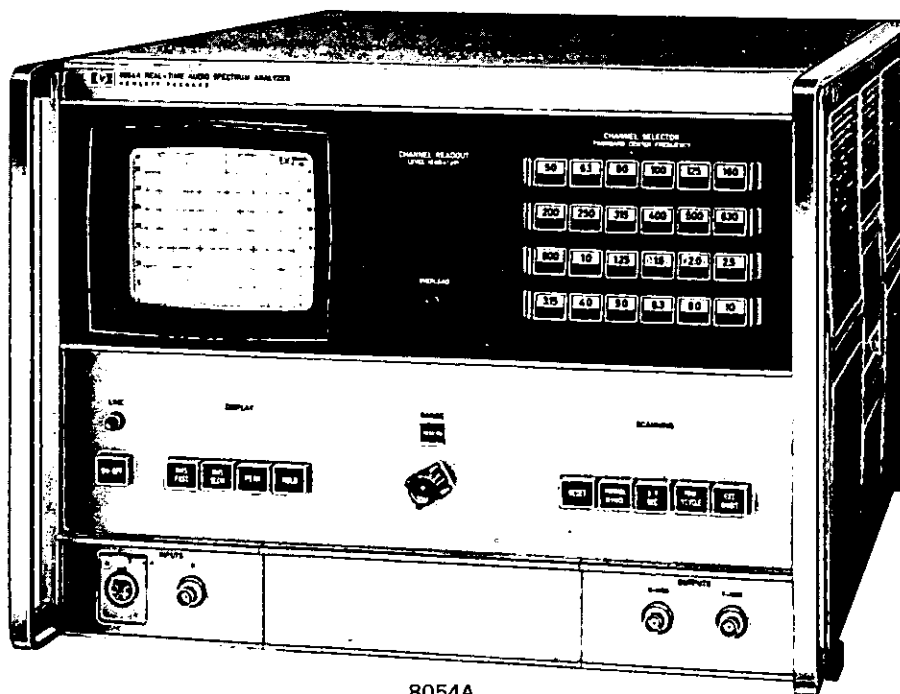
Measurements that previously took many hours to complete can now be performed in a few seconds with the Hewlett-Packard 8054A Real-Time Audio Spectrum Analyzer. Unlike other spectrum analyzers, which measure signal frequency components one at a time, the 8054A looks at twenty-four $\frac{1}{3}$ -octave frequency bands simultaneously, evaluates them in parallel, and displays the spectrum on a crt in less than 30 milliseconds, doing so at rates up to 42 spectra per second. The $\frac{1}{3}$ -octave bands have center frequencies from 50 Hz to 10 kHz in the standard instrument, other ranges are optional. The spectrum can be stored for detailed analysis, and a digital logarithmic voltmeter displays the signal levels in each channel. In addition to the visual displays, the 8054A can be connected to either analog or digital data processing instruments, giving it an unprecedented flexibility and speed in the processing of data.

The overall capability of the instrument permits measurements of signals as low as $1 \mu\text{V}$ and as high as 10 volts, an amplitude measurement range of 140 dB. The crt itself has a 40-dB display range which can be shifted in 10-dB steps to display any portion of the 140-dB amplitude range. The read-out is in dB above one microvolt or in dB of sound pressure

level when the input transducer is a condenser microphone with a sensitivity of $5 \text{ mV}/\mu\text{bar}$ (HP 15109B). The parallel filters, with a $\frac{1}{3}$ -octave bandwidth relative to their center frequency, have an attenuation at the center frequency of the adjacent filter of typically 20 dB and at twice and half the center frequency of typically 50 dB. All filters meet the requirements of international standards (IEC 225). One-third octave filters ranging from 2 Hz to 40 kHz are available.

The display modes are selected by the front-panel push buttons designated FAST, SLOW, PEAK, and HOLD. In the FAST position an integrating time constant of about 0.1 s is used in the rms detector for rapid measurement of fast changing signals. The SLOW position provides a 1-second time constant for more random signals which require a longer integrating time. These time constants are chosen in accordance with IEC Rec. 179. Other rms time constants between 100 ms and 100 seconds can be provided on special order. The rms detectors are accurate, fast-responding devices for continuous input signals with crest factors up to 5. The PEAK mode indicates and stores the maximum peak amplitude of the spectrum over a selected period. The HOLD mode can be used in the RMS FAST, RMS SLOW, or PEAK position. The spectrum display can be retained at any instant for more extensive analysis when the HOLD push button is pressed. A maximum RMS mode instead of true PEAK is available as a no-cost option.

The crt controls are conveniently located in the center of the front panel. A hinged door conceals these controls during operation to prevent any accidental misadjustments.



8054A

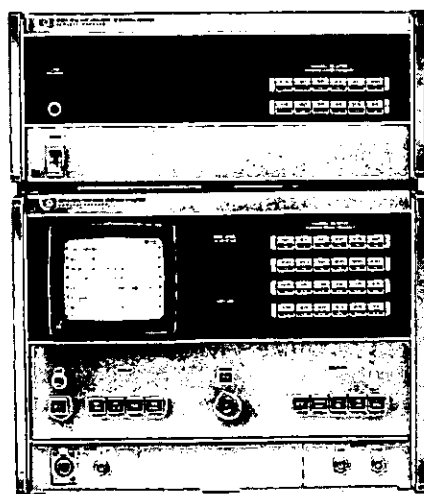
ACOUSTICAL INSTRUMENTATION *continued***Spectrum analysis in real time**

Models 8054A, 8060A

These controls adjust the horizontal and vertical position of the crt display as well as intensity, focus, and horizontal gain. No other calibration or adjustments are required.

Several scanning modes are possible to provide maximum versatility. In the MANUAL/REMOTE position any channel can be selected manually by front-panel push button or remotely by contact closure to ground. The DVM indicates the level of the signal in dB above 1 μ V for the selected channel. The X-Y RECORDER scanning mode is used in conjunction with the HOLD display mode to record the displayed spectrum on an X-Y recorder; the channels are scanned at a rate of 1 s/channel. The channel being scanned is always indicated by a brightened portion of the trace on the crt and by an illuminated push button corresponding to that channel. In the PRINT 1 CYCLE mode a digital recorder can be used to scan and print out just one spectrum. For continuous recording the EXTERNAL INHIBIT mode allows the digital recording device to operate up to a speed of 1 channel/msec. If the recorder or data processing device must accept data at a rate of less than 1 channel/msec, an inhibit signal from the recorder to the 8054A prevents new data from being taken during the recording cycle. For instance, with a 5050B Digital Recorder the maximum rate of recording is 20 lines or 20 channels per second, whereas the 8054A can provide data at a rate of 1000 channels per second.

The Hewlett-Packard 8060A Real-Time Analyzer Module provides a twelve-channel extension for the 8054A Real-Time Audio Spectrum Analyzer. The unit is self-contained and extends the frequency range by twelve additional $1/3$ -octave



8060A

filters, giving the 8054A a thirty-six-channel display covering all frequencies within 12 octaves.

Applications

The 8054A can analyze any phenomena occurring in the audio spectrum and will find uses in a number of scientific disciplines. It is especially well suited for analyzing airborne or solid-borne sound, vibration, and noise.

For measurements of airborne sound the 8054A has a microphone input which is calibrated for condenser microphones such as the HP 15109B 1" Microphone Assembly (Page 60) having a sensitivity of 5 mV/ μ bar. The 8054A supplies a 200 V polarization voltage to the condenser microphone, and microphone correction factors from -1 to $+4.5$ dB can be compensated in 0.5 dB steps by a rear panel switch. The HP 15119A $1/2$ " Microphone Assembly can also be used with the 8054A if the operator makes a 10 dB correction to all readings to compensate for the 1.58 mV/ μ bar sensitivity of the $1/2$ " microphone. The HP 15127A Cable Amplifier can be used with the HP 15119A Microphone Assembly to provide the 10 dB gain.

Using a vibration pick-up or accelerometer as the input transducer the 8054A becomes a real-time vibration analyzer for shock and vibration testing. The operational condition of machinery can be determined through such a vibration analysis. The 8054A can be a most useful quality control measurement tool to anyone who manufactures or maintains anything with moving parts. Thus, the 8054A finds many applications in the manufacture of automobiles, office equipment, industrial machines, and aircraft.

Since vibration causes the sensation of sound, the acoustical applications of the 8054A are often closely related to those applications in vibration analysis. Among the acoustical applications are aircraft noise analysis for determination of Effective Perceived Noise Level (EPNL), reverberation time measurements, frequency response testing of sound systems, determination of airborne and impact sound protection in architectural acoustics, and analysis of noise generated by industrial machines, automobiles, and jet engines. Underwater acoustical applications include studies of marine sounds and propagation. The 8054A is also a useful tool in speech analysis and in the manufacture of loudspeaker and Hi-Fi equipment. Waveform analysis and the characterization of earth tremors are other possible applications.

The major functions of the 8054A including display mode, range, scanning mode, and channel selection, can be selected remotely by contact closure or saturated npn transistor to ground. Thus the 8054A can be used in closed-loop data processing systems when used with HP Computers 2114A, 2115A, or 2116A. The 8054A easily fits into virtually any automated system whose input signal is in the audio range.

With the advent of the small digital computer it is now possible to carry both the Analyzer and a computer to the measurement site to obtain processed results as the measurements are made. The flat response of the 8054A makes it possible for the computer to apply a desired weighting factor to the data. The computer can also subtract background noise, make adjustments that account for barometric pressure or relative humidity, and perform other manipulations to give the data in the desired form within an instant of the experiment. See page 63.

Specifications, 8054A

ACOUSTICAL INSTRUMENTATION *continued*

Spectrum analysis in real time

Models 8054A, 8060A

Frequency range: refer to Table 1.

Filter characteristics: attenuation outside the passband

at $0.79f_0$ and $1.26f_0$ *: typically 20 dB

at $0.5f_0$ and $2f_0$: typically 50 dB

at $0.25f_0$ and $4f_0$: typically 70 dB

All filters meet the requirements of international standards (IEC225, USAS S1.11-1966 Class III, and DIN 45652).

* f_0 is the center frequency of the passband, $0.79f_0$ and $1.26f_0$ correspond to the center frequencies of the adjacent 1/3-octave filters.

Amplitude range: 0 to 140 dB above 1 μ V rms. (1 μ V rms to 10 V rms). The 40 dB dynamic range displayed on the crt can be shifted in 10 dB steps over the entire amplitude range. Peak noise < 15 dB for each channel, 50 Hz to 10 kHz.

Display modes

RMS slow and rms fast: dynamic characteristics of rms modes are as specified in IEC179. Other combinations of rms time constants between 100 milliseconds and 100 seconds with the following characteristics are available on special order. Sine wave tone burst with a length of twice the time constant indicates $-1 \text{ dB} \pm 1 \text{ dB}$ with respect to the steady sine wave level; sine wave tone burst with a length of half the time constant indicates $-4 \text{ dB} \pm 1 \text{ dB}$.

Peak: rise time of the peak detector is less than 4 milliseconds.

Hold: storage of the instantaneous crt display can be accomplished in any of the above modes by pressing the HOLD pushbutton. Display changes less than $\pm 1 \text{ dB/hr}$ at full scale, less than $\pm 1 \text{ dB/min}$ over the entire display range.

Displays

Digital display: four-digit Nixie readout of selected passband level in dB above 1 μ V. Resolution of 0.1 dB. The display is blanked for both overrange and under-range conditions.

CRT display: 40 dB display range, calibrated in dB (5 dB/div) with internal graticule. Range indicated. Two channels per horizontal division.

Display accuracy

Digital display: for steady sine wave signal at filter center frequency: $\pm 1 \text{ dB}$ in upper 30 dB of the selected range, $\pm 1.5 \text{ dB}$ in the lower 10 dB of the selected range.

CRT display: $\pm 1 \text{ dB}$ with respect to the digital display accuracy.

RMS detector accuracy: for tone burst signals with crest factors of less than or equal to 3: $\pm 1 \text{ dB}$ with respect to the steady sine wave indication. For signals with crest factors between 3 and 5: $\pm 1.5 \text{ dB}$ with respect to the steady sine wave indication. For random noise: $\pm 0.2 \text{ dB}$ with respect to the steady sine wave indication. The test signal is fed to the detector without any frequency weighting. For overall accuracy of the 8054A indications, filter characteristics such as response time and effective bandwidth must be taken into account.

Peak detector accuracy: the following characteristics apply to the peak detector when tone burst signals with a duration of at least 10 ms, or one signal period, whichever is greater, are applied. In the upper 30 dB of the selected

range: $+3 \text{ dB} \pm 1 \text{ dB}$ with respect to the steady sine wave rms indication. In the lower 10 dB of the selected range: $+3 \text{ dB} \pm 1.5 \text{ dB}$ with respect to the steady sine wave rms indication.

Scanning

Manual/remote: any channel can be selected manually by front-panel pushbutton, or remotely by contact closure to ground. The digital display indicates the band level, and the channel is identified by illuminating the relevant channel button and brightening the respective zone on the crt display.

X-Y recorder: automatic sequential scanning at a rate 1 channel/s of all 24 channels (36 channels with the 8060A) provides analog outputs suitable for processing by standard X-Y recorders. Scanning can be repeated by remote control.

Ext. inhibit: the rate of scanning is controlled by the hold-off signal (voltage greater than 10 V) from the digital recorder or the computer which is processing the BCD output. The scanning is sequential and continuous. A maximum scanning rate of 1 channel/ms can be achieved with a relatively fast computer.

Print 1 cycle: this mode is similar to EXT. INHIBIT, but only one sequential scanning of the 24/36 channels is completed. Scanning can be repeated by remote control.

Reset: X-axis and Y-axis outputs are grounded; digital outputs produce blanking signals.

Inputs

Input A: directly calibrated in dB of sound pressure level for microphones with a nominal sensitivity of 5 mV/ μ bar. Microphone correction factors from -1 dB to $+4.5 \text{ dB}$ can be compensated for in $0.5 \text{ dB} \pm 0.25 \text{ dB}$ steps by a rear-panel switch. A built-in power supply provides a $200 \text{ V} \pm 4 \text{ V}$ polarization voltage for condenser microphones and operating voltage for preamplifiers. Up to 12.5 mA can be supplied for the preamplifier and additional cable amplifiers. The input connector is a three-pin Cannon type XLR-3-31 audio connector. Input impedance is $> 100 \text{ k}\Omega$.

Input B: directly calibrated in dB above 1 μ V. BNC input connector. Input impedance is $> 100 \text{ k}\Omega$. The input amplifier has an overload capability of greater than 30 dB.

Maximum input: $\pm 150 \text{ V}$ dc and 50 V peak ac. A and B.

Outputs: all analog outputs, loading $\leq 1 \text{ nF}$ and $\geq 10 \text{ k}\Omega$.

Analog X-Y recorder:

X-axis 200 mV/channel $\pm 30 \text{ mV}$ total.

Output impedance: $< 20 \Omega$. BNC connector.

Y-axis 0 to 8 V full scale, calibrated in dB (200 mV/dB).

Output impedance: $< 20 \Omega$. BNC connector.

Pen lift: contact closure to operate "Pen".

Telephone jack.

Ext oscilloscope:

X: Linear ramp 0 to 8 V.

Output impedance: $< 20 \Omega$. BNC connector.

ACOUSTICAL INSTRUMENTATION *continued*

Spectrum analysis in real time
Models 8054A, 8060A

- Y: Pos. "Log" 200 mV/dB.
Pos. "Lin" 8 V full scale.
Output impedance: <20Ω. BNC connector.
- Z: Provides blanking pulse of +6 V open circuit, dc coupled.
Output impedance: <15 kΩ. BNC connector.

Auxiliary output: output of input amplifier.
Gain range: -40 dB to +60 dB in 10 dB steps.
Maximum output swing: 10 V_{pp}, accuracy ±0.2 dB.
Output impedance: <20Ω. BNC connector.

Digital outputs:
Connector type: Amphenol 57-40500 (50-pin).
Mating connector: Amphenol 57-30500.
Code: 1-2-4-8 BCD "1" state positive. "0" level: 0 V nominal; "1" level: +5 V open circuit, nominal.
Source impedance: 7.5 kΩ max each line.
Reference levels: ground; +5 V, low impedance.
Print command: step from 0 V to +6 V, dc coupled, 40 μs minimum duration, 5 V/μs minimum rise rate, source impedance: 100Ω maximum.
Hold-off requirement: voltage must be more than +10 V.

Input impedance: 62 kΩ.
Minimum indication: for band levels below selected range, blanked output.
Maximum indication: for band levels above selected range, indication is 400.0 dB.

Accuracy of digital outputs and Y-axis output: same as digital display.

Remote control: selection of range, channel, and display mode, made by contact closure or saturated NPN transistor to ground.

Environment: ambient temperature 0°C to 50°C and relative humidity to 95% at 40°C.
Power requirements: 115 V or 230 V, -15%, +10%, 50 Hz to 400 Hz, approximately 100 W.
Dimensions: 16¾" wide (425 mm), 12" high (306 mm) (without feet), 24¾" deep overall (619 mm).
Weight: 66 pounds.

- Accessories furnished**
- 200 sheets of Diagram Paper (08054-90100).
 - 10 sheets of Diagram Paper (08054-90101).
 - 1 15-pin Extender Board (5060-1744-6).
 - 1 18-pin Extender Board (5060-1746-6).
 - 1 Rack Mounting Kit (5060-0779).
 - 1 Connector Amphenol St-30500 (1251-0086).
 - 1 BNC Male to Binding Post Adapter (10110-60001).
 - 2 Pen-lift Connectors (Telephone Jacks) (1251-1020).
 - 2 BNC to Banana Cables (11001A).

- Price:** see Table 1.
- Option 001:** a maximum rms display mode (fast) replaces the normal peak mode. No charge.
- Option 101:** a maximum rms display mode (slow) replaces the normal peak mode. Plus \$100.
- Option 002:** analog-to-digital converter and digital display not included. Less \$600.
- Option 020:** special network for power density measurements (-3 dB/octave). Plus \$100.

Specifications, 8060A

Power requirements: 115 or 230 V, -15% +10%, 50 Hz to 400 Hz, approximately 47 VA.
Dimensions: 16¾" wide (425 mm), 7¼" high (185 mm) (without feet), 18¾" deep overall (476 mm).
Weight: net 26.5 lbs (12 kg); shipping 34 lbs (15.5 kg).
Price: see Table 1.
Accessories furnished: connector cable (08060-61604-6), 100 sheets of Diagram Paper (08054-90102).
Other specifications, where applicable, same as for Model 8054A.

TABLE 1. 8054A/60A Configuration Chart

STANDARD TIME CONSTANTS		2/20 s	1/10 s	1/10 s	0.5/5 s	0.5/5 s	0.2/2 s	0.2/2 s	RMS Fast and Slow as specified by IEC 179															
CENTER FREQUENCY OF THIRD-OCTAVE FILTER (TWO FILTERS PER P.C. BOARD)		2.5 Hz	4 Hz	6.3 Hz	10 Hz	16 Hz	25 Hz	40 Hz	63 Hz	100 Hz	160 Hz	250 Hz	400 Hz	630 Hz	1 kHz	1.6 kHz	2.5 kHz	4 kHz	6.3 kHz	10 kHz	16 kHz	25 kHz	40 kHz	
PRICES*		2 Hz	3.15 Hz	5 Hz	8 Hz	12.5 Hz	20 Hz	31.5 Hz	50 Hz	80 Hz	125 Hz	200 Hz	315 Hz	500 Hz	800 Hz	1.25 kHz	2 kHz	3.15 kHz	5 kHz	8 kHz	12.5 kHz	20 kHz	31.5 kHz	
8060A	8054A																							
\$3900-(3545)	\$9590-(8740)																							
\$4000-(3630)	\$9455-(8620)																							
\$4100-(3715)	\$9350-(8525)																							
\$4200-(3800)	\$9325-(8500)																							
\$4230-(3825)	\$9420-(8585)																							
	\$9485-(8645)																							
	\$9555-(8710)																							
	\$9660-(8805)																							
	\$9820-(8950)																							
	\$9870-(8995)																							
	\$10025-(9090)																							

*Prices in parentheses are prices in West Germany.

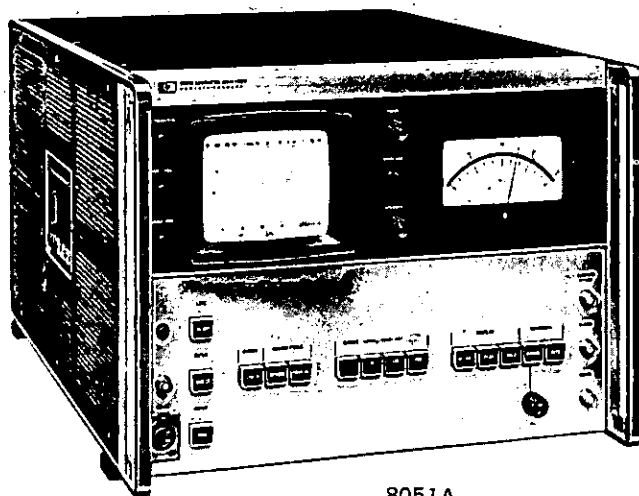
Standard configuration
Peak mode not available RMS MAX only

LOUDNESS ANALYZER

A powerful new tool for sound analysis
Model 8051A



ACOUSTICS



8051A



Until recently, much too little was known about how the ear translates sound pressure into loudness. Early sound level meters attempted to measure loudness by measuring the level of a frequency-weighted sound pressure. They gave good results for continuous narrow-band sounds but were often in error, by up to 20 dB for wide-band or impulsive sounds. Recent research has given us a much better understanding of how the human ear works. One result of this research is an instrument that responds to the loudness of sounds in very much the same way that the ear does.

The Hewlett-Packard 8051A Loudness Analyzer gives data which correspond closely to the subjective sensation of loudness. It does this by simulating the known characteristics of the human ear according to Zwicker's method, which is described in ISO Recommendation 532, Method B. The 8051A divides the audio range into approximately critical bands by use of filters with bandwidths of one-third octave or multiples thereof. The range between 45 Hz and 14 kHz is covered by 20 such filters, according to ISO Recommendation 532. The Analyzer works for wide-band or narrow-band, continuous or impulsive sounds. It can even handle single-shot sounds.

The Analyzer takes inputs from a microphone or a tape recorder and makes a continuous analysis of them. It displays the resulting Zwicker diagram (a plot of loudness density versus subjective pitch) on a crt showing how the loudness components in each of 20 frequency bands contribute to the total loudness. A new plot is made every 25 ms so that even transient sounds can be analyzed conveniently. Total loudness of a sound, that is, the integral of the Zwicker diagram, is also computed by the Analyzer and displayed on a meter.

The 8051A has four measurements ranges which accom-

modate sounds with loudnesses of 1 to 400 sones_G, equivalent to the loudness level of 40 to 127 phons_G. (The subscript G indicates that his loudness is calculated in terms of critical bands, not subjectively measured). This range includes sounds like those present in a 'quiet room' as well as very large sounds which can cause ear damage. Corrections for frontal or diffuse sound fields are made automatically by the Analyzer according to the settings of front-panel buttons.

How to measure short, impulsive sounds—like the sound of a stamping machine or a single typewriter stroke—has always been one of the most vexing problems in loudness measurement. Previously, the only way to analyze a single-shot phenomenon was to capture it on magnetic tape, make a tape loop and try to analyze the sound by playing it back over and over. With the new loudness analyzer, impulsive sounds are no longer a serious problem. The Analyzer has electronic storage circuits which can be called on to 'remember' the peak loudness of sounds occurring during any desired interval. If, as is usually the case, the single-shot sound is much louder than the background noise in the area, the loudness analysis stored by the Analyzer will be that of the short sound.

The 8051A can also be instructed to hold its most recent loudness analysis for several minutes. This allows the analysis of a changing sound to be frozen at any desired time and held long enough for it to be recorded or photographed. Both the hold and peak modes can be remotely controlled. Using the hold feature together with a built-in display scanner, the 8051A can make Zwicker plots automatically on an X-Y recorder. Sound pressure levels in each channel can be read from the special Zwicker recorder paper. An additional recorder output is provided for recording total loudness versus time.

Specifications

Loudness range: 1. sones_G - 400 sones_G (corresponding to 40 phons_G - 127 phons_G) in 4 ranges. Full-scale meter deflections: 12, 40, 120, and 400 sones_G . Corresponding sensitivity ranges of loudness density display: 0.12, 0.4, 1.2, and 4 ($\text{sones}_G/\text{Bark}$)/division.

Accuracy: deviation less than $\pm 5\%$ of full scale from the results obtained by Method B for Calculation of Loudness Level according to ISO Recommendation 532 (DIN 45631; BS4 198, 1967).

Noise: less than 0.3 sones_G in the most sensitive range for source resistances of 600 Ω or less.

Sound pressure level ranges: representative values of SPL for loudness and loudness density readings at 1 kHz (frontal field).

Range sones_G	SPL dB	Loudness Density divisions	Loudness sones_G
400	110	5.5 ± 0.3	128 ± 20
120	90	5.7 ± 0.3	32 ± 6
40	70	5.35 ± 0.3	8 ± 2
12	50	5.25 ± 0.3	2 ± 0.6

The maximum measurable SPL at 1 kHz is 114 dB. 0 dB = 2×10^{-4} μBar .

Microphone input: suitable for condenser microphones with a nominal sensitivity factor of 5 mV/ μBar . Microphone correction factors from -1 to +4.5 dB can be compensated in 0.5 dB steps by rear panel switch. A 200 V $\pm 2.5\%$ is provided as polarization voltage and to supply the microphone preamplifier and/or additional cable amplifiers.

Maximum current: 12 mA.

Input impedance: 100 k Ω .

Connector: Cannon XLR-3-3.

Direct input: accepts signals with 1 mV corresponding to a sound pressure level of 60 dB.

Input impedance: 100 k Ω .

Connector: BNC.

Filter specifications:

Channel	Relative Bandwidth	Center Frequency
1	octave	63 Hz
2	octave	125 Hz
3	two-third octave	224 Hz
4...20	one-third octave	315 Hz ... 12.5 kHz

The $\frac{1}{3}$ octave filters have an attenuation of about 20 dB in the center of the next pass band and about 60 dB at twice the center frequency. Roll-off of the octave filters is approximately 40 dB/octave. The filters exceed the requirements laid down in IEC Recommendation 225.

Diffuse field network: response as per ISO Recommendation 454.

Accuracy: 45 Hz - 4 kHz: ± 0.5 dB

5 kHz - 12.5 kHz: ± 1 dB.

Environment: ambient temperature from 32°F to 122°F (0°C to 50°C) and relative humidity to 95% at 104°F (40°C).

Outputs:

Meter: positive 4 V for full-scale deflection of the meter. Load resistance 1 k Ω or more.

X-axis: positive 10 V for full horizontal deflection of the sampling point on the crt.

Load resistance 1 k Ω or more.

Y-axis: positive 7 V for full vertical deflection of the sampling point on the crt.

Load resistance 1 k Ω .

Crt. sync: positive pulse to trigger external equipment coincident with the start of the internal sweep, about +6 V.

Crt. vertical: output waveform of vertical amplifier to drive external oscilloscopes or fast recorders. Positive 1 V/div. of the vertical deflection on the crt. Load resistance 1 k Ω or more.

Auxiliary output: output of preamplifier. The gain of the preamplifier depends on the range setting, for DIRECT input and FRONTAL sound field as follows:

Range - sones	Amplifier - Gain
400	-20 dB ± 0.5 dB
120	0 dB ± 0.5 dB
40	+20 dB ± 0.5 dB
12	+40 dB ± 0.5 dB

Display:

Instant: display of the instantaneous loudness spectrum on the crt and indication of the total loudness on the meter.

Peak: display of the maximum total loudness on the meter with the crt displaying the corresponding spectrum. Remote operation by contact closure.

Hold: storage of display on the crt and loudness reading on the meter. Less than 0.3 div. change of the crt display for up to 2 minutes of storage. Remote operation by contact closure.

Check: internal noise generator checks overall operation of the instrument.

Scanning: manual or automatic. Scanning time for the whole spectrum in the automatic mode is 90 seconds ± 30 seconds.

Overload: overload lamp glows if the crest factor of the signal in any channel exceeds 7 at full scale, or if any of the circuits are overdriven.

Power requirements: line voltage 110 V or 220 V, -10%, +15%, 50 Hz - 400 Hz.

Power consumption: approximately 80 W.

Dimensions: 16 $\frac{3}{4}$ " wide (425 mm), 12" high (306 mm) (without feet), 24 $\frac{3}{8}$ " deep overall (708 mm).

Weight: 64 lbs (29 kg).

Accessories supplied: detachable power cord with Schuko or NEMA plug.

200 sheets of Loudness Analysis Diagram (ISO Recommendation 532) covering each range in the frontal and diffuse sound field.

12 sones free field	P/No. 08051-90100
40 sones free field	P/No. 08051-90101
120 sones free field	P/No. 08051-90102
400 sones free field	P/No. 08051-90103
12 sones diffuse field	P/No. 08051-90104
40 sones diffuse field	P/No. 08051-90105
120 sones diffuse field	P/No. 08051-90106
400 sones diffuse field	P/No. 08051-90107
Rack mounting	5060-0779
15-pin extender board	5060-1744

Price: Model 8051A, \$5925 (\$5350 at factory in West Germany).

Manufactured in West Germany by Hewlett-Packard GmbH.

PRECISION NOISE GENERATOR

Pseudo-random pink and white noise

Model 8057A



ACOUSTICS

Description

The Hewlett-Packard 8057A Precision Noise Generator is an audio frequency noise generator producing pseudo-random signals, available at binary and Gaussian distribution outputs. These signals are repeated noise patterns of known content and duration. Both white and pink noise with an equal rms value can be selected by push buttons. By producing a defined rms value, the high stability of the output level allows the use of a directly calibrated attenuator with 0.1 dB resolution. This makes the 8057A a highly accurate noise source.

The basis of the 8057A is a clock-controlled binary waveform generator arranged so that the transitions between output levels can occur only on "beats" of an internal clock. Alternately, the waveform generator can be timed by an external clock of frequency up to 1 MHz. Hence, the bandwidth can be varied externally. A predictable noise pattern can be produced by applying a trigger to the gate input.

A shift register and a digital-to-analog converter together form a low-pass digital filter. This filtering mechanism converts the family of two-level outputs from the shift register into a multi-level signal having a Gaussian probability density function and a nearly rectangular power spectrum. Crest factors up to 3.5 give a remarkably close fit to the Gaussian distribution. The unique feature of the digital filter produces a bandwidth which is directly proportional to the clock frequency.

Outputs from the 8057A are available at a fixed amplitude of 10 volts (binary) and 3.126 volts rms (Gaussian). A precision step attenuator provides control of the Gaussian output in 0.1, 1, and 10 dB steps from 129.9 down to 20 dB above 1 μ V rms. Push buttons allow an output impedance selection of 50 or 600 Ω . A positive 2 μ s trigger pulse available from a rear-panel connector indicates the period of the noise pattern. Hewlett-Packard also manufactures Model 3722A Noise Generator.

Specifications

Gaussian output

White noise

Frequency spectrum: dc to 26 kHz (-3 dB point) (with external clock, upper frequency limit is equal to 1/20th of external clock frequency). Effective bandwidth: 27 kHz. Spectrum is flat within ± 0.3 dB up to 15 kHz and more than 25 dB down at 52 kHz.

Power density: 362×10^{-6} V²/Hz.

Crest factor: 3.5.

Probability density: near Gaussian.

Pink noise

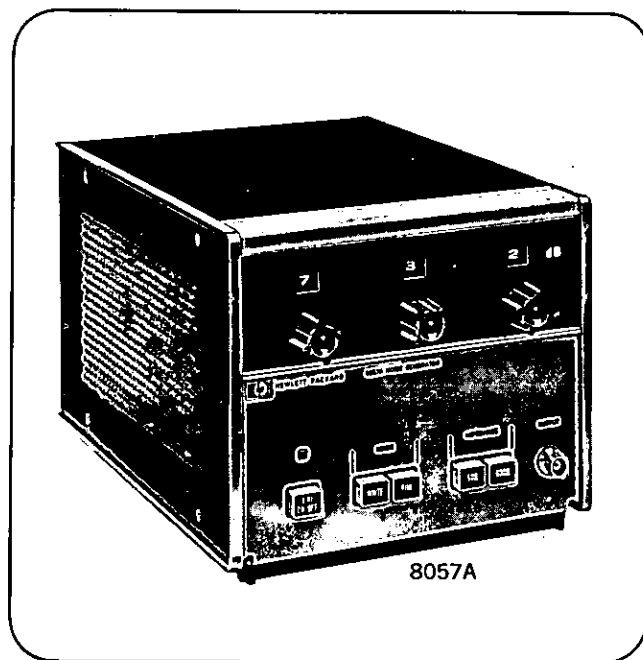
Frequency spectrum: 3 dB/octave decreasing from 2 Hz to 20 kHz. Accuracy: ± 0.5 dB up to 15 kHz; $+0$ dB, -1 dB at 20 kHz.

Crosspoint from white and pink noise frequency spectrum: 2.5 kHz.

Period of noise pattern: approx. 2 sec. (for external clock: 1 048 575 x clock period)

Amplitude (open circuit): 3.126 V rms or 129.9 dB above 1 μ V.

Amplitude attenuator: 0.1; 1 and 10 dB steps from 129.9 to 20 dB above 1 μ V. Overall attenuator accuracy: ± 0.5 dB.



Output impedance: 50 Ω or 600 Ω $\pm 3\%$.

Zero drift: $< \pm 30$ mV from 32° to 122°F (0° to 50°C).

Binary output

Output signal: pseudo-random binary sequence. Clock rate: 520 kHz (or external clock) Sequence length: 1 048 575 Bit.

Amplitude (open circuit): 10 V $\pm 10\%$.

Output impedance: approx. 600 Ω .

Rise, fall time: < 50 nsec.

Trigger output (Positive trigger pulse indicates period of the noise pattern).

Trigger pulse amplitude: approx. 10 V.

Output impedance: approx. 1 k Ω .

Trigger pulse width: 2 μ sec (or equal to clock period of external clock frequency).

External clock input: only for white noise output. (Pink noise should not be used with external clock. Overloading amplifiers distorts output).

Positive clock pulses: min. +2 V; max. +20 V amplitude.

Sine wave at least 4 V peak to peak.

Maximum clock rate: 1 MHz.

Minimum pulse width: 15 nsec.

Input impedance: approx. 1 k Ω .

Gate input: -1 V to $+2.8$ V or connected to ground disables Noise Output. (Gate input connected to ground: Output current approx. 2.5 mA). $+4.5$ V to 12 V or not connected enables Noise Output.

General:

Power: 115 V or 230 V $+10\%$, -15% , 50 Hz to 400 Hz, 14 VA.

Dimensions: standard HP $\frac{1}{2}$ module; 6" high, $7\frac{3}{4}$ " wide, 11" deep (155 x 190 x 279 mm).

Weight: net 6 $\frac{1}{2}$ lb (3.25 kg), shipping 8 lb (4 kg).

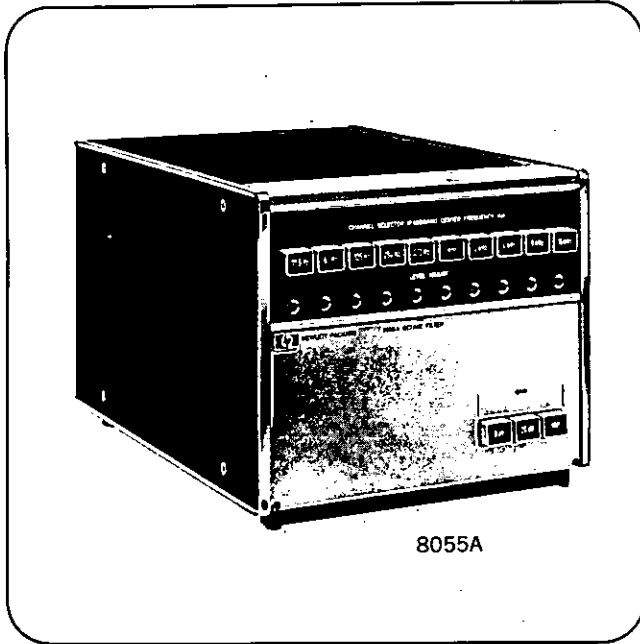
Price: 8057A, \$800 (\$725 at factory in West Germany).

Option 01: without attenuator, subtract \$100.



FILTER SETS

Low cost, easy to use
Models 8055A, 8056A



8055A

8055A Filter Set

The HP Model 8055A is furnished with eight octave filters, center frequencies from 63 Hz to 8 kHz in the standard version. However, two additional filters with center frequencies of 31.5 Hz and 16 kHz may be added to extend the measurement range (Option 001). Alternatively, the 16 kHz filter may be replaced by a D-weighted broadband network (Option 002). An Impulse Sound Level Meter (see page 49) and an Option 002 Filter Set in a 1051A Combining Case thus make an extremely versatile combination, permitting A, B, C and D-weighted broadband measurements, and octave analysis from 31.5 Hz to 8 kHz (the

frequency range required for a US Standard Type E octave band filter set).

Selection of individual filter outputs and bandpass gain is by pushbutton. Three gain modes are available: 0 dB, 20 dB and Variable. In the Variable mode, the gain of each passband may be set independently from -20 dB to +20 dB by screwdriver adjustment. Thus any weighting curve may be preset for a specific measurement, while still permitting general measurements in the 0 dB and 20 dB modes without disturbing the special calibration. A useful variation in this connection is Option 003, which has a summing amplifier in channel 10 for the outputs of the remaining 9 filters (31.5 Hz to 8 kHz). The result is a very compact spectrum shaping device when used in the Variable mode.

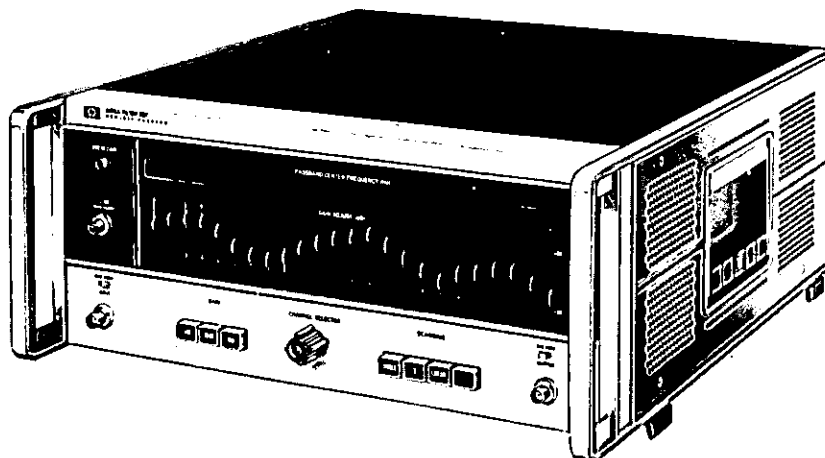
A slide switch on the rear panel of the 8055A permits switching to a "parallel" mode, in which the parallel filter outputs are made available at a 24-pin connector and a set of BNC connectors.

8056A Filter Set

The Model 8056A Filter Set comprises twenty-four $\frac{1}{3}$ -octave filters with center frequencies in the range 2 Hz to 40 kHz. (The standard version covers the range from 50 Hz to 10 kHz). Filter characteristics are in accordance with IEC Recommendation 225, US Standard S1.11 Class III, and DIN 45632. In addition, octave filters and broadband weighting networks (A, B, C, D) are available on special order.

Its three modes of operation enable the instrument to function as an audio-frequency analyzer, as a spectrum shaper or a straight-forward fixed-gain amplifier.

In the SINGLE mode of operation, the output of any one of the 24 filters may be selected by means of a rotary switch. The passband center frequency is indicated on a



8056A

display strip. Gain may be fixed at 0 dB or 20 dB, or varied from -20 dB to +20 dB continuously. Use of a suitable indicating instrument such as the HP Model 8052A Impulse Sound Level Meter permits a manual spectrum analysis.

In the Σ mode, the outputs of all the filters are summed. The same choice of gain (0 dB, 20 dB or Variable) is available in this mode, the last of these being an extremely useful tool for spectrum shaping. Uses range from compensation of unfavorable transducer responses to complete or partial suppression of any number of signal components. The passband gain of each channel is adjusted by front-panel thumbwheels—the physical position of the thumbwheels giving an approximate view of the overall transmission characteristics

of the instrument. A rack-and-pinion-type reduction gearing in the thumbwheel mechanism lengthens the effective slide-wire travel by a factor of three, with a corresponding improvement in the resolution.

The LIN mode converts the instrument to a fixed-gain amplifier with either 0 dB or 20 dB gain—a useful fringe benefit. The choice of input and output impedances is particularly useful in this mode, for impedance matching.

In all three modes of operation, the parallel filter outputs are available at a rear-panel connector for external scanning. Another connector provides access to the internal summing point, making possible parallel operation of several 8056A's, to widen the frequency range.

Specifications

8055A

Frequency range: eight octave filters with center frequencies from 63 Hz to 8 kHz.

Filter characteristics

Passband uniformity: peak-to-valley ripple < 1.5 dB.

Attenuation outside the passband: one octave from center frequency: approx 23 dB. Two octaves from center frequency: approx 47 dB. Three octaves from center frequency: approx 65 dB.

All filters satisfy the requirements of IEC Recommendation 225, US Standard S1.11 - 1966 Class II, and DIN 45651.

Voltage gain (at center frequency): 0 dB \pm 0.5 dB, +20 dB \pm 0.5 dB, or Variable. In the Variable mode, passband gain of each filter is individually adjustable between -20 dB and +20 dB.

Maximum input signal: 15 V p-p.

Maximum permissible input: ac, 50 V peak; dc 200 V.

Signal/noise ratio: > 70 dB referred to 3 V rms output.

Filter selection: singly by front-panel pushbutton. Separate outputs for each filter available for parallel operation.

Input impedance: 100 k Ω .

Chassis isolation: chassis isolated from cabinet by > 100 M Ω .

Output impedance: < 20 Ω ; load resistance > 10k.

Operating environment: 14°F to 122°F (-10°C to 50°C); relative humidity up to 95% at 104°F (40°C).

Power requirements: +12 V (-0.5, +3 V) and -12 V (+0.5, -3 V) referred to the common terminal; 20 mA (80 mA in parallel filter operation). Power can be supplied via rear-panel binding posts or multi-pin connector; power furnished by 8052A or 8062A when connected by supplied cable.

Dimensions: standard Hewlett-Packard 1/2 module, 7 3/4" wide, 6 1/8" high, 11" deep (190 x 155 x 279 mm). Add 7/16" (11 mm) to height to include feet.

Weight: 7 lbs (3,2 kg) net; 9 lbs (4 kg) shipping.

Furnished: 8" (20 cm) cable assembly for direct connection to 8052A or 8062A.

Price: \$600 (\$525 at factory in W. Germany).

Options:

001: Furnished with two additional octave filters, center frequencies 31.5 Hz and 16 kHz. Add \$100.

002: Furnished with one additional octave filter, center frequency 31.5 Hz, and one broadband filter with D-weighted frequency response. Add \$100.

003: Furnished with one additional octave filter, center frequency 31.5 Hz, and one amplifier section for summing the outputs of remaining nine octave filters. Individual outputs still available. Add \$100.

8056A

Frequency range: 50 Hz to 10 kHz, covered by twenty-four 1/3-octave filters. Filters available from 2 Hz to 40 kHz.

Filter characteristics: meet requirements of IEC 225, US Standard S1.11, Class III and DIN 45652. Attenuation outside the passband,

at $0.79f_0^*$ and $1.26f_0$: typically 20 dB

at $0.5f_0$ and $2f_0$: typically 50 dB

at $0.25f_0$ and $4f_0$: typically 70 dB

Passband uniformity: peak-to-valley ripple < 0.5 dB.

Modes of operation: SINGLE, SUM (Σ) and LINEAR.

Signal/noise ratio: in SINGLE, > 75 dB referred to 3 V rms output; in Σ , > 65 dB referred to 3 V rms output; in LIN, > 65 dB referred to 3 V rms output.

Gain modes: fixed 0 dB \pm 0.5 dB and +20 \pm 0.5 dB; variable from -20 dB to +20 dB, resolution better than 0.5 dB.

Maximum operational input: 9 V p-p (0 dB mode).

Maximum permissible input: dc + ac peak 250 V for 100 k Ω input; dc + ac peak 50 V for 600 Ω input.

Input impedance: selectable 600 Ω , 100 k Ω .

Maximum summing input signal: 3 V rms.

Maximum output: 9 V p-p without load.

Output impedance: selectable 50 Ω , 600 Ω .

Maximum load: resistance \geq 600 Ω ; capacitance \leq 1 nF.

Overload indicator: overload lamp lights up if either pre-amplifier or output amplifier is overloaded. Circuit responds to overload peaks \geq 100 μ s. Duration of indication is 100 ms.

Operating environment: 14°F to 122°F (-10°C to +50°C); relative humidity up to 95% at 104°F (+40°C).

Power requirements: 115/230 V ac, +10%, -15%, 21 W (30 W in Σ).

Line frequency: 50 to 400 Hz.

Weight: net 28.5 bs (13 kg); shipping 36 bs (16,5 kg).

Dimensions: 16 3/4" wide, 7 1/4" high, 18 3/4" deep (426 x 185 x 576 mm).

Price: standard instrument \$2025 (\$1800 at factory in W. Germany). Prices of 10 frequency range options covering from 2 Hz to 40 kHz on request.

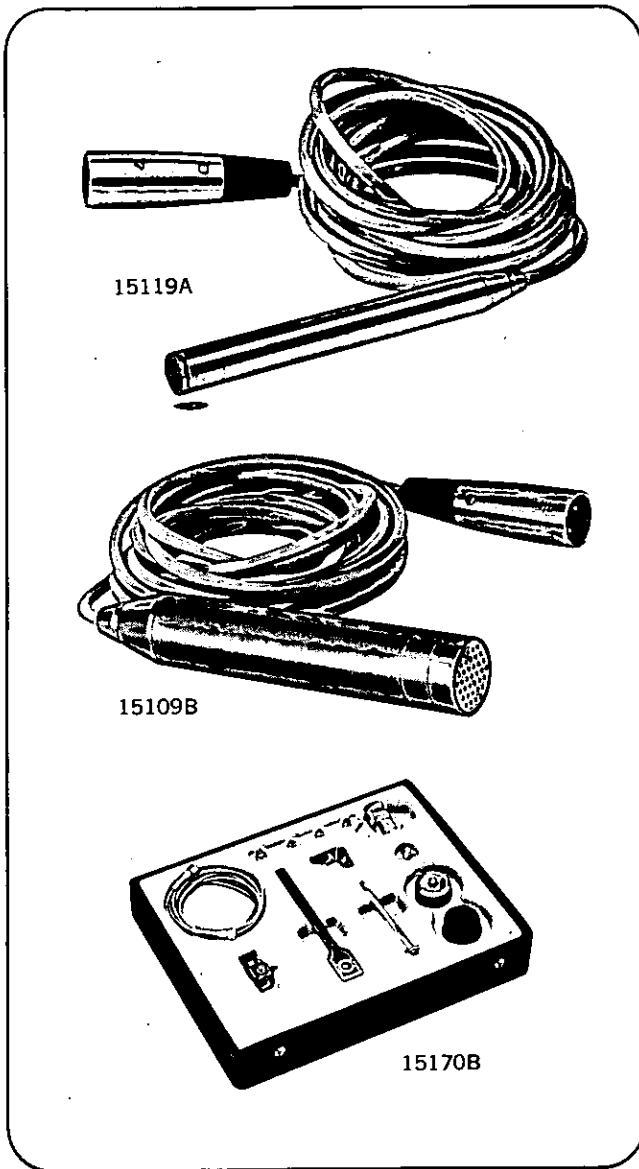
* f_0 is the center frequency of the passband.



TRANSDUCERS, ACCESSORIES

High quality pick-ups for sound and vibration

Models 15119A, 15109B, 15170A, 15114A, 15127A, 15117A



15119A and 15109B Microphone Assemblies

The Hewlett-Packard 15119A 1/2-in. Condenser Microphone Assembly, consisting of cartridge, preamplifier, and 10-foot cable, is a precision tool for making critical acoustic measurements. Its frequency response for a plane frontal sound field is flat within 1 dB over the range from 20 Hz to 20 kHz. Because of its omnidirectional properties, the 15119A can be used to investigate diffuse as well as directional sound fields. Its small dimensions ensure a virtually negligible disturbance of the sound field by the microphone itself—a prerequisite for accuracy at higher frequencies. Thus full advantage can be taken of the flat response.

Hewlett-Packard also offers a 1-in. Condenser Microphone Assembly (Model 15109B), for measuring extremely low sound levels. A full 10 dB more sensitive than the 15119A, the 15109B otherwise has similar characteristics.

An important feature of both the 1-in. and 1/2-in. microphone cartridges is the built-in electrostatic actuator. This device greatly simplifies microphone calibration since the protective face plate need not be removed and the diaphragm, exposed to possible damage. In addition, simpler external equipment can be used to drive the built-in actuator.

15118A and 15108B Preamplifiers

Both the 1/2-in. and 1-in. Microphone Assemblies are sold without cartridges, i.e. as preamplifier and cable only, under model numbers 15118A and 15108B respectively. These preamplifiers are all solid state with source-follower FET input stages. Input impedance is greater than 1000 M Ω shunted by less than 2 pF. In addition, the frequency response for both preamps is flat to within 0.25 dB from 5 Hz to 200 kHz. They have an extremely low noise figure and are free from microphonics.

With essentially unity gain, these preamplifiers make excellent broadband audio impedance converters and isolators, and are ideal preamplifiers for vibration pick-ups such as the HP Model 15170A. BNC adapters supplied with the preamps provide convenient input connections and increase the input shunting capacitance to only 4 pF. Operating voltage for the preamplifiers is derived from the same power supply which provides the polarization voltage (+200 V) required by the microphone cartridge. All Hewlett-Packard acoustic measurement instruments have appropriate microphone input connectors which supply the 200 V.

15170A Piezoelectric Accelerometer

The Model 15170A Accelerometer is suitable for most commonly-encountered vibration measurements. The device is particularly well-suited for high accelerations and shocks. Its light aluminum body is capable of withstanding severe environmental conditions, and the side-mounted electrical output and relative flatness of the body permit mounting in difficult-to-reach areas. An additional attraction is the internally-calibrated sensitivity of 10 mV/g.

The 15170A is intended primarily for use with the HP Model 15118A Preamplifier. The output of the preamp may be fed directly into any of the Sound Level Meters and the Spectrum Analyzer, and, with the 15114A Power Supply, into either the 8055A or 8056A Filter Sets. Thus broadband analyses such as peak and rms measurements, and octave or 1/3-octave measurements may be performed.

The Accelerometer is delivered in a case complete with a light metal probe, insulation flange, fastening screws, magnetic clamp, adhesive wax, cable with BNC adapter and cable holder.

15114A Microphone Power Supply

The 15114A Power Supply permits the use of Hewlett-Packard Microphone Assemblies and Preamplifiers with in-

struments which do not provide the necessary voltage or connector. The microphone preamplifier cable connects directly to the supply, and the audio signal is available from a BNC connector.

The 15114A is a truly portable unit, operating for at least eight hours from four standard 1.5 volt cells. Price: Model 15114A, \$140 (\$130 at factory in W. Germany).

15127A Cable Amplifier

The 15127A Cable Amplifier permits Hewlett-Packard Microphone Assemblies and Preamplifiers to be operated at greater distances from associated equipment. A single 15127A can drive up to 330 feet (100 meters) of cable (even more if a reduction in the upper frequency limit and/or maximum output is permissible). Operating power is obtained from the microphone supply (+200 V), so the number of 15127A's which can be cascaded is limited only by the ability of the power supply to furnish the required current. The standard 15127A has 0 dB gain, Option 001 has 10 dB gain. The gain may be changed by a simple wiring change.

The Model 15127A is particularly useful with less portable instrumentation such as the HP 8051A Loudness Analyzer and 8054A Real-Time Audio Spectrum Analyzer. Both these instruments can supply enough current from their microphone power supplies to feed a Cable Amplifier. The Option 001 15127A also restores the direct display calibration of these instruments when used with the 10 dB less sensitive 1/2-in. microphone. Price: Model 15127A, \$90.

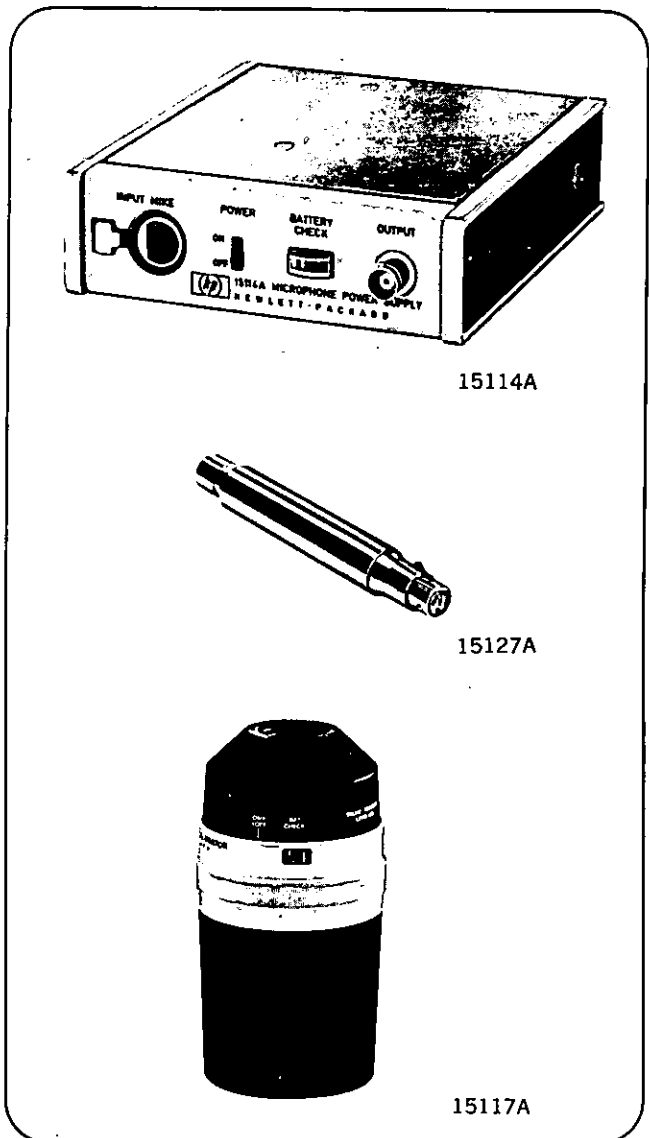
15117A Sound Level Calibrator

The 15117A is a precision acoustic signal source for field calibration of acoustic instrumentation which uses Hewlett-Packard 1-in. or 1/2-in. microphones. Suitable adapters to accommodate other manufacturers' microphones will be made available on special order.

The Model 15117A uses a special loudspeaker driven by a stabilized solid-state oscillator. This permits the use of a higher frequency (1000 Hz) than is possible with a mechanically-actuated pistonphone. The instrument generates sound pressure levels of 94, 104, 114 and 124 dB referred to 2×10^{-5} N/m² with an accuracy of ± 0.3 dB in a coupler which fits over the microphone cartridge.

Since the frequency of calibration is 1000 Hz, the equipment under test will give the same reading regardless of whether the level is A-, B-, C-, or D-weighted, or is linear, in fact, the Calibrator may be used to check the deviation of these weighting networks at 1000 Hz.

Direct calibration of sound-measuring equipment without using a microphone is also possible with the 15117A, since the 1000 Hz electrical signal is available from a telephone jack in the side of the instrument. This source provides 1 volt rms (120 dB above 1 μ V) into an open circuit, with an accuracy of ± 0.1 dB, independent of the acoustic signal level setting. With the selector switch in the OFF position, signals fed into the telephone jack from an external oscillator are applied directly to the loudspeaker, allowing higher sound pressure levels and different frequencies to be generated in the coupler. A convenient battery check meter indicates the state of the batteries under maximum load conditions.



15114A

15127A

15117A

15124A, 15125A Insert Voltage Adapters

For the 1-in. and 1/2-in. Microphone Assemblies respectively, these adapters permit determination of microphone cartridge open-circuit voltage for calibration purposes. Price: \$50.

15142A, 15134A Capacitive Terminations

For the 1-in. and 1/2-in. Microphone Assemblies respectively, these capacitive loads permit measurement of noise under operating conditions. Price: \$12.50.

1000-0501 Tripod

Support to keep microphone away from bulky objects such as measuring instrumentation which interferes with the sound field. Price: \$35.

Specifications

15119A

Sensitivity (nominal): 15.8 mV/Nm⁻² (individual calibration supplied).

Frequency response: free field (frontal incident), ± 1 dB from 20 Hz to 25 kHz.

Maximum deviation from free field for diffuse field: -1 dB up to 3 kHz; -2 dB up to 5 kHz; -4 dB up to 10 kHz; -6 dB up to 20 kHz.

Dynamic range (from equivalent A-weighted noise level to 3% harmonic distortion): 30 to 150 dB above 2×10^{-5} Nm^{-2} .

Temperature coefficient: ≤ 0.01 dB/ $^{\circ}\text{C}$ (0.006 dB/ $^{\circ}\text{F}$) change in sensitivity, -10 to $+50^{\circ}\text{C}$ (14 to 122°F).

Effect of atmospheric pressure: ± 0.1 dB for 10% change in ambient pressure from 1 atm.

Power requirements: $+200$ V ± 5 V, < 5 mV ripple, 2.5 mA max.

Dimensions: 0.50" (12.7 mm) diameter, approx $5\frac{1}{8}$ " (130 mm) long.

Weight: net 1 lb (0.45 kg); shipping 3 lbs (1.4 kg).

Environment: -10 to $+50^{\circ}\text{C}$ (14 to 122°F) relative humidity up to 95% at $+40^{\circ}\text{C}$ (104°F).

Accessories furnished: 1000 pF input adapter, tripod mounting adapter.

Price: Model 15119A, \$275 (\$250 at factory in W. Germany).

15109B

Sensitivity (nominal): 50 mV/ Nm^{-2} (individual calibration supplied).

Frequency response: free field (frontal incident), ± 1.5 dB from 20 Hz to 16 kHz; $+0$, -3 dB from 16 kHz to 18 kHz.

Maximum deviation from free field for diffuse field: -1 dB up to 1.5 kHz; -2 dB up to 3 kHz; -4 dB up to 6 kHz; -6 dB up to 9 kHz.

Dynamic range (from equivalent A-weighted noise level to 3% harmonic distortion): 17 to 140 dB above 2×10^{-5} Nm^{-2} .

Temperature coefficient: ≤ 0.01 dB/ $^{\circ}\text{C}$ (0.006 dB/ $^{\circ}\text{F}$) change in sensitivity, -10 to $+50^{\circ}\text{C}$ (14 to 122°F).

Effect of atmospheric pressure: $< \pm 0.2$ dB for 10% change in ambient pressure from 1 atm.

Power requirements: $+200$ V ± 5 V, < 5 mV ripple, 2.5 mA max.

Dimensions: 0.95" (23.8 mm) diameter, approx $5\frac{1}{4}$ " (135 mm) long.

Weight: net $1\frac{1}{2}$ lb (0.65 kg); shipping 4 lbs (1.8 kg).

Environment: -10 to $+50^{\circ}\text{C}$ (14 to 122°F), relative humidity up to 95% at 40°C (104°F).

Accessories furnished: 1000 pF input adapter, tripod mounting adapter.

Price: Model 15109B, \$270 (\$250 at factory in W. Germany).

15118A, 15108B

Gain (at 1 kHz with input adapter attached): 0 dB $+0$, -0.25 dB.

Frequency response (with input adapter attached): with nominal load and 1 V rms maximum output, ± 0.25 dB from 5 Hz to 200 kHz; with nominal load and 10 V rms maximum output, ± 0.25 dB from 5 Hz to 20 kHz.

Maximum input: 10 V rms (sine wave).

Dynamic range (from equivalent A-weighted noise level to 1% distortion)

15108B: 17 to 140 dB above $1 \mu\text{V}$.

15118A: 20 to 140 dB above $1 \mu\text{V}$.

Noise (A-weighted)

15108B: $< 7 \mu\text{V}$ rms with 68 pF across input.

15118A: $< 10 \mu\text{V}$ rms with 27 pF across input.

Input impedance: > 1000 $\text{M}\Omega$ shunted by < 2 pF without input adapter, < 4 pF with input adapter.

Output impedance (at 1 kHz): $< 100\Omega$.

Nominal load: 100 $\text{k}\Omega$ shunted by 500 pF.

Maximum output current: 0.6 mA.

Power requirements: $+200$ V ± 5 V, < 5 mV ripple, 2.5 mA max.

Environment: -10 to $+50^{\circ}\text{C}$ (14 to 122°F), relative humidity up to 95% at 40°C (104°F).

Dimensions

15108B: 0.95" (23.8 mm) diameter, $4\frac{3}{4}$ " (120 mm) long.

15118A: 0.5" (12.7 mm) diameter, $4\frac{3}{4}$ " (120 mm) long.

Weight

15108B: net $1\frac{1}{2}$ lb (0.65 kg); shipping 4 lbs (1.8 kg).

15118A: net 1 lb (0.45 kg); shipping 3 lbs (1.4 kg).

Price:

15108B: \$140 (\$130 at factory in W. Germany).

15118A: \$145 (\$130 at factory in W. Germany).

15170A

Voltage sensitivity with 1.5 m cable: 10 mV/g $\pm 3\%$.

Insulation resistance: > 1000 $\text{M}\Omega$.

Capacitance with 1.5 m cable: approx 1000 pF.*

Resonance frequency when bonded to 20 mm dia. x 10 mm steel mass: approx 45 kHz.*

Frequency range when working into 100 $\text{M}\Omega$: 5 Hz to 10 kHz.

Frequency response: 50 Hz to 500 Hz, $\pm 2\%$.
5 Hz to 10 kHz, $\pm 5\%$

Minimum measurable acceleration: 0.004 g rms at min output voltage of 40 μV .

Maximum measurable sinusoidal acceleration: 5000 g.

Maximum transverse sensitivity: approx 3% of main-axis sensitivity.*

Magnetic sensitivity: 1 to 2 $\mu\text{V}/\text{Gauss}$.

Acoustic sensitivity: 2 $\mu\text{V}/\text{Nm}^{-2}$.

Operating temperature range: -50 to $+85^{\circ}\text{C}$ (-48 to 176°F); -50 to $+250^{\circ}\text{C}$ (-48 to 482°F) with special cable.

Body: aluminum.

Weight: 10 grams.

Price: \$140 (\$130 at factory in W. Germany).

*Exact values given on individual calibration charts.

15117A

Acoustic output: sound pressure levels of 94, 104, 114 and 124 dB referred to 2×10^{-5} Nm^{-2} ; accuracy ± 0.3 dB; frequency 1 kHz $\pm 2\%$.

Electrical output: 1 V rms (120 dB above $1 \mu\text{V}$) open circuit voltage; accuracy ± 0.1 dB; frequency 1 kHz $\pm 2\%$; distortion less than 0.3%; output impedance $600\Omega \pm 1\%$.

Operating environment: -10 to $+50^{\circ}\text{C}$ (14 to 122°F); relative humidity up to 95% at 40°C (104°F).

Power requirements: 11.5 to 13.5 V dc, current up to 6 mA, depending on S.P.L. (two Mallory TR115 batteries).

Dimensions: height 4.95" (126 mm), max dia 2.65" (67 mm).

Weight: with batteries 1.45 lb (0.66 kg) net.

Price: \$275 (\$250 at factory in W. Germany).

AUDIO DATA PROCESSOR

Short- and long-term processing in real time
Model 80501A



ACOUSTICS

The HP 80501A Audio Data Processor is the most powerful and flexible system available for making nearly any kind of audio measurement. Basically a combination of a digital computer (HP Model 2114A) and a third-octave analyzer (HP Model 8054A), the system is easily adapted to changes in investigation techniques and/or standards. By nature of the varying requirements, virtually no two Processors are identical—each is tailor-made to the user's application. In spite of this, the system is made up entirely of Hewlett-Packard catalog instruments, with the resulting advantages of uniform interface conditions and a single service contractor.

In its simplest form, the system consists of only teleprinter, for program input and data output, computer and analyzer. A high-speed punched tape reader and a high-speed tape punch can be added to increase the input and output rates (this configuration is shown in Figure 1). Additional peripherals such as incremental magnetic tape, X-Y plotter, crt display and so forth, can be readily incorporated in the system since each peripheral is connected to the computer through a standard interface card.

Communication between the analyzer and the computer is bidirectional, i.e. $\frac{1}{3}$ -octave band-level information flows from the analyzer to the computer, and ranging instructions are issued by the computer and executed via a duplex register. Autoranging is incorporated in the software by treating it as a subroutine in a main program. In essence the computer scans the 24 channels of the 8054A (36 with the 8060A Module), finds the maximum band pressure level, compares it with the upper and lower limits in the current range, and then makes one of the following decisions: no change in range, change to the next more sensitive range, change to the next less sensitive range.

The Model 8054A can measure and deliver band levels at a rapid rate (see page 51). One way to record this information is to use a printer. With the HP Model 5050B Digital Printer, 24 band levels can be printed out in 1.2 seconds (using the storage option, this time can be halved). A much higher data transfer rate is obtained by using the combination of analyzer and computer, taking advantage of the computer's fast memory. Two hundred scans (of 24 levels) can be dumped in an 8K computer at the rate of 10 scans per second, and the information can later be punched out on paper tape. The punched tapes can be retained as records—a must if the signals are to be processed according to several different procedures.

Applications

An important application of the system is in long-term integration calculations. In the analyzer, band levels are obtained by using quasi-rms detectors. These are entirely adequate for measurements with small time constants (the standard 8054A uses 100 ms in the "RMS Fast" mode). However, for long-term integration (i.e., long-term rms evaluation or long-term averaging), a digital approach may be more suitable. Consider for example the problem of forming, in real-time, the long-term effective value in each third-octave channel, over a period of seconds, minutes,

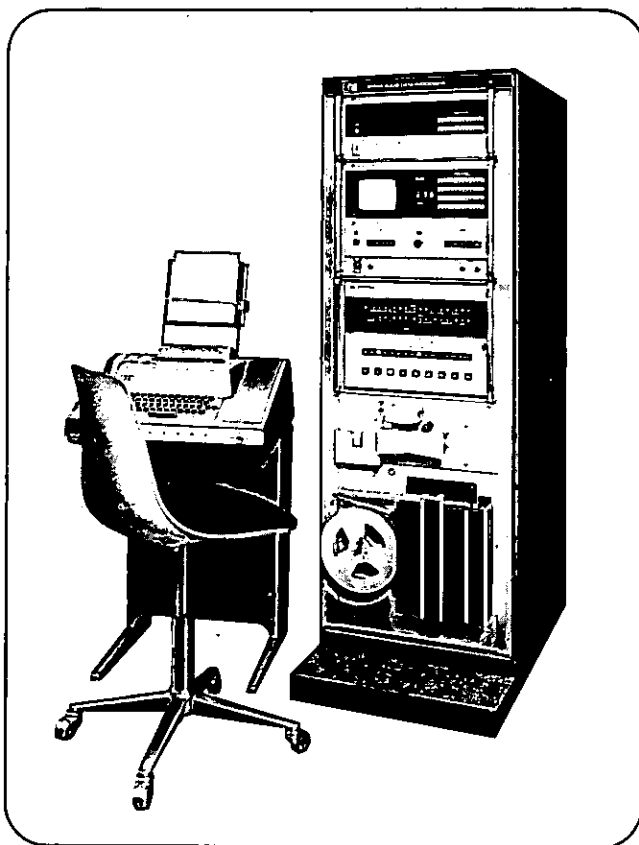


Figure 1. Model 80501A

hours, days, or more. By definition, the effective value V_{eff} of a signal $V(t)$ over an interval T is given by:

$$V_{\text{eff}} = \left(\frac{1}{T} \int_0^T V^2(t) dt \right)^{1/2}$$

Replacing the signal $V(t)$ by instantaneous samples of its level L_i in dB, it can be shown that the long-term level \bar{L} is given by:

$$\bar{L} \approx 10 \log_{10} \left(\frac{1}{T} \sum_{i=1}^n 10^{0.1 L_i} \Delta t \right)$$

where $T = n \Delta t$.

The speed with which this expression will be computed depends mainly on the speed of the exponential routine. Assuming an average time of 8 ms, about 0.2 second is required just to calculate the exponentials for the 24 band levels. It will then be impossible to attain a scanning rate of 10 scans/second. However, there is another approach to the problem. Band levels from the analyzer lie between 0.1 and 140.0 dB. With a resolution of 0.1 dB, there are 1400 different band levels that could be read. Exponentials for these levels can be computed once and then stored in an array. Now the repetitive operations are simply fetching and adding. Dividing and extracting logarithms will only be required just before printing the results. The fetch and add

Short- and long-term processing in real time Model 80501A

operations can easily be performed between band level readings. In fact, the channels may be extended to 36, without reducing the scanning rate of 10 spectra/second. Using the switch register on the front panel of the computer, many variations of the procedure can be programmed. For example, a program may be written so that long-term integration is interrupted and the computed level printed out when the operator actuates a predetermined switch on the switch register.

Other extremely complex calculations which may be performed along similar real-time lines are the calculation of Loudness Level according to Stevens, Perceived Noise Level according to Kryter (see below), power density calculations, and statistical manipulations.

Fields in which the possibilities of the 80501A System are only beginning to be realized include pattern and speech recognition studies. The Processor can analyze sound patterns produced by engines and other noise- and vibration-producing machinery, and compare the measured spectra with stored spectra in the computer memory. The system might thus diagnose faults and/or inform personnel of the operational condition of any given machinery.

There is also great potential for the system in the field of speech analysis. Figure 2 shows two patterns generated by the system, both of which represent the word "eight" as spoken by different people. The third dimension (amplitude) is represented by the numbers 1 through 5. The similarity of the two patterns is striking, and the system has little difficulty in identifying the spoken digit.

Aircraft Noise

The two main approaches to this problem being used at the moment are the development of standards for aircraft

noise performance, and the design of special flight patterns and techniques, consistent with safety requirements, to reduce the noise level from existing planes at existing airports. While the first approach attempts to solve the problem on a long-range basis, the second offers an immediate solution.

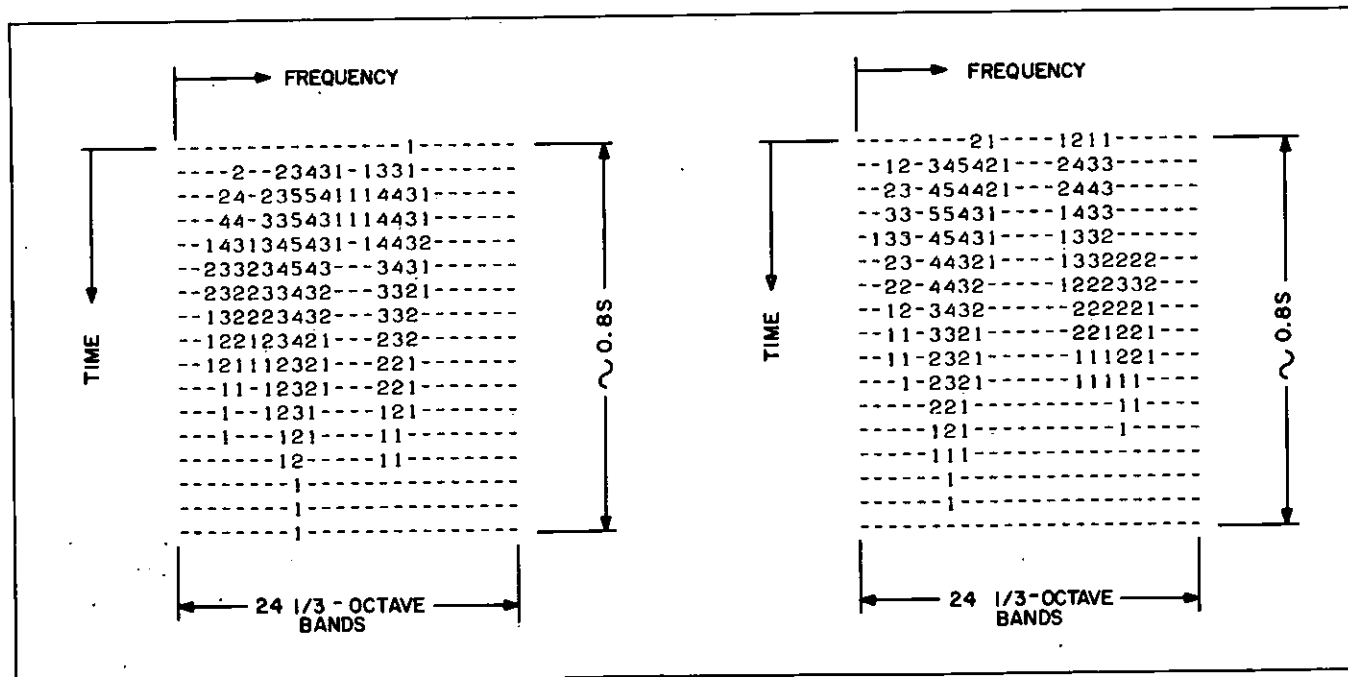
Hewlett-Packard Audio Data Processors are available to assist in both cases. Aircraft certification with respect to noise involves extensive manipulation of vast amounts of data. The recommended procedure is based on a method devised by Kryter and is described in ISO Recommendation R507 and its latest amendment, ISO DR1760. The 80501A System can collect and reduce the data according to this procedure in real time. Basically the steps are:

1. Analyzing the signal into 24 $\frac{1}{3}$ -octave bands and measuring the band sound pressure levels.
2. Computing the corresponding 24 perceived noisiness values.
3. Conversion of perceived noisiness in the individual channels to total perceived noisiness.
4. Computation of perceived noise level.
5. Computation of the tone-corrected perceived noise level.

The above five steps are performed for every scan, that is, every 0.5 second (this is the scanning rate required by the Standards). At the end of an aircraft flyover, the effective perceived noise level, which depends on the time history of the noise, is computed. The system thus arrives at a single number which describes precisely the effect of an aircraft flyover, from calculations performed on all 24 band levels at intervals of 0.5 sec. This value, along with the maximum tone-corrected perceived noise level and the time at which it occurred, is printed out at the end of the flyover. On request, the teleprinter will also print out the histogram of tone-corrected perceived noise levels.

The second approach to the problem of airport noise in-

Figure 2. Sample Speech Patterns



volves such things as bringing aircraft in on a steeper landing approach, avoiding flying over certain areas, and taking off under reduced power. In extreme cases flying hours may have to be restricted to certain hours of the day. This last step is a drastic one, but some European airports have already been forced to take it.

Here again, the need for monitoring, measuring and analyzing noise is evident. Measurement and analysis are the first steps in enforcing standards, in gathering information for planners, and in keeping track of local conditions so flight patterns can be altered to minimize noise.

The HP Model 80500A Aircraft Noise Monitoring System is designed to measure the sound level at a number of locations in or around an airport and then immediately process the data at a central location to provide results in the optimal form for evaluation by relatively untrained personnel. The results can be used to determine effective methods of reducing the annoyance to neighbors of the airport and to detect unusually low flying or deviations from preset flight routes. An important advantage of the system is the fact that meaningful results are available while the offending aircraft is still in the vicinity of the airport. Corrective action, such as scheduling an inspection of the aircraft or instructing the pilot to alter his flight path or flying technique, can be initiated as soon as a violation is detected.

The 80500A System can be considered a specialized version of the 80501A. It differs from the latter in that no spectrum analysis is involved in the routine calculations, although a spectrum analyzer can be included in the system to increase its versatility. All routine analysis is made on a broadband basis.

The monitoring system consists of a number of noise monitoring terminals and a central processing unit containing the digital computer. One or more mobile units, which in their simplest form may consist of only sound level meter and tape recorder, are optional. Whenever sound levels defined as excess occur, the equipment prints out the time of the occurrence, the terminal number at which the excess was observed, the amount and duration of the excess, and calibration information. It computes equivalent sound pressure levels hourly and daily, using different weighting factors for day and night measurements.

The outdoor monitoring terminals (Model 80510A) consist primarily of standard Hewlett-Packard instruments. Aircraft noise is picked up by a wind- and weather-protected microphone assembly (Model 15149B) which incorporates a self-regulating heater to protect the unit from effects of humidity. The output of the microphone assembly (which includes an FET preamplifier) is fed to two Impulse Sound Level Meters operating in parallel, but with a gain difference of 25 dB, so as to cover a dynamic range of 50 dB. The sound level can be measured in dB(A), dB(C), or dB(D), or in unweighted dB of sound pressure level; however, dB(A) and dB(D) are most commonly used.

The outputs from the two impulse sound level meters are combined and amplified, and used to control the frequency of an HP 3300A Function generator. This frequency, which varies between 900 Hz and 3400 Hz, is linearly proportional to the sound level in dB (A, C, D, or unweighted), and is transmitted by telephone line to the central processing unit.

Every 24 hours, at a time preset on a built-in time switch, each noise monitoring terminal is calibrated by a 1 kHz signal applied to an electrostatic actuator in the rain cover of the condenser microphone.

At the central processing unit (Figure 3) the telephone lines converge at the Monitoring Scanner (Model 15143A). Controlled from the computer via a duplex register, the scanner sequentially selects the incoming telephone lines, amplifies the signals and applies them to a counter. The computer converts the readings from the counter into sound levels and compares them with the preselected threshold levels for the corresponding terminals. If an excess is detected, visual and audible indicators are activated, and the maximum noise level and the duration of the excess are printed out on the teleprinter.

Without a computer, a six-terminal system might require six to eight people to evaluate the data. Not only are these unnecessary with a computerized system such as the 80500A, but the computed results are available instantly so airport personnel can communicate with the pilot as soon as excess noise is detected.

The above is only one example of the versatility and degree of specialization possible with a computerized audio data processor. For complete system information or a quotation on a system designed to meet your special requirements, call your local Hewlett-Packard field engineer. Price varies with instrumentation and computer peripheral equipment options. The systems are tailor-made to meet individual needs and range in price from \$35,000 to \$75,000.

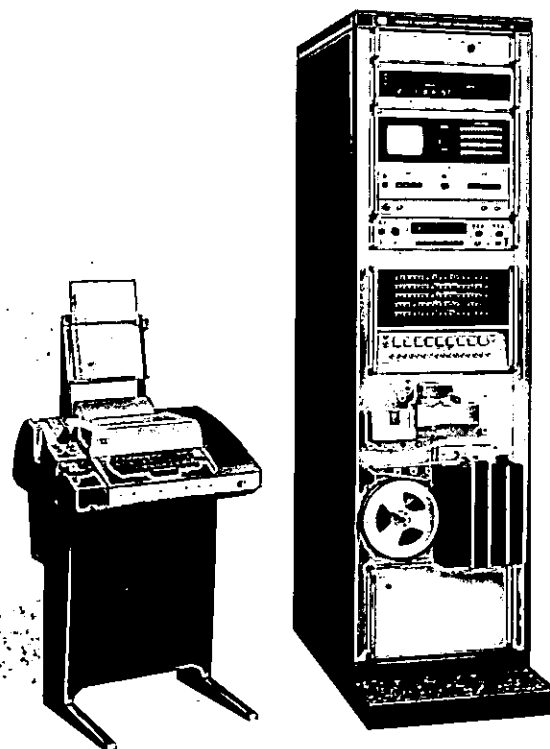


Figure 3. 80500A Central Processor



Computers may be divided into two main classes, "digital" and "analog". A digital computer is one that obtains the solution to a problem by operating on information in the form of coded numbers, while the information processed by an analog machine is in the form of physical analogs, such as voltages or shaft positions, that represent numbers. Principal advantages of the digital computer are its ability to store vast amounts of data and to perform calculations to any required degree of precision, while the analog computer lends itself to direct solution of complicated equations (such as differential equations) through simulation of many variable parameters. In recent years, "hybrid" computers have been developed which combine digital computer memory, logic and accuracy with the dynamic simulation and differential equation solving capability of the analog computer. The hybrid computer is capable of solving problems which lie in both the digital and analog domains, but is necessarily more difficult to use, and more expensive, than a straightforward digital or analog machine.

Digital computers, in turn, may be divided into two classes, general purpose and special purpose. Special-purpose computers are designed to solve only a specific class of problem. One example is a differential data analyzer, a digital computer tailored to the solution of problems that can be reduced to a set of differential equations. Machine tool controllers represent another type of special purpose computer.

General-purpose computers, on the other hand, are not oriented toward specific tasks, but may be programmed to compute and manipulate information for many different purposes. However, certain broad areas of application are better serviced by computers emphasizing particular hardware characteristics. Thus, the general field of general-purpose digital computers breaks down into business data processors, which emphasize large internal memory and external data storage capacity to perform relatively simple calculations on very large amounts of data, and scientific computers, which stress computational capability to solve complex problems, and input/output flexibility for ease of interface with instruments.

The Hewlett-Packard family of computers (models 2116B, 2115A and 2114B) are general-purpose digital computers for scientific and industrial applications. They may be used (with appropriate data input and output devices) as laboratory tools for solving scientific research and engineering design problems, and can be incorporated into instrumentation systems to compute data and perform control functions while experiments are in progress.

Computer hardware

A computer system is composed of two parts: hardware and software. The hardware

comprises the computing machine or 'central processor' and peripheral equipment such as paper tape readers, typewriters and tape punches. Software consists of the programs or lists of instructions that control operation of the computer; these programs are commonly recorded on punched cards, punched tape or magnetic tape, and are then read into the computer through one of its input devices.

The computer itself is made up of five elements: input section, output section, arithmetic unit, memory, and control.

Input: The input section, in conjunction with appropriate external devices, receives data and instructions from various storage media (e.g. punched tape or magnetic tape) or via a manual-entry keyboard. The incoming information is stored by the computer in its memory.

The basic function of the input section is to translate the external data into a form in which it can be stored in the computer memory (e.g. 16-bit binary words). Input devices used with the Hewlett-Packard computers include punched tape readers, keyboards, magnetic tape and magnetic disc units, card readers, and also digital voltmeters, counters, and other measuring instruments.

Output: The output section of the computer transmits data to output devices such as typewriters, tape punches, magnetic tape and magnetic disc units, and printers, performing code translation and formulating as appropriate. The output section also transmits signals for controlling external devices; for example, function commands for instruments such as digital voltmeters and scanners. Some peripheral units can function both as input and output devices. For example, the computer can both read from and record on magnetic tape and magnetic disc units.

Arithmetic: The arithmetic unit performs calculations (using basic arithmetic operations) and manipulates data. Multiplication and division are accomplished either by successive additions and subtractions initiated by software, or with additional hardware, usually offered as an option (e.g. Hewlett-Packard Extended Arithmetic Unit). An example of data manipulation is the rearrangement of a string of characters so that they may be recorded by the computer in a desired format.

The arithmetic unit consists of one or more registers or 'accumulators', and associated logic circuitry. The accumulators hold the results of arithmetic and logical operations performed by instructions, while the logic enables data in the accumulators to be combined with information transferred from memory. The Hewlett-Packard computers have two accumulators, usable independently for computational flexibility.

Memory: This section is the heart of the computer; all information processed by the computer passes through the memory. Hewlett-Packard computer memories use ferrite-

core storage modules consisting of an intricate matrix of ferromagnetic cores, each capable of storing one bit of information. The basic memory of the HP 2115A and 2114B Computers can hold 4096 (4K) words, each consisting of 16 bits of information. This can be expanded to 8K words. Basic memory of the HP 2116B is 8K, expandable to 32K words.

Besides word capacity, the speed with which information can be stored or read from memory is one of the principal characteristics defining the performance of the computer. In the HP 2116B the memory cycle time is 1.6 microseconds, which means that information can be written into or read from memory at a rate of 625,000 words per second. This allows, for example, 312,500 additions to be performed in one second.

Control: This section controls and coordinates the whole operation of the computer. It directs the transfer of data between the computer registers and controls the operations performed. It also interprets the instructions read from memory and sets up the gating functions to carry out their execution.

Software

Even the simplest tasks involve intricate movements of numerous binary bits of information within the computer, such that exhaustively explicit instructions must be given to the computer to perform each task. Therefore, while it is possible to write programs for the computer which are coded in the binary form the computer uses, called "machine language", it is too time-consuming and susceptible to errors to be practical. Various aids have therefore been devised to make programming a computer easier, and consequently more effective.

Software is the general term given to the programs which, when loaded into the computer, utilize the computer itself to perform all the detail work, leaving the programmer free to concentrate on designing a program to solve the problem at hand. The function of software is therefore to make the computer usable. It is usually (but not necessarily) designed by the computer manufacturer and furnished along with the hardware, in a form ready for reading into the computer—punched tape, magnetic tape or punched cards.

Software can be divided loosely into four classes:

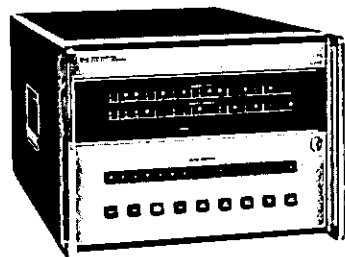
- a) Translators—programs which translate human-oriented languages into machine language.
- b) Control systems—programs which take care of all the functions essential to operation of the computer system.
- c) Utility routines—program editors, program debugging routines, hardware diagnostics.
- d) Applications programs—these adapt the computer system for maximum effectiveness in a specific application.

COMPUTERS

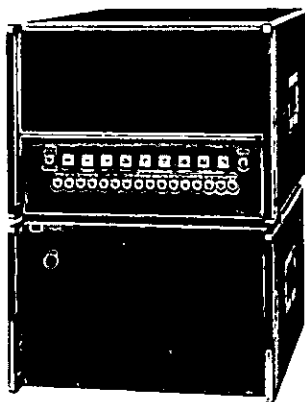
For general computation and systems
Models 2114B, 2115A, 2116B



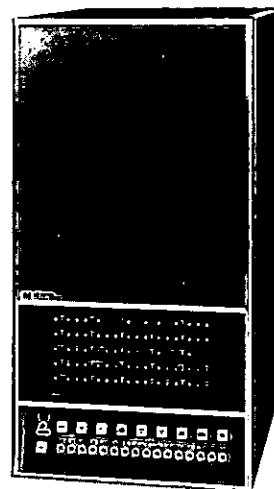
COMPUTATION



2114B



2115A



2116B

The 2114B, 2115A, and 2116B are versatile general-purpose digital computers, particularly suited in computational power and input/output flexibility to scientific and industrial measurement applications. Each may be used as a free-standing system for solving scientific and engineering design problems, or in instrumentation systems, in combination with Hewlett-Packard measuring instruments, or many other devices to provide complete solutions in a broad spectrum of measurement tasks.

Each Hewlett-Packard computer is compact, flexible, and fast. The essential differences between the computers are: maximum memory size and cycle time, the number of priority interrupts, environmental tolerance, and price. Significant features of all three computers are given on page 71.

Optional equipment to expand the power and versatility of each computer is available on a plug-in basis. Options include disc or drum memory, direct memory access, and an extended arithmetic unit (2115A and 2116B only) which significantly reduces multiply and divide time, and also provides variable length, long shift and rotate instructions.

Hewlett-Packard computers are completely software compatible and offer a flexible instruction repertoire of 70 basic one-word instructions, with the capability of extensive micro-programming through one-word combinations of register reference instructions. The software package includes ASA Basic FORTRAN (Extended) and ALGOL compilers, an assembler, a symbolic editor, a basic control system, and conversational BASIC. Software is also furnished for reconfiguring the basic control system to accommodate changes in the I/O hardware system, program debugging, and diagnosing hardware malfunctions. All software except the ALGOL compiler and BASIC are fully operable in the minimum hardware configuration, consisting of 4096-word memory and teleprinter I/O. The ALGOL compiler and BASIC require 8K memory.

2114B

The 2114B is the most compact member of the Hewlett-Packard computer family, yet it contains the same multilevel priority interrupt system and uses the same powerful instruction set as the larger 2115A and 2116B Computers. Its extremely compact design allows the central processor up to 8K of memory (2 μ s cycle time), 7 device interfaces, and all power supplies to be housed in a single, small cabinet. Input/output capability can be expanded to a total of 24 channels by use

of an externally located 2151B I/O Extender. The extender and its interface kit provides all necessary cards and cables to interface the 2114B with the extender on a plug-in basis. For high-speed input/output applications, such as magnetic tape or disc memory, the 2114B can be equipped with direct memory access (DMA). The single-channel DMA can be switched to any I/O channel through software control. Data transfer rate is 500 kHz. The 2114B also offers a unique multiplexed input/output system. This system consists of only one plug-in card and provides easy-to-use interfacing for the connection of up to 56 peripheral devices. Other standard features such as Power Fail Interrupt and lockable power switch and panel controls make it ideal for O.E.M. or systems applications.

2115A

The medium-sized 2115A Computer allows 4K or 8K of memory in the basic mainframe, a memory cycle time of 2 microseconds, and I/O slots for 8 device interfaces (expandable to 24 using the 2151A I/O Extender). The computer is packaged in two small instruments: a 12 $\frac{1}{4}$ " tall processor and a 10 $\frac{1}{2}$ " tall power supply. The unit offers both high-speed extended arithmetic and direct memory access (DMA) capabilities. These provide for high-speed computation and throughput rates for more demanding problems, as well as providing for effective use of external equipment such as high-speed recorders and disc memories. The two-channel DMA can be individually switched to any two I/O channels under program control and permits data transfer rates of 250 kHz per channel or 500 kHz using both channels. The 2115A includes other features found only in much larger computers.

2116B

The 2116B is the largest, most powerful Hewlett-Packard computer. It has a 1.6-microsecond memory cycle time, memory expandable to 32K in 8K modules, and 16 I/O slots in the mainframe for device interfacing. An additional 32 device interfaces can be accommodated in an optional I/O extender. The 2116B also makes provision for two program-selectable direct memory access (DMA) channels and an extended arithmetic unit. The high-speed 2116B memory provides DMA transfer rates of 312 kHz per channel or 625 kHz using both channels.

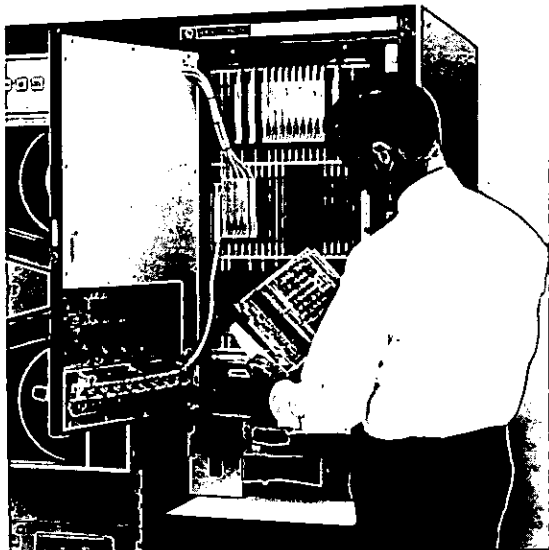
A Real-Time Executive software system makes the full potential of the 2116B realizable. This multiprogramming capability allows the running of foreground programs in real-time concurrently with background programs. The programs may be in (real-time) FORTRAN or Assembly language.

Standard systems are produced by Hewlett-Packard which contain the 2116B and reflect its power and versatility. These include: Data Acquisition Systems operating in real-time; a Time-Shared BASIC system which allows 16 users to program the 2116B, simultaneously, in the popular BASIC language; the 2005A Real-Time Executive System; and a Digital Logic Module Tester using the 2116B for high-speed automatic testing of digital logic modules. Thus, the 2116B is truly a computer for complex scientific and industrial applications.

Input/Output flexibility

The computers operate through standard plug-in interfaces with all the standard computer peripherals, and virtually all Hewlett-Packard instruments capable of being programmed and/or providing a digital data output. General purpose plug-in interfaces are also available which enable the customer to operate a wide variety of devices of his own choosing with the computer. Besides the convenience of plug-in interface cards, the computers provide, as standard features, unique channel identification, an automatic multichannel identification and an automatic multichannel priority interrupt system. Priority levels can be altered simply by interchanging the positions of the interface cards.

Input/output channels may be run one at a time under program control, or simultaneously under interrupt control. Peripherals can be added, upgraded, or deleted, and service priorities changed on a plug-in basis—no wiring changes are involved. Interface circuitry to run a specific peripheral is contained on one or more cards that plug into any I/O slot in the computer or extender. To achieve this, all interface cards have identical pin assignments and the computer backplane is uniformly wired. Interconnecting cables mate directly with the I/O interface cards (see photo), reducing the number of mechanical connections in the system and minimizing the possibility of noise injection from the I/O device into the backplane. All peripherals draw their power directly from the power line; the interface cards are powered from the computer's internal power supply.



External devices are interfaced by inserting the appropriate interface card and connecting the device cable.

Multichannel priority interrupt capability is a standard hardware feature in each Hewlett-Packard computer; an interrupt channel associated with a unique memory location is provided with each I/O interface. That is, an interrupt request from an I/O device directly executes a location in memory uniquely associated with that I/O channel. This interrupt location will typically contain the entry instruction for a subroutine to service the I/O device. Priority level is determined by the I/O slot into which the interface card is installed, so priority levels can be rearranged simply by moving cards into different slots. Peripherals can also be programmed 'in' or 'out' of the interrupt chain under program control. (The interrupt system can also be bypassed and all peripherals run under direct program control.)

Interrupts are recognized by the end of the current machine cycle. More important, overall response is fast. In a multidevice system, a service request by a higher priority device causes the first 'useful' instruction which communicates with that device to be executed in less than 7 microseconds for the 2116B. When operating with only one I/O device, the response time is less than 3 microseconds. Times of 8 and 4 μ s, respectively, are required by the 2114B and 2115A. The multichannel interrupt feature and fast response promote efficient operation in a real time environment, as in instrumentation systems.

Machine organization

Each of the Hewlett-Packard computers has nine internal registers. Eight of these are flip-flop (integrated circuit) registers and the ninth consists of switches for manual data entry. The contents of all but one of the flip-flop registers are available to the programmer; the 2115A and 2116B display these registers on the front panel. The 2114B displays two 16-bit flip-flop registers (Memory Data and Memory Address), two 1-bit registers (Extend and Overflow), and the switch register contents.

T register (memory transfer): All data transferred into or out of memory is routed through the T register. The T register display indicates the information that went into or out of a memory cell during the preceding memory cycle.

P register (program counter): Holds address of next instruction to be fetched from memory (or address of current instruction in the case of a multiphase instruction). The P register increments by one after the execution of each instruction (or by two if executing a skip instruction). A jump instruction can set the P register to any core location.

M register (memory address): Holds address of next memory cell to be accessed.

A and B registers (accumulators): The A and B registers execute and hold the results of arithmetic and logical operations performed by programmed instructions. The registers operate independently, allowing the programmer considerable freedom in program design. While they are flip-flop registers, they may be addressed by any memory reference instruction as location 00000 and 00001 respectively, thus permitting interregister operations such as "add (B) to (A)," "compare (B) with (A)," etc., using a single-word instruction.

E register (extend): A 1 bit register, used to link A and B registers by rotate instructions or to indicate a carry from bit 15 of the A or B register by any add or increment instruction (only) which references these registers.

OV register (arithmetic overflow): This 1 bit register indicates if an add or increment instruction referencing the A or B register has caused one of these accumulators to exceed the maximum positive or negative number which can be contained (+32767 or -32768, decimal). The overflow bit is not complemented if a second overflow occurs before it is cleared, by program instructions. It is not set by shift or rotate instructions.

I register (instruction): Decodes each of the memory reference instructions, and identifies the register reference and input/output instruction types. The I register also holds indicators to

**For general computation and systems
Models 2114B, 2115A, 2116B**

direct the computer to page zero or remain on the current page, and to denote direct or indirect addressing. (Contents of I register are not displayed.)

S register (switch register): A 16-bit register which permits manual data entry through 16 switches on the front panel of each computer. The 2115A and 2116B contain toggle-type switches; the 2114B contains proximity-type sense switches. The setting of the switch register may be transferred into the computer either by program or manually.

Note: On the 2114B only, the contents of the A or B register may be output to the switch register and displayed by a programmed output instruction. Also, the contents of the A or B register may be displayed in the Memory Data register using the load address and display memory switches after clearing the switch register with the clear register switch.

Programming

The Hewlett-Packard computers all have 70 basic one-word (16 bit) instructions, all executable in one or two machine cycles (plus 1 cycle for each step of indirect addressing). These instructions are grouped in three types:

- Memory reference (2 cycle), 14 total
- Register reference (1 cycle), 43 total
- Input/output (1 cycle), 13 total

The register reference instructions are micro-operations that can be combined to form over 1000 one-word, single-cycle instructions.

Word formats

Memory reference instructions

15	14	13	12	11	10	9	8	7	6	5	4	3	2	1	0
D/I		Instruction								Z/C		Memory address			

Register reference instructions

15	14	13	12	11	10	9	8	7	6	5	4	3	2	1	0
Reg. ref. instruction				A/B	SR/AS	Micro-instruction									

Input/output instructions

15	14	13	12	11	10	9	8	7	6	5	4	3	2	1	0
I/O instruction				A/B	Instruction								I/O select code		

Full address

15	14	13	12	11	10	9	8	7	6	5	4	3	2	1	0
D/I		Page address								Word address					

D/I Direct/Indirect; Z/C Page Zero/Current Page; A/B Register Identifier; SR/AS Shift-Rotate/Alter-Skip Identifier

Data, fixed point

15	14	13	12	11	10	9	8	7	6	5	4	3	2	1	0
Sign		Integer													

**Data, floating point
(Magnitude, 23 bits & sign; Exponent, 7 bits & sign)**

15	14	----- 0													15	14	13	12	11	10	9	8	7	6	5	4	3	2	1	0
Mag sign		Magnitude, most sig. bits													Mag, least sig. bits		Exponent		Exp sign											

Instruction repertoire

Type	Mnemonic	Description	Machine Cycles	
Memory Reference Instructions (14)	AND	'And' (M) to A; result in A	2	
	XOR	Exclusive 'or' (M) to A; result in A	2	
	IOR	Inclusive 'or' (M) to A; result in A	2	
	JSB	Jump to subroutine	2	
	JMP	Jump, unconditionally	1	
	ISZ	Increment (M); skip if result zero	2,25	
	ADA/B	Add (M) to A or B; result in A or B	2	
	CPA/B	Compare (M) with A or B; skip if not equal	2	
	LDA/B	Load (M) into A or B	2	
	STA/B	Store (A) or (B) into M; A, B unchanged	2	
Register Reference Instructions (43)	Shift-Rotate Group (20)	NOP	No operation	All 1*
		CLE	Clear E-Register	
		SLA/B	Skip if least significant bit of A/B is zero	
		A/BLS	A or B arithmetic left shift one bit	
		A/BRS	A or B arithmetic right shift one bit	
		RA/BL	Rotate A or B left one bit	
		RA/BR	Rotate A or B right one bit	
		A/BLR	A or B left shift one bit (sign cleared)	
		ERA/B	Rotate E right one bit with A or B	
		ELA/B	Rotate E left one bit with A or B	
	A/BLF	Rotate A or B left four bits		
	Alter-Skip Group (19)	CLA/B	Clear A or B	All 1*
		CMA/B	Complement A or B (ones complement)	
CCA/B		Clear, then complement A or B (sets A/B to -1)		
CLE		Clear E-Register		
Overflow (4)**	CME	Complement E-Register	All 1	
	CCE	Clear, then complement E-Register (sets E to 1)		
	SEZ	Skip if E-Register is zero		
	SSA/B	Skip if sign of (A) or (B) is zero (A/B positive)		
	SLA/B	Skip if least significant bit of (A) or (B) is zero		
I/O Instructions (13)	INA/B	Increment (A) or (B) by one	All 1	
	SZA/B	Skip if (A) or (B) is zero		
	RSS	Reverse skip sense		
	STO	Set arithmetic overflow		
	CLO	Clear arithmetic overflow		
	SOC	Skip if arithmetic overflow clear		
	SOS	Skip if arithmetic overflow set		
	HLT	Halt program		
	STF	Set flag bit of selected channel		
	CLF	Clear flag of selected channel		
	SFC	Skip if flag clear		
	SFS	Skip if flag set		
	MIA/B	Merge contents of selected channel into A or B (inclusive 'or')		
LIA/B	Load contents of selected channel into A or B			
OTA/B	Output from A or B to selected channel			
STC	Set control bit of selected device			
CLC	Clear control bit of selected device			

*Register Reference Instructions can be combined to execute in 1 cycle. This allows, for example, shifts and rotations up to 8 places in 1 cycle.

**Coded under I/O group.
(M) = Contents of memory Location M.

Memory Reference: Memory addressing of HP computers is based on a 1024-word page structure. All memory reference instructions address either the current page or the base page, thus up to 2048 words are directly addressable. The large page size of Hewlett-Packard computers allows compact programs with a minimum of indirect addressing. Also, programs can share a large block of storage in the base page, easing communication between routines using common data. Accumulators

are directly addressable as memory locations 0 and 1, enabling their contents to be added and compared. You can also load from one accumulator into the other.

Register Reference: Hewlett-Packard's extensive set of register reference instructions make it easy to edit character strings, shift data within and between accumulators, test the accumulators for condition (zero/non-zero, positive/negative, odd/even) and to clear, set, increment and form the one's and two's complement of the accumulator contents.

Software

Hewlett-Packard computers are supported by a full range of software, furnished in the form of punched tape or magnetic tape. The following software packages are available:

FORTRAN compiler	Magnetic Tape System
ALGOL compiler	Conversational BASIC
Assembler	Hardware diagnostics
Symbolic editor	Time-shared BASIC Executive
Basic Control system	Real-Time Executive

With the exception of ALGOL, Conversational BASIC, Magnetic Tape System, and the large software executives, the software packages will run in the minimum hardware configuration—4K memory and teleprinter input/output. ALGOL, Conversational BASIC, and the Magnetic Tape System require 8K of memory. Programs written in FORTRAN, ALGOL or assembly language are independent of the hardware I/O configuration. All I/O devices are identified by logical unit numbers which the programmer uses to specify I/O operations.

At execution time the Basic Control System relates these logical unit numbers to physical numbers that correspond to the I/O slots occupied by the cards for the I/O device in question. The Basic Control System is therefore configured to suit a particular system.

An auxiliary software package, Prepare Control System, is furnished which allows the user to change his Basic Control System to fit different input/output arrangements. A dynamic program debugging package is also supplied.

FORTRAN compiler: Accepts source programs written in American Standards Association Basic FORTRAN. It produces a relocatable machine language object program that can be loaded and executed under control of the Basic Control System. In addition to the ASA Basic FORTRAN language, Hewlett-Packard's FORTRAN compiler includes a number of features that extend the flexibility of the system.

ALGOL compiler: Accepts source programs written in ALGOL. It produces a relocatable machine language object program that can be loaded and executed under control of the basic control system. Operable in 8K memory.

Assembler: Translates symbolic source language instructions into an object program for execution on the computer. The source language provides operation codes, assembly-directing pseudocodes, and symbolic addressing. The assembled program may be absolute or relocatable. The source program may be assembled as a complete entity or it may be divided into several subprograms (or a main program and several subroutines), each of which may be assembled separately. The loader of the Basic Control System loads and links relocatable programs; the basic binary loader loads absolute programs.

Symbolic editor: Enables the user to edit and update a symbolic file tape that can be an assembler program, a compiler program, or a data file. The editor produces an updated tape from the source tape and change instructions. Individual characters and entire source statements can be inserted, deleted, or replaced. The editor will also provide a listing of a symbolic file (sequentially numbering the statements). Diagnostic messages are produced for errors detected in format of edit control statements.

Basic Control System: Provides an efficient loading, input/output control and debugging capability for relocatable programs produced by the assembler, FORTRAN compiler, or ALGOL compiler. The system is modular in design and may be constructed or modified to fit the user's particular hardware configuration. The following modules are provided:

Relocating loader: Loads, links, and initiates the execution of relocatable object programs produced by the assembler or compiler.

Input/output control: Provides for general input/output device control and software buffered data transmission between I/O devices and computer memory.

Input/output drivers: Provide the instructions necessary to operate specific input/output devices, and serve as an interface between the I/O control system and the peripheral devices.

Two other software packages associated with BCS are:

Prepare control system: Combines the basic control system component modules—loader, I/O control, and I/O drivers together with equipment tables—to generate a basic control system for a particular hardware configuration.

Debugging package: A relocatable program that interprets and executes machine instructions. Functions to be performed are normally selected by typing in control statements on the teleprinter.

Subroutines: The basic control system loads and links object code library subroutines according to calls generated by assembler or compiler programs. A complete library of mathematical and Input/Output subroutines are available.

Magnetic Tape System: Provides a convenient method of computer operation for users with 8K of memory and digital magnetic tape. It greatly reduces operator intervention for FORTRAN, ALGOL, Assembler, Symbolic Editor, and Basic Control System software packages. In addition, the system may be operated in a batch processing mode. Modular design allows the system to be configured to fit the user's hardware.

BASIC Interpreter: One of the most useful languages available with Hewlett-Packard computers is "BASIC," developed by Dartmouth College. In the design of BASIC, primary emphasis was placed on ease of learning and ease of operation. The result was a language which could be learned in a few hours. Because of the ease with which it can be learned and retained it has become the most widely used language for people in engineering and the sciences.

BASIC is an interpretive language; the program is stored in the computer in a form similar to the original alphanumeric statements which are interpreted by the compiler at execution time. Since the program is stored in essentially its original form, program editing can be accomplished by simply adding new statements or modifying old ones without the need for recompiling the entire program.

BASIC is also a conversational language; the computer responds to the programmer's inputs with English language statements. For example, the compiler checks each statement after it is entered for proper format, and any illegal syntax is immediately identified for the programmer with a diagnostic message. If errors are encountered during the program execution the computer types a diagnostic message and may halt or continue depending upon the type of error.

The combined features of the interpretive compiled and the conversationality serve to greatly reduce the effort required to prepare and debug programs. The proof of the power of the language as a computational tool is its predominance among the languages used by the non-professional programmers.

For general computation and systems
Models 2114B, 2115A, 2116B

Specifications

	2116B	2115A	2114B
Core Memory			
Word size (bits)	16	16	16
Parity check with interrupt	Optional	Optional	Optional
Basic configuration size (words)	8K	4K	4K
Maximum size in mainframe	16K	8K	8K
Maximum size using extender	32K	—	—
Direct memory access	Optional	Optional	Optional
Memory area protect	Optional	—	—
Cycle time (us)	1.6	2.0	2.0
Instruction execution speed (us)			
Store word	3.2	4.0	4.0
Add (full word)	3.2	4.0	4.0
Multiply (subroutine)	120	150	150
Divide (subroutine)	300	375	375
Multiply (hardware option)	19.2	24.0	—
Divide (hardware option)	20.8	26.0	—
Number of basic instructions	70	70	70
Multilevel indirect addressing	Yes	Yes	Yes
Priority interrupt system			
Number of prewired input/output slots in mainframe	16	8	7
Maximum number of I-O slots using extender	48	24	24
Number of devices that can be interfaced using multiplexed I/O	—	—	56
Hardware			
Circuitry	CTL I.C.	CTL I.C.	CTL/TTL I.C.
Power failure protection	Yes	Yes	Yes
Automatic restart	Optional	Optional	Optional
Height	31½"	12¼"	12¼"
Width	16¾"	16¾"	16¾"
Depth	19¾"	24¾"	24¾"
Environmental temperature	0° to 55°C	10° to 40°C	10° to 40°C
Environmental relative humidity (at 40°C)	95%	80%	80%
Prices			
with 4K memory	—	\$14,500	\$ 8,500
with 8K memory	\$24,000**	19,500	13,000

Interface Kits

- Prices for the following options are for the Interface Kit only; order by Interface Kit number.
For example: To order the Relay Output Register, specify Interface Kit 12551B.

NAME	CAPABILITY	BASIC KIT NO.	PERIPHERAL	PRICE	
				115 V, 60 Hz	230 V, 50 Hz
TIME BASE GENERATOR	Generates real time intervals in decade steps from 100 μs to 1000 sec (derived from crystal oscillator). Used as source of timed interrupts for software clock.	12539A	None required	1,000	1,000
DATA PHONE INTERFACE	Interfaces computer with Bell System Data Phone service.	12540A	Bell System Data Set 103A	1,000	Not Available
RELAY OUTPUT REGISTER	Provides 16 form-A contacts for operating external devices. (Interface kit includes 48-pin mating connector.)	12551B	Determined by user	600	600
16-BIT GENERAL PURPOSE DUPLEX REGISTER	Dual 16-bit flip-flop register. Permits bi-directional transfer of information between computer and external devices. (Interface kit includes 48-pin mating connector.)	12554A	Determined by user	750	750
D-A CONVERTER	Provides two D-A conversion channels, 8 bits/channel.	12555A	Determined by user	1,000	1,000
MICROCIRCUIT INTERFACE	Dual 16-bit flip-flop register. Permits bi-directional data transfer between computer and external device at DTL/TTL voltage levels. (Interface kit includes cable and mating connector.)	12566A	Determined by user	750	750
8-BIT GENERAL PURPOSE DUPLEX REGISTER	Dual 8-bit flip-flop register. Permits bi-directional transfer of information between computer and external devices. (Interface kit includes 48-pin mating connector.)	12597A	Determined by user	600	600

*Power Supply Unit in 2115A is 10½" high, 16¾" wide, and 18¾" deep.

**Prices for 2116B with 16K, 24K or 32K memory are available upon request.

Input/Output Options

Interface Kits for the following I/O options include software, consisting of I/O Driver and Diagnostic tapes. I/O Driver tapes are not included with Interface Kits 12551B, 12554A, 12555A, 12566A, 12597A, 12606A and 12610A.

Orders for I/O options subsequent to original purchase of system must state computer model and serial number, so that proper software is furnished.

- Prices for the following options include Interface Kit and Peripheral. When ordering, specify both Interface Kit and Peripheral-Device numbers. For Example: To order Low Density Magnetic Tape Input/Output, specify Interface Kit 12538B and HP (H27) 2020A Magnetic Tape Unit.

I/O Option	Capability	Interface Kit	Peripheral	Price	
				115 V, 60 Hz	230 V, 60 Hz
TELEPRINTER INPUT/OUTPUT	Typewriter and paper tape output, keyboard and paper tape input, at 10 characters/sec. ASCII code; friction-feed platen	12531B	HP 2752A Teleprinter (modified Teletype ASR-33)	2,000	2,200
HEAVY-DUTY TELEPRINTER INPUT/OUTPUT	Similar to option above, except heavy-duty teleprinter with pin-feed platen. Recommended where use exceeds 5 hrs/day or 30 hrs/week	12531B	HP 2754B Teleprinter (modified Teletype ASR-35)	4,600	5,000
HIGH-SPEED PUNCHED TAPE INPUT	Paper tape input at 300 characters/sec.	12532A	HP 2737A Punched Tape Reader	2,100	2,200
OPTICAL MARK READER	Reads punched and marked cards. 200 cards/min; automatic feed	12602A	HP 2761A-07 Optical Mark Reader (parallel output)	3,700	Not available
HIGH-SPEED PUNCHED CARD READER	Reads 12-bit parallel columns, 80 columns/card at 1000 cards/min.	12558A	HP 2779A Card Reader	9,500	Not available
HIGH-SPEED PUNCHED TAPE OUTPUT	Punched tape output at 120 characters/sec.	12597A-03	HP 2753A Tape Punch	4,100	4,150
PAPER TAPE WINDER	Hand-held electric winder for rerolling paper tape	—	HP 12575A Tape Winder	50	—
LOW DENSITY MAGNETIC TAPE INPUT/OUTPUT	Computer records on, and reads from, IBM-compatible 1/2 inch 7-channel NRZI tape. Bit density 200 bpi. Speed 30 ips.	12538B*	HP (H27) 2020A Magnetic Tape Unit	13,300	13,500
DUAL DENSITY MAGNETIC TAPE INPUT/OUTPUT	Similar to option above, except bit density is 200 and 556 bpi, switch selectable	12538B*	HP (H27) 2020B Magnetic Tape Unit	13,895	14,095
9-CHANNEL MAGNETIC TAPE INPUT/OUTPUT	Computer records on, and reads from, IBM-compatible 1/2 inch 9-channel tape. Bit density 800 bpi. Speed 75 ips. Requires DMA 12578A.	12559A*	HP (H01) 3030G Magnetic Tape Unit	18,500	18,700
DISC MEMORY (184K WORDS: EXPANDABLE)	A. Provides storage for 184,320 16-bit words in 64 word sectors, 90 sectors/track. Transfer rate: 160K words/sec. Access time: 17.4 ms average B. Expandable to 368K words using Installation Kit 12837A. Kit cost: \$8,000	12606B*	HP 2770A Disc Memory with HP 2772A Disc Memory Supply	23,500	23,900
DISC MEMORY (368K WORDS: NON-EXPANDABLE)	Similar to A above but stores 368,640 words. This unit is not expandable	12606B*	HP 2770A-01 Disc Memory with HP 2772A Disc Memory Power Supply	28,500	28,900
DISC MEMORY (368K WORDS: EXPANDABLE)	Similar to A above but stores 368,640 words. Expandable to 737,280 words using Installation Kit 12838A. Kit cost: \$12,000	12606B*	HP 2771A Disc Memory with HP 2772A Disc Memory Power Supply	30,000	30,400
DISC MEMORY (737K WORDS: NON-EXPANDABLE)	Similar to A above but stores 737,280 words. This unit is not expandable	12606B*	HP 2771A-01 Disc Memory with HP 2772A Disc Memory Power Supply	36,500	36,900
DRUM MEMORY (393,216 WORDS: EXPANDABLE)	A. Provides storage for 393,216 16-bit words in 64 word sectors, 32 sectors/track. Transfer rate: 120K words/sec. Access time: 8.7 ms average, 17.4 maximum B. Expandable to 786,432 words	12610A*	HP 2773A Drum Memory with HP 2776A Drum Power Supply	30,000	30,400
DRUM MEMORY (786,432 WORDS: NON-EXPANDABLE)	Similar to A above but stores 786,432 words. This unit is not expandable	12610A*	HP 2774A Drum Memory with HP 2776A Drum Power Supply	36,500	36,900
DRUM MEMORY (1,572,864 WORDS: NON-EXPANDABLE)	Similar to A above but stores 1,572,864 words. This unit is not expandable	12610A*	HP 2775A Drum Memory with HP 2777A Drum Power Supply	61,500†	—
LINE PRINTER (120 COLUMNS/LINE)	Prints data at 300 lines/min, 120 columns/line. ASCII character set	12617A	HP 2778A Line Printer	23,000	—
LINE PRINTER (132 COLUMNS/LINE)	Prints data at 300 lines/min, 132 columns/line. ASCII character set	12617A	HP 2778-01 Line Printer	24,000	—
DIGITAL PLOTTER	Draws and labels graphs and charts. Plots at 300 steps/min, 0.01 inch resolution. Plotting width 11 inches	12560A	HP 2791A Digital Plotter	9,000	9,200
DIGITAL PLOTTER	Draws and labels graphs and charts. Plots at 200 steps/min, 0.01 inch resolution. Plotting width 29.5 inches	12560A-01	HP 2792A Digital Plotter	13,000	13,200
POWER SUPPLY EXTENDER	Supplements Internal I/O power supply	—	HP 2160A Power Supply Extender	2,000	2,000

*Uses 2 I/O slots

†208 V, 3ϕ, 60 Hz

REAL-TIME & TIME-SHARED COMPUTER SYSTEMS



COMPUTATION

A data processing system can be broadly defined as a combination of several pieces of computer hardware which are integrated to perform a specific function. Two of the most important system approaches to computer operation are the time-shared system and the real-time system. Both time-shared and real-time systems permit concurrent utilization of the same central computer. In time-sharing, two or more users (programmers) working at a remote device have equivalent access to the central processing equipment. A real-time system also receives parallel inputs, however, the user is replaced by electronic instrumentation. In addition, the computer processes all data inputs and outputs information on a *job priority* basis.

Time-Sharing versus Batch Processing

The largest class of computer systems still operate on the so-called batch processing principle. In batch processing, the user's programs are prepared off-line using primarily punched cards as the input/output media. Jobs are sequentially fed into the computer for execution by the system. The efficiency of the batch processing system depends upon maintaining a queue or lineup of programs ready for execution. Elimination of the input/output (I/O) bottleneck created by batch processing has been vastly reduced by the development of parallel I/O techniques. Foremost in this category is the time-shared computer system where many users have simultaneous access to the computer's hardware and software. With time-sharing the user can perform his computations when he wants without waiting for a turn in the batch processing queue. Time-share terminals, from one on up to the system's maximum capacity, are connected in parallel to the central processor.

Time-Sharing Software

A time-share system is said to be conversational if it responds to user inputs in a helpful and error-preventive manner. With conversational programming, the user interacts with his program and the time-sharing system from the remote terminal. The computer identifies format mistakes and brings them to the programmer's attention as they are made.

The user does not have to wait for his program to pass through the batch processing cycle to find out he has made a minor syntax error.

The time-sharing executive is stored in the main memory of the central processing unit (CPU). The executive program is responsible for controlling all communications between the system and the remote users. It establishes user priorities, directs operation of the accounting system, supervises the organization of and utilization of mass storage and in general acts as the controlling element which assures continuous, accurate operation of the time-sharing system.

Time-Sharing Hardware

Many data terminals are available as input/output devices for time-sharing. Most terminals consist of a single human-oriented device which contains a keyboard and either a hard copy (printed) output or a CRT display. Other time-share peripherals such as tab card readers, instrumentation couplers (for on-line computation of test data) and graphics plotters provide for extending the capabilities of the basic terminal device.

Some CPU additions and/or modifications are necessary for effective operation of a time-shared system. Hardware requirements include a means of communicating with the remote terminals, and an interrupt system which permits a program to be interrupted and then resumed without losing any information. A real-time clock is needed to generate timed interrupts and to keep track of the amount of service each user has received. Direct memory access is required to provide high-speed swapping of programs between main memory and a large random-access file.

In general, time-sharing systems require more main memory than other computers. However, by optimizing the executive software the core-resident requirements can be significantly reduced. The HP 2116B Computer, for example, requires only 16,384 words of main memory when used in the HP 2000A Time-Shared Basic System. In order to provide adequate response time for time-share users, a high-speed disc or drum memory is utilized. These devices are used for everything from system backup to program and data storage. The selection of discs or drums for random-access

storage must be analyzed according to operational considerations of speed and volume balanced against cost.

Real-Time Systems

Because the computer is able to process data and perform operations many times faster and with much greater accuracy than they can be performed manually, many systems have been devised which will accomplish these tasks automatically. A computer installation of this type is classified as a real-time system. A real-time system can be defined as one in which the computer receives data directly from the point of origin, processes it and returns the results sufficiently fast to affect the environment at that time. Such systems are being used to operate water distribution systems, production machinery and even complete factories.

Response time is the time the system takes to react to a given input. When using real-time control of a critical process, a short response time from the computer is essential. In a system controlling a nuclear reactor, a response time of milliseconds is needed, while a system controlling paper production may require a five-minute response time.

Real-Time Software Development

Implementation of real-time systems to give them an adequate response time and sufficient reliability has required new advances in programming techniques. Many of the hardware problems have been solved, and standard off-the-shelf equipment is available to do the job. An example of low-cost, off-the-shelf real-time systems is the Hewlett-Packard 2005A Real-Time Executive System. The 2005A custom-tailors a standard HP 2116B computer, disc storage and other computer hardware into a true real-time, multi-programming system.

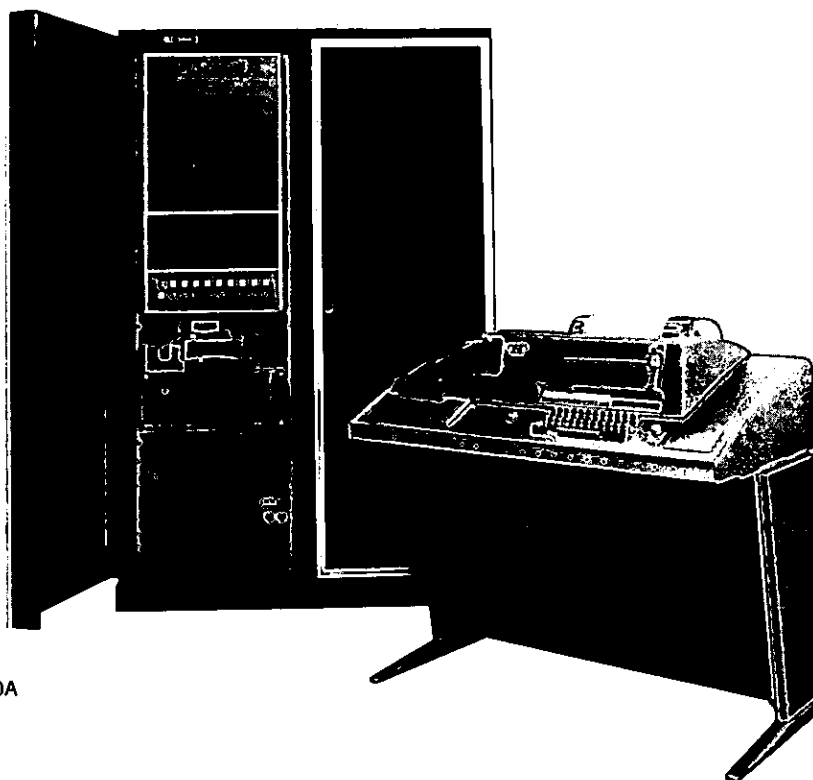
In general the programming for a real-time system is much more complex than on an equivalent batch processing machine. For example the system will normally handle all error conditions without requesting help from the operator. There are no end-of-reel conditions, card decks to be loaded or other operations which would ever require halting the computer. The system can consist of one computer or several computers communicating with each other.



TIME-SHARED BASIC SYSTEM

An economical 16 terminal system

Model 2000A



2000A

System philosophy

The HP 2000A Time-Shared BASIC System represents a new philosophy in the design of time-sharing computer systems. *It brings the problem solving power of the digital computer to the scientist, engineer, educator or businessman for a fraction of the cost of other time-sharing systems.* The HP 2000A uniquely combines a standard, low-cost computer (the HP 2116B) with BASIC language programming for simultaneous servicing of up to 16 users. In addition, HP conversational BASIC is an easy-to-learn yet powerful language. The extended features of HP BASIC cover a wide range of capabilities from simple arithmetic operations to advanced programming projects requiring the use of matrices, strings and files. For users also requiring a general-purpose single-terminal capability, the 2000A System offers the flexibility of FORTRAN, ALGOL and HP Assembly language programming.

Also of major importance, the HP 2000A is supplied as a completely operational system, ready for connection to the user's terminals. The system consists of a central computer, disc or drum memory, high speed tape reader, rack cabinet, a heavy-duty system teleprinter, and all necessary internal options. Terminals can be connected by use of standard telephone communication equipment or cabled directly up to distances of one mile, resulting in even greater savings.

Time Sharing Benefits

In order to understand the utility of time-sharing it is helpful to list some of the features of time-sharing systems that have made them the success they are.

1. Time-sharing systems are economical to use; the power of a high speed processor is available to each user at a fraction of the total cost.

2. The user can perform his computations when he wants to without waiting for a turn in a batch system queue.

3. Conversational interpretive languages, not economically practical on a single terminal-per-processor basis because of their on-line program preparation and slower execution times, become powerful and practical tools when built into a time-sharing system. These languages, which can be learned in hours instead of weeks are perhaps the major factor in the success and growth of time-sharing.

4. Program debugging is greatly simplified by the combination of on-line, two-way communication and lower operating costs, which makes it possible for the user to debug a program on-line without repeated cycles through the batch queue.

5. In some applications time-shared operation makes it possible for many users to simultaneously access a large common data base.

Conversational BASIC Programming

With time-sharing, almost anyone can have access to a computer. However, the computational power of the computer isn't really useful to someone unless he has the necessary programming knowledge. BASIC, the language of the 2000A, is not only easy to learn but also conversational; that is, the user can interact with his program and with the time-sharing system from the remote terminal. The simplicity of BASIC permits the inexperienced user to perform useful programming after only a few hours of training or self-teaching. This feature is of major significance when the user requires the use of a computer only periodically and can't be expected to maintain his programming knowledge. For the accomplished programmer BASIC also permits more powerful, general-purpose programming while retaining its simplicity. Although the present time-sharing services collectively offer more than twenty program-

ming languages, the conversational languages enjoy the greatest use. Of these, BASIC, developed at Dartmouth College, is the most often used.

System Hardware

The HP time-sharing system is built around the HP Model 2116B Computer with a 16-bit word length (plus parity) and 16,384 words of magnetic core memory. For time-sharing operation the computer is equipped with the following:

Internal

Direct memory access	Memory parity check
Extended arithmetic unit	Time base generator
Power fail interrupt	Teletype multiplexer

External

Magnetic disc memory	Power supply extender
High speed tape reader	Heavy duty teleprinter

The first four internal options provide the high speed data transfer and computation, and the internal checking of power levels and parity errors necessary for best efficiency and reliability. The time base generator provides for timed intervals which can then be used by the system software for determining time of day and measuring terminal usage. Simultaneous servicing of all sixteen user channels is provided by the Teletype multiplexer.

Disc or Drum Memory

For bulk high speed memory, the system uses either disc or drum memory providing a minimum of either 368,640 or 393,216 words of storage respectively. The disc (or drum) is used by the system for storage of current programs (16 tracks), for storage of system tables (2 tracks) required for the library and accounting system, for storage of the system itself (5 tracks) and for storage of saved user programs (all remaining tracks). Disc storage can be expanded by adding additional heads to expandable units or complete disc or drum units up to the system limit of 256 tracks. Maximum storage provides over 1.9 million words of program storage. The short disc and drum access times, coupled with the executive's optimum timing techniques assure the efficiency required for handling the maximum of 16 users at once.

High-Speed Punched Tape Input

A high-speed punched tape input unit is included with the 2000A System to permit rapid loading of the system executive and other software systems. Once loaded into core memory the time-sharing software can be stored and reloaded from the disc memory in milliseconds, or from the optional magnetic tape unit in a few seconds. Availability of the paper tape reader also permits greatly reduced program assembly and compilation times during non-time-sharing operating modes.

System Control Teleprinter

The heavy duty teleprinter serves as the system control console and is connected to the computer through a separate input/output interface. It is used for operator communication with the system and for logging system information. Using the system control teleprinter, the operator can also control access to the system by assignment of user numbers and passwords.

User Terminals

The teleprinters used as terminals with the system are the Teletype Models ASR-33 or ASR-35. Communication with the system at rates up to 10 characters per second is possible through the teleprinter keyboard or paper tape reader. For local service, up to one mile, the terminals can be wired directly to the system. For longer distances or for greater operating flexibil-

ity, the terminals can be connected to the system through regular voice-grade telephone lines using coupling equipment such as the Bell System Data Set 103A. Use of the telephone system allows a greater number of terminals to be served by the system; up to sixteen users can be handled simultaneously on a first-call first-served basis.

General specifications

Operating conditions: ambient temperatures 0° to 50°C (32° to 122°F), relative humidity to 80% at 40° C, except for drum memory, which is limited to ambient temperatures from 5° to 40°C (40° to 105°F) at relative humidity to 80%.

Equipment Furnished:

2000A Time-Shared BASIC System, \$90,500; 115V, 60 Hz operation or \$91,400; 230V, 50 Hz operation. Four year lease = \$2353/month. Provides minimum hardware configuration consisting of:

- 2116B Computer with Option 05, 16,384-Word Memory
- Direct Memory Access, Accessory No. 12578A
- Extended Arithmetic Unit, Accessory No. 12579A
- Power Fail Interrupt/Auto Restart, Accessory No. 12588A
- Memory Parity Check, Accessory No. 12591A
- Time Base Generator, Accessory Kit No. 12539A
- 12584A-01 Teleprinter Multiplexer
- High Speed Tape Reader, consisting of:
HP 2737A High Speed Tape Reader (300 char/sec) with HP 12532A High Speed Punched Tape Input Interface Kit
- Teleprinter Input/Output, consisting of:
HP 2754B Heavy-Duty Teleprinter (modified Teletype ASR-35) with HP 12531B Teleprinter Input/Output Interface Kit
- Disc Memory consisting of:
HP 2770A-01 Disc Memory, 368,640 words
HP 2772A Disc Memory Power Supply
HP 12606B Disc Memory Interface Kit
- 2160A Power Supply Extender
- 2992Z Two-Bay Cabinet with doors
- System Integration and Accessories

Options

	115V, 60Hz	230V, 50 Hz
Telephone Auto-Disconnect, Accessory Kit No. 12584A-02	\$ 1,500	\$ 1,500
Teleprinter Input/Output, HP 2749A Teleprinter	1,750	1,950
Data Set Cable HP Part # 12584-6006	50
Digital Magnetic Tape, HP (H01) 3030G Magnetic Tape HP 12559A 9-Channel Magnetic Tape Input/Output Interface Kit	18,500	18,700
Additional Disc Memory Storage, refer to computer input/output options page 72.		
Additional Drum Memory Storage, refer to computer input/output options page 72.		
Power: 115/230 vac, 50/60 Hz, 10,000 watts		
Cabinet Dimensions. 72" high, 47" wide 30" deep		
Net Weight: 1500 lb (675 kg)		



REAL-TIME EXECUTIVE SYSTEM

Low-cost multi programming

Model 2005A



2005A

System philosophy

The HP 2005A Real-Time Executive custom tailors an HP 2116B Computer and disc storage into a true real-time multi-programming system. With the Executive System controlling the computer, several programs can run in real-time concurrent with general-purpose background programs. The Real-Time Executive (RTE) schedules the running of programs on a priority basis under both time and event control. It supervises all interrupts, I/O operations, and bulk memory transfers plus the housekeeping necessary to a system where multi-programming is performed. The availability of background programming provides maximum utilization of hardware and a practical solution where separate computers are not economically feasible. Time not needed for real-time processing may be used for computation, compiling, program debugging and other operations while keeping the foreground and executive safe through memory protect.

Programs for the 2005A can be written using HP Real-Time Assembly Language or HP Real-Time FORTRAN. The number of programs in the system is limited only by disc capacity and the dynamics of the application. Core memory is minimized by configuring a tailored-system from standard modules. The Real-Time Executive is configured and operated on the same computer system. Test instruments and peripherals are easily added to the system by inserting circuit interface cards into the mainframe. Interface cards and modular software are available for many peripherals and instruments.

A new standard in computer efficiency

The 2005A is designed to provide for monitoring and controlling all aspects of the operating environment. Inputs are ac-

cepted, processed and returned to external equipment fast enough to affect the system environment. Processor time is granted to the highest priority program or function. Critical real-time functions may be assigned higher priority to assure optimum response and service. Up to 99 levels of program priority are possible with more than one program grouped into the same priority. Multiprogramming capability permits many concurrent real-time programs and a background program to be in the process of executing.

Dynamic and fixed memory protection

Dynamic memory protection is provided by the system for core and disc memory. The memory protect for core memory uses a hardware fence register which is loaded by software. Disc memory tracks are dynamically assigned to a user program upon request. These tracks are protected from being overwritten until released by the requesting program. The disc memory also has a fixed hardware memory protect for a specified number of lower tracks which protects the Real-Time Executive and the user's program library.

System generation

User real-time programs, user background programs and Real-Time Executive Modules are incorporated into a configured real-time system. Since HP real-time software is modular and of a general nature, the user simply configures his particular programs and I/O device drivers into a real-time system tailored to his exact needs. A configured real-time system dynamically incorporates new user programs to the maximum number of programs specified at system generation. Using the Real-Time Generator (RTGEN), a Real-Time Executive System can be configured in a matter of minutes. The RTGEN converts relocatable software modules and user programs into a configured Real-Time Executive System in absolute binary format.

Operating characteristics

Program scheduling provides for dynamic allocation of the system facilities in a real-time environment. Processor time is granted dynamically to the highest priority program scheduled for execution. Foreground and background program priorities can be intermixed although real-time programs usually require the highest priority. Programs may also be scheduled on-line or set to execute at specific intervals. Overall the RTE includes the following functions:

Program Scheduling	System Requests
Interrupt Processing	Operator Requests
Input/Output Processing	

The following subsystems functions (or programs) are included:

Real-Time Assembler	Real-Time Debug
Real-Time FORTRAN Compiler	Real-Time Relocating Loader
Real-Time Symbolic Editor	FORTRAN Library

Equipment furnished

2005A Real-Time Executive System, \$74,100; 115V, 60 Hz operation or \$74,800; 230V, 50 Hz operation. Provides minimum hardware configuration consisting of an HP 2116B computer (with 16K memory, direct memory access, extended arithmetic unit, memory protect, and time base generator), a High Speed Tape Reader, a head-per-track Disc Memory (184K words, expandable to 368K), Teleprinter Input/Output (modified Teletype ASR-33), and two-bay cabinet.

EDUCATIONAL COMPUTER SYSTEM

Model 2007A



COMPUTATION

With the availability of low-cost computers and more manageable computer languages, the teaching of computers and computer applications has become a valuable addition to school curriculums. The 2007A Educational Computer System was specifically developed for use in the classroom. It consists of a digital computer with 8K memory, an optical mark reader (card reader) and a teleprinter. Adding a 2007A to your school provides for:

- Solving real problems associated with classroom study in math, science, social studies, etc.
- Learning the principles of digital computers and computer programming.
- Speeding up the learning process through computerized techniques.

Basic language programming

The key to effective student usage of the computer is an efficient programming language. The 2007A is programmed by an easy-to-learn yet powerful language called BASIC (Beginner's All-purpose Symbolic Instruction Code). This language was developed by Dartmouth College and is used by all major computer manufacturers. It is a conversational language which can be learned in four to six hours. This ability to learn the language quickly enables teachers to concentrate on applications to course material; students can develop their programming skills, concentrate on concepts, and examine them under varying conditions. Complex rules and formats do not have to be memorized.

Marked-card programming

An entire class can simultaneously program the computer through the use of tab cards which can be marked by an ordinary soft-lead pencil. The 2761A-07 Optical Mark Reader (refer to description on page 79) used in the system reads these cards to enter programs into the computer. Eliminating the need for traditional punched cards permits the students to program at their desks, in the library, or at home, without the inherent delay and expense of a key-punching facility. Standard size tab cards (3¼ by 7⅞ inches) are used. In general, each card represents a single BASIC language statement. An example of a properly marked card is shown in figure 1.

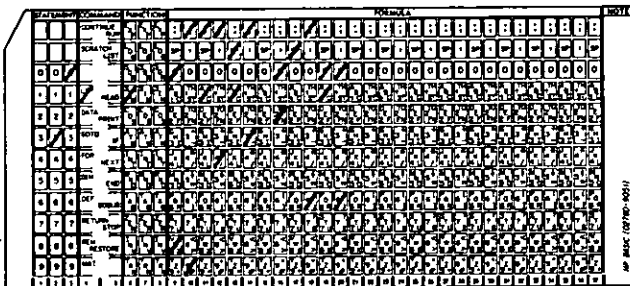


Figure 1. Example of properly marked HP BASIC program card.



2007A

Batch processing

During class, many independent marked-card programs submitted by the students may be stacked in the card reader hopper and processed continuously without operator intervention. For each program processed, the teleprinter in the system prints answers to the programmed problems or prints any error messages which may result from an incorrectly written program.

Additional challenges

The power of the 2114 computer in the 2007A System offers additional challenges to those students wanting to study other computer applications and languages. Assembly language or languages such as FORTRAN or ALGOL can be used to program the computer, offering opportunities for special projects, and expanding the capabilities of ambitious students.

General Specifications

Operating conditions: ambient temperatures 10° to 40°C (+50° to 104°F), relative humidity to 80% at 40°C.

Equipment furnished: 2007A Educational Computer System with cabinet, \$21,400 (four year lease \$556/mo.) consisting of

2114B Computer with Option 04, 8192 word memory

2761A-07 Optical Mark Reader and Interface Kit 12602A

2752A Teleprinter with Interface Kit 12531B

2991Z Cabinet

Options:

2737A High Speed Tape Reader with 12532A

Interface Kit\$2,100

Power: 115 V ac $\pm 10\%$, 60 Hz $\pm 5\%$, 1600 watts.

Cabinet dimensions: 59½" high, 49" wide, 31" deep.

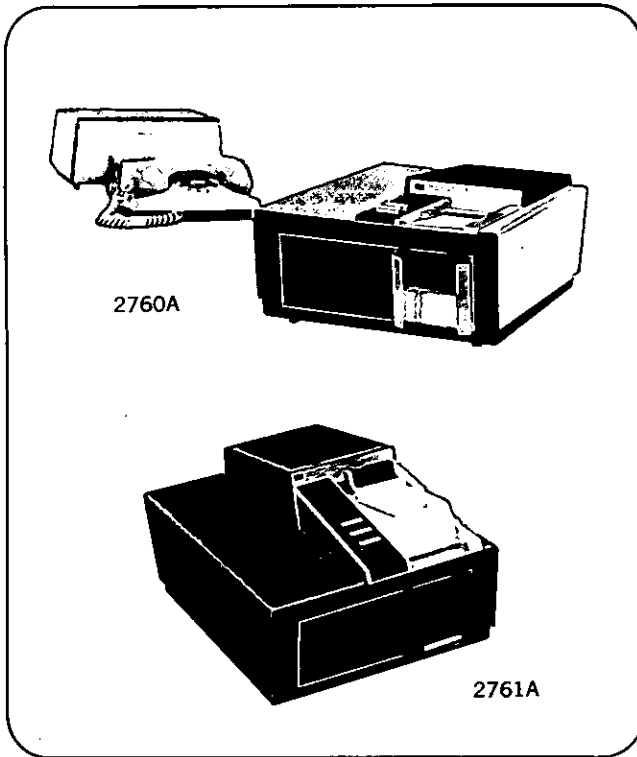
Net weight: 550 lbs. (1210 kg).



OPTICAL MARK READERS

For data entry and communication

Models 2760A, 2761A



The 2760A and 2761A Optical Mark Readers are low cost, desk-top, remote data-transmission terminals which read punched and marked tabulating cards. They are designed for use with standard telephone data sets in communication networks where limited information must be gathered from many sources; or where it is desirable to use the original document as direct input to the system, rather than punched cards, perforated paper tape, or manual entry of information by key-stroke. The 2760A is a manual feed Reader. The 2761A provides the extra convenience of automatic card feed.

The Readers are human-oriented data entry systems that take advantage of two common and portable data entry devices—pencil and paper. The input document is a standard tabulating card, coded by marking lines through pre-printed boxes with a regular soft lead pencil. Up to 80 columns of alpha-numeric information may be marked or punched on a single card.

Since the tab cards are hand-marked, and are read directly as marked, keypunch operations are bypassed. This eliminates the cost, error potential, and noise associated with key-stroke equipment—and speeds delivery of data to the receiving terminal.

In application, immediate data transmission can speed input of orders, payroll charges, inventory entries, shipments, billings, and similar operating data to a central data processor. Because the Readers are low-cost portable units, it is practical to locate them for data entry at many remote points.

Tab Card Specifications

Data entry documents: Standard tabulating cards, printed with reflective ink visible to the eye, but not to the photosensors of the Reader. A row of "clock" marks printed on the cards synchronizes reading with the data entry marks on the card.

Card design: The information can be arranged in almost any manner, with considerable positional freedom in the horizontal direction. For example, the cards can be divided into data fields; they can include printed instructions for data entry; and space can be provided for handwritten information not to be read by the Readers.

Coding formats: Models of the 2760A/2761A are available to read any one of three formats:

Hollerith Punch Format: The Readers read holes and marks interchangeably, and both on the same card. Mark positions occupy the punch positions of a standard tab card.

Dial Code Format: Hewlett-Packard's new "dial" code uses a simple alphabetic coding, arranged in a manner like a familiar dial telephone.

Marking cards: Data is written on the cards by marking diagonal lines in pre-printed boxes enclosing the characters to be read, using a regular soft black lead pencil. Skipping a column enters a space.

Correction of entries: A feature of the optical mark system is easy correction of errors. When undesired marks are erased completely they are not read; new marks entered correctly will be read instead.

Pre-punched cards: Cards can be pre-punched or pre-printed with identifiers and routine information for turn-around applications, reducing the amount of hand-entered data, and assuring correct identification of the turn-around document.

Reader Specifications

Installation: The 2760A/2761A requires only connection to ac power and an interface cable between Reader and Data Set.

Receiver compatibility: The 2760A/2761A Optical Mark Readers transmit at 105 characters/second or 10 characters/second to receiving terminals equipped to accept data transmissions from Bell Telephone System type 202C or 103A Dataphones, or equivalent common carrier data transmission equipment. Many receiving terminals are compatible, including AT & T Dataspeed Type 11 and Teletype Telespeed 1050 Tape Receivers; and Teletype 33 and 35 Teleprinters. Many digital computers, including Hewlett-Packard's are compatible for direct input, making possible multi-terminal networks, automatic polling, multiplexing, and preliminary processing.

Environment: The 2760A/2761A Readers are rugged, electrically-conservative units designed to operate not only in office environments, but also in construction sites, industrial plants; marine weather stations, and other locations where dirt, vibration, temperature, and humidity conditions are far from ideal. The Reader operates from 0 to 55°C; relative humidity to 95% at 40°C, not including Data Sets or cards.

Input power required: 115 V ac \pm 10%, 60 Hz.

Overall dimensions: 2760A: 12 $\frac{3}{4}$ " wide, 6 $\frac{7}{8}$ " high, 19 $\frac{1}{2}$ " deep (330 x 175 x 495 mm); 2761A is 9 $\frac{1}{4}$ " (235 mm) high.

Weight: 2760A: net 22 lbs (10,0 kg); shipping 29 lbs (13,2 kg); 2761A: net 28 lbs (12,7 kg); shipping 37 lbs (16,8 kg).

Accessories available: HP 12657A Simultaneous Teletype Coupler for dual operation of Teletype and Reader through a single type 103A Dataphone, \$150.

Price: HP Model 2760A or 2761A for 52 character Hollerith formats, \$2950; Model 2760A or 2761A for Hollerith formats, \$3100; dial code format adds \$50.

PARALLEL OUTPUT READER

For direct computer input
Model 2761A-07



COMPUTATION

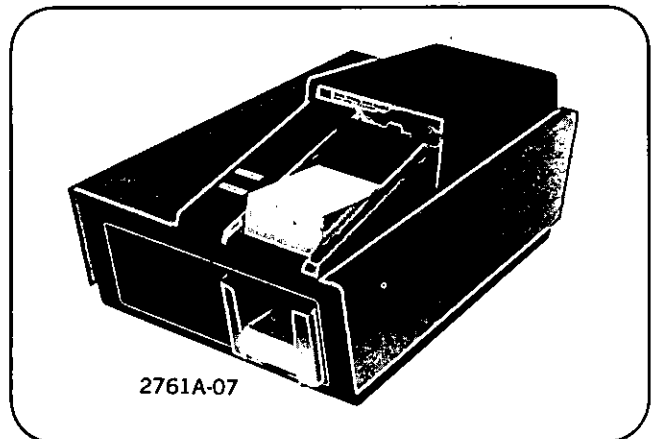
The HP 2761A-07 Optical Mark Reader is designed to read data directly into a computer or other data acquisition system in 12-bit parallel form. All necessary status and control lines are provided to permit operation of the Reader under program control. A minimum of standard logic and control circuits are required to completely interface the reader for a variety of applications. The automatic input hopper holds up to 300 cards. In the free-run mode, cards are fed at 250 cards per minute. In the demand mode, cards are fed under computer control at 200 cards per minute. The same advantages of marking or punching and card design flexibility available to users of the HP 2760A and 2761A Optical Mark Readers apply to the 2761A-07.

Application with HP computers

All Hewlett-Packard computers can utilize the 2761A-07 as a standard peripheral. Adding card capability to your Hewlett-Packard computer is accomplished by simply plugging in a single computer interface card and connecting a cable. Under program control, the tab cards are read character-by-character until the number of cards specified in the program have been read. The maximum number of characters per card and the encoded characters allowed are a function of the system software.

Specifications

Specifications for the 2761A-07 Reader are the same as shown for the HP 2761A Reader with the following exceptions:



2761A-07

Data rate: 200 cards per minute externally controlled, or 250 cards per minute when operated at the internal read rate. Maximum of 80 marked or punched columns per card, exact requirements being determined by computer software. 80 column cards, 455 char/sec $\pm 10\%$, 40 column cards, 277 char/sec $\pm 10\%$.

Data outputs: logic levels on 12 lines; 0.5 V true, open to maximum of +12 V for false at 12 mA maximum current.

Optional accessories: HP 12602A Interface Kit for reader use with a Hewlett-Packard computer, \$950.

Price: HP Model 2761A-07, \$2,750.

Digital magnetic tape units

Both the 2020 and 3030 Series tape units are system oriented, designed as highly reliable, economical peripherals for computers and other digital systems.

The 2020 Series are slow-to-medium speed tape units, offering tape speeds to 45 ips—rack-mountable with the other components of your system (optional cabinet available). 2020's offer the maximum in economy, with prices starting at \$4,500.

The 3030 Series offer tape speeds to 75 ips, providing data transfer rates in the medium-speed range (to 60,000 cps). Each tape unit in the 3030 Series is self-contained in a 30" wide free-standing castered cabinet. Prices start at \$7,000.

All Hewlett-Packard Digital Magnetic Tape Units are standardized on the industry-compatible IBM 7- or 9-track $\frac{1}{2}$ " digital tape formats, with NRZI recording.

Hewlett-Packard offers 3 models of Digital Magnetic Tape Units for use in conjunction with Hewlett-Packard computers:

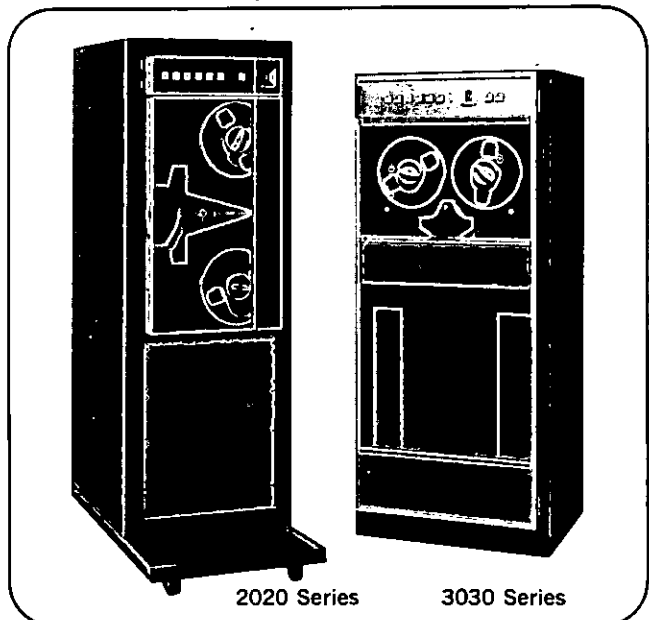
(H26)2020A, records on and reads from 7-channel tape at 200 bpi. Tape speed: 30 ips.

Price (complete with interface and software) . . . \$13,300*

(H26)2020B, similar to the 2020A, but records and reads at 200 and 556 bpi, switch selectable. Tape speed: 30 ips.

Price (complete with interface and software) . . . \$13,895*

(H01)3030G, records on and reads from 9-channel tape at 800 bpi. Tape speed: 75 ips. (Due to the speed of data



2020 Series

3030 Series

transfer, an HP computer requires the Direct Memory Access option for operation with this tape unit.)

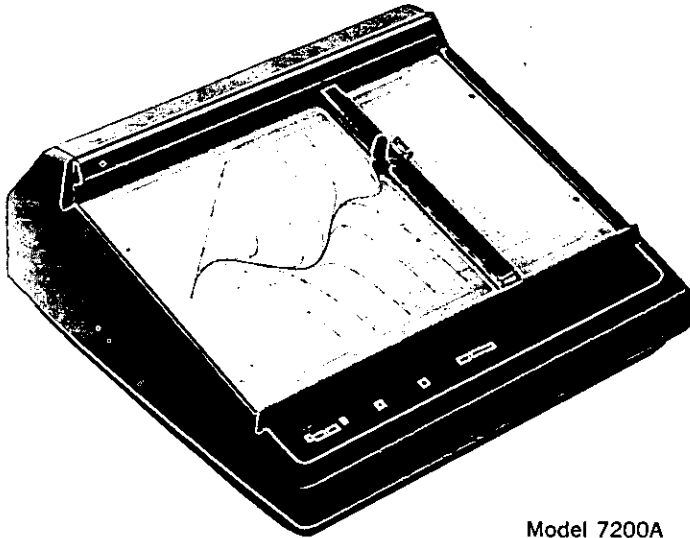
Price (including interface and software) \$18,500*

*Note: Prices are for 115 Vac, 60 Hz operation. For 230 Vac 50 Hz operation add \$200.



GRAPHIC PLOTTER

Low Cost Graphics
Model 7200A



Model 7200A

Automatic generation of graphics

Graphic solutions

Visual presentation of mathematical functions

Graphics output for time share application programs

Graphics for reports

The HP 7200A Graphic Plotter offers operator convenience coupled with problem-solving power that has never before been available in the computer graphics field. It can be used to form a graph from numerical data and through its software can also be used to manipulate the data, expand the data, and plot a finished graph, all with a minimum of operator effort. In addition, the operator can develop graphics directly, without using the Hewlett-Packard software. Using any source language, such as Basic or Fortran, the plotter format is easily achieved. The pen position is described by one absolute coordinate pair and is transmitted in ASCII code.

The 7200A is uniquely suited for the time share environment because of its teletype compatibility as well as its use of absolute coordinates. The machine logic monitors the input data and if there is an error in data transmission, the plot will stop and resume with the next correct input. Input characters are decoded as commands and the plotter will optionally plot points or straight lines between the co-ordinates.

The interface is designed such that the 7200A may be used anywhere there is a teletype model 33 or 35. The interface has the features of optionally suppressing the printer during plotter operation and plotting directly from punched paper tape or keyboard in the local mode.

Hewlett-Packard Autogrip electrostatic holddown grips the graph paper firmly; any size of paper up to 11 in. x 17 in. can be used. Manual controls on the front panel allow adjustment of graph limits to permit fitting of plot to preprinted grids. Disposable pens can be changed quickly and easily. Several colors of ink are available, permitting plots to be superimposed for comparison.

Extensive Software

An extensive system of graphics software has been written in Hewlett-Packard Basic and proven on Hewlett-Packard time share systems. This software provides a powerful system of graphics generation while maintaining maximum operator convenience. Program listings will be made available to 7200A users. The software system provides for curve generation, curve synthesis, absolute representation, and convenience routines. Algebraic functions or input data files along with descriptive control terms such as limit, increment, semilog, etc., are the inputs.

In contrast to specific applications programs that only scale and plot data, the 7200A software is oriented towards accomplishing the basic processes of graphics. The software is designed to help the operator in developing his own graphics applications.

Software Capabilities

All the graphic processes provided by the software are organized within a generalized input structure: the result in all cases is a graph on blank paper or on paper with preprinted linear, polar, log-linear, or log-log grids with optional axis and optional tic marks giving units in a 1, 2, 5 system. The input structure provides for three alternative problem inputs and two control inputs.

The problem input options are: 1) implicit, explicit or parametric algebraic functions, 2) a file of input data points, and 3) a file of input numeric elements. The control input includes a qualitative description of the graph paper and three scaling options: 1) a single continuous curve, 2) a family of curves with common scaling, and 3) singularity suppression.

Software Features

Curve Generation. Given as an input an explicit, implicit or parametric algebraic function, the 7200A will automatically plot a smooth curve of the function. The only inputs required are the algebraic expression, the range of interest to the user, and an optional specification of accuracy.

The specification of accuracy is particularly interesting; it controls the increment taken in the independent variable to achieve optimized plotting rate. This is accomplished by plotting the longest possible vector that falls within acceptable error limits from the exact curve segment; vector length and the corresponding increment are computed automatically by the curve generation software. This specification of accuracy provides several benefits: 1) the accuracy of the derived graph is known, 2) a faster but less accurate plot can easily be made to check form, and 3) in general, plotting time and data transmission time is reduced.

Curve Synthesis. A file of data points can be plotted as a smooth curve by deriving a function (or a system of functions) from the original data points and then plotting this function, using curve generation. In this way, the information inherent in the original data is extended to the region between adjacent points. Several curve-fitting options are provided to control the form of the derived function; the one used is selected on the basis of qualitative knowledge about the original data. The original data points are stored. Thus, several forms of curve fitting can be superimposed for comparison.

Using curve synthesis, the following operations are available:

Data handling—1) arrange the data file in the desired order;
2) select a range of data from the file to be plotted.

Curve fitting—1) high-order polynomial through the given points;
2) spline function through the points given; 3) least-square line;
4) least-square fit of standard function; 5) least-square fit with user-supplied function.

The spline function and least-square fitting with user-supplied functions are of particular interest in curve synthesis; each of these programs is capable of providing results similar to hand plotting. The spline function behaves like a flexible strip forced to run through each data point.

Absolute Representation. Here a literal plot of the input is made with no computational modification except that required for scaling. Function or file inputs can be represented by points or points connected by line segments.

Convenience Routines and Scaling. The convenience routines perform all the functions of scaling, coordinate transformation, and composition. These routines automatically determine the optimum size of the graph in relation to the graph paper used, place the graph in position on the paper, transform coordinates from one system to any desired system (Cartesian to polar, etc.) and rotate the graph in space to obtain the desired perspective on three-dimensional plots.

Future software expansion will include contour mapping, projection of families of curves, and simple layouts. Data and/or functions can be input to produce charts in any one of many projection systems representing three dimensional information. Arbitrary rotation as well as "planar slices" to show behavior with one variable constant is possible.

Simple geometric figures may be plotted by inputting elements and form descriptions and forming a graph from previously stored geometric figures. The range of this plotting routine is very large and can be used for such applications as plotting standard geometric figures such as circle, line, ellipse, etc.; plotting various forms of business graphs such as bar charts, pie-charts, etc.; or fixed figures such as alpha-numerics. Also, if the desired form is not present, a file containing simple geometric figures, with or without modifying parameters, may be inputted.

Specifications

Organization: the 7200A is a digital plotter that accepts ASCII digits which define each point as a 4 digit X and 4 digit Y coordinate and plots them as points or vectors up to 3 in. in length.

Graph limits: the usable grid limits are 10 in. on the Y axis by 15 in. on the X axis (25 cm by 38 cm) on a 11.5 in. x 17 in. platen surface. The X and Y graph limits are independently variable and can be continuously adjusted as follows: the lower left corner can be placed anywhere in the lower left quarter of the plotting surface, the upper right corner can be adjusted such that the resulting graph will be anywhere from 5 in. x 7.5 in. to 10 in. x 15 in. in size. These adjustments change the physical deflection for the same input. Front panel pushbuttons are provided to enter coordinates corresponding to lower left and upper right positions for alignment of graph with preprinted grids.

Paper holddown: electrostatic.

Writing method: disposable pen.

Static accuracy: ± 0.030 in.

Input range: 1 to 10^4 ; X and Y = 0000 for lower left, X and Y = 9999 for upper right.

Resolution: 0.005 in.

Resettability: 0.007 in.

Plotting speed: 1.1 s/point or line.

Interface: EIA RS 232; 20 mA or 60 mA TTY current drive; DTL & TTL logic compatible.

Packaging: all major units packaged on plug-in assemblies.

Graph paper: nine precision-ruled papers are available in linear, semi-log and log-log grids. Blank paper with scaling indicators also available.

Power requirements: 115/230 V ac, 50 to 400 Hz, 100 VA.

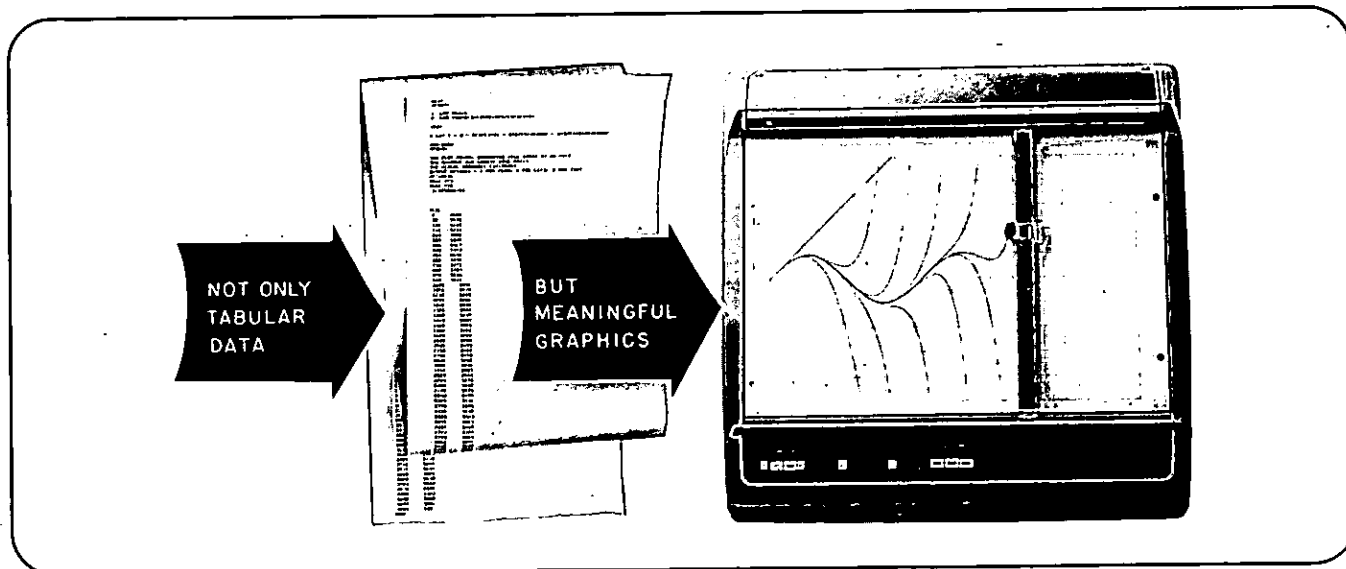
Dimensions: 20" wide, 19 $\frac{3}{8}$ " deep, 8 $\frac{1}{2}$ " high (50,8 x 49,2 x 21,6 cm).

Weight: net, 40 lb (18,1 kg); shipping, 50 lb (22,7 kg).

Price: HP 7200A (includes either option.001 or 002) \$3300

Options:

001	Interface cable for 33 or 35 TTY	N/C
002	Interface cable for Bell System TTY	N/C

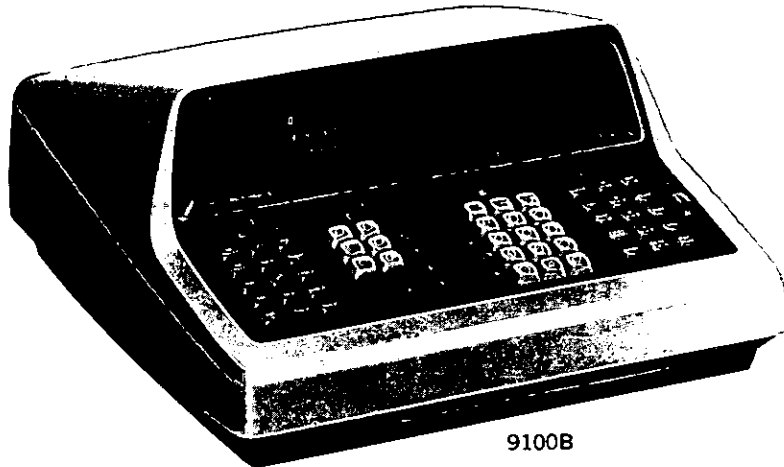


CALCULATOR



COMPUTING CALCULATOR

Scientific and engineering problem-solver
Model 9100A, 9100B



9100B

COMPUTING CALCULATOR

The HP 9100A and 9100B are programmable, electronic calculators which perform operations commonly encountered in scientific and engineering problems. Their log, trig and mathematical functions are each performed with a single key stroke, providing fast, convenient solutions to intricate equations. Computer-like memory enables the calculator to store instructions and constants for repetitive or iterative solutions. The easily-readable cathode ray tube instantly displays entries, answers and intermediate results.

Operations

Direct keyboard operations include

Arithmetic: addition, subtraction, multiplication, division and square-root.

Logarithmic: $\log x$, $\ln x$ and e^x .

Trigonometric: $\sin x$, $\cos x$, $\tan x$, $\sin^{-1}x$, $\cos^{-1}x$ and $\tan^{-1}x$. (x in degrees or radians.)

Hyperbolic: $\sinh x$, $\cosh x$, $\tanh x$, $\sinh^{-1}x$, $\cosh^{-1}x$, and $\tanh^{-1}x$.

Coordinate transformation: polar-to-rectangular, rectangular-to-polar, cumulative addition and subtraction of vectors.

Miscellaneous: other single-key operations include—taking the absolute value of a number, extracting the integer part of a number, and entering the value of π . Keys are also available for positioning and storage operations.

Speed

Times for total performance of functions, including worst-case decimal-point placement and carrying

Add, subtract: 2 milliseconds.

Multiply, divide: 35 milliseconds.

Square-root: 40 milliseconds.

Sin, cos, tan: 354 milliseconds.

Coordinate transformation: 332 milliseconds.

$\ln x$: 56 milliseconds.

e^x : 141 milliseconds.

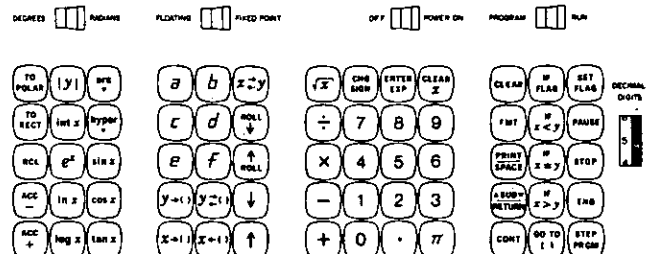
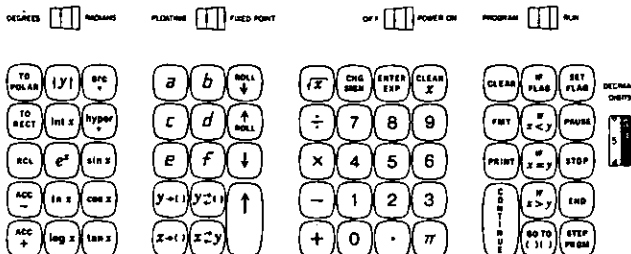
Numerical Format

The operator can select either **FIXED** point (eg. 1234.5678-90) or **FLOATING** point (scientific notation; eg. 1.234567890 $\times 10^3$) for display of entries and answers. The calculator's dynamic range is 10^{-98} to 10^{99} with up to 10 significant digits.

In **FIXED** point mode the operator selects the number of decimal places desired between 0-9 on the decimal wheel. Whenever more digits are placed left of the decimal point than the decimal wheel will allow, the Calculator automatically reverts to **FLOATING POINT** notation to allow completion of the calculation, with no loss of information.

Programming

The calculators are programmed either by use of the keyboard or by magnetic cards: The program mode allows entry of program instructions, via the keyboard, into program memory.



Programming consists of pressing keys in the proper sequence. Any key on the keyboard is available as a program step. The program capacity of the 9100A is 196 steps and the capacity of the 9100B is 392 steps. No language or code conversions are required.

The self-contained magnetic cardreader/recorder can record programs from program memory onto wallet-size magnetic cards. The reader/recorder can also read the magnetic cards back into program memory for repetitive use. Two programs of 196 steps each may be recorded on each reusable card. Cards may be cascaded for longer programs.

Program Instructions

Conditional branching: "IF" statements make the comparisons—less-than, equal-to, greater-than—and can be programmed to branch to any of the program addresses.

Unconditional branching: GO-TO statement can be programmed to branch to any of the program addresses. (Also used for manual addressing and correction of individual program steps.)

Subroutine: a true subroutine capability permitting instant access to subroutines from any point in a program. By using GO-TO-SUB/RET instruction, subroutines may be nested up to 5 deep. (9100B only)

Flag: provides conditional branching dependent on manual or programmed setting of flag.

Stop: halts program for data entry or display.

Pause: brief display of interim results in computation.

Step program: operator may step through program for visual verification of instructions. A "dual display" feature on the 9100B greatly simplifies program editing and modification. It allows the program step and the succeeding one to be displayed simultaneously.

Memory

Magnetic core memory includes

3 display registers (keyboard, accumulator, temporary.)

9100A has 16 storage registers with capacity for 196 program steps plus 2 constants. Total of 2208 bits of core memory.

9100B has 32 storage registers with capacity for 392 program steps plus 4 constants. Total of 3840 bits of core memory.

Capacity: register accommodates floating point number with 12 significant digits (including 2 undisplayed guard digits) and 2 digit exponent. Alternately, register accommodates 14 program steps.

Read-only-memory: contains over 32,000 bits of fixed information for keyboard routines.

9100A and 9100B COMPARISON

Items	9100A	9100B ¹
Storage Registers	16	32
Program Steps	196	392
Price	\$4400	\$4900

¹The 9100B also includes:

An additional positioning instruction X←() for more convenient data recall.

A dual program display for more convenient program edification.

A greater subroutine capability.

General

Temperature: operating range, 0-45°C.

Weight: net 40 lbs (18,1 kg); shipping 65 lbs (29,5 kg).

Power: 115 or 230 V ±10% (slide switch), 50-60 Hz, 70 W.

Dimensions: 8¼" high by 16" wide by 19" deep (210 mm x 406 mm x 483 mm).

Accessories furnished (no charge)

For 9100A: 09100-90001	Operating and programming manual. Additional copies—\$2.50
For 9100B: 09100-90021	
For 9100A: 09100-90002	Program Library binder containing sample programs. Additional copies—\$30.
For 9100B: 09100-90022	
5060-5919	Box of 10 magnetic program cards. Additional box—\$10.
For 9100A: 09100-90003	Pad of 100 program sheets. Additional pads—\$2.50.
For 9100B: 09100-90023	
For 9100A: 09100-90004	Magnetic card with pre-recorded diagnostic program. Additional card—\$2.50.
For 9100B: 09100-90024	
For 9100A: 9320-1157	Pull out instruction card mounted in calculator. Additional card—\$5.
For 9100B: 9320-1183	
4040-0350	Plastic dust cover. Additional cover—\$2.50.

Additional Accessories Available

All of above

5000-5884 Single magnetic card, \$2.

09100-90000 Box of 5 program pads, \$10.

09100-90007 200 magnetic cards without envelopes, \$80.

Purchase Plan

Purchase: HP 9100A, \$4400.

HP 9100B, \$4900.

Rent: HP 9100A, \$260 per month.

HP 9100B, \$285 per month.

Lease: HP 9100A, \$115 per month.

HP 9100B, \$128 per month.

Service contracts available.

Option 001 Pull-out instruction card in French

Option 002 Pull-out instruction card in German

Option 003 Pull-out instruction card in Italian

Option 004 Pull-out instruction card in Spanish

No additional charge for options.



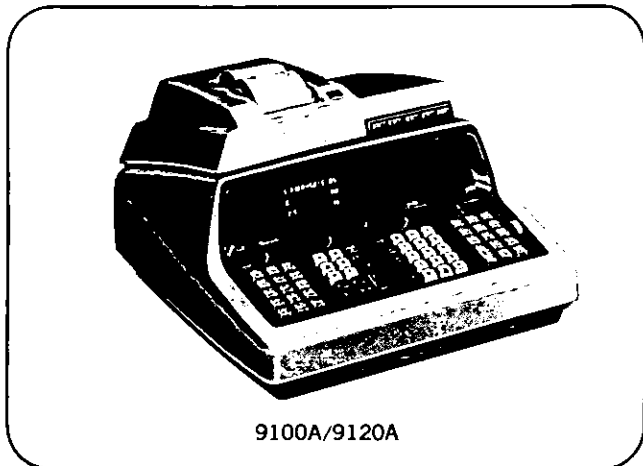
Program Library

The Program Library furnished with the 9100's include programmed solutions to practical problems in a wide range of scientific and engineering fields. It serves both as an illustration of programming techniques and as a source of ready-to-use programs. Program Library holders also receive the Hewlett-Packard KEYBOARD, a periodic publication which provides updating information and a forum for the exchange of programs by 9100 users. Program categories include:

Business	Mechanics
Chemistry	Physics
Electronics	Statistics
Fluid Mechanics	Structures
Life Sciences	Surveying
Mathematics	Thermodynamics

CALCULATOR PRINTER

The HP 9120A provides fast, quiet printer capability for use with the 9100 Calculators. The Printer prints the contents of any combination of X,Y and Z Calculator display registers upon manual or programmed command. It also lists contents of the Calculator's program memory upon command. Quiet operation is obtained using a unique electrosensitive printing principle. The 9120A Printer mounts on top of the 9100 calculators to ensure easy access and minimum space requirement. Operation of the Printer is initiated either manually by a single keystroke or in a program by one program step.



Print Characteristics

Printing rate: 180 lines/min. at 60 Hz, 150 lines/min. at 50 Hz.
Print format: any combination of X, Y, Z registers can be printed by depressing the appropriate key on the 9120A panel.
 Lists contents of program on command.
 Line capacity is up to 15 characters per line.
 Vertical printing at 5 lines per inch.
 Vertical formatting available on command.
Paper required: HP electrosensitive printer paper. (Roll 250' long by 2½" wide.)

General

Temperature: operating range 0-45°C.
Weight: net 13 lbs (5,9 kg); shipping 24 lbs (10,9 kg).
Power: 115 or 230 V ±10% (slide switch), 50 to 60 Hz, 45 W.
Dimensions: 4" high by 14¾" wide by 13½" deep (102 mm x 371 mm x 343 mm).

Accessories

Furnished: package of 3 rolls HP 9270-0802 paper. (Approx. 3 month supply).
Available: 9270-0802 pkg. of 3 rolls, \$9.75. 9270-0815 pkg. of 24 rolls, \$72.

Purchase Plans

Purchase: HP 9120A, \$975.
Rent: \$75 per month.
Lease: \$25.35 per month.
 Service contracts available.

CALCULATOR PLOTTER

Description: The 9125A provides permanent graphic solutions to problems solved by the Calculator. The Plotter plots the point, specified by the numbers in the Calculator's X and Y registers, when the format (FMT) instruction is activated. The relationship between the variables is ordinarily programmed in the Calculator which then drives the Plotter. The Calculator can also be used in the manual mode to transfer data coordinates to the Plotter directly.

Specifications

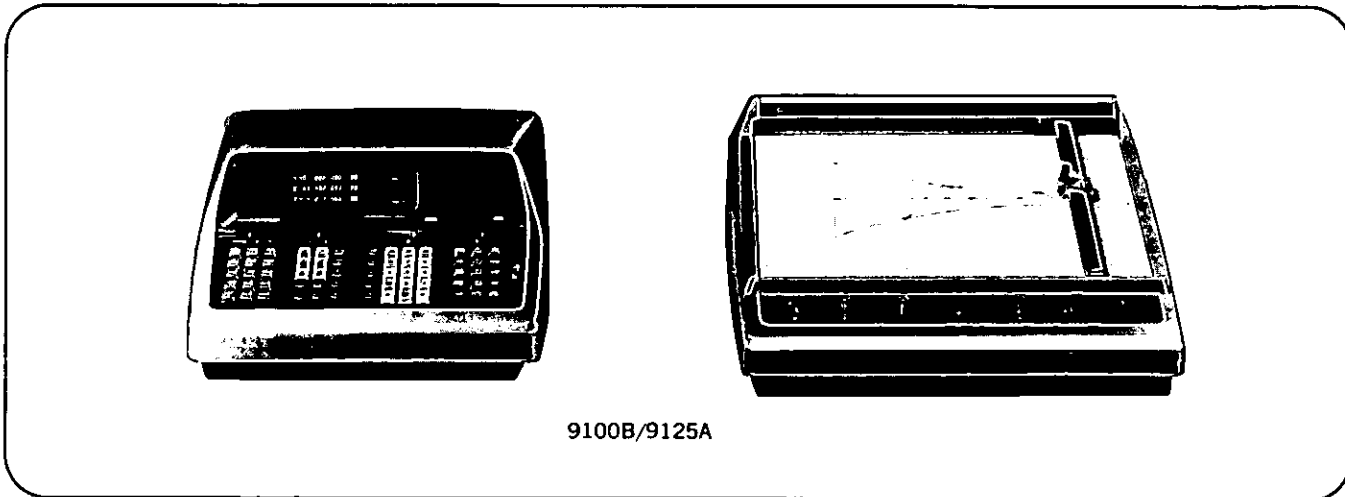
Plotting area: 10 inches on the Y-axis by 15 inches on the X-axis. (25 cm by 38 cm on metric paper.)
Origin: origin can be set anywhere on the plotting surface, allowing four-quadrant plotting.
Scale factor: 500 counts per inch (200 counts per cm) adjustable by at least ±10 counts per inch (4 counts per cm) by front panel scale vernier control.
Plotting accuracy: ±0.03 inches (0,08 mm).
Dynamic accuracy: deviation from straight line between two data points is less than ±0.04 inches (1,0 mm) for data points up to 5 inches (12,5 cm) apart, at constant ambient temperature.
Resettability: ±0.007 inches (0,18 mm).
Plotting time: minimum of 0.9 seconds from one plot point to the next. Total plotting time depends upon calculation time.

General

Temperature: operating range 5-45°C.
Weight: net 36 lbs (16,3 kg); shipping 48 lbs (21,8 kg).
Power: 115 or 230 V ±10% (slide switch), 50-400 Hz, 100 W.
Dimensions: 8½" high by 20" wide by 19¾" deep, (213 mm x 500 mm x 484 mm).

Accessories furnished at no charge:

09125-90001	Operating Manual
09125-90002	Magnetic card with Diagnostic Program
4040-0477	Dust Cover
09125-90000	Pull-out instruction card contained in the bottom of the 9125A
5080-3605	Slidewire cleaner
5080-3635	Slidewire lubricant
5080-7979	Pkg. of 3 red pens
5080-7980	Pkg. of 3 blue pens
9270-1004	Graph Paper, 20 sheets
9270-1024	Graph Paper, 10 sheets



Purchase Plans

Purchase: HP 9125A, \$2,475.00.

Rent: \$185.00 per month.

Lease: \$64.35 per month.

Service Contracts available.

Plotter Paper

To gain maximum benefit from the highly-accurate 9125A Calculator Plotter, we recommend precision-ruled plotting paper. Hewlett-Packard Company offers a wide variety of papers, available through all field offices. These are 11" by 16½" overall. Price: \$4.90 per box.

Linear:

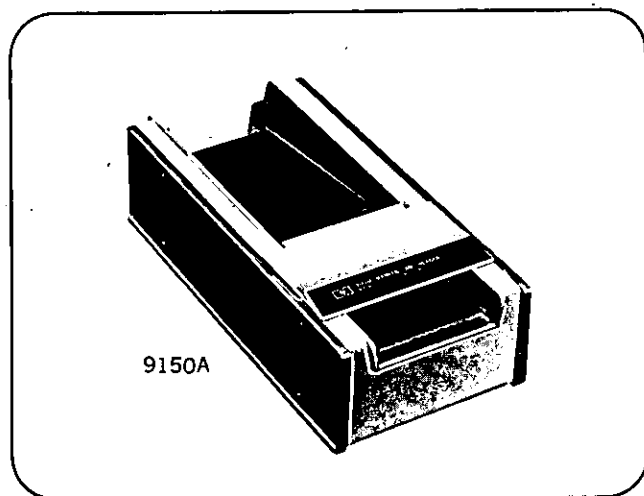
PART NO.	DESCRIPTION
9270-1004	10" x 15" plot area
9270-1024	25 cm. x 38 cm. metric plot area

Semi-log:

9280-0159	10" x 2 cycle plot area
9280-0160	10" x 3 cycle plot area
9280-0169	2 cycle x 15" plot area
9280-0168	3 cycle x 15" plot area

Log-log:

9280-0167	2 cycle x 3 cycle plot area
9280-0165	3 cycle x 2 cycle plot area
9280-0171	3 cycle x 4 cycle plot area



9150A

Cardreader

Description: The 9160A optically reads cards marked with a soft lead pencil. By using the standard size tab cards properly formatted, programs and numerical data can be entered quickly and conveniently. Each card can hold 28 program instructions or data. Cards can be cascaded easily.

The cardreader reads marks as contrasts in light reflection. This allows the operator to mark cards quickly and without special equipment for rapid entry into the Calculator.

Specifications

Line width: minimum 0.020 inch pencil mark required for reliable sensing.

Reading rate: 20 ms per character. Inserting card starts motor which pulls cards through the reader.

Codes: column weights of marked columns are added to total the calculator key code.

General

Weight: net 4.5 lbs (2.03 kg); shipping 5.5 lbs (2.5 kg).

Power: takes power from HP 9100 Calculator. (Idle 2.5 W, running 3.5 W.)

Dimensions: 3½" high by 5-1/3" wide by 11¼" deep.

Temperature: operating range, 0-45°C.

Cards

Furnished: package of 100 Calculator program cards.

Available: 9320-1182 Calculator program format.

9320-1192 Calculator data format.

Pkg of 2,000 \$15.00.

Pkg of 10,000 \$60.00.

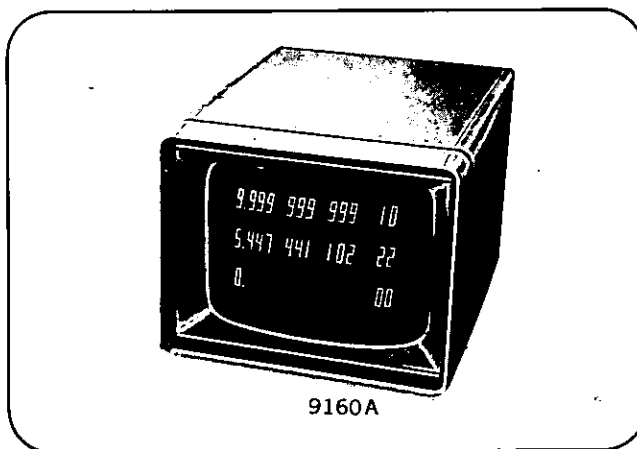
Purchase Plans

Purchase: HP 9160A, \$490.00.

Rent: \$35.00 per month.

Lease: \$12.74 per month.

Service Contracts available.



9160A

Calculator Display

Description: The 9150A is a large screen display of the 9100's X, Y and Z registers, which allows a large group to see the calculations. Instructors find this peripheral exceptionally valuable. They can better explain scientific concepts using the display.

Specifications

Character height: ⅜" wide by 1" high.

Brightness: capable of being viewed in normally illuminated room.

Viewing angle: 45° either side of center screen.

Mounting: options available for ceiling; wall; rack; and desk top mounting.

General

Operating ambient temperature range: 0-45°C.

Dimensions: 15" high by 17" wide by 21" deep.

Weight: 65 lbs (29.3 kg).

AC input requirements: 115 V ±10%, 50-60 Hz (230 V available as an option), 250 W.

Price: to be announced.

Available: early 1970.



Digitally Controlled Power Sources

(DCPS's) are complete digital-to-analog links between a computer (or other digital source) and any application requiring a fast, accurately settable source of dc or low frequency ac power. Initially these applications may be thought of as requiring a digital-to-analog converter with augmented output power capability, a digitally controlled power supply, or a digitally controlled waveform synthesizer. However, such applications generally require more than a programmable power supply or the simple tandem combination of a D/A converter and an operational amplifier. Interface circuitry must be added to ensure compatibility between the computer and the D/A Converter. Additional circuits required to complement the D/A converter include:

- reference and B+ sources
- isolation between input and output
- internal storage to:
 - A. Increase computer operating efficiency.
 - B. Minimize programming overshoots.
- programmable current limiting protection for the output power amplifier and the load
- feedback signals to inform the computer of the power source status

The name "Digitally Controlled Power Source" denotes a single compact, trouble-free package which includes *all* of these functions—interfacing, storage, D/A conversion, bipolar power amplification, protection, digital feedback, and all necessary bias supplies.

The illustration is a simplified block diagram of Model 6130B (± 50 V @ 0-1A) and Model 6131B (± 100 V @ 0-0.5A) Digitally Controlled Power Sources. Model 6933B Digital/Analog System Interface (± 10 V @ 0-10 mA) is similar except for its lower output rating and the elimination of the function selection block, the current limit

D/A converter, and its associated reference. The specifications for all three models are shown on the following pages.

Interface

Customized plug-in interface cards match the Digitally Controlled Power Source to the computer (8421 BCD or Binary).

Isolation

All digital inputs are floating and isolated from the floating analog output, thus avoiding troublesome loops between the output ground and computer ground.

Storage

Inputs from all digital data lines are stored upon receipt of a gate signal from the computer; this stored information is provided as input to the D/A converter. 55 μ sec after the gate, a flag signal informs the computer that enough time has elapsed for the commanded output voltage level to be achieved. This output level will be maintained until a new gate signal is received—thus, the computer is free to perform other tasks in the interval between voltage level commands.

Storage also insures that non-simultaneous arrival of signals on all digital input lines will not cause programming overshoot or undershoot—eliminates the necessity of programming the output to zero before setting each new output level.

Function Selection

Selects the output voltage range, and isolates the three input bits to the current limit D/A converter. It also selects whether output voltage range and current limit setting are to be determined by switches inside the DCPS or controlled by the computer.

Output Voltage D/A Converter

Converts one polarity bit plus 16 BCD voltage bits or 15 binary voltage bits to an analog voltage for input to the power amplifier. Thus, resolution is 0.5 mV for straight binary and 1 mV for BCD operation.

Reference #1

Provides reference voltage for Output Voltage D/A Converter.

Current Limit D/A Converter

Sets current limit of power amplifier to one of eight values.

Reference #2

Provides reference voltage for Output Current D/A Converter.

Bipolar Power Amplifier

Programs either side of zero or through zero without output polarity switches or "notch" effects, with an accuracy of 0.5 mV or 10 mV depending on range.

Output programs over the following voltage spans, in less than the time listed below, with a resistive load equal to or less than rated output current:

6130B: -50 to $+50$ V @ 0-1A in less than 100 μ sec.

6131B: -100 to $+100$ V @ 0-0.5A in less than 100 μ sec.

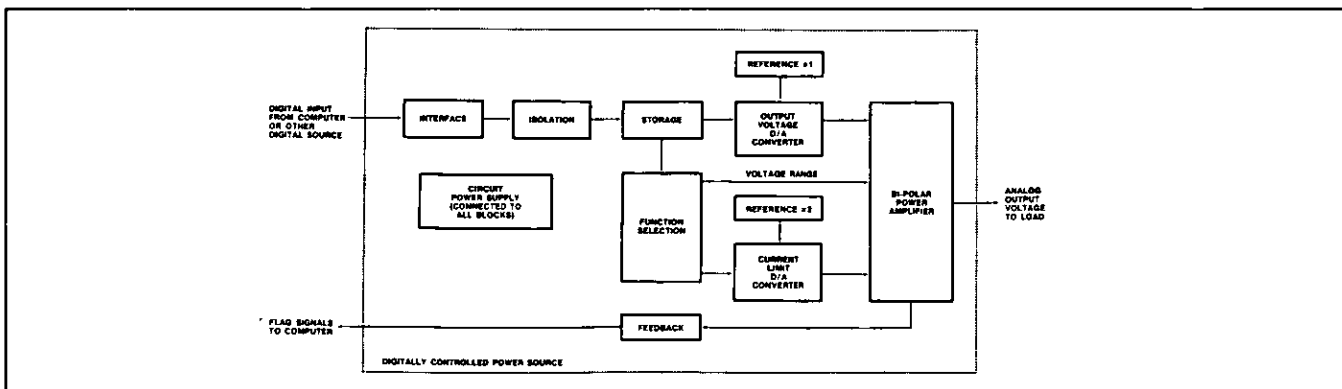
6933B: -10 to $+10$ V @ 0-10 mA in less than 20 μ sec.

Circuit Power Supplies

This functional block provides the necessary dc power to all the other functional blocks—no external power supplies are required.

Feedback

The simplified format in the block diagram only suggests the nature of the three feedback signals to the computer. The first of these is a flag (completion of tack) signal which occurs 55 μ sec after the input gate signal (2 msec after input gate signal if range is changed) and informs the computer that the programmed level exists at the output. The remaining two bits send overload information through isolated data lines—the computer is continuously informed of any current overload and power amplifier shut-down.

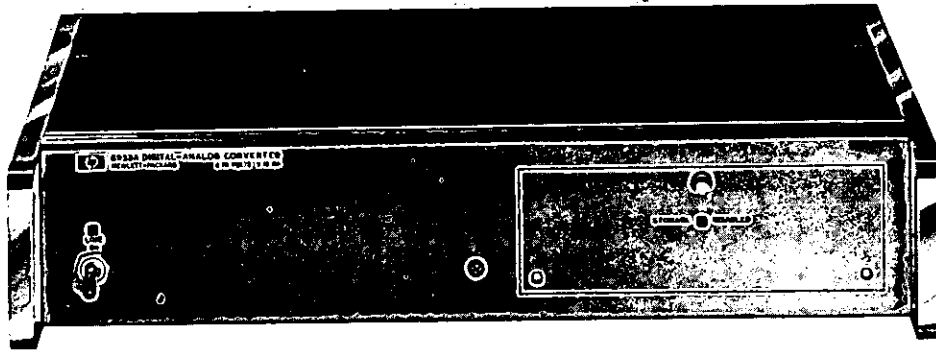


DIGITAL VOLTAGE SOURCES

D-A System interface
Model 6933B



COMPUTER PERIPHERAL



6933B

SPECIFICATIONS

	Binary 6933B	BCD 6933B
DC analog output voltage:	-16.384 V to +16.3885 V	-9.999 V to +9.999 V
Source current compliance: Source current flows out of the more positive voltage terminal	10 mA @ ± 16.384 V 20 mA @ ± 10.000 V 30 mA @ ± 5.000 V 40 mA @ 0.000 V	20 mA @ ± 9.999 V 30 mA @ ± 5.000 V 40 mA @ ± 0.000 V
AC line regulation: Output voltage change for a change in line voltage between 103.5 Vac and 126.5 Vac (or 207 Vac and 253 Vac for option 28)	200 μ V	150 μ V
Temperature coefficient: Output voltage change per $^{\circ}$ C change in ambient tem- perature following 30 min- utes warm-up	160 μ V	100 μ V
Instability: Output voltage drift under constant line, load, and ambient tempera- ture for 24 hours after 30 minutes warm-up	500 μ V	300 μ V

Sink current compliance: 10 mA.

NOTE: sink current flows *into* the more positive voltage terminal. The 6933B may be damaged if the sink current exceeds 10 mA.

AC power input (48-440 Hz)

115 V ac standard: 115 V $\pm 10\%$, 0.4A, 40 W.

230 V ac (Option 28): 210-250 V, 0.2A, 40 W.

Load regulation: 100 μ V. Output voltage change for a change in output source or sink current within ratings.

Calibration error: 500 μ V. Maximum absolute voltage accuracy deviation at 23 $^{\circ}$ C $\pm 3^{\circ}$ C, 115 V ac input, no load, following 30 minutes warm-up.

P-P ripple and noise: at any line, load and temperature conditions within ratings; dc to 400 KHz: 1 mV.
DC to 50 MHz: 60 mV.

Temperature ratings

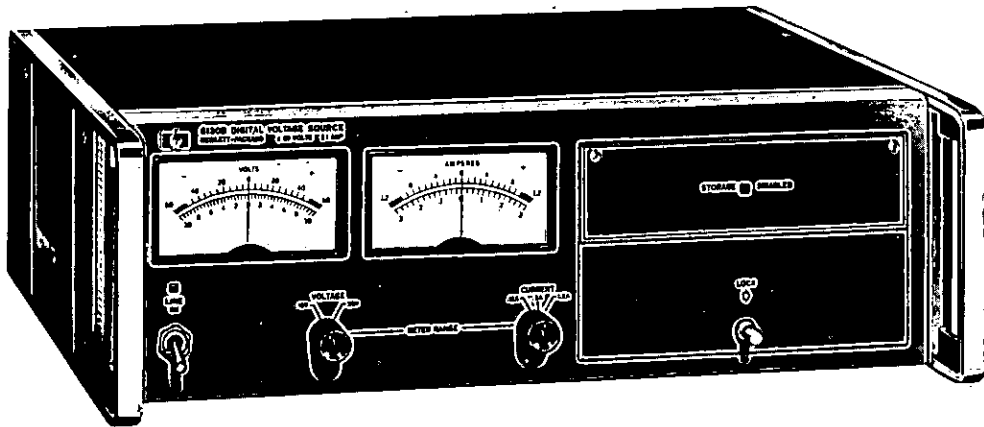
Operating: 0 to 55 $^{\circ}$ C.

Storage: -40 to +75 $^{\circ}$ C.

Load transient recovery time: 5 μ sec. Time required for the output voltage to recover within 1 mV of the programmed value following a 10 mA change in output current.

Programming time: 20 μ sec. Maximum total time required for the output voltage to change and settle to 99.9% of programmed value using a resistive load.

Worst case overshoot and undershoot of programmed voltage with a resistive load: 5 V.

COMPUTER PERIPHERAL**DIGITAL VOLTAGE SOURCES**System-compatible, fast bipolar output
Models 6130B, 6131B

6130B

SPECIFICATIONS

Model:	Binary 6130B Dual range		BCD 6130B Dual range		Binary 6131B Dual range		BCD 6131B Dual range	
	X1	X10	X1	X10	X1	X10	X1	X10
Range:								
DC Analog Output Voltage:	-16.384 to +16.3835 V	-50.00 to +50.00 V	-9.999 to +9.999 V	-50.00 to +50.00 V	-16.384 to +16.3835 V	-99.99 to +99.99 V	-9.999 to +9.999 V	-99.99 to +99.99 V
Source Current Compliance: Source current flows out of the more positive terminal	1 Amp				0.5 Amps			
Sink Current Compliance:	0.5 Amp				0.25 Amp			
	Sink current flows into the more positive voltage terminal. Sink current can be forced into a 6130B or 6131B by an active load, a discharging capacitor, or an inductive load. A sink current of more than the ratings above may damage the instrument.							
Load Regulation: Output voltage change for a change in source or sink current within ratings	150 μ V	500 μ V	150 μ V	500 μ V	150 μ V	1 mV	150 μ V	1 mV
Temperature Coefficient: Output voltage change per de- gree Centigrade change in am- bient following 30 minutes warmup	160 μ V	800 μ V	100 μ V	500 μ V	160 μ V	1.6 mV	100 μ V	1 mV

Specifications (continued)

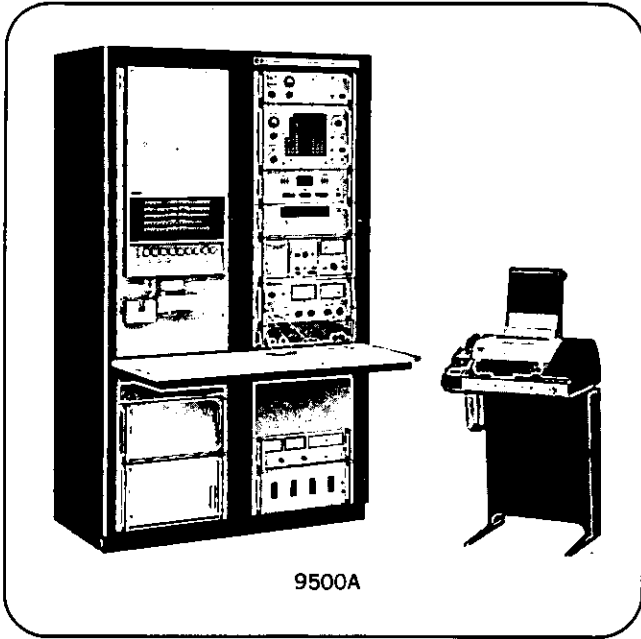
Model:	Binary 6130B or 6131B Dual Range		BCD 6130B or 6131B Dual range	
Range:	X1	X10	X1	X10
AC power input 48-440 Hz:	115 Vac, 1.2 A, 100 W (Standard) (230 Vac, 0.6 A, 100 W Option 28 only)			
AC Line regulation: Output voltage change for a change in line voltage between 103.5 Vac and 126.5 Vac (or 210 Vac and 250 Vac for option 28 only).	500 μ V	5 mV	400 μ V	4 mV
Calibration error: Maximum absolute voltage accuracy deviation at 23°C \pm 3°C, 115 Vac input, no load, following 30 minutes warm-up.	500 μ V	5 mV	500 μ V	5 mV
Instability: Output voltage drift under constant line, load, and ambient temperature for 24 hours, after ½ hour warm-up.	500 μ V	2.5 mV	300 μ V	1.5 mV
P-P Ripple and noise: At any line, load, and temperature conditions within ratings.	DC to 400 kHz	0.5 mV	1 mV	0.5 mV
	DC to 50 MHz	10 mV	10 mV	10 mV
Load transient recovery time: Time required for the output voltage to recover within 0.1% of full range voltage rating following a full load current change.	150 μ sec	50 μ sec	150 μ sec	50 μ sec
Programming time: Maximum total time required for the output voltage to change within one range and settle within 0.1% of the programmed value using a resistive load. Voltage range programming requires 2 msec.	300 μ sec	100 μ sec	300 μ sec	100 μ sec
Worst-case overshoot and undershoot of programmed voltage with a resistive load.	4 V	10 V	4 V	10 V
Temperature Ratings:	Operating 0 to 55° C		Storage -40° to +45° C	

AUTOMATIC TEST SYSTEMS



STIMULI • RESPONSE MEASUREMENTS

Processing data • Recording results
DC to 500 MHz — Model 9500A



9500A

The Model 9500A Automatic Test System is a computer-controlled versatile test system using a family of Hewlett-Packard programmable instruments for providing output stimuli, response measurement, and processing and recording the resultant test data. The Model 9500A is suited ideally for production or assembly line testing where high reliability and little maintenance is required. It offers a number of options (as shown in the table) to suit most customer test requirements.

Software/Programming. The Model 9500A Automatic Test System uses a simple computer language called HP BASIC which enables the operator or programmer to write his programs in English-like statements. By using an interpretive compiler, resident in the System's computer memory at all

times, an operator can become a "programmer" since a program can be written by typing instructions directly into the computer on the Teleprinter and then executing the program upon command via the same Teleprinter.

HP BASIC, used with the Model 9500A, consists of the popular BASIC language extended to include instrumentation control statements. This computer test language is so simple that it can be learned in approximately 4 to 8 hours.

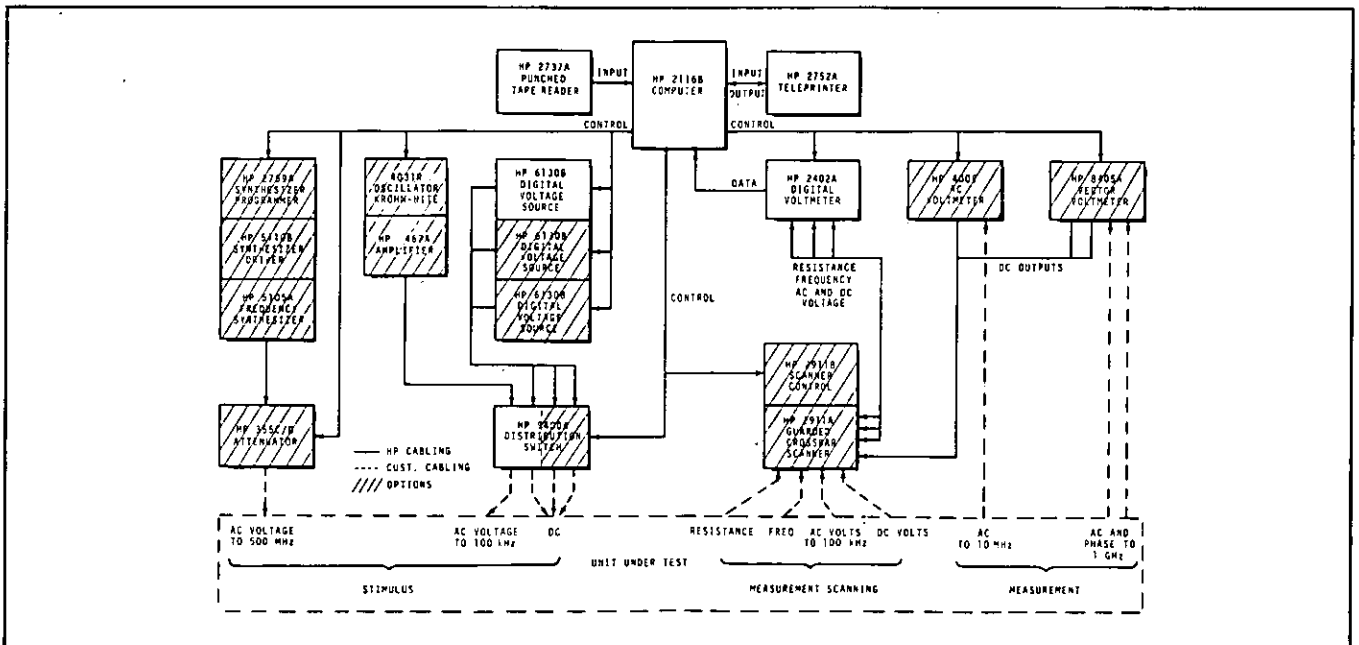
The test engineer using the Model 9500A is normally the most qualified person to write a test program since he is the one most familiar with the tests to be made. After a test program is written it can be checked immediately for inaccuracies and failures. Corrections can be made without time-consuming delays associated with off line compiling.

Hardware. The Model 9500A uses the HP 2116B Computer and other instruments from Hewlett-Packard's expanding family of programmable instruments. The table shows the instruments and components which comprise the Model 9500A.

System Operation. The block diagram shows the System complete with all options. System control is either through manual keyboard entry on the teleprinter or by previously prepared programs via the punched tape reader. The stimuli consists of dc, ac to 100 kHz, and ac to 500 MHz. DC and low frequency ac stimuli are routed through the distribution switch to the unit under test (UUT).

Measurement inputs consist of dc, ac to 1 GHz, ohms, and frequency. AC measurements above 100 kHz are recorded on the digital voltmeter (DVM) as a dc voltage by routing the dc outputs of the respective meters through the measurement scanner to the DVM. The input scanner also has signal switching to route ohms, frequency, and ac/dc inputs to the appropriate DVM connector for direct measurement.

The System (less options) is supplied with a two-section distribution switch, with one section for switching dc stimuli outputs to the UUT and one section to switch dc voltages to the DVM for measurement.



HIGH PERFORMANCE TO COST RATIO
Reliable • Easy to program
Modular • Computer-controlled



AUTOMATIC TEST SYSTEMS

HP 9500A automatic test system data

Function	Key Specifications	*Instrument
Standard system equipment		
Computer	8k memory, 16 I/O channels	HP 2116B
Teleprinter	Input typing: 100 words/min punched paper tape output = 10 char/sec, printed page output = 10 char/sec	HP 2752A (modified ASR-33)
Punched tape reader	300 char/sec, 1" paper tape	HP 2737A
DC stimulus	± 50 V, 0.01 V resolution; ± 10 V, 0.001 V resolution; 0 to 1A output, current limit programmable	HP 6130B
DC voltage measurement	100 mV to 1,000 V in 5 ranges, 5 full digits + over-range, 1 μ V resolution on lowest range, guarded	HP 2402A
Distribution switch	Two relay trees, each with 1 four-wire input + 16 four-wire outputs	HP 9400A
System options		
DC stimulus (additional)	Same as above; 8 total (max.)	HP 6130B
Distribution switch (additional plug-in modules)	Relay tree, 1 four-wire input and 16 four-wire outputs, (HP 9400A holds 4 total, max.)	Switch modules
AC voltage stimulus to 100 kHz	0.1 to 99,900 Hz, 0.1% resolution; 0.00 to 9.99 V, 0.01 V steps; amplifier provides low output impedance	4031R (Krohn-hite)
AC voltage stimulus to 500 MHz	0.1 Hz to 500 MHz, 0.1 Hz resolution; 0 dBm output into 50 ohms	HP 5105A HP 5110B HP 2759B
Attenuator	DC to 1 GHz, 0 to 132 in 1 dB steps	HP 355C/D (programmable)

Highlights of HP automatic test systems

High Performance to Cost Ratio—HP Automatic Test Systems use standard programmable instruments and computers specifically designed for automated testing. I/O card interfaces are generally standard items. The HP BASIC language used for programming minimizes the cost of application software. Software and hardware training are also included in the price.

Reliability—Instruments and computers used in HP systems are the same proven reliable equipment in use in laboratory production test, and field service environments throughout the world.

Easy to Program—The new HP BASIC language provides easy programming and program change capability. By using an *on-line* interpretive compiler, each test statement is checked automatically for errors during programming and executed one step at a time. This eliminates off-line compiling and tedious debugging. Test operators familiar with the devices to be tested can do the actual programming with only four to eight hours of instruction in HP BASIC.

Function	Key Specifications	*Instrument
Options (continued)		
AC measurement to 100 kHz	50 Hz to 100 kHz, 1 V to 1000 V full-scale (750 V peak) (4 ranges); full 5 digit readout with over-range; 10 μ V resolution on lowest range	HP 2402A/02
AC measurement to 10 MHz	1 mV to 100 V full-scale—10 Hz to 10 MHz	HP 400E (programmable)
AC and phase measurement to 100 MHz	1 MHz to 1,000 MHz (10 bands) 0.1 mV to 1 V full-scale (9 ranges) $\approx 180^\circ$ phase measurement	HP 8405A (programmable)
Measurement scanning	200 three-wire channels, random access, 3-wire ac/dc, 2-wire freq., 6-wire ohms measurement	HP 2911B HP 2911A/ M23
Frequency measurement	0.1 V to 100 V input, 5 Hz to 199.999 kHz, 1 Hz resolution	HP 2402/05
Resistance measurement	1 k Ω to 10 M Ω full-scale (5 ranges) 6-wire measurement, full 5-digit readout with over-range, 0.01 Ω resolution on lowest range	HP 2402A/03
Cabinet	Mounting rails, power strip, caster base, fans, filters	1, 2, or 3 bays as req. All equip. installed
Additional 8k memory	Offers total of 16k memory system	HP 2116B/M5
Heavy duty teleprinter	When equipment usage exceeds 5 hrs/day or 30 hrs/week	HP 2754A (ASR-35) replaces HP 2752A

*Also includes computer I/O interface boards, cables, software driver, instrument modifications as required.

Modularity—The interface to instruments is made through standard I/O cards. Therefore, systems can be expanded or reconfigured as a customer's requirements change.

Computer-controlled—Most HP systems are controlled by a general-purpose digital computer along with a powerful language. This permits easy program branching to subroutine for fault isolation and offers an inherent system capability for calculating parameters on the devices under test. It also allows processing of data into test reports and statistical records for engineering or management evaluation.

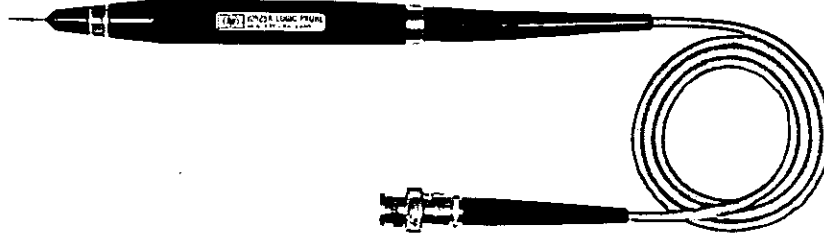
Custom systems

Custom automatic test systems, similar to the HP 9500A, are being produced for module and component testing, R.F. and microwave testing, calibration of equipment, data acquisition and processing, nuclear instrumentation, and avionics and communications devices. These systems are most useful when large quantities or varieties of items must be tested rapidly and the results made available immediately.

Hewlett-Packard will assume system responsibility for interfacing equipment supplied and any required instrument software drivers.

**LOGIC PROBE**

Rapid visual pulse
Model 10525A



10525A

Model 10525A Logic Probe**Advantages:**

- Rapid Visual Pulse and Logic Level Indicator
- Compatible with TTL, DTL, and most other IC logic
- Protected against Extreme Overload

Tracing logic levels and pulses through IC circuitry for logic design, maintenance checks, troubleshooting or training becomes easy with the Model 10525A Logic Probe. It has a preset threshold of 1.4 volts which is compatible with conventional TTL and DTL circuits. When touched to a high level or open-circuited, a band of light appears around the probe tip; when touched to a low level the light goes out. Single pulses of 25 ns or wider are stretched to give an indication time of 0.1 s. The light flashes on or blinks off depending on the pulse's polarity. Pulse trains up to 1 MHz produce partial brilliance; pulse trains from 1 MHz to 20 MHz produce either partial brilliance or momentary extinction, depending on duty cycle.

The circuit under test can first be run at normal speed while checking for the presence of such key signals as clock, reset, start, shift, and transfer pulses. Next, the circuit can be stepped, one pulse at a time while checking the truth tables of the logic packages for defects. A complete digital system can be checked by clocking it slowly through its internal states.

With no adjustments needed and with an indicator at the finger tips, the Model 10525A frees the user to concentrate on circuit analysis, rather than measurement technique.

Model 10525A functions equally well with logic schemes other than TTL or DTL, as long as the switching threshold is near 1.4 volts. It is not, however, compatible with ECL current mode logic. A variety of power connecting accessories makes connection to the required 5 volt power supply (eg., HP Model 6213A or 6214A) easy. The circuit under test can frequently provide the necessary drive.

Specifications**Input**

Impedance: 10 k Ω .

Trigger threshold: +1.4 V, nominal.

Minimum pulse width: 25 ns.

Overload protection: -50 V to +200 V continuous, -200 V to +200 V transient, 120 V ac for 10 s.

Power: 5 V \pm 10% at 75 mA, BNC power connector. Internal overload protection to \pm 7 V supply.

Temperature: 0 to 55°C.

Accessories included: BNC to Alligator Clips, BNC to banana plug adapter, BNC bulkhead connector, ground cable assembly.

Price: Model 10525A, 1 to 4 units, \$95; 5 to 9, \$90; 10 to 20, \$85; for larger quantities please consult Hewlett-Packard.

LOGIC MODULE TEST SYSTEM

Comparison testing at 10,000 points/second

Model 2060A

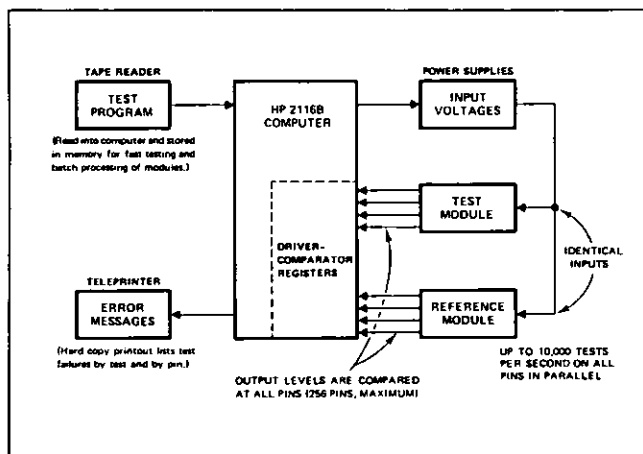
The HP 2060A Digital Logic Module Test System is a computer-controlled automatic system engineered to be easy to put to work and efficient to use. The fast test capabilities of this system will help you to: cut test costs, break production test bottlenecks and improve product reliability.

The system employs a comparison technique in which the responses of 'test' modules are checked against responses of a known-good 'reference' module. The same test inputs are applied to both modules in a programmed sequence, and responses at all module pins are compared simultaneously, at rates to 10,000 tests per second. As shown in the block diagram, the system controller is the HP 2116B Digital Computer, (page 67), with driver-comparator registers forming the heart of the system. The output signals from the two modules are tested to see if there is an error that is outside the programmable tolerance of the comparator. Results, based on success or failure of comparison on a pin-by-pin, test-by-test basis, are logged by the system on a teleprinter for reporting of module faults. The comparison technique does not require test responses to be specified in the test program—a significant shortening of test programming time.

Test conditions are program specified. High and low logic levels, positive and negative current limits, and test tolerances are generated according to test program instructions. Thus, the 2060A System can test a wide variety of logic circuits without special adaptation. The system can be equipped to generate up to four separate sets of test conditions simultaneously, for testing different types of logic (DTL, CTL, TTL, RTL, ECL, etc.) on the same module.

The system operates in accordance with programming instructions written in a test-oriented software language—AuTest—which takes advantage of the benefits of comparison testing. The language minimizes the time spent learning programming, and maximizes the number and scope of tests performed. These features result in savings to the user in startup and operation costs, and minimum disruption of the users normal production line functions.

AuTest speaks the language of digital design engineers and technicians. Less than one day of instruction is necessary to learn the statements needed to write usable test procedures. To effectively program the system, the programmer



AUTOMATIC TEST SYSTEMS



does not have to know the function of the board for which he is writing a program; he only need be familiar with the functions of digital logic.

Actual time spent programming is a function of the complexity of the module to be tested. With experience, even the most complex modules can be programmed in a couple of days time.

The language is powerful. Permute statements permit a few program statements to produce thousands of individual tests, a powerful multiplication of the programmers time.

The 2060A is capable of two modes of operation. A 'run' mode is used for quickly sorting modules on a production run basis. Each module to be tested is plugged into a test fixture, and the system is commanded on the teleprinter to run the test. At the end of each test, the system prints out the module defects, detailed down to the connector pins which represent the faulty circuit. At this point, the system can be used in a 'conversational' mode to help debug module faults. The operator can modify test conditions, specify additional tests, and set up special sequences to provide repetitive waveforms for oscilloscope display.

The 2060A system is flexible. In its minimum configuration, it tests up to 16 module connector pins; it can be easily expanded to 256 pin capacity in 8-pin increments for check-out of the most complex modules. Interchangeable plug-in module test fixtures and fast read-in of test programs convert the system easily and rapidly to changing module configurations, making it economical to test small batches of modules.



Hewlett-Packard has for many years been an industry leader in the development, manufacture, and supply of automatic digital data acquisition systems. Hundreds of Hewlett-Packard digital data systems of the type described in this catalog are on duty worldwide, performing data acquisition tasks automatically and often on a 100% duty cycle basis during tests. These systems far surpass any manual data taking methods in accuracy and dependability, while at the same time releasing skilled people from the costly routine of meter reading and other test procedures to more creative engineering tasks. The advent of solid-state circuitry, in combination with valuable systems application knowledge gained through experience, plus the increasing complexity of measurement requirements, has resulted in significant Hewlett-Packard contributions to the field of automatic digital data acquisition, namely, the widest selection of the most versatile systems-oriented instrumentation available.

Standard-system concept

Hewlett-Packard employs a "standard-system" modular concept in configuring the wide range of data acquisition capability offered. Many data acquisition installations using Hewlett-Packard systems have proved this approach to be of sound engineering value with added user benefits of:

- Better specifications.** Each system is a thoroughly engineered, tested package, and is completely specified on a data sheet.
- Greater reliability.** Through the use of production techniques as applied to standard Hewlett-Packard instruments.
- Shorter delivery.** Because systems are composed of standard instruments produced in volume.
- Easy expandability.** Systems are offered with many standard options allowing easy reconfiguration, even after initial purchase, to suit changing needs. This also makes it easier, and less expensive, to satisfy special requirements. Hewlett-Packard has made it particularly easy, for example, to convert from hardware-control to a computer-automated system by merely adding the computer, suitable interface cards, and cables.

Typically a digital data acquisition

system accepts analog inputs—dc/ac voltages, resistances, and frequencies—converts them to digital form and provides a permanent record of the measurement results.

The complete line of Hewlett-Packard digital data acquisition systems is described here and in more detail on the following pages. The systems are of two basic forms: (a) All-hardware-controlled systems, i.e., instruments are manually preset to perform their respective functions in the data acquisition process. These systems are characterized by high-resolution (6 digits) at relatively low speeds (up to 40 channels per second). (b) Computer-controlled systems, i.e., all measurement functions are software programmed by a digital computer. These systems may be used with low-speed, high resolution front ends similar to those of the non-computer systems, and/or high-speed subsystems with multiplex rates to 100 kHz and resolution in the order of 3 or 4 digits.

Digital data system elements

The elements comprising an HP data acquisition system are shown in the block diagram. A brief description of the various system modules is presented here, however, each is described in more detail on the pages referenced.

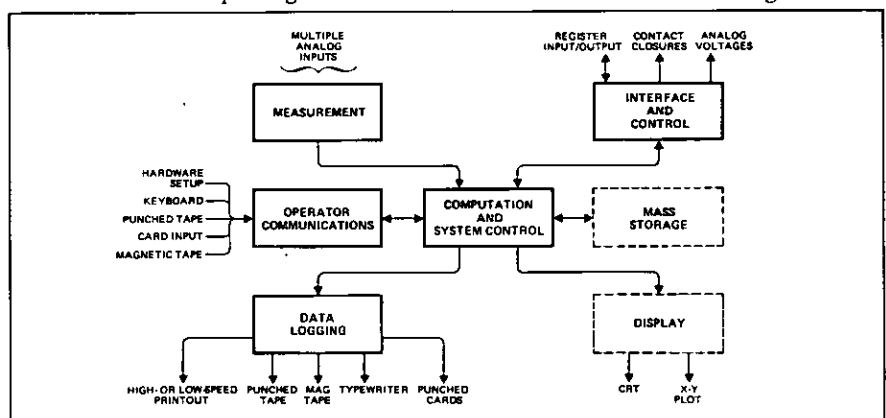
Measurement. This is the analog input/digitizing function, commonly called the system "front-end". In all-hardware controlled systems (pages 100-101) and also in high resolution, low-speed computer-controlled systems (page 102) this consists of an analog input scanner (page 97) capable of switching up to 1000 inputs plus a digitizer (integrating digital voltmeter, pages 208-214). The scanner connects the input signals to the

digitizer either consecutively or in a programmed sequence. In hardware-controlled systems, all measurement functions are programmed by means of diode pinboards in the scanner. In high-speed computer-controlled systems (page 103), inputs (up to 512) are switched through a multiplexer (page 104) to an analog-to-digital converter.

Computation and system control. The central element of these systems is a system data coupler (page 105) for hardware-controlled systems, or a computer for computer-controlled systems. The coupler receives digital information from the digitizer and translates it to the proper form for entry into a data logging device (digital recorder). The recorded characters can be arranged in any desired order up to 20 digits long by means of an internal formatter. Coupler options include a digital clock and manual data register. The clock provides time-of-day recording before each measurement scan and also allows measurements to be initiated at preset time intervals. Up to 12 digits of manually-set data may be added to the digital record.

Software programmed computer-controlled systems offer virtually unlimited control of the data acquisition process. The computer controls all instrument measurement function and recording devices, provides temporary data storage, and performs on-line calculations.

Data logging. Data can be logged on ASCII coded punched tape, 7- or 9-channel magnetic tape, strip printers, typewriters, and punched cards. Computer-controlled systems are additionally capable of logging data on high-speed line printers, X-Y CRT display and X-Y plotter; magnetic discs and drums are also available for mass storage.



Hardware and computer-controlled data acquisition system composite block diagram.

Operator communications. In hardware-controlled systems, this function involves manually presetting or programming DVM measurements, selecting channels to be scanned, and manual data entry. In computer-controlled systems the operator enters programs and reference data into the system by means of punched or mark-sense cards. A typewriter keyboard (teleprinter) can also be used to request data and programs from mass (disc) storage.

Interface and control. Many versions of bidirectional registers are available to interface user-furnished equipment to the system computer. Hard-contact relay output registers are available for controlling external circuits; digital-to-analog converters for controlling analog-type devices are also available. Since Hewlett-Packard computers include up to 48 I/O channels, the inherent flexibility of computer-controlled systems can be utilized to monitor and control many external devices, over and above the basic system capabilities.

Hardware-controlled systems

Three series of hardware-controlled systems are available. These offer high accuracy and resolution (to 6 digits), common mode and superimposed noise rejection, and the ability to handle dc, ac, resistance, frequency, and period inputs. These systems are used for measuring slowly changing phenomena, or static analysis at speeds up to 40 channels per second. All are available with a choice of measurement recording devices including printed strip, magnetic tape, punched tape, typewritten sheet, and punched cards. The principal differences are in the system "front-ends".

The 2010 Series systems (page 100) use the 2401C Integrating Digital Voltmeter as the digitizing element, along with the 2901A or 2911A/B Input Scanner. The 2010 Series are characterized by exceptional common mode and superimposed noise rejection, selectable integration time, and built-in programming capability. Measurements include dc and ac voltage, resistance, frequency, and period.

2012 Series systems (page 100) are designed principally for applications requiring the ability to measure millivolt-level dc signals at higher speeds than the 2010 or 2014 systems—up to 40 channels/second. 2012 systems are furnished with either the 2911A/B Crossbar Scanner or 2912A Reed Scanner, and can measure dc and ac voltage, resistance, and frequency.

2014 Series systems (page 100) are built around the 2911A/B Scanner and the 3450A Multi-Function Meter. 2014 systems measure dc and ac voltage, resistance, and dc, ac and resistance ratios.

Computer-controlled systems

Computer-controlled systems for data acquisition use low- and high-speed analog-to-digital subsystems in several standard configurations to suit specific measurement applications. The subsystems are supplied complete and ready for operation with any of the Hewlett-Packard computers described on pages 67-72. Additionally, these computerized systems are able to provide stimuli and control outputs to the unit under test or the process being monitored. The major benefits of computerized systems are:

- (a) Raw data is processed as it is taken, yielding meaningful information on-the-spot. Besides shortening overall times to complete projects, this immediacy of feedback allows equipment set-ups to be changed if necessary during critical tests, while conditions still prevail.
- (b) Total flexibility is provided in data gathering. Under computer control, sampling rates for various inputs to the system can be automatically adjusted to follow the rates at which input values may change. Data from several sources can be correlated and the sequence and nature of measurement and computations changed accordingly, in the course of a test.
- (c) Much greater versatility in data input-outputting is possible. Data can be entered, recorded, and displayed concurrently in many different forms.

High resolution subsystems. These subsystems (page 102) are a natural outgrowth of the hardware-controlled systems, using identical front-end instrumentation but transferring system coupler functions to computer control, while retaining the noise rejection, resolution, speed and other excellent system measurement capabilities. The subsystems include computer interface hardware, interconnecting cables, software drivers, and an analog scan routine. A choice of four high resolution computer-controlled subsystems is available.

The 2320A subsystem offers the best combination of measuring speed and versatility. It measures up to 14 dc channels per second and accepts plug-ins to measure ac voltage, resistance, and fre-

quency. The front-end is identical to the 2012A/B systems.

The 2321A subsystem measures dc and dc ratio with a plug-in for ac voltage and ac ratio and also resistance and resistance ratio. It provides excellent accuracy for true rms ac measurements. The front-end is identical to the 2014 A/B systems, with dc measurement speed to 10 channels per second.

The 2322A subsystem offers maximum rejection of superimposed noise and measures dc and ac voltage, resistance, and frequency. A choice of three integration periods, 0.01, 0.1, and 1 second provides 3-, 4-, and 5-digit resolution, respectively, offering a trade-off of resolution and noise rejection for increased speed. The front-end is identical to the 2010M/N systems.

The 2323A subsystem offers the fastest measuring speed on dc inputs—up to 40 channels per second—with full integration and measuring accuracy even for low-level inputs such as thermocouples. The subsystem measures dc and ac voltages and frequency. The front-end is identical to the 2012C/D systems.

High speed subsystems

High speed computer-controlled subsystems (page 103) are available in six versions for measuring dynamic parameters with multiplexed sampling rates to 100 kHz. Each consists of an analog-to-digital converter, plus computer interface, software driver, and verification software.

The 2310A subsystem is available in 14-bit and 12-bit (including sign) versions with throughput rates of 19 kHz and 64 kHz, respectively. It includes sample-and-hold with aperture time of 50 nanoseconds, and accepts ± 10 volts full scale input.

The 2310B subsystem adds multiplexing capability to the 2310A subsystem. Input capacity can be expanded to 64 channels in 8-channel increments. Throughput rates are 18 kHz and 50 kHz, respectively, for the 14-bit and 12-bit versions. The 2310B is also available with differential input to alleviate common mode noise problems.

The 2310C subsystem is applicable where the high resolution, speed, and accuracy of the 2310B are not required. It is a lower cost multiplexed ADC with 12-bit (including sign) resolution, 100 nanosecond aperture time, and 35 kHz throughput rate. Capacity is 8 to 64 channels.

The 2311A subsystem is an ADC with optional 8-channel or 16-channel multi-

plexer. Resolution is 10 bits (including sign), aperture time is 50 nanoseconds, and throughput rate is 100 kHz. It is available with ± 10 , 2.5, or 1 volt full scale input.

The 2312A subsystem offers fast, low-level measurements with excellent common mode rejection. It consists of a low-level multiplexer with up to 64 channels and a 12-bit ADC. As many as eight multiplexers may be used with this subsystem. Program-selectable ranges allow full-resolution measurements from ± 10 mV to ± 10 V full scale. Throughput rate is 12 kHz.

The 12564A subsystem is a single channel high-speed ADC on a card that plugs into the computer I/O system. It is applicable in systems of fewer than three channels. It provides 10-bit (including sign) resolution with 17.6 or 22 microseconds conversion time, depending on the model of computer used. Selectable sensitivity is ± 10 V or ± 1 V full scale.

The HP 2781A Pacer is a hardware timing reference optionally available to provide precise timing of samples for applications such as spectrum analysis.

Peripherals

Peripherals for data input/output include low- and high-speed paper tape readers and punches, 7- and 9-channel magnetic tape units, fast-access fixed-head disc memories and, in addition to printout available from the teleprinter, there is a 20 lines/second strip printer and a 300 lines/minute line printer. Graphical presentations may be obtained with a CRT display and, for a permanent record, a drum type X-Y recorder. All these devices are interfaced with the computer simply through standard plug-in cards, installed either in the computer or an optional I/O extender.

For interfacing user-furnished equipment eight different plug-in interfaces for the computer I/O system are available. The 12554A is a dual 16-bit register for bidirectional data transfer, mating with transistor equipment. The 12597A is an 8-bit version of this register. For mating with microcircuit equipment, a 16-bit dual register, 12566A, is available. And for control of external equipment, there is a hard-contact 16-bit relay output register, 12551B.

In addition, for data input there is 12604B, a 32-bit interface, and for data output there is 12556B, a 40-bit output register. For programming power sup-

plies, there is a 20-bit output register, 12661A. And for analog devices (such as X-Y CRT display or plotter), there is a dual-channel digital-to-analog converter, 12555A.

Modular software drivers for all these peripherals allow easy expansion or reconfiguration of the software operating system; source programs are not burdened with the minutiae of driving these peripherals. Multilevel priority interrupt is standard; service priorities are changed simply by transposing the corresponding interface cards.

Computer-controllers

Any one of the Hewlett-Packard digital computers, Model 2114B, 2115A, or 2116B may be used as a system controller. Selection of the appropriate computer will normally be based on input/output capacity, memory size and speed capability (usually in that order). Possible need for future I/O or memory expansion should be considered.

The 2114B and 2115A are available with 4K of 8K internal memory; cycle time is 2 microseconds. The larger 2116B is available with 8K or 16K memory, externally expandable to 32K; cycle time is 1.6 microseconds. Main frame I/O capacities are: 8 channels for the 2114B, 2115A and 16 channels for the 2116B. A 16-channel I/O extender can be used with any of the Hewlett-Packard computers and a 32-channel extender can be used with the 2115A and 2116B. Plug-in options for the 2115A and 2116B include an Extended Arithmetic Unit for high-speed multiply/divide and long shift-rotate instructions, recommended for applications involving substantial on-line computation, and Direct Memory Access, recommended for high-speed data acquisition and magnetic tape recording, and required for disc memory.

The 2114B therefore, is suitable for relatively small systems requiring no more than 24 I/O channels. Model 2115A is a good all-round machine for the majority of applications. Model 2116B should be selected where maximum memory or I/O capacity is needed.

All are 16-bit machines, sharing the same word structure, instruction repertoire and software. Assuming the equivalent memory configuration and processor options are used, programs are interchangeable from one model to another.

System software

Software furnished with computer-controlled data acquisition subsystems includes a FORTRAN compiler, Hewlett-Packard Assembler, Basic Control System, and utility routines. (Software available for Hewlett-Packard computers is listed on page 70). The basic software is operable in 4K memory but offers additional capabilities with 8K memory. The FORTRAN compiler and Hewlett-Packard Assembler both generate relocatable object code, giving convenient page-free programming and the ability to write programs in several FORTRAN and assembly language sections, which are automatically linked together when they are loaded.

For applications where maximum simplicity of programming is desired, Hewlett-Packard BASIC language is an alternative to FORTRAN. With CALL statements, the user can exchange instrument control parameters and measurement results between his BASIC program and instrument control subroutines (drivers). The data acquisition capability provided with BASIC is most suitable for 'on-demand' or conversational use, in keeping with the primary intent of BASIC as a conversational language.

Supplementing the basic software is a Data Acquisition and Control Executive program (DACE) which greatly facilitates operation of the system in real time, and permits modification of the stored program with respect to system timing, channel assignments and computation constants directly through the teleprinter keyboard, without program recompilation.

For real-time data acquisition and control applications where multi-programming capability is advantageous, Hewlett-Packard offers the HP 2005A Real-Time Executive System. In this system, the Real-Time Executive (RTE) schedules the running of programs on a priority basis under both time and event control. The availability of background processing concurrent with fast response to high-priority demands for service, makes possible maximum utilization of the hardware. The RTE is used with 2116B computers with 16K memory, direct memory access, memory protect, and extended arithmetic capability. Also required are 184K of disc memory and high-speed punched tape input.

DATA SYSTEM ELEMENTS

Instruments for data acquisition systems



DATA ACQUISITION

Input Scanners

2912A Reed Scanner is a multi-function scanner which switches guarded 3-wire inputs at speeds to 40 channels per second. Interchangeable modules plug into the main-frame:

- 10 channels of low level dc with the 2921A
- 10 channels of high level dc and ac with the 2922A
- 9 channels of frequency with the 2923A

Up to four modules can be installed; further input expansion is through 2920A Scanner Extenders which hold up to 10 modules each. As many as 10 extenders can be controlled by a 2912A, for 1000 channel scanning capacity.

Integrity of millivolt level signals, such as those from strain gage bridges or thermocouples, is preserved through the scanner.

System programming capability is a built-in feature of the 2912A. Diode pinboards, conveniently located behind the front panel, provide easy control of all DVM functions. Additionally, channels may be individually selected for measurement or skip-over by front panel switch selection. Groups of 10 channels may be handled in the same manner. Upper/lower scan limits select the first and last channel address, and operating modes include single and continuous scan, manual scan, and single channel monitor.

Optional interface for Hewlett-Packard computer is available. Panel height of 2912A or 2920A 5 $\frac{1}{4}$ " (113 mm).

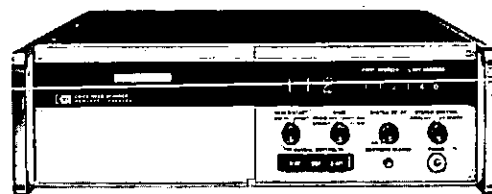
Prices: 2912A Scanner, \$3500; 2921A Low-Level DC Module, \$600; 2922A DC AC Module, \$600; 2923A Frequency Module, \$600; 2920A Extender, \$1500.

2911 Guarded Crossbar Scanner offers user choice of 600 1-wire, 300 2-wire, 200 3-wire, or 100 6-wire inputs. Permits guarded 2-wire voltage or 4-wire resistance measurements. Lower and upper scan limits selectable at front panel, with random access to any channel. Roller-mounted switch withdraws from rear for easy cabling. Maximum scanning rate is 30 channels/second. Interface for Hewlett-Packard computers available. Panel height 14" (355 mm).

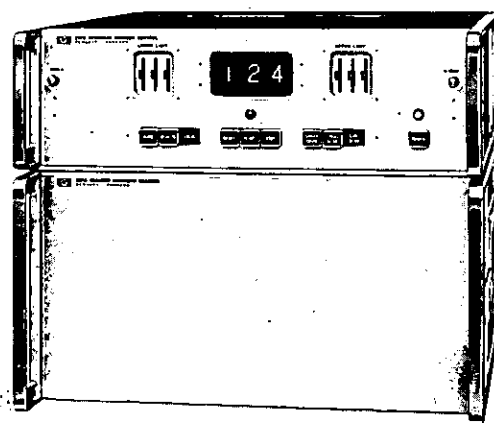
Price 2911, \$5600.

2901A Input Scanner/Programmer scans 25 3-wire inputs and programs all functions of associated system. May be expanded to 100 channels with 2902 Slave Units. Easy system set-up with individual quick-release input connectors and pushbutton selection of channels to be scanned. System functions and measurement delay are programmed individually for each channel with built-in pinboard. Maximum scanning rate is 12 channels/second. Panel height 7" (178 mm).

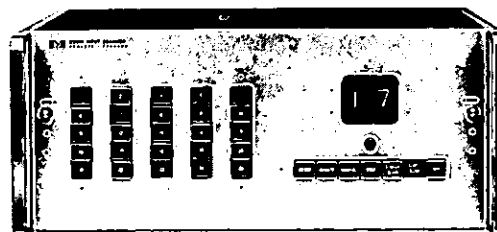
Prices: 2901A Master, \$2375; 2902 Slaves (25 channels each), \$1975.



2912A



2911



2901A

Peripheral Equipment

2930A Low-Level Multiplexer (page 104) is a fast, solid-state analog signal scanner that enables analog-to-digital converters to make usable low-level measurements in fast-sampling computer-automated data acquisition systems. It accepts up to 64 differential analog inputs with 20 kHz multiplex rate. Eleven input ranges programmable in binary increments to 1024 provide full scale inputs from ± 10 mV to ± 10 V. A choice of input filters provides rejection of undesired signal frequencies and superimposed noise; an internally-driven guard provides common mode rejection. Digital interface for analog-to-digital converters and Hewlett-Packard computers is available. Panel height 7" (178 mm).

Signal converters

2410B AC/Ohms Converter (page 214) is used in conjunction with 2401C Digital Voltmeter for measurement of ac voltages and resistances. Converter features floated, guarded input compatible with the voltmeter. Combined common mode rejection is 110 dB at 60 Hz. 2410B is fully programmable for systems use. Converter function and range information included in voltmeter display and recording outputs. Panel height 7" (178 mm).

Price: HP 2410B, \$2350.

Analog-to-digital converters

2401C Integrating Digital Voltmeter (page 214) features floated and guarded input and is average-reading, yielding an effective common mode noise rejection better than 140 dB at all frequencies, including dc. All operating functions may be controlled manually or by external contact closures to ground, enabling it to be used on the bench or in systems. BCD outputs provided. Panel height 7" (178 mm).

Price: 2401C, \$4300.

2402A Integrating Digital Voltmeter (page 212) combines 40 samples per second system measuring speed with 5 digit resolution. Get low-level measurements without pre-amplification. Common mode noise rejection >120 dB is provided by guarding and integration. Optional plug-in circuit cards for ac, resistance and frequency measurements yield a multimeter useful for both bench and system applications. Panel height 5 $\frac{1}{4}$ " (133 mm).

Price: 2402A, \$5450.

3450A Digital Multi-Function Meter (page 208) is basically a five-digit integrating DVM with five dc voltage ranges from 100 mV to 1000 V. Guarding and integration provide 140 dB CMR at dc, 120 dB at 60 Hz, at system speeds to 10 measurements per second. Isolated four terminal dc voltage ratio measurements are standard; options ex-

pand instrument to ac and ac ratio (true rms response), ohms and ohms ratio. Panel height 3 $\frac{1}{2}$ " (88 mm).

Price from \$3150.

5610A High-Speed A to D Converter (page 99) for measurements at rates to 100 kHz of signals to ± 1 V full scale (optionally ± 2.5 V, ± 10 V). Used in data systems employing a digital computer. Resolution is 9 bits plus sign, and aperture time with sample and hold is 50 ns. Multiplexer capability available for 8 or 16 channels with 100 kHz throughput rate. Panel height 5 $\frac{1}{4}$ " (133 mm).

Price: \$2000.

12564A High-Speed A to D Converter (page 103) is a plug-in circuit card for use with HP 2116B, 2115A and 2114B Digital Computers. Makes ± 1 V or ± 10 V (switch selectable) full scale single-ended measurements at rates to 50 kHz. Resolution is 9 bits plus sign, and aperture time is 17.6 μ s with 2116B, 22 μ s with 2115A or 2114B.

Price: 12564A, \$1100.

System controllers

2114B, 2115A or 2116B Digital Computers (page 67) provide methods for flexible, sophisticated system control. Timing and sequencing of the input scanning, measuring and recording functions is controlled by the computer. It can also perform limit comparison, code conversion and output formatting otherwise accomplished by separate instruments. Data manipulation such as solving multiple variable equations on stored data or measured inputs from one or more channels is easy when the system includes one of these devices.

In high speed system applications, the computer serves additionally as a data buffer storage unit to permit accumulation of data at rates beyond that of the fastest recording devices.

Price: 2114B with 4096 word memory, \$9950; 2115A with 4096 word memory, \$14,500; 2116B with 8192 word memory, \$24,000.

Output coupler, recorders

2547A Coupler (page 105) operates with a variety of input and output devices. As a data acquisition system element, it translates BCD information from a digital voltmeter into the correct code and format for the following digital recorders.

Price: 2547A Magnetic Tape output, \$7325 to \$10,050; 2547A Punched Tape output, \$6275; 2547A Teleprinter output, \$4500 to \$7100; 2547A Typewriter output, \$5100; 2547A Flexowriter output, \$8825; 2547A Card punch compatible, \$3800; Manual data input, \$1000; Digital clock \$1500 to \$2100.

DATA ACQUISITION

High speed, general purpose ADC

Model 5610A



DATA ACQUISITION

Analog-to-digital converter Model 5610A

The Model 5610A Analog-to-Digital Converter is a general purpose ADC that offers the following features: 100 kHz throughput rate for a 10-bit word (including sign); a sample-and-hold amplifier that provides an extremely short (50 nanosecond) aperture time; a 1, 8 or 16-channel capacity; a choice of input levels (the standard ± 1 volt level for full-scale at 10 megohms input impedance or the optional ± 2.5 or ± 10 volts levels for full scale at reduced input impedance).

The Model 5610A can operate in an internal or external sequence, or a random access mode, either with or without an encode command required. The operating modes are determined by a seven-bit command word from the associated computer. The converter samples the analog signal on each of the input channels and converts it to a binary number to be read into computer memory. After a channel is sampled in the internal sequencing mode, the converter automatically samples the next channel. The external sequencing mode permits one channel to be sampled as many times as desired; the converter only transfers to the next channel when an "external sequence pulse" is provided. For either mode, the converter can be wired on site to recycle after any number of channels. The random access mode allows any channel to be addressed by supplying the appropriate channel number in binary code as part of the command word. In any mode, an encode command is required for each conversion unless the command word specifies a free run condition. In free run, a conversion is made every 10 microseconds with no requirement for an encode command.

Digital outputs include the ten data bits, four bits for channel identification, a flag bit that specifies when the data is ready, and one line with clock pulses from the internal 8 MHz clock.

When the 5610A is used with any Hewlett-Packard computer, an interface kit is available, consisting of the interface printed circuit card and cable, as well as the necessary software to test the performance. Programming in FORTRAN or ALGOL can be done easily. An internal calibration voltage facilitates either manual or automatic checking of converter electrical accuracy.

Specifications

Input

Input range: ± 1 V full scale (± 2.5 V or ± 10 V optional), single-ended.

Resolution: 9 bits plus sign.

Accuracy: for calibration at 25°C; ± 3.5 mV, 20 to 30°C, worst case.

Crosstalk with 16-channel multiplexer: -70 dB at 1000 Hz.

Aperture time: instrument aperture time is less than 50 nanoseconds.

Input impedance: 10 megohms minimum shunted by 1000 pF (6 K ohms on ± 2.5 V and 15 K on ± 10 V range).

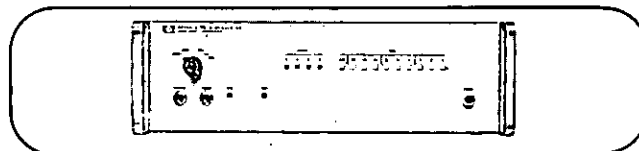
Channel capacity: 1, 8, or 16 channels.

Maximum input voltage: 5 times full scale. ± 5 V with ± 1 V full scale, ± 50 V with ± 10 V full scale.

Logic interface

Levels: logic levels are Transistor-Transistor Logic. A binary "1" is +2.4 V to +5.0 V. A binary "0" is 0.0 V to +0.4 V.

Output drive capability: A "1" output can supply up to 400 μ a and remains above 2.4 V. A "0" output can sink up to 16 ma and remains below 0.4 V.



Commands

Encode: a transition from "1" to "0" is required. This starts the internal clock and initiates sample and hold. Sampling begins 2.0 μ sec after the encode is received. Hold occurs 3.0 μ sec after encode.

Command word: the command word is 7 bits long. Bits 0, 1, 2 and 3 are the random access address. Bit 4 is random access enable. Bit 5 is free run enable. And bit 6 is internal or external sequence enable. The External Sequence pulse line is not part of the command word.

Operating modes:

Function	Command word			Encode Required
	Bit number	6	543	
Random Access	Y	00X	XXX	Yes
Internal Sequence	1	01Y	YYY	Yes
Free run, int. seq*	1	11Y	YYY	No
External sequence	0	01Y	YYY	Yes
Free run, ext. seq	0	11Y	YYY	No
Free run, random access	Y	10X	XXX	No

Where X XXX—Selects the desired channel.

Y—Indicates the bit doesn't matter.

*Note that this is the case for no connection also.

Outputs

Data outputs: 10 parallel lines at logic interface. Negative numbers are represented by the binary two's complement of the positive number.

Flag or data ready: a transition from "0" to "1" is provided. (A "1" to "0" is a hard-wired option.) The flag is automatically cleared in free run mode and is otherwise cleared by the encode command.

Channel ID: 4 parallel lines at logic interface.

Clock standard: 8.000 MHz ± 0.006 percent, 0-55°C. Clock standard is capable of delivering 1.2 ma at > 2.4 V and sinking 48 ma at < 0.4 V.

General

Internal calibration: A—998 V ± 2 mV at 25°C internal calibration is provided. TC is ± 6 μ V/°C. Provision is made for internally connecting two input channels to the zero and cal signals for calibration under computer command.

Operating temperature range: 0-55°C (10 to 40°C at specified accuracy).

Size: Hewlett-Packard full module, 5 $\frac{1}{4}$ " high, 11 $\frac{1}{4}$ " deep, 16 $\frac{3}{4}$ " wide (135 x 290 x 432 mm).

Weight: Approximately 16 pounds (7.3 kg).

Power: 115/230 V ± 10 percent, 50/60 Hz, 90 watts.

Connectors: two 36-pin rear panel printed circuit connectors are used—one for analog input and one for digital input/output.

Price: HP Model 5610A A to D Converter including power cable and two mating connectors for analog input and digital input/output cables. \$2000.

Option 05: Eight channels of ± 1 volt full scale input and channel sequencer, \$500.

Option 06: Eight channels of ± 2.5 volt full scale input and channel sequencer, \$600.

Option 07: Eight channels of ± 10 volt full scale input and channel sequencer, \$600.

Option 15: Additional eight channels of ± 1 volt full scale input, \$200.

Option 16: Additional eight channels of 2.5 volt full scale input, \$300.

Option 17: Additional eight channels of ± 10 volt full scale input, \$300.

Note: Options 15, 16, or 17 must be ordered in conjunction with either Option 05, 06, or 07.

DATA ACQUISITION



DATA ACQUISITION SYSTEMS

Measure and record multiple inputs

Models 2010, 2012, 2014 series

Hewlett-Packard offers a choice of ten data acquisition systems in the low-speed, non-computerized category. Specifically these systems provide excellent measurement accuracy, even for low-level signals, with multiplex rates to 40 channels per second. The systems are modular assemblies of standard laboratory-quality HP instruments combined to provide the best solution to data acquisition requirements, with the added benefit of enabling system selection to be more closely related to actual measurement needs and budgetary allowances. Typical inputs are dc and ac voltages, frequencies, resistances and physical parameters that are convertible by transducers to these analog forms. All perform the same functions, i.e., scan multiple analog input signals, convert them to digital form, and visually display and permanently record the resultant measurements. The differing capabilities of the systems are: (1) number and types of inputs, (2) programming, (3) accuracy, (4) speed, and (5) output recorders.

Noise rejection. A high degree of noise rejection is provided by the 2402A, 2401C and .3450A Integrating Digital Voltmeters (pages 208-214) used in these systems. They are average-reading and fully guarded, thereby greatly reducing superimposed noise errors and common mode noise errors. (These circuit design techniques are described on pages 97-98).

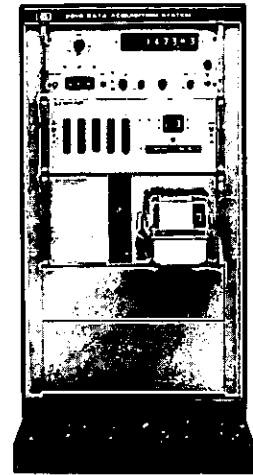
Input scanning. These systems incorporate three different input signal switching scanners, combined with other system modules to match user requirements. All systems feature three-wire scanning for guarded voltage measurements; 6-wire scanning for guarded 4-wire resistance measurements is also available, offering maximum accuracy in measuring low values of resistance. Scanners feature front panel digital display of the channel being measured. (Input signal scanners used in these systems are described on page 97.)

System programming. Systems are available with fully-programmable measurement functions including type of mea-

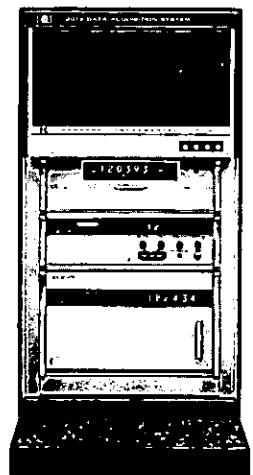
surement, sample period, settling delay, voltmeter range, and channel selection. Programming is accomplished by scanner front panel pushbutton selection, diode pinboard selection, or a combination of switch and diode selection. Systems without programming capability are used for applications involving the same type of input signals, e.g., all dc voltages; these systems retain the optional voltmeter autoranging capability.

Output recording. A choice of six output recorders is available to suit the application needs. Some systems record measurements on printed paper type, while others are supplied with an output coupler (2547A, page 105) to enable any of the other output recorders to be used. Computer-compatible magnetic tape systems (7- or 9-track) offer the highest speed (40 channels per second) and storage capacity. Optionally, data may be printed simultaneously on paper tape to obtain an immediately readable output. (System speed is reduced to about 20 channels per second.) Punched tape systems are available with computer-compatible ASCII output code and simultaneous recording on typed log, at a speed of 50 channels per minute. Alternatively, a high-speed punch provides ASCII punched tape at 10 channels per second; the tape printer may be used concurrently with the punch, as an option. A punched card output interface is available for users who already have an IBM 526 Summary Punch. Measurement results may also be recorded on typed log only for applications not requiring computer input of the data.

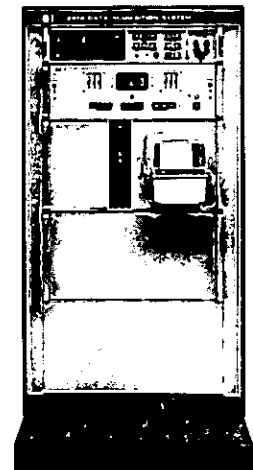
System options. All systems measure dc voltage inputs. In addition, systems can optionally measure dc ratio, ac voltage, ac ratio, resistance, resistance ratio, period, and frequency. Manual data may be inserted, either manually or automatically, at the beginning of each scan along with the recorded measurement. An optional clock provides time-of-day recording with each measurement when part of the printed paper tape recorder and at the beginning of each scan when part of the system coupler.



2010K



2012D with magnetic tape recorder



2014A

DATA ACQUISITION *continued*

2010, 2012, 2014 Series

2010 Series

- 2010K consists of: 2901A-63 Scanner, 2401C-21 IDVM, H006-5050B Printer
 2010L consists of: 2901A-63 Scanner, 2401C-21 IDVM, 2547A Coupler, choice of output recorder
 2010M consists of: 2911-33 Scanner, 2401C-21 IDVM, H006-5050B Printer
 2010N consists of: 2911-33 Scanner, 2401C-21 IDVM, 2547A Coupler, choice of output recorder

	2010K	2010L						2010M	2010N					
Number of input channels	Up to 25 3-wire inputs							Up to 200 3-wire inputs. Also 100 6-wire or 300 2-wire inputs						
Programming	Built-in; all DVM functions, delays							Not available						
DC measurement	100 mV to 1000V, 5 ranges, $\pm 750V$ max., resolution determined by gate time													
AC measurement	100 mV to 1000V, 5 ranges, 750V max., resolution determined by gate time													
Ohms measurement	100 Ω to 10M Ω , 6 ranges, .001 Ω resolution on 100 Ω range													
Frequency measurement	5 Hz to 300 kHz, resolution determined by gate time													
Period measurement	5 Hz to 10 kHz, resolution determined by gate time													
DC accuracy	100 mV: .01% rdg \pm .01% fs; other ranges: .01% rdg \pm .005% fs							100 mV: .01% rdg \pm .007% fs; other ranges: .01% rdg \pm .005% fs						
Measurement speed (max. dc volts)	6 chan/sec	9 chan/sec	9 chan/sec	54 chan/min	54 chan/min	1 chan/sec	1.6 chan/sec	9.5 chan/sec	18 chan/sec	10 chan/sec	50 chan/min	50 chan/min	1 chan/sec	1.5 chan/sec
Output	Digital Printer	Magnetic Tape	Punched Tape	Tele-printer	Type-writer	Flexo-writer	Punched Card	Digital Printer	Magnetic Tape	Punched Tape	Tele-printer	Type-writer	Flexo-writer	Punched Card
Price	\$9515	From \$14,625	\$13,575	From \$11,800	\$12,400	\$15,625	\$11,100	\$12,955	From \$18,050	\$17,000	From \$15,225	\$15,825	\$19,050	\$14,525
Options	AC, ohms, period, time, manual data entry, additional inputs, cabinet													

2012 Series

- 2012A consists of: 2911-33 Scanner, 2402A IDVM, 5050B Printer
 2012B consists of: 2911-33 Scanner, 2402A IDVM, 2547A Coupler; choice of output recorder
 2012C consists of: 2912A Reed Scanner, 2402A IDVM, 5050B Printer
 2012D consists of: 2912A Reed Scanner, 2402A IDVM, 2547A Coupler; choice of output recorder

	2012A	2012B						2012C	2012D					
Number of input channels	Up to 200 3-wire inputs. Also 100 6-wire, 300 2-wire inputs.							Expands to 1000 channels in 10 channel modules. 3-wire channels (2-wire frequency). Modules not included, order separately.						
Programming	Not available							Built-in; all DVM functions and delays.						
DC measurement	100 mV to 1000V, 5 ranges, 1 μV resolution													
AC measurement	1V to 1000V, 4 ranges, 750V peak, 10 μV resolution													
Ohms measurement	1k Ω to 10M Ω , 5 ranges, .01 Ω resolution							Not available						
Frequency measurement	5 Hz to 200 kHz, 1 Hz resolution							5 Hz to 200 kHz, 1 Hz resolution						
DC accuracy	100 mV: .01% rdg \pm .006% fs; other ranges: .01% rdg \pm .003% fs													
Measurement speed (max dc volts)	9 chan/sec	15 chan/sec	10 chan/sec	50 chan/min	50 chan/min	1 chan/sec	1.4 chan/sec	13 chan/sec	40 chan/sec	10 chan/sec	50 chan/min	50 chan/min	1 chan/sec	1.5 chan/sec
Output	Digital printer	Magnetic tape	Punched tape	Tele-printer	Type-writer	Flexo-writer	Punched card	Digital printer	Magnetic tape	Punched tape	Tele-printer	Type-writer	Flexo-writer	Punched card
Price	\$13,890	From \$19,000	\$17,950	From \$16,175	\$16,775	\$20,000	\$15,475	\$12,390	From \$17,500	\$16,450	From \$14,675	\$15,275	\$18,500	\$13,975
Options	DC, AC, ohms, frequency, time, manual data entry, additional inputs, cabinet													

2014 Series

- 2014A consists of: 2911-33 Scanner, H20-3450A-04, 06 DVM, HP J11-5050B Printer
 2014B consists of: 2911-33 Scanner, H20-3450A-04, 06 DVM, 2547A Coupler, choice of output recorder

	2014A	2014B					
Number of input channels	Up to 200 3-wire guarded inputs or 100 5-wire inputs						
Programming	Not available						
DC measurement	100 mV to 1000V, 5 ranges, $\pm 500V$ max., 1 μV resolution						
DC ratio	4-terminal, 1:1 to 1000:1, 4 ranges						
AC measurement	True RMS, 1V to 1000V, 4 ranges, 500V max.						
AC ratio	4-terminal, 1:1 to 1000:1, 4 ranges						
Ohms measurement	100 Ω to 11M Ω , 6 ranges, .001 Ω resolution on 100 Ω range						
Ohms ratio	4-terminal, 1:1 to 1000:1, 4 ranges						
DC accuracy	Not ratio, 100 mV: \pm (.008% rdg \pm .012% fs) other ranges: \pm (.008% rdg \pm .002% fs)						
Measurement Speed (max. dc volts)	6 chan/sec	10 chan/sec	9 chan/sec	42 chan/min	42 chan/min	54 chan/min	1.2 chan/sec
Output	Digital Printer	Magnetic Tape	Punched Tape	Tele-printer	Type-writer	Flexo-writer	Punched Card
Price	\$12,270	From \$17,275	\$16,225	From \$14,450	\$15,050	\$18,275	\$13,750
Options	AC, ohms, time, manual data entry, cabinet						



LOW-SPEED SUBSYSTEMS

Computer-controlled data acquisition

Models 2320A, 2321A, 2322A, 2323A

Hewlett-Packard offers a choice of four low-speed computer-controlled data acquisition subsystems. Each consists of an analog-input signal scanner and a 5-digit integrating digital voltmeter plus complete hardware/software interface to a Hewlett-Packard computer. The subsystems measure dc voltages with optional ac, resistance, and frequency measurements as indicated below. They accept multiple-input analog signals and convert them to digital form for computer processing. Input signals are randomly or sequentially scanned through a scanner incorporating mechanical crossbar switches or reed relays. Analog-to-digital conversion is performed by the integrating digital voltmeter. Both the scanner and voltmeter are fully guarded, virtually eliminating errors caused by common mode noise; further noise rejection is provided by the averaging of superimposed noise in the voltmeter.

2320A Subsystem. Consists of 2911A/2911B Crossbar Scanner (page 97) and 2402A Digital Voltmeter (page 212). Features dc, resistance, and frequency measurements. 5-digit dc resolution at 14 channels/second. 200 guarded inputs (expandable to 1000 on special order).

Price: 2320A (dc only ± 100 mV to ± 1000 V full scale, ± 1000 V max.), \$14,685. Option 01 Autoranging, add \$265; Option 02 Frequency measurement (5 Hz to 200 kHz), add \$350; Option 03 AC measurement (1 V to 1000 V full scale, 530 V rms max.), add \$475; Option 04 Resistance measurement (1 k Ω to 10 M Ω), add \$775; Option 08 50 Hz noise rejection, add \$100. Options are voltmeter plug-ins.

2321A Subsystem. Consists of 2911A/2911B Crossbar Scanner (page 97) and 3450A Multi-Function Meter (page 208). Features exceptionally accurate true rms ac measurement, dc and resistance measurement, plus 4-terminal measurement of dc ratio, ac ratio, and ohms ratio. 5-digit dc resolution at 10 channels/second. 200 guarded inputs (expandable to 1000 on special order).

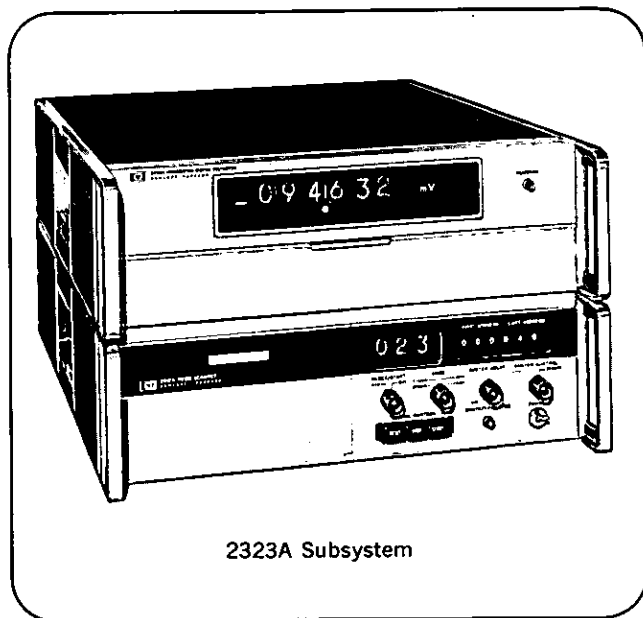
Price: 2321A (dc only ± 100 mV to ± 1000 V full scale, ± 500 V max.), \$13,700. Option 01 AC measurement (1 V to 1000 V full scale, 700 V rms max.), add \$1250; Option 02 Resistance measurement (100 Ω to 10 M Ω), add \$400. Options are multi-meter plug-ins.

2322A Subsystem. Consists of 2911A/2911B Crossbar Scanner (page 97) and 2401C Digital Voltmeter (page 214). Features measurement of long-term integrals of slowly-varying signals with choice of .01-, .1-, and 1-second fixed intervals yielding 3-, 4-, and 5-digit resolution, respectively. In addition to dc, the subsystem measures frequency, plus ac and resistance. 200 guarded inputs (1000 on special order).

Price: 2322A (dc ± 100 mV to ± 1000 V full scale, ± 1000 V max.; also frequency 5 Hz to 300 kHz), \$13,475. Option 01 Autoranging, add \$250; Option 05 HP 2410B AC/Ohms Converter, add \$3350.

2323A Subsystem. Consists of 2912A Reed Scanner (page 97) and 2402A Digital Voltmeter (page 212). Features 40 channels/second measuring speed with 5-digit resolution even for low-level signals. Inputs can be combined to allow measurements in 10-channel modular increments for voltages (expandable to 1000) and 9-channel modular increments for frequencies (expandable to 900). Requires at least one scanner module (Option 04, 05, or 06) for connection of analog inputs.

Price: 2323A (less plug-in modules), \$12,060. Option 01 Autoranging, Voltmeter plug-in, add \$265; Option 02 Frequency measurement voltmeter plug-in, additionally requires Option 06, add \$350; Option 03 AC measurement (1 V to 1000 V full scale, 140 V rms) voltmeter plug-in, additionally requires Option 05, add \$475; Option 04 10-channel Low-Level Module for scanning 10 dc inputs to ± 10 V peak, scanner plug-in, add \$600; Option 05 10-channel High-Level Module for scanning 10 dc or ac inputs to 100 V peak, scanner plug-in, add \$600; Option 06 9-channel Frequency Module for scanning 9 frequency inputs 5 Hz to 200 kHz, scanner plug-in, add \$600; Option 07 Reed Scanner Extender holds 10 scanner modules—required if more than 4 modules are used in the subsystem, add \$1500. Option 08 50 Hz noise rejection, add \$100.



2323A Subsystem

HIGH-SPEED SUBSYSTEMS

Dynamic measurements at rates to 100 kHz
Models 2310A/B/C, 2311A, 2312A, 12564A



DATA ACQUISITION

Hewlett-Packard offers a choice of six high-speed computer-controlled data acquisition subsystems. Each consists of an analog-to-digital converter plus computer interface, software driver, and verification software. The subsystems accept fast-changing analog input voltages and convert them to digital form for computer processing. The 2310B,C, 2311A, and 2312A Subsystems include input signal multiplexing. Sample-and-hold amplifiers with 50 nanosecond or 100 nanosecond aperture times minimize conversion uncertainty.

The 2310A is directly applicable where dynamic analysis of a single analog input requires maximum accuracy with fast sampling and 50 nanosecond aperture time. The 2310B is equally as fast and also includes input signal multiplexing for scanning up to 64 inputs. The 2310C features sample-and-hold plus input multiplexing (to 64) and is used in applications where the high resolution, speed, and accuracy of the A and B systems are not required. The 2311A offers maximum throughput rate with up to 16 multiplexed inputs at less resolution. The 2312A features sample-and-hold plus input multiplexing (to 512) and features fast, low-level measurements with excellent common mode rejection. The 12564A is a single-channel converter which plugs into the computer I/O system and offers real-time acquisition of data at a lower price. For precise timing of samples, a 2781A Pacer may be used with these high-speed subsystems.

Description

2310A Subsystem. Consists of an analog-to-digital converter. Features single input, sample-and-hold amplifier with 50 nanosecond aperture time. ± 10 V full scale input:

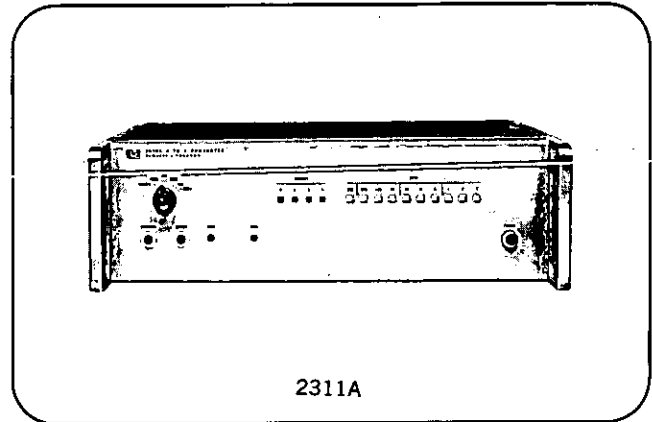
Price: 2310A Option 01: 14-bit output, throughput rates to 19 kHz, \$6005; 2310A Option 02 12-bit output, throughput rates to 64 kHz, \$6660; Option 03 250 V, 50 Hz ac power, add \$200.

2310B Subsystem. Consists of an analog-to-digital converter with input signal multiplexing. Features up to 64 inputs, in 8-channel increments, sample-and-hold amplifier with 50 nanosecond aperture time, ± 10 V full scale input.

Price: 2310B Option 01 14-bit output, throughput rates to 18 kHz, \$7275; 2310B Option 02 12-bit output, throughput rates to 50 kHz, \$7900; Option 03 Eight-Channel Multiplex Card (converter accepts up to 8 cards), add \$225 per card; Option 04 230 V, 50 Hz ac power, add \$200.

2310C Subsystem. Consists of an analog-to-digital converter with input signal multiplexing. Features up to 64 inputs, in 8-channel increments, sample-and-hold amplifier with 100 nanosecond aperture time, 12-bit output at throughput rates to 35 kHz. ± 10 V full scale input.

Price: 2310C, \$5440. Option 01 Eight-Channel Multiplex Card (converter accepts up to 8 cards), add \$210 per card; Option 02 Multiplexer Control Card (required for multiplexing more than 16 inputs), add \$100.



2311A

2311A Subsystem. Consists of a single-channel analog-to-digital converter. Features up to 16 multiplexed inputs, in 8-channel increments, sample-and-hold amplifier with 50 nanosecond aperture time, 10-bit output at throughput rates to 100 kHz. ± 1 V full scale input standard, ± 2.5 V (Option 06), ± 10 V (Option 07).

Price: 2311A: \$3400. Option 05 ± 1 V Eight-Channel Input with Sequencer, add \$500; Option 06 ± 2.5 V Eight-Channel Input with Sequencer, add \$600; Option 07 ± 10 V Eight-Channel Input with Sequencer, add \$600; Option 15 additional ± 1 V Eight-Channel Input, add \$200; Option 16 additional ± 2.5 V Eight-Channel Input, add \$300; Option 17 additional ± 10 V Eight-Channel Input, add \$300. Options 15, 16, and 17 may be ordered in conjunction with either Option 05, 06, and 07.

2312A Subsystem. Consists of an analog-to-digital converter and input signal multiplexer. Features up to 512 multiplexed inputs in 8-channel increments, sample-and-hold amplifier with 50 nanosecond aperture time, 12-bit output at throughput rates to 12 kHz. Eleven program-selectable ranges from ± 10 mV to ± 10 V full scale.

12564A A-D Converter. Combines a single-channel A-D converter and computer interface on one plug-in card, for Hewlett-Packard computers. Features 17.6 μ s conversion time (HP 2116B Computer) or 22 μ s conversion time (HP 2115A or 2114B Computers), 10-bit output. Jumper selectable ± 1 V or ± 10 V full scale input.

Price: \$1100.

2781A Pacer. Consists of HP 241A Pushbutton Oscillator and HP 8003A Pulse Generator in an HP 1051A Combining Case. Features precise sample timing at rates from 10 Hz to 1 MHz with timing accuracy better than .05% of the interval between commands plus 10 nanoseconds.

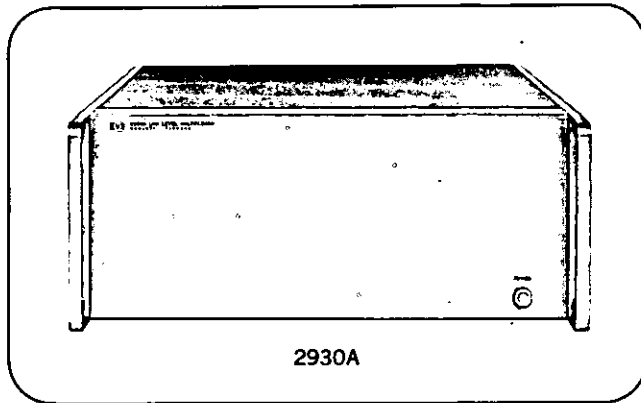
Price: 2781A Pacer, \$1500.

DATA ACQUISITION



LOW-LEVEL MULTIPLEXER

Fast, accurate millivolt-level measurements
Model 2930A



The Model 2930A Low-Level Multiplexer is a fast, solid state analog signal scanner that enables high speed analog-to-digital converters to meet all principal data measurement requirements in computer-automated data acquisition and control systems. Up to 64 differential analog inputs, in eight channel increments, can be accepted. MOSFET switches in the multiplexing circuits and a fast-settling (40 microsec-

onds) differential amplifier combine to provide multiplex rates to 20 kHz. Eleven input ranges programmable in binary increments to 1024 provide full scale inputs from ± 10 mV to ± 10 V.

Plug-in signal filtering is an integral part of the 2930A design. A choice of five R-C filters provides rejection of ac noise riding on dc and for very-low-frequency ac input signals. Cutoff frequencies are at 5 Hz, 10 Hz, 20 Hz, 40 Hz, and 80 Hz. A choice of four L-C (Butterworth) filters provide band limiting of undesired signals with cutoff frequencies at 31 Hz, 62 Hz, 125 Hz, and 250 Hz. An internally-driven guard provides common mode rejection.

Both the amplifier gain and the channel address are programmable. A typical 16-bit control word handles all control functions plus addressing capacity for up to eight 2930A Multiplexers (512 inputs).

Interface compatibility problems are solved by a choice of five different kits with logic levels and polarity to match most ADC—computer interface requirements. Two cables interconnect the 2930A, ADC, and computer in a data acquisition system.

PROGRAMMABLE GAINS	1	2	4	8	16	32	64	128	256	512	1024
FULL SCALE INPUT	± 10.24 V	± 5.12 V	± 2.56 V	± 1.28 V	± 640 mV	± 320 mV	± 160 mV	± 80 mV	± 40 mV	± 20 mV	± 10 mV
FILTER CARD	12701A	12702A	12703A	12704A	12705A	12706A	12707A	12708A	12709A		
FILTER TYPE	Two-Pole R-C, cutoff at -6 dB, 12 dB/octave slope						Three-Pole Butterworth, cutoff at -3 dB, 18 dB/octave slope				
FILTER CUTOFF FREQUENCY	5 Hz	10 Hz	20 Hz	40 Hz	80 Hz	31 Hz	62 Hz	125 Hz	250 Hz		

Channel multiplex rate: 20 kHz, maximum.

Inputs: to 64, added in 8-channel increments.

Input resistance: > 10 megohms.

Crosstalk rejection: 100 dB between inputs to the same multiplex switch card—140 dB between inputs to different switch cards.

Common mode rejection: 120 dB (gains 32 to 1024), 90 dB (gains 1 to 16), dc to 60 Hz.

Accuracy (steady state): $\pm 0.02\%$ reading for 6 months.

Transient response: output settles to $\pm 0.05\%$ of final value in 40 μ s after encode command.

Linearity: $\pm 0.02\%$ reading.

Maximum overvoltage: ± 12 V differential (any gain), ± 20 V command mode.

Output: ± 10.24 V peak.

Output impedance: $< 1\Omega$ in series with 50 μ H.

Power required: 115/230 V $\pm 10\%$, 50 to 400 Hz, 25 watts.

Operating conditions: 0° to 55°C. R.H. to 95% at 40°C.

Weight: net, 35 lb (15.9 kg); shipping, 42 lb (19.1 kg). Add 0.5 lb (0.23 kg) (net or shipping) for each Butterworth filter card.

Dimensions: 7" (178 mm) high, 19" (483 mm) wide, 24" (610 mm) deep.

Price: 2930A, Low-Level Multiplexer (main frame), \$3600.

Each 2930A requires the following for operation:

One to eight 8-channel multiplex switch cards, 12710A.

One to eight 8-channel filter cards, selected from 12701A through 12709A.

One to eight 8-channel input connector assemblies, 12711A.

I/O card, selected from 12712A through 12716A.

Mating connectors for J1 and J2.

NOTE: Additional 8-channel inputs (switch and filter cards and connector assembly) up to the maximum of 64 inputs can be installed at any time.

12710A, 8-Channel Multiplex Switch Card, \$300.

8-channel R-C filter cards (12 dB/octave rolloff above cutoff frequency):

12701A, 5 Hz cutoff frequency, \$150.

12702A, 10 Hz cutoff frequency, \$150.

12703A, 20 Hz cutoff frequency, \$150.

12704A, 40 Hz cutoff frequency, \$150.

12705A, 80 Hz cutoff frequency, \$150.

8-channel L-C (Butterworth) Filter Cards (18 dB/octave roll-off above cutoff frequency):

12706A, 31 Hz cutoff frequency, \$450.

12707A, 62 Hz cutoff frequency, \$450.

12708A, 125 Hz cutoff frequency, \$450.

12709A, 250 Hz cutoff frequency, \$450.

12711A, 8-channel input connector assembly, \$18.

I/O Interface Cards:

12712A, microcircuit, +2.4 to +5 V false, grd true, \$85.

12713A, +12 V, grd true, \$180.

12714A, -12 V, grd false, \$180.

12715A, +12 V grd false, \$180.

12716A, -12 V, grd true, \$180.

5060-2464, mating plug for computer interface connector J1, \$20.

5060-2468, mating plug for ADC interface connector J2, \$22.50.

12717A, standard program cable (2930A to HP Computer), \$150.

12718A, extender board (for maintenance), \$35.

COUPLER

Records measurements for computer processing

Model 2547A



DIGITAL RECORDERS

The HP 2547A Coupler operates with any one of ten digital recording devices to translate the binary-coded-decimal (BCD) outputs of instruments such as counters, digital voltmeters, and nuclear scalars into serially-coded records on computer-compatible input media. After initially setting up the instrument-coupler-recorder set, measurements are automatically recorded as the instruments provide input data.

The 2547A with teleprinter output allows measurements to be recorded in ASCII code on punched tape suitable for processing through commercial time-sharing computer terminals. Thus, the benefits of immediate and local data reduction are available to instrument users. In addition, options are available for on-line data entry to time-sharing computers. Other output options allow higher speed recording on punched tape, punched cards, or magnetic tape for batch processing.

Input versatility

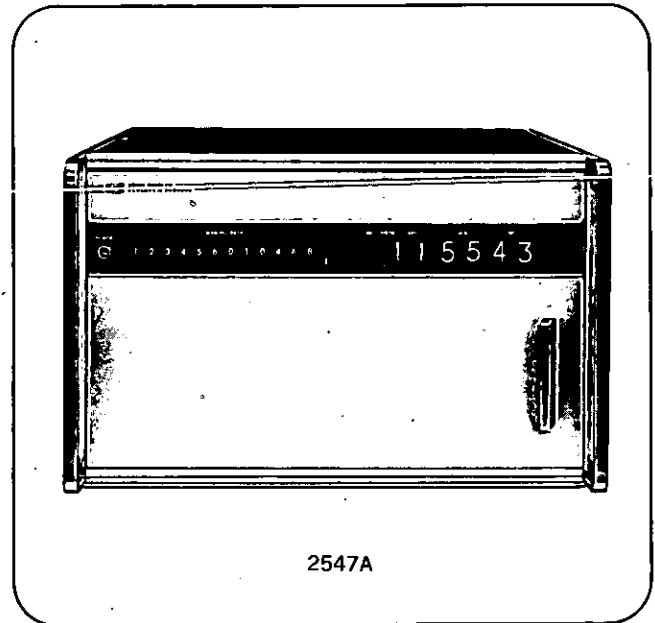
The coupler features modular design in both the input and output circuits. Plug in circuit cards can be arranged in various combinations to meet changing applications requirements. The coupler accepts BCD data from as many as six separate instruments through cables which plug into the front of 10-digit input cards. Over 40 standard Hewlett-Packard instruments are directly compatible. Optional plug-ins allow supplementary information such as time-of-day (clock) and manually entered data to be recorded along with the measurement results. When used in data acquisition systems employing a digital voltmeter and an input scanner, the coupler records both channel identification and measurement data.

Output versatility

The 2547A is directly compatible with any one of ten popular digital recording devices including paper tape punches, teleprinters, incremental magnetic tape recorders, Flexowriters, card punches, and typewriters. Changing from one to another is simply a matter of changing the device and its output card. Each output recorder set is supplied complete with peripheral recorder, output card, and all inter-cabling. The output data is optionally available in parallel BCD form for operation of a printed strip recorder, to allow immediate analysis of measurements being simultaneously recorded on magnetic tape, punched tape, or punched cards.

Controllable output format

An outstanding feature of the coupler is the built-in capability of formatting the order in which characters are recorded and the length of the recorded word. The data word



2547A

can be as long as 20 digits or as short as necessary. This feature offers considerable flexibility in providing a readily usable output record. A small jumper wire patch panel is used to:

- a. Record characters in any order.
- b. Determine word length, omitting character inputs that are not desired in the recording.
- c. Insert up to four 'blanks' or 'spaces' in the formatted word.
- d. Record up to two characters in alphabetic or symbolic form to identify measurement function (such as + volts dc) or condition (such as overload) when used with the HP 2401C and 2402A Digital Voltmeters.

The word format set on the patch panel applies to all sources. The coupler automatically inserts spaces between words recorded on punched tape and typed log. In addition, the coupler inserts interrecord gaps on magnetic tape and carriage returns in typed log or punched tape records (carriage return and line feed with teleprinters) as programmed by switches on the control card.

Fifteen useful applications of the coupler with various instrument configurations are described in Application Note 113, "Recording Digital Measurements with the HP 2547A Coupler", available without charge from Hewlett-Packard.

2547A Coupler	PRICE
NOTE: Must be ordered with at least one Data Input (Option 02, 47, or 48) and one Output Recorder Set (Option 34 through 45 or 94 through 103). To order separately, consult HP Field Sales Office.	\$2200

DATA INPUT (Includes Plug-in Interface and Cabling)

	OPTION NO.	PRICE
10-Digit Data Interface Kit 12642A, Amphenol Data Cable	02	add \$ 600
10-Digit Data Input Interface Kit 12642A-01, Winchester Data Cable	47	add 625
10-Digit Data Input Interface Kit 12642A-02, IC Counter Data Cable	48	add 600

OUTPUT RECORDER SETS (Includes Peripheral Recorder, Plug-in Interface, and Cabling)

	CODE	OPTION NO.	PRICE
Incremental Magnetic Tape Recorder Sets	7-track, 1200 feet tape capacity, 200 bpi, Kennedy 1600H, 500 char/sec. Specify Option 98 for 556 bpi instead of 200 bpi, Add \$150	+8421	94 add \$4525
		+4221	95 add 4625
	7-track, 2400 feet tape capacity, 200 bpi, Kennedy 1510, 500 char/sec. Specify Option 98 for 556 bpi instead of 200 bpi, Add \$150	+8421	96 add 5500
		+4221	97 add 5600
	9-track, 1200 feet tape capacity, 800 bpi, Kennedy 1600/360, 500 char/sec.	+8421	99 add 5750
		+4221	101 add 5850
9-track, 2400 feet tape capacity, 800 bpi, Kennedy 1510/360, 500 char/sec.	+8421	102 add 7150	
	+4221	103 add 7250	
Teleprinter Output Sets	Typewriter and punched tape output, ASCII code, 10 char/sec, HP 2752A (Light Duty)	+8421	36 add 1700
		+4221	37 add 1800
	Typewriter and punched tape output, ASCII code, 10 char/sec, HP 2754B (Heavy Duty)	+8421	38 add 4300
		+4221	39 add 4400
Tape Punch Output Set	ASCII code, 120 char/sec. HP 2753A	+8421	34 and 73 add 3475
		+4221	35 and 127 add 3575
	IBM 8-level code, 120 char/sec. HP 2753A	+8421	34 and 128 add 3725
		+4221	35 and 129 add 3825
Typewriter Output Set. 10 char/sec, IBM Model B	+8421	40 add 2300	
	+4221	41 add 2400	
Flexowriter Output Set. Typewriter and punched tape output. IBM 8-level code, 12 char/sec, Friden Model 2303	+8421	42 add 5525	
	+4221	43 add 5625	
Card Punch Output Set. HP 2780A Junction Panel connects to IBM 526 Summary Punch (not supplied), Hollerith code, 17 char/sec.	+8421	44 add 1000	
	+4221	45 add 1100	

230V, 50 Hz Operation for Output Recorder Sets

	OPTION NO.	PRICE
For Incremental Magnetic Tape Output Sets, Options 94 through 103	50	add \$ 50
For Teleprinter Output Sets (Options 36 and 37)	52	add 200
For Teleprinter Output Sets (Heavy Duty Options 38 and 39)	53	add 400
For Tape Punch Output Sets (Options 34 and 73, 35 and 127, 34 and 128, 35 and 129)	51	add 50
For Typewriter Output Sets (Options 40 and 41)	54	add 50
For Flexowriter Output Sets (Options 42 and 43)	55	add 50

OTHER OPTIONS (Includes Plug-in Interface and Cabling)

	OPTION NO.	PRICE
Scanner Channel ID Input	Compatible with 2901A Scanner	46 add \$ 325
	Compatible with 2911B and 2912A Scanners	01 add 325
Digital Clock (+8421)	50/60 Hz line frequency time reference	08 add 1500
	Crystal oscillator time reference (instead of line frequency reference)	09 add 1750
	X1 to X9 interval multiplier, line frequency time reference	10 add 1850
	Crystal oscillator reference and X1 to X9 interval multiplier	06 add 2100
Manual Data Input, 12 digits, +8421	07	add 1000
Retransmitted BCD output (20 parallel characters)	49	add \$475 at time of purchase or add \$850 if ordered separately

DIGITAL RECORDER

20 lines/s; quiet; versatile
Model 5050B



DIGITAL RECORDERS

Advantages:

- Inexpensive mixed codes column by column
- Versatility of quick-change code discs
- Few moving parts
- Quiet operation
- Data storage and digital clock optional

This recorder is compatible with HP solid state and integrated circuit instruments, and its versatile circuitry adapts it for use with a wide variety of other equipment and data systems. It prints up to 18 columns of 4 line BCD data from one or two sources up to 20 lines/s.

The user can easily change the code base to 8421+, 8421-, or 4221+ by an inexpensive substitutable code disc. In addition, the user can change print wheels to have a different code base and/or character set in each column.

Character suppression allows the user to determine which character is suppressed in each column and whether or not only leading characters are suppressed; typical use is to suppress leading zeros.

A reduction in moving parts leads to reliable operation. Particular attention has been paid to ensuring quiet operation.

Data storage options reduce data loading time from 50 ms to 0.1 ms and decrease input voltage requirements. A built-in digital clock is also optional.

Specifications

Accuracy: identical to input device used.

Printing rate: 20 lines per second, maximum (asynchronous).

Column capacity: to 18 columns.

Print wheels: 16 positions, numerals 0 through 9, -, +, A, V, Ω , *; other symbols available.

Input requirements—without data storage

Data input: parallel entry, BCD (8421, 4221), "1" state must differ from "0" state by at least 4.5 V but by no more than 75 V.

Reference voltages: BCD codes require both "0" and "1" state references; reference voltages may not exceed ± 150 V to chassis; "0" and "1" reference voltage must differ by at least 4.5 V; amplitude of each ref. voltage must not exceed its like-polarity data input level by more than 0.5 V.

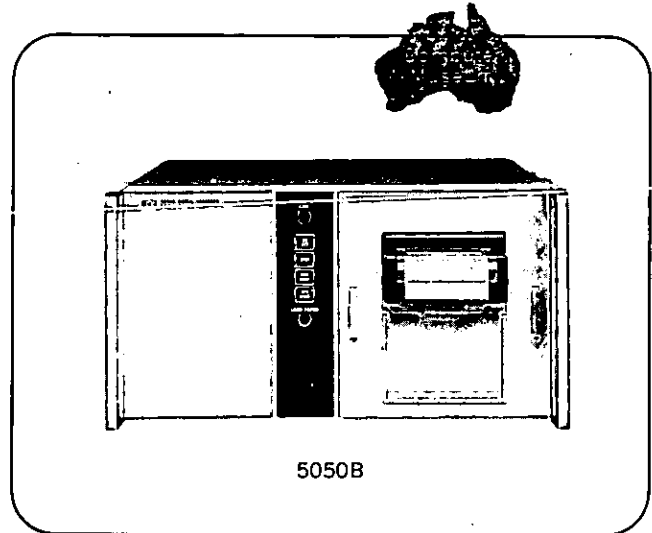
Hold-off voltage: both polarities are available simultaneously for BCD codes and are diode-coupled; 10 mA maximum load ± 15 V open circuit from 1 k Ω source.

Print command: + or - pulse, 4.5 to 20 V amplitude, 1 V/ μ s minimum rise time, 20 μ s or greater in width, ac coupled. Input impedance is approximately 1500 Ω .

Input requirements—with data storage options

Data input: parallel entry, BCD, "1" state must differ from "0" state by at least 1.3 V but by no more than 35 V. Input drive ≥ 100 μ A. Data must be on lines when print command occurs and remain until release of hold-off (85 μ s after print command).

Reference voltages: the data source must provide reference voltages, either both levels (High and Low) or one level (Low). If both levels are provided, maximum reference voltage may not exceed ± 50 V to chassis. Load between the reference lines: 20 k Ω . Internal control can vary BCD trigger level within reference voltages. If Low reference voltage only is provided, maximum reference voltage may not exceed ± 20 V to chassis. The reference line must be able to supply up to 20 mA. The minimum BCD High voltage is approximately 2.1 V above the reference voltage. The maximum BCD Low voltage is approximately 0.8 V above the reference voltage.



Hold-off voltage: both polarities are available simultaneously for BCD codes and are diode coupled; 10 mA max load ± 15 V open circuit from 1 k Ω source.

Print command: + or - pulse, 2 to 20 V amplitude, 1 V/ μ s minimum rise time, 6 μ s or greater in width, ac coupled.

Transfer time: 50 ms without storage, 0.1 ms with.

Line spacing: adjustable, 3.5 to 4.5 lines/inch.

Inking: ink roller or pressure sensitive paper. Pressure-sensitive paper should be used where the 5050B is idling more than printing, or for temperature extremes. Conversion between ink and pressure sensitive operation can typically be performed in five minutes.

Operating temperature: -20°C to $+55^{\circ}\text{C}$ with pressure sensitive paper, $+10^{\circ}\text{C}$ to $+40^{\circ}\text{C}$ with ink roller.

Power: 115 or 230 V $\pm 10\%$, 50 to 60 Hz, approx. 100 W idle, 190 W at 20 lines/sec. 50 Hz model with 20 prints/sec available.

Dimensions: cabinet: 16 $\frac{3}{4}$ " wide, 8 $\frac{1}{2}$ " high, 18 $\frac{3}{8}$ " deep (426 x 226 x 467 mm).

Weight: net, 40 lbs (18 kg); shipping, 53 lbs (24 kg).

Accessories furnished: one pack fan fold paper, one pack folded pressure sensitive paper, ink roller, rack mount kit.

Price: HP 5050B, \$1900; Option 001, 002, or 003 must be specified at time of order (no charge). Column boards (one required for each two columns to be operated), \$100 each.

Accessories available: fan fold paper HP 9281-0386, \$1.50; Pressure sensitive paper HP 9281-0387, \$4.00; (15,000 prints per pack). Ink roller (black) HP 9260-0071, \$10.00. Input cables, \$50 (accommodates 10 input columns from HP solid-state instruments). Input cable for IC counters, \$65.

Options: 001 - 8421 "1" state positive code disc.

002 - 8421 "1" state negative code disc.

003 - 4221 "1" state positive code disc.

All three code discs are supplied with each 5050B at no charge. However, one of the above options must be specified so 5050B can be delivered with desired disc installed.

010 - 50 Hz operation, add \$15.

050 - Storage for 20 columns, add \$400.

051 - Storage for 10 columns, add \$200.

(Only 10 columns can then be operated.)

055 - Digital clock, installed at time of manufacture, \$950. Also available as field installation kit.

DIGITAL RECORDERS



DIGITAL CLOCKS

Time recording and print-rate control
Model 571B; Option 055 for Model 5050B

Option 055 for 5050B recorder

Option 055 Clock, for use with the HP 5050B Digital Recorder, provides a convenient method for recording time while also serving as a programmer for the measuring-recording system. Integrated circuits and transistors perform all timing and logic functions. Column boards required for 5050B operation are built into the clock.

Easy-to-read display tubes indicate time to 23 hours, 59 minutes, 59 seconds. In the printout there is a seventh digit available for indicating tenths of a second. The BCD output code of the clock is selectable to be either +8-4-2-1 or -8-4-2-1, but information is easily adaptable to any other code used on the recorder.

As a programmer, the clock is extremely versatile. Print intervals of 1 second, 10 seconds, 1 minute, 10 minutes, or 1 hour are chosen by a front panel switch. Rates as high as 20 prints per second, determined by an external signal, are acceptable.

The clock is available in kit form for model 5050B or may be installed at the factory in new 5050B Recorders.

Specifications, Option 055

Time base: selectable to be 50 Hz, 60 Hz or external. External requires 10 pps negative pulse.

Print interval:

Internal: selectable to be 1 s, 10 s, 1 min., 10 min., or 1 hour between prints.

External: rates up to 20 prints per second.

Time-of-measurement accuracy: time recorded may be 0.1 s less than correct time \pm line accuracy.

Visual indication: 6 in-line digital display tubes indicate to 23 hours, 59 minutes, 59 seconds.

Printed output: seven digits indicate to 23 hours, 59 min, 59.9 s.

BCD output code: +8-4-2-1 or -8-4-2-1 selectable. Output adaptable to other recorder codes.

Print format: time printable in any recorder columns.

Clock set: 4 switches electronically set clock to desired initial time.

Power: 115 V or 230 V \pm 10%. 50 Hz or 60 Hz.

Weight: net, 3 lbs (1.4 kg).

Price: HP Option 055 (factory installed), \$950.00. Price of kit for field installation available on request.

571B clock

The 571B Digital Clock, which mounts in the left side of the 561B Digital Recorder provides time-of-day information and controls the rate at which measurements are made. Time is indicated in hours, minutes, and seconds on a 24 hour basis.

The display is available for printing alongside other data. Location and number of time digits on the printed record are determined by connector arrangements on the rear panel of the digital recorder.

The rate at which sampling and printing occur can be controlled by the clock or by an external device. The clock provides five rates selectable by a front panel switch.

A modified 571B (Option H03-571B) is available for use with the HP 562A Digital Recorder.

Specifications, 571B

Indication: 6 display tubes to 23 hours, 59 min, 59 s; 12 hour format on special order.

Time base: front-panel switch selects: (1) 60 Hz (50 Hz on special order), (2) counter (1 pps, HP vacuum tube counters), external (5 V positive pulses, 200 μ s long, 1 pps; input impedance approx. 500 Ω).

Time-of-measurement accuracy: time recorded may be up to 1 s less than correct time.

Print control: print rate controlled by clock or by external device. Internally generated rates are 1 per second, 6 per minute, 1 per minute, 6 per hour, and 1 per hour.

Time print format:

In 561B: six time digits recorded in right-hand columns of recorder with clock connected to J101; with clock connected to J102, time recorded in 5 left-hand columns without tens of hours.

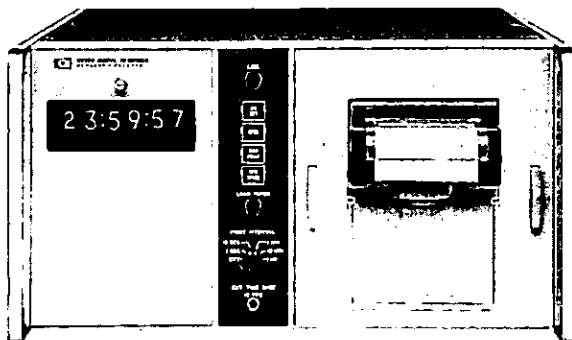
In 562A: recording format (all columns) is set up by plug-in connectors and column boards in 562A.

Weight: net 20 lbs (9 kg); shipping 26 lbs (12 kg).

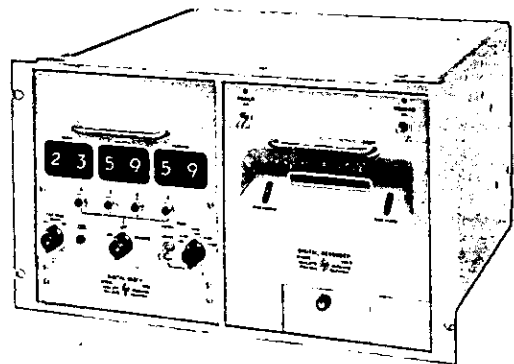
Power: ac and dc supplied by digital recorder; approximately 15 watts.

Price: Model 571B, \$1100.00.

Because of the many options available for the 571B clock, please contact your HP sales office when ordering.



Option 055 with 5050B



571B with 561B

DIGITAL RECORDER

Flexible data input with information storage
Model 562A



DIGITAL RECORDERS

HP Model 562A Digital Recorder is a solid-state electro-mechanical device providing a printed record of digital data from any of a number of sources. Parallel data entry and low-inertia moving parts allow printing rates as high as 5 lines per second, each line containing up to 11 digits. Twelve-digit capacity is available on special order.

Data enter the unit through rear-mounted 50-pin connectors. Internal plug-in connectors route the information to any desired sequence of print wheels. A separate storage binary unit is associated with each individual print wheel for 4-line BCD input codes.

Model 562A may be equipped to translate 4-2-2-1 BCD, other 4-line codes or 10-line code by substituting plug-in column boards and input connector and cable assemblies.

Specifications

Accuracy: identical to input device used.

Printing rate: 5 lines per second, maximum.

Column capacity: to 11 columns (12 available on special order).

Print wheels: 12 positions, numerals 0 through 9, a minus sign and a blank; other symbols available.

Input requirements

Data input: parallel entry, BCD (4-2-2-1, 8-4-2-1, 2-4-2-1) or 10-line, see Options; "1" state must differ from "0" state by at least 4 Volts but by no more than 75 Volts.

Reference voltages: BCD codes require both "0" and "1" state references; 10-line codes require reference voltage for "0" state; reference voltages may not exceed ± 150 V to chassis; input impedance is approximately 270 k ohms.

Hold-off signals: both polarities are available simultaneously for BCD codes and are diode-coupled; 10 mA maximum load +15 V open circuit from 1 k source, -5 V open circuit from 2.2 k source (160 msec hold-off is provided for 10-line codes).

Print command: + or - pulse, 4.5 to 20 volts amplitude, 1 V/ μ s minimum rise time, 20 μ s or greater in width, ac coupled.

Analog output (optional): (from 4-2-2-1 or 8-4-2-1 boards) accuracy is $\pm 0.5\%$ of full scale or better; 100 mV for potentiometer recorder; 50 k ohm minimum load resistance; 1 mA into 1.5 k ohm maximum for galvanometer recorder.

Transfer time: 2 ms for BCD codes.

Paper required: HP folded paper tape (15,000 prints per packet with single spacing) HP Stock No. 560A-131A or standard 3-inch roll tape. 25 packet carton, \$21.00.

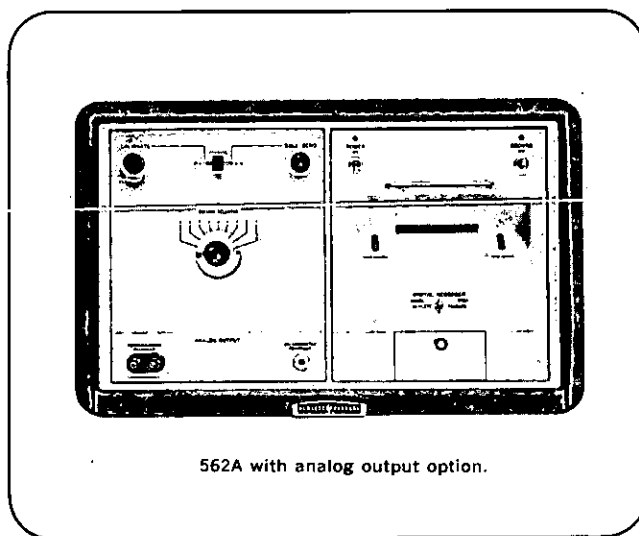
Line spacing: single or double.

Power: 115 or 230 V $\pm 10\%$, 50 to 60 Hz, approx. 130 W. (4 prints/s at 50 Hz; 50 Hz model with 5 prints/s available.)

Dimensions: cabinet: 20 $\frac{3}{4}$ " wide, 12 $\frac{1}{2}$ " high, 18 $\frac{1}{2}$ " deep (527 x 318 x 470 mm); rack mount: 19" wide, 10-15/32" high, 16 $\frac{1}{2}$ " deep (483 x 266 x 419 mm).

Weight: net 35 lbs (16 kg), shipping 80 lbs (36 kg) (cabinet); net 30 lbs (13 kg), shipping 63 lbs (31 kg) (rack mount).

Price: HP 562A, \$1185 (cabinet); HP 562A, Option 002, \$1160 (rack mount); basic unit with 11-column capacity; column



562A with analog output option.

boards, input connector assemblies and cables required for operation are not included, see Options.

Options, Group 1

(Completely equips 562A for operation with Hewlett-Packard instruments.)

Option 011. For 6-column operation from 4-2-2-1 "1" state positive code, add \$555.00.

Option 012. For 9-column operation from 4-2-2-1 "1" state positive code, add \$780.

Option 013. For 11-column operation from 4-2-2-1 "1" state positive code, add \$1023.

Option 014. For operation with 5245L; 10-column operation; prints measurement unit and indicates decimal position - e.g., 16942.496 kHz would be printed as 3 kHz 16942496; the first digit shows how far to move the decimal to the left; add \$880.

Options, Group 2, column boards

Option 021. 4-2-2-1 "1" state positive, \$75 each.

Option 022. 8-4-2-1 "1" state positive, \$75 each.

Option 023. 8-4-2-1 "1" state negative, \$75 each.

Option 024. 4-2-2-1 "1" state negative, \$75 each.

Option 025. 10-line "1" state positive (no storage), \$50 each.

Option 026. 10-line "1" state negative (no storage), \$50 each.

Option 027. 2-4-2-1 "1" state negative, \$75 each.

NOTE: Input connector assemblies and input cables (Group 3 options) are required for use with Group 2 column boards.

Options, Group 3, connector assemblies

Option 030. BCD input connector assembly for up to 9 columns, \$55.

Option 031. BCD input connector assembly for up to 6 columns, \$43.

Option 032. Input cable, for up to 10 BCD columns or three 10-line columns, \$50.

Option 033. 10-line input connector assembly for up to 3 columns, \$35.

Option 034. BCD input connector assembly for up to 10 columns, \$60.

Option 035. Input cable 10513A for IC counters, \$65.

NOTE: More than one input connector assembly and input cable are required for: 1. more than ten BCD columns; 2. operation from two sources; 3. more than three 10-line columns.

Options, Group 4

Option 041. Analog output (from 4-2-2-1 boards), \$175.

Option 042. Analog output (from 8-4-2-1 boards), \$175.

DIGITAL RECORDERS



DIGITAL RECORDERS

Print 10-line data at 5 lines/sec
Models 561B, 565A

The 561B Digital Recorder accepts only 10-line decimal code inputs, but is otherwise similar in operation to the HP 562A. The HP 565A Printer Mechanism, mechanically similar to the mechanism in the 561B and 562A, is available for use in custom systems.

Specifications, 561B

Column capacity: 11 columns (12 available on special order).

Print rate: 5 lines per second.

Print wheels: 12 positions having numerals 0 through 9, a minus sign and a blank; other symbols are available on special order.

Input: decimal code, 10 lines plus 2 lines for blank and minus sign for each column.

Driving sources: HP electronic counters (521D, 521E, 523C) with recorder kits, 405CR Digital Voltmeter, stepping switches, relays, beam switching tubes, contact closures, or -15 to -100 volts connected to appropriate input wire.

Print command signal: ± 15 volts peak, 10 μ s or greater in width, 1 V/ μ s minimum slope; manual control with momentary-contact switch.

Line spacing: zero, single or double; in "zero" does not print, paper does not advance.

Paper required: 560A-131A folded paper tape or standard 3" roll; tape sufficient for 15,000 single-spaced lines.

Power: 115 or 230 volts $\pm 10\%$ approximately 75 W, 50 to 60 Hz (4 prints/s maximum at 50 Hz); 50 Hz model available which retains 5 print/s capability.

Dimensions: 20 $\frac{3}{4}$ " wide, 12 $\frac{3}{4}$ " high, 18 $\frac{1}{2}$ " deep (527 x 324 x 470 mm) (cabinet); 19" wide, 10-15/32" high, 16 $\frac{1}{2}$ " deep (483 x 266 x 419 mm) (rack mount).

Weight: 561B, net 42 lbs (19,7 kg), shipping 70 lbs (31,5 kg) (cabinet mounted); 561BR, net 30 lbs (18 kg), shipping 65 lbs (29,2 kg) (rack mounted).

Accessories furnished: 9281-0018 folded paper tape, one packet, 9283-0002 inked ribbon, 560A-95N Digital Recorder Service Kit; 561B-16A Cable, accommodates 6 columns, connects to Option 002.-equipped vacuum tube counters.

Price: HP 561B, \$1400 (cabinet); \$1385 (rack mount).

Accessories available: 560A-131A folded paper tape, 24-packet carton \$19.50. Inked ribbon 9283-0002, \$3.50. 561-B-16A Cable, 6 ft., 6 columns, \$100, 561B-95D Connectors (mates with J101 or J102), \$8.50.

Specifications, 565A

Number of columns: 11 (12 available on special order).

Data entry: parallel entry to all columns; one line required for each position of each print wheel to be operated.

Maximum print rate: 5 lines per second.

Standard characters: 0 through 9, minus sign and blank (others available on special order); dimensions: approximately 0.085" wide, 0.1" high.

Column spacing: $\frac{1}{4}$ ".

Line spacing: 5/32" single space; 5/16" double space.

Power

Motor: 115 V $\pm 10\%$, 60 W, 50 to 60 Hz (50 Hz provides 4 prints/s max.).

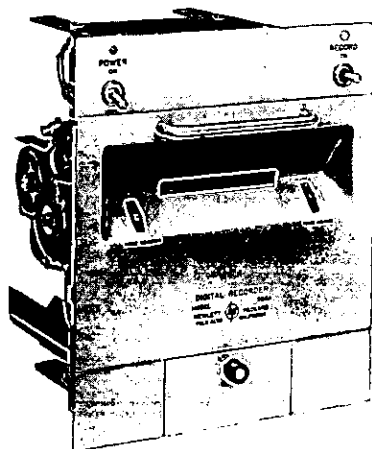
Clutch solenoid: 240 to 260 V dc, 75 mA (operates for approx. 15 ms to start printing cycle); coil designed for vacuum tube switching networks; lower voltage coils are recommended and available on special order for transistor switching.

Pawl magnets: 60 to 70 V dc, 15 mA (operate when needed during printing cycle); coils designed for vacuum tube switching networks; lower voltage coils are recommended and available on special order for transistor switching.

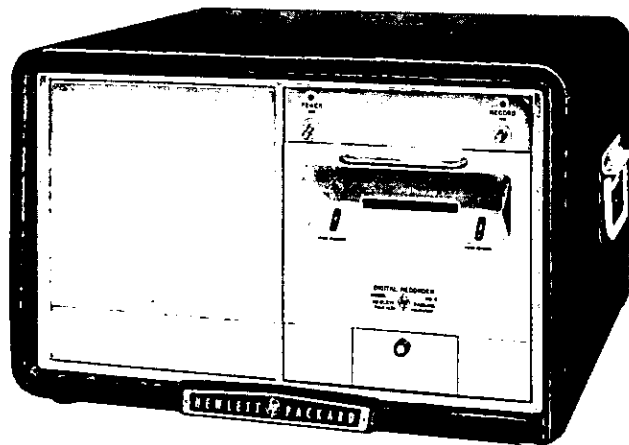
Dimensions: 9 $\frac{3}{4}$ " high, 8 $\frac{3}{8}$ " wide, 9 $\frac{3}{4}$ " deep (248 x 213 x 248 mm).

Weight: net 15 lbs (7 kg); shipping 28 lbs (12,7 kg).

Price: HP 565A (with high-voltage clutch and pawl coils for vacuum tube drive), \$850; for 115 V, 50 Hz operation with 5 print/s capability specify Option H27-565A, for 230 V 50 Hz operation with 5 print/s capability specify Option H24-565A.



565A



561B

DIGITAL TO ANALOG CONVERTERS

For high resolution recording
Models 580A, 581A



DIGITAL RECORDERS

Digital-to-Analog Converters make possible automatic, high-precision analog records from electronic counters, digital voltmeters and other devices providing the proper 4-line BCD output code. These converters operate directly with HP Quartz Thermometers, HP Nuclear Scalers and most HP solid-state counters; output kits are available for HP vacuum tube counters. Since the digital-to-analog converters tolerate a wide range of input voltages, they are suitable for use with other tube and solid-state devices.

Output signals for strip-chart or x-y recorders of both the potentiometer and galvanometer types are available, and controls for recorder calibration and zero adjustment are provided. A 50-pin connector accepts 4-line data from a maximum of nine decade counting units. This information is transferred to storage binary units upon receipt of a command pulse from the counting source. The stored data are then translated and weighted to provide the proper analog output voltage or current.

Specifications, 580A, 581A

Accuracy: 0.5% of full scale or better.

Potentiometer output: 100 mV full scale; minimum load resistance 20 K; calibrate control; dual banana plugs front and rear; typical 5 mV residual output at "000".

Galvanometer output: 1 mA full scale into 1500 ohms; zero and calibrate controls; phone jack front and rear.

Driving source: parallel entry 4-line BCD (9 digits maximum); "1" state +4 to +75 volts with reference to "0" state.

Reference voltages: reference voltages required for both the "0" and "1" state, reference voltages not to exceed ± 150 V to chassis.

Command pulse: positive or negative pulse, 20 μ s or greater in width, 6 to 20 volts amplitude.

Transfer time: 1 millisecond.

Power: 115 or 230 volts $\pm 10\%$, 50 to 1000 Hz, 11 W.

Options: please specify one of the following input code options (Option 001, 002, or 003):

001: 1-2-2-4 BCD code "1" state positive; "1" state +4 to +75 V with reference to "0" state. No additional cost.

002: 1-2-4-8 BCD code "1" state positive (voltages same as above). No additional cost.

003: 1-2-4-8 BCD code "1" state negative; "0" state +4 to

Any three successive digits (or the right-hand two) of the input may be chosen for analog output. By selecting the two or three least significant digits, analog records of high resolution and accuracy may be obtained with conventional strip chart and X-Y recorders. For example, recording the three right-hand digits of eight- or nine-column data can provide an analog record with resolution of 1 part in 10^3 .

Since the data in three successive columns can range only from 000 to 999, automatic zero-shifting is inherent in the output, keeping the record "on scale" at all times. As an example, consider successive readings of: 000, 120, 257, 496, 732, 998, 1024. Except for the last reading, the analog record would proceed up-scale to 998 (99.8% of full scale). Recording of the 1024 value would be made at 024 (2.4% of full scale). The quick transition of the pen from 998 to 024 would serve to indicate that the range has been shifted up by 1000. Down-scale shifts of zero are similarly indicated.

+75 V with reference to "1" state. No additional cost.

004: Special input cable 10513A for HP integrated circuit counters (e.g., 5221B, 5216A, 5331A/B, 5332A/B, 5325A) in lieu of 562A-16C input cable normally supplied. Add \$15.00.

Dimensions:

580A (rack mount): 16 $\frac{3}{4}$ " wide, 3-15/32" high, 11 $\frac{1}{4}$ " deep (425 x 88 x 286 mm).

581A: 7-25/32" wide, 6-3/32" high, 8" deep (198 x 155 x 203 mm).

Weight:

580A:

net: 13 lbs (6 kg)

shipping: 16 lbs (7,2 kg)

581A:

net: 8 lbs (3,5 kg)

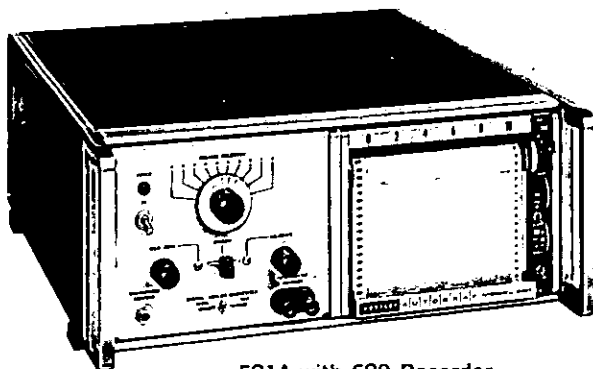
shipping: 13 lbs (6 kg).

Accessory furnished: 562A-16C Cable, 6' (1830 mm) long with an Amphenol 57-30500 connector at each end. See also Option 004.

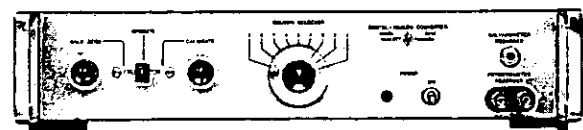
Price:

Model 580A, \$550.

Model 581A, \$575.



581A with 680 Recorder



580A

X-Y RECORDERS



X-Y RECORDERS

The Cartesian coordinate graph is one of the most effective methods for presenting related data clearly. As a result, X-Y recorders have found wide application in areas from general purpose laboratory use to a specialized system read-out. Typical applications are in plotting E vs I at the lab bench, or plotting the output of a Multi-channel Pulse Height Analyzer. Recorders are extremely effective where precise X-Y plots are needed, either to obtain accurate data or to allow rapid interpretation of data. An X-Y recorder automatically and conveniently plots the value of an independent variable versus a dependent variable, directly on conventional graph paper, working from readily derived electrical signals.

Over 15 years of experience in pioneering and manufacturing X-Y recorders has made Hewlett-Packard recorders the most useful of their kind.

Basic operation of X-Y recorders

The X-Y recorder uses closed loop servo systems to produce a pair of crossed motions, moving a pen to write precise X-Y plots. It consists of basic balancing circuits, plus auxiliary elements to make the instrument versatile.

Common controls and circuits used to provide versatility are:

1. A stepped attenuator for each axis so that input voltages from the microvolt range to 500 volts may be handled directly.
2. A variable attenuator which provides continuous adjustment to allow a transducer's output to correspond directly to the paper's coordinates in the desired units of measurement (psi, °C, etc.).
3. A zero control which allows the plotting origin to be placed anywhere on the paper or suppressed electrically off the paper.
4. A time base is often incorporated since it is frequently desirable to plot a function against time.

Main features

Long Life Slidewires. All Hewlett-Packard X-Y recorders use accurate, stable wire-wound slidewires which, through a proprietary manufacturing and cleaning process, eliminate the common problem of "dirty" slidewires. The slidewires are linear, open potentiometers located adjacent to the pen tip. This position affords the best possible linearity and minimum hysteresis.

Paper Holddown. Paper holddown for X-Y recorders must accomplish two

basic functions 1) Hold a reasonable size of standard graph paper, and 2) Hold the paper securely so that it cannot accidentally be moved while making notes, etc. Hewlett-Packard's proprietary electric paper holddown (Autogrip) holds any size paper securely through a combined electrostatic and electrodynamic effect. Autogrip is completely silent, maintenance-free, and does not require special paper.

Reliability. Hewlett-Packard recorders incorporate the results of conservative mechanical and electrical design plus thorough life and environmental testing. All critical parts, including slidewires and motors, are designed and manufactured in-house, resulting in optimum performance, quality, and reliability. Reliability is assured through 1) Maintenance-free electric paper holddown, 2) Long life slidewires, 3) Hewlett-Packard environmental testing, and 4) Hewlett-Packard quality control.

Accessories/Options. Flexibility and usefulness are assured by numerous accessories and options for each recorder model. Examples are the 17108A External Time Base which attaches to the 7035B X-Y Recorder and will drive all other Hewlett-Packard recorders, and the 17005A Chart Advance which converts 11 in. x 17 in. X-Y Recorders to 10 in. Strip-Chart Recorders.

Selecting an X-Y recorder

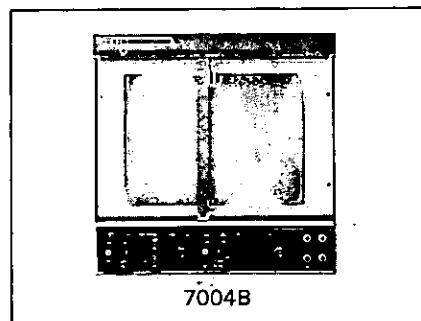
Hewlett-Packard X-Y Recorders may be selected from models in three basic chart sizes, and three basic levels of performance. The basic chart sizes are 8½ in. x 11 in., 11 in. x 17 in., and 30 in. x 30 in. The basic levels are general purpose, high sensitivity, and high performance.

The general purpose recorders are intended for average laboratory use where neither high sensitivity nor high dynamic performance are required. This group is comprised of a low cost type (Models

7005B, 7035B), a general purpose with time base (Models 135, 135A), two-pen (Models 2FA, 136A), and large display (Model 7).

The high sensitivity type is intended for applications requiring the direct plotting of very low level signals (microvolt range) as well as for general purpose usage. This group is comprised of the Models 7000A, 7001A, and 7030A.

The high-performance type is intended for applications requiring fast pen response in addition to general purpose usage. This fast response is effected through the use of a very low inertia drive system providing high slewing speed and extremely high acceleration. These units also incorporate input plug-in modules which provide versatility, allowing inexpensive plug-ins to be purchased to accommodate changing applications. This group is comprised of the Models 7004B and 7034A.



Accessories and options

Accessories include a line follower, roll chart adapters, an incremental chart advance, plotters for high speed point plotting, logarithmic converters, and an external time base.

Options include rack mounting (standard on most models), metric calibration and scaling, retransmitting potentiometers, event markers, special input characteristics, rear input connectors and others. The range of accessories is constantly being expanded.

Hewlett-Packard X-Y Recorders

Performance Level	Model	Chart size (in.)	Page	Max Sensitivity (mV/in.)	Other	Price
General Performance	7005B	11 x 17	113	1.0	Time base Two pen and Time Base	\$1195
	7035B	8½ x 11	113	1.0		\$ 985
	135/135A	8½ x 11	114	0.5		\$1650
	7	30 x 30	114	0.5		\$5500
	2FA 136A	11 x 17 8½ x 11	115 115	0.5 0.5		{ \$3375 \$1975
High sensitivity	7000A	11 x 17	116	0.1	Ac/Dc Converter and Time Base Time Base Time Base	\$2600
	7001A	11 x 17	116	0.1		\$2175
	7030A	8½ x 11	116	0.1		\$1975
High Performance	7004B	11 x 17	117	0.5①	Very fast response, input plug-in modules	{ \$1395②
	7034A	8½ x 11	117	0.5②		{ \$1195②

① External time base available (Model 17108A)

② Depends on plug-in selected (see page 118)

GENERAL PURPOSE

Low Cost
Models 7005B and 7035B



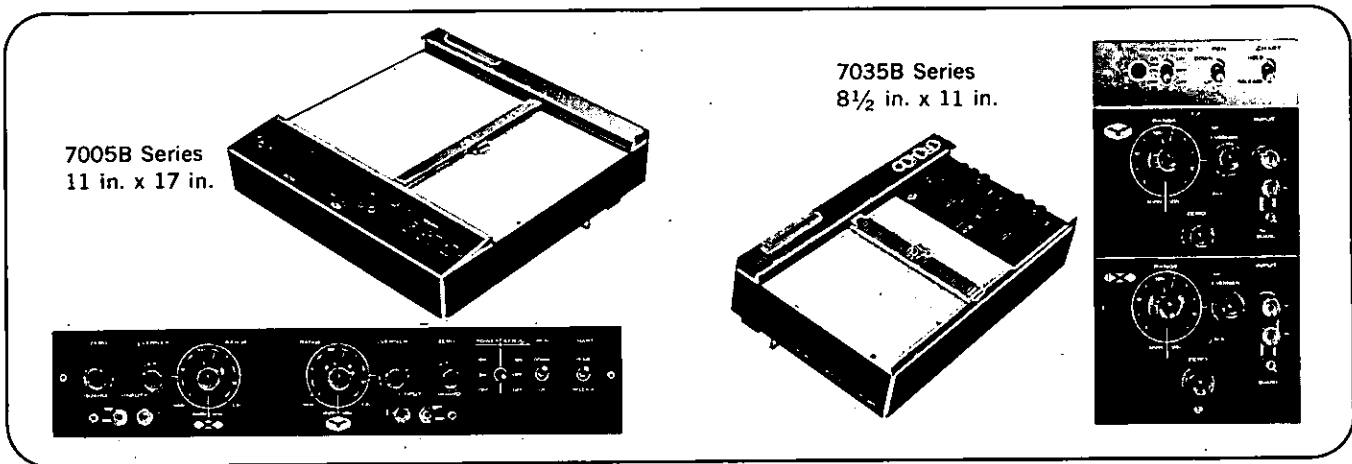
X-Y RECORDERS

Models 7005B and 7035B are low cost, solid-state X-Y Recorders for general purpose applications. Each axis has an independent servo system with no interaction between channels. The recorders graph two related functions from two dc signals representing the functions. The ultra-compact design is convertible to rack mounting by addition of two wing brackets (supplied). Metric scaling and calibration are optional.

The input terminals accept either open wires or plug-type connectors. Five calibrated ranges from 1 mV/in. to 10 V/in. are provided in each axis. A variable range control permits scaling of signal for full scale deflection. Standard features include high input impedance (one megohm on all but the first two ranges), floated and guarded signal pair input, 0.2%

accuracy, Autogrip electric paper holddown, electric pen lift, adjustable zero set, lockable zero and variable range controls, and rear input connector. A plug-in time base (Model 17108A) operates on either axis to provide five sweep speeds from 0.5 to 50 s/in.

Each closed-loop servo system employs a high-gain solid-state servo amplifier, Hewlett-Packard servo motor, long-life balance potentiometer, photochopper, low pass filter, guarded inputs, precision attenuator and balance circuit. Both models are designed for easy maintenance with most components mounted on a printed circuit board and accessible by removing the rear cover. Both balance potentiometers are accessible for inspection or cleaning by removing a snap-on strip.



Specifications

Performance specifications

Input ranges: English: 1, 10, 100 mV/in.; 1 and 10 V/in.; Metric: 0.4, 4, 40, 400 mV/cm and 4 V/cm. Continuous vernier between ranges.

Type of inputs: floated and guarded signal pair; rear input connector.

Input resistance:

Range	Input resistance
1 mV/in (0.4 mV/cm)	Potentiometric (essentially infinite at null)
Variable	11 k Ω
10 mV/in (4 mV/cm)	100 k Ω
Variable	100 k Ω
100 mV/in (40 mV/cm)	1 M Ω
Variable	1 M Ω
1 mV/in (400 mV/cm)	1 M Ω
Variable	1 M Ω
10 V/in (4 V/cm)	1 M Ω
Variable	1 M Ω

Input filter: > 30 dB at 60 Hz; 18 dB/octave above 60 Hz.

Maximum allowable source impedance: no restrictions except on fixed 1 mV/in. (0.4 mV/cm) range. Up to 20 k Ω source impedance will not alter recorder's performance.

Accuracy: $\pm 0.2\%$ of full scale.

Linearity: $\pm 0.1\%$ of full scale.

Resettability: $\pm 0.1\%$ of full scale.

Zero set: zero may be set up to one full scale in any direction from zero index. Lockable zero controls.

Slewing speed: 20 in./s, 50 cm/s nominal at 115 V.

Interference rejection: conditions for the following data is line frequency with up to 1 k Ω between the negative input and guard connection point.

Range		DC (CMR)	AC (CMR)
English	Metric		
1 mV/in	0.4 mV/cm	130 dB	100 dB
10 mV/in	4 mV/cm	110 dB	80 dB
100 mV/in	40 mV/cm	90 dB	60 dB
1 V/in	400 mV/cm	70 dB	40 dB
10 V/in	4 V/cm	50 dB	20 dB

General specifications

Paper holddown: Autogrip electric paper holddown grips any chart up to size of platen.

Pen lift: electric pen lift capable of being remotely controlled.

Dimensions: 7005B: 17 $\frac{1}{2}$ " high, 17 $\frac{1}{2}$ " wide, 4-5/16" deep (445 x 445 x 110 mm). 7035B: 10-15/32" high, 17 $\frac{1}{2}$ " wide, 4 $\frac{3}{4}$ " deep (266 x 445 x 121 mm).

Weight: net, 18 lb (8 kg); shipping, 24 lb (10.9 kg).

Power: 115 or 230 V $\pm 10\%$, 50 to 60 Hz, approximately 45 VA.

Time base accessory: Model 17108A self-contained external time base has five sweep speeds. Price \$ 175

Price:

Model 7005B—11 in. x 17 in. Chart Size	\$ 1195
Model 7035B—8 $\frac{1}{2}$ in. x 11 in. Chart Size	\$ 985

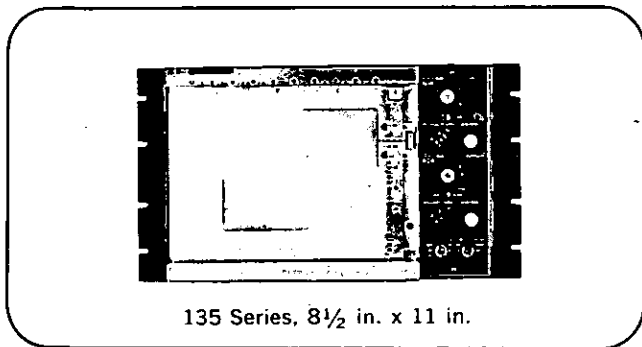
Options:

01. Metric calibration	N/C
03. Retransmitting potentiometer on X-axis	
5 k Ω $\pm 3\%$	\$ 75
04. Disposable pen tips	N/C
05. Cartridge ink supply	N/C
06. Cartridge pen with disposable tips	N/C
H10. 100 mV/in. on each axis or	
40 mV/in. if option 01 also ordered	deduct \$ 50
(7035B only)	

X-Y RECORDERS



GENERAL PURPOSE 8½ in. x 11 in. and built-in time base Models 135 and 135A



135 Series, 8½ in. x 11 in.

The Models 135 and 135A X-Y recorders are adaptable to almost any laboratory or system application. The 135 and the 135M (metric) feature 16 dc input voltage ranges on each axis with a minimum input resistance of 200 k Ω /V full scale. The 135A and 135AM (metric) feature 11 calibrated voltage ranges with 1 megohm resistance at null.

Standard features include transistor circuitry, calibrated time base on the X-axis, zero set and zero suppression, potentiometric input mode, scale factor vernier and Autogrip electric paper holddown which holds any chart up to 8½ in. x 11 in.

Specifications

Performance specifications

Input ranges:

Model 135: (English) 0.5, 1, 2, 5, 10, 20, 50 mV/in.; 0.1, 0.2, 0.5, 1, 2, 5, 10, 20, 50 V/in. (Metric) 0.2, 0.5, 1, 2, 5, 10, 20, 50, 100 mV/cm; 0.2, 0.5, 1, 2, 5, 10, 20 V/cm.

Model 135A: (English) 0.5, 1, 5, 10, 50 mV/in.; 0.1, 0.5, 1, 5, 10, 50 V/in. (Metric) 0.2, 0.5, 2, 5, 20, 50 mV/cm; 0.2, 0.5, 2, 5, 20 V/cm.

All models: vernier control covers range between settings. Potentiometric mode available on both axes on the most sensitive range of 135 and four most sensitive ranges on 135A.

Type of inputs: floating up to 500 Vdc above ground.

Input resistance:

Model 135: 200 k Ω /V full scale through 1 V/in. range; 2 M Ω on all higher ranges. **Model 135M:** 200 k Ω /V full scale through 0.5 V/cm range; 2.5 M Ω on all higher ranges. **Models 135A/135AM:** one M Ω at null on all fixed ranges. Variable range control mode, 100 k Ω on four most sensitive ranges and one M Ω on all other ranges.

Maximum allowable source impedance:

Model 135/135M: no restrictions on calibrated ranges; 1 k Ω on most sensitive range (potentiometric input). **Model 135A/135AM:** 10 k Ω on four most sensitive ranges; no restrictions on higher ranges.

Slewing speed: 20 in./s, maximum, each axis for 60 Hz; 16 in./s maximum for 50 Hz.

Accuracy: 0.2% of full scale.

Linearity: 0.1% of full scale.

Resettability: 0.1% of full scale.

Zero offset: adjustable zero may be set up to one full scale in any direction from the zero index.

Reference stability: better than 0.002%/°C.

Time sweeps: (X-axis only) **Model 135:** 0.5, 1, 2, 5, 10, 20, 50 s/in. **Model 135M:** 0.2, 0.5, 1, 2, 5, 10, 20 s/cm. **Model 135A:** 0.5, 1, 5, 10, 50 s/in. **Model 135 AM:** 0.2, 0.5, 2, 5, 20 s/cm. Accuracy 5% of full scale.

General specifications

Paper holddown: Autogrip electric paper holddown grips charts 8½ in. x 11 in. or smaller.

Pen lift: local and remote pen lift.

Power: 115 or 230 V, 50 to 60 Hz, approximately 120 VA.

Dimensions: (bench) 17⅞" wide, 10-15/32" high, 4¾" deep (454 x 265 x 121 mm); (rack) 19" wide, 10-15/32" high, 4½" deep (483 x 266 x 114 mm).

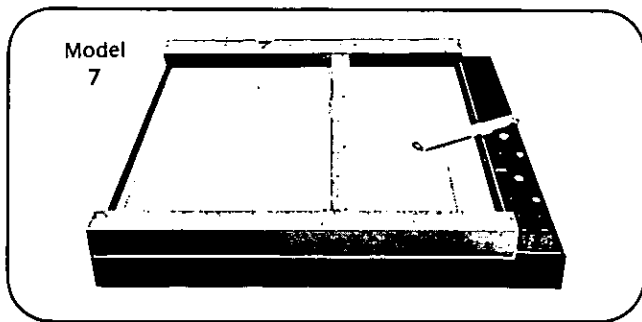
Weight: net, 20 lb (9 kg); shipping, 32 lb (13.6 kg).

Price: Models 134/135M/135A/135AM \$1650

Options:

02 Rear input connectors (with mating connector)	\$ 15
04 Cartridge ink supply	N/C
05 5 k Ω retransmitting potentiometer (X-axis)	\$100
06 3.5 k Ω retransmitting potentiometer (Y-axis)	\$100
07 Retransmitting potentiometer (both axes)	\$200
08 Disposable pen tips	N/C
09 Cartridge pen with disposable tips	N/C

LARGE DISPLAY X-Y RECORDER 30 in. x 30 in. Model 7



Model
7

The Model 7 is an X-Y recorder especially designed for large systems display in console, wall or special floor stand mountings. The Model 7 is ideal for display of data plotted with digital to analog conversion equipment. It incorporates tachometer damping, adjustable on the front panel, which allows the user to optimize the writing characteristics to meet his own demands.

Specifications

Input ranges: 1, 2, 5, 10, 20, 50 mV/in.; 0.1, 0.2, 0.5, 1, 2, 5, 10 V/in. Variable range control; potentiometric input on most sensitive range.

Input resistance: 200,000 ohms/V, full scale up to 0.5 V/in.; 3 M Ω on all higher ranges.

Slewing speed: 20 in./s maximum pen speed, each axis.

Accuracy: better than 0.1% of full scale, resettability better than 0.05% of full scale.

Power: 115 V, 60 Hz, approx. 185 VA.

Dimensions: 40⅜" wide, 7-1/16" deep, 37-5/16" high (1026 x 180 x 948 mm).

Paper size: standard 32 in. x 32 in. graph paper with 30 in. x 30 in. (762 x 762 mm) plotting area; vacuum holddown.

Weight: net, 90 lb (40.5 kg); shipping, 180 lb (81 kg).

Price: Model 7 \$5500

Option 01: 230 volt operation add \$100.

TWO PEN X-Y₁, Y₂ Simultaneous plotting of three parameters Models 2FA and 136A

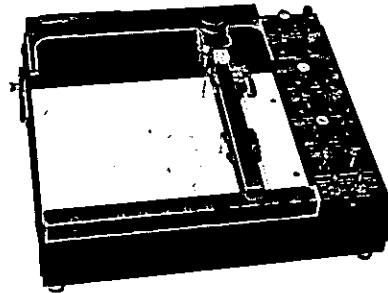
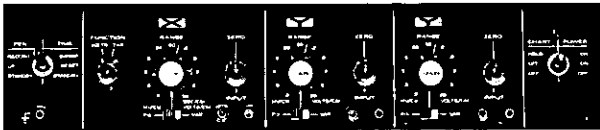
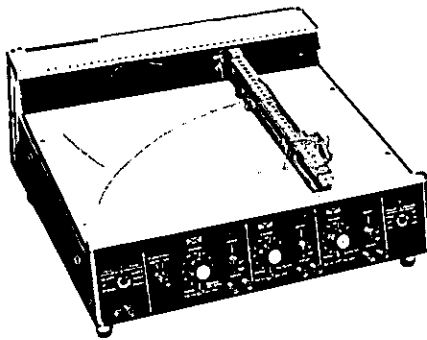


X-Y RECORDERS

The 2FA and 136A are two-pen X-Y₁, Y₂ graphic recorders available with English or Metric scaling for bench or rack mounting. Features include a built-in time base on the X axis with 5 calibrated sweeps, 11 input voltage ranges with a continuous vernier that scales input voltages to fit the paper, a full-scale zero set and suppression, local and remote pen lift and potentiometric inputs. Two-pen capability makes these recorders extremely useful for plotting 3 parameters simultaneously.

The two pens traverse the full X axis with no more than 0.1 inch horizontal separation. The servo drives are independent and free of electrical ground. The servo amplifiers and power supplies are combined in a single compact modular unit. A simplified self-balancing system using linear slidewires and a continuous zener-controlled reference provides for non-interacting and accurate recording versatility. Autogrip electric paper holddown provides a positive grip on chart paper up to the size of the platen. Operation is silent and maintenance free.

2FA Series
11 in. x 17 in.



136A Series, 8½ in. x 11 in.



Specifications

Performance Specifications

Input ranges: 0.5, 1, 5, 10, 50 mV/in.; 0.1, 0.5, 1, 5, 10, 50 V/in. Metric models: 0.2, 0.5, 2, 5, 20, 50 mV/cm; 0.2, 0.5, 2, 5, 20 V/cm. Variable range mode all positions.

Input resistance: one megohm at null on all fixed ranges. Variable range mode, 100,000 ohms on four most sensitive ranges and one megohm on all others. On the Model 2FA, potentiometric input is available on the four most sensitive ranges of each axis by removing an internal strap. On the Model 136A, potentiometric input is available on the four most sensitive ranges of the X-axis by removal of an internal strap and on both Y axes by a front panel switch.

Maximum allowable source impedance: up to 10 kΩ source impedance will not alter recorder's performance on the four lowest ranges. No source impedance restrictions on ranges above 10 mV/in.

Time Sweeps: (on X axis only) 0.5, 1, 5, 10, 50 s/in.; metric: 0.2, 0.5, 2, 5, 20 s/cm. Accuracy, 5% of full scale.

Accuracy: 0.2% of full scale.

Linearity: 0.1% of full scale.

Resettability: 0.1% of full scale on all ranges.

Reference stability: better than 0.002%/°C.

Slewing speed

2FA series: 60 Hz operation: 10 in./s (25 cm/s) on the X-axis; 20 in./s (50 cm/s) on Y₁ and Y₂ axes max. 50 Hz operation: 8 in./s (20 cm/s) on the X-axis; 16 in./s (40 cm/s) on Y₁ and Y₂ axes max.

136A/AM: 60 Hz operation: 20 in./s (50 cm/s) on the X-axis; 15 in./s (38 cm/s) on Y₁ and Y₂ axes max. 50 Hz operation: 16 in./s (40 cm/s) on the X-axis; 12 in./s (30 cm/s) on the Y₁ and Y₂ axes max.

General Specifications

Paper holddown: Autogrip paper holddown electronically grips charts of any size up to size of platen.

Pen lift: local and remote.

Power: 115 or 230 V, 50 or 60 Hz, 130 VA.

Dimensions: 2FA/2FAM (bench): 18¼" deep, 17½" wide, 8½" high (464 x 445 x 206 mm); 2FRA/2FRAM (rack): 8" deep, 19" wide, 19-7/32" high (203 x 483 x 488 mm); 136A/M (bench): 14" high, 17⅞" wide, 6-3/16" deep (355 x 454 x 157 mm); (rack) 14" high, 19" wide, 6-3/16" deep (355 x 483 x 157 mm).

Weight: 2FA series: net, 42 lb (18,9 kg); shipping, 55 lb (24,75 kg). 136A/AM: net, 34 lb (15,45 kg); shipping, 47 lb (21,3 kg).

Price: 2FA/2FRA (English), 2FAM/2FRAM (Metric) \$3375
136A/136AR (English), 136AM/136AMR (Metric) \$2650

Options

2FA Option Number	136A Option Number	Description	Price
01	02	Rear input connectors (supplied with mating connectors)	add \$15
02	—	Event marker	add \$100
—	03	5 kΩ retransmitting potentiometer-X axis	add \$100
03	04	Disposable pen tips	N/C

GRAPHIC RECORDERS

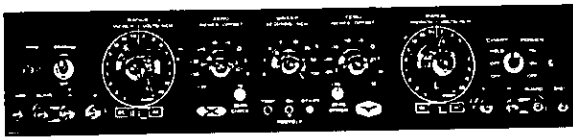
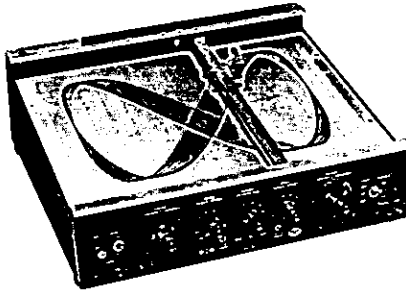


HIGH SENSITIVITY

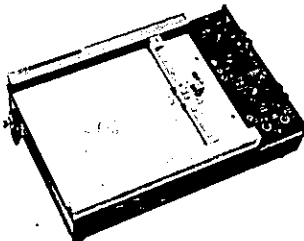
100 $\mu\text{V}/\text{inch}$

Models 7000A, 7001A, and 7030A

7000A Series
11 in. x 17 in.



7030A Series
8½ in. x 11 in.



The 7000A X-Y recorder has high sensitivity, high common mode rejection and accepts either ac or dc signals on either axis. The 7001A is identical to the 7000A except for the omission of ac input ranges. The 7030A is similar to the 7001A except for the chart size (8½ in. x 11 in.). Specially guarded and shielded circuitry provides one megohm input resistance at null on all ranges. Units are available for bench, or rack mounting and with metric or English scaling.

The chart is held firmly by the silent, maintenance-free Autogrip electric platen. The electronic time base may be switched to operate in either axis. Sweep features include automatic reset, adjustable sweep length, and automatic recycling.

Zero offset for each axis may be preset, in 5-inch calibrated steps, up to 4 scale lengths in Y and 3 scale lengths in X with continuous adjustability between steps.

AC sensitivity up to 5 mV/in. (2.5 mV/cm) on the Model 7000A is a convenience when using Hewlett-Packard Model 1110A and 456A ac clip-on current probes without additional amplification.

Performance Specifications

DC input: (English) 0.1, 0.2, 0.5, 1, 2, 5, 10, 20, 50 mV/in.; 0.1, 0.2, 0.5, 1, 2, 5, 10, 20 V/in. (Metric) 0.05, 0.1, 0.25, 0.5, 1, 2.5, 5, 10, 25 mV/cm; 0.05, 0.1, 0.25, 0.5, 1, 2.5, 5, 10 V/cm. Continuous vernier between ranges.

AC input: (7000A only) 5, 10, 20, 50 mV/in.; 0.1, 0.2, 0.5, 1, 2, 5, 10, 20 V/in. (Metric) 2.5, 5, 10, 25, mV/cm; 0.05, 0.1, 0.25, 0.5, 1, 2.5, 5, 10 V/cm.

AC frequency range: 20 Hz to 100 kHz.

Type of inputs: floated and guarded signal pair. AC input (7000A only) is single-ended, capacitively coupled.

DC input resistance: one megohm at null on all calibrated and variable dc ranges. Potentiometric input on 6 most sensitive ranges by disconnecting an internal buss wire (front panel switch optional).

AC input impedance: (7000A only) 1 M Ω , all calibrated ac ranges.

Maximum allowable source impedance: up to 10 k Ω source impedance will not alter recorder's performance on the first six ranges. No source impedance restrictions on ranges above 5 mV/in.

Interference rejection: dc common mode rejection 140 dB on 3 most sensitive ranges; 120 dB at power line frequency on 2 most sensitive ranges.

Slowing speed: 20 in./s, each axis for 60 Hz; 16 in./s for 50 Hz.

Accuracy: dc—0.2% fs; ac—0.5% fs, 20 Hz to 100 kHz.

Linearity: dc—0.1% fs; ac—0.2% fs; time sweep—1% fs.

Resetability: 0.1% fs on all ranges.

Reference stability: better than 0.005%/°C.

Time sweeps: may be applied to either axis: 0.5, 1, 2, 5, 10, 20, 50, 100 s/in. Metric models: 0.25, 0.5, 1, 2.5, 5, 10, 25, 50 s/cm.

Time base accuracy: 2% fs.

Zero set (dc range only): continuously adjustable with 5 in. (10 cm) calibrated steps for up to 3 full scale lengths on X and 4 on Y. Zero check pushbutton switches on each axis.

General Specifications

Paper holddown: Autogrip paper holddown grips charts of any size up to size of platen.

Pen lift: local and remote control (contact closure).

Power: 115 or 230 V, 50 to 60 Hz, approximately 120 VA.

Dimensions: 7000A/AM, 7001A/AM (bench): 6½" high, 17½" wide, 17" deep (164 x 445 x 432 mm). 7000AR/AMR, 7001AR/AMR (rack): 17-7/16" high, 17¾" wide inside rack clearances, 5¾" deep (443 x 451 x 136 mm). 7030A/AM: (bench) 12-1/6" high, 17⅞" wide, 4¾" deep (306 x 454 x 421 mm). (Rack) 4¾" deep, 10-15/32" high, 19" wide (121 x 265 x 483 mm).

Weight: 7000A/7001A series: net, 38 lb (17.2 kg); shipping, 46 lb (20.9 kg). 7030A series: net, 27 lb (12.2 kg); shipping, 33 lb (16 kg).

Prices: 7000A/AR (English), 7000AM/AMR (Metric)

11 in. x 17 in. chart size \$2600

7001A/AR (English), 7001AM/AMR (Metric)

11 in. x 17 in. chart size \$2175

7030A (English), 7030AM (Metric)

8½ in. x 11 in. chart size \$1975

Options

Option Number			Additional Price	
7000A/ 7001A Series	7030A		7000A/ 7001A Series	7030A
01	01	Potentiometric switch for 6 most sensitive ranges	\$ 55	\$ 55
04	05	5 k Ω retransmitting potentiometer on X-axis	\$ 75	\$150
05	06	Rear input terminals	\$ 50	\$ 50
	07	3.5 k Ω retransmitting potentiometer on Y-axis		\$150
06		5 k Ω retransmitting potentiometer on Y-axis	\$ 75	
07	08	Retransmitting potentiometers on both axes	\$150	\$300
09		Event marker (X-axis)	\$100	
	09	Remote sweep capability		\$ 75
10	10	Disposable pen tips	N/C	N/C

HIGH PERFORMANCE

Plug-in versatility and fast response
Models 7004B and 7034A



X-Y RECORDERS

The 7004B and the 7034A are flexible to meet the constantly changing requirements of laboratory measurements. Plug-in modules and a variety of accessories form a versatile high-performance X-Y Recorder. Circuitry common to all plug-in modules (power supplies, interfaces, etc.) is located in the main frame. This allows the user to purchase additional low-cost plug-ins to expand the measurement capabilities of the system. The plug-in approach allows the user to purchase only the capabilities required.

With an acceleration of more than 1500 in./s², and slewing speed of 30 in./s, the 7004B and 7034A record more phenomena than earlier X-Y recorders.

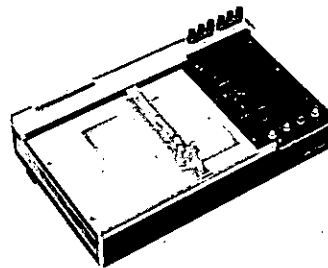
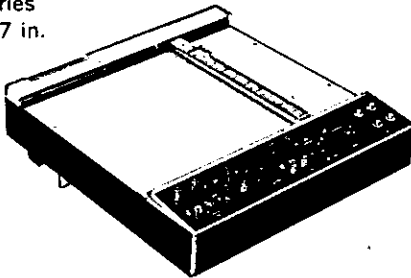
These recorders use the most advanced technology available.

They use all-silicon integrated circuitry and the proven Auto-grip electrostatic paper holddown.

Guarded input circuits are provided to utilize the superior performance fully. Guarding eliminates the effects of unwanted ac and dc common-mode voltages which can be troublesome in low level recording signals from thermocouples, strain gages and similar sources.

Plug-in modules provide a versatile X-Y Recorder for a variety of applications. If your application changes, the needed measurement capability is available by simply adding an inexpensive plug-in. In addition to these advantages, their high dynamic performance allows recorders to be used in practically any X-Y Recorder application.

7004B Series
11 in. x 17 in.



7034A Series
8½ in. x 11 in.



Performance specifications

Number of plug-ins: frame will accept the equivalent of four single-width plug-ins, two per axis.

Type of input: floating and guarded signal pair. Available at the front panel or at the rear connector.

Zero set: zero may be set ± 1 full scale from zero index.

Zero check switches: pushbutton zero check switch in each axis allows verification of recorder's zero position without removal or shorting of the input signal.

Mainframe accuracy: 0.2% of fs.

Range vernier: lockable, covers 2.5 times range setting.

Slewing speed: more than 30 in./s (75 cm/s) independent of line voltage and frequency.

Acceleration: more than 1500 in./s² (300 cm/s²).

Reference stability: better than 0.003%/°C.

Terminal based linearity: $\pm 0.1\%$ of fs.

Resettability: $\pm 0.05\%$ of fs.

General specifications

Paper holddown: Autogrip paper holddown grips charts of any size up to size of platen.

Pen lift: local and remote control (contact closure).

Dimensions: 7004B: 17½" wide, 17½" high, 4¾" deep (445 x 445 x 121 mm). 7034A: 17½" wide, 10½" high, 4¾" deep (445 x 267 x 121 mm).

Weight: 7004B: net, 24 lb (10.9 kg); shipping, 32 lb (14.5 kg). 7034A: net, 16 lb (7.3 kg); shipping, 22 lb (10 kg).

Power: 115 or 230 volts ac $\pm 10\%$, 50 to 400 Hz, approximately 85 VA (depending on the plug-ins used).

Price

Model 7004B—11" x 17"	\$1395
Model 7034A—8½" x 11"	1195

Options

01 Metrically scaled and calibrated	N/C
02 X-axis retransmitting potentiometer, 5 k Ω $\pm 0.1\%$ linearity (7004B only)	\$ 75
04 Power supply for 17005-04 incremental chart advance (7004B only)	\$ 50

X-Y RECORDERS



PLUG-IN MODULES

For recorder Models 7004B and 7034A



DC Coupler
Model 17170A

The DC Coupler couples the input signal to the recorder main frame. The input signal range of 100 mV/in. (50 mV/cm) may be adjusted to 250 mV/in. (125 mV/cm) with a vernier control on the recorder front panel.



DC Amplifier
Model 17171A

The DC Pre-amplifier is a stable, low noise, dc amplifier. The 14 calibrated input ranges are supplemented by a vernier control on the recorder front panel to provide a continuously variable range from 0.5 mV/in. (0.25 mV/cm) to 25 V/in. (12.5 V/cm).



Time Base
Model 17172A

The Time Base plug-in makes X-T or Y-T recordings possible. It employs all-silicon solid-state construction including the latest integrated circuits. Standard features include eight speeds, automatic reset and pen lift at completion of sweep, and remote start control. A vernier control on the recorder front panel extends the sweep speed through 250 s/in. (125 s/cm).



Null Detector
Model 17173A

The Null Detector plug-in provides closed-loop plotting of data in point form, at up to 50 pps. Plotting is accomplished with the Model 17012B/C Point Plotter. The 17012B/C cable plugs into a jack on the 17173A panel and the plotting head is substituted for the recorder pen.

Upon receipt of a seek signal and after the recorder reaches balance, the Null Detector commands the 17012B/C Point Plotter to plot and initiates a plot-complete pulse.

17170A Specifications

Input range: a single fixed calibrated range of 100 mV/in. (50 mV/cm).

Input resistance: constant, 1 M Ω .

Common-mode rejection: 120 dB at dc and 70 dB at 50 Hz and above with 100 ohms between low side and guard connection point with source impedance 10 k Ω or less.

Price: Model 17170A

\$ 25

17171A Specifications

Input ranges: English: 0.5, 1, 2, 5, 10, 20, 50 mV/in., 0.1, 0.2, 0.5, 1, 2, 5, 10 V/in.; Metric: 0.25, 0.5, 1, 2.5, 5, 10, 25 mV/cm, 0.05, 0.1, 0.25, 0.5, 1, 2.5, 5 V/cm.

Input resistance: 1 M Ω .

Maximum allowable source resistance

Range	Max. Source Resistance
0.5 mV/in. (0.25 mV/cm)	10 k Ω
1 mV/in. (0.5 mV/cm)	20 k Ω
2 mV/in. (1.0 mV/cm)	40 k Ω
5 mV/in. (2.5 mV/cm)	100 k Ω
10 mV/in. (5.0 mV/cm)	200 k Ω
20 mV/in. (10.0 mV/cm)	400 k Ω
50 mV/in. (25 mV/cm) and up	1 M Ω

Common-mode rejection: 120 dB at dc and 100 dB at 50 Hz and above with 100 ohms between low side and guard connection point (at 0.5 mV/in. or 0.25 mV/cm). On other ranges CMR decreases 20 dB per decade step in attenuation.

System accuracy: $\pm 0.2\%$ of full scale.

Zero drift: < 1 mV/ $^{\circ}$ C with a maximum of 25 μ V from 0 to 55 $^{\circ}$ C.

Price: Model 17171A

\$ 250

Option: 01 metrically scaled

N/C

17172A Specifications

Sweep speeds: English: 0.5, 1, 2, 5, 10, 20, 50, 100 s/in.; Metric: 0.25, 0.5, 1, 2.5, 5, 10, 25, 50 s/cm.

System accuracy: $\pm 1\%$ of full scale on the six fastest ranges, $\pm 2.5\%$ on the remaining two ranges.

Terminal based linearity: $\pm 0.5\%$ of full scale.

Price: Model 17172A

\$ 200

Option: 01 metrically scaled

N/C

17173A Specifications

Plot rate: up to 50 plots/s.

Enable-disable: required disable voltage +3 volts minimum to +20 volts maximum. Required enable voltage: 0 V dc or no connection. Other voltage combinations available on request.

Muting: local or remote.

Plotting accuracy: $\pm 0.25\%$ of full scale.

Input: all inputs, except analog inputs, are available through rear input connectors in the module. Analog inputs are applied to the input terminals of the main frame. Mating connector supplied.

Price: Model 17173A

\$ 200

Options

- | | |
|-------------------------------------|-----------|
| 01. +3 to +20 V enable, 0 V disable | add \$ 25 |
| 02. -3 to -20 V disable, 0 V enable | add \$ 25 |
| 03. -3 to -20 V enable, 0 V disable | add \$ 25 |

PLUG-IN MODULES

For recorder Models 7004B and 7034A



X-Y RECORDERS



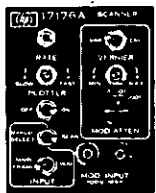
DC Offset
Model 17174B

The DC Offset plug-in provides the recorder with the capabilities of recording small signals superimposed on a steady-state dc voltage. The offset plug-in suppresses the steady-state dc voltage allowing recorder sensitivity to be increased.



Filter
Model 17175A

The Filter plug-in rejects ac input signal components above 50 Hz. Insertion of the 17175A in front of any other signal conditioning input module will improve normal mode rejection.



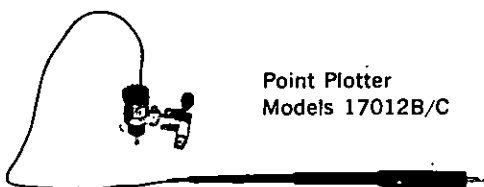
Scanner
Model 17176A

The Scanner plug-in electrically scans between two inputs, similar to the chopped mode on an oscilloscope, and provides the capability of plotting two dependent variables vs. one independent variable. The Scanner plug-in, utilizing the Model 17012B/C high speed point plotter, can scan two selectable inputs (module or main frame) in two scan modes (multiplexing both inputs or singularly). The scan rate is adjustable from 0.1 s/scan to 4 s/scan.



DC Attenuator
Model 17178A

The DC Attenuator offers a stable, passive attenuator with eight ranges. A vernier control on the recorder control panel allows continuously variable settings between fixed ranges of the 17178A.



Point Plotter
Models 17012B/C

17174B Specifications

Offset: less than 1 mV to approximately 1 volt.

Controls: two lockable, ten-turn high resolution controls. (less than 1 mV to approximately 10 mV and less than 1 mV to approximately 1 V). An offset polarity switch allows upscale or downscale zero offset.

Offset voltage stability: greater than 0.005%/°C.

Insertion loss: less than 0.05%.

Price: Model 17174B

\$ 100

17175A Specifications

Input voltage range: -5 to +50 V dc, 10 V ac maximum peak-to-peak.

Maximum source impedance: 1 k Ω , higher impedance decreases filter response.

Rejection: more than 55 dB at 50 Hz and higher ($\frac{1}{4}$ s rise time) or more than 70 dB at 50 Hz and higher (1 s rise time). Front panel selectable.

Insertion loss: 1%; filter may be switched out with no change in insertion loss.

Price: Model 17175A

\$ 75

17176A Specifications

Input: module input; front panel miniature binding posts isolated from ground (high and low only). Main frame input; utilizes existing input connectors on main frame.

Attenuator: fixed attenuator in decade steps from X1 to X0.001. Variable attenuator provides continuous coverage.

Input impedance: 100 k Ω .

Accuracy: 0.2% of full scale.

Scan rate: adjustable from 0.1 to 4 s/scan.

Price: Model 17176A

\$ 300

17178A Specifications

Input ranges: English: 0.1, 0.2, 0.5, 1, 2, 5, 10, 20 V/in.; Metric: 0.05, 0.1, 0.25, 0.5, 1, 2.5, 5, 10 V/cm.

Input resistance: 1 M Ω .

Common-mode rejection: 120 dB at dc and 70 dB at 50 Hz and above with 100 ohms between low side and point where the guard is connected (at 100 mV/in. or 50 mV/cm). On other ranges CMR decreases 20 dB per decade step in attenuation.

System accuracy: $\pm 0.2\%$ of full scale.

Price: Model 17178A

\$ 100

Option: 01 metrically scaled

N/C

17012B/C Specifications

The 7004B or 7034A, equipped with the 17012B or 17012C Point Plotter respectively, is capable of point plotting when used with the appropriate plug-in. The 17173A Null Detector plug-in allows rapid point plotting for applications such as a high speed readout for a multichannel pulse height analyzer. The 17176A Scanner plug-in allows plotting of two inputs on a single axis to form a X-Y₁, Y₂ or X₁, X₂-Y recorder.

Plotting rate is up to 50 points per second; power is supplied from the recorder.

Price: Model 17012B (fits Model 7004B)

\$ 95

Model 17012C (fits Model 7034A)

\$ 95

X-Y RECORDERS



RECORDER ACCESSORIES

Expanded X-Y recording capability

Models 17005A, 17006A, 17009B, 17108A

17005A Incremental Chart Advance

Model 17005A is an extremely versatile accessory compatible with most Hewlett-Packard 11 in. x 17 in. bench recorders. It has two basic modes of operation, incremental chart advance and continuous chart advance. The 17005A converts compatible recorders to operation as strip chart recorders.

Specifications

Compatible recorders: 2FA, 7000A, 7001A, 7004B Opt. 04, and the 7005B, Opt. H06.

Incremental advance mode

Plot density/rate:

Plot density: 200, 100, 50, 20, 10 plots/in. Metric: 80, 40, 20, 8, 4 plots/cm.

Max advance rate: 100, 90, 50, 20, 10 plots/s.

Time base mode

Speeds: 1, 5, 10, 50, 100 s/in. Metric: 0.4, 2, 4, 20, 40 s/cm.

Accuracy: $\pm 2\%$.

Frame advance mode

Advance distance: 24 in. (60 cm).

Accuracy: ± 0.005 in. (0,0125 cm) noncumulative.

Advance time: less than 20 s.

Major division advance

Advance distance: selectable major divisions are in 3 in. (7.5 cm) increments.

Accuracy: ± 0.005 in. (0,0125 cm) noncumulative.

Advance time: (maximum) 2.5 s.

Weight: net, 11 lb (5 kg); shipping, 16 lb (7,3 kg).

Price: Model 17005A

\$ 995

Options

- | | |
|---|--------|
| 01. Fan Fold adapter | \$ 125 |
| 02. Metric calibration | N/C |
| 03. Cable connector compatible with 7590A/C (recorders prior to serial prefix 729 require modification) | N/C |
| 04. Compatibility with 7004B, Opt. 04 | N/C |

17006A Manual Chart Advance

Model 17006A permits manual chart advance by operating a hand crank. A crank handle also is provided on the supply reel for re-winding chart. Tear-off wire is included for chart "pull-through, tear-off."

Price: Model 17006A

\$ 125

G-2B Null Detector

The G-2B Null Detector is an accessory device designed for use with the 7000A and 7001A X-Y recorders. It controls the operation of the recorder during the plotting of continuous, discontinuous or point function data. The source may be any analog signal producing system or digital system with conversion accessories.

Specifications

Plot rate

Point mode: 6 plots/s, maximum, using the Model 17009B Character Printer.

Line mode: 7 points/s, maximum, when points are displaced an average of 0.05 in. and using a regular recorder pen.

Sensitivity: better than 0.4% of full scale.

Price: Model G-2B

\$ 325

17009B Character Printer

The Model 17009B Character Printer is specially designed to replace the pen on the 7000A and 7001A. The points are identified with a character, six of which are supplied with the 17009B.

Specifications

Plot rate: up to 6 plots per second (with G-2B Null Detector).

Compatible recorders: 7000A and 7001A.

Power source: supplied from the recorder.

The 17108A is a self-contained external time base designed to

Actuating source: external contact closure, or manually operated penlift control of recorder.

Price: Model 17009B

\$ 95

Option 01: extra symbols (see data sheet)

\$1 each

F-3B Line Follower System

The F-3B Line Follower, available for the 7000A and 7001A X-Y Recorders, regenerates original data directly from previously recorded curves. Any line prepared with pencil or pigment-type ink will be followed automatically by means of an optical photo-electric sensing element.

Specifications

Displacement analog output: an external voltage may be applied to an existing slidewire.

Straight-line accuracy: ± 0.03 in., 0° to 45° and time sweeps through 0.5 s/in.; angular ranges from 0° up to 85° up to 5 s/in.; square waves or spike functions of 0.1 in. maximum amplitude will remain within the scanned area at time sweeps up to 10 s/in.

Scanned area: 0.1 in. on either side of its center line and 0.05 in. along its center line.

Power: 115 or 230 volts, 50 to 60 Hz, single phase; approximately 5 VA.

Price: Model F-3B

\$ 895

17108A Time Base

The 17108A is a self-contained external time base designed to plug directly into the input terminals of the 7035B and operate on either axis. An adapter supplied allows the use with a variety of Hewlett-Packard recorders. Any number of recorders may be driven simultaneously, provided the combined parallel input resistance is 20 K ohm or more.

Specifications

Sweep speeds: 0.5, 1, 5, 10, 50 s/in. Metric: 0.2, 0.4, 2, 4, 20 s/cm.

Accuracy: 5% of recorder full scale.

Linearity: 0.5% of full scale (20°C to 30°C).

Output voltage: 0 to 1.5 V.

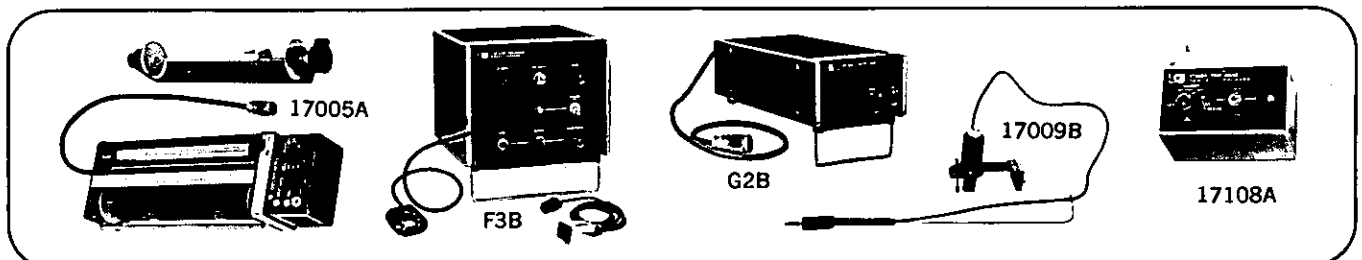
Power: replaceable mercury battery (100 hr).

Price: 17108A

\$ 175

17108AM (metric)

\$ 175



SPECIAL PURPOSE RECORDS

Point Plotting and Trend Recording

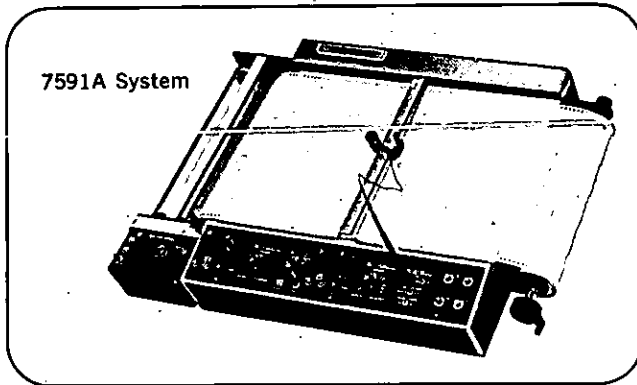
Models 7591A and 7825A



GRAPHIC RECORDERS

POINT PLOTTING SYSTEM

Model 7591A



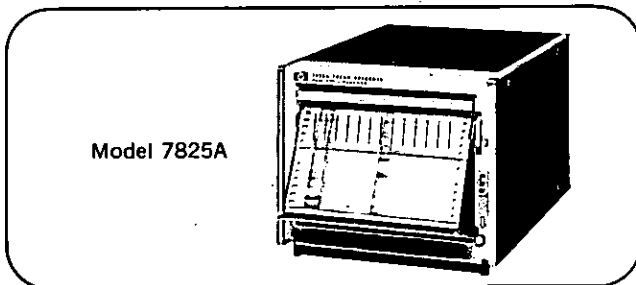
7591A System

The fastest and most economical way to point plot analog data from computers, pulse height analyzers, signal averagers, or multi-channel analyzers is to use the versatile HP 7591A Point Plotting System.

The 7591A was designed to accept plug-in accessories to meet high-speed point-plotting requirements and to plot on any size of flat sheet up to 11 in. x 17 in. on roll or fan-fold paper. The 17005A Incremental Chart Advance provides frame advance, incremental advance, time-base and major-division advance with a position accuracy of ± 0.005 inch; incremental advance is an ideal way to increase plot resolution. The 17173A Null Detector plug-in and the 17012B Point Plotter give you closed-loop plotting at rates up to 3000 plots/minute.

TREND RECORDER

Model 7825A



Model 7825A

The 7825A Trend Recorder is a compact, light weight instrument capable of recording up to four slowly changing variables, 24 hours a day for two months (50 foot roll of recording paper). With an input sensitivity of ± 2.5 volts, it is electrically compatible with HP 8800 Series Signal Conditioners.

A single time shared electrostatic stylus and a galvanometer-mounted feedback system provide analog or bar graph recording with 1% linearity in each of the four independent channels. Each channel is recorded in sequential order. Repetition rate is based on the number of channels in operation and the type of recording. With all four channels turned on, the scanning rate for bar graph recording is 30 seconds for a complete scan cycle (4 channels). For analog recording, the rate is 15 seconds for a complete scan cycle.

Standard chart speed is 1 cm/hr (approx 9½ inches in 24 hours). The chart paper has a full scale width of 12 cm and

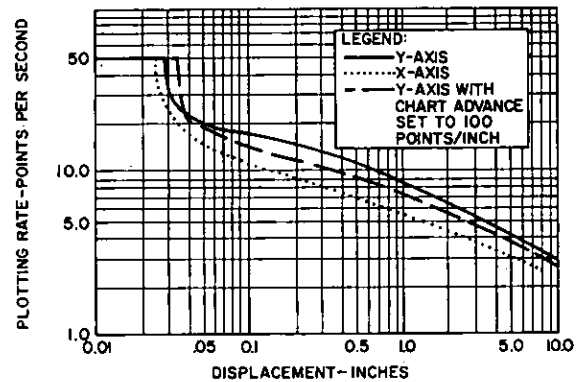
Specifications

Price

Model 7591A Point Plotting System, including 7004B (Option 04), 17173A, 17012B, and 17005A (Option 04) \$2755
(One plug-in module is required for each axis.)

Options

001	Metrically scaled and calibrated	N/C
002	X-axis retransmitting potentiometer, 5 k Ω , $\pm 0.1\%$ linearity	add \$ 75
003	Fan fold adapter (used with 17005A)	add \$ 125
005	17173A with +3 to +20 V enable, 0 V disable	add \$ 25
006	17173A with -3 to -20 V disable, 0 V enable	add \$ 25
007	17173A with -3 to -20 V enable, 0 V disable	add \$ 25
008	7591A without 17005A (Option 04) Incremental Chart Advance	less \$ 995



is marked in hours along each centimeter of length. The record is permanent, smudge free, easily reproduced, and well suited for mounting or filing.

Specifications

Input impedance: 15 k Ω to 20 k Ω depending on sensitivity setting.
Linearity: 1% of full scale.
Sensitivity: adjustable from zero to full scale for ± 2.5 volts.
Input signal: 0 to 50 volts maximum. Positive signal corresponds to right-hand scale deflection.
Pen position: anywhere on the paper for any sensitivity adjustment. All eight positions (4 input and 4 bar graph base lines) are independent.
Pen repetition rate: all eight positions, less than 30 seconds.
Chart speed: standard 1 cm/hr. Other speeds available on special order up to 10 cm/hr.
Input: 14-pin micro ribbon connectors or phone plugs.
Paper: electrosensitive type, 12 cm (60 div) wide chart, margins perforated. Hours indicated at each centimeter mark.
Weight: 13 lb (5.9 kg).
Dimensions: 6½" high x 7¾" wide x 11" deep (165 x 197 x 279 mm).
Power: 115 or 230 volts ($\pm 10\%$), 60 Hz, 50 VA. Option 08 Recorders: 115 or 230 volts ($\pm 10\%$), 50 Hz, 50 VA.
Price: HP Model 7825A Trend Recorder (white paint) \$ 925

Options

01	Gray paint	N/C
05	3 cm/hr, 50 Hz power	add \$ 25
06	3 cm/hr, 60 Hz power	N/C
08	50 Hz operation	add \$ 25

STRIP CHART RECORDERS



RECORDING TIME RELATED PHENOMENA

Much of the instrumentation which extends, refines or supplements human perception produces information in the form of electrical analog signals. Records of such data are, of course, necessary. Electrical data acquired in serial fashion, comprising a chain of meaningful changes in a signal, record naturally on continuous instruments such as strip-chart recorders. The character of the signal will determine the appropriate recording instrument. Permanent records of slowly changing analog values are conveniently made by Hewlett-Packard servo driven strip-chart recorders; oscillographic recorders can handle signals from dc to 150 Hz.

Strip-chart recorders

Laboratory and industrial recorders are available that produce records in rectilinear coordinates with considerable accuracy—typically 0.2%. Two-pen models permit both channels to realize the full resolution of the chart width simultaneously, since the pens can overlap on the same chart without interference. Active development of servo-driven strip-chart recorders has yielded high reliability, improved writing systems and other advances. Important features are: solid-state circuitry, electric writing, optical slidewires, modular construction, and versatile multi-range performance for laboratory applications.

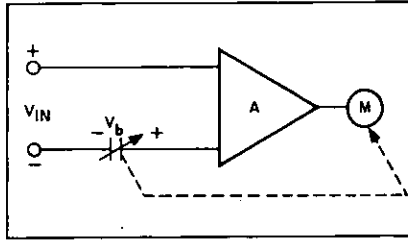
Basic operation

Each Hewlett-Packard servo-driven strip-chart recorder uses an individual electrical servo system for each channel employed. All servos are similar. Each consists of a basic balancing circuit, plus auxiliary elements for instrument versatility.

A basic potentiometric servo recorder is shown in Figure 1. The illustration shows a single range recorder in its simplest form. V_{in} is the input signal voltage to the recorder and is applied to the input of the amplifier causing the motor to be driven. The motor rotates, causing an electrical tap at V_b to be adjusted to a point where V_b equals V_{in} . At this point, the input voltage to the amplifier is zero, and the motor stops. This is considered a balanced condition and the degree of balance attained is largely a function of the amplifier's gain. If the input voltage (V_{in}) changes, the balancing action is repeated.

Controls and circuits used to provide versatility are:

1. Stepped attenuators for each axis so that input voltages from the microvolt



- range to 500 volts can be handled directly.
2. Variable attenuators provide continuous adjustment to allow a transducer's output to correspond directly to the paper's coordinates in the desired units of measurement (psi, °C, etc.).
 3. Zero controls allow the plotting origin to be placed anywhere on the paper or suppressed electrically off the paper.

Types of writing systems

Hewlett-Packard strip-chart recorders provide three types of writing systems: ink, electric and thermal writing. Thermal and ink writing is used on Hewlett-Packard oscillographic recorders.

Ink recording is standard on Hewlett-Packard servo-driven recorders. Most models employ the capillary ink feed system in which the ink supply is a cartridge. Uniform flow is maintained by the capillary process. Disposable pen tips are also available to minimize maintenance problems and to optimize the writing characteristics. These disposable pen tips consist of two basic types, high speed and low speed.

Disposable tips can be changed quickly when the application changes and allow quick and inexpensive replacement of worn or clogged pen tips.

The high speed pen tip is designed for high speed recording. It is composed of nylon fibers, which create many ink passages to ensure a sufficient ink flow for high speed writing.

Electric writing is also available on strip-chart recorders. With the elimination of ink refilling, long term unat-

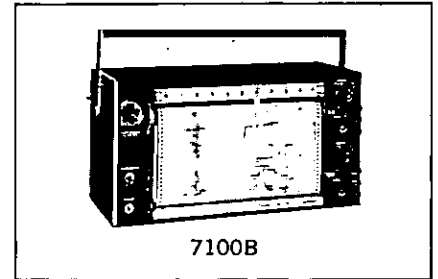
tended recording with maximum reliability is possible. Electric writing features crisp, clean, permanent records with the advantage of instant start-up. The record is not sensitive to light or pressure, thus eliminating special handling; it is permanent, without processing.

Options and accessories

A variety of options and accessories is available to customize the recorder for individual applications. Options include event markers, retransmitting potentiometers, remote electric pen lift, remote chart drive switch, disc integrator, limit switches, etc.

An option available for the Model 680 is the photo slidewire. This unique balance slidewire employs optical coupling to eliminate mechanical contacts, thus reducing wear and noise and increasing reliability.

Available accessories include input filters, logarithmic converters, BNC adapters, etc.



Trend recorders

The HP 7825A Trend Recorder is a compact, light weight, time sharing instrument capable of recording up to four slowly changing physical or physiological variables on a 12 cm wide chart channel. The instrument is electrically compatible with HP 8800 Series Preamplifiers.

A single, time shared electric writing pen and a galvanometer-mounted feedback system provide analog or bar graph recording with 1% linearity in each of four independent channels.

Hewlett-Packard Servo-driven Strip Chart Recorders

No. of channels	Chart width	Model number	Pre-Amp configuration	Chart speeds	Page	Price
1	5"	680	Built-in	8	126	\$ 800
		7101B	Plug-in	12	124	\$1000*
	7127B	Plug-in	4	124	\$ 850*	
2	10"	7100B	Plug-in	12	124	\$1400*
		7128B	Plug-in	4	124	\$1250*
4	5"	7825A	Built-in	4	121	\$ 925

*Price does not include preamplifier.

RECORDING TIME-RELATED PHENOMENA



STRIP CHART RECORDERS

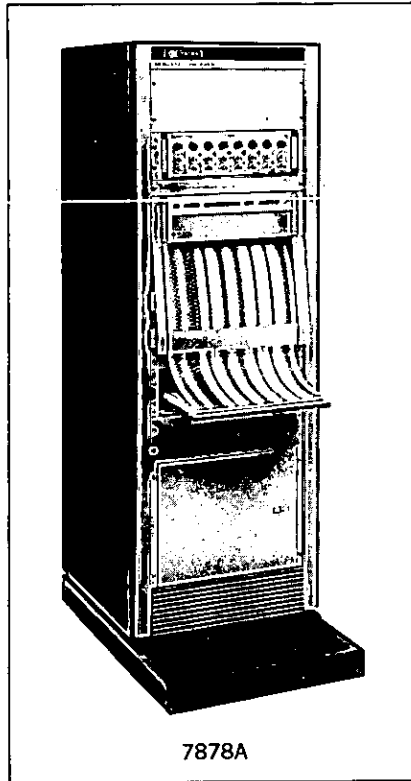
Thermal writing oscillographic recorders and systems

A wide need exists in data recording for continuous, highly visible records of analog signals with maximum reliability and instant record availability. These requirements are well filled by Hewlett-Packard thermal writing oscillographic recorders, which use the heated stylus technique to produce truly rectilinear chart traces on heat sensitive Permapaper.® Significant advantages include: an absolutely reliable writing method, a resolution of 4 cycles per mm of paper travel even at small amplitudes and unattended operation for greatly extended time periods with an optional 1000-foot paper supply.

Hewlett-Packard thermal recorders are available with 1, 2, 4, 6, 8 and 16 channels and are compatible with standard Hewlett-Packard recording preamplifiers. All recorders and preamplifiers are available as systems in upright cabinets, less cabinet for mounting in standard RETMA equipment enclosures or in portable cases for field or laboratory use.

Ink writing oscillographic recorders and systems

The ink writing oscillographic recorder used in the 7858B and 7878A systems is a compact, all solid-state, 8-channel recorder that produces retilinear traces on Hewlett-Packard Z-fold or roll chart paper. The Z-fold chart paper permits instant access to any part of the recording. The recording fluid, a permanent blue ink that dries rapidly on contact with the paper, permits high resolution copying of recorded data. Brown chart coordinates can be dropped out when photographically copying the record. Position feedback from a contactless, capacitive pickup near the pen tip means long-lived recording accuracy. An ink supply system using a modulated, low pressure technique ensures uniform traces at all chart speeds, and over all points of the waveform. This technique controls the ink at the pen tip at all times, prevents spattering, and permits use of a Z-fold chart paper for instant data retrieval. The plug-in, disposable ink cartridge is cleanly replaced from the front of the system in less than 10 seconds, without stopping the recorder. The ink recorder provides a ratio of 8000:1 from the lowest chart speed of 0.025 mm/s to the highest, 200 mm/s, to give the best possible data resolution by matching the chart speed with the recorded waveform.



7878A

All mechanical sub-assemblies are modular for fast "on-line" maintenance.

Hewlett-Packard ink recording systems feature a frequency response of dc to 150 Hz (-3 dB) at 10 divisions pp deflection and dc to 58 Hz (max) for full scale deflection. Linearity is 0.5% at full scale.

Ink recording systems such as the 7858B and 7878A are ideal for scientific and industrial research, production and environmental testing, quality control, telemetry, process control and analog computer monitoring.

Amplifier and signal conditioners

Hewlett-Packard amplifiers and signal conditioners cover an extremely wide range of measurement applications, matching the recording system to the signal source. The source can be an electrical signal from an external circuit or from a transducer that measures a physical variable such as pressure, force, flow, velocity or temperature. A wide choice of amplifiers and signal conditioners is provided for the thermal and ink systems, including the interchangeable, single-channel 8800 Series Plug-in Preamplifiers and the multichannel 8820A and 8821A Amplifiers, which provide up to eight identical channels of amplification on a common front panel.

Recording chart paper

Recording chart papers are available for all Hewlett-Packard recording systems. Excellent recording characteristics are assured by matching the paper to the recorder and by rigid quality control. Paper comes in Z-fold packs for the ink recorder and is standard roll lengths for all recorders, with green grid for industrial use, translucent orange for diazo duplication, and brown for the ink recorder.

Hewlett-Packard Oscillographic Recorders

No. of Channels	Writing Method	Model Number	Pre-Amp configuration	Chart speeds	Page	Price
1	Thermal	299A	Built-in	2	127	\$ 800
		301	Built-in	2	127	\$ 850
		7701B	Plug-in	4	130	\$1650*
2	Thermal	322A	Built-in	4	127	\$1750
		321	Built-in	4	127	\$1950
		320	Built-in	4	127	\$1950
		7702B	Plug-in	4	131	\$1775*
4	Thermal	7704B	Plug-in	9	132	\$4020*
6	Thermal	7706B	Plug-in	9	133	\$4820*
		7727A	Bank	9	140	\$4030*
8	Thermal	7729A	Bank	9	140	\$4705*
		7708B	Plug-in	9	133	\$5495*
		Pressure Ink	7858B	Plug-in	14	134
	Ink	7878A	Bank	14	141	\$9500*
16	Thermal	7731A	Bank	9	140	\$8000*

*Price does not include preamplifier.

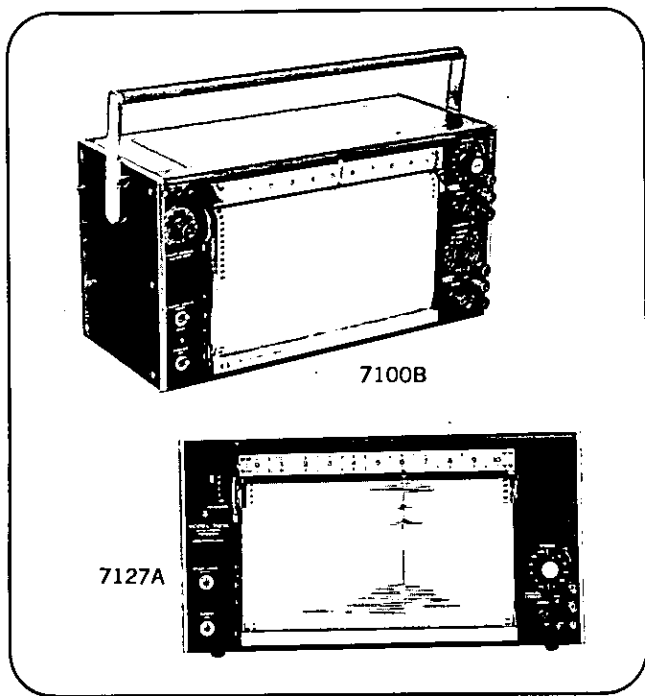
STRIP CHART RECORDERS



10 in. PLUG-IN RECORDERS

Ink and electric writing

Models 7100B, 7101B, 7127A, 7128A



Ten-inch strip chart recorders are widely used in laboratory and industrial applications. Hewlett-Packard strip chart recorders feature high performance, low cost, and solid-state construction for reliability, compactness, and light weight. Models 7100B and 7128A have two servo pen drives and require two input modules. The 7101B and 7127A are single pen units and take one input module. Ordering information should specify basic frame and exact input modules required.

Each main frame is equipped with selectable chart speeds (4 for 7127A, 7128A; 12 for 7100B, 7101B) and a modular chart magazine. The chart magazine will swing out to a 10° or 30° angle for convenient note writing. An optional integrator that computes the area under the chart curve is available.

Specifications

Performance specifications

Recording mechanism

Ink: servo actuated ink pen drive.

Electric: a stylus with associated electronics and electro-sensitive paper are furnished.

Chart dimensions: (ink writing) 120' chart rolls, 11" wide with 10" (250 mm) calibrated writing width. (Electric writing) 100' chart rolls, 11" wide with 10" (250 mm) calibrated writing width.

Chart speeds: 7100B/7101B (English): 1, 2 in./hr; 0.1, 0.2, 0.5, 1, 2 in./min; 0.1, 0.2, 0.5, 1, 2 in./s. 7100BM/7101BM (Metric): 2.5, 5, 15, 30 cm/hr; 1.25, 2.5, 5, 15, 30 cm/min; 1.25, 2.5, 5 cm/s. 7127A/7128A (English): 1/4, 1/2, 1, 2 in./min.

Linearity: terminal based, 0.1% of full scale.

Resetability: 0.1% of full scale.

(Other specifications listed under plug-in modules.)

General specifications

Power: 115 or 230 V $\pm 10\%$, 60 Hz, 65 VA for 7100B and 7128A; 42 VA for Models 7101B and 7127A. 115 or 230 V, 50 Hz models available as option.

Dimensions: 7100B/7101B series (cabinet): 11-31/32" high, 17 1/2" wide, 8 1/4" deep (304 x 445 x 210 mm). 7100BR/7101BR (rack): 8-23/32" high, 19" wide, 8 1/4" deep (222 x 483 x 210 mm). 7127A/7128A series (cabinet): 9-3/32" high, 16 3/4" wide, 8 1/4" deep (231 x 425 x 210 mm). (rack; brackets supplied) 8-23/32" high, 19" wide, 8 1/4" deep (222 x 483 x 210 mm).

Weight: 7100B series: net, 28 lb (12.7 kg); shipping, 39 lb (17.7 kg). 7101B series: net, 28 lb (12.7 kg); shipping, 33 lb (17.3 kg). 7127A series: net, 25 lb (11.4 kg); shipping, 35 lb (15.9 kg). 7128A series: net, 28 lb (12.7 kg); shipping, 38 lb (17.3 kg).

Prices

Dual channel: 7100B/BR (English), 7100BM/BMR (metric) \$1400; 7128A (English only) \$1250.

Single channel: 7101B/BR (English), 7101BM/BMR (metric) \$1000; 7127A (English only) \$850.

Options

7100B 7101B	7127A 7128A	Description	Additional price	
			7100B 7101B	7127A 7128A
02	—	10 to 1 remote speed reducer	\$85	—
04	14	5k Ω retransmitting potentiometer (channel 1)	50	\$50
05	01	High-low limit switches (channel 1)	50	50
06	08	Remote control of electric pen lift	50	50
07	02	Remote on-off chart control	25	25
10	03	50 Hz operation	N/C	N/C
11	13	Locking glass door	50	50
12	04	Event marker (ink) left side	35	35
14	06	Event marker (ink) both sides	70	70
15	07	Integrator (7127A, 7101B series or channel 2 of 7128A, 7100B series)	685	685
16	15	5k Ω retransmitting potentiometer (channel 2)	50	50
17	09	High-low limit switches (channel 2)	50	50
18	10	High-low limit switches (both channels)	100	100
19	17	Electric writing	75	75
20	20	Scale with "0" right side	N/C	N/C
21	21	Gray control panel	N/C	N/C
22	22	Event marker (elec) left side	35	35
23	23	Event markers (elec) both sides	70	70
24	24	Disposable pen tips (servo pens only)	N/C	N/C
25	25	Soft zero right side	N/C	N/C
—	26	GC compatibility	—	N/C
—	11	Carrying handle	supplied	25
—	16	Retransmitting potentiometer (both channels)	—	100
—	H01	6, 12, 24, 48 in./hr.	—	N/C
—	H02	1 1/2, 3, 6, 12 in./hr.	—	N/C

Note: 7100B, 7101B: Option 15 is not compatible with options 14, 16, 19, 22, or 23. Options 15, 19, and 25 require special paper. 7127A, 7128A: Options 06, 15, 16, 17, 22, or 23 cannot be installed when instrument is equipped with Option 07. Options 07, 17, and 25 require special paper. Electric and ink writing systems are not compatible. Event markers must be of same type as the main writing system.

STRIP CHART RECORDERS

Plug-in Modules

For the Model 7100B, 7101B, 7127A, 7128A



GRAPHIC RECORDERS

17500A/17501A Specifications

Voltage spans: 17500A: 5, 10, 50, 100, 500 mV; 1, 5, 10, 50, 100 V full scale. 17501A: 1, 2, 5, 10, 20, 50, 100, 200 mV; 0.5, 1, 2, 5, 10, 20, 50, 100 V full scale.

Accuracy: $\pm 0.2\%$ of full scale.

Input resistance: 1 megohm at null on all fixed calibrated and variable spans except 100 k Ω in the variable mode on the four most sensitive spans on the 17500A only. Potentiometric operation is available on the 17500A on the four most sensitive spans and to the 17501A on the six most sensitive spans.

Interference rejection: dc common mode; 120 dB on the four most sensitive spans of the 17500A and the three most sensitive of the 17501A. Line frequency, 100 dB on the four most sensitive spans of 17500A and the three most sensitive of 17501A.

Zero-set: adj. full scale, plus one full scale of suppression. 5 scales of zero suppression available on the 17501A.

Maximum source impedance: up to 10 k Ω source impedance will not alter the recorder's performance on the four most sensitive spans of the 17500A and the six most sensitive of the 17501A. No source impedance restrictions on spans above 100 mV fs.

Reference stability: 0.005%/°C.

Weight: net, 2 lb (0.9 kg); shipping, 5 lb (2.2 kg).

Prices

Model 17500A \$ 250 Model 17501A \$ 350

Options

01	five-scale zero suppression (17501A only)	\$ 50
02	calibrated for use with integrator (8" span)	N/C
04	gray control panel	N/C

17502A Specifications

Voltage spans: single span to match cold-junction thermocouples of types J, K, R, S, and T at ranges as listed on the data sheet.

Accuracy: $\pm 0.5\%$ or $\pm 1^\circ\text{C}$, (whichever is greater); refer to NBS CIR 561, dated 1955.

Input resistance: potentiometric.

Interference rejection: dc common mode, 120 dB; line frequency, 100 dB.

Weight: net, 4 lb (1.8 kg); shipping, 7 lb (3.2 kg).

Price: Model 17502A

\$ 375

Options

02	calibrated for use with integrator (8" span)	add \$ 25
04	gray control panel	N/C

17503A/17504A Specifications

Voltage spans: 17503A: 1 mV full scale. 17504A: 10 range cards available, which allow any span from 5 mV to 100 V full scale.

Accuracy: $\pm 0.2\%$ of full scale.

Linearity: terminal based: 0.1% of full scale.

Dead band: 0.1% of full scale.

Input resistance: 17503A: potentiometric. 17504A: 1 M Ω at null.

Interference rejection: (17503A) dc CMR, 120 dB; line freq CMR, 100 dB. Normal mode, more than 60 dB at line freq (17504A) dc CMR, 100 dB on four most sensitive range cards; line freq CMR, 90 dB on four most sensitive range cards. Normal mode more than 60 dB at line freq.

Zero-set: continuously adjustable over full scale, plus one full scale of zero suppression.

Maximum source impedance: up to 5 k Ω with the 17503A and 10 k Ω on the 17504A will not alter the recorder's performance.

Frequency: 60 Hz (line frequency) 50 Hz operation optional.

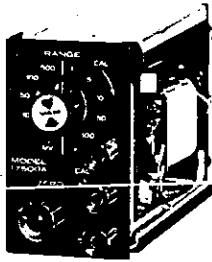
Weight: net, 2 lb (0.9 kg); shipping, 5 lb (2.2 kg).

Price

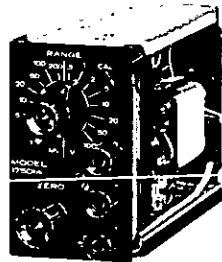
Model 17503A	\$ 250
Model 17504A	\$ 200
Additional range cards	\$ 25

Options

17503A	17504A	Description	
01	—	Detector selector switch	N/C
02	01	50 Hz operation	N/C
03	02	Calibrated for integrator use (8" span)	N/C
04	04	Gray control panel	N/C



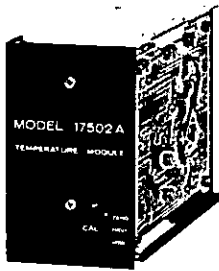
5 mV to 100 V
17500A



1 mV to 100 V
17501A

Multiple Input Span Modules

The Models 17500A (5 mV full scale) and 17501A (1 mV full scale) Multiple Span plug-ins offer high input resistance and a continuously variable span control. Common mode rejection is high and input impedance is one megohm at null on all calibrated spans.



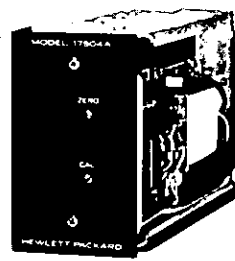
Temperature
17502A

Single Input Span Modules

The Model 17502A Temperature Measuring Input Module has a single span selectable to match almost any commonly used thermocouple. Corrections for changes in ambient temperature are made within the module, eliminating need for a remote compensation junction. Non-linear thermocouple output is converted in the module to a linear function of temperature permitting use of standard ruled graph paper.



Gas Chromatography
17503A



Choice of Spans
17504A

The Model 17503A plug-in, designed specifically for use with gas chromatography systems, is equipped with a single span of one millivolt full scale and potentiometric input. The Model 17504A plug-in may be ordered with any single span from a range of 5 mV to 100 V full scale. Potentiometric input is available, on the four most sensitive range cards, by removing an internal buss wire in the 17504A. Common mode rejection is high and zero may be positioned full scale or suppressed up to one full scale.

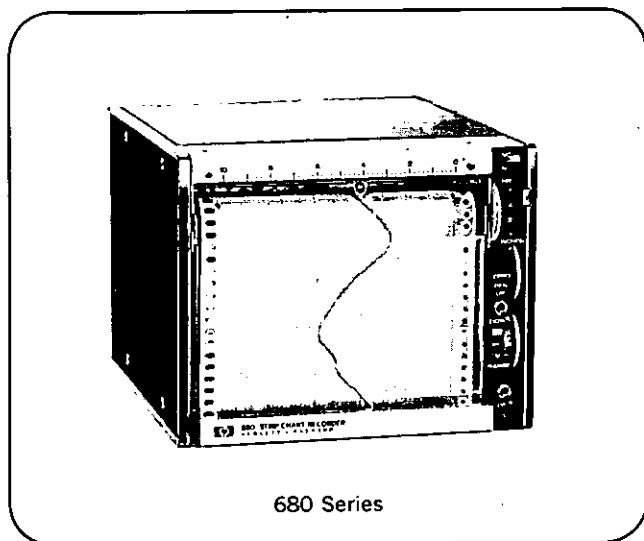
GRAPHIC RECORDERS



5 in. COMPACT RECORDER

Ink or electric writing

Model 680



680 Series

The Models 680 and 680M 5-inch strip-chart recorders provide a wide range of performance for general or specialized use. The 680 is equipped with multi-range input, multi-speed chart transport, full-range zero set, and electric pen lift, features essential for general purpose applications. The instrument is available with standard (English) or metric scaling (680M). It is useful as a monitor for instrumentation with dc outputs and for digital devices utilizing D-A converters.

The recorder features modular construction with all-transistor circuitry, high accuracy, fast response, synchronous motor chart drive, and full-view tilting chart magazine. Standard facilities include instant chart speed transfer, local and remote pen lift control, tear-off or chart roll storage, and cartridge-fed ink pen. Optional electric writing provides crisp, clean, permanent records for long-term unattended recording.

Specifications

Performance specifications

Recording mechanism:

Ink: servo-actuated ink pen.

Electro sensitive: a stylus and associated electronics for electrosensitive paper are furnished in place of the ink pen.

Chart dimensions:

Ink: 6" by 100' roll charts, 5" (12 cm) writing width. Approximately 4" by 6" visible chart area during operation.

Electrosensitive: 6" by 80' roll charts, 5" (12 cm) writing width.

Response time: one-half second or less for full scale.

Chart speeds: eight synchronous-motor-controlled speeds at 1, 2, 4, 8 in./min; 1, 2, 4, 8 in./hr. Metric model: 2.5, 5, 10, 20 cm/min; 2.5, 5, 10, 20 cm/hr.

Spans: ten calibrated spans of 5, 10, 50, 100, and 500 mV; 1, 5, 10, 50, and 100 V full scale. Metric model has spans of 6, 12, 60, 120, and 600 mV; 1.2, 6, 12, 60, and 120 V. An extra span of 1 mV, full scale, is available at extra cost (1.2 mV on metric model).

Input: input resistance is 200,000 ohms per volt (166,666 ohms/volt on metric models), full scale, through 10 volt span; 2 megohms on all others. Potentiometric input on most sensitive span permits operation with essentially zero current drain at null. Constant 100 k Ω input resistance on all spans optionally available on both models.

Reference stability: $\pm 0.005\%/^{\circ}\text{C}$.

Zero set: continuously adjustable over full recorder span.

Accuracy: better than 0.2% of full scale.

Resettability: 0.1% of full scale.

Linearity: 0.1%.

Interference rejection: dc common mode rejection better than 100 dB on the most sensitive range.

General specifications

Pen lift: local and remote.

Power requirements: 115/230 V, 60 Hz, 22 VA. 50 Hz models available at no extra cost, (Option 10).

Dimensions: 6 $\frac{1}{2}$ " high, 8 $\frac{5}{8}$ " deep, 7 $\frac{3}{4}$ " wide (165 x 219 x 197 mm). Rack mounting requires 7" (178 mm) of vertical space.

Weight: net, 11 lb (5 kg); shipping, 17 lb (7.6 kg).

Accessory kit supplied: spare pen, syringe, remote pen lift mating connector, pen cleaning wire, slidewire cleaner and lubricant, 8 ink cartridges (4 red and 4 blue), and one roll of chart paper.

Price: Model 680 (English) or 680M (Metric) \$800

Options:

01	With installed 5 k Ω , 0.1% linearity retransmitting potentiometer	add \$ 50
02	With ink event marker installed	add \$ 25
03	With installed high-low limit switches	add \$ 90
08	With 16/1 instead of 60/1 speed reducer	add \$ 25
09	With remote chart drive switch	add \$ 25
10	For 50 Hz operation	N/C
13	For operation with 7560A, 7561A	add \$ 25
14	Glass door with lock	add \$ 45
15	Electric writing (special paper required)	add \$ 75
16	Electric writing event marker	add \$ 35
17	Photoslidewire (not available on Option H01)	add \$100
18	Disposable pen tips	N/C
H01	1 mV span added (H01-680)	add \$ 50
	1.2 mV span added (H01-680M)	add \$ 50
H02	100 k Ω input resistance, all spans	add \$ 75

Note: ink and electric systems are not compatible. Event markers must be the same type as the main writing system. Options H01 and H02 not compatible.

PORTABLE RECORDERS

1-, 2-channel portables
Models 299A, 301, 320 Series

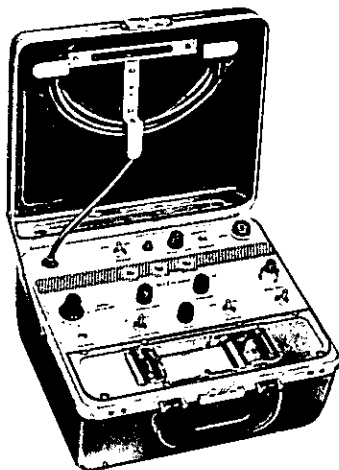


OSCILLOGRAPHIC RECORDERS

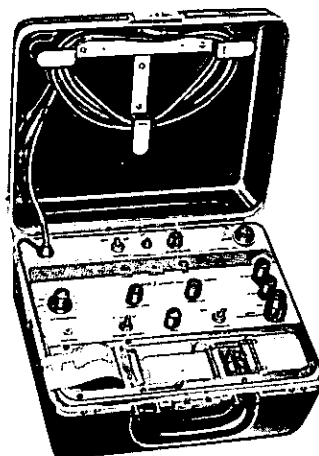
1-Channel portables

The 299A and 301 are single-channel, all solid-state, 22 lb. recorders, useful for field and laboratory equipment check-out and servicing. The 299A is a general purpose recorder, designed for broad dc coverage. Model 301 with built-in 2400 Hz carrier wave (carrier voltage 4.5 to 5.5 V rms, not adjustable), is designed for carrier inputs from inductive

transducers, strain gages, resistance bridges and other ac transducers. Both units produce high resolution traces on a 3.2 cm (40 div) wide channel and possess most of the features found in larger systems. Four inches of chart are displayed at all times for study and marking. Each unit occupies less than $\frac{1}{2}$ cubic foot and operates in any position.



299A

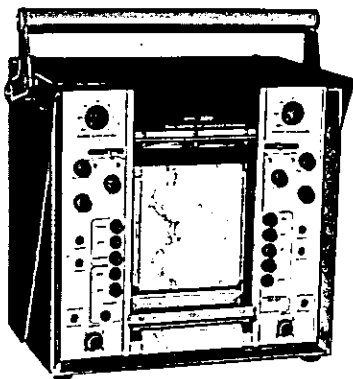


301

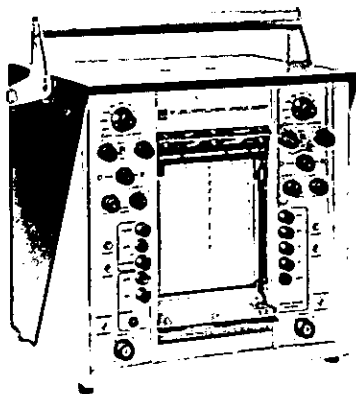
2-Channel portables

Models 320, 321 and 322A are complete recording systems widely used in the field when two similar variables must be simultaneously analyzed and permanently recorded. They operate in any position, record signals on two 5 cm (50 div) channels, have electrical limiting to protect recorder styli and current feedback circuits to reduce drift. Model 320 has guarded and floating inputs designed for broad dc and ac

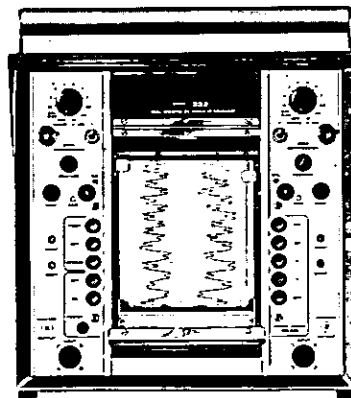
signals even with excess ground loop noise. Model 322A has two general purpose direct-coupled amplifier channels for single-ended or balanced inputs. Calibrated zero suppression is available as Option 02. Model 321, with built-in 2400 Hz carrier excitation source, is designed to measure signals from resistance bridges, variable reluctance devices, differential transformers and other ac transducers.



320



321



322

OSCILLOGRAPHIC RECORDERS



PORTABLE RECORDERS

1-Channel

Models 299A, 301, and Model 53

Specifications, Single Channel Portables

Recorder Model	Model 299A	Model 301
Input range	10, 20, 50, 100, 200, 500 mV/div; 1, 2, 5, 10 V/div; attenuator accuracy $\pm 2\%$	X1, 2, 5, 10, 20, 50, 100, 200 attenuation factors; attenuator accuracy $\pm 2\%$ max
Input circuit	Balanced to ground; 5 M Ω each side	6 k Ω min resistance, 13 k min reactance, measured with full zero suppression and R & C bal; 7 k resistance, 13 k reactance, with R & C bal control centered and zero suppression out; transducer impedance, 100 Ω min.
Common mode rejection	50:1 on most sensitive ranges; 25:1 on other ranges	Quadrature rejection ratio is greater than 100:1
Common mode tolerance	± 2.5 V max on most sensitive range, higher on other ranges to ± 500 V max	Quadrature rejection is within specification if input amplitude does not exceed 2X inphase signal which causes stylus deflection from chart center to edge
Zero suppression	± 2 V max in series with output of input attenuator; used for single-ended and balanced inputs	5-step switch, center out, two positions (for positive and negative signal)
Frequency response (-3 dB max at 10 div pp) (-3 dB max at full scale)	dc to 100 Hz dc to 50 Hz	dc to 100 Hz dc to 50 Hz
Zero drift Temperature, 0 to 50°C Line voltage, 103 to 127 V Time	0.5 div/10°C 0.25 div 0.5 div/hr, 2 div/24 hrs, max	0.25 div/10°C 0.1 div -
Noise (pp max)	0.1 div	0.25 div
Internal calibration	0.2 V, $\pm 1\%$	40 μ V/excitation volt, $\pm 1\%$ (200 μ V/20 div deflection)

Gain stability: better than 1% up to 50°C on all models; better than 1% for line voltage variation from 103 to 127 V ac, all models.

Non-linearity: 0.25 div max with respect to straight line through centerline and calibration point 20 div from chart center, all models.

Response time: 5 ms, 10% to 90% with 4% or less overshoot, over center 10 div.

Paper speeds: two speeds (5 and 50 mm/s).

Channel width: 3.2 cm (40 div).

Timer-marker: separate stylus for edge marking (60 Hz excitation); extra event marker can be added on special order; remote operation of marker coil by external contact closure.

Monitor output: approx 40 mV/div across min external load of 100 k Ω .

Electrical limiting: approx 125% of full scale.

Power requirements: 115 V $\pm 10\%$, 60 Hz, 45 VA.

Dimensions: 7" high, 12" wide, 10 $\frac{1}{2}$ " deep (178 x 305 x 267 mm).

Weight: 22 lb (10 kg) net, 25 lb (11.3 kg) gross.

Optional accessory equipment: paper take-up (299-300) \$60.

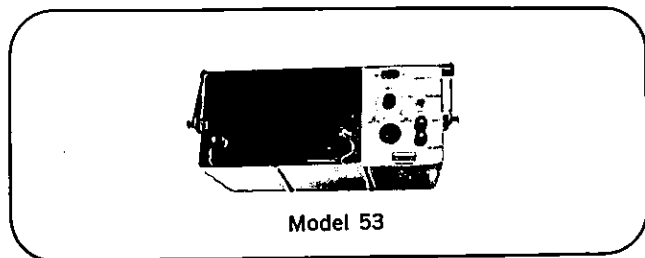
Prices

299A single-channel dc recorder	\$ 800
301 single-channel carrier recorder	\$ 850

Options

08	115/230 V switch, 50 Hz	add \$ 25
12	(60 Hz) 2.5, 25 mm/s	add \$ 50
13	(50 Hz) 2.5, 25 mm/s	add \$ 50
16	(60 Hz) 10, 100 mm/s	add \$ 150
17	(50 Hz) 10, 100 mm/s	add \$ 150
18	(60 Hz) 1, 10 mm/s	add \$ 135
19	(50 Hz) 1, 10 mm/s	add \$ 135
20	(60 Hz) 0.5, 5 mm/s	add \$ 135
21	(50 Hz) 0.5, 5 mm/s	add \$ 135
22	(60 Hz) 5, 50 mm/min	add \$ 150

Model 53 Battery Converter



Model 53

The Model 53 Battery Converter is a portable source of ac power that will operate single- and dual-channel recorders in most field applications. The combination charger/converter converts the 12 V dc supplied by a self-contained lead-acid

battery to 128 V at 60 Hz. Continuous duty rating is 125 VA with intermittent loads to 175 VA permissible.

Specifications

Output voltage: 128 V (nominal), 60 Hz (adjustable). Dependent on load, essentially square wave.

Output power: 125 VA, approx 2 h; 35 VA, approx 7 h.

Power source: 12 V lead-acid battery, 26 Ah, self-contained.

Charging time: approx 10 h from full discharge.

Weight: 12 lb (5.4 kg) net; 18 lb (8 kg) gross.

Dimensions: 16" x 6 $\frac{3}{4}$ " x 9 $\frac{1}{2}$ " (406 x 171 x 242 mm).

Price: Model 53 (less battery) \$ 225

Option 01: with battery (less acid) add \$ 50

PORTABLE RECORDERS

2-Channel

Models 320, 321, 322



OSCILLOGRAPHIC RECORDERS

Specifications, Dual Channel Portables

Recorder Model	Model 320	Model 321	Model 322A
Attenuation range	0.5, 1, 2, 5, 10, 20 mV/div and V/10 div; attenuator accuracy = 2% max	X1, 2, 5, 10, 20, 50, 100, 200 attenuation factors; attenuator accuracy = 2% max	10, 20, 50, 100, 200, 500 mV/div; 1, 2, 5, 10 V/div; attenuator accuracy = 2% max
Input circuit	Floated and guarded signal pair; 0.5 M Ω on mV/div; 1 M Ω on V/10 div.	6 k Ω min resistance, 13 k min reactance, measured with full zero suppression and R & C bal; 7 k resistance, 13 k reactance with R & C bal control centered and zero suppression out; transducer impedance, 100 Ω min	Balanced to ground; 5 m Ω each side
Common mode rejection	140 dB max dc; 120 dB min, 60 Hz with no input unbal; 100 dB min, 60 Hz with 5 k	Quadrature rejection ratio is greater than 100:1	50:1 on most sensitive range, 25:1 on other ranges
Common mode tolerance	= 500 V max	Quadrature rejection is in specification if input amplitude does not exceed 2X inphase signal which causes stylus deflection from chart center to edge	= 2.5 V max on most sensitive ranges; higher on other ranges to = 500 V max
Zero suppression	None	5-step switch, center out, two positions (for positive and negative signals)	Order option 02: 5-step switch, center out, positions for positive and negative signals
Frequency response (-3 dB max at 10 div pp) (-3 dB max at full scale)	dc to 125 Hz dc to 50 Hz	dc to 125 Hz dc to 50 Hz	dc to 125 Hz dc to 50 Hz
Zero drift 0 to 50°C 103 to 127 V Time	0.25 div/10°C 0.1 div -	0.25 div/10°C 0.1 div -	0.5 div/10°C 1.0 div 0.5 div/hr, 2 div/24 hrs. max
Noise (pp max)	0.25 div	0.25 div	0.1 div
Internal cal	10 mV, = 2%	40 μ V/excitation volt, = 1% (200 μ V/20 div deflection)	0.2 V, = 1%

Gain stability: better than 1% up to 50°C on all models; better than 1% for line voltage variation from 103 to 127 V ac, all models.

Non-linearity: 0.25 div max with respect to straight line through centerline and calibration point 20 div from chart center, all models.

Response time: 5 ms, 10% to 90% with 4% or less overshoot, over center 10 div.

Paper speeds: four speeds (1, 5, 20 and 100 mm/s).

Channel width: 5 cm (50 div).

Timer-marker: 1 s timers internal; extra event marker can be added on special order; remote operation of marker coil by external contact closure.

Monitor output: approx 40 mV/div across min external load of 100 k Ω .

Electrical limiting: approx 115% of full scale.

Power requirements: 115 V \pm 10%, 60 Hz, 100 VA.

Dimensions: portable cases: 13 $\frac{3}{4}$ " high, 14 $\frac{1}{2}$ " wide, 9 $\frac{1}{2}$ " deep (349 x 361 x 241 mm); rack mounts: 14" high, 19" wide, 16" deep (356 x 483 x 406 mm); paper take-up: 4 $\frac{3}{4}$ " high, 14 $\frac{1}{2}$ " wide, 9 $\frac{1}{2}$ " deep (121 x 370 x

241 mm); paper take-up rack mounted adds 5 $\frac{1}{4}$ " (133 mm) to recorder height.

Weight: 55 lb (24 kg) net, 66 lb (29.7 kg) gross.

Optional accessory equipment: paper take-up 320-300 for portable cases, \$150; 320R-300 for rack mounted, \$175.

Prices

320 two-channel dc amplifier-recorder	\$1950
321 two-channel carrier amplifier-recorder	\$1950
322A two-channel dc coupling recorder	\$1750

Options

02 (322A only) zero suppression	add \$ 100
03 rack mount	add \$ 150
08 115/230 V switch, 50 Hz	add \$ 25
15 extra marker	add \$ 76
16 (60 Hz) 2, 10, 40, 200 mm/s	add \$ 125
17 (50 Hz) 2, 10, 40, 200 mm/s	add \$ 175
18 (60 Hz) 0.5, 2.5, 10, 50 mm/s	add \$ 175
19 (50 Hz) 0.5, 2.5, 10, 50 mm/s	add \$ 175
20 (60 Hz) 0.1, 0.5, 2, 10 mm/s	add \$ 195
21 (50 Hz) 0.1, 0.5, 2, 10 mm/s	add \$ 195
22 (60 Hz) 1, 5, 20, 100 mm/s	add \$ 175
23 (50 Hz) 1, 5, 20, 100 mm/s	add \$ 175

OSCILLOGRAPHIC RECORDERS

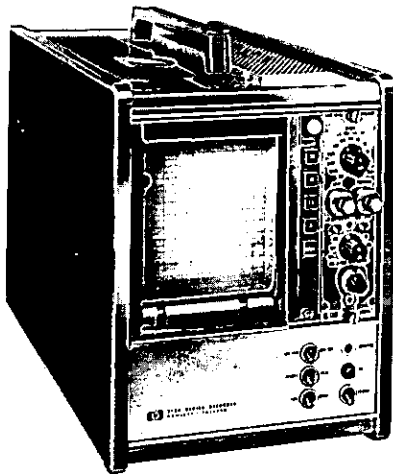


1-CHANNEL RECORDER

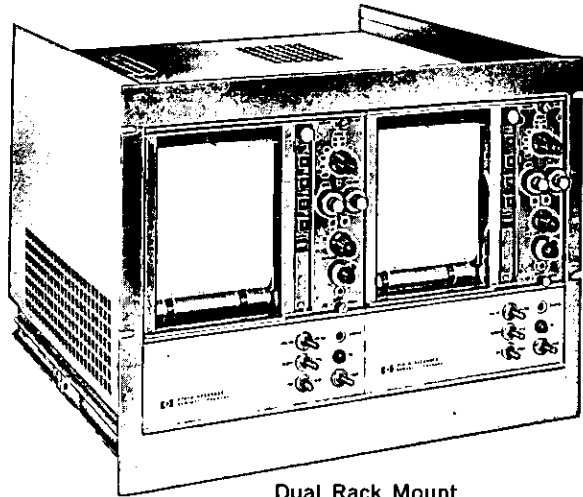
Wide channel for greater resolution
Model 7701B

Model 7701B is a single-channel, all solid-state, portable recorder that accepts any one of the versatile, interchangeable 8800 Series Plug-in Preamplifiers. Frequency response is dc to less than 3 dB down at 30 Hz, independent of amplitude. Featuring a 100 mm wide recording channel, the 7701B provides over twice the resolution offered by standard 50 mm wide channel recorders.

A high torque, low impedance galvanometer with velocity feedback moves the stylus over a knife-edge platen producing true rectilinear traces which can be correlated with timing marks in the chart margin. Trace accuracy is achieved by electrical galvanometer damping; thermal drift is minimized by current feedback. Adjustable electrical limiting protects the stylus and prevents overload. Over 2000 hours of continuous recording at 0.5 mm/min is possible without changing the chart roll.



7701B in Portable Case



Dual Rack Mount

Specifications

(Full performance specifications determined by choice of 8800 Series Preamplifiers, see pages 136 through 139.)

Chart speeds: four speeds standard (0.5, 2.5, 10 and 50 mm/s), mechanically shifted and selected by front panel pushbuttons; four additional speeds (0.5, 2.5, 10 and 50 mm/min) can be added as Option 03 for a total of 8 speeds.

Event marker: right margin, manually operated from front panel; 1 s or 1 min plug-in timer and one additional event marker optional.

Front panel controls: stylus heat adjust, pushbutton speed selectors, local-remote switch, timer-off marker switch, mm/s-mm/min switch, power switch and galvanometer damping (screwdriver adjust).

Paper: 200 ft roll of 10 cm wide Permapaper® (651-217); time lines every 5 mm, amplitude lines every 2 mm (50 div full scale).

Paper take-up: automatic paper take-up standard (concealed in recorder).

Power: 115 V $\pm 10\%$, 60 Hz, 105 VA; 115/230 V $\pm 10\%$, 50 Hz, 100 VA; (Option 08).

Dimensions: 7701B, in carrying case: 13 $\frac{3}{4}$ " high, 9 $\frac{3}{4}$ " wide, 18 $\frac{1}{2}$ " deep (349 x 247 x 460 mm); without case: 10 $\frac{1}{2}$ " high, 8-11/16" wide, 17 $\frac{1}{2}$ " deep (269 x 221 x 445 mm); rack mounting adapter (mounts 2 recorders): 14" high, 19" wide, 17 $\frac{1}{2}$ " deep (356 x 483 x 445 mm).

Weight: 7701B in carrying case, including typical 8800 Series Preamplifier weight: 32 $\frac{1}{2}$ lb (14,5 kg) net; 42 lb (18,9 kg) gross; rack mounting adapter: 20 lb (9,1 kg) net; 30 lb (13,5 kg) gross.

Price: single channel wide chart recorder, 115 V, 60 Hz, with case, uses 8800 Series preamplifiers. Order Option 01 or Option 02 **\$1650**

Options

01	(440 Hz) regulator card for use with any 8800 Series Preamp except 8805A	add \$ 60
02	(2400 Hz) regulator card for use with any 8800 Series Preamp except 8803A	add \$ 60
04	Left event marker	add \$ 45
05	One minute timer (60 Hz unit)	add \$ 30
06	One second timer (60 Hz unit)	add \$ 20
07	Less 7701-04A Portable Case	deduct \$ 90
08	115/230 V switch, 50 Hz operation	add \$ 50
09	mm/min speed reduction kit (60:1), 50 Hz	add \$ 110
10	mm/min speed reduction kit (60:1), 60 Hz	add \$ 110
15	One minute timer (50 Hz unit)	add \$ 30
16	One second timer (50 Hz unit)	add \$ 25

Note: add price of preamplifier to the above basic assembly prices for complete system cost. See pages 136 through 139 for specifications and prices.

DUAL-CHANNEL RECORDER

Mount in cart, cabinet or portable case
Model 7702B

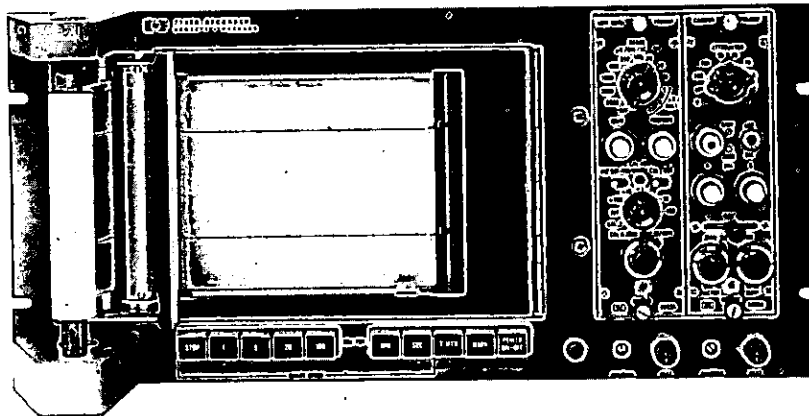


OSCILLOGRAPHIC RECORDERS

Model 7702B is a 2-channel thermal recorder using any pair of the eight versatile 8800 Preamplifiers as signal conditioners. The reliable heated stylus recording technique provides sharp, high resolution images that will not fade or smudge on plastic-coated Permapaper.®

The 7702B is designed to include many operator convenience features. Four pushbutton chart speeds are standard and four

additional speeds may be obtained (Option 11). For accurate time correlation on the recording chart, a one-second marker is provided on standard units and a one-minute marker may be added as an option. Remote marking is standard with a second marker optional and may be used for information coding. The recorded paper is collected on a front panel paper take up and is easily changed from the front of the instrument. Each recording channel is 5 cm wide (50 divisions).



7702B

Specifications

(Full performance specifications determined by choice of 8800 Series Preamplifier, see pages 136 through 139.)

Chart speeds: four speeds standard (1, 5, 20 and 100 mm/s) mechanically shifted and selected by front panel pushbuttons; other speed combinations available as options; provision is made for optional remote control of chart drive from suitable 115 V ac source.

Timer-off-marker: separate stylus marks edge of chart with 1 s pulses in TIME position or with line frequency pulses in MARK position; remote marking provision at rear connector by simple contact closure (115 V ac).

Front panel controls: individual stylus heat controls; push-buttons for power, timer, marker and speed selection; individual galvanometer damping adjustments (screwdriver adjust).

Paper: standard 200 ft rolls of 5 cm wide, 2-channel Permapaper® (651-52), easily loaded from the recorder front panel; 1-channel Permapaper® (651-51), may be used if only one channel is operated; orange, translucent Permapaper® (651-182), is available for making multiple copies of recording on contact copier (ozalid).

Paper take-up: automatic paper take-up standard equipment.
Power: 115/230 V $\pm 10\%$, 60 Hz, approx 200 VA; 115/230 V $\pm 10\%$, 50 Hz, available in Option 08.

Dimensions: rack mounted: 8 $\frac{3}{4}$ " high, 19" wide, 17" deep (222 x 483 x 432 mm); portable case (Option 02): 10-7/16" high, 20 $\frac{7}{8}$ " wide, 21-13/16" deep (265 x 530 x 576 mm); mobile cart (Option 05): 39 $\frac{1}{4}$ " high, 26 $\frac{3}{4}$ " wide, 20 $\frac{1}{2}$ " deep (997 x 680 x 521 mm).

Weight (approx): typical with 2 preamplifiers, rack mounted: 60 lb (27.2 kg) net; 89 lb (40.4 kg) gross; portable case (Option 02): 89 lb (40.4 kg) net; 135 lb (60.8 kg) gross; mobile cart (Option 05): 130 lb (59 kg) net; 172 lb (77.4 kg) gross.

Price: two channel thermal recorder, 115/230 V switch, 60 Hz, for rack mounting, uses 8800 Series Preamplifiers, specify Portable Case or Mobile Cart by Option \$1775

Options

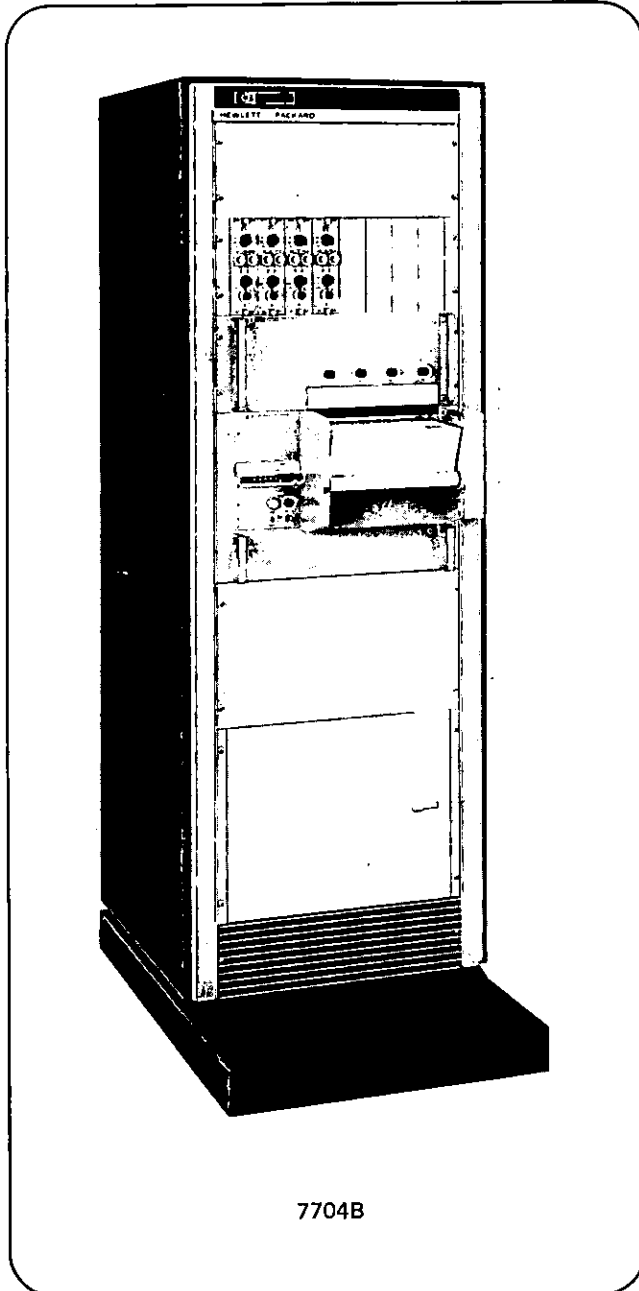
02	Portable case	add \$ 195
03	One channel decrease	deduct \$ 50
05	Mobile cart (1059-03A)	add \$ 195
08	50 Hz operation	add \$ 50
09	Speeds, 2.5, 5, 25 and 50 mm/sec (50 Hz)	N/C
10	Speeds, 2.5, 5, 25 and 50 mm/sec (60 Hz)	N/C
11	60:1 Speed Reduction (60 Hz)	add \$ 150
12	60:1 Speed Reduction (50 Hz)	add \$ 150
13	One-Minute Timer (60 Hz). (Available only when Option 11 is ordered.)	add \$ 34
14	One-Minute Timer (50 Hz). (Available only when Option 12 is ordered.)	add \$ 34
15	Extra Marker between channels	add \$ 76
18	60 Hz, 2:1 reduction, speeds of 0.5, 2.5, 10 and 50 mm/sec	add \$ 175
19	50 Hz, 2:1 reduction, speeds of 0.5, 2.5, 10 and 50 mm/sec	add \$ 175

Note 1: add price of preamplifiers to the above basic assembly prices for complete system cost; see pages 136-139 for specifications and prices.

OSCILLOGRAPHIC RECORDERS



4-CHANNEL RECORDER Pullout tabletop facilitates chart notes 7704B



7704B

The Model 7704B is a 4-channel thermal recording system featuring nine paper speeds, horizontal paper flow for marking ease and a marker (either one second/pulses or external event contact closure) for accurate time correlation. Any combination of the eight versatile 8800 Series Preamplifiers may be used as signal conditioners. The knife-edge recording technique provides recordings on true rectangular coordinates and gives a sharp, high resolution trace on Permapaper®. Frequency response is dc to less than 3 dB down at 125 Hz for chart deflection of 10 div pp, damping set for 4% overshoot on a 10 div square wave. Individual power amplifiers have adjustable electrical limiting over span from ± 12 div (referenced from channel centerline) to beyond edge of chart coordinates to protect the galvanometer and stylus.

Specifications

(Full performance specifications determined by choice of 8800 Series Preamplifiers, see pages 136 through 139.)

Chart speeds: 0.25, 0.5, 1, 2.5, 5, 10, 25, 50 and 100 mm/s standard, mechanically shifted. Remote operation of chart drive start-stop functions.

Event marker: right margin; built-in timer provides 1 s marks; manual or remote operation from contact closure. Optional event marker can be installed between channels.

Front panel controls: individual stylus heat controls, speed selector handle, motor starting switch, timer-off-marker switch, remote control connector for motor and marker.

Chart type: 4-channel green or translucent Permapaper®, 10 in. (25.4 cm) wide, 5 cm (50 div) per channel, 200 ft long, amplitude lines every 1 mm, time lines every 1 mm. Front panel paper loading and take-up. Two-channel paper may be used for economy when recording either one or two variables.

Chart footage indicator: indicates paper footage remaining on the supply roll; located on right side of recorder.

Cooling: convection, cabinet vented top and bottom. External ambient temperature should not exceed 40°C.

Power: 115 V $\pm 10\%$, 60 Hz, approx 180 VA (less preamplifiers).

Dimensions: mobile cabinet: 72½" high, 24" wide, 26" deep excluding base (1841 x 610 x 660 mm), 36½" deep with base (927 mm); rack mount (Option 01): 28" high, 19" wide, 20¾" deep max (711 x 483 x 527 mm).

Weight (approx): 4-channel recorder with four amplifiers, less preamplifiers, in cabinet: 408 lb (185 kg) net; 504 lb (228 kg) shipping. Rack mount (Option 01): 200 lb (91 kg) net; 275 lb (125 kg) shipping.

Price: Model 7704B, less preamplifiers \$4020

Options

01	less cabinet	deduct \$ 375
08	114 V, 50 Hz operation	add \$ 50
09	230 V, 50 Hz operation	add \$ 100
12	one channel decrease	deduct \$ 50
18	60 Hz, 2:1 reduction of standard speeds	add \$ 85
22	60 Hz, 60:1 reduction of standard speeds	add \$ 100
23	50 Hz, 60:1 reduction of standard speeds (includes Option-08)	add \$ 100
24	less 440 Hz card (do not order if using 8803A)	deduct \$ 50
25	less 2400 Hz card (do not order if using 8805A/B)	deduct \$ 50
31	event marker installed between channels 1 and 2	add \$ 70
32	event marker installed between channels 2 and 3	add \$ 70
33	event marker installed between channels 3 and 4	add \$ 70

Note: Only one Option 31, 32, or 33 may be ordered.

6- AND 8-CHANNEL SYSTEMS

Record 6 or 8 variables simultaneously
7706B/7708B



OSCILLOGRAPHIC RECORDERS

The Models 7706B and 7708B are 6- and 8-channel thermal systems that offer the measurement versatility of the 8800 Series interchangeable, individual channel preamplifiers. The 7706B and 7708B use space saving vertical recorders.

Transistorized power amplifiers incorporate galvanometer damping circuits to ensure recorder accuracy, current feedback to reduce drift and adjustable electrical limiting to prevent overloading and to protect the styli. Frequency response is dc to 125 Hz for the 6-channel system; dc to 150 Hz for the 8-channel system.

Four and six channel paper may be used for economy when recording less than the maximum number of channels. Permapaper® in opaque or translucent forms is available.

Systems are available in RETMA standard mobile cabinets, less cabinet for mounting in RETMA standard equipment racks or in portable cases.

Specifications

(Full performance specifications determined by choice of 8800 Series Preamplifiers, see pages 136 through 139.)

Chart speeds: 0.25, 0.5, 1, 2.5, 5, 10, 25, 50, and 100 mm/s, electrically shifted and selected by front panel pushbuttons; provision is made for remote operation of chart speeds and chart drive.

Event marker: right margin; built-in timer provides 1 s marks; manual or remote operation from contact closure. Optional event marker can be installed between channels.

Front panel controls: individual stylus heat controls; pushbutton speed selectors; motor starting switch, timer-off-marker switch.

Chart type: 6 or 8 channel green or translucent Permapaper®, 50 div/channel, 200 ft long. Optional 1000 ft paper supply available.

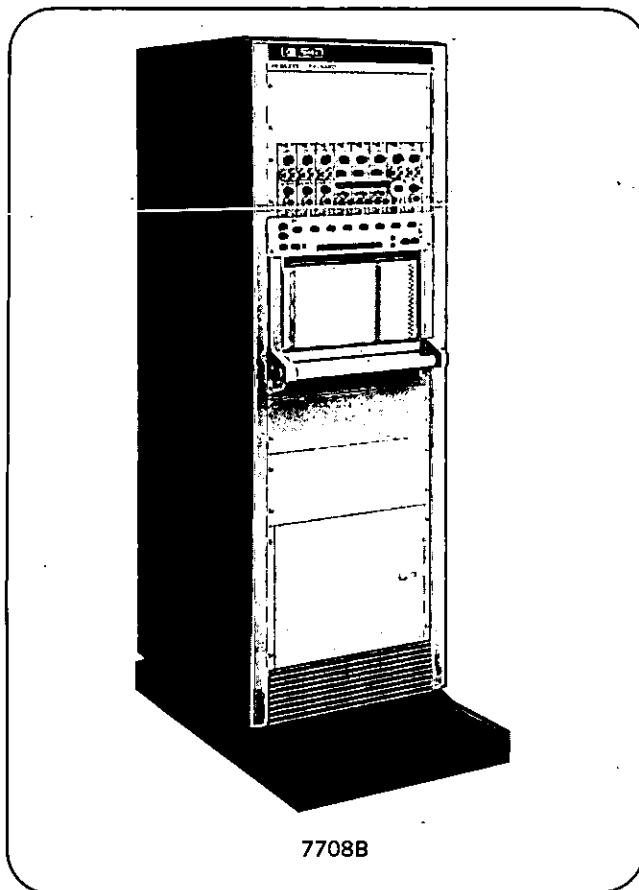
Chart footage indicator: front panel indicator shows number of feet remaining on the supply roll.

Power: recorder: 115 V \pm 10%, 60 Hz, 230 VA; 115 or 230 V, 50 Hz available on special order. 7706B, 115 V \pm 10%, 60 Hz, 330 watts approx. 7708B, 115 V \pm 10%, 60 Hz, watts approx.

Weight (less preamplifiers): cabinet mount: 7706B: 458 lb (214 kg) net; 582 lb (264 kg) shipping; 7708B: 515 lb (232 kg) net; 617 lb (280 kg) shipping. Recorder in portable case. 7706B: 200 lb (91 kg) net; 228 lb (103 kg) shipping; 7708B: 232 lb (105 kg) net; 322 lb (146 kg) shipping. 7706B, 7708B: power supply and preamplifiers in case (typical), 103 lb (46 kg) net; 190 lb (86 kg) shipping.

Dimensions: mobile cabinet mount: 72½" high, 24" wide, 26" deep excluding base (1842 x 610 x 660 mm), 36½" deep with base (927 mm); rack mount (Option 01): (recorder) 17½" high, 19" wide, 24½" deep (445 x 483 x 613 mm); (typical 8800 Preamplifier) 7" high, 2-1/6" wide (178 x 52 mm); portable cases (Option 02): (recorder case) 19¾" high, 21" wide, 21½" deep (502 x 533 x 546 mm); (amplifier case) 7-9/16" high, 22" wide, 21½" deep (200 x 570 x 546 mm).

Prices: (see Note 1) Model 7706B (6-channel cabinet assembly, less preamplifiers) \$4820
Model 7708B (8-channel cabinet assembly, less preamplifiers) \$5495



7708B

Options

01 less cabinet	deduct \$ 395
02 less cabinet, mounted in portable cases	
7706B Option 02	\$4970
7708B Option 02	\$5645
03 concealed paper take-up	add \$ 475
04 1000 ft paper supply	add \$ 178
05 dc event marker amplifier for use with Options 31 through 37	add \$ 100
08 50 Hz operation	add \$ 50
09 230 V operation	add \$100
11 mm/min speeds	add \$ 250
12 one channel decrease	deduct \$ 50
13 two channel decrease	deduct \$ 100
16 60 Hz, 2:1 increase of standard speeds	add \$ 75
17 50 Hz, 2:1 increase of standard speeds	add \$ 75
24 less 440 Hz card (do not order if using 8803A)	deduct \$ 50
25 less 2400 Hz card (do not order if using 8805A/B)	deduct \$ 50
27 60 Hz, 2½:1 reduction of standard speeds	add \$ 140
28 50 Hz, 2½:1 reduction of standard speeds	add \$ 140
29 50 Hz, 60:1 reduction yielding 9 additional speeds in mm/min	add \$ 250
31 - 37 event marker between channels (31 between 1 and 2, 32 between 2 and 3, etc.)	add \$ 70

Note 1: Add price of preamplifiers to above prices for total system cost; see pages 136 through 139 for specifications and prices.

Note 2: Consult factory before ordering more than one extra event marker, Option 31-37.

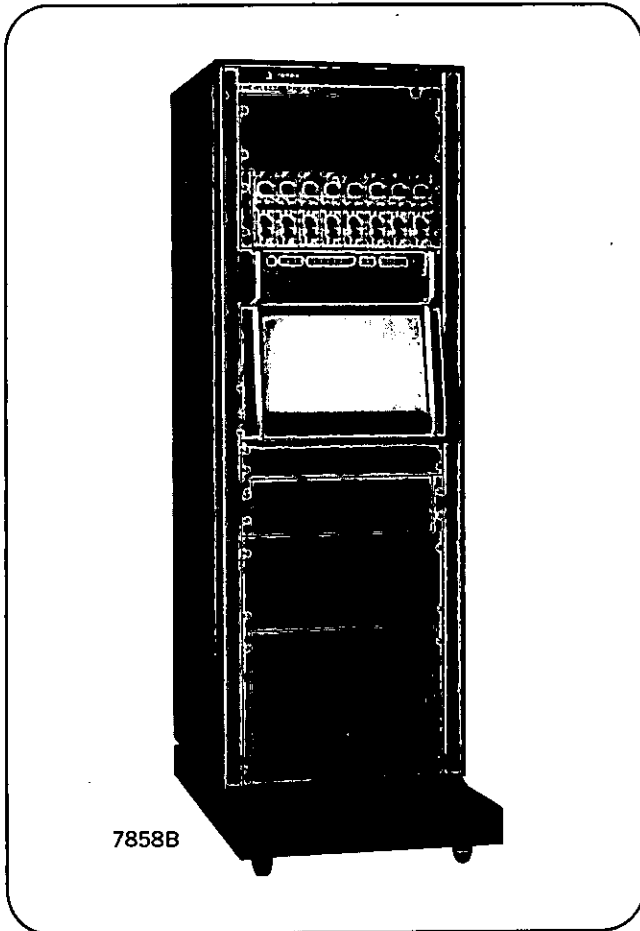
OSCILLOGRAPHIC RECORDERS



INK RECORDER

New system records on Z-fold paper or rolls

Model 7858B



7858B

Operating conveniences

The 7858B System includes many features for more efficient use and for increased operator convenience. For example:

Fourteen chart speeds having a dynamic range of 8000:1 (0.025 to 200 mm/sec) provide convenient pushbutton selection of chart drive speeds to assure the best display of the data.

A left-edge marker pen provides one second or one minute indications (switch-selected from recorder front panel) for accurate time correlation on the recording chart. A right-hand marker pen permits event or time code monitoring.

All operating controls are front-panel accessible.

A front-panel warning light indicates when the ink supply is low and a new cartridge is required. An additional indicator can also be lighted at a remote location.

Z-fold chart paper and paper rolls are edge-numbered at intervals to indicate remaining sheets of paper footage and for easy reference to specific recorded data.

Z-fold paper take-up permits writing pertinent notes on the Z-fold chart paper during the recording process.

A "remote" connector on the recorder rear panel enables an operator to select the desired chart speed and to activate the 1 second or 1 minute and event markers from a remote location. Simple contact closure activates these functions; no external voltages or currents are required.

Description

Model 7858B is an eight-channel, modulated pressure ink recording system. The system features the reliability of contactless position-feedback from near the pen tip, the convenience of Z-fold paper take-up, and the economy of ink-writing paper. The broad selection of versatile interchangeable Hewlett-Packard plug-in signal conditioners make the system extremely flexible. Vital data from dc to 150 Hz, -3 dB, 10 div pp and dc to 58 Hz full scale can be recorded with exceptional clarity over long periods.

HP8800 Series plug-in signal conditioners, which are purchased as needed, include:

Four dc preamplifiers. Sensitivity ranging from $50 \mu\text{V}$ to 250 V full scale.

Carrier preamplifier with calibrated zero suppression; adjustable calibration factor.

Phase-sensitive demodulator with plug-in calibrated phase shifters, 60 Hz, 400 Hz, and 5 kHz ranges—uncalibrated plug-in 50 Hz to 40 kHz.

AC to dc converter with 10 ms response, 1 mV sensitivity, input from 50 Hz to 100 kHz.

Log-level preamplifier with 100 dB dynamic range; $10g$ zero = 1 V.

Signal pick-up can be optimized between source and signal conditioners through a complete line of Hewlett-Packard (and other manufacturers') high performance transducers. Model 7858B can be expanded economically for complete data acquisition, Hewlett-Packard monitor scopes, Hewlett-Packard tapes, Hewlett-Packard digital readouts, etc., and still retain the feature of one system, from one source with *unmatched* service.

Z-fold chart paper

Z-fold chart paper permits immediate access to any data without interrupting the recorder. Z-fold chart paper comes in 500-sheet packs; each sheet is $15\frac{3}{8}$ in. wide x $11\frac{9}{10}$ in. high. Z-fold chart paper is perforated so that individual sheets can be readily removed from the pack. Z-fold chart paper can be stored flat or filed in book form by punching and binding the sheets into laboratory notebooks, reports, etc. The Z-fold chart paper is printed with eight 4-centimeter wide channels,

50 divisions per channel, with timing lines every (1) millimeter. Rolls of chart paper 500 ft long x 15 $\frac{5}{8}$ in. wide are also available. Printed coordinates are the same as for Z-fold chart packs.

The recording fluid, a permanent blue ink that dries rapidly on contact with the recording paper, allows high-resolution copying of the recorded data. The disposable plug-in fluid cartridge can be replaced anytime—even while the system is operating—permitting uninterrupted tracings. One cartridge supplies over 1000 miles of recorded line.

The low pressure ink system is modulated to match the recording pen velocity and chart speed, assuring sharp, constant width traces over all points of the signal waveform.

Tracings and chart coordinates can be readily reproduced by copying machines, offset duplicators, photocopy machines, copy camera machines, etc.

All recorder subassemblies, including the modular gear box, are easily accessible for maintenance.

Specifications

(Full performance specifications determined by choice of 8800 Series Preamplifiers, see pages 136 through 139.)

Ink system: low pressure, permanent blue ink, modulated to match recording pen velocity and chart speed. Dries rapidly on contact with paper. Disposable, plug-in cartridge can be replaced while operating system; 1/2 hour reserve.

Chart: 15 $\frac{5}{8}$ " wide (4 cm, 50 div channels), rectilinear coordinates on 500 ft roll or 500 sheet folded, numbered pack 11-9/10" x 15 $\frac{5}{8}$ ".

Chart speed: 14 speeds selected by seven speed pushbuttons plus 1X and 100X multiplier pushbuttons (0.025, 0.05, 0.1, 0.25, 0.5, 1.0, 2.0, 2.5, 5, 10, 25, 50, 100 and 200 mm/sec).

Paper take-up: internal roll accessible by pivoting writing table down from top. Z-fold take-up is below recorder.

Timer/marker: left margin marker provides timing pulse every second or minute. Right side marker provides event marking by local or remote switch or simple contact closure.

Linearity

Method 1: after calibrating for zero error at center scale and +20 div, less than ± 0.25 div, including hysteresis.

Method 2: after calibrating for zero error at lower and upper end of printed coordinates, less than ± 0.5 div, including hysteresis.

Limiting: electrical limiting from ± 12 div (referenced from channel centerline) to beyond channel edge.

Power: 115 V $\pm 10\%$, 60 Hz, approx 600 VA. 50 Hz available as Option 08; 230 V operation on Option 12.

Weight (approx): in cabinet with preamplifiers, 550 lb (249 kg).

Dimensions: in cabinet, 72 $\frac{1}{2}$ " high, 24" wide, 26" deep excluding base (1842 x 610 x 660 mm); 36 $\frac{1}{2}$ " deep with base (927 mm); recorder: 17" high, 19" wide, 23" deep (444 x 482 x 585 mm).

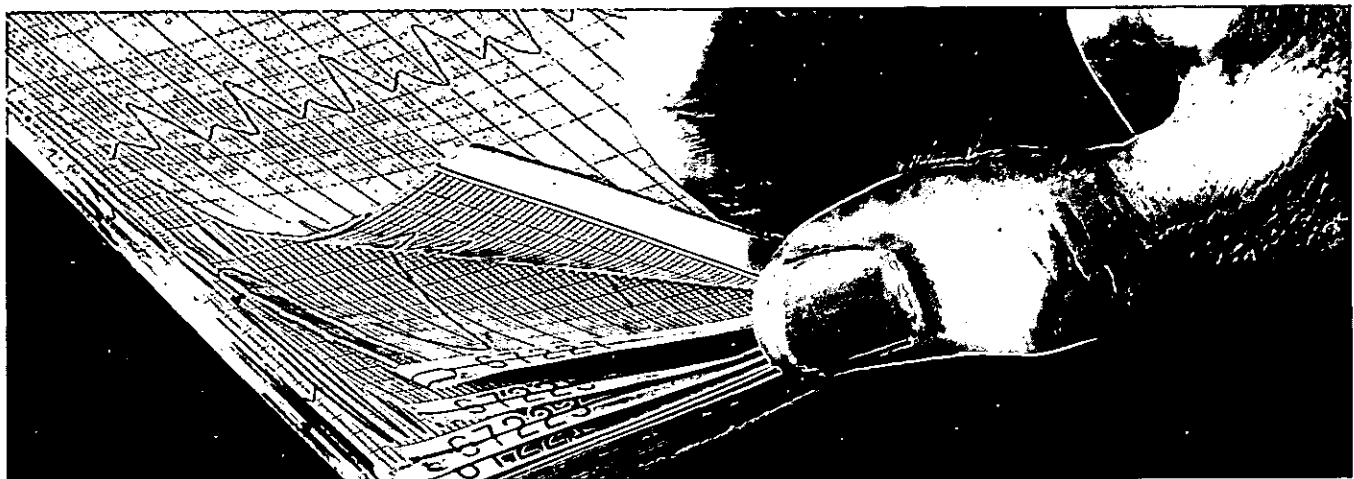
Cooling: cabinet vented top and bottom for natural convection cooling. Maximum external ambient temperature, 40°C.

Remote operation: connector provided for remote operation of chart drive, chart speed selector and timer/marker. Provides a voltage to indicate remote readiness.

Price: \$10,350

Options

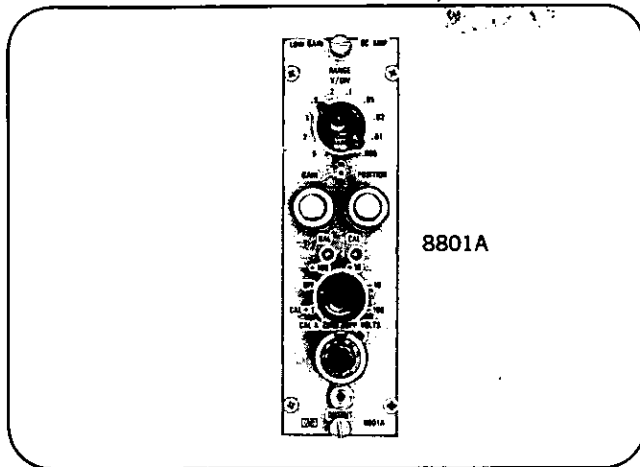
01 less cabinet	deduct \$ 425
02 portable cabinet	N/C
08 50 Hz operation	add \$ 50
09 230 V, (Transformer installed in cabinet)	add \$ 100
12 one channel decrease	deduct \$ 200
13 two channel decrease	deduct \$ 400
24 less 440 Hz card (do not order if using 8803A)	deduct \$ 50
25 less 2400 Hz card (do not order if using 8805A/B)	deduct \$ 50





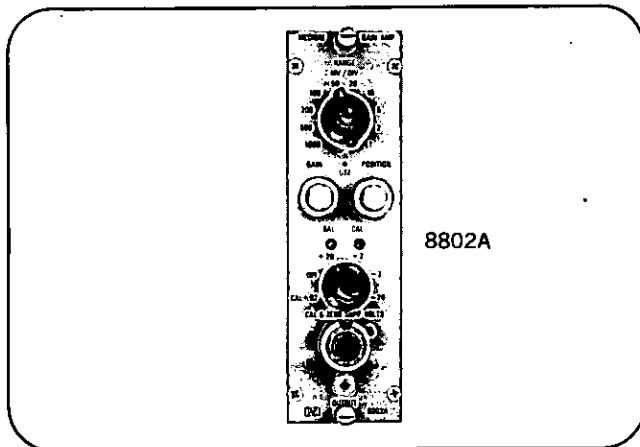
PREAMPLIFIERS

Plug-in signal conditioners for recording
8800 Series



8801A low gain dc preamplifier

The 8801A features calibrated zero suppression ranges of ± 10 and ± 100 V with 0.1% resolution, differential inputs and an internal calibration source (100 mV, $\pm 1\%$). At a maximum sensitivity of 5 mV/div, it provides stable and precise amplification at any frequency from dc to 10 kHz; if the output signal is recorded, the response may be limited by the recorder bandwidth. Typical applications include: linear velocity measurements using Hewlett-Packard LVsyn® transducers; linear displacement measurements with Hewlett-Packard DCDT transducers, analog computer output amplification.



8802A medium gain amplifier

The 8802A has a gain five times greater than the 8801A, and zero suppression ranges of ± 2 and ± 20 V with 0.1% resolution. Except for the common mode tolerance, which is smaller by a factor of five on the high sensitivity positions, the choice between the 8801A and 8802A depends directly on signal input requirements.

Typical applications include: linear velocity measurements with Hewlett-Packard LVsyn® and linear displacement with Hewlett-Packard DCDT transducers, analog computer output amplification, and motor speed analysis with dc tachometers.

Specifications, Model 8801A

- Input ranges:** 5, 10, 20, 50, 100, 200 mV/div; 0.5, 1, 2, 5 V/div.
- Type of input:** balanced to ground; 500 k Ω $\pm 1\%$ in parallel with approx 100 pF each side.
- Common mode rejection and tolerance:** 48 dB min dc to 140 Hz; ± 50 V on 5, 10, 20 mV/div ranges; ± 500 V max on other ranges for less than $\pm 1\%$ change in differential sensitivity.
- Frequency response (10 div, to -3 dB):** 7701B: dc to 30 Hz; 7702B, 7704B, 7706B: dc to 125 Hz; 7708B, 7858B: dc to 150 Hz.
- Rise time (10 div, 10% to 90%, 4% overshoot):** 7701B: 20 ms; 7702B, 7704B, 7706B: 5 ms; 7708B: 4 ms; 7858B: 3 ms.
- Output linearity (less trace width)**
All systems: 0.25 div, mechanical zero of stylus within ± 1 div of chart center and calibrated for zero error at center scale and $+20$ div.
- Output noise (max, less trace width):** all systems: 0.2 div p-p.
- Gain stability (20 to 40 C, 103 to 127 V):** 7701B, 7702B: 0.35%/10°C; 0.6% line. All other systems: 0.2%/10°C; 0.25% line.
- Zero drift (less trace width):** temperature (20° to 40°C). 7706B, 7708B: 1.05 div/10°C, 0.5 div/8 hr constant ambient. All other systems: 1.25 div/10°C, 0.5 div/8 hr, constant ambient. Line voltage (103 to 127). 7701B: 0.35 div. 7702B: 0.2 div. All others: 0.15 div.
- Price:** HP Model 8801A \$ 275
- Option 01:** bench-top unit with power supply and portable case add \$ 415

Specifications, Model 8802A

- Input ranges:** 1, 2, 5, 10, 20, 50, 100, 200, 500, 1000 mV/div.
- Type of input:** balanced to ground; 180 k Ω ($\pm 1\%$) in parallel with approx 100 pF each side.
- Common mode rejection and tolerance:** 48 dB min dc to 60 Hz, 1000 mV/div range; 48 dB min dc to 150 Hz all other ranges; ± 12.5 V on 1, 2, 5 mV/div ranges; ± 125 V on 10, 20, 50 mV/div ranges; ± 500 V max on other ranges for less than $\pm 1\%$ change in differential sensitivity.
- Frequency response (10 div, to -3 dB):** 7701B: dc to 30 Hz. 7702B, 7704B, 7706B: dc to 125 Hz. 7708B, 7858B: dc to 150 Hz.
- Rise time (10 div, to 10 to 90%, 4% overshoot):** 7701B: 20 ms. 7702B, 7704B, 7706B: 5 ms. 7708B: 4 ms. 7858B: 3 ms.
- Output linearity (less trace width):** all systems: 0.25 div; mechanical zero of stylus within 1 div of chart center and calibrated for zero error at center scale and $+20$ div.
- Output noise (max, less trace width):** all systems: 0.2 div p-p.
- Gain stability (20 to 40°C, 103 to 127 V):** 7701B, 7702B: 0.35%/10°C, 0.6% for line. 7704B, 7706B, 7708B, 7858B: 0.25%/10°C, 0.25% for line.
- Zero drift (less trace width):** temperature (20 to 40°C). 7706B, 7708B: 1.05 div/10°C, 0.5 div/8 hrs, constant ambient. All other systems: 1.25 div/10°C, 0.5 div/8 hrs, constant ambient.
- Line voltage (103 to 127 V):** 7701B: 0.35 div. 7702B: 0.20 div. All others: 0.15 div.
- Price:** HP Model 8802A \$ 325
- Option 01:** bench-top unit with power supply and portable case add \$ 415

Specifications, Model 8803A

Input ranges: 1, 2, 5, 10, 20, 50, 100, 200, 500, 1000, 2000, 5000 $\mu\text{V}/\text{div}$; 10, 20, 50, 100, 200, 500, 1000, 2000, 5000 mV/div ; max error $\pm 2\%$.

Type of input: floated and guarded signal pair; 1 $\text{M}\Omega$ min on μV ranges; 5 $\text{M}\Omega$ on mV ranges.

Common mode rejection: μV range: greater than 160 dB at dc and greater than 120 dB at 60 Hz with maximum source unbalance of 1 $\text{k}\Omega$; mV range: greater than 100 dB at dc and greater than 60 dB at 60 Hz with maximum source unbalance at 500 $\text{k}\Omega$.

Maximum common mode voltage: dc: $\pm 300\text{ V}$; 60 Hz: 1 $\mu\text{V}/\text{div}$, 10 V rms ; 2 $\mu\text{V}/\text{div}$, 20 V rms ; 5 $\mu\text{V}/\text{div}$, 50 V rms ; 10 $\mu\text{V}/\text{div}$, 10 mV/div , 100 V rms ; all other ranges 220 V rms .

Frequency response (10 div, dc to -3 dB): 7701B: 30 Hz. 7702B, 7704B, 7706B: 90 Hz. 7708B, 7858B: 100 Hz.

Rise time (10 div, 10% to 90%): 7701B: 20 ms (4% overshoot). 7702B, 7704B, 7706B: 7 ms (5% overshoot). 7708B: 6.4 ms (approx 6% overshoot). 7858B: approx 5.5 ms (4% overshoot).

Output linearity (less trace width): all systems: 1 μV range, 0.35 div; other ranges 0.25 div, mechanical zero of stylus within ± 1 div of chart center and calibrated for zero error at center scale and $+20$ div.

Output noise (max, less trace width): all systems: 0.1 div p-p min gain.

Gain stability: temperature (20° to 40°C): 7701B, 7702B: 0.35%/10 $^\circ\text{C}$. All other systems: 0.2%/10 $^\circ\text{C}$. Line voltage (103 to 127 V): 7701B, 7702B: 0.75%, 1 to 5 mV/div ; 0.55% all other ranges. All other systems: 0.4% on 1 to 5 mV/div ranges, 0.2% on all other ranges.

Zero drift (less trace width): temperature (20° to 40°C): 7701B, 7702B, 7704B: μV range: 1 $\mu\text{V}/10^\circ\text{C}$ referred to input, ± 0.65 div/10 $^\circ\text{C}$ for full scale output. 7706B, 7708B, 7858B: μV range: 1 $\mu\text{V}/10^\circ\text{C}$ referred to input; ± 0.45 div/10 $^\circ\text{C}$ for full scale output.

Price: HP Model 8803A \$ 695

Option 01: bench top unit with power supply and portable case add \$ 505

Specifications, Model 8805A

Sensitivity: 10 $\mu\text{V rms}/\text{div}$.

Input attenuator: X1, 2, 5, 10, 20, 50, 100 and 200; accuracy $\pm 2\%$.

Type of input: approx 10 $\text{k}\Omega$.

Transducer impedance: transducer load impedance connected to excitation terminals 100 ohms min; transducer impedance connected to signal input terminals 5 $\text{k}\Omega$ max.

Excitation: 5 V rms nominal; 2400 Hz $\pm 2\%$.

Quadrature rejection: greater than 40 dB; tolerance: error less than $\pm 2\%$ full scale when quadrature voltage is equal to twice inphase signal required for full scale output.

Zero suppression: 0 to 100% of transducer full load rating.

Calibration: 2% $\pm 0.02\%$ of transducer full scale output.

Frequency response (10 div, to -3 dB): 7701B: dc to 30 Hz. 7702B, 7704B, 7706B: dc to 110 Hz. 7708B: dc to 120 Hz. 7858B: dc to greater than 110 Hz.

Rise time (10 div, 10-90%, 4% overshoot): 7701B: 20 ms. 7702B, 7704B, 7706B: 5.6 ms. 7708B: 4.75 ms. 7858B: approx 4 ms.

Output linearity (less trace width): all systems: 0.4 div. mechanical zero of stylus within ± 1 div of chart center and calibrated for zero error at center scale and $+20$ div.

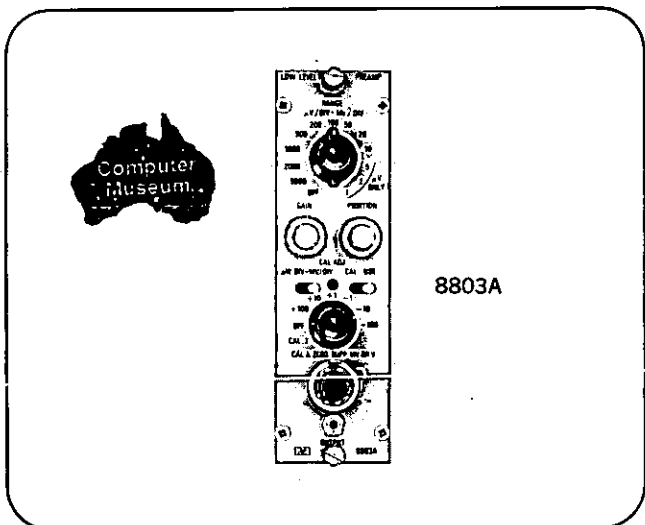
Output noise (max, less trace width): all systems: approx 0.25 div.

Gain stability (20° to 40°C , 103 to 127 V): 7701B, 7702B: 0.45%/10 $^\circ\text{C}$; 0.75% line. All other systems: 0.3%/10 $^\circ\text{C}$; 0.4% line.

Zero drift (less trace width): temperature (20° to 40°C): 7701B, 7702B: 0.45%/10 $^\circ\text{C}$; 7704B: 0.45 div/10 $^\circ\text{C}$; all others 0.25%/10 $^\circ\text{C}$. Line voltage (103 to 127 V): 7701B, 7702B: 0.35 div; all others 0.25 div.

Price: HP Model 8805A \$ 400

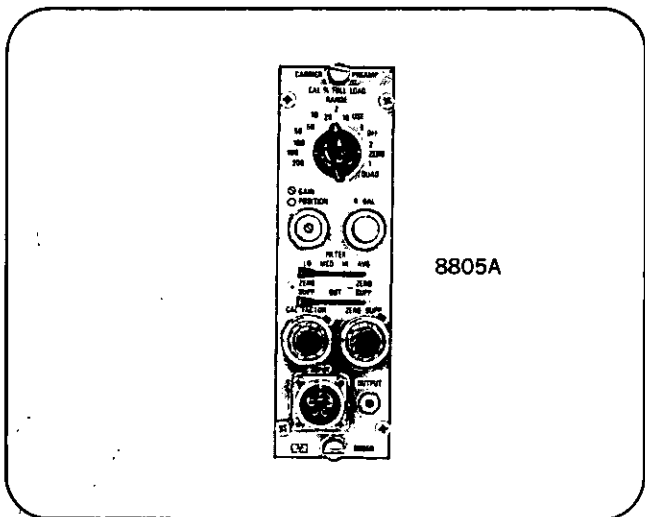
Option 01: bench-top unit with power supply and portable case add \$ 485



8803A low level preamplifier

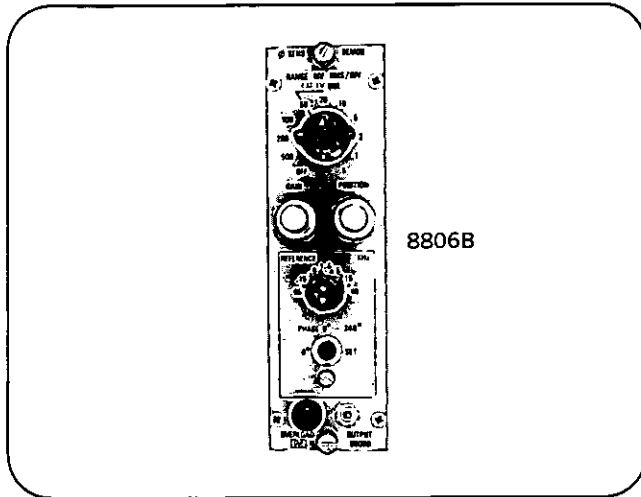
The 8803A, with a maximum sensitivity of 1 $\mu\text{V}/\text{div}$ (at a gain of 100,000), accommodates a much wider range of signal amplitudes than the 8801A or 8802A. The 8803A features a fully guarded input circuit, operating in conjunction with the floating input capability for a common mode rejection as high as 100 dB at dc. In addition, the input circuit will tolerate a common mode voltage as high as $\pm 300\text{ V}$ dc at any position of the range control. Twelve calibrated zero suppression ranges, each with 0.1% resolution, provide full scale suppression of ± 1 , ± 10 and $\pm 100\text{ mV}$ when attenuator is in μV ranges and volts when attenuator is in mV ranges.

Typical uses of the 8803A include: dc strain gage measurements, analysis of small variations in a large dc signal, such as the output of a regulated power supply.



8805A carrier preamplifier

The 8805A measures any physical variable that can be coupled to suitable carrier excited transducers, i.e., strain gage bridges, differential transformer transducers, and resistance or reactance transducers. Typical applications include measuring linear displacement with Hewlett-Packard Linearsyn® (585, 595 Series) transducers and temperature with thermistors. An oscillator in the recording system provides an excitation voltage for the external transducer, eliminating the need for external excitation circuitry. Calibrated zero suppression permits analyzing small signals when large static loads are present on the transducer. An internal switch is provided for full or half bridge use.

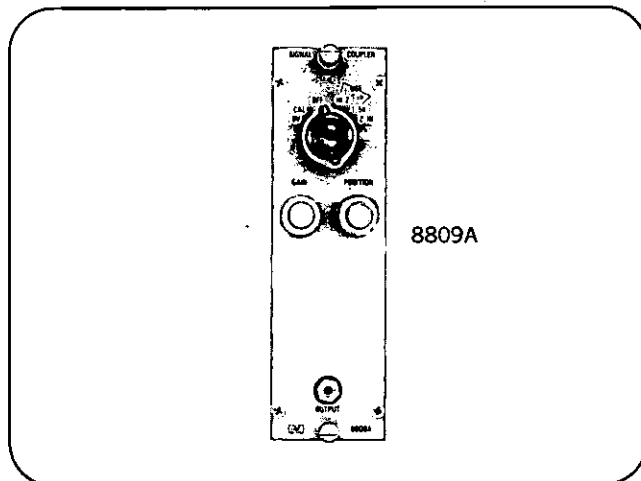
OSCILLOGRAPHIC RECORDERS *continued*
Plug-in signal conditioners
 8800 Series


8806B

8806B phase sensitive demodulator

The 8806B provides a dc output proportional to the rms value of the input signal that is in phase or 180° out of phase with respect to a reference voltage. For maximum flexibility, the phase of the reference voltage is varied by calibrated plug-in phase shift networks for 60 Hz, 400 Hz, or 5000 Hz operation. An additional plug-in covers 6 frequency bands from 50 Hz to 40 kHz with continuous uncalibrated 0° to 360° phase shift. Other features include transformer isolation of both signal and reference voltage input circuits, and a maximum calibrated sensitivity of 0.5 mV rms/div, corresponding to a gain of 200 rms ac to dc.

Typical applications include: error signal measurements; servo, synchro, gyro and resolver system response; and amplitude and phase response.



8809A

8809A signal coupler

The 8809A is a solid state preamplifier with switch-selected high or low input impedance and variable gain for signal coupling to the driver amplifier input of Hewlett-Packard direct writing (thermal or ink) recorders in single or multi-channel systems.

Specifications, Model 8806B

Input ranges: 0.5, 1, 2, 5, 10, 20, 50, 100, 200 and 500 mV rms/div. Reference voltage: 3-133 V rms in two overlapping ranges, internal range switch.

Type of input: signal input: transformer isolated, floating and guarded, resistance approx 1 MΩ. Reference input: differential, transformer coupled; resistance approx 500 kΩ each side to ground; may be used single-ended.

Common mode rejection and tolerance: more than 40 dB up to 10 Hz; 500 V rms, max. Quadrature tolerance; equal to amplitude of a full scale in-phase signal.

Reference frequency range: 50 Hz to 40 kHz in six bands with variable frequency plug-in; fixed frequency calibrated plug-ins 60 Hz, 500 Hz, 5 kHz.

Output frequency response and rise time (10 div, 4% overshoot)

Recorder	$f_c = 60 \text{ Hz}$		$f_c = 400 \text{ Hz}$		$f_c = 5 \text{ kHz}$	
	-3 dB @	T_R^*	-3 dB @	T_R^*	-3 dB @	T_R^*
7701B	10 Hz	54 ms	27 Hz	23 ms	30 Hz	20 ms
7702B						
7704B	12 Hz	50 ms	65 Hz	9 ms	125 Hz	5 ms
7706B						
7708B	12 Hz	50 ms	70 Hz	8.5 ms	150 Hz	4 ms
7858B	12 Hz	50 ms	71 Hz	8 ms	160 Hz	3 ms

*10% to 80%.

Output linearity (less trace width): all systems: 0.4 div, mechanical zero of stylus within ± 1 div of chart center and calibrated for zero error at center scale and +20 div.

Gain stability (20° to 40°C, 103 to 127 V): 7701B, 7702B: 0.5%/10°C; 0.6% line volts. All other systems: 0.3%/10°C; 0.25% line volts.

Zero drift (20° to 40°C, 103 to 127 V): 7701B, 7702B: 0.5 div/10°C; 0.3 div. 7704B: 0.5 div/10°C, 0.25 div. All other systems: 0.3 div/10°C; 0.25 div.

Price: HP Model 8806B \$ 495

Options

- 01 bench-top unit with power supply and portable case add \$ 415
- 02 uncal. phase shifter plug-in, 50 Hz to 40 kHz add \$ 175
- 03 calibrated phase shifter plug-in, 60 Hz add \$ 125
- 04 calibrated phase shifter plug-in, 400 Hz add \$ 125
- 05 calibrated phase shifter, 5 kHz add \$ 125

Specifications, Model 8809A

Input ranges: continuously adjustable from 20 to 50 mV/div. **Type of input:** switch selected 1.5 kΩ $\pm 2\%$ or 100 kΩ min, single-ended (floating in 7701B only).

Common mode rejection and tolerance: 50,000: 1 at dc: +50 V max (7701B only).

Rise time (10 div, 10-90%, 4% overshoot): 7701B: 20 ms. 7702B, 7704B, 7706B: 5 ms. 7708B: 4 ms. 7858B: 3 ms.

Output linearity (less trace width): all systems: 0.4 div, mechanical zero of stylus within ± 1 div of chart center and calibrated for zero error at center scale and +20 div.

Gain stability (20°C to 40°C, 103 to 127 V): 7701B, 7702B: 0.75%/10°C; line volts 1%. All other systems: 0.6%/10°C; line volts 0.65%.

Zero drift (20°C to 40°C, 103 to 127 V): 7701B, 7702B: 0.4 div/10°C at 30 mV/div; 0.5 div. 7704B: 0.4 div/10°C at 30 mV/div; 0.5 div. All other systems: 0.2 div/10°C at 30 mV/div; 0.3 div.

Price: HP Model 8809A \$ 110

Option 01: bench-top unit with power supply and portable case add \$ 415

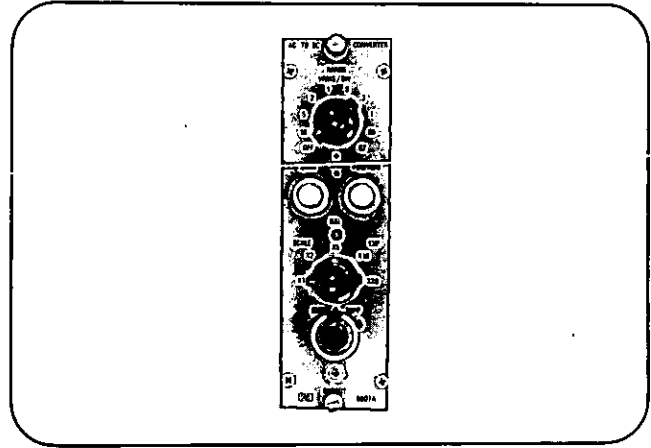
Plug-in signal conditioners 8800 Series

Specifications, Model 8807A

- Input range:** 0.02, 0.05, 0.1, 0.2, 0.5, 1, 2, 5, 10 V rms/div.
Type of input: floated and guarded signal pair; approx 1 M Ω resistance shunted by 10 pF and stray cable capacitance.
Common mode rejection and tolerance: 60 dB min at 60 Hz; 40 dB min at 400 Hz, up to 10 K source unbalance; ± 500 V peak.
Input frequency range: standard model: 330 Hz to 100 kHz; Option 01: 50 Hz to 100 kHz.
Frequency response (10 div, to -3 dB): 7701B: 27 Hz; Option 01: 9 Hz. All other systems: 54 Hz; Option 01: 9 Hz.
Rise time (10 div, 10 to 90%, 4% overshoot): 7701B: 22 ms. 7702B, 7704B, 7706B, 7858B: 11.2 ms. 7708B: 10.8 ms.
Output linearity (less trace width): all systems: 0.55 div \pm 0.05 div \times scale expansion 60 Hz to 5 kHz, mechanical zero of stylus within ± 1 div of chart center and calibrated for zero error at lower and upper ends of printed coordinates.
Gain stability (20° to 40°C, 103 to 127 V): 7701B, 7702B: 0.2%/10°C \times scale expansion \pm 0.45%/10°C; line volts 0.24% \times scale expansion \pm 0.75%. All other systems: 0.2%/10°C \times scale expansion \pm 0.3%/10°C; line volts 0.24% \times scale expansion \pm 0.4%.
Zero drift (less trace width): temperature (20° to 40°C). 7701B, 7702B, 7704B: 0.3 div/10°C \times scale expansion \pm 0.15 div/10°C. All other systems: 0.03 div/10°C \times scale expansion \pm 0.15 div/10°C. Line volts (103 to 127 V). 7701B, 7702B: 0.005 div \times scale expansion \pm 0.3 div. All other systems: 0.005 div \times scale expansion \pm 0.1 div.
Price: HP Model 8807A \$ 700
Options
 01 60 Hz filter for 50 Hz to 100 kHz signal frequencies N/C when substituted
 02 dc plug-in N/C when substituted
 03 bench-top unit with power supply and portable case add \$ 415

Specifications, Model 8808A

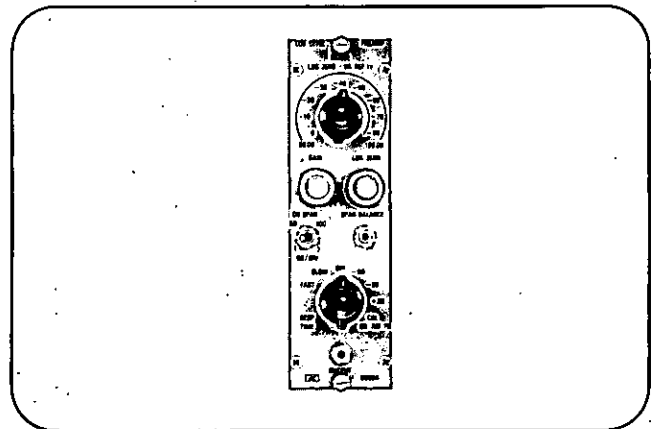
- Sensitivity ranges:** 50 dB span: bottom scale at -80, -70, -60, -50, -40, -30, -20, -10, and 0 dB below 1 V. 100 dB span: bottom scale at -80, -70, -60, and -50 dB below 1 V.
Type of input: single-ended, 1 M Ω min resistance.
Input frequency range: 5 Hz to 100 kHz for less than -3 dB from midband level on slow response range; 500 Hz to 100 kHz on fast range.
Rise time (10 div, 10 to 90%, 4% overshoot): 7701B: fast: 28 ms (825 dB/s); slow: 2 s (9 dB/s). All other systems: fast: 20.5 ms; slow: 2 s.
Output linearity: departure from log characteristics (less trace width): 7701B: 50 dB: 1.25 div; 100 dB: 1.0 div, mechanical zero of stylus within ± 1 div of chart center and calibrated for zero error at lower and upper ends of printed coordinates. 7702B, 7704B: 50 dB: 1.2 div; 100 dB: same as 7701B. All other systems: 50 dB: 1.5 div; 100 dB: same as 7701B.
Gain stability (20° to 40°C, 103 to 127 V): 7701B, 7702B: 50 dB: 2.13 dB/10°C, 0.75 dB; 100 dB: 2.25 dB/10°C, 1.0 dB. All other systems: 50 dB: 2.05 dB/10°C, 0.58 dB from 103 to 127 V; 100 dB: 2.1 dB/10°C, 0.65 dB from 103 to 127 V.
Price: HP Model 8808A \$ 625
Option 01: bench-top unit with power supply and portable case add \$ 415



8807A ac-dc converter

The 8807A provides a dc voltage output proportional to the average value of a full wave rectified ac input signal. Range sensitivity is calibrated in terms of rms for sinusoidal waveforms. The input circuit is transformer coupled, floating and guarded for high common mode rejection, allowing measurements over a wide range of input signal conditions. Calibrated zero suppression and variable scale expansion permit clear analysis of small excursions in large input signals.

Typical applications include: single and polyphase line voltage and current monitoring, motor starting current analysis, and fading analysis on short wave communication links using heterodyne frequency converters.



8808A log level preamplifier

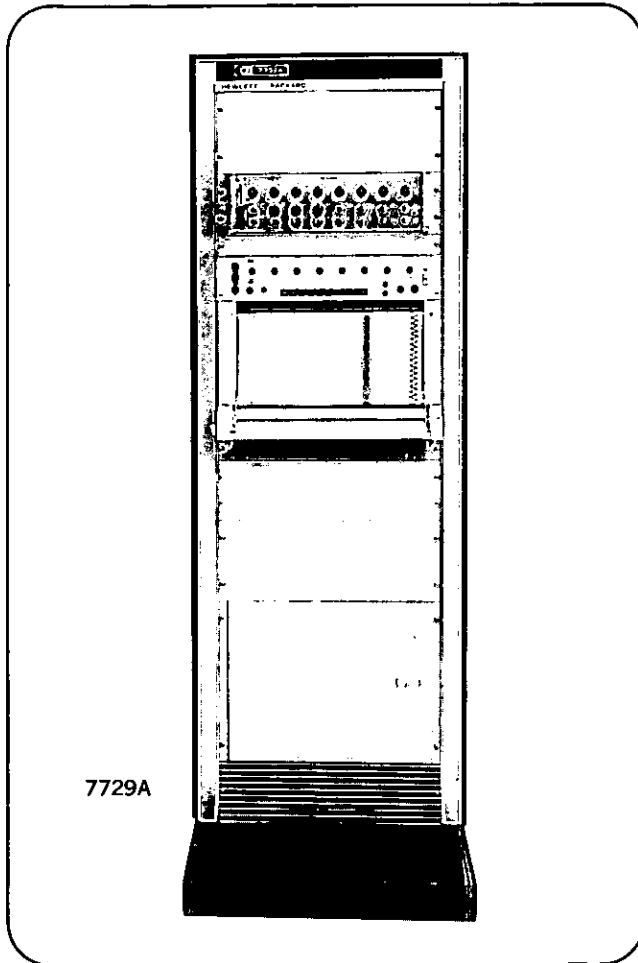
The 8808A compression and full wave detection circuits express the amplitude of an ac input signal in terms of decibels, with zero dB taken as a 1 V rms sine wave input voltage. Features of 100 dB span range, also a 50 dB span for greater signal resolution. Full span preamplifier output is either ± 2.5 V or 0 to +5 V.

Typical applications include: analysis of wide ranges of signal amplitude on 100 dB linear scale (5 Hz to 100 kHz), analysis of RF and sonar radiation patterns, and use with wide band vibration and acoustic transducers.

OSCILLOGRAPHIC RECORDERS



BANK AMPLIFIER SYSTEMS 6, 8, or 16 Channels, Thermal Models 7727A, 7729A, 7731A



7729A

Hewlett-Packard 6, 8 and 16 channel basic assemblies offer complete versatility for making accurate, permanent records of multiple variables. These basic assemblies accept multi-channel 8820A and 8821A Amplifiers designed to condition and control simple or complex signals. Variables appear as sharp, clean, permanent traces on Permapaper® charts, opaque or translucent (for copying). Traces from dc to 150 Hz, 3 dB down, 10 div pp can be recorded with exceptional clarity on the 8-channel systems and dc to 125 Hz, 10 div pp on 6 and 16-channel systems.

Specifications

System specifications including the 8820A (Option 20) and 8821A (Option 21) are given in the table at the bottom of this page.

Chart speeds: 0.25, 0.5, 1, 2.5, 5, 10, 25, 50 and 100 mm/s, electrically shifted and selected by front panel pushbuttons; provision is made for remote operation of chart speeds and chart drive.

Event marker: right margin; built-in timer provides 1-second timing marks; provision for manual or remote event marking; DC Marker Driver Amplifier 14040A is available for dc event marking (produces more than 1 mm event marker deflection with ± 1.5 V, 0.5 mA signal input).

Front panel controls: individual stylus heat controls; pushbutton speed selectors; motor starting switch, timer-off-marker switch.

Chart footage indicator: front panel indicator shows number of feet remaining on the supply roll.

Power: 115 V $\pm 10\%$, 60 Hz, 7727A/7728A: 330 VA, 7731A: 550 VA.

Weight (less preamplifiers): (cabinet mount): 7727A: 432 lb (196 kg) net; 7729A: 436 lb (188 kg) net; 7731A: 517 lb (223 kg) net; (recorder in portable case): 7727A: 200 lb (86 kg) net; 7729A: 232 lb (105 kg) net.

Dimensions: mobile cabinet mount: 72½" high, 24" wide, 26" deep excluding base (1842 x 610 x 660 mm), 36½" deep with base (927 mm); rack mount: (recorder) 17½" high, 19" wide, 24½" deep (445 x 483 x 613 mm); (amplifier 5-7/32" high, 19" wide, 13¼" deep (133 x 483 x 337 mm)); (7727A, 7729A) portable case: (recorder) 19¾" high, 20" wide, 20½" deep (502 x 508 x 521 mm), (amplifier) 5-7/32" high, 16¾" wide, 13¼" deep (133 x 425 x 337 mm).

Prices

Model 7727A (6-channel cabinet assembly less amplifiers) \$4030

Model 7729A (8-channel cabinet assembly less amplifiers) \$4705

Model 7731A (16-channel cabinet assembly less amplifiers) \$8000

Options

01 less cabinet (including master power panel)	deduct \$ 425
02 portable case (excluding 7731A)	deduct \$ 75
03 concealed paper take-up	add \$ 475
04 1000 ft paper supply	add \$ 178
05 dc event marker amplifier for use with options 31 through 37	add \$ 110
08 50 Hz operation	add \$ 50
09 230 V (transformer installed in rack cabinet)	add \$ 100
11 60 Hz, 60:1 speed reduction yielding 9 additional speeds in mm/min (adds 1 min timing marks)	add \$ 250
16 60 Hz, 2:1 speed increase of standard speeds	add \$ 75
17 50 Hz, 2:1 speed increase of standard speeds	add \$ 75
20 add 8820A Amplifier (8 channel)	add \$1150
add 8820A Amplifier (6 channel, 7727A)	add \$1120
21 add 8821A Amplifier (8 channel)	add \$2500
add 8821A Amplifier (6 channel, 7727A)	add \$2300
27 60 Hz, 2½:1 reduction of standard speeds	add \$ 140
28 50 Hz, 2½:1 reduction of standard speeds	add \$ 140
29 50 Hz, 60:1 reduction yielding 9 additional speeds in mm/min (adds 1 min timing marks)	add \$ 250
31 - 37 event marker between channels (31 between 1 and 2, 32 between 2 and 3, etc., not available on 7731A)	add \$ 70

Note: consult factory before ordering more than one extra channel marker, i.e., Option 31 or higher.

Model 7727A, 7729A, 7731A, . . .

System	Option	Sensitivity ranges	Input circuit
7727A 7729A 7878A	20	0.05 thru 5 V/div (1, 2, 5 sequence)	Single ended, 1 M Ω shunted by approx. 150 pF
	21	.001 thru 5 V/div (1, 2, 5 sequence)	1 to 50 mV/div, floated and guarded signal pair, 9 M Ω ; others balanced to ground, 4.5 M Ω
7731A	20	0.1 thru 10 V/div (1, 2, 4 sequence)	Single ended, 1 M Ω shunted by approx. 150 pF
	21	.002 thru 10 V/div (1, 2, 4 sequence)	1 to 50 mV/div, floated and guarded signal pair, 9 M Ω ; others balanced to ground, 4.5 M Ω

BANK AMPLIFIER SYSTEMS

8 channel, Z-fold, pressurized ink

Model 7878A



OSCILLOGRAPHIC RECORDERS

The 7878A is an 8-channel, modulated pressure ink recording system. The system features the reliability of contactless position-feedback from near the pen tip, the convenience of Z-fold paper take-up, and the economy of ink writing paper. Vital data from dc to 140 Hz, 10 div pp and dc to 58 Hz full scale can be recorded with exceptional clarity over long periods. The 7878A recording system utilizes the same recorder described for use with the 7858B Multichannel Recorder (see page 134).

The 7878A can be equipped with either the 8820A Low Gain Multichannel Amplifier or with the 8821A Medium Gain Multichannel Amplifier. Each bank amplifier contains eight channels of amplification mounted on one front panel.

Specifications

System specifications including the 8820A (Option 20) and 8821A (Option 21) Amplifiers are given in the table at the bottom of this page.

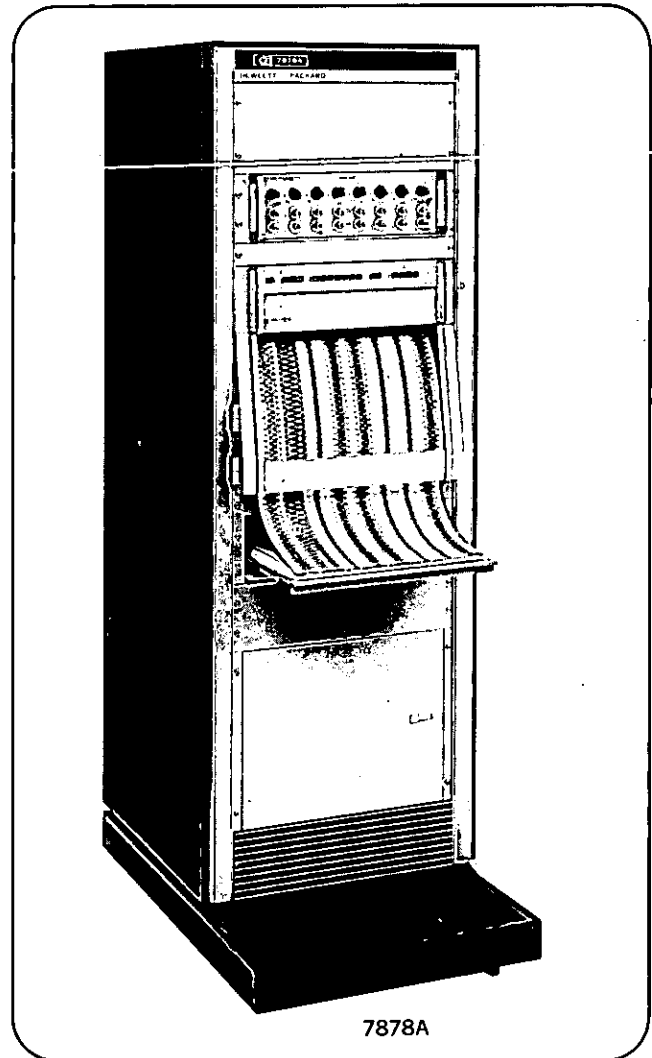
Price: Model 7878A \$9500

Options

01 less cabinet	deduct \$ 425
02 portable cabinet	N/C
08 50 Hz operation	add \$ 50
09 230 V (transformer installed in rack cabinet)	add \$ 100
20 add 8820A Amplifier	add \$1150
21 add 8821A Amplifier	add \$2500

When ordering standalone amplifiers, the following price schedule applies:

Model 8820A Low Gain Amplifier (8 channel)	\$1150
Option 02 two channel reduction	deduct \$ 30
Model 8821A Medium Gain Amplifier (8 channel)	\$2500
Option 02 two channel reduction	deduct \$ 200



7878A

... 7878A Performance Specifications

Common mode Rejection (1 k Ω unbalanced, 60 Hz)	Frequency response (10 div pp, -3 dB)	Rise time (10 div, 10% to 90%)	Output linearity	Gain stability (20° - 40°C)	Zero drift (20° - 40°C)	Internal calibration	System
N/A	7727A: 125 Hz 7729A: 150 Hz 7878A: 150 Hz	(4% overshoot) 7727A: 5 ms 7729A: 4 ms 7878A: 3 ms	± 0.25 div at chart center and ± 20 div	$< 0.5\%/10^\circ\text{C}$ $\pm 0.15\%$ (103 to 127 V)	$< 0.5\%/10^\circ\text{C}$ $\pm 0.15\%$ (103 to 127 V)	Single and common 1 V ref, accuracy $\pm 1\%$ ± 0.02 V $\pm 1\%$ on six most sensitive ranges, ± 2 V $\pm 2\%$ on others	7727A 7729A 7878A
N/A	125 Hz	(4% overshoot) 4 ms	± 0.2 div at chart center and ± 10 div	$< 0.5\%/10^\circ\text{C}$ $< 0.25\%$ (103 to 127 V)	< 0.25 div/ 10°C < 0.1 div (103 to 127 V)	Single and common 1 V ref, accuracy $\pm 1\%$ ± 0.02 V $\pm 1\%$ on six most sensitive ranges, ± 2 V $\pm 2\%$ on others	7731A

ANALOG TAPE RECORDERS



INSTRUMENTATION MAGNETIC TAPE RECORDING

Magnetic tape recording is used in all walks of life, to record and reproduce information of various kinds. In the case of the familiar *audio* home tape recorder and business dictating machine, that information is voice and music, converted to electrical form by a microphone. Another type, the *video* tape recorder, finds daily use in today's television programming. Your bank account is most likely recorded on a *digital* tape unit, used extensively with computer systems for the mass storage of digitized data. All of the above are considered *special purpose* in that each is designed for a specific application.

The instrumentation recorder is, on the other hand, a *general-purpose instrument*, used in any scientific field where there is a need to preserve analog data for later evaluation. The data may already be in electrical form (from dc to 2.0 MHz) or may be one of an almost unlimited variety of physical or scientific phenomena converted to electrical form by a transducer.

Standards for instrumentation recording were established within the field of telemetry by the Inter-Range Instrumentation Group (IRIG). These standards are rigidly adhered to throughout the instrumentation magnetic tape recording industry. Compatibility and exchange of recorded data between various magnetic recording systems demand such standardization, regardless of the specific area of application. "IRIG Telemetry Standards," Document No. 106-69 dated Feb 69, represents the latest publication of these standards. (Copies are obtained from the Defense Documentation Center for Scientific and Technical Information, Cameron Station, Alexandria, Virginia 22314, or Secretariat Range Commanders Council, White Sands Missile Range, New Mexico 88002).

Three categories of instrumentation recorders are established by IRIG: low-band, intermediate-band and wide-band, each of these categories providing corresponding bandwidths of 100 kHz, 500 kHz and 1.5 MHz.

Standardized tape speeds are $1\frac{1}{8}$, $3\frac{3}{4}$, $7\frac{1}{2}$, 15, 30, and 60 ips for lowband and $1\frac{1}{8}$, $3\frac{3}{4}$, $7\frac{1}{2}$, 15, 30, 60, and 120 ips for intermediate band and $3\frac{3}{4}$ to 120 ips for the Wideband Recorders. The *higher tape speeds* are used for recording greater bandwidths; the *lower tape speeds* for the maximum in recording time.

Two recording methods have been specified to meet various requirements: *Direct recording* and *Frequency Modulation recording*.

Direct recording provides the greatest bandwidth available from a magnetic tape recorder, and requires only relatively simple, moderately priced electronics. With this recording method, the intensity of magnetization on tape is made proportional to the instantaneous *amplitude* of the input signal.

In the *reproduce* process a signal is induced from tape to heads only in response to *changes* in flux on the recorded tape; the direct reproduce process cannot extend down to dc.

The direct recording method is also characterized by some amplitude instability, caused primarily by random surface inhomogeneities in the tape. These variations are normally a few percent at the lower recording frequencies, and can exceed as much as 10% near upper bandwidth limits. Occasional momentary signal decreases of over 50% may occur; these are commonly referred to as "drop-outs."

Uses for direct recording, then, have a common requirement: economy, a maximum bandwidth, and applications where amplitude variation errors are not critical. Typical applications include recordings where the signal's frequency, not amplitude, is of primary importance.

Frequency modulation recording (FM) overcomes some of the basic limitations of the direct recording process, but at the expense of high frequency bandwidth; response does, however, extend down to dc. This recording technique significantly improves the signal amplitude stability, since it is now proportional to carrier deviation, rather than the intensity of magnetization on tape.

In the FM recording method, a carrier oscillator is frequency-modulated by the input signal. The oscillator's center frequency corresponds to a zero-level input with deviation from center frequency being proportional to the amplitude of the input signal. The polarity of the input signal determines the direction of deviation.

FM recording is used primarily when the dc component of the input signal is to be preserved, or when the amplitude variations of the direct recording method cannot be tolerated. Accuracy of the reproduce signal is another factor in favor

of FM recording, being in the order of 1%; vs 5% for the direct recording process.

Advantages of magnetic recording

Recording on magnetic tape is an economical, time-saving method of preserving almost any type of information for later analysis. Once converted to electrical form and recorded, it is available indefinitely. It can be easily compared or studied alone by means of X-Y or strip-chart recorders, oscilloscopes, wave analyzers, digitizing systems, etc.

Time compression or expansion techniques (record at one tape speed; play back at another) offer unique opportunities for data analysis. For example; slowly varying phenomena may be recorded at a low tape speed, then reproduced at tape speeds up to 128 times faster... now acceptable for oscilloscope viewing. Conversely, high frequency information can be recorded at high tape speeds, then reproduced at a slower tape speed with a corresponding downward frequency-translation; 2.0 MHz recorded at 120 ips is translated to 15.625 kHz ($2.0 \text{ MHz} \div 128$) when reproduced at 15/16 ips. At this lower speed, low frequency test equipment is readily used for analysis of a relatively high frequency signal.

Continuous monitoring is another important advantage of magnetic tape recording. Unexpected and/or unpredictable events are preserved; if no significant phenomenon occurs, the tape is simply erased and reused. Continuous monitoring records such irreplaceable data as powerline transients, seismic tremors, the effects of atomic blasts, etc.

Time relationships among several rapidly occurring events can be readily evaluated, each event being simultaneously recorded on one of up to 14 data channels. Later analysis finds this capability extremely important in establishing cause and effect relationships between recorded phenomena.

Recorded information is immediately available for reproduction; there is no delay for processing of any kind. On the other hand, tapes can be stored for long periods without degradation of the recorded material; thus, events separated widely in time can be compared easily.

HP magnetic tape recording systems

Hewlett-Packard offers a selection of quality 1-inch, 1/2-inch, and 1/4-inch magnetic tape recording systems for laboratory facilities or field data collection. All laboratory instruments are IRIG compatible and use 1-inch (14-track) or 1/2-inch (7-track) magnetic tape. There are no IRIG specifications for 1/4-inch (4-track) magnetic tape systems, although performance is comparable to the larger laboratory instruments.

Laboratory instrumentation magnetic tape recording systems consist of four basic parts: (1) the tape transport, (2) the magnetic head assemblies, (3) the record/reproduce electronics, and (4) the magnetic tape. In some instances, it is the tape that imposes the limitations of performance; care in selecting tape to match recording requirements is well justified.

The tape transport moves the tape past the head assemblies at a precise and constant speed. Hewlett-Packard transports do this using a rugged, reliable uncomplicated mechanism. By using a high degree of mechanical filtering, flutter caused by scraping or eccentricities is reduced to a minimum.

The magnetic tape is reeled in a manner that insures no loss of valuable data from tape stretching, tearing, or other accidents. *Fail-safe* brake design; with optimum braking torque on each reel assures fast, smooth starts and stops. Even during a power failure, there's no danger of tape spillage or stretching.

Any of *six tape speeds* are selected simply by depressing the appropriate pushbutton; no capstan or belt changes are required. *Snap-on reel* hub design allows easy mounting of tape reels; tape threading is quick and simple.

The *tape footage counter* has consistently enabled users to locate specific data on tape with accuracies of $\pm 0.05\%$, even after repeated high-speed end-to-end shuttlings of a reel of tape.

No maintenance is required other than the normal cleaning of the heads and tape guides to remove tape oxide dust. The rugged cast aluminum transport frame, precision finished on numerically-controlled machine tools, assures proper alignment and interchangeability of all parts in the tape drive system.

Magnetic head assemblies have both record and reproduce sections, one im-

pressing the input data onto the tape as variations in magnetization, the other converting these variations back into electrical signals.

Instrumentation recorders use magnetic head assemblies with four interleaved head stacks; two for recording, two for reproducing. The tape first passes the head stack where the odd-numbered data channels are recorded, then past the next stack for recording the even-numbered channels.

Likewise, the two following stacks reproduce the respective data tracks. It is this IRIG-compatible head-stack configuration that keeps interchannel crosstalk to a minimum. Spacing between individual heads in each stack is 70 mils for recording 7 data channels on 1/2-inch tape, or 14 on 1-inch tape.

Hewlett-Packard designed and manufactured magnetic heads are coupled to current-sensing preamplifiers; it is this combination that offers users of HP tape systems very high signal-to-noise ratio at frequencies up to 2.0 MHz.

All four head stacks are mounted on a single precision baseplate and prealigned for easy replacement in the field. Precision machining of the cast aluminum transport frame eliminates the need for adjustments. (On the wideband, 1.5 MHz or 2.0 MHz systems, azimuth adjustments of the reproduce heads assure optimum performance.)

Conversion from 1/2- to 1-inch or 1- to 1/2-inch tape width is straightforward and can be made any time after original purchase. Only the head assembly, tape guides, pinch roller, and reel hubs need be changed.

The record and reproduce electronics within a recording system apply input data to the record heads and recover the data from the reproduce heads. Direct and FM electronics are available for present-day applications.

Direct Record electronics present a nominally high impedance to the data source to minimize loading and shape the frequency response appropriately to assure a constant-flux recording characteristic over the required bandwidth.

Direct Reproduce electronics raise the microvolt-level signals from the reproduce heads to a usable output signal. Since these low-level signals are subject to noise pickup, the very high signal-to-noise ratio of HP direct reproduce elec-

tronics becomes an even more important factor in the reliable reproduction of low level input signals.

FM Record electronics present a high impedance to the data source and convert the input signal to a proportional frequency modulated carrier for recording onto the tape.

FM Reproduce electronics discriminate the frequency-modulated carrier recorded on the tape, thereby recovering the data.

Record Mainframes house up to seven record amplifiers. Each amplifier contains a meter, switchable between dc or average responding ac. A switch matrix provides a means of substituting a test signal from a front panel BNC connector to any of the record amplifiers without manually disconnecting normal data inputs from the rear of the mainframe.

Reproduce Mainframes house up to seven reproduce amplifiers. A meter, switchable between dc or average responding ac, monitors any of the seven switch-selected reproduce amplifier outputs. Monitoring is also accomplished through a front-panel BNC connector by paralleling any one of the switch-selected data outputs on the rear of the mainframe.

Portable 4-track, 1/4-inch instrumentation recording systems, like the laboratory systems, consist of four basic parts: (1) tape transport, (2) magnetic head assemblies, (3) record/reproduce electronics, and (4) magnetic tape.

The tape transport is mechanically simple, using a torque motor for each reel and a single capstan motor. The transport assembly also includes the record and reproduce heads, tape guides and tension arms, power supply, preamplifiers, meter system, and the operator controls.

All tape drive components are mounted on a solid casting. The tape guides and the record and reproduce heads mount directly on the capstan bearing support, assuring permanent alignment.

Plug-in solid-state circuit boards contain the necessary circuitry for FM Record/Reproduce, for direct record/reproduce, and for an accessory Voice Channel.

Input and output connectors (BNC) are located on the control panel. A connector on the rear panel also provides input/output connections, when rack-mounting the systems.

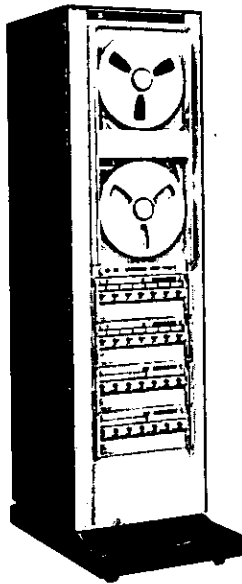
ANALOG TAPE RECORDERS



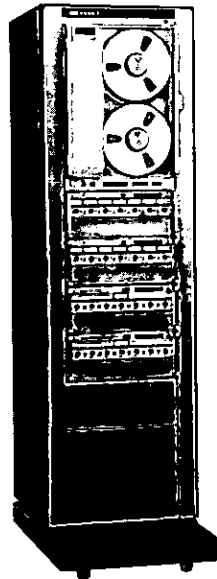
MAGNETIC TAPE RECORDERS

Instrumentation recording systems

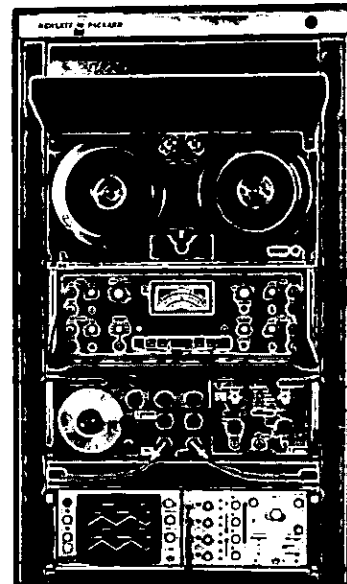
Series 3950, 3955, 3960



3950 SERIES
Wide-band recording
DC to 2.0 MHz



3955 SERIES
Intermediate band
DC to 300 kHz



3960 SERIES
Portable recorder
(Shown rack-mounted)

ANALOG INSTRUMENTATION RECORDER SYSTEM CAPABILITIES

Model	Tape width	Number of tracks	Max. reel size	Number of speeds	Std. speed range (ips)	Direct passband	Typical system price
3950A-Opt 10	1"	14	15"	6	3¼-120	2.0 MHz	\$21,200
3950B-Opt 10	½"	7	15"	6	3¼-120	2.0 MHz	\$14,615
3950A	1"	14	15"	6	3¼-120	1.5 MHz	\$18,580
3950B	½"	7	15"	6	3¼-120	1.5 MHz	\$12,790
3955A	1"	14	15"	6	1⅞-60	300 kHz	\$13,800
3955B	½"	7	15"	6	1⅞-60	300 kHz	\$ 9,700
3955C	1"	14	10½"	6	1⅞-60	300 kHz	\$13,300
3955D	½"	7	10½"	6	1⅞-60	300 kHz	\$ 9,200
3960A	¼"	4	7"	3	15/16-15	5 kHz*	\$ 4,285
3960B	¼"	4	7"	3	15/16-15	60 kHz	\$ 4,085
3960C	¼"	4	7"	3	1.5-15	60 kHz	\$ 4,085
3960D	¼"	4	7"	3	1.5-15	5 kHz*	\$ 4,285

NOTES:

1. Direct passband listed is for highest standard speed
 2. Typical system prices for 3950 and 3955 series are for 7- or 14-channel Direct record/reproduce systems
 3. Typical system prices for 3960A/D models are for a 4-channel FM system
 4. Typical system prices for 3960B/C models are for a 4-channel system with 2 Direct and 2 FM channels
 5. For 3950 and 3955 series, a low speed of 15/16 ips is optionally available
 6. For 3955A/B models, a high speed of 120 ips is optionally available
- *3960 models A and D do not have Direct electronics. Passband shown is for FM

INSTRUMENTATION RECORDERS

Intermediate and wide-band systems
3950 and 3955 Series



ANALOG TAPE RECORDERS

The HP 3955 and 3950 Series Magnetic Tape Recorders provide highly flexible, yet easy-to-operate systems to record and/or reproduce electrical signals. Both 7- and 14-channel capacity is available; plug-in electronics (Direct and FM) can be intermixed as desired. Maximum bandwidth of the 3955 at 60 ips is 300 kHz for Direct recording. Maximum bandwidth of the 3950 at 120 ips is 1.5 MHz for standard unit and 2.0 MHz for 3950-Option 10.

Each 3955/3950 System includes a high performance Tape transport and a number of interchangeable Record and Reproduce Amplifiers, offering an extremely wide latitude in determining the exact system configuration. Seven or fourteen track capability in either of two basic tape transports is available.

The smaller transport, which can handle tape reels up to 10½" in diameter, provides economy as well as performance. This transport is for applications requiring average recording times.

The larger transport accepts tape reels up to 15" in diameter to provide over 19 hours of recording time at a tape speed of 1⅞ ips.

The 7- and 14-track Record and Reproduce head assemblies conform to the generally accepted industry standards for magnetic heads and tape format, as specified in IRIG (Inter-Range Instrumentation Group). In addition, for best alignment, the head stacks are mounted on a single precision baseplate. Because they are prealigned, head assemblies are easily field replaceable.

Tape reels snap on and off specially designed hubs, and the open tape path allows quick, convenient tape threading.

All operating controls for the system are located on the transport chassis. Pushbuttons are utilized throughout to obtain the desired mode of operation. Rear connections are provided for remote control operation, accessories, and interconnecting cabling.

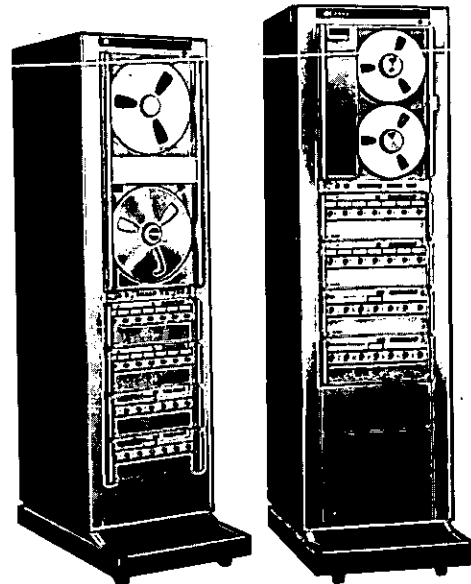
Direct electronics, with 300 kHz bandwidth, is provided for the 3955 series, and 1.5 MHz or 2.0 MHz (option 10) bandwidth for the 3950 series.

An equalizer is required for each speed at which data is reproduced in the Direct mode. Each equalizer is mounted on a convenient plug-in circuit card. The push-bar on the front of the card indicates the tape speed numerically, as well as by a colored stripe to match the color of the speed pushbutton on the Tape Transport. Direct reproduce amplifiers accommodate equalizers for any three tape speeds. The desired equalizer is selected by pushing on the equalizer push-bar. A mechanical "teeter-totter" automatically removes the previously operating equalizer from the circuit. The plug-in design of the equalizers allows reliable and rapid front-panel substitution of units for any speed, or of any entirely new set.

FM electronics have maximum bandwidths of dc to 20 kHz, dc to 40 kHz, dc to 80 kHz, and dc to 400 kHz at 120 ips for the 3950 series; and maximum bandwidths of dc to 10 kHz, dc to 20 kHz and dc to 40 kHz at 60 ips for the 3955C/D series. A tuning unit is required for each speed at which data is recorded and a filter unit is required for each speed at which data is reproduced. These are similar to the equalizers described above.

The transport cover door completely encloses the reels and tape drive path to protect these parts from dust and damage. The control buttons are left uncovered for ready access when changing operating modes.

IRIG-compatible wide-band and intermediate band instrumentation recorders



3950

3955

The transports are slide-mounted. When withdrawn, they can be tilted in either direction for complete front-of-system accessibility of all parts for maintenance purposes.

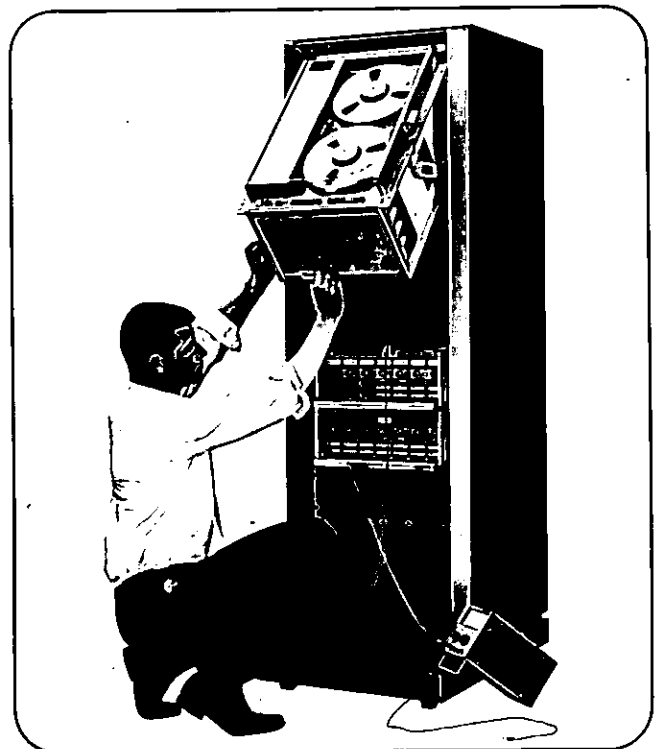


Figure 1. Complete serviceability from front-of-system.

TYPICAL 3950/3955 SERIES 14-TRACK SYSTEM

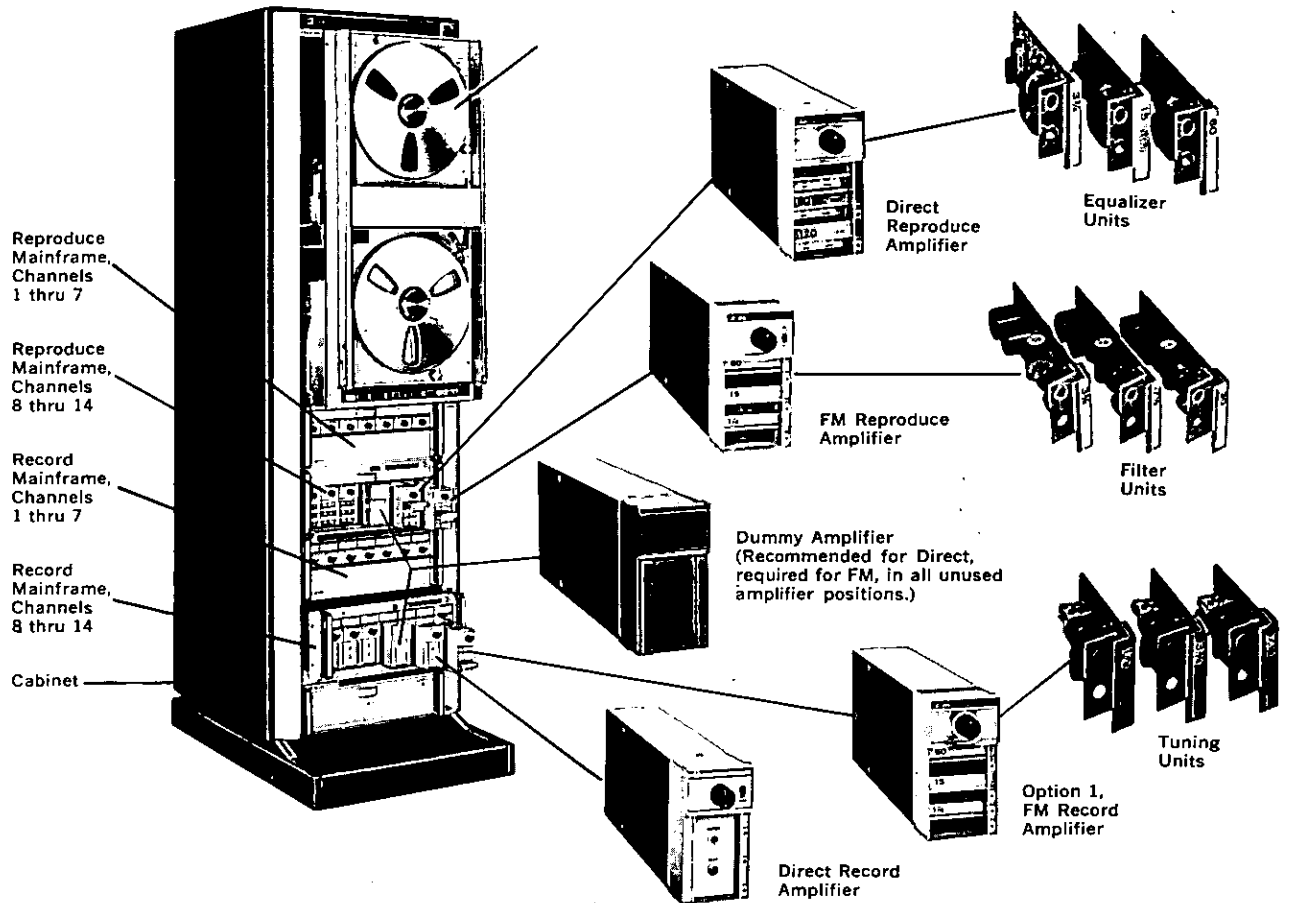


Figure 2. Modular system configuration.

The outstanding electrical and mechanical performance of the tape transports used in the 3955/3950 Series Tape Systems is inherent in their simple, straightforward design. The rugged cast aluminum transport frame is precision-finished on automated machine tools to insure proper alignment of all parts of the tape drive system. Close tolerances in the computer-con-

trolled machining process assure parts interchangeability without need for complex alignment, adjustments, or shims in the transport mechanism.

Record and Reproduce Electronics

The solid-state Record and Reproduce Amplifiers for the 3955 and 3950 Series are separately packaged, modular units, designed as front-panel plug-ins (see figure 2). Supply voltages, signal connections, and metering for all amplifiers are provided by the Record and Reproduce Mainframes. Two mainframes are used in 7-channel systems; four in 14-channel systems.

On the front of the Record Mainframe (see figure 3), 7 pushbuttons provide means of introducing test signals to the desired record amplifier. To apply a test signal, simply connect it to the front panel TEST INPUT jack and depress the appropriate pushbutton. This removes the normal data-signal and inserts the test-signal into the selected Record Amplifier.

In reproduce mode the recorded test signal is simultaneously reproduced with a delay equal to 3.5 inches divided by the tape speed (in/sec) and is available at the output of the appropriate Reproduce Amplifier. It can be monitored by depressing the channel pushbutton on the Reproduce Mainframe (see figure 3); this connects the reproduce monitor meter and front panel OUTPUT jack to the desired Reproduce Amplifier. Using this technique, it is easy to quickly check all channels for proper operation from the front panel.

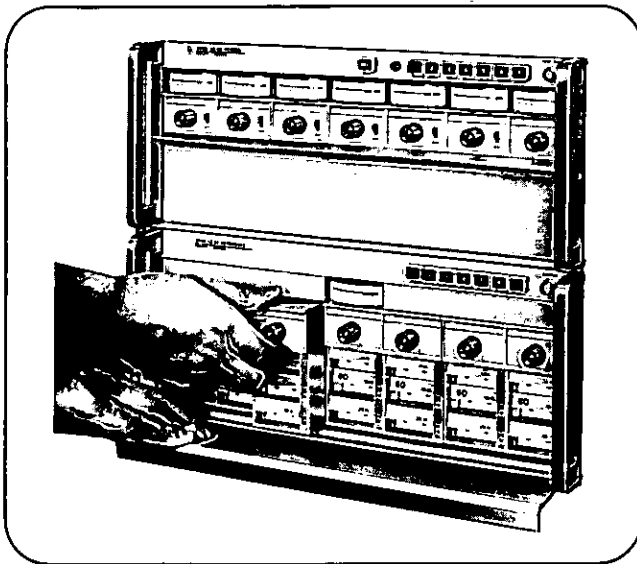


Figure 3. Record and reproduce mainframes.

INSTRUMENTATION RECORDERS

Wide-band (to 2.0 MHz) recording
3950 Series



ANALOG TAPE RECORDERS

SPECIFICATIONS — 3950 SERIES

TAPE TRANSPORT

Magnetic tape: 4600 feet of 1-mil tape on 10½" reel, 10,800 feet of 1-mil tape on 15" reel.

Tape speeds: 120, 60, 30, 15, 7½, 3¾, 1⅞, and 15/16 ips.
Note: only 6 provided on a system.

Tape speed accuracy: standard $\pm 0.25\%$ of nominal speed selected, using line power of 117 V ac $\pm 10\%$, 60 Hz $\pm 0.03\%$. With ac power supply (HP Model 3680A): $\pm 0.25\%$ of nominal speed selected, using line power of 117 V ac $\pm 10\%$, with 47 to 63 Hz line frequency variations.

Absolute time base accuracy: with tape speed servo (HP Models 3681A and 3680A); absolute time-base accuracy of reproduce data time base will be within $\pm 0.01\%$ of recorded data time base when using 200 kHz at 120 ips constant-amplitude reference (HP Model 3681A), and within $\pm 0.02\%$ of recorded data time base when using 60 Hz modulated with 17 kHz reference (HP Model 3681A-Option 001).

Start time: at nominal speed in approximately 6 seconds. Flutter will be within specifications in approximately 10 seconds at 60 ips and proportionally less time at lower tape speeds.

Stop time: less than 5 seconds from a manually operated "stop" command, end-of-tape, or power failure.

Rewind time: less than 4 minutes for 9200 feet of tape.

Braking: mechanical differential brakes which provide power *fail-safe* operation when engaged from any mode of operation or by power failure.

Flutter: measured in accordance with IRIG Document 106-69, paragraph 5.6.3.2.3, dated Feb 1969.

0.35%, p-p over 0.2 Hz to 10 kHz, at 120 ips

0.40%, p-p over 0.2 Hz to 10 kHz, at 60 ips

0.35%, p-p over 0.2 Hz to 2.5 kHz at 15 ips

0.85%, p-p over 0.2 Hz to 156 Hz at 15/16 ips

Jitter: random jitter in the reproduce signal between any two events will be typically within the following 3-sigma (99.7%) peak-to-peak limits:

120 ips 0.3 μ s @ 0.1 ms, and 1.5 μ s @ 1.0 ms

60 ips 0.4 μ s @ 0.1 ms, and 2.0 μ s @ 1.0 ms

30 ips 0.4 μ s @ 0.1 ms, and 3.0 μ s @ 1.0 ms

15 ips 0.6 μ s @ 0.1 ms, and 5.0 μ s @ 1.0 ms

Interchannel time displacement error (ITDE): dynamic ITDE will be less than ± 0.5 μ sec at 120 ips, between any two adjacent tracks on the same head stack.

Tape breakage sensor: *tape breakage* or *end-of-tape*, sensed by take-up reel tension-sensing arm, will stop tape drive.

Tape footage counter: five-digit counter with $\pm 0.05\%$ accuracy when operating in any tape movement mode.

Elapsed time meter: monitors tape motion time up to 9999.9 hours.

Remote control: connector (mating connector supplied) on rear of tape transport assembly permits remote control of all transport operating controls.

Tape-pack sensor: optional three modes of operation:

1. Stops tape motion when less than ⅛" tape remains on either supply or take-up reel.
2. Stops tape when less than ⅛" tape remains on supply reel, rewinds tape back on supply reel and stops when less than ⅛" tape remains on take-up reel.
3. Provides remote output signal when less than ⅛" tape remains on supply reel and continues to drive tape

until supply reel is emptied.

Heads: the head assembly complies with IRIG Document 106-69, dated Feb 1969, para 5.6.2.2.2 and 5.6.2.2.3, including mechanical geometry, track numbering, azimuth, and polarity. Seven data tracks on ½-inch tape; 14 data tracks on 1-inch tape.

DIRECT ELECTRONICS

Includes combined performance while *recording* on and *reproducing* from magnetic tape.

Signal-to-noise ratio: (at 120 ips) 30 dB, or better, over 400 Hz to 1.5 MHz bandwidth and 23 dB, or better, over 600 Hz to 2.0 MHz bandwidth. (System noise is limited by the magnetic tape used.) S/N referenced to a signal frequency at 0.1 x upper band edge; record level at 1% third harmonic distortion on tape using an 18 dB/octave filter 2 dB down at band edge.

Total harmonic distortion: less than 1.2%.

Input sensitivity: 0.15 to 10.0 V rms continuously adjustable.

Input impedance: 1000 ohms minimum, shunted by 70 pF, unbalanced to ground.

Output level: adj to 1.0 V rms into 75 ohms, or greater.

Output impedance: 75 ohms $\pm 20\%$, single ended.

Equalizers: one per speed (passband) per reproduce amplifier. Each reproduce amplifier can house any three push-bar selectable equalizers for the tape speed and passband.

FM ELECTRONICS

Signal-to-noise ratio: low band at 120 ips: 50 dB S/N over dc-20 kHz passband. Intermediate Band at 120 ips: 48 dB S/N over dc-40 kHz passband. Wideband Group I at 120 ips: 47 dB S/N over dc-80 kHz passband. Wideband Group II at 120 ips: 36 dB S/N over dc-400 kHz passband.

Total harmonic distortion: Low Band: less than 1.5%. Intermediate Band: less than 2.0%. Wideband Group I: less than 2.5%. Wideband Group II: less than 2.5%.

Linearity: within $\pm 0.5\%$ from best straight line.

Zero drift with temperature variation: less than $\pm 0.5\%$ of p-p output for any 10°F change between 32° and 131°F external ambient for 24 hours after 20-minute warmup.

Zero drift with line voltage variation: less than $\pm 0.5\%$ of peak-to-peak output for 117 V ac $\pm 10\%$ change.

Input level: ± 0.7 V peak (0.5 V rms) to ± 15.0 V peak (10 V rms), adjustable. Wideband Group II: ± 0.35 V peak (0.25 V rms) to ± 12.0 V peak (8.5 V rms), adjustable.

Input impedance: 20 k Ω shunted by 150 pF, unbalanced. Wideband Group II: 1 k Ω shunted by 200 pF, unbalanced.

Output level: adj to 2.8 V p-p (1 V rms) into 600 ohms. Wideband Group II: adj to 2.8 V p-p (1 V rms) into 75 ohms.

Output impedance: 600 ohms $\pm 20\%$, unbalanced to ground. Wideband Group II: 75 ohms $\pm 10\%$, unbalanced to ground.

SYSTEM POWER, WEIGHT, AND DIMENSIONS

Voltage and frequency: 115 V $\pm 10\%$, 60 Hz. (230 V 50 Hz optional.)

Power consumption: from 600 to 700 watts.

Weight: depends on number of channels and complementary equipment included. Typical 14-channel system 675 lb (304 kg); 7-channel system 575 lb (257 kg).

Size: refer to dimensions of 3955 series (page 148).

Note: for complete specifications, request current technical data sheet.

ANALOG TAPE RECORDERS *continued*

Intermediate band (to 300 kHz) recording 3955 Series

SPECIFICATIONS — 3955 SERIES

TAPE TRANSPORT

Magnetic tape: 3955A/B: 10,800 feet of 1-mil tape on 15" reel. 3955C/D: 4600 feet of 1-mil tape on 10½" reel.

Tape speeds: 3955A/B: 120, 60, 30, 15, 7½, 3¾, 1⅞, and 15/16 ips. 3955C/D: 60, 30, 15, 7½, 3¾, 1⅞, and 15/16 ips. Note: only 6 provided on a system.

Tape speed accuracy: standard $\pm 0.25\%$ of nominal speed selected, using line power of 117 V ac $\pm 10\%$, 60 Hz $\pm 0.03\%$.

With ac power supply (HP Model 3680): $\pm 0.25\%$ of nominal speed selected, using line power of 117 V ac $\pm 10\%$, with 47 to 63 Hz line frequency variations.

Absolute time base accuracy: with tape servo (HP Models 3681A and 3680A), absolute time-base accuracy of reproduced data time base will be within $\pm 0.01\%$ of recorded data time base when using 100 kHz at 60 ips constant-amplitude reference (HP Model 3681A) and within $\pm 0.02\%$ of recorded data time base when using 60 Hz modulated with 17 kHz reference (HP Model 3681A-Option 001).

Start time: at nominal speed in approximately 6 seconds. Flutter will be within specifications in approximately 10 seconds at 60 ips and proportionally less time at lower tape speeds.

Stop time: less than 5 seconds from a manually operated "stop" command, end-of-tape, or power failure.

Rewind time: less than 4.5 min for 10,800 ft of tape (3955A/B). Less than 2.5 min for 4600 ft of tape (3955C/D).

Braking: mechanical differential brakes which provide power *fail-safe* operation when engaged from any mode of operation or by power failure.

Flutter: measured in accordance with IRIG Document 106-69, paragraph 5.6.3.2.3, dated Feb 1969.

0.35%, p-p over 0.2 Hz to 10 kHz at 120 ips

0.30%, p-p over 0.2 Hz to 10 kHz at 60 ips

0.35%, p-p over 0.2 Hz to 2.5 kHz at 15 ips

0.85%, p-p over 0.2 Hz to 156 Hz at 15/16 ips

Jitter: random jitter in the reproduce signal between any two events will be typically within the following 3-sigma 99.7%) peak-to-peak limits:

60 ips 0.4 μ s @ 0.1 ms, and 2.0 μ s @ 1.0 ms

30 ips 0.4 μ s @ 0.1 ms, and 3.0 μ s @ 1.0 ms

15 ips 0.6 μ s @ 0.1 ms, and 5.0 μ s @ 1.0 ms

Interchannel time displacement error (ITDE): dynamic ITDE will be less than ± 1 μ sec at 60 ips, between any two adjacent tracks on the same head stack.

Tape breakage sensor: *tape breakage* or *end-of-tape*, sensed by take-up reel tension-sensing arm, will stop tape drive.

Tape footage counter: five-digit counter with $\pm 0.05\%$ accuracy when operating in any tape movement mode.

Elapsed time meter: reads tape motion time in tenths of hours up to 9999.9 hours. (3955A/B only)

Remote control: connector (mating connector supplied) on rear of tape transport assembly permits remote control of all transport operating controls.

Tape-pack sensor: three modes of operation provided with plug-in printed-circuit cards:

1. Stops tape motion when less than ⅛" tape remains on either supply or take-up reel.
2. Stops tape when less than ⅛" tape remains on supply

reel, rewinds tape back on supply reel and stops when less than ⅛" tape remains on take-up reel.

3. Provides remote output signal when less than ⅛" tape remains on supply reel and continues to drive tape until supply reel is emptied.

Heads: the head assembly complies with IRIG Document 106-69, dated Feb 1969, para 5.6.2.2.2 and 5.6.2.2.3, including mechanical geometry, track numbering, azimuth, polarity. Seven data tracks on ½-inch tapes; 14 data tracks on 1-inch tape; plus 1 edge track for voice annotation.

DIRECT ELECTRONICS

Includes combined performance while *recording* on and *reproducing* from magnetic tape.

Signal-to-noise ratio: (at 60 ips) 40 dB, or better, over 300 Hz to 300 kHz bandwidth. (System noise is limited by the magnetic tape used.) S/N referenced to a 1 kHz sine wave with a maximum of 1% third harmonic distortion on tape, using an 18 dB/octave passband filter set at 3 dB down at passband limits.

Total harmonic distortion: less than 1.2%.

Input sensitivity: 0.15 to 10.0 V rms, continuously adj.

Input impedance: 20 k Ω minimum, shunted by 150 pF, unbalanced to ground.

Output level: adj to 1.0 V rms into 1 k Ω or greater.

Output impedance: 50 ohms $\pm 20\%$, single ended.

Equalizers: one per speed (passband) per reproduce amplifier. Each reproduce amplifier can house any three push-bar selectable equalizers for the tape speed and passband.

FM ELECTRONICS

Signal-to-noise ratio: Low Band at 60 ips: 50 dB S/N over dc-10 kHz passband. Intermediate Band at 60 ips: 48 dB S/N over dc-20 kHz. Wideband Group I at 60 ips: 47 dB S/N over dc-40 kHz.

Total harmonic distortion: Low Band: less than 1.5%. Intermediate Band: less than 2.0%. Wideband Group I: less than 2.5%.

Linearity: within $\pm 0.5\%$ from best straight line.

Zero drift with temperature variation: less than $\pm 0.5\%$ of p-p output for any 10°F change between 32° and 131°F external ambient for 24 hours after 20-minute warmup.

Zero drift with line voltage variation: less than $\pm 0.25\%$ of peak-to-peak output for 117 V ac $\pm 10\%$ change.

Input level: ± 0.7 V peak (0.5 V rms) to 15.0 V peak (10 V rms), adjustable.

Input impedance: 20 k Ω shunted by 150 pF, unbal to ground.

Output level: 2.8 V peak-to-peak (1 V rms) into 600 ohms.

Output impedance: 600 ohms $\pm 20\%$, unbalanced to ground.

SYSTEM POWER, WEIGHT, AND DIMENSIONS

Voltage and frequency: 115 V $\pm 10\%$, 60 Hz. (230 V, 50 Hz optional.)

Power consumption: from 350 to 500 watts.

Weight: depends on number of channels and complementary equipment included; the following are typical:

675 lbs (304 kg) net, for in-cabinet 14-channel system.

575 lbs (275 kg) net, for in-cabinet 7-channel system.

Size: height 82⅞" (2083 mm) for cabinet with 73½" (1854 mm) of vertical panel space, including casters; (stationary base optional).

Width: 23⅞" (608 mm).

Depth: 35-11/16" (906 mm) including anti-tilt base.

Note: for complete specifications, request current technical data sheet.

PORTABLE TAPE RECORDER

Laboratory performance and accuracy
3960 Series



ANALOG TAPE RECORDERS

Laboratory performance and accuracy in a portable, ¼-inch tape, instrumentation recorder are provided by the Hewlett-Packard Model 3960 Instrumentation Tape Recorder. The 3960 records and reproduces, at three electrically switched speeds, up to four channels simultaneously. Any of the four channels can be operated in either an FM or a Direct record/reproduce mode. And five standard (7 available) tape speeds and five FM/Direct channel combinations are available to meet the varying requirements of varied applications.

PORTABILITY

The advantages of portability and ruggedness allow you to take the 3960 to otherwise inaccessible or unrepeatable signal sources. Subsequently, tapes can be played back in the laboratory; if necessary, can be digitized by analog-to-digital converters; or can be repeatedly and variously analyzed by a diversity of sophisticated laboratory equipment.

Portability does not mean compromise. The rugged 3960 meets stringent environmental specifications—and it is easy to maintain because it is mechanically uncomplicated. Only two solenoids are used—one for the pinchroller and one to release the brakes. Speeds are electrically changed, thereby eliminating the need for any capstan, belt, or pulley changes. A separate motor is used for each reel and for the capstan. Controls are interlocked to avoid any possibility of operator error and subsequent damage to tape or machine.

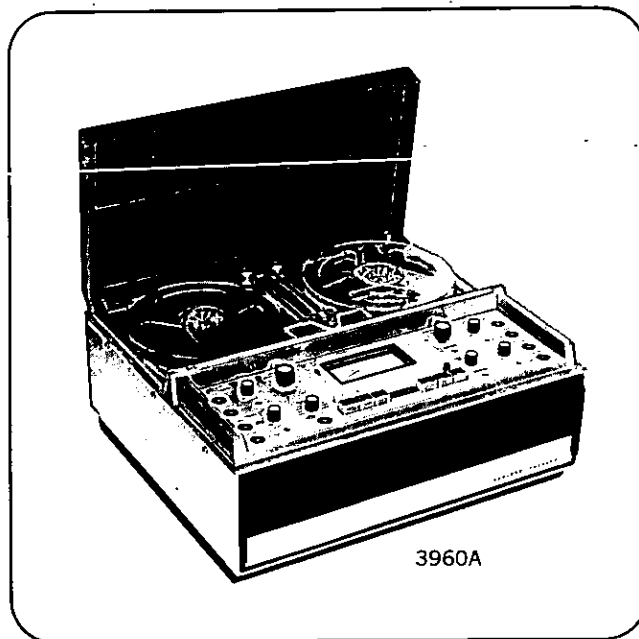
VERSATILITY

The 3960 can be equipped for either FM or Direct recording on any of its four channels. It can be set up as a 4-channel FM recorder, a 4-channel Direct recorder, or any one of three different 4-channel combinations of FM and Direct. Thus, it can be tailored to *your* special requirements. And to change the combination, you merely pull out certain solid-state circuit boards and insert certain others in their stead. These circuit boards are readily available from Hewlett-Packard and you can quickly and easily change them in the field.

Tape speed requirements are, of course, dependent on your applications. As you can see in the chart on page 150, there are 10 *basic* models of the 3960; four of these are *standard* models. In addition, there are special speed options available (at additional cost). So tape speeds also can be tailored to your special requirements. For example, the three speeds can be 15/16 ips, for long-term FM recording of slowly changing phenomena; 3¼ ips, which is well suited in the Direct recording mode for acoustic evaluation and other audio-range applications; and 15 ips, which is useful for vibration studies and other applications requiring Direct recording response up to 60 kHz or FM up to 5 kHz. Or—for those three speeds there might be substituted the combination of 1.5, 3, and 15 ips. The speed combinations are available either in octave or decade progressions.

The variety of tape speeds makes the 3960 useful in situations requiring time-base compression or expansion of signals in playback, as in slowing down high-frequency signals to permit recording on a strip-chart recorder, or speeding up slowly changing phenomena to permit faster evaluation. Although *wave-length* changes as a result of speed changes, there is no change in signal *waveform*.

The versatility of the 3960 does not end here. You can change not only the *methods* and the *speeds* of recording and



playback, but also the *direction* of recording and playback. Now, with the capability for bidirectional record and playback, with the interchangeability of FM and/or Direct electronics, with an accessory Voice Channel to add comments, and with a wide range of speeds available, practically any requirement you have can be met with the versatility of the 3960.

PERFORMANCE

The most outstanding characteristic of the 3960 is its low-speed performance. This is especially important to medical researchers and others who wish to record slowly changing variables over long periods of time.

When operating in the FM recording mode at a tape speed of 15/16 ips, the 3960's signal-to-noise ratio is better than 46 dB, several dB better than previous recorders; and this exceptional performance is achieved *without* the use of electronic flutter compensation. At higher speeds, the 3960 has a signal-to-noise ratio of better than 48 dB, equal to or better than many expensive laboratory instrumentation recorders.

In the Direct recording mode, the 3960's performance of 38 dB unfiltered signal-to-noise ratio *at all speeds* is presently unmatched. This great dynamic range makes it possible to accurately record signals that would be buried in noise on other recorders, especially at 15/16 ips.

STABILITY

A second outstanding technical characteristic is represented by the 3960's phaselock servo capstan drive, controlled by a crystal oscillator. The tape speed is held constant by monitoring the capstan speed with an optical tachometer on the capstan shaft, which generates an ac signal with a frequency proportional to capstan speed. Any deviation in phase of this signal, when compared to a precision ac reference signal derived from a crystal-controlled oscillator, is used as an error signal to correct the amplitude of the dc current driving the capstan motor. Besides assuring tape-speed accuracy, the drive

ANALOG TAPE RECORDERS *continued***Ruggedness and portability****3960 Series**

simplifies tape-speed changes; a change in speed being readily effected simply by selecting a different ratio for the crystal frequency division of the reference.

Exceptional low flutter is assured in the 3960 by mounting the record and reproduce heads immediately adjacent to the capstan. Because of the short length of tape between head and capstan, tape stretch caused by disturbances in reel take-up and pay-out is minimal.

ACCURACY

To insure accurate recording levels, the 3960 uses a *peak-reading* meter to monitor input signals. In the Reproduce mode, the meter indicates the output voltage. The meter is driven by peak-detecting circuits in the recorder that respond to and retain the *true peak* value of the input signal. With the peak-reading monitor meter constantly on the alert, there is little danger of inadvertently over-driving the tape with signals that have high crest factors (high peak-to-rms ratio values). See *specifications* below for more details about the meter.

CALIBRATION

Built in facilities make it possible to calibrate the FM electronics of the 3960 without using external equipment. The FM demodulators can be aligned with carrier signals derived from the recorder's internal quartz crystal oscillator. In the Stop, Fast Forward, and Rewind modes, the FM carriers are automatically transferred from the record into the reproduce electronics, thereby making it possible to perform a complete calibration without running tape. The demodulators then may

be aligned with a jumper connecting the FM center carrier (crystal-controlled) to the limiter input (this overrides the automatic transfer from FM record).

Precision dc voltages (± 10 , ± 5 , ± 2.5 , ± 1.414) are available within the recorder to permit adjustment of modulator (FM record amplifier) sensitivity.

SERVICEABILITY

Very few mechanical adjustments are required in the 3960. Tape guides and the record and reproduce heads mount directly on the capstan bearing support, assuring permanent alignment. All tape drive components are mounted on a solid casting. The 16 solid-state circuit boards used in the 3960 are so arranged that all calibration adjustments for the circuits they contain are available by opening an access door in the front side of the recorder. The only adjustments that require opening the case are those that very infrequently require attention.

APPLICATION

Portability, versatility, laboratory performance, stability, accuracy, and serviceability—the 3960 can be of great advantage for a broad variety of users—the oceanographer in studying sounds made by undersea fish and mammals; the physician in making diagnoses and evaluating treatments; the biomedical researcher in recording and analyzing physical-process data; the acoustical engineer in studying and controlling urban, aircraft, and industrial noise environments; the automotive engineer in conducting vibration and stress analysis; these are but a few of literally hundreds of applications for the 3960.

Standard Speeds (ips)	Channel Configuration				
	4 FM	2 FM 2 Dir	3 FM 1 Dir	1 FM 3 Dir	4 Dir
15, 3 $\frac{3}{4}$, 15/16	3960A	3960B	3960E	3960F	3960G
15, 3, 1.5	3960D	3960C	3960H	3960J	3960K

Note: Bias oscillator included in systems equipped with Direct electronics.

SPECIFICATIONS**TAPE TRANSPORT**

Tape drive: modified zero loop.

Capstan drive: dc motor with phaselock servo. Drive accuracy is $\pm 0.01\%$ over environmental temperature range.

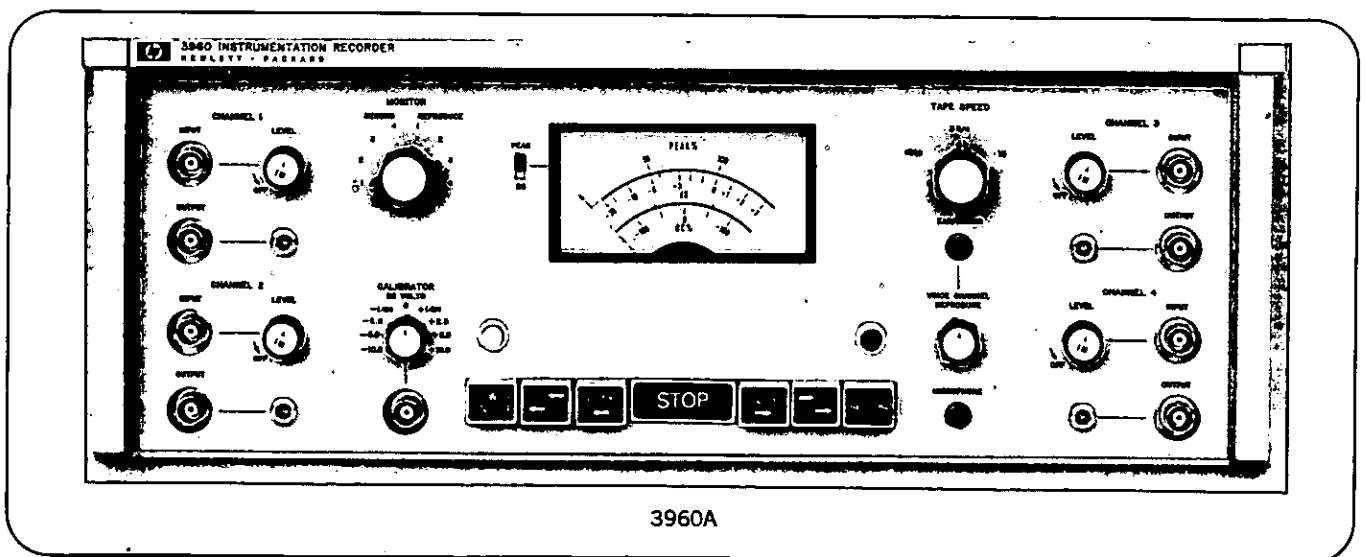
Reel size: standard 7-inch (or 5-inch) plastic reels (5/16-inch hole size); totally enclosed by reel cover.

Tape width: $\frac{1}{4}$ inch. **Number of channels:** four.

Heads: 4-track record head and 4-track reproduce head.

Tape speeds: three; electrically selected. Bidirectional. Five standard (7 available) tape speeds. **Tape speed accuracy:** $\pm 0.2\%$.

Operating modes: Forward and Reverse Record, Forward and Reverse Play, Fast Forward, Fast Rewind, Stop. Push-



3960A

button selected. Interlocked pushbuttons prevent operating errors and protect recorded data.

Start and stop times (typical):

Tape speed: (ips)	15	3¾	15/16
Start: (seconds)	2.0	0.9	0.25
Stop: (seconds)	0.25	0.25	0.25

Rewind time (typical): 2300 feet in 130 seconds.

Braking: mechanical differential brakes, solenoid actuated. Brakes apply if power fails.

End-of-tape sensing: tape drive is stopped by tension arms retracting at end of tape.

Reel revolution counter: 4-digit revolution counter with pushbutton reset. Enables locating specific points on tape.

Flutter: measured in accordance with IRIG Document 106-69.

Tape Speed (ips)	Passband (Hz)	Flutter (%p-p)
15	0.2-2500	0.35
7½	0.2-1250	0.35
3¾	0.2-625	0.40
3	0.2-500	0.45
1-¾	0.2-312	0.50
1.5	0.2-250	0.55
15/16	0.2-156	0.70

RECORD CONTROL

Combination record disable switch/level control for each channel. In OFF position no signal is fed to record head. Any combination of tracks can be recorded, including one track at a time.

SIGNAL MONITORING

Peak-reading meter: the meter has two modes: PEAK and DC, selected with slide switch on control panel.

Peak mode: in PEAK mode, the meter reads peak of absolute value, including any dc components. *In record*, meter reads in percentage of full-scale record level. *In reproduce*, meter reads output voltage. On meter, 100% (0 dB) corresponds to 5 volts peak-to-peak. Red calibration marks are provided for 1 volt rms.

DC mode: in dc mode, reads dc component of signal. Also used to calibrate FM system because of dc response.

Meter accuracy: better than 1 dB for signals with duty cycle 1% or larger.

FM RECORD/REPRODUCE

FM system conforms with IRIG Standard Intermediate Band.

Tape Speed (ips)	Carrier Center Frequency ⁽¹⁾ (kHz)	Passband ⁽²⁾ (Hz)	S/N Ratio ⁽³⁾ (rms/rms) (dB)	Distortion (%)
15	27	0 to 5000	48	1.5
7-1/2	13.5	0 to 2500	48	1.5
3-3/4	6.75	0 to 1250	48	1.5
3	5.40	0 to 1000	48	1.5
1-7/8	3.38	0 to 625	48	1.5
1.5	2.70	0 to 500	47	2.0
15/16	1.69	0 to 312	46	2.0

(1) Signal measured with carrier deviation = 40% at 10% of upper band-edge modulation frequency.

(2) Frequency response over passband is = 1.0 dB referenced to 10% of upper band-edge frequency.

(3) Without Flutter Compensation. Output filters of reproduce amplifiers selected for constant amplitude response. May also be selected for linear phase (transient) response.

Flutter compensation: standard on all models. Permanently wired with channel 2 as the reference. Can be switched on and off with slide switch behind front access door.

Linearity: ±1% of p-p output of best line through zero.
DC drift: ±0.1% of p-p output/degree C (record-reproduce).

Input level: 1 V p-p to 30 V p-p (continuously variable).

Input impedance: 50 kΩ, or greater, shunted by 200 pF maximum, single-ended.

Output level: 0 to 5 V p-p (continuously variable).

Output impedance: 140 ohms maximum, single-ended.

Crystal reference: FM center frequencies for reproduce calibration. Crystal accuracy is 100 parts per million (0.01%) over specified environmental conditions.

DC calibration voltages: rotary switch selects ±10, ±5, ±2.5, or ±1.414 V dc. Accuracy ±2%.

"E-to-E" mode: electronics-to-electronics mode enables input signal to be automatically transferred (bypassing heads) to output during Fast Forward, Rewind, or Stop.

DIRECT RECORD/REPRODUCE

Tape Speed (ips)	Passband (±3 dB)	Signal/Noise Ratio* (dB)
15	70 Hz-60 kHz	38
7-1/2	50 Hz-30 kHz	38
3-3/4	50 Hz-15 kHz	38
3	50 Hz-12 kHz	38
1-7/8	50 Hz-7.5 kHz	38
1.5	50 Hz-6 kHz	38
15/16	50 Hz-3.75 kHz	38

*Referenced to a 500 Hz sine wave with a maximum of 1% third harmonic distortion on tape. (Measured with 3M Type 951 instrumentation tape.) Using an 18 dB/octave bandpass filter, a 3 dB improvement can be obtained.

Input level: 0.1 volt rms to 10 volts rms.

Input impedance: 50 kΩ, or greater, shunted by 200 pF maximum, single-ended.

Output level: 0 to 5 volts peak-to-peak (adjustable).

Output impedance: 140 ohms maximum, single-ended.

GENERAL SPECIFICATIONS

Configuration: supplied as a portable. Rack mounting kit available for standard 19-inch equipment racks.

Power requirements: 115 or 230 V ±10%, 48 to 1000 Hz. Consumption 80 watts. Also operates on 12-volt battery, using accessory DC/AC Inverter (Model 13061A).

Size: 16¾" wide, 15" high, 7¾" deep (425 x 381 x 187 mm).

Weight: 50 pounds (22,7 kg).

Environment: temperature range is 0° to +55°C, operating; -40° to +75°C, nonoperating.

Altitude: 15,000 ft, operating; 25,000 ft, nonoperating.

Humidity: 10% to 95% (+25° to +40°C), noncondensing.

Shock: 30 g maximum (11 ms), nonoperating.

ACCESSORIES FURNISHED

One 7" reel of 2300', 1-mil tape and one empty 7" reel.
 One 13070A Accessory Kit containing: 2 Jumper Cables, 4 Locking Knobs, 1 Extender Board, 1 Can Cleaner, 100 Applicators, 1 Male System Connector, and 1 Vinyl Cover.

ACCESSORIES AVAILABLE*

- 13060A Remote Control: \$40. 13061A DC/AC Inverter: \$190
- 13063A Voice Channel: \$190. 13065A Rack Mount Kit: \$21
- 13066A Transit Case: \$375. 9160-0023 Demagnetizer: \$12.50

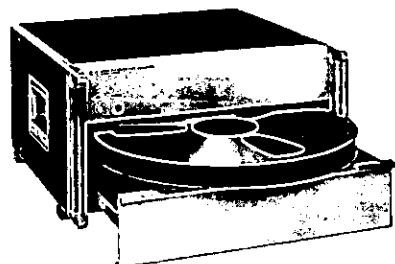
PRICE LIST FOR STANDARD MODELS**

- 3960A:** 4 FM channels; 15, 3¾, 15/16 ips \$4285
- 3960B:** 2 FM/2 Direct channels; 15, 3¾, 15/16 ips \$4170
- 3960C:** 2 FM/2 Direct channels; 15, 3, 1.5 ips \$4170
- 3960D:** 4 FM channels; 15, 3, 1.5 ips \$4285

*Refer to Data Sheet for details on 3960 accessories.

**Special speed combinations available at additional cost.

Complementary instrumentation

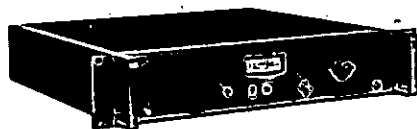


Automatic
Tape Degausser
Model 3603A

Voice Channel
Model 3604A

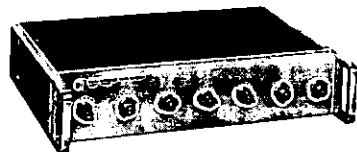
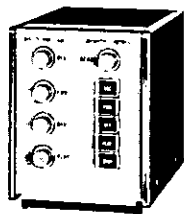


AC Power Supply
Model 3680A



Tape Servo
Model 3681A

Remote Control Unit
Model 3907-11A



Reproduce
Track Selector
Model 11539A

Automatic Tape Degausser, HP Model 3603A \$900

Degausses magnetic tape to 90 dB below saturated recorded level. Automatic operation; complete erasure every time. Designed for continuous operation. Accepts 3" to 15" diameter reels; 1/4" to 1"-wide tape. Use in rack or on table top. Digital Reel Hub Adapter Model 11572 \$17.00

Voice Channel, HP Model 3604A \$550

Records voice commentaries along with data. Provides for edge-track or multiplex recording. Multiplex operation combines voice with data for recording on any direct-record channel. Includes loudspeaker and retractable microphone.

FM Frequency Source (not shown), HP Model 3605A \$675

Provides precise carrier-frequency signals for alignment of Model 3538A FM Reproduce Amplifiers.

AC Power Supply, HP Model 3680A \$1,100

Used to obtain crystal-controlled drive speed accuracy when system is operated from variable-frequency (47-63 Hz) power source. Eliminates minor tape speed changes resulting from abnormal frequency variations in the ac power line. Amplifier is driven from either an internal crystal or an external frequency source. Ideal for laboratory or field use, supplying up to 100 watts, 115 volts, at any frequency from 30 Hz to 1.5 kHz.

Tape Servo, HP Model 3681A \$1,380

Generates IRIG-specified speed-control signal for recording on tape with data. When the tape is replayed, the reproduced speed-control signal drives the 3680A AC Power Supply (above); it, in turn, controls the tape speed such that data signals are reproduced at exactly the same frequency as recorded.

Option 01 Amplitude Modulation 17 kHz \$1,210

Option 02 Constant Wavelength and AM, 17 kHz \$1,580

Remote Control Unit

Includes all functions for tape recorder operations from another location. With 25' cable. Rack mounting optional.

HP Model 3907-11A (for 10 1/2" reel systems) \$385

HP Model 3907-11A, Option 02 (for 15" reel systems) \$435

Reproduce Track Selector

Permits system economy by using less than a full complement of Reproduce Amplifiers. Each front-panel switch connects any of the 14 recorded data-tracks to the input of a single Reproduce Amplifier. With seven switches available, only one Reproduce Mainframe, and from 1 to 7 Reproduce Amplifiers may be used with a 14 channel system.

HP Model 11539A, Option 01 (for 10 1/2" reel systems) \$340

HP Model 11539A, Option 02 (for 15" reel systems) \$340

Pack Sensor (not shown) HP Model 11553A \$350

Senses the remaining tape-pack on both supply and take-up reels. Permits system to be stopped before tape runs off end of reel; used for recycling tape, or turning on a second tape recording system before the first one runs out of tape. For 15" reel systems, only.

TRANSDUCERS

Sensors of linear motion, force, size and pressure
Models 585, 311A, DCDT, LV



PHYSICAL PHENOMENA TRANSDUCERS

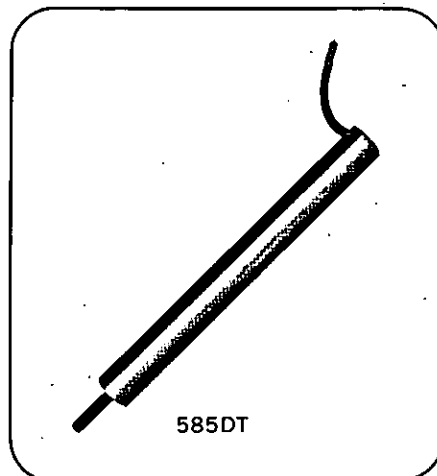
Linear Displacement (AC excitation), Model 585DT, 595DT

Linearsyn® (585DT, 595DT) Transducers produce an electrical output proportional to a relative displacement of the transducer's core in the coil assembly. A wide selection of transducers is available for Hewlett-Packard or equivalent carrier amplifiers (linear displacements to 0.000001 in. may be resolved). Non-linearity error will not exceed 1.0% of total

stroke; temperature range, -46°C to $+96^{\circ}\text{C}$. Linearsyns are shielded, immersible in non-corrosive fluids, resistant to shock and vibration, and void of mechanical hysteresis and friction. Standard carrier excitation frequency is 2.4 kHz, with a range of excitation frequencies from 400 Hz to 10 kHz (585DT), or 20 kHz (595DT).

Model	585DT				595DT		
	-050	-250	-500	-1000	-005	-025	-100
Stroke range (in.)	0.05	0.25	0.5	1	0.005	0.025	0.1
Sensitivity* (V/in./V _{ex})	4.8	1.7	1.1	0.79	2.2	3.4	2.7
Impedance* (ohms) primary: secondary:	163 2140	151 176	332 370	157 247	93 154	303 365	330 365
V _{ex} * (max)	21	17	25	30	5	11.5	13
Dimensions diameter: (in.) (mm)	0.75 19	0.75 19	0.75 19	0.75 19	0.375 10	0.375 10	0.375 10
length: (in.) (mm)	1.63 41	3.31 84	4.88 124	6.88 155	0.90 23	1.09 28	1.09 28
Weight (gm) armature assembly net shipping	5 47 227	7 104 227	12 132 227	18 178 227	0.10 7.1 84	0.25 7.9 84	0.29 7.9 84
Price	\$55	\$60	\$65	\$70	\$40	\$45	\$45

*At standard carrier frequency.



Transducer Amplifier Indicator, Model 311A

The 311A Transducer Amplifier-Indicator is a convenient, portable unit for quickly measuring any physical variable to which a transducer requiring ac excitation may be attached. The 311A provides 2.4 kHz excitation to the transducer, and provides two indications of the variable under measurement: (1) a 4-inch panel meter, to follow slowly changing variables, and (2) an electrical output for an oscilloscope, recorder, or other indicator for frequencies up to 200 Hz. Internal calibration and five-position zero suppression are standard features.

Specifications

Sensitivity: 250 μV rms for full scale meter deflection.

Input attenuator: X 1, 2, 5, 10, 20, 50, 100, and 200; accuracy $\pm 2\%$.

Type of input: approx 10 k Ω .

Transducer impedance: transducer load impedance connected to excitation terminals 100 Ω min; transducer impedance connected to signal input terminals ≤ 5 k Ω max.

Excitation: 5 V rms nominal; 2400 Hz $\pm 2\%$.

Balance: two ten-turn controls correct resistive (R) and capacitive (C) unbalance of transducer and cabling.

Zero suppression: positive and negative suppression steps, two per polarity. Each step equivalent to approx $\frac{1}{2}$ R-BAL control range.

Calibration: 40 $\mu\text{V}/\text{V}$ excitation $\pm 1\%$.

Frequency response: meter: 0 to 2-3 Hz (depends on meter response); output: 0 to 200 Hz ± 3 dB at 6 V pp.

Output: single ended, ± 3 V across load 1 k Ω or higher.

Output linearity: 0.25 div max.

Output noise: 50 mV pp plus 1% of dc output pp ripple.

Zero drift: temperature (20° to 50°C): 30 mV/ 10°C ; line voltage (103 to 127 V): 10 mV.

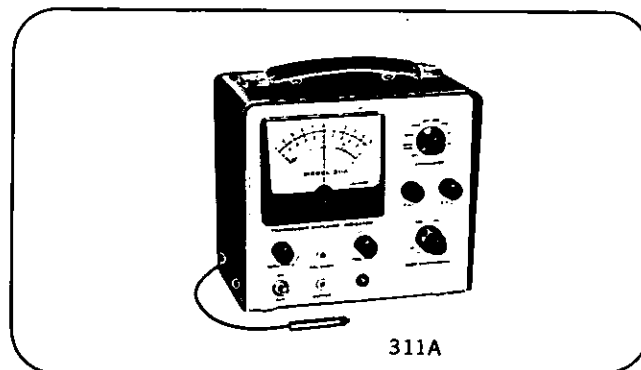
Power: 115 V/230 V, 50-400 Hz, 7 VA.

Dimensions: 8 $\frac{1}{4}$ " high x 9 $\frac{1}{4}$ " wide x 6" deep (206 mm x 232 mm x 152 mm).

Weight: 8 lb (3.6 kg) net, 15 lb (6.8 kg) gross.

Price: Model 311A

\$ 475



PHYSICAL PHENOMENA TRANSDUCERS



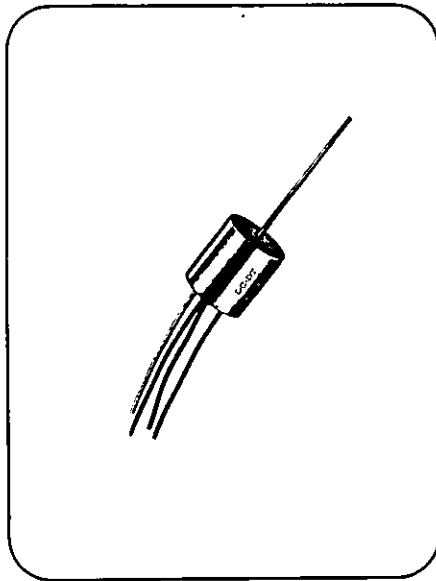
TRANSDUCERS

Sensors of linear motion, force, velocity

Linear Displacement (DC excitation), Model 7DCDT/24DCDT

The 7DCDT and the 24DCDT linear displacement transducers are extremely convenient to use for measuring, monitoring or controlling mechanical displacement. No external carrier system is required nor are phase shift and balancing adjustments necessary. Each DCDT has a built-in carrier oscillator and demodulator which produces a high-level dc output voltage proportional to the linear displacement of the

core. Both series have extremely high resolution, zero hysteresis and non-linearity less than $\pm 0.5\%$ of the total stroke. The 24DCDT's have approximately three times the sensitivity of the 7DCDT's and an operating temperature to 120°C (7DCDT, 60°C). Excitation of 7DCDT models is 5 to 7 volts dc; for 24DCDT models, 20 to 28 volts dc.

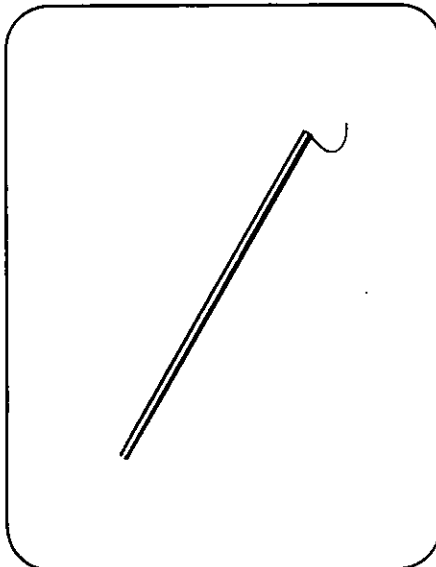


Model	Model 7 DCDT/24 DCDT						
	—050	—100	—250	—500	—1000	—3000	
Stroke (in.)	± 0.05	± 0.1	± 0.25	± 0.5	± 1	± 3	
Output, (volts f.s.)	7 DCDT 24 DCDT	1.5 5.0	2.8 9.0	1.5 7.0	3.3 12.5	4.8 18.0	5.0 13.0
Output impedance	7 DCDT 24 DCDT	2.2 k 2.5 k	3.0 k 3.5 k	5.0 k 5.2 k	5.3 k 5.5 k	5.5 k 5.6 k	5.0 k 5.6 k
Dimensions, diameter	7 DCDT } 24 DCDT }	0.75 in. (19.2 mm)					
length	7 DCDT (in.) (mm)	0.81 20.6	1.06 27.0	3.00 76.2	3.50 89.2	4.50 115	10.50 267
	24 DCDT (in.) (mm)	0.87 22.2	1.12 28.5	3.21 81.8	3.71 94.2	4.71 120	10.52 286
Weight (gm)	Armature Assembly net shipping	1.6 23 84	2.1 28 84	3.4 68 168	3.8 78 168	4.3 100 196	8.1 210 308
Price	7 DCDT 24 DCDT	\$100 \$145	\$105 \$150	\$120 \$165	\$130 \$175	\$140 \$185	\$160 \$210

Linear Velocity (no excitation), Model LVsyn Series

LVsyn® Linear Velocity Transducers are designed for sensitive measurements of relative velocity. The basic design eliminates the need for external excitation and makes the transducers easy to set up and use. DC voltages are generated by moving a high flux-density permanent magnet in the bore of differentially wound coils. Voltage amplitude is proportional to core velocity. Resolution of an LVsyn output is nearly un-

limited—sensitivity over the rated stroke range is constant within 5%—temperature range is from -46°C to 93°C . Linearity is better than 1%. LVsyn's can be operated single-ended or push-pull; while immersed in non-corrosive fluids; without end stops or displacement limits. Each transducer is supplied with a calibration record.



Model	3LVA5	3LV1	6LV1	6LV2	6LV3	6LV4	7LV6	7LV9	7LV20
Sensitivity (mV/in/sec)	120 40*	90 35*	500 250*	500 250*	500 250*	500 250*	350 150*	350 150*	20 7*
Resistance (k ohms)	2	2.5	13	19	25	32	11.5	17	3
Inductance (henrys)	0.085	0.065	1.6	2.9	3.2	4	1.69	2.8	0.035
Stroke inches (mm)	0.5 13	1 25	1 25	2 51	3 76	4 101	6	9 229	20 508
Dimensions diameter: (in.) (mm)	0.37 10	0.37 10	0.63 16	0.63 16	0.63 16	0.63 16	0.75 19	0.75 19	0.75 19
length: (in.) (mm)	3.16 80	4.22 108	5 128	7 178	9 230	11.25 275	15.75 410	22.75 580	30 760
Weight (gm) armature assembly	3.5 2.5*	4.5 3.8*	11 10*	15 14*	17 17*	22 23*	34 49*	69 66*	40 34*
coil	20	25	110	150	200	250	420	610	800
core	3.5	4.5	11	15	17	22	54	69	40
shipping	84	84	224	252	308	336	544	756	900
Price	\$50	\$50	\$50	\$55	\$60	\$65	\$85	\$100	\$120

*With non-breakable magnet cores, Option '01. Prices same as standard models.

PRECISION ANALOG VOLTMETERS & SOURCES



PRECISION ANALOG VOLTMETERS AND SOURCES

As industrial and military electronics become more sophisticated, measurements require greater precision in normal working environments. To help alleviate today's measurement demands, Hewlett-Packard offers a broad line of precision instruments. Refer to HP Application Note 70, revised Oct. '69, for additional information.

Traceable to NBS

The absolute accuracy of Hewlett-Packard's precision instruments and calibrators is traceable to the National Bureau of Standards, as shown in the flow chart, Figure 1. Special care has been taken to develop instruments with state-of-the-art stability so that specified accuracy and traceability can be maintained for long periods of time.

0.1 mV to 1100 V AC Calibrator (10 Hz to 110 kHz)

The 745A AC Calibrator with the 746A High Voltage Amplifier now makes

it possible to calibrate precision ac voltmeters from 0.1 millivolt to 1100 volts. The wide band frequency range, from 10 Hz to 110 kHz, has an accuracy up to 0.022% at midrange. Voltage long term stability is 0.01% over a calibration period of six months for frequency from 50 Hz to 20 kHz. The AC-Calibrator has a six digit readout and the error of the instrument under test can be read directly in % of setting without time consuming calculations.

The 745A AC Calibrator has six voltage ranges of 1 millivolt to 100 volt full scale with 10% overrange. The 746A High Voltage Amplifier complements the 745A by extending its voltage range to 1000 volts +10% overrange. The output level is controlled by the 745A as shown in Figure 2. (Refer to pages 160 and 161 for specifications).

The 745A is programmable for frequency range, frequency setting and volt-

age ranges. Local or remote sensing can be selected by a front panel switch. Separate sense terminals are provided for remote sensing on the 745A ranges. The 746A 1000 volt range has a special output cable and the voltage is sensed at the output of the cable.

The accuracy of this ac calibrator is dependent on the reference square wave generator which contains an ultra stable Zener diode in a temperature-controlled oven. This Zener diode is a reference for two voltages; +9.9 V and -9.9 V.

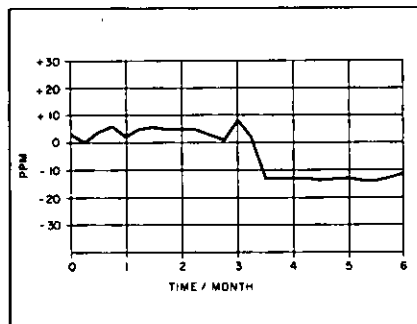


Figure 3. 6 month stability of a 745A reference supply.

These voltages are used to generate a square wave with a special patented circuit that maintains the basic accuracy of the two dc voltages in the square wave (refer to the block diagram, Figure 2). The accuracy of the rms value of the square wave thus generated is approximately 0.001% (Figure 3). A magnetic divider is used to obtain a 1.1 V rms square wave which is applied to the input of a 6-place magnetic divider to provide 6 digits of settability. The output of the calibrator is compared to this reference either directly or through an attenuator by the sampling amplifier. The 100 V range attenuator is a precision resistive divider manufactured by Hewlett-Packard. It has an excellent T.C. and long-term stability. All other range attenuators are inductive dividers. The rms value of the square wave is compared to the rms value of the sine wave output through a single thermocouple. The error signal is demodulated, amplified, and sent back to the oscillator to correct the voltage at the output.

The sine wave oscillator of the 745A Calibrator uses a beat-frequency technique combined with frequency dividers. The output from a 5 MHz crystal oscillator is divided by a factor of 9, resulting in an output of 555 kHz. This signal is heterodyned with a variable-frequency oscillator of 445 to 545 kHz. The difference, or beat frequency, is the out-

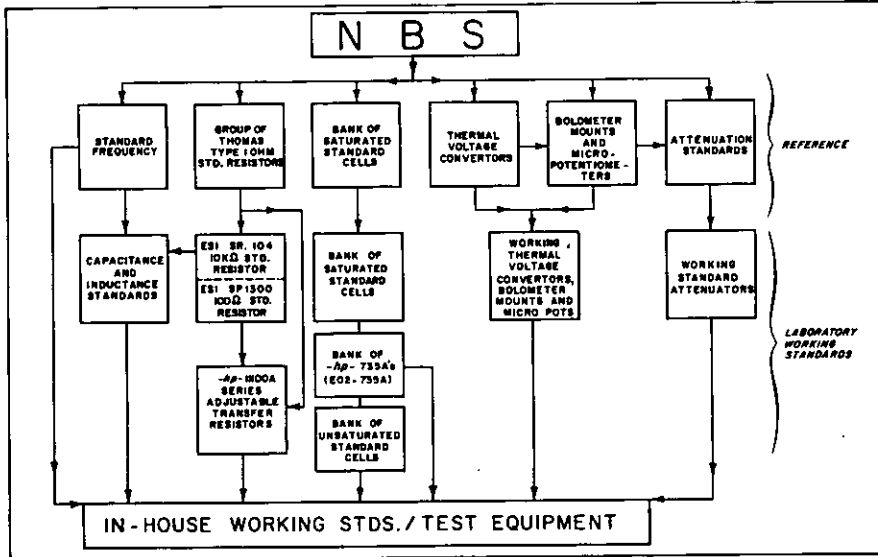


Figure 1. HP instrument traceability to NBS.

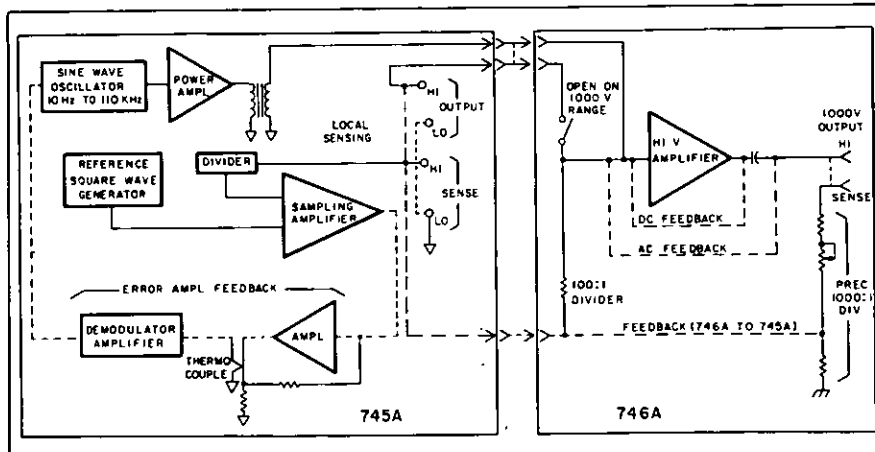


Figure 2. 745A, 746A AC calibrator block diagram.

put frequency on the upper range (10 kHz to 110 kHz). Each successive lower range is a result of heterodyning different frequencies and using a 10:1 divider. This variable-frequency oscillator is locally tuned on the front panel by a variable air dielectric capacitor or remotely controlled by a varying dc voltage or resistance.

The output of the sine wave oscillator is amplified and transformer-coupled to the output terminals. The purity of the sine wave output at 25 kHz is shown in Figure 4 as the 745A output is swept by the 3590A Wave Analyzer.

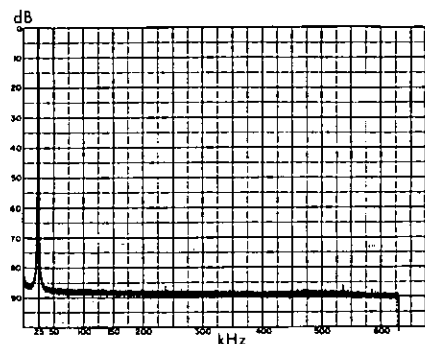


Figure 4. Recording of the 745A output, set at 25 kHz, as it is swept by the HP 3590A Wave Analyzer. The signal at zero frequency is the zero response of the 3590A.

The 746A is basically a X10 amplifier which supplies an additional 1000 volt range for the 745A AC Calibrator. The 746A contains logic circuits that insure proper operation and include safety features that disconnect the high voltage if any operating condition is not normal.

The 746A receives input voltages from the rear terminal of the 745A. The 745A transformer output is returned to the 745A output terminals if the voltage range switch is in any range except 1000 volts. On the 1000 volt range, this 745A transformer voltage is the input to the High Voltage Amplifier. Internal dc and ac feedback in the 746A provides constant bias voltages and stability for the ac output on the 1000 volt range. Overall feedback from the precision divider to the 745A sampling network maintains the accuracy and stability of the 745A for the 1000 volt range.

DC precision sources

The long-term accuracy and stability of the Hewlett-Packard dc precision sources are dependent on selected Zener diodes. Three distinct steps are necessary to provide a reliable reference diode: 1) process control in its original fabrication, 2) design of a compatible circuit, and 3) a 100% thorough test of the completed circuit.

To achieve the stability and accuracy necessary for the HP precision dc sources, a selected Zener diode and its associated circuitry is housed in a temperature-

controlled oven. The inner-oven temperature is held nominally at $80^{\circ}\text{C} \pm 0.01^{\circ}\text{C}$ during normal room variations.

The HP 735A Transfer Standard uses this reference supply to obtain accurate stable voltages of 1.000 volts, 1.018 to 1.020 volts, and 0 to 1000 μV . It is quickly calibrated by a front-panel adjustment using a standard cell (or another 735A) and a null meter.

This precision voltage source transfers standard-cell voltages to 1.000 volts with an accuracy of 10 ppm and a stability of 10 ppm per month.

Transfer accuracy between saturated standard cells or unsaturated standard cells is 2 ppm.

The 735A op. E02 is a bank of four 735A's combined with a switch and terminals that make it possible to compare an external voltage with any one of the four 735A's or to compare an external voltage with the arithmetical mean of the four 735A outputs.

Included with each 735A op. E02 is a graph on the 1.018 position showing that 95% of the time, the mean of the four 735A's vary from a straight line less than $\pm 1 \mu\text{V}$, over a period of 120 days.

The HP 740B and 741B DC Standards use the oven-reference supply for a reference voltage to generate the 0 to 1000-volt accurate, stable output. This reference voltage is applied to a precision resistive divider, which is the input to an amplifier chain, as shown in Figure 5.

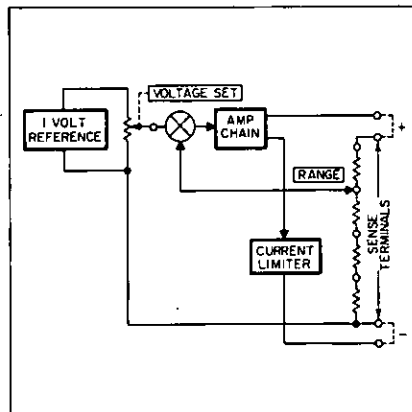


Figure 5. HP simplified dc standards diagram.

The summing point compares the input of the amplifier to an attenuated sample of the output taken from the range voltage divider. The current limit control is nominally adjusted for the protection of the output load.

Precision dc differential voltmeters

Measurements made by the differential voltmeter technique (sometimes called a potentiometric or manual voltmeter) are recognized as one of the most accurate means of relating an unknown voltage to a known reference. These measurements are made by adjusting a precision

resistive divider to divide down an accurately known reference voltage. The divider is adjusted to the point where the divider output equals the unknown voltage, as shown by the null voltmeter (Figure 6).

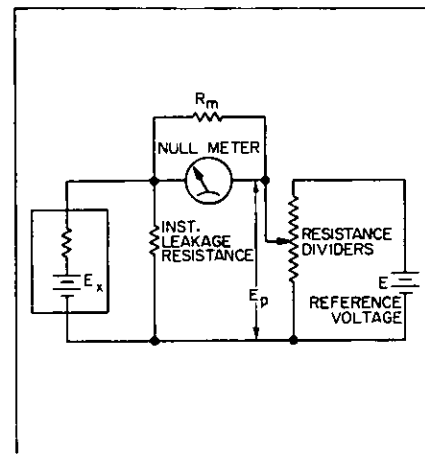


Figure 6. Classic differential voltage measurement.

The unknown voltage is determined to an accuracy limited only by the accuracies of the reference voltage and the resistive divider: the meter serves only to indicate any residual differential between the known and unknown voltage.

The differential method is highly accurate (Hewlett-Packard currently offers $\pm 0.002\%$ accuracy).

A high-voltage standard is required to measure high voltage. This need may be overcome by inserting a voltage divider between the source and the null-meter (Figure 7). This, however, results

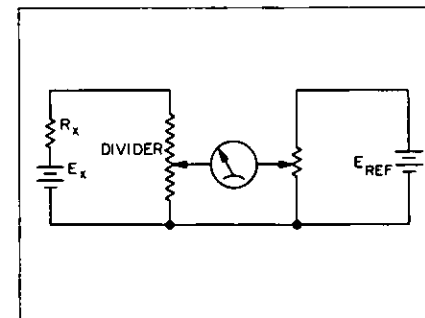


Figure 7. Potentiometric method of measuring unknown voltages.

in relatively low-input resistance for voltages higher than the reference standard. This low-input resistance is undesirable because accurate measurements may not be obtained if substantial current is drawn from the source being measured. Most differential voltmeters used today offer input resistance approaching infinity only at a null condition, and then only if an input voltage divider is not used.

To overcome these limitations, Hewlett-Packard has developed an input isolation stage which develops an input resistance exceeding 10^{10} ohms and mea-

sures voltages up to 1000 volts dc. This high resistance is maintained independent of null condition.

As shown in the block diagram of Figure 8, the HP 740B DC Standard/

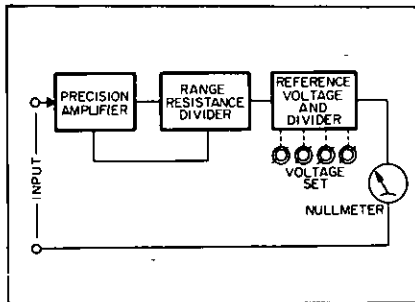


Figure 8. Simplified diagram of dc standard, differential voltmeter in differential voltmeter mode.

Differential Voltmeter has the principal parts of the conventional differential voltmeter.

In a marked departure from conventional differential voltmeter design, the circuitry also includes a high-gain feedback amplifier as an impedance converter between the measured voltage source and the measurement circuits. The amplifier insures that the high-input impedance is maintained regardless of whether the instrument is adjusted for a null reading.

A further advantage provided by the amplifier is that the resistive voltage divider which enables voltages as high as 1000 volts to be compared to a precision 1-volt reference may be placed at the output of the amplifier rather than being in series with the measured voltage source. The isolation provided by the amplifier between the input and the range "stick" thus enables the instrument to have high-input impedance on all ranges.

The range dividers, amplifier, and voltage reference supply are used in the 740B and 741B for both the precision dc source and the differential voltmeter.

Precision ac differential voltmeter

Highest accuracy in ac voltage measurements is accomplished by using an ac differential voltmeter.

The HP 741B uses a precision rectifying circuit to convert the unknown ac directly to dc (equivalent to the average value of the ac), and the resulting dc is read to 5-place resolution by a potentiometric voltmeter technique. The measurement is straightforward in that the ac remains connected to the converter at all times and can be monitored continuously. Besides being a precision ac/dc differential voltmeter, the instrument is also an ultra stable, high-resolution dc standard source. Refer to page 164 for additional information.

The accuracy of ac measurements is enhanced by the high-impedance probe attached to the instrument. The input impedance is 1 M Ω shunted by ≤ 5 pF.

The low-input capacitance is important in measurements where capacitance loading is critical. Using the 741B, it is possible to measure high ac voltages without drawing large reactive currents.

A block diagram of the HP 741B in the ac differential voltmeter mode of operation is shown in Figure 9.

With compensation for both the frequency and the amplitude of the input signal, it has been possible to accomplish accurate ac-to-dc conversion that is linear over an amplitude range from 1/10 full scale to full scale throughout a broad frequency range. With proper calibration procedures, it is possible to reduce errors to less than $\pm 0.02\%$ end scale between 100 Hz and 100 kHz under normal laboratory conditions.

Differential voltmeter/ratiometer

Recently introduced, the HP 3420A/B carries a 0.002% accuracy specification with stability of 1 ppm per hour (of range) and 5 ppm per day. Nullmeter resolution is 0.2 ppm of range on all ranges. These specifications set new standards in the state of the art for differential voltmeters.

To make 0.002% accuracy meaningful, the HP Models 3420A/B have six ten-digit decade dividers, plus the usual last-digit meter with $\pm 10 \mu\text{V}$ full-scale sensitivity. A further feature is rechargeable battery operation, available in the 3420B version. A self-contained power source is important when it is necessary to measure dc voltages with common-mode noise. Because the instrument can be completely isolated from the power line, these common-mode voltages do not influence the reading.

A block diagram of the HP 3420A/B is shown in Figure 10. DC voltage measurements in the 1 and 10-volt ranges are performed by the differential voltmeter technique, comparing the input voltage to a known internal voltage. This comparison is performed by a nullmeter. On the 100 and 1000-volt ranges, the input voltage is scaled to the 1-volt level by a precision 10 M Ω resistance divider.

The outstanding accuracy of the instrument is controlled by the internal voltage reference supply and the precision resistor networks. To enable the instrument to operate on battery power, an oven was not used.

All six decades are binary-coded dividers. The first decade has a 10% over-range capability to aid in measuring standard cells and other voltages that occur slightly above full scale. This feature enables the user to determine measurements with a resolution of <math><1</math> ppm.

The combination of high stability in the voltage reference supply, high resolution and zero stability in the null detector, and six-decade divider gives a useful sensitivity of 0.2 ppm of range on all ranges.

Besides being a precision differential voltmeter, the 3420A/B is also a precision ratiometer.

When making dc voltage measurements, there are cases where the absolute value of the voltage is of little interest. Instead, the point of interest is its value in relationship to some other voltage level or the ratio of it to some other level, i.e.,

$$N = \frac{V_b}{V_a} = \text{ratio}$$

This ratio appears often in engineering work. Examples are resistor dividers, po-

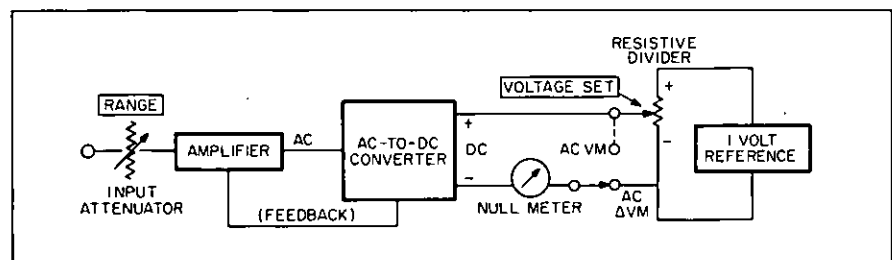


Figure 9. Simplified block diagram of an ac differential voltmeter.

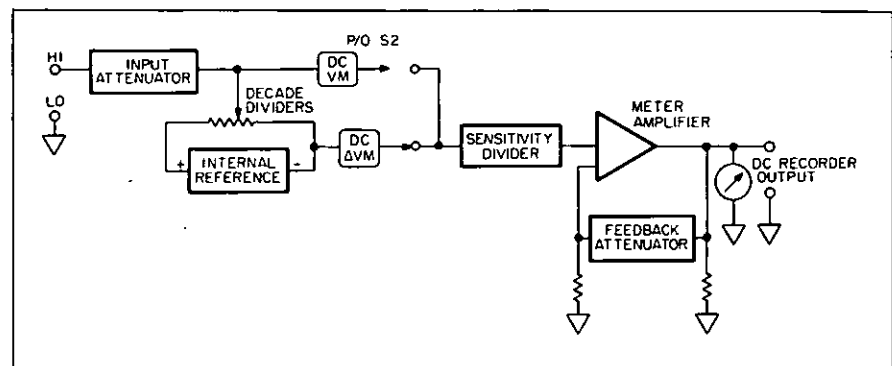


Figure 10. HP 3420A/B DC Differential Voltmeter mode.

tentiometer linearity, and power at various voltage levels.

Hewlett-Packard's precision differential voltmeters are multifunction instruments. Table 1 summarizes these instruments, giving the functions of each with the major specifications. By selecting the accuracy and stability necessary in anticipated tests and the functions most useful for specific needs, a precision instrument can be selected.

Thermal converters

Hewlett-Packard thermal converters are true rms detectors, yielding a dc output proportional to the temperature rise resulting from the ac input power. The Models 11049A, 11050A, and 11051A offer an exceptionally flat response and nearly constant impedance (50Ω) over a frequency range of 5 Hz to 10 MHz. Option 001 has a frequency range from 5 Hz to 60 MHz, and Option 002 has a frequency range from 5 Hz to 100 MHz.

Each thermal converter is shipped with a calibration report with statement of uncertainty traceable to NBS. Each option has an additional individual correctional data sheet attached to the calibration report.

AC/DC meter calibration systems

The HP 738BR Op. E02 Voltmeter Calibration System includes the Model 652A Test Oscillator and the Model 738BR Voltmeter Calibrator, mounted in a convenient cabinet. This system was designed specifically for calibrating high-impedance voltmeters and oscilloscopes.

The 738BR provides a 400 Hz rms or peak-to-peak ac voltage and a dc voltage output from $300\ \mu\text{V}$ to 300 volts. The accuracy is better than 0.1% dc and 0.2% ac. The 652A provides a frequency response, by using the expand position of the meter, from 10 Hz to 10 MHz with a flatness of $\pm 0.25\%$.

The HP Model 6920B Meter Calibra-

tor is an easily portable, simple device used to calibrate ac and dc meters from 0.01 volt to 1 kV, and from 0.01 mA to 5 A. The output setting of voltage or current is adjusted by means of a three-digit, ten-turn readout on any volt, milli-ampere, or ampere range. The dc accuracy is 0.2%, and ac accuracy is 0.4% of output.

Designed primarily for calibrating production test equipment where moving vane meters are employed, the Model 6921A offers 0.25% accuracy at moderate cost. Moreover, the basic amplifier design of the ac meter calibrator allows it to operate into fully reactive loads. It offers four voltage ranges covering from 1.4 volts to 280 volts, and five current ranges covering from 1.4 milliamperes to 5 amperes. An internal oscillator provides frequencies of 60 Hz, 400 Hz and 1 kHz. An extra bandwidth is provided to accept external oscillators from 50 Hz to 2 kHz.

Table 1. HP Multifunction Precision Analog Instruments

Features	Model 740B (pg 162)	Model 741B (pg 164)	Model 3420A/B (pg 166)
DC STANDARD	Yes	Yes	No
Ranges	4 (1 V to 1000 V)	4 (1 V to 1000 V)	
Accuracy	$\pm(0.002\%$ setting $+0.0004\%$ range)	$\pm 0.01\%$ setting or $\pm 0.001\%$ range $+10\ \mu\text{V}$	
Remote sensing	Yes	Yes	
Current limit	5 to 50 mA	4 to 20 mA	
DC Δ VOLTMETER	Yes	Yes	Yes
Ranges	7 (1 mV to 1000 V)	7 (1 mV to 1000 V)	4 (1 V to 1000 V)
Accuracy	$\pm(0.005\%$ reading $+0.0004\%$ range)	$\pm 0.02\%$ reading or $\pm 0.004\%$ range)	$\pm(0.002\%$ reading $+0.0002\%$ range)
AC Δ VOLTMETER	No	Yes	No
Voltage range		7 (1 mV to 1000 V)	
Frequency range		20 Hz to 100 kHz	
Accuracy		$\pm(0.02\%$ reading $+0.01\%$ range) 400 Hz to 5 kHz for 50 mV 100 V to $\pm(0.4\%$ reading $+0.01\%$ range)	
HIGH IMPEDANCE VM	Yes	Yes	Yes
Ranges	10 (1 μV to 1000 V dc)	7 (1 mV to 1000 V) ac and dc	9 (10 μV to 1000 V) dc
Accuracy	$\pm(2\%$ range $+0.1\ \mu\text{V})$	$\pm 2\%$ ac and dc ($+200\ \mu\text{V}$ for 1 mV - 50 mV (20 Hz - 50 kHz)	$\pm 3\%$
DC RATIO METER	No	No	Yes
Ranges			4 (X1 to X.001)
Accuracy			$\pm(0.002\%$ reading $+0.0004\%$ range)
GENERAL			
Readout	5-digit display tubes and meter	4-digit readout and meter	6-digit readout and meter
Stability	$\pm(15\ \text{ppm}$ setting $+2\ \text{ppm}$ range/mo.)	dc 10 ppm setting $+1\ \text{ppm}$ range/day ac $< 50\ \text{ppm/day}$ (20 Hz to 20 kHz)	$\pm 5\ \text{ppm/day}$
Floating	Yes	Yes	Yes
Guarding	Yes	No	No
Recorder output	1 V dc max at 1 mA end scale	1 V dc max at 1 mA end scale	1 V dc at 1 mA end scale
Amplifier output	Yes	Yes	No
Voltage gain	60 dB max (1 V to 1000 V dc)	Unity (0 to 1 kV dc)	

Note: Refer to pages 197-220 to obtain information on Hewlett-Packard Precision Digital Instruments. Refer to page 160 for the AC Precision Calibrator.

DC TRANSFER STANDARD

Portable instrument transfers std. voltages
Model 735A



PRECISION ANALOG VOLTMETERS AND SOURCES

The HP 735A is a general purpose laboratory transfer standard. It may be used as a 1 V standard output with standard cell accuracy, a standard cell comparator with seven digits, or as a 0 to 1000 μV standard source for dc and potentiometric measurements.

Specifications

Standard outputs: 1.00000 V; 1.018 $\pm \Delta^*$; 1.019 $\pm \Delta^*$; 0 to 1000 μV Δ^* .

Transfer accuracy: (after 30 min. warmup) 2 ppm between saturated standard cells or unsaturated standard cells; 10 ppm standard cell to 1 V; 10 ppm saturated standard cell to unsaturated standard cells.

Stability: (after 30 min. warmup) better than 10 ppm/month.

Line regulation: $< 1 \mu\text{V}$ for 10% line change.

Output impedance: $1 \text{ k}\Omega \pm 1\%$.

Short-circuit current: $< 1.5 \text{ mA}$.

Temperature coefficient: $< 1 \text{ ppm}/^\circ\text{C}$, 0° to $+50^\circ\text{C}$.

Variable output

Range: 0 to 1000 μV .

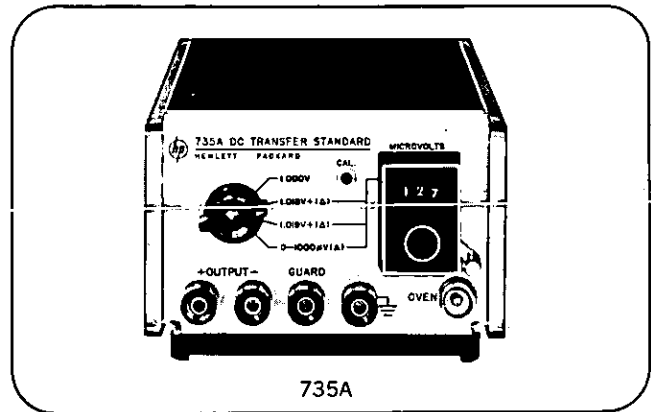
Accuracy: 0.1% to $\pm 1.5 \mu\text{V}$.

Resolution: 1 μV .

Output impedance: $146\Omega \pm 1\%$.

Output noise: dc to 1 Hz $< 1 \mu\text{V}$ p-p. 1 Hz to 1 MHz: $< 100 \mu\text{V}$ rms.

Output: floating and guarded.



735A

Power: 115 or 230 V $\pm 10\%$, 50 to 400 Hz, 12 W.

Output terminals: four 5-way binding posts. Positive, negative, circuit-guard shield, and chassis ground, positive and negative terminals are solid copper with gold flash. A maximum of 500 V dc may be connected between chassis ground and guard or circuit ground.

Dimensions: standard 1/3 module: $5\frac{1}{8}$ " wide, 3" high (without removable feet), 11" deep (130 x 76 x 279 mm).

Weight: net $5\frac{1}{2}$ lbs (2,5 kg); shipping 8 lbs (3,6 kg).

Price: HP 735A DC Transfer Standard, \$400.

*3-digit direct-reading 0 to 1000 μV offset voltage.

ULTRA-ACCURATE TRANSFER STANDARD

Mean of four 735A's with 120 days calculated drift

Model 735A Option E02

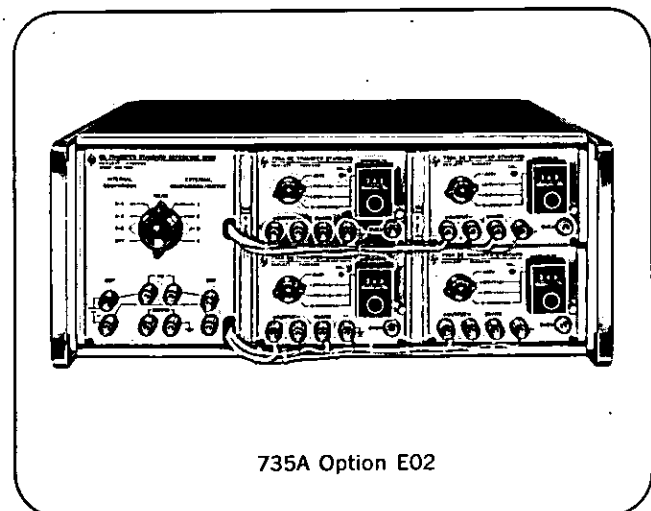
The Model 735A Option E02 consists of four 735A Transfer Standards, with a nine position switch mounted in a 1052A combining case. The four instruments can be connected in parallel to the output terminals resulting in the arithmetical mean of the four voltages. In the 1.018 position of the function switch, a graph is furnished with the instrument showing drift deviation from a straight line over a 120 day period. With this graph, the accuracy of the bank of 735A's can be predicted within a ppm for a 120 day calibration period. An external voltmeter can be inserted in the circuit so that when the output terminals are connected to a saturated standard cell or another external voltage, the meter will read the difference between the mean of the four 735A's and the external voltage.

In other positions of the 735A Option E02 switch, the (No. 1) 735A can be connected opposing each of the other 735A's so that the meter reads the difference of the two voltages. Each of the four 735A's can also be connected to the output terminals so that an external source can oppose any one of the 735A's with the meter reading the difference in voltages.

Specifications

(In addition to the specifications of the Model 735A.)

A graph is furnished with each 735A Option E02 showing that the arithmetical mean of the four 735A's in the 1.018 position of the function switch has a drift deviation from a straight line of $< \pm 1 \mu\text{V}$, 95% of the time, for 120 days.



735A Option E02

Power: 115 or 230 V $\pm 10\%$, 50 to 400 Hz, 48W.

Dimensions: $16\frac{3}{4}$ " wide, $7\frac{1}{4}$ " high, $18\frac{3}{4}$ " deep (425 x 185 x 467 mm).

Weight: net 35 lbs (15,8 kg); shipping 42 lbs (18,9 kg).

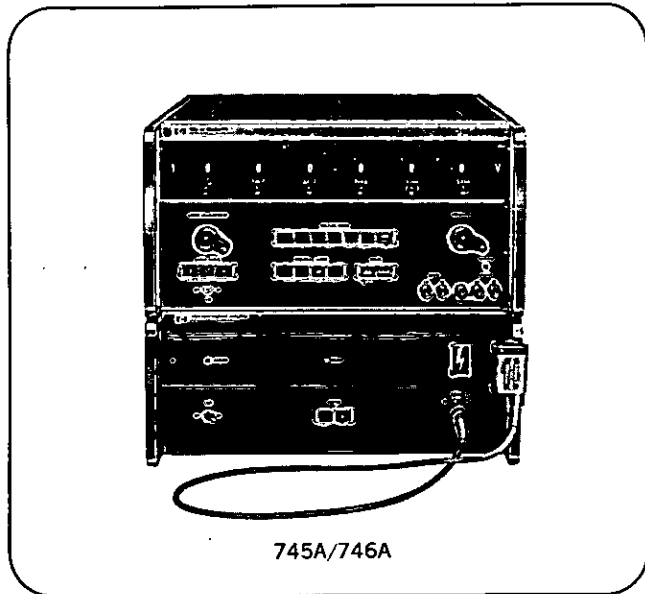
Price: HP 735A Option E02, add \$2055.

PRECISION ANALOG VOLTMETERS & SOURCES



AC CALIBRATION SYSTEM

Precision Source; to 1100 V; 10 Hz to 110 kHz
Models 745A & 746A



Description

The Model 745A AC Calibrator combined with the Model 746A High Voltage Amplifier, is a compact, calibrated ac source with a continuously-adjustable frequency output from 10 Hz to 110 kHz. The output voltage can be varied from 0.1 mV to 1099.999 V in steps as small as 1 ppm of range over the entire frequency band.

The Model 745A provides the first six voltage ranges, 0.1 mV to 109.9999 V, while the combination of the Models 745A and 746A permits the expansion to 1099.999 V as a seventh range.

The Model 746A is not being specified as an independent instrument and must always be combined with the 745A to meet its specifications. It not only amplifies the signal coming from the latter, but feeds back to it a signal proportional to the output for regulation purposes.

The Models 745A and 746A are particularly suitable as a precision source for laboratory ac calibration, production-line calibration and maintenance testing of ac instruments and ac signal conditioners.

Error Measurement

The error of the instrument under test can be read directly in % from the error scale on the front panel. The error range switch provides for a zero error, $\pm 3\%$ or $\pm 3\%$ end scale.

Usability

Momentary-contact switches are used to activate reed relays through logic circuits. This provides fast, reliable switching. Front-panel controls are conveniently grouped for fast, easy operation.

Output and power supplies are current limited. Shorts on the output will not cause damage on any voltage range. A front-panel indicator illuminates automatically whenever designed output limits are exceeded. After the conditions which caused the overload are removed reset is automatic for the 745A, but must be pushbutton activated for the 746A.

An automatic safety turn-on feature protects lower voltage devices. When turned on, the 745A/746A come on in a preferred state, lowest voltage range, 0% error range and local sense, regardless of switch position on turn-off.

Because of the lethal capability of the 746A output, additional safety features are included. A special output cable with a warning sign attached was used for this range to further remind the operator that whenever using this cable, lethal voltages may be present. Two distinct actions must take place in the correct sequence to obtain an output. First the 1000 V range must be selected, then the 746A output ON must be selected. Whenever an output is present the international symbol for high voltage, a red lightning bolt, is back lighted. Should a short circuit or an overload occur the output voltage is automatically removed. To restore the output the 746A output ON pushbutton must be reactivated.

Sensitive instruments or devices under test need not be disconnected when changing voltage range or frequency range. Switching transients are insignificant.

Programmability

The Model 745A/746A voltage range, frequency range and error range are programmable through a rear-panel connector by transistor or switch closures to ground. The output frequency can also be varied remotely over a given range by applying an adjustable analog voltage or an adjustable resistance between a programming pin and ground. Local or remote sense on the 1, 10 and 100 V ranges can be selected by contact closure to ground. Furthermore, the 1100 V output ON, OFF can be programmed through a 746A rear-panel connector by transistor or switch closures to ground.

Calibration

The 745A and 746A are easily calibrated. The voltage decade dividers and all range dividers except two are magnetic (ratio transformers) and need no adjustment. If the units are functioning correctly, specified midband accuracy can be achieved by the adjustment of two dc voltages and a resistive voltage divider 100/1 on the 745A and 1000/1 on the 746A. These adjustments can be made with an accurate dc voltmeter or ratiometer. Voltage calibration can be accomplished over all voltage ranges and frequencies using an HP Model 3420A/B Differential Voltmeter and a thermocouple with a known response.

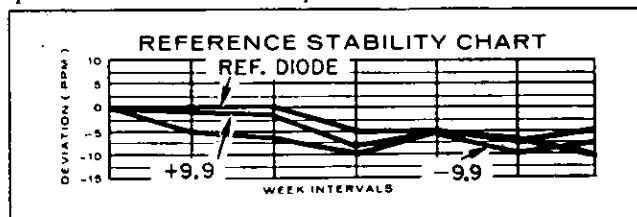
Stability

The 745A long term stability is derived from a zener diode maintained in a temperature controlled oven. Only those diodes are selected which have a 6 weeks drift of less than 20 ppm.

A reference stability chart, showing a six week's record of the reference supply for the specific instrument, is included.

Logic circuits provide safety features for the protection of the 745A, 746A, for the protection of the instrument under test and for the protection of the operator.

All of these features, plus ruggedness and temperature operating range, make the 745A and the 746A ideal choices for bench and production area ac calibration procedures that require state-of-the art accuracy.



Starting Date _____ Serial No. _____

745A/746A Combined Specifications

Ranges

Output voltage ranges: 7 ranges with 10% overrange as follows:

Range	Settability and Resolution
1 mV	0.100000 mV to 1.099999 mV in 1 nV steps
10 mV	1.00000 mV to 10.99999 mV in 10 nV steps
100 mV	10.0000 mV to 109.9999 mV in 100 nV steps
1 V	0.100000 V to 1.099999 V in 1 μ V steps
10 V	1.00000 V to 10.99999 V in 10 μ V steps
100 V	10.0000 V to 109.9999 V in 100 μ V steps
1000 V	100.000 V to 1099.999 V in 1 mV steps

The output voltages from 100 μ V to 110 V are available from 745A output terminals; voltages from 100 V to 1100 V are available from the 746A output cable.

Output frequency ranges: continuously adjustable from 10 Hz to 110 kHz in 4 decade ranges with 10% overlap.

Error measurement: 2 ranges with zero center dial; $\pm 0.3\%$, $\pm 3\%$. A zero range is provided to easily switch out the effects of the error measurement system.

Performance Rating

Accuracy: accuracy holds for a 90-day period and is met after a 1-hr warmup period at $25^\circ\text{C} \pm 5^\circ\text{C}$ with $<95\%$ RH. This applies only to the 745A. 746A warmup time required is approximately 30 s.

Voltage: specifications are absolute, traceable to the National Bureau of Standards.

1 mV to 100 V ranges:

Frequency	Accuracy
50 Hz to 20 kHz	$\pm(0.02\%$ of setting $+0.002\%$ of range $+10 \mu\text{V})$
20 Hz to 50 Hz	$\pm(0.05\%$ of setting $+0.005\%$ of range $+50 \mu\text{V})$
20 kHz to 110 kHz	$\pm(0.2\%$ of setting $+0.005\%$ of range $+50 \mu\text{V})$

1000 V range:

Frequency	Accuracy
50 Hz to 20 kHz	$\pm 0.04\%$ of setting
20 Hz to 50 Hz	$\pm 0.08\%$ of setting
20 kHz to 50 kHz	$\pm 0.15\%$ of setting
50 kHz to 110 kHz	$\pm(0.2\%$ of setting $+0.005\%$ of range)

Frequency: $\pm(2\%$ of setting $+0.2\%$ of end scale).

Error measurement: $\pm(0.5\%$ of setting $+0.5\%$ of range).

Temperature coefficient

Voltage: 1 mV to 100 V ranges: $\pm 0.0003\%$ of setting per $^\circ\text{C}$, 0°C to 55°C . 1000 V range: $\pm 0.0005\%$ of setting per $^\circ\text{C}$, 0°C , to 55°C .

Frequency: $\pm 0.05\%$ of end scale per $^\circ\text{C}$, 0°C to 55°C . Derate accuracy specifications by this temperature coefficient for operation in temperature range of 0°C to 20°C and 30°C to 50°C .

Voltage stability: stability met after 1-hr warmup period at constant temperature with $<95\%$ RH.

1 mV to 100 V ranges

Long-term: $\pm 0.01\%$ of setting for 6 mo.

Short-term: $\pm 0.005\%$ of setting for 24 hr.

1000 V range

Long-term: 50 Hz to 20 kHz: $\pm 0.01\%$ of setting for 6 mo. 10 Hz to 50 Hz and 20 kHz to 110 kHz: $\pm 0.02\%$ of setting for 6 mo.

Short-term: $\pm 0.005\%$ of setting for 24 hr.

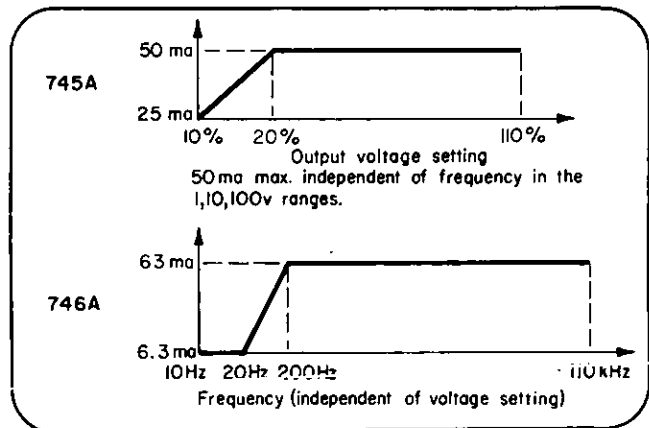
Output Characteristics

Total distortion and noise: 0.05% of setting $+10 \mu\text{V}$ over 100 kHz bandwidth on all ranges.

Total distortion, cycle-to-cycle instability and noise: will cause $< \pm 0.005\%$ of error when used to calibrate an average-responding or true rms-responding instrument from 1 mV to 1100 V.

Load regulation (no load to full load)

Output impedance $< 1\Omega$ on 1 mV, 10 mV, 100 mV ranges.



On the 1 V, 10 V, 100 V and 1000 V ranges for output current equal to or less than that shown in the diagram above, error is included in the accuracy specification.

Load capability

1000 pF or 50 mA on 1 mV to 100 V ranges (50 mA allows 800 pF at 100 V, 100 kHz).

1000 pF or 63 mA on 1000 V range (63 mA allows 100 pF at 1000 V, 100 kHz).

Line regulation: $\pm 0.001\%$ of setting change in output voltage for a 10% change in line voltage (included in accuracy spec).

Output terminals: high and low output terminals can be floated ± 500 V dc above chassis ground.

Counter output: frequency counter output on 745A rear panel, 2.2 V $\pm 20\%$, protected against short circuits.

Remote Programming

Voltage, Frequency, Error Ranges, and Senses	Requirements
Contact Closure	Less than 400 Ω to ground
NPN Transistor	Open circuit voltage 5 V.
Reed Switch Through Diode	Short circuit current 2 mA.
NPN Transistor Through Diode	Maximum voltage on programming line at closure 0.8 V.
Frequency Vernier	Minimum to Maximum of Range
Analog Voltage	+1 V to +10 V dc
Resistance to ground	500 Ω to 10 k Ω

General

Operating temperature: 0°C to 55°C .

Storage temperature: -40°C to $+75^\circ\text{C}$.

RFI: meets MIL-I-6181D when using shielded output connectors.

Power: 745A: 115 V or 230 V $\pm 10\%$, 50 Hz to 400 Hz, 100 W max. 746A: 115 V or 230 V $\pm 10\%$, 50 Hz to 60 Hz 850 W max. 746A aux power output rated at 120 W max.

Dimension: 745A: 16 $\frac{3}{4}$ " wide, 8 $\frac{3}{4}$ " high, 18 $\frac{3}{8}$ " deep (425 x 221 x 467 mm). 746A: 16 $\frac{3}{4}$ " wide, 7" high, 18 $\frac{1}{4}$ " deep (425 x 177 x 464 mm).

Weight: 745A: net 65 lb (29.3 kg); shipping 80 lb (36.3 kg). 746A: net 75 lb (34 kg); shipping 85 lb (38.5 kg).

Accessories furnished

745A: Rack mount kit; HP Part No. 5060-0630, 22-pin printed circuit board extender; HP Part No. 5060-0043, 15-pin printed circuit board extender; HP Part No. 5060-0031, 10-pin printed circuit board extender; HP Part No. 1251-0084 remote programming mating plug.

746A: Accessory kit HP Part No. 00746-84401; HP Part No. 1251-0485, remote right angle connector; HP Part No. 1450-0356, incandescent lamp; HP Part No. 4040-0427, extractor; HP Part No. 5040-0404, probe holder; HP Part No. 5060-0216, joining kit bracket; HP Part No. 5060-0630, 22-pin printed circuit board extender; 7H rack mounting kit; HP Part No. 00746-02701, foam filter.

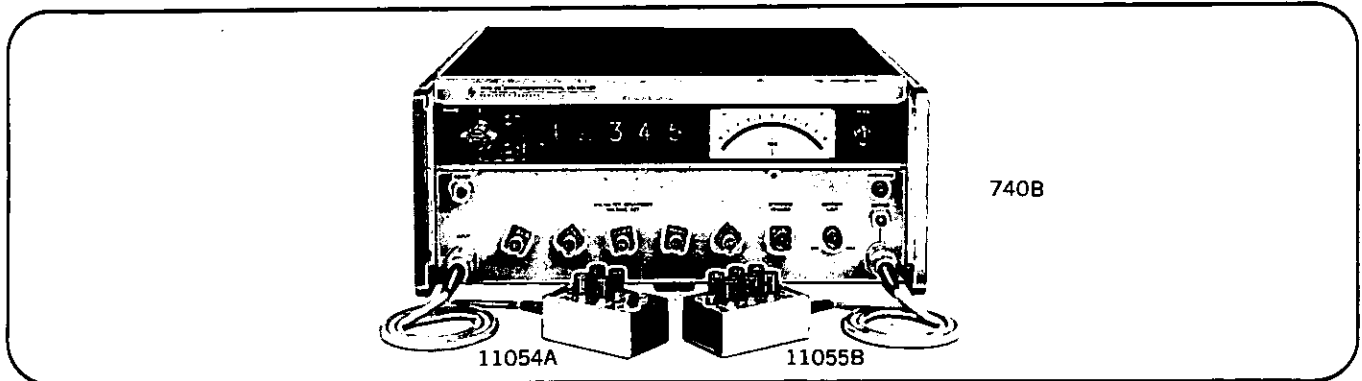
Price: HP 745A, \$4500; HP 746A, \$2000.

PRECISION ANALOG VOLTMETERS AND SOURCES



DC STANDARD / ΔVOLTMETER

So much instrument at so great a value
Model 740B



DC Standard

The 740B is an ultra-stable, high-resolution dc calibration source which delivers output voltage from zero to 1000 V with specified accuracy of $\pm(0.002\%$ of setting $+0.0004\%$ of range). Designed for calibrating digital voltmeters, differential voltmeters, potentiometers, voltage dividers and for general standards lab application, the 740B has 6-digit resolution with discrete steps of 1 ppm at full scale.

The 740B will deliver current up to 50 mA and may be set at any desired limit between 5 mA and 50 mA by a continuously adjustable front-panel control. A front-panel indicator displays overload conditions as the load current exceeds the current limit setting. Low output impedance is maintained by remote sensing terminals which control the output voltage at the load. The entire circuit is floating and guarded.

The stability of the 740B is dependent primarily on the stability of the reference source and the stability of the precision wire-wound resistors which comprise the decade and range dividers. The heart of the reference voltage supply is a temperature-compensated Zener diode which, with other critical components, is housed in a proportionally controlled oven.

Differential Voltmeter

As a differential voltmeter, the 740B measures voltage from 1 mV to 1000 V dc full scale in seven decade ranges. Meter sensitivity pushbuttons allow input voltages to be measured to six digits for a maximum resolution of 1 ppm of range, with a maximum usable sensitivity of 1 μ V full scale. Specified accuracy is $\pm(0.005\%$ of reading $+0.0004\%$ of range $+1 \mu$ V).

As a differential voltmeter, the 740B is unique in maintaining an input impedance of $>10^{10}\Omega$ (on all ranges above 10 mV) regardless of whether or not the voltage dials are nulled. This feature simplifies operation by eliminating any calculations of loading error by the voltmeter. In addition, the high-input impedance simplifies the measurement or comparison of standard cells or other devices that are sensitive to small current drains.

Voltage setting is indicated by five digital display tubes plus an individually calibrated taut-band meter.

High-impedance Voltmeter

The HP 740B is also a $\pm 2\%$ floating and guarded voltmeter with ranges from 1 μ V to 1 kV. Input impedance is $>10^{10}\Omega$ on most ranges.

Precision DC Amplifier

The instrument can be used as a dc power amplifier in differential voltmeter or voltmeter modes by connecting the source to the input terminals and taking the output from the terminals that normally supply the standard calibrated voltages. It is thus possible to augment the capabilities of a standard cell, for example, by using the amplifier as an impedance converter to provide power amplification. The available gain depends on the selected voltage range. The 740B functions as a unity gain amplifier on the 1 V and higher ranges, but on lower ranges the gain increases in 20 dB steps to a maximum of 60 dB on the 1 mV range.

By taking output from a rear-panel recorder connector, the 740B supplies up to 120 dB of voltage gain (depending upon range).

Specifications

DC Standard

Ranges

Output voltage: 0 to 1000 V* in 4 decade ranges as follows: 0 to 1 V in 1 μ V steps; 0 to 10 V in 10 μ V steps; 0 to 100 V in 100 μ V steps; 0 to 1000 V in 1 mV steps. Digital display tubes indicate first 5 digits; meter displays 6th digit.

Performance

Accuracy ($<70\%$ RH, constant line, load and temperature $\pm 1^\circ\text{C}$. Calibrated at factory at 115 V and 23°C .)
30 day: $\pm(0.002\%$ of setting $+0.0004\%$ of range).
90 day: $\pm(0.005\%$ of setting $+0.0004\%$ of range).

Stability ($<70\%$ RH, constant line, load and temperature $\pm 1^\circ\text{C}$):

Period	Zero stability ppm of range	Voltage stability (excludes zero stability) setting + range
1 hr	≈ 1 ppm	$\approx(0$ ppm $+1$ ppm)
24 hr	≈ 2 ppm	$\approx(5$ ppm $+1$ ppm)

*A maximum of -500 V dc with respect to line ground can be applied to or obtained from the HP 740B.

Temperature coefficient

10°C to 40°C: $< \pm 0.0002\%$ of setting/°C or $\pm 0.0001\%$ of range/°C, whichever is greater.

Line regulation: $< \pm (0.0005\%$ of setting $+ 0.0001\%$ of range) for 10% line voltage change.

Load regulation (no load to full load): $< (0.0005\%$ of setting $+ 10 \mu\text{V})$.

Output characteristics

Terminals: plus and minus output, plus and minus sense, circuit guard, and chassis ground. Minus output and circuit guard can be floated up to ± 500 V with respect to chassis ground.

Output current: maximum output current 50 mA at 1 V output, decreasing linearly to 20 mA at 1000 V output. Current limiter continuously adjustable from 10% to 100% of maximum output current.

Output resistance: $< (0.0002 + 0.0001 E_{\text{out}}) \Omega$.

Noise (rms value)

Range	0.01 Hz - 1 Hz	1 Hz - 1 MHz
1 V	$< 1 \mu\text{V}$	$< 100 \mu\text{V}$
10 V	$< 10 \mu\text{V}$	$< 100 \mu\text{V}$
100 V	$< 100 \mu\text{V}$	$< 1 \text{ mV}$
1000 V	$< 1 \text{ mV}$	$< 10 \text{ mV}$

DC differential voltmeter**Ranges**

Voltage: 1 mV to 1000 V* in 7 decade ranges.

Resolution: 6-digit readout yields resolution of 0.0001% of range (6th digit indicated on meter).

Performance

Accuracy ($< 70\%$ RH, constant line and temperature $\pm 1^\circ\text{C}$. Calibrated at factory at 115 V and 23°C .)

30 day: $\pm (0.005\%$ of reading $+ 0.0004\%$ of range $\pm 1 \mu\text{V})$.

90 day: $\pm (0.008\%$ of reading $+ 0.0004\%$ of range $+ 1 \mu\text{V})$.

Stability ($< 70\%$ RH, constant line and temperature $\pm 1^\circ\text{C}$):

Period	Zero stability	Reading stability (excludes zero stability) reading + range
1 hr	$\pm (1 \text{ ppm of range} + 1 \mu\text{V})$	$\pm (0 \text{ ppm} + 1 \text{ ppm})$
24 hr	$\pm (1 \text{ ppm of range} + 2 \mu\text{V})$	$\pm (5 \text{ ppm} + 1 \text{ ppm})$

Temperature coefficient

10°C to 40°C: $< \pm (0.0002\%$ of reading $+ 1 \mu\text{V})/^\circ\text{C}$.

Line regulation: $< \pm (0.001\%$ of reading $+ 2 \mu\text{V})$ for 10% line voltage change.

Input characteristics

Terminals: plus and minus input, circuit guard and chassis ground. Minus input and circuit guard can be floated up to ± 500 V with respect to chassis ground.

Input resistance (independent of null)

100 mV to 1000 V ranges: $> 10^{10} \Omega$.

10 mV range: $> 10^9 \Omega$.

1 mV range: $> 10^8 \Omega$.

Effective common-mode rejection (ECMR): ECMR is the ratio of the common-mode signal to the resultant error in readout with 1 k Ω unbalance resistor in either lead.

At 60 Hz and above: > 120 dB.

Normal-mode rejection (NMR): NMR is the ratio of the ac normal-mode signal to the resultant error in readout.

At 60 Hz and above: > 100 dB.

Maximum ac normal-mode signal: 25 V rms.

Overload protection: 1000 V* dc may be applied on any range or sensitivity without damaging instrument.

DC voltmeter

Voltage ranges: 1 μV to 1000 V* in 10 decade ranges.

Accuracy: $\pm (2\%$ of range $+ 0.1 \mu\text{V})$.

Input resistance: 100 mV to 1000 V range: $> 10^{10} \Omega$; 10 mV range: $> 10^9 \Omega$; 1 μV to 1 mV range: $> 10^8 \Omega$.

Zero drift: $< 2 \mu\text{V}$ per day; zero control limits: $> \pm 10 \mu\text{V}$.

Normal-mode rejection: same as DC Differential Voltmeter.

DC amplifier

Voltage gain: 1 mV range, 60 dB; 10 mV range, 40 dB; 100 mV range, 20 dB; 1 V to 1000 V ranges, 0 dB.

Bandwidth: dc to 0.2 Hz.

Gain accuracy: $\pm (0.01\%$ of input $+ 0.0005\%$ of range $+ 2 \mu\text{V})$ referred to input.

Linearity: $\pm 0.002\%$ on any range.

Stability, temperature coefficient, line regulation, input resistance, ECMR, NMR, and overload protection: same as DC Differential Voltmeter.

Load regulation, output current, and output resistance: same as DC Standard.

Noise (rms value, referred to input)

Range	0.01 Hz - 1 Hz	1 Hz - 1 MHz
1 mV	$< 0.2 \mu\text{V}$	$< 100 \mu\text{V}$
10 mV	$< 0.4 \mu\text{V}$	$< 100 \mu\text{V}$
100 mV	$< 1 \mu\text{V}$	$< 100 \mu\text{V}$
1 V	$< 1 \mu\text{V}$	$< 100 \mu\text{V}$
10 V	$< 10 \mu\text{V}$	$< 100 \mu\text{V}$
100 V	$< 100 \mu\text{V}$	$< 1 \text{ mV}$
1000 V	$< 1 \text{ mV}$	$< 10 \text{ mV}$

General

Recorder output: provides voltage proportional to meter deflection in all modes of operation. Adjustable output supplies up to ± 1 V dc across 1 k Ω load; voltage polarity same as meter deflection.

Operating temperature: 10°C to 40°C unless specified otherwise.

Storage temperature: -40°C to $+65^\circ\text{C}$.

RFI: meets MIL-I-6181D#.

Power: 115 V or 230 V $\pm 10\%$, 50 Hz to 400 Hz, < 125 W.

Dimensions: full module, $16\frac{3}{4}$ " wide, $6\frac{7}{8}$ " high, $18\frac{1}{4}$ " deep. (425 x 175 x 464 mm).

Weight: net 47.3 lb (21.3 kg); shipping 60 lb (27 kg).

Accessories furnished

11054A input cable assembly; 4 banana jacks mounted on terminal box with 3-ft cable and mating connector. Terminals include positive and negative input, circuit guard, and chassis ground. Positive and negative terminals are solid copper, gold flashed. A switch allows reduction of input resistance to 2 M Ω .

11055B output cable assembly; 6 banana jacks mounted on terminal box with 3-ft cable and mating connector. Terminals include positive and negative output, positive and negative sense, circuit guard, and chassis ground. Output and sense terminals are solid copper, gold flashed.

Price: HP 740B, \$2450.

*Maximum of -500 V dc with respect to line ground can be applied to or obtained from the HP 740B.

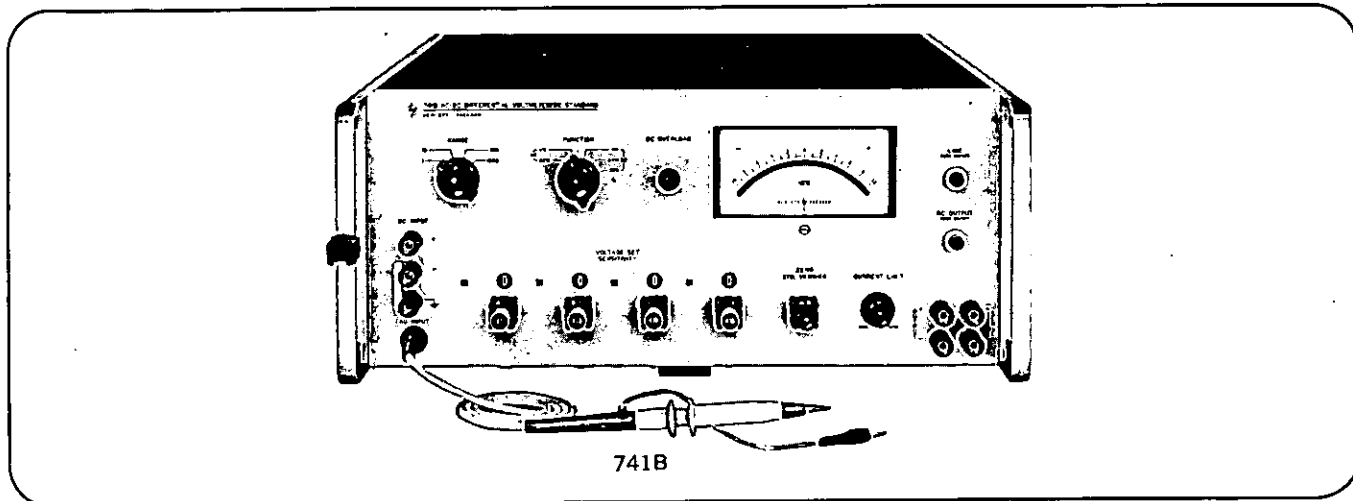
#Positive or negative output terminals of the output box (HP 11055B) connected to chassis, and guard and chassis terminals of the input box (HP 11054A) connected together.

PRECISION ANALOG VOLTMETERS & SOURCES



AC-DC ΔVM/DC STANDARD

Multi-function calibration instrument
Model 741B



The Hewlett-Packard Model 741B is a versatile and accurate instrument with six modes of operation. Now it is possible to solve most measurement problems with one convenient instrument.

The 741B is easy to use. The four most significant digits are digitally displayed; the meter displays the remaining resolution. The decimal point is placed automatically by the range switch. The voltage set switches are concentric with the sensitivity buttons; thus, there is no confusion about which switch to turn.

DC Standard Source

As a dc standard, the 741B delivers 0 to 1000 volts with an accuracy of 0.01% of setting. Designed for calibrating digital voltmeters, differential voltmeters and for general standards lab use, the 741B delivers voltages quickly and easily. Sense terminals allow sensing voltage at distant loads, eliminating errors due to voltage drop in long leads.

DC Differential Voltmeter

The high input resistance of $>10^9\Omega$ distinguishes the 741B as a dc differential voltmeter. This high resistance is maintained for voltages up to 1000 volts independent of null. Accuracy is $\pm 0.02\%$ of reading.

AC Differential Voltmeter

As an ac differential voltmeter, the 741B offers two features unique to ac voltage measurement: high accuracy and low input capacitance. With <5 pF input capacitance, the 741B has a minimal loading effect at higher frequencies.

High-Impedance AC or DC Voltmeter

The model 741B is a $\pm 2\%$ floating dc voltmeter with ranges from 1 mV to 1000 V. It is also a $\pm 2\%$ floating ac voltmeter from 50 mV to 1000 V with reduced accuracy to the 1 mV range.

Amplifiers

As a voltage amplifier, up to 60 dB gain is available at the recorder terminals.

As a $\pm 0.02\%$ power amplifier, the HP 741B provides unity voltage gain from 0 to 1000 V at the output terminals.

Specifications*

DC Standard

Ranges

Voltage: 0 to 1000 V in 4 decade ranges as follows: 0 to 1 V with $10\ \mu\text{V}$ resolution; 0 to 10 V with $100\ \mu\text{V}$ resolution; 0 to 100 V with 1 mV resolution; 0 to 1000 V with 10 mV resolution.

Performance rating (after 1-hour warmup)

Accuracy:** $<80\%$ RH, constant line, load and temp $\pm 1^\circ\text{C}$.
Calibrated at factory at 23°C and 115 V line.

90 day: $\pm 0.01\%$ of setting or $\pm 0.001\%$ of range, whichever is greater.

180 day: $\pm 0.015\%$ of setting or $\pm 0.0015\%$ of range, whichever is greater.

Stability: $<80\%$ RH, constant line, load and temp $\pm 1^\circ\text{C}$.

1 hr: $<(0.0003\%$ of setting $+ 0.0001\%$ of range).

24 hr: $<(0.001\%$ of setting $+ 0.0001\%$ of range).

Temperature coefficient: $<(0.0003\%$ of setting $+ 0.0001\%$ of range) per $^\circ\text{C}$.

Line regulation: $<(0.0001\%$ of setting $+ 1\ \mu\text{V})/1\%$ change.

Load regulation (no load to full load): $<(0.001\%$ of setting $+ 10\ \mu\text{V})$.

Output characteristics

Terminals: plus and minus output, plus and minus sense. Minus output can be floated up to ± 500 V dc to ground.

Output current: current limiter continuously adjustable from <4 mA to >20 mA; 0°C to 40°C . Reduced to 10 W maximum from 40°C to 50°C .

Output resistance: $<(0.0005 + 0.0005E_{\text{out}})\Omega$.

Zero control range: 0.0015% of range. Rezeroing may be required if range is changed.

Noise (rms value)

Range	DC - 1 Hz	1 Hz - 1 MHz
1 V	$<10\ \mu\text{V}$	$<200\ \mu\text{V}$
10 V	$<100\ \mu\text{V}$	$<200\ \mu\text{V}$
100 V	$<1\ \text{mV}$	$<1\ \text{mV}$
1000 V	$<10\ \text{mV}$	$<10\ \text{mV}$

AC Differential Voltmeter

Ranges

Voltage: 1 V, 10 V, 100 V, 1000 V.

Resolution: 4-digit readout yields resolution of 0.01% of range; 0.002% of range indicated on meter.

Performance rating (after 1-hour warmup)

Accuracy: <80% RH, constant line and temp ($\pm 1^\circ\text{C}$).
Calibrated at factory at 23°C and 115 V line.

90 day:

Frequency	Voltage	Accuracy \pm (% of reading + % of range)
400 - 5 kHz	50 mV - 100 V	0.02% + 0.01%*
20 Hz - 30 Hz	50 mV - 1 kV	0.2% + 0.01%
30 Hz - 50 Hz		0.15% + 0.01%
50 Hz - 100 Hz		0.1% + 0.01%
100 Hz - 10 kHz		0.04% + 0.01%
10 kHz - 50 kHz		0.2% + 0.01%
50 kHz - 100 kHz		0.4% + 0.01%
20 Hz - 50 kHz	1 mV - 50 mV	0.4% + 0.01%
50 Hz - 100kHz	500 V - 1000 V	1% + 1%

*After 8-hour warmup.

180 day:

20 Hz to 20 kHz: add \pm (0.02% of reading + 0.01% of range) to 90-day specification.

20 kHz to 100 kHz: add \pm (0.4% of reading + 0.02% of range) to 90-day specification.

Stability: <80% RH, constant line and temp $\pm 1^\circ\text{C}$, 20 Hz to 20 kHz <500 V with 8-hour warmup.

1 hr: <0.003% of range. 24 hr: <0.005% of range.

Temperature coefficient

Temperature	Frequency	Change per $^\circ\text{C}$
$5^\circ\text{C} - 40^\circ\text{C}$	20 Hz - 10 kHz	<0.002% of range
	10 kHz - 100 kHz	<0.006% of range
$0^\circ\text{C} - 5^\circ\text{C}$ $40^\circ\text{C} - 50^\circ\text{C}$	20 Hz - 10 kHz	<0.004% of range
	10 kHz - 100 kHz	<0.008% of range

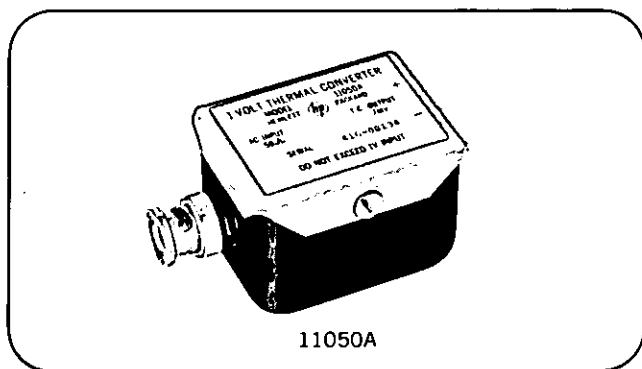
Line regulation: <0.001% of range per 1% line change.

Input characteristics

Input: probe with 3-ft cable can be floated up to ± 500 V dc.

Input impedance: 1 M Ω shunted by <5 pF.

Overload protection: 1000 V can be applied on any range.

Models 11049A, 11050A, 11051A Thermal Converters

Hewlett-Packard Thermal Converters are true rms indicators, yielding a dc output voltage proportional to the temperature rise resulting from the input power. The Models 11049A, 11050A and 11051A offer an exceptionally flat response and nearly constant impedance over a wide frequency range. These characteristics make the thermal converters ideal to check the response of precision ac voltmeters, oscilloscopes and amplifiers.

Specifications

Maximum input voltage:

11049A: 3 V rms; 11050A: 1 V rms; 11051A: 0.45 V rms.

DC Differential Voltmeter

Voltage ranges: 1 V, 10 V, 100 V, 1000 V.

Resolution: 4-digit readout yields resolution of 0.01% of range; 0.002% of range indicated on meter.

Performance rating (after 1-hour warmup)

Accuracy:** <80% RH, constant line and temp $\pm 1^\circ\text{C}$. Calibrated at factory at 23°C and 115 V line. 90 day: $\pm 0.02\%$ of reading or $\pm 0.004\%$ of range, whichever is greater. 180 day: $\pm 0.025\%$ of reading or $\pm 0.004\%$ of range, whichever is greater.

Stability: with 8-hour warmup, <80% RH, constant line and temp $\pm 1^\circ\text{C}$.

1 hr: <(0.0003% of reading + 0.0001% of range).

24 hr: <(0.001% of reading + 0.0001% of range).

Temperature coefficient: <(0.0003% of reading + 0.0001% of range) per $^\circ\text{C}$.

Line regulation: <0.0002% of range per 1% line change.

Input characteristics

Terminals: plus and minus input terminals and chassis ground. Minus input can be floated up to ± 500 V dc with respect to chassis ground.

Input resistance: >10 Ω , independent of null.

Normal mode rejection (NMR): 50 Hz and above; >80 dB.

Maximum ac normal mode voltage: 50% of dc input or 25 V whichever is less.

Overload protection: 1000 V can be applied on any range.

High Impedance AC/DC Voltmeter and Power Amplifier*

General

Recorder output: available for all modes of operation. Recorder voltage output directly proportional to meter deflection, 60 dB gain (max.), 1 mA into 1 k Ω load.

Power supply: 115 or 230 V $\pm 10\%$, 50 Hz to 400 Hz, 125 W max.

Dimensions: 16 $\frac{3}{4}$ " wide, 6 $\frac{7}{8}$ " high, 18 $\frac{1}{4}$ " deep (425 x 175 x 464 mm).

Weight: net 42 lbs (18.9 kg); shipping 55 lbs (24.8 kg).

Accessories furnished: rack mounting kit for 19" rack.

Price: HP 741B, \$1875, HP 741B, option 001**, \$1875.

*For complete specifications, refer to Data Sheet.

**Option 001: accuracies for DC Δ VM and DC Standard are interchanged.



Input impedance: 50 Ω $\pm 0.15\Omega$ to 10 MHz.

Output voltage for maximum input voltage: 7.5 mV dc.

Output impedance: <10 Ω .

Calibration accuracy

Frequency range	In reference to std.	Standard measurement uncertainty
20 Hz to 20 kHz	within $\pm 0.01\%$	$\pm 0.02\%$
20 kHz to 50 kHz	within $\pm 0.01\%$	$\pm 0.03\%$
50 kHz to 1 MHz	within $\pm 0.01\%$	$\pm 0.06\%$
5 Hz to 20 Hz and 1 MHz to 10 MHz	within $\pm 0.05\%$	$\pm 0.12\%$
10 MHz to 30 MHz		$\pm 0.25\%$
30 MHz to 60 MHz		$\pm 0.50\%$
60 MHz to 100 MHz		$\pm 1.50\%$

Dimensions: 3" wide, 1 $\frac{3}{4}$ " high, 1 $\frac{1}{2}$ " deep (7,6 x 4,4 x 3,8 cm).

Weight: net 2.2 oz (62 g); shipping 1 lb (450 g).

Price: HP Model 11049A*, \$125; HP Model 11050A*, \$125; HP 11051A*, \$125.

Option 001*: calibration to 60 MHz, add \$25.

Option 002*: calibration to 100 MHz, add \$50.

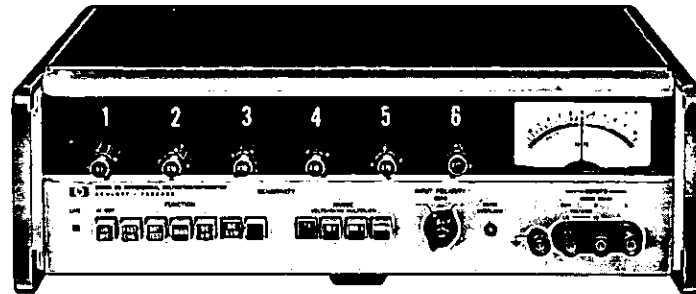
*Includes individual calibration report with statement of uncertainty; traceable to NBS. Options include individual correctional data sheet attached to calibration report.

PRECISION ANALOG VOLTMETERS AND SOURCES



DC ΔVOLT/RATIOMETER

1 ppm stability with ±0.002% accuracy
Models 3420A & 3420B



3420B

Differential Voltmeter

As a dc differential voltmeter the HP 3420A/B measures dc voltages in four ranges: 1 V, 10 V, 100 V and 1000 V full scale with an accuracy of ±(0.002% of reading +0.0002% of range) with a 10% over-range on all ranges.

The 3420A/B has infinite ($>10^{11}$ ohms) input resistance at null on 1 V and 10 V ranges with at least 10 MΩ off null on all ranges. The 6-digit in-line read-out plus meter gives a meter resolution of 0.2 ppm of range.

Ratiometer

The HP 3420A/B may be used to measure resistance divider ratios and voltage ratios rapidly without using conventional, tedious, mathematical computations. Voltage and resistance ratios can be measured from $10^3:1$ to 1:1 in four ranges; X1, X.1, X.01 and X.001. The resolution is 0.2 ppm of range. Accuracy is 20 ppm of reading +4 ppm of range.

Specifications*

DC differential voltmeter

Ranges

Voltage: ±1 V, ±10 V, ±100 V and ±1000 V with up to 10% over-ranging available on all ranges.

Resolution: 6-digit readout yields resolution of 1 ppm of range; 0.2 ppm of range indicated on meter.

Performance rating

Accuracy

30 day: ±(0.002% of reading +0.0002% of range) at 23°C ±1°C, <70% RH.

90 day: ±(0.003% of reading +0.0002% of range) at 23°C ±1°C, <70% RH.

Stability: (at 23°C ±1°C, <70% RH): 1 hr: <1 ppm of reading; 24 hr: <5 ppm of reading.

Temperature coefficient: <4 ppm of range /°C (20°C-30°C); <5 ppm of range /°C (10°C-20°C and 30°C-40°C).

Zero adjustment range: >±12 ppm of range.

Meter noise: <0.2 ppm of range p-p.

Input characteristics

Inputs: floated binding posts on front panel can be operated up to ±500 V dc (350 V rms) with respect to chassis ground.

Input resistance: >10¹¹Ω at null, <70% RH; at least 10 MΩ ±0.05% off null (1 V, 10 V ranges); 10 MΩ ±0.05% (100 V, 1000 V ranges).

Effective common-mode rejection (ECMR)

DC: >140 dB on all ranges, <70% RH.

60 Hz and above: >150 dB on all ranges, <70% RH.

Normal mode-rejection (NMR)

60 Hz and above: >102 dB.

Maximum normal-mode signal: 25 V rms on 1 V range, 200 V rms on 10 V, 100 V, 1000 V ranges.

Overload protection: ±1100 V dc may be applied on any range or sensitivity for up to 1 min without damaging instrument. Meter indicates within 5 s after removal of overload.

DC ratiometer

Ranges

Ratio: X1, X.1, X.01 and X.001.

Resolution: 6-digit readout yields resolution of 1 ppm of range; 0.2 ppm of range indicated on meter.

Performance rating

Accuracy

30 day: ±(0.002% of reading +0.0004% of range) at 23°C ±1°C, <70% RH. $\frac{E(A \text{ to Common})}{E(A \text{ to Common})}$

90 day: ±(0.003% of reading +0.0004% of range) at 23°C ±1°C, <70% RH. $\frac{E(A \text{ to Common})}{E(A \text{ to Common})}$

Stability: (at 23°C ±1°C, <70% RH) 1 hr: <1 ppm of reading; 24 hr: <5 ppm of reading.

Temperature coefficient: (10°C to 40°C) X1 range: <1 ppm of range per °C.

X.1, X.01, X.001 ranges: <5 ppm of range per °C.

Zero adjustment range: >±12 ppm of range.

Meter noise: <0.2 ppm of range (p-p).

Input characteristics

Input: 3 terminals, A, B, Common

Displayed $\frac{E(B \text{ to COM})}{E(A \text{ to COM})}$ with $E(A \text{ to COM}) > E(B \text{ to COM})$

Voltage Ratio = $\frac{E(A \text{ to COM})}{E(A \text{ to COM})}$

and of same polarity.

Range	A to Common Input Voltage	Input Resistance	
		A to Common	B to Common
X1	10 V	10 kΩ ±0.05%	>10 ¹⁰ Ω at null; at least 10 MΩ ±0.05% off null
X.1	70 V	100 kΩ ±0.05%	
X.01	500 V	1 MΩ ±0.05%	
X.001	1000 V	10 MΩ ±0.05%	

DC voltmeter*

General

Recorder output: fully adjustable 0 to ±1 V supplies 1 mA to 1 kΩ minimum resistance (in ratiometer mode, recorder ground must be isolated from COM terminal by >10¹⁰Ω).

Recorder output noise: <50 mV p-p (<0.5 ppm of range referred to input at maximum sensitivity).

Operating temperature: instrument will operate within rated specifications from 10°C to 40°C unless otherwise specified.

Power: 3420A: 115 V or 230 V ±10%, 50 Hz to 400 Hz, <2 W.

3420B: 115 V or 230 V ±10%, 50 Hz to 400 Hz, <2 W or rechargeable batteries (8 furnished) 30 hours operation per recharge; input for fast charge mode, <3 W.

Dimensions: 16¾" wide, 5-7/32" high, x 11¼" deep (425 x 132 x 286 mm).

Weight: 3420A net 20 lb (9 kg); shipping 25 lb (11.3 kg).

3420B net 21 lb (9.3 kg); shipping 27 lb (12.2 kg).

Accessories furnished: rack mount kit for 19" rack.

Price: HP 3420A, \$1400; HP 3420B, \$1550.

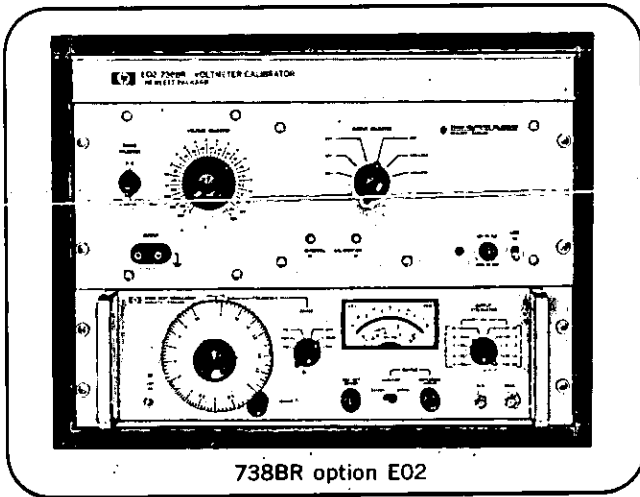
*For complete specifications, refer to Data Sheet.

VOLTMETER CALIBRATOR

DC, rms and p-p volts; flatness 10 Hz-10 MHz
Model 738BR option E02 (738BR & 652A)



PRECISION ANALOG VOLTMETERS & SOURCES



738BR option E02

The 738BR Option E02 Voltmeter Calibration system combines two moderately priced basic Hewlett-Packard instruments. These two instruments, the 652A Test Oscillator and the 738BR Voltmeter Calibrator, calibrate high impedance voltmeters and oscilloscopes for both frequency response and voltage accuracy. The system calibrates for ac and dc voltage levels from 300 μ V to 300 V in precise preselected steps and calibrates for frequency response from 10 Hz to 10 MHz.

The two instruments are available individually or in a single enclosure provided with a rear access door and power strip as the 738BR option E02.

The 738BR is a highly stable precision voltage source with drift less than 0.1% per week for dc voltage, less than 0.2% per week for ac voltage. The 652A provides a convenient con-

stant-amplitude ac output voltage at an adjustable frequency from 10 Hz to 10 MHz. The instrument's expanded meter scale monitors the frequency response rapidly and accurately with $\pm 0.25\%$ flatness.

Specifications

738BR op. E02 Voltmeter Calibration System

738BR

Voltage range: 300 μ V to 300 V, dc or ac (rms and p-p, 400 Hz).

Levels: calibration voltage 300 μ V to 300 V in steps of 1, 3, 1.5 and 5; tracking voltages 0.1 to 1 V in 0.1 V steps and 0.05 to 0.5 V in 0.05 V steps.

Accuracy: 300 V working voltage into attenuator, accurate within 0.1% dc and 0.2% ac, after a 30-minute warmup.

Attenuator accuracy: within $\pm 0.1\%$ or $\pm 2.5 \mu$ V, whichever is larger, open circuit.

Long-term stability: $< 0.1\%$ dc drift per week, $< 0.2\%$ ac drift per week.

Power: 115 or (230 V must be specified) $\pm 10\%$ 50 to 60 Hz, 350 W.

Dimensions: 19" wide, 7" high, 15 $\frac{3}{4}$ " deep behind panel (483 x 178 x 400 mm).

Weight: net 38 lbs (17 kg); shipping 53 lbs (24 kg).

Price: HP 738BR, \$1100 (rack mount).

652A

Specifications are listed on page 281 of this catalog.

General (738BR op. E02)

Dimensions: 20 $\frac{1}{2}$ " wide, 15 $\frac{3}{8}$ " high, 18 $\frac{1}{2}$ " deep (521 x 397 x 470 mm).

Weight: net 75 lbs (33.8 kg); shipping 110 lbs (49.8 kg).

Accessories furnished: cable HP part number 739A-16A, flat response to 10 MHz, BNC to shielded 50 Ω terminated dual banana plug.

Price: HP 738BR option E02, \$2110.

PORTABLE DC NULL VOLTMETER

Battery operation, 0.1 μ V resolution
Model 419A

The Model 419A DC Null Meter is a solid-state, battery operated micro-voltmeter with 0.1 μ V resolution.

The 419A is an excellent dc null detector for comparing a standard voltage with another source voltage, resistive divider or amplifier. By connecting the two voltages to the + and - floating input terminals, the voltages oppose each other and the instrument under test may be adjusted to the exact dc voltage of the standard instrument. This is accomplished by nulling the difference between the two sources on the 419A's 3 μ V range with a resolution of 0.1 μ V. Internal noise is very low, even at this resolution.

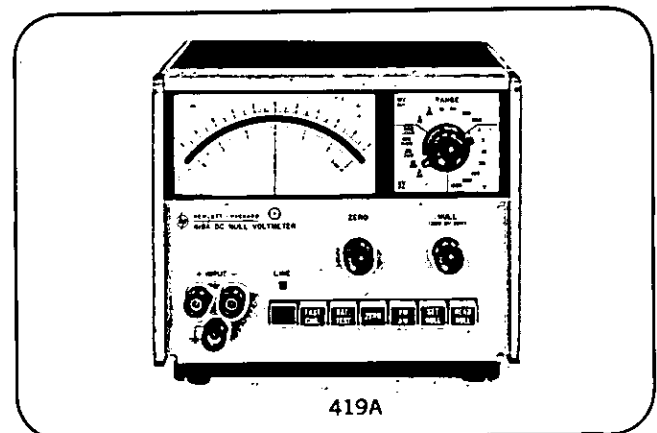
The 419A is operated from a rechargeable battery-power source so that it can be isolated from the ac power line, eliminating ground loops.

The 419A offers a feature not available in any other dc null meter: an adjustable internal nulling supply. An infinite input impedance is obtained (even on the 3 μ V range) when used as a null detector with the internal nulling supply.

Additional applications

(1) The 419A, because of its high-input impedance and sensitivity, may be used for measurements where a voltage must be read, compared or adjusted across a resistor.

(2) Transistor collector voltages can be measured.



419A

(3) Voltages may be measured across a resistive divider.

(4) Because of its high sensitivity, the 419A may be used to measure thermocouple voltages and other low-level transducer sources.

(5) Nerve potentials in biology and medicine as well as chemically-generated emf may be measured.

For complete specifications, see page 189.

PRECISION VOLTAGE SOURCES



AC/DC METER CALIBRATOR

Four calibrators in one

Model 6920B



6920B

Can be used to check:

1. DC Voltmeters up to 1000 volts
2. Average reading AC Voltmeters up to 1000 volts
3. DC Ammeters up to 5 amps
4. Average reading AC Ammeters up to 5 amps

Description

Model 6920B is a versatile ac/dc meter calibrator, capable of both constant voltage and constant current output. Its absolute accuracy makes it suitable for laboratory or production testing of panel meters, multimeters, and other meters having accuracy of the order of 1.0% or higher. This calibrator has been designed for convenience, and combines in one instrument all the outputs needed to test the more commonly used meters. Model 6920B has been packaged in an HP cabinet module suitable for bench or rack use.

Output switch

An output switch selects the safest mode of operation for the particular type of meter being tested. A "lock" position leaves the testing parameters in operation to free both hands for attaching and disconnecting successive meters. A "test" position, springloaded so that the meter calibrator output is presented to the terminals only while finger pressure is applied, facilitates testing meters with several full-scale values and reduces the danger of burn-out.

AC Output waveshape

When the function switch is set on "AC", the output waveshape is sinusoidal (to a first approximation) and has the same frequency as the input line power applied to the instrument (except when an external ac reference is used). The feedback loop, which controls and regulates this ac, is actually monitoring the average value of the ac output, although the front panel controls are calibrated in terms of rms. Thus, this calibrator is suitable for use with average

reading ac voltmeters scaled in rms. In addition, the calibrator can be used with true rms meters, provided allowance is made for the total output distortions. This distortion is approximately equal to the line input waveshape distortion (or distortion of the external ac reference) plus 3%.

Specifications

Input: 115 V ac $\pm 10\%$, single phase, 58-62 Hz, 0.7 A, 65 W max.

Output voltage ranges:

- | | |
|-----------|-----------------------------|
| 0.01-1 V | current capability 0-5 A |
| 0.1-10 V | current capability 0-1 A |
| 1-100 V | current capability 0-100 mA |
| 10-1000 V | current capability 0-10 mA |

Above output voltage ranges and maximum current capabilities for each range apply in full for either dc or ac operation.

Output current ranges: (5 A maximum output)

- | | |
|---------------|---|
| 1-100 μ A | voltage capability 0-500 V (uncalibrated) |
| 0.01-1 mA | voltage capability 0-500 V |
| 0.1-10 mA | voltage capability 0-500 V |
| 1-100 mA | voltage capability 0-50 V |
| 0.01-1 A | voltage capability 0-5 V |
| 0.1-10 A | voltage capability 0-0.5 V |

Above output current ranges and maximum voltage capabilities for each range apply in full for either dc or 60 Hz, operation.

Output accuracy: DC—0.2% of set value plus 1 digit. AC—0.4% of set value plus 1 digit (when used with average reading meters). Above accuracy applicable over a temperature range from 15°C to 35°C and over full input voltage range.

Controls:

FUNCTION SWITCH—This is a 3-position switch: "OFF", "AC", and "DC". In the "OFF" position the ac power input is disconnected from the unit. In the "AC" position the meter calibrator produces an ac output; similarly, in the "DC" position the calibrator produces a dc output.

RANGE SWITCH—10 positions, one for each voltage and current range.

CALIBRATED OUTPUT CONTROL—Digital potentiometer readout control (3 significant digits) determines exact value of output.

OUTPUT SWITCH—Switch described at left.

Output terminals: two front panel terminals are provided; these are the output terminals for both ac and dc operation. In voltage ranges, the negative terminal is grounded.

Ripple: in dc operation the output ripple is typically less than 1.0% rms/5% p-p of the output range switch setting.

Operating temperature range: 0-50°C.

Size: 6 $\frac{3}{4}$ " (172 mm) H x 7-13/16" (198 mm) W x 11" (279 mm) D.

Weight: 15 lbs (6,8 kg) net, 17 lbs (7,71 kg) shipping.

Price: \$695.

Option 005: 50 Hz ac input regulation realignment, add \$25.

Option 028: 230 V ac $\pm 10\%$, single phase input, add \$10.

AC METER CALIBRATOR

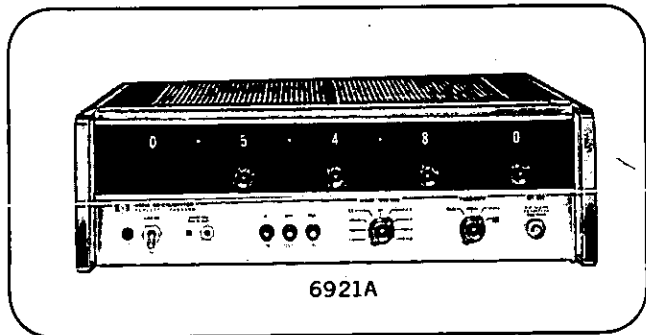
Low-cost, 0.25% accuracy
Model 6921A



PRECISION
VOLTAGE SOURCES

Advantages:

- Constant voltage or constant current output
- Programming accuracy—0.25%
- High output power—up to 28 watts
- Overtoltage and overcurrent load protection
- Handles fully reactive loads
- Easily calibrated
- Low cost
- Front-panel choice of 3 output frequencies



Description

Model 6921A is a calibrated ac source that can provide a constant voltage or a constant current output. The output waveshape is sinusoidal and its rms amplitude is within 0.25% of the set value.

Output frequencies of 60 Hz, 400 Hz, and 1 kHz (with an accuracy of 10%) are standard with the calibrator; or an external oscillator (of 1-2 V p-p amplitude) can be used to obtain any output frequency between 50 Hz and 2 kHz.

Specifications

Input 115/230 V ac $\pm 10\%$, 1 ϕ , 50-400 Hz, 120 W nominal.

Output voltage (rms): voltage setability in the chart below indicates the minimum and maximum limits for each range. The calibrator can be set below the lower limit in each range, but performance within spec is not guaranteed below this limit. The current limit in the 14 V and 140 V ranges is automatically switched to lower values when the voltage is set above 5 V and 50 V, respectively.

Voltage range	Output capability		Resolution
	Voltage setability	Current limit	
1.4 V	0.1000-1.4000 V	5 A	0.1 mV
14 V	1.000-5.000 V	5 A	1 mV
	5.001-14.000 V	2 A	
140 V	10.00-50.00 V	0.5 A	10 mV
	50.01-140.00 V	0.2 A	
140 V x 2 (280 V)	20.00-280.00 V	0.1 A	20 mV

Output current (rms): current setability in the chart below indicates the minimum and maximum limits for each range. The calibrator can be set below the lower limit in each range, but performance within spec is not guaranteed below this limit. The voltage limit in the 1.4 A range is automatically switched to 20 V when the current is set above 0.5 A.

Current range	Output capability		Resolution
	Current setability	Current limit	
1.4 mA	0.1000-1.4000 mA	140 V	0.1 μ A
14 mA	1.000-14.000 mA	140 V	1 μ A
	10.00-140.00 mA	140 V	
1.4 A	0.1000-0.5000 A	50 V	100 μ A
	0.5001-1.4000 A	20 V	
5 A	0.500-5.000 A	5 V	1 mA

Output voltage and current accuracy: 0.25% of output voltage or current setting after one hour warm up, with a relative humidity of less than 95%. The accuracy specification includes the deviations resulting from distortion, line changes, 0.1% load regulation, and $\pm 7^\circ\text{C}$ change in temperature from 25 $^\circ\text{C}$.

Output frequency: one of three internal frequencies, 60 Hz, 400 Hz, or 1 kHz, can be selected by means of a front panel switch. Frequency accuracy is $\pm 10\%$ of setting.

External oscillator input: unit can be driven by input from external oscillator at any frequency from 50 Hz to 2 kHz while meeting all specifications. Input signal must be 1-2 Vac p-p. Any distortion in the external oscillator will be present in the calibrator output and may affect output accuracy.

Temperature coefficient: less than 0.01% of output voltage or current range per $^\circ\text{C}$ from 0 $^\circ\text{C}$ to 55 $^\circ\text{C}$.

Stability: total drift for 24 hours is less than 0.1% of output voltage or current range under constant ambient temperature conditions and after 1-hour warm up.

Load regulation:

Calibrated voltage: $0.1\% + \left(\frac{0.2}{R_L}\right)\%$ of output voltage, where

R_L = load resistance in ohms.

Calibrated current: $0.1\% + (Z_L f_o \times 10^{-1})\%$ of output current, where Z_L =load impedance in ohms, and f_o =output frequency in Hz.

Line regulation: less than 0.01% of voltage or current setting for any line voltage change within input rating.

Temperature range: operating, 0 to +55 $^\circ\text{C}$; storage, -40 to +75 $^\circ\text{C}$.

Overload protection: the unit and its load circuits are fully protected against any overload condition, including a continuous short circuit.

Output terminals: HI, COMMON, and GND terminals are included on the front panel. The common terminal can be grounded or the output can be floated up to 300 V off ground.

Controls: output dials and range and frequency switches are included on the front panel.

Size: 16 $\frac{1}{2}$ " (41.9 cm) W x 5" (12.7 cm) H x 17 $\frac{3}{4}$ " (45 cm) D.

Weight: net 28 lbs. (12.6 kg); shipping 32 lbs. (14.4 kg).

Price: \$975.

Option 001: 50 Hz output frequency in place of 60 Hz; no charge.

VOLTAGE, CURRENT, RESISTANCE



ANALOG MEASURING EQUIPMENT

Voltage, current and resistance measurements are easy, fast, and accurate with electronic instruments using meter movements. Most electronic voltmeters, ammeters and ohmmeters use rectifiers, amplifiers and other circuits to generate a current proportional to the quantity being measured, which then drives a meter movement. Devices of this type are called analog instruments.

Meter Movements—the meter-movement readout should continue to be popular since it is economical and suitable for many jobs. It also lends itself well to special, nonlinear scales such as dB scales.

The pivot-jewel suspension is being replaced more and more by taut-band suspension. This has resulted in excellent repeatability with hysteresis virtually eliminated. This repeatability, in turn, makes practical the individually-calibrated meter scale. Both of these improvements are standard in most HP analog voltmeters.

Figure 1 shows scales for two different individually calibrated meters printed on one face by Hewlett-Packard's calibrator. By combining HP-produced taut-band meter movements with individually calibrated meter faces, Hewlett-Packard's meters are outstanding in ruggedness and precision.

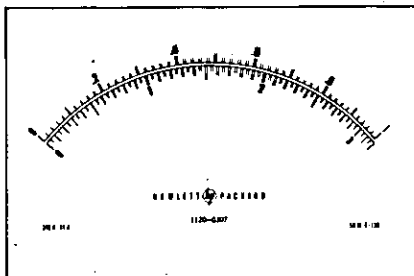


Figure 1. Scales for two different individually calibrated meters printed on one face by Hewlett-Packard's calibrator

DC Voltage Measurements

The dc voltmeter represents a straightforward application of electronics to measuring instruments. This instrument usually has a dc amplifier preceding the meter movement.

Dc amplifiers can be classified as (a) direct-coupled and (b) chopper stabilized.

Direct-coupled amplifiers are attractive for their economy and find application in lower-cost electronic voltmeters.

The direct-coupled amplifier is used to obtain sensitive ranges and higher input impedance than can be realized with non-electronic types of voltmeters.

An amplifier also limits the maximum current supplied to the meter movement so that there is little danger that unexpected overloads will burn out the meter movement. The HP 427A is representative of this class of instruments.

To supply ranges of a few millivolts or microvolts full scale, chopper stabilized amplifiers are generally used. Hewlett-Packard choppers convert the input dc to a proportional ac with zero offsets of 1 μ V or less. The ac signal is first amplified and then converted to dc (demodulated). The HP 410C uses this technique to minimize the drift characteristics of direct-coupled amplifiers.

The HP solid-state 419A DC Null Voltmeter also uses a chopper-stabilized amplifier and has 0.1 μ V resolution with 18 ranges from 3 μ V to 1000 V. An internal, adjustable, bucking voltage allows the operator to null the input signal with a front-panel control, making the input impedance effectively infinite. This dc null voltmeter is powered by rechargeable batteries.

Automatic polarity and range selection features are available. The operator can detect polarity and measure any voltage within the range of the instrument without setting controls. The meter indication is automatically maintained between 1/3 and full scale, while the range also is automatically displayed. These features are offered in the HP 414A Autovoltmeter.

DC Current Measurements

For most dc current measurements, the meter movement by itself serves the purpose admirably. In these cases, the meter coil requires relatively few turns to generate sufficient magnetic flux for deflecting the meter pointer. For lower current measurements, the sensitivity of the meter movement must be increased. This is usually accomplished by adding more turns on the coil. These added turns increase the resistance of the current path which can be troublesome in low-impedance circuits.

Electronic instruments overcome this difficulty by measuring the small voltage drop across a low-value resistance placed in series with the current to be measured. The HP 412A and 425A Voltmeters are equipped with internal-calibrated shunt resistors for reading dc currents without accessory equipment.

Resistance Measurements

Resistance is customarily determined through the familiar Ohm's relation:

$$E = IR.$$

By applying a known voltage, E, to the unknown resistance, R, and then measuring the current, I, passing through it, R can be computed.

A modified procedure for doing this is incorporated in the HP 410B, 410C, 412A, and 427A multi-function voltmeters.

The HP 414A employs a feedback-stabilized current source, allowing the use of a linear ohms scale and avoiding a special meter scale for resistance measurements. The resulting meter scales are easy to read with good resolution at lower-resistance values.

To measure extremely low resistances such as are found in short lengths of large wire, relay and switch contacts, earth ground terminals or in commutator brushes, the HP 4328A Milliohm-meter is recommended (see page 192). The HP 4328A measures resistance from 0.001 to 100 ohms full scale over 11 ranges with $\pm 2\%$ accuracy. (No additional error is caused by series reactances up to 2 times full scale resistance.)

Although the four terminal method is used to insure accurate measurements, only two probes are connected to the sample. To eliminate error due to thermal emf, contact potential differences and electrolytic polarization, the milliohm-meter is internally driven by a 1 kHz signal. The probes are floating and contain dc blocking capacitors to protect the 4328A from damage and to prevent measuring error when the probes come in contact with a dc circuit. Thus, the resistance of a sample can be measured at dc potentials.

Resistance measurements in the 4328A are accomplished by two major circuits (Figure 2). One is a 1 kHz constant-current oscillator which supplies a current to the resistance under test. The other is a voltmeter which senses voltage drop across the resistance under test and calibrates it in ohms. The voltmeter incorporates a phase-discriminator, eliminating errors caused from series reactance.

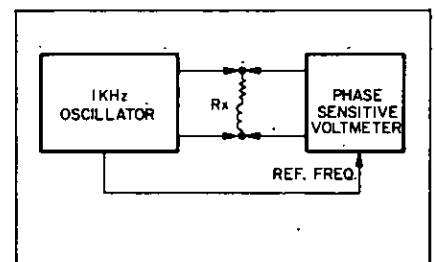


Figure 2. Simplified block diagram of HP 4328A Milliohm-meter.

With the 4328A, the voltage and current applied to the sample are extremely small. The current is constant for each range and varies from 150 μ A rms on the 100 Ω range to 150 mA on the 1 m Ω range. Even when the resistance value of the sample is greater than the range setting, the voltage protective circuit prevents any voltage higher than 20 mV from being applied to the sample.

The HP 4329A is a solid-state ohmmeter designed to measure very high resistance values found in resins, porcelain and insulating oils. This one instrument can also measure voltage and current. Accessories include a cell for resistivity measurements. Refer to page 193 for additional information.

AC Voltage Measurements

Electronic instruments for measuring ac voltages also use an amplifier with the meter movement. Analog ac voltmeters are ac-to-dc converters which derive a dc current proportional to the ac input being measured, employing this current for meter deflection. In some situations, conversion to dc by use of external probe diodes precedes amplification. The required amplifiers must then be dc amplifiers, either direct-coupled or chopper type. In other cases, the dc may be derived as a final step with sufficient power available to directly drive the meter movement of the voltmeter. Any ac amplifier may readily be a broadband dc amplifier preceded by an input-blocking capacitor.

Analog (meter) indicating ac voltmeters fall into three broad categories: average-responding, peak-responding, and rms-responding. AC voltmeters in general use are average and peak-responding types, although rms values are of principal interest.

Average-Responding Voltmeters

Probably the most widely used measurement technique combining acceptable accuracy and reasonable cost is the average-responding (absolute average) method. Figure 3 shows a typical arrangement for making an average measurement. The signal is amplified (or attenuated) and

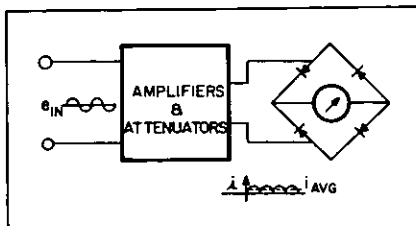


Figure 3. Average-responding voltmeter.

fed to the meter circuit through a diode bridge. For good linearity, the amplifier should be a current source at all frequencies of interest.

The average value of an ac voltage is simply the average value of voltage measured point by point along the waveform. For a sine wave and any waveform symmetrical about zero, the true average value is zero. However, a resistive load is heated by both the positive and negative current excursions in proportion to the absolute average of voltage above and below zero. Accordingly, when we speak of average voltage, we mean the average value of a full-wave rectified voltage. This value for sine wave is 0.636 times the peak voltage.

For a sinusoidal waveform, then, the rms value can easily be calibrated on a meter responding to the average value because the rms value is greater by the constant $k = 0.707/0.636 = 1.11$. Many waveforms encountered in electronic measurements are sinusoidal; in these instances, the average-responding meter, calibrated in the rms value of a sine wave, provides an accurate indication of the rms value. The widely used HP 400 series Voltmeters are average-responding voltmeters.

Average-responding voltmeter error due to harmonic distortion is low—less than 3% for about 10% harmonic distortion.

AC Microvoltmeter

Most broadband average-responding voltmeters are limited in sensitivity (100 μ V full scale) by inherent noise and spurious signals. An extension of the average-responding voltmeter, the new HP 3410A uses a synchronous phase-lock detector to read very low-level signals (3 μ V full scale) obscured in other instruments by noise. Noise and spurious signals up to 20 dB above full scale can be tolerated.

The block diagram in Figure 4 illustrates the basic operation of the HP 3410A AC Microvoltmeter. The circuit

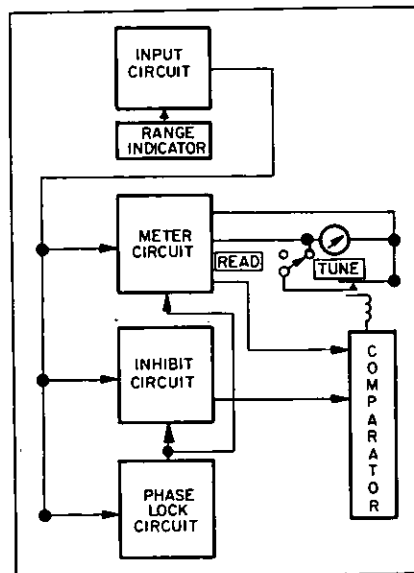


Figure 4. Block diagram of HP 3410A AC Microvoltmeter.

consists of four major sections: the input or signal-conditioning circuit, the phase-lock loop, an inhibit circuit, and a meter circuit. When tuned to any discrete frequency between 5 Hz and 600 kHz, the meter indicates the rectified average value of the signal. All noise and non-harmonically related signals are rejected. Most voltmeters using this technique require a clean, high-level reference signal input from the test signal source or use of the local oscillator output of the voltmeter by the system under test. When using the HP 3410A, such a hook-up is not necessary. By using a phase-lock oscillator to drive the synchronous detector, the need for a reference input is eliminated. Some useful 3410A applications are measuring frequency of signals in noise, separating closely-spaced coherent signals, measuring power supply ripple, measuring signal-to-noise ratios, calibrating attenuators, and measuring summing junction voltages. Refer to HP Journal, Vol. 18, No. 9.

RF Voltmeters

Conventional voltmeters responding to the absolute average or the true rms value of an ac waveform are sometimes limited in sensitivity and bandwidth by the input impedance converter, amplifier and detector. These restrictions may be relieved by sampling the signal prior to amplification and detection. This technique constructs low-frequency equivalents of high-frequency signals and permits voltmeters to make measurements over wide frequency and voltage ranges.

The HP 3406A uses an incoherent sampling technique. Unlike coherent sampling, it requires neither a triggering source nor a periodic input signal. The sampling voltmeter operates equally well with sinusoidal, pulsed, random, or frequency-modulated signals.

The HP 3406A Sampling Voltmeter responds to the absolute-average values of unknown voltages and is calibrated to read both the rms value of a sine wave and dBm in 50 ohm systems. Its sensitivity is high enough to measure voltages as small as 50 μ V over a 25 kHz to >1 GHz frequency range. Voltage scales are linear, and resolution is 20 μ V on the 1 mV range. Unlike some RF voltmeters with peak detectors that are rms-responding on the lower ranges and gradually change to peak-detecting on the higher ranges, the HP 3406A is average-responding on all ranges. This means that measurements of non-sinusoidal voltages are more accurate because its detector law does not change with the amplitude of the input signal.

An output connector from the zero-order hold circuit is available at the rear panel of the instrument for connection to other measuring equipment. Since the

statistics available at this point are the same as those of the input signal, properties such as peak, average, and rms can be measured by instruments with narrow bandwidth capabilities. Peak voltages, amplitude modulation envelopes, true rms values, pulse height information, and probability density functions of broadband signals can be determined by observing the output of the zero-order hold circuit. Much of this information has never before been accessible for broadband signals. For a detailed description of applications and operation of the HP 3406A Sampling RF Voltmeter, ask for a copy of the HP Journal, Volume 17, No. 11.

Recently introduced, the HP 8405A RF Vector Voltmeter can measure amplitudes and phase angles simultaneously from 1 to 1000 MHz. The 8405A RF Vector Voltmeter operates on the principle of coherent sampling.

Peak-Responding Voltmeter

Peak-responding voltmeters can perform over a bandwidth extending to several hundred MHz. They have a low-shunt capacitance to minimize circuit loading. Good linearity is possible for input sinusoidal signals of 0.5 volts and above. For signals smaller than 0.5 volts, special compensation techniques must be used to achieve linear meter indications.

The indication of the peak-responding voltmeter block diagram shown in Figure 5 places the rectifier in the input circuit where it charges the small input capacitor to the peak value of the input signal. This voltage is passed to a dc amplifier, which drives the meter.

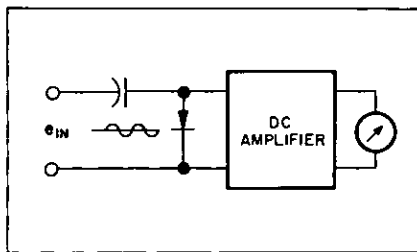


Figure 5. Peak-responding voltmeter.

Since ac-to-dc conversion is usually accomplished in the peak-responding voltmeter at the input, a dc meter circuit is required. Often dc volts, ohms and ampere scales are added to make the peak-responding meter a multi-function instrument as is the HP 410C.

Like the average-responding voltmeters, peak-responding voltmeters are usually calibrated in the rms value of a sine wave. The average-responding type, therefore, indicates 1.11 times higher than the average voltage, while the peak-responding type indicates 0.707 times the peak voltage. Consequently, both meters may be in error if the measured signal is not a pure sine wave. Peak-reading instru-

ments are generally sensitive to harmonic distortion, and care must be taken in the interpretation of the measured peak value of a non-sinusoidal waveform. For a detailed discussion of the limits of error introduced into peak and average-responding voltmeters by various harmonics, refer to HP Application Note 60.

RMS-Responding Voltmeter

The true-rms measurements technique is most often used when a high degree of accuracy is required. Instrument indication is proportional to the rms heating value of the impressed waveform. Mathematically, the root-mean-square (rms) value of any complex quantity is obtained by summing the squares of each component and taking the square root of the sum, defined as the equivalent heating power of the waveform.

The 3400A uses the thermocouple approach to measure the true rms value of waveforms. When a signal is applied, the dc voltage generated at the output of the thermocouple is proportional to the true rms value of the input. Non-linear characteristics of the thermocouple have previously been a problem in accuracy calibration. Other problems have been sluggish response and a tendency to burn out.

These thermocouple problems have been solved in the 3400A by using a thermocouple pair which acts as a summing point. The output of the ac amplifier (as shown in Figure 6) and the feedback from the dc emitter follower are inputs to the two thermocouple heaters. The difference between the two thermocouple voltages is the dc input to the chopper amplifier. This difference is modulated, amplified, demodulated, and supplied to the meter. This voltage is also fed back to TC 2 (Figure 6). This amplified dc voltage represents the true rms value of the ac signal applied to the input after it is attenuated for range. By using two matched thermocouples and measuring the dc difference, the output of the dc amplifier is linear. Using two thermocouples also provides stability against ambient temperature changes.

The dc voltage driving the meter is available at the dc output. This dc voltage provides a true rms ac-to-dc converter output.

The true rms value is measured in-

dependently of the waveshape provided that the peak excursions of the measured waveform do not exceed the dynamic range of the instrument. Distortion is not an error-contributing factor. This arrangement allows the Model 3400A to provide accurate readings of the rms value of complex waveforms having crest factors (ratio of peak-to-rms) as high as 10:1 at full scale. At 10% of full scale deflection where there is less likelihood of amplifier saturation, waveforms with crest factors as high as 100:1 can be permitted.

Voltmeter Considerations

The most appropriate instrument for ac or dc voltage measurement is the instrument reliably giving the performance needed for the existing conditions. Some considerations are:

Accuracy — Before we can discuss meter accuracy we must have a familiarity with the various meter scales available. Many instruments have meter scales marked in both volts and decibel (dB) units. It should be noted that dB and voltage are complements of each other. That is, if a voltage scale is made linear, the dB scale on the same meter face will be logarithmic or nonlinear. Likewise, if the dB scale is made linear, the voltage scale becomes nonlinear. The term "linear-log scale" is applied to an instrument that has a linear dB scale and therefore a nonlinear voltage scale. Several different types of meter faces are illustrated in Figure 7.

Accuracy specifications are usually expressed in one of three ways: 1. (percent of the full-scale value) 2. (percent of the reading) 3. (percent of reading + percent of full-scale). The first is probably the most commonly used accuracy specification. The second (percent of reading) is more commonly applied to meters having a logarithmic scale. The last method has been used more recently to obtain a tighter accuracy specification on a linear-scale instrument.

To understand the relative value of applying several accuracy specifications to any given instrument, percent uncertainty should be understood. Percent uncertainty can be defined as the ratio (in percent) of the calculated reading uncertainty to the actual meter reading, both expressed in the same scale units.

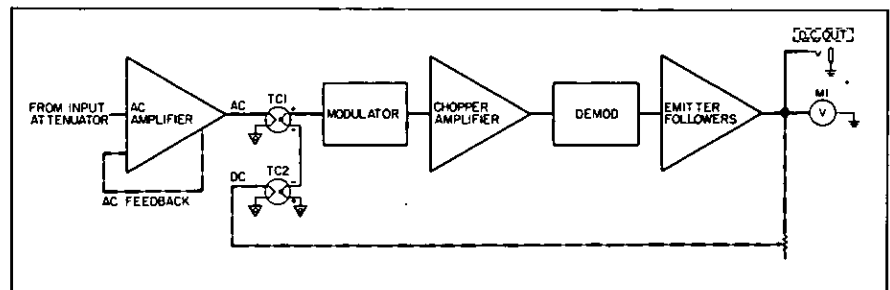


Figure 6. True rms-responding voltmeter.

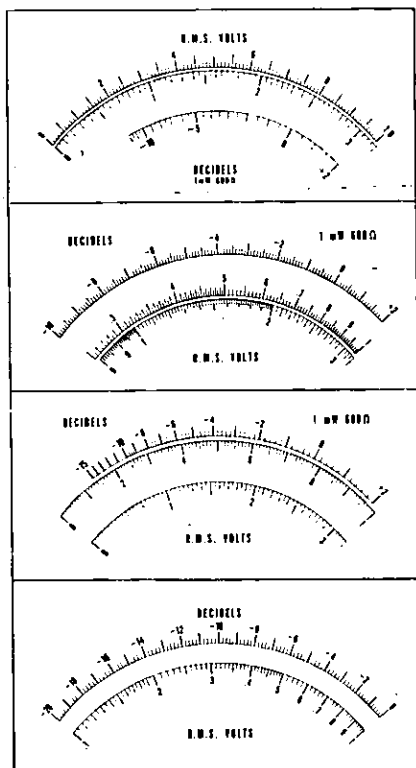


Figure 7. Four different types of meter scales available. (a) Linear 0-3 V and 0-10 V scales plus a dB scale. (b) Linear dB scale plus nonlinear (logarithmic) voltage scales. (c) dB scale placed on larger arc for greater resolution. (d) Linear -20 to 0 dB scale useful for acoustical and communications applications.

If the uncertainty is calculated from the (percent of reading) spec and then divided by the reading, the percent uncertainty will be constant for all readings and, thus, have the same value as the accuracy spec. Applying this type of accuracy specification to an instrument is practical only if the lower end of the scale is greatly expanded.

The (percent of reading) spec is employed for instruments having a log scale. If this type of spec is employed for linear scale instruments, the percent uncertainty will be unrealistically small for the lower portion of the scale. Many linear-scale instruments commonly employ (percent of full scale) specification. However, most meters of this type are capable of better accuracy than the percent uncertainty indicates. Hewlett-Packard uses the two-part accuracy specification to take advantage of the upper-scale accuracy and yet maintain a reasonable specification for the lower portion of the scale (see Figure 8).

Downranging is a method by which the improved upper-scale accuracy is utilized. In Figure 8 note that the knee of the curve for the two-part accuracy specification occurs at about 30 percent of full-scale. Thus, it is convenient to design voltage ranges in a 1-3-10 sequence. With this approach, all readings can be made on the upper two-thirds of the scale

where accuracy is best. Downranging is illustrated by the inset in Figure 8 showing a case where a maximum uncertainty of approximately 2 percent can be attained.

For a thorough evaluation of accuracy, the following should be considered: Does it apply at all input-voltage levels up to maximum overrange point? (Linearity specifications may be added to qualify this point.) Does it apply to all frequencies throughout its specified bandwidth? Does it apply on all ranges? Does it apply over a useful temperature range for the application? If not, is temperature coefficient specified?

An affirmative answer to all items is required for a complete accuracy specification. Accuracy ratings generally apply for a zero-impedance source; the same accuracies can be achieved for higher source impedances by calculating the loading effect of the input impedance on the source. Complex impedances may limit the usefulness of this technique with ac voltmeters.

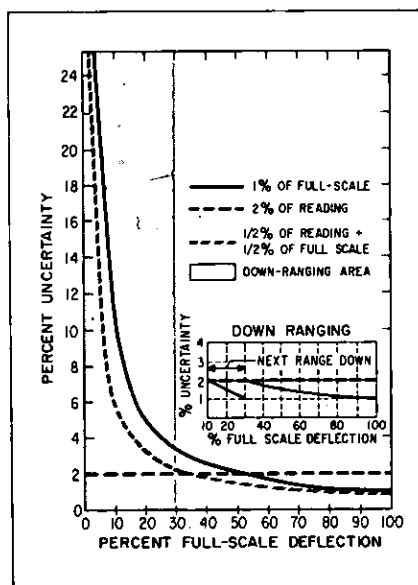


Figure 8. Percent uncertainty for three methods of specifying accuracy.

Outputs—Some voltmeters provide several analog outputs besides the meter reading. For instance, there may be both ac and dc output proportional to the pointer deflection. The ac output is useful for monitoring the waveform on an oscilloscope or for lowering the output impedance of the circuit under test. The dc output can be used to drive a strip chart or X-Y recorder for a permanent record or to drive a dc digital voltmeter to increase accuracy and resolution of broadband instruments.

Battery operation—For field work, an instrument powered by internal batteries is necessary. If an area contains troublesome ground loops, a battery powered instrument should be used to remove the ground path.

SENSITIVITY VS. BANDWIDTH—Noise is a function of bandwidth. A voltmeter with a broad bandwidth will pick up and generate more noise and is less sensitive than one operating over a narrow range of frequencies. For example, an instrument with a bandwidth of 10 Hz to 10 MHz typically can have a sensitivity of 1 mV. On the other hand, a voltmeter with bandwidth extending only to 500 kHz could have a sensitivity of 100 μ V.

AC current probe

The HP 456A Current Probe enables ac current to be measured without disturbing the circuit. This probe clips around the wire carrying the current to be measured and, in effect, makes the wire the one-turn primary of a transformer formed by ferrite cores and a many-turn secondary within the probe. The signal induced in the secondary is amplified and can be applied to any suitable ac voltmeter for measurement. The amplifier constants are chosen so that 1 mA in the wire being measured produces 1 mV at the amplifier output. Current is read directly on the voltmeter.

Summary

The basic specifications for Hewlett-Packard analog voltmeters are summarized in Table I. To help you select a voltmeter suitable to your needs, our guidelines are restated as follows:

- (1) For measurements involving dc applications, select the instrument with the broadest capability meeting your requirements.
- (2) For ac measurements involving sine waves with only modest amounts of distortion (<10%), the average-responding voltmeter provides the best accuracy and most sensitivity per dollar.
- (3) For ac measurements involving low-level signals that may be obscured by noise or other unrelated signals, the tuned voltmeter provides the best accuracy and most sensitivity per dollar.

(4) For high-frequency measurements (>10 MHz), the peak-responding voltmeter with the diode-probe input is the most economical choice. Peak-responding circuits are acceptable if inaccuracies caused by distortion in the input waveform can be tolerated.

(5) For measurements where it is important to determine the effective power of waveforms that depart from a true sinusoidal form, the true rms-responding voltmeter is the appropriate choice.

(6) For very wide bandwidths (up to 1 GHz) and high-sensitivity measurements of sinusoidal or non-sinusoidal waveforms, the HP 3406A is the proper choice. Although the 3406A is average-responding, it has a sample hold output which makes analysis of waveforms possible.

Table 1 Hewlett-Packard Analog Voltmeters

DC VOLTMETERS	Voltage Range	Frequency Range Accuracy at F.S.*	Input Impedance	Model	See Page
DC NULL VOLTMETER Internal nulling supply battery operation dc amplifier, Ammeter 30 pA-30 nA	$\pm 3 \mu\text{V} - \pm 1 \text{ kV}$ end scale 0.1 μV resolution (18 ranges)	dc $\pm 2\% + 1 \mu\text{V}$	100 k - 100 M Ω depending on range (infinite when nulled)	419A	189
DC NULL VOLTMETER Amplifier	$\pm 1 \text{ mV} - \pm 1 \text{ kV}$ end scale (13 ranges)	dc $\pm 2\%$	10M - 200 M Ω depending on range	413A	188
AC VOLTMETERS	Voltage Range	Frequency Range Typical Accuracy	Response Input Impedance	Model	See Page
BATTERY OPERATED AC VOLTMETER	1 mV - 300 V (12 ranges)	1 Hz - 1 MHz $\pm 3\% - \pm 5\%$	Average 2 M Ω / $< 25 - 60 \text{ pF}$	403A	180
RECHARGEABLE BATTERY AC VOLTMETER	1 mV - 300 V (12 ranges)	5 Hz - 2 MHz $\pm 2\% - \pm 5\%$	Average 2 M Ω / $< 30 - 60 \text{ pF}$	403B	180
VACUUM-TUBE VOLTMETER, also useful as ac amplifier	1 mV - 300 V (12 ranges)	10 Hz - 4 MHz $\pm 2\% - \pm 5\%$	Average 10 M Ω /15 - 25 pF	400D	179
Similar to 400D except has 1% accuracy		$\pm 1\% - \pm 5\%$		400H	179
Similar to 400H except has linear 12 dB log scale	-70 dB - +52 dB (12 ranges)	$\pm 2\% - \pm 5\%$		400L	179
FAST-RESPONSE AC VOLTMETER 100 kHz low-pass filter ac amplifier	100 μV - 300 V (14 ranges)	20 Hz - 4 MHz $\pm 1\% - \pm 4\%$	Average 10 M Ω /10 - 25 pF	400F	176
Similar to 400F except has linear 12 dB log scale	-90 dB - +52 dB	$\pm 1\% - \pm 4\%$		400FL	176
HIGH ACCURACY dB VOLTMETER 20 dB log scale (0 dB = 1 V)	-100 dB - +60 dB (8 ranges)	20 Hz - 4 MHz $\pm 0.2 \text{ dB} - 0.4 \text{ dB}$	Average 10 M Ω /10 - 25 pF	400GL	177
HIGH ACCURACY AC VOLTMETER has dc output ($\pm 0.5\%$) for driving recorder	1 mV - 300 V (12 ranges)	10 Hz - 10 MHz $\pm 1\% - \pm 5\%$	Average 10 M Ω /8 - 21 pF	400E	178
Similar to 400E except has linear 12 dB log scale uppermost	-70 dB - +52 dB (12 ranges)	$\pm 1\% - \pm 5\%$		400EL	178
AC MICROVOLTMETER; measures signals obscured by noise	3 μV - 3 V (13 ranges) -110 dBm to +10 dBm	5Hz - 600 kHz $\pm 3\% - \pm 10\%$	Average 10 M Ω / $< 10 - 20 \text{ pF}$	3410A	175
RMS VOLTMETER provides rms readings of complex signals. Has dc output for driving DVM's or recorders	1 mV - 300 V (12 ranges)	10 Hz - 10 MHz $\pm 1\% - \pm 5\%$	10 M Ω /15 - 40 pF	3400A	181
SAMPLING RF VOLTMETER provides true rms measurements when used with 3400A. Many accessories	1 mV - 3 V (8 ranges)	10 kHz - >1.2 GHz $\pm 3\% - \pm 13\%$	Statistical Average: Input Z depends on probe tip used	3406A	186
RF MILLIVOLTMETER	10 mV - 10 V (7 ranges)	500 kHz - 1 GHz $\pm 3\% - 1 \text{ dB}$	Average Input Z depends on probe tip used	411A	187
VECTOR VOLTMETER phase and amplitude measurements	100 μV - 10 V (9 ranges)	1 MHz - 1 GHz $\pm 0.5 \text{ dB} - \pm 1 \text{ dB}$	Average 0.1 M Ω /2.5 pF	8405A	377
MILLIOHMETER; two probes used when making 4 terminal measurements	0.001 to 100 Ω F.S. (11 ranges)	1 kHz (fixed) $\pm 2\%$ F.S.	Max. output Voltage: 20 mV	4328A	192
HIGH RESISTANCE METER and picoammeter	0.5M Ω to $2 \times 10^{16}\Omega$ F.S. 7 ranges 0.05pA to 20 μA	Voltage: $\pm 10\%$ Current: $\pm 5\%$	Max. output Voltage: 1 kV	4329A	193
MULTIFUNCTION METERS	Voltage Range (Accuracy)	Current Range (Accuracy)	Resistance Range (Accuracy)	Model	See Page
AUTOVOLTMETER has automatic ranging and polarity; input impedance 10 - 100 M Ω	DC: $\pm 5 \text{ mV} - \pm 1500 \text{ V}$ $\pm (0.5\% \text{ f.s.}, +0.5\% \text{ rdg})$ 12 ranges		5 Ω - 1.5 M Ω ($\pm 1\%$ rdg, $\pm 0.5\%$ f.s.) 12 ranges	414A	188
BATTERY-OPERATED MULTIFUNCTION METER has 10 M Ω dc input impedance and 10 M Ω /20 pF ac input impedance	DC: $\pm 100 \text{ mV} - \pm 1000 \text{ V}$ ($\pm 2\%$) 9 ranges AC: 10 mV - 300 V 10 Hz - 1 MHz ($\pm 2\%$) 10 ranges		10 Ω - 10 M Ω midscale $\pm 5\%$; from .3 to 3 on the meter scale 7 ranges	427A	183
VERSATILE VOLTMETER has 100 M Ω dc input impedance and 10 M Ω /1.5 pF ac impedance	DC: $\pm 15 \text{ mV} - \pm 1500 \text{ V}$ ($\pm 2\%$) 11 ranges AC: 0.5 V - 300 V 20 Hz - >700 MHz ($\pm 3\%$ at 400 Hz) 7 ranges	DC: $\pm 1.5 \mu\text{A}$ to $\pm 150 \text{ mA}$ ($\pm 3\%$) 11 ranges	10 Ω - 10 M Ω midscale; $\pm 5\%$ from .3 to 3 on the meter scale 7 ranges	410C	184
VACUUM-TUBE VOLTMETER has 122 M Ω dc input impedance and 10 M Ω /1.5 pF ac impedance	DC: $\pm 1 \text{ V} - \pm 1000 \text{ V}$ ($\pm 3\%$) 7 ranges AC: 1 - 300 V 20 Hz - 700 MHz ($\pm 3\%$ at 400 Hz) 6 ranges		10 Ω - 10 M Ω midscale; $\pm 5\%$ from 3 to 30 on meter scale (1 Ω on X1 range)	410B	185
DC VACUUM-TUBE VOLTMETER has 10 M Ω to 200 M Ω input impedance.	DC: $\pm 1 \text{ mV} - \pm 1000 \text{ V}$ ($\pm 1\%$) 13 ranges	DC: $\pm 1 \mu\text{A}$ to $\pm 1 \text{ A}$ ($\pm 2\%$) 13 ranges	1 Ω - 100 M Ω ($\pm 5\%$ midscale) 9 ranges	412A	190
DC MICROVOLT-AMMETER has 1 M Ω input impedance	DC: $\pm 10 \mu\text{V} - \pm 1 \text{ V}$ ($\pm 3\%$) 11 ranges	DC: $\pm 10 \text{ pA}$ to $\pm 3 \text{ mA}$ ($\pm 3\%$) 18 ranges		425A	191
CURRENT METERS	Current Range	Accuracy	Frequency Range	Model	See Page
DC MILLIAMMETER with clip-on probe eliminates direct connection	1 mA - 10 A f.s. (9 ranges)	$\pm 3\%$	dc-400 Hz	428B	194
AC CLIP-ON CURRENT PROBE makes measurements without breaking circuit	1 mA - 1 A rms (to 25 A with divider)	$\pm 2\%$ to 3 dB	25 Hz - 20 MHz	456A	195

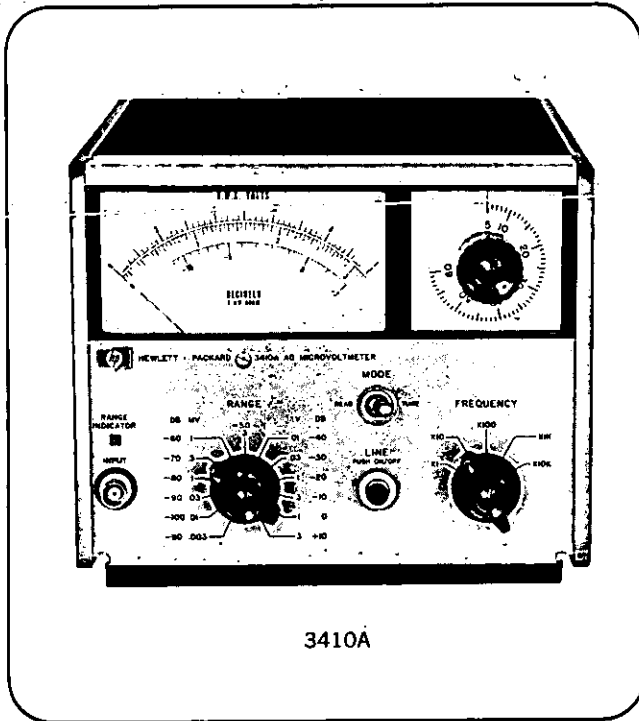
*For exact accuracy refer to page designated.

AC MICROVOLT METER

Measure signals obscured by noise
Model 3410A



VOLTAGE, CURRENT,
RESISTANCE



Uses:

- Measure amplitude of signal buried in noise
- Measure amplitude of ripple frequency
- Measure amplitude of superimposed frequency
- Use as a Preamp/Noise Discriminator for frequency measurements

The HP Model 3410A AC Microvoltmeter is a tuneable, phase lock voltmeter designed to measure low level repetitive signals obscured by noise or in the presence of other non-harmonically related signals. Its sensitivity is $3 \mu\text{V}$ to 3 V full scale in 13 ranges over a frequency range of 5 Hz to 600 kHz. Signals obscured by noise 20 dB above full scale can be detected and measured with no degradation in accuracy.

Frequency of low level and noise repetitive signals can be accurately measured using a frequency counter connected to the local oscillator output on the rear panel of the 3410A. This signal is a 4 V square wave, phase locked to the tuned input signal. Counter sensitivity can be increased to better than 300 nanovolts (the point at which phase lock is lost on the 3 microvolt range) with excellent noise discrimination.

A dc recorder output enhances the usefulness of the 3410A as a sensitive detector for graphic recording.

Specifications

Voltage range: $3 \mu\text{V}$ full scale to 3 V full scale in 13 ranges.

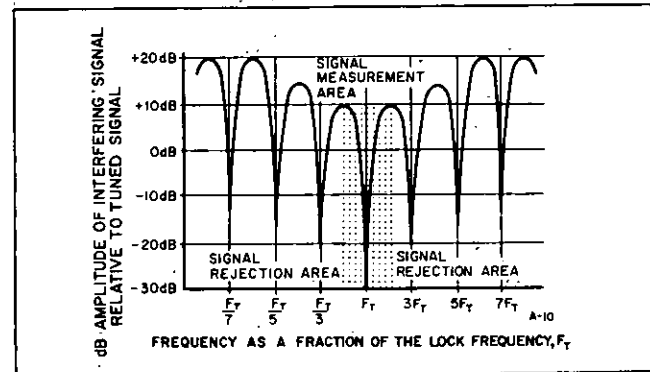
Voltage accuracy: (% of full scale).

Frequency

	5 Hz	10 Hz	25 Hz	100 Hz	50 kHz	600 kHz
30 μV TO 3V	$\pm 10\%$	$\pm 3\%$			$\pm 5\%$	
10 μV	$\pm 15\%$	$\pm 10\%$	$\pm 3\%$		$\pm 5\%$	
3 μV	$\pm 20\%$		$\pm 10\%$	$\pm 3\%$	$\pm 10\%$	

*At lower frequencies and microvolt signal levels, meter fluctuations in the READ MODE may give the impression of an unstable lock condition. However, the 3410A will lock and track at these lower frequencies and provide a usable voltage indication.

Rejection Characteristics



Frequency range: 5 Hz to 600 kHz in 5 decade ranges.

Frequency dial accuracy: $\pm 10\%$ full scale (unlocked).

Phase lock range: pull in $\pm 1\%$ of full scale frequency.
Track $\pm 5\%$ of full scale frequency. Tracking speed 0.5% of full scale frequency/second.

Maximum noise rejection: 20 dB rms above full scale on all ranges for rated accuracy.

Input impedance: 10 mV to 3 V range, 10 M Ω shunted by $< 10 \text{ pF}$. $3 \mu\text{V}$ to 3 mV range, 10 M Ω shunted by $< 20 \text{ pF}$.

Meter indication: responds to average value of input waveform; calibrated in rms value of sine wave. Linear voltage scales 0 to 1 and 0 to 3; dB scale -12 to +2 dB (0 dB = 1 mW into 600 Ω).

Local oscillator output: $> 4 \text{ V}$ square wave into open circuit at the same frequency as the phase locked input signal.

DC output: 1 V into 1000 Ω for full scale, proportional to meter deflection; $\pm 0.5 \text{ V}$ adjustable offset level.

AC power: 115 or 230 V $\pm 10\%$, 50 to 400 Hz, 22 W.

Weight: net 10 lbs (4,5 kg); shipping 12.5 lbs (5,6 kg).

Dimensions: 7 $\frac{3}{4}$ " wide, 6 $\frac{1}{4}$ " high (without removable feet), 11" deep (197 x 159 x 279 mm).

Accessories available: HP 11074A Voltage Divider Probe. Provides 10:1 division ratio to extend 3410A input to 30 V rms full scale, \$50.

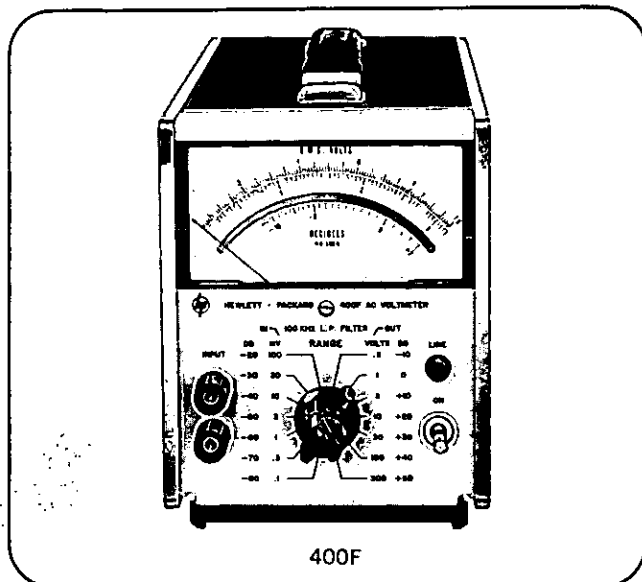
Price: HP 3410A, \$895. HP 3410A Option 001, dB scale uppermost, add \$10.

VOLTAGE, CURRENT, RESISTANCE



AC VOLTMETERS

Measure 20 Hz to 4 MHz, 100 μ V to 300 V
Models 400F, 400FL



Description

The HP 400F/FL Solid-State AC Voltmeters are ruggedly built precision instruments for measuring ac voltages from 100 microvolts to 300 V rms full scale. They cover a frequency range from 20 Hz to 4 MHz and have constant 10 megohm input resistance on all ranges. Input capacity is 25 pF on the 100 μ V to 300 mV range and 10 pF on the 1 volt to 300 volt range. The instruments are simple to operate and give direct voltage and dBm readings. The 400F/FL may also be used as a stable, high-gain ac amplifier with up to 80 dB amplification.

100 kHz Low Pass Filter

In order to reduce the effect of unwanted high frequencies (noise, etc.) on the accuracy of measuring lower frequency signals, a 100 kHz low-pass filter is provided. It may be activated by a front-panel switch. The filter is effective on all ranges but will be of greater use on more sensitive ranges. It has 3 dB of attenuation at 100 kHz \pm 5 kHz.

Battery Operation

The Models 400F/FL can be operated from two 35-to-55-volt batteries connected to the rear-panel battery terminals. This feature is ideal for communications usage or for trouble caused by ground loops.

Model 400F

The 400F has all the characteristics mentioned in the general description with $\frac{1}{2}\%$ of reading plus $\frac{1}{2}\%$ of full scale accuracy on a $4\frac{1}{2}$ " mirror-backed taut-band meter. The meter is individually calibrated with 100 divisions to provide greater resolution. The Model 400F option 001 with dB scale uppermost is recommended for greater resolution in dB measurements.

Model 400FL

The 400FL has all the characteristics mentioned in the general description with 1% of reading accuracy on a linear 12 dB logarithmic scale. This meter is also individually calibrated with 120 divisions and is ideal for dB measurements. It in-

corporates a Hewlett-Packard taut-band, mirror-backed, logarithmic meter. A range switch changes sensitivity in 10 dB steps which, combined with the 12 dB scale, provides the overlap desirable in decibel-level measurements.

Specifications

Frequency range: 20 Hz to 4 MHz.

Voltage range: 100 μ V to 300 V full scale, 14 ranges.

HP MODEL 400F	
ACCURACY % Full Scale Plus % Reading	
100 μ V to 300 V RANGES	
Frequency	20 Hz 40 Hz 100 Hz 1 MHz 2 MHz 4 MHz
	$\pm(2 + 2)$ $\pm(1 + 1)$ $\pm(1/2 + 1/2)$ $\pm(1 + 1)$ $\pm(2 + 2)$
100 μ V RANGE	
Frequency	30 Hz 60 Hz 100 kHz 500 kHz
	$\pm(2 + 2)$ $\pm(1 + 1)$ ± 0 ± 1

HP MODEL 400FL	
ACCURACY % Reading	
100 μ V to 300 V RANGES	
Frequency	20 Hz 40 Hz 100 Hz 1 MHz 2 MHz 4 MHz
	± 1 ± 2 ± 1 ± 2 ± 1
100 μ V RANGE	
Frequency	30 Hz 60 Hz 100 kHz 500 kHz
	± 1 ± 2 ± 1 ± 1

*Noise referred to input (1000 Ω termination)

Voltage Ranges	Filter In	Filter Out
300 μ V to 300 V	< 5 μ V	< 30 μ V
100 μ V	< 5 μ V	< 15 μ V

Note: Noise adds to the signal approximately by the relation:

$$\text{Reading} = \sqrt{(\text{signal})^2 + (\text{noise})^2}$$

Calibration: reads rms value of sine wave; voltage indication proportional to absolute average of applied wave.

400F: dB scale -10 to +2 dB, 10 dB between ranges; 100 divisions on 0 to 1 scale.

400FL: linear dB scale -10 dB to +2 dB, 10 dB between ranges; logarithmic voltage scales 0.25 to 1 and 0.8 to 3; 120 divisions from -10 to +2 dB.

Input impedance: 10 M Ω shunted by < 30 pF on the 100 μ V—300 mV ranges; 10 M Ω shunted by < 15 pF on the 1 V—300 V ranges.

Amplifier ac output: 1 V rms, open circuit, for full scale indication; output impedance 600 Ω , frequency response 20 Hz to 4 MHz on 1 mV to 300 V ranges. 30 Hz to 100 kHz on 100 μ V and 300 μ V range; 100 kHz filter in the "in" position on the 100 μ V and 300 μ V range.

Recovery from overload: < 2 s for 80 dB overload; 300 V max.

Meter response: < 0.7 s after application of signal.

Temperature range: 0°C to +55°C.

AC power: 115 or 230 V \pm 10%, 50 to 400 Hz, 5 W.

External battery operation: terminals are provided on rear panel.

Positive and negative voltages between 35 V and 55 V are required; current drain from each voltage is approx. 45 mA (external switching and on/off monitoring should be used for battery operation).

Dimensions: 5 $\frac{1}{8}$ " wide, 6 $\frac{1}{4}$ " high (without removable feet), 11" deep (130 x 159 x 279 mm).

Weight: net 5 lb 10 oz (2,5 kg); shipping 7 lb 10 oz (3,5 kg).

Accessories available: 11041A 100:1 Capacitive Divider for 400 series VMS, \$60; 11074A Voltage Divider Probe, \$50.

Price: 400F, \$300; 400FL, \$310.

400F, option 001: reads directly in volts and dB with dB scale uppermost; add \$10. 400 F/FL option H10 (constant input capacity).

AC VOLTMETER

20 dB linear scale, measures -100 to +60 dB
400GL



VOLTAGE, CURRENT,
RESISTANCE

Description

The HP Model 400GL features 20 dB dynamic range on a large 4½ inch linear scale—permitting measurements of voltages of widely different levels with a minimum of range switching. This is especially beneficial when measuring input and output levels of devices such as amplifiers and attenuators, since it saves times and reduces errors. The 400GL has only one voltage scale; reading time is faster and the possibility of reading errors is further minimized. Furthermore, accuracy and resolution is uniform over the entire scale, making each range completely usable.

In order to reduce the effect of unwanted high frequencies (noise, etc.) on the accuracy of measuring small low frequency signals, a switchable low pass filter is provided. When activated, the filter attenuates frequencies above 100 kHz.

For field applications and for ground loop isolation, the 400GL can be battery operated by connecting two 35-50 volt batteries to the rear panel terminals.

The 400GL can also be used as a stable, high gain 4 MHz amplifier, with up to 80 dB gain on the lower ranges. Output is proportional to the voltage indicated on the meter.

Specifications

Voltage range: 100 μ V to 1000 V full scale, 8 ranges.

Frequency range: 20 Hz to 4 MHz.

Calibration: responds to average value of input waveform; calibrated in rms value of a sine wave. Linear dB scale, 100 divisions from -20 to 0 dB. Logarithmic voltage scale 0 dB = 1 V.

ACCURACY (dB of Reading)

1 mV-1000V* Ranges

20 Hz	40 Hz	500 kHz	2 MHz	4 MHz
± 0.4 dB	± 0.2 dB	± 0.4 dB	$+0.2$ dB	-0.6 dB

100 μ V Range

30 Hz	60 Hz	100 kHz	500 kHz
± 0.4 dB	± 0.2 dB	$+0.2$ dB	-0.6 dB

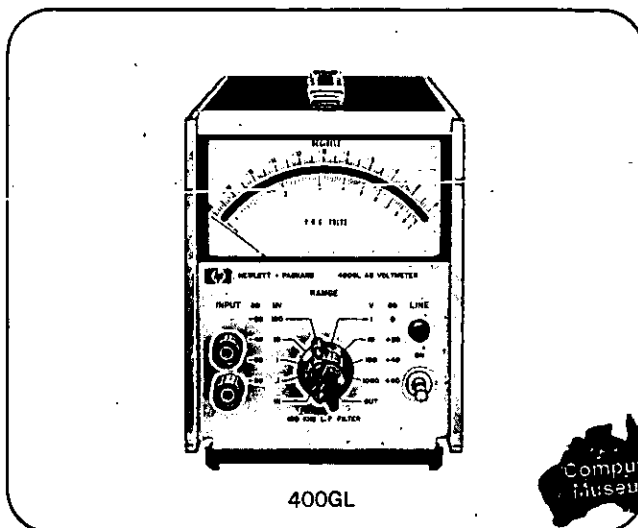
* For input voltages greater than 300 volts, the high frequency range is limited to 100 kHz.

Noise referred to input (1000 Ω termination):

	Filter in	Filter out
1 mV - 1000 V	<5 μ V	<30 μ V
100 μ V Range	<5 μ V	<15 μ V

Note: Noise adds to the signal approximately by the relation:

$$\text{Reading} = \sqrt{(\text{signal})^2 + (\text{noise})^2}$$



400GL

Temperature range: 0 to +55°C.

Recovery from overload: <2 seconds for 80 dB overload (1200 V max. input).

Input impedance: resistance: 10 M Ω all ranges.

capacitance: <30 pF for 100 μ V-100 mV ranges.
<15 pF for 1 V-1000 V ranges.

Amplifier ac output: 1 V rms, open circuit (for full scale deflection), proportional to meter indication on voltage scale; frequency response 20 Hz to 4 MHz on 1 mV to 1000 V range, 30 Hz to 100 kHz on 100 μ V range. 100 kHz filter in the "in" position on 100 μ V range.

AC power: 115 or 230 V $\pm 10\%$, 50 to 400 Hz, 5 W.

External battery operation: terminals are provided on rear panel; positive and negative voltages between 35 V and 55 V are required; current drain from each battery is approximately 45 mA (external switching and on/off monitoring should be used for battery operation).

Dimensions: 5½" wide, 6¼" high (without removable feet), 11" deep (130 x 159 x 279 mm).

Weight: net 6 lbs (2,7 kg); shipping 8 lbs (3,6 kg).

Accessories available: HP 11074A, 10:1 Voltage Divider Probe.

Price: HP 400GL, \$350.

Voltage Divider Probe

The Voltage Divider Probe (HP 11074A) with a banana post to BNC adapter (HP 10111A) provides low input capacitance at the point of measurement when using the 400 series voltmeters.

Specifications

Input impedance: 10 M Ω shunted by 10 pF.

Division ratio: 10:1.

Division ratio accuracy: $\pm 2\%$.

Bandwidth: dc to 10 MHz.

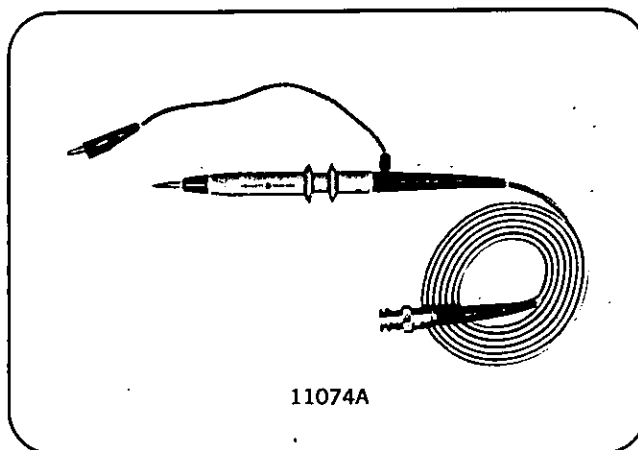
Maximum input voltage: 1000 V rms.

Terminals: alligator clip contactor with BNC output connector.

Length and weight: 5 feet; approximately 4 oz.

Price: HP 11074A Voltage Divider Probe, \$50. HP 10111A Adapter, \$7.

HP 11076A Instrument Case (refer to page 636). Price, \$45.



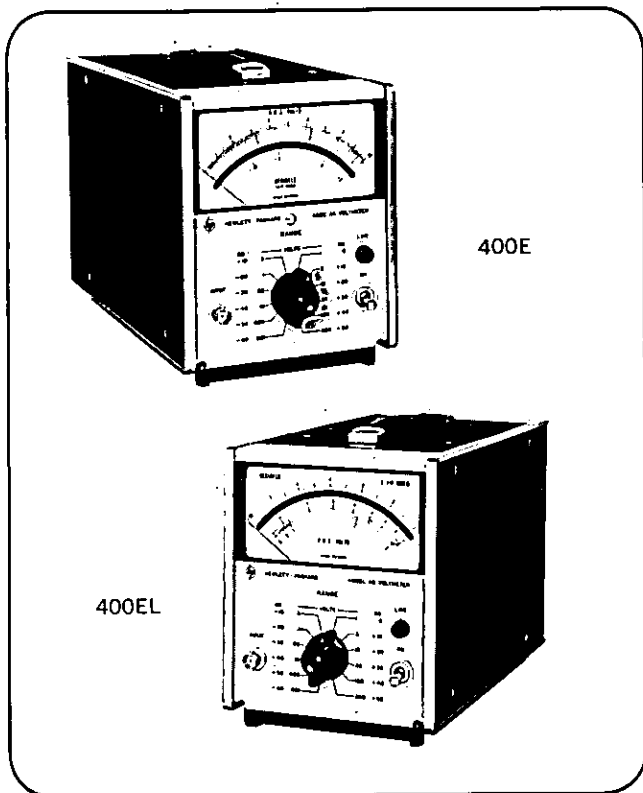
11074A

VOLTAGE, CURRENT, RESISTANCE



AC VOLTMETERS

Measure 10 Hz to 10 MHz, 1 mV to 300V
Models 400E, 400EL



Description

The HP 400E and 400EL Solid-State AC Voltmeters are ruggedly built precision instruments for measuring ac voltages from 1 mV to 300 V rms full scale. They cover a frequency range from 10 Hz to 10 MHz and have constant 10 M Ω input resistance on all ranges. Input capacity is <25 pF on the 1 mV to 1 volt range and <12 pF on the 3 volt to 300 volt range. The instruments are simple to operate and give direct voltage and dBm readings.

The Models 400E and 400EL provide a linear dc output proportional to meter deflection. One volt dc is available at full scale with an output impedance of 1000 ohms. Refer to specifications for the accuracy of this ac to dc converter.

The 400E and 400EL also provide a stable low-distortion ac output of 150 millivolts at full scale. The output impedance is 50 ohms. These outputs are available on the rear panel of the instrument.

Both instruments can be operated from two 35-to-55-volt batteries connected to the rear panel battery terminals. This feature is ideal for communications usage or for measurements when troublesome ground loops are prevalent.

Specifications, 400E, 400EL

Voltage range: 1 mV to 300 V full scale, 12 ranges.
Frequency range: 10 Hz to 10 MHz.

Model 400E

Calibration: reads rms value of sine wave; voltage indication proportional to absolute average value of applied wave; dB scale -10 to +2 dB, 10 dB between ranges; 100 divisions on 0 to 1 scale.

Model 400EL

Calibration: reads rms value of sine wave; voltage indication proportional to absolute average value of applied wave; linear dB scale -10 dB to +2 dB, 10 dB between ranges; logarithmic voltage scales 0.3 to 1 and 0.8 to 3; 120 divisions from -10 to +2 dB.

Models 400E, 400EL

ACCURACY \pm (% of Full Scale + % of Reading)

3 mV to 300V Ranges

Frequency	10 Hz	40 Hz	2 MHz	4 MHz	10 MHz
	$\pm(2.5+2.5)$		$\pm(1+0)$	$\pm(1.5+1.5)$	$\pm(2.5+2.5)$

1 mV Range

(1/3 full scale to full scale)

Frequency	10 Hz	40 Hz	500kHz	4 MHz
	$\pm(2.5+2.5)$	$\pm(1+0)$		$\pm(2.5+2.5)$

AC to DC Converter Output

3 mV to 300 V Ranges

Frequency	10 Hz	20 Hz	100 Hz	500 kHz	1 MHz	10 MHz
	$\pm(2.5+2.5)$	$\pm(1+1)$	$\pm(1/4+1/4)^*$	$\pm(1/2+1/2)$		$\pm(2.5+2.5)$

1 mV Range

(1/3 full scale to full scale)

Frequency	10 Hz	20 Hz	100 Hz	100 kHz	1 MHz	4 MHz
	$\pm(2.5+2.5)$	$\pm(1+1)$	$\pm(.4+.1)^*$	$\pm(1+1)$		$\pm(2.5+2.5)$

*For 15°C To 40°C on 1mV and 1V ranges only.

Input impedance: 10 M Ω shunted by <25 pF on the 1 mV to 1 V ranges, and 10 M Ω shunted by <12 pF on the 3 V to 300 V ranges.

Amplifier ac output: 150 mV rms for full scale meter indication; output impedance 50 Ω ; 10 Hz to 10 MHz (105 mV on the 1 mV range); accuracy \pm 10%, 10 Hz to 4 MHz.

AC-DC converter output: 1 V dc output for full scale meter deflection (linear output).

Output resistance: 1000 Ω \pm 5%.

Response time: 1 s to within 1% of final value for a step change.

Meter response time: <1 s, 0 to full scale.

Temperature range: 0 to +55°C (except where noted on accuracy charts).

AC power: 115 or 230 V \pm 10%, 50 to 400 Hz, 5 W.

External battery operation: terminals are provided on rear panel; positive and negative voltages between 35 V and 55 V are required; current drain from each voltage is 50 mA to 75 mA (external switching and on/off monitoring should be used for battery operation).

Dimensions: standard 1/3 module 5 1/8" wide, 6 1/4" high (without removable feet), 11" deep (130 x 165 x 279 mm).

Weight: net 6 lbs (2,7 kg); shipping 8 lbs (3,6 kg).

Accessories available: 11076A Instrument Case (refer to page 636, \$45. 11074, 10:1 voltage divider probe, \$50.

Price: HP 400E, \$335, HP 400EL, \$345.

Option 001(400E only): reads directly in V and dB with dB scale uppermost, add \$10.

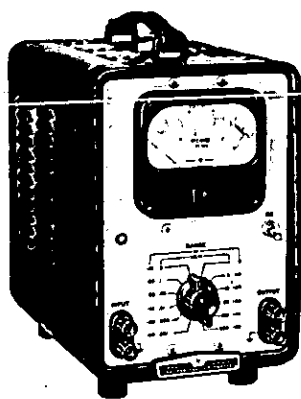
400E, 400EL option M05: constant input capacity available on special order; price on request (optimum performance for 11074A Voltage Divider Probe).

VACUUM TUBE VOLTMETERS

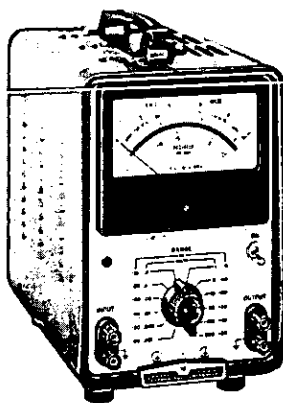
Quality linear and log voltmeters
Models 400D, 400H, 400L



**VOLTAGE, CURRENT,
RESISTANCE**



400D



400H



400L

Description

Model 400D is essentially a low-priced precision voltmeter offering wide voltage range, 2% accuracy, and the broad frequency coverage of 10 Hz to 4 MHz.

Model 400H is an adaptation of Model 400D but offering individual meter-face calibration and 1% accuracy on an extra large 5" mirror-scale meter.

Model 400L, a logarithmic version of Model 400D, has an

accuracy of $\pm 2\%$ of reading or $\pm 1\%$ of full scale, whichever is more accurate. The 5" meter is mirror backed.

Special dB-measuring options

As normally supplied, Models 400D and 400H read direct in volts and dB, with the voltage scale uppermost. For greater resolution in dB measuring, these instruments are available as Models 400D option 001, and 400H option 001 (\$25 extra) with the dB meter scale uppermost.

Specifications

	400D,DR	400H,HR	400L,LR
Voltage range:	1.0 mV to 300 V full scale, 12 ranges	1.0 Mv to 300 V full scale, 12 ranges	-70 dB to +52 dB in 12 ranges 1.0 mV to 300 V full scale, 12 ranges
Frequency range:	10 Hz to 4 MHz		
Accuracy:	10 Hz to 20 Hz: $\pm 10\%$ f.s. 20 Hz to 1 MHz: $\pm 2\%$ f.s. 1 MHz to 2 MHz: $\pm 3\%$ f.s. 2 MHz to 4 MHz: $\pm 10\%$ f.s.	10 Hz to 20 Hz: $\pm 10\%$ f.s. 20 Hz to 50 Hz: $\pm 2\%$ f.s. 50 Hz to 500 kHz: $\pm 1\%$ f.s. 500 kHz to 1 MHz: $\pm 2\%$ f.s. 1 MHz to 2 MHz: $\pm 3\%$ f.s. 2 MHz to 4 MHz: $\pm 10\%$ f.s.	10 Hz to 20 Hz: $\pm 5\%$ of rdg. 20 Hz to 50 Hz: $\pm 3\%$ of rdg. or $\pm 2\%$ of f.s.† 50 Hz to 500 kHz: $\pm 2\%$ of rdg. or $\pm 1\%$ of f.s.† 500 kHz to 1 MHz: $\pm 3\%$ of rdg. or $\pm 2\%$ of f.s.† 1 MHz to 2 MHz: $\pm 4\%$ of rdg. or $\pm 3\%$ of f.s.† 2 MHz to 4 MHz: $\pm 5\%$ of rdg.
Calibration:	reads rms value of sine wave; voltage indication proportional to average value of applied wave; linear voltage scale 0 to 3 and 0 to 1; dB scale -12 to +2 dB (0 dB = 1 mW in 600 Ω); 10 dB interval between ranges		reads rms value of sine wave; logarithmic voltage scale 0.3 to 1 and 0.8 to 3; linear dB scale, -10 dB to +2 dB (based on 0 dB = 1 mW in 600 Ω); 10 dB intervals between ranges
Input impedance:	10 M Ω shunted by <20 pF on ranges 1 to 300 V; <35 pF on ranges 0.001 to 0.3 V		
Amplifier:	output 0.15 V max.; output impedance 50 Ω ; max. gain 150 on 0.001 range		
Power:	115 or (230 V must be specified) $\pm 10\%$, 50 to 400 Hz; 80 W (100 W for 400 H,L)		
Dimensions:	cabinet mount: 7½" wide, 11½" high, 12" deep (191 x 292 x 305 mm) rack mount: 19" wide, 7" high, 10⅞" deep behind panel (483 x 389 x 276 mm)		
Weight:	net 18 lbs (8,1 kg), shipping 20 lbs (9,0 kg) (cabinet mount); net 21 lbs (9,45 kg), shipping 31 lbs (14 kg) (rack mount)		
Price:	HP 400D, \$300* HP 400DR, \$305**	HP 400H, \$375* HP 400HR, \$380**	HP 400L, \$385* HP 400LR, \$390**

*Cabinet. † % of full scale (f.s.) or % of reading (rdg.) whichever is more accurate.

**Rack mount.

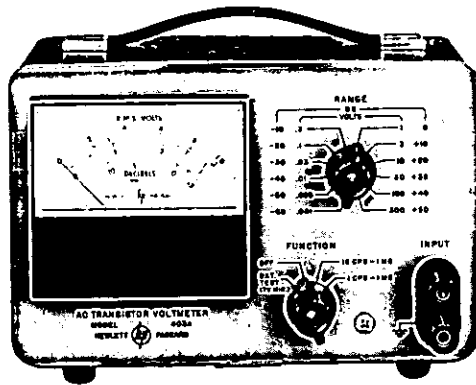
VOLTAGE, CURRENT, RESISTANCE



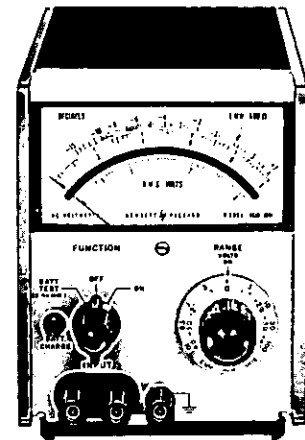
AC VOLTMETERS

Solid-state, battery-operated, portable

Model 403A, 403B



403A



403B

Description

Models 403A and 403B ac voltmeters are versatile, general purpose instruments for laboratory and production work and are ideal for use in the field since they are solid-state, battery-operated, and portable.

Both measure from 100 microvolts to 300 volts, the 403A covering 1 Hz to 1 MHz and the 403B covering 5 Hz to 2 MHz. Both operate from internal batteries and thus may be completely isolated from the power line and external grounds, permitting accurate measurements at power-line frequency and its harmonics without concern for beat effects. Isolation from external ground also permits use where ground loops are troublesome. Turnover effect and waveform errors

are minimized because the meters respond to the average value of the input signal.

The 403B operates from an ac line as well as from the internal battery pack, and batteries recharge during ac operation. Battery charge may be easily checked with a front-panel switch to assure reliable measurements. Normally, about 60 hours of ac operation recharge the batteries; but an internal adjustment is provided which nearly doubles the charging rate. The Model 403B can be used while its batteries charge. A sturdy taut-band meter eliminates friction and provides greater precision and repeatability.

For improved resolution in dB measurements, the 403B option 001 is available. This version spreads out the dB scale by making it the top scale of the meter.

Specifications

HP Model	403A	403B	403B Option 001
Range	0.001 to 300 V rms full scale, 12 ranges, in a 1, 3, 10 sequence.		
Meter	responds to average value of input waveform, calibrated in the rms value of a sine wave.		
Frequency range	1 Hz to 1 MHz	5 Hz to 2 MHz	5 Hz to 2 MHz
Accuracy	within $\pm 3\%$ of full scale, 5 Hz to 500 kHz; within $\pm 5\%$ of full scale, 1 to 5 Hz and 500 kHz to 1 MHz	within $\pm 2\%$ of full scale from 10 Hz to 1 MHz; within $\pm 5\%$ of full scale from 5 to 10 Hz and 1 to 2 MHz, except $\pm 10\%$ 1 to 2 MHz on the 300 V range (0 to 50°C)*	within ± 0.2 dB of full scale from 10 Hz to 1 MHz; within ± 0.4 dB of full scale from 5 to 10 Hz and 1 to 2 MHz, except ± 0.8 dB 1 to 2 MHz on the 300 V range (0 to 50°C)*
Input impedance	2M Ω shunted by < 60 pF, 0.001 to 0.1V ranges; 2M Ω shunted by < 25 pF on 0.3 to 300 V ranges	2M Ω ; shunted by < 60 pF; 0.001 to 0.03 V ranges; < 30 pF, 0.1 to 300 V ranges	same as 403B
Maximum input	600 VP, 0.3 V and higher ranges; 25 V rms on 0.1 V and lower ranges (fused).	600 VP, 0.3 to 300 V range; 25 V rms, 60 VP, 0.001 to 0.1 V ranges (fused).	same as 403B
Power	5 standard radio-type mercury cells. Battery life approx. 400 hours	4 rechargeable batteries, 40 hr' operation per recharge, up to 500 recharging cycles; self-contained recharging circuit functions during operation from ac line	same as 403B
Dimensions	8 $\frac{1}{4}$ " wide, 5 $\frac{1}{2}$ " high, 6 $\frac{3}{8}$ " deep (210 x 140 x 162 mm)	5 $\frac{1}{8}$ " wide, 6 $\frac{1}{4}$ " high (without removable feet), 8" deep (130 x 159 x 203 mm)	same as 403B
Weight	net 4 $\frac{3}{4}$ lbs (2,1 kg); shipping 7 lbs (3,2 kg)	net 6 $\frac{1}{2}$ lbs (2,9 kg); shipping 8 lbs (3,6 kg)	same as 403B
Price	\$350	\$340	\$365

*Use 10001A 10:1 Divider and 10111A Adapter to retain $\pm 5\%$ (± 0.4 dB) accuracy while measuring up to 425 V rms at 1 to 2 MHz.

RMS VOLTMETER

True RMS ac to dc converter
Model 3400A



**VOLTAGE, CURRENT,
RESISTANCE**

Description

The Hewlett-Packard Model 3400A is a true root-mean-square (rms) voltmeter, providing a meter indication proportional to the dc heating power of the input waveform. In addition to its meter indication, the Model 3400A provides a dc output proportional to meter deflection making it a useful true rms detector for graphic recording and digitizing with a dc digital voltmeter, such as the HP Model 3440A.

Versatility

Versatility of the Model 3400A is enhanced by its wide 10-Hz to 10-MHz frequency response, high crest factor, 1-mV to 300-Volt full-scale sensitivity and 10-M Ω input impedance. Six-decade frequency coverage makes the 3400A extremely flexible for all audio and most rf measurements and permits the measurement of broadband noise and fast-rise pulse. A wide range of sensitivity (12 ranges) allows measurement of anything from "down in the grass" signal and noise, to transmitter and amplifier outputs (with 30-dB overload protection). Pulses or other non-sinusoids with crest factors (ratio of peak to rms) up to 10:1 can be measured full scale. Crest factor is inversely proportional to meter deflection, permitting up to 100:1 crest factor at 10% of full scale. The ability of the 3400A to accept waveforms with such large crest factors insures accurate noise and pulse measurements without the need for correction factors. Permanent plots of measured data and higher resolution measurements can be obtained by connecting an X-Y plotter, strip chart recorder or digital voltmeter to the convenient rear-panel dc output. The dc output provides a linear 0 to 1-volt drive proportional to meter deflection.

True-rms current measurements can be made conveniently by using the HP Model 456A Current Probe with the Model 3400A. See page 195.

Specifications

Voltage range: 1 mV to 300 V, 12 ranges.

dB range: -72 to +52 dBm (0 dBm = 1 mW into 600 Ω).

Frequency range: 10 Hz to 10 MHz.

Response: responds to rms value (heating value) of the input signal for all waveforms.

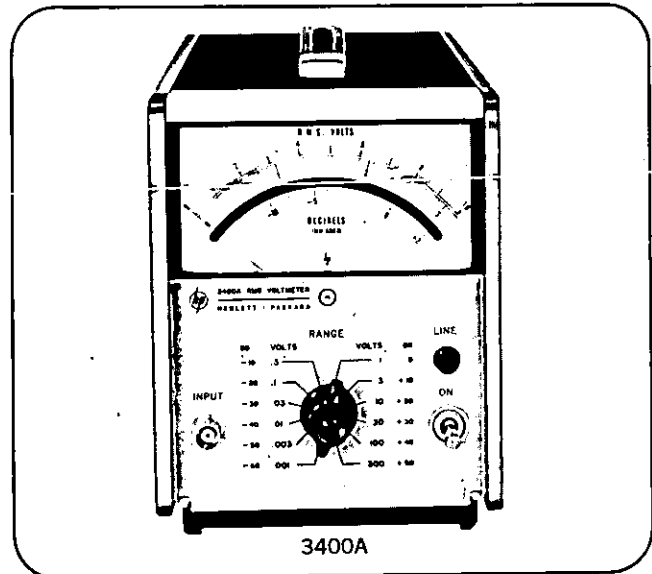
Meter accuracy: % of full scale (20°C to 30°C)*

10 Hz	50 Hz	1 MHz	2 MHz	3 MHz	10 MHz
±5%	±1%	±2%	±3%		±5%

Ac-to-dc converter accuracy: % of full scale (20°C to 30°C)*

10 Hz	50 Hz	1 MHz	2 MHz	3 MHz	10 MHz
±5%	±0.75%	±2%	±3%		±5%

Crest factor: (ratio of peak amplitude to rms amplitude): 10 to 1 at full scale (except where limited by maximum input) inversely proportional to pointer deflection, (e.g., 20 to 1 at half-scale, 100 to 1 at tenth scale).



Maximum continuous input voltage: 350 V rms or 500 V p at 1 kHz on all ranges; 600 V dc on all ranges.

Input impedance: from 0.001 V to 0.3 V range: 10 M Ω shunted by <50 pF. From 1.0 V to 300 V range: 10 M Ω shunted by <20 pF.

Response time: for a step function, <5 s to final value.

AC overload: 30 dB above full scale or 800 V p, whichever is less, on each range.

Output: negative 1 V dc into open circuit at full-scale deflection, proportional to pointer deflection from 10-100% of full scale. 1 mA maximum; nominal source impedance is 1000 Ω . Output noise <1 mV rms.

Power: 115 or 230 V \pm 10%, 50 to 400 Hz, 7 W.

Dimensions: 5 1/8" wide, 6 1/4" high (without removable feet), 11" deep (1/3 module). (130 x 159 x 279 mm).

Weight: net: 7 1/4 lbs (3,3 kg); shipping: 10 lbs (4,5 kg).

Accessories furnished: 10110A Adapter, BNC to dual banana jack.

Accessories available: 11001A Cable, 45 in. long, male BNC to dual banana plug, \$6.00. 10503A Cable, 4 ft. long, male BNC connectors, \$7.00. 11002A Test Lead, dual banana plug to alligator clips, \$8.00. 11003A Test Leads, dual banana plug to probe and alligator clip, \$10. 11076A Carrying Case (refer to page 639), \$45. HP Model 456A AC Current Probe, 1 mV/1mA, \$250.

Price: HP 3400A, \$575.

HP Model 3400A option 001 spreads out the dB scale by making it the top scale of the meter, add \$25.

Rear terminals in parallel with front panel terminals and linear log scale uppermost on the meter face are available on special order.

*TC: \pm 0.1% from 0°C to 20°C and 30°C to 55°C.

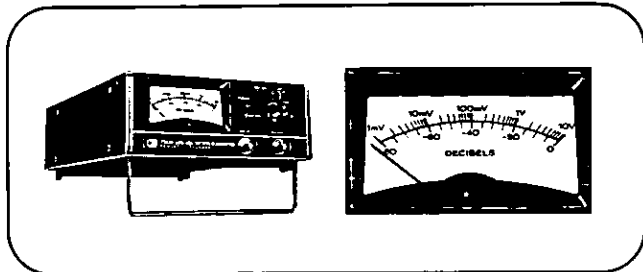
VOLTAGE, CURRENT, RESISTANCE



LOGARITHMIC VOLTMETERS

Convert ac or dc signals to logarithmic scaling
Models 7562A and 7563A

Log Voltmeter/Converter Model 7562A



The Model 7562A is a wide range (80 dB), single channel logarithmic voltmeter/converter designed to produce dc output voltages in a logarithmic relationship to dc input voltages or the true RMS value of an ac input voltage. The 7562A contains a true RMS detector which, inherently, is not dependent on pure sinusoidal signals to achieve measurement accuracy. A self-contained meter calibrated in volts and dB makes the 7562A an accurate voltmeter. A constant amplitude oscilloscope output makes the converter compatible with a variety of oscilloscope readout and phase meter applications.

Specifications

Performance specifications

Ac and dc modes

Input:

Dynamic range: 80 dB.

Voltage range: 1 mV to 10 V or 10 mV to 100 V selectable by front panel switch. Accepts either ac or positive signals.

Output:

Voltage: 0 to 800 mV dc corresponding to 10 mV/dB.

Output impedance: 100 ohms.

Dc mode

Accuracy: ± 0.25 dB at 25°C.

Input impedance: 100 k Ω , shunted by less than 100 pF; single ended.

Temperature coefficient: ± 0.02 dB/°C maximum.

Zero stability: ± 0.25 dB.

Ac mode

Input impedance: 1 M Ω , shunted by less than 100 pF; single ended.

Accuracy and frequency response: (at 25°C).

RANGE SETTING	0.5Hz	2	5	20	50	200Hz	50KHz	100KHz
0.5Hz	± 1 dB	± 0.5 dB					± 1 dB	
5Hz	± 1 dB		± 0.5 dB					± 1 dB
50Hz	± 1 dB			± 0.5 dB			± 1 dB	

Temperature coefficient: ± 0.04 dB/°C maximum.

Slewing speed:

Range setting	Minimum slewing speed
0.5 Hz	1 dB/s
5 Hz	10 dB/s
50 Hz	60 dB/s

Oscilloscope output: approx. 0.5 V rms regardless of input.

Crest factor: 5:1 unless limited by max. input voltage.

General specifications

Maximum peak input voltage: ± 25 V on 1 mV to 10 V range; ± 250 V on 10 mV to 100 V range.

Operating temperature: 10°C to 40°C.

Warm-up time: 20 minutes nominal.

Connectors: front and rear-input and output-BNC connectors.

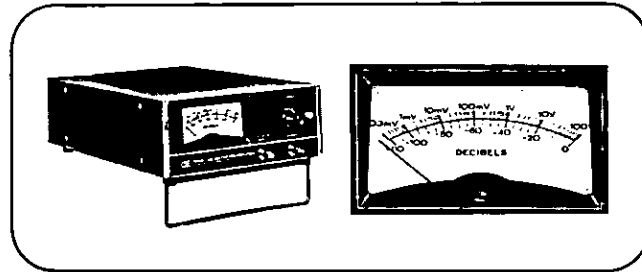
Power requirements: 115/230 Vac, 50 to 400 Hz, 40 VA.

Dimensions: 3-7/16" high, 7/8" wide, 11 1/2" deep (88 x 197 x 292 mm).

Weight: net, 8 lb (3,6 kg); shipping, 12 lb (5,4 kg).

Price: Model 7562A \$995.

Log Voltmeter/Amplifier Model 7563A



The Model 7563A Logarithmic Voltmeter/Amplifier is a low cost, single channel, dc logarithmic amplifier with a very high dynamic range (110 dB) designed to produce a logarithmic-related dc output voltage for a very wide range of dc input voltages. A single input range of 316 μ V to 100 V is coupled with an input polarity switch for ease and versatility of operation. A high (100 k Ω) input impedance and low (less than 5 Ω) output impedance allows the 7563A to be used in systems or on the bench. A front panel meter calibrated in dB and mV provides instantaneous visual indication of operating levels. Applications include: log scaling of recorder axes, pulse height analyzers, scope displays, and almost any circumstance where log compression of dc voltage ranges is required. The 7563A is an accurate voltmeter. Dual or single rack mounting capability is afforded by a field installable rack mounting adapter, utilizing a minimum of rack space.

Specifications

Performance specifications

Input

Dynamic range: 110 dB.

Voltage range: 316 μ V to 100 V. Accepts either positive or negative signals, selectable by front panel switch.

Output

Voltage: 0 to 1.1 V dc corresponding to 10 mV/db. Rear Terminals; adjustable 1 to 10 mv/dB.

Output impedance: less than 5 Ω front panel, 300 Ω rear.

Meter accuracy: reading accurate to ± 1.5 dB, referred to output.

Input impedance: 100 k Ω , shunted by less than 100 pF; single ended.

Accuracy: (at 25°C).

316 μ V	1 mV	10 V	31.6 V	100 V
± 0.5 dB	± 0.25 dB	± 1.0 dB	± 1.5 dB	

Temperature coefficient: ± 0.02 dB/°C maximum and ± 3 μ V/°C referred to input.

Zero stability: ± 0.25 dB at constant temperature.

Rise time:

Maximum Rise Time	
Signal Level	1 mV-10 V Range
316 μ V- 1 mV	2000 μ s
1 mV- 10 mV	400 μ s
10 mV-100 mV	40 μ s
100 mV- 1 V	4 μ s
1V-100 V	2 μ s

General specifications

Operating temperature: 10°C to 40°C.

Warm-up time: 20 minutes nominal.

Connectors: front and rear-input and output-BNC connectors.

Power requirements: 115/230 V ac, 50 to 400 Hz, 40 VA.

Dimensions: 3-7/16" high, 7/8" wide, 11 1/2" deep (88 x 197 x 292 mm).

Weight: net, 8 lb (3,6 kg); shipping, 12 lb (5,4 kg).

Price: Model 7563A \$695.

MULTI-FUNCTION METER

Low-cost, solid state, battery operated
Model 427A



VOLTAGE, CURRENT,
RESISTANCE

Description

The Hewlett-Packard Model 427A is a portable, versatile, low cost multi-function meter which is valuable in any laboratory, production line, service department, or in the field. It is capable of measuring dc voltages from 100 mV to 1 kV full scale; ac voltage from 10 mV to 300 V full scale at frequencies up to 1 MHz (>500 MHz with the 11096A High Frequency Probe); and resistance from 10 Ω to 10 M Ω center scale.

The 427A will operate continuously for more than 300 hours on its internal 22.5 V dry cell battery. AC line and battery operation is available as an option.

Specifications

DC voltmeter

Ranges: ± 100 mV to ± 1000 V in 9 ranges in 10 dB steps.

Accuracy: $\pm 2\%$ of range.

Input resistance: 10 M Ω .

AC normal-mode rejection (ACNMR): ACNMR is the ratio of the normal-mode signal to the resultant error in read-out. 50 Hz and above: >80 dB.

Overload protection: 1200 V dc.

AC voltmeter

Ranges: 10 mV to 300 V in 10 ranges in 10 dB steps.

Frequency range: 10 Hz to 1 MHz.

Response: responds to average value, calibrated in rms.

Accuracy

Frequency	Range	
		.01 V to 30 V
10 Hz to 100 kHz	2% of range	2% of range
100 kHz to 1 MHz		

Input impedance: 10 mV to 1 V range, 10 M Ω shunted by <40 pF; 3 V to 300 V range, 10 M Ω shunted by <20 pF.

Overload protection: 10 mV to 1 V range, 300 V rms momentarily (<5 s); 3 V to 300 V range, 450 V rms max.

Ohmmeter

Ranges: 10 Ω to 10 M Ω center scale in 7 decade ranges.

Accuracy (from .3 to 3 on scale): $\pm 5\%$ of reading.

Source current (ohms terminal positive). Short circuit current: from 10 mA on the X10 range to 0.1 μ A on the X10 M range.

Open circuit voltage: from 0.1 V on the X10 range to 1 V on the X10 M range.

General

Input: may be floated up to ± 500 V dc above chassis ground. Ohms input open in any function except ohms. Volts input open when instrument is off.

Operating temperature: 0°C to 50°C.

Power: >300-hr operation per battery.

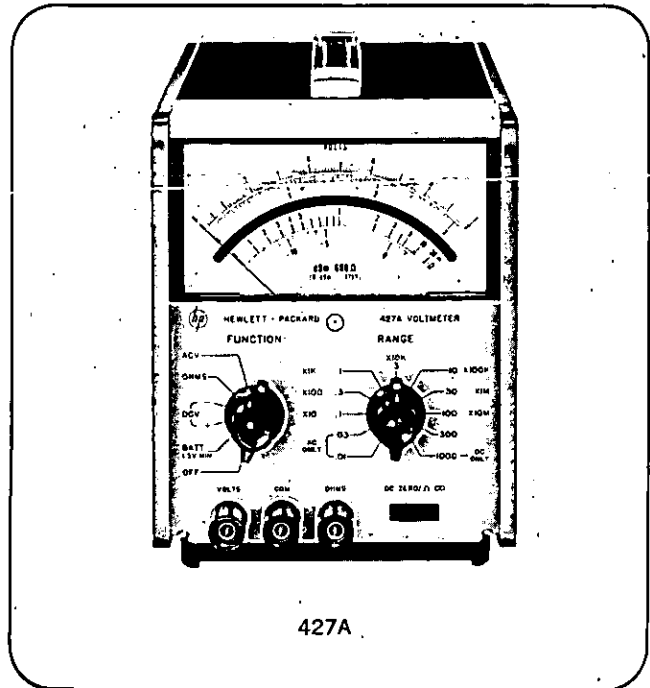
HP 427A: 22.5 V dry cell battery, Eveready No. 763 or RCA VS102. HP 427A Option 001: battery operation or ac line operation, selectable on rear panel. 115 V or 230 V $\pm 20\%$ 50 Hz to 400 Hz, <0.5 W.

Dimensions (standard $\frac{1}{3}$ module): 5 $\frac{1}{8}$ " wide, 6 $\frac{1}{4}$ " high (without removable feet), 8" deep (130 x 159 x 203 mm).

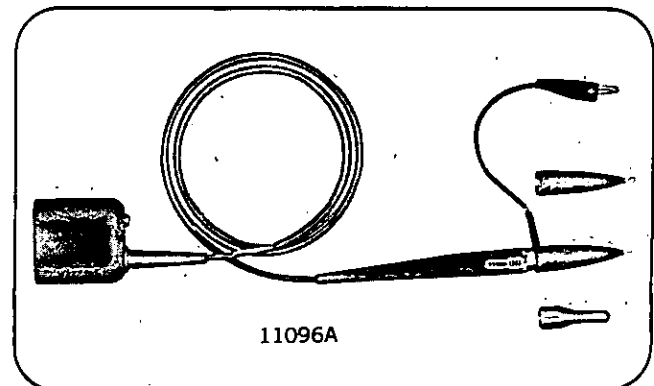
Weight: net 5.3 lb (2.4 kg); shipping 7 lb (3.2 kg).

Price (includes battery): HP 427A, \$250.

HP 427A Option 001, add \$25.



427A



11096A

Accessories available

HP 11096A High Frequency AC Probe extends range to >500 MHz. With the 11096A you can measure 0.25 to 30 V rms signals out to 500 MHz with better than ± 1 dB accuracy. Usable relative measurements can be made up to 1 GHz (3 dB point at 700 MHz). The 11096A is a peak-responding detector calibrated to produce a dc output proportional to the rms value of a sine wave input. Input impedance is 4 M Ω shunted by 2 pF.

Price: HP 11096A, \$60.

HP 11075A High Impact Case. A rugged case for carrying, storing and operating the 427A, \$45.

HP 11001A 45" test lead, dual banana plug to male BNC, \$6.

HP 11002A 60" test lead, dual banana plug to alligator clips, \$8.

HP 11003A 60" test-lead, dual banana plug to pencil probe and alligator clip, \$10.

HP 11039A 1000: 1 capacitive voltage divider, 25 kV max, \$200.

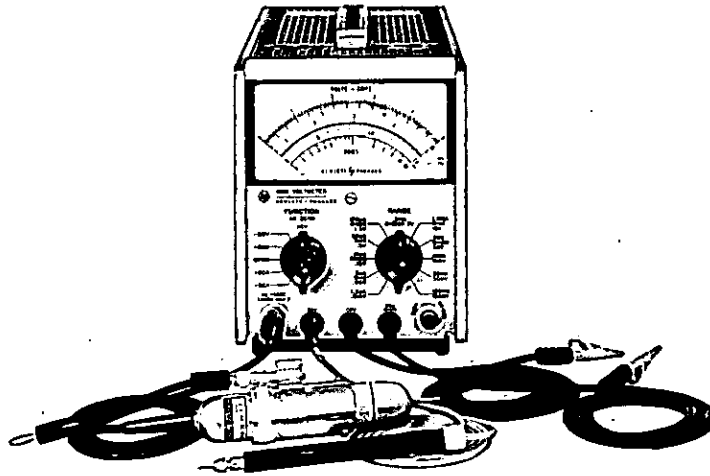
HP 10111A BNC female to dual banana adapter, \$7.

VOLTAGE, CURRENT, RESISTANCE



MULTIFUNCTION VOLTMETERS

All-purpose instruments measure to 700 MHz
Models 410C, 410B, accessories



410C

Description

The HP Model 410C is a versatile general purpose instrument for use anywhere electrical measurements are made. This one instrument measures dc voltages from 15 mV to 1500 V, direct current from 1.5 μ A to 150 mA, and resistance from 0.2 Ω to 500 M Ω . With a standard plug-in probe, ac voltages at 20 Hz to 700 MHz from 50 mV to 300 V and comparative indications to 3 GHz are attainable.

410C Specifications

DC voltmeter

Voltage ranges: ± 15 mV to ± 1500 V full scale in 15, 50 sequence (11 ranges).

Accuracy: $\pm 2\%$ of full scale on any range.

Input resistance: 100 M Ω $\pm 1\%$ on 500 mV range and above, 10 M Ω $\pm 3\%$ on 150 mV range and below.

AC voltmeter

Voltage ranges: 0.5 V to 300 V full scale in 0.5, 1.5, 5 sequence (7 ranges).

Frequency range: 20 Hz to 700 MHz.

Accuracy: $\pm 3\%$ of full scale at 400 Hz for sinusoidal voltages from 0.5 V to 300 V rms. The ac probe responds to the positive peak-above-average value of the applied signal. The meter is calibrated in rms.

Frequency response: $\pm 2\%$ from 100 Hz to 50 MHz (400 Hz ref.); $\pm 10\%$ to -4% from 50 MHz to 100 MHz; $\pm 10\%$ from 20 Hz to 100 Hz and from 100 MHz to 700 MHz.

Input impedance: input capacitance 1.5 pF, input resistance > 10 M Ω at low frequencies. At high frequencies impedance drops off due to dielectric loss.

Safety: the probe body is grounded to chassis at all times for safety. All ac measurements are referenced to chassis.

DC ammeter

Current ranges: ± 1.5 μ A to ± 150 mA full scale in 1.5, 5 sequence (11 ranges).

Accuracy: $\pm 3\%$ of full scale on any range.

Input resistance: decreasing from 9 k Ω on 1.5 μ A range to approximately 0.3 Ω on the 150 mA range.

Special current ranges: ± 1.5 , ± 5 and ± 15 nA may be measured on the 15, 50 and 150 mV ranges using the dc voltmeter probe, with $\pm 5\%$ accuracy and 10 M Ω input resistance.

Ohmmeter

Resistance range: resistance from 10 Ω to 10 M Ω center scale (7 ranges).

Accuracy: 0 to midscale, $\pm 5\%$ of reading or $\pm 2\%$ of mid-scale, whichever is greater.

Amplifier

Voltage gain: 100 maximum.

AC rejection: 3 dB at 0.5 Hz; approximately 66 dB at 50 Hz and higher frequencies for signals < 1600 V p or 30 times full scale, whichever is smaller.

Isolation: impedance between common and chassis is > 10 M Ω in parallel with 0.1 μ F. Common may be floated up to 400 V dc above chassis for dc and resistance measurements.

Output: proportional to meter indication; 1.5 V dc at full scale, maximum current, 1 mA.

Output impedance: < 3 Ω at dc.

Noise: $< 0.5\%$ of full scale on any range (p-p).

DC drift: $< 0.5\%$ of full scale/yr at constant temperature; $< 0.02\%$ of full scale/ $^{\circ}$ C.

Overload recovery: recovers from 100:1 overload in < 3 s.

General

Maximum input: dc: 100 V on 15, 50 and 150 mV ranges, 500 V on 0.5 to 15 V ranges, 1600 V on higher ranges.

ac: 100 times full scale or 450 V p, whichever is less.

Power: 115 V or 230 V $\pm 10\%$, 50 Hz to 400 Hz, 20 W maximum.

Dimensions: 5 $\frac{1}{8}$ " wide, 6 $\frac{1}{4}$ " high (without removable feet), 11" deep (130 x 159 x 279 mm) behind panel.

Weight: net 8 lb (4 kg); shipping 12 lb (5, 44 kg).

Accessories furnished: detachable power cord, NEMA plug.

Accessories available: 11076A carrying case (page 636), \$45.

Price: HP 410C with HP 11036A Detachable AC Probe, \$495. 410C Option 002 (less ac probe), deduct \$50.

VACUUM TUBE VOLTMETER

Model 410B



**VOLTAGE, CURRENT,
RESISTANCE**

Because of the large number of tasks it will perform, the 410B Vacuum Tube Voltmeter can play a uniquely valuable role in any laboratory, broadcast station, or production test department. It combines in one instrument an ac voltmeter covering the frequency range from audio to radar frequencies, a dc voltmeter with 100 M Ω input impedance, and an ohmmeter capable of measuring resistance from 0.2 Ω to 500 M Ω .

410B Specifications

Ranges: 1 V to 300 V full scale in 6 ranges; 1, 3, 10, 30, 100 and 300 V ac or dc, and 1000 V dc. Resistance, 0.2 Ω to 500 M Ω in 7 ranges. Midscale reading of 10 Ω , 100 Ω , 1 k Ω , 10 k Ω , 100 k Ω , 1 M Ω and 10 M Ω .

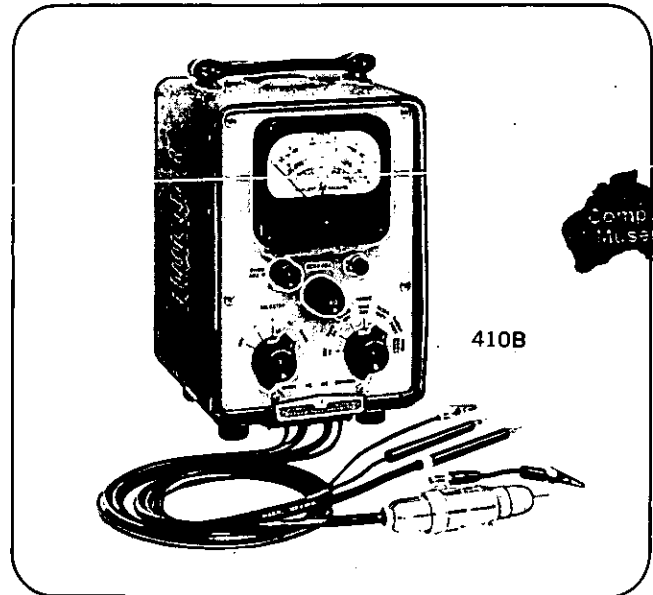
Accuracy: $\pm 3\%$ of full scale on all ranges for sinusoidal ac voltages at 400 Hz and for dc voltages. The ac portion of the instrument is p responding, calibrated in rms volts. Ohmmeter accuracy is $\pm 1 \Omega$ at midscale on Rx1 range, $\pm 5\%$ at midscale on all other ranges (midscale is 3 to 30 on the meter face).

Frequency response: ± 1 dB, 20 Hz to 700 MHz. Probe resonant frequency is about 1250 MHz, and an indication can be obtained up to 3000 MHz.

Input impedance: input capability is 1.5 pF, input resistance is 10 M Ω at low frequencies. At high frequencies resistance drops off due to dielectric losses. DC input resistance is 122 M Ω for all ranges.

Power: 115 V or (230 V must be specified) $\pm 10\%$, 50 Hz to 400 Hz, 40 W.

Dimensions: cabinet; 7 $\frac{3}{8}$ " wide, 11 $\frac{1}{2}$ " high, 8 $\frac{3}{4}$ " deep (187



Computer
Museum

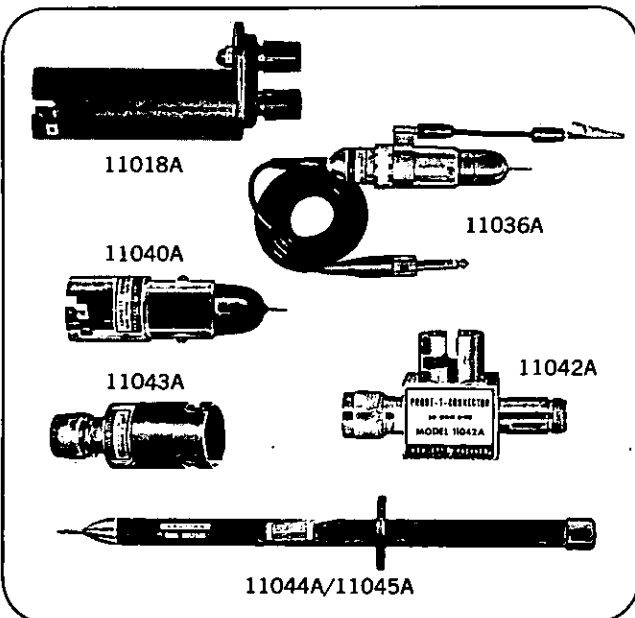
410B

x 292 x 223 mm). Rack; 19" wide, 6 $\frac{3}{32}$ " high, 6" deep behind panel (483 x 177 x 152 mm).

Weight: cabinet; net 12 lb (5,4 kg), shipping 13 lb (5,9 kg). Rack; net 12 lb (5,4 kg), shipping 19 lb (8,6 kg).

Price: HP 410B, \$300 (cabinet); HP 410BR, \$320 (rack mount).

410 Series Accessories



11018A

11040A

11043A

11044A/11045A

11036A

11042A

HP 11039A Capacitive Voltage Divider

Safely measures power voltages to 25 kV (see page 195). Division ratio 1000:1 price 11039A, \$200.

(Use HP 11018A adapter to connect to 410 series voltmeter).

11018A Adapter

Connects 410 series ac probe to dual banana plugs. Price: HP 11018A, \$35.

11036A Probe

AC probe for the 410C. Price: HP 11036A, \$70.

11040A Capacitive Voltage Divider

For 410 series voltmeters. Increases range so transmitter voltages can be measured quickly, easily. Accuracy, $\pm 1\%$; division ratio, 100:1; input capacity, approximately 2 pF. Maximum voltage, 2000 V at 50 MHz, decreasing to 100 V at 400 MHz. Frequency range, 10 kHz to 400 MHz. Price: HP 11040A, \$35.

11042A Probe Coaxial "T" Connector

For 410 series voltmeters. Measures voltage between center conductor and sheath of 50 Ω transmission line. Maximum SWR, 1.1 at 500 MHz, 1.2 at 1 GHz. Male and female Type N fittings. Price: HP 11042A, \$60.

11043A Probe Coaxial "N" Connector

For 410 series voltmeters. Measures at open end of 50 Ω transmission line (no terminating resistor). Has male Type N fittings. Price: HP 11043A, \$45.

11044A DC Voltage Divider

For 410B Voltmeter. Gives maximum safety and convenience for measuring high voltages as in television receivers, etc. Accuracy, $\pm 5\%$; division ratio, 100:1. Input impedance, 12 G Ω . Maximum voltage, 30 kV. Maximum current drain, 2.5 μ A. Price: HP 11044A, \$50.

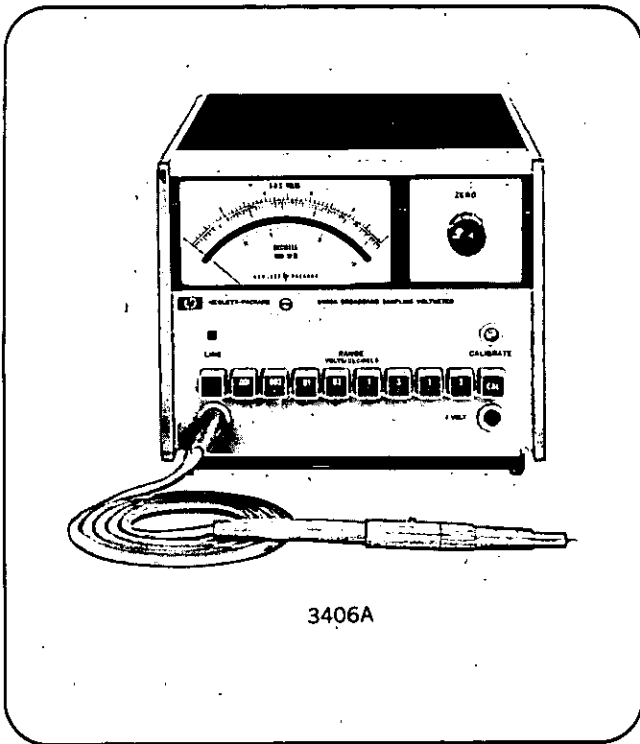
11045A DC Voltage Divider

For 410C Voltmeter. Same as 11044A except input impedance, 10 G Ω . Price: HP 11045A, \$60.

**VOLTAGE, CURRENT,
RESISTANCE**



RF VOLTMETER
20 μV sensitivity; average-response
Model 3406A



Description

Average-response (calibrated in rms of a sine wave) of high frequency signals previously impractical can now be made easily with the HP 3406A Sampling Voltmeter. Employing incoherent sampling techniques, the HP 3406A has extremely wide bandwidth (10 kHz to 1.2 GHz) with high input impedance. Signals as small as 50 μV can be resolved on the sampling voltmeter's linear scale. Full scale sensitivity from 1 mV to 3 V is selected in eight 10 dB steps and may be read directly from -62 dBm to $+23$ dBm for power measurements. Accessory probe tips make the HP 3406A suitable for voltage measurements in many applications such as receivers, amplifiers and coaxial transmission lines.

Measurement indications can be retained on the 3406A meter by depressing a push-button located on the pen-type probe. This feature is useful when measurements are made in awkward positions where the operator cannot observe the meter indication and probe placements at the same time. Other features include a dc recorder output and sample hold output for connection to oscilloscopes, and peak or true rms voltmeters if other than absolute average measurements are required.

Specifications

Voltage range: 1 mV to 3 V full scale in 8 ranges; decibels from -50 to $+20$ dBm (0 dBm = 1 mW into 50 Ω); average-responding instrument calibrated to rms value of sine wave.

Frequency range: 10 kHz to 1.2 GHz; useful sensitivity from 1 kHz to beyond 2 GHz.

Full-scale accuracy (%) with appropriate accessory (after probe is properly calibrated)

10 kHz 20 kHz 25 kHz 100 kHz 100 MHz 700 MHz 1 GHz 1.2 GHz

± 13	± 8	± 5	± 3	± 5	± 8	± 13
----------	---------	---------	---------	---------	---------	----------

Input impedance: input capacity and resistance will depend upon accessory tip used. 100,000 Ω shunted by < 2.1 pF at 100 kHz with bare probe; < 10 pF with 11072A isolator tip supplied.

Sample Hold Output

Provides ac signal whose unclamped portion has statistics that are narrowly distributed about the statistics of the input, inverted in sign (operating into > 200 k Ω load with < 1000 pF). Output is 0.316 V at f.s. on any range.

Noise: < 175 μV rms referred to input.

Accuracy (after probe is properly calibrated): 0.01 V range and above: same as full scale accuracy of instrument.

0.001 V to 0.003 V range: value of input signal can be computed by taking into account the residual noise of the instrument.

Jitter: meter indicates within $\pm 2\%$ p of reading 95% of time (as measured with HP 3400A True RMS Voltmeter).

RMS crest factor: 0.001 V to 0.3 V, 20 dB; 1 V, 13 dB; 3 V, 3 dB.

Meter

Meter scales: linear voltage, 0 to 1 and 0 to 3; decibel, -12 to $+3$. Individually calibrated taut-band meter.

Response time: indicates within specified accuracy in < 3 s.

Jitter: $\pm 1\%$ p (of reading).

General

DC recorder output: adjustable from 0 to 1.2 mA into 1000 ohms at full scale, proportional to meter deflection.

Overload recovery time: meter indicates within specified accuracy in < 5 s (30 V p-p max.).

Maximum input: ± 100 V dc, 30 V p-p.

RFI: conducted and radiated leakage limits are below those specified in MIL-6181D and MIL-1-16910C except for pulses emitted from probe. Spectral intensity of these pulses are nominally 50 nV/ $\sqrt{\text{Hz}}$; spectrum extends beyond 2 GHz.

Temperature range: instrument, 0 $^{\circ}\text{C}$ to $+55^{\circ}\text{C}$; probe, $+10^{\circ}\text{C}$ to $+40^{\circ}\text{C}$.

Power: 115 or 230 V $\pm 10\%$, 50 Hz to 400 Hz, nominally < 20 W.

Dimensions: $7\frac{3}{4}$ " wide, $6\frac{1}{4}$ " high (without removable feet), 11" deep (197 x 159 x 279 mm); $\frac{1}{2}$ module.

Weight: net 12 lbs (5.4 kg); shipping 14 lbs (6.4 kg).

Price: HP 3406A, \$750.

Accessories furnished

Nut Driver, HP Part Number 8710-0084: nut driver for tip replacement, \$1.

11072A Isolator Tip: eliminates the effect of source impedance variations when the 11063A "T" and 10:1 divider are not used. Frequency range, 10 kHz to 250 MHz; input capacitance, <10 pF; \$15.

10213-62102 Ground Clips
5020-0457 Replacement Tips
5060-4991 Ground Lead

Accessories available

11064A Accessory Probe Kit: consists of the following: 11063A 50Ω "T" 11061A 10:1 divider tip; 10218A BNC adapter; 0950-0090 50Ω termination; 10213-62102 ground clips (2 ea.); 5020-0457 probe tip (5 ea.); 5060-4991 ground leads (2 ea.). Price HP 11064A, \$100.

11063A "T": should be used whenever measurements are made in 50Ω systems; useful to about 1.5 GHz.

VSWR: <1.15 at 1 GHz (bare probe in "T").

Insertion loss: <1 dB up to 1 GHz.

Price: HP 11063A, \$55.

10218A BNC Adapter: probe to male BNC adapter. Frequency range: 10 kHz to 250 MHz. Price: HP 10218A, \$6.

11061A 10:1 Divider: as well as dividing the input voltage by a factor of 10, this accessory eliminates the effects of source impedance variations.

Accuracy (divider alone): ±5% 1 kHz-400 MHz.

±12% 400 MHz-1 GHz.

Maximum input: 150 V p-p ac, 600 V dc. Price: HP 11061A, \$35.

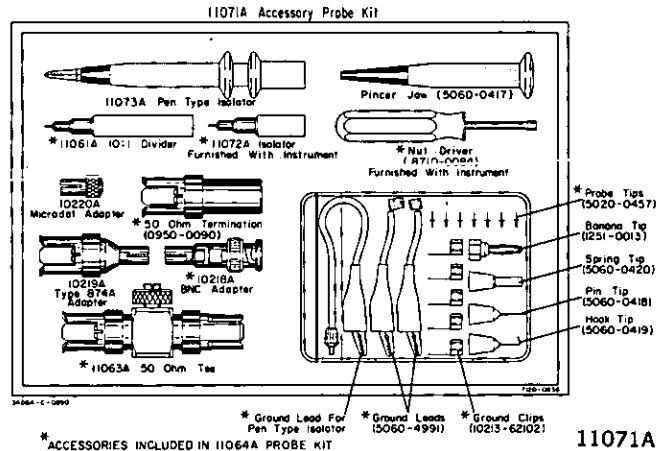
50 ohm termination: (0950-0090) Price: \$45.

Ground clips: 2 each (10213-62102) Price: \$1.

Probe tips: 5 each (5020-0457) Price: \$1.50.

Ground leads: 2 each (5060-4991) Price: \$2.

11071A Accessory Probe Kit: consists of all the 11064A accessories plus 11073A Pen Type Probe (with 11073-62101 ground lead); 10219A Type 874A Adapter; 10220A



* ACCESSORIES INCLUDED IN 11064A PROBE KIT

11071A

Microdot Adapter; 5060-0418 Pin Tip. 5060-0419 Hook Tip; 5060-0420 Spring Tip; 5060-0417 Pincer Jaw; 1251-0013 Banana Tip. Price: HP 11071A, \$185.

11073A Pen Type Isolator: frequency range is 10 kHz to 50 MHz. Various accessories adapt the 11073A to alligator jaws and other tips which facilitate point-to-point measurements. Input capacitance: <10 pF. Price: HP 11073A, \$45.

10219A Type 874A Adapter: Price: HP 10219A, \$15.

10220A Microdot Adapter: Price: HP 10220A, \$4.

Pincer jaw: (5060-0417). Price: \$4.

Ground lead for pen type isolator: (11073-62101). Price: \$2.50.

Ground leads: 2 each (5060-4991). Price: \$2.

Ground clips: 5 each (10213-62102). Price: \$1.

Probe tips: 7 each (5020-0457). Price: \$1.50.

Banana tip: (1251-0013). Price: \$0.50.

Spring tip: (5060-0420). Price: \$1.50.

Pin tip: (5060-0418). Price: \$0.50.

Hook tip: (5060-0419). Price: \$0.75.

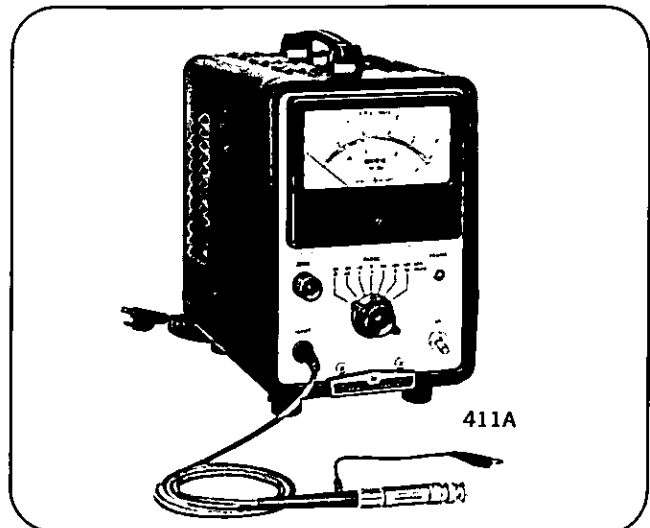
RF MILLIVOLTMETER Measurements, 10 mV to 10 V, 500 kHz to 1 GHz Model 411A

Description

RF voltmeter offers millivolt sensitivity and two easy-reading linear voltage scales in 1-to-3 ratio. Range is 10 mV to 10 V full scale rms, 500 kHz to 1 GHz. DB scale is calibrated from +3 to -12 dB. Accuracy is ±3% of full scale to ±1 dB, depending upon frequency and probe used. Five probe tips increase versatility. The probe tips, available individually, are offered along with a spare diode cartridge as a complete set in a compact kit. A galvanometer recorder output is proportional to meter deflection. For complete specifications, refer to data sheet.

BNC open circuit probe tip furnished with the instrument. HP 11027A Probe Kit includes a pen-type probe tip (11022A), a VHF probe tip (11023A), a type N-tee (11024A), a 100:1 (500 kHz to 250 MHz) capacitor divider (11026A), and a spare diode cartridge: \$153. HP 11025A probe tip (500 kHz to 500 MHz) is available: \$18.

Price: HP 411A, \$525 (cabinet); HP 411AR, \$530 (rack).

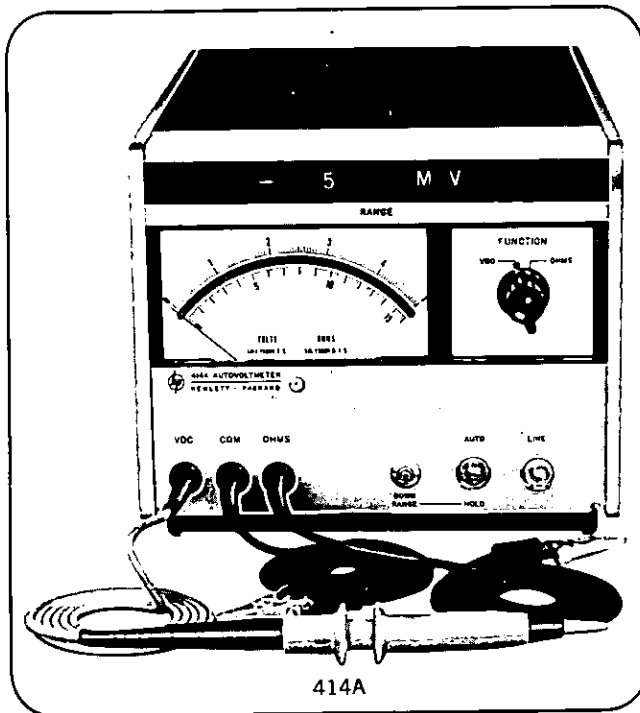


VOLTAGE, CURRENT, RESISTANCE



AUTOVOLTMETER

Automatic voltage and resistance measurements
Model 414A

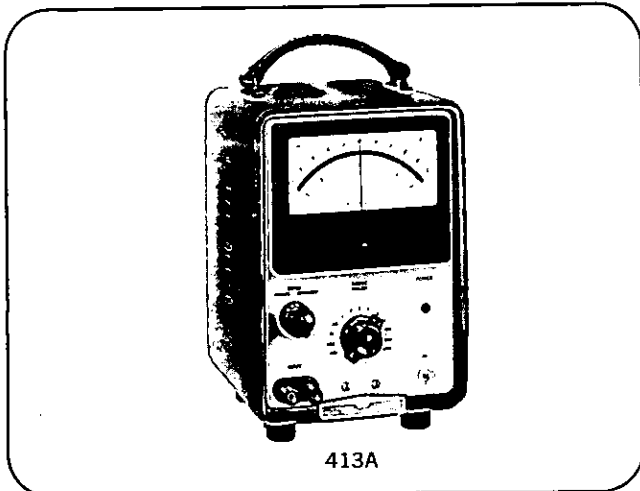


Description

The 414A is a 12-range, all solid-state dc volt-ohmmeter which provides accurate measurements immediately because of its automatic range selection. Operation is simply touch and read. Both range and polarity are displayed by illuminated characters and the meter pointer indicates the correct reading for the range that has been automatically selected.

DC NULL VOLTMETER

Floating, high-impedance input; 1 mV end-scale sensitivity
Model 413A



The 413A has 13 zero-centered ranges running from 1 mV to 1000 V end scale.

High-input impedance (10 M Ω on the most sensitive range, 200 M Ω on the 300 mV range and above) makes the 413A especially valuable in resistance bridge measurements. Accuracy of this instrument is within 2% of end scale.

Specifications

DC voltmeter

Voltage Ranges: ± 5 mV to ± 1500 V in 12 ranges in a 5-15 sequence. Automatic or manual range selection.

Accuracy: $\pm (0.5\%$ of reading $+0.5\%$ of range).

Input: voltage probe and common lead. COM lead can be floated up to ± 500 Vdc above chassis ground.

Input Resistance: 100 M Ω on 50 mV range and above; 10 M Ω on 5 mV and 15 mV ranges.

AC Normal-Mode Rejection: reading not affected by 50 Hz or 60 Hz signal having p values $<$ the following:

In Auto: 15% of dc input.

In Hold: 600% of range.

Ohmmeter (linear scale)

Resistance ranges: 5 Ω to 1.5 M Ω in 12 linear ranges in 5-15 sequence (manual or automatic range selection).

Accuracy: $\pm (1\%$ of reading $+0.5\%$ of range).

Source current: up to 5 k Ω range, 1 mA; above 5 k Ω range, 1 μ A.

General

Automatic range selection: automatically selects correct voltage and resistance range in <300 ms.

Manual range selection: down-ranges one range each time down-range button is pressed. Starts over at 1500 V from 5 mV range.

Polarity selection: automatic.

Operating temperature: instrument will operate within specifications from 0 $^{\circ}$ C to $+50^{\circ}$ C.

Power: 115 or 230 V $\pm 10\%$, 50 to 400 Hz, <18 W.

Dimensions: ($\frac{1}{2}$ module) $7\frac{3}{4}$ " wide, $6\frac{1}{4}$ " high (without removable feet), 11" deep (197 x 159 x 279 mm).

Weight: net 10 $\frac{1}{4}$ lbs (4,6 kg); shipping 13 lbs (6,4 kg).

Price: HP 414A, \$725.

Specifications

Voltmeter

Range: positive and negative voltages from 1 mV to 1000 V end scale in 13 zero-centered ranges.

Accuracy: $\pm 2\%$ of end scale.

Limits of zero control: more than \pm end scale on any range when using expanded scale.

Input Resistance: 10 M Ω on 1, 3 and 10 mV ranges; 30 M Ω on 30 mV range; 100 M Ω on 100 mV range; 200 M Ω on 300 mV range and above.

AC rejection: a voltage at power line or twice power-line frequency 40 dB $>$ end scale affects reading $<1\%$; p voltage must not exceed 1500 V.

Amplifier (refer to data sheet for detailed specifications)

Gain: 0.001 to 1000 in 13 steps.

General

Input terminals: dual banana jacks.

Input isolation: >100 M Ω shunted by 0.1 μ F to case (power-line ground).

Common signal rejection: may be operated with up to 500 V dc or 130 V ac above ground.

Power: 115 or 230 V $\pm 10\%$, 50 to 60 Hz, 35 W.

Dimensions: cabinet $7\frac{1}{2}$ " wide, $11\frac{1}{2}$ " high, 10" deep (191 x 292 x 254 mm); rack mount 19" wide, $5\frac{1}{2}$ " high, $6\frac{3}{8}$ " deep (483 x 134 x 168 mm).

Weight: cabinet net 12 lbs (5,4 kg), shipping 14 lbs (6,4 kg); rack net 12 lbs (5,4 kg), shipping 19 lbs (8,6 kg).

Price: HP 413A, \$385 (cabinet); HP 413AR, \$390 (rack).

DC NULL VOLT-AMMETER

18 Voltage, 7 current ranges; 0.1 μV resolution

Model 419A



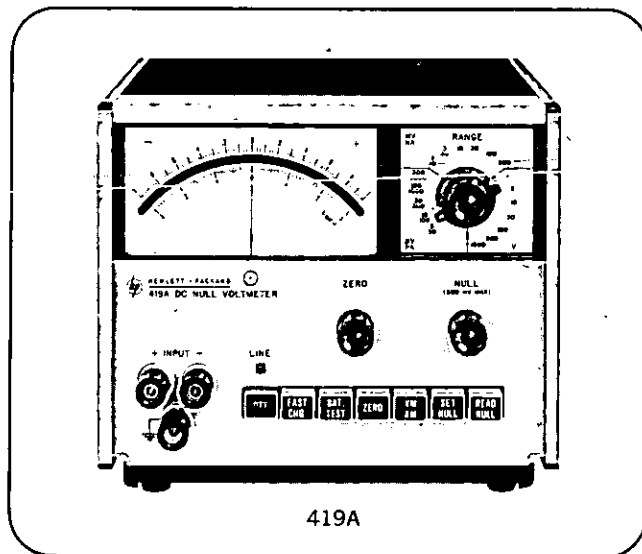
VOLTAGE, CURRENT,
RESISTANCE

Eighteen voltage ranges with 0.1 μV resolution on the lowest range set this HP solid-state DC Null Voltmeter apart from previous dc null meters. The accuracy of this rechargeable battery-operated instrument is $\pm 2\%$ of end scale $\pm 0.1 \mu\text{V}$ on all ranges. Noise is less than 0.3 μV p-p, and drift is less than 0.5 μV /day.

An internal bucking source allows input voltages up to 300 mV to be nulled giving an infinite input impedance. Input impedance above the 300 mV range is 100 megohms.

Pushbutton Selection Provides Convenience-versatility

Seven pushbuttons allow the operator to select rapidly the desired function of the HP 419A. This dc null voltmeter operates from the ac line or from the internal rechargeable batteries. During operation from the ac line, the batteries are trickle-charged. A fast-charge pushbutton is provided to increase the charging rate, recharging the batteries in approximately 16 hours. Battery voltage may be easily checked with the battery-test pushbutton. The zero pushbutton enables the operator to compensate for any internal offsets before making a measurement. When this pushbutton is depressed, the positive leg of the voltmeter is disconnected from the positive input terminal and connected to the negative input terminal.



When the VM pushbutton is depressed, the HP 419A functions as a zero-center scale 3 μV to 1000 V dc voltmeter. When the AM pushbutton is depressed, the HP 419A functions as a zero-center scale 30 pA to 30 nA ammeter.

Specifications

DC null voltmeter

Ranges: $\pm 3 \mu\text{V}$ to $\pm 1000 \text{ V}$ dc in 18 zero-center ranges.

Accuracy: $\pm (2\%$ of range $\pm 0.1 \mu\text{V})$.

Zero control range: $> \pm 15 \mu\text{V}$.

Zero drift: $< 0.5 \mu\text{V/day}$ after 30 min warm-up.

Zero temperature coefficient: $< 0.05 \mu\text{V}/^\circ\text{C}$.

Response time: 3 s to within 95% of final reading on 3 μV range; 1 s to within 95% of final reading on 10 μV to 1000 V ranges.

Noise: $< 0.3 \mu\text{V}$ p-p, input shorted.

[Noise amplitude approximates Gaussian distribution. RMS value (standard deviation) is $< 0.075 \mu\text{V}$, p-p noise value is $< 0.3 \mu\text{V}$ 95% of the time.]

Input characteristics

At null: infinite resistance on 3 μV through 300 mV ranges in SET NULL mode. Negative input terminal can be floated up to $\pm 500 \text{ V}$ dc from powerline ground.

Off null:

Voltage range	Input resistance
3 μV - 3 mV	100 k Ω
10 mV - 30 mV	1 M Ω
100 mV - 300 mV	10 M Ω
1 V - 1000 V	100 M Ω

Negative input terminal can be floated up to $\pm 500 \text{ V}$ dc from powerline ground.

AC normal-mode rejection: ac voltages 50 Hz and above and 80 dB greater than end scale affect reading $< 2\%$. Peak ac voltage not to exceed maximum overload voltage.

DC ammeter

Ranges: $\pm 30 \text{ pA}$ to $\pm 30 \text{ nA}$ in 7 zero-center ranges.

Accuracy: $\pm (3\%$ of range $+ 1 \text{ pA})$.

Zero control range: $> \pm 150 \text{ pA}$.

Zero drift: $< 5 \text{ pA/day}$ after 30 min warm-up.

Zero temperature coefficient: $< 0.5 \text{ pA}/^\circ\text{C}$.

Noise: $< 3 \text{ pA}$ p-p, input shorted.

Input resistance: 100 k Ω on all ranges.

Amplifier

Gain: 110 dB on 3 μV range, decreases 10 dB per range.

Output: 0 to $\pm 1 \text{ V}$ at 1 mA maximum for end-scale reading. Output level adjustable for convenience when used with recorders.

Output resistance: depends on setting of output level control. $< 35 \Omega$ when output control is set to maximum.

Noise: 0.01 Hz to 5 Hz: same as voltmeter (referred to input). $> 5 \text{ Hz}$: $< 10 \text{ mV rms}$ (referred to output).

General

Overload protection: the following voltages can be applied without damage to instrument.

1 V to 1000 V range: 1200 V dc.

10 mV to 300 mV range: 500 V dc.

3 μV to 300 mV range: 50 V dc.

Operating temperature: instrument will operate within specifications from 0°C to 50°C .

Operating humidity: $< 70\%$ RH.

Storage temperature: -20°C to $+50^\circ\text{C}$.

Power: 115 V or 230 V $\pm 10\%$, 50 Hz to 400 Hz, $< 1.5 \text{ W}$, or 4 internal rechargeable batteries (furnished). 30-hr operation per recharge. Operation from ac line permissible during recharge.

Dimensions: $7\frac{3}{4}$ " wide, $6\frac{1}{4}$ " high (without removable feet), 8" deep (197 x 159 x 203 mm).

Weight: net 8.3 lb (3.7 kg); shipping 11 lb (5 kg).

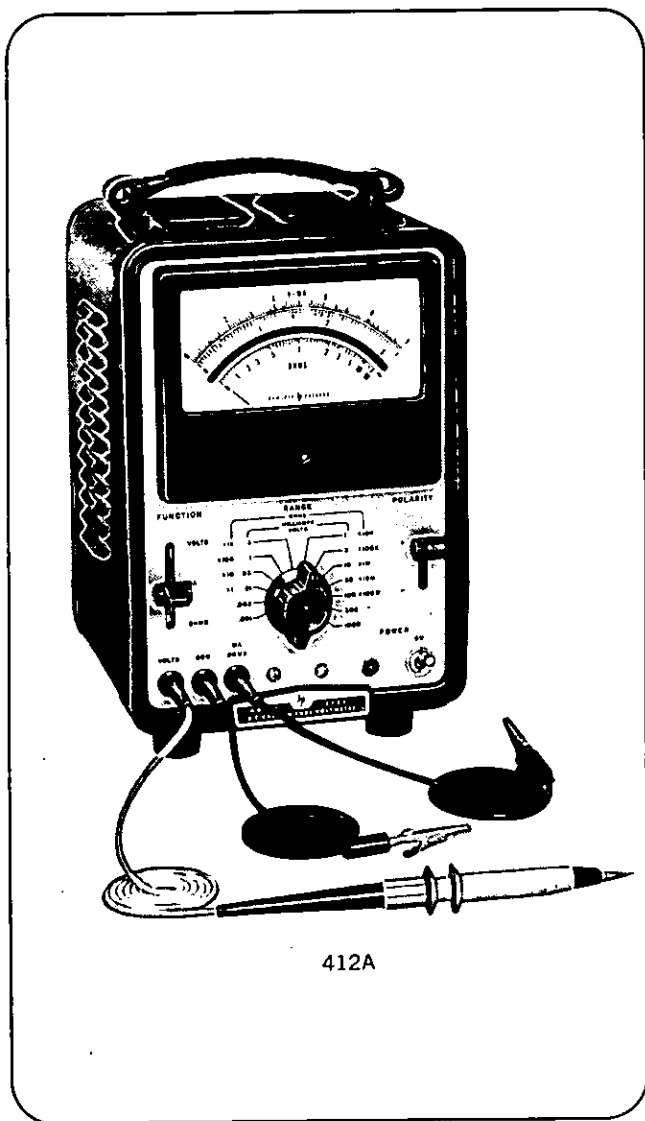
Price: HP 419A, \$475.

**VOLTAGE, CURRENT,
RESISTANCE**



DC VOLT-OHM-AMMETER

1% accuracy vtvm is also ohmmeter, ammeter
Model 412A



Features:

- Versatile, measures voltage, resistance, current
- Floating input
- High input resistance
- Use as a 60 dB amplifier
- Individually calibrated meter minimizes tracking error

Description

The HP Model 412A is a multipurpose meter designed to measure dc voltage, current, and resistance with laboratory accuracy and yet be of great utility in production-line test-bench work. Simplicity of operation and low cost permit its use wherever dc measurements are made.

Model 412A may also be used as a stable 60 dB amplifier which has an output proportional to meter indication.

There are only three controls: a lever-type function selector, a 13-position range switch, and a lever-type polarity switch. The extreme stability of the 412A makes it easier

to use by eliminating the need for constantly re-zeroing the meter. The stability of the HP 412A is such that the usual front-panel, zero-set control has been eliminated.

The precision six-inch meter has two scales used for both voltage and current and a third scale which is calibrated in ohms. The meter face has a mirror back for greatest accuracy in reading.

Specifications

Voltmeter

Voltage range: pos. and neg. voltages from 1 mV to 1000 V full scale, 13 ranges.

Accuracy: $\pm 1\%$ of full scale on any range.

Input resistance: 10 M Ω $\pm 1\%$ on 1 mV, 3 mV and 10 mV ranges; 30 M Ω $\pm 1\%$ on 30 mV range; 100 M Ω $\pm 1\%$ on 100 mV range; 200 M Ω $\pm 1\%$ on 300 mV range and above.

AC rejection: a voltage at power line or twice power line frequency 40 dB > full scale affects reading < 1%. Peak voltage must not exceed 1500 V.

Ammeter

Current range: pos. and neg. currents from 1 μ A to 1 A full scale, 13 ranges.

Accuracy: $\pm 2\%$ of full scale on any range.

Input resistance: decreasing from 1000 Ω on 1 μ A range to 0.1 Ω on 1 A range.

Ohmmeter

Resistance range: resistance from 1 Ω to 100 M Ω center scale, 9 ranges.

Accuracy: $\pm 5\%$ of reading at center scale.

Short circuit current: from 0.01 μ A on the X100M Ω range to 10 mA on the X1 Ω range.

Amplifier

Voltage gain: 1000 maximum.

DC bandwidth: dc to 0.7 Hz on all voltage ranges.

Output: proportional to meter indication; 1 V at full scale; max. current, 1 mA (full scale corresponds to 1 on upper scale).

Output impedance: < 2 Ω at dc.

Noise: < 2.0 μ V rms referred to the input.

Drift: negligible.

General

Common terminal isolation: may be operated up to 500 V dc, or 130 V ac above ground.

Power: 115 or 230 V $\pm 10\%$, 50 to 60 Hz, 47 W max.

Dimensions: cabinet: 7 $\frac{1}{2}$ " wide, 11 $\frac{1}{2}$ " high, 10" deep (191 x 292 x 254 mm); rack mount: 19" wide, 5-7/32" high, 7 $\frac{1}{2}$ " deep behind panel (483 x 134 x 191 mm).

Weight: net: 12 lbs (5,5 kg); shipping: 14 lbs (6,4 kg) (cabinet); net 12 lbs (5,5 kg); shipping: 20 lbs (9 kg) (rack mount).

Price: HP 412A, \$475 (cabinet).

HP 412AR, \$480 (rack mount).

DC MICROVOLT-AMMETER

10 μV , 10 pA full scale sensitivity
Model 425A



VOLTAGE, CURRENT,
RESISTANCE

Description

Hewlett-Packard 425A DC Microvolt-Ammeter makes measurements of extremely small dc voltages and currents, even in the presence of relatively strong ac signals.

Since the 425A measures dc voltages from 1 μV to 1 V and dc currents from 1 pA to 3 mA, it is an extremely useful tool in all branches of scientific measurement. For example, it can be used to study nerve potentials for the biologist and medical researcher and to study chemically generated emf, minute voltages in thermocouples, and current in ionization chambers.

Since currents as small as 1 pA can be measured directly, the Model 425A is valuable for measuring transistor currents and photomultiplier currents in ionization chambers. Thus this meter has great utility in physics research, as well as in electronics. Further, its current and voltage sensitivity permits measurement of both extremely high and very low resistances.

Model 425A is provided with output terminals so that it may be used as a dc amplifier having 100 dB (10^5) voltage gain. Output from the amplifier is 1 V for an end-scale deflection or 1 mA into approximately 1000 ohms, so that it will operate either a potentiometer or galvanometer recorder to make permanent records of measurements.

Specifications

Microvolt-ammeter

Voltage range: pos. and neg. voltages from 10 μV end scale to 1 V end scale, 11 steps, 1, 3, 10 sequence.

Current range: pos. and neg. currents from 10 pA end scale to 3 mA end scale, 18 steps, 1, 3, 10 sequence.

Input impedance: voltage ranges, 1 M Ω $\pm 3\%$; current range, depends on range, 1 M Ω to 0.33 Ω .

Accuracy: within $\pm 3\%$ of range; line frequency variations ± 5 Hz affect accuracy $< \pm 2\%$.

Amplifier

Gain: 100,000 maximum.

DC bandwidth:

dc to 0.1 Hz on 10 μV range.

dc to 0.3 Hz on 30 μV range.

dc to 0.7 Hz on 100 μV range and above.

Output: 0 to 1 V for end-scale reading, adjustable (5000 Ω shunt potentiometer); 1 mA maximum at 1 V output.

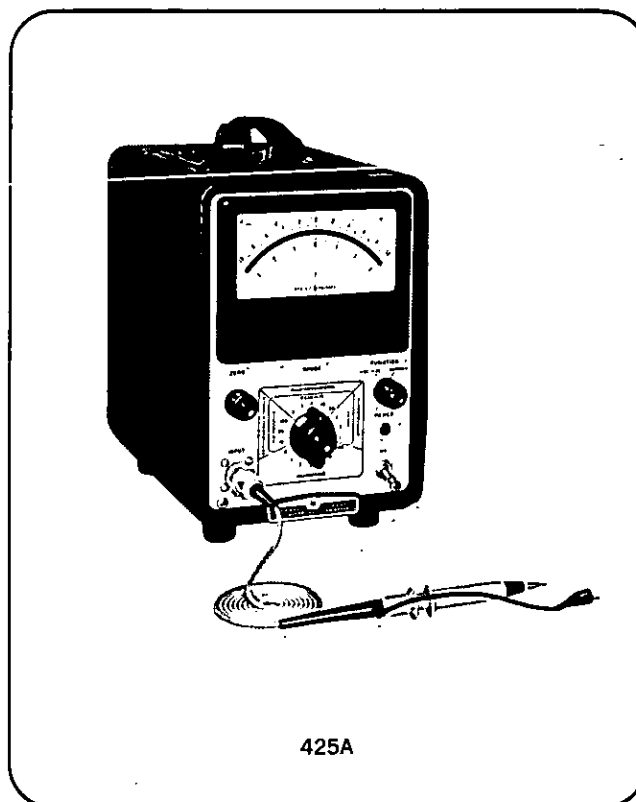
Output impedance: depends on setting of output potentiometer; 10 Ω when potentiometer is set for maximum output.

Noise: 0 to 1 Hz: < 0.25 μV rms referred to input (noise amplitude approximates Gaussian distribution. P-P noise value is < 1.0 μV 95% of the time). > 1 Hz: < 5 mV rms referred to output.

Drift: after 15 minutes warm-up, drift is $< \pm 4$ μV per day referred to input.

General

Power: 115 or (230 V must be specified) $\pm 10\%$, 60 Hz, < 46 W; 50 Hz operation is available as option 001.



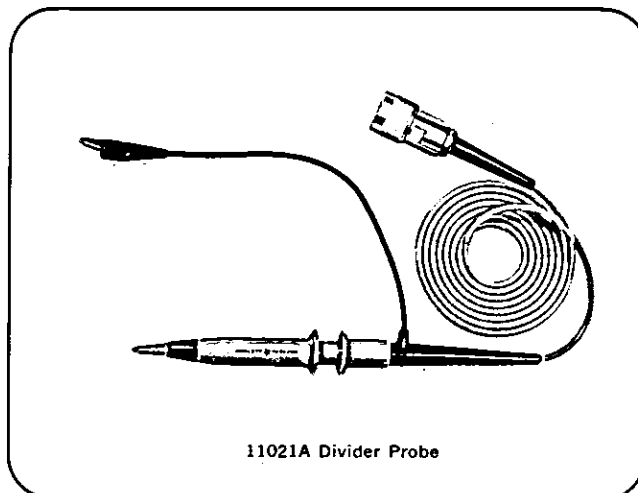
425A

Dimensions: cabinet: 7 $\frac{3}{8}$ " wide, 11 $\frac{3}{4}$ " high, 12" deep (186 x 299 x 305 mm); rack mount: 19" wide, 7" high, 11" deep behind panel (483 x 178 x 279 mm).

Weight: net 17 lbs (7,7 kg); shipping 18 lbs (8,2 kg) (cabinet); net 21 lbs (9,5 kg); shipping 29 lbs (13,2 kg) (rack mount).

Accessories available: 11021A 1000:1 Divider Probe, increases range of 425A to 1000 V; division accuracy $\pm 2\%$, input resistance 10 M Ω , \$55.

Price: HP 425A, \$550 (cabinet). HP 425AR, \$555 (rack mount). HP 425A Option 001, for operation from 50 Hz power, no extra charge.



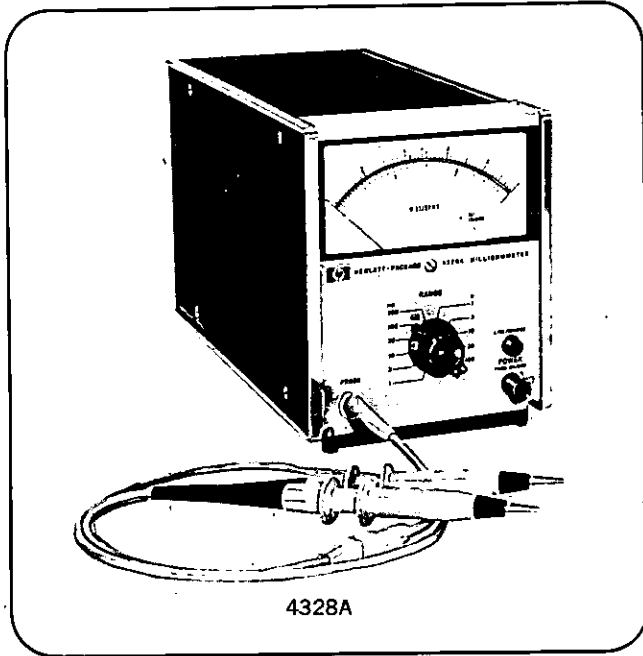
11021A Divider Probe

VOLTAGE, CURRENT, RESISTANCE



MILLIOHMMETER

Convenient two probe measurements
Model 4328A



4328A

Description

The HP 4328A Milliohmmeter is a portable instrument for measurement of low resistances. It uses a Kelvin Bridge method to obtain high sensitivity. It has both current and voltage drives incorporated in one probe so only two probes are needed in the actual measurement. Maximum sensitivity is 20 μ ohms, making it ideal for measuring the contact resistance of switches, relays and connectors; it is also useful for safe testing of fuses and squibs.

A unique phase discriminator in the meter circuit permits accurate

resistive measurements on samples with a series reactance up to twice full scale resistance.

Specifications

Range: 0.001 to 100 ohms full scale in a 1, 3, 10 sequence.
Accuracy: $\pm 2\%$ of full scale. No additional error is caused by series reactance of samples up to 2 times full scale.
Measuring frequency: 1000 Hz ± 100 Hz.
Voltage across sample: 200 μ V peak at full scale.
Maximum voltage across sample: 20 mV peak in any case.
Superimposed DC: 150 V dc maximum may be superimposed on samples from an external source.
Recorder output: 0.1 V dc output at full scale meter deflection.

Range (ohms)	Applied Current (mA)	Maximum Dissipation in Samples (μ W)
0.001	150	23
0.003	50	8
0.01	15	2.3
0.03	5	0.8
0.1	1.5	0.23
0.3	0.5	0.08
1	0.15	0.023
3	0.05	0.008
10	0.015	0.0023
30	0.005	0.0008
100	0.0015	0.00023

General

Power requirements: 115/230 V switch $\pm 10\%$, 50 to 60 Hz, 1.5 W.

Weight: 7 lbs (3.2 kg).

Dimensions: 5 $\frac{1}{8}$ " wide, 6-3/32" high, 11" deep.

Accessories furnished: Model 16005A Probe (clip-on), 16006A Probe (pin-contact) and 16007A Test Leads. Detachable Power Cord.

Price: HP 4328A, \$450; Option 01 (rechargeable battery operation), add \$25.

DECADE CAPACITOR

High accuracy from 40 pF to 1.2 μ F
Model 4440B

Description

The HP 4440B Decade Capacitor is a high accuracy instrument providing usable capacitances from 40 pF to 1.2 μ F. Its 0.25% accuracy makes it an ideal aid for circuit design or ac bridge measurements. The 4440B is also highly suited for production line testing and use as a working standard.

Use of silvered-mica capacitors in four decades of 100 pF provides

higher accuracy, low dissipation factors and good temperature coefficients. An air capacitor vernier provides 100 pF (from 40 pF to 140 pF) with resolution of 1 pF. Capacitors are housed in a double shield in such a way that increased capacitance from two terminals to three terminals is held to 1 pF.

Specifications

Capacitance: 40 pF to 1.2 μ F in steps of 100 pF with a 40 pF to 140 pF variable air capacitor providing continuous adjustment to better than 2 pF between steps. 0.1 μ F x 11 steps +0.01 μ F x 9 steps +0.001 μ F x 9 steps +0.0001 μ F x 9 steps +40 to 140 pF.

Direct reading accuracy: $\pm (0.25\% + 3 \text{ pF})$ at 1 kHz for three-terminal connection, capacitance increase for two-terminal connection is less than 1 pF.

Resonant frequency: typical values of the resonant frequency are 450 kHz at 1 μ F, 4 MHz at 0.01 μ F and 40 MHz at 100 pF.

Dissipation factor: 0.001 maximum at 1 kHz.

Temperature coefficient: +70 ppm/ $^{\circ}$ C.

Insulation resistance: 5 G ohms minimum, after 5 minutes at 500 V dc.

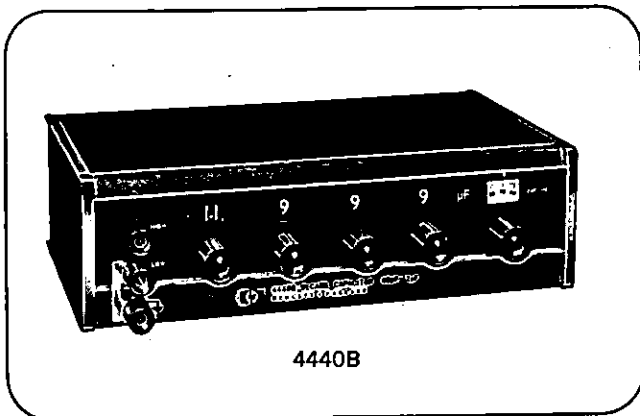
Maximum voltage: 500 V peak.

Weight: 5 $\frac{1}{2}$ lbs (2.5 kg).

Dimensions: 11" wide (264 mm), 6" deep (152 mm), 3" high (76 mm).

Price: HP 4440B, \$260.

Manufactured by Yokogawa-Hewlett-Packard Ltd., Tokyo



4440B

RESISTANCE METER

Wide range for high resistance, low current
Model 4329A



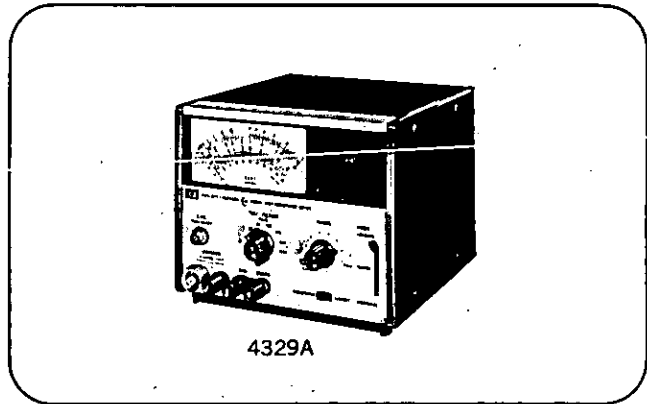
VOLTAGE, CURRENT,
RESISTANCE

Description

The HP 4329A is a solid-state insulation resistance meter designed for easy, accurate and direct readings of the very high resistance values typically found in synthetic resins, porcelain, insulating oils and similar materials. It is also useful for measurements in electrical components like capacitors, transformers, switches and cables. Seven fully regulated dc test voltages (between 10 and 1000 V) are provided as test sources.

Selected scales are identified by illuminated indicators on the meter face. Selected resistance or current multiplying factors are also illuminated for rapid, error-free measurement. Three resistance scales and one current scale are provided. The HP 4329A is instantly convertible from ungrounded- to grounded-sample operation via a simple relocation of the front panel ground strap from "guard" to "+" position. The instrument cabinet itself is always at ground potential. Test voltage shorts or sample breakdown currents will not damage instrument circuitry.

The HP 4329A also has a current measurement capability. Minute currents as low as 0.05 pA can be readily measured. The standard instrument package includes HP 16117A Low Noise Test Leads;



4329A

these are used in most types of measurement. An HP 16008A resistivity cell is also available for use with the high resistance meter, for those customers engaged in measurement of volume and surface resistivity of sheet samples.

Specifications

Resistance measurement:

Range: 500 K Ω to 2 x 10¹⁴ Ω .

Test voltage	10 V	25 V	50 V	100 V	250 V	500 V	1000 V
Available resistance readings	5 x 10 ⁵ Ω to 2 x 10 ¹⁴ Ω	1.25 x 10 ⁶ Ω to 5 x 10 ¹⁴ Ω	2.5 x 10 ⁶ Ω to 1 x 10 ¹⁵ Ω	5 x 10 ⁶ Ω to 2 x 10 ¹⁵ Ω	1.25 x 10 ⁷ Ω to 5 x 10 ¹⁵ Ω	2.5 x 10 ⁷ Ω to 1 x 10 ¹⁶ Ω	5 x 10 ⁷ Ω to 2 x 10 ¹⁶ Ω
Meter scale	.5 to 20	.13 to 5	.25 to 10	.5 to 20	.13 to 5	.25 to 10	.5 to 20
Upper limit	5	1.25	2.5	5	1.25	2.5	5

Accuracy: total accuracy is determined by test voltage and range used. At low resistance end of each scale accuracy is $\pm 3\%$; near center scale $\pm 5\%$, and near the specified upper limit on the meter scale (see table above) accuracy is $\pm 10\%$. Above these limits accuracy is not specified. On all voltage ranges, if multiplier is set to Rmax., an additional $\pm 3\%$ is included.

Current measurement

Range: 0.5 x 10⁻¹² to 2 x 10⁻¹⁵ A in 8 ranges.

Meter scale: 0 to 20 in 40 linear divisions.

Input resistance: 10⁴ to 10¹¹ Ω $\pm 1\%$, depending on range.

Accuracy: $\pm 5\%$ of full scale deflection (there can be an additional $\pm 3\%$ error at the top decade).

General

Recorder output: 0 to 100 mV dc, proportional to meter deflection; 1 k Ω output resistance.

Power: 114/230 V $\pm 10\%$, 50-60 Hz, 3 W.

Dimensions: 6 $\frac{1}{2}$ " high (166 mm), 7-25/32" wide (198 mm), 8-25/32" deep (223 mm).

Weight: 8 lbs (3.5 kg).

Accessory furnished: HP 16117A Low Noise Test Leads.

Price: HP 4329A, \$750.

Model 16008A Resistivity Cell

Description

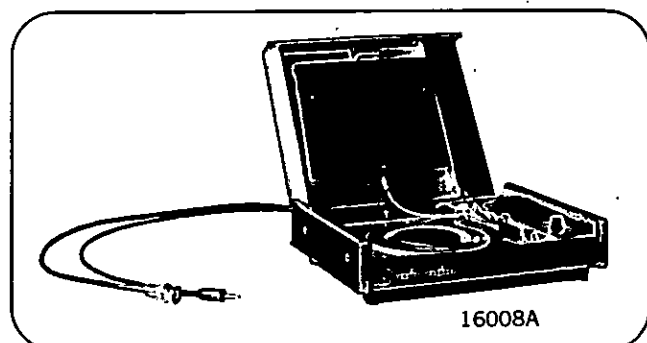
The HP 16008A can safely, rapidly and conveniently measure the volume and surface resistivity of sheet insulation materials. Conversion from volume to surface resistivity measurement requires operation of one switch only; no lead interchange or disconnection is necessary. Designed for use with the HP 4329A Resistance Meter (other voltage supplies and picoammeters may be used), the complete system allows direct measurement of volume resistivity up to approximately 4 x 10¹⁵ Ω (on samples 0.1 cm thick)—and surface resistivity up to approximately 4 x 10¹⁵ Ω . Test voltages up to 1000 V may be used. Excellent sample-to-electrode contact is maintained through use of a conducting plastic layer bonded to the inner electrode's outer surface. An interlock switch automatically disconnects the test voltage when the cover is raised. Convenient low noise test leads are supplied for direct connection to the HP 4329A.

Specifications

Inner electrode: 50 mm \varnothing .

Guard electrode: 70 mm \varnothing .

Auxiliary electrode: 100 x 120 mm.



16008A

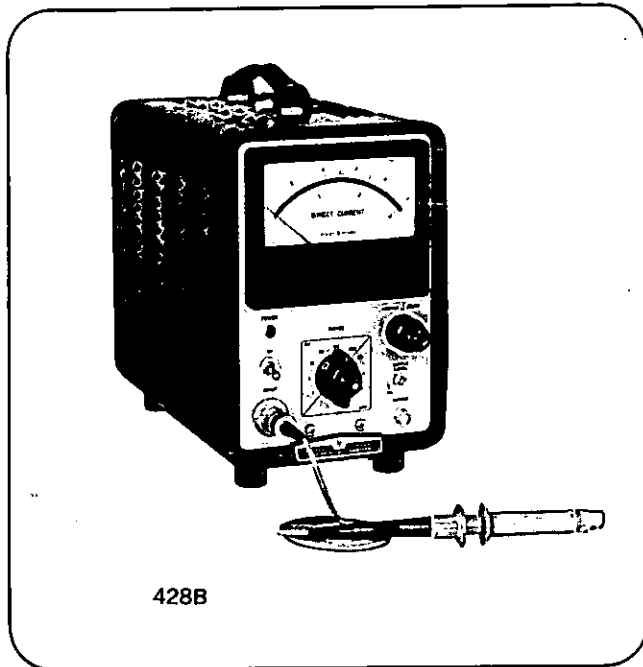
Manufactured by Yokogawa-Hewlett-Packard Ltd., Tokyo

**VOLTAGE, CURRENT,
RESISTANCE**



CLIP-ON MILLIAMMETER

Measures current without interrupting circuit
Model 428B and probes



428B

Description

Direct current from 0.02 milliamperes to 10 amperes can be measured with the HP 428B without interrupting the circuits and without the error-producing loading of conventional methods.

For any measurement of dc within its range, simply clamp the jaws of the 428B around a wire and read.

This ease and speed of operation are unparalleled, especially for applications where many dc measurements must be made. Wide current range of the 428B will handle most signals directly. For even greater sensitivity, several loops may be put through the probe, increasing the sensitivity by the same factor as the number of loops.

In addition to making current measurements directly, the 428B is also valuable for measuring sums and differences of currents in separate wires. When the probe is clipped around two wires carrying current in the same direction, their sum is indicated on the meter; when one of the wires is reversed, their difference is measured. Thus, current balancing is possible by obtaining a zero difference reading.

Model 428B provides an output voltage proportional to the measured current, which is useful for driving recorders or making low-frequency (dc to 400 Hz) current measurements.

Specifications

- Current range:** 1 mA to 10 A full scale, nine ranges.
- Accuracy:** $\pm 3\%$ of full scale from 0°C to 55°C (when instrument is calibrated to probe).
- Probe inductance:** $< 0.5 \mu\text{H}$.
- Probe inducted voltage:** $< 15 \text{ mV p}$ (worst case at 20 kHz and harmonics).
- Output:** variable linear output level with switch position for calibrated 1 V into open circuit (corresponds to full scale deflection). 1.5 V max. into open circuit in uncalibrated position. $0.73 \pm .01 \text{ V}$ into 1 K Ω in calibrated position.
- Noise:** 1 mA range, $< 15 \text{ mV rms}$ across 1 K Ω .
3 mA range, $< 5 \text{ mV rms}$ across 1 k Ω .
10 mA through 10 A ranges, $< 2 \text{ mV rms}$ across 1 K Ω .
- Frequency range:** dc to 400 Hz (3 dB point).

AC rejection: signals above 5 Hz with p value $<$ full scale affect meter accuracy $< 2\%$ (except at 40 kHz carrier frequency and its harmonics). On the 10 A range, ac p value is limited to 4 A.

Power: 115 or 230 V $\pm 10\%$, 50 to 60 Hz, approx. 70 W.

Operating temperature range: -20°C to $+55^\circ\text{C}$.

Storage temperature: -40°C to $+65^\circ\text{C}$.

Probe insulation: 300 V maximum.

Probe tip size: approximately $\frac{1}{2}$ " by $2\frac{3}{32}$ "; aperture diameter $\frac{5}{32}$ ".

Dimensions: $7\frac{1}{2}$ " wide, $11\frac{1}{2}$ " high, $14\frac{1}{4}$ " deep (191 x 292 x 272 mm); rack mount: 19" wide, $6\frac{3}{32}$ " high, 13" deep (483 x 177 x 330 mm).

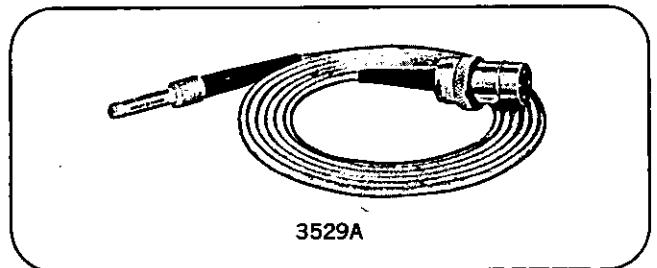
Weight: net 17 lbs (7.7 kg), shipping 20 lbs (9 kg) (cabinet); net 24 lbs (10.8 kg), shipping 33 lbs (14.9 kg) (rack mount).

Price: HP 428B, \$650 (cabinet); HP 428BR, \$655 (rack mount).

Accessories Available

3528A Large Aperture Current Probe

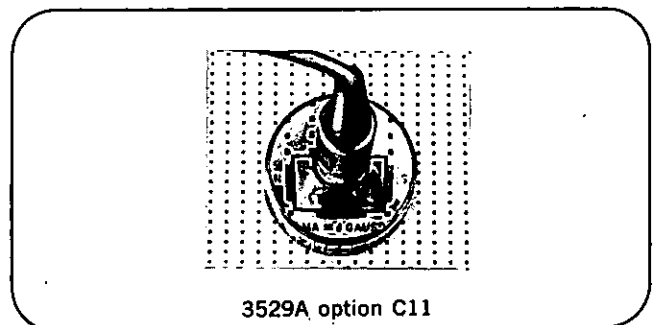
The HP 3528A permits clip-on current measurements in conductors up to $\frac{1}{2}$ inches in diameter. Price: HP 3528A, \$525.



3529A

3529A Magnetometer Probe

The HP 3529A Magnetometer Probe is useful in applications where determination must be made of the direction or magnitude of a magnetic field. It is useful in applications ranging from acoustical transducer design to investigations involving the Zeeman effect. Conversion factor is 1:1, producing a reading on the 428B in milliamperes which is directly equal to the measured field strength in milligauss. Range is 1 milligauss to 10 gauss with the 428B. The bandwidth is dc to 80 Hz, and accuracy is $\pm 3\%$ of full scale when the probe is calibrated with the instrument (5% when not calibrated to specific 428B). Price: HP 3529A, \$95.



3529A option C11

3529A Option C11 Magnetometer Probe

The 3529A Option C11 is a special magnetometer probe used to convert the Hewlett-Packard 428A or 428B DC Milliammeter into a direct reading magnetometer (1 G = 1 mA indication on 428 A/B meter). The 3529A Option C11 Magnetometer Probe is specifically designed to measure the relative magnetic field strength of individual bar magnets on twistor memory cards used in the Western Electric Electronic Switching System (No. 1ESS). Refer to data sheet for further information.

VOLTMETER ACCESSORIES

Voltage dividers, current probe for VM's.
Model 456A, 11000 Series



**VOLTAGE, CURRENT,
RESISTANCE**

456A AC Current Probe

The conventional voltmeter or oscilloscope can measure current quickly and dependably—without direct connection to the circuit under test or any appreciable loading to the test circuit. The HP 456A AC Current Probe clamps around the current-carrying wire and provides a voltage output you can read on a voltmeter or scope. Model 456A's 1 mA to 1 mV conversion permits direct reading up to 1 ampere rms.

Specifications, 456A

Sensitivity: 1 mV/mA $\pm 1\%$ at 1 kHz.

Frequency response: $\pm 2\%$, 100 Hz to 3 MHz; $\pm 5\%$, 60 Hz to 4 MHz; -3 dB at < 25 Hz and > 20 MHz.

Pulse response: rise time is < 20 ns, sag $< 16\%$ /ms.

Maximum input: 1 A rms, 1.5 A p; 100 mA above 5 MHz.

Effect of dc current: no appreciable effect on sensitivity and distortion from dc current up to 0.5 A.

Input impedance: (impedance added in series with measured wire by probe) < 50 m Ω in series with 0.05 μ H (this is approximately the inductance of $1\frac{1}{2}$ " of hookup wire).

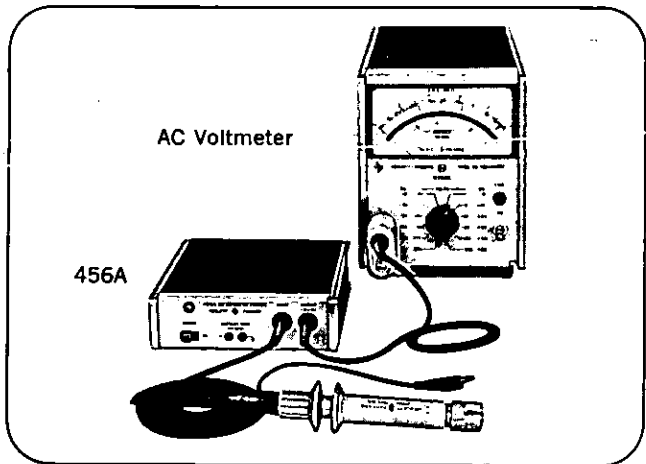
Probe shunt capacity: approx. 4 pF added from wire to ground.

Distortion at 1 kHz: for 0.5 A input at least 50 dB down; for 10 mA input at least 70 dB down.

Equivalent input noise: < 50 μ A rms (100 μ A when ac powered).

Output impedance: 220 Ω at 1 kHz; approximately +1 V dc component; should work into load of not less than 100,000 Ω shunted by approximately 25 pF.

Power: two Mallory TR 233R and one TR 234 batteries (1420-0005 and 1420-0006); battery life approximately 400 hrs; ac power



supply optional, 115 or (230 V must be specified) $\pm 10\%$, 50 to 400 Hz, 1 W.

Dimensions: 5" wide, $1\frac{1}{2}$ " high (127 x 38 x 152 mm), 6" deep; probe cable is 5' long; 2' output cable terminated with dual banana plug. Probe aperture: $\frac{5}{32}$ " (4 mm) diameter.

Weight: net 2 lbs, 4 oz (1 kg); shipping 3 lbs, 10 oz (1,6 kg).

Accessory available: 456A-11A AC Supply for field installation; 11028A 100:1 Current Divider, \$48.

Price: HP 456A with batteries, \$250.

Option 001: ac supply installed in lieu of batteries, add \$20.

11039A Capacitive Voltage Divider

For 400 and 410 series voltmeters. Safely measures power voltages to 25 kV; accuracy $\pm 3\%$. Division ratio, 1000:1. Input capacity, 15 pF ± 1 . Maximum voltage ratings (sea level) 60 Hz, 25 kV; 100 kHz, 22 kV; 1 MHz, 20 kV; 10 MHz, 15 kV; 20 MHz, 7 kV. Usable for dielectric heating, power and ultrasonic voltages. Price: HP 11039A, \$200. (HP 11018A should be used to connect the 410 series voltmeter).

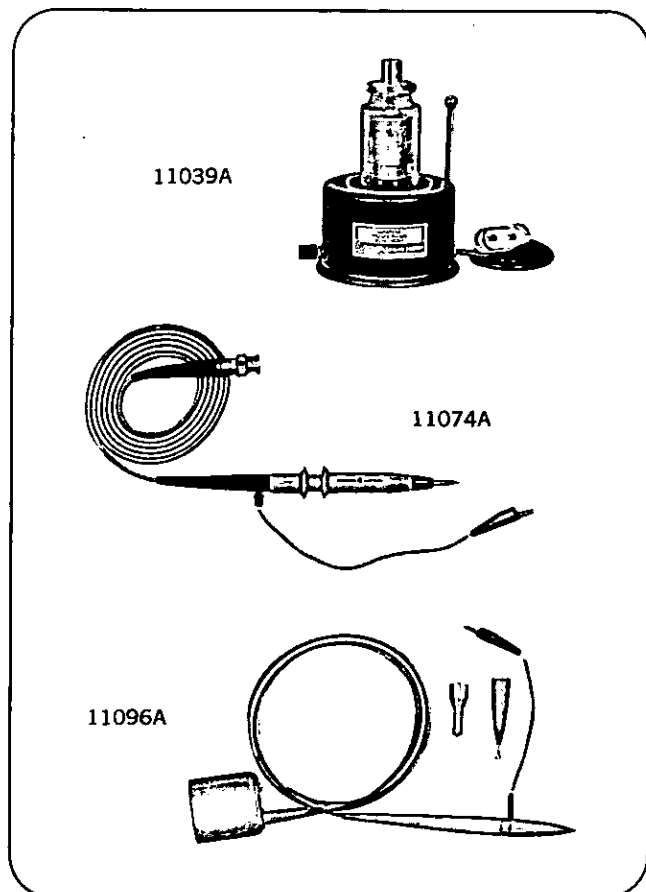
11074A Voltage Divider Probe

For 400 series voltmeters. Provides low-input capacitance and high-input resistance at the point of measurement. Division ratio 10:1 $\pm 2\%$ (400 Hz reference), 10:1 $\pm 2\%$ (100 kHz reference depends on adjustment of compensating capacitor). Bandwidth, dc to 10 MHz. Maximum input voltage 1 kV rms.

Input impedance: 10 M Ω shunted by 10 pF (when connected to an input impedance of 10 M Ω shunted by not more than 25 pF). Price: HP 11074A, \$50.

11096A High Frequency Probe

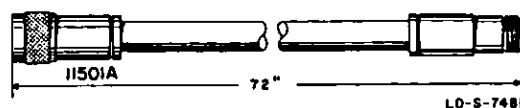
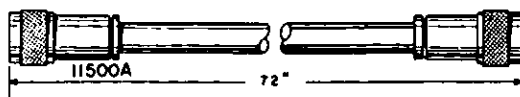
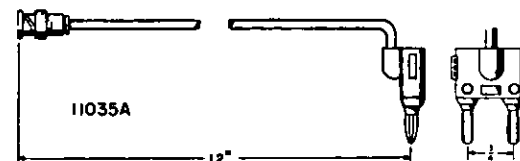
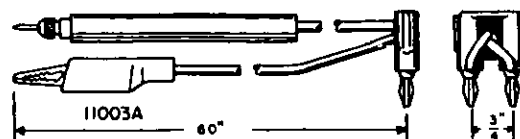
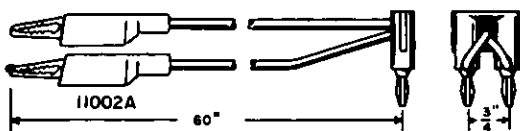
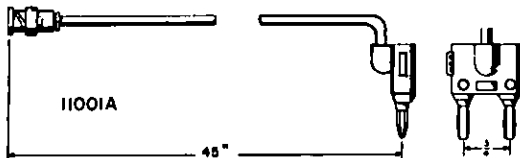
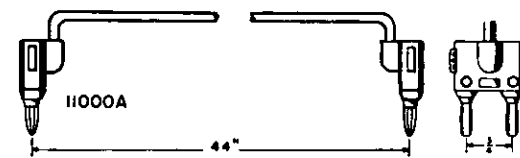
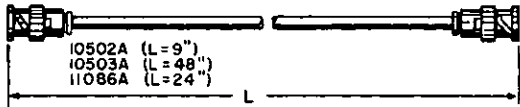
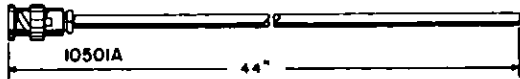
Converts dc voltmeter with 10 M Ω input resistance to high frequency ac voltmeter. Compatible voltmeters: HP 427A, HP 3430A, HP 3439A and HP 3440A. Voltage range, 0.25 to 30 V rms; transfer accuracy (20-30°C) $\pm 5\%$, 100 kHz to 100 MHz. Usable for relative measurements from 1 kHz to 1 GHz; peak responding, calibrated to read rms value of a sine wave; input impedance, 4 M Ω shunted by 2 pF; max. input, 30 V rms ac, 200 V dc; accessories provided include a straight tip, a hook tip, a ground clip, and a high frequency adapter that fits available HP adapters for BNC (HP 10218A); GR Type 874 (HP 10219A), Microdot connectors (HP 10220A) and that also fits a 50 Ω tee (HP 11536A). Price: HP 11096A, \$60.





CABLE ACCESSORIES

Cable assemblies



LD-S-748B

10501A Cable Assembly

44" of 50Ω coaxial cable terminated on one end only with UG-88C/U BNC male connector; HP 10501A, \$4 each.

10502A Cable Assembly

9" of 50Ω coaxial cable terminated on both ends with UG-88C/U BNC male connectors; HP 10502A, \$6 each.

11086A Cable Assembly

24" of 50Ω coaxial cable terminated on both ends with UG-88C/U BNC male connectors; HP 11086A, \$7 each.

10503A Cable Assembly

4' of 50Ω coaxial cable terminated on both ends with UG-88C/U BNC male connectors; HP 10503A, \$7 each.

11000A Cable Assembly

Dual banana plugs terminate a section of 50Ω cable, 44" over-all; plugs for binding posts spaced $\frac{3}{4}$ "; HP 11000A, \$5 each.

11001A Cable Assembly

Identical with 11000A except dual banana plug on one end and UG-88C/U BNC male on the other; HP 11001A, \$6 each.

11002A Test Leads

Dual banana plug to alligator clips, 5'; HP 11002A, \$8 each.

11003A Test Leads

Dual banana plug to probe and alligator clip, 5'; HP 11003A, \$10 each.

11035A Cable Assembly

12" 50Ω coaxial cable terminated on one end with a dual banana plug and on the other end with a UG-88C/U BNC male connector; HP 11035A, \$6 each.

11500A Cable Assembly

6' of 50Ω coaxial cable terminated on both ends with UG-21D/U Type N male connectors; HP 11500A, \$15 each.

11501A Cable Assembly

6' of 50Ω coaxial cable terminated with UG-21D/U Type N male and UG-23D/U Type N female; HP 11501A, \$15 each.

DIGITAL VOLTMETERS



DIGITAL VOLTMETERS

Digital voltmeters (DVM's) display measurements as discrete numerals, rather than as a pointer deflection on a continuous scale commonly used in analog devices. Direct numerical readout in DVM's reduces human error and tedium, eliminates parallax error and increases reading speed. Automatic polarity and range-changing features reduce operator training, measurement error and possible instrument damage through overload.

Digital instruments are available to measure ac and dc voltages, dc currents resistance and ratio. Other physical variables can also be measured by use of suitable transducers. Many have outputs which can be used to make permanent records of measurements with printers, card and tape punches, and magnetic tape equipment. With data in digital form, it may be processed with no loss of accuracy.

Most popular digital voltmeters on the market today fit into one of the following categories: (1) ramp, (2) staircase ramp, (3) dual slope integrating, (4) integrating, (5) integrating and potentiometric, (6) successive approximation, and (7) continuous balance.

Types currently in use by HP are described below (refer to Table 1, p. 198).

Ramp Types: the operating principle of the ramp digital voltmeter is to measure the time a linear ramp takes to change from the input level to ground (or vice versa). This time period is measured with an electronic time-interval counter and displayed on in-line indicating tubes. The advantages of this type of instrument are low price and simplicity. Conversion of a voltage to a time interval is illustrated by the timing diagram in Figure 1. At the start of a measurement cycle, a ramp voltage is initiated. The ramp is compared continuously with the voltage being measured; at the instant they become equal, a coincidence circuit generates a pulse which opens a gate. The ramp continues until

a second comparator circuit senses that the ramp has reached zero volts. The output pulse of this comparator closes the gate.

The time duration of the gate opening is proportional to the input voltage. The gate allows pulses to pass to totalizing circuits, and the number of pulses counted during the gating interval is a measure of the voltage. Figure 2 illustrates the technique used in the HP 3440A Digital Voltmeter.

The 3440A has an accuracy of $\pm 0.05\%$ of reading with reading rates up to 5 per second. These features, coupled with its capability of 10 μ V resolution, 4-digit readout, and plug-in versatility, make it a popular and economical choice.

The HP 3430A is a 3-digit DVM priced not much higher than an analog voltmeter.

The speed, convenience, and accuracy of digital readout now becomes available at a moderate price for general-purpose applications in the laboratory, on production test stands, in repair shops, and at inspection stations. The new DVM has a floating input, a feature not commonly

found in low cost digital voltmeters. An optional version of the instrument permits ratio measurements, a useful feature for normalizing the readings of dc transducer outputs and taking readings using an external reference. A precision dc amplifier output is an additional benefit of this model.

Referring to Figure 3, the 3430A makes voltage measurements by comparing the input voltage to an internally generated "staircase ramp" voltage. When the input and the staircase ramp voltages are equal, a comparator generates a signal to stop the ramp. Then the instrument displays the number of counts necessary to make the staircase ramp equal to the input. At the end of the sample, a reset pulse resets the staircase to zero and the measurement starts over. The display circuits store each reading until a new reading is completed, eliminating any blinking or counting during computation. The sample rate is fixed at two samples per second.

Integrating types: an integrating digital voltmeter measures the true average of the input voltage over a fixed measuring period, in contrast to ramp-types

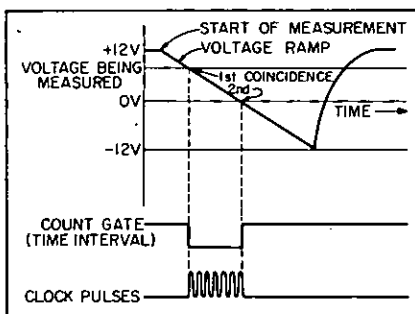


Figure 1. Voltage-to-time conversion.

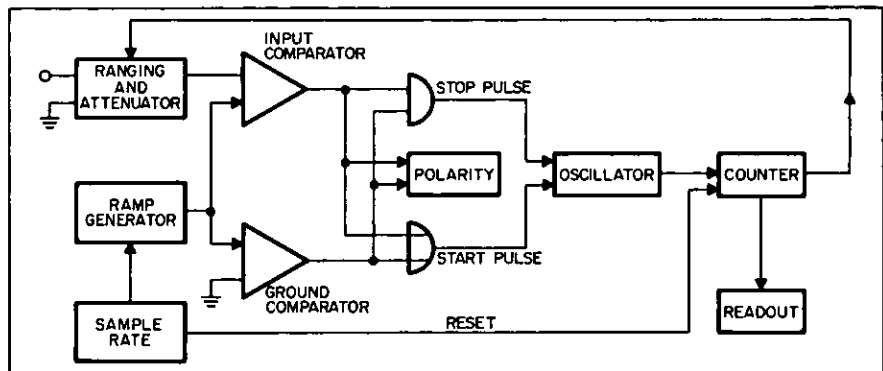


Figure 2. Block diagram of HP 3440A Digital Voltmeter.

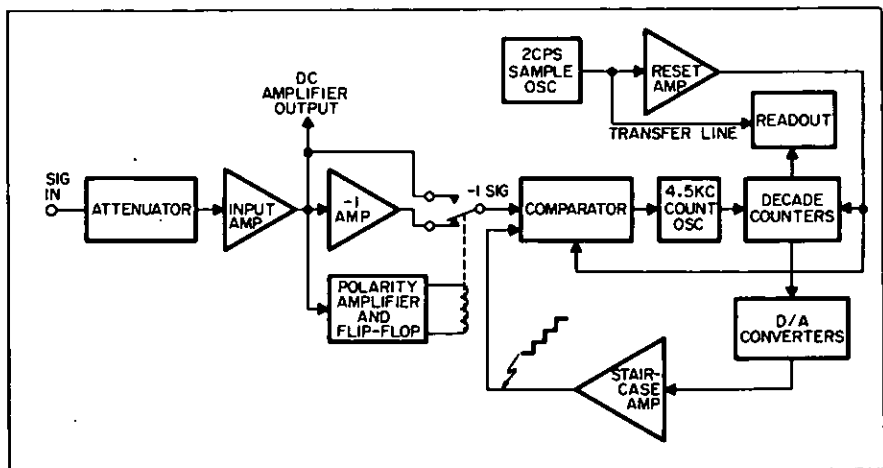


Figure 3. Block diagram of HP 3430A Digital Voltmeter.

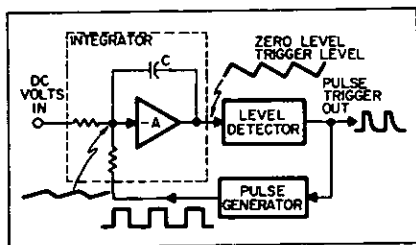


Figure 4. Voltage-to-frequency conversion.

which measure the voltage at the end of the measuring interval. A widely-used technique to accomplish integration is the use of a voltage-to-frequency converter, as indicated in Figure 4. The circuitry functions as a feedback control system which governs the rate of pulse generation, making the average voltage of the rectangular pulse train equal to the dc input voltage.

The major advantage of this type of analog-to-digital conversion is its ability to measure accurately in the presence of large values of superimposed noise, because the input is *integrated* over the sampling interval. The reading represents a true average of the input voltage.

The HP 2402A Integrating Digital Voltmeter, which is in the 0.01%-accuracy class, uses the voltage-to-frequency conversion technique, achieving the ability to reject the effects of superimposed noise. A floated and guarded input circuit eliminates common-mode noise error. Combined, these techniques yield effective common-mode rejection of 126 dB at any frequency.

This model measures the average value of the applied voltage over a 1/60 second sample period. Used in a data system, it provides the benefit of integration and in one second can make 40 separate 5-digit measurements with a maximum resolution of 1 part in 130,000. When used on the bench without external triggering, it takes up to 10 readings per second. In addition, it has constant 10-megohm input resistance and is designed for completely programmable operation within a digital data acquisition system.

DC voltage, ac voltage, resistance, frequency and range (or autorange) can all be selected by remote programming. The simplified block diagram illustrated in Figure 5 represents the basic functional components which enable the HP 2402A to accept analog signals and convert them to digital information.

Basically, the instrument consists of a voltage-to-frequency converter and a counter. A dc voltage applied to an integrating amplifier in the converter is changed to a pulse rate proportional to the applied voltage. AC voltage and resistance inputs are converted to dc voltage before being applied to the converter.

During the 1/60-second interval, the output of the V/F converter is applied to the 10⁰ decade (see Figure 5). An

interpolation technique is used after the sampling period when pulses are entered into the 10⁰ decade. These pulses are proportional to the charge remaining on the integrating capacitor after the 1/60-second sampling time. After the interpolation period, the counts present in all decades are displayed by in-line digital readout tubes.

The V/F converter is isolated from the counter by a shielding technique known as guarding, which isolates the input interconnected between the converter and counter sections by thru-guard transformers and thru-guard relays. Each section has its own power supply.

The converter section includes attenuating and switching circuits in addition to the voltage-to-frequency converter. The counter section includes a time-base generator, decade dividers and control logic circuits in addition to the reversible counter.

The HP 2401C Integrating Digital Voltmeter is also in the 0.01% accuracy class, and uses the voltage-to-frequency conversion technique, achieving outstanding ability to reduce the effects of *superimposed* noise; it achieves *common-mode* noise rejection by guarding.

This model applies especially well to measurements of extremely noisy signals. Measurements down to 99.999 mV full scale can be made without an accessory amplifier. Complete remote-control ability makes it ideal for system applications. It can also be used as an electronic counter to measure frequency or period.

Integrating/Potentiometric Types: by using techniques exploiting the best qualities of several systems, a totally new result is achieved in the HP 3460B. Besides being an integrating-type voltmeter which continually measures the true average of the input voltage, it is also a potentiometric type providing high accu-

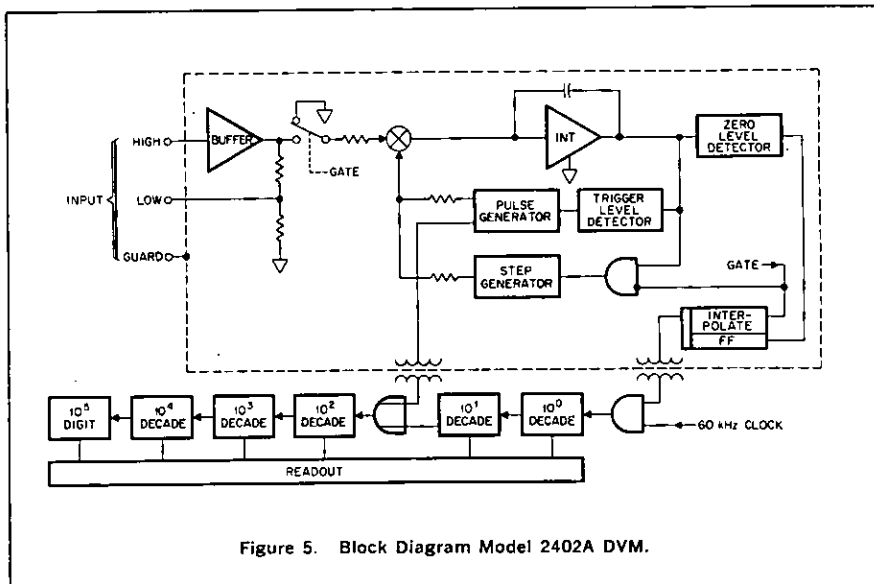


Figure 5. Block Diagram Model 2402A DVM.

Table 1. Hewlett-Packard Digital Voltmeters.

Model (Type)	Accuracy (% of reading)	Number Digits	Overrange %	Speed (Max.) Readings/sec	AC Volts	DC Volts	DC Amps	Ohms	Ratio	Auto Ranging	Floating Input	Guarding (CMR)	Printer Output	Remote Ranging	Remote Triggering	Plug-ins	Systems Application	Limit Test
Dual-slope/Integrating																		
3450A (pg 208)	0.008	5	120	15	▲	X		▲	†	X	X	X	▲	▲	X	▲	X	▲
Integrating/Potentiometric																		
3462A (pg 218)	0.004	6	120	1		X				X	X	X	X	X	X		X	
3460B (pg 216)	0.004	5	120	15	+	X		+		X	X	X	X	X	X		X	
Integrating																		
HP-2402A (pg 212)	0.01	5	120	43	▲	X		▲		▲	X	X	X	X	X	▲	X	
HP-2401C (pg 214)	0.01	5	300	1**	≠	X		≠		*	X	X	X	X	X		X	
Ramp																		
3440A (pg 204)	0.05	4	105	5	●	●	●	●		X	X		X	X	X	●	X	
3439A (pg 203)	0.05	4	105	5	X	X	X	X		X	X			X		●		
3430A (pg 202)	0.1	3	160	2		X				X	X							

*Optional: ±HP-2410B AC/Ohms Converter; +HP 3461A AC/Ohms Converter.
 **4 digits/9 readings per sec; 3 digits/50 readings per sec.
 ▲ plug-in circuit cards. ● plug-in drawer
 †Ratio for ac, dc, and ohms.

racy from precision resistance ratios and a stable reference voltage. A block diagram of the Integrating/Potentiometric Digital Voltmeter is shown in Figure 6.

The HP 3460B is a good choice for applications requiring extremely high accuracy ($\pm 0.004\%$ of reading) and high speed with high resolution. The 3460B takes up to 15 readings per second with 5-digit resolution (1.20000 full scale). Since the instrument is guarded, all readings can be made in the presence of large common-mode signals. The integration characteristic also allows a maximum reading rate, even with noise superimposed on the signal.

To be useful as the central analog-to-digital converter in an automatic system, a DVM must have several features which are not needed in a bench meter. Among these are binary-coded decimal output and remote controls. If system use is not intended, cost can be reduced by omitting these features.

The HP 3462A, which also uses the integrating/potentiometric technique, has a resolution of 1 part in 1,200,000 and a sensitivity of $1 \mu\text{V}$ on the 1 volt range. Its measurement accuracy is $\pm (0.004\%$ of reading $+ 0.0002\%$ of range).

Dual-Slope Integration Type: this entirely different technique is used in the HP 3450A Multi-Function 5-digit Voltmeter. The 3450A measures dc voltages by the use of an integrator which produces a time interval proportional to the average value of the applied dc voltage. The time interval determines the gate time of the counter, and therefore the number of pulses totalized. Thus, the number of pulses is proportional to the average of the dc voltage measured.

This technique of integrating the input signal over a precise time interval takes care of normal-mode rejection (line frequency, noise and varying signals) without the use of input filters which reduce the speed of readings considerably.

During a precisely controlled time period of $1/10$ or $1/60$ of a second, selectable for optimum performance, the 3450A integrates the input signal forming an up-slope. This voltage, stored after integration, is proportional to the average of the dc input voltage. To start the down-slope a precise reference voltage of opposite polarity is switched to discharge the integrator. The zero crossing of the output voltage is detected by a zero detect circuit. The counter is enabled to totalize pulses from a crystal oscillator during the discharge time or down-slope of the integrator. As the discharge time is proportional to the stored voltage, the number of pulses totalized is proportional to the input voltage.

After completion of the integration cycle, the input amplifier is disconnected and automatically zeroed before the next measurement is taken. This autozeroing

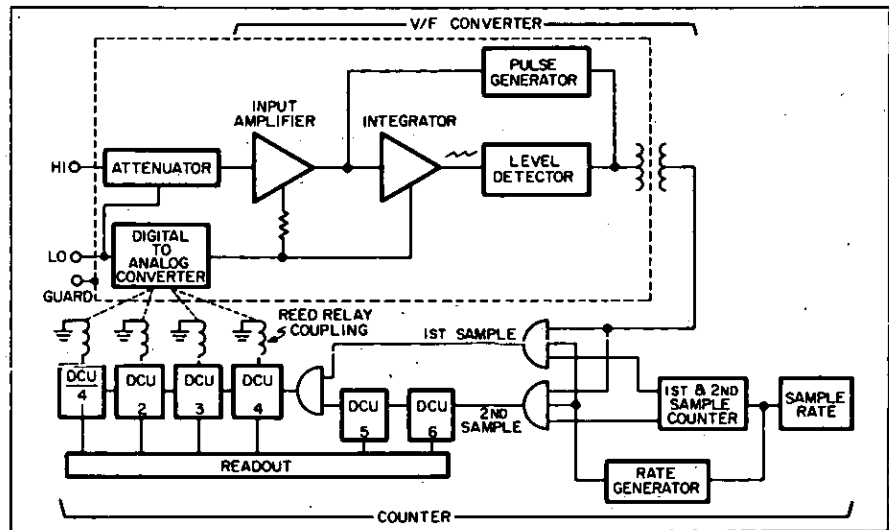


Figure 6. Block diagram of HP 3460B DVM.

effectively compensates for dc drift and eliminates the need for a chopper amplifier and front panel zero controls.

For dc voltage measurement the input is connected to the X input terminals (refer to Figure 7). For dc ratio measurement the ratio is the voltage applied to the X terminals over the voltage applied to the Y terminals (X/Y). The ratio measurement is performed in the same manner as a dc voltage measurement except the down-slope is not determined by the reference voltage but by the Y input voltage. The measurement sequence is as follows: 1) The Y input is measured to determine the proper range for Y. 2) This information is stored. The Y ranging is always performed automatically even if the instrument is switched to manual ranging. 3) The X input is applied to the integrator and the proper range determined. (The range for X must be equal to or higher than that of Y.)

4) After the ranges for both inputs are determined, the X input will be enabled to charge the integrator. 5) Then, the Y input will be enabled (on the proper range) to discharge the integrator. The front panel digital display is the ratio of X/Y.

The X and the Y inputs are measured sequentially. The inputs are switched off and on in sequence. By switching both the high and the low of each input, complete isolation of X and Y and identical input impedances are achieved.

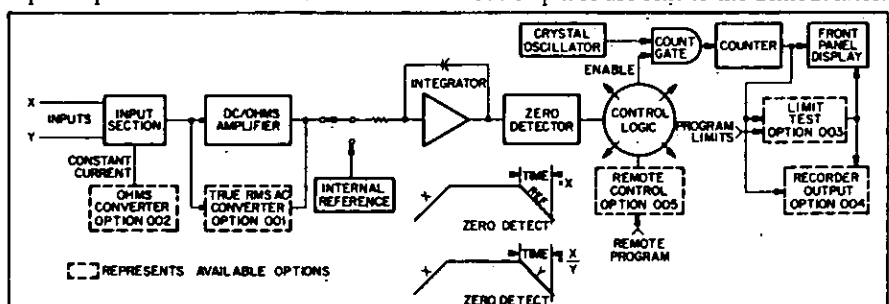


Figure 7. Block diagram of the 3450A Multi-Function Meter.

True rms ac to dc converter: ac voltage and ac ratio is a true rms responding measurement for frequencies from 45 Hz to 1 MHz. The input circuitry (shown in the block diagram Figure 8) consists of an operational amplifier whose gain is accurately controlled to achieve attenuation of the input signal. An ac output from the input amplifier is sent to the modulator, and a second output is used as a trigger for the sync generator (nominally 5 Hz). The sync square-wave generator is used to synchronize the modulator and demodulator to the input signal.

A 1 kHz oscillator drives the dc-to-square wave converter which converts the dc output of the ac converter into a reference square wave. The amplitude of the square wave is proportional to the dc output. The output of the modulator, at a nominal 5 Hz rate, consists of a composite signal made up of one-half input signal and one-half reference square-wave (refer to waveshape in Figure 8).

The AGC amplifier controls the gain of the sampling amplifier and the integrator. This keeps the rms value of the signal applied to the thermocouple constant and holds the gain of the system constant regardless of the level of the input signal. The output of the thermocouple varies between two levels, reflecting a difference in the rms value of the input and the reference signal. This error signal is amplified, and two signals 180° out of phase are sent to the demodulator.

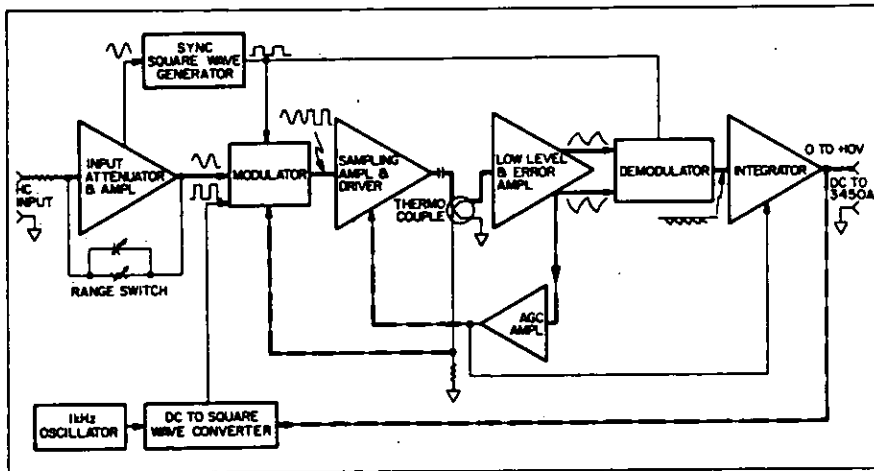


Figure 8. Ac-dc converter for the 3450A.

The demodulator acts as a full-wave rectifier. The output pulses are amplified and integrated to develop the positive dc voltage output. This dc voltage is continuously corrected at nominally 5 times per second to insure a dc voltage output proportional to the rms value of the input signal. From this true rms converter the 3450A provides ac measurements and ac ratio as described for dc measurements.

Ohms Converter: a 4 wire ohms measurement and a 4 terminal ohms ratio measurement can be made with a maximum current of 1 mA applied to the external resistor on the 10 k Ω range. This minimizes errors caused by self-heating of the unknown resistor.

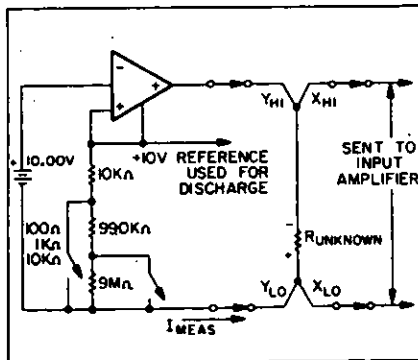


Figure 9. Ohms converter for the 3450A.

A current source supplies three constant currents of 1 mA, 10 μ A and 1 μ A and an open loop voltage of 17 volts maximum. In ohms operation the X input is the sense terminals, and the Y input is the current terminals. These must be connected for operation (refer to Figure 9), and for optimum accuracy the Hi input for both should be connected to one end of the unknown resistor and the Lo for both to the other end of the unknown resistor. In ohms ratio the four terminals are used as in any other ratio operation with complete isolation between the X and Y inputs.

The resistance measurements are made by feeding a constant current through the unknown resistor and measuring the

resultant voltage across the resistor. This current source is similar to an emitter follower with a constant ten volts across the emitter resistor. To increase measurement accuracy, the 3450A reference voltage is disabled, and the ohms reference voltage is used to discharge the integrator.

Limit Test: This operation provides Hi, Go or Lo indication according to two preset limits. If the front panel digit readout is between the two preset limits, the Go indicator will light. If the reading is above the higher limit, the Hi indicator will light, and if the readout is lower than either limit, the Lo indicator will light. This function may also be used for ratio measurements.

Options for remote operation, BCD output and rear input terminals can be obtained. Any combination of options can be purchased. Refer to pages 208 through 211 for additional information and specifications.

Selecting a digital voltmeter: DVM's offer three major advantages over other voltmeters. These advantages are (1) speed, (2) reduction in operator error, and (3) the ability to be remotely controlled or to control another device such as a printer or computer.

The first consideration in selecting a DVM is to determine the requirements necessary for the measurement to be made. Then select a voltmeter that will meet these requirements. For long range use anticipate all the needs for the future.

If the DVM is to be used in a data acquisition system, binary-coded decimal (BCD) output and remote programming capability are necessities. Compatibility with the related equipment (refer to pages 97 and 98) should be determined.

If more than one electrical property is to be measured in the specific applications, a multi-function meter is an advantage. Hewlett-Packard has many multi-function digital meters with different accuracies and different capabili-

ties. The 3460B Digital Voltmeter with the 3461A AC/Ohms Converter/DC Preamplifier gives the best accuracy and resolution as well as BCD outputs and remote programming capabilities (refer to pages 216 and 217). The 3450A Multimeter with plug-in cards gives a vast variety of options including a true RMS ac digital voltmeter and a Hi-Go-Lo Comparator (refer to pages 208 through 211). The 2402A Integrating DVM has a selection of dc only or ac voltage, resistance, frequency and auto-ranging can be added. Other Hewlett-Packard digital multimeters are the 2401C with the 2410B ac voltage or resistance converter and the 3439A or 3440A with plug-in drawers giving a large selection of functions including an ammeter.

The art of dc voltage measurements has reached levels of accuracy which were formerly obtained only in the standards laboratory. When selecting a voltmeter to make accurate measurements in the presence of noise, the DVM must discriminate between the real signal and the noise appearing at its input. These noise signals take the form of either superimposed noise or common-mode noise.

Besides the usual external source of common-mode voltages, the measuring instrument can also contribute additional common-mode voltages. Internal double shielding is effective in eliminating the internal causes of common-mode voltages. A third shield or guard can be used to reduce the effects of external common-mode signals.

Superimposed noise upon the input voltage can also cause inaccuracies. A low-pass filter added to the input circuitry of the voltmeter can solve this problem but it does cause a considerable slowing of the digitizing process. Superimposed noise rejection by integration permits high accuracy in the presence of severe noise. Refer to page 198 for the description of the integration process.

The 3462A has a resolution of 1 part in 1,200,000 and a sensitivity of 1 μ V on the 1 V range. Transducer and load cell performance can be monitored for incremental changes in their outputs. Accurate determination of diode breakdown and transistor voltages as a function of temperature can be determined.

The maintenance cost should always be considered. Sometimes a DVM is selected with more accuracy than necessary for the measurement so that the calibration period can be extended and still maintain the necessary accuracy. Preventative maintenance or thorough checks at the end of the calibration period often prevent extensive repair at a future date. Refer to Table 1—a Hewlett-Packard DVM is available to meet most application requirements.

AC/DC Converters: the ac-to-dc converter (Figure 10) typically produces a dc output voltage between 0 and 1 V dc proportional to the average value of the applied ac voltage calibrated in rms.

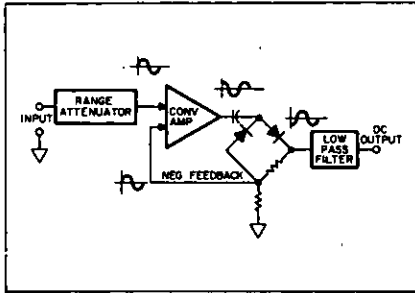


Figure 10. Typical ac/dc converter.

Ohms-to-Dc Converter: the ohms-to-dc converter, frequently an additional function of ac-to-dc converters, produces a dc output voltage between 0 and 1 V dc proportional to the value of the unknown resistance applied. Most ohms-to-dc converters require a high input impedance dc preamplifier.

The HP 3461AC/Ohms Converter DC Preamplifier has total compatibility with the 3460B, and can measure ac voltages up to 1200 V rms, and resistances up to 12 megohms. It is fully guarded, automatic ranging on all functions, and is remotely programmable.

The compatible AC-ohms converter for the 2401C is the HP Model 2410B.

Plug-in AC/DC Converters: the HP 3445A and 3446A Plug-ins are companions to the HP 3439A and 3440A Digital Voltmeters.

Analog Voltmeters used as AC/DC Converters: connect any dc DVM with a 1 V dc range to the dc output of an analog voltmeter, such as the HP 400E/EL.

True rms measurements from 10 Hz to 10 MHz can similarly be made by combining any dc digital voltmeter having a 1-volt range with the HP 3400A RMS Voltmeter.

Typical specifications of Hewlett-Packard ac-to-dc and ohms-to-dc converters are listed in Table 2.

Table 2. Hewlett-Packard AC/Ohms Converters/Preamplifiers.

Converter type (refer to page)	Companion HP DVM	Ranges	Auto ranging	Floating	Guarded	Plug-ins	Remote ranging	Remote triggering	Systems application	Calibration period (days)	Accuracy of measurement at full scale 20°C to 30°C	Can be used with other 1 V range DVM's
AC to DC												
3450A Option 001 True rms (pg. 209)	Part of 3450A	1 to 1000 V 4 ranges	X	X	X	**	X	X	X	30	True rms (45 Hz to 1 MHz) ±0.05% to ±2.1%	No
2402A Option 02 (pg 212)	Part of 2402A	1 to 1000 V 4 ranges	X	X	X	**	X	X	X	180 [‡]	(50 Hz to 100 kHz) ±0.12% to ±0.31%	No
3461A (pg 217)	3460B	1 to 1000 V 4 ranges	X	X	X		X	X	X	90	(50 Hz to 100 kHz) ±0.07% to ±0.15%	Yes
2410B (pg 214)	2401C	0.1 to 1000 V 5 ranges	+ +	X			X	X	X	90 [‡]	(50 Hz to 100 kHz) ±0.175% to 0.5%	Yes
3445A/3446A (pg 207)	3439A/3440A	10 to 1000 V 3 ranges	X	X		X	X	X	X	90 [‡]	(50 Hz to 100 kHz) ±0.1% to ±0.3%	No
457A* (pg 220)		1 mV to 1000 V 4 ranges		X							(50 Hz to 500 kHz) ±1.05%	Yes
3400A* (true rms) (pg 181)	3439A/3440A	1 mV to 300 V 12 ranges									(10 Hz to 10 MHz) ±0.75% to ±5.0%	Yes
400E/EL* (avg) (pg 178)	3439A/3440A	1 mV to 300 V 12 ranges								365	(10Hz to 10 MHz) ±0.5% to ±5.0%	Yes
OHMS to DC												
3450A Option 002 (pg 210)	Part of 3450A	100Ω to 10MΩ 6 ranges	X	X	X	**	X	X	X	30	±0.012 to 0.102%	No
2402A Option 003 (pg 212)	Part of 2402A	1 kΩ to 10 MΩ 5 ranges	X	X	X	**	X	X	X	180 [‡]	±0.055%	No
3461A (pg 217)	3460B	1 kΩ to 10 MΩ 5 ranges	X	X	X		X	X	X	90	0.016% to ±0.02%	Yes
2410B (pg 214)	2401C	100Ω to 10 MΩ 6 ranges	‡	X	X		X	X	X	90 [‡]	±0.089%	Yes
3444A (pg 206)	3439A/3440A	1 kΩ to 10 MΩ 5 ranges		X		X			X	90 [‡]	±0.3% to ±1.0%	No
DC AMPLIFIERS												
3461A (pg 217)	3460B	0.1 V dc to 1 kV dc 5 ranges	X	X	X		X	X	X	90	±0.008% to ±0.011%	Yes
3443A (pg 205)	3439A/3440A	100 mV to 1 kV 5 ranges	X	X		X	X	X	X	90 [‡]	±0.05% to ±0.1%	No
3444A (pg 206)	3439A/3440A	100 mV to 1 kV 5 ranges		X		X		X	X	90 [‡]	±0.05% to ±0.1%	No

‡Standard 2401B autoranges with 2401C option 31.

*Accuracy of converter only. Accuracy of readout device should be added to determine accuracy of measurement.

**Options added by plug-in circuit modules and boards.

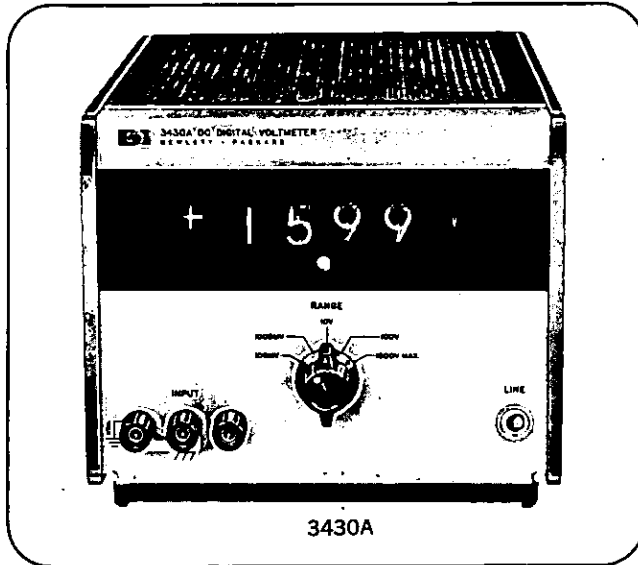
‡Assumes daily calibration of basic instrument against internal calibration standard after 30 minute warm-up.

DIGITAL VOLTMETERS



DC DIGITAL VOLTMETER

3 Digit DVM at the price of analog voltmeters
Model 3430A



Description

The Hewlett-Packard 3430A DC Digital Voltmeter offers precision performance at an economical price. The 3430A may be used in the laboratory or for continuous service under rigorous operating conditions in the production area.

Designed for easy operation, the 3430A may be used by inexperienced personnel. The input voltage is indicated by a large, easy-to-read display with the proper units shown by an annunciator. Polarity and decimal point are automatic.

The 3430A is able to make full-scale dc voltage measurements from ± 100.0 mV to ± 1000 V with up to 60% over-ranging. To save costly frequent calibration, the 3430A maintains its $\pm (0.1\%$ of reading $+0.1\%$ of range) accuracy for 90 days. This digital voltmeter has a 3-digit display with 60% over-ranging indicated by a 4th digit. The chance of circuit loading is reduced by the 10 M Ω input resistance.

DC Amplifier

A precision ($\pm 0.1\%$) analog dc output is available on the rear panel. This permits the 3430A to be used as a dc amplifier with a non-inverting voltage gain up to 100.

Voltage Ratio Option

Three-terminal ratio measurements may be made with the option 001. A rear-panel switch permits either normal or ratio mode of operation. In the ratio mode, the voltmeter indication is proportional to the ratio of the input voltage (front terminals) to the reference voltage (rear terminals).

Specifications

Ranges

Voltage: ± 100.0 mV, ± 1000 mV, ± 10.00 V, ± 100.0 V and ± 1000 V f.s.

Over-ranging: 60% on all ranges except the 1000 V range (indicated by the 4th digit).

Range selection: manual.

Performance rating

Accuracy: $\pm (0.1\%$ of reading $+0.1\%$ of range) for 90 days, 15°C to 35°C.

Accuracy over the temperature ranges of 0°C to 15°C and 35°C to 50°C is $\pm (0.25\%$ of reading $+0.1\%$ of range).

Reading rate: fixed at 2 readings/s by internal trigger.

Input characteristics

Inputs: floated binding posts on front panel may be operated up to ± 500 V dc (350 V rms) above chassis ground.

Input Resistance: 10 m Ω $\pm 3.0\%$ on all ranges.

Effective common-mode rejection (ECMR): ECMR is the ratio of the common-mode signal to the resultant error in the reading.

DC to 60 Hz: >90 dB on the 100 mV range, decreasing 20 dB per range.

AC normal-mode rejection (ACNMR): ACNMR is the ratio of the ac normal-mode signal to the resultant error in the reading.

60 Hz: 40 dB increasing 12 dB/octave.

Overload protection: ± 1050 V may be applied on any range except the 100 mV range, where the limit is ± 700 V. Overload is indicated by a flashing display.

DC amplifier

Gain (non-inverting): X100 on the 100 mV range, X10 on 1000 mV range, X1 on 10 V range, X0.1 on 100 V range, and X0.01 on 1000 V range.

Output: ± 16 V dc maximum at 1 mA maximum current.

Accuracy: $\pm 0.1\%$ from 15°C to 35°C.

Response time: <0.5 s to 99.9% of final value.

Ratio option (option 001)

Ratio: 0.1:1, 1:1, 10:1, 100:1, and 1000:1.

Overrange: 60% for reference voltage inputs <1 V, decreasing to 33% at 1.2 V.

Range selection: manual by front panel range switch.

Ratio mode selection: manual by rear panel switch.

Accuracy: $\pm (0.15\%$ of reading $+0.1\%$ of range) for 90 days from 15°C to 35°C.

Accuracy over the temperature ranges of 0°C to 15°C and 35°C to 50°C is $\pm (0.3\%$ of reading $+0.1\%$ of range).

Input: 3 terminal with circuit ground common.

Front terminals: ± 100.0 mV, ± 1000 mV, ± 10 V, ± 100 V and ± 1000 V ranges.

Rear terminals (reference voltage): 0.8 V to 1.2 V.

Polarity selected manually by rear panel switch.

Displayed voltage ratio: $\frac{\text{front terminal voltage}}{\text{rear terminal voltage}}$

Input resistance: front terminals: 10 M Ω $\pm 3\%$.

Rear terminals: positive polarity, 50 k Ω $\pm 2\%$. Negative polarity, 511 k Ω $\pm 2\%$.

General

Power: 115 V or 230 V $\pm 10\%$, 50 Hz to 400 Hz, <20 W.

Dimensions: 7 $\frac{3}{4}$ " wide, 6 $\frac{1}{4}$ " high (without removable feet), 11" deep (197 x 159 x 279 mm).

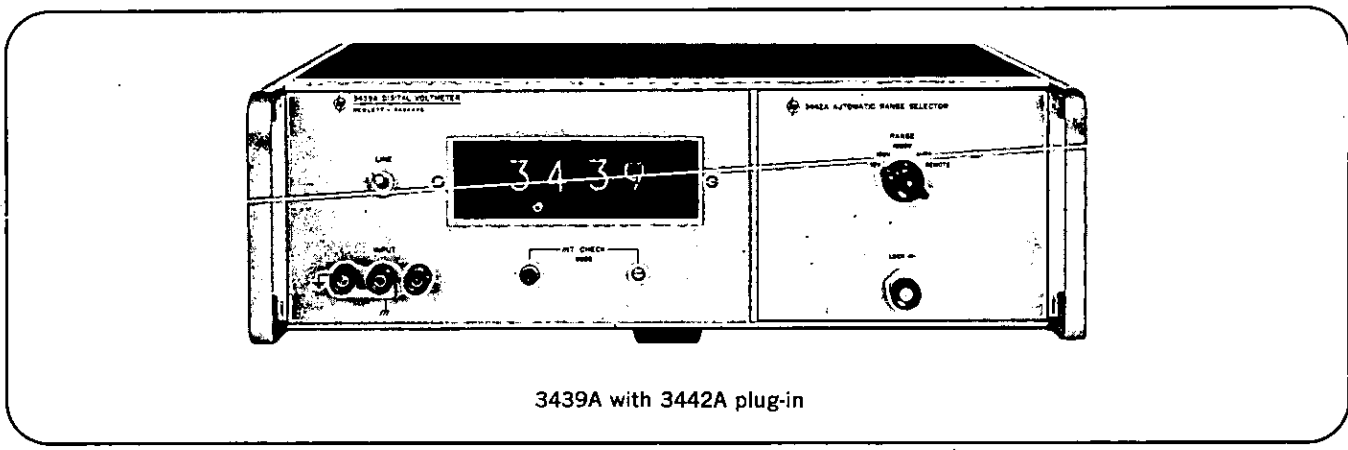
Weight: net 9.75 lb (4.4 kg), shipping 12 lb (5.4 kg).

Price: HP 3430A, \$595.

HP 3430A option 001, voltage ratio, add \$80.

DIGITAL VOLTMETERS

Interchangeable Plug-ins Increase Versatility
Models 3439A, 3440A



3439A with 3442A plug-in

Interchangeable Plug-ins Increase Voltmeter Versatility

The HP Models 3439A and 3440A are compact, accurate, rapid, and multiple-function digital voltmeters. The choice of automatic ranging, remote, and manual operation is obtained by using the 3441A, 3442A, 3443A, 3444A, 3445A or 3446A plug-ins, which are interchangeable with any 3439A or 3440A. The basic voltmeter is solid-state with easy-to-service plug-in circuit cards mounted in the Hewlett-Packard modular enclosure.

DC voltages up to 999.9 V of either polarity are displayed in four significant digits with an accuracy of better than $\pm 0.05\%$ of reading ± 1 digit and with the polarity of the applied signal indicated automatically. Modes of range selection available for the plug-ins include manual, remote, and automatic. Refer to Table 1 for data. The bright, easy-to-read display reduces operator fatigue. Readout storage is another feature of the 3439A and 3440A with large rectangular digital display tubes which display the previous reading, changing only if the input voltage changes. A polarized light filter reduces the reflection of external light so that a good contrast results when the digits are lighted.

Accuracy and Speed

The 3439A and 3440A Digital Voltmeters have a dc accuracy of better than $\pm 0.05\%$ of reading ± 1 digit over the ambient temperature of $+15^{\circ}\text{C}$ to $+40^{\circ}\text{C}$ with a line voltage variation of $\pm 10\%$. In addition, specified accuracy is retained to 5% beyond full scale, a feature that permits 5-digit resolution at the decade range change points. The ac input filter has a rejection of 30 dB at 60 Hz and the response time to a step change is 450 ms to read 99.95% of final value without a range change.

The input signal pair may be floated up to 500 V above chassis ground without affecting accuracy. An additional feature which results in high accuracy is the constant 10.2 megohm impedance. This impedance presents a constant load on all voltage ranges.

Plug-in Units

Figure 1 illustrates the features obtained by using the

3441A, 3442A, 3443A, 3444A, 3445A or 3446A plug-ins with any 3439A or 3440A.

Plug-in function chart						
Plug-in*	3441A	3442A	3443A	3444A	3445A	3446A
AC volts 10 V to 1000 V	**	**	**	**	✓	✓
DC volts 10 V to 1000 V	✓	✓	✓	✓	✓	✓
DC volts 100 mV to 1000 V			✓	✓		
DC amps				✓		
Ohms				✓		
Manual ranging	✓	✓	✓	✓	✓	✓
Auto ranging		✓	✓		✓	
Floating input	✓	✓	✓	✓	✓	✓
Remote ranging		✓	✓		✓	✓
Remote function						✓

*3439A and 3440A require a plug-in to operate.
**Average response measurements: 100 μV to 300 V, 50 Hz to 500 kHz use HP 457A; 1 mV to 300 V, 10 kHz to 10 MHz use HP 400 E/EL. True rms measurements: 1 mV to 300 V, 10 Hz to 10 MHz, use HP 3400A.

Table 1. Plug-in Function Chart.

BCD Recorder Output (3440A only)

Each of the four digits, with polarity, function and decimal location, is represented by four-line, binary-coded decimal voltages in the 1-2-2-4 weighted code (1-2-4-8 available on special order). The decimal, polarity and the four digits are in parallel-coded form and are completely compatible with the HP 562A Digital Recorder which will print the information in six columns.

Performance

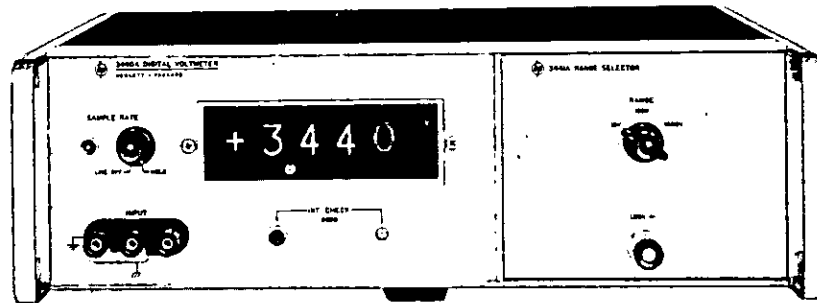
The operator can instantly verify the accuracy of the 3439A and 3440A by pressing a front-panel button. Typical performance on the 3440A internal calibration source is better than 0.002%/ $^{\circ}\text{C}$ TC with stability typically better than $\pm 0.05\%$ over a three-month period. The linearity is approximately $\pm 0.01\%$ for the 10, 100, and 1000 V ranges with 0.03% linearity full scale for the 100 mV and 1000 mV range. The stability of reading is approximately ± 1 count.

DIGITAL VOLTMETERS



DIGITAL VOLTMETERS

Interchangeable Plug-Ins Increase Versatility
Models 3439A, 3440A



3440A with 3441A plug-in

Specifications

(Main Frame HP 3439A and 3440A)

Model	HP 3440A	HP 3439A
Sample Rate:	5 samples per s to 1 per 5 s with storage during samples and "Hold." In "Hold" a sample may be initiated by applying a +10-V pulse 20 μ s wide or greater (ac coupled) or by contact closure.	Fixed at between 2 and 3 per s
DC Isolation:	Signal common may be floated up to 500 V dc from chassis ground.	
Printer Output:	4-line BCD (1-2-2-4) 6 columns consisting of 4 digits of data, polarity, function and decimal. 4-line BCD (1-2-4-8) "1" state positive is 3440A option HO2*. Impedance: 120 k Ω maximum, each line. "0" state level -24 V to -30 V, "1" state level 0 to -2 V (both voltages are negative).	
Reference Levels:	Positive: approximately -2.5 V, 330 Ω source impedance. Negative: approximately -27 V, 920 Ω source impedance.	
Print Command:	Step from -12 V to -2 V dc from a 100 Ω source.	
Hold-off Requirements:	Anywhere from +6 V to +15 V max. from source impedance less than 2000 Ω (provided by HP 562A Digital Recorder).	
Remote Triggering:	+10 V pulse 20 μ s wide or greater, or a contact closure.	
Power:	115 or 230 V \pm 10%, 50 to 400 Hz, approximately 20 to 30 W, depending upon plug-in.	
Weight:	Net, 18 lbs (8 kg); Shipping, 24 lbs (10,8 kg).	
Dimensions:	16 $\frac{3}{4}$ " wide x 5-7/32" high x 11 $\frac{1}{4}$ " deep (425,5 x 132,5 x 285,6 mm).	
Price:	\$1195	\$995

*3440A option H02 requires modified plug-ins.

Accessories Available

(HP 3440A Only)

HP 562A/AR option J74: Digital Recorder for use with HP 3440A accepting 1-2-2-4 BCD code. (Floating Operation to \pm 500 V dc.) Includes special print-wheel, 6 BCD column boards, input connector assembly with cable.

HP 562A/AR option J75: Same as 562A/AR option J74 except for single character function symbol.

HP 562A/AR option J76: Digital Recorder for use with HP 3440A accepting 1-2-4-8 BCD code. (Floating operation to \pm 500 V dc.) Includes special printwheel, 6 BCD column boards, input connector assembly with cable.

HP 562A/AR option J77: Same as 562A/AR option J76 except for single character function symbol.

Note:

If the 3440A is used to drive an HP 562A Printer with a 2nd floating input to the 562A, a special 3440A is available. It allows 150 V dc to exist between the 3440A common and the low side of

the 2nd input. Up to 500 V dc can exist between the 3440A common and chassis.

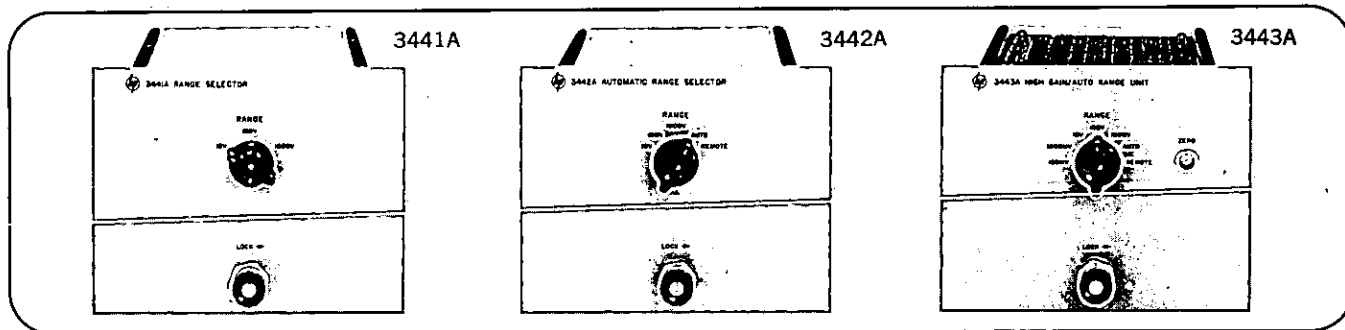
Data	Function	Logic 1-2-2-4	Logic 1-2-4-8	HP 562A Print wheel		
				Std.	J75-562A J77-562A	J74-562A J76-562A
0	+ volts	0000	0000	0	+	+V
1	- volts	1000	1000	1	-	-V
2	+ amps	0100	0100	2	A	+A
3	- amps	1100	1100	3	v	-A
4	ac volts	0110		4	~	AC
5	ohms	1110	1010	5	Ω	Ω
6	ac volts		0110	6	~	AC
7	overrange		1110	7	*	**
8				8		
9	overrange	1111		9	*	**

PLUG-INS FOR 3439A, 3440A

Interchangeable plug-ins increase versatility
Plug-in Models 3441A, 3442A, 3443A



DIGITAL VOLTMETERS



3441A Range Selector

The HP 3441A Range Selector is a plug-in unit with a range switch to manually select one of three voltage ranges: 10, 100, or 1000 volts.

3442A Automatic Range Selector

HP Model 3442A Automatic Range Selector is also available for use with the 3439A, 3440A Digital Voltmeters. The 3442A retains the manual range selection and adds automatic and remote range features. Ten percent hysteresis is built into the automatic ranging function of the 3442A.

3443A High Gain/Auto Range Unit

HP Model 3443A High Gain/Auto Range Unit, available for use with the 3439A or 3440A Digital Voltmeters features automatic or remote range selection from 100 mV to 1000 volts full scale. A front-panel, zero offset control enables the operator to obtain a zero indication at the DVM to compensate for the thermal offset voltages of external connections. The 3443A has the same ranging capabilities as the 3442A with the additional features of two added ranges and 10 μ V resolution, making it ideal for thermocouple and transducer measurements.

Specifications, 3441A, 3442A

Voltage range: 4-digit presentation of 9.999 V, 99.99 V, and 999.9 V full scale with 5% overrange capability and overrange indicator.

Voltage accuracy: $\pm 0.05\%$ of reading ± 1 digit including line voltage variations of $\pm 10\%$ from nominal. A front-panel adjustment on the 3440A insures accuracy over the temperature range between $+15^\circ\text{C}$ and $+40^\circ\text{C}$ and $\pm 0.1\% \pm 1$ digit over the temperature range of 0°C to $+15^\circ\text{C}$ and $+40^\circ\text{C}$ to $+50^\circ\text{C}$.

Range selection: with 3441A, manual. With 3442A: manual, automatic and remote range change. Speed: automatic (max.) achieves accurate reading in < 1 s after new voltage is applied; remote (max.) will change range within 40 ms.

Voltmeter input impedance: constant 10.2 M Ω (to dc) all ranges.

Polarity: automatic indication.

Input filter characteristics: response time; < 450 ms to a step function to within 99.95% of final value (without a range change).

Input filter ac rejection: 10, 100 and 1000 V ranges: 30 dB at 60 Hz, increasing at 12 dB/octave.

Weight:

3441A: net 1 lb (0,45 kg); shipping 4 lbs (1,8 kg).

3442A: net 1.5 lbs (0,7 kg); shipping 4 lbs (1,8 kg).

Price: HP 3441, \$50; HP3442A, \$160.

HP 3441A option H01 (plug-in for 3440A option H02).

HP 3442A option H02 (plug-in for 3440A option H02).

Specifications, 3443A

Voltage range: 4-digit presentation of 99.99 mV, 999.9 mV, 9.999 V, 99.99 V, and 999.9 V full scale with 5% overrange capability and overrange indicator.

Voltage accuracy:

9.999 V to 999.9 V full scale: $\pm 0.05\%$ of reading ± 1 digit including line voltage variations of $\pm 10\%$ from nominal. A front-panel adjustment on the 3440A insures accuracy over the temperature range between $+15^\circ\text{C}$ and $+40^\circ\text{C}$ and $\pm 0.1\% \pm 1$ digit over the temperature range of 0°C to $+15^\circ\text{C}$ and $+40^\circ\text{C}$ to $+50^\circ\text{C}$.

99.99 mV and 999.9 mV full scale: $\pm 0.1\%$ of reading ± 1 digit including line voltage variations of $\pm 10\%$ from nominal. A front-panel adjustment on the 3440A insures accuracy over the temperature range between $+15^\circ\text{C}$ and $+40^\circ\text{C}$ and $\pm 0.15\% \pm 1$ digit over the temperature range of 0°C to $+15^\circ\text{C}$ and $+40^\circ\text{C}$ to $+50^\circ\text{C}$.

Range selection: manual, automatic and remote; range change speed: automatic (max.) achieves accurate reading within 1.5 s after new voltage is applied; remote (max.) will change range within 40 ms.

Voltmeter input impedance: constant 10.2 M Ω (to dc) all ranges.

Polarity: automatic indication.

Input filter characteristics (to a step function to within 99.95% of final value without a range change): 10, 100, 1000 V dc ranges; response time < 450 ms. 100, 1000 mV ranges; < 1 s.

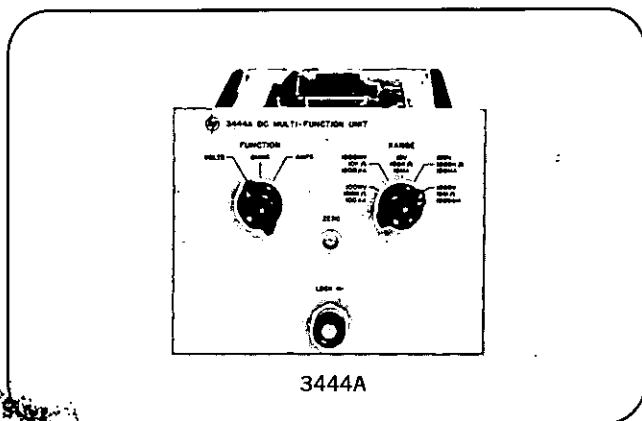
Input filter ac rejection: 10, 100, and 1000 V ranges: 30 dB at 60 Hz increasing at 12 dB/octave. 100 and 1000 mV ranges: maximum of 40 mV and 400 mV p-p respectively at 60 Hz for $< 0.1\%$ of full-scale error; allowable ac increasing at 6 dB per octave.

Weight: net 3 lbs (1,35 kg); shipping 5 lbs (2,3 kg).

Price: HP 3443A, \$525.

HP 3443A option H02 (plug-in for 3440A option H02).

DIGITAL VOLTMETERS


PLUG-INS FOR 3439A, 3440A
 Interchangeable plug-ins increase versatility
 Plug-in Model 3444A


3444A DC Multi-Function Unit

The HP 3444A DC Multi-Function Unit, available for use with the 3439A, 3440A Digital Voltmeters, features voltage, current, and resistance-measurement capabilities in one plug-in module.

This plug-in offers manual-ranging dc voltage, dc current and resistance measuring capabilities. Full-scale ranges of 100 mV to 1000 V with 10 μ V resolution make this plug-in ideal for thermocouple and transducer measurements. Full-scale current ranges of 100 μ A, 1, 10, 100 and 1000 mA are available with a maximum sensitivity of 10 nA. Five resistance ranges of 1000 ohms to 10 megohms are provided.

Specifications, 3444A

Voltage range: 4-digit presentation of 99.99 mV, 999.9 mV, 9.999 V, 99.99 V, and 999.9 V full scale with 5% overrange capability and overrange indicator.

Current range: 4-digit presentation of 99.99 μ A, 999.9 μ A, 9.999 mA, 99.99 mA and 999.9 mA with 5% overrange capability and overrange indicator.

Resistance range: 4-digit presentation of 999.9 Ω , 9.999 k Ω , 99.99 k Ω , 999.9 k Ω and 9.999 M Ω with 5% overrange capability and overrange indicator.

Voltage accuracy

9.999 V to 999.9 V full scale: $\pm 0.05\%$ of reading ± 1 digit including line voltage variations of $\pm 10\%$ from nominal. A front-panel adjustment on the 3440A insures accuracy over the temperature range between $+15^\circ\text{C}$ and $+40^\circ\text{C}$ and $\pm 0.1\%$ ± 1 digit over the temperature range of 0°C to $+15^\circ\text{C}$ and $+40^\circ\text{C}$ to $+50^\circ\text{C}$.

99.99 mV and 999.9 mV full scale: $\pm 0.1\%$ of reading ± 1 digit including line voltage variations of $\pm 10\%$ from nominal. A front-panel adjustment on the 3440A insures accuracy over the temperature range between $+15^\circ\text{C}$ and $+40^\circ\text{C}$ and $\pm 0.15\%$ ± 1 digit over the temperature range of 0°C to $+15^\circ\text{C}$ and $+40^\circ\text{C}$ to $+50^\circ\text{C}$.

Current accuracy: $\pm 0.2\%$ of reading ± 1 digit with line variations of $\pm 10\%$ from nominal.

Resistance accuracy: $\pm 0.3\%$ of reading ± 1 digit for all ranges up to the 10 M Ω range with line variations of $\pm 10\%$ from nominal. $\pm 1\%$ of reading ± 1 digit on the 10 M Ω range with line variations of $\pm 10\%$ from nominal.

Ohmmeter current

Range	Short circuit current
1 k	1 mA
10 k	100 μ A
100 k	10 μ A
1 M	1 μ A
10 M	0.1 μ A

Range selection: manual.

Voltmeter input impedance: constant 10.2 M Ω (to dc) all ranges.

Ammeter input resistance

Range	Input resistance
100 μ A	1000 Ω
1000 μ A	100 Ω
10 mA	10 Ω
100 mA	1.3 Ω
1000 mA	0.4 Ω

Polarity: automatic indication.

Input filter characteristics

Voltage: < 450 ms to 99.95% of final value for full-scale step function on 10, 100 and 1000 V ranges. < 1 s to within 99.95% of final value for a full-scale step function on 100 and 1000 mV ranges.

Current: < 1 s to 99.95% of final value for a full-scale step function on all current ranges.

Resistance: 1000 Ω to 1 M Ω ; > 1 s to 99.95% of final value. 10 M Ω ; < 5 s to 99.95% of final value.

Input filter ac rejection

Voltage: 10, 100 and 1000 V ranges; 30 dB at 60 Hz, increasing 12 dB/octave. 100 and 1000 mV ranges; maximum of 40 mV and 400 mV p-p respectively at 60 Hz for $< 0.1\%$ of full-scale error; allowable ac increasing at 6 dB/octave.

Current: p-p ripple current may be up to 40% of full-scale range at 60 Hz for $< 0.1\%$ of full-scale error; allowable ac increasing at 6 dB/octave.

Weight: net 3 lbs (1.35 kg); shipping 5 lbs (2.3 kg).

Price: HP 3444A, \$600.

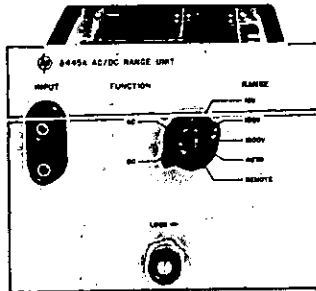
HP 3444A option H02 (plug-in for 3440A option H02).

PLUG-INS FOR 3439A, 3440A

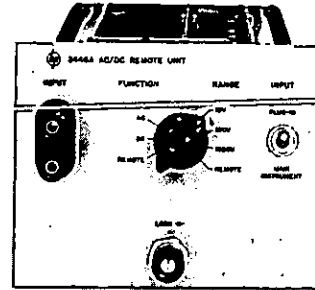
Interchangeable plug-ins increase versatility
Plug-in Models 3445A, 3446A



DIGITAL VOLTMETERS



3445A



3446A

3445A AC/DC Range Unit

3446A AC/DC Remote Unit

The HP Model 3445A AC/DC Range Unit or the HP Model 3446A AC/DC Remote Unit may be used with the 3439A, 3440A Digital Voltmeters, for ac or dc measurements. These solid-state units have three full-scale ranges for both ac and dc from 10 to 1000 volts. The ac conversion circuit of the 3445A and 3446A produces a dc output voltage proportional to the average value of the applied ac voltage and is calibrated in rms. The table in the specifications illustrates the differences between the 3445A and 3446A Plug-ins. Permanent test records of function, polarity, range and overload are available with either unit when using the 562A option J74 Printer for 1-2-2-4 code or 562A option J76 for 1-2-4-8 code with the 3440A.

Combining the HP 463A Precision Amplifier with the 3445A or 3446A increases the sensitivity of either plug-in from 10 volts full scale to as low as 10 mV full scale over a frequency range of 50 Hz to 100 kHz. For further information refer to the 463A Data Sheet.

Specifications, 3445A, 3446A

Voltage range (ac & dc): 4-digit presentation of 9.999, 99.99, and 999.9 V full scale with 5% overrange capability and overrange indicator.

Voltage accuracy (ac): from 20°C to 30°C including line voltage variations of $\pm 10\%$ from nominal.

% Reading % Full Scale Chart (± 2 counts)

	50 Hz	20 kHz	50 kHz	100 kHz
10 V to 1 kV Full Scale	± 0.1 rdg	± 0.1 f.s.	± 0.1 to ± 0.3 linearly derated f.s.	

$\pm 0.005\%/^{\circ}\text{C}$ T.C. applies from 0°C to +20°C (use +20°C as zero T.C. reference point) and from +30°C to +50°C (use +30°C as zero T.C. reference point).

Voltage accuracy (dc): $\pm 0.05\%$ of reading ± 1 digit including line voltage variations of $\pm 10\%$ from nominal. A front-panel adjustment on the 3440A insures accuracy over the temperature range between +15°C and +40°C and $\pm 0.1\%$ ± 1 digit over the temperature range of 0°C to +15°C and +40°C to +50°C.

Response speed (ac): achieves specified accuracy within 3 s when on proper range. Allow 2 extra seconds for recovery if overloaded.

Floating measurements: signal common may be floated up to 500 V dc above chassis ground.

Input impedance:

10 M Ω shunted by 20 pF nominal on all ac ranges; 10.2 M Ω on all dc ranges.

Input filter characteristics (dc):

Response time: <450 ms to 99.95% of final value for a step function.

AC rejection: 30 dB at 60 Hz, increasing 12 dB/octave.

Remote selection: remote selection is made by contact closure to ground through <100 Ω . Change will be completed <40 ms (refer to table for modes available).

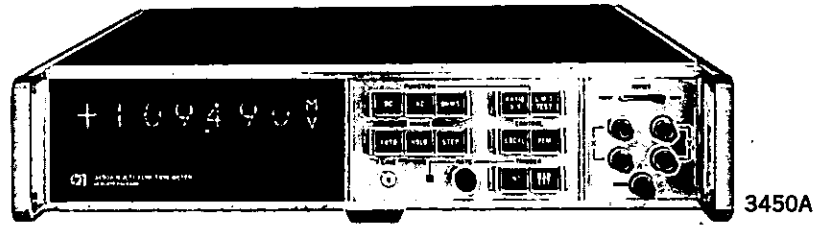
Table of modes

	3445A	3446A
Input Terminals	Plug-In only	Plug-in & Main Frame selected by Front Panel Switch
Range Selection	Manual, Automatic, Remote	Manual, Remote
Function Selection	Manual	Manual, Remote
Input Impedance (nominal)	10 M Ω /20 pF	Plug-in Input: 10 M Ω /35 pF Main-Frame input: 10 M Ω /175 pF

Polarity: automatic indication.

Weight: net 2.75 lbs (1.24 kg); shipping 5 lbs (2.3 kg).

Price: HP 3445A, \$600; HP 3446A, \$625. HP 3445A option H02 (plug-in for 3440A option H02).

DIGITAL VOLTMETERS**MULTI-FUNCTION METER****12 modes of operation, true RMS****Model 3450A****General Description**

The Hewlett-Packard Model 3450A Multi-Function Meter is a five-digit, integrating digital voltmeter. The basic instrument measures dc voltage and dc voltage ratios. Added measurement capability is achieved by the addition of plug-in options.

The 3450A uses a dual-slope integration technique and is fully guarded, providing excellent noise immunity at 15 readings per second on all dc ranges. Ranging is automatic over all ranges on all functions. Ratio measurements are made in a truly isolated fashion, allowing measurements never before possible. All the immense capability of the 3450A is contained in less than 3½ inches of rack height and requires no cooling fan.

Additionally, the Limit Test option allows digital comparisons against two preselected limits. This capability is applicable to all functions with no degradation in function performance. Digital Output, Remote Control, and Rear Input options are also available, allowing you to tailor the 3450A to meet your precise measurement needs.

Display

The 3450A presents polarity, function, and digital information in an easy-to-read, non-glare, front-panel display. Maximum resolution at full scale for all functions is made possible by the 20% overranging feature. HI (red), GO (green) and LO (amber) limit test indications are also displayed on the front panel.

Standard Functions

DC and DC Ratio: The basic 3450A includes five ranges of dc with 1 μ V sensitivity on the 100 mV range and four ranges of true four-terminal dc ratio. Measurements can be made on all five voltage ranges at 15 readings per second. The high input resistance, $>10^{10}$ ohms for the 100 mV, 1 V, and 10 V ranges, makes it possible to measure high impedance sources without detectable loading errors. Ratio (unknown and reference input) ranges are selected automatically. Reference voltages from ± 100 mV to ± 120 V can be used for ratio measure-

ments. Input impedance for the reference input is the same as for the unknown input.

Optional Functions

AC and AC Ratio (Option 001): Four ranges of true rms ac are provided by the AC Converter. Frequency response is from 45 Hz to 1 MHz. In addition, four ranges of true four-terminal ac ratio are provided with the ac converter.

Ohms and Ohms Ratio (Option 002): Six resistance ranges and four resistance ratio ranges are provided with the Option 002 Ohms Converter. The 100 Ω range permits resistance measurements to be made with 1 m Ω sensitivity. Maximum current for the 100 Ω range is 1 mA at 100 mV. The four-wire measuring technique permits low resistance measurements to be made without errors due to lead resistance.

Limit Test (Option 003): The capability of making limit test measurements on any one of the six basic functions (dc, dc ratio, ac, ac ratio, ohms, and ohms ratio) is accomplished by adding the Limit Test Option. This rear panel plug-in board permits you to make a limit test measurement without affecting the speed and accuracy of the six functions described above. The value of the unknown as well as a HI, GO, or LO indication is displayed on the front panel. Both indications are available in BCD form at the digital output.

The HI-GO-LO limits are programmed through a 50-pin connector provided on the limit selector accessory (11112A). Each limit includes four digits, an overrange digit, and polarity.

Digital Output (Option 004) and Remote Control (Option 005): The digital output provides nine columns of information which include function, polarity, data information, and range or ratio multiplier. An end-of-reading signal is provided to serve as a print command for a digital recorder or as an advance signal in a system.

Data Acquisition

The 3450A is available in the HP 2014 Data Acquisition System and in the HP 2321A Computer Compatible Data Acquisition Subsystem. Refer to page 100.

Specifications**DC VOLTAGES****Ranges**

Full range display: ± 100.000 mV; ± 1.00000 V; ± 10.0000 V; ± 100.000 V; ± 1000.00 V.

Overranging: 20% on all ranges.

Range selection: manual or automatic; remote optional.

Performance**Accuracy**

24 hr (23°C ± 1 °C, <50% RH. This accuracy is referenced to the calibrating source.)

Range	Specification
1 V thru 1000 V	$\pm(0.003\%$ of reading +0.001% of range)
100 mV	$\pm(0.003\%$ of reading +0.004% of range)

30 day (25°C ± 5 °C)

Range	Specification
1 V thru 1000 V	$\pm(0.008\%$ of reading +0.002% of range)
100 mV	$\pm(0.008\%$ of reading +0.01% of range)

90 day (25°C ±5°C): add 0.002% of range to 30-day specifications.

Temperature coefficient (0°C to 50°C): ±(0.0004% of reading + 0.0003% of range) per °C.

Measuring speed

Integration Period	Reading Period (without range change)	Autorange Time (per range change)
1/10 s	380 ms	380 ms
1/60 s	65 ms	65 ms

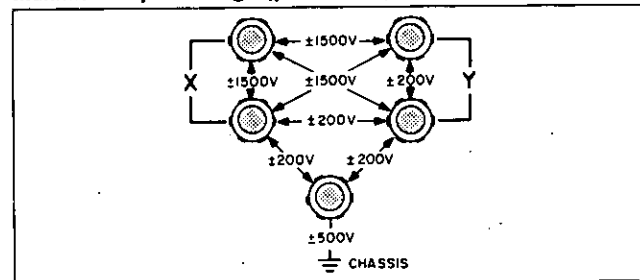
Instrument reads within specified accuracy when triggered coincident with step input voltage.

Input Characteristics

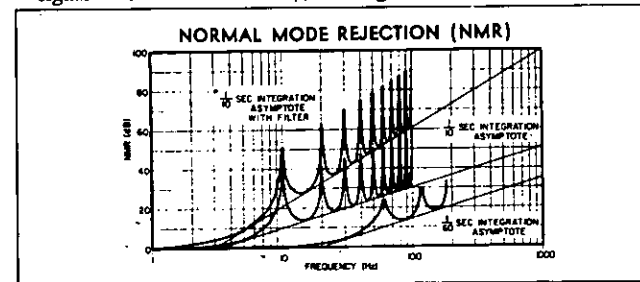
Input resistance

Range	Specification
100 mV, 1 V and 10 V	>10 ¹⁰ Ω (10 MΩ ±0.1% selectable by external closure to ground)
100 V and 1000 V	10 MΩ ±0.1%

Maximum input voltage (peak value)

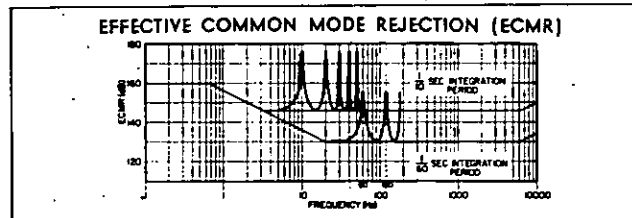


Normal-mode rejection (NMR): NMR is the ratio of the peak normal-mode signal to the peak error in reading. Applies to dc and ohms functions. Sum of dc input and peak normal-mode signal must not exceed 140% of range.



*Filter available in 3450A op. H01 (60 Hz) or 3450A op. H13 (50 Hz).

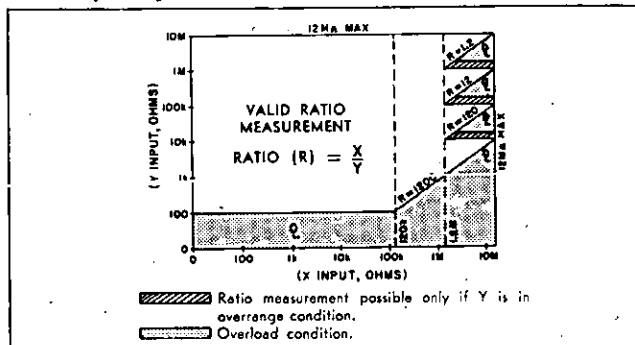
Effective common-mode rejection (ECMR): ECMR is the ratio of the peak common-mode voltage to the resultant error in reading with 1 kΩ unbalance in either lead. Applies to dc and ohms functions.



DC RATIO Ranges

Full range display: ±1.00000; ±10.0000; ±100.000; ±1000.00.

Ratio capability



Overranging: 20% on all ranges.

Range selection: manual or automatic for X input. Remote optional for X input; automatic for Y input.

Performance

Accuracy: 30 day (25°C ±5°C), ±(0.01% of reading* + 0.002% of ratio range + [Y range/Y voltage] x 0.002%); 90 day (25°C ±5°C), ±(0.01% of reading* + 0.002% of ratio range + [Y range/Y voltage] x 0.003%).

*Add 0.005% of reading for X input > 100 V.

Temperature coefficient (0°C to 50°C): ±(0.0006% of reading + 0.0003% of range) per °C.

Measuring speed

Integration Period	Reading Period (without range change)	Autorange Time (per range change)	
		Y Input	X Input
1/10 s	840 ms	380 ms	840 ms
1/60 s	210 ms	65 ms	210 ms

Input Characteristics

Input configuration: isolated 4-terminal, guarded. No common ground necessary between signals.

Input resistance: same as dc voltage for both X and Y inputs.

Effective common-mode rejection (ECMR): same as dc voltage for X input.

Normal-mode rejection: same as dc voltage for X input.

Maximum input voltage: same as dc voltage.

AC VOLTAGE OPTION 001 (True RMS-Responding, 45 Hz to 1 MHz)

Ranges

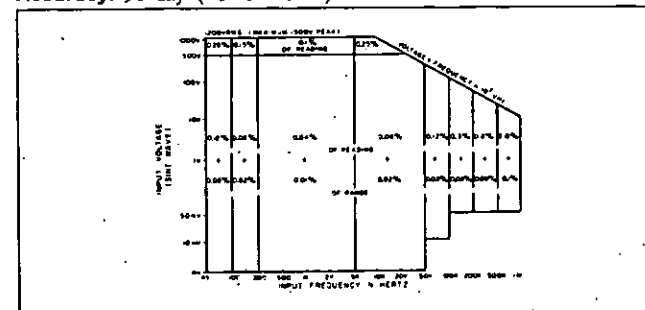
Full range display: 1.00000 V; 10.0000 V; 100.000 V; 1000.00 V.

Overranging: 20% on all ranges (1500 V p on 1 kV).

Range selection: manual or automatic; remote optional.

Performance

Accuracy: 90 day (25°C ±5°C).



Stability (24 hr, 23°C ± 1°C, 10 mV to 500 V)

Frequency Range	Specification
45 Hz to 200 Hz	±(0.03% of reading + 0.003% of range)
200 Hz to 5 kHz	±(0.01% of reading + 0.002% of range)
5 kHz to 100 kHz	±(0.03% of reading + 0.003% of range)

Measuring speed

Integration Period	Reading Period (without range change)	Autorange Time (per range change)
1/10 s	2.7 s	2.7 s

Instrument reads within 0.1% of final value in one reading from 10% of range to 100% of range.

Temperature coefficient (0°C to 50°C)

Frequency Range	Coefficient ±(% of reading + % of range) per °C	
45 Hz to 100 Hz	0.003%	0.001%
100 Hz to 200 Hz	0.002%	0.0005%
200 Hz to 5 kHz	0.001%	0.0004%
5 kHz to 50 kHz	0.002%	0.0005%
50 kHz to 200 kHz	0.003%	0.001%
200 kHz to 500 kHz	0.01%	0.001%
500 kHz to 1 MHz	0.02%	0.002%

Input Characteristics

Input impedance: front terminals, 2 MΩ shunted by 90 ± 10 pF in series with 0.1 μF; rear terminals, 2 MΩ shunted by 135 ± 15 pF in series with 0.1 μF.

Crest factor: 7:1 (f > 1 kHz, bandwidth = 1 MHz).

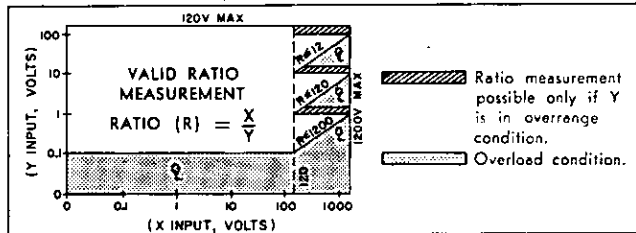
Maximum input voltage: same as dc voltage except < ± 1000 V dc offset on X terminals (± 1500 V p max including dc offset).

AC RATIO OPTION 001 (True RMS-Responding)

Ranges

Full range display: 1.00000; 10.0000; 100.000; 1000.00.

Ratio capability



Overranging: 20% on all ranges.

Range selection: manual or automatic for X input; remote optional for X input; automatic for Y input.

Performance

Accuracy: 90 day (25°C ± 5°C), ±(0.02% of reading + 0.01% of ratio range + sum of measurement accuracy of each input).

Temperature coefficient (0°C to 50°C): 200 Hz to 5 kHz, ±(0.002% of reading + 0.001% of range) per °C.

Measuring speed

Integration Period	Reading Period (without range change)	Autorange Time (per range change)	
		Y Input	X Input
1/10 s	8.1 s	2.7 s	8.1 s

Input Characteristics

Input configuration: isolated 4-terminal, guarded.

Input impedance: same as ac voltage for X and Y.

Interterminal capacitance between X and Y: < 10 pF.

Crest factor: 7:1 (f > 1 kHz, bandwidth = 1 MHz).

Maximum input voltage: same as dc voltage, except < ± 1000 V dc offset voltage on X terminals.

OHMS OPTION 002

Ranges

Full range display: 100.0000Ω; 1.00000 kΩ; 10.0000 kΩ; 100.000 kΩ; 1000.00 kΩ; 10000.0 kΩ.

Overranging: 20% on all ranges.

Range selection: manual or automatic; remote optional.

Performance

Accuracy 30 day (25°C ± 5°C)

Range	Specification
100Ω	±(0.01% of reading + 0.01% of range)
1 kΩ 10 kΩ 100 kΩ	±(0.01% of reading + 0.002% of range)
1000 kΩ	±(0.02% of reading + 0.002% of range)
10000 kΩ	±(0.1% of reading + 0.002% of range)

90 day (25°C ± 5°): add 0.002% of range to 30 day specifications.

Stability (24 hr, 23°C ± 1°C)

Range	Specification
100Ω	±(0.004% of reading + 0.004% of range)
1 kΩ through 10000 kΩ	±(0.004% of reading + 0.001% of range)

Temperature coefficient (0°C to 50°C): ±(0.0006% of reading + 0.0003% of range) per °C.

Measuring speed

Integration Period	Reading Period (without range change)	Autorange Time (per range change)
1/10 s	380 ms	380 ms
1/60 s	65 ms (165 ms on 10 MΩ range)	65 ms (165 ms on 10 MΩ range)

Instrument reads within specified accuracy when triggered coincident with step input resistance at terminals.

Input Characteristics

Input configuration: 4-wire, guarded.

Current through resistance

Range	Signal Current
100 Ω 1 kΩ 10 kΩ	1 mA
100 kΩ 1000 kΩ	10 μA
10000 kΩ	1 μA

Effective common-mode rejection (ECMR): same as dc voltage.

Normal-mode rejection: same as dc voltage.

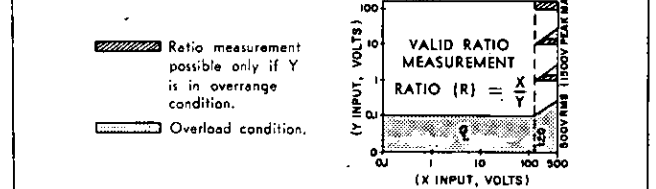
Overload protection: ± 200 V p for X or Y input.

OHMS RATIO OPTION 002

Ranges

Full range ratio display: 1.00000; 10.0000; 100.000; 1000.00.

Ratio capability



Overranging: 20% on all ranges.

Range selection: manual or automatic for X input; remote optional for X input; automatic for Y input.

Performance

Accuracy

30 day (25°C ± 5°C at terminals): ±(% of ratio range error + % of ratio reading error) where % of ratio range error = + (0.004% + $\frac{Y \text{ Range}}{Y \text{ Resistance}} \times 0.002\%$); % of ratio reading error is the greater percentage given below for either the X or Y resistance.

5	0.55	0.1	0.05	0.02*	0.05	0.2	%
0	100	1k	2k	9k	500k	5M	12M Ω

*0.01% for ratios between 0.95 and 1.05 if X and Y are between 10 k and 500 k.

Y ranges: 1 kΩ, 10 kΩ, 100 kΩ, 1 MΩ, 10 MΩ.

90 day (25°C ± 5°C at terminals): same as 30-day specifications.

tion except % of ratio range error = $+(0.004\% + \frac{Y \text{ Range}}{Y \text{ Resistance}} \times 0.003\%)$.

Temperature coefficient (0°C to 50°C): $\pm(0.0009\%$ of reading $+ 0.0003\%$ of range) per °C.

Measuring speed

Integration Period	Reading Period (without range change)	Autorange Time (per range change)	
		Y Input	X Input
1/10 s	840 ms	380 ms	840 ms
1/60 s	210 ms	65 ms	210 ms

Input Characteristics

Input configuration: isolated 4-terminal, guarded. Two wires per resistor.

Current through X and Y resistance: same as ohms function.

Effective common-mode rejection (ECMR): same as dc voltage for X input.

Normal-mode rejection: same as dc voltage for X input.

Overload protection: $\pm 200 \text{ V}$ p for X or Y input.

LIMIT TEST OPTION 003

Capability

Applicable to: dc, dc ratio, ac, ac ratio, ohms, and ohms ratio. No degradation in performance of above six functions.

Limit Selection

Two 4-digit limits (with 20% overranging), including polarity, are selectable in 1-2-4-8 BCD form with external closure to ground through $<3 \text{ k}\Omega$ (2.8 mA max) or application of -0.5 V to $+2.5 \text{ V}$ for the "0" state as shown below.

State	12 V Level	5 V Level*
"0"	-0.5 V to $+2.5 \text{ V}$	-0.5 V to $+1.0 \text{ V}$
"1"	$+5.5 \text{ V}$ to $+12 \text{ V}$	2.5 V to 5.0 V

*5 V level may be selected by moving jumper wire on Limit Test PC board. Limits must be on same range and same polarity.

Output Signals

Limit indications: HI, GO, LO front-panel lights defined as follows: high limit, $\leq \text{HI}$; lower limit, $\leq \text{GO} < \text{high limit}$, LO $< \text{lower limit}$.

Digital display: 5 digits plus overrange.

Digital output: 9 columns of information including HI, GO, LO decisions are available in 4-line 1-2-4-8 "1" state positive BCD form with DIGITAL OUTPUT (Option 004).

DIGITAL OUTPUT OPTION 004

Three switches on the digital output PC board may be closed to select print command for any desired combination of HI, GO, LO Limit Test decisions.

Print command: dc coupled.

Print level: 0 V, 12 mA max current.

No print level: 12 V or 5 V, determined by logic level selected.

Trigger or print command holdoff: $*-0.5 \text{ V}$ to $+2.5 \text{ V}$, 9 mA max current.

BCD outputs: 4-line BCD (1-2-4-8) "1" state positive, 9 columns of information as follows: 2 columns for function and polarity, 1 column for range or ratio range, 6 columns for digital data.

BCD levels

State	12 V Level	Output Characteristics
"0"	$+0.5 \text{ V} \pm 0.5 \text{ V}$	12 mA max sink current
"1"	$+11.5 \text{ V} \pm 0.5 \text{ V}$	12 k Ω source resistance

State	5 V Level*	Output Characteristics
"0"	$+0.5 \text{ V} \pm 0.5 \text{ V}$	20 mA max sink current
"1"	$+4.5 \text{ V} \pm 0.3 \text{ V}$	12 k Ω source resistance

*5 V level may be selected by moving jumper wire on Digital Output PC board.

BCD reference levels

Ref Level	12 V Level	5 V Level	Source Resistance
Negative	+1 V	+0.4 V	3 k Ω
Positive	+6 V	+3 V	10 k Ω

*Holdoff on internal trigger or print command may be selected by moving jumper wire.

Storage: BCD signal levels for previous reading are held until print command of next reading is initiated.

REMOTE CONTROL OPTION 005

All remote control lines are selected by an external closure to ground through $<3 \text{ k}\Omega$ (2.8 mA max) or application of -0.5 V to $+2.5 \text{ V}$ for the "0" state as shown below.

State	12 V Level	5 V Level*
"0"	-0.5 V to $+2.5 \text{ V}$	-0.5 V to $+1.0 \text{ V}$
"1"	$+5.5 \text{ V}$ to $+12 \text{ V}$	2.5 V to 5.0 V

*5 V level may be selected by moving jumper wire on Remote Control PC board.

Remote controls

**1/60 s integration period (normal integration period is 1/10 s).

**100 ms delay: adds 100 ms delay between trigger and start of measurement for source settling time. 3450A op. H01 and 3450A op. H13: add 470 ms delay and program filter.)

**10 M Ω input resistance: selects 10 M Ω input resistance on dc 100 mV, 1 V, and 10 V ranges (normal input resistance on these dc ranges is $>10^{10} \Omega$).

**External trigger: actuated by external contact closure or application of "0" state as shown above for a duration of $>50 \mu\text{s}$ with at least 20 ms in "1" state before "0" state will cause encode. Duration of $<10 \mu\text{s}$ will not cause encode.

Remote function: 4-line code selects desired function.

Program remote: disables all front-panel pushbutton controls except MANUAL/EXTERNAL trigger.

Program external trigger: selects external trigger in remote operation (normal trigger is selected if this line is not programmed).

Front-panel lockout: disables all front-panel pushbutton controls.

Non-ratio remote range: 4-line code selects desired range.

Remote ratio range: 3-line code selects desired ratio range.

Remote decimal: 4-line code selects desired decimal location independent of actual range.

General

Operating temperature: 0°C to 50°C, unless otherwise specified.

Storage temperature: -40°C to $+75^\circ\text{C}$.

Power: 115 V or 230 V $\pm 10\%$, 50 Hz to 400 Hz, $<75 \text{ W}$ (including all options, normal environmental conditions).

Dimensions: 16 $\frac{3}{4}$ " wide, 3-15/32" high, 21 $\frac{3}{8}$ " deep (425 x 88 x 542 mm).

Weight

Basic instrument: net 31 lb (14.1 kg), shipping 41 lb (18.5 kg).

Including all options: net 36 lb (16.3 kg), shipping 50 lb (22.7 kg).

Accessories available: HP 11133A rear input cable assembly, \$30; HP 11112A limit selector, \$150. The standard HP 5050B Printer is compatible with the 3450A. The HP 5050B op. H089 Printer is equipped with special alphameric wheels for use with the 3450A. The following accessory numbers are for ordering optional capabilities not included with initial purchase: HP 11077A Ohms Converter, \$400; HP 11078A AC Converter, \$1250; HP 11079A Limit Test, \$400; HP 11080A Digital Output, \$175; HP 11099A Remote Control, \$225.

Accessories furnished: rack mounting kit; lamp replacement kit; extender kit for option 001; connector kit for option 003; connector kit for option 004; HP 11133A rear input cable assembly for option 006.

Price: HP 3450A (includes dc and dc ratio), \$3150; HP 3450A option H50, optimum noise rejection for 50 Hz line, add \$60; HP 3450A option H01, optimum noise rejection for 60 Hz line with programmable filter, add \$300; HP 3450A option H13, optimum noise rejection for 50 Hz line with programmable filter, add \$360; Option 001 AC Converter (adds ac, ac ratio), add \$1250; Option 002 Ohms Converter, add \$400; Option 003 Limit Test (adds limit test capability), add \$350; Option 004 Digital Output (adds BCD output, 1-2-4-8 code), add \$175; Option 005 Remote Control (adds remote control capability), add \$225; Option 006 Rear Input Terminals (adds front/rear selector switch and rear terminals), add \$50.

**These remote capabilities are included in the basic 3450A and do not require the addition of Option 005.

DIGITAL VOLTMETERS



INTEGRATING DVM Precise measurements despite severe noise Model 2402A

The 2402A Integrating Digital Voltmeter combines 43 measurements per second sampling rate and the precision and measurement flexibility expected from a laboratory instrument with the programming and electrical output features necessary for data acquisition systems use both computerized (page 102) and non-computerized (page 100). It achieves high speed and high accuracy at low levels, without preamplifiers.

Instrument design virtually eliminates errors caused by extraneous noise without imposing any restrictions on the grounding of the signal source, recording device, or programmer, or upon the measuring speed of the instrument. The controls and input/output features of the 2402A permit maximum versatility of application, yet the instrument is straightforward to use.

High accuracy in a DVM is of little practical value unless this accuracy can be maintained in the presence of noise and under the far from ideal conditions of everyday use. The 2402A is average-reading, which greatly reduces the effects of superimposed noise. A floated and guarded input circuit eliminates common mode noise error. Combined, these techniques yield effective common mode noise rejection greater than 126 dB (2 million to 1) at any frequency, including dc.

The 2402A reads the average value of the applied voltage over a 1/60 second sample period, and provides maximum rejection of superimposed noise at 60 Hz (1/50 second optional). Since no input filters are employed, it provides both noise rejection capability and rapid accurate response to step input required for data acquisition system applications. Superimposed

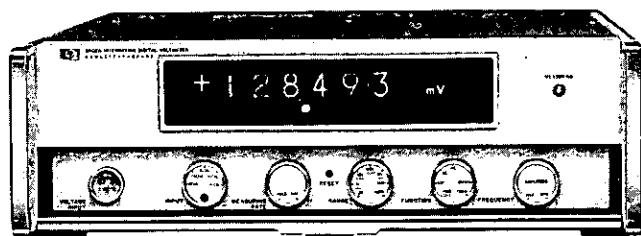
noise rejection holds for combined signal plus noise amplitudes to 130% of full scale.

The 2402A features a guard that completely isolates the floating measuring circuit from the chassis, breaking the common mode loop. To take a practical example of the 2402A noise rejection, the combined effect of guarding and averaging at 60 Hz is such that a 100 V peak-to-peak common mode potential will not cause a discernible error in reading on any range.

AC voltages to 750V peak can be measured on four ranges from 1V to 1000V when the 2402A is equipped for optional ac voltage measurement. It is adapted for ac voltage measurement by installation of plug-in ac-to-dc converter and control boards. The converter is average-reading and is calibrated in rms with respect to sinusoidal input. The dc voltage input connectors are also used for ac input. The same guard provides common mode rejection for ac and dc voltage measurements. The overload detection circuit of the basic 2402A protects the ac converter.

Resistance measurements to 13 megohms can be made on five ranges from 1k Ω to 10M Ω when the 2402A is equipped with this option. It is adapted for resistance measurement by installation of plug-in ohms-to-dc converter and control boards and a 4-wire guarded rear panel connector. The converter is installed inside the guard, assuring freedom from common mode errors.

The 2402A may be equipped for frequency measurements to 199.999 kHz. Frequency measurement is a plug-in option.



2402A Integrating Digital Voltmeter



Cover flips up to protect controls in systems use.

Specifications

(For $\pm 10\%$ line voltage variation and 6 months operation, assuming daily calibration against internal standard after 30-minute warm-up.)

DC voltage measurement

Noise rejection: overall effective common mode rejection: (ratio of common mode signal to its effect upon readings): 160 dB at dc, decreasing to 126 dB above 30 Hz (infinite rejection cusp gives 168 dB effective cmr at 60 Hz $\pm 15\%$). Overall rejection combines common mode rejection and superimposed noise rejection.

Input circuit: type: floated and guarded signal pair. Signal low and guard may be floated up to 500 V above chassis ground with up to 1000 V input signal (maximum low-to-guard voltage is 50 V).

Ranges: 100 mV and 1, 10, 100, and 1000 V full scale selected by front panel switch, external programming or autoranger.

Overranging: to 130% of full scale, except on 1000 V range. Self protected on any range against input voltage to 1000 V. Protective circuits reset automatically for each new reading.

Input impedance: greater than 1000 M Ω on 100 mV, 1 V and 10 V ranges; 10 M Ω on 100 and 1000 V ranges.

Internal calibration standard: (independent of measuring circuit). Derived from stabilized reference diode operating in a constant temperature oven; maintain specified accuracy for 6 months.

Accuracy: (source impedance 10 k Ω , 43 measurements per sec, $\pm 10\%$ line voltage variation.)

	1 V, 10 V, 100 V, 1000 V	100 mV
Short term (24 hour) Accuracy (at 25 ± 1°C)	.003% rdg ± .003% fs (.006% rdg in overrange)	.003% rdg ± .005% fs (.008% rdg in overrange) Below 30 mV accuracy improves to 3µV ± .008% rdg.
Long term (6 months) Accuracy (at 25 ± 1°C)	.01% rdg ± .003% fs (.013% rdg in overrange)	.01% rdg ± .005% fs (.015% rdg in overrange) Below 30 mV accuracy improves to 3µV ± .015% rdg.

TEMP EFFECT	Per °C change from Calibrate temperature	
15 to 40°C	.0015% rdg ± .00015% fs	.0015% rdg ± .0006% fs
10 to 15°C or 40 to 50°C	.002% rdg ± .00015% fs	.002% rdg ± .0006% fs

Measurement speed: to 43 measurements per second when triggered externally. Self-triggers at speeds continuously adjustable from 1 measurement every 10 seconds to 10 per second.

Resolution: 1 part in 130,000 on 6-digit display; 100 mV range displays readings to 1 µV.

AC voltage measurement option

Common mode rejection: 160 dB at dc, decreasing to 120 dB at 60 Hz and 6 dB per octave for noise frequencies above 60 Hz, with 10Ω between guard connected to low side of source and low side of input.

Input circuit: floated and guarded signal pair. Signal low and guard may be floated up to 500 V above chassis ground with maximum input voltage applied.

Input voltage limitations: 240 V peak on 1 V range 750 V peak on all other ranges.

Input impedance: 1 MΩ ± 1% shunted by 200 pF (maximum).

AC only operation: frequency range: 50 Hz to 100 kHz.

Ranges: 1, 10, 100, and 1000 V full scale, selected by front panel switch, external programming or autoranger.

Overranging: to 130% of full scale, except 750 V peak, on 1000 V range.

Accuracy (with respect to standard used for calibration):

SIGNAL FREQUENCY ①	50 Hz		100 Hz		10 kHz		30 kHz		100 kHz	
	%rdg	%fs	%rdg	%fs	%rdg	%fs	%rdg	%fs	%rdg	%fs
Accuracy (at 25 ± 1°C)	.09	.05	.06	.03	.06	.03	.09	.05	.3	.09
Response error ②	.1	—	.05	—	.02	—	.02	—	.02	—
Ripple error ③	.03	—	.02	—	—	—	—	—	—	—
Temperature effect ④ (Per °C change in ambient from 25°C, over 10 to 50°C range)	.004	.003	.004	.003	.004	.003	.007	.003	.013	.003

- ① Straight line interpolation holds for frequencies between points.
- ② Applicable only to step input (received from data system signal scanner) or autorange operation.
- ③ Ripple error decreases 18 dB per octave above 85 Hz, is zero at 60 Hz because of superimposed noise rejection of basic instrument.
- ④ Assumes calibration of 2402A against internal standard at 25°C ambient. Calibration of 2402A at operating temperature decreases % rdg temperature effect .0009%.

AC on DC operation: maximum dc component: ±200 V on any range.

Ranging: must start from 1000 V range, proceeds to lower range as required.

Peak input: ac plus dc to 100% of full scale, except 750 V peak maximum on 1000 V range.

Measurement speed: to 1.9 externally-triggered measurements per second. Self-triggered measurement rate adjustable from 1 measurement every 10 seconds to 1.6 per second.

Resolution: 1 part in 130,000 on 6-digit display; 10 µV on 1 V range.

Resistance measurement option

Noise rejection: measurement circuit enclosed in same guard as dc circuit, reducing effect of ac common mode noise when guard is connected to low side of test resistance. Double-shielded cable extends guard to test resistance.

Input circuit: guarded, modified four-terminal circuit; unknown resistor can be either grounded or floating.

Ranges: 1 kΩ, 10 kΩ, 100 kΩ, 1 MΩ, and 10 MΩ full scale, selected by front panel switch, external programming or optional autoranger.

Overranging: to 130% of full scale. Self-protected on all ranges against up to 50 V across resistance input.

Absolute accuracy:

Resistance range	1 kΩ	10 kΩ	100 kΩ	1 MΩ	10 MΩ
Measurement current	1 mA	1 mA	100 µA	10 µA	1 µA
Accuracy at 25°C	% rdg ± % fs		.013% rdg ± .003% fs		% rdg ± % fs
	.016	.003			.025 .005
Temperature effect ①	.004% rdg ± .0003% fs per °C difference of ambient with respect to 25°C over 10 to 50°C range				

① Calibration of 2402A against internal standard at operating temperature decreases % rdg temperature effect .0015% per °C, to .0025% rdg per °C.

Measurement speed: to 8 externally triggered readings per second. Self-triggered measurement rate is adjustable from 1 measurement every 10 seconds to 4.5 per second.

Resolution: 1 part in 130,000; .01Ω on 1 kΩ range.

Frequency measurement option

Frequency range: 5 Hz to 199,999 kHz.

Gate time: 1 second; provides 1 Hz resolution.

Accuracy: (±1 count ± time base stability); time base aging rate: 2 ppm per week over 20 to 30°C; time base temperature effect: 100 ppm over range 10 to 50°C.

Input

Amplitude range: .1 to 100 V rms.

Pulse or square wave input: negative 1 to 100 V amplitude, 2 µs minimum duration, 50% maximum duty cycle.

Impedance: 1 MΩ shunted by 150 pF.

Maximum voltage: 150 V peak dc plus ac or pulse.

Autorange option

Range selection: DC voltage ranges; each time autoranger is programmed, it starts on 1 V range to take advantage of fast up-ranging. While autoranging is continuously programmed, autoranger starts at range selected for previous reading, sequences to higher or lower range as required. AC voltage ranges; autoranger starts at 1000 V range, sequences to lower range as required. Up-ranges at 136% of full scale, down-ranges at 10.2%.

General

Display and system interface: 6-digit display, BCD output and program inputs. Polarity, decimal, measurement units, calibration, and overload conditions indicated automatically and included in output as function and decimal digits.

Operating conditions: specifications apply for ambient temperatures 10 to 50°C, relative humidity to 90% at 40°C, altitude to 15,000 feet.

Power: 115 or 230 V ±10%, 50 to 60 Hz, 150 W.

Dimensions: 16¼" wide, 5¼" high, 19½" deep behind panel (425 x 133 x 494 mm); hardware furnished for 19" wide rack mount.

Weight: net 49 lbs (22,2 kg); shipping 56 lbs (25,4 kg).

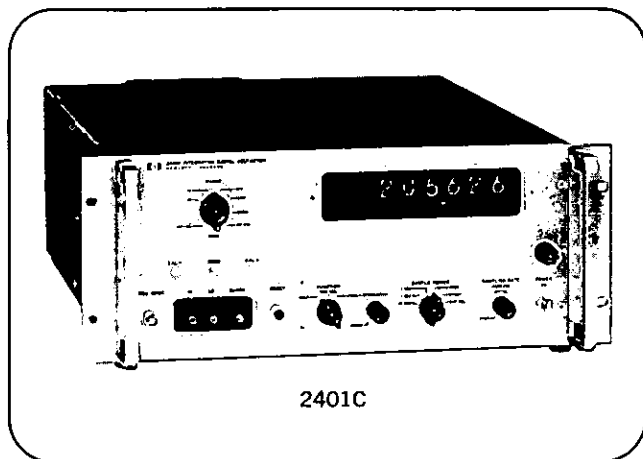
Price: 2402A for DC measurements, \$5450; AC adds \$475; resistance adds \$775; frequency adds \$350; autoranging adds \$265.

DIGITAL VOLTMETERS



INTEGRATING DVM

Precise measurements despite severe noise
Model 2401C



The 2401C Integrating Digital Voltmeter combines the precision and measurement flexibility of a laboratory instrument with programming and electrical outputs for systems use.

Design features virtually eliminate measurement errors due to extraneous noise superimposed on the signal, without restriction on grounding of the signal source, recorder, or programming device. Signals as small as a few per cent of full scale can be accurately measured even in the presence of noise approaching three times full scale.

The 2401C measures the average value of the applied voltage over one of three fixed crystal-controlled sample periods. Reversing counter circuits permit signals to be integrated around zero with full instrument accuracy.

Operation of the optional autoranger is extremely fast—34 msec maximum range change time. The 2401C with autoranging finds excellent application at high sampling rates with varying input signals and at rapid scanning rates when employed in multi-channel systems with widely varying signal levels. The autoranger also will select proper range of ac/ohms converter at reduced ranging speeds.

The 2401C is designed for fully automatic operation within a digital data acquisition system, both computerized (page 102) and non-computerized (page 100). Measurement function, voltage range, sample period, sampling rate and integration interval all can be selected by external circuit closures to ground. While the measurement circuit of the 2401C is guarded, all remote control lines and electrical outputs are referred to chassis ground and do not interfere with the guard.

AC/Ohms measurement

The Model 2410B AC/Ohms Converter (page 98) enables ac voltages and resistances to be measured with the 2401C Digital Voltmeter. AC voltages up to 750 V peak and resistances up to 10^7 ohms are converted to proportional dc voltages between 0 and 1 volt.

Specifications, 2401C

DC voltage measurements, noise rejection: overall effective common mode rejection: 140 dB at all frequencies 160 dB at dc (0.1 second sample period); superimposed noise rejection; more than 20 dB at 55 Hz for 0.1 second sample

period, increases 20 dB per decade increase in frequency, infinite rejection at frequencies evenly divisible by 10.

Input circuit: type: floated and guarded signal pair, may be operated up to 500 V above chassis ground; ranges: 5 from 0.1 to 1000 V f.s., selection by front-panel switch or remote circuit closure to ground, polarity sensed automatically; over-ranging: to 300% f.s. except 1000 V range; overload: range automatically switched to 1000 V at 310% f.s., reset by next read command; input impedance: 10 M Ω on 10, 100, 1000 V ranges, 1 M Ω on 1 V range, 100 k Ω on 0.1 V range, <150 pF on all ranges.

Absolute accuracy: 0.01% of reading $\pm 0.005\%$ f.s. ± 1 digit at 25°C; temperature coefficient $\pm 0.001\%$ of reading per °C, 10 to 40°C.

Internal calibration source: ± 1 V standard for self-calibration; maintains rated accuracy for 6 months after initial calibration to 0.002% at 25°C.

Measurement speed: fixed sample periods of 0.01, 0.1 of 1 s selected by front-panel switch or remote circuit closure to ground.

Resolution: depends on sample period; max 1 μ V per digit.

Autoranger (optional) voltage ranges: automatically selects range from 5 input ranges of standard instrument (0.1 V to 1000 V f.s.). 34 ms max range change time.

DC voltage integration: input signal is integrated over selected sample period; using fixed sample period, integral is average of input.

Frequency measurements: 5 Hz to 300 kHz, optionally to 1.2 MHz; gate time 0.01, 0.1, 1 sec or manual; accuracy: ± 1 count \pm time base accuracy; time base: stability at constant temperature ($\pm 5^\circ\text{C}$) is $\pm 2/10^6$ /week, temperature effect $\pm 100/10^6$ over range 10 to 50°C, provisions for external time base; display time: variable from 0.2 to 7 sec, or held until reset; input sensitivity: 0.1 to 100 V rms; impedance: 1 M Ω shunted by 150 pF.

Period measurements (optional): 1, 10, and 100 periods; 5 Hz to 10 kHz; display is in ms; resolution referred to single period; 1 period, 100 μ sec; 10 periods, 10 μ s; 100 periods, 1 μ sec; accuracy is ± 1 count \pm time base accuracy \pm trigger error divided by number of periods. Sensitivity and impedance same as frequency measurements.

General

Display: 6 digit in-line digital-tube readout; polarity, decimal point, function and overload condition indicated automatically.

Recording outputs: BCD output provided for function and polarity, 1 digit; data, 6 digits; decimal point, 1 digit.

External programming: circuit closures to ground.

Operating conditions: specifications apply for ambient temperatures 10 to 50°C, relative humidity to 95% at 40°C.

Power: 115 or 230 V $\pm 10\%$, 50 to 60 Hz, 150 W.

Dimensions: 19" wide, 7" high, 18 $\frac{3}{8}$ " deep behind front panel (483 x 177 x 467 mm).

Weight: net 48 lbs (22 kg); shipping 57 lbs (25.7 kg).

Price: 2401C, for dc and frequency measurements, \$4300. Option 31 Autoranger, add \$250. Option 30 Period measurements, add \$250.

V-TO-F CONVERTER

Accurate bipolar, low-level dc V-to-F conversion
Model 2212A



VOLTAGE, CURRENT,
RESISTANCE

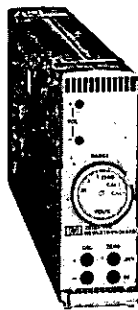
The HP 2212A is a compact Voltage-to-Frequency Converter, well suited to low-level signal applications. Low input drift and high common mode rejection (114 dB at 60 Hz) are achieved without a chopper by differential circuits. The VFC produces an output pulse train with a rate directly proportional to the magnitude of an applied dc voltage. Pulse rate rises linearly and instantaneously from 0 to 100,000 pulses per second as the dc input level is increased from zero to full scale. The 2212A provides outstanding linearity, stability and noise immunity.

The output of the HP 2212A, when connected to an electronic counter provides a convenient method of making digital measurements of dc voltages; the converter provides a polarity signal. This converter-counter combination can be connected

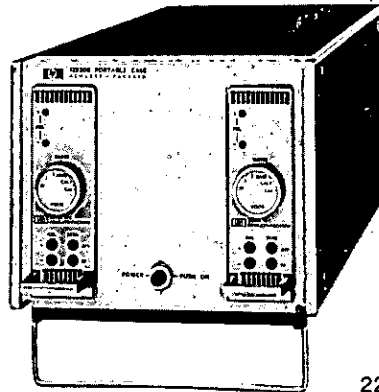
directly to a digital printer or through an output coupler to other common digital recording devices.

The converter-counter combination integrates dc voltages over any period of time and can therefore be used to read the average of the input over a selected sample period, or over an externally-controlled period. This provides accurate dc measurements in the presence of noise superimposed on the signal. Combining the VFC with an HP 5321B all-IC Counter, (page 610) provides an Integrating DVM with .01, .1, 1 and 10 sec sample periods.

The modular package with self-contained power supply allows the 2212A to be used in both bench and systems applications. An inexpensive combining case is available to mount 10 instruments side-by-side in only 5¼" of 19" rack panel space.



2212A



2212A shown in portable case

Specifications

Specifications include $\pm 10\%$ line voltage variation, hold for 1 k Ω max. source resistance, any unbalance, and assume daily calibration after specified warmup.

DC voltage ranges: 3 ranges; 0 to 10 mV, 100 mV, 1 V. Vernier option, (10-turn potentiometer) extends range to x3.5, for any setting. Overrange: to 250% of full scale, all ranges. Instrument is sensitive to positive and negative inputs; polarity indication and output signal provided.

Accuracy: 'Worst case' accuracy of pulse rate over 1-second sample period with respect to the source used for calibration is as follows:

	.01 V		.1 V		1 V	
	% rdg \pm % fs	% rdg \pm % fs	% rdg \pm % fs	% rdg \pm % fs	% rdg \pm % fs	% rdg \pm % fs
Stability	.07	.06	.05	.015	.02	.011
Linearity	.01	.01	.01	.01	.01	.01
Temp. Coeff.	.004	.017	.004	.0035	.004	.0022

Internal calibration source: 1 V standard for self-calibration.

Accurate to within $\pm 0.02\%$ for six months; temp. coeff of $\pm 0.005\%$ per $^{\circ}\text{C}$ (0° to 55°C).

Differential input impedance: 1000 M Ω shunted by 0.001 μF .

Common mode rejection: 120 dB at dc; 114 dB at 60 Hz.

Common mode return: From input common to output common, 1 megohm, max.

Normal mode rejection: More than 40 dB at 55 Hz with 1 second sample period; increases 20 dB per decade increase in noise frequency. Infinite rejection cusp every cycle.

Slewing: 10^6 V/sec rti (referred to input) with dc offset caused by slew limiting less than 0.1% of peak ac, provided 250% of full scale is not exceeded.

Maximum input signal: ± 11 V, signal plus common mode.

Combined input up to ± 20 V will not damage instrument.

Output (dc coupled): 0 to 100 kHz fs, overranging to 250 kHz; 5 Ma available; short circuit will not damage instrument.

Settling time: 100 μsec to within 0.01% of final pulse rate.

Overload recovery: 200 μsec to 0.01% of final pulse rate for signal to 10 times full scale. Less than 5 ms for signal plus common mode input up to 20 V.

Polarity indication: electrical and visual for + and -.

Operating conditions: Ambient temperatures from 0° to 55°C ; relative humidity to 95% at 40°C .

Warmup: operates immediately after turn-on, but requires 1½ hours in free air, 30 minutes in portable case or combining Case (plus 1 hour additional warmup for each 10°C difference between storage temperature and operating ambient) for specified accuracy and zero drift.

Reliability: predicted MTBF (with 90% confidence) is 10,000 hours when operated at 25°C ambient.

Power: 115 or 230 V $\pm 10\%$, 50 to 400 Hz, 9 W approx.

Dimensions: 1½" wide, 4¾" high, 15" deep (39.7 x 123.8 x 381 mm).

Weight: net 4 lb (1.8 kg), shipping 6½ lb (2.9 kg).

Accessories available: mating rear connector; mating rear connector with power cord, input/output cable; combining case: holds up to 10 instruments in 5¼" of 19" rack space (mating connectors furnished), includes power cord and fan; portable case: holds two VFC's (mating connectors furnished) and includes power switch, pilot light, power cord and fan.

Price: HP 2212A Voltage-to-Frequency Converter, \$1200.

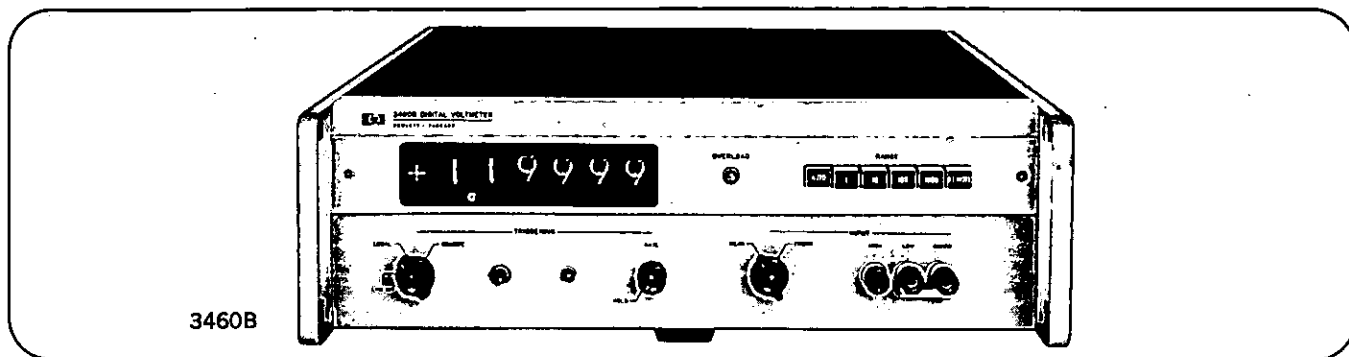
DIGITAL VOLTMETERS



DIGITAL VOLTMETER

±0.004% accuracy, lab precision, systems speed

Model 3460B



3460B

The Hewlett-Packard Model 3460B is a full five-digit digital voltmeter which combines in one instrument the benefits of high accuracy, high speed, and high noise rejection. The unique method by which the potentiometric and integrating techniques are combined in this instrument is primarily responsible for this combination of outstanding features. A unique two-sample system enables 15 independent readings to be made in one second at this accuracy. Integration during the second of these two samples plus guarding results in excellent effective common-mode rejection and ac normal-mode rejection characteristics. Voltage ranges and integration periods can be selected by contact closures to ground.

DC Voltage Specifications*

Ranges

Full range display: ±1.00000 V; ±10.0000 V; ±100.000 V; ±1000.00 V.

Overranging: 20% on all ranges.

Range selection: manual, automatic or remote.

Performance rating

Accuracy (accuracy applies over a temperature range of 25°C ±5°C):

90 day calibration cycle: ±(0.004% of reading + 0.002% of range).

180 day calibration cycle: ±(0.007% of reading + 0.003% of range).

Stability: ±(0.002% of reading + 0.001% of range) 24 hr, constant temperature ±1°C.

Temperature coefficient: ±(0.0002% of reading + 0.0001% of range) per °C (from 0°C to 20°C and 30°C to 50°C).

Reading period

10, 100, 1000 V ranges: <66 ms; **1 V range:** <150 ms.

Integration period: 1/10 s (1/60 s selectable by external contact closure to ground on 10, 100 and 1000 V ranges).

Response time: reads within specified accuracy when triggered coincident with step input voltage.

Autorange time: 33 ms per range change. Remote ranging time: 8 ms.

Input characteristics

Input resistance: 1 V and 10 V ranges, >10¹⁰Ω within ±5% of null, otherwise 10 MΩ ±0.03%; 100 V and 1000 V range, 10 MΩ ±0.03%.

Isolation parameters: floated and guarded input terminals; guard can be operated up to ±500 V p with respect to chassis ground, low can be operated up to ±50 V p with respect to guard.

Noise rejection: overall effective common-mode rejection (ratio of indicated error voltage to common-mode voltage) 145 dB at all frequencies (0.1 s sample period); common-mode rejection 160 dB at dc, 120 dB at 60 Hz with 1000Ω between low side of input and the point where the guard is connected; superimposed noise rejection; >20 dB at 55 Hz for 0.1 s sample period increased 20 dB per decade of frequency; infinite rejection at frequencies divisible by 10 (0.1 s sample period) or 60 (1/60 s sample period).

*For complete specifications refer to Data Sheet.

Remote control

Range selection: remote: all ranges can be selected by a contact closure to ground with impedance of <100Ω for a period >100 μs. Automatic: automatic mode of range selection can be programmed by a contact closure to ground with impedance <100Ω.

D/A converter reset: contact closure to ground of <100Ω.

Trigger hold-off: hold-off voltage is +3 to +10 V with a maximum current of 6.3 mA (provided by an external device).

Input resistance: 10 MΩ ±0.03% can be programmed by contact closure to ground of <100Ω.

Recorder data

BCD outputs: 4-line BCD (1-2-4-8) "1" state positive, 9 columns of information: function, decimal, overload, and 6 of digit data.

General

Operating temperature: instrument will operate within specifications from 0°C to 50°C unless otherwise specified.

Storage temperature: -40°C to +75°C.

RFI: conducted and radiated leakage limits are below those specified in MIL-I-6181D.

Power: 115 V or 230 V ±10%, 50 Hz to 60 Hz, 60 W.

HP 3460B is available on special order for operation with power-line frequencies between 50 Hz and 400 Hz.

Dimensions: 16¾" wide, 5" high (without removable feet), 19¾" deep (425 x 127 x 492 mm).

Weight: net 38 lbs (17,6 kg); shipping, 52 lbs (23,5 kg).

Accessories furnished

HP 11065A 6-ft rear input cable, guarding preserved; \$15.

HP 11085A remote control cable, \$30; rack mount kit for 19" rack.

Accessories available: HP 3461A AC/Ohms Converter-DC Pre-amplifier; HP 562A/AR Digital Recorder (refer to page 204 for special versions); HP 5050A Digital Recorder.

Optional Filter

An optional programmable filter can be added (as indicated in the table below) to increase the ac normal-mode rejection by 26 dB at 60 Hz (24 dB at 50 Hz). With this added rejection the 3460B accommodates ac normal-mode signals up to 100% of range (peak value).

When using the filter, 725 ms is added to the reading period and 363 ms is added to the auto-range time listed in the 3460B specifications.

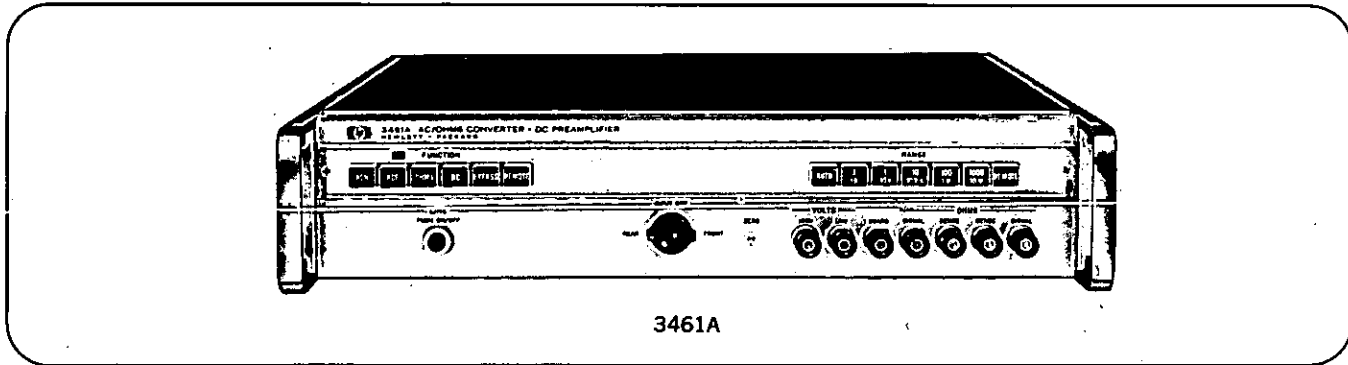
Price: HP 3460B, 1-2-4-8 BCD "1" state positive, \$3800.

Options	BCD Code ("1" state positive)		3461A Compatibility	Filter	Additional Price
	1-2-4-8	1-2-2-4			
001		X			N/C
002	X		X		\$150
003		X	X		\$150
004	X			X	\$250
005		X		X	\$250
006	X		X	X	\$400
007		X	X	X	\$400

HP 3460B option H50, optimum noise rejection for 50 Hz line frequency (3460B Options in chart apply).

AC/OHMS CONVERTER/PREAMP

Automatic ranging in all functions
Model 3461A



3461A

The Model 3460B Digital Voltmeter and 3461B AC/Ohms Converter DC Preamplifier combine to provide a multiple-function instrument system capable of making high-accuracy dc voltage, ac voltage (average responding) and resistance measurements. The 3460B/3461A combination is a fully programmable multi-function digital voltmeter. These features make the 3460B/3461A multi-function package an ideal choice for systems applications.

Combined Specifications* (3460B option 002 or 003 and 3461A)

DC Voltage

The 3461A provides a 0.1 V range and can be used on the 1 V and 10 V ranges when $10^{10} \Omega$ input impedance is required (accuracy is slightly demoted). The 3461A Bypass mode can be selected when dc accuracy of the 3460B alone is desired.

AC Voltage

Ranges: full range, 1.00000 V, 10.0000 V, 100.000 V, 1000.00 V.
Overranging: 20% all ranges from 50 Hz to 100 kHz.
Range selection: manual, automatic or remote.

Performance rating

Accuracy: (90 day calibration cycle, temp range of $25^{\circ}\text{C} \pm 5^{\circ}\text{C}$)

Frequency	Specification
50 Hz to 100 Hz	$\pm(0.08\%$ of reading $+0.02\%$ of range)
100 Hz to 10 kHz	$\pm(0.07\%$ of reading $+0.01\%$ of range)
10 kHz to 20 kHz	$\pm(0.08\%$ of reading $+0.02\%$ of range)
20 kHz to 100 kHz	$\pm(0.15\%$ of reading or 0.1% of range)

Stability: $\pm(0.012\%$ of reading $+0.006\%$ of range) 24 hr, C.T. $\pm 1^{\circ}\text{C}$.

Temperature coefficient: $\pm(0.0022\%$ of reading $+0.0006\%$ of range) per $^{\circ}\text{C}$ for temps of 0°C to 20°C and 30°C to 50°C .

Reading period: ACF (above 200 Hz), <550 ms; ACN, <1.2 s.

Autorange time: ACF, <445 ms; ACN, <1.1 s (per range change).

Input characteristics

Input: floated and guarded input terminals.
Impedance: front panel, $5 \text{ M}\Omega \pm 0.1\%$ shunted by <50 pF.

Ohms

Ranges: full range display of 1.00000 k Ω , 10.0000 k Ω , 100.000 k Ω , 1.00000 M Ω , 10.0000 M Ω ; 20% overranging, all ranges.

Range selection: manual, automatic or remote.

Performance rating

Accuracy: (90 day calibration cycle, temp range of $25^{\circ}\text{C} \pm 5^{\circ}\text{C}$)

Range	Specification
1 k Ω to 100 k Ω	$\pm(0.012\%$ of reading $+0.004\%$ of range)
1 M Ω and 10 M Ω	$\pm(0.016\%$ of reading $+0.004\%$ of range)

Stability (24 hr, constant temperature $\pm 1^{\circ}\text{C}$)

Range	Specification
1 k Ω to 100 k Ω	$\pm(0.004\%$ of reading $+0.002\%$ of range)
1 M Ω and 10M Ω	$\pm(0.005\%$ of reading $+0.002\%$ of range)

Temperature coefficient

Range	Coefficient per $^{\circ}\text{C}$
1 k Ω to 100 k Ω	$\pm(0.0007\%$ of reading $+0.0002\%$ of range)
1 M Ω and 10 M Ω	$\pm(0.0012\%$ of reading $+0.0002\%$ of range)

Derate the above specifications by these temperature coefficients for operation in temp range of 0°C to 20°C and 30°C to 50°C .
Reading period: 1 k Ω to 1 M Ω range, <150 ms; 10 M Ω range <66 ms.

Input characteristics

Input configuration: resistance measurements are made by a 4-terminal guarded system.
Current through unknown resistance: signal-circuit current is from 1 mA on the 1 k Ω range to $1 \mu\text{A}$ on the 10 M Ω range.

Remote control

Function and range selection
Remote: selected by contact closure to ground, $<100\Omega$.
Automatic: programmed by closure to ground, $<100\Omega$.

Recorder data

Print command and BCD outputs: provided by the 3460B.

General

Effective common-mode rejection and normal-mode rejection: dc >160 dB (all functions); ac >139 dB (dc and ohm functions).

Operating temperature: 0°C to 50°C unless otherwise specified.
RFI: conducted and radiated leakage limits are below those specified in MIL-I-6181D.

Power: 115 V or 230 V $\pm 10\%$, 50 Hz to 60 Hz, 95 W (3460B and 3461A with all functions). Available on special order for operation with power-line frequencies between 50 Hz and 400 Hz.

Dimensions: 16 $\frac{3}{4}$ " wide, 3 $\frac{3}{8}$ " high (without removable feet), 18 $\frac{1}{2}$ " deep (425 x 86 x 467 mm).

Weight (3461A): net 24 lbs (11.2 kg); shipping 33 lbs (14.9 kg).

3460B Option 002 or Option 003 accessories furnished: refer to 3460B specifications.

3461A accessories furnished

- HP 11065A volts rear input cable assembly; \$15.
- HP 11090A ohms rear input cable assembly (only with standard 3461A and 3461A Option 003); \$30.
- HP 11091A output cable assembly; \$30.
- HP 11092A interface logic cable assembly; \$30.
- HP 11093A remote control cable assembly; \$15.
- Rack mounting kit for 19" rack.

Accessories available

HP Part No. 5060-6026 joining bracket kit for combining 3460B and 3461A.

Refer to 3460B specifications for other accessories.

Price: HP 3460B Option 002 or Option 003, \$3950.
HP 3461A, AC/Ohms Converter-DC Preamp, \$2400.
HP 3461A Option 002 AC/DC Converter, \$1700.
HP 3461A Option 003 Ohms/DC Converter-DC Preamp, \$1950.

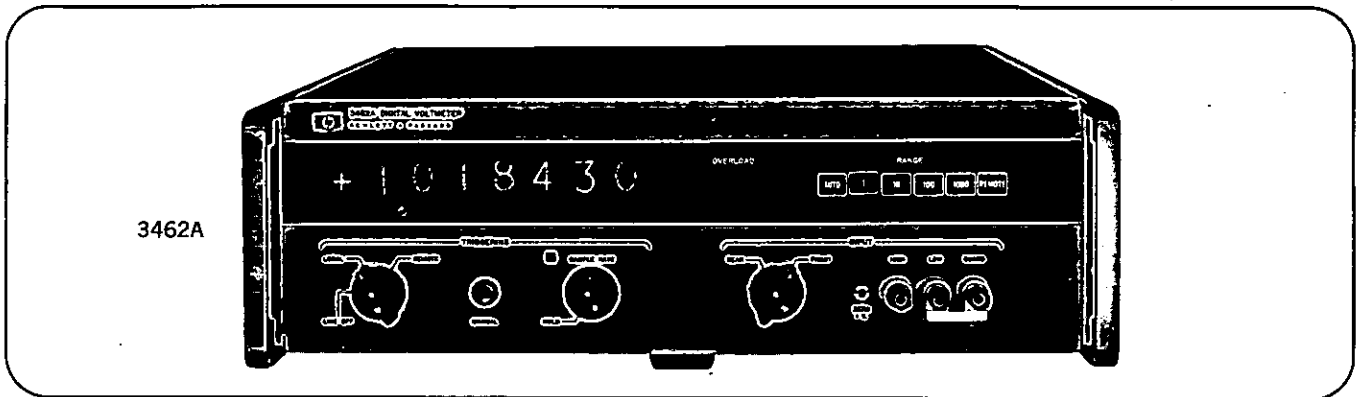
*For complete specifications refer to data sheet.

**VOLTAGE, CURRENT,
RESISTANCE**



DIGITAL VOLTMETER

Resolution: 1 μ V on 1 V; 1 mV on 1000 V range
Model 3462A



Description

The solid-state Model 3462A, 6-digit DVM, offers a resolution of 1 part in 1,200,000 at 20% overrange—four times more resolution than any other digital voltmeter in its price range. Accuracy is $\pm(0.004\%$ of reading $+0.002\%$ of range) over a 10°C temperature variation for a period of 90 days.

The potentiometric-integrating technique used in the 3460B is also used in the 3462A. The true average of the input voltage is measured over a fixed sample period. Accuracy results largely from the potentiometric principle using precision resistance ratios and a stable reference voltage. This, in combination with the integration and guarding system, results in the superimposed noise immunity of the integrating DVM's while retaining potentiometric accuracy. Virtually no loading errors result from an input impedance of greater than 10^7 ohms.

The 3462A offers a maximum reading rate of 1.1 seconds per reading on all ranges. The 3462A is fully programmable. Digital output for all readings include polarity, decimal location, overload, and seven digits of data.

Null measurements can be performed with 1 μ V sensitivity. A front-panel, high-resolution zero adjust is provided to compensate for any thermals in connections to external circuitry. BCD output capability permits recording of data, and remote programmability permits system applications.

Ranging

Voltages are measured on four ranges from ± 1 V to ± 1000 V full scale. Ranges can be selected automatically, manually, or remotely. An important advantage is the ability to read up to 20% above full scale on any range (1200 V dc on the 1000 V range). An overload condition is indicated on both the front panel and the recorder output when the input is greater than 1.2 times full scale on any range during manual operation or greater than 1200 V in automatic operation.

Automatic selection of the appropriate input voltage range may be made with the front-panel selector or by an external circuit closure to ground. The autoranging circuitry utilizes the full 20% overranging capability of the 3462A.

Programming

The HP 3462A is designed for fully automatic operation within a digital data acquisition system. Voltage range can be selected by external circuit closures to ground.

To simplify system cabling, input connections can also be made at the rear of the instrument. All remote-control lines and electrical outputs are referred to chassis ground and do not interfere with the guard.

Recorder Output

1-2-4-8* binary-coded decimal voltages (ground referenced) are produced for each measurement and for indication of measurement function, voltage range, and polarity. A complete printed record of the 3462A output information can be obtained with an HP Model 562A/AR or HP 5050B Digital Recorder.

Specifications Ranges

Full range display: ± 1.000000 V; ± 10.00000 V; ± 100.0000 ; ± 1000.0000 .

Overranging: 20% on all ranges.

Range selection: manual, automatic, or remote.

Performance

Accuracy (90 days, $25^\circ\text{C} \pm 5^\circ\text{C}$, $<50\%$ RH): $\pm(0.004\%$ of reading $+0.0002\%$ of range).

Accuracy (90 days, $25^\circ\text{C} \pm 5^\circ\text{C}$, $<95\%$ RH): $\pm(0.004\%$ of reading $+0.0004\%$ of range).

Stability (constant temperature $\pm 1^\circ\text{C}$, $<50\%$ RH)

24 hr: $\pm(0.0015\%$ of reading $+0.0002\%$ of range).

180 day: $\pm(0.006\%$ of reading $+0.0004\%$ of range).

Temperature coefficient (0°C to 50°C): $\pm(0.0002\%$ of reading $+0.00002\%$ of range) per $^\circ\text{C}$.

Measuring speed

Range	Integration Interval	Reading Period (without range change)	Auto-range Time	Remote Range Time	Polarity Selection Time
1 V 10 V 100 V 1000 V	1 s	1.1 s	60 ms	8 ms	no delay

Reads within specified accuracy when triggered coincident with step input voltage.

Input Characteristics

Input: floated and guarded signal pair (special gold-plated binding post on front panel or connector on rear panel are selected by front-panel switch). Guard may be operated up to ± 500 V dc with respect to chassis ground (350 V rms). Low may be operated up to ± 50 V dc with respect to guard.

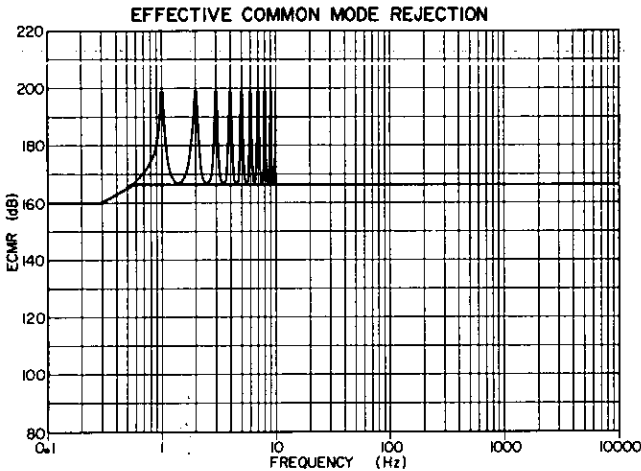
*1-2-2-4 available with HP 3462A Option 001.

Input resistance

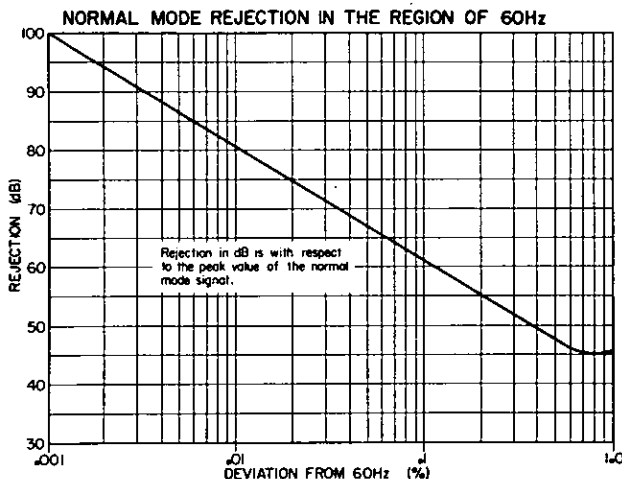
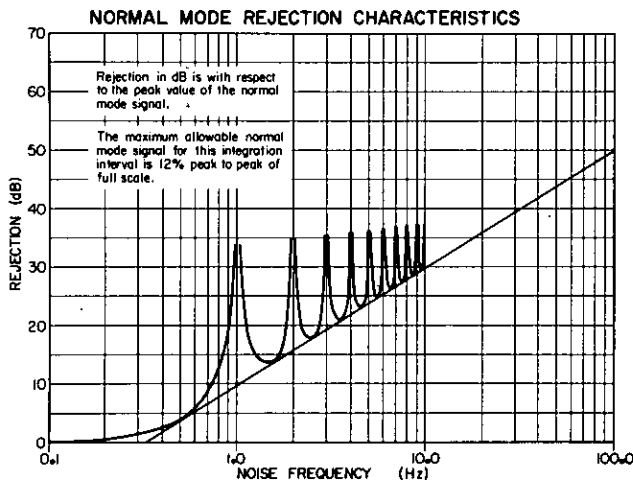
Range	Specifications
1 V and 10 V	$10^{10}\Omega$ within $\pm 5\%$ of null, otherwise $10^7\Omega \pm 0.03\%$
100 V and 1000 V	$10^7\Omega \pm 0.03\%$

Input impedance: 40 pF in parallel with $10^7\Omega$ at front panel.

Effective Common-Mode Rejection (ECMR): ECMR is the ratio of the peak common-mode voltage to the resultant error in reading with 1 k Ω unbalance in either lead.



Normal-Mode Rejection (NMR): NMR is the ratio of the peak normal-mode signal to the resultant error in reading.



Remote Control

Range selection

Automatic: pushbutton selector or a switch closure to ground through $<100\Omega$ provides autorange operation. 60 ms is required per range change, 180 ms max.

Remote: a switch closure to ground through $<100\Omega$ for a period $>100 \mu s$ selects range desired.

Manual: pushbutton selector.

External Read Command

Trigger	Open Ckt Voltage	Trigger Level	Duration	Load
Positive going Direct coupled	-10 V	0 V or contact closure to ground	100 μs to 10 ms	1 mA at 0 V 6 mA at +30 V
Negative going Direct coupled	+10 V	-10	100 μs to 10 ms	2 mA at -10 V, 5 mA at -30 V
AC Coupled		20 V p-p with rise time $\leq 10 \mu s$	$>100 \mu s$	6 k Ω in parallel with 25 pF (0.01 μF coupling capacitor used)

Voltmeter reset: switch closure to ground through $<100\Omega$ assures minimum reading period.

Trigger hold-off: hold-off level is +3 V to +10 V with max. current of 6.3 mA (provided by an external device).

Input resistance: $10^7\Omega \pm 0.03\%$ can be programmed by contact closure to ground of $<100\Omega$.

Recorder Data

Print command: dc coupled.

Print level: -1.0 V with 2 k Ω source resistance.

Print hold-off level: -17 V with 7.5 k Ω source resistance (minimum load resistance is 15 k Ω).

BCD outputs: 4-line BCD (1-2-4-8), 9 columns, consisting of polarity and decimal location, overload, and 7 digits of data (HP 3462A Option 001 is available for 1-2-2-4 BCD).

General

Operating temperature: 0°C to 50°C unless specified otherwise.

Storage temperature: -40°C to +75°C.

RFI: meets MIL-I-6181D.

Power: 115 V or 230 V $\pm 10\%$, 50 Hz to 60 Hz, 60 W. Available on special order for operation with powerline frequencies between 50 Hz and 400 Hz.

Dimensions: 16 $\frac{3}{4}$ " wide, 5" high, 21 $\frac{3}{8}$ " deep (425 x 127 x 543 mm).

Weight: net 38 lbs (16 kg); shipping 56 lbs (25.5 kg).

Accessories furnished

HP 11065A 6-ft rear input cable, guarding preserved, terminated end mates with 3462A. \$15.

HP 11085A remote control cable, \$30.

HP rack mount kit.

Accessories available

HP 562A/AR Digital Recorder, basic instrument with 11-column capacity. Column boards, input connector assemblies and cables required for operation are not included. Cabinet, \$1185; rack, \$1160.

HP 5050B Digital Recorder, basic instrument with 18-column capacity and 3 code discs. Column boards and cables required for operation are not included, \$1900.

Price: HP 3462A, \$4900.

HP 3462A option 001 (1-2-2-4 BCD output), \$4900.

HP 3462A option H50 (optimum noise rejection for 50 Hz line frequency).

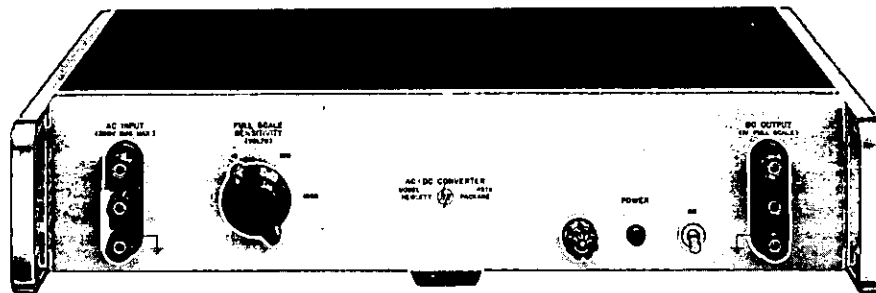
HP 3462A option 001, option H50 (1-2-2-4 BCD output and optimum noise rejection for 50 Hz line frequency).

DIGITAL VOLTMETERS

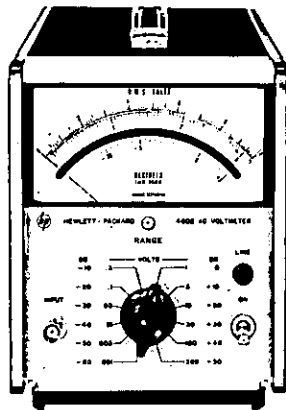


AC TO DC CONVERTERS

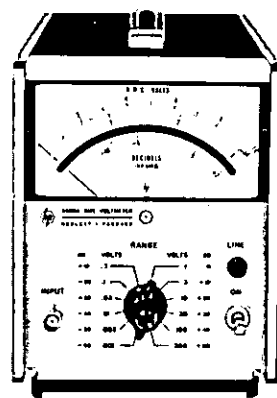
Economical AC to DC converters
Models 457A, 400E, 3400A



457A



400E



3400A

Model 457A is an average-responding, rms calibrated ac-to-dc converter. Thus, a one-volt rms sine wave input provides a one-volt dc output.

A frequency range from 50 Hz to 500 kHz is covered with conversion accuracy of $\pm 1 \text{ mV} \pm 0.75\%$ of full scale; from 50 Hz to 50 kHz, accuracy is $\pm 1 \text{ mV} \pm 0.3\%$ of reading.

Specifications, 457A

Input range: 100 μV to 300 V rms, in 4 decade ranges corresponding to 1, 10, 100 and 1000 V rms full scale; over-ranging to 200% of full scale, all ranges except 1000 V.

Frequency range: 50 Hz to 500 kHz.

Accuracy: $\pm 0.3\%$ of reading $\pm 1 \text{ mV}$ from 50 Hz to 50 kHz; $\pm 0.75\%$ of reading $\pm 1 \text{ mV}$ from 50 kHz to 500 kHz.

Floating input: permits measurement of ac voltages at dc potentials of $\pm 500 \text{ V}$ above power-line ground.

Output: 0 to 1 Vdc, responding to average value of ac input, with output calibrated as rms value of sine wave; input step attenuation of 1, 10, 100 or 1000.

Output impedance: 10,000 Ω .

Input impedance: 1 M Ω , shunted by 30 pF.

Power: 115 or 230 V $\pm 10\%$, 50 to 400 Hz, approx. 31 W.

Dimensions: 16 $\frac{3}{4}$ " wide, 3 $\frac{3}{4}$ " high, 13 $\frac{3}{4}$ " deep (426 x 95 x 324 mm).

Weight: net 12 lbs (5.4 kg); shipping 20 lbs (9 kg).

Accessories available: 1110A Current Probe, \$100; 10100B Feed-Through Termination (100 Ω), \$18; 11000A Cable, \$5; 11001A Cable, \$6.

Price: HP 457A, \$500.

Two Hewlett-Packard analog voltmeters provide a dc output voltage that is directly proportional to the meter current and may be used as ac-to-dc converters. By connecting a dc digital voltmeter to the dc output of these instruments, an economical ac digital voltmeter is available. The output voltage of the HP 400E/EL and 3400A is 1 V dc for full-scale deflection.

The HP 3400A may be used as a true rms ac/dc converter. Typical dc output accuracy is $\pm 0.75\%$ of full scale from 50 Hz to 1 MHz. For additional information, refer to page 181.

The 400E/EL may be used with 0.5% accuracy as an ac/dc converter in its frequency range from 100 Hz to 500 kHz. For complete specifications, refer to page 178.

AC/DC Converter Output

400E/EL output: 1 V dc at full-scale deflection, proportional to meter deflection (linear output for Models 400E/EL).

Output resistance: 1000 Ω .

Response time: 1 s to within 1% of value.

Price: HP 400E, \$335; HP 400EL, \$345.

3400A output: —1 V dc at full-scale deflection, proportional to meter deflection (from 10 - 100% of full scale).

Output resistance: 1000 Ω .

Price: HP 3400A, \$575.

IMPEDANCE AND PHASE MEASUREMENTS

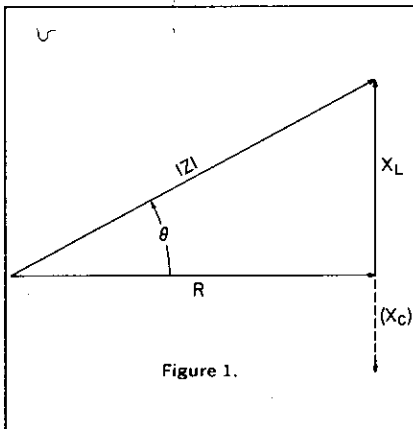


IMPEDANCE

Impedance measurements are concerned with the magnitude and the nature of the opposition of a component or network to the flow of ac current. Not only is a measure of the total opposition to current flow desired, but it is also important to determine the ratio of reactance to resistance and whether the reactance is inductive or capacitive.

At frequencies below 100 MHz, these qualities are most easily determined by measuring the voltage resulting from the flow of a known ac current into the component or network under test. The voltage amplitude indicates the absolute value of the impedance.

The nature of the reactance can be determined by comparing the phase difference between the current and voltage waveforms at the point of measurement. With the magnitude and phase angle θ thus determined, the ratio of reactance X to resistance R and whether the reactance is inductive or capacitive can be determined (see diagram Fig. 1).



Such measurements must be made at several frequencies if the component or network is to be fully characterized.

In the past, measurements of impedance at RF frequencies and above required several pieces of test equipment and were time-consuming, requiring many steps to acquire the desired information at each discrete frequency. Recently developed instruments from Hewlett-Packard, however, have greatly simplified the measurement of impedance over a broad range of frequencies. With these instruments, it is possible to make sweep frequency plots of the absolute value of impedance $|Z|$ and phase angle (θ) vs. frequency and in so doing

acquire complete coverage within the frequency band of interest.

Vector impedance meters

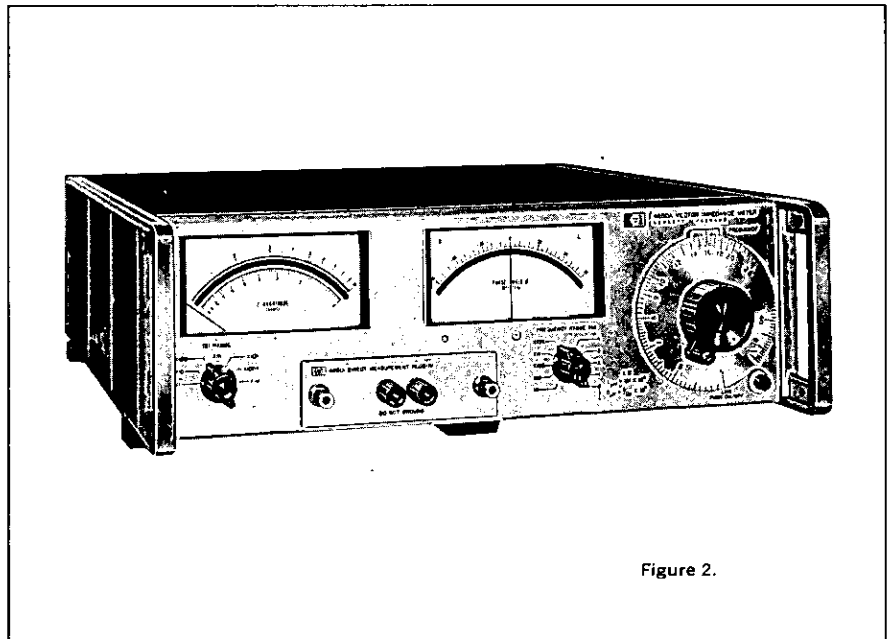
Direct readout of $|Z|$ and θ are presented on adjacent meters by the remarkable new HP 4800A Vector Impedance Meter and the HP 4815A RF Vector Impedance Meter.

The 4800A (Fig. 2) which operates in a frequency range from 5 Hz to 500 kHz, requires only that frequency (and range) be selected; the unknown is connected across front-panel terminals. The magnitude of Z is read in ohms directly on

same time, the voltage response of the test circuit is sensed and converted by a second sampling channel, located within the same probe, to read out directly in impedance. A phase detector monitors the difference between the voltage and current channels to yield the phase angle of the impedance vector. One probe, both excites the test circuit and measures its impedance and phase angle.

Operating range of the 4815A is 500 kHz to 108 MHz, 1 to 100,000 ohms, 0 to 360° phase angle.

The 4815A provides all of the convenience of "probe and read" measurements. In use, the probe is connected directly into the circuit to be evaluated,



one meter, while the second meter, centered on zero, indicates phase angle and, by needle deflection, whether the reactance is capacitive or inductive.

Outputs at the rear provide dc analog signals proportional to meter deflections for Z , θ , and frequency for convenient recording. The operating range of the Model 4800A is 1 ohm to 10 megohms, $\pm 90^\circ$ phase angle.

In the Model 4815A RF Vector Impedance Meter, an internal LC oscillator supplies a low-level excitation signal to the circuit under test through a convenient probe attached to a 5-foot cable. A sampling AGC loop maintains the excitation constant at 4 microamps. At the

frequency is selected, and complex impedance is read. This method allows a straightforward adaptation to various jigs and fixtures for special measurements.

Where only component values are to be determined, a quick-mount adapter is provided to allow rapid measurements. For critical component applications, the unit to be evaluated may be mounted directly in its working circuit and its value determined in its actual environment, at the frequency of interest.

Analog output of frequency, magnitude, and phase angle are provided so that these values may be recorded on an X-Y recorder.

IMPEDANCE



VECTOR IMPEDANCE METER

Quickly, easily measure Z & θ , 5 Hz to 500 kHz
Model 4800A

Advantages:

- Reads impedance and phase angle directly
- Easy to operate, no balancing or nulling
- Versatile, plug-in measuring terminals
- Reliable, solid-state circuits

The HP 4800A Vector Impedance Meter will make fast measurements of impedance to 10 megohms and phase to $\pm 90^\circ$ of unknown two-terminal networks. Measurement can be made at a particular frequency or over a continuous range from 5 Hz to 500 kHz. The instrument may be mechanically swept to produce continuous measurements over its full frequency range. Analog outputs of frequency, impedance, and phase are available for X-Y recording. The instrument provides the design engineer with an easy-to-use, one-instrument method for checking components and circuits.

Specifications

Frequency characteristics

Range: 5 Hz to 500 kHz in five bands: 5 to 50 Hz, 50 to 500 Hz, 0.5 to 5 kHz, 5 to 50 kHz, 50 to 500 kHz.

Accuracy: $\pm 2\%$ from 50 Hz to 500 kHz, $\pm 4\%$ from 5 to 50 Hz, $\pm 1\%$ at 15.92 on frequency dial from 159.2 Hz to 159.2 kHz, $\pm 2\%$ at 15.92 Hz.

Monitor output: level: .2 volt rms minimum; source impedance: 600 ohms nominal in series with 50 μ F.

Impedance measurement characteristics

Range: 1 ohm to 10 megohms in seven ranges: 10 ohms, 100 ohms, 1000 ohms, 10 k ohms, 100 k ohms, 1 megohm, 10 megohms full scale.

Accuracy: $\pm 5\%$ of reading.

Phase angle measurement characteristics

Range: $0^\circ \pm 90^\circ$; **Accuracy:** $\pm 6^\circ$; **Calibration:** increments of 5° .

Direct inductance measurement capabilities

Range: 1 μ H to 100,000 H, direct reading at decade multiples of 15.92 Hz.

Accuracy: $\pm 7\%$ of reading for Q greater than 10 from 159.2 Hz to 159.2 kHz; $\pm 8\%$ of reading for Q greater than 10 at 15.92 Hz.

Direct capacitance measurement capabilities

Range: 0.1 pF to 10,000 μ F, direct reading at decade multiples of 15.92 Hz.

Accuracy: $\pm 7\%$ of reading for D less than 0.1 from 159.2 Hz to 159.2 kHz, $\pm 8\%$ of reading for D less than 0.1 at 15.92 Hz.

Measuring Terminal Characteristics

Configuration: electrical: both terminals above ground, ground terminals provided for shielding convenience; mechanical: binding posts spaced $\frac{3}{4}$ " at centers.

Waveshape: sinusoidal.

External Oscillator Requirements: 0.9 V $\pm 20\%$ into 20 k ohms.

Recorder outputs:

Frequency: level, 0 to 1 volt nominal; source impedance, 0 to 1000 ohms nominal; proportional to frequency dial rotation.

Impedance: level, 0 to 1 volt nominal; source impedance, 1000 ohms nominal.

Phase angle: level, 0 ± 9 volt nominal; source impedance, 1000 ohms nominal.

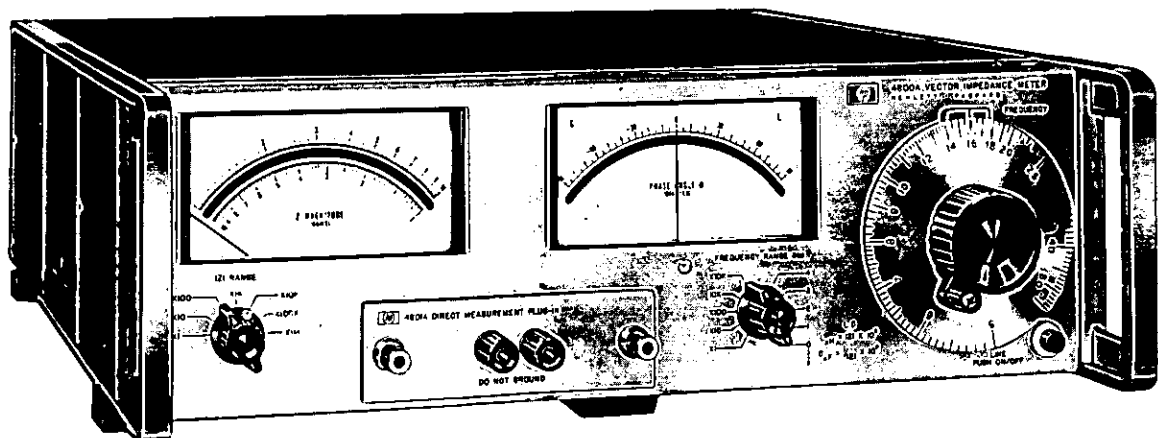
Accessories furnished: 13525A Calibration Resistor, 00610A Terminal Shield.

Dimensions: 16 $\frac{3}{4}$ " wide, 5 $\frac{1}{4}$ " high, 18 $\frac{3}{8}$ " deep (426 x 133 x 467 mm).

Weight: net 24 lbs (10,8 kg), shipping 30 lbs (13,5 kg).

Power: 105 to 125 V or 210 to 250 V, 50 to 400 Hz, 27 W.

Price: HP 4800A, \$1,650.



4800A

RF VECTOR IMPEDANCE METER

Quickly, easily measure Z & θ , .5 to 108 MHz
Model 4815A



IMPEDANCE

Advantages:

- Direct reading of impedance and phase
- Convenient probe for in-circuit measurements
- Self calibration check provides measurement confidence
- Analog outputs for data recording
- Low-level test signal minimizes circuit disturbance

The HP 4815A RF Vector Impedance Meter provides all of the convenience of "probe and read" measurements. In use, the probe is connected directly into the circuit to be evaluated, frequency is selected, and complex impedance is read. This type measurement allows a straightforward adaptation to various jigs and fixtures for special measurements. Where only component values are to be determined, a quick-mount adapter is provided to allow rapid measurements. For critical component applications, the unit to be evaluated may be mounted directly in its working circuit and its value determined in its actual environment, at the frequency of interest.

Specifications

Frequency

Range: 500 kHz to 108 MHz in five bands: 500 kHz to 1.5 MHz, 1.5 to 4.5 MHz, 4.5 to 14 MHz, 14 to 35 MHz, 35 to 108 MHz.

Accuracy: $\pm 2\%$ of reading, $\pm 1\%$ of reading at 1.592 and 15.92 MHz.

RF monitor output: 150 mV minimum into 50 ohms.

Impedance magnitude measurement

Range: 1 ohm to 100 k ohms; full-scale ranges: 10, 30, 100, 300, 1 k, 3 k, 10 k, 30 k, 100 k ohms.

Accuracy: $\pm 4\%$ of full scale $\pm \left(\frac{f}{30 \text{ MHz}} + \frac{Z}{25 \text{ k ohms}} \right)$

% of reading, where f = frequency in MHz and Z is in ohms; reading includes probe residual impedance.

Calibration: linear meter scale with increments 2% of full scale.

Phase angle measurement

Range: 0 to 360° in two ranges: $0 \pm 90^\circ$, $180^\circ \pm 90^\circ$.

Accuracy: $\pm \left(3 + \frac{f}{30 \text{ MHz}} + \frac{Z}{50 \text{ k ohms}} \right)$ degrees; where f = frequency in MHz and Z is in ohms.

Calibration: increments of 2°.

Adjustments: front panel screwdriver adjustments for Magnitude and Phase Zero.

Recorder outputs

Frequency: 0 to 1 volt from 0 to 1 k ohm source, proportional to dial rotation.

Impedance magnitude: 0 to 1 volt from 1 k ohm source.

Phase angle: 0 ± 0.9 volt from 1 k ohm source.

Dimensions: 16 $\frac{3}{4}$ " wide, 7 $\frac{1}{4}$ " high, 18 $\frac{3}{4}$ " deep (426 x 185 x 476 mm).

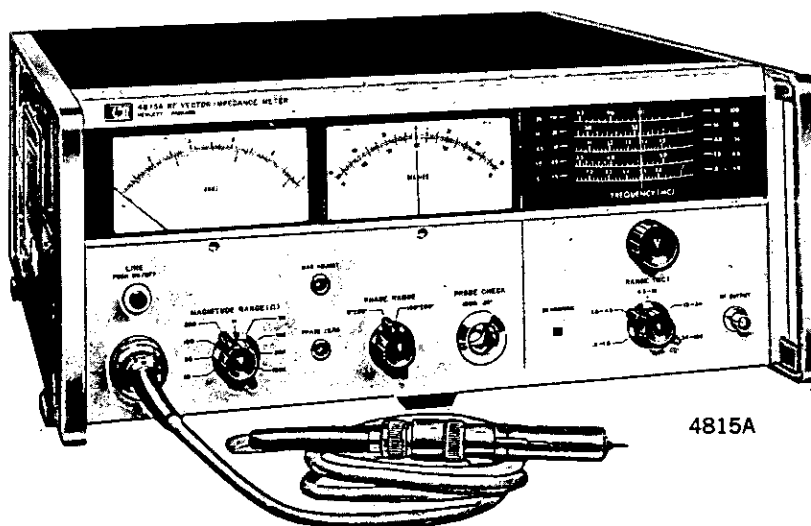
Weight: net 39 lbs (17,6 kg), shipping 55 lbs (24,8 kg).

Power: 105 to 125 V or 210 to 250 V, 50 to 400 Hz, 50 W.

Accessories furnished:

- 00600A Probe Accessory Kit: contains BNC Type "N" adapter, Probe Socket, 00601A Component Mounting Adapter, 2 probe center pins, probe ground assembly.
- Rack Mount Kit.

Price: HP 4815A, \$2650.





The impedance bridge

The versatile bridge circuit, long a standard technique for impedance parameter measurements, can be used to provide high accuracy, high speed and flexibility in a single instrument. Figure 1 illustrates the generalized bridge circuit from which simple manually-operated, semi-automatic and fully-automatic measuring instruments have evolved.

In the traditional circuit, an oscillator (1 KHz is very common) applies a signal to two corners of the "bridge", and a detector monitors the other two. Z_a and Z_b are convenient values of resistance, determining the range of values measurable, while Z_s acts as a "standard" against which Z_x (the unknown) will be compared. Through suitable manipulation of the values of Z_a , Z_b and Z_s , an equal division of voltage across Z_a and Z_x can be established, indicated by "null" or no current at the detector. The unknown value is then calculated, either within the measuring instrument itself or by the operator.

Semi-automatic universal bridge

Eliminating the time-consuming adjustments required of a traditional manual bridge, the HP 4260A brings speed and convenience to a Universal Bridge with a wide range of measurement capability. Achieving "null" in the 4260A is aided by an internal feedback control system, which automatically sets one of the bridge arms, enabling rapid readings of L and C. In addition, the Universal Bridge measures R, D and Q. Only two adjustments are required to read quality factor (Q) or dissipation (D), interacting controls being eliminated.

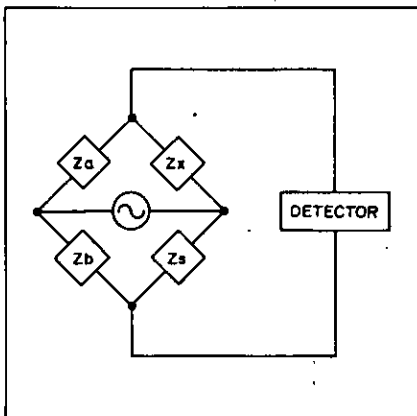


Figure 1. Generalized Bridge Circuit

Completely automatic capacitance bridge

Further evolution of bridge measurement technology has given rise to the fully automatic, high accuracy, high speed capacitance bridge. An extremely useful and needed measurement in today's electronics laboratory, the automatic capacitance bridge (HP Model 4270A) is indispensable to capacitance manufacturers and high-volume capacitor users. In the automatic bridge, the simple reactance arms of the basis bridge circuit are replaced by combinations of operational amplifiers and digitally controllable resistances. Using suitable feedback control, all bridge balance operations, range selection, readout of C, D, G, range and decimal point are performed almost instantly . . . only an unknown is required.

Q meters

The Q of a resonant circuit, comprising a variable known capacitor (C_n) contained in the Q meter and an external inductor (L_x), is measured by impressing a signal of known voltage (E_1) and variable known frequency in series in the circuit, and measuring the voltage (E_n)

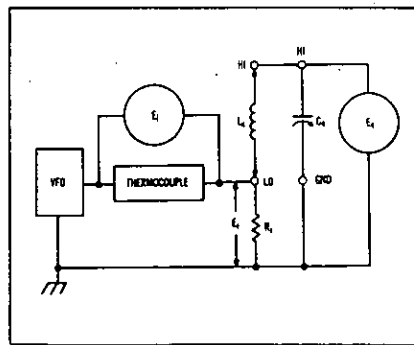


Figure 2. Q Meter.

across the capacitor when the circuit is resonated to the chosen frequency of the impressed voltage. Q of the circuit is the ratio E_n/E_1 . With E_1 known, the voltmeter measuring E_n can be calibrated directly in Q. By inserting low impedances in series with the inductor L_x , or high impedances in parallel with the capacitor C_n , the constants of unknown circuits or components may be measured in terms of their effect on the original circuit Q and tuning capacitance.

To calibrate these meters, Hewlett-Packard provides Q standards which are standard inductors of calibrated Q.

There are two Q meters in the HP family. Model 260A is for the frequency range 50 kHz to 50 MHz which may be extended down to 1 kHz by using a suitable external oscillator with a Model 00564A Coupling Unit. Model 190A serves the range 20 MHz to 260 MHz.

RX meter

The HP Model 250B RX Meter directly presents the parallel resistive and reactive constituents of Z, for two-terminal networks, in the range from 0.5 to 250 MHz.

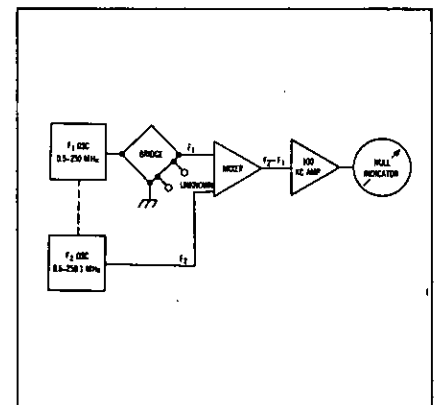


Figure 3. RX Meter.

The output of the 0.5 to 250 MHz test oscillator (F_1) is fed into a Schering bridge. When the impedance to be measured is connected across one arm of the bridge, the equivalent parallel resistance and reactance unbalance the bridge, and the resulting voltage is fed to the mixer. The output of the 0.6 to 250.1 MHz oscillator (F_2), tracking 100 kHz above F_1 , also is fed to the mixer, resulting in a 100 kHz difference frequency proportional in level to the bridge unbalance. This is amplified selectively to provide desired balance sensitivity. When the bridge R and C controls are nulled, their respective dials accurately indicate the parallel impedance components of the test sample.

The instrument's range of measurement is 15 to 100,000 ohms for parallel resistance (0 to 15 ohms by indirect means) for C, and 0.001 μ H to 100 mH for L.

AUTOMATIC CAPACITANCE MEASUREMENT



IMPEDANCE

General

The measurement of capacitance is largely an impedance measurement technique using an a.c. bridge operating at frequencies that make the impedances a reasonable size. Considering that capacitance values today range from fractions of a picoFarad up to one Farad, the potential range of impedance values at a given frequency is enormous. For this reason, capacitance bridge normally measure at a frequency determined by the application and the range of capacitance values covered. It is common to measure large, low-valued electrolytic capacitors at 120 Hz—this is not only convenient, but is the "ripple" frequency of 60 Hz power supply circuits, where this type of capacitor is commonly used. Capacitors ranging in values less than a microfarad are often measured at the commonly accepted value of 1 kHz. As the values of capacitance become still smaller, a 1 MHz value becomes most appropriate. The HP 4270A measures capacitance values below 1 μ F.

Generally, the loss component in capacitance is equivalently represented as a conductance in parallel with a capacitance, or as a resistance in series with a capacitance. The 4270A measures an unknown as capacitance (C) with parallel conductance, and displays the conductance (G) or dissipation factor (D) according to the following formula:

$$D = \tan \delta = G/\omega C$$

The measured value of capacitance depends on the series or parallel equivalent circuit used for measurement. The relationship between capacitance C_{p1} of a parallel equivalent circuit and capacitance C_{s1} of a series circuit is as follows:

$$C_{s1} = (1 + D^2) \cdot C_{p1}$$

Where D is the dissipation factor measured in either the parallel or series circuit. The difference between C_{p1} and C_{s1} is large when D is greater than 0.1, but is within 1% if D is 0.1 or less—a normal condition for a practical capacitor. When D is less than 1, changes in the value of parallel conductance will not affect capacitance values measured by the 4270A.

Automatic Bridge Network

Although a transformer-bridge is commonly applied in automatic measurement circuits, the arrangement shown in Figure 1 represents a unique approach to achieving increased performance and

wider frequency range over traditional designs. The unknown capacitor (C_x) and the standard capacitor (C_s) are connected as two arms of the bridge, the C_x and C_s amplifiers comprise the other two arms. The additional loop containing G_s and the conductance/dissipation amplifiers provides for measurement of these two quantities. Bridge balance is indicated by zero current out of the bridge assembly and into the current detector. The magnitude of the unbalance current will be determined by the value of the unknown, the amplifiers, and the attenuators. The control circuits switch the standards, and digitally select values of attenuation such that a balance condition is achieved and maintained. Quantities to be measured can be expressed in terms of the voltages e_1 , e_2 , and e_3 under balance conditions, and with e_2 180° out

$$\text{of phase with } e_3; C_x = C_s \frac{e_2}{e_1}; G_x =$$

$$G_s \frac{e_3}{e_1}; D_x = \frac{G_s}{\omega C_s} = \frac{e_3}{e_2}. \text{ The voltage}$$

ratios must then be measured and converted to a digital display in units of the specific parameter.

The 4270A measures capacitance with terminals floating from ground, or with one terminal grounded. This feature is accomplished by providing a complete guard-chassis which protects the bridge circuit from stray capacitance and superimposed noise. Most measurements will be made under floating conditions.

However, it is sometimes important to measure capacitance between some terminal and ground, such as in grounded cables and the input capacitance of amplifiers. By using coaxial cable from the UNKNOWN connectors to an unknown capacitor (outer conductor is GUARD), guarding is valid even if one terminal of the unknown is grounded.

Test Voltages Applied

Accurate operation of capacitance-measuring bridges can be enhanced if the voltage applied to the capacitor under test is reasonably large. This may not be convenient however, in testing semiconductor devices, where a relatively low test voltage is desirable. The HP 4270A is provided with two values of test voltage for this reason. In addition, test voltages are maintained constant with range-changing—a useful feature when testing voltage-sensitive dielectrics.

DC Bias

Many capacitances of measurement interest are parameters of active devices such as field effect transistors, varactors and other semiconductors. Using the Automatic Capacitance Bridge, dc bias may be applied from internal or external sources to the unknown. The internal supply of the 4270A provides manually or remotely controllable d.c. voltages up to 200 VOLTS.

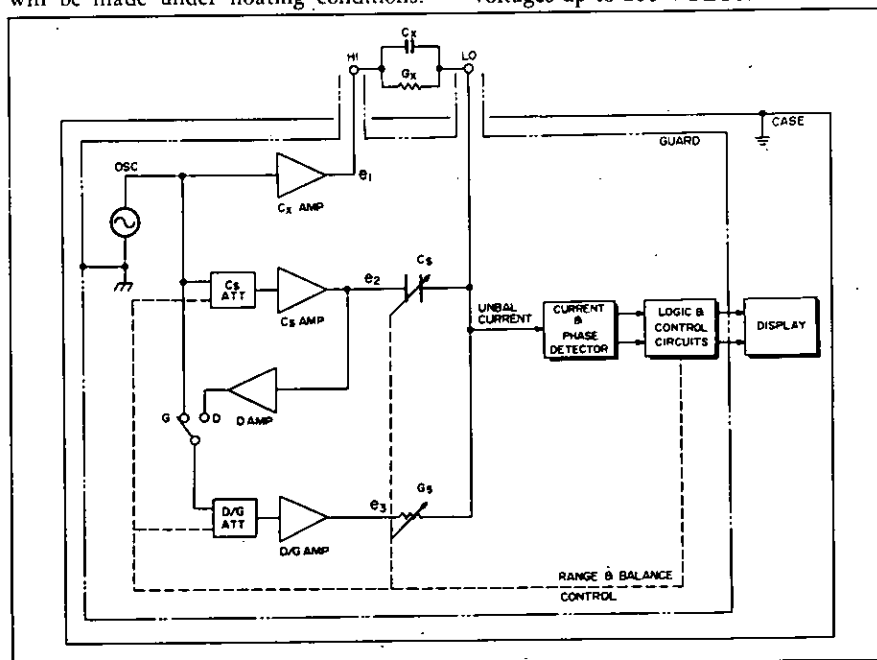


Figure 1. Simplified block diagram of HP 4270A Automatic Capacitance Bridge

IMPEDANCE



UNIVERSAL BRIDGE

Simplified, easy to read impedance measurement
Model 4260A



4260A

Advantages:

- Electronic AUTOBALANCE — single control null
- Digital Readout for C, R, L
- Direction Indicators for fast range selection and balance

Measurements of C, R, L, D (dissipation factor of capacitors), and Q are easily made with the new Model 4260A Universal Impedance Bridge.

The readout for C, R and L is digital with the decimal point automatically positioned. Units of measurement and the equivalent circuit automatically appear with a twist of the function switch. There are no multipliers or confusing non-linear dials which need interpolation.

Operation is simple. Set the function knob for the parameter to be measured, adjust the range switch for an on-scale indication, and obtain a null with the CRL control. There are no interacting controls to adjust and readjust. There are no false nulls. A unique electronic AUTOBALANCE circuit solves all these problems. Components with low Q or high Q are as easy to measure as those without loss.

For D or Q measurements, switch out of AUTO and turn the DQ control until another null is obtained. Only one adjustment is needed for each measurement.

Five bridge circuits are incorporated in the 4260A; each is composed of stable, high-quality components for good accuracy and linearity. An internal 1 kHz drives the bridge.

Nulling is easy. Illuminated pointers (< CRL >) automatically tell whether a null is up- or down-scale. Both range and CRL controls can be set watching these pointers.

Components may be biased by connecting a battery to the rear terminals. An external oscillator and detector can be used for measurements in the 20 Hz - 20 kHz range.

The compact modular cabinet is ideal for bench use; and it may be rack mounted using accessory hardware. A tilt stand is provided to raise the viewing angle; it also serves as a convenient carrying handle.

Specifications

Capacitance measurement

Capacitance

Range: 1 pF to 1000 μ F, in 7 ranges.

Accuracy:

- \pm (1% + 1 digit), from 1 nF to 100 μ F.
- \pm (2% + 1 digit), from 1 pF to 1 nF and 100 μ F to 1000 μ F.

Dissipation factor

Range:

- LOW D—(of series C): 0.001 to 0.12.
- HIGH D—(of parallel C): 0.05 to 50.

Accuracy: for C > 100 pF.

- LOW D $\pm \frac{2}{\sqrt{D \text{ of Reading}}} \%$.
- HIGH D $+ (10 D \text{ of Reading} + 4) \%$
 $- (10 \sqrt{D \text{ of Reading}} + 2) \%$.

Inductance measurement

Inductance

Range: 1 μ H to 1000 H, in 7 ranges.

Accuracy:

- \pm (1% + 1 Digit), from 1 mH to 100 H.
- \pm (2% + 1 Digit), from 1 μ H to 1 mH and 100 H to 1000 H.

Quality factor

Range:

- LOW Q—(of series L): 0.02 to 20.
- HIGH Q—(of parallel L): 8 to 1000.

Accuracy: for L > 100 μ H.

- LOW Q $+ \left(\frac{10}{Q \text{ of Reading} + 4} \right) \%$
 $- \left(\frac{10}{\sqrt{Q \text{ of Reading} + 2} \right) \%$.
- HIGH Q $\pm 2 \sqrt{Q \text{ of Reading}} \%$.

Auto-balance

Eliminates need for DQ adjustments in parallel C and series L measurements at 1 kHz.

Accuracy: for D < 1 and Q > 1 add $\pm 0.5\%$ to C and L accuracy specifications.

Resistance measurement

Range: 10 milliohms to 10 megohms, in 7 ranges.

Accuracy:

- \pm (1% + 1 digit), from 10 ohms to 1 megohm.
- \pm (2% + 1 digit), from 10 milliohms to 10 ohms and 1 megohm to 10 megohms; for greater accuracy in this high range, Model 419A is recommended.

Oscillator and detector

Internal oscillator: 1 kHz $\pm 2\%$, 100 mV rms $\pm 20\%$.

Internal detector: tuned amplifier at 1 kHz; functions as a broadband amplifier for measurements with external oscillator.

General

Power: 115 or 230 volts $\pm 10\%$, 50-60 Hz, approx. 7 watts.

Dimensions: 7-25/32" wide, 6-17/32" high, 11" deep (190 x 166 x 279 mm).

Weight: net, 11 lbs (5 kg); shipping, 15 lbs (6.8 kg).

Optional accessories:

HP 419A for accurate R measurements < 10 ohms and > 1 M ohms.

HP 204B for measurements 20 Hz - 20 kHz.

HP 140A/1400A or external tuned null detector with 90 dB gain and $Z_{in} > 10$ k ohms for measurements 20 Hz - 20 kHz.

Price: Model 4260A Universal Bridge, \$550.00.

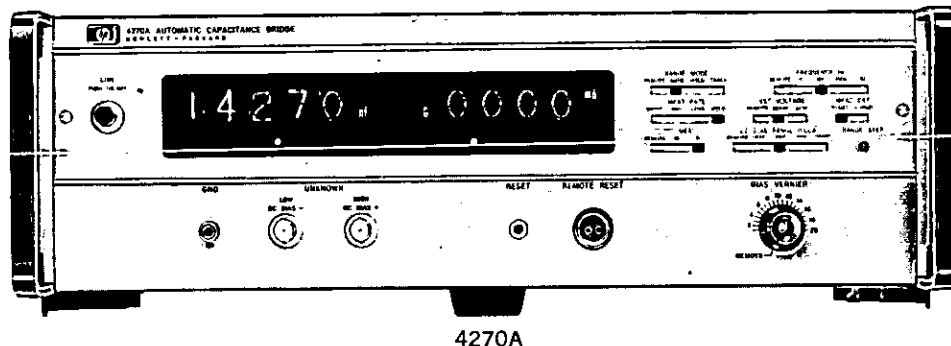
Manufactured by Yokogawa Hewlett-Packard Ltd., Tokyo.

CAPACITANCE BRIDGE

Fully Automatic, 1 kHz to 1 MHz
Model 4270A



IMPEDANCE



Description

A new instrument from Hewlett-Packard, the 4270A Automatic Capacitance Bridge provides a wide variety of high speed measurements of both active and passive capacity values. Five-digit readout of capacitance from full-scale ranges of 18,000 pF to 1.2000 μ F is complemented by .001 pF resolution and measurement speed of 0.5 seconds. In addition, a second in-line 4-digit Nixie® display of capacitor loss is given simultaneously in terms of parallel conductance (G) or dissipation factor (D). In the laboratory, the 4270A will be extremely useful for examination of semiconductor junction capacities, input capacitances of amplifiers and other active devices, as well as the analysis of stray capacity values, cables and simple capacitors. DC biasing, four frequencies from 1 kHz to 1 MHz and a fully guarded measurement will add to laboratory flexibility.

In manufacturing or incoming inspection applications the auto-ranging, high speed and digitally-coded outputs can significantly increase handling speed and data recording capability. Remote programming of all functions is built in to enable completely automatic control for system applications.

Specifications

Measuring circuit

Float: guarded terminals of unknown are floated from ground.

L-ground: one side of known terminals is grounded, guard is retained.

Parameters measured: capacitance, equivalent parallel conductance and dissipation factor.

Measuring frequency: 1 kHz, 10 kHz, 100 kHz and 1 MHz.

Range modes

Auto: range selection and balance performed automatically.

Hold: range is held on fixed position, balance begins with most significant digit. Range determined by previous AUTO or TRACK range selected or by manually stepping RANGE STEP.

Track: range held on fixed position, balance begins with last digit.

Balancing time: typically 0.5 s.

Measuring rate: measurement cycle equals balance time plus display time. Balance time typically 0.5 s; display times

selected by MEAS RATE are 70 ms, 2 secs, 5 secs and MANUAL.

Test voltage across unknown

Normal: 1 V rms constant, at capacitance units displayed in pF or nF; 100 mV rms constant at μ F.

Low: 200 mV rms constant at pF or nF. 20 mV rms constant at μ F.

Repeatability: ± 2 digits at NORMAL TEST VOLTAGE, ± 10 digits at LOW TEST VOLTAGE.

DC bias: INTERNAL or EXTERNAL to ± 200 V, in HOLD and TRACK mode.

Internal bias at float measurement

Voltage: 0 to 20 V dc; 0 to 200 V dc; continuously variable on front panel, monitored on rear panel.

Dial accuracy: $\pm 5\%$ of full scale.

Source resistance: 100 k Ω .

Polarity: LOW unknown terminal (—), HIGH unknown terminal (+) in FLOAT position of MEAS CKT control.

Remote: programmable by resistor with 250 Ω /V rate at 20 V range, 25 Ω /V rate at 200 V range.

Remote accuracy: $\pm 2\%$ of full scale.

Internal bias at L-ground: an additional connection using a blocking capacitor and a coaxial cable is necessary for INTERNAL source.

Basic accuracy

	Frequency	1 kHz & 10 kHz	100 kHz	1 MHz
C	D < .1	$\pm 1\% \pm 1$ digit $\pm .01$ pF	$\pm 3\% \pm 1$ digit $\pm .01$ pF	$\pm 1\% \pm 1$ digit $\pm .01$ pF
	Basic Accuracy .1 < D < 1	$\pm 2\% \pm 1$ digit $\pm .01$ pF	$\pm 5\% \pm 1$ digit $\pm .01$ pF	$\pm 2\% \pm 1$ digit $\pm .01$ pF
G	Basic accuracy	$\pm 1\% \pm 10$ digits	$\pm 3\% \pm 10$ digits	
D	Basic accuracy	$\pm 1\% \pm (10 + C_s/C_x)$ digits	$\pm 3\% \pm (10 + C_s/C_x)$ digits	

Outputs: 4 line BCD.

Inputs

Trigger hold off level: level must be between 10 V and 15 V.

Remote programming: eight front-panel functions can be remotely controlled by external contact closure to ground with impedance less than 400 Ω . Programmable functions are RESET, FREQUENCY, RANGE MODE, TEST VOLTAGE, LOSS MEAS, RANGE STEP, DC BIAS, BIAS VERNIER.

Operating temperature: 0°C to 50°C.

Power requirements: 115 or 230 V ac $\pm 10\%$, 50 to 60 Hz, approx 110 W.

Weight: 34 lb (15.5 kg).

Price: \$4825.

IMPEDANCE



RX METER

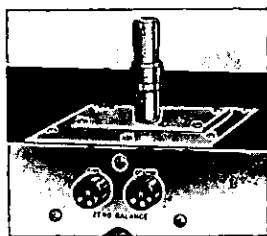
Self-contained rf bridge, 500 kHz to 250 MHz
Model 250B

The HP 250B RX Meter is a completely self-contained instrument for use in measuring the equivalent parallel resistance and capacitance or inductance of two-terminal networks. The instrument's design includes an accurate, continuously tuned oscillator, high-frequency bridge, amplifier-detector and null/RF level indicator.

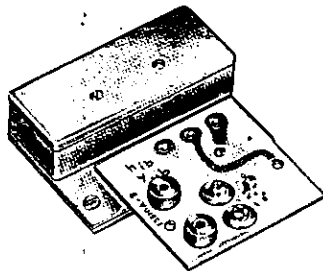
The oscillator, which is carefully designed to minimize temperature effects, is mounted inside a rigid casting in order to obtain a high degree of accuracy, stability and low leakage. A long-life sub-miniature triode is used, and the unit is carefully shielded to avoid any leakage of signal to the amplifier-detector by any path other than through the

bridge. The high-frequency bridge is also mounted inside a casting and is specially designed to minimize the effects of coupling between arms.

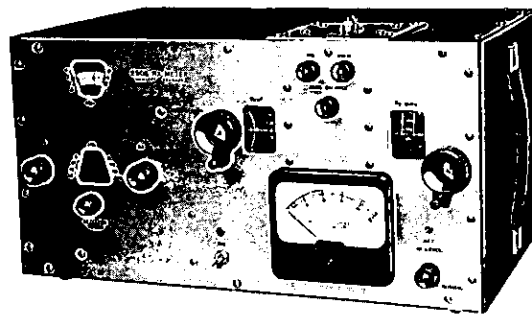
Connections to the unknown impedance are arranged for almost zero lead length. Convenient, easily adjusted bridge balance controls are provided on the front panel. Controls are also provided for adjustment and indication of the relative RF signal level at the test terminals. A connector on the rear panel provides an IF output for a sensitive tuned voltmeter for improved resolution when nulling during reduced signal level operation.



00515A



13510A



250B

Specifications

Radio frequency characteristics

RF range: total range: 500 kHz to 250 MHz; number bands: 8; band ranges: 0.5 to 1 MHz, 1 to 2 MHz, 2 to 4 MHz, 4 to 9 MHz, 9 to 21 MHz, 21 to 48 MHz, 48 to 110 MHz, 110 to 250 MHz.

RF accuracy: $\pm 2\%$.

RF calibration: increments of approximately 1%.

Resistance measurement characteristics

Resistance range: 15 to 100,000 ohms.

Resistance accuracy: $\pm \left[2 + \frac{F}{200} + \frac{R}{5000} + \frac{Q}{20} \right] \%$
 ± 0.2 ohm; F = frequency (MHz), R = RX Meter R_p reading (ohms), $Q = \omega CR \times 10^{-12}$, where C = RX Meter C_p reading (pF).

Resistance calibration: increments of approximately 3% throughout most of range.

Capacitance measurement characteristics

Capacitance range: 0 to 20 pF (may be extended through use of auxiliary coils).

Capacitance accuracy: $\pm (0.5 + 0.5 F^2 C \times 10^{-5}) \%$
 ± 0.15 pF; F = frequency (MHz), C = RX Meter C_p reading (pF).

Capacitor calibration: 0.1 pF increments.

Inductance measurement characteristics

Inductance range: 0.001 μ h to 100 mh (actual range depends upon frequency; auxiliary resistors employed).

Inductance accuracy: basic accuracy is capacitance accuracy given above.

Measurement voltage level

RF: 0.05 to 0.75 V approx, depending on frequency, with SET RF LEVEL control in NORMAL position. RF level adjustable to below 20 mV; relative level indicated when SET RF LEVEL switch is depressed.

DC: 0 V; (external dc current up to a 50 mA, may be passed through RX meter terminals).

Accessories available: 00515A Coax Adapter Kit (designed to permit connection to the RX meter bridge circuit of any coaxial transmission line or fixture fitted with a Type "N" male connector), \$50; 13510A Transistor Test Jig (provides a convenient means for measuring Y parameters Y_{11b} , Y_{11e} , and Y_{22e} of transistors on the RX meter over the frequency range of 500 kHz to 250 MHz), \$195.

Physical characteristics

Dimensions: 20" wide, 10 $\frac{3}{8}$ " high, 13 $\frac{1}{2}$ " deep (508 x 264 x 343 mm).

Weight: net 40 lbs (18 kg); shipping 50 lbs (22.5 kg).

Power: 105 to 125 volts or 210 to 250 volts, 50 to 400 Hz, 60 watts.

Price: HP 250B, \$2050.

Q METER, INDUCTORS

Direct Q measurements, 20 to 260 MHz
Models 190A, 00590A



IMPEDANCE

190A Q Meter

The HP 190A Q Meter finds applications similar to those described for the 260A Q Meter (page 259), but in the VHF range of frequencies. This instrument does not have a thermocouple, but employs a special coupling impedance to introduce voltage across the series-tuned, resonant circuit. This voltage, as well as the reactive voltage developed across the internal Q capacitor, is measured by two high-impedance, low input capacitance vacuum tube voltmeters and indicated on a single front-panel parallax-free meter.

Specifications, 190A

Radio frequency characteristics

RF range: total range: 20 to 260 MHz; number bands: 4; band ranges: 20 to 40 MHz, 40 to 80 MHz, 80 to 160 MHz, 160 to 260 MHz.

RF accuracy: $\pm 1\%$.

RF calibration: increments of approximately 1%.

Q measurement characteristics

Q range: total range: 5 to 1200; low range: 10 to 100; Δ range: 0 to 100.

Q accuracy: $\pm 7\%$ 20 to 100 MHz; $\pm 15\%$ 100 to 260 MHz (for circuit Q of 400 read directly on indicating meter).

Q calibration: main scale: increments of 10 from 50 to 400; low scale: increments of 2 from 10 to 100; Δ scale: increments of 2 from 0 to 100; XQ scale: increments of 0.1 from 0.5 to 1.5, increments of 0.5 from 1.5 to 3.

Resonating capacitor characteristics

Capacitor range: 7.5 to 100 pF.

Capacitor accuracy: ± 0.2 pF, 7.5 to 20 pF; ± 0.3 pF, 20 to 50 pF; ± 0.5 pF, 50 to 100 pF.

Capacitor calibration: 0.1 pF increments.

Accessories available: 00590A Inductors.

Physical characteristics

Dimensions: 14 $\frac{1}{4}$ " wide, 10 $\frac{1}{8}$ " high, 10 $\frac{1}{2}$ " deep (362 x 257 x 267 mm).

Weight: net 25 lbs (11,3 kg); shipping 32 lbs (14,4 kg).

Power: 190A: 95 to 130 volts, 60 Hz, 55 watts; 190 AP: 115/230 volts, 50 Hz, 55 watts.

Price: HP 190A, AP, \$1475.

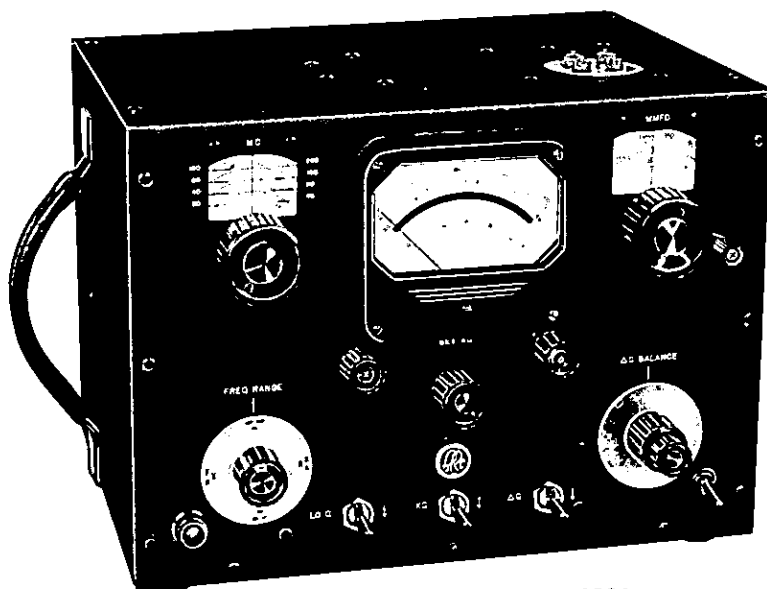
00590A Inductors

HP 00590A Inductors are designed specifically for use in the Q Circuit of the 190A Q Meter for measuring the radio-frequency characteristics of capacitors, resistors, and insulating materials. They have general usefulness as reference coils and may be used for periodic checks to indicate any considerable change in the performance of the Q meters.

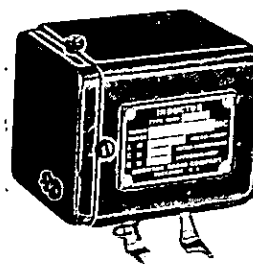
Specifications, 00590A

HP model	Inductance μ H	Capacitance pF	Approx. resonant freq. MHz	Approx. Q	Approx. distributed C pF
00590-A1	0.05	95-7.5	70-230	350	1.5
00590-A2	0.1	95-7.5	50-160	320	1.7
00590-A3	0.25	100-7.5	30-100	380	2.3
00590-A4	0.5	80-7.5	25-70	360	2.3
00590-A5	1.0	60-7.5	20-50	350	2.9
00590-A6	2.5	15-8.0	20-30	330	2.9

Price: HP 00590A, \$25 each; HP 00591A, complete set of six \$130.



190A



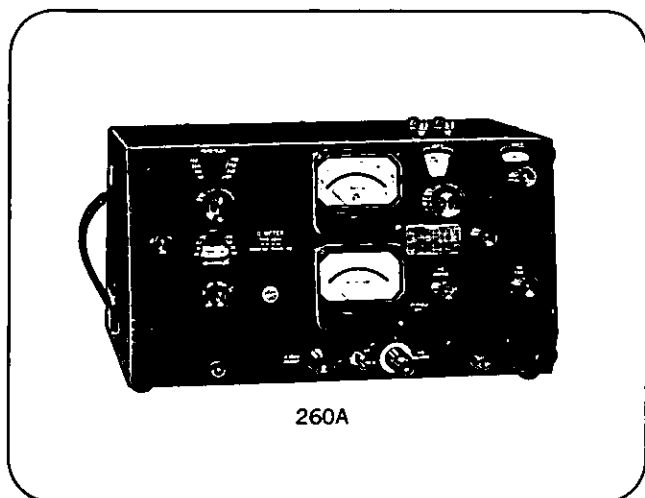
00590A



Q METER

Expanded scale for Q measurements

Model 260A



The direct-reading expanded scale of the HP 260A Q Meter permits measurement of Q down to 10 and also permits reading of very small changes in Q resulting from the variation of the test parameter.

The Q meter was first designed and introduced as a means of measuring the Q or "figure of merit" of coils. Improved models and broadened applications have kept pace with new measuring needs, and today the Q meter is recognized as a flexible general-purpose device with a large number of uses.

Circuit technique

The Q meter consists of a self-contained, continuously variable, stable oscillator, whose controlled and measured output is applied in series with a series-tuned, resonant circuit. A vacuum tube voltmeter with high input impedance is connected across the internal variable capacitor portion of the tuned circuit to measure the reactive voltage in terms of circuit Q. The coil portion of the tuned circuit is connected externally and represents the unknown to be measured. By inserting low impedances in series with the coil or high impedances in parallel with the capacitor, the parameters of unknown circuits or components can be measured in terms of their effect on the circuit Q and resonant frequency.

Usefulness, special features of the 260A

The 260A is typical of these instruments. It is useful for direct reading of circuit Q on its parallax-free meter. From such measurements, the distributed capacitance, effective inductance and self-resonant frequency can be determined. On capacitors, capacitance from 0.1 pF to 100 μ F and Q from 10 to 10,000 can be evaluated from measurements made with and without the component connected. Capacitor self-resonant frequency also can be determined.

Effective RF resistance, inductance or capacitance, and Q of resistors also may be determined, and, used on IF and RF transformers, the 260A will measure effective impedance, Q, coefficient of coupling, mutual inductance and frequency response. The Q meter also is useful for making measurements of dielectric constant and dissipation factor on insulating materials.

The HP 260A utilizes a rugged thermocouple operating at half rated power; oscillator output is factory-adjusted to avoid overload. Both these features guard against accidental thermocouple overload. Through the use of an internal regulating transformer and an electronically regulated power supply, the operation of the instrument is not affected by normal power line fluctuations.

Teflon insulation has been provided for 260A terminals, providing mechanical stability and low electrical loss. The oscillator output is controlled by varying the screen grid voltage of the oscillator tube to obtain smooth operation, as well as good waveshape. A 0.02-ohm annular insertion resistor is used to improve 260A accuracy. Provision is made for use of an external oscillator to supply the Q meter through a matching transformer (HP 00564A) to provide operation below 50 kHz down to 1000 Hz. A scale also is provided to read inductance directly at selected frequencies.

Specifications

Radio frequency characteristics

RF range: total range: 50 kHz to 50 MHz, 1 kHz to 50 kHz (with external oscillator); number bands: 8; band ranges: 50 to 120 kHz, 120 to 300 kHz, 300 to 700 kHz, 700 to 1700 kHz, 1.7 to 4.2 MHz, 4.2 to 10 MHz, 10 to 23 MHz, 23 to 50 MHz.

RF accuracy: $\pm 2\%$.

RF calibration: increments of approximately 1%.

Q measurement characteristics

Q range: total range: 10 to 625; low range: 10 to 60; Δ range: 0 to 50.

Q accuracy: $\pm 5\%$, 50 kHz to 30 MHz; $\pm 10\%$, 30 MHz to 50 MHz (for circuit Q of 250 read directly on indicating meter).

Q calibration: main scale: increments of 5 from 40 to 250; low scale: increments of 1 from 10 to 60; Δ scale: increments of 1 from 0 to 50; XQ scale: increments of 0.1 from 1 to 1.5 and increments of 0.5 from 1.5 to 2.5.

Inductance measurement characteristics

L range: 0.09 μ H to 130 mH, (effective inductance), direct reading at six specific frequencies.

L accuracy: $\pm 3\%$ (for resonating capacitance > 100 pF and inductance > 5 μ H).

Resonating capacitor characteristics

Capacitor range: main: 30 to 460 pF; vernier: -3 to $+3$ pF.

Capacitor accuracy: main: $\pm 1\%$ or 1 pF, whichever is greater; vernier: ± 0.1 pF.

Capacitor calibration: main: 1 pF increments 30 to 100 pF, 5 pF increments 100 to 460 pF; vernier: 0.1 pF increments.

Physical characteristics

Mounting: sloping front cabinet, for bench use.

Finish: gray wrinkle, engraved panel (other finishes available on special order).

Dimensions: 21 $\frac{1}{4}$ " wide, 11 $\frac{3}{4}$ " high, 10" deep (540 x 298 x 254 mm).

Weight: net 40 lbs (18 kg); shipping 55 lbs (24.8 kg).

Power: 260A: 95 to 130 V, 60 Hz, 65 W; 260AP: 95 to 130 V, 50 Hz, 65 W.

Accessories available: 00103A Inductors, 00513/00518A Q Standards, 00564A Coupling Unit.

Price: HP 260A, AP, \$1350.

Q METER ACCESSORIES

Q standards, inductors, coupling transformer
Models 00513A, 00518A, 00103A, 00564A



IMPEDANCE

00103A Inductors

The HP 00103A Inductors are designed specifically for use in the Q circuit of the 160A and 260A Q Meters, for measuring the RF characteristics of capacitors, insulating materials, resistors, etc. Price: HP 00103A, \$25 each; HP 00127A, set of 16 inductors for 260A, \$360; HP 00128A, set of 17 inductors for 160A, \$380.

Specifications, 00103A

HP model	Inductance	Approx. resonant frequency for tuning capacitance of:			Approx. Q	Capacitance pF
		400 pF	100 pF	50 pF		
00103-A1	1 μ H	8	16	20 MHz	180	6
00103-A2	2.5 μ H	5	10	14 MHz	200	6
00103-A5	5 μ H	3.5	7	10 MHz	200	6
00103-A11	10 μ H	2.5	5	7 MHz	200	6
00103-A12	25 μ H	1.5	3	4.5 MHz	200	6
00103-A15	50 μ H	1.1	2.2	3 MHz	200	6
00103-A21	100 μ H	800	1600	2000 kHz	200	6
00103-A22	250 μ H	500	1000	1400 kHz	200	6
00103-A25	500 μ H	350	700	1000 kHz	170	7
00103-A31	1 mH	250	500	700 kHz	170	7
00103-A32	2.5 mH	150	300	450 kHz	170	8
00103-A35	5 mH	110	220	300 kHz	160	8
00103-A41	10 mH	80	160	200 kHz	140	9
00103-A42	25 mH	50	100	140 kHz	110	9
		100 pF	35 pF			
00103-A50	0.5 μ H	20 MHz	35 MHz	225	5.5	
00103-A51	0.25 μ H	30 MHz	50 MHz	225	5.5	
00103-A52	0.1 μ H	45 MHz	75 MHz	225	3.5	

00513A Q Standards

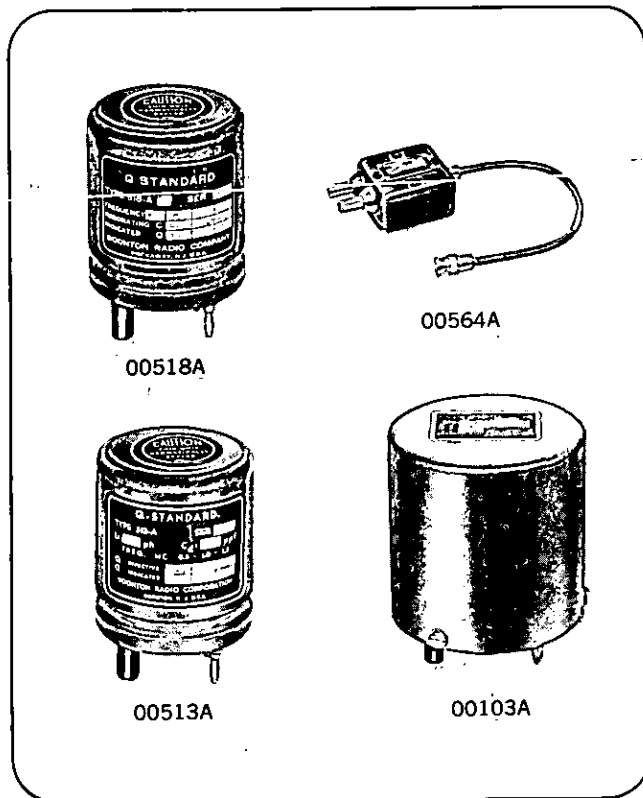
HP 00513A Q Standards are shielded reference inductors which have accurately measured and highly stable inductance and Q characteristics. Specifically designed for use with the 160A and 260A Q Meters, the Q standards are particularly useful as a means for checking the overall operation and accuracy of these instruments, as well as for providing precisely known supplementary Q circuit inductance desirable for many impedance measurements by the parallel method. Price: HP 00513A, \$125 each.

Nominal values for HP 00513A			
L-250 μ H		Cd-8 pF	
	0.5 MHz	1 MHz	1.5 MHz
Q_e	190	250	220
Q_i	183	234	200

* Actual values of all these quantities are marked on the name plate of the Q standard; with the unit in the Q circuit, approximate resonant frequencies of 500, 1000 and 1500 kHz are obtained with tuning capacitances of 400, 100 and 50 pF, respectively.

00518A Q Standards

HP 00518A Q Standards, used in conjunction with the 00513A Q Standards, provide frequency coverage from 50 kHz to 50 MHz—the entire range of the 260A Q Meter. These units are useful as precision inductors and as a fast, convenient means for checking the overall operating accuracy of Q meters. Price:



HP 00518A, \$125 each; HP 00538A, set of five 00518A and one 00513A, \$675.

Specifications, 00518A

HP model	00518-A1	00518-A2	00518-A3	00518-A4	00518-A5
Inductance	0.25 μ H	2.5 μ H	25 μ H	2.5 mH	25 mH
Low freq. data:					
Frequency	15 MHz	5 MHz	1.5 MHz	150 kHz	50 kHz
Resonating C	420 pF	395 pF	440 pF	440 pF	400 pF
Indicated Q	175	195	175	170	90
Middle-freq. data:					
Frequency	30 MHz	10 MHz	3 MHz	300 kHz	100 kHz
Resonating C	100 pF	95 pF	105 pF	100 pF	85 pF
Indicated Q	235	235	225	180	130
High-freq. data:					
Frequency	45 MHz	15 MHz	4.5 MHz	450 kHz	150 kHz
Resonating C	40 pF	40 pF	45 pF	40 pF	35 pF
Indicated Q	225	205	230	135	125

(Table shows nominal values)

00564A Coupling Transformer

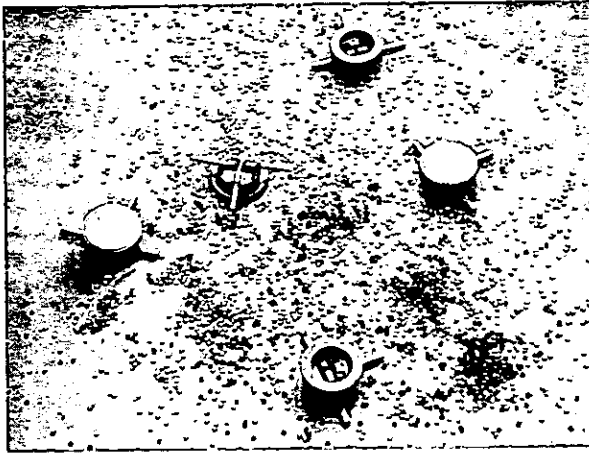
The 00564A Coupling Transformer Unit is designed to couple the output of an external oscillator into the 160A or 260A Q Meter for the purpose of extending the operation range of the Q meter to the low-frequency region. By means of the coupling unit and an auxiliary oscillator, the Q meter may be operated down to a low-frequency limit of 1 kHz. The oscillator should supply a variable voltage of 22 volts maximum into an impedance of 500 ohms. Price: HP 00564A, \$50.

MICROWAVE SOLID STATE DEVICES



MICROWAVE TRANSISTORS

Models 35800-35807



- TYPICAL f_{max} TO 7 GHz
- POWER HANDLING TO 200 mW
- HERMETIC PACKAGE OR CHIPS
- ACCURATE CHARACTERIZATION
- UNIFORM PERFORMANCE

Description

Models 35803B/E, 35804B/E, 35805B/E, 35806B/E. This family of microwave transistors offers the ultimate performance for stripline applications to 7 GHz. All devices in the family are hermetically sealed in a rugged metal-ceramic package that is optimum for stripline circuitry. The alpha suffix on the model number denotes whether the base or emitter of the transistor is common with the conductive disc on one face of the package. The common base versions are ideal for oscillator service, the common emitter for amplifier use. All devices are available with optional S parameter characterization versus frequency and operating point.

Models 35800A, 35801A, 35802A and 35807A. These devices make up a family of high performance, fully speci-

fied microwave transistor *chips*. Unpackaged transistors, or chips, are of increasing importance as microwave integrated circuits become attractive replacements for the functions traditionally satisfied by short lived expensive microwave tubes. The 35800, 35801, and 35802 are attractive devices for these microwave integrated circuit applications not only because they are accurately characterized by their S parameters and are available with guaranteed microwave characteristics. A unique test method allows accurate, nondestructive testing of each and every chip so that uniform circuit performance is assured. Moreover, each device can be supplied, at additional charge, with its own individual test data to simplify the design phase of a microwave integrated circuit.

Specifications

Model	Package	BV_{CEO} (VOLTS)	h_{FE}	f_{max} (GHz)	f_t (GHz) (typical)	G_{max} dB @ (1 GHz) (typical)	P_{out} (1 dB Gain Comp) (typical)		P_{out} (Oscillator) (typical)	
35800A	Chip	>15	>20	6.5	4.0	14.0	20 mW	2 GHz	20 mW	4 GHz
35801A	Chip	>15	>20	4.3	3.5	10.0	100 mW	1 GHz	100 mW	3 GHz
35802A	Chip	>20	>20	3.0	3.0	7.0	175 mW	1 GHz	200 mW	2 GHz
35803B/E	Metal/ceramic	>15	>20	6.0	4.0	14.0	20 mW	2 GHz	40 mW	4 GHz
35804B/E	Metal/ceramic	>15	>20	4.3	3.5	10.0	100 mW	1 GHz	100 mW	3 GHz
35805B/E	Metal/ceramic	>20	>20	3.0	2.0	7.0	175 mW	1 GHz	200 mW	2 GHz
35806B/E	Metal/ceramic	>15	>20	6.5	4.0	15.0	20 mW	2 GHz	20 mW	4 GHz
35807A	Chip	>15	>20	6.0	4.0	15.0	20 mW	2 GHz	40 mW	4 GHz

For more information please see our Solid State Devices catalog or call your local Hewlett-Packard office for data

sheets with complete specifications.

AMPLIFIERS, OSCILLATORS



**MICROWAVE SOLID
STATE DEVICES**

Microcircuit Amplifiers

VHF Pre/Power Amplifiers, Models 35000A/35001A

- 0.1 - 100 MHz Bandwidth
- PreAmp with >30 dB Gain, 3 mW Maximum Output
- Power Amp with >20 dB Gain, 80 mW Maximum Output
- Flat Gain, Low Distortion



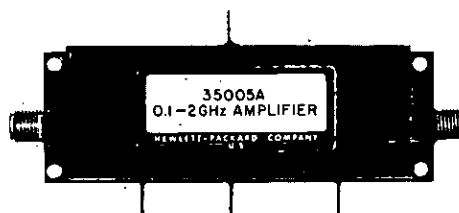
35000A



35001A

Low Noise VHF Pre-Amplifier, Model 35002A

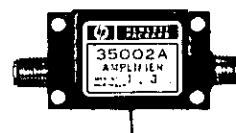
- 0.1 - 400 MHz Bandwidth
- Flat Gain: 20 ± 0.5 dB
- Low Noise Figure: <5 dB
- Low Distortion: Harmonics Typically 40 dB Down at 1 mW Output
- Options with Extended Frequency Range Available (Ex: 17 dB Min. Gain at 650 MHz)



35005A

Ultra Broadband Microwave Amplifier, Model 35002A

- Cover VHF, UHF, L Band With One 0.1 - 2.0 GHz Amplifier
- High Gain: >40 dB
- High Output: >20 mW
- Low Distortion: Harmonics >30 dB Down at +10 dBm Out

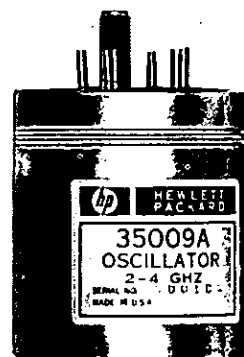


35002A

Microcircuit Oscillators

S Band, YIG Tuned Oscillator, Model 35009A

- Linear Tuning, 2.0 - 4.0 GHz
- High, Flat Output: >10 mW, ± 1.5 dB
- Good Load Immunity: $\Delta f \leq \pm 0.75\%$ For Any Load
- Linear FM: dc - 100 KHz, Deviations to >10 MHz
- Good Spectral Purity
- Built In Magnetic Shielding



35009A

For more information please call your local Hewlett-Packard office for a data sheet with complete specifications.

MICROWAVE SOLID STATE DEVICES



SWITCHES, LIMITERS, MODULATORS, ATTENUATORS

SPST Switches

Low Cost, Broadband 33100 Series

- Cover 0.1 - 18 GHz With A Single Switch
- On-Off Ratios To 80 dB
- Volume Prices From Under \$100
- Solid State For Speed, Reliability

High Performance, Octave Band 33600 Series

- Models For Bands From 1 - 18 GHz
- Low VSWR; Insertion Loss
- Isolation To 80 dB
- Broad Choice of Connectors: SMA, TNC, N, BNC
- Solid State For Speed, Reliability

Other SPST Switch Families

- High Performance, Broadband Series, 0.2 - 18 GHz
- Stripline and Coax Modules, 0.1 - 18 GHz

SPDT Switches

High Performance, Broadband Model 33006A

- One Switch For 0.1 - 18 GHz Range
- Low Insertion Loss: 1.5 dB to 8 GHz, 3 dB to 18 GHz
- High Isolation: 60 dB to 8 GHz, 50 dB to 18 GHz
- Solid State
- Also Available For Stripline Applications, 33007A

Precision Electromechanical Models 8761A,B

- Broadband: dc - 18 GHz
- Less Than 0.8 dB Loss to 18 GHz
- VSWR Less Than 1.3:1 to 18 GHz
- Choice of Any Combination of SMA, N, or 7 mm Connectors
- Available With Built-on Termination

Limiters

Broadband Model 33711A

- 0.4 - 12.4 GHz
- High Power: Safely Handles 75 Watt Peak, 1 Watt Average
- +10 dBm Limiting Threshold
- Also Available Without Connectors, 33701A

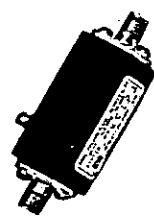
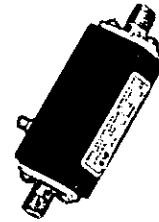
Attenuators

Flat, Low VSWR Model 33900A

- dc - 18 GHz
- 3, 6, 10, 20, or 30 dB Attenuations
- Volume Prices From Under \$50.00

For more information please call your local Hewlett-Packard office for a data sheet with complete specifications.

①



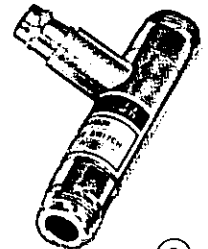
②

①

①

①

③



④

②

②

⑤



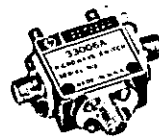
③

③

③

③

④

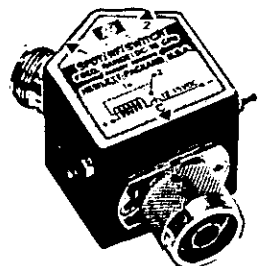
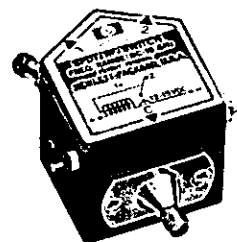


④



⑤

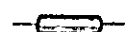
⑥



⑦

⑤

⑤



⑥

⑥

⑦

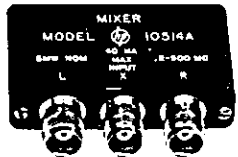
MIXERS, DETECTORS FREQUENCY MULTIPLIER



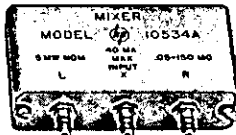
MICROWAVE SOLID STATE DEVICES



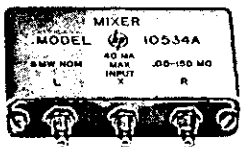
8



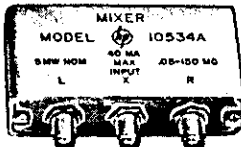
9



9



9



9



9



9



10



10



11



11



12



12

Modulators

8 Models 33000, 33001, 33008C/D

- Covering Greater Than Octave Bands, 1 - 18 GHz
- On Off Ratios To 80 dB
- Matched At All Attenuations

Mixers

9 Double Balanced Models to 500 MHz

- Model 10514: 0.2 - 500 MHz
- Model 10534: 0.05 - 150 MHz
- Both Models Available in Three Package Styles (A,B,C)
- Both Feature Low Conversion Loss, Good Balance, require only +7 dBm Local Oscillator Power

10 Microwave Models 33801, 33802, 33803A/B

- Broadband: 2 - 12.4 GHz
- Low Noise Figure, 8.5 dB to 12.4 GHz
- Well Matched: VSWR < 2.5:1 to 12.4 GHz
- Choice of Output Polarity, Matched Pairs Available
- Also Available as Microwave Detector

Detectors

11 Burn Out Protected X - Band Model 33820A/B

- Built In Limiter Protects Detector to 100 Watts Peak
- Covers 7 - 11 GHz Band
- High Sensitivity: -54 dBm TSS @ 10 GHz
- Small, Light, Rugged

Frequency Multipliers

12 Comb Generator Models 33002-5A/B

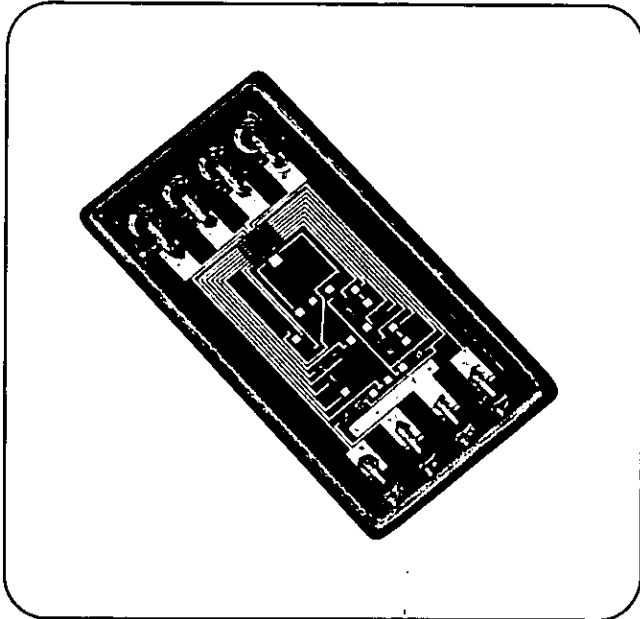
- Four Models Optimized For 100, 250, 500, or 1000 MHz Input
- Flat Spectra Extending to 12.4 GHz
- High Efficiency at 0.5 Watt Input Level
- Well Matched at Input Port at 0.5 Watt Level
- Available With or Without Connectors

For more information please call your local Hewlett-Packard office for a data sheet with complete specifications.



Solid state numeric displays

For information display where space and reliability are critical considerations. Combines advantages of very small size and brightness adequate for full daylight viewing. Switching logic circuit integral with display module. HP 5082-7000/7001. Also available installed in mounting hardware.



5082-7000 Series

PIN Diodes. For modulating and switching microwave signals. High voltage, high speed, low intermodulation products. Surface-passivated for improved stability and reliability. MIL spec. Wide package option. HP 5082-3000 series.

Digital & RF products

Hot Carrier Diodes. Extremely fast turn-on, turn-off times. Excellent forward and reverse characteristics. Especially useful for RF mixer/detector applications. Matched pairs and quads. New low prices.

Step Recovery Diodes. X and Ku-band SRD's offering very fast transition times, low reverse bias capacitance, low thermal resistance, and high breakdown voltage. Prices are low. Ideal applications include: comb generators, frequency multipliers, local oscillators and low-power transmitters. Highly reliable performance in a variety of standard packages.

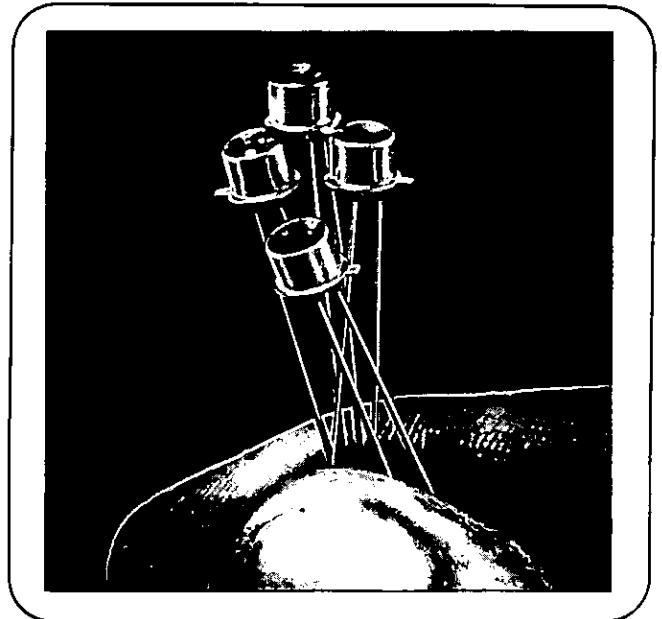
New, Low-cost, Hot Carrier Diode. 100 picosecond switching time. 70-volt breakdown. Low turn-on voltage at 410 mV at 1 mA. Ideal for subnanosecond switching and sampling applications. Has silicon temperature capabilities and turn-on equal to germanium. 55c in 1000 quantities.

Ministrips, lids, beamleads, chips

Most of our conventional diode types are available now as chips or in ministrip, beamlead or LID configurations.

Optoelectronic devices

Solid State Visible Light Source. Compatible with integrated circuits. GaAs phosphide diodes offer long life, shock and vibration resistance. Free from catastrophic failure. Use it anywhere you need high reliability, small size, low drive power and long life.



5082-4200 Series

PIN Photodiodes. Ultrafast light detectors for visible and near-infrared radiation. Unusually good response to blue and violet. Excellent dynamic range. Low noise. HP 5082-4200 series.

GaAs Infrared Sources. Radiates high-intensity, narrow band, infrared light. Well suited for use in card and tape readers, encoders and similar applications. HP 5082-4100 series.

Photon Coupled Isolators. A wide bandwidth DC coupling device combining a GaAs emitter and silicon PIN photodiode. Small, light-weight, rugged, and about half the price of electromagnetic transformers. Isolation up to 200 V dc. HP 5082-4300 series.

Want more information?

Complete, detailed, product literature, application information and prices are as near as your phone. Call any Hewlett-Packard sales office for information or assistance. Or . . . write or call Hewlett-Packard, 620 Page Mill Road, Palo Alto, California 94304; (415) 321-8510.

. . . Ask for our catalog of solid state devices.



Pulse and square wave generators are most often used with an oscilloscope as the measuring device. Waveform shapes as seen by the oscilloscope, either at the output or at pertinent points within a system under test, provide both qualitative and quantitative evaluations of system or device performance.

Square waves or pulses

The fundamental difference between pulse and square wave generators concerns the signal duty cycle. Square wave generators have equal "on" and "off" periods, this equality being retained as the repetition frequency is varied. The duration of a pulse generator "on" period, on the other hand, is independent of pulse repetition rate. The duty cycle of a pulse generator can be made quite low so that these instruments are generally able to supply more power during the "on" period than square wave generators. The HP Model 214A, for instance, supplies up to 200 watts in its output pulse.

Short pulses reduce power dissipation in the component or system under test. For example, measurements of transistor gain are made with pulses short enough to prevent junction heating and the consequent effect of heat on transistor gain.

Square wave generators are used where the low-frequency characteristics of a system are important, such as in the testing of audio systems. Square waves also are preferable to short pulses if the transient response of a system requires some time to settle down.

Pulse generators

In the selection of a pulse generator, the quality of the output pulse is of primary importance. High-quality test pulses

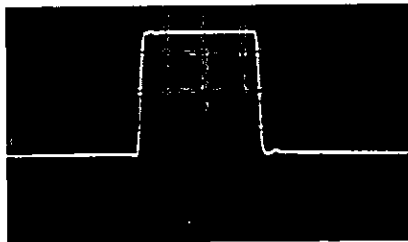


Figure 1. Carefully controlled pulse shapes insure accurate measurements.

insure that degradation of the displayed pulse may be attributed to the test circuit alone.

The pertinent characteristics of a test pulse, shown in Figure 2, are controlled and specified accurately in Hewlett-Packard pulse generators. Rise and fall times should be significantly faster than the circuits or systems to be tested.

Variable risetime and falltime, available in HP 1900 pulse system, HP Model 8002A, and HP Model 8005A, are useful for testing over a wide range of operating conditions.

Any overshoot, ringing and sag in the test pulse should be known, so as not to be confused with similar phenomena caused by the test circuit.

The range of pulse width control should be broad enough to fully explore the range of operation of a circuit. Narrow pulse widths are useful in determining the minimum trigger energy required by some circuits.

Maximum pulse amplitude is of prime concern if appreciable input power is required by the tested circuit, such as a magnetic core memory. At the same time, the attenuation range should be broad enough to prevent overdriving the test circuits, as well as to simulate actual circuit operating conditions.

The range of pulse repetition rates is of concern if the tested circuits can operate only within a certain range of pulse rates, or if a variation in the rate is needed. The HP Model 216A is capable of rep rates to 100 MHz for testing fast circuits and has a pulse burst feature which allows trains of pulses rather than a continuous output to be used to check systems more thoroughly.

Triggering

The trigger requirements for synchronizing a pulse generator should be evaluated in light of the triggers available in anticipated measurement set-ups. Most Hewlett-Packard pulse generators have versatile trigger circuits similar to oscilloscopes. These circuits synchronize on most waveforms of more than 1 V amplitude.

Hewlett-Packard pulse generators also supply fast rise output triggers for operation of external equipment. The output triggers may be timed to occur either before or after the main output pulse.

Source impedance

Generator source impedance is an important consideration in fast pulse systems. This is because a generator which has a source impedance matched to the connecting cable will absorb reflections resulting from impedance mismatches in the external system. Without this match, reflections would be re-reflected by the generator, resulting in spurious pulses or perturbations on the main pulse.

DC coupling of the output circuit is necessary when retention of dc bias levels in the test circuit is desired in spite of

variations in pulse width, pulse amplitude, or repetition rate.

Applications of pulse and square wave generators

Pulse generators with fast risetimes are widely used in the development of digital circuits. Teamed with a fast oscilloscope, these generators enable evaluation of transistor and diode switching times.

Variable rise and fall time pulses are invaluable for testing devices whose output changes with rise and fall times, such as magnetic memories. Variable transition time pulses are useful in checking logic circuits where the input signal characteristics must be carefully specified.

Pulse generators are used as modulators for klystrons and other rf sources to obtain high peak power while maintaining low average power.

Pulse generators also are used for impulse testing. A very short pulse is rich in harmonic frequency components, so that impulse testing amounts to simultaneous frequency response testing of components or systems.

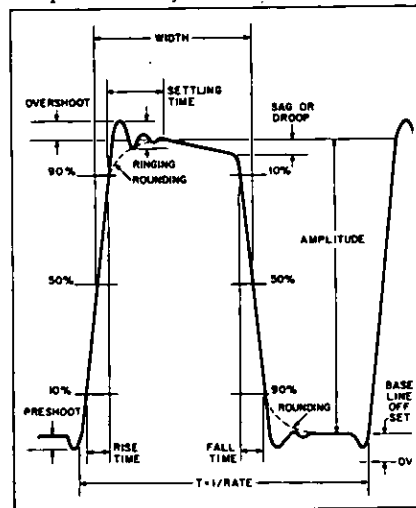


Figure 2. Test pulse description in terms of primary characteristics.

A relatively new application of fast pulse instruments is the testing of transmission lines. Very fast pulse generators (HP Models 213B, 215A, 1105A/1106A and 1920A) used with fast oscilloscopes (HP Model 183A/B) also can measure the stray inductances and capacitances of components.

Tests of linear systems with pulse or square wave generators and oscilloscopes are dynamic tests which quickly analyze system performance.

Hewlett-Packard designs pulse generators with the fast risetimes (fixed or variable), matched source impedance, flexible pulse width and amplitude con-

SIGNAL SOURCES

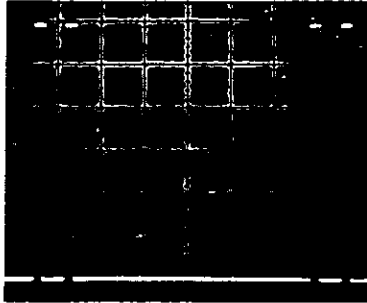


PULSE GENERATOR SELECTION CHART

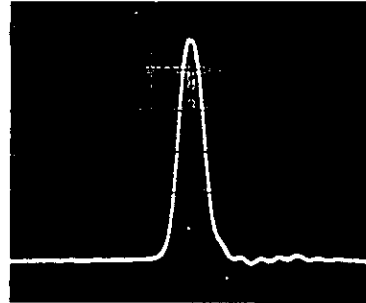
ontrol, and versatile triggering capabilities required by a wide range of measure-

ments. Particular attention has been paid to the quality of the output pulse, with

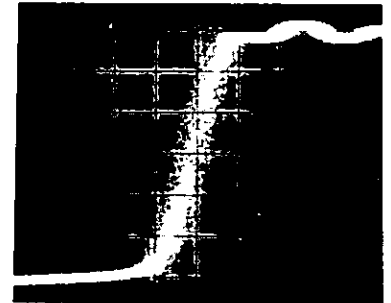
all aspects of pulse shape carefully controlled and specified in detail.



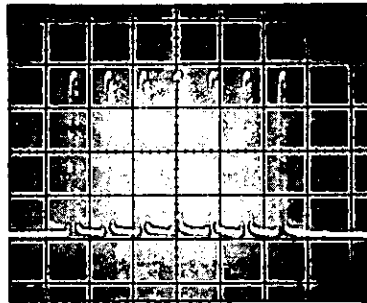
The double pulse is useful for testing memory cores counter circuits and other applications that require a double pulse at a low duty cycle.



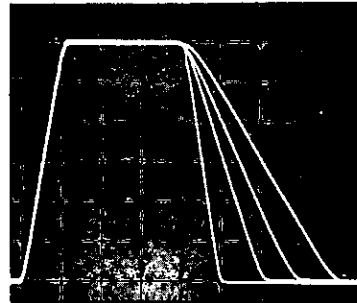
Since the impulse has a wide flat frequency spectrum it is useful in obtaining frequency-domain information.



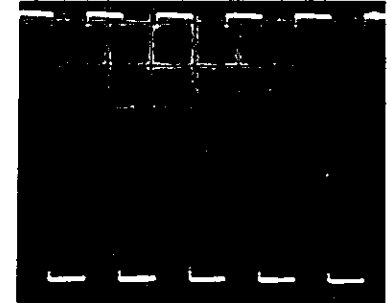
Fast risetime pulses are used as standards to check the risetime of oscilloscopes, amplifiers, and components. Fast step is also used in Time Domain Reflectometry.



Pulse bursts are used to test many types of logic circuits.



Variable rise- and falltimes aid checks over wide range of operating conditions.



The square wave is useful in amplifier testing and calibration, and attenuator checking.

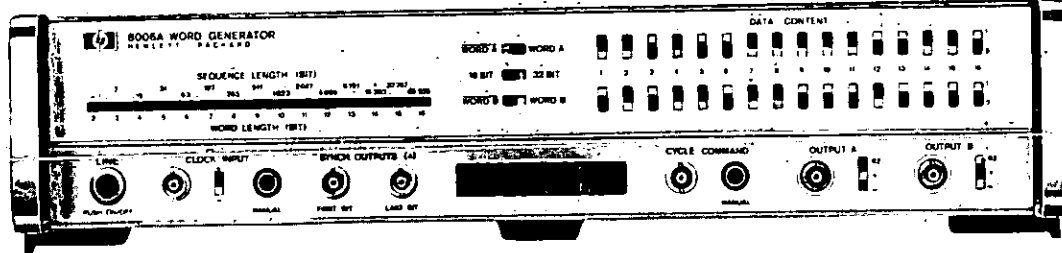
Type	Square Wave			Fast Rise Pulse		General Purpose Pulse									System
	211B	220A 221A	213B	1105A/ 1106A	1105A/ 1108A	214A	215A	216A	222A	8002A	8003A	8004A	8005A	8010A	
Output impedance (ohms)	50/600	50	50	50	50	50	50	50	50	50	50	50	50	50	50/5k
Waits into 50 ohms	-5/ -30	-5/ +5	±0.175	+0.2	+0.2	±100	±10	±10	±10	+5	±5	±5	±5	+5	25/50
Risetime (ns)	5/70	10	0.1	0.02	0.06	15	1	2.5	4	10ns- 2s	5	1	10ns- 2s	10ns- 1s	350 ps 10ms
Max rep rate (MHz)	10/1	10	0.1	0.1	0.1	1	1	100	10	10	10	10	10	10	125
Pulse width	sq	sq	fixed	fixed	fixed	var	var	var	var	var	var	var	var	var	var
Pulse delay						var	var	fixed	var	fixed	fixed	var	var	var	var
Variable rise and fall										•			•	•	•
Double pulse						•						•	•	•	•
Internal gating								•							
External gating						•	•	•	•	•	•	•	•	•	•
Programmable											•				•
Price	\$450	\$225	\$300	\$750	\$375	\$975	\$1975	\$1775	\$690	\$700	\$470	\$720	\$1050	on req	\$1325 and up
Page no.	246	247	248	248	248	250	251	252	253	240	240	242	242	244	254

WORD GENERATOR

Two channel binary waveform generator
Model 8006A



SIGNAL SOURCES



8006A

8006A WORD GENERATOR

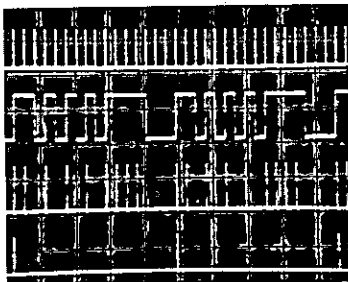
The 8006A Word Generator, combined with an external clock source, is capable of generating variable length, serial digital words at clock rates up to 10 MHz. An easy selection of two 16 bit word sequences is available at your finger tips. A single action combines the two 16 bit words in series to provide a 32 bit word at each output. Selectable operating modes include, positive return-to-zero (RZ) format, positive and negative non-return-to-zero (NRZ) format, manual or automatic word cycling, complementary output signals, and remote programming of the data content. The remote programming feature allows a fast conversion of parallel words to serial words. Synchronous outputs provide trigger pulses coincident with the first and the last bit.

Additionally, a pseudo-random binary sequence variable from 7 to 65535 bits can be obtained from channel A output, with the inverted sequence available at channel B.

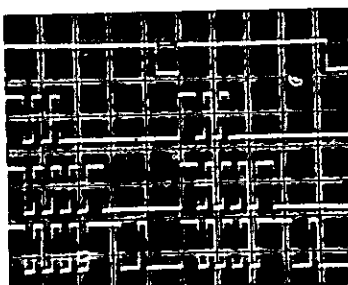
Specifications

Word generation: two 16 bit or one 32 bit word.

Word length: 2 to 16 bit—or 4 to 32 bit (only even number of bits).



1. External clock
2. NRZ Output (16 bit continuous word recycling)
3. RZ Output signal
4. First bit synch pulse



1. Cycle command pulse
2. Single Cycle Mode
3. 6 bit word
4. 11 bit word
5. 16 bit word

Word content: independently set for both words by front panel switches or remote programming (parallel data input). Complement of each word selectable by front panel switches, WORD A - WORD A, WORD B - WORD B.

Word cycling: continuous or by cycle command (external trigger or manual).

Bit rate: manual triggering or external clock up to 10 MHz.

Word format: +NRZ/-NRZ/+RZ selectable for each word output. Positive outputs have a fan-out capability for IC's (TTL) of up to 50.

Synch outputs: trigger pulses corresponding to the first and last bit.

Pseudo-random sequence generation: provides a linear shift register sequence at channel A output and the inverted sequence at channel B output.

Sequence length: variable from 7 to 65535 bits.

Trigger pulse: selectable for each bit in the pseudo-random binary sequence.

Interface:

Clock input:

Repetition rate: 0 to 10 MHz.

Amplitude: $> \pm 1$ V, $< \pm 10$ V.

Width: > 15 ns at ± 1 V.

Input impedance: approx. 500 Ω .

Cycle command input:

Repetition rate: word length plus 100 ns.

Amplitude: $> +1.9$ v, $< +10$ V.

Width: > 15 ns.

Input impedance: approx. 500 Ω .

External data inputs:

Low state: contact closure, saturated DTL or voltage source (TTL) > 0 V, $< +0.8$ V.

High state: open, off DTL or voltage source (TTL) $> +2.4$ V, $< +5$ V.

Synch outputs:

Amplitude: $> +2$ V across 50 Ω .

Width: approx. 40 ns.

Output impedance: 50 Ω .

Words outputs:

Positive NRZ, RZ: true; $+5$ V unterminated.

false; > -0.2 V, $< +0.2$ V.

current sink capability; 80 mA maximum.

RZ pulse width: approx. 50 ns.

Negative NRZ: true; -5 V across 50 Ω .

false; 0 V.

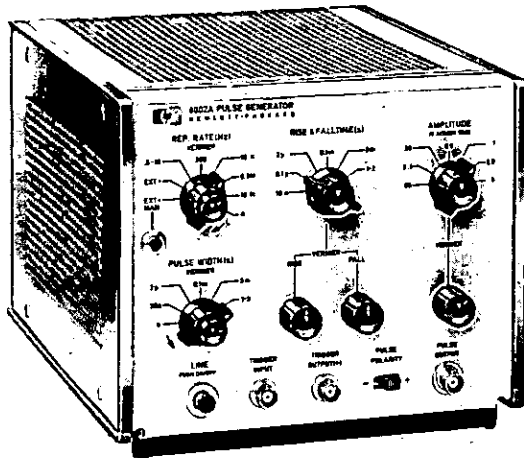
Price: \$825 at factory in West Germany.



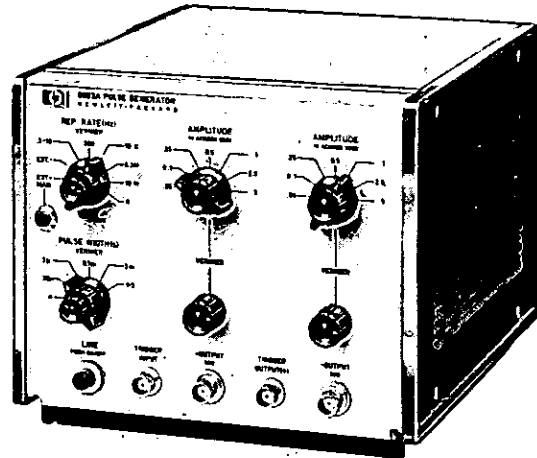


PULSE GENERATORS

Ideal pulsers for general circuit work
Models 8002A, 8003A



8002A



8003A

The Hewlett-Packard 8002A generates pulses with variable rise and fall times over an extremely wide range of repetition rates. These features enable you to test circuits under actual operating conditions rather than conditions dictated by the pulse generator itself. Indeed, in the 8002A you have a high-speed function generator capable of delivering triangular, sawtooth, and trapezoidal shapes as well as pulses and square waves.

Either positive or negative output signals can be selected, giving the pulse generator another degree of flexibility. In addition, the source impedance is a constant 50 Ω for minimum reflections in matched systems. In such systems output amplitude is continuously adjustable from 0.02 to 5 volts with a step attenuator and vernier control. When greater amplitude is required, it can be doubled by switching out the internal 50 Ω terminating resistor (the source impedance then becomes about 300 Ω). In either case the output is protected against damage from a short circuit.

The broad repetition range of the 8002A makes it well suited for driving slow as well as fast circuits. And when the pulses must be synchronized with external signals, the generator can be triggered with sine waves or pulses of either polarity. The 8002A also generates a trigger of its own. This trigger has an amplitude of at least 2 volts and precedes the output pulse by 180 ns. This delay is essential for viewing the pulses on most sampling oscilloscopes. Should this delay be excessive, it can be reduced to about 35 ns by switching out the internal delay line.

A synchronous gating mode is also available. In this mode

the generator is "on" for the duration of the gating signal, producing signals with the repetition rate, rise and fall times, etc. selected on the front panel. The first pulse is coincident with the start of the gate; however, the final pulse is always completed even if the gating signal is removed during the time the pulse is on. This mode of operation is extremely useful for testing logic and other circuits requiring pulse trains or bursts.

The 8003A is a highly flexible, general-purpose pulse generator. Except for its fixed rise and fall time of 5 ns, its characteristics are similar to those of the 8002A. The 8003A is well suited for testing analog devices such as wide-band amplifiers, filters, and oscilloscopes. Its ability to generate pulses as narrow as 30 ns at repetition rates up to 10 MHz makes it ideal for fast switching applications.

The combination of fast rise time and long pulse duration means that systems having very broad frequency characteristics also can be tested by these generators. The maximum duty cycle is greater than 90% over most of the repetition range.

Remote programming of repetition rate, pulse width, and amplitude is offered as an option for the 8003A. Contact closure programs the repetition rate, ext. triggering, and pulse width while resistive changes program the vernier adjustments for repetition rate, pulse width, and amplitude. Remote programming makes the 8003A suitable for use in automatic and semi-automatic test systems, saving both time and manpower.

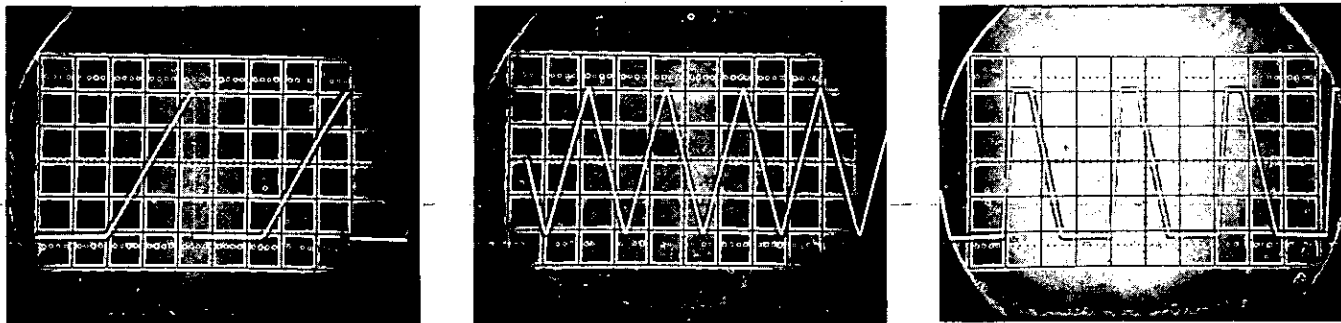


Figure 1. Typical Waveforms produced by the 8002A. Variable Rise and Fall Time Pulse Generator.

Specifications

Source impedance:

8002A: $50\Omega \pm 10\%$ shunted by typically 20 pF at any output voltage.

8003A: $50\Omega \pm 3\%$ shunted by typically 20 pF at any output voltage.

Pulse shape: (measured at 5 V across 50Ω).

Rise and fall time:

8002A: 10 ns to 2 s, 6 ranges, ranges are common for rise and fall times, two verniers for independent control of rise and fall times.

8003A: < 5 ns.

Overshoot and ringing: < 5% of pulse amplitude.

Preshoot: < 5% of pulse amplitude.

Linearity:

8002A: for transition time > 20 ns, maximum amplitude deviation from a straight line between the 10 and 90% points is less than 4% of pulse amplitude.

Maximum output: 5 V across 50Ω , 10 V across an open circuit. Output circuit protected, cannot be damaged by shorting. With internal load disconnected (switch provided); 10 V across 50Ω (rise and fall time < 7 ns for 8003A).

Amplitude: provides 7 steps from 0.05 V to 5 V in a 1, 2.5, 5 sequence (positive and negative output can be set independently on 8003A). Vernier provides continuous adjustment between ranges.

Polarity:

8002A: positive or negative, selectable.

8003A: positive and negative simultaneously within 5 ns.

Pulse width

Range: continuously variable from 30 ns to 3 s in 5 ranges.

Maximum duty cycle: > 90% from 0.3 Hz - 1 MHz.

> 50% from 1 MHz - 10 MHz.

Width jitter: < 0.1% of pulse width at any width setting.

Delay:

8002A: approximately 180 ns fixed delay between trigger and pulse. Internal switch permits removal of delay line, reducing delay to about 35 ns.

8003A: 150 ns fixed delay between Trigger Output and both Pulse Outputs. Slide switch permits switching out the 140 ns delay line.

Internal

Repetition rate: continuously variable from 0.3 Hz to 10 MHz in 5 ranges.

Period jitter: 0.1% of period at any repetition rate setting.

Manual: pushbutton for single pulse.

Triggering

Trigger input: dc coupled. Sine waves, or pulses of either positive or negative polarity, up to 10 MHz.

Sensitivity: sine waves, 2 V p-p minimum.

External pulses: at least 1 V, and at least 15 ns wide.

External trigger delay: approximately 35 ns between leading edge of external input pulse and leading edge of trigger output pulse.

Input impedance: approximately 1 k Ω .

Trigger output pulse (suitable for triggering another Model 8002A or 8003A).

Width: 15 ns \pm 5 ns at 50% amplitude points.

Amplitude: > 2 V across 50Ω .

Polarity: positive.

Synchronous gating: gating signal turns generator "on"; pulse repetition rate, rise and fall time, amplitude, polarity, and width determined by panel control settings; first pulse is coincident with the leading edge of the gate, last pulse is completed even if gate ends during the pulse.

Minimum gating signal: -2 V.

Maximum input: -20 V.

Input impedance: approximately 1 k Ω , dc-coupled.

Power: 115 V or 230 V +10%, -15%. 50 Hz - 400 Hz, 40 W (8002A); 30 W (8003A).

Dimensions: 6-17/32" high, 7-25/32" wide, 11" deep (166 x 190 x 279 mm).

Weight: net 9 lbs (4 kg); shipping 11 lbs (5 kg).

Price:

Model 8002A, \$700.

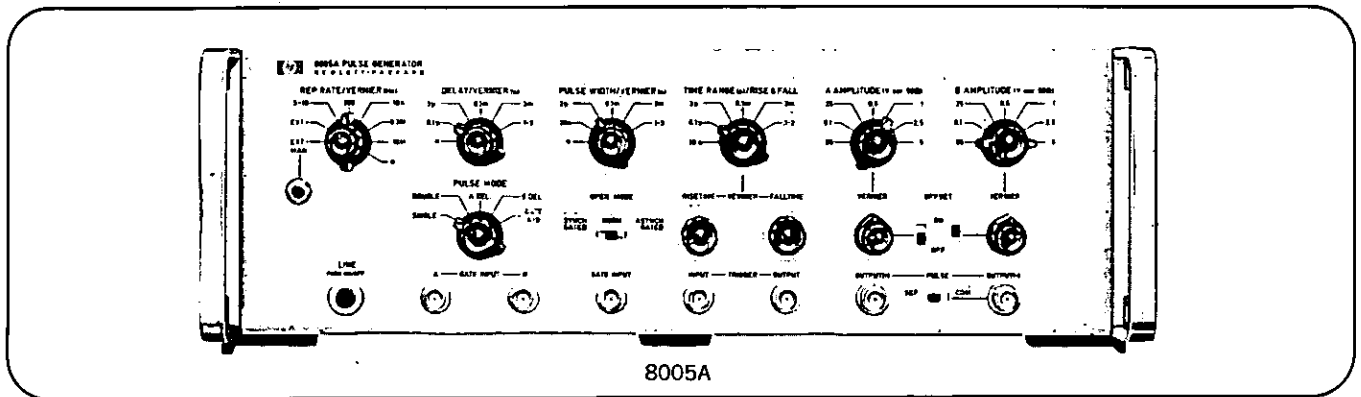
Model 8003A, \$470.

Option 01 (8003A only): remote programming of repetition rate, pulse width, and amplitude. Repetition rate and pulse width programmed by contact closure to ground. Rep rate, pulse width, and amplitude verniers programmed by resistance changes. The amplitude switch is not programmable. Add \$70.00.



PULSE GENERATORS

Complete control of output waveforms
Models 8005A, 8004A



8005A Pulse Generator

With adjustable rise and fall times, variable width and delay features, simultaneous positive and negative outputs that can be combined into a single complex signal, the Model 8005A gives you virtually complete control of the output waveform. Both output amplitudes are separately adjustable and dc offset controls allow independent setting of the baseline. Repetition rate is variable over a wide range, and a double pulse mode effectively increases the maximum repetition rate to 20 MHz.

Versatile gating possibilities further enhance the utility of the 8005A. Pulse trains of various lengths can be generated in the synchronous gating mode turning the instrument on and off. While in the asynchronous mode the repetition rate generator continues to run, so the trigger output is always available. This trigger can then synchronize external gating instruments (e.g. an 8006A Word Generator) which in turn can gate the outputs on and off. Signals of even greater complexity can be generated using the A/B gating mode. Figure 1 illustrates some of the waveshapes and pulse combinations available from the 8005A.

Specifications

Pulse characteristics (50Ω source and load impedance)

Rise and fall time: separate outputs: <10 ns to 2 s in six ranges; ranges are common for rise and fall times; independent verniers provide separate control of rise and fall times within each range with a ratio of 1:30. Common outputs: <12 ns to 2 s.

Linearity: for transition time 30 ns, maximum amplitude deviation from a straight line between 10 and 90% points is 4% of pulse amplitude.

Overshoot and ringing: <5% of pulse amplitude.

Preshoot: <5% of pulse amplitude.

Pulse width: 30 ns to 3 s in five ranges; vernier provides continuous adjustment between ranges.

Maximum duty cycle: >90% for repetition rates from 0.3 Hz to 1 MHz; >50% from 1 to 10 MHz.

Width jitter: <0.1% on any width setting.

Amplitude: 5 V maximum (10 V across an open circuit);

seven-step attenuator reduces output to 0.05 V in 5, 2.5, 1 sequence; vernier provides continuous adjustment between steps and reduces the minimum output to <0.02 V. Turning vernier fully ccw may increase overshoot to 10% (only on the 50 mV ranges).

Output mode

Separate: positive and negative pulses available from separate connectors simultaneously or with either one delayed with respect to the other. Delay is variable.

Source impedance: 50Ω ±10% shunted by typically 20 pF.

DC offset: ±2 V across 50Ω load; independent of attenuator and vernier settings; can be switched off.

Pulse delay: 100 ns to 3 s with respect to trigger output; five ranges; vernier provides continuous adjustment between ranges.

Delay jitter: <0.1% on any delay setting.

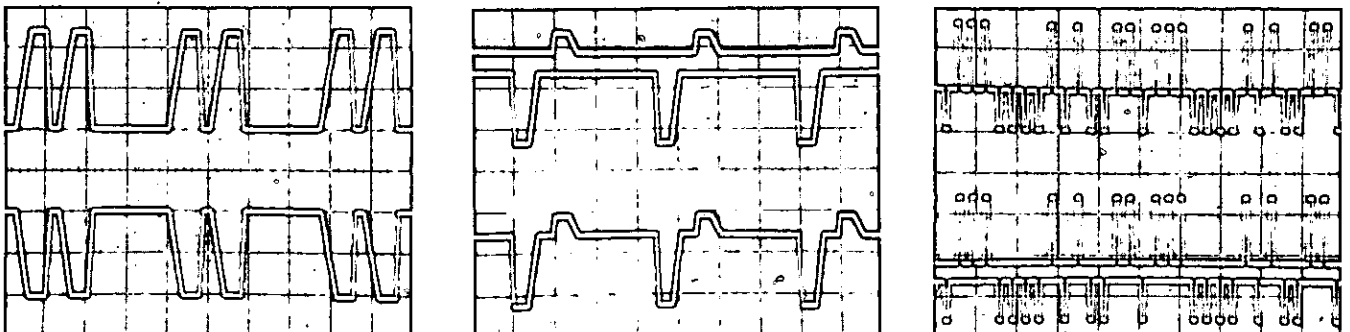


Figure 1. (a) Separate output in double pulse mode. (b) Combined and separate non-simultaneous outputs. (c) A/B gating of combined and separate outputs.

Repetition rate and trigger

Free running: repetition rate 0.3 Hz to 10 MHz in five ranges; vernier provides continuous adjustment between ranges. Period jitter: <0.1%.

Double pulse: minimum pulse spacing of 50 ns allows maximum repetition rate of 20 MHz.

External triggering: repetition rate: 0 to 10 MHz; can be triggered with sine waves or pulses of either polarity.

Sensitivity: sine waves, 2 V p-p; pulses 1 V peak at least 15 ns wide; maximum input, ± 10 V. Delay: approx 35 ns between trigger input and trigger output. Input impedance: approx 1 k Ω , dc coupled.

Manual: pushbutton for single pulse.

Trigger output: amplitude: > +2 V across 50 Ω . Width: 15 ns \pm 5 ns.

Gating

Synchronous gating: gating signal turns pulse "on". Pulse repetition rate, rise and fall time, amplitude, polarity,

and width determined by panel control settings; first pulse is coincident with the leading edge of the gate, last pulse is normal even if gate ends during pulse.

Asynchronous gating: gating signal turns output pulse "on". Trigger output always available; last pulse ends with gate.

Gate A/B: independent gating signal for each pulse; last pulse ends with gate.

Gate input: -2 V to -20 V enabling.

Input impedance: approx 1 k Ω , dc coupled.

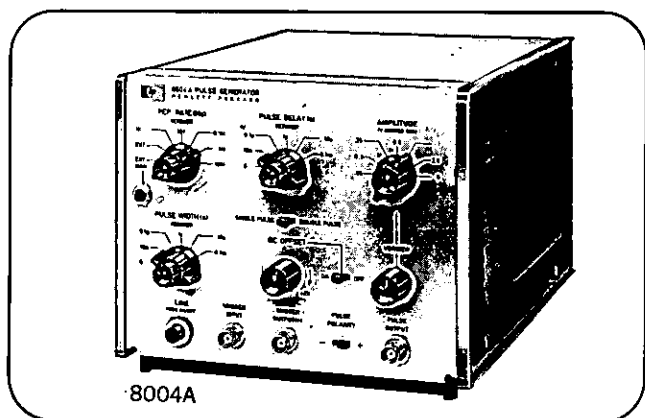
General

Power: 115 or 230 V, $\pm 10\%$, -15%, 50 to 400 Hz, 68 W.

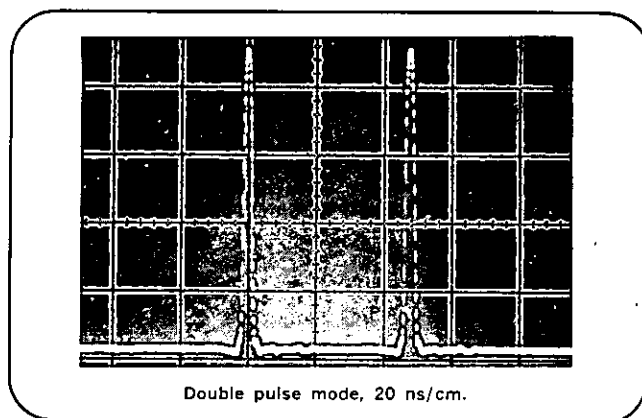
Weight: net 16 lb (7 kg); shipping 20 lb (9 kg).

Dimensions: 16 $\frac{3}{4}$ " wide, 5 $\frac{1}{2}$ " high, 13 $\frac{1}{4}$ " deep (425 x 140 x 336 mm); hardware furnished for conversion to rack mount 19" wide, 5 $\frac{1}{4}$ " high, 11 $\frac{3}{4}$ " deep behind panel (483 x 133 x 298 mm).

Price: \$1100 (\$1000 at factory in West Germany).

8004A Pulse Generator

The 8004A generates pulses with extremely fast rise and fall times, typically less than 1 ns, yet provides a versatility seldom found in such generators. Pulse width is variable over a wide range. Minimum width is about 4 ns at full pulse amplitude; however, pulse width can be reduced to zero with reduced amplitude. The variable pulse delay can also be reduced to zero. A double pulse mode provides con-



Double pulse mode, 20 ns/cm.

venient test signals for logic and memory circuits. In addition, the double-pulse mode effectively doubles the maximum pulse repetition rate to 20 MHz. Synchronous and asynchronous gating enables the 8004A to generate a wide variety of pulse trains and "words", and a dc offset permits the pulse baseline level to be set up to ± 2 V off ground independent of the setting of the pulse amplitude controls.

Specifications**Pulse characteristics (50 Ω source and load impedance)**

Rise and fall time: <1.5 ns.

Overshoot and ringing: <5% of pulse amplitude.

Preshoot: <5% of pulse amplitude.

Corner rounding: occurs no sooner than 95% of pulse amplitude.

Amplitude: 5 V maximum across 50 Ω ; seven-step attenuator reduces output to 0.05 V in 5, 2.5, 1 sequence; vernier provides continuous adjustment between steps and reduces minimum output to <0.02 V. Output short-circuit proof.

Polarity: positive or negative, selectable.

Source impedance: 50 Ω shunted by typically 10 pF.

DC offset: ± 2 V across 50 Ω load; independent of attenuator and vernier settings; can be switched off.

Pulse width: 0 to 1 ms in six ranges; vernier provides continuous adjustment between ranges.

Maximum duty cycle: >50% from 100 Hz to 1 MHz; >25% from 1 to 10 MHz.

Width jitter: <0.1% on any width setting, plus 50 ps.

Pulse position: (with respect to trigger output: 0 to 1 ms delay in 5 ranges; vernier provides continuous adjustment between ranges.

Delay jitter: <0.1% on any delay setting.

Repetition rate and trigger: same as 8005A except:

Free running: repetition rate: 100 Hz to 10 MHz, five ranges.

External triggering: delay: approx 125 ns between trigger input and trigger output. May be reduced to approx 35 ns (slide switch on board).

Trigger output width: 15 ns \pm 10 ns.

Gating: same as 8005A except no A/B gate.

General

Power: 115 or 230 V, +10%, -15%, 50 to 400 Hz, 35 W.

Weight: net 7 lb (3.5 kg); shipping 9 lb (4.5 kg).

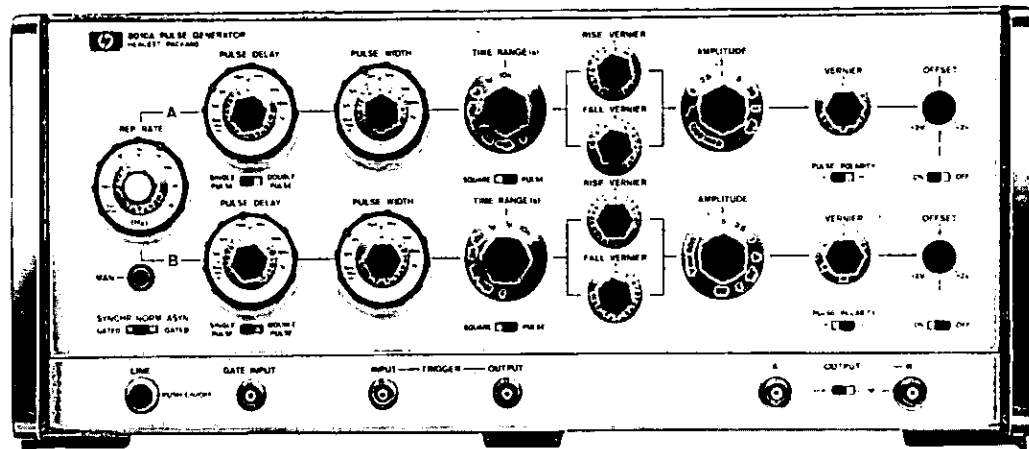
Dimensions: 7 $\frac{3}{4}$ " wide, 6 $\frac{1}{2}$ " high, 11" deep from panel (197 x 165 x 279).

Price: \$750 (\$675 at factory in West Germany).



PULSE GENERATOR

Two Channels for Complex Waveforms
Model 8010A



8010A

8010A Pulse Generator

The Model 8010A Pulse Generator offers all the advantages of the 8005A (page 242) plus many additional features. The 8010A comprises two channels with the repetition rate, from 1 Hz to 10 MHz, common to both. Pulse delay, width, rise and fall times, amplitude, and dc-offset controls are independent for each channel. With the exception of dc-offset all front panel controls are calibrated. Rise and fall times are adjustable from less than 10 ns to 1 s with a ratio of rise to fall or fall to rise of up to 10:1. Amplitude of each pulse is independently adjustable from 5 volts to less than 0.02 volts into 50 ohms. A seven-step attenuator reduces the output in a 5, 2.5, 1 sequence.

In the normal delay mode both pulses are referenced to the trigger output, and so the delay of either pulse can be fixed while that of the other remains variable. Thus Output A can be delayed from 50 ns to 1 s with respect to Output B or vice versa. Additionally, besides the normal delaying modes, a front panel switch makes Output A the reference for Output B. In this mode both waveforms are controlled

by pulse delay A. Hence, the pulse combination of Outputs A and B can be delayed as one complete waveshape with respect to the trigger output. An illustration of the delaying modes is given in Figure 2.

As an extra feature, the Pulse Generator can be operated in a square wave mode. Symmetrical, dc coupled, square waves from 1 Hz to 10 MHz with variable rise and fall times are available at both outputs.

The polarity of either output can be selected individually. Complex waveshapes, of the order shown in Figure 1 are generated by Channels A and B together with the 8010A's combining capabilities. Synchronous gating effectively turns the instrument on and off, permitting the generation of pulse trains of various lengths. On the other hand, in the asynchronous gating mode the repetition rate generator continues to run, so the trigger output is always available. Furthermore, it is possible to gate both channels separately making the 8010A an ideal synchronizing source for the 8006A Word Generator.

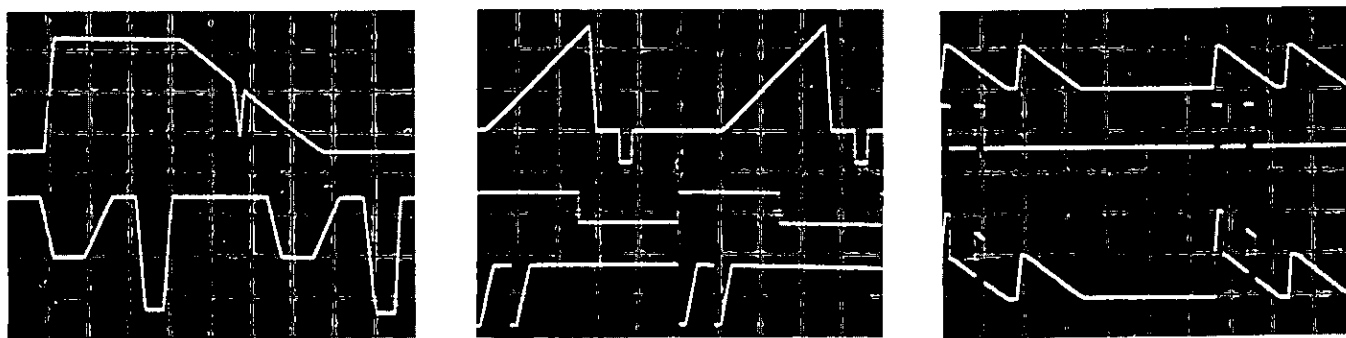


Figure 1. A selection of waveforms showing single and combined outputs.

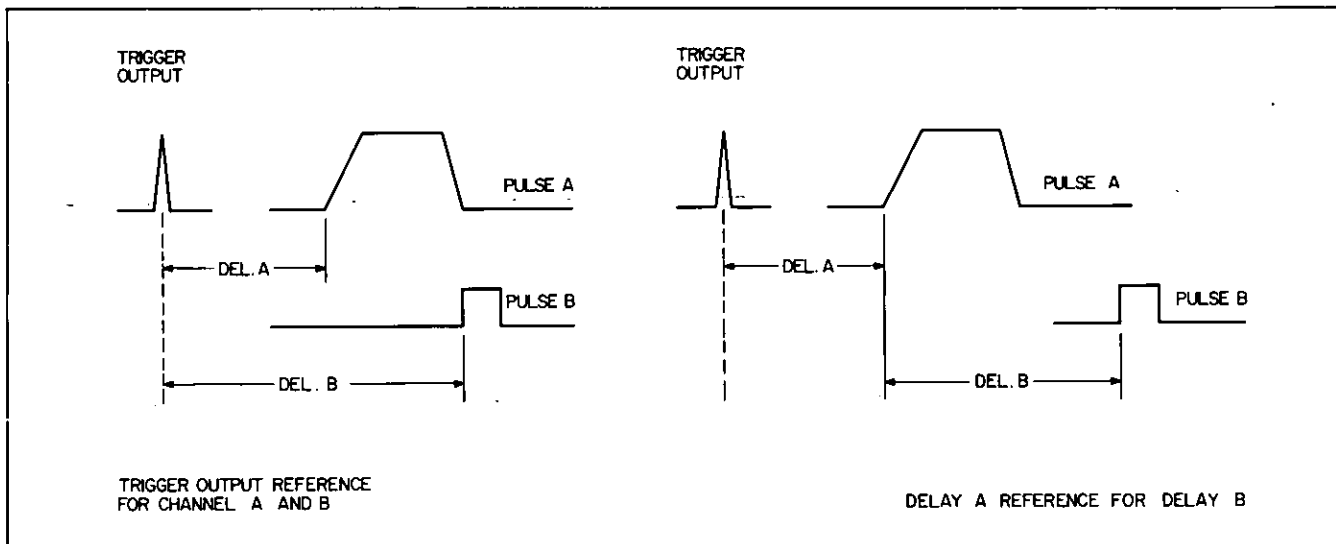


Figure 2.

Specifications

Pulse characteristics (with 50 Ω load impedance)

Rise and fall times: sep outputs: <10 ns to 1 s in eight ranges; ranges are common for rise and fall times. Independent verniers provide separate control of rise and fall times within each range up to a max ratio of 1:10.

Common outputs: <12 ns to 1 s.

Accuracy: $\pm 15\%$ of setting.

Linearity: for transition time >30 ns maximum amplitude deviation from a straight line between the 10% and 90% points is less than 4% of pulse amplitude.

Overshoot and ringing: <5% of pulse amplitude.

Pulse width (A and B): <20 ns to 1 s in eight ranges. Vernier provides continuous adjustment between ranges.

Accuracy: $\pm 15\%$ of setting.

Maximum duty cycle: >90% for repetition rates from 1 Hz to 1 MHz. >50% from 1 to 10 MHz.

Width jitter: <0.1% on any width setting.

Maximum output: 5 V (10 V across an open circuit) sep or common output.

Attenuator: seven-step attenuator reduces output to 0.05 V in 5, 2.5, 1 sequence. Vernier provides continuous adjustment between steps and reduces minimum output to <0.02 V.

Pulse outputs: sep outputs: two outputs, each pos or neg selectable. Com outputs: polarity of A and B independently selectable.

Source impedance: 50 Ω $\pm 10\%$ shunted by typically 20 pF.

DC offset: ± 2 V across 50 Ω load. Independent of attenuator and vernier setting; can be switched off.

Pulse delay: (A and B) <50 ns to 1 s delay with respect to trigger output. Eight ranges. Vernier provides continuous adjustment between ranges.

Accuracy: $\pm 15\%$ of setting.

Delay jitter: <0.1% on any delay setting.

Repetition rate and trigger

Free running: 1 Hz-10 MHz in seven ranges. Vernier provides continuous adjustment between ranges.

Accuracy: $\pm 15\%$ of setting.

Period jitter: <0.1%.

Square wave: 1Hz-10MHz output symmetrical to ground.

Double pulse: separate for channel A and B. Minimum pulse distance of <50 ns allows maximum rep rate up to 20 MHz.

External triggering

Rep rate: 0 to 10 MHz. Can be triggered with sine waves or pulses of either polarity. (For Square Wave Output frequency divided by a factor of 2).

Trigger input: sine waves 1 V p-p. Pulses 0.5 V peak at least 20 ns wide.

Delay: approximately 30 ns between trigger input and trigger output.

Input impedance: 1.0 k Ω .

Manual: pushbutton for single pulse.

Sep triggering for both channels: positive spikes +2 V amplitude <50 ns width. Input impedance 50 Ω (inputs on rear panel).

Trigger output

Amplitude: >2 V across 50 Ω .

Width: 15 ns ± 10 ns.

Polarity: positive.

Impedance: 50 Ω .

Gating

Synchronous gating: gating signal turns generator "on" pulse rep rate, rise and fall time, amplitude, polarity, delay and width determined by panel control settings. First pulse is coincident with the leading edge of the gate, last pulse is normal width, even if gate ends during the pulse.

Asynchronous gating: gating signal turns the output pulse "on" trigger output always available.

Gate inputs: at least -2 V enabling.

Power: 115 or 230 V +10%, -15%, 50 to 400 Hz.

Dimensions: 16 $\frac{3}{4}$ " wide, 7 $\frac{1}{4}$ " high, 18 $\frac{3}{8}$ " deep overall (425 x 184 x 466 mm).

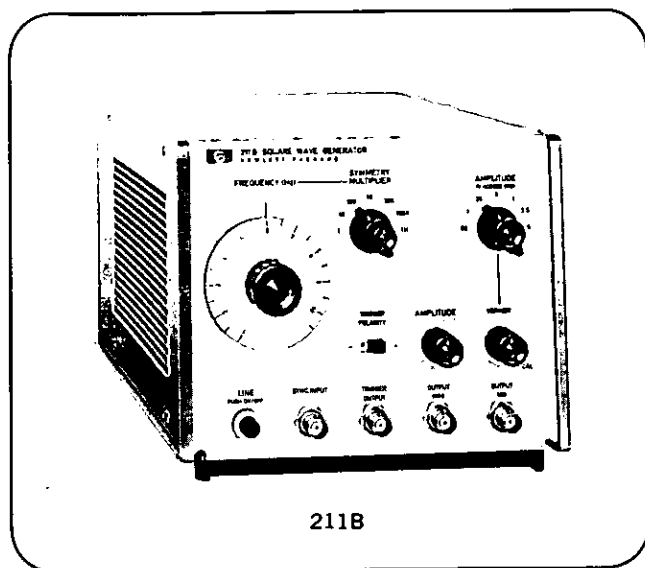
Price: \$1700 at factory in West Germany.



SQUARE WAVE GENERATOR

Fast undistorted square waves

Model 211B



211B

Features

- All solid-state.
- 5 V across 50 ohms to 10 MHz, 5 ns risetime.
- 30 V across 600 ohms to 1 MHz, 70 ns risetime.
- Positive or negative trigger output.

Model 211B Square Wave Generator

The Model 211B Square Wave Generator with fast risetime, undistorted squarewaves and a 10 MHz repetition rate is ideal for fast switching applications. Two negative-going output pulses are available simultaneously, one from a 50-ohm source with a 5 nanosecond risetime and falltime, the other from a 600-ohm source with a 70 nanosecond risetime and falltime. Phase difference between the two pulses is 180°.

DC coupling prevents baseline shift with rep rate changes. A true 50-ohm output impedance absorbs reflections from load mismatches.

A symmetry control varies the "on" time from 25% to 75% of the rep rate period and the rate jitter has been held to 0.2% of any rep rate period or symmetry setting. Synchronization on external signals is possible through an input trigger circuit. In addition to the output pulse, either a positive or negative trigger pulse is provided so external test equipment can be triggered without loading the circuit. The trigger pulse has an amplitude of 2 volts and coincides with the leading edge of the output pulse.

Specifications, Model 211B

Symmetry control: variable from 25-75% duty cycle.

Polarity: negative.

Source: 50 ohms $\pm 3\%$ shunted by approximately 15 pF.

Pulse Shape: (measured at 5V into 50 ohms).

Rise and fall times: less than 5 ns.

Amplitude:

Peak voltage: 5 V into 50 ohms, 10 V into an open circuit; output circuit protected, cannot be damaged by shorting.

Attenuator: 0.05 to 5 V, in a 1, 2.5, 5 sequence.

Vernier: provides continuous adjustment between ranges.

600 ohm Source: 600 ohms $\pm 10\%$.

Rise and fall times: < 70 ns into 600 ohms, < 140 ns into an open circuit; decreased amplitude setting improves risetime.

Amplitude:

Peak voltage: at least 30 V into 600 ohms, at least 60 V into an open circuit.

Attenuator: provides continuous adjustment from full output to less than 0.3 V into 600 ohms.

Repetition rate and triggering

Internal:

Repetition rate:

50 ohm output: 1 Hz to 10 MHz, 7 ranges.

600 ohm output: 1 Hz to 1 MHz, 6 ranges.

Period jitter: less than 0.2% at any duty cycle and rep rate setting.

External:

Sync input: sine waves or positive pulses from 1 Hz to 10 MHz; frequency of synchronizing signal must be 105-140% of dial setting.

Sensitivity: dc coupled positive pulses, 2 V peak; sine waves, 4 V peak-to-peak.

Input resistance: approximately 500 ohms.

Trigger output pulse: (suitable for synchronizing with another Model 211B).

Width: 10 (± 5) ns at 50% points.

Amplitude: at least 2 V into 50 ohms.

Timing: coincident with leading edge of 50 ohm pulse.

Polarity: positive or negative.

Power: 115 or 230 V $+10\%$ -15% ; 50 to 400 Hz; 23 W.

Dimensions: 7 $\frac{3}{4}$ " wide, 6 $\frac{1}{8}$ " high, 11" deep over-all (197 x 156 x 279 mm).

Weight: net 9 lbs (4 kg); shipping 11 lbs (5 kg).

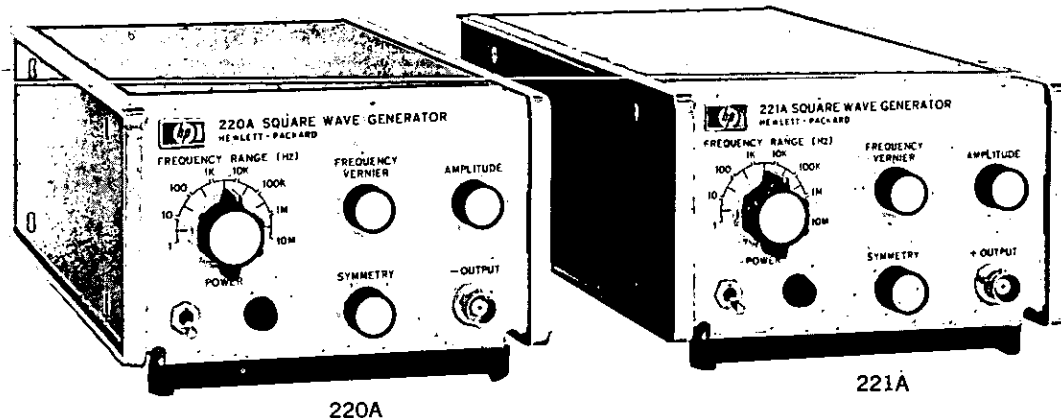
Price: HP Model 211B, \$450.

SQUARE WAVE GENERATORS

General purpose testing
Models 220A, 221A



SIGNAL SOURCES



Models 220A and 221A are small, lightweight square wave generators with all solid-state circuitry. High quality and reliability combined with a low price results in a truly general-purpose laboratory instrument.

Clean waveshapes are assured by the 50-ohm source impedance, even when driving other than 50-ohm loads. Amplitudes from 0 to -5 V into ohms are available from the Model 220A, while the Model 221A provides amplitudes from 0 to $+5$ V into 50 ohms. (The two instruments differ only in the output polarity.)

Frequency programming capability is standard on both

Models 220A and 221A. They may be operated as a voltage-controlled oscillator (VCO) by supplying a dc voltage to a rear panel connector. This allows the frequency vernier to be swept over the full 10:1 range selected. The output may also be gated on and off by applying a pulse to the rear panel connector.

Some typical uses for these instruments include checking video or audio amplifier performance, and making risetime and pulse response measurements. The voltage-controlled oscillator operation is useful for computer logic testing and for applications requiring pulse frequency modulation.

Specifications, 220A and 221A

Source impedance: 50 ohms.

Risetime: less than 15 ns.

Overshoot and ringing: less than 5% at 5 volts into 50 ohms.

Amplitude

Model 220A: continuously variable from 0 to -5 volts into 50 ohms.

Model 221A: continuously variable from 0 to $+5$ volts into 50 ohms.

Symmetry: variable from approximately 40% to 60%.

Repetition rate

Ranges: from 1 Hz to 10 MHz (8 positions) in decade steps.

Vernier: continuously variable between all ranges.

Frequency programming: -1.2 to -13 volts applied to external input will program the frequency over selected frequency range.

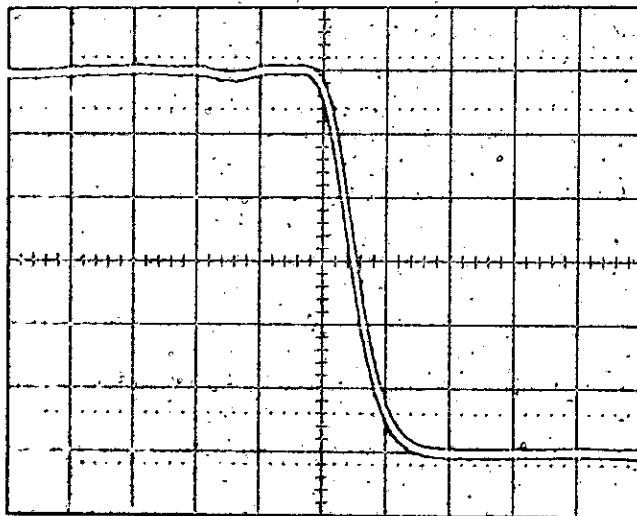
Weight: net, 4 lb (1.8 kg); shipping, 6 lb (2.7 kg).

Power: 115 or 230 volts $\pm 10\%$, 50 to 400 Hz, 9 watts.

Dimensions: $5\frac{1}{8}$ " wide x $3\text{-}7\frac{1}{16}$ " high x $11\frac{1}{8}$ " deep (131 x 87 x 295 mm).

Price: HP Model 220A, \$225.

HP Model 221A, \$225.



The clean, fast rise of the 220A's output delivers -5 V into 50 ohms.

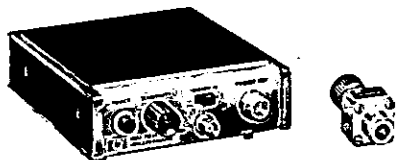
SIGNAL SOURCES



PULSE GENERATORS

Fast rise pulsers

Models 1105A/1106A, 1105A/1108A, 213B



Model 1105A/1106A 20 ps Pulse Generator

The Model 1105A/1106A produces a pulse of 20 ps rise time, ideal for fast circuit testing or high resolution TDR. The pulser is made up of two parts: the Model 1105A Pulse Generator Supply and the Model 1106A Tunnel Diode Mount. The Model 1106A may also be used with the Model 1104A Countdown Supply to form an 18 GHz trigger countdown.

Specifications, Model 1105A/1106A

Output

Rise time: approximately 20 ps; less than 35 ps observed with HP Model 1411A/1430A 28 ps Sampler and HP Model 909A 50 Ω termination.

Overshoot: less than $\pm 5\%$ as observed on Model 1411A/1430A with Model 909A.

Droop: less than 3% in first 100 ns.

Width: approximately 3 μ s.

Amplitude: greater than +200 mV into 50 Ω .

Output characteristics (Model 1106A):

Mechanical: precision 7 mm (Amphenol APC-7) connector.

Electrical: dc resistance, 50 $\Omega \pm 2\%$; source reflection, less than 10%, using a 40 ps TDR system; dc offset voltage, approximately 0.1 V.

Triggering:

Amplitude: at least ± 0.5 V peak required.

Rise time: less than 20 ns required; jitter less than 15 ps when triggered by 1 ns rise time sync pulse from Model 1424A or 1425A Sampling Time Base sync pulse; jitter increased with slower trigger rise times.

Width: greater than 2 ns.

Maximum safe input: 10 volts.

Input impedance: 200 Ω , ac coupled through a 20 pF capacitor.

Repetition rate: 0 to 100 kHz; free runs: approximately 100 kHz.

Accessories provided (with Model 1105A): one 6-ft 50 Ω cable with male Type N connectors, HP Model 10132A.

Weight:

Model 1105A: net, 3 lbs (1.4 kg); shipping, 8 lbs (3.9 kg).

Model 1106A: net, 1 lb (0.5 kg); shipping, 3 lbs (1.4 kg).

Price: HP Model 1105A, \$200; HP Model 1106A, \$550.



Model 1105A/1108A 60 ps Pulse Generator

The Model 1105A/1108A is similar to the 1105A/1106A in that the 60 ps rise time pulse can be used for circuit testing and TDR. When used with the 1104A Countdown Supply the 1108A is a 10 GHz trigger countdown.

Specifications, Model 1105A/1108A

Output

Rise time: less than 60 ps

Overshoot: less than $\pm 5\%$.

Droop: less than 3% in first 100 ns.

Width: approximately 3 μ s.

Amplitude: greater than plus 200 mV into 50 Ω .

Output characteristics (1108A):

Mechanical: GR-874 connector

Electrical: dc resistance, 50 $\Omega \pm 2\%$. Source reflection less than 10%, using a 40 ps TDR dc system. DC offset voltage—approximately 0.1 V.

Triggering:

Amplitude: ± 0.5 V peak minimum

Rise time: less than 20 ns required. Jitter less than 15 ps when triggered by 1 ns rise time sync pulse from 1424A or 1425A Sampling Time Base. Slow risetimes produce more jitter.

Width: greater than 2 ns.

Maximum safe input: 10 volts.

Input impedance: 200 Ω , ac coupled through 20 pF.

Repetition rate: 0 to 100 kHz; free runs at approximately 100 kHz, nominal.

Accessories provided (with Model 1105A): one 6-ft. 50 Ω cable with male Type N connectors, HP Model No. 10132A.

Weight:

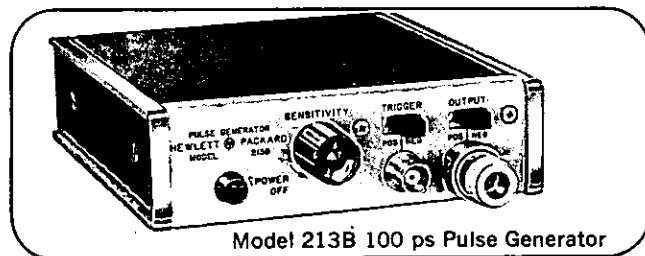
1105A: net, 3 lbs (1.4 kg). Shipping, 8 lbs (3.9 kg).

1108A: net, 1 lb (0.5 kg). Shipping, 3 lbs (1.4 kg).

Price:

1105A, \$200.

1108A, \$175.



Model 213B 100 ps Pulse Generator

The outstanding performance of the Model 213B makes it convenient for many small amplitude pulse test applications ranging from circuit risetime testing and bandwidth determinations to the measurement of transistor switching speeds.

Specifications, Model 213B

Output

Rise time: less than 100 ps.

Top droop: less than 2% in first 100 ns following the rise.

Width: approximately 2 μ s.

Amplitude: greater than 175 mV into 50 Ω , 350 mV open circuit, either polarity.

Source: 50 Ω .

Jitter: less than 20 ps when triggered with the sync pulse from a Model 1424A or 1425A.

Repetition rate: free runs at a rate greater than 100 kHz, or may be triggered.

Trigger input

Amplitude: 0.5-volt peak, either polarity.

Rise time: 20 ns or faster.

Width: at least 2 ns.

Maximum current: 200 mA peak.

Impedance: 200 Ω for signals less than 0.75 volt peak; limiting lowers impedance to larger signals.

Repetition rate: 0 to 100 kHz.

General

Power: 115 or 240 V $\pm 10\%$, 50 to 400 Hz, approximately 1 W.

Dimensions: 1 $\frac{1}{2}$ " high, 5 $\frac{1}{8}$ " wide, 5" deep (38 x 130 x 127 mm).

Weight: net 2 lbs (0.9 kg); shipping, 4 lbs (1.9 kg).

Price: HP Model 213B, \$300.

DIGITAL DELAY GENERATOR

Digitally controlled time intervals, pulses
Model 218A



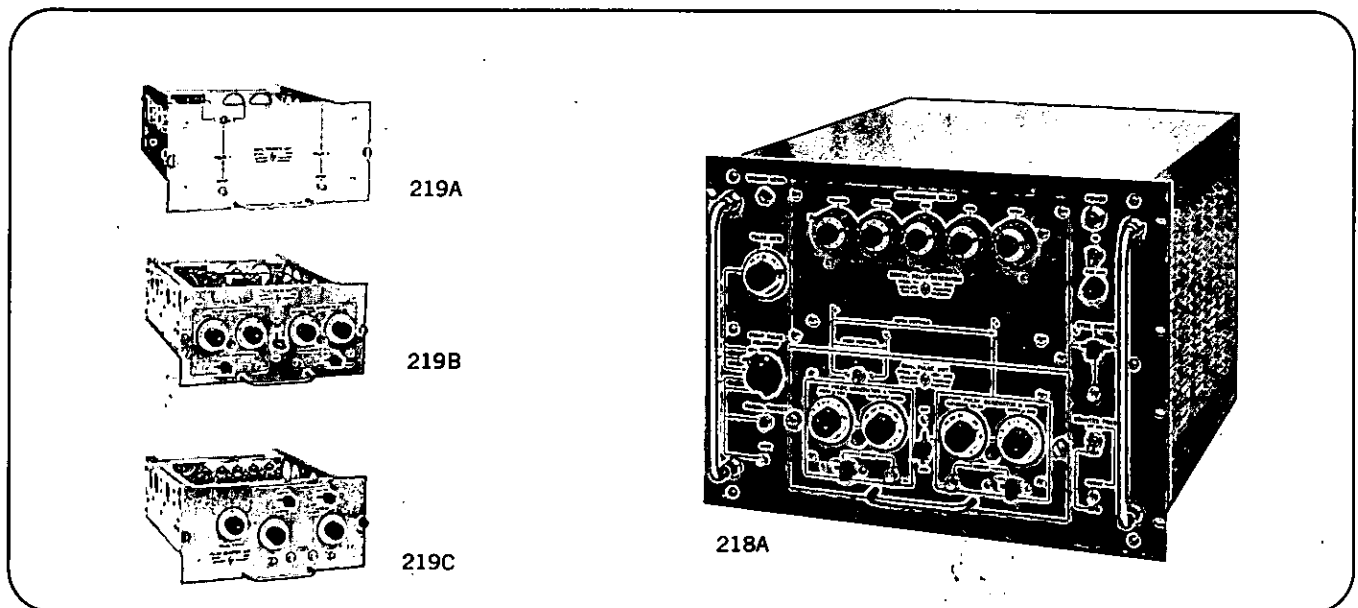
SIGNAL SOURCES

The HP 218A Digital Delay Generator is designed to generate precise time intervals and single, double or superimposed pulses. It is useful as a general-purpose laboratory pulse generator and because of its versatile plug-in pulse generators, it often can take the place of several special-purpose instruments.

The 218A consists of (1) a pulsed crystal oscillator which is started in known phase by the initial trigger (start) pulse, eliminating the ± 1 count error; (2) a dual-preset digital counter which counts the crystal or externally applied frequency, and operates (3) two preset gates which pass the selected pulses.

Plug-ins include the 219A Dual Trigger Unit to supply

trigger pulses for controlling auxiliary equipment, \$200; the 219B Dual Pulse Unit to deliver fast-rise-time, high-power pulses that are digitally delayed, \$650; and the 219C Digital Pulse Duration Unit, which produces a high-power output pulse whose delay and duration may be digitally controlled, \$500. Output pulses of the 219A are identical to the sync output of the 218A. The 219B pulses are individually adjustable, 0 to ± 50 V peak open circuits from a 50Ω source. Pulses from the 219C are 90 V peak (or more), open circuit, from a 500Ω source or adjustable from 0 to 15 V peak from a 90Ω source. The positive excursion of the pulses is clamped to ground, and both positive- and negative-going pulses are available simultaneously.



Specifications

(Plug-in necessary to operate)

Time interval range: (T_0 to T_1 and T_0 to T_2) 1 to 10,000 μs ; accuracy $\pm 0.1\mu\text{s} \pm 0.001\%$ of time interval selected.

Digital adjustment: 1 to 9999 μs in 1 μs steps.

Interpolation: continuously adjustable; adds 0 to 1 μs to digital setting.

Input trigger: internal: 10 Hz to 10 kHz, 3 decade ranges; external: sine wave, 10 to 100 Hz, 5 to 40 V rms, 100 Hz to 10 kHz, 2 to 40 V rms; pulse, 0 to 10 kHz, positive or negative, 2 to 40 V peak; for trigger rise time of 0.05 μs or less, delay between external trigger and T_0 is less than 0.5 μs ; manual: pushbutton operation initiates single pulse cycle.

Jitter: 0.02 μs or less.

Recovery time: 70 μs or 10% of selected interval, whichever is greater.

Sync output: positive pulse, 50 to 70 V peak, open circuit,

0.1 μs rise time; width more than 1.5 μs ; available at T_0 , T_1 , or T_2 as selected by a switch.

1 MHz output: 1 MHz positive pulses (1 V from 500Ω source) provide timing comb synchronized to start pulses; available at panel connector for duration of longer delay when counting internal 1 MHz oscillator.

External counting: external sine waves, 100 Hz to 1 MHz, 2 V rms minimum; 10 to 100 Hz, 5 V rms minimum, and positive pulses, periodic or random, 0 to 1 MHz, 2 V peak, can be counted instead of internal standard; time interval range becomes 3 to 9999 periods in 1-period steps, and accuracy is $\pm 0.1\mu\text{s} \pm 1$ period.

Power: 115 or 230 V $\pm 10\%$, 50 to 60 Hz, 555 W.

Dimensions: 14" high, 19" wide, 21 $\frac{3}{4}$ " deep behind panel (355 x 483 x 553 mm).

Weight: net 74 lbs (34 kg); shipping 104 lbs (47 kg).

Price: HP 218A, \$2600.00 (requires HP 219A,B,C Series plug-in units).



PULSE GENERATOR

Delivers 200 watts pulse power
Model 214A

The HP Model 214A features 200 watts pulse power, controlled pulse shape, external trigger slope and level selection, and a 50-ohm source impedance for general-purpose lab and production measurements.

The 200-watt (2 amps peak) pulse power is particularly suited for testing current-driven devices such as magnetic memory cores, as well as high-power modulators. At output levels below 50 volts, the pulse generator has a matched source impedance of 50 ohms, eliminating error-producing reflections. The pulse characteristics are carefully controlled, and pulse rate, width, and delay jitter are kept to a minimum to insure

accurate, dependable test results.

The 214A offers an extremely wide range of trigger control for syncing on external signals. In addition, slope and level may be selected so that triggering occurs at a given point on the trigger waveform. Also provided is a variable delay or advance trigger output signal for use in synchronizing external equipment.

The pulse generator may be gated to provide bursts of pulses. This feature is especially useful for computer logic measurements. Also, a double pulse feature is provided for pulse resolution tests of amplifiers and memory cores.



214A

Specifications

Output pulse

Source resistance: 50 ohms on the 50 V and lower ranges; approximately 1500 ohms on the 100 V range.

Pulse shape:

Rise and fall time: <13 ns on the 20 V and lower ranges and the -50 V range, <15 ns on the +50 V range; typically <10 ns with the vernier set for maximum attenuation, and typically 15 ns on 100 V range.

Pulse amplitude: 100 V into 50 ohms. An attenuator provides 0.2 to 100 V in a 1, 2, 5, 10 sequence (9 ranges); vernier reduces output of 0.2 V setting to 80 mV and provides continuous adjustment between ranges.

Polarity: positive or negative.

Overshoot: <5%, both leading and trailing edges.*

Pulse top variations: <5%.

Droop: <6%.

Preshoot: <2%.

Pulse widths: 50 ns to 10 ms in 5 decade ranges; continuously adjustable vernier.

Width jitter: <0.05% of pulse width +1 ns.

Pulse position: 0 to 10 ms advance or delay with respect to trigger output (5 decade ranges) continuously adjustable vernier.

Position jitter: <0.05% of advance or delay setting +1 ns (between trigger pulse and output pulse).

Repetition rate and trigger

Internal:

Repetition rate: 10 Hz to 1 MHz (5 ranges), continuously adjustable vernier.

Rate jitter: <0.5% of the period.

Manual: pushbutton single pulse, 2 Hz maximum rate.

External:

Repetition rate: dc to 1 MHz.

Sensitivity: <0.5 V peak.

Slope: positive or negative.

Level: adjustable from -40 V to +40 V.

Delay: delay between input trigger and leading edge of pulse out is approx 250 ns in Pulse Advance mode (approx 420 ns minimum in Pulse Delay mode).

External gating: +8 V signal gates pulse generator on; maximum input, 40 V peak.

Double pulse:

Minimum spacing: 1 μ s on the 0.05 to 1 μ s pulse width range and 25% of upper limit of width range for all other ranges.

Trigger output:

Amplitude: >10 V open circuit.

Source resistance: approximately 50 ohms.

Width: 0.05 μ s nominal.

Polarity: positive or negative.

General

Maximum duty cycle: 10% on 100 and 50 V ranges; 25% on 20 V range; 50% on 10 V and lower ranges.

Power: 115 or 230 V \pm 10%, 50 to 60 Hz, 325 W.

Dimensions: 16 $\frac{3}{4}$ " wide, 7 $\frac{1}{4}$ " high, 18 $\frac{3}{8}$ " deep over-all (425 x 184 x 467 mm); hardware furnished for quick conversion to 7" x 19" rack mount, 16 $\frac{3}{8}$ " deep behind panel (178 x 483 x 416 mm).

Weight: net 35 lbs (16.8 kg); shipping 41 lbs (19.7 kg).

Price: HP Model 214A, \$975.

*Measured on a 50 MHz oscilloscope.

PULSE GENERATOR

Controlled, fully specified output pulses
Model 215A



SIGNAL SOURCES

The Model 215A Pulse Generator combines in one compact unit the many capabilities desired for fast pulse testing. The fast rise and fall time and extremely low pulse jitter make the Model 215A particularly useful in measuring transition storage times of semiconductors, logic circuits and thin film memory units.

The output pulse of the Model 215A is carefully controlled to approximate an ideal pulse shape and is specified in every respect for accurate, dependable measurements. One nano-

second rise and fall time pulses of either polarity with nearly an ideal pulse shape, combined with calibrated pulse width and delay controls, adjustable pulse amplitude, variable pulse rate to 1 MHz and a true 50-ohm source impedance provide maximum measurement capabilities.

The true 50-ohm source impedance insures clean output pulses, regardless of the load impedance, since any reflection from the circuit under test will be absorbed by the 50-ohm generator impedance.



215A

Specifications

Source impedance: 50 ohms $\pm 3\%$; 3% maximum reflection when driven by a pulse with 1 ns risetime from an external 50-ohm system.

Leading edge only

Risetime: < 1 ns (10 to 90% points).

Overshoot and ringing: $< \pm 5\%$ of pulse amplitude.

Corner rounding: occurs no sooner than 95% of pulse amplitude.

Time to achieve flat top: < 6 ns.

Trailing edge only

Falltime: < 1 ns (10 to 90% points).

Overshoot: $< 5\%$.

Rounding: occurs no sooner than 95% of fall.

Time to settle within 2% of baseline: 10 to 25 ns, varies with width setting.

Baseline shift: $< 0.1\%$ under all conditions.

Preshoot: $< 1\%$.

Perturbations on flat top: $< 2\%$ of pulse amplitude.

Peak voltage: > 10 volts into 50 ohms; > 20 volts open circuit.

Polarity: positive or negative.

Attenuator: 0 to 12 dB in 1 dB steps, absolute accuracy within ± 0.1 dB.

Pulse width (between 50% points): continuously adjustable, to 100 ns; dial accuracy within $\pm 5\% \pm 3$ ns; width jitter < 50 ps.

External bias: up to ± 100 mA (± 5 V dc) may be safely applied to the output; at 0 dB attenuator setting, up to 10 mA (0.5 V dc) may be applied without significant change in pulse shape (5% droop), increasing to 40 mA at 12 dB; in most cases, adjusting the front-panel pulse-shape controls will restore original pulse shape.

Repetition rate sources

Internal repetition rate: < 100 Hz to > 1 MHz in 4 ranges, continuously variable between ranges; period jitter $< 0.3\%$ of one period.

Manual: pushbutton single pulse.

Trigger timing: adjustable from 10 ns delay to 140 ns advance with respect to leading edge of output pulse; dial accuracy within $\pm 10\% \pm 5$ ns; jitter < 50 ps.

External triggering: ac coupled, sine waves from 10 Hz to 1 MHz; pulses from 0 to 1 MHz, either positive or negative slope.

Trigger level: external trigger level continuously variable, from approximately +8 to -8 volts.

Sensitivity: 1 V peak to peak min.; external pulses must be at least 30 ns wide; max. input 50 V peak, 0.5 W max. average power.

Input resistance: approx 50 ohms or High Z available by front-panel switch; High Z is approx 100 k Ω for negative slope setting approx 5 k Ω for positive slope setting.

Countdown: counts down from frequencies to 100 MHz, 2 V rms amplitude; resulting pulse repetition rate is always < 1.3 MHz; jitter is $< 10\%$ of one period of the triggering signal.

External trigger delay: approximately 250 ns between leading edge of trigger pulse (2 volt step, 2 ns risetime into 50 ohms) and leading edge of output base; < 50 ps jitter.

External gating: gates on with a +1 volt pulse; maximum input 50 V peak, 20 V rms.

Trigger output pulses

Width: 50 ns, nominal.

Amplitude: > 1 volt peak into 50 ohms.

Rise time: < 6 ns.

Polarity: positive or negative.

Power: 115 or 230 volts $\pm 10\%$, 50 to 60 Hz, 60 W.

Dimensions: 5 $\frac{1}{2}$ " high, 16 $\frac{3}{4}$ " wide, 18 $\frac{3}{8}$ " deep (140 x 425 x 467 mm); hardware furnished for quick conversion to 5 $\frac{1}{4}$ " x 19" rack mount, 16 $\frac{3}{8}$ " deep behind panel (133 x 483 x 416 mm).

Weight: net 34 lbs (16.3 kg); shipping 41 lbs (19.7 kg).

Accessories furnished: Model 10120A cable, 3 feet, BNC-to-BNC, 50 ohms ± 0.5 ohm.

Accessories available: Model 10122A cable, 3 feet, BNC-to-Type N, 50 ohms ± 0.5 ohm, \$10; Model 908A, 50-ohm Coaxial Termination, \$35; Model 10240A Blocking Capacitor, 0.1 μ F, isolates Model 215A from up to 200 V dc, \$100.

Price: HP Model 215A, \$1975.



PULSE GENERATOR

Fast-rise 100 MHz pulses
Model 216A

The Model 216A offers pulse repetition rates up to 100 MHz for testing fast circuits, yet retains a nearly ideal pulse shape with 2.5 ns risetime for accurate, dependable measurements. In addition, bursts of pulses may be produced internally to simulate pulse trains for logic circuit testing.

Pulse height is continuously variable, allowing exact pulse amplitudes to be selected for precise testing. The dc-coupled output eliminates baseline shift with changes in rep rate, and the 50-ohm output impedance prevents multiple reflections, insuring clean, easy-to-interpret waveforms.



216A

Specifications

Source impedance: 50 ohms, $\pm 3\%$, shunted by approximately 10 pF at any output up to 15 V.

Leading edge only (at 10 V output into 50-ohm load).

Risetime: < 2.5 ns.

Overshoot and ringing: $\pm 4\%$ p-p of pulse amplitude.

Corner rounding: occurs no sooner than 96% of pulse amplitude.

Time to achieve flat top: < 20 ns.

Preshoot: $< 2\%$.

Trailing edge only (at 10 V output into 50-ohm load).

Fall time: < 2.5 ns.

Overshoot: $< 4\%$.

Corner rounding: occurs no sooner than 96% of fall.

Time to settle within 2% of base line: < 20 ns.

Preshoot: $< 5\%$.

Perturbations on flat top: $< 3\%$ of pulse amplitude.

Peak voltage: 0.4 to 10 volts into 50 ohms to 100 MHz (15 volts maximum amplitude into open circuit).

Attenuator: 1, 2, 5, 10 volt steps.

Polarity: positive or negative.

Vernier: provides continuous adjustment from approximately 0.3 volts to 10 volts.

Pulse width: continuously variable in two ranges, from approximately 5 ns to 25 ns and from 25 ns to 100 ns; width jitter < 100 ps $+ 0.3\%$ of pulse width with countdown ratio set for minimum jitter.

Maximum duty cycle: $\geq 45\%$ up to 50 MHz decreasing to approximately 20% at 100 MHz.

Internal repetition rate: 1 MHz to 100 MHz in 3 ranges.

External triggering

Frequency: sine waves from 1 MHz to 100 MHz, negative pulses from 0 to 100 MHz; pulse risetime < 100 ns; pulse width > 2 ns.

Sensitivity: at least 0.5 volt peak minimum; maximum input, 10 volts peak.

Input impedance: approximately 50 ohms, ac coupled.

External trigger delay: approximately 140 ns between leading edge of input trigger pulse and leading edge of output pulse.

Trigger output pulse

Width: 3.5 ns ± 1 ns.

Amplitude: > 0.7 volt peak into 50 ohms.

Polarity: negative.

Trigger timing: approximately 130 ns advance with respect to leading edge of output pulse.

Countdown trigger output

Amplitude: > 0.5 volt peak into 50 ohms.

Polarity: positive.

Countdown frequency: variable from approximately 250 kHz to 450 kHz.

Gating of pulse bursts

Internal

Gate width: variable from approx 20 ns to 750 ns.

Gate repetition rate: variable from approximately 250 kHz to 450 kHz.

External: gates on with +2 volt pulse having rise and fall times of < 5 ns; maximum input, 10 volts.

Perturbations: perturbations on gate envelope $< 5\%$ into 50 ohms; above 50 MHz, width varies slightly from pulse to pulse.

General

Power: 115 or 230 volts $\pm 10\%$, 50 to 60 Hz, 120 W.

Dimensions: 5½" high, 16¾" wide, 18¾" deep (140 x 425 x 467 mm), hardware furnished for quick conversion to 5¼" x 19" rack mount, 16¾" deep behind panel (133 x 483 x 416 mm).

Weight: net 25 lbs (12 kg); shipping 31 lbs (14.9 kg).

Accessories available: Model 10120A Cable, 3 feet, BNC-to-BNC, 50 ohms ± 0.5 ohm, \$10; Model 10122A Cable, 3 feet, BNC-to-Type N, 50 ohms ± 0.5 ohm, \$10; Model 908A 50-ohm Coaxial Termination, \$35; Model 10240A Blocking Capacitor, 0.1 μ F, isolates Model 216A from up to 200 V dc, \$100.

Price: HP Model 216A, \$1775.

PULSE GENERATOR

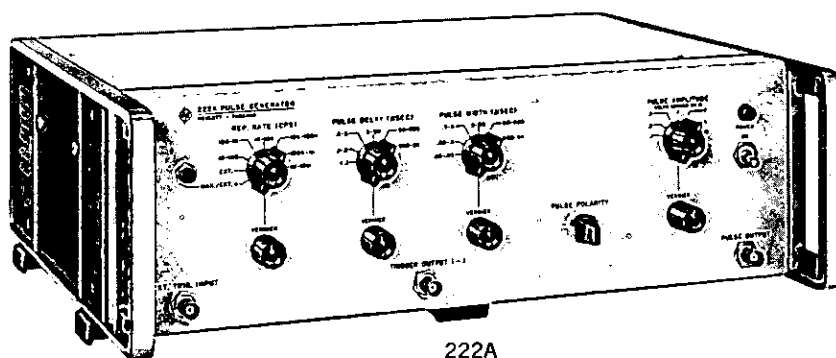
Economical general-purpose testing
Model 222A



SIGNAL SOURCES

The Model 222A combines many features normally found only in more expensive instruments to provide an easy-to-use, yet versatile, general-purpose pulse generator. The 4 ns risetime and full complement of controls permit a wide variety of pulse testing, including square wave testing. Oscilloscope-type triggering, variable pulse width, repetition

rates to 10 MHz, closely specified pulse shape and many other features provide accurate, dependable measurements. The Model 222A, like other HP pulse generators, has a 50-ohm output impedance for eliminating error-producing reflections. The output pulse may be delayed from the trigger output by up to 5 ms for further measurement convenience.



Specifications

Output pulse

Source impedance: 50 ohms shunted by approximately 15 pF at any output up to 12 V.

Amplitude

Peak voltage: 10 volts across 50 ohms; approx. 12 V max.

Amplitude control: step attenuator provides 0.1, 0.2, 0.5, 1, 2, 5, 10 volts across 50 ohms; continuously variable between steps; minimum output <0.05 volts

Polarity: positive or negative.

Pulse width

Range: 30 ns to 5 ms in 6 ranges, continuously variable between ranges.

Duty cycle: maximum duty cycle $\geq 50\%$ from 100 Hz to 10 MHz; for maximum stability at high duty cycles, select width range which allows maximum clockwise rotation of width vernier; duty cycle from 10 to 100 Hz limited by 5 ms maximum pulse width.

Width jitter: <0.2% of maximum range width.

Pulse shape

Leading edge only (measured at 10 volts into 50 ohms)

Rise time: <4 ns.

Overshoot and ringing: <4% peak of pulse amplitude.

Corner rounding: occurs no sooner than 95% of pulse amplitude.

Time to settle within 3% of flat top: <20 ns.

Preshoot: <2%.

Trailing edge only (measured at 10 volts into 50 ohms)

Fall time: <4 ns.

Overshoot and ringing: <4% peak of pulse amplitude.

Corner rounding: occurs no sooner than 95% of pulse amplitude.

Time to settle within 2% of base line: <20 ns.

Preshoot: <4%.

Perturbations on flat top: <3% of pulse amplitude.

Repetition rate and trigger

Internal

Repetition rate: 10 Hz to 10 MHz in 6 ranges, continuously variable between ranges.

Jitter: period jitter in any frequency range <0.2% of maximum period of that range.

Manual: pushbutton single pulse.

External

Triggering: ac coupled; sine wave from 10 Hz to 10 MHz, pulse from 0 to 10 MHz, either positive or negative slope.

Sensitivity: 1 volt p-p minimum; external pulses must be at least 10 ns wide; maximum input 20 volts peak; 0.25 watt maximum average power.

Input resistance: approximately 500 ohms.

External trigger delay: <20 ns between leading edge of external trigger input pulse and leading edge of trigger pulse.

Trigger output pulse:

Width: 22 (± 8) ns at 50% points.

Amplitude: >1 volt into 50 ohms.

Polarity: negative.

Pulse delay: pulse delayed from trigger output by <100 ns to 5 ms in 6 ranges, continuously variable between ranges.

Delay jitter: <0.2% of maximum delay of that range.

General

Power: 115 or 230 V $\pm 10\%$, 50 to 60 Hz, 80 W.

Dimensions: 16 $\frac{3}{4}$ " wide, 5 $\frac{1}{2}$ " high, 13 $\frac{1}{4}$ " deep (425 x 140 x 337 mm); hardware furnished for quick conversion to 5 $\frac{1}{4}$ " x 19" rack mount, 11 $\frac{3}{4}$ " deep behind panel (133 x 483 x 298 mm).

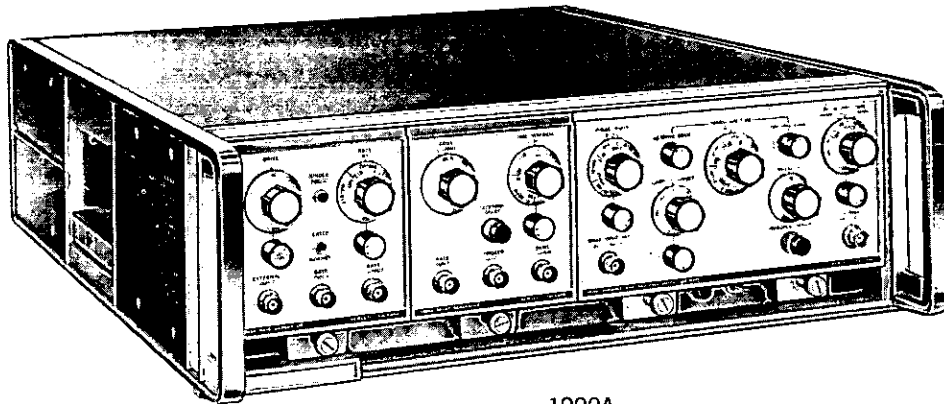
Weight: net 18 lbs (8,7 kg); shipping 23 lbs (11,1 kg).

Price: HP Model 222A, \$690.



PULSE GENERATOR

Plug-in, variable risetime/falltime
Model 1900 system



1900A

The new, all solid-state 1900 Pulse System from Hewlett-Packard is a major advancement in flexibility and versatility. Plug-in capability, programmability (optional), and low radiated or conducted electromagnetic interference (RFI and EMI) are representative of the improved performance in this system.

Until the 1900, no pulse system could be so economically tailored to fit exact requirements, from general laboratory use to fully automated production test systems.

Plug-in flexibility

The 1900 system mainframe contains only power supplies, with optional programming wiring added if desired. The plug-in compartment accepts any combination of half-size or quarter-size plug-ins.

Updating the 1900 pulse system is easy and economical. Mainframes and plug-ins will be compatible with newer output stages which will provide different pulse parameters such as faster rise- and falltimes.

In addition to simpler pulse generators, complex pulse systems may be formed by using several mainframes and ap-

propriate plug-ins. For example, one rate generator can be used with several delay generators, in turn, driving several output stages. The resulting system provides several pulse sources whose shape and timing are independently variable, yet it uses a minimum of instruments. This pulse system is illustrated in Figure 2.

The rack-mount version of the 1900 system is only 5 inches high and a standard 19 inches wide. This saves valuable rack space, allowing additional instrumentation for increased versatility. The Hewlett-Packard modular cabinet enclosure allows quick conversion to a bench instrument by removing two rack flanges and installing plastic feet.

Maintenance is fast and easy with the 1900 system. Entire plug-ins can be quickly replaced for minimum downtime. More complex plug-ins have replaceable plug-in circuit boards, also facilitating calibration and replacement. Multi-layer circuit boards are used in the 1900 system, minimizing point-to-point wiring and resulting in more consistent and reliable electrical performance.

Programming

All major functions of the 1900 system can be easily programmed. This capability may be ordered initially or easily added later for a nominal cost. Thus the same instrument bridges between a laboratory general purpose test instrument and a programmable unit for automated production testing.

Range switch programming is accomplished by grounding appropriate pins on a rear panel connector, using external switches, relays, or DTL logic. Verniers are programmed by applying an external dc current (1 to 10 mA) to a connector pin. Any front panel manual setting can be duplicated by this programming technique. Program inputs can be overridden at any time by turning front panel function switch out of its PGM position.

Programming capability requires only addition of circuit boards and connectors. Some circuit boards are the plug-in type and others mount easily with a few screws. No solder connections are required for either type of circuit board.

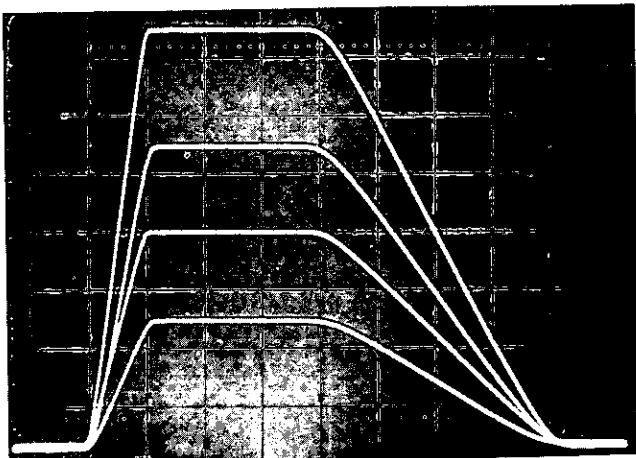


Figure 1. HP 1900 pulse system provides clean pulse shapes with variable risetimes and falltimes as well as variable output currents.

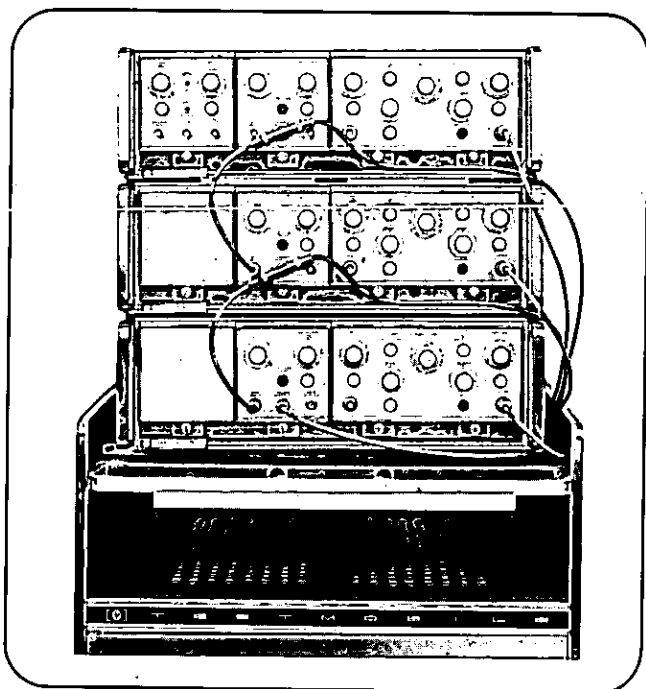


Figure 2. Pulse system versatility is demonstrated with one rate generator serving as clock for three delay generators, each delay generator in turn driving a variable transition time output plug-in. Same rate generator could provide clock signal to additional delay generators. Three output pulses have separately controlled delay, width, risetime, falltime, polarity, offset, and amplitude.

External width input

A unique external width function of the Model 1915A or 1917A output plug-in, extends usability to many new applications such as pulse-code modulation (PCM) and digital circuits requiring non-return-to-zero (NRZ) logic.

Most pulse generators are triggered by a narrow pulse and generate a pulse with a width set by a panel control. Although the 1915A/1917A usually operates this way, it can be set to function as a pulse amplifier. In this operation, width and spacing of pulse trains are maintained.

This feature allows application of variable width pulses to

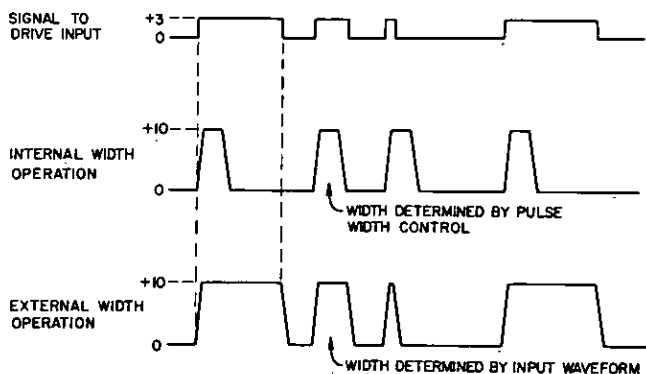


Figure 3. Middle waveform illustrates use of internal width control with pulses triggered by the top waveform. Lower waveform shows external width capability, using 1900 system as pulse amplifier with output pulse width determined by top waveform.

the drive input with these pulses reproduced at the output. However, risetime, falltime, amplitude, and baseline offset are controlled by the Models 1915A/1917A. Figure 3 illustrates internal and external width operation.

One of the most common uses for the external width capability is with word generators to obtain NRZ formats, essentially a variable width pulse train. These NRZ pulse trains may be amplified, risetimes varied, baseline offset, or polarity changed. Figure 4 shows how the external width capability can be used as a regenerator to clean up noisy pulse trains.

The external width feature of the 1900 system accepts three of the most commonly used formats: RZ, NRZ, and biphas.

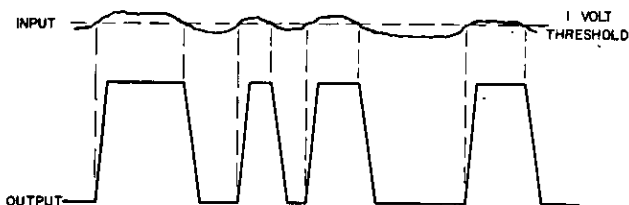


Figure 4. External width feature of 1900 system turns on output at 1 volt threshold. Output then remains on until input drops below threshold.

The 1900-system components are:

1900A—high power mainframe for applications requiring up to 50 volts pulses. Price: \$750. Page 256.

1901A—low power mainframe for applications which require variable rise- and falltimes or fast transition times up to 10 volt pulses. Price: \$450. Page 256.

1905A—25 MHz rate generator. Price: \$200. Page 257.

1906A—125 MHz rate generator. Price: \$275. Page 257.

1908A—electronic delay generator variable from 15 ns to 10 ms. Price: \$200. Page 258.

1910A—incremental delay generator with delays from 5 ns to 100 ns. Price: \$150. Page 258.

1925A—2 to 16 bit word generator with 50 MHz clock rate and pseudo-random noise sequence. Price: \$850. Page 261.

Output Plug-In

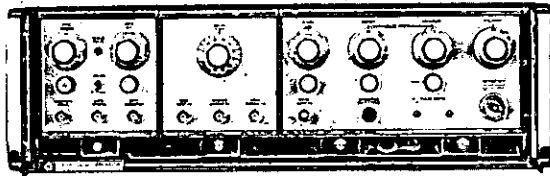
	1915A*	1917A	1920A
Max Rep Rate	25 MHz	25 MHz	25 MHz
Output Amplitude	±2.5 to ±50 V	0.2 to 10 V	0.5 to 5 V
Risetime	7 ns to 1 ms	7 ns to 500 μs	< 350 ps
Falltime	7 ns to 1 ms	7 ns to 500 μs	< 400 ps
Offset	±1.5 V	±2.5 V	±2 V
Ext Width Input	Yes	Yes	No
Pulse Width	10 ns to 40 ms	10 ns to 40 ms	0 to 10 μs
Price	\$1600	\$525	\$1750
Page	259	260	261

*Only use in 1900A mainframe.

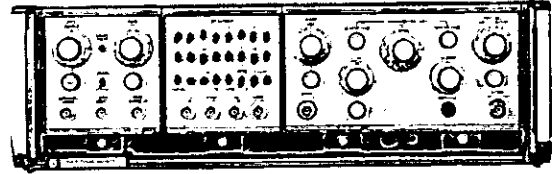


PULSE GENERATOR

Plug-in, variable risetime/falltime
Model 1900 system



1900A



1901A

Model 1900A and 1901A Pulse Generator mainframes accept 1900-series plug-ins. The plug-in compartment holds any combination of quarter-size or half-size plug-ins. Plug-ins are interchangeable and may be interconnected by internal wiring and switches or by external cables.

Model 1900A mainframe contains power supplies for the 1900 series plug-ins including the 50 volt high power (1 ampere into 50 ohms) 1915A output plug-in. Model 1901A mainframe contains power supplies for the 1900 series plug-ins, except the 1915A, for pulse systems that do not require more than 10 volt pulse amplitudes.

Specifications, 1900A, 1901A

Plug-ins: 1900 series quarter-size or half-size plug-ins. Plug-ins may be interchanged in any manner within the mainframe.

Interconnection between plug-ins: either external (with BNC cables) or internally selectable with switches in the plug-ins.

Dimensions: 16 $\frac{3}{4}$ " wide, 5 $\frac{1}{4}$ " high, 21 $\frac{3}{8}$ " deep over-all (425 x 133 x 543 mm); hardware furnished for quick conversion to 19" x 5 $\frac{1}{4}$ " x 19 $\frac{3}{8}$ " behind panel rack mount (483 x 133 x 492 mm).

Weight: 1900A, net 35 lb (16 kg); shipping, 46 lb (21 kg). 1901A, net 28 lb (13,5 kg); shipping, 39 lb (18,8 kg).

Power: 115 or 230 volts \pm 10%, 50 to 60 Hz; 1900A, 300 watts max. 1901A, 250 watts max.

Options

Option 001: programming cables and four rear panel connectors, providing 36 pins to each quarter-size plug-in (or 72 pins for double-size). Price: Option 001, \$175 (additional).

Option 002: factory-installed chassis slides, non-pivoting. Price: Option 002, \$75 (additional).

Accessories available

Chassis slides kit for field installation; non-pivoting. Order HP Part No. 01900-69401. Price: \$75.

Programming kit for field installation, HP Part No. 01900-69502. Price: \$175.

Price: HP Model 1900A, \$750.

HP Model 1901A, \$450.

Blank plug-ins

Blank plug-ins are available for either filling of unused compartment space in a 1900 system, or for construction of special purpose plug-ins. Price: HP Model 10481A quarter-size unit, \$20; HP Model 10482A half-size unit, \$25.

Plug-in extender

The 1900 pulse generator system may be serviced and calibrated by removing the top covers. However, for greater convenience, a plug-in extender is available which accommodates both quarter-size and half-size units. The extender allows access to either quarter-size or half-size plug-ins outside the mainframe with the system operating. Extender also includes wiring for programming options. Price: HP Model 10484A, \$135.

Pulse adder

Model 15104A Adder is useful when outputs from two pulse sources must be combined to produce complex signals. It also serves as a signal splitter when one pulse source must drive two paths. Two or more adders may be used to combine outputs of three or more pulse sources.

Reflection: 10% in 150 ps pulse system (dc to over 2 GHz equivalent bandwidth).

Risetime: <150 ps.

Maximum input: 2 W into two inputs with third connector terminated in 50 ohms. Maximum average voltage not to exceed 5 V between two connectors.

Output voltage: algebraic sum of half the voltage from each input.

Input connectors: two BNC female, one BNC male.

Price: HP Model 15104A, \$20.

Splitter inverter

Model 15115A Splitter Inverter converts a single input pulse into two opposite polarity pulse outputs. This facilitates driving push-pull stages and flip-flops with one pulse source.

Reflection: 10% in a 50-ohm, 150 ps pulse system.

Risetime: 250 ps non-inverted output; 500 ps inverted output.

Droop at 500 ns pulse width: <2.5% non-inverted output; <4% inverted output.

Maximum average input: 6 dB non-inverted output; 6.2 dB inverted output.

Delay between inverted and non-inverted outputs: <1 ns.

Price: HP Model 15115A, \$50.

Inverter

Model 15116A Inverter reverses polarity of input pulses. Extends possible variety of complex pulse waveforms when used with Model 15104A Adder and Model 15115A Splitter Inverter.

Reflection: 10% in a 50-ohm, 150 ps pulse system.

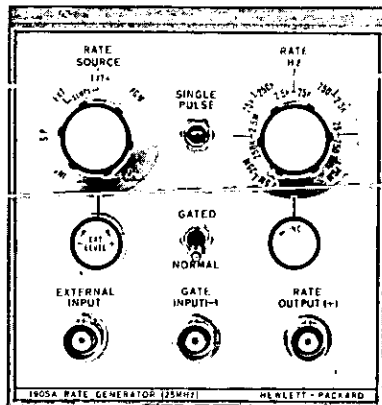
Risetime: 500 ps.

Droop at 500 ns pulse width: <5%.

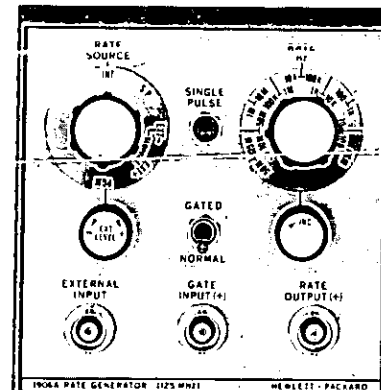
Insertion loss: 0.3 dB.

Price: HP Model 15116A, \$30.

Rate generators Models 1905A, 1906A



1905A



1906A

The Model 1905A Rate Generator is a quarter-size plug-in which serves as a clock source for the 1900 system. The Model 1905A provides output triggers at repetition rates from 25 Hz to 25 MHz.

Either external triggering or internal rate generator operation may be used. Rate generator outputs are obtained using either sinusoidal or pulse waveforms as the external input. Outputs from Model 1905A may be synchronously gated externally by applying a suitable pulse waveform.

Rate source, rate range, and rate vernier may be externally programmed; see specifications.

Specifications, 1905A

Internal

Repetition rate: 25 Hz to 25 MHz in 6 decade ranges. 10:1 vernier allows continuous adjustment on any range.

Period jitter: <0.1% of selected period.

External input

Repetition rate: 0 to 25 MHz.

Input impedance: 50Ω, dc-coupled.

Sensitivity: 0.5 volts pk-pk.

Level: continuously variable over ±3 volt range.

Slope: + or -, selectable.

Delay: approximately 10 ns between trigger input and rate output.

Synchronous gating

Sensitivity: -2 volts or more required to gate pulse train on.

Input impedance: 50Ω, dc-coupled.

Delay: approx 27 ns between gate input and first rate output.

Manual operation: pushbutton for single pulse.

Rate output

Amplitude: >+1 volt into 25Ω (drives two 1900 series plug-ins).

Risetime: <5 ns.

Width: <10 ns.

Connection: rate output may be connected internally or externally to other plug-ins, selected by internal switch.

Weight: net, 1½ lbs (0.7 kg); shipping, 3½ lbs (1.6 kg).

Option 001: programming connector and circuits allowing Rate Source and Rate Range selection by contact closure to ground; Rate vernier programmed by analog current allowing continuous rate selection. Price: Model 1905A Option 001, \$100 (additional).

Accessories available

Programming kit: field installation of same capability as Option 001. Price: \$100.

Price: HP Model 1905A, \$200.

Model 1906A Rate Generator is a quarter size plug-in that is a 125 MHz clock source for the 1900 pulse system. Either external triggering or internal rate generator operation may be selected. Rate generator outputs are obtained using sinusoidal or pulse waveforms as the external input. Outputs from the 1906A may be synchronously gated externally by applying a pulse waveform. Also, as an option, rate source, range, and vernier may be externally programmed. See specifications.

Specifications, 1906A

Internal

Repetition rate: 10 Hz to 125 MHz in 8 ranges. 10:1 vernier allows continuous adjustment on any range.

Period jitter: <0.1% of selected period.

External input

Repetition rate: 0 to 125 MHz.

Input impedance: 50 ohms, dc-coupled.

Sensitivity: 0.5 volts pk-pk up to 50 MHz; 1.5 volts p-p from 50 MHz to 125 MHz.

Level: continuously variable over ±3 volt range.

Slope: + or -, selectable.

Delay: approximately 12 ns between trigger input and rate output.

Maximum input: ±5 volts.

Synchronous gating

Sensitivity: +1 volt to +5 volts required to gate pulse train on.

Input impedance: 50 ohms, dc-coupled.

Delay: approximately 15 ns between gate input and first rate output.

Manual operation

Pushbutton for single pulse.

Rate output

Amplitude: >+1.5 volts into 25 ohms (drives two 1900 series plug-ins).

Risetime: <2 ns.

Width: >4 ns.

Connection: rate output may be connected internally or externally to other plug-ins, selected by internal switch.

Weight: net, 1½ lb (0.7 kg); shipping, 3½ lb (1.6 kg).

Option 001: programming connector and circuits allowing Rate Source (int and ext only), and Rate Range selection by contact closure to ground; Rate vernier programmed by analog current allowing continuous rate selection.

Price: Model 1906A Option 001, \$100 (additional).

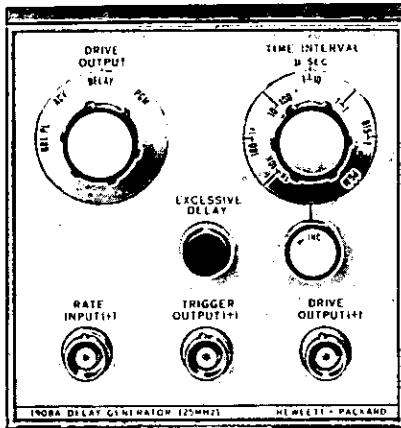
Programming kit: field installation of same capability as Option 001.

Price: \$100.

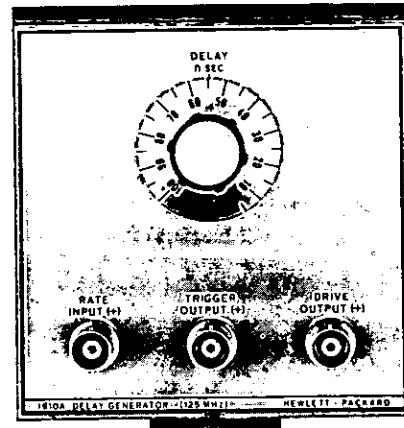
Price: Model 1906A, \$275.



Delay Generators Models 1908A, 1910A



1908A



1910A

Pulses up to 25 MHz in frequency may be advanced or delayed with the Model 1908A Delay Generator, a quarter-size plug-in for the 1900 pulse system. Range for pulse advance or delay is from 15 ns to 10 ms.

A double pulse mode can be used to generate pulse pairs with variable separation of pulses.

The trigger output is useful for triggering other external equipment or it is sufficient to drive two variable transition time output plug-ins.

Drive output mode, time interval range, and time interval vernier can be externally programmed; see specifications.

Specifications, 1908A

Functions (drive output switch)

Delay: drive output delayed with respect to trigger output.

Advance: trigger output delayed with respect to drive output.

Double pulse: generated from drive output connector. Spacing determined by time interval setting.

Time interval

Range: 15 ns to 10 ms in 6 ranges. 10:1 vernier allows continuous adjustment on any range.

Jitter: 0.1% of selected time interval.

Excessive delay indicator: light comes on when selected time interval exceeds pulse period.

Rate input

Repetition rate: 0 to 25 MHz.

Input impedance: 50Ω, dc-coupled.

Sensitivity: >1 volt peak.

Width: portion of input trigger above 0.8 volts must be <7 ns.

Connection: rate input may be connected internally or externally from other plug-ins, selected by internal switch.

Trigger and drive outputs

Amplitude: >+1 volt into 25Ω drives two 1900 series plug-ins.

Width: <10 ns.

Risetime: <5 ns.

Minimum delay after rate input:

Trigger output: approx 14 ns in drive output delay mode; approx 29 ns in drive output advance mode.

Drive output: approx 29 ns in drive output delay mode; approx 14 ns in drive output advance mode.

Connection: drive output may be connected internally or externally to other plug-ins, selected by internal switch.

Weight: net, 1½ lbs (0,7 kg); shipping, 3½ lbs (1,6 kg).

Option 001: programming connector and circuits allowing Drive Output mode and Time Interval range selection by contact closure to ground; Time Interval vernier programmed by analog current allowing continuous time interval selection. Price: Model 1908A Option 001, \$100 (additional).

Accessories available

Programming kit: field installation of same capability as Option 001, HP Part Number 01908-69501, Price: \$100.

Price: HP Model 1908A, \$200.

1910A Delay Generator

Pulses up to 125 MHz in frequency may be delayed with the Model 1910A Delay Generator, a quarter-size plug-in for the 1900 pulse system. Range for pulse delay is from 5 to 100 ns in 5 ns steps.

The 1910A has very low jitter (<10 ps) and can delay pulses greater than a pulse period.

Specifications, 1910A

Time interval

Range: 5 ns to 100 ns in 5 ns steps.

Jitter: <10 ps.

Rate input

Repetition rate: 0 to 125 MHz.

Input impedance: 50 ohms, dc-coupled.

Sensitivity: <+1.5 volt peak.

Connection: rate input may be connected internally or externally from other plug-ins, selected by internal switch.

Trigger and drive outputs

Amplitude: >+1.5 volt into 25 ohms (drives two 1900-series plug-ins).

Base width: approx 8 ns.

Risetime: <3 ns.

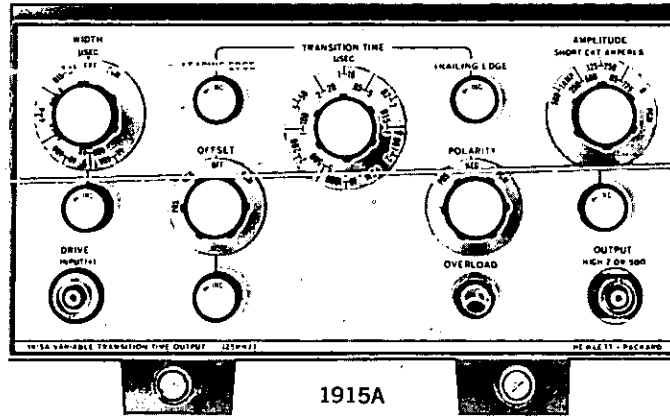
Minimum delay between rate input and trigger output: approximately 5 ns.

Connection: drive output may be connected internally or externally to other plug-ins, selected by internal switch.

Weight: net 2½ lb (1,1 kg); shipping 4¾ lb (2,2 kg).

Price: HP Model 1910A, \$150.

High power, variable rise and fall Variable transition time output Model 1915A



Model 1915A Variable Transition Time Output, a half-size plug-in, provides high-power, variable risetime and falltime output pulses. These pulses, with reversible polarity and with risetime and falltime as fast as 7 ns, are useful in testing magnetic memory devices and in other applications requiring high currents and voltages. Maximum current available is 1 ampere (50 volts into 50 ohms).

Either 50-ohm or high impedance source is available. The 50-ohm source impedance preserves the clean pulse shape by absorbing reflections from an external load. The high impedance source provides maximum current and voltage.

Risetimes and falltimes are variable from 7 ns to 1 ms. A common control selects the range and verniers select risetime and falltime separately. Ratios between transition times up to 100:1 provide a wide degree of flexibility.

Specifications, 1915A (operates in 1900A mainframe only)

Output pulse

Source impedance: 50 Ω or high Z; self-contained 50 Ω termination may be connected or disconnected.

High Z output: approximately 5 k ohms shunted by 45 pF.

50 Ω output: approximately 50 Ω shunted by 45 pF.

Amplitude (short circuit current): 50 milliamperes to 1 ampere in 4 ranges; 2.5:1 vernier allows continuous adjustment on any range. Voltage into external 50 Ω is ± 2.5 V to ± 50 V with high Z source; ± 1.25 V to ± 25 V with 50 Ω source. Maximum amplitude (including offset) is ± 50 V.

Pulse top variations

With 50 Ω source and 50 Ω load: $\pm 5\%$ for transition times 7 ns to 20 ns; $\pm 2\%$ for transition times > 20 ns.

With high Z source and 50 Ω load: $\pm 5\%$ for all transition times.

Polarity: + or -, selectable.

Duty cycle: 0 to $> 90\%$, internal width mode; 0 to 100%, external width mode.

Baseline offset: ± 60 milliamperes. Maximum offset into external 50 Ω is ± 1.5 volts with 50 Ω source; ± 3 volts with high Z source.

Overload: overload light comes on to indicate protection circuits are limiting output to prevent damage to output transistors. Two common combinations of overload conditions are: (a) 25-ohm combined load (source and external), $< 0.2\%$ duty cycle, and width > 2 μ s; and (b) 50-ohm combined load, > 2 μ s transition time, and > 35 volts amplitude.

Transition times: 7 ns (10 ns with high Z source) to 1 ms in 11 ranges (1,2,5 sequence); two 100:1 verniers allow independent control of rise- and falltimes.

Width

Internal

Ranges: 10 ns to 40 ms in 7 decade ranges (except for first

range which is 10 to 40 ns); 10:1 vernier allows continuous adjustment on any range.

Width jitter: $< 0.5\%$ of selected pulse width.

External: provides pulse amplifier operation; output pulse width determined by width of drive input.

Drive input

Repetition rate: 0 to 25 MHz.

Input impedance: 50 Ω , dc-coupled.

Sensitivity: $> +1$ volt peak.

Connection: drive input may be connected internally or externally from other plug-ins, selected by internal switch.

Options

Option 001: programming connector and circuitry allowing width range, Transition Time range, Amplitude range, Offset and Polarity selection by contact closure to ground; verniers for Width, Leading Edge, Trailing Edge, Offset, and Amplitude programmed by analog current allowing continuous control on any range. Price: Model 1915A Option 001, \$275 (additional).

Option 002: provides positive-only pulse output and positive-only offset. Price: Model 1915A Option 002, deduct \$225.

Option 003: provides negative-only pulse output and negative-only offset. Price: Model 1915A Option 003, deduct \$225.

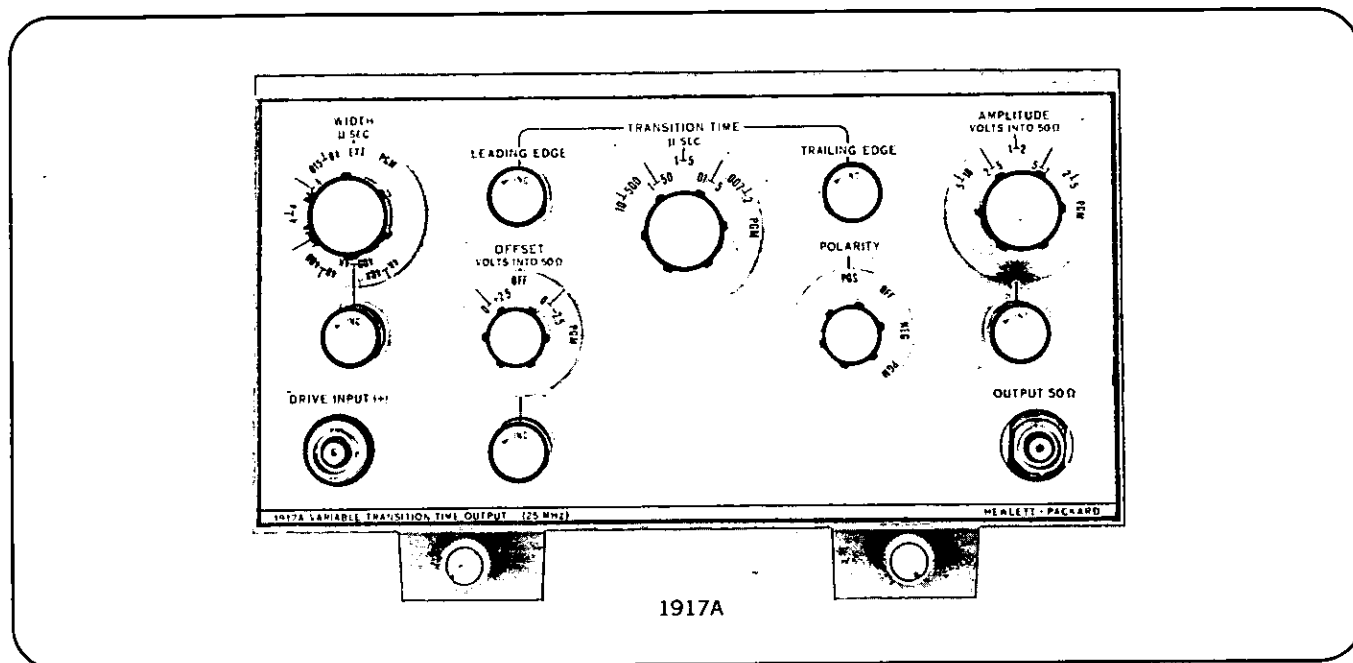
Option 004: calibration of pulse amplitude in voltage. Four ranges provide from ± 2.5 V to ± 50 V from high Z source into 50 Ω external load or ± 1.25 V to ± 25 V from 50 Ω source into 50 Ω external load. Price: Model 1915A Option 004, add \$25.

Accessories available

Programming kit: field installation of same capability as Option 001. Price: HP Part No. 01915-69501, \$275.

Price: HP Model 1915A, \$1600.

Variable transition time output Model 1917A



Description

Model 1917A Variable Transition Time Output, a plug-in for the 1900 Pulse System, provides low-power, variable rise-time and falltime output pulses. The 1917A provides pulses with reversible polarity and with rise and falltimes as fast as 7 ns. It is designed for use with the Model 1901A or 1900A mainframes and has a voltage output of up to ± 10 volts into 50 ohms. A 50-ohm source impedance preserves the clean pulse shape by absorbing reflections from an external load.

Risetime and falltimes are variable from 7 ns to 500 μ s. A common control selects the range, and verniers select risetime and falltime separately. Ratios between transition times up to 50:1 provide a wide degree of flexibility.

A unique external width function extends useability to many

new applications such as pulse-code modulation (pcm) and digital circuits requiring return-to-zero (RZ) or non-return-to-zero (NRZ) word formats. It also may be used as a pulse amplifier.

Offset capability of the 1917A allows the pulse baseline to be varied over a ± 100 mA range. A zero position on the current offset switch allows setting the baseline quickly and accurately to ground.

All front panel control functions can be externally programmed. This capability is available initially as Option 001, or a kit may be ordered at a later date. Two Model 1917A's may be operated in one mainframe.

Specifications, 1917A

Output pulse

Source impedance: approximately 50 ohms shunted by 45 pF.

Amplitude: (volts into 50 ohms) 0.2 to 10 volts; 2.5:1 vernier allows continuous adjustment on any range.

Pulse top variations: $\pm 5\%$ for transition times > 7 ns.

Polarity: + or -, selectable.

Duty cycle: 0 to approximately 90%, internal width mode; 0 to 100%, external width mode.

Baseline offset: ± 2.5 volts into external 50 ohms.

Transition times: 7 ns to 500 μ s in 5 ranges; two 50:1 verniers allow independent control of rise and fall times.

Width

Internal

Ranges: 10 ns to 40 ms in 7 decade ranges (except for first range which is 10 to 40 ns); 10:1 vernier allows continuous adjustment on any range.

Width jitter: $< 0.5\%$ of selected pulse width.

External

Provides pulse amplifier operation; output pulse width determined by width of drive input.

Drive input

Repetition rate: 0 to 25 MHz.

Input impedance: 50 ohms, dc-coupled.

Sensitivity: $> +1$ volt peak.

Connection: drive input may be connected internally or externally from other plug-ins, selected by internal switch.

General

Options

Option 001: programming connector and circuits allowing width range, transition time range, amplitude range, offset and polarity selection by contact closure to ground; verniers for width, leading edge, trailing edge, offset, and amplitude programmed by analog current allowing continuous control on any range. Price: Model 1917A Option 001, \$275 (additional).

Programming kit

Field installation of same capability as Option 001. HP Part No. 01917-69501. Price: \$275.

Weight: net, 2½ lbs (1,1 kg); shipping, 6¼ lbs (2,8 kg).

Price: HP Model 1917A, \$525.

SIGNAL SOURCES 1900 SYSTEM *continued*
350 ps risetime, digital formatting
Models 1920A, 1925A

Model 1920A Fixed Transition Time Output, a plug-in for the 1900 Pulse System, provides very fast fixed rise and fall-times with variable width and amplitude. These pulses, with reversible polarity, are useful in checking pulse responses of digital systems and propagation times.

The 50-ohm impedance preserves the clean pulse shape by absorbing reflections from an external load.

Offset capability of the Model 1920A allows the pulse baseline to be varied over a ± 2 volt range into 50 ohms.

Width, amplitude vernier, and offset functions can be externally programmed. This capability is available as Option 001, or a kit may be ordered at a later date.

Specifications, 1920A
Output pulse

Source impedance: approximately 50 ohms.

Amplitude: 0.5 to 5 volts in three ranges; 2.5:1 vernier allows continuous adjustment on any range.

Transition time:

Risetime: < 350 ps

Falltime: < 400 ps

Pulse top variations: < 10% at maximum amplitude.

Polarity: + or -, selectable.

Baseline offset: maximum offset into external 50 ohms is ± 2 volts.

Width: 0 to 10 μ s in four ranges. 10:1 vernier allows continuous adjustment on any range.

Drive input

Repetition rate: 0 to 25 MHz.

Input impedance: 50 ohms $\pm 5\%$, dc-coupled.

Sensitivity: > +1 volt peak.

Connection: drive input may be connected internally or externally from other plug-ins, selected by internal switch.

Options

Option 001: programming connector and circuits allowing width range and offset selection by contact to ground; verniers for width, offset, and amplitude programmed by analog current allowing continuous control on any range. Price: Model 1920A Option 001, on request.

Programming kit

Field installation of same capability as Option 001. HP Part No. 01920-69501. Price: on request.

Weight: net, 4 lbs (1,8 kg); shipping, 7 $\frac{3}{4}$ lbs (3,5 kg).

Price: HP Model 1920A, \$1750.

1925A Word Generator

The 1925A Word Generator plug-in, for the 1900 Pulse System, will generate a 2 to 16-bit, serial digital word at a clock rate of up to 50 MHz. Operating modes available at the flick of a switch are: return-to-zero (RZ) or non-return-to-zero (NRZ) format, complementary output, manual or automatic word recycling, and programming. Front-panel controls allow you to set or clear the internal registers to establish reference levels and sequences. In addition, a pseudo-random noise (PRN) sequence of 32,767 bits is provided for testing communication channels and LSI memories.

Any one or all Word Generator inputs and outputs may be switched to the front panel or the mainframe connector. This allows complicated configurations to be patched inside the mainframe and clears the front panel of transmission lines.

Specifications, 1925A
Functions

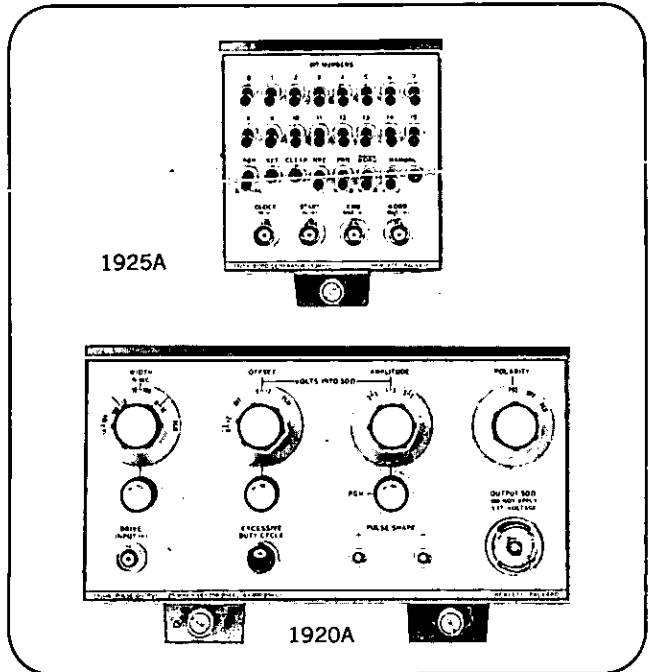
Word length: 2 to 16 bits, set by internal switches; not programmable.

Word content: set by front-panel switches or rear-panel programming.

Word format: NRZ/RZ, selectable from front panel or programmed. RZ PULSE width less than $\frac{1}{2}$ clock period. WORD or WORD selectable from front-panel switch.

Word cycling: automatic (continuous with one clock period delay between words), external start command, or manual pushbutton.

Manual/auto: selectable from front-panel switch or programmed.



In AUTO mode, word continuously recycles with one clock period delay between words. In program mode, content of each word corresponds to the previous parallel word input that existed > 200 ns before and during END. In manual mode, a word starts after receiving an external start signal or pressing MANUAL pushbutton and stops after 16 clock pulses.

End out: available from front panel BNC corresponding to end-of-word.

Set: serially loads 1's into shift register. Output word bits are all 1's after 16 clock pulses.

Clear: parallel reset of shift register. Output word bits are all zero.

Pseudo-random noise: provides a linear shift register sequence of 32,767 bits. The sequence starts with the last 16-bit word in the shift register.

Programming: all data bits, NRZ/RZ, PRN/WORD, and MAN/AUTO.

Interface
Clock input

Repetition rate: 0 to 50 MHz.

Amplitude: > 1 volt, ± 5 V max.

Width: > 4 ns, < 18 ns at +0.6 volts.

Input impedance: 50 ohms dc-coupled.

Start input

Period: word length plus 15 ns.

Amplitude: > 1 volt, ± 5 V max.

Width: > 5 ns.

Input impedance: 50 ohms dc-coupled.

Programming inputs

True: contact closure, saturated DTL, or voltage source (T^L) < +0.2 V.

False: open, off DTL or voltage source (T^L) > 2.5 V, < 4.0 V.

Word and end output

True: 40 \pm 10 mA current source or 2.0 \pm 0.5 V into 50 ohms.

False: < 1 mA.

Rise and fall times: < 4 ns (10% to 90%).

Perturbations: < 15%.

Source impedance: unterminated current source.

Price: HP Model 1925A, \$850.



Most systems, from simple servos to suspension bridges, are subject to random disturbances which must be accounted for in the design and—if possible—simulated at the prototype test stage. For the purpose of simulation it seems appropriate to use a randomly varying test signal—that is, low frequency noise—rather than the traditional sine wave. In environmental testing, too, the real-life 'shock environment' can often be reproduced accurately with a noise-stimulated transducer. The desirability of noise as a test signal has been appreciated for many years, but general acceptance of the technique has been slow—principally owing to the lack of satisfactory generators and related test gear for low frequency noise.

Conventional noise generators employ natural sources such as the gas discharge tube and temperature-limited diode. Generators of this type have the disadvantage that their total power output is subject to unpredictable long term variations: their power spectra, too, can often be unpredictable at low frequencies—in particular, below 50 Hz, where much of the interest in noise testing is focused.

Characterizing noise

The power spectrum describes only the frequency content of the noise signal, but does not characterize its waveshape: this is specified by the probability density function (p.d.f.), a statistical indication of the proportion of time spent by the signal at various amplitudes. The most commonly encountered p.d.f. is the classical bell-shaped, or Gaussian curve so familiar in statistics: this particular p.d.f. characterizes most random phenomena (for example, atmospheric changes) and for this reason, a noise signal designed to simulate such phenomena must have a p.d.f. which closely approximates the Gaussian curve. The question of p.d.f. is another problem area with conventional noise generators. How can 'Gaussianness' be specified? And, more difficult, over what period of time must the signal be evaluated to be certain that its amplitude characteristics tend to be Gaussian? Are the signal properties observed in a given period representative of the next similar period? This suggests that a series of identical experiments involving truly random noise will yield different results each time. This 'statistical variance' can often be reduced to acceptable limits by increasing the observation (that is, aver-

aging) time—but it can never be entirely eliminated.

Pseudo-random noise

The need exists, then, for a test signal having the desirable properties of random noise—that is, broad spectrum and Gaussian probability density function—yet not having the bad property . . . randomness. In other words, the signal should be one which introduces no statistical variance into test results, even though the measurements are made in a finite time.

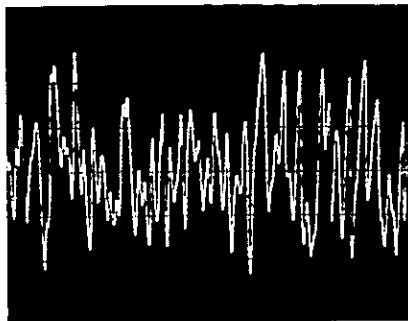
Such a signal exists . . . *pseudo-random* noise is a signal which looks and acts like random noise, but is in fact periodic. This kind of noise is the main product of the Hewlett-Packard Model 3722A Noise Generator.

Pseudo-random waveforms from the 3722A consist of completely defined patterns of selectable length, repeated over and over without interruption. They have power spectra and p.d.f.'s similar to those of random noise but, because the waveforms are synthesized, their statistical properties are precisely known. Perhaps the most important feature of pseudo-random noise testing is the fact that, if the measurement time is made exactly equal to the length of one pseudo-random pattern, the results of the experiment will be identical at every repetition, provided nothing else has changed.

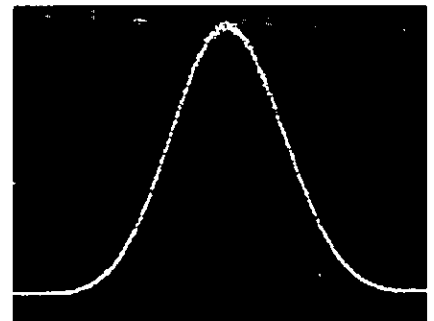
This repeatability of pseudo-random noise is especially valuable when parameters of the system under test are varied—for example, in an analog computer model of a complex system. In such tests,

it is reassuring to know that changes in test results arise from parameter manipulation and not from statistical variance in the test signal. The basic output from the Model 3722A is two-level, binary noise (random telegraph signal), available as a pseudo-random signal in a variety of pattern lengths, and also as a truly random, non-repeating signal. Binary noise is commonly used in testing systems controlled by two-state elements such as switches, relays, fluid control valves, and so on. Recently, however, binary noise has assumed greater importance in connection with actual identification of systems . . . that is, obtaining the impulse response of a system by injecting low-level binary noise into the system and then cross-correlating the input and output signals. This technique can be demonstrated very simply using the 3722A option H01 Generator, a standard Model 3722A instrument with two separate binary outputs, one of which can be variably delayed with respect to the other.

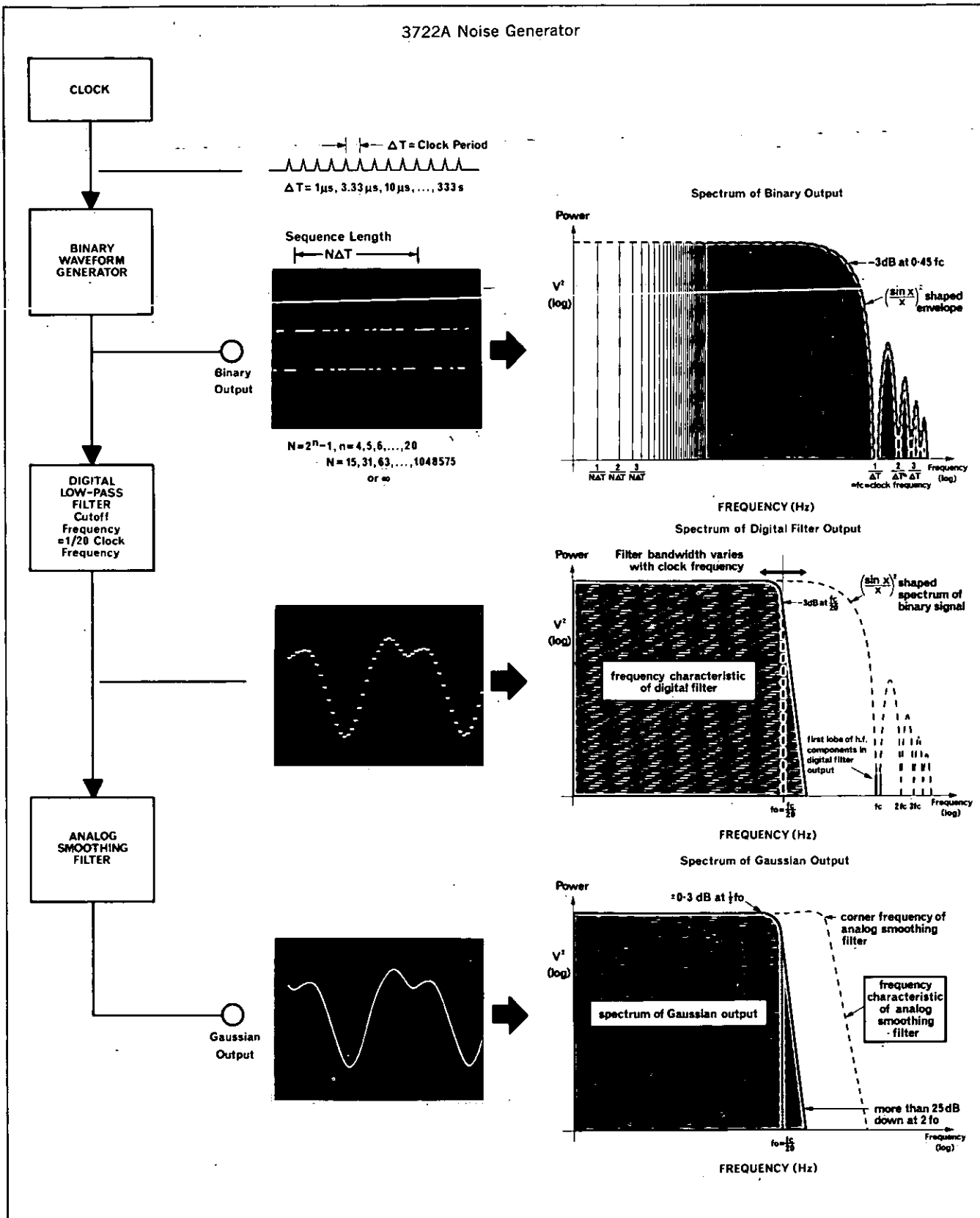
The principal output from the Model 3722A is Gaussian noise, which is derived from the binary signal by low-pass filtering. A unique method of digital filtering is employed to give an almost rectangular power spectrum with very little power beyond a selectable cut-off frequency. The particular advantage of this digital filter, as opposed to the conventional analog filter, is that it yields a signal of constant power regardless of cut-off frequency (in any event, analog filtering is not practicable at the very low frequencies useful in noise testing—the lowest cut-off frequency of the digital filter in the Model 3722A is about 1 cycle in 100 minutes!).



Part of a pseudo-random Gaussian noise sequence generated in Model 3722A from 524, 287-bit binary pattern. Clock period is 1 μ s, giving noise bandwidth of 50 kHz.



Probability density function of pseudo-random Gaussian noise (same sequence as at left) displayed on Model 5400A Multi-channel Analyzer.



Model 3722A Noise Generator synthesizes pseudo-random or random binary signal in a digital waveform generator which is timed by a crystal-controlled clock. Clock rate and length of pseudo-random sequences are variable. Gaussian signal is derived from binary output by digital low-pass filtering. Discrete steps in digital filter output are removed by analog filter. Pseudo-random binary output of noise generator has line power spectrum having a flat envelope from dc to an upper 3 dB frequency which is selectable from 0.00135 Hz to 450 kHz. Spectrum of pseudo-random Gaussian output has flat envelope from dc to an upper 3 dB frequency which is selectable from 0.00015 Hz to 50 kHz. Random outputs have continuous power density spectra having same shapes as envelopes of spectra of pseudo-random outputs.



NOISE GENERATOR

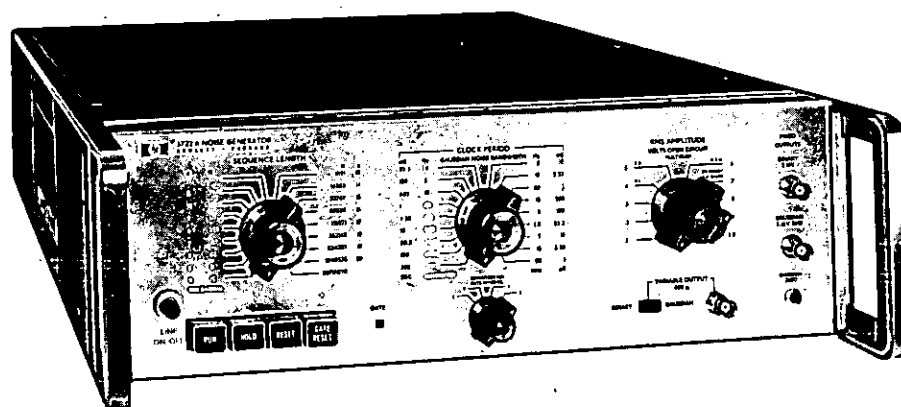
Produces calibrated noise patterns
Model 3722A

The Model 3722A Noise Generator uses digital techniques to synthesize binary and Gaussian noise patterns. These 'pseudo-random' patterns, which are of known content and duration, are repeated over and over without interruption. Since one pattern is identical with the next, each pattern has the same effect on the system under test: for this reason, pseudo-random noise signals cause no statistical variance in test results. The Model 3722A also generates truly random binary and Gaussian noise.

Basis of the Model 3722A is a binary waveform generator—a shift register which operates under the control of either a feedback mechanism (pseudo-random mode) or a random noise source (random mode). The shift register is clock triggered, with the result that transitions between output levels of the binary waveform can occur only in time with beats of the clock—although whether or not a transition occurs on a given beat is determined by the feedback mechanism or random noise

source. The binary output has a $(\sin x/x)^2$ shaped spectrum and the Gaussian output, which is derived from the binary signal by precision low-pass filtering, has an almost rectangular spectrum. Both binary and Gaussian outputs are controllable in bandwidth, but the output power remains constant regardless of selected bandwidth—a particularly useful feature, of importance in applications where usable noise power must be made available in a very restricted frequency band. Frequency of the first null in the binary spectrum is selectable from 0.003 Hz to 1 MHz, and the bandwidth (at -3 dB point) of the Gaussian noise is selectable from 0.00015 Hz to 50 kHz.

Outputs from the Model 3722A are available at fixed amplitudes of ± 10 V (binary) and 3.16 V rms (Gaussian), and a precision amplitude control provides a variable output of either signal ranging from 0.1 V rms up to the level of the fixed outputs.



3722A

Specifications

Binary output (fixed amplitude)

Amplitude: ± 10 V.

Output impedance: $< 10\Omega$.

Load impedance: 1 k Ω minimum.

Rise time: < 100 ns.

Power density: approximately equal to (clock period \times 200) V²/Hz, at low frequency end of spectrum.

Power spectrum: $(\sin x/x)^2$ form: first null occurs at clock frequency and -3 dB point occurs at $0.45 \times$ clock frequency.

Gaussian output (fixed amplitude)

Amplitude: 3.16 V rms.

Output impedance: $< 1\Omega$.

Load impedance: 600 Ω minimum.

Zero drift: < 5 mV change in zero level in any 10°C range from 0° to +55°C.

Power density: approximately equal to (clock period \times 200) V²/Hz at low frequency end of spectrum.

Power spectrum: rectangular, low pass: nominal upper frequency f_0 (-3 dB point) equal to $1/20$ th of clock frequency. Spectrum is flat within ± 0.3 dB up to $1/2 f_0$, and more than 25 dB down at $2f_0$.

Crest factor: up to 3.75, dependent on sequence length.

Variable output (Binary or Gaussian)

Amplitude (open circuit)

Binary: 4 ranges: ± 1 V, ± 3 V, ± 3.16 V and ± 10 V, with ten steps in each range, from $\times 0.1$ to $\times 1.0$.

Gaussian: 3 ranges: 1 V rms, 3 V rms, and 3.16 V rms, with ten steps in each range, from $\times 0.1$ to $\times 1.0$.

Output impedance: 600 $\Omega \pm 1\%$.

Main controls

Sequence length switch: first 17 positions select different pseudo-random sequence lengths; final position selects random mode of operation (INFINITE sequence length). Sequence length (N) is number of clock periods in sequence: possible values of N are 15, 31, 63, 127, 255, 511, 1023; 2047, 4095, 8191, 16383, 32767, 65535, 131071, 262143, 524287, 1048575. $N = 2^n - 1$, where n is in the range 4 to 20 inclusive.

Clock period switch: selects 18 frequencies from internal clock:

Clock period	Clock frequency	Gaussian noise bandwidth
333 s	0.003 Hz	0.0015 Hz
100 s	0.01 Hz	0.0005 Hz
33.3 s	0.03 Hz	0.0015 Hz
10 s	0.1 Hz	0.005 Hz
3.33 μs	300 kHz	15 kHz
1 μs	1 MHz	50 kHz

Internal clock

Crystal frequency: 3 MHz nominal.

Frequency stability: $< \pm 25$ ppm over ambient temperature range 0° to +55°C.

Output: +12.5 V rectangular wave, period as selected by CLOCK PERIOD switch.

External clock

Input frequency: usable BINARY output (pseudo-random only) with external clock frequencies up to 1 MHz.

Input level: negative-going signal from +5 V to +3 V initiates clock pulse.

Maximum input: ± 20 V.

Secondary outputs

Sync: negative-going pulse (+12 V to +1.5 V) occurring once per pseudo-random sequence; duration of pulse equal to selected clock period.

Gate: gate signal indicates start and completion of selected number of pseudo-random sequences (1, 2, 4 or 8, selected by front panel control). Two outputs are provided:—

1. Logic signal: output normally +12.5 V, falls to +1 V at start of gate interval and returns to +12.5 V at end of interval.
2. Relay changeover contacts: gate relay switching is synchronous with logic signal.

Binary relay: relay changeover contacts operate in sync with binary output signal.

Remote control

Control inputs: remote control inputs for RUN, HOLD, RESET and GATE RESET functions are connected to 36-way receptacle on rear panel.

Sequence length indication: 18 pins plus one common pin on the 36-way receptacle are used for remote signalling of selected sequence length (contact closure between common pin and any one of the 18 pins).

General

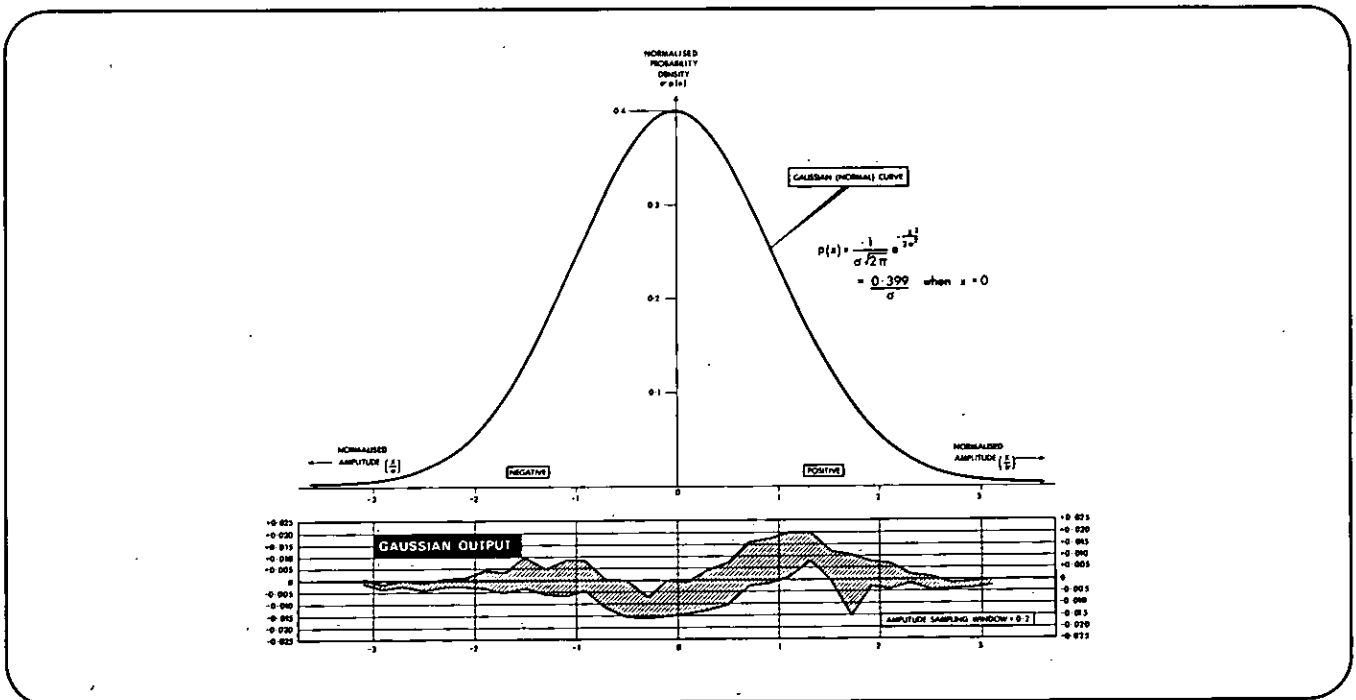
Dimensions: 16 3/4" wide, 5-7/32" high, 16 3/8" deep (425 x 132.6 x 416 mm).

Weight: net 23 lbs (10.5 kg); shipping 30 lbs (13.5 kg).

Price: Model 3722A, \$2,650 (\$2,400 at factory in Scotland).

Option 010

Zero moment option: shifts relative position of sync pulse and pseudo-random binary sequence such that first time moment of sequence, taken with respect to sync pulse, is zero (sequence shift mechanism is operative only when selected sequence length is ≤ 1023): option 010 also provides facility for inverting binary output signal. ADD \$50 (\$45 at factory in Scotland).



Envelope (shaded area) shows measured departures from the normal curve of 3722A Gaussian output p.d.f.'s for sequence lengths of 8,191 and greater.

SIGNAL SOURCES



NOISE GENERATOR

For cross-correlation experiments
Model 3722A option H01

Hewlett-Packard 3722A option H01, with only an integrator as additional equipment, provides all the facilities required for measurements of point-by-point correlation. Specification 3722A option H01 is a standard Model 3722A Noise Generator modified to provide a second binary output which can be delayed by a selectable number of clock periods with respect to the main binary output. The delayed binary output is available only when the instrument is in the pseudo-random mode, that is, generating repeated noise patterns.

The delay introduced between the two binary outputs is selected by three decade switches on the front panel. These switches, which are set according to a conversion table supplied with the instrument, provide almost all possible delays ranging from zero to the number of bits (N) in the sequence in use.

Delayed binary output

Typical performance figures for the delayed output are:—

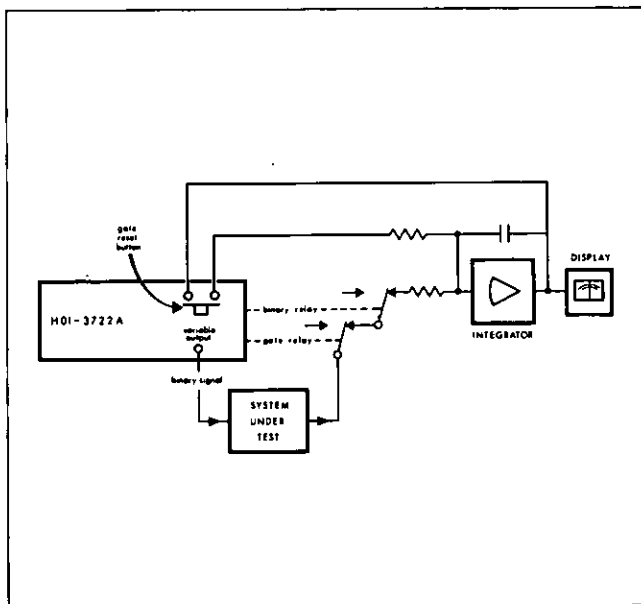
Amplitude: switches between +1.5 V and +12 V.

Maximum sink current at 1.5 V level: 10 mA.

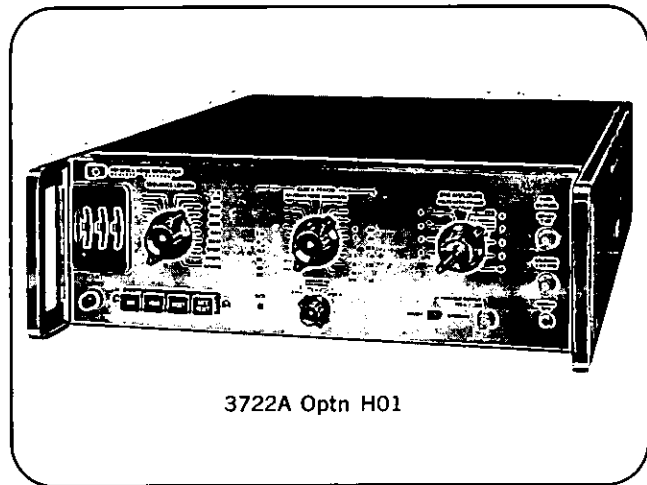
Rise time: <50 ns.

Fall time: <20 ns.

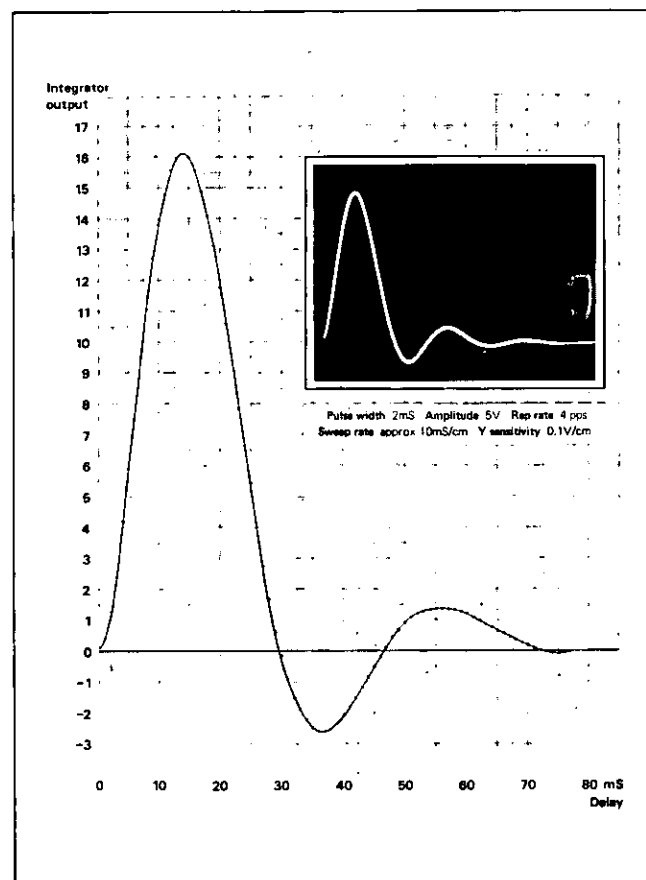
Price: 3722A option H01, \$2,950. (\$2,620 at factory in Scotland).



Typical set-up for cross-correlation with the 3722A option H01. Here, the main binary output is applied to the system under test, and the output from the system is multiplied by the delayed binary signal (the binary relay is controlled by the delayed signal: relay contact closed is equivalent to multiplication by 1, and contact open is equivalent to multiplication by zero). Integration time is controlled by the gate relay, which closes for a pre-selected number of noise constants. This set-up is suitable only for systems having long time constants (greater than 1 second). For systems with short time constants, electronic switches must be substituted for the relays.



3722A Optn H01



Impulse response of LC filter measured using 3722A option H01. Photo inset shows filter's response to a 2 ms pulse.

FUNCTION GENERATORS AND OSCILLATORS



SIGNAL SOURCES

This section contains technical information for function generators and oscillators covering frequencies from 0.00005 Hz to 32 MHz. Table 1 illustrates the frequency range and power output of Hewlett-Packard oscillators and function generators. The following explanations are divided into two parts. First will be the multi-output function generators and the next will be the sine-wave oscillators.

FUNCTION GENERATORS

A function generator is a signal generator that delivers a choice of different waveforms with frequencies adjustable over a wide range. The keynote of the modern function generator is versatility. The function generators now produce sine, triangle, square-wave, sawtooth waves, and pulses with a provision to sweep or analog program frequency up to four decades. This is useful for automatic testing systems and sweeping audio amplifiers, filters, and servo systems. The function generator is also used extensively in medical research projects for nerve stimulation and electroanesthesia.

HP's function generators extend from a low frequency of 0.00005 Hz (HP 203A Option 002) up to a high frequency of 5 MHz (HP 3310A).

HP 3310A

A compact function generator with the selection of seven output waveforms is available as the Model 3310A. The frequency range is from 0.0005 Hz to 5 MHz. The output wave shapes consist of sine, square, triangular, positive or negative going ramps, and positive or negative pulses. An open circuit dc offset of ± 10

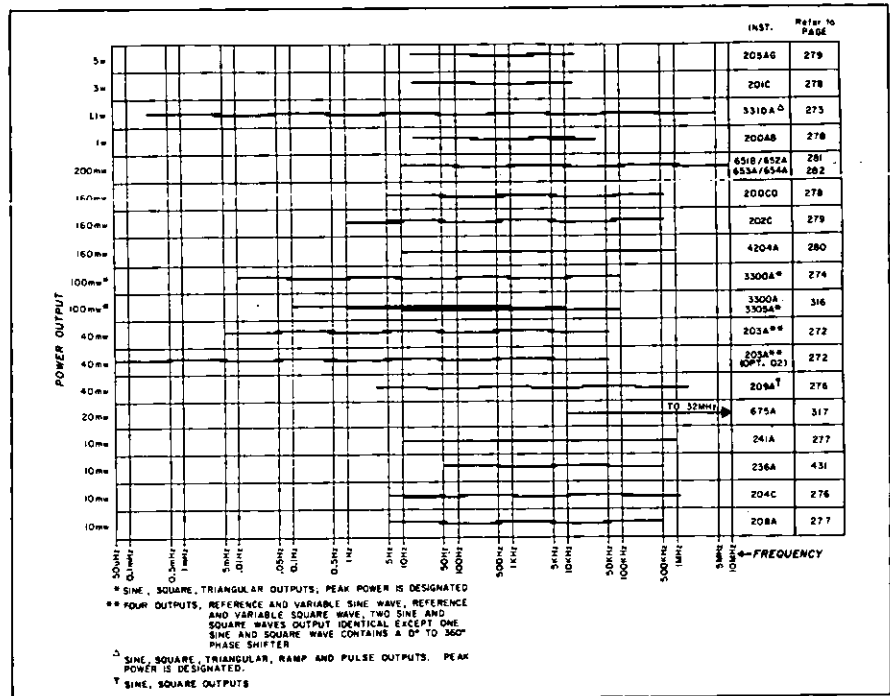


Table 1. Frequency range and power output of HP oscillators. Line segments show span of each range.

volts (± 5 volts into 50 ohms) can be applied to the output. Two output connectors provide a maximum of 15 volts peak to peak into a 50-ohm load and a low output 30 db less. Both outputs can be attenuated by the OUTPUT LEVEL control. A sync square or pulse output of 2 volts peak to peak into a 50-ohm load is simultaneously supplied. This can also be used for phase locking to a fundamental or a harmonic of another signal if an external detecting circuit is employed.

This instrument is primarily a voltage-to-frequency conversion device. A volt-

age from 0 to 10 volts is applied through the VCO or controlled by the frequency dial and through amplifiers is applied to the current source. Refer to Figure 1.

The input to the Triangle Amplifier is first a positive current, then a negative current. In the symmetrical functions SQ, SINE, and TRI, the positive current, is equal to the negative current. In the asymmetrical RAMP and PULSE functions, the positive and negative currents are unequal. The currents are reversed when the output of the triangle amplifier reaches either $+5$ or -5 volts as detected by the ± 5 Volt Level Detector.

The negative current linearly charges the integrating capacitors in a negative direction. This linearly changing voltage is the input to the Triangle Amplifier, causing the voltage output of the Triangle Amplifier to change linearly in a negative direction. When the output reaches -5 volts, the ± 5 Volt Level Detector flips; and the positive current output of the Current Source begins to linearly discharge the integrating capacitors. As the integrating capacitors are discharged, the Triangle Amplifier output continues in a positive direction until it reaches $+5$ volts. At $+5$ volts the ± 5 Volt Level Detector flips, and one cycle of the triangle wave is complete.

The time required to charge and discharge the integrating capacitors deter-

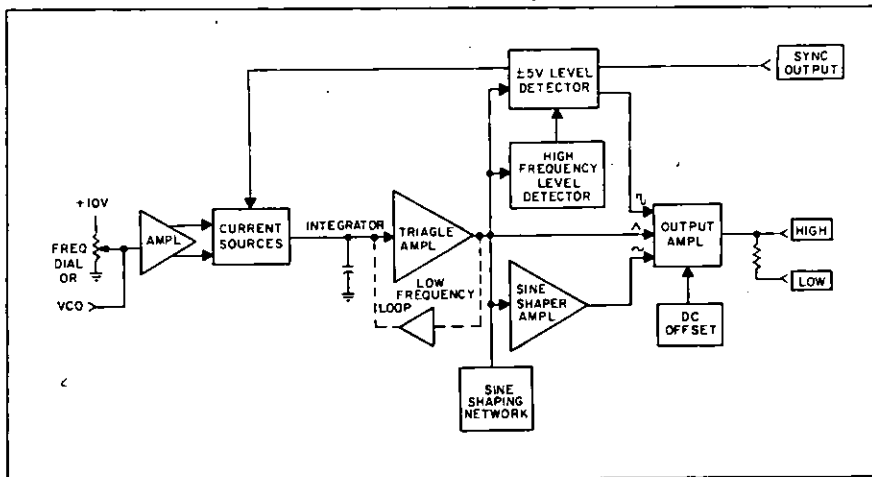


Figure 1. Block diagram of 3310A Function Generator.

mines the period of one cycle and therefore the frequency. The charge time could be changed by varying either the integrating current or the integrating capacitors. Depending on the range of frequency, either method is used.

Varying the Frequency Dial varies the integrating current at all frequencies. The wide frequency range of the 3310A is accomplished by a low frequency feedback loop and a high frequency level detector. On the 1 range and below, the Low Frequency Feedback Amplifier supplies an opposing integrating current. The amount supplied depends upon the RANGE position.

At frequencies above 50 kHz, the High Frequency Level Detector prevents overshoot in the ± 5 Volt Level Detector. To maintain high frequency accuracy, it is necessary to flip the ± 5 Volt Level Detector before the 5-volt level is reached. The High Frequency Level Detector determines how early the changes of state must take place to correct for loop delay.

The output of the Integrator Triangle Amplifier is the triangular or ramp output waveshape. The square, rectangular, or pulse output is derived from the ± 5 Volt Level Detector. The Triangle Amplifier output is synthesized into a sine wave by the Sine Shaping Network and Sine Shaping Amplifier. Each of these waveshapes is amplified by the Output Amplifier and sent to the output terminals.

HP 3300A

This function generator is made versatile by the use of plug-ins. The instrument with the HP 3301A Plug-in delivers sine, triangular, and square waves with a frequency range of 0.01 Hz to 100 kHz.

The 3300A Function Generator is a voltage-to-frequency network governed internally by the frequency dial or externally through the rear-panel frequency control voltage regulates the current sources shown in Figure 2, and the range switch controls the integration capacitance. As a result, there are no transients when switching between ranges or tuning to other frequencies.

The 3300A has two output amplifiers that provide simultaneous, individually selected outputs of any of the waveform functions.

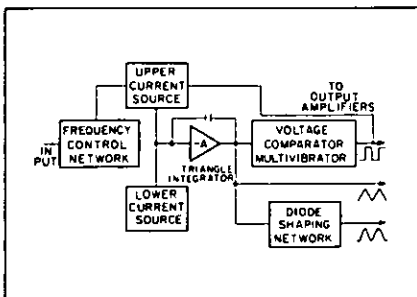


Figure 2. 3300A Function Generator.

3300A Plug-ins

The 3300A is made more versatile by the use of plug-ins (the 3300A must have a plug-in to operate). The HP Model 3301A Auxiliary Plug-in, 3302A Trigger/Phase Lock Plug-in, the 3304A Sweep/Offset Plug-in and the 3305A Sweep Plug-in are now available. The HP 3301A Auxiliary Plug-in provides internal connections for the basic operation of the unit, as described in the specifications for the 3300A Function Generator.

The HP Model 3302A Trigger/Phase Lock plug-in employs two basic operating principles. In the "Trigger" mode, it suppresses waveform generation in the main frame circuits, thus restricting the generator output to a single waveworm cycle or burst of cycles. In the "Phase-Lock" mode, it contributes a correction voltage to the Function Generator frequency-control circuits, phase-locking the output frequency to an external frequency source.

A front-panel meter indicates when phase lock is achieved. The phase relationship between the input and output signals can be adjusted by the front panel PHASE control over a range of 0° to 180° (180° to 360° by using the inverted output or by reversing the input polarity switch). The phase multivibrator acts as a detector (see Figure 3) which is set by the input signal and reset by the main frame square wave. These pulses are filtered to derive a dc control voltage.

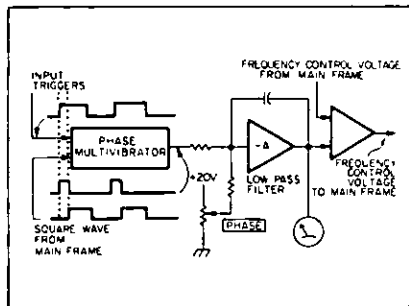


Figure 3. Block diagram of 3302A plug-in phase lock mode.

Thus, the 3300A frequency is continuously locked to the input. The 3300A may be locked to a harmonic of the input signal.

When the MODE switch is set to "Free Run", the plug-in circuits are disabled and the function generator operates in its basic manner. With the MODE switch set to either "Single" or "Multiple", the plug-in circuits stop the generation of waveforms by clamping the output of the triangle integrator to its input at a selected phase (see Figure 4). The waveform generating circuits are released by pressing the MANUAL TRIGGER button on the plug-in or by applying a trigger pulse or gate to the plug-in input. The point in the waveform at which waveform generation starts and stops is determined by the START/

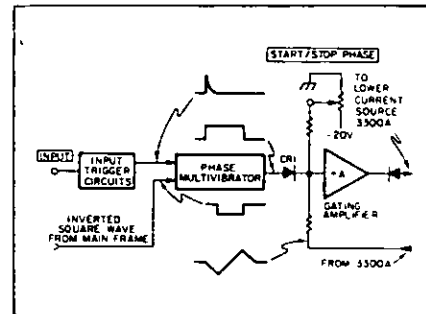


Figure 4. Block diagram of 3302A plug-in shown in single and multiple modes.

STOP-PHASE control, which can be adjusted over a range of -90° to $+90^\circ$ of the waveform.

The HP 3304A Sweep/Offset Plug-in provides internal sweeping up to a decade of frequency. It generates a sawtooth waveform and delivers it to either of the 3300A output terminals, and it also provides an offset square wave and a dc offset for all of the signals generated by the 3300A and 3304A.

For the sawtooth mode of operation, the 3304A uses a sawtooth generator, a RANGE switch, a FREQUENCY control and a \pm SAWTOOTH selector switch (see photo page 275).

For the internal sweeping of the 3300A output functions, the 3304A uses the negative sawtooth output. The start frequency is set by the 3300A FREQUENCY dial and RANGE selector (it may be by remote control). The circuitry of the 3304A adds the start frequency control voltage and the negative sawtooth ramp. The negative voltage swing of the ramp is controlled by the 3304A SWEEP WIDTH control. The rate of the sweep is controlled by the 3304A sawtooth frequency.

For the dc offset which is applied to all output functions of the 3300A, the 3304A applies a dc voltage between output ground and circuit ground. This dc offset voltage is controlled by a front-panel + and - switch and by a fine and coarse adjustment.

The 3305A is a Sweep Plug-in for the 3300A main frame which sweeps frequencies from 0.1 Hz to 100 kHz in three overlapping ranges (each range covers four-decades of frequency: 0.1 Hz to 1 kHz, 1 Hz to 10 kHz and 10 Hz to 100 kHz). Here, a low-frequency logarithmic sweeper can be obtained merely by purchasing another plug-in for the 3300A Function Generator.

The 3305A Sweep Plug-in is basically a controlled-current generator for the 3300A main frame. It provides automatic sweep, manual sweep, triggered sweep and it may be programmed by an external analog voltage.

The start and stop frequencies can be independently adjusted to any point on any range. The sweep of the preset frequencies allows logarithmic frequency

plots to be made and a good approximation to a linear sweep can be obtained when the sweep width is small. A linear sawtooth output is available for the X-axis of oscilloscopes or X-Y recorders. This Sweep Plug-in also includes signal blanking and pen lift during retrace.

For additional information on this 3305A Sweep Plug-in, refer to the Sweep Generator technical information, page 312, and the product pages 275 and 316.

Because of its versatility, the HP 3300A with its various plug-ins may be used for all of the applications listed in the first few paragraphs of this section.

HP 203A

Another HP function generator is the 203A Variable Phase Function Generator. This instrument has a sine wave and square wave output with a second channel that can be phase-shifted continuously through a full 360° range.

Although this function generator is intended primarily for low-frequency work, it has a frequency range extending from 60 kHz down to 0.005 Hz or, with options, down to as low as 0.00005 Hz (5 hours for 1 cycle). All four output signals are supplied simultaneously and all have individual 40 dB attenuators.

For a stable, low-distortion sine wave source, the 203A is ideal, for it has less than 0.06% combined harmonic distortion, hum and noise at full output.

HP 209A

A modification to the Wien bridge oscillator is the 209A Sine-Square Wave Oscillator. Stable, accurate signals which can be synchronized with an external source are instantly available over a frequency range of 4 Hz to 2 MHz. The amplitude of the sine and square wave outputs are separately adjustable and are available simultaneously. Distortion and flatness can be improved at low frequencies by a low distortion mode switch.

The block diagram in Figure 5 shows the basic construction of the sine-square oscillator. The Wien bridge oscillator requires a loop gain of unity in order to oscillate. This requirement is met by posi-

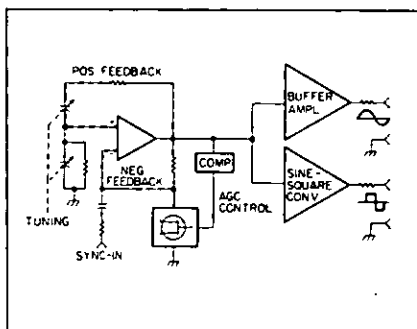


Figure 5. Block diagram of 209A Sine and Square Wave Oscillator.

and negative feedback circuits. The amplitude of the output is held constant by a peak comparator and an automatic gain control (AGC), as explained in the 204C operation page 270.

The sine wave output from the oscillator circuit is amplified by the buffer amplifier and fed to the output terminals. The amplifier has a high open loop gain that is controlled by the negative feedback to provide a gain of 2. This enables the circuit to have very low distortion characteristics. The output is fed through a complementary symmetry transistor pair similar to the oscillator amplifier output.

The sine wave output from the oscillator circuit is also applied to the sine-square converter. The sine wave is fed to a tunnel diode which produces a small square wave output with fast rise and fall times. This small square wave signal is then shaped and amplified. It appears at the output as a 20 volt peak-to-peak square wave.

OSCILLATORS

Signal sources have been described by various names—oscillators, test oscillators, audio signal generators, etc. Different names are applied, depending on the design and intended use of the source. The oscillator is basic to all the sources and generates sine-wave signals of known frequency and amplitude. In the recently developed transistorized sources, the name "test oscillator" has been used to describe an oscillator having a calibrated attenuator and output monitor. The term "signal generator" is reserved for an oscillator with modulation capability.

Basic oscillator requirements

In selecting an oscillator, the user will be most interested in its frequency coverage. The question to be answered here is, "Will the instrument supply both the lowest and highest frequencies of interest for anticipated tests?" As shown in Table 1, page 267, Hewlett-Packard manufactures a broad range of oscillators and function generators covering the frequency spectrum from 0.00005 Hz to 32 MHz.

The user's next concern will be with the available output power or voltage. Some tests require large amounts of power, while others merely require sufficient voltage output. For almost any application, there is a Hewlett-Packard oscillator capable of delivering the desired voltage output into a high-impedance load or of supplying the desired power into lower-impedance loads.

Some Hewlett-Packard oscillators have a low internal impedance. This low impedance can easily be converted to a desired output impedance with a resistive

network. This assures a constant impedance over a wide frequency range. In most HP oscillators, transformer coupling is used to provide a balanced and isolated output. Some instruments have transformer taps for supplying the wide variety of impedances encountered in normal test work. Since many audio-range oscillators are used with 600-ohm systems, several include 600-ohm adjustable attenuators on the output.

Besides frequency range and power output, the user will be interested in the oscillator's stability, its dial resolution and the amount of harmonic distortion, hum and noise in the output signal.

In the ideal case, the user should be able to set the tuning dial of his oscillator to a particular frequency with assurance that the oscillator will deliver that frequency at all times. Most Hewlett-Packard oscillators have dial accuracies of $\pm 2\%$. The dials may be precisely set by a vernier control, and the calibration marks are easily read. The accuracy with which the frequency tracks the tuning dial enters into the overall accuracy figure.

Frequency stability

The frequency stability of the oscillator determines the ability of the instrument to maintain a selected frequency over a period of time. Component aging, power-supply variations and temperature changes all affect stability. The Hewlett-Packard designed RC oscillator circuits, described later, assure stability by using large amounts of negative feedback. Carefully chosen components, such as precision resistors and variable capacitors in the frequency-determining networks, contribute to long-term stability. Oscillator stability is included in the overall 2% dial accuracy figure.

Amplitude stability

Amplitude stability is important in certain oscillator applications. Amplitude stability is inherent in the Hewlett-Packard RC oscillator circuit because of the large negative feedback factor and the amplitude stabilizing techniques. The "frequency response," or amplitude variation as the frequency is changed, is of special interest when the oscillator is used for response measurements throughout a wide range of frequencies.

Distortion

Distortion in the oscillator's output signal is an inverse measure of the purity of the oscillator's waveform. Distortion is undesirable in that a harmonic of the

test signal may feed through the circuits under test, generating a false indication at the output. If the oscillator is used for distortion measurements, the amount of distortion that it contributes to the measurements should be far less than that contributed by the circuits under test.

The Hewlett-Packard Wien bridge RC oscillator is a low-distortion, sine-wave generator; all Hewlett-Packard Wien bridge oscillators have less than 1% distortion. The 203A Function Generator, 204C, 204D and 209A Oscillators are ideal sources with low distortion and wide frequency coverage. See pages 272 and 276.

Hum and noise

Hum and noise can be introduced at a variety of points in oscillator circuits; but when the circuit operates at a relatively high level, the amount of hum and noise introduced into the device under test is usually negligible. Hum and noise introduced by a power amplifier usually remain constant as the output signal amplitude is diminished. Hence, even though the hum and noise power may be quite small compared to the rated output, these spurious signals sometimes become a significant portion of low-level output signals. To overcome such a limitation, many Hewlett-Packard oscillators have their amplitude control on the output side of the power amplifier so that hum and noise are reduced proportionally with the signal when low-level signals are desired for test purposes.

Synchronization

Recent Hewlett-Packard oscillators have incorporated capabilities to synchronize the oscillator with an external signal (refer to Figures 5 and 8).

At the frequency setting of the Wien bridge oscillator, the closed loop gain is theoretically infinite. An applied sync voltage will be amplified and sent to the AGC circuit. This increase in AGC voltage will disable the oscillator. Now the oscillator becomes a highly selective amplifier at the tuned frequency of the oscillator. The AGC circuit maintains a constant voltage to the output attenuator, and because of the high selectivity of the amplifier, the output will be a clean sine wave at the sync frequency. This synchronization of the sine wave oscillator output to an external signal is possible even with a square wave sync signal input.

Theory of operation

The Wien bridge RC oscillator has become the standard oscillator circuit for adjustable frequency test signals. These oscillators are far less cumbersome than the LC types and far more stable than the beat-frequency types formerly used for the below-*rf* range.

The basic Hewlett-Packard Wien bridge oscillator circuit, shown in Figure 6, is a two-stage amplifier with both negative and positive feedback loops. Positive feedback for sustaining oscillations is applied through the frequency selective network, R_1C_1 - R_2C_2 , of the Wien bridge.

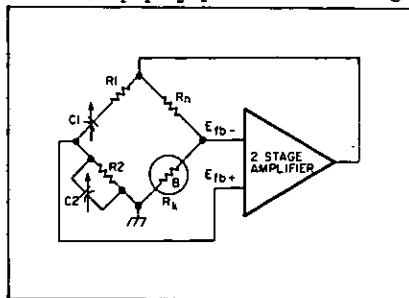


Figure 6. Basic HP Wien bridge RC oscillator circuit.

The amplitude and phase characteristics of the network, with respect to its driving voltage, are shown in Figure 7. These curves show the amplitude response is maximum at the same frequency at which the phase shift through the network is zero. Oscillations are therefore sustained at this frequency. The resonant frequency, f_0 , is expressed by the equation:

$$f_0 = \frac{1}{2\pi RC}, \text{ when } R_1 = R_2 \text{ and } C_1 = C_2.$$

Unlike LC circuits, where the frequency varies inversely with the square root of C , the frequency of the Wien bridge oscillator varies inversely with C . Thus, frequency variation greater than 10-to-1 is possible with a single sweep of an air-dielectric tuning capacitor. Range switching usually is accomplished by switching the resistors.

The negative feedback loop involves the other pair of bridge arms, R_n and R_k . In a Wien bridge RC oscillator, R_k is often a temperature-sensitive resistor with a positive temperature coefficient. It is an incandescent lamp operated at a temperature level lower than its illumination level. This lamp, being sensitive to the amplitude of the driving signals, adjusts the voltage division ratio of the branch accordingly. Thus, as the amplitude of oscillations increases, the resistance of R_k increases. The negative feedback also increases, reducing the gain of

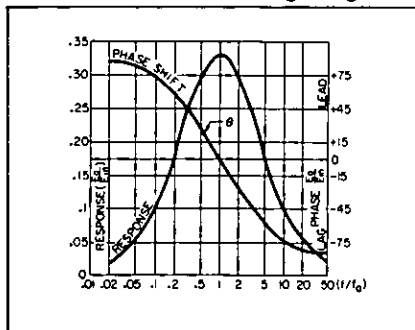


Figure 7. Characteristics of frequency-determining network.

the amplifier and restoring the amplitude to normal.

The amplitude of oscillations in any oscillator increases because of the positive feedback until some form of limiting occurs. The Hewlett-Packard Wien bridge RC oscillator depends on the temperature-sensitive resistor for amplitude control. Thus the amplifier may be operated entirely within the linear portion of its transfer characteristic, resulting in a low-distortion, sinusoidal output.

A different type of amplitude stabilization is used in the solid-state Hewlett-Packard RC oscillators, such as the 208A, 651B and the 652A. Because the current drawn by a lamp would be incompatible for use with transistors and battery power sources, these instruments use a peak-detector circuit which provides a bias voltage proportional to the oscillator output voltage.

Another variation of the solid state Wien bridge RC oscillator is used in the 204C shown in Figure 8. The oscillator with this type of amplitude stabilization will hold the amplitude constant ($\pm 1\%$) up to a frequency of 1.2 MHz.

As the amplitude of the amplifier changes, a peak comparator sends an error signal to the automatic gain control (AGC) which contains a field effect transistor. The purpose of the AGC is to continuously control the oscillator gain to maintain unity loop gain. The resistance of the AGC circuit can be varied slightly to change the divider ratio of the negative feedback network. An error in output voltage is detected by the peak comparator and sent to the AGC field effect transistor. This changes the resistance ratio in the negative feedback loop, thus bringing the output back to a constant level. The Wien bridge RC oscillator is capable of stable oscillations with low distortion output. The 204C has less than 0.01% hum and noise with distortion of 0.1% from 30 Hz to 100 kHz.

The 204D Oscillator is identical to the 204C Oscillator with the addition of an attenuator. This attenuator is calibrated in dB from +10 dB (5 volts maximum) to -70 dB in 10 dB steps.

With the addition of a power amplifier to isolate the oscillator from the load, this circuit is capable of providing useful test signals for a broad variety of purposes. The low-cost HP Model 200AB Oscillator uses such an arrangement.

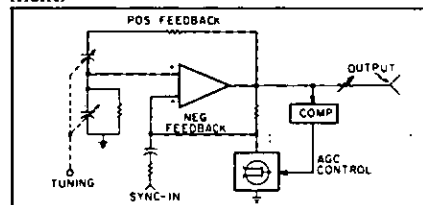


Figure 8. Block diagram of the 204C Oscillator.

Pushbutton tuning

Pushbutton oscillator tuning is possible with a modified Wien bridge. Here, the resistive branches of the frequency-selective network are made up of parallel combinations of resistors. The 241A Pushbutton Oscillator has three pushbutton, decade-switch selectors for changing the resistors in the frequency selective network. Each decade selects resistive value for one pair of resistors in the frequency-determining network.

Ranges are switched by changing capacitors with a five-position pushbutton switch. Total frequency range of the 241A Oscillator is from 10 Hz to 1 MHz in 4500 discrete steps. An overlapping vernier control permits setting to intermediate frequencies.

Pushbutton tuning enables the frequency to be changed by precise increments. Frequency selection to three-digit resolution with 1% accuracy and resettability to within 0.02% are possible.

Digital Oscillator

Another HP oscillator is the 4204A Digital Oscillator. This instrument has five switches enabling $\pm 0.2\%$ selection from any of 36,900 discrete frequencies between 10 Hz and 999.9 kHz. An overlapping vernier control permits setting of intermediate frequencies and extension of the top range to over 1 MHz. An output monitor allows accurate determination of output levels. This instrument provides the functions of an audio oscillator, ac voltmeter, and an electronic counter, in applications requiring an accurate frequency source of known amplitude. Refer to page 280 for complete specifications.

Balanced RC oscillator

A more refined circuit is the balanced vacuum tube Wien bridge RC oscillator used in the HP200CD and 202C. This circuit provides several advantages over the basic single-ended oscillator circuit.

The circuit has zero-output impedance because of the positive feedback from the plate of each output tube to the control and screen grids of the opposite output tube. Zero output impedance means that the circuit is insensitive to load changes. Positive feedback effectively increases the amplifier gain, A , to infinity. From the equation, $Z_o = Z_o / (1 + A\beta)$, where Z_o is the output impedance without feedback and β is the stabilizing negative feedback factor, it can be seen that the output impedance Z_o becomes zero if A is infinite. Series resistors are inserted in the output leads to present a 600-ohm impedance load and also to prevent short circuiting of the power tubes' cathodes.

In the balanced circuit, no dc passes

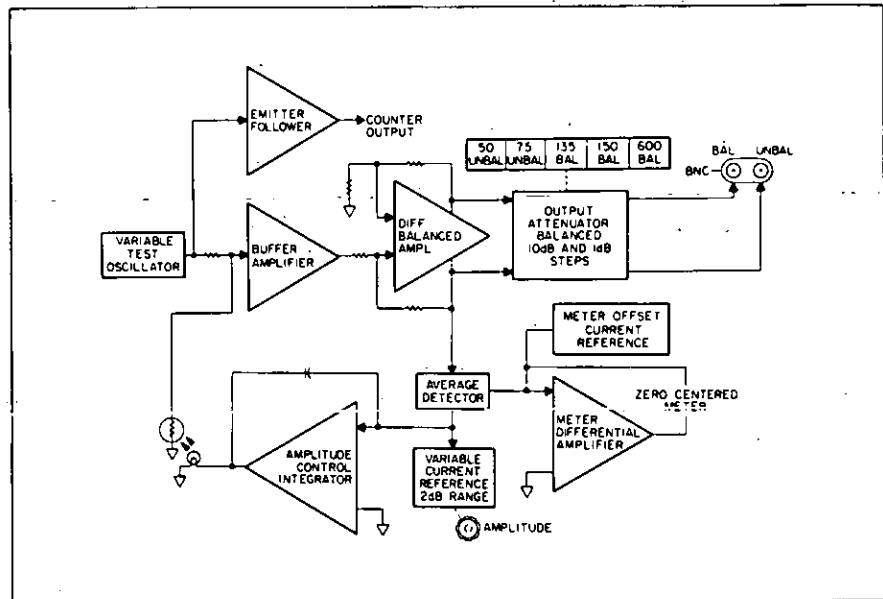


Figure 9. Block diagram of the balanced 654A Oscillator.

through the lamp circuit; the lamp current is pure ac. This means that lamp heating occurs at twice the oscillating frequency, enabling the circuit to be operated down to half of the low-frequency limit of the single-ended oscillator. In addition, the capacitor-tuning rotors are near ground potential, reducing leakage effects in these capacitors and permitting larger resistors to be used in the RC circuits for low-frequency operation.

Broadband balanced Wien bridge oscillator

A more recent balanced, solid state test oscillator covering the frequency range of 10 Hz to 10 MHz is shown in Figure 9. The RC oscillator uses a different approach for level accuracy. The output of the RC capacitor tuned bridge oscillator is sent through a variable attenuation pad to a balanced differential amplifier. The output of this amplifier is +10 dBm at 0 on the meter. Level control over this wide frequency range is accomplished by controlling the intensity of a light shining on a photo cell. This controls the attenuation of the pad at the input of the balanced amplifier. The output of the differential balanced amplifier is average detected and compared against a reference current (set by front panel control) in the amplitude control integrator. This integrator controls the intensity of the lamp, hence the resistance of the photo cell. The input to the balanced attenuator is kept constant as the frequency is changed. A special common mode feedback loop assures excellent balance in the output over the full frequency range. The output attenuator is balanced in 10 dB and 1 dB steps. The impedance switch connects different resistors to the output connectors for 50 and 75 ohms unbalanced and

135, 150 and 600 ohms balanced outputs.

The meter is 0 centered and reads in dBm for the various impedances. An offset current source and a meter differential amplifier set the meter pointer at center deflection for a +10 dBm input to the attenuator. A change of ± 1 dB gives full meter deflection with a resolution of 0.02 dB. The maximum output of +11 dBm at each of the output impedances can be attenuated in 10 dB and 1 dB steps. Refer to page 435 for the communications version of this oscillator.

Broadband Unbalanced RC Oscillators

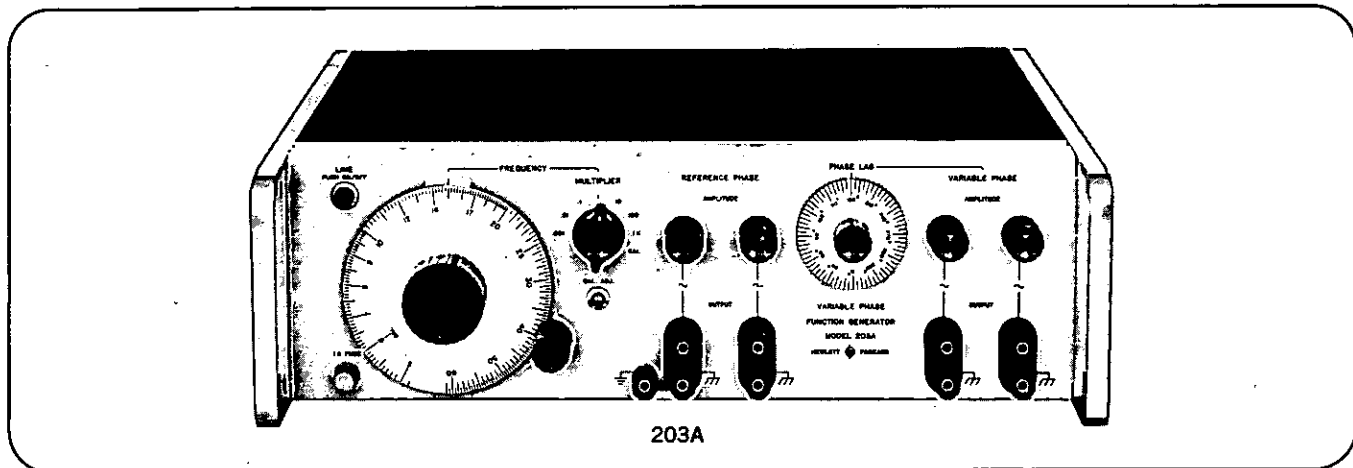
The 651B and 652A Test Oscillators, covering a frequency range of 10 Hz to 10 MHz, employ a wideband solid-state oscillator-amplifier with the phase shift controlled several octaves past the oscillator's upper 10 MHz frequency. An impedance converter provides a high impedance in series with the input of a differential amplifier on the first four ranges. This prevents the RC bridge from being overloaded at low frequencies. A complementary symmetry circuit provides power gain and increases the dynamic voltage range of the oscillator.

The oscillator circuits described here are used in Hewlett-Packard's broad line of signal sources. These signal sources span a frequency range of 0.00005 Hz to 32 MHz, encompassing the subsonic, audio, ultrasonic, video and rf ranges. All of the Hewlett-Packard oscillators and test oscillators described in this catalog have been designed with the requirements of a maximum number of applications in mind. The various techniques were chosen in order to maximize the performance offered while minimizing the cost so that a Hewlett-Packard oscillator is available to meet your application.



VARIABLE-PHASE GENERATOR

Sine- and square-waves 0.00005 Hz to 60 kHz
Model 203A



The solid-state HP Model 203A Low-Frequency Function Generator provides two transient-free low-distortion square and sinusoidal test signals particularly useful for a wide variety of low-frequency applications. Field and laboratory testing of servo, geophysical, medical and high-quality audio equipment become practical when using the 203A.

The 203A frequency range of 0.005 Hz to 60 kHz is covered in 7 overlapping bands (2 additional ranges available on special order, offering frequency range to 0.00005 Hz). Accurate $\pm 1\%$ frequency setting is provided by 180 dial divisions. A vernier drive allows precise adjustment.

30 volt output

The 203A provides a maximum output voltage of 30 V peak-to-peak for all waveforms. The sinusoidal signals have a distortion that is less than 0.06% and provide virtually transient-free outputs when frequency and operating conditions are varied rapidly. The four output circuits of the 203A have individual 40 dB continuously variable attenuators.

Outputs consist of a reference sine and square wave, and a variable-phase sine and square wave. The two sine- and square-wave outputs are electrically identical except that one sine- and square-wave output contains a 0-to-360 degree phase-shifter. These four signals (two reference phase and two variable phase) are available simultaneously from the 203A. The output system is floating with respect to ground and may be used to supply an output voltage that is terminal grounded, or may be floated up to 500 volts dc above chassis ground. The output impedance is 600 ohms for all outputs.

Special features

A front-panel calibration provision permits the user to easily calibrate the oscillator frequency to the environment in which the instrument is used. The HP 203A features a unique method of mixing, filtering and dividing the frequency to maintain an exact decade relationship. Interchangeable decade modules provide greater reliability and ease of servicing.

Specifications, 203A

Frequency range: 0.005 Hz to 60 kHz in seven decade ranges.*

Dial accuracy: $\pm 1\%$ of reading.

Frequency stability: within $\pm 1\%$ including warmup drift and line voltage variations of $\pm 10\%$.

Output waveforms: sine and square waves are available simultaneously; all outputs have common chassis terminal.

Reference phase: sine wave, 0 to 30 V peak-to-peak; square wave, 0 to 30 V peak-to-peak (open circuit).

Variable phase: sine wave, 0 to 30 V peak-to-peak; square wave, 0 to 30 V peak-to-peak; continuously variable, 0 to 360°; phase dial accuracy, $\pm 5^\circ$ sine wave, $\pm 10^\circ$ square wave (open circuit).

Output impedance: 600 ohms.

Output power: 5 volts into 600 ohms (40 mW); 40 dB continuously variable attenuation on all outputs.

Distortion: total harmonic distortion hum and noise > 64 dB below fundamental ($< 0.06\%$) at full output.

Output system: direct-coupled output is isolated from ground and may be operated floating up to 500 V dc.

Frequency response: $\pm 1\%$ referenced to 1 kHz.

Square wave response: rise and fall time, < 200 ns; overshoot, $< 5\%$ at full output.

Power: 115 or 230 volts $\pm 10\%$, 50 to 1000 Hz, approximately 25 W.

Dimensions: cabinet: 5 $\frac{1}{4}$ " high, 16 $\frac{3}{4}$ " wide, 11 $\frac{1}{2}$ " deep (133 x 425 x 286 mm); rack mount kit(00203-84401) furnished with instrument.

Weight: net 20 lbs (9,17 kg); shipping 28 lbs (12,6 kg).

Price: HP 203A, \$1250; Option 01 (0.0005 Hz range), add \$50; Option 02 (0.00005 Hz range), add \$150.

*Two lower ranges of 0.0005 Hz (Option 01) and 0.00005 Hz (Option 02) are available on special order.
Manufactured by Yokogawa-Hewlett-Packard Ltd., Tokyo.

FUNCTION GENERATOR

Compact, 7 functions, 10 decades of frequency
Model 3310A



SIGNAL SOURCES

Description

The 3310A Function Generator is a compact voltage-controlled generator with 10 decades of range. Ramp and pulse functions in addition to sine, square and triangle plus dc offset and external voltage control provide wide versatility.

Also on the front panel is the fast rise time sync output, square wave in symmetrical functions and rectangular in pulse and ramp. Aspect ratio of non-symmetrical function is 15%/85%.

Output

15 V p-p into 50 Ω (30 V p-p open circuit) provides enough power for most applications. A 30 dB pad between HIGH and LOW outputs assures clean, low-level signals with good amplitude settability. Overlap between the outputs allows selection of any amplitude from 15 V p-p to 15 mV p-p into 50 Ω (30 V to 30 mV open circuit).

DC Offset

DC offset up to plus or minus 5 V when loaded with 50 Ω (10 V open circuit) allow positioning all functions except sync to most desired levels. This capability adds to the usefulness of all functions, especially the ramp and pulse functions in areas such as analogue programming or digital testing. Pulse widths as narrow as 35 ns are available (5 MHz).

VCO

The dc coupled voltage control input further extends the usefulness of the 3310A Function Generator. The output frequency is a function of both the dial setting and VCO voltage. With the dial set at 1, a linear positive ramp from 0 to +10 V will increase the frequency from 1 to 50 (times RANGE). With the dial set at 50, a linear negative ramp from 0 to -10 V will decrease the frequency from 50 to 1 (times RANGE). An ac voltage will FM the frequency about a dial setting within the output frequency limits of $1 < f < 50$ (times RANGE).

Specifications

Output waveforms: sinusoidal, square, triangle, positive pulse, negative pulse, positive ramp and negative ramp. Pulses and ramps have a 15% or 85% duty cycle.

Frequency range: 0.0005 Hz to 5 MHz in 10 decade ranges.

Sine wave frequency response

0.0005 Hz to 50 kHz: $\pm 1\%$; 50 kHz to 5 MHz: $\pm 3\%$.
Reference, 1 kHz at full amplitude into 50 Ω .

Dial accuracy

0.0005 Hz to 500 kHz all functions: $\pm (1\% \text{ of setting} + 1\% \text{ of full scale})$.
500 kHz to 5 MHz sine, square and triangle: $\pm (3\% \text{ of setting} + 3\% \text{ of full scale})$.
500 kHz to 5 MHz pulse and ramps: $\pm (10\% \text{ of setting} + 1\% \text{ of full scale})$.

Maximum output on HIGH: > 30 V p-p open circuit; > 15 V p-p into 50 Ω (except for pulses at frequency > 2 MHz).

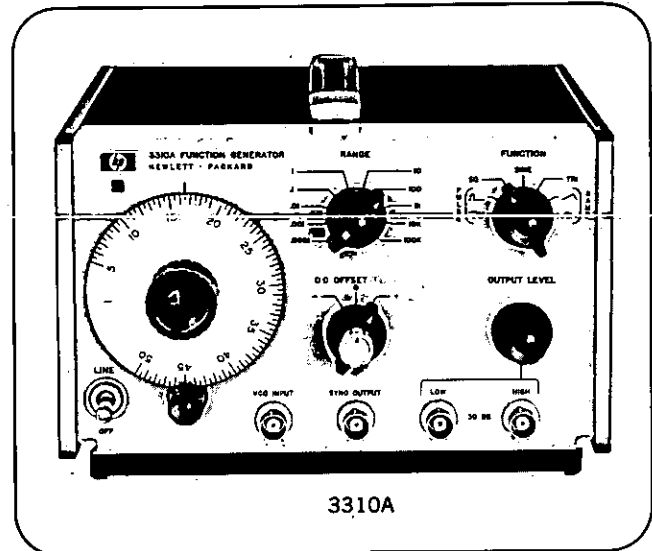
Pulse (frequency > 2 MHz)

> 24 V p-p open circuit; > 12 V p-p into 50 Ω .

Minimum output on LOW

< 30 mV p-p open circuit; < 15 mV p-p into 50 Ω .

Output level control: range > 30 dB. HIGH and LOW outputs overlap for a total range of > 60 dB; LOW output is 30 dB down from HIGH output.



Sine wave THD (below fundamental)

0.0005 Hz to 10 Hz: > 40 dB (1%).
10 Hz to 50 kHz (on 1 k range): > 46 dB (0.5%).
50 kHz to 500 kHz: > 40 dB (1%).
500 kHz to 5 MHz: > 30 dB (3%).

Square wave and pulse response

< 30 ns rise and fall times at full output; < 35 ns rise and fall times with AMPLITUDE control not fully CW; $< 5\%$ total aberrations.

Triangle and ramp linearity: 0.0005 Hz to 50 kHz, $< 1\%$.

Triangle symmetry

0.0005 Hz to 20 Hz: $< 1\%$; 20 Hz to 50 kHz: $< 0.5\%$.

Impedance: 50 Ω .

Sync

Amplitude: > 4 V p-p open circuit, > 2 V p-p into 50 Ω .

Rise and fall times: < 20 ns.

Waveform: square for symmetrical functions, rectangular for pulse and ramp.

Output impedance: 50 Ω .

Offset

Amplitude: ± 10 V open circuit, ± 5 V into 50 Ω , continuously adjustable.

NOTE: max Vacp + Vdc offset is ± 15 V open circuit; ± 7.5 V into 50 Ω .

External frequency control

Range: 50:1 on any range.

Input requirement: with dial set to low end mark, a linear positive ramp of 0 to +10 V ± 1 V will linearly increase frequency 50:1. With dial set at 50, a linear negative ramp of 0 to -10 V ± 1 V will linearly decrease frequency 50:1. An ac voltage will FM the frequency about a dial setting within the limits $(1 < f < 50) \times$ range setting.

Sensitivity: approximately 100 mV/minor division.

Input impedance: 10 k Ω .

NOTE: specifications apply from 5 to 50 on the frequency dial.

General

Power: 115 V or 230 V $\pm 10\%$, 50 Hz to 400 Hz, < 20 W.

Dimensions: 7 $\frac{3}{4}$ " wide, 4 $\frac{1}{2}$ " high (without removable feet) 8" deep (197 x 114 x 203 mm).

Weight: net 6 lb (2,7 kg); shipping 7 lb (3,2 kg).

Accessories available

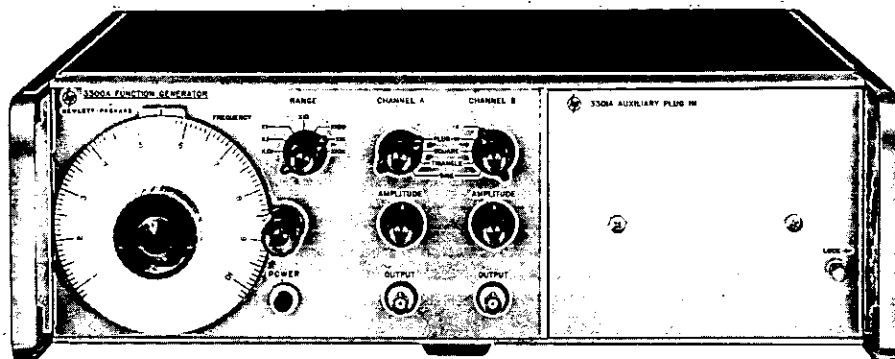
HP Part No. 5060-0105 filler strip for use with HP 1051A combining case or HP 5060-0797 rack adapter frame.

Price: HP 3310A, \$575.



FUNCTION GENERATOR

Plug-ins, multiple outputs, versatility
Model 3300A & 3301A plug-in



3300A/3301A

Description

Plug-ins and multiple outputs set the HP 3300A Function Generator apart from other function generators. Any two of three waveforms—sine, square or triangular—may be selected by a front-panel switch over the frequency range from 0.01 Hz to 100 kHz, continuously adjustable in seven decade ranges. This solid-state, multi-purpose source provides simultaneous signals of any two waveforms over the entire frequency range with independent variable amplitudes.

Plug-ins, which insert directly into the front panel, include the HP 3301A Auxiliary Plug-in to provide internal connections for basic unit operation. The 3302A plug-in provides single and multiple-cycle operation with adjustable start-stop phase. A phase-lock loop in the 3302A permits synchronizing the 3300A with an external signal and gives adjustable phase control. The HP 3304A Sweep/Offset Plug-in provides internal sweeping, dc offset, sawtooth waves and offset square waves. The 3305A Sweeper Plug-in supplies internal log sweep and manual sweep over four decades with calibrated variable start-stop frequency control within four decades. Sweep width is continuously adjustable. It has manual or external triggering. Sweep can be analog-programmed with horizontal sweep available for driving scopes or recorders.

The frequency of the HP 3300A can be controlled by either the front-panel frequency dial or an external voltage applied to a rear-terminal connector. This feature is useful for sweeping filters, amplifiers and other frequency-dependent devices and for externally programming frequencies for production testing.

The output system of the HP 3300A is dc coupled and fully floating with respect to power-line ground. An internal shield reduces radiated interference and provides common-mode rejection with floating output. A balanced output can be obtained by using both output amplifiers. Each output amplifier will deliver 35 V p-p into an open circuit.

Specifications

Output waveforms: sinusoidal, square and triangular selected by panel switch (any two outputs available simultaneously).

Frequency range: 0.01 Hz to 100 kHz in 7 decade ranges.

Frequency response: $\pm 1\%$, 0.01 Hz to 10 kHz; $\pm 3\%$, 10 kHz to 100 kHz on the X10 k range.

Dial accuracy: $\pm 1\%$ of maximum dial setting (1 minor division), 0.01 Hz to 10 kHz at $+25^\circ\text{C}$; $\pm 2\%$ of maximum dial setting (2 minor divisions), 10 kHz to 100 kHz on the X10 k range.

Maximum output per channel: >35 V p-p open circuit; >15 V p-p into 600Ω ; >2 V p-p into 50Ω .

Output attenuators (both channels): 40 dB range.

Sine-wave distortion: $<1\%$, 0.01 Hz to 10 kHz; $<3\%$, 10 kHz to 100 kHz on the X10 k range.

Square-wave response: <250 ns rise and fall time on all ranges; $<1\%$ sag, $<5\%$ overshoot at full output; $<1\%$ symmetry error; <500 ms rise and fall time (-A).

Triangle-linearity error: $<1\%$, 0.01 Hz to 10 kHz; $<2\%$, 10 kHz to 100 kHz at full output; $<1\%$ symmetry error.

Sync-pulse output: >10 V p-p open circuit. <5 μs duration.

Output impedance (both channels): $600\Omega \pm 20\%$.

DC stability: drift: $<\pm 0.25\%$ of p-p amplitude over a period of 24 hours (after 30-min. warmup).

Remote frequency control: 0 to -10 V will linearly change frequency >1 decade within a single range. Frequency resettability with respect to voltage $\pm 1\%$ of maximum frequency on range selected.

Power: 115 or 230 V $\pm 10\%$, 50 to 400 Hz, 60 W max.

Dimensions: standard HP full module $16\frac{3}{4}$ " wide, 5" high (without removable feet), 11" deep (425 x 127 x 279 mm).

Weight: net 20 lbs (9 kg); shipping 24 lbs (10.8 kg).

Accessories furnished: rack mount kit for 19" rack.

Plug-ins available

HP 3301A Auxiliary Plug-in, \$30.

HP 3302A Trigger Plug-in (see page 275).

HP 3304A Sweep/Offset Plug-in (see page 275).

HP 3305A Sweeper Plug-in (see page 275).

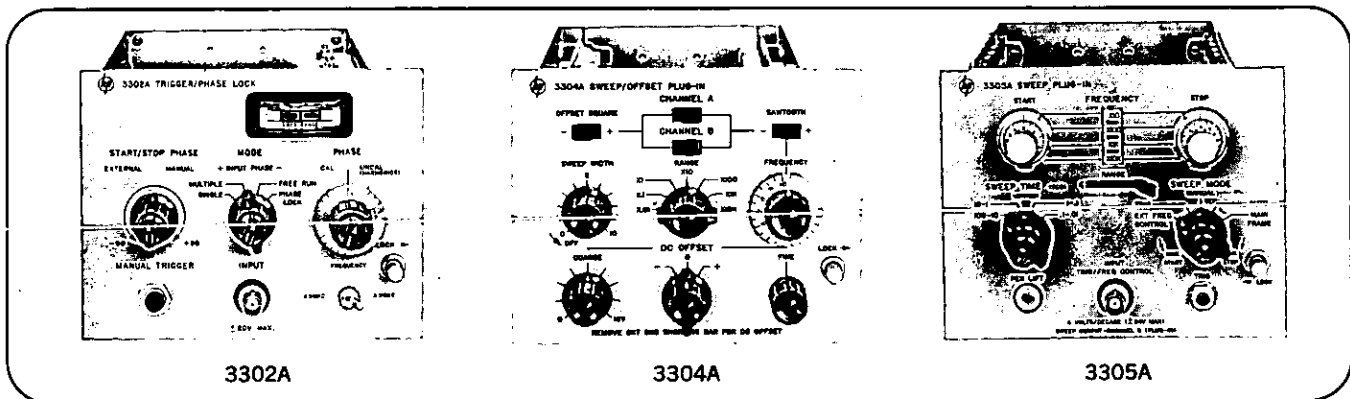
Price: HP 3300A Function Generator, \$700.

PLUG-INS FOR 3300A

Lin/log sweep, phase lock, dc offset
Models 3302A, 3304A, 3305A



SIGNAL SOURCES



The HP 3302A Trigger/Phase Lock Plug-in provides single-cycle, multiple-cycle, and phase-lock operation. The instrument can be triggered over the entire frequency range, either manually or by applying an external voltage.

The HP 3304A Sweep/Offset Plug-in provides internal sweeping, dc offset, sawtooth waves, and offset square waves. Up to ± 16 V of dc offset is available for all signals generated in the main frame and plug-in. In addition, the independently frequency-controlled sawtooth wave may be switched internally to the frequency control circuit of the HP 3300A Function Generator to permit sweeping over a decade of frequency within a single range.

The HP 3305A Sweep Plug-in will sweep logarithmically, repetitively between any two frequencies within one of the three (4-decade) ranges: 0.1 Hz to 1 kHz, 1 Hz to 10 kHz, and 10 Hz to 100 kHz. Calibrated independent START-STOP controls greatly simplify setting desired sweep end points. Adjustable sweep time from 0.01 to 100 seconds provides sweep times slow enough for accurate response testing of low-frequency high-Q systems and fast enough for good visual displays of higher frequency responses.

Specifications, 3302A

Trigger requirements

Single cycle: manual or external, dc coupled. Requires at least 0.5 V to trigger externally. May be triggered with positive or negative input voltage which starts at or goes through 0 V (± 20 V p max.).

Multiple cycle: manual or external start/stop, dc coupled. Requires at least 0.5 V to start, 0 V to stop. May be triggered with either positive or negative (± 20 V p max.).

Phase lock: 10 Hz to 100 kHz (upper 4 ranges only), dc coupled. Requires + and -0.5 V p to lock, 10 V p-p for specified accuracy with sine wave input. The 3302A will lock on a fundamental or harmonic of the input signal.

Phase dial accuracy: $\pm 10^\circ$ from 10 Hz to 10 kHz; $\pm 20^\circ$ from 10 kHz to 100 kHz on X10 k range (fundamental).

Introduced distortion: 1%, 10 Hz to 10 kHz; 3%, 10 kHz to 100 kHz on X10 k range (fundamental).

Specifications, 3304A

DC offset

Voltage range: adjustable 0 to ± 16 V open circuit and ± 1 V vernier.

DC stability: ± 50 mV over 24-hr period (after 30-min. warm-up).

Offset square wave

Output polarity: positive or negative, from dc offset voltage or ground potential.

Amplitude: > 15 V p-p open circuit; continuously adjustable with 3300A amplitude control. Rise time: < 400 ns. Overshoot: $< 5\%$ at full output. Sag: $< 1\%$.

Sawtooth waveform

Frequency range: 0.01 Hz to 100 kHz, continuously adjustable over 7 decade ranges.

Dial accuracy: $< \pm 10\%$ full scale, 0.01 Hz to 1 Hz; $< \pm 5\%$ full scale, 1 Hz to 100 kHz.

Amplitude: > 15 V p-p open circuit; continuously adjustable over a 40 dB range with 3300A amplitude control.

Frequency response: $< 2\%$, 0.01 Hz to 10 kHz; $< 5\%$, 10 to 100 kHz.

Output polarity: positive or negative, from dc offset voltage or ground potential.

Linearity: $< 1\%$, 0.01 Hz to 10 kHz; overshoot, $< 5\%$.
 $< 2\%$, 10 kHz to 100 kHz; overshoot, $< 5\%$.

Flyback time: $< 5\%$ +250 ns.

Internal sweep

Controls: start frequency set by 3300A frequency dial; sweep range set by sweep width control on plug-in.

Sweep rate: determined by sawtooth frequency setting.

Sweep width: adjustable from 0 to at least 1 decade on any one range.

Specifications, 3305A

Frequency range: 0.1 Hz to 100 kHz in 3 overlapping ranges.

Sweep width: limits adjustable 0 to 4 decades in any of 3 (4-decade) bands: 0.1 Hz to 1 kHz, 1 Hz to 10 kHz, 10 Hz to 100 kHz. Start-stop dial accuracy: $\pm 10\%$ of setting.

Sweep modes

Automatic: repetitive logarithmic sweep between start and stop frequency settings.

Manual: vernier adjustment of frequency between start and stop frequency settings.

Trigger: sweep between start and stop frequency settings and retrace with application of external trigger voltage or by depressing front-panel trigger button.

Trigger requirements: ac coupled, positive going at least 1 V p with > 2 V per ms rise rate. Max. input, ± 90 V p.

Sweep time: 0.01 s to 100 s in 4 decade steps, continuously adjustable vernier.

Retrace time: < 0.003 s for 0.1 to 0.01 s sweep times; < 0.03 s for 1 to 0.1 s sweep times; < 4 s for 100 to 1 s sweep times.

Blanking: oscillator disabled during retrace.

Pen lift: terminals shorted during sweep; open during retrace in auto and trigger modes for 100 to 1 s sweep times.

Sweep output: linear ramp at CHANNEL B OUTPUT (PLUG-IN); amplitude adjustable independently of sweep width; max. output > 15 V p-p into open circuit, > 7 V p-p into 600 Ω .

External frequency control

Sensitivity: 6 V/decade (refer: START setting), ± 24 V max.

V-to-F_c conversion accuracy: for each 6 V change in programming voltage, frequency changes 1 decade $\pm 5\%$ of end F.

Input impedance: 400 k Ω $\pm 5\%$. Max. rate: 100 Hz.

General

Dimensions: 6-1/16" wide, 4 3/4" high, 10 1/4" deep (154 x 121 x 260 mm).

Weight: net 4 lbs 6 oz (2 kg); shipping 6 lbs (2,7 kg).

Price: HP 3302A, \$245; HP 3304A, \$285; HP 3305A, \$975.

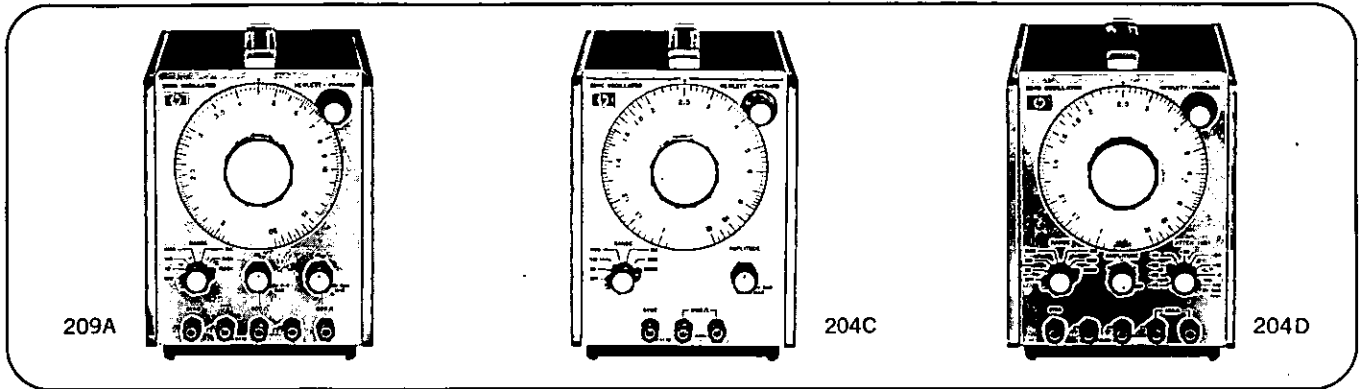
SIGNAL SOURCES



SINE, SQUARE OSCILLATORS

Low distortion; wide range; balanced output

Models 209A, 204C, 204D



The HP 209A is a small, lightweight, sine/square oscillator. Stable, accurate signals which can be synchronized with an external source are instantly available over a frequency range from 4 Hz to 2 MHz. Separately adjustable sine/square outputs are located on the front panel. Distortion and flatness can be minimized at low frequencies by a rear panel LOW DISTORTION MODE switch.

The HP 204C is a small, lightweight capacitive-tuned oscillator. Interchangeable power packs, line, rechargeable batteries or mercury batteries make this instrument ideal for both field and laboratory use. Internal heat generation and temperature coefficient is small, resulting in unusually low drift. Stable, accurate signals which can be synchronized with an external source are instantly available over a frequency range from 5 Hz to 1.2 MHz. Distortion can be minimized at low frequencies by a rear panel Low Distortion Mode switch; however, settling time with a rapid frequency change is increased.

The HP 204D Oscillator is identical to the 204C with the addition of an 80 dB attenuator and vernier. The attenuator with the vernier provides excellent output amplitude settability.

Specifications (209A)

Frequency: 4 Hz to 2 MHz in 6 ranges.

Dial accuracy: $\pm 3\%$ of frequency setting.

Flatness: at maximum output into 600 Ω load, 1 kHz reference.

Low distortion mode	$\pm 1\%$	$\pm 0.5\%$	$\pm 1\%$	$\pm 5\%$
Normal mode	+5%, -1%	$\pm 0.5\%$	$\pm 1\%$	$\pm 5\%$
	4	100	300k	1M 2M (Hz)

Distortion: 200 Hz to 200 kHz, 0.1% (-60 dB); 4 Hz to 200 Hz, <0.2% (-54 dB); 200 kHz-2 MHz, <1% (-40 dB).

Hum and noise: <0.01% of input.

Output characteristics sine wave

Output voltage: 5 V rms (40 mW) into 600 Ω ; 10 V open circuit.

Output impedance: 600 Ω .

Output control: >26 dB range continuously adjustable.

Output balance: >40 dB below 20 kHz. Output can be floated up to ± 500 V p between output and chassis ground.

Output characteristics square wave

Output voltage: 20 V p-p open circuit symmetrical about 0 V. Output can be floated up to ± 500 V p.

Rise and fall time: 50 ns. Symmetry: $\pm 5\%$.

Output impedance: 600 Ω .

Synchronization

Sync output: sine wave in phase with output; 1.7 V rms open circuit; impedance 10 k Ω .

Sync input: same as 204C.

Price: HP 209A, \$345.

Specifications (204C)

Frequency: 5 Hz to 1.2 MHz in 6 overlapping ranges.

Dial accuracy: $\pm 3\%$ of frequency setting.

Flatness (at maximum output into 600 Ω load, 1 kHz reference)

Low distortion mode	$\pm 1\%$	$\pm 0.5\%$	$\pm 1\%$	
Normal mode	+5%, -1%	$\pm 0.5\%$	$\pm 1\%$	
	5	100	300k	1.2M (Hz)

Distortion: 30 Hz to 100 kHz, 0.1% (-60 dB); 5 Hz to 30 Hz, <0.6% (-44 dB); 100 kHz-1.2 MHz, linearly derated to <1%.

Hum and noise: <0.01% of output.

Output characteristics

Output voltage: 2.5 V rms (10 mW) into 600 Ω ; 5 V rms open circuit.

Output impedance: 600 Ω .

Output control: >40 dB range; continuously adjustable.

Output balance: >40 dB below 20 kHz. Can be floated up to ± 500 V p between output and chassis ground.

Synchronization

Sync output: sine wave in phase with output; >100 mV rms into <100 pF over entire range; impedance 10 k Ω .

Sync input: oscillator can be synchronized to external signal. Sync range, the difference between sync frequency and set frequency, is a linear function of sync voltage. $\pm 1\%/V$ rms for sine wave with a maximum input of ± 7 V p.

Specifications (204D)

(Identical to 204C except "output control" is replaced by the following:)

Output attenuator

Range: 80 dB in 10 dB steps.

Overall accuracy: ± 0.3 dB, +10 dB through -60 dB ranges; ± 0.5 dB on -70 dB range.

Output vernier: >10 dB range, continuously adjustable.

General

Operating temperature: specifications are met from 0°C to 55°C.
Power: standard: ac-line 115 V or 230 V $\pm 10\%$, 50 Hz to 400 Hz, <4 W. Opt. 001: mercury batteries 300 hours operation. Opt. 002: line/rechargeable batteries 115 V or 230 V $\pm 10\%$, 50 Hz to 400 Hz, <4 W. 40 hours operation per recharge.

Dimensions: 5 $\frac{1}{2}$ " wide, 6 $\frac{1}{4}$ " high (without removeable feet), 8" deep (130 x 159 x 203 mm).

Weight: net 6 lbs (2,7 kg); shipping 8 lbs (3,6 kg).

Accessories available: HP 11135A AC Power Pack for 204C, \$60. HP 11136A Mercury Power Pack for 204C, \$75. HP 11137A Rechargeable Battery/AC Power Pack for 204C, \$95. HP 11075A Instrument Case, \$45.

Price: HP 204C (ac line), \$250; HP 204D, \$325; HP 204C or 204D option 001 (mercury batteries), add \$15. HP 204C or 204D option 002 (rechargeable batteries, ac-line), add \$35.

TEST OSCILLATORS

Pushbutton or rechargeable battery operation
Models 241A, 208A



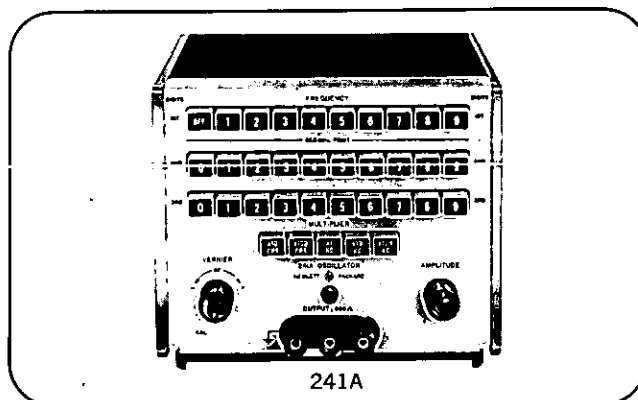
SIGNAL SOURCES

Pushbutton Oscillator (241A)

Frequency response is flat $\pm 2\%$ over the entire range at any attenuator setting. This is obtained by using special, fixed-precision resistors and large amounts of negative feedback in a unique biased-diode control circuit. A front-panel control adjusts the bridged-tee attenuator for output levels of -30 dBm to $+10$ dBm presenting a constant output impedance of 600 ohms.

Specifications 241A

Frequency range: 10 Hz to 1 MHz, 5 ranges, 4500 frequency increments with vernier overlap.
Calibration accuracy: $\pm 1\%$.
Frequency response: $\pm 2\%$ into rated load.
Output impedance: 600 Ω .
Distortion: 1% maximum.
Hum and noise: .05% of output.
Output: $+10$ to -30 dBm into 600 Ω (2.5 V maximum).
Power: 115 or 230 V, 50 to 400 Hz, 1 W.
Dimensions: standard $\frac{1}{2}$ module $7\frac{3}{4}$ " wide, $6\frac{1}{4}$ " high (without removable feet), 8" deep (197 x 159 x 203 mm).
Weight: net $7\frac{3}{4}$ lbs (3.5 kg); shipping 10 lbs (4.5 kg).
Accessory furnished: detachable power cord, NEMA plug.
Accessories available: HP 11000A Cable, 44" long, dual banana plugs, \$5.00. HP 11002A Test Leads, 60" long, dual banana plug to alligator clips, \$8.00. HP 11004A, Line Matching Transformer, (5 kHz to 600 kHz) balanced output for 135 or 600 Ω , \$65. HP 11005A Line Matching Transformer (20 Hz to 45 kHz), balanced output for 600 Ω , \$85.
Price: HP 241A, \$490.



Any frequency between 10 Hz and 999 kHz can be selected to three significant figures by simply pushing the three appropriate frequency pushbuttons and one of five decade multipliers. These pushbuttons control 900 base frequencies in increments of 0.1 Hz from 10.0 to 99.9 Hz, providing 4500 discrete frequency settings. Infinite resolution is provided by a vernier control, extending the upper frequency to 1 MHz.

Since each discrete frequency setting is a digital function effectively isolated from every other setting, a high degree of calibration dependability is achieved—a major advantage for user convenience. Accuracy is within $\pm 1\%$ of selected value on any range.

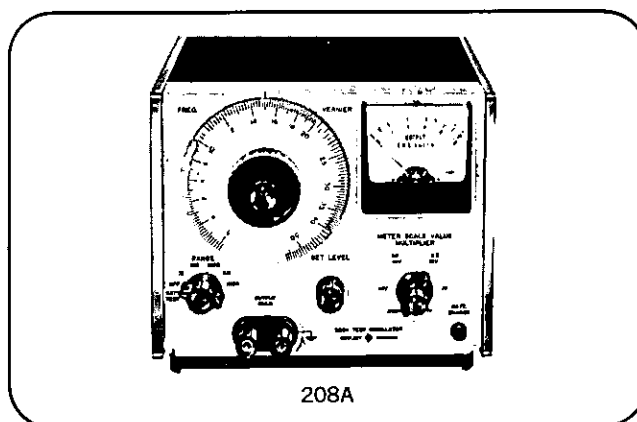
Test Oscillator (208A)

Rechargeable Battery Operation

The solid-state design, light weight modular construction, and battery operation of this oscillator contribute to its portability. Rapid attenuation selection and monitored oscillator levels ideally suit the 208A Oscillator to transmission line work, production line tests and similar situations where output levels must be known.

Specifications 208A

Frequency range: 5 Hz to 560 kHz—in 5 ranges. 5% overlap between ranges, vernier control.
Dial accuracy: $\pm 3\%$.
Frequency response: $\pm 3\%$ into rated load.
Output: 10 mW nominal 2.5 V rms ($+10$ dBm) into 600 Ω .
Output impedance: 600 Ω .
Output attenuator
Meter scale value: 0.01 mV to 1 V full scale (6 steps).
Multiplier: 2.5 multiplier, concentric with Meter Scale Value switch, to obtain 0.025 mV to 2.5 V.
Output attenuator accuracy: 5 Hz to 100 kHz, error is $< \pm 3\%$ at any step. From 100 kHz to 560 kHz, error is $< 5\%$ at any step. Specifications include multiplier accuracy.
Output monitor: transistor voltmeter monitors level at input to attenuator and after set level. Accuracy $\pm 2\%$ of full scale into 600 Ω .
Set level: continuously variable bridged "T" attenuator with 10:1 voltage range.
Distortion: $< 1\%$.
Hum and noise: $< 0.05\%$ at maximum output.
Operating temperature range: 0°C to $+50^\circ\text{C}$.
Power source: 4 rechargeable batteries (furnished); 30 hr operation per recharge. Oscillator may be operated during recharge from ac line (115 V or 230 V $\pm 10\%$, 50 to 400 Hz, 3 W).
Dimensions: 7-25/32" wide, $6\frac{1}{4}$ " high (without removable feet), 8" deep (197 x 155 x 203 mm).
Weight: net $8\frac{1}{4}$ lbs (3.5 kg); shipping 11 lbs (5 kg).
Price: HP 208A, \$565.



208A option 001

(same as 208A except)

Output attenuator: 0 to 110 dB in 1 dB steps.

Accuracy, 10 dB section: from 5 Hz to 100 kHz, error is $< \pm 0.125$ dB at any step; from 100 kHz to 560 kHz, error is $< \pm 0.25$ dB at any step.

Accuracy, 100 dB section: from 5 Hz to 100 kHz error is $< \pm 0.25$ dB at any step; from 100 kHz to 560 kHz error is $< \pm 0.5$ dB at any step.

Output monitor: solid-state voltmeter monitors level at input to attenuator and after set level; scale calibrated -10 dBm to $+11$ dBm; accuracy ± 0.25 dB at $+10$ dBm into 600 Ω .

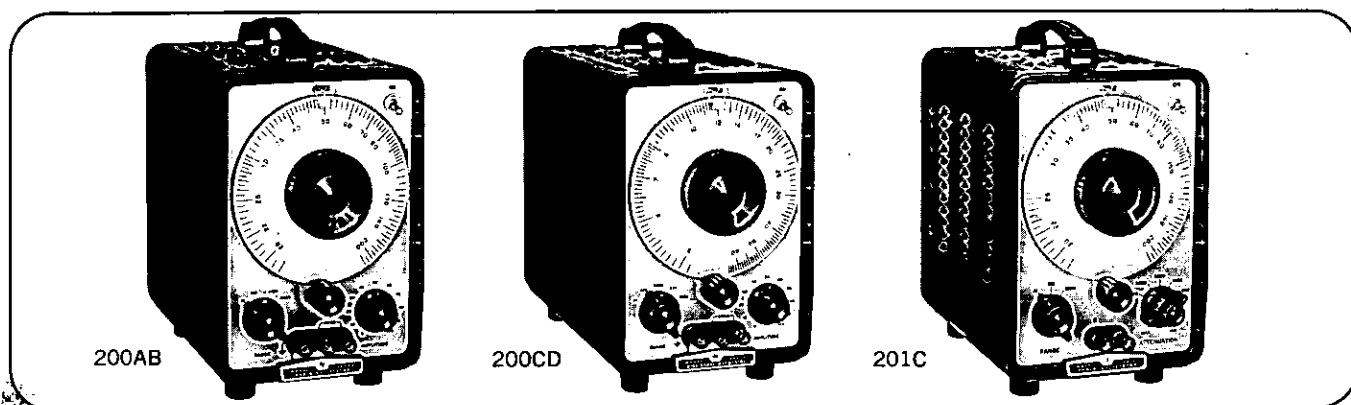
Set level: continuously variable bridged "T" attenuator with 20 dB minimum range.

Price: HP 208A, option 001, add \$10.

SIGNAL SOURCES**AUDIO OSCILLATORS**

Exceptional value, highest quality

Models 200AB, 200CD, 201C

**Features:**

- No zero setting, high stability
- Constant output, low distortion
- Wide frequency range, log scale
- No frequency change with load variation

Hewlett-Packard RC oscillators have long been basic tools for making electrical and electronic measurements of precise accuracy. These world-famous test instruments provide the most compact, dependable, accurate, and easy-to-use commercial oscillators available.

The HP 200 series oscillators have high stability and accurate, easily resettable tuning circuits. Low-impedance operating levels together with superior insulation guarantee peak performance throughout years of trouble-free service. The instruments have a wide frequency range and long dial lengths and feature an improved vernier frequency control. Operation is simplified — just three controls are required. Instruments are compact, light in weight, and enclosed in a convenient, aluminum case with carrying handle. They occupy minimum bench space and are easily portable. Rack mounting is available on order.

200AB Audio Oscillator, Low Cost, 20 Hz to 40 kHz

The 200AB sinewave oscillator's frequency range of 20 Hz to 40 kHz is covered in four overlapping decade bands. Accurate frequency setting is provided by a dial (90 divisions) and an effective scale length of 63 inches. The oscillator provides one watt or 24.5 volts into 600 ohm load. The output circuit is balanced and floating over the entire frequency range so that the instrument may be used to drive off-ground loads. The cabinet form is convenient for bench operation and the rack mount permits combining the 200AB with other instruments in a standard rack. The panel arrangement aids in swift and straightforward operation. HP 200AB, \$235 (cabinet); HP 200ABR, \$240 (rack mount).

200CD Wide-Range Oscillator, Multi-Purpose, 5 Hz to 600 kHz

One of the most popular of all HP oscillators, Model

200CD covers the range of 5 Hz to 600 kHz in five overlapping decade bands. Accurate frequency setting is provided by 112 dial divisions and an effective scale length of 78 inches. A vernier drive allows precise adjustment.

The 200CD gives a maximum sinewave output of at least 10 volts across its rated load of 600 ohms and at least 20 volts open circuit. Its distortion rating is very low, less than 0.2% from 20 Hz to 200 kHz. A special feature of the 200CD is that its waveform purity does not depend on load. The output impedance is nominally 600 ohms. The output transformers are balanced within 0.1% at the lower frequencies and within approximately 1% at the higher frequencies. The 200CD is particularly useful for testing servo and vibration systems, medical and geophysical equipment, audio amplifiers, sonar and ultrasonic apparatus, carrier telephone systems, video frequency circuits, etc. Waveform purity is maintained with extremely low loads. Frequency is covered in 5 decade ranges, and accuracy is $\pm 2\%$ including warm-up, aging, tube changes, etc. Frequency response is ± 1 dB full range. A convenient panel grounding terminal is provided to ground one of the output terminals when single-ended operation is desired. A simple bridged T Attenuator is provided to control output power. Where a well-balanced adjustable output source is desired, the HP 11004A Line Matching Transformer can be used. HP 200CD, \$275 (cabinet); HP 200CDR, \$280 (rack mount).

The 200CD option H20 is a standard 200CD modified to have an extremely low distortion output. Refer to the Table of Specifications, page 279. HP 200CD option H20, add \$55.

201C Audio Oscillator, High Power, 20 Hz to 20 kHz

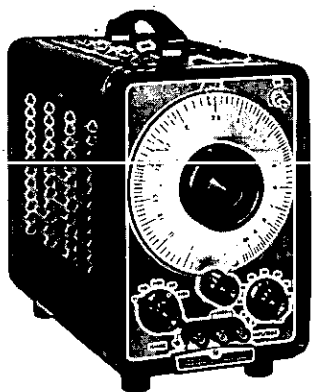
Particularly designed for amplifier testing, transmission line measurements, loudspeaker testing, frequency comparison, and other high fidelity tests, this audio oscillator meets every requirement for speed, simplicity and pure waveform. The frequency range, 20 Hz to 20 kHz, is covered in 3 bands; response is ± 1 dB full range. Output is 3 watts or 42.5 volts into 600 ohms; an attenuator adjusts output 0 to 40 dB in 10 dB steps and provides either low impedance or constant 600-ohm impedance. Distortion at 1 watt output and above 50 Hz is less than 0.5%. HP 201C, \$295 (cabinet); HP 201CR, \$300 (rack mount).

AUDIO OSCILLATORS

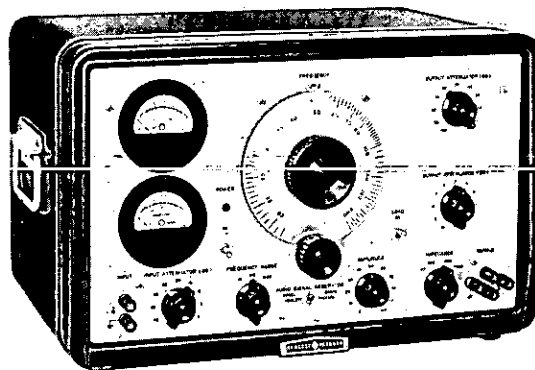
Exceptional value, highest quality
Models 201C, 202C, 205AG



SIGNAL SOURCES



202C



205AG



202C Low-Frequency Oscillator, Excellent Waveform 1 Hz to 100 kHz

Model 202C brings to the low-frequency oscillators the accuracy and stability associated with audio measurements. It provides excellent waveforms as low as 1 Hz.

The transformer-coupled, balanced output of the Model 202C enables it to meet the signal source requirements for tests of a wide variety of systems. The instrument provides an output of at least 10 volts across its rated load of 600 ohms and at least 20 volts open circuit. A special feature is that waveform purity does not depend upon load. Distortion is less than 0.5%; hum voltage is less than 0.1%, and recovery

time is extremely short—5 seconds at 1 Hz. HP 202C, \$325 (cabinet); HP 202CR, \$330 (rack mount).

205AG Audio Signal Generator 20 Hz to 20 kHz

The 205AG provides a maximum of 5 watts output into 50, 200, 600, or 5000 ohms. The output is balanced and center tapped; any terminal can be grounded. The various output impedances are selected by a front-panel switch. Two voltmeters measure the input and output of devices under test. The output level is adjusted by means of attenuators in 10 dB and 1 dB steps. HP 205AG, \$700 (cabinet); HP 205AGR, \$685 (rack).

Specifications

HP Model	Frequency range	Calibration accuracy	Output to 600 ohms	Output impedance	Maximum distortion	Maximum hum and noise†	Input power (watts)	Weight—lb (kg)		Size—inches (mm)			Price
								net	ship	W	H	D	
200AB	20 Hz to 40 kHz (4 bands)	±2%	1 W (24.5 V)	75 Ω (mid-freq)	1% 20 Hz to 20 kHz; 2% 20 kHz to 40 kHz	0.05%	80	15 (6,7)	16 (7,2)	7½ x 11½ x 12 (191 x 292 x 305)		\$235	
200CD	5 Hz to 600 kHz (5 bands)	±2%	>160 mW (>10 V)	600 Ω	0.2% 20 Hz to 200 kHz; 0.5% 5 Hz to 20 Hz and 200 kHz to 600 kHz	>60dB below (<0.1% of) rated output	90	22 (9,9)	24 (10,8)	7¾ x 11½ x 14¾ (187 x 292 x 365)		\$275	
200CD Op HO2			(7.5 V)								**		\$330
201C	20 Hz to 20 kHz (3 bands)	±1%†	3 W (42.5 V)	600* Ω	0.5% ‡	0.03%	85	16 (7,2)	19 (8,6)	7½ x 11½ x 12½ (191 x 292 x 318)		\$295	
202C	1 Hz to 100 kHz (5 bands)	±2%	160 mW (10 V)	600 Ω	0.5% §	0.1%	85	25 (11,3)	27 (12,2)	7½ x 11½ x 14¼ (191 x 292 x 368)		\$325	
205AG	20 Hz to 20 kHz (3 bands)	±2%	5 W 50 V	50, 200, 600, 5kΩ	1%	>60dB	160	56 (25 kg)	67 (30 kg)	20¾" x 12¾" x 15½" (527 x 324 x 394 mm)		\$700	

*Output impedance: 600Ω ±10%, 20 dB, 30 dB and 40 dB settings; <600Ω, 0 dB and 10 dB settings. †Internal controls permit precise calibration of each band, ±0.5% 50 Hz to 20 kHz at 1 W output; 1% over full range at 3 W output. §Above 5 Hz.

**Same as 200CD except: distortion; 0.06% 60 Hz to 50 kHz; 0.1% 20 Hz to 50 Hz and 50 kHz to 400 kHz; 0.5% 5 Hz to 20 Hz and 400 kHz to 600 kHz. Output: 7.5 V into 600Ω load.

‡Measured with respect to full rated output.

General:

Frequency response: flat ±1 dB over instrument range; reference level at 1 kHz.

Size and weight: maximum overall size and weights are given for cabinet models; 19" rack models also available.

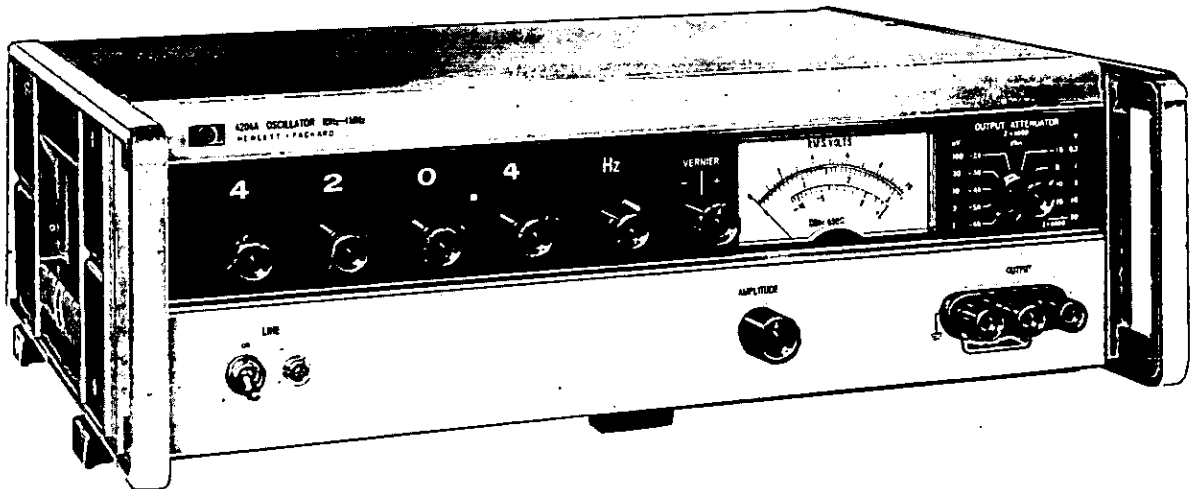
Power: 115 or (230 V must be specified) ±10% at 50 to 400 Hz.

Accessories available: 11000A Cable Assembly, \$5; 11001A Cable Assembly, \$6; 11004A, 11005A Line Matching Transformers, see page 283. Cables are on page 196.



DIGITAL OSCILLATOR

Four digit frequency resolution, 10 Hz to 1 MHz
Model 4204A



4204A

Advantages:

- Simple, rapid 0.2% frequency selection
- Flat frequency response, 10 Hz to 1 MHz
- 0.01% frequency repeatability
- Excellent stability

Uses:

- Production line and repetitive testing
- Standard source for calibrating ac to dc converters
- Response testing of wide or narrow band devices
- Filter checkout

The HP 4204A Digital Oscillator provides accurate, stable test signals for both laboratory and production work. This one instrument does the jobs of an audio oscillator, and ac

voltmeter, and an electronic counter, in applications requiring an accurate frequency source of known amplitude.

Any frequency between 10.0 Hz and 999.9 kHz can be digitally selected with an in-line rotary switch. As many as 36,900 discrete frequencies are available. Infinite resolution is provided by one vernier control, which also extends the upper frequency limit to 1 MHz. Frequency accuracy is better than $\pm 0.2\%$ and repeatability is typically better than $\pm 0.01\%$.

A built-in high impedance voltmeter measures the output. The meter is calibrated to read volts or dBm into a matched 600 ohm load. (0 dBm = 1 mW into 600 ohms.) The output attenuator has an 80 dB range, adjustable in 10 dB steps with a 20 dB vernier. Maximum output power can be increased to 10 volts (22 dBm) into 600 ohms.

Specifications

Frequency range: 10 Hz to 1 MHz, 4 ranges.

Frequency accuracy: $\pm 0.2\%$ or ± 0.1 Hz (at 25°C).

Frequency stability:

$\pm 10\%$ line voltage variation: Less than $\pm 0.01\%$.

Change of frequency with temperature: $< \pm 100$ ppm/°C.

Frequency response: flat within $\pm 3\%$.

Output: 10 V (22 dBm) into 600 ohms, (160 mW). 20 V Open Circuit.

Output attenuators: 80 dB in 10 dB steps; $< \pm 0.5$ db error.

Distortion: less than 0.3%, 30 Hz to 100 kHz. Less than 1%, 10 Hz to 1 MHz.

Hum and noise: less than 0.05% of output.

Dimensions: cabinet; 5¼" high, 16¾" wide, 11¼" deep. (134 x 426 x 286 mm).

Power: 115 V/230 V switch, $\pm 10\%$, 10 watts, 50 to 60 Hz.

Weight: net, 19 lbs (8.5 kg); shipping, 28 lbs (11 kg).

Price: \$695.

Option 01: Output monitor top scale calibrated in dBm/600Ω; bottom scale calibrated in volts; add \$10.

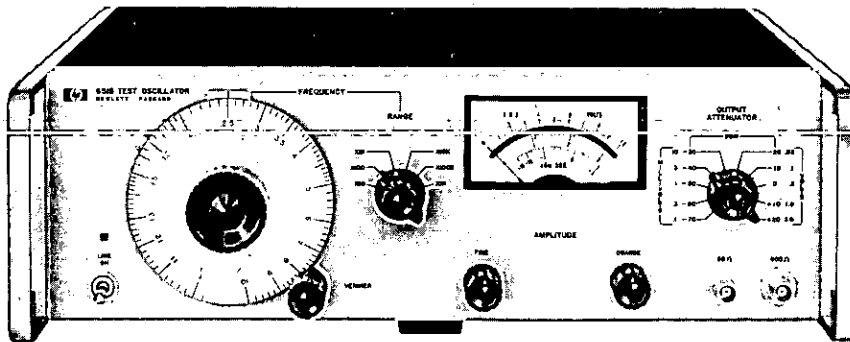
Manufactured by Yokogawa-Hewlett-Packard Ltd., Tokyo.

TEST OSCILLATORS

10 Hz to 10 MHz; 0.75% attenuator accuracy
Models 651B, 652A



SIGNAL SOURCES



651B

HP 651B Description

Amplitude and frequency stability of this solid-state capacitance tuned Hewlett-Packard Test Oscillator provides test quality signals for laboratory or production measurements from 10 Hz to 10 MHz. Two output impedances are available from the front panel providing 200 mW into 50Ω or 16 mW into 600Ω.

HP 651B Specifications

Frequency range: 10 Hz to 10 MHz, 6 bands, dial calibration: 1 to 10.

Amplitude stability: $\pm 2\%$ per mo., 20°C-30°C.

Dial accuracy (indicating warmup and $\pm 10\%$ line voltage variation): $\pm 2\%$, 100 Hz to 1 MHz; $\pm 3\%$, 10 Hz to 100 Hz and 1 MHz to 10 MHz.

Output (max): 3.16 V into 50Ω or 600Ω; 6.32 V open circuit.

Ranges: 0.1 mV to 3.16 V full scale, 10 steps in 1, 3, sequence; -70 dBm to +23 dBm (50Ω output) full scale, 10 dBm per step; coarse and fine adjustable.

Flatness (amplitude not readjusted to a reference on the output monitor): $\pm 2\%$ 100 Hz to 1 MHz; $\pm 3\%$ 10 Hz to 100 Hz; $\pm 4\%$ 1 MHz to 10 MHz*.

(amplitude readjusted to a reference on the output monitor)

Range	Frequency			
	10 Hz	20 Hz	4 MHz	10 MHz
3 V and 1 V	2%	1%		2%
.3 V to .3 mV	2.5%	1.5%		2.5%
.1 mV	3%	2%		3%

Distortion: $< 1\%$, 10 Hz to 2 MHz; $< 2\%$, 2 MHz to 5 MHz; $< 4\%$, 5 MHz to 10 MHz.

Hum and noise: $< 0.05\%$ of maximum rated output.

Output monitor: voltmeter monitors level at input of attenuator in volts or dB.

Accuracy: $\pm 2\%$ of full scale.

Attenuator

Range: 90 dB in 10 dB steps.

Accuracy: ± 0.075 dB, -60 dBm to +20 dBm; ± 0.2 dB, -70 dBm to -60 dBm.

Amplitude control: 20 dB range, coarse and fine.

Temperature range: 0°C to +50°C.

Power: 115 or 230 V $\pm 10\%$, 50 to 400 Hz, 30 W.

Dimensions: 16 $\frac{3}{4}$ " wide, 5" high (without removable feet), 13 $\frac{1}{4}$ " deep (425 x 127 x 337 mm).

Weight: net 17 lbs (7,7 kg); shipping 22 lbs (9,9 kg).

Accessories furnished: rack mount kit for 19" rack.

Price: HP 651B, \$590.

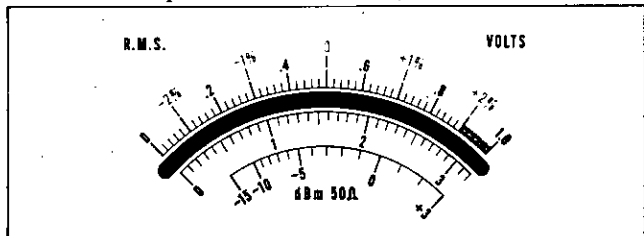
Option 001: output monitor calibrated to read dBm for 600Ω add \$25.

Option 002: outputs, 75Ω and 600Ω; calibrated in dBm/75Ω, add \$25.

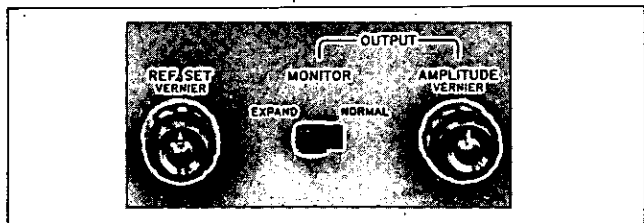
Note: other output impedances above 50Ω are available.

HP 652A Description

The HP Model 652A also incorporates an expandable output monitor for amplitude control to 0.25% across the band.



HP 652A expanded meter scale



HP 652A output controls

HP 652A Specifications

(Same as Model 651B except as indicated below)

Expand scale: expands reference voltage of the Normal Scale from 0.9 to 1.0 or 2.8 to 3.2.

Flatness (amplitude readjusted using expanded scale on output monitor): $\pm 0.25\%$ 3 V and 1 V range; $\pm 0.75\%$ 0.3 V to 0.3 mV range; $\pm 1.75\%$ 0.1 mV range.

Accessories furnished: HP 11048B 50Ω feed-thru termination; rack mounting kit.

Price: HP 652A, \$725.

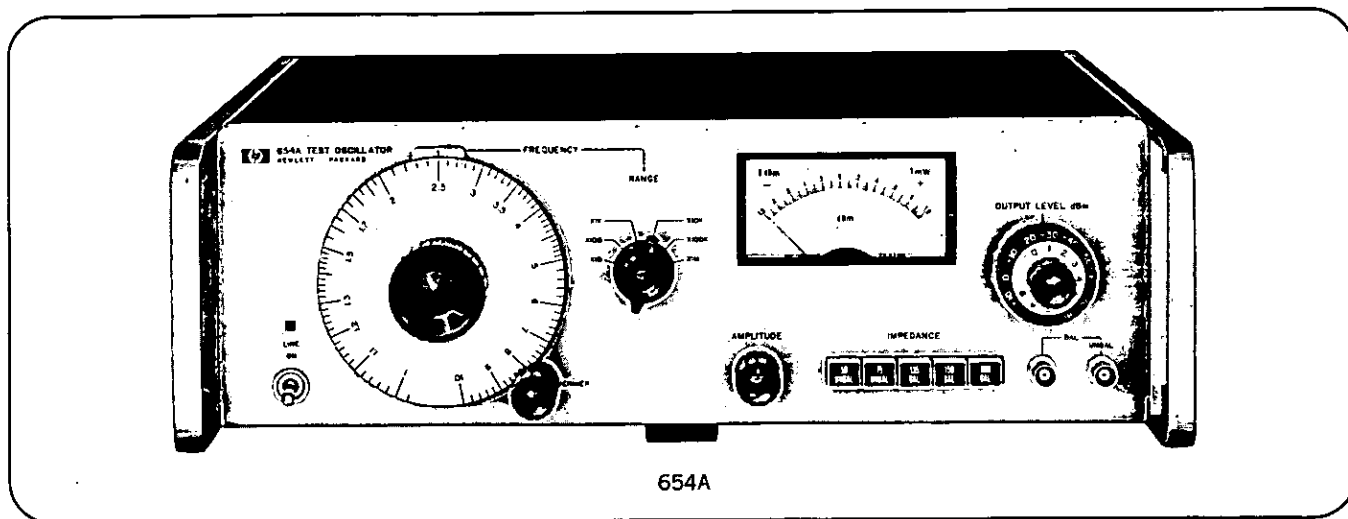
(refer to page 167 for calibration system)

*The response above 1 MHz at 600Ω output is affected by capacitive loads.



TEST OSCILLATOR

Balanced, unbalanced, auto leveled outputs
Models 654A, 653A



The 654A Test Oscillator is a lightweight, portable solid-state signal source. Its 10 Hz to 10 MHz frequency band, amplitude stability, accuracy, and level flatness make it an ideal general purpose test oscillator. The selective output impedances of 50 Ω , 75 Ω unbalanced, and 135 Ω , 150 Ω , 600 Ω balanced make it useful in electronic research laboratories, in production testing, and for use as a commercial test instrument.

The meter is zero centered and reads in dBm. The expanded meter scale from -1 dBm to $+1$ dBm coupled with 10 dB $+1$ dB step attenuators gives good resolution on all ranges from -80 dBm to $+10$ dBm.

The 653A Test Oscillator is similar to the 654A but is specialized for adjustment of transmission characteristics of television video loops.

Adjustable test frequencies from 10 Hz to 10 MHz cover the complete video frequency range. The internal 300 kHz reference oscillator, conveniently selected by a front-panel switch for comparison measurements, eliminates the need for a separate reference oscillator. Amplitude stability, accuracy, and frequency response good for 90 days from calibration eliminate the need to monitor the level with an external power meter.

The 653A option H01 Test Oscillator is a lightweight, portable, solid-state signal source especially designed for alignment of video transmission channels. In addition to the features of the standard 653A, the H01 version includes a 60 Hz square wave, a simulated video signal, a modulated video signal, and a separate sync-only pulse. The simulated video signal, useful for qualitative monitoring, contains a blanking pulse, sync pulse, and white window.

Specifications, 654A

Frequency range: 10 Hz to 10 MHz in 6 bands.
Frequency accuracy: 100 Hz to 5 MHz, $\pm 2\%$; 10 Hz to 100 Hz, $\pm 3\%$; 5 MHz to 10 MHz, $\pm 4\%$.
Level flatness ($+10$ dBm and 0 dBm): $\pm 0.5\%$ from 10 Hz to 10 MHz for unbalanced outputs, 10 Hz to 5 MHz for 135 Ω and 150 Ω outputs, and 10 Hz to 1 MHz for 600 Ω output.

Output impedance: 50 Ω unbalanced, 75 Ω unbalanced, 135 Ω balanced, 150 Ω balanced, and 600 Ω balanced.

Output level: $+11$ dBm to -90 dBm, 10 dB and 1 dB steps with adjustable ± 1 dB meter range; calibrated for each impedance.

Attenuator

Range: 99 dB in 10 dB and 1 dB steps.

Accuracy: $\pm 1.5\%$ (0.15 dB) except $\pm 10\%$ (1 dB) at output levels below 60 dBm at frequencies > 300 kHz.

Amplitude control: > 2 dB (for setting output between 1 dB steps).

Amplitude accuracy: $\pm 1\%$ for 90 days (1 kHz $+10$ dBm).

Meter resolution: 0.02 dB.

Meter tracking: ± 0.05 dB.

Balance (on balanced impedances): > 50 dB for frequencies from 10 Hz to 1 MHz, > 40 dB to 5 MHz.

Distortion (THD): 10 Hz to 1 MHz, > 40 dB below fundamental; 1 MHz to 10 MHz, > 34 dB below fundamental.

Hum and noise: > 70 dB down at full output.

Output connectors: BNC; maximum voltage which can be applied to the output: $< \pm 3$ V p.

Counter output: > 0.1 V rms into 50 Ω , BNC connector.

Specifications, 653A*

Reference accuracy (0 dBV): frequency: 300 kHz $\pm 2\%$; level: ± 0.1 dB for 90 days.

Output impedance: 75 Ω unbalanced, 124 Ω balanced.

Return loss (on 0 dB range and below): > 40 dB to 5 MHz; > 30 dB, 5 MHz to 10 MHz.

Meter range: ± 1 dBV full scale.

Output level: $+11$ dBV to -90 dBV.

Output jacks: accepts WE 358A and 408A plugs.

General

Operating temperature: 0°C to $+55^\circ\text{C}$ (32°F to 130°F).

Power: 115 V or 230 $\pm 10\%$, 50 Hz to 400 Hz, 30 W nominal, 35 W max.

Dimensions: 16 $\frac{3}{4}$ " wide, 5" high (without removable feet), 11 $\frac{1}{4}$ " deep (425 x 127 x 286 mm).

Weight: net 21 lb (9.5 kg); shipping 26 lb (11.8 kg).

Accessories furnished: rack mounting kit for 19" rack.

Price: HP 654A, \$875; HP 653A, \$990.

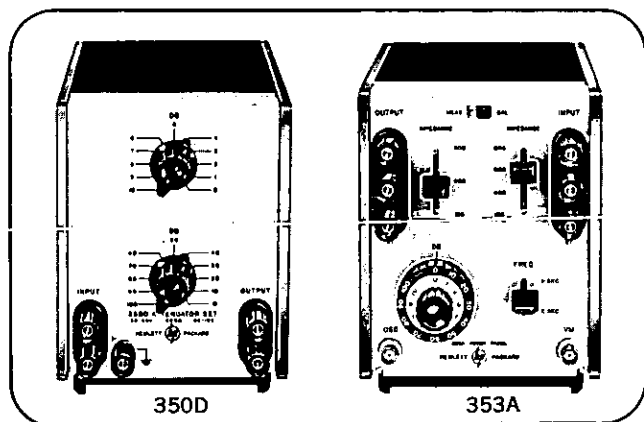
*For complete specifications for the 653A and 653A option H01, refer to page 435.

ATTENUATORS, ACCESSORIES

Match 900, 600, 500 or 135-ohm lines
Models 350C,D, 353A, 11004A, 11005A



SIGNAL SOURCES



HP 353A Patch Panel

This Patch Panel contains a precision attenuator variable in 1 dB steps to 110 dB and two sets of impedance matching transformers. One set of transformers matches 900 ohm, 600 ohm or 135 ohm lines. The other set of transformers terminates the line in 900 ohms, 600 ohms, 135 ohms or in 10 k ohms for bridging measurements. Refer to page 429 for specifications.

HP 350C, 350D Attenuators

When a high order of accuracy, wide frequency response, large power-handling capacity or special features are required, HP 350 Series Attenuators are of great value and convenience. They are particularly useful in attenuating output of audio and ultrasonic oscillators, measuring gain and frequency response of amplifiers, measuring transmission loss, and increasing the scope and usefulness of other laboratory equipment.

11004A Line-Matching Transformer

The 11004A Transformer, with a frequency response between 5 kHz and 600 kHz, provides fully balanced 135 or 600 Ω output from single-ended input. Maximum level +22 dBm. HP 11004A, \$65.

11005A Line-Matching Transformer

The 11005A Transformer, with a frequency response between 20 Hz and 45 kHz, provides a fully balanced 600 Ω output from single-ended input. Maximum level is +15 dBm. HP 11005A, \$85.

10110A, 10111A BNC-to-Binding-Post Adapters

These adapters mate with a BNC or binding post receptacle, respectively, and provide either binding post or BNC output connectors. The 10110A is a BNC male-to-binding-post adapter; the 10111A is a BNC female-to-banana-plug adapter. Spacing between binding posts is $\frac{3}{4}$ ". HP 10110A, \$5; HP 10111A, \$7.

11048B 50-ohm Feed Thru 11094A 75-ohm Feed Thru 11095A 600-ohm Feed Thru

Precision feed-thru termination with male and female connectors. HP 11048B, \$10; HP 11094A, \$10; HP 11095A, \$10.

350C/D Specifications

Attenuation: 110 dB in 1 dB steps.

Accuracy: 10 dB section

	0 dB	10 dB
dc to 100 kHz	< ± 0.125 dB/step	
100 kHz to 1 MHz	< ± 0.25 dB/step	

Accuracy: 100 dB section

	0 dB	70 dB	100 dB
dc to 100 kHz	< ± 0.25 dB	< ± 0.5 dB/step	
100 kHz to 1 MHz	< ± 0.5 dB	< ± 0.75 dB/step	

Power capacity: 350C, 500 Ω ; 5 W (50 V dc or rms) maximum, continuous duty. 350D, 600 Ω ; 5 W (55 V dc or rms) maximum, continuous duty.

DC isolation: signal ground may be ± 500 V dc from external chassis.

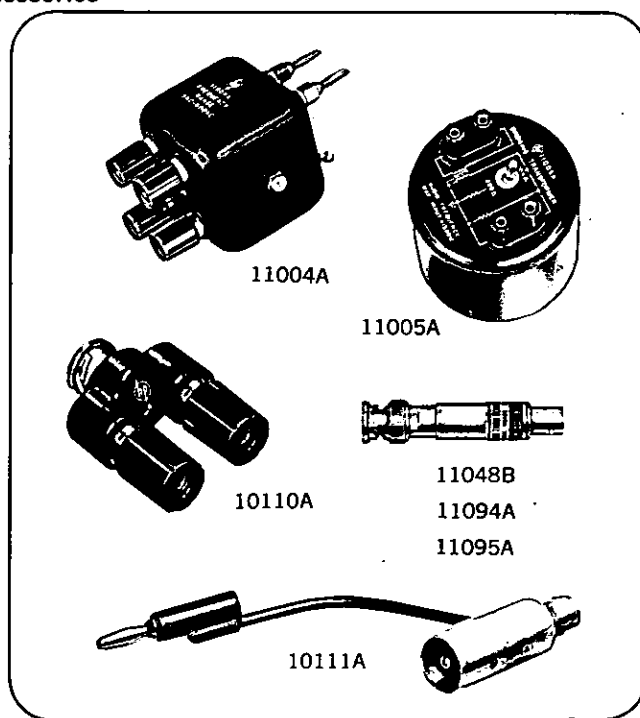
Dimensions: 5 $\frac{1}{8}$ " wide, 6 $\frac{1}{4}$ " high (without removable feet), 8" deep (130 x 159 x 203 mm).

Weight: net 4 lbs (1,8 kg); shipping 5 lbs (2,3 kg).

Accessories available: HP 11000A Cable Assembly, 44" of RG-58C/U 50 Ω coaxial cable terminated by dual banana plugs, \$5. HP 11001A Cable Assembly, as above but with one BNC male connector, \$6. 11075A Carrying Case (refer to pages 636 and 637), \$45.

Price: HP 350C; 500 Ω attenuator, \$160. HP 350D; 600 Ω attenuator, \$160.

Oscillator Accessories



SIGNAL GENERATORS



SIGNAL GENERATORS TO 40 GHz

Signal generators

Hewlett-Packard offers a complete line of easy-to-use HF, VHF, UHF, and SHF signal generators covering frequencies between 50 kHz and 40 GHz. Each Hewlett-Packard generator incorporates the following:

- (1) accurate, direct-reading, frequency calibration
- (2) variable output, accurately calibrated and direct reading
- (3) constant output impedance, well matched
- (4) varied modulation capabilities
- (5) low RF leakage
- (6) low harmonic content

(7) freedom from spurious or incidental modulation.

This ensures the utmost convenience and accuracy for all kinds of measurements and signal simulations, including receiver sensitivity, selectivity or rejection, signal-to-noise ratio, gain bandwidth characteristics, conversion gain, antenna gain, transmission line characteristics, as well as power to drive bridges, slotted lines, filter networks, etc.

Sweeping signal generators

A result of Hewlett-Packard thin film and hybrid microcircuit technology, the 8601A Generator/Sweeper is one of a new breed of signal generators that also

sweep. Intended to be a general purpose instrument, the 8601A also satisfies many specialized test and design applications. From 10 kHz to 32 MHz, the 675A Sweep Signal Generator also offers many convenient features, as described on Page 317.

HF to UHF signal generators

These signal generators, including HP 606A, 606B, 608E, 608F, and 612A, collectively cover frequencies from 50 kHz to 1.23 GHz and are characterized by extremely low drift and incidental frequency modulation. All may be amplitude (sine, square, pulse) modulated. A feedback loop in the 606A and 606B keeps their output and percent modula-

Table 1

Model	Frequency range	Characteristics	Page
606A/B Signal Generator	50 kHz to 65 MHz 606B also has:	output 3 V to 0.1 μ V, mod. BW dc to 20 kHz, low drift and noise, low incidental FM, low distortion, auxiliary RF output, stabilized phase lock capability	286
8601A Generator Sweeper	100 kHz to 110 MHz	$\pm 1\%$ of frequency dial accuracy, cal output ± 20 to -110 dBm into 50 ohms, leveled to ± 0.25 dB, very low drift, residual FM and RFI leakage, 30% AM, 75 kHz dev FM, aux output, crystal cal	288
608E Signal Generator	10 to 480 MHz	output 1 V to 0.1 μ V, into 50-ohm load; AM, pulse modulation, direct calibration, leveled power output, aux RF output	292
608F Signal Generator	10 to 455 MHz	output 0.5 V to 0.1 μ V into 50 ohms, amplitude, pulse modulation, direct calibration, low incidental FM and drift, leveled output, aux RF output, stabilized phase lock capability	292
8708A Synchronizer	50 kHz to 455 MHz	Companion for 606B or 608F permitting $2/10^7$ continuous settability & stability, FM and phase modulation	294
612A Signal Generator	450 to 1230 MHz	output 0.5 V to 0.1 μ V into 50-ohm load; AM, pulse or square-wave modulation, direct calibration	297
614A Signal Generator	0.8 to 2.1 GHz	output at least 0.5 mW to -127 dBm (0.1 μ V) into 50 ohms, pulse or frequency modulation, direct calibration	300
8614A Signal Generator	0.8 to 2.4 GHz	output ± 10 to -127 dBm into 50 ohms, leveled below 0 dBm; internal square-wave; external pulse, AM and FM; auxiliary RF output	298
8614B Signal Source	0.8 to 2.4 GHz	output 15 mW; precision attenuator 130 dB range; internal square-wave, external pulse and FM; auxiliary RF output	298
616B Signal Generator	1.8 to 4.2 GHz	output 1 mW to -127 dBm (0.1 μ V) into 50-ohm load, pulse or frequency modulation, direct calibration	300
8616A Signal Generator	1.8 to 4.5 GHz	output ± 3 to -127 dBm into 50 ohms, leveled below 0 dBm; internal square-wave, external pulse, AM and FM; auxiliary RF output	298
8616B Signal Source	1.8 to 4.5 GHz	output 3 mW; precision attenuator 130 dB range; internal square-wave, external pulse and FM; auxiliary RF output	298
618C Signal Generator	3.8 to 7.6 GHz	output 1 mW to -127 dBm (0.1 μ V) into 50 ohms, pulse, frequency or square-wave modulation, direct calibration, ext FM and pulse modulation, auxiliary RF output	302
620B Signal Generator	7 to 11 GHz	output 1 mW to -127 dBm (0.1 μ V) into 50 ohms, pulse, frequency or square-wave modulation, direct calibration, ext FM and pulse modulation, auxiliary RF output	302
626A Signal Generator	10 to 15.5 GHz	output ± 10 dBm to -90 dBm; pulse, frequency or square-wave modulation, direct calibration	304
628A Signal Generator	15 to 21 GHz	output ± 10 dBm to -90 dBm; pulse, frequency or square-wave modulation, direct calibration	304
938A Frequency Doubler	18 to 26.5 GHz	driven by 9 to 13.25 GHz source, HP 626A, 8690 series sweepers or klystrons; 100 dB precision attenuator	306
940A Frequency Doubler	26.5 to 40 GHz	driven by 13.25 to 20 GHz source, HP 628A, 8690 series sweepers or klystrons; 100 dB precision attenuator	306

tion constant as frequency is varied. The 608E and 608F also offer level power output resulting in significant time saving and convenience when the generator is being used to conduct tests at several frequencies. The 606B, 608E, and 608F offer an auxiliary, fixed-level, CW signal which can be applied to a counter for very accurate indication of carrier frequency.

Stabilized RF signal generation

The HP 606B and 608F contain voltage variable capacitors in their oscillator circuits enabling phase-locked operation with the HP Model 8708A RF Synchronizer obtaining $2/10^7$ settability and stability. Phase-locked operation of the HP 606B and 608F Signal Generators can be obtained without compromise of the instruments' modulation or attenuation characteristics. The HP 8708A Synchronizer enables continuous tuning permitting continuous frequency response examination of devices such as highly-selective, narrow-band filters. The HP 8708A Synchronizer provides the additional benefit of phase and frequency modulation capability with the 606B and 608F Signal Generators.

Signal sources above 10 MHz

Signal generators available from Hewlett-Packard include general-purpose oscillators and amplifiers, FM signal generators, and specialized signal generators for aircraft navigation systems.

The 3200B VHF Oscillator is a compact, versatile source in the 10 to 500 MHz range suitable for general-purpose laboratory work. The 230B Signal Generator Power Amplifier provides a convenient means of obtaining power levels up to 4.5 watts in the 10 to 500 MHz range when operated in conjunction with a signal generator.

HP's FM signal generators offer unusual modulation linearity and stability. The 202H FM-AM Signal Generator operates in the 54 to 216 MHz range and is designed to serve the broadcast FM, VHF-TV, and mobile communications markets. The 202J Telemetry Signal Generator is specifically designed for VHF telemetry and covers the 195 to 270 MHz frequency range. An accessory 207H Uni-

Special purpose signal sources

Application	Frequency range	Modulation	Output	Model	Page
Down converter for 202H	100 kHz to 55 MHz	See specifications		207H	291
Test, calibrate FM receivers	54 to 216 MHz	FM, AM	0.2 V	202H	290
Telemetry tests	1430 to 1540 MHz 2150 to 2310 MHz	FM	-10 to -127 dBm	3205A	307
VOR/ILS tests	88 to 140 MHz	AM	0.2 V	211A	309
ILS tests	329.3 to 335 MHz	AM	0.2 V	232A	
DME/ATC tests	962 to 1213 MHz	Pulse	-10 dBm	8925A	308
Receiver, Transmitter Tests	5280 to 7780 MHz ¹	FM, AM	1 mW	623B	301
	7100 to 8500 MHz	FM, AM	31.6 mW	5636	
	8500 to 10,000 MHz	FM, AM	1 mW	624C	

¹ Not continuous coverage, see specifications.

verter provides additional coverage when used with either the 202H or 202J Signal Generators.

The 211A Signal Generator is specifically designed for the testing and calibration of aircraft VOR omni-range and ILS localizer receivers; an external modulator, such as the Collins 479-F3, is required to provide simulated course and bearing. The 232A Glide Slope Signal Generator is specifically designed for the testing and calibration of ILS glide slope receivers. The 8925A DME/ATC Test Set is designed to provide complete facilities for the testing and calibration of aircraft DME radios and ATC transponders; suitable external modulators are required, such as the Collins 578D-1 and 578X-1, to simulate ground station operation.

UHF to SHF signal generators and sources

This group of instruments, covering 800 MHz to 21 GHz, features extremely simple operation. The 614A, 616B, 618C, 620B, 626A and 628A Signal Generators provide large, direct-reading frequency and attenuator dials. They may be pulse, square-wave, and frequency modulated. Their versatility makes them useful for measuring signal-to-noise ratio, receiver sensitivity, SWR and transmission line characteristics.

The HP 8614A and 8616A Signal Generators are particularly easy to use. Frequency and attenuation are set on direct-reading digital dials, and leveled

output enables frequency response testing without time-consuming readjustment of the generator at each new frequency. Each unit contains a unique PIN diode modulator which permits such a wide range of amplitude modulation that remote control of output level or precise leveling with external equipment is possible.

PIN modulators

The 8730 series of PIN Modulators increases the modulation capability of microwave signal sources and at the same time virtually eliminates incidental FM. The model 8403A provides complete control of the 8730 series of PIN modulators, supplying the bias wave-shapes and levels for fast rise times, rated on-off ratios and amplitude modulation as well as providing pulse and square wave signals for direct application to signal sources. See page 310.

Frequency doublers

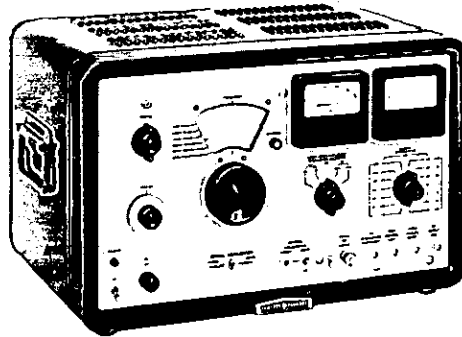
Broadband frequency doublers, HP 938A and 940A, provide low-cost signal generator capability in the 18 to 40 GHz range. Designed to be driven by signal sources in the 9 to 20 GHz range, the frequency doublers preserve the versatility and stability of the driving source. Thus, the signals may be CW, pulsed or swept. An output monitor and precision attenuator provide a metered output, even though the input signal is uncalibrated.

SIGNAL GENERATORS



HF SIGNAL GENERATORS

Convenience and performance 50 kHz-65 MHz
Models 606B, 606A



606B

Description

The Hewlett-Packard 606B Signal Generator provides you with high quality, versatile performance with distinctive ease of operation in the important and widely used 50 kHz to 65 MHz frequency range. Output signals are stable and accurately known, output amplitude can be precisely established over a very wide dynamic range, and versatile modulation capabilities are incorporated to satisfy virtually all measurement requirements. Convenient size and shape, together with a simple, straightforward control panel layout, make the 606B well suited for production line use as well as laboratory or field applications.

Design

The 606B is a master oscillator-power amplifier (MOPA) design with a broadband buffer amplifier stage between the oscillator and power amplifier circuits for isolation. The MOPA design permits optimization of the oscillator circuit for highest stability including low drift, minimum residual FM, low harmonics, etc., without restricting the modulation characteristics. Modulation is applied to the power amplifier circuit with negligible effect on the oscillator frequency (because of the buffer stage). Very fine frequency settability is achieved through incorporation of a ΔF control which provides better than 10 ppm resolution.

Highest frequency stability

While the basic frequency stability of the 606B is excellent (less than 0.005% drift over a 10-minute period after warm-up), the inclusion of frequency control circuitry in the 606B makes it possible to achieve 250 times greater stability by phase-locking the 606B with the HP 8708A Synchronizer. The 8708A, which is fully compatible with the 606B in every respect, can stabilize the 606B at any frequency (not just at discrete points) with a resultant stability of $2 \times 10^{-7}/10$ minutes and a very high degree of spectral purity. The combination of the 606B and 8708A also permits you to perform narrow band frequency- or phase-modulation of the 606B carrier with very low modulation distortion. The 8708A is described on page 294.

Simplified operation

An outstanding feature of the 606B is the employment of feedback in the RF power amplifier section which results in superior performance characteristics and true ease of operation. The feedback circuit maintains both the output level and the percentage of modulation essentially constant over the entire frequency range, thus making it unnecessary to readjust

controls when changing the operating frequency. The use of feedback also enables you to change the output level without affecting the degree of modulation. The constant output, constant modulation feature results in significant time saving as well as operator convenience, making the 606B an ideal choice for production line operations where semi-skilled personnel can make meaningful measurements.

Versatile amplitude modulation

The use of feedback in the power amplifier section also yields excellent amplitude modulation characteristics. Up to 95% modulation can be achieved with modulating frequencies ranging from dc to 20 kHz. Envelope distortion is very low, less than 1% at 30% AM and less than 3% at 70% AM; this allows you to make more accurate measurements of the distortion characteristics on receivers or detectors. Internal modulation oscillators of 400 Hz and 1000 Hz are provided, and the modulation percentage can be set and read directly on the accurate front panel modulation meter. The wide modulation bandwidth (dc to 20 kHz) means the 606B may be modulated with square waves or other complex signals including tone-burst modulation, or you can remotely program the output amplitude. The buffer stage between the master oscillator and power amplifier holds incidental FM with AM to a minimum, ensuring accurate measurements.

Accurate output level

The output level from the 606B is continuously adjustable from 3 volts to 0.1 microvolts rms into a 50 ohm load. Direct calibration is provided in both volts and dBm (+23 to -120 dBm) and the output calibration is accurate to within 1 dB at any frequency or level setting. The output system of the 606B is a well matched 50 ohm circuit which minimizes mismatch ambiguities as a factor in overall measurement accuracy. The extremely wide range of output amplitude control makes the 606B very useful for driving bridges and filters as well as complete receiver measurements including sensitivity, selectivity, and image rejection.

The 606B provides an auxiliary RF output; this fixed level (100 millivolts rms minimum) CW signal is for use with the 8708A Synchronizer and can also be applied to an HP 5245L Counter for very accurate indication of carrier frequency. Using the auxiliary RF output does not place any restriction on the modulation capabilities nor on the main RF output level. The 606B also contains a crystal calibrator to provide accurate frequency checkpoints at every 100 kHz or 1 MHz throughout the frequency range of the instrument.

Specifications, 606B

Frequency characteristics

Range: 50 kHz to 65 MHz in 6 bands (50-170 kHz, 165-560 kHz, 0.53-1.8 MHz, 1.76-6 MHz, 5.8-19.2 MHz, 19-65 MHz); total scale length approximately 95 in.

Accuracy: $\pm 1\%$.

Drift: (attenuator on 1 volt range and below) less than 50 parts in 10^6 (or 5 hertz, whichever is greater) per 10 minute period after 2-hour warmup; less than 10 minutes to restabilize after changing frequency.

Stability when used with 8708A Synchronizer: 5×10^{-8} /minute, 2×10^{-7} /10 minutes, 2×10^{-6} /day; $2 \times 10^{-7}/^{\circ}\text{C}$, 0° to 55°C ; $2 \times 10^{-7}/10\%$ line voltage change.

Resettability: vernier control resettability better than 0.15% after initial warmup.

ΔF control: ultra-fine frequency vernier provides better than 10 parts in 10^6 settability; total range of ΔF control approximately 0.1%.

Crystal calibrator: provides frequency checkpoints every 100 kHz and 1 MHz; headphone jack provided for audio frequency output (headphone not included); crystal frequency accuracy better than 0.01% from 0° to 50°C ; cursor on frequency dial adjustable over small range to aid in interpolation adjustment; calibrator may be turned off when not in use.

Residual FM: less than ± 1 part in 10^6 or ± 20 hertz peak, whichever is greater.

Frequency control input: BNC female connector for "frequency control output" from 8708A Synchronizer; can also be used for external frequency control: voltage change from -2 to -32 volts changes frequency more than 0.2% at low end of each band, and more than 2% at high end; nominally 4 k Ω input impedance, direct-coupled; voltage limits: 0 volt \leq applied voltage \leq 50 volts negative.

Output level: continuously adjustable from 0.1 microvolt to 3 volts into 50-ohm resistive load; output attenuator calibrated in 10-dB steps from 3 volt full scale to 1.0 microvolt full scale (into 50 ohms), also calibrated in dBm (0 dBm=1 milliwatt in 50 ohms); vernier control provides continuous adjustment of voltage between full scale ranges; output level indicated on RF output meter calibrated in volts (0 to 1 and 0 to 3 volts) and dBm (-10 to $+3$ dBm).

Frequency response and output accuracy: at any output voltage below 1 volt, output level variation with frequency is less than 2 dB across the entire frequency range; output accuracy is better than ± 1 dB at any frequency.

Impedance: 50 ohms, SWR less than 1.2 on 0.3 volt attenuator range and below.

RFI: meets all conditions specified in MIL-I-6181D; permits receiver sensitivity measurements down to at least 1.0 microvolt.

Harmonic output: at least 30 dB below the carrier.

Spurious AM: hum and noise sidebands are 70 dB below carrier down to thermal level of 50 ohm output system.

Auxiliary RF output: fixed level CW signal from RF oscillator provided at front panel BNC female connector for use with HP 8708A Synchronizer or other external equipment (e.g., frequency counter). Minimum output: 100 mV rms into 50 ohms from 50 kHz to 19.2 MHz, 200 mV rms from 19 to 65 MHz.

Modulation characteristics

Internal AM:

Frequency: 400 and 1000 Hz, $\pm 5\%$; modulation signal available at front panel BNC female connector for synchronization of external equipment.

Modulation level: 0 to 95% on 1 volt range and below; 0 to at least 30% on 3 volt range.

Carrier envelope distortion: less than 1% at 30% AM; less than 3% at 70% AM (attenuator on 1 volt range and below).

Incidental frequency modulation (attenuator on 1 volt range and below, 30% modulation): less than $5 \times 10^{-6} + 100$ Hz peak.

External AM:

Frequency: dc to 20 kHz maximum, dependent on carrier frequency (f_c) and percent modulation as tabulated:

Maximum modulation frequency:

30% Mod:

0.06 f_c ;

70% Mod:

0.02 f_c ;

Squarewave Mod:

0.003 f_c (3 kHz max).

Modulation level: 0 to 95% on 1 volt attenuator range and below, 0 to at least 30% on 3 volt range.

Input required: 4.5 volts peak produces 95% modulation (maximum input 50 volts peak); input impedance 1000 ohms.

Carrier envelope distortion: less than 1% at 30% AM, less than 3% at 70% AM (attenuator on 1 volt range and below).

Modulation meter accuracy: $\pm 5\%$ of full scale, 0 to 90%, for modulation frequencies to 10 kHz, $\pm 10\%$ of full scale for frequencies from 10 kHz to 20 kHz.

Modulation level constancy (internal or external AM; attenuator on 1 volt range and below): modulation level stays constant within $\pm 1/2$ dB regardless of carrier frequency and output level changes.

General

Power: 115 or 230 V $\pm 10\%$, 50 to 400 Hz, 135 W.

Dimensions: cabinet mount, 20 $3/4$ " wide, 12 $1/2$ " high, 14 $3/4$ " deep, (527 x 318 x 370 mm).

Weight: cabinet mount, net, 55 lb (24.8 kg); shipping, 65 lb (29.3 kg); rack mount, net, 50 lb (22.5 kg); shipping, 63 lb (28.4 kg).

Accessories available:

11507A Output Termination, provides 3 positions: 50 ohms (for use into high impedance); 5 ohms (10:1 voltage division); IEEE Standard Dummy Antenna (driven from 10:1 divider); see page 294.

11509A Fuse Holder, provides protection for output attenuator when 606B is used for transceiver tests; see page 294.

10534A Mixer, for use as nanosecond pulse modulator; see page 294. Price, \$70.

Price: Model 606B (cabinet mount), \$1650; Model 606BR (rack mount), \$1635.

Model 606A

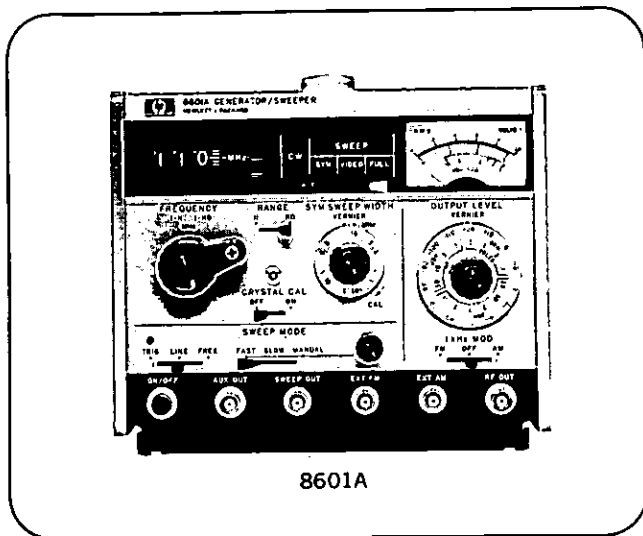
The Model 606A covers the same frequency ranges as the 606B, but does not include the frequency control input feature that allows frequency stabilization by the Model 8708A Synchronizer. Model 606B specifications apply to the 606A with the following exceptions: an auxiliary uncalibrated RF output is not included; harmonic output is less than 3%; the crystal calibrator provides check points at 100 kHz (useful to 6 MHz) and 1 MHz intervals; output power level frequency response is ± 1 dB over the entire frequency range.

Price: HP 606A (cabinet), \$1540; HP 606AR (rack mount) \$1525.



GENERATOR/SWEEPER

A general-purpose production and lab tool
Model 8601A



Signal generator performance

The 8601A offers good CW characteristics with $\pm 1\%$ of frequency dial accuracy and a wide range of continuously adjustable output power levels accurate to ± 1 dB from +13 dBm to -110 dBm. A power output meter is calibrated in both dBm and rms volts into 50 ohms. These features and low RFI leakage mean that receiver sensitivity can be measured. In addition, flatness (power output versus frequency) is better than ± 0.25 dB over the entire band and ± 0.1 dB over any 10-MHz portion from 1 to 110 MHz. Many other signal generator applications can also be satisfied by the 8601A because of its low noise output—more than 70 dB down in a 1-kHz bandwidth.

A unique AM marker system built into the automatic leveling circuit provides 0.01% frequency identification at 5-MHz intervals. The frequency vernier with $\pm 0.1\%$ of frequency variation and the AUX output signal that's always between 100 kHz - 11 MHz regardless of band allow 2-kHz settability on high band (200-Hz on low band) when used with the 5321A Opt. H01 low-frequency counter.

A small amount of modulation is available at the flick of a switch to provide a convenient test situation. For example, discriminator sensitivities to AM and FM can be checked without the use of an external oscillator. 30% AM and 75 kHz deviation FM (7.5 kHz on low band) are provided by an internal 1-kHz oscillator. External AM and full band external FM allow the 8601A to be programmed in both frequency and amplitude.

Options

- 001, 002, 011—Variable AM/FM-Meter Monitor.
- 003—Reduced External FM Sensitivity.
- 004—Rear Panel Auxiliary Output.
- 005—400 Hz Internal Oscillator.
- 006—22.5 kHz Peak FM Deviation.
- 008, 009, 010—75 Ohm Calibrated Output.

Major Specifications 8601A as a generator

(Refer to complete specifications on pages 318, 319)

Frequency characteristics

Coverage: low range, 0.1-11 MHz; high range, 1-110 MHz.

Accuracy: (In CW).

Low range, $\pm 1\%$ of frequency ± 10 kHz.

High range, $\pm 1\%$ of frequency ± 100 kHz.

Settability: vernier settability, $\pm 0.01\%$; vernier range, $\pm 0.1\%$; coarse settability using 10-turn pot is 5 kHz, low range; 50 kHz, high range.

Drift in CW:

(0.01% +500 Hz)/10 min, high range, after 1 hr warmup.

(0.01% +50 Hz)/10 min, low range, after 1 hr warmup.

0.1%/°C temperature change.

0.001%/V line voltage change.

Harmonics and spurious signals (CW above 250 kHz, +10 dBm on the +10 dBm attenuator step or below): harmonics at least 35 dB below carrier. Spurious signals at least 40 dB below carrier.

Residual FM in CW: less than 50 Hz rms, low range; 500 Hz rms high range.

Incidental FM with 30% AM: negligible.

Residual AM: AM noise modulation index (rms, 10 kHz bandwidth) is < -50 dB. (Typically -60 dB at 25°C.)

Incidental AM: incidental AM modulation index is < -55 dB with 75 kHz deviation.

Output characteristics

Level: +20 to -110 dBm. 10-dB steps and 13-dB vernier provide continuous settings over entire range. Meter monitors output in dBm and rms volts into 50 Ω .

Accuracy: ± 1 dB accuracy for any output level from +13 dBm to -110 dBm.

Flatness: ± 0.25 dB over full range, ± 0.1 dB over any 10-MHz portion.

Amplitude modulation

Internal AM: fixed 30% $\pm 5\%$ at 1 kHz, less than 3% distortion. Typically $< 1\%$ distortion for output readings on upper half of meter scale.

External AM: 0 to 50%, dc to 400 Hz. 0 to 30%, up to 1 kHz. Applied through external AM input on front panel. Sensitivity typically 2 V peak/10% modulation index at 400 Hz (10-50% AM).

Frequency modulation

Internal FM: high range: fixed 75 kHz $\pm 5\%$ peak deviation, 1-kHz rate; low range: 7.5 kHz $\pm 5\%$ peak deviation, 1-kHz rate; less than 3% distortion. Typically $< 1\%$.

External FM: sensitivity: 5 MHz per volt $\pm 5\%$, high range; 0.5 MHz per volt $\pm 5\%$, low range; negative polarity. Deviations to the band edges are possible for rates to 100 Hz; voltage-to-frequency linearity is $\pm 0.5\%$, allowing remote frequency programming. FM rates to 10 kHz are obtainable with less linearity and accuracy.

Crystal calibrator

Internal 5-MHz crystal allows frequency calibration to $\pm 0.01\%$ at any multiple of 5 MHz.

Price: Model 8601A, \$2250.

VHF OSCILLATOR

10 to 500 MHz; to 1000 MHz with Accessory Probe
Model 3200B



SIGNAL SOURCES

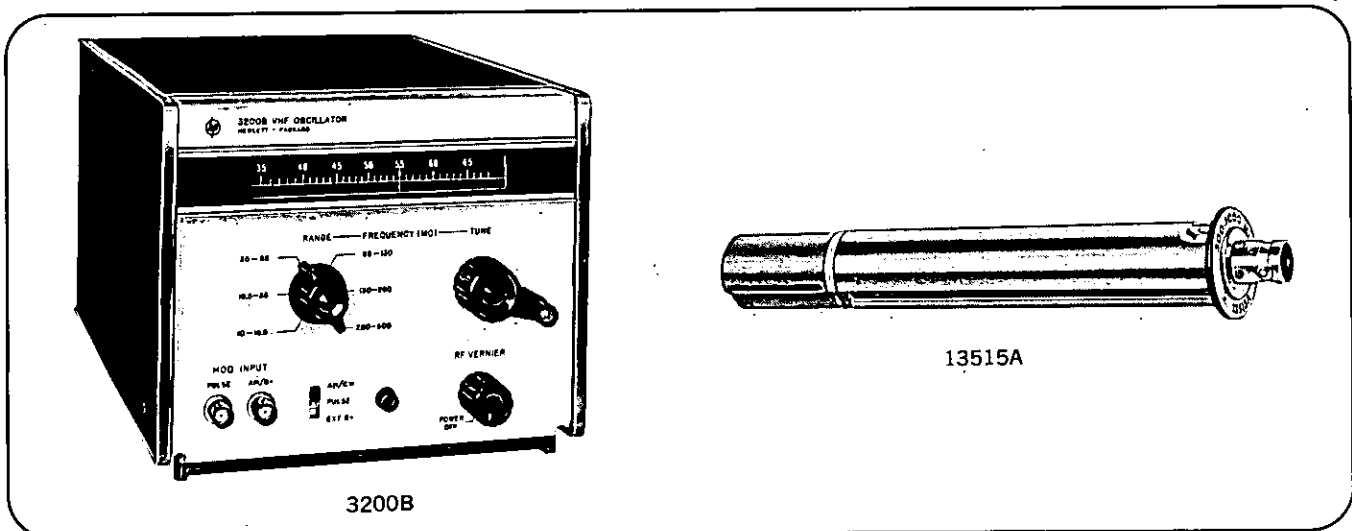
The HP 3200B VHF Oscillator provides low cost, stable, 10 to 500 MHz RF for testing receivers and amplifiers, and driving bridges, slotted lines, antennas, and filter networks. Good pulse modulation sensitivity allows standard audio oscillators to be used to provide usable square-wave modulation; a 2.5-volt sine wave will provide adequate drive for this type application. The 3200B can also serve as a local oscillator for heterodyne detector systems and as a marker source for swept systems. An optional accessory Frequency Doubler Probe, HP 13515A, provides additional frequency coverage from 500 to 1000 MHz.

The 3200B will typically recover specified stability in 30 minutes following a frequency band change. Long-term

warmup (24 hours) can reduce this time as much as 50%. Following in-band frequency dial changes, the oscillator typically requires 10 minutes to recover specified stability. With the instrument in thermal equilibrium with its surroundings, (i.e., long-term warmup and constant temperature lab), stabilities of 0.0001% are typical at some frequencies, if sufficient settling time is allowed after a frequency change.

Effective RF shielding permits measurements at levels down to $1 \mu\text{V}$.

RF is read on an expanded slide-rule type scale. The oscillator may be precisely tuned by means of a mechanical vernier activated by the main tuning control.



Specifications

Frequency range: 10 to 500 MHz in six bands: 10 to 18.8 MHz; 18.5 to 35 MHz; 35 to 68 MHz; 68 to 130 MHz; 130 to 260 MHz; 260 to 500 MHz.

Frequency accuracy: within $\pm 2\%$ after $\frac{1}{2}$ hour warmup.

Frequency calibration: increments of less than 4%.

Frequency stability (after 4-hour warmup under 0.2 mW load): short term (5 minutes) $\pm 0.002\%$; long term (1 hour) $\pm 0.02\%$; line voltage (5-volt change) $\pm 0.001\%$.

RF output:

Maximum power (across 50-ohm external load): > 200 mW (10 to 130 MHz); > 150 mW (130 to 260 MHz); > 25 mW (260 to 500 MHz).*

Range: 0 to > 120 dB attenuation from maximum output.

Load impedance: 50 ohms nominal.

RF leakage: sufficiently low to permit measurements at $1 \mu\text{V}$.
RFI: meets requirements of MIL-I-6181D.

Amplitude modulation: externally modulated.

Range: 0 to 30%.

Distortion: $< 1\%$ at 30% AM.

External requirements: approximately 20 volts rms into 600 ohms for 30% AM, 200 Hz to 100 kHz.

Pulse modulation: externally modulated.

External requirements: 2.5-volt negative pulse into 2000 ohms.

Power: 105 to 125 V or 210 to 250 V, 50 to 400 Hz, 30 W.

Dimensions: $7\frac{5}{8}$ " wide, $6\frac{1}{2}$ " high, $13\frac{1}{8}$ " deep (194 x 165 x 333 mm).

Weight: net 15 lbs (6,8 kg), shipping 19 lbs (8,6 kg).

Accessories available: 13515A Frequency Doubler Probe; 00501B, 00514B, 00517B Output Cables; 00502B, 00506B Patching Cables.

Price: HP 3200B, \$525; HP 13515A, \$95.

*For higher RF power output, to 4.5 watts, use of the 2308 Power Amplifier is recommended. See page 471.

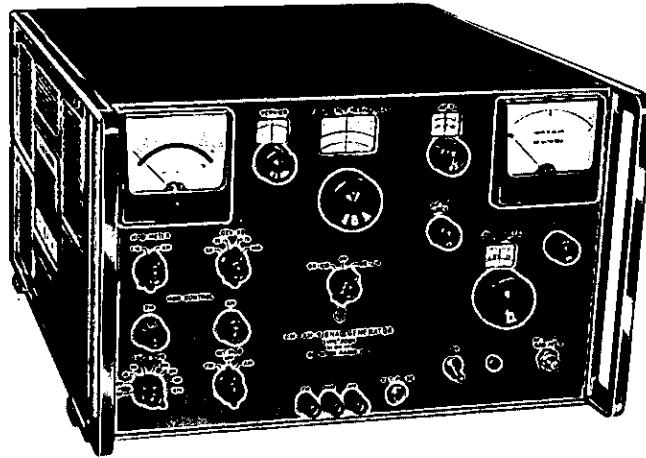


FM-AM SIGNAL GENERATOR

FM, AM, CW and pulse coverage 54 to 216 MHz
Model 202H

The HP 202H FM-AM Signal Generator covers the frequency range from 54 to 216 MHz and is designed for the testing and calibration of FM receiving systems in the areas of broadcast FM, VHF, TV, mobile and general communica-

tions. The generator consists of a three-stage RF unit, together with a modulating oscillator and power supply, all housed in a single cabinet which may be readily adapted for rack mounting.



202H

Specifications

Radio frequency characteristics

RF range: total range: 54 to 216 MHz; number bands: 2; band ranges: 54 to 108 MHz 108 to 216 MHz.

RF accuracy (after 1 hour warm-up): main dial: $\pm 0.5\%$; electronic vernier: $\pm (10\% + 1 \text{ kHz})$.

RF stability: $< 0.01\%$ per hour (after two hour warm-up).

RF output: range: $0.1 \mu\text{V}$ to 0.2 V (across external 50-ohm load at panel jack); accuracy: $\pm 10\%$, $0.1 \mu\text{V}$ to $50 \text{ K} \mu\text{V}$; $\pm 20\%$, $50 \text{ K} \mu\text{V}$ to 0.2 volts ; auto level set: holds RF monitor meter to "red line" over band.

Impedance: 50 ohms.

VSWR: < 1.2 .

Spurious output: All spurious RF output voltages are at least 30 dB below desired fundamental.

RF leakage: sufficiently low to permit measurements at $0.1 \mu\text{V}$.

Amplitude modulation characteristics

AM range: internal: 0 to 50%; external: 0 to 100%.

AM accuracy: $\pm 10\%$ of reading at 400 Hz at 30% and 50% AM.

AM calibration: 30, 50, 100%.

AM distortion: $< 5\%$ at 30%, $< 8\%$ at 50%; $< 20\%$ at 90%.

AM fidelity: $\pm 1 \text{ dB}$, 30 Hz to 200 kHz.

External AM requirements: approximately 60 volts rms into 500 ohms for 100% AM.

Frequency modulation characteristics

FM deviation range: internal or external, 0 to 250 kHz in 4 ranges.

FM deviation accuracy: $\pm 5\%$ of full-scale (for 400 Hz sine wave).

FM calibration: 0 to 7.5 kHz in increments of 0.5 kHz, 0 to 25 kHz in increments of 1 kHz, 0 to 75 kHz in increments of 5 kHz, 0 to 250 kHz in increments of 10 kHz.

FM distortion (at 400 Hz mod. freq.): $< 0.5\%$ at 75 kHz (100 MHz), $< 1\%$ at 75 kHz (54 to 216 MHz), $< 10\%$ at 250 kHz (54 to 216 MHz).

FM fidelity: $\pm 1 \text{ dB}$, 5 Hz to 200 kHz.

Signal-to-noise ratio: $> 50 \text{ dB}$ below 10 kHz (31.6 Hz peak deviation).

External FM requirements: $< 3 \text{ volts rms}$ into 2 K ohms for 250 kHz deviation.

DC FM input: permits control of output frequency over a limited range with an external dc voltage.

Pulse modulation characteristics

PM source: external, PM rise time: $\leq 0.6 \mu\text{s}$.

PM decay time: $< 0.8 \mu\text{s}$.

Modulating oscillator characteristics

OSC frequency: 50 Hz, 400 Hz, 1000 Hz, 3000 Hz, 7.5 kHz, 10 kHz, 15 kHz, 67 kHz.

OSC accuracy: $\pm 5\%$.

OSC distortion (at FM terminals): $< 0.5\%$, 50 Hz to 15 kHz; $< 1.0\%$, 67 kHz.

Physical characteristics

Dimensions: $16\frac{3}{4}$ " wide, $10\frac{1}{4}$ " high, $18\frac{3}{8}$ " deep (425 x 260 x 467 mm).

Weight: net 45 lbs (20.3 kg), shipping 66 lbs (29.7 kg).

Power: 105 to 125 or 210 to 250 V, 50 to 400 Hz, 100 W.

Accessory furnished: 00502B Patching Cable.

Price: HP 202H, \$1475.

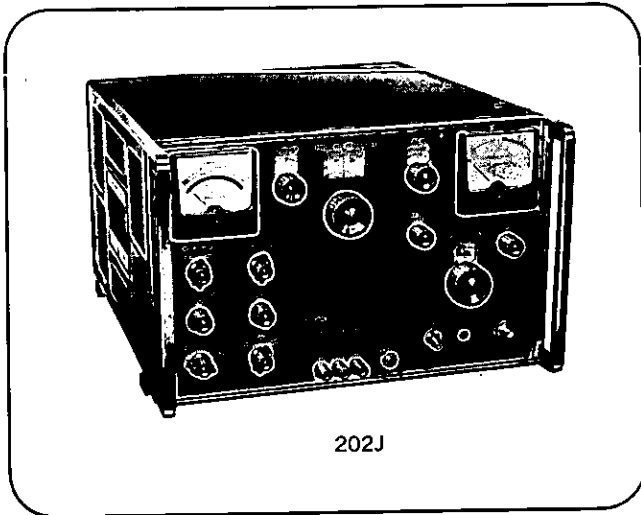
FM-AM SIGNAL GENERATOR

FM, AM, CW and pulse coverage, 195 to 270 MHz
Model 202J



SIGNAL GENERATORS

The HP 202J FM-AM Signal Generator covers the frequency range from 195 to 270 MHz and is designed for the testing and calibration of FM telemetering receiving systems in the 215 to 260 MHz band.



202J

Specifications

RF characteristics

RF range: 195 to 270 MHz.

RF accuracy: main dial: $\pm 0.5\%$; electronic vernier: $\pm(10\% + 1 \text{ kHz})$ after one-hour warm-up.

RF stability: $< 0.02\%$ per hour, after two-hour warm-up.

RF output: range: $0.1 \mu\text{V}$ to 0.2 V (across external 50-ohm load at panel jack); accuracy: $\pm 10\%$, $0.1 \mu\text{V}$ to $50 \text{ k} \mu\text{V}$; $\pm 20\%$, $50 \text{ k} \mu\text{V}$ to 0.2 V ; auto level set: holds RF monitor meter to "red line" over band; impedance: 50 ohms; VSWR: < 1.2 ; spurious output: all spurious RF output voltages are at least 25 dB below desired fundamental.

RF leakage: sufficiently low to permit measurements at $0.1 \mu\text{V}$.

AM characteristics

AM range: internal, 0 to 50%; external, 0 to 100%.

AM accuracy: $\pm 10\%$ of reading at 400 Hz at 30% and 50%.

AM calibration: 30, 50, 100%.

AM distortion: $< 5\%$ at 30%, $< 8\%$ at 50%, $< 20\%$ at 90%.

AM fidelity: $\pm 1 \text{ dB}$, 30 Hz to 200 kHz.

External AM requirements: approx. 50 V rms into 7500 ohms for 100% AM.

FM characteristics

FM deviation range: internal, 0 to 300 kHz in 4 ranges; external, 0 to 300 kHz in 4 ranges.

FM deviation accuracy: $\pm 5\%$ of full scale (indication proportional to pk-pk modulating waveform at 400 Hz).

FM calibration: 0 to 15 kHz in increments of 0.5 kHz, 0 to 30 kHz in increments of 1 kHz, 0 to 150 kHz in

increments of 5 kHz, 0 to 300 kHz in increments of 10 kHz.

FM non-linearity: $< 1.5\%$ at 150 kHz, $< 5\%$ at 300 kHz, ("least squares" departure from straight line passing through origin.)

FM fidelity: $\pm 1 \text{ dB}$, 5 Hz to 500 kHz; $\pm 3 \text{ dB}$, 3 Hz to 1 MHz.

Spurious FM: total rms spurious FM from 60 Hz power source is at least 60 dB below 150 kHz ($< 150 \text{ Hz}$).

External FM requirements: $< 1 \text{ V}$ rms into 100 k ohms in parallel with less than 50 pF for 150 kHz deviation.

PM characteristics: source: external; rise time: $< 0.25 \mu\text{s}$; fall time: $< 0.8 \mu\text{s}$.

Modulation oscillator characteristics: frequency: 50 Hz, 400 Hz, 1700 Hz, 3900 Hz, 10.5 kHz, 30 kHz, 70 kHz, 100 kHz; accuracy: $\pm 5\%$; distortion: $< 0.5\%$.

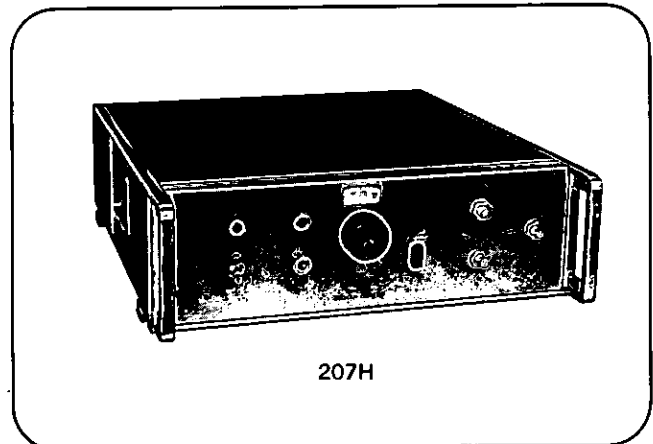
Power: 105 to 125 or 210 to 250 V, 50 to 400 Hz, 100 W.

Price: HP 202J, \$1595. Option 001: auxiliary RF output ($> 50 \text{ mV}$), add \$100.

Model 207H univertter

0.1 to 55 MHz for 202H and 202J Signal Generators

The HP 207H Univertter, a frequency converter with unity gain, is designed for use with the HP 202H and 202J Signal Generators to provide additional frequency coverage from 100 kHz to 55 MHz, including commonly used intermediate frequencies.



207H

Major Specifications

(when used with 202H and 202J Signal Generators)

RF range: 100 kHz to 55 MHz (with 199.9 to 145 MHz input from 202H; 200.1 to 255 MHz input from 202J).

RF output: $1 \mu\text{V}$ to 0.1 V and $0.01 \mu\text{V}$ to 1 mV across external 50-ohm load at panel jack; $> 1 \text{ V}$ with 0.1 V input and 300-ohm output load.

Modulation: duplicates FM and AM modulation of 202H or 202J with no appreciable distortion for input levels $< 0.05 \text{ V}$.

Power: 105 to 125 V or 210 to 250 V, 50 to 400 Hz, 50 W.
Price: 207H, \$595.

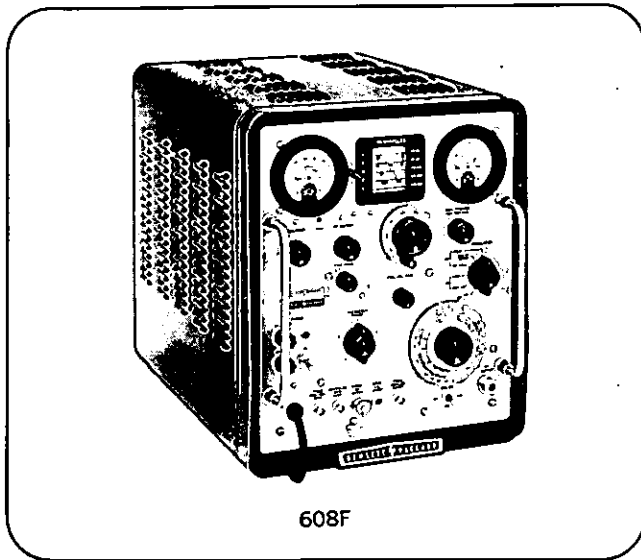
SIGNAL GENERATORS



VHF SIGNAL GENERATORS

Versatility and value 10-480 MHz

Models 608E/F; 8708A



608F

Description

Models 608E and 608F provide high-quality, versatile performance with distinctive ease of operation. The 608E provides an output of up to 1 volt over the range from 10 to 480 MHz, and the 608F provides an output of up to 0.5 volt from 10 to 455 MHz.

The 608E is an improved version of the popular and time-proven HP 608C/D Signal Generators. The instrument is a master oscillator-power amplifier (MOPA) type with a broadband buffer amplifier stage between the oscillator and power amplifier circuits for isolation. The MOPA design permits optimization of the oscillator stage for high stability of 0.005% per 10 minutes, minimum residual FM, and low harmonics without restricting the modulation characteristics. Modulation is applied to the power amplifier stage with negligible effect on the oscillator frequency.

Modulation capability

The use of feedback in the power amplifier section yields excellent amplitude modulation characteristics. Up to 95% modulation can be achieved with modulating frequencies ranging from 20 Hz to 20 kHz. Envelope distortion is very low, less than 2% at 30% AM and less than 5% at 70% AM; thus you can make more accurate measurements of the distortion characteristics on receivers or detectors. Internal modulation oscillators of 400 Hz and 1000 Hz are provided, and the modulation percentage can be set and read directly on the accurate front panel modulation meter. The buffer amplifier stage between the master oscillator and power amplifier holds incidental FM with AM to a minimum, ensuring accurate measurements.

Accurate output level

Output levels of the Models 608E/F are accurately attenuated to provide continuously adjustable calibrated output from 0.1 microvolt to 1 volt rms (608E) or 0.5 volt rms (608F) into a 50-ohm load. Direct calibration is provided in both volts and dBm (to -127 dBm) and the output calibration is accurate within 1 dB at any frequency or level setting. The output system of the 608E/F is a well matched 50-ohm circuit which

minimizes mismatch ambiguities as a factor in overall measurement accuracy. The extremely wide range of output amplitude control makes the 608E/F very useful for driving bridges and filters as well as complete receiver measurements including sensitivity, selectivity, and image rejection.

Models 608E/F provide an auxiliary RF output; this fixed level (180 millivolts rms minimum) CW signal is for use with an HP 5245L Counter for very accurate indication of carrier frequency. On the 608F, this output is also for use with the 8708A Synchronizer. Using the auxiliary RF output does not place any restriction on the modulation capabilities nor on the main RF output level. The units also contain a crystal calibrator to provide frequency checkpoints at every 1 or 5 MHz throughout the frequency range.

High settability

The fine frequency vernier is an electronic fine tuning adjustment of the output frequency. Frequency settability with better than 10 ppm resolution is possible to obtain precise settings for critical tests. When used with the internal crystal calibrator, 608E frequency accuracy can be increased by a factor of 50 (factor of 100 for the 608F) over the main dial calibration of 1% without the use of an external frequency meter.

608F/8708A combination

The Model 8708A Synchronizer is an easy-to-use frequency stabilizer that allows the 608F to be phase-locked from 50 kHz to 430 MHz. Full AM and output level features of the 608F are retained during phase-lock. The 8708A increases frequency stability by a factor of 250 with the extra benefit of 8708A precise tuning resolution for settability to 2 parts in 10^7 . The 608F/8708A combination also permits narrowband frequency and phase modulation to be applied with very low distortion.

Specifications, 608E/F

Frequency characteristics

Range: 608E: 10 - 480 MHz in 5 bands (10-21, 21-43, 43-95, 95-215, and 215-480 MHz. 608F: 10 - 455 MHz in 5 bands (10-21, 21-44, 44-95, 95-210, and 210-455 MHz).

Accuracy: 608E: $\pm 0.5\%$. 608F: $\pm 1\%$.

Drift: 608E: less than 50 parts in 10^6 per 10 minute period after one hour warmup. 608F: less than 50 parts in 10^6 per 10 minute period after one hour warmup; stability when used with 8708A Synchronizer: 5×10^{-5} /minute; 2×10^{-7} /10 minutes; 2×10^{-6} /day; $2 \times 10^{-7}/^\circ\text{C}$ (0° to 55°C); 2×10^{-7} /10% line voltage change.

Frequency control input (608F ONLY): BNC female connector for "Frequency Control Output" from 8708A Synchronizer can also be used for external frequency control; voltage change from -2 to -32 volts changes frequency more than 0.2% at low end of each band and more than 1% at high end; nominal 4 k Ω input impedance, direct-coupled; voltage limits, 0 to -50 V.

Resettability: 608E: main frequency control resettability better than $\pm 0.1\%$ after initial warmup; Fine Frequency Adjust provides approximately 25 kHz settability at 480

MHz (proportionately finer adjustment at lower frequencies). 608F: main frequency control resettability better than $\pm 0.1\%$ after initial warmup; Fine Frequency Adjust provides approximately 25 kHz settability at 455 MHz (proportionately finer adjustment at lower frequencies).

Tuning control: frequency control mechanism provides a main dial calibrated in megahertz and a vernier dial for interpolation purposes; total scale length, approximately 45 inches; calibration, every other megahertz 130 to 270 MHz; every 5 MHz above 270 MHz.

Crystal calibrator: provides frequency check points every 1 MHz up to 270 MHz or every 5 MHz over the range of the instrument; headphone jack provided for audio frequency output (headphones not included); crystal frequency accuracy better than 0.01% at normal room temperatures; cursor on frequency dial adjustable over small range to aid in interpolation adjustment; calibrator may be turned off when not in use.

Residual FM: less than ± 5 parts in 10^7 peak.

Harmonic output: at least 35 dB below the carrier for harmonic frequencies below 500 MHz.

Output characteristics

Output level: 608E: continuously adjustable from 0.1 μV to 1.0 volt into a 50-ohm resistive load; output attenuator calibrated in volts and dBm (0 dBm = 1 mW in 50 ohms).

608F: continuously adjustable from 0.1 μV to 0.5 volt into a 50-ohm resistive load; output attenuator calibrated in volts and dBm (0 dBm = 1 mW in 50 ohms).

Accuracy: within ± 1 dB of attenuator dial reading at any frequency when RF Output Meter indicates "ATTENUATOR CALIBRATED."

Leveling: internal feedback circuit retains "ATTENUATOR CALIBRATED" reference on RF Output Meter over wide frequency ranges (typically octave bands); adjustment of front panel AMP. TRIMMER control (only) for maximum RF output indication automatically restores initial carrier level for greater frequency changes.

Impedance: 50 Ω with a maximum SWR of 1.2 for attenuator setting below -7 dBm.

RFI: meets all conditions specified in MIL-I-6181D; permits receiver sensitivity measurements down to at least 1.0 μV .

Auxiliary RF output: 608E: fixed level CW signal from RF Oscillator (minimum amplitude 180 mV rms into 50 ohms) provided at front panel BNC female connector for use with external equipment (e.g., frequency counter).

608F: fixed level CW signal from RF Oscillator provided at front panel BNC female connector for use with HP 8708A Synchronizer or other external equipment (e.g., frequency counter). Power levels into 50 Ω are: 10 to 215 MHz, -1.8 to $+7$ dBm; 215 to 400 MHz, $+2.0$ to $+6$ dBm; 400 to 430 MHz $+1.0$ to $+5$ dBm.

Modulation characteristics

(Front panel AMP TRIMMER control adjusted for maximum indication on RF Output Meter and RF Output Meter set to "ATTENUATOR CALIBRATED.")

Internal AM

Frequency: 400 and 1000 Hz, $\pm 10\%$; modulation signal available at front panel BNC female connector for synchronization of external equipment.

Modulation level: 608E: 0 to 95%, modulation at carrier

levels 0.5 volt and below; continuously adjustable with front panel MOD LEVEL control.

608F: 0 to 95% modulation with Output Attenuator at 0.224 volt (1 mW) or below; continuously adjustable with front panel MOD LEVEL control.

Carrier envelope distortion: less than 2% at 30% AM and less than 5% at 70% AM.

External AM

Frequency: 20 Hz to 20 kHz.

Modulation level: 608E: 0 to 95% modulation at carrier levels of 0.5 volt and below; continuously adjustable with front panel MOD LEVEL control; input required, 1-10 volts, rms (1000 Ω input impedance).

608F: 0 to 95% modulation with Output Attenuator at 0.224 volt (1 mW) or below; continuously adjustable with front panel MOD LEVEL control; input required, 1-10 volts, rms (1000 Ω input impedance).

Carrier envelope distortion: less than 2% at 30% AM, less than 5% at 70% AM (modulation source distortion less than 0.5%).

External control of carrier level can be achieved through application of dc voltage in EXT AM mode.

Modulation meter accuracy: $\pm 5\%$ of full scale 0 to 80%, $\pm 10\%$ from 80% to 95% (for INT AM or 20 Hz to 20 kHz EXT AM).

Incidental frequency modulation (at 400 and 1000 Hz modulation): less than 1000 Hz peak at 50% AM for frequencies above 100 MHz; for frequencies below 100 MHz, less than 0.001% at 30% AM.

External pulse modulation:

Rise and decay time: from 40 MHz to 220 MHz, combined rise and decay time less than 4 μs ; above 220 MHz combined rise and decay time less than 2.5 μs .

On-off ratio: at least 20 dB for pulsed carrier levels of 0.5 volt and above.

Input required: positive pulse, 10-50 volts peak, input impedance 2000 Ω .

General:

Power: 115 or 230 V $\pm 10\%$, 50 to 400 Hz; approximately 220 W.

Dimensions: cabinet: 13 $\frac{1}{4}$ " wide, 16 $\frac{3}{8}$ " high, 21" deep (337 x 416 x 533 mm); rack mount: 19" wide, 13-31/32" high, 18 $\frac{3}{8}$ " deep behind panel (483 x 335 x 467 mm).

Weight:

Cabinet mount: net, 62 lb (28 kg); shipping, 74 lb (33.4 kg).

Rack mount: net, 62 lb (28 kg); shipping, 83 lb (37.4 kg).

Accessories available:

11508A output cable provides 50 ohms termination and standard binding posts at the end of a 24-inch (610 mm) length of cable; allows direct connection of the signal generator to high impedance circuits. \$18.

11509A Fuse Holder provides protection for the output attenuator when the Model 608E/F is used for transmitter tests. See page 294.

10514A Mixer for use as nanosecond pulse modulator or balanced modulator. Price, \$95.

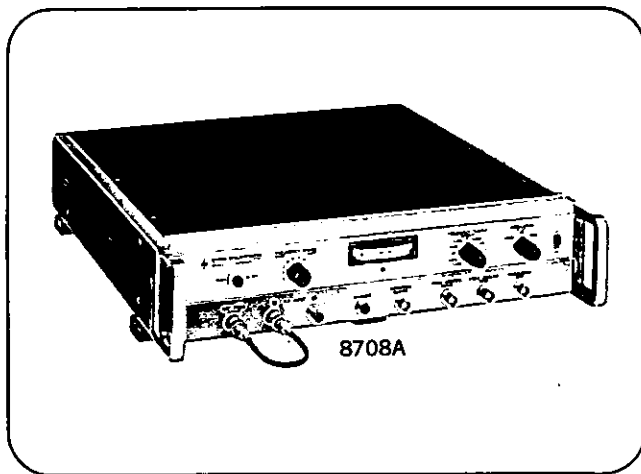
Price: Model 608E (cabinet), \$1500, Model 608ER (rack mount), \$1680; Model 608F (cabinet), \$1800, Model 608FR (rack mount), \$1840.

SIGNAL GENERATORS



HF-VHF SYNCHRONIZER AND SIGNAL GENERATOR ACCESSORIES

Models 8708A, 11507A, 11509A



HP Model 8708A Synchronizer

The 8708A Synchronizer is a phase-lock frequency stabilizer that allows you to obtain crystal-oscillator frequency stability in the 606B (and to 430 MHz in the 608F) Signal Generator. The outstanding AM and output level control capabilities of the signal generators are retained. Phase-locking eliminates microphonics and drift, resulting in a frequency stability of 2×10^{-7} per 10 minutes, an increase by a factor of 250. The 8708A includes an ultrafine frequency vernier which can tune the reference oscillator over a range of $\pm 0.25\%$ permitting frequency settability to 2 parts in 10^7 . This high order of stability and settability can be achieved over continuous frequencies in the 606B and 608F range, eliminating phase-locking at only discrete points. This provides a very stable, yet tunable signal generator that satisfies many critical applications including measurements on SSB and narrowband receivers.

An external 20 MHz frequency reference can be used; the resultant stability is that of the external reference. Use of an external reference, however, results in just fixed discrete lock points (unless the reference is frequency tunable $\pm 0.25\%$ around 20 MHz).

Narrowband frequency and phase modulation with very low distortion (better than 1% linearity) of the 606B and 608F Signal Generators can be applied through the 8708A. Narrowband sweeping of the carrier under very stable conditions is valuable for filter or amplifier skirt response tests as well as Q studies of frequency selective circuits.

Specifications, 8708A

Frequency range: 50 kHz to 430 MHz; phase-locks 606B (608F to 430 MHz) Signal Generator at any carrier frequency*, with 2×10^{-7} settability.

Input signal level (signal to be stabilized): proper signal level automatically provided by 606B and 608F; general requirements into 50 Ω at less than 20% distortion:

50 kHz to 20 MHz: 0.1 V to 2 V rms
 10 to 215 MHz: 180 to 500 mV rms
 215 to 400 MHz: 280 to 450 mV rms
 400 to 430 MHz: 250 to 450 mV rms

Frequency reference: internal or external 20 MHz ($\pm 0.25\%$).

External reference requirements:

When signal to be synchronized is between 50 kHz and 20 MHz: 180 to 400 mV rms (<20% distortion) into 50 Ω .
 When signal to be synchronized is between 10 and 430 MHz: 0.1 to 2 V rms into 50 Ω .

Internal frequency reference stability:

Short term (RMS deviation): 5×10^{-8} /minute; 2×10^{-7} /10 minutes.

Long term: 2×10^{-6} /day.

With temperature: $2 \times 10^{-7}/^{\circ}\text{C}$, 0 to 55 $^{\circ}\text{C}$.

With line voltage: $2 \times 10^{-7}/10\%$ line voltage change.

(Note: stability in "External Reference" mode is that of external reference source).

Spectral purity (stabilized RF output of 606B or 608F Signal Generator):

Spurious signals: non-harmonically related signals greater than 60 dB below carrier.

Signal-to-AM noise ratio:** >70 dB.

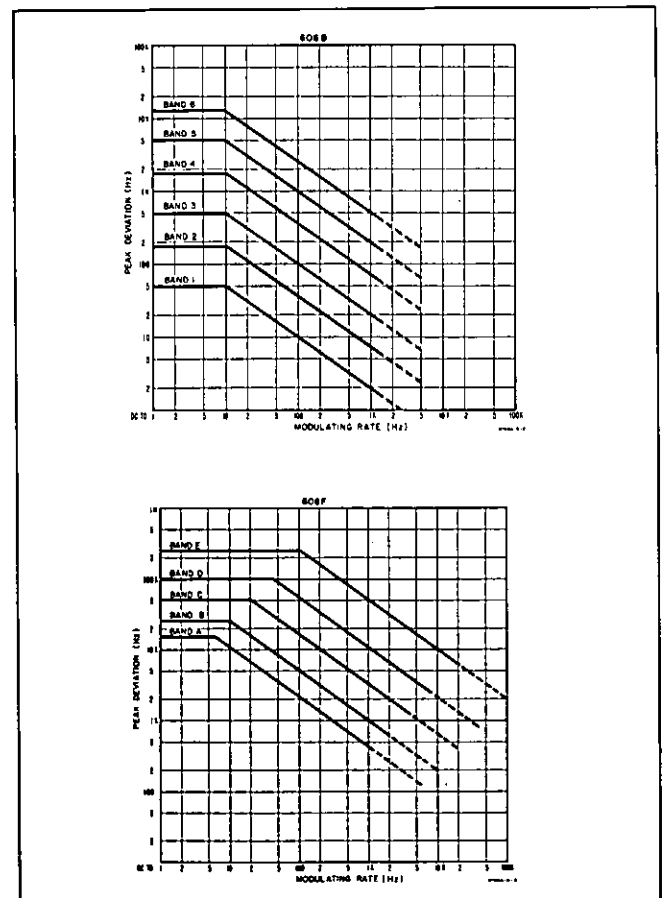
Signal-to-phase noise ratio:** >60 dB, 10 MHz and below;
 >60 dB $-20 \log \frac{f \text{ MHz}}{10}$, above 10 MHz.

RMS fractional frequency deviation: less than 5×10^{-8} averaged over 10 ms (30 kHz noise bandwidth).

Frequency control output: frequency control voltage directly compatible with 606B and 608F Signal Generators; output voltage range, -2 to -32 volts (max).

Modulation

Frequency modulation: maximum modulation rates and frequency deviation for $\leq 1\%$ distortion:



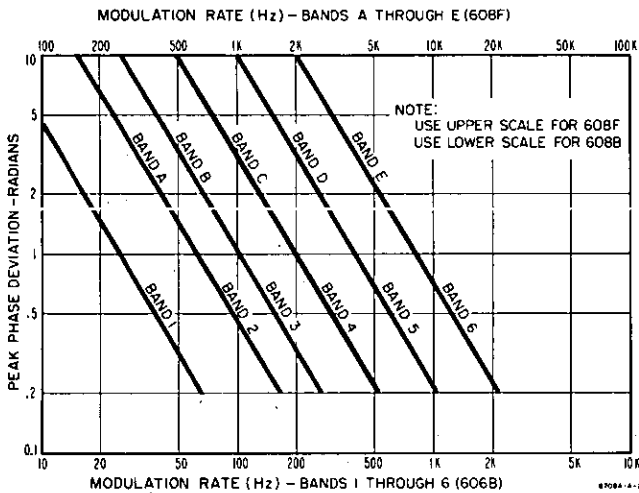
*Using 8708A Internal Reference, or external reference adjustable over 0.5% frequency range. With fixed frequency external reference, interval between lock points varies from 62.5 Hz at 50 kHz to 500 kHz above 210 MHz.

**In a 30 kHz band centered on the carrier, excluding a 1 Hz band centered on the carrier.

Frequency modulation sensitivity (ac or dc—Mod. level control at maximum): 0.5 kHz/V (carrier freq. in MHz).

Note: dc input limits, 0 to 10 volts (input connector biased at +10 V from a 10K ohm source).

Phase modulation: maximum modulation rate and phase deviation for $\leq 1\%$ distortion:



Phase modulation sensitivity (ac only—Mod. level control at maximum): 0.01 radian/V (carrier freq. in MHz).

Deviation monitor: dc output voltage which is proportional to frequency and phase deviation; output voltage, deviation ratio varies with carrier frequency, output voltage range approximately -1 to $+3$ V.

RFI: meets all conditions specified in MIL-I-6181D.

Warm-up time: $1\frac{1}{2}$ hr.

Power: 115- or 230 V $\pm 10\%$, 50 to 400 Hz; approximately 48 W.

Dimensions: $16\frac{3}{4}$ " wide, $3-25/32$ " high, $18\frac{3}{8}$ " deep (425 x 96 x 467 mm); hardware furnished for rack mount, 19" wide, $3-15/32$ " high, $16\frac{3}{8}$ " deep behind panel (483 x 88 x 416 mm).

Furnished: interconnecting cables for use with 606B and 608F Signal Generators.

Weight: net, 27 lb (12.2 kg); shipping, 31 lb (14 kg).

Price: Model 8708A, \$1950.

HF-VHF Signal Generator Accessories

11507A Output Termination

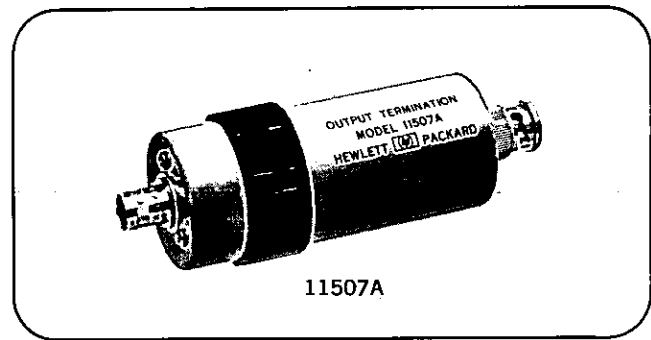
The HP 11507A Output Termination is a multi-purpose termination which enhances the usefulness of the 606A or 606B by providing:

1. A matched 50-ohm termination to permit use into high impedance circuits.
2. A 20 dB (10:1) terminated voltage driver which reduces the source impedance to 5 ohms.
3. A dummy antenna having the IEEE standard characteristics for receiver measurements (driven from 10:1 divider).

Specifications, 11507A

Frequency range: 50 kHz to 65 MHz on 0 to 20 dB positions, 540 kHz to 23 MHz on dummy antenna.

Attenuation: 1.0 dB on 0 dB position, 20 ± 1 dB on 20 dB and



11507A

dummy antenna positions.

Input impedance: 50 ohms.

Output impedance: 0 dB position 25 ohms, 20 dB position 5 ohms.

Reflection coefficient: less than .11 on 0 dB and 20 dB positions.

SWR: less than 1.25 on 0 dB and 20 dB positions.

Maximum input power: 180 milliwatts (3 volts across 50 ohms).

Dimensions: $4\frac{3}{8}$ " (11.1 mm) long, $1-7/16$ " (3.6 mm) diameter.

Weight: net, 4 oz. (112 g); shipping, 10 oz. (283 g).

Price: Model 11507A, \$70.

11509A Fuseholder

The 11509A Fuseholder prevents accidental burnout of attenuators in HP 606 and 608 Signal Generators during transceiver testing by introducing a fuse element between the signal generator and the transceiver. Several watts of RF power could otherwise be applied to the signal generator attenuator should the transceiver accidentally be switched to "Transmit". While the fuseholder provides protection, it in no way limits the useable output from the signal generators.

Specifications, 11509A

Overload protection: burnout occurs at about 0.4 W. Can be operated continuously at 0.2 W.

Impedance: 50 ohms nominal. Reflection coefficient 0.15 (1.35 SWR, 16.5 dB return loss) when terminated by 50-ohm matched load, 0.23 (1.6 SWR, 12.7 dB return loss) when terminated by HP 608 attenuator.

Insertion loss: 1 dB.

Fuse: 8 AG 1/16 A fast instrument fuse (F01GR062A or Littlefuse X1149).

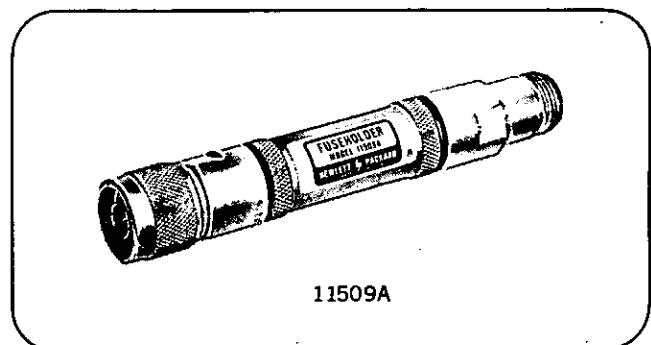
Connectors: type N, one male, one female.

Dimensions: $4\frac{3}{8}$ " long, $13/16$ " diameter (118 x 21 mm).

Shipping weight: 1 lb (0.45 kg).

Accessories furnished: 10 extra fuses.

Price: HP 11509A (MX-1730/U), \$35.



11509A



SPECTRUM GENERATOR/DOUBLER

Versatile broadband operation

Models 10511A, 10515A

HP 10511A Spectrum Generator

The Hewlett-Packard 10511A Spectrum Generator is a passive device that generates a train of 1 nanosecond wide pulses when driven by a sinusoidal signal source. The 10511A was specifically designed as an accessory to the HP 5100B Frequency Synthesizer. However, it is useful with any 50Ω source that can provide the proper input signal.

With a sine wave input, in the frequency range of 10 MHz to 75 MHz, a spectrum of harmonics is generated. This spectrum contains all harmonics of the input frequency to the 1 GHz region. To extract a desired harmonic, a 50Ω bandpass filter can be cascaded with the 10511A to give a sinusoidal output. The HP 230B Power Amplifier (tuned) may be used for higher level outputs for harmonics up to 500 MHz.

Operation of the 10511A with the 5100B without a bandpass filter on the output produces a pulse train whose repetition rate is precisely controlled. The 10511A, with a tuned filter, produces precise CW frequencies between 50 MHz and 500 MHz.

Specifications 10511A

Input requirements

Frequency range: 25 to 50 MHz.*

Drive level: 1 to 3 volts RMS available to 50Ω.

Output

Pulse width: 1 nanosecond, $\pm 15\%$ at mid-amplitude.

Pulse height: 0.75 volt minimum for minimum drive level.

Impedance: 50Ω (nominal).

Available harmonic power: -19 dBm minimum for any harmonic number between 1 and 10.

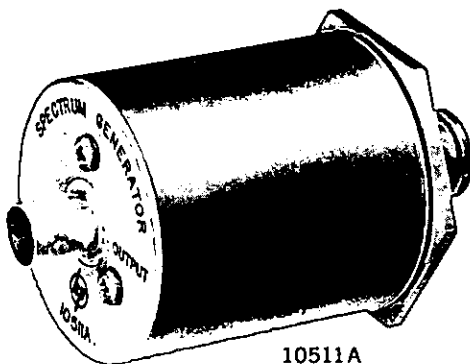
General

Dimensions: 3 in. long, 1 $\frac{5}{8}$ in. dia. (76 x 41 mm).

Weight: net, 4 oz. (112 grams). Shipping, 1/2 lb (0,23 kg).

Price: model 10511A, \$150.00.

*Useful operation is obtained for input frequencies from 10 MHz to 75 MHz.



10511A

HP 10515A Frequency Doubler

The Hewlett-Packard Model 10515A Frequency Doubler is an ideal accessory for use in extending the usable frequency range of signal generators, frequency synthesizers or other signal sources. Operating on input frequencies of 0.5 MHz to 500 MHz it provides a doubled output in the range of 1 MHz to 1 GHz. This 50 ohm device uses a full-wave rectifier circuit which is extremely flat over its entire frequency range. The frequency response is very flat ($< \pm 1$ dB over entire range typically), and undesired harmonics are very well suppressed.

The output of this unit does not have an internal dc return so that it can provide a very broadband ac to dc conversion (when used with an appropriate resistive termination on the output). This mode of operation is useful for detection of low level amplitude modulations.

The 10515A may be used with the following Hewlett-Packard instruments (this is only a partial listing):

5100B Frequency Synthesizer	606 Signal Generators
5102A Frequency Synthesizer	3200B VHF Oscillator
5103A Frequency Synthesizer	608 Signal Generators
5105A Frequency Synthesizer	8601A Generator/Sweeper

Specifications 10515A

Frequency range: 0.5-500 MHz input; 1-1000 MHz output.

Impedance: 50Ω nominal (source and load).

Input signal voltage: 0.5 - 3.0 V_{RMS}.

Input signal power: 180 mW (maximum).

Conversion loss:*

< 13 dB (typically < 11 dB) for > 1 volt, 0.5 to 50 MHz input.

< 14 dB (typically < 12 dB) for > 0.5 volt, 0.5 to 500 MHz input.

Suppression of 1st and 3rd harmonic of input:*

> 30 dB for 0.5 to 50 MHz input (typically > 35 dB).

> 10 dB for input to 500 MHz (typically > 15 dB).

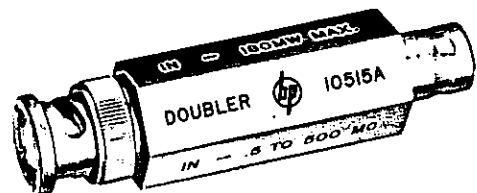
Connectors: input: BNC male; output: BNC female.

Dimensions: diameter, 0.7" (18 mm); length, 2.5" (64 mm).

Weight: net, approximately 2 oz (56 grams); shipping, 1/2 lb (0,23 kg).

Price: model 10515A, \$120.00.

*With a 50 ohm resistive load and a single input frequency. Suppression values are referred to the desired output level.



10515A

UHF SIGNAL GENERATOR

All-purpose UHF signal generator, 450 to 1230 MHz
Model 612A



SIGNAL GENERATORS

Here is an all-purpose, precision signal generator particularly designed for utmost convenience and applicability throughout the important UHF-TV frequency band. It is ideally suited for measurements in UHF-television broadcasting, studio-transmitter links, citizen's radio and public service communications systems. The HP 612A also covers the important frequencies used in aircraft navigation aids such as DME, TACAN and airborne transponders. Accessory modulators, available from many of the manufacturers of these navigational aids, enable the 612A to provide the complex modulation patterns required for testing and aligning these systems. In the laboratory, the 612A is a convenient power source for driving bridges, slotted lines, antennas and filter networks. In addition, the HP 8731 PIN Modulators can be used with the 612A to obtain RF pulses with 30 ns rise time and 0.1 μ s minimum duration—with on-off ratios approaching 80 dB.

MOPA circuit

The master oscillator-power amplifier circuit in the HP 612A provides 0.5 volt into 50 ohms over the full frequency range of 450 to 1230 MHz. There is very low incidental FM (less than 0.002% at 30% AM) and excellent amplitude modulation capabilities by all frequencies from 20 Hz to 5 MHz. The degree of modulation is easily read from the large percent modulation meter. The instrument can be amplitude-modulated (either internally or externally), and provision is made for external pulse modulation as well. Pulse modulation can be applied to the amplifier or directly to the oscillator when high on-off signal ratios are required (signal may be completely cut off between pulses). Modulation can be up or down from a pre-set level to simulate TV modulation characteristics accurately.

Advanced design

The oscillator-amplifier circuit in the 612A employs high-frequency pencil triodes in a cavity-tuned circuit for precise tracking over the entire band. Noncontacting cavity plungers are die-cast to precise tolerances, then injection-molded with a plastic filler for optimum Q. The frequency drive is a direct screw-operated mechanism, free from backlash. A waveguide-beyond-cutoff piston attenuator and crystal monitor circuit are used to ensure accurate, reliable output down to 0.1 μ V. The attenuator is calibrated over a range of 131 dB and has been carefully designed to provide a constant impedance-versus-frequency characteristic. The SWR of the 50-ohm output system is less than 1.2 over the complete frequency range.

Specifications

- Frequency range:** 450 to 1230 MHz in one band; scale length approximately 15 inches (381 mm).
- Calibration accuracy:** within $\pm 1\%$; resettability better than 5 MHz at high frequencies.
- Output voltage:** 0.1 μ V to 0.5 V into 50-ohm load; calibrated in V and dBm (0 dBm = 1 mW).
- Output accuracy:** ± 1 dB, 0 to -127 dBm over entire frequency range.
- Internal impedance:** 50 ohms; maximum reflection coefficient, 0.091 (1.2 SWR, 20.8 dB return loss) for attenuator settings of 0 dBm and below.
- Amplitude modulation:** above 470 MHz, 0 to 90% at audio frequencies, indicated by panel meter; accuracy $\pm 10\%$ of full scale, 30 to 90% modulation.
- Incidental FM:** less than 0.002% for 30% AM.
- Internal modulation:** 400 and 1000 Hz $\pm 10\%$; envelope distortion less than 3% at 30% modulation.



612A

External modulation: 20 Hz to 5 MHz; above 470 MHz, 2 V rms produces 85% AM at modulating frequencies up to 500 kHz, at least 40% AM at 5 MHz; modulation may be up or down from the carrier level or symmetrical about the carrier level; positive or negative pulses may be applied to increase or decrease RF output from the carrier level.

Pulse modulation:

Pulse 1 (pulse applied to amplifier): positive or negative pulses, 4 to 40 V peak produce an RF on-off ratio of at least 20 dB; minimum RF output pulse length, 1.0 μ s.

Pulse 2 (pulse applied to oscillator): positive or negative pulses, 4 to 40 V peak; no RF output during off time; minimum RF output pulse length, 1.0 μ s.

RFI: conducted and radiated leakage limits are below those specified in MIL-I-6181D; permits receiver sensitivity measurements down to 1 μ V.

Power: 115 or 230 volts $\pm 10\%$, 50 to 400 Hz, 215 watts.

Dimensions: cabinet: 13 $\frac{1}{2}$ " wide, 16 $\frac{1}{2}$ " high, 21 $\frac{1}{2}$ " deep (333 x 419 x 546 mm); rack mount: 19" wide, 13-31/32" high, 20 $\frac{1}{4}$ " deep behind panel (483 x 355 x 514 mm).

Weight: net 56 lb (25,2 kg), shipping 68 lb (30,6 kg) (cabinet); net 56 lb (25,2 kg), shipping 77 lb (34,6 kg) (rack mount).

Accessories available: 11500A RF Cable Assembly; 10503A Video Cable Assembly; 360B Low-Pass Filter (may be used where harmonic output must be reduced to a minimum, as in slotted line measurements).

Price: HP 612A, \$1600 (cabinet); HP 612AR, \$1640 (rack mount).



SIGNAL GENERATORS; SOURCES

Stable, easy to use, 800 to 4500 MHz

Models 8614A, 8616A; 8614B, 8616B

Advantages:

- High frequency accuracy, digital dial
- Precision attenuator, digital dial
- Amplitude modulation capability and automatic power leveling in the signal generators
- At least 10 mW output
- Compact, only 5 1/4" (133 mm) high

Use to measure:

- Receiver sensitivity, signal-to-noise ratio
- Standing-wave ratios
- Transmission line, antenna characteristics
- Conversion gain

The HP 8614A and 8616A Signal Generators are easy-to-use instruments which provide stable, accurate signals from 800 to 2400 MHz (8614A) and from 1800 to 4500 MHz (8616A). Both frequency and attenuation are set on direct-reading digital dials, while function is easily selected by pushbuttons. Selectable functions include CW, leveled output, square-wave modulation, and external amplitude, pulse or frequency modulation. Amplitude, frequency and square-wave modulation can be accomplished simultaneously with or without leveling.

Two outputs

Two RF power outputs are simultaneously available from separate front-panel connectors. One provides at least 10

mW (2 mW above 3000 MHz) or a leveled output from 0 to -127 dBm. The leveled output is flat within ± 0.75 dB (8614A) or ± 1.0 dB (8616A) across the respective bands with no resetting of the attenuator or power monitor.

The second output is at least 0.5 mW across the band and is independent of attenuator setting. This signal can be used for phase-locking the signal generators when extreme stability is desired, or it can be monitored with a frequency counter for extreme frequency resolution. In any case, the second output can be utilized without adversely affecting the primary output.

Modulation capabilities

A unique PIN diode modulator permits amplitude modulation from dc to 1 MHz or furnishes RF pulses with a 2 μ s rise time. This broad modulation bandwidth permits remote control of output level or precise leveling using external equipment. The internal leveling is also obtained by using a PIN modulator.

When up to one watt output is required above 1 GHz, the HP 489A (1 to 2 GHz) or HP 491C (2 to 4 GHz) Microwave Amplifiers (see page 472) serve as ideal power boosters. The HP 8731 and 8732 series PIN Modulators, driven by the HP 8403A Modulator are available for use with the signal generators when a sophisticated high-speed, low-jitter, modulation system is required.



8614A

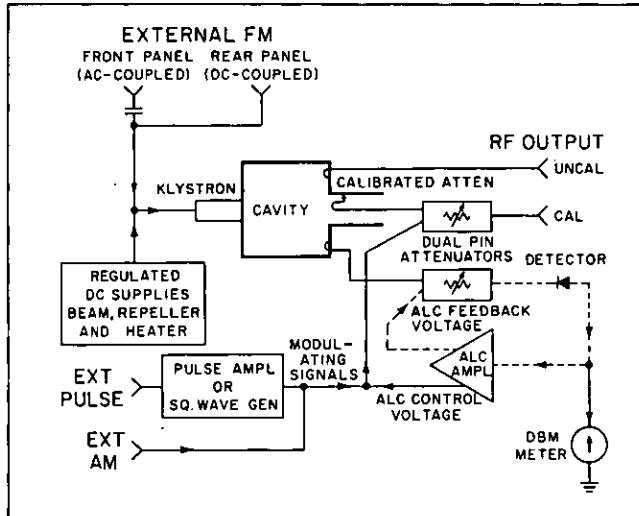


8614B

Signal Sources

The HP 8614B and 8616B retain the convenience of the "A" models. Functions are selected by pushbuttons, and frequency and attenuation are set on digital dials. Although the signal sources do not have power monitors or internal PIN diode modulation, relative power measurements can be made, using the precision attenuator. Modulation capabilities include internal square-wave modulation, plus external pulse and frequency modulation. For added convenience, a friction clutch arrangement permits setting the attenuator dial to any suitable reference while output power is held constant. Thus the attenuator can be calibrated directly in dBm or insertion loss.

The versatility of the HP 8614B and 8616B makes them suitable for both laboratory and general-purpose measurements. Indeed, these signal sources can be used in many applications previously requiring signal generators.



Simplified block diagram of HP 8614A and 8616A Signal Generators. The dashed line shows the leveling control circuit.

Specifications

Frequency range: 8614A and 8614B, 800 to 2400 MHz; 8616A and 8616B, 1800 to 4500 MHz.

Leveled output: constant within ± 0.75 dB (8614A) and ± 1.0 dB (8616A) across entire frequency range at any attenuator setting below 0 dB; output power can be adjusted from the normal calibrated level with the Automatic Level Control; not available with 8614B and 8616B.

Frequency calibration accuracy: 8614A, ± 5 MHz; 8614B, ± 5 MHz or $\pm 0.5\%$, whichever is greater; 8616A, ± 10 MHz; 8616B, ± 10 MHz or $\pm 0.5\%$, whichever is greater.

Vernier: ΔF control has a minimum range of 1.5 MHz for fine tuning (1.0 MHz for 8614B, 8616B).

Frequency stability

With temperature: approximately 0.005%/°C change in ambient temperature.

With line voltage: less than 0.003% change for line voltage variation of $\pm 10\%$.

Residual FM: 8614A and 8616A, less than 2500 Hz peak; 8614B, less than 0.0003% peak; 8616B, less than 6 kHz peak.

RF output power

8614A: +10 dBm (10 mW) to -127 dBm (0.1 μ V) into a 50-ohm load; output attenuator dial directly calibrated in dBm from 0 to -127 dBm.

8614B: at least 15 mW max., controlled by attenuator.

8616A: +10 dBm (10 mW) to -127 dBm (0.1 μ V) into a 50-ohm load, 1800 to 3000 MHz; +3 dBm (2 mW) to -127 dBm (0.1 μ V) into a 50-ohm load, 3000 to 4500 MHz; output attenuator directly calibrated in dBm from 0 to -127 dBm.

8616B: at least 15 mW maximum, 1800 to 3000 MHz; at least 3 mW maximum, 3000 to 4500 MHz; controlled by attenuator.

All models: a second, uncalibrated RF output (approximately 0.5 mW) is provided on the front panel.

RF output power accuracy (with respect to attenuator dial)

8614A: ± 0.75 dB + attenuator accuracy from 0 to -127 dBm, including leveled output variations.

8616A: ± 1 dB + attenuator accuracy from 0 to -127 dBm, including leveled output variations.

Attenuator accuracy

8614A: +0, -3 dB from 0 to -15 dBm; ± 0.2 dB ± 0.06 dB/10 dB from -15 to -127 dBm.

8614B and 8616B: ± 0.2 dB ± 0.06 dB/10 dB below -10 dBm.

8616A: +0, -1 dB from 0 to -10 dBm; ± 0.2 dB ± 0.06 dB/10 dB from -10 to -127 dBm.

All models: direct-reading linear dial, 0.2 dB increments.

Internal impedance: 50 ohms nominal.

Reflection coefficient:

8614A: less than 0.33 (2.0 SWR, 9.5 dB return loss).

8614B: less than 0.2 (1.5 SWR, 14 dB return loss).

8616A: less than 0.33 (2.0 SWR, 9.5 dB return loss).

8616B: less than 0.26 (1.7 SWR, 11.7 dB return loss).

Modulation

Internal square wave: 950 to 1050 Hz.

Square-wave sync: square wave can be synchronized with a +1 to +10 volt signal applied to the Pulse input.

External AM (8614A and 8616A only): dc to 1 MHz.

Incidental FM (8614A and 8616A only): negligible for power levels below -10 dBm.

External pulse:

8614A and 8616A: 50 Hz to 50 kHz, 2 μ s rise time, +20 to +100 volts input.

8614B and 8616B (below 4000 MHz): 50 Hz to 500 kHz; +25 to +50 volts peak input; minimum RF pulse width, 300 ns; RF rise time, typically 200 ns.

External FM: (a) front-panel connector capacitively coupled to klystron repeller; input impedance, 220 k Ω shunted by approximately 300 pF; (b) rear-panel connector is dc-coupled to the klystron repeller.

Power: 115 or 230 volts $\pm 10\%$, 50 to 60 Hz, approximately 125 watts.

Dimensions: 16 $\frac{3}{4}$ " wide, 5 $\frac{1}{2}$ " high, 18 $\frac{3}{8}$ " deep (426 x 141 x 467 mm); hardware furnished for conversion to rack mount 19" wide, 5-7/32" high, 16 $\frac{3}{8}$ " deep behind panel (483 x 133 x 416 mm).

Weight: 8614A and 8616A: net 44 lb (19.8 kg); shipping 48 lb (22.0 kg), 8614B and 8616B: net 38 lb (17.1 kg); shipping 44 lb (19.4 kg).

Price: HP 8614A, \$2350; HP 8614B, \$1600; HP 8616A, \$2350; HP 8616B, \$1600.

Option 001: External modulation input connectors on rear panel in parallel with front-panel connectors; RF connectors on rear panel only; add \$25.

SIGNAL GENERATORS



UHF SIGNAL GENERATORS

Direct-reading, direct control, 800 to 4200 MHz
Models 614A, 616B

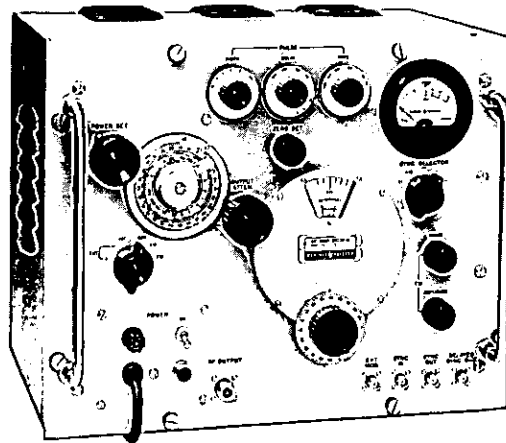
Ease of operation, direct-reading one-dial frequency control, high stability and accuracy and broad frequency coverage are all advantages of these widely used signal generators.

The 614A covers frequencies from 800 to 2100 MHz, has constant internal impedance with less than 1.6 SWR, and output accuracy of ± 1.5 dB over the range of -10 dBm to -127 dBm. The 616B gives complete coverage of frequencies from 1.8 to 4.2 GHz, has constant internal impedance with less than 1.8 SWR, and output accuracy of ± 1.5 dB from -7 dBm to -127 dBm.

On both instruments, operation is extremely simple. Carrier frequency is set and read directly on the large tuning dial. No voltage adjustments are necessary during operation because of the coupling device which causes oscillator repeller voltage to track frequency changes automatically. Oscil-

lator output is set and read directly on a simplified dial. Output may be continuous or pulsed, or frequency-modulated at power line frequency. Pulse modulation may be provided externally or internally. Internal pulsing may be synchronized with either positive or negative external pulses, or sine waves.

The oscillator portion of both the 614A and 616B consists of a reflex klystron in an external coaxial resonator. Frequency of oscillation is determined by a movable plunger which varies the resonant frequency of the resonator. Oscillator output is monitored by a temperature-compensated thermistor bridge circuit which is virtually unaffected by ambient temperature conditions. Voltage output is read directly. A logging scale on the frequency dial provides a resettability of 0.1%.



614A

Specifications

Frequency range: 614A, 800 to 2100 MHz; 616B, 1.8 to 4.2 GHz.

Frequency accuracy: $\pm 1\%$.

Frequency stability: 0.005%/°C change in ambient temperature; line voltage changes of $\pm 10\%$ cause 0.01% frequency change.

Output power range (into 50-ohm load): 614A, 0.5 mW or 0.158 volt to 0.1 μ V (-3 to -127 dBm) from 800 to 900 MHz, 1 mW or 0.224 volt to 0.1 μ V (0 to -127 dBm) from 900 to 2100 MHz; 616B, 1 mW or 0.224 volt to 0.1 μ V (0 to -127 dBm).

Power accuracy (at the end of 6-ft output cable, terminated in 50-ohm load): 614A, within ± 1.5 dB from -10 to -127 dBm; 616B, within ± 1.5 dB from -7 to -127 dBm.

Internal impedance: 614A, 50 ohms, reflection coefficient less than 0.23 (1.6 SWR, 12.7 dB return loss); 616B, 50 ohms, reflection coefficient less than 0.285 (1.8 SWR, 10.9 dB return loss).

Modulation: internal or external pulse or FM.

Internal pulse modulation: pulse repetition rate variable from 40 to 4000 per sec; pulse length variable from 1 to 10 μ s; delay variable from 3 to 300 μ s between synchronizing signal and RF pulse.

External pulse modulation: ext $-$: -40 to -70 V, 1 to 2500 μ s wide, ext $+$: $+40$ to $+70$ V, 1 to 400 μ s wide, square wave: ± 40 to ± 70 V p-p, 40 to 4000 Hz.

Trigger pulses out: (1) simultaneous with RF pulse; (2) in advance of RF pulse, variable from 3 to 300 μ s (both approximately 1 μ s rise time, amplitude ± 10 to ± 50 volts).

External synchronization: pulses, ± 10 to ± 50 volts, 1 to 20 μ s wide; may also be synchronized with sine waves.

Frequency modulation: oscillator sweeps at power line frequency; deviation and phase adjustable; maximum deviation approx. 3 MHz p-p.

RFI: conducted and radiated leakage limits are below those specified in MIL-I-6181D.

Power: 115 or 230 volts $\pm 10\%$, 50 to 400 Hz, approx. 160 watts.

Dimensions: cabinet: 17 $\frac{1}{4}$ " wide, 13 $\frac{5}{8}$ " high, 13 $\frac{1}{2}$ " deep (438 x 346 x 343 mm); rack mount: 19" wide, 13-31/32" high, 12 $\frac{1}{8}$ " deep behind panel (483 x 355 x 308 mm).

Weight: net 60 lb (27,0 kg); shipping 72 lb (32,4 kg).

Accessory furnished: 11500A RF Cable Assembly.

Accessories available: 614A: 360C Low-Pass Filter, $f_c = 2200$ MHz; 10503A Video Cable Assembly; 616B: S281A Waveguide-to-Coax Adapter, 2.6 to 3.95 GHz; G281A Waveguide-to-Coax Adapter, 3.95 to 5.85 GHz; 360D Low-Pass Filter, $f_c = 4.1$ GHz.

Price: HP 614A or HP 616B, \$2400 (cabinet); HP 614AR, \$2440 (rack mount); 616BR, \$2449 (rack mount).

RF TEST SETS

For testing transmitters, receivers
Models 623B, 624C, 5636



SIGNAL GENERATORS

Advantages:

- Direct reading of power, frequency
- Stable accurate input, output attenuators
- Compact package for portability in field

Uses:

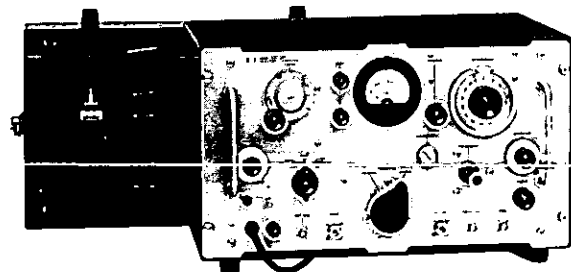
- Measure receiver sensitivity, selectivity
- Test transmitter tuning power level

Each of these test instruments consists of a combination signal generator, frequency meter and power meter and permits measurement of receiver sensitivity and selectivity, transmitter tuning and power level. Each is easy to use, fast and accurate.

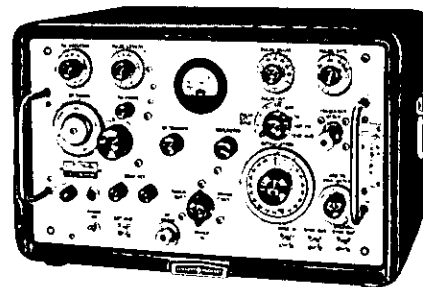
The HP model 623B SHF Test Set is an ideal one-piece unit for measuring receiver sensitivity or selectivity, transmitter tuning or power level. It is particularly adapted to testing complete communications, control, and video relay station equipment in the range of 5925 to 7750 MHz, using any of 3 klystrons. Its klystron source can be frequency modulated and externally pulse modulated.

From 8.5 to 10.0 GHz, the 624C X-Band Test Set provides a one-piece unit particularly adaptable for testing complete radar, gunfire control systems, or radio beacon equipment. It has internal frequency modulation capability and provision for a 35 Hz to 3.5 kHz pulse, FM, or square wave external modulation.

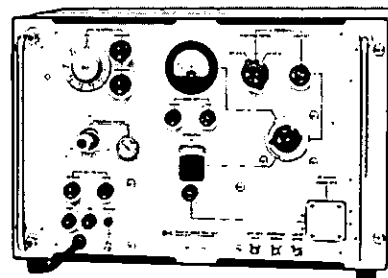
Nearly overlapping the frequency ranges of the 623B and 624C, the 5636 H-Band-Test Set more than covers the entire government communications band. It performs the same task but offers greater output power and a wider power measurement range than the 623B and 624C.



623B



624C



5636

Computer
Museum

Specifications

Model	Frequency range (MHz)	Frequency meter range (MHz)	Output power (dBm)	Output attenuator range (dB)	Internal modulation	External modulation	Power measurement range (CW)	Panel height	Shipping Weight Price
623B	5925-6575 or 6575-7175 or 7125-7750	5820-7780	0 (1 mW)	70	FM, 1 kHz	FM, pulse, square-wave, 30 Hz to 100 kHz	-6 to +3 dBm	11½" (292 mm)	76 lbs. \$3550 (transit case)
5636	7100-8500	7100-8500	15 (30 mW)	100	FM, 1 kHz	FM, pulse, square-wave, 30 Hz to 100 kHz	-6 to +40 dBm	14" (355 mm)	98 lbs. \$5300 (transit case)
624C	8500-10,000	8500-10,000	0 (1 mW)	100	FM at power line frequency; pulse, 35 to 3500 pps	FM, pulse, square-wave, 35 to 3500 Hz	-6 to +28 dBm	10½" (266 mm)	78 lbs. \$3550 (cabinet or rack)

SIGNAL GENERATORS



SHF SIGNAL GENERATORS

Multiple-purpose instruments, 3.8 to 11 GHz
Models 618C, 620B

Advantages:

- Direct-reading frequency dial
- Direct-reading output in voltage or dBm
- Internal FM, CW, pulsed or square-wave modulation
- Broadband coverage
- Wide frequency range
- High stability, high accuracy

Use to measure:

- Receiver sensitivity
- Selectivity or rejection
- Signal-to-noise ratio
- Antenna gain
- Transmission line characteristics

The Models 618C and 620B SHF Signal Generators provide versatility, accuracy, and stability in the range from 3.8 to 11 GHz. Thus such measurements as sensitivity, selectivity, signal-to-noise ratio, SWR, and antenna gain are made with ease. Frequency is set on a large, direct-reading dial. A ΔF vernier control provides ultra-fine tuning capability. There is also a provision for remote fine tuning.

A calibrated output from 0 to -127 dBm (0.224 volts to 0.1 microvolt) is also set on a large, direct-reading dial. The dial is calibrated in both dBm and volts, permitting measurements in terms of either and eliminating any computation in converting from one to the other. In addition, the zero set control for the power monitor has been eliminated, simplifying measurements by reducing the number of steps required. A second, uncalibrated output is available. This auxiliary output is at least 0.3 milliwatt and is independent of attenuator setting. Thus it can be used for phase-locking the signal generator when crystal-oscillator stability is required, or it can be monitored with a frequency counter for extreme frequency resolution.

Reflex klystron oscillator

The 618C and 620B Generators both feature oscillators of the reflex klystron type, with external resonant cavity. Oscillator frequency is determined by a movable plunger which varies the length of the cavity. Oscillator output is monitored by a temperature-compensated detector circuit. This circuit operates virtually unaffected by ambient temperature conditions. Identical piston attenuators couple power to the monitor and output terminal. The power monitor attenuator is linked to the output attenuator cursor to compensate for klystron output variation as frequency is changed.

Broad modulation capabilities

Modulation includes internal pulse, square-wave, and frequency modulation plus external pulse and frequency modulation. Internal pulse and square-wave repetition rates are continuously variable from 40 to 4000 pps, and pulse width is variable from 0.5 to 10 microseconds. Synchronization pulses are available simultaneously with the RF pulse or in

advance of the RF pulse from 3 to 300 microseconds. The internal pulse and square-wave modulation can be synchronized with external sine waves or pulses of either polarity, or external pulses can themselves be used as the modulating signal.

For internal frequency modulation, each generator has a sawtooth sweep variable from 40 to 4000 Hz with deviation adjustable up to about 5 MHz peak-to-peak. External FM is accomplished through one of two input connectors. The front-panel input is capacitively coupled to the repeller of the klystron oscillator for standard FM applications. The rear-panel input is dc-coupled to the klystron to permit phase-locking of the oscillator.

Specifications

Output

Frequency range: 618C: 3,800 to 7,600 MHz covered in a single band; 620B: 7 to 11 GHz covered in a single band; repeller voltage automatically tracked and proper mode automatically selected.

Calibration: direct reading; frequency calibration accuracy better than $\pm 1\%$.

Vernier: ΔF control has a minimum range of 0.5 MHz (618C), 1.5 MHz (620B) for fine tuning; remote ΔF connector on rear panel permits fine tuning with external potentiometer; tuning range at least 0.5 MHz (618C), 1.5 MHz (620B) with potentiometer ≥ 2 megohms.

Frequency stability: with temperature: less than 0.006%/°C change in ambient temperature; with line voltage: less than 0.02% change for line voltage variation of $\pm 10\%$; residual FM: < 15 kHz peak.

Output range: 1 milliwatt or 0.224 volt to 0.1 microvolt (0 dBm to -127 dBm) into 50 ohms; directly calibrated in microvolts and dB; coaxial type N connector.

Output accuracy: within ± 2 dB from -7 to -127 dBm, within ± 3 dB from 0 to -7 dBm, terminated in 50-ohm load; temperature-compensated detector circuit monitors RF oscillator power level; an auxiliary, fixed-level RF output (at least 0.3 mW) is provided on the front panel for use with other equipment such as a frequency counter or phase-lock instrumentation.

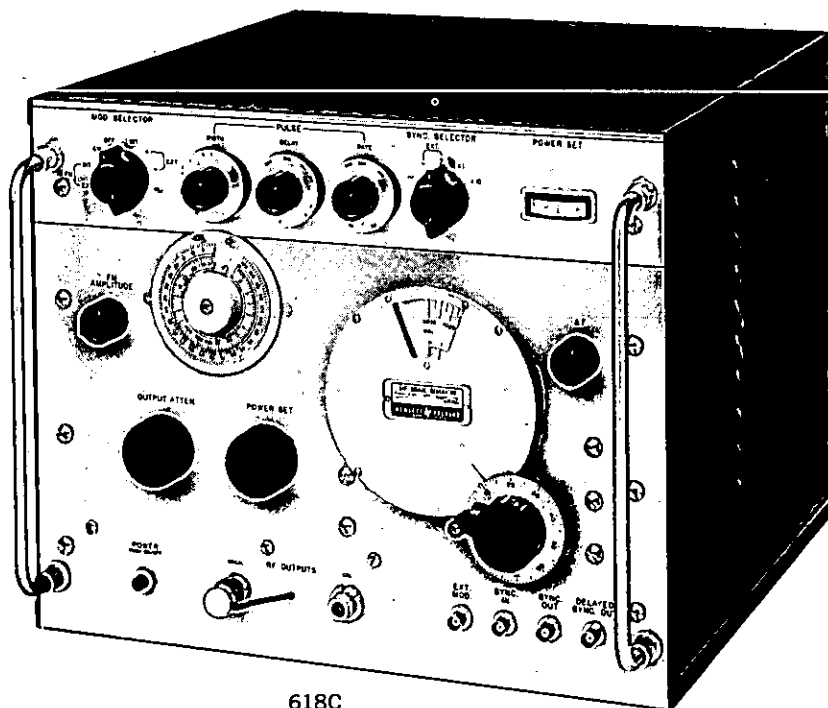
Source impedance: 50 ohms nominal; reflection coefficient less than 0.33 (2 SWR, 9.6 dB return loss).

Modulation

Modulation: internal or external pulse, FM, and square-wave.

Internal pulse modulation: repetition rate variable from 40 to 4,000 pps, pulse width variable $\frac{1}{2}$ to 10 microseconds.

Sync out signals: simultaneous with RF pulse, positive; in advance of RF pulse, positive, variable 3 to 300 microseconds (better than 1 microsecond rise time and 25 to 100 volts amplitude into 1,000-ohm load).



618C

External synchronization: sine wave: 40 to 4,000 Hz, 5 to 50 V rms; pulse: 40 to 4,000 pps, 20 to 70 V peak, positive or negative, 0.5 to 5 μ s wide, 0.1 to 1 μ s rise time.

Internal square-wave modulation: variable 40 to 4,000 Hz, controlled by "pulse rate" control.

Internal frequency modulation: sawtooth sweep rate adjustable 40 to 4,000 Hz; frequency deviation to 5 MHz peak-to-peak over most of the frequency range.

External pulse modulation: pulse requirements: amplitude from 20 to 70 volts positive or negative, width 0.5 to 2,500 microseconds.

External FM: frequency deviation approximately 5 MHz peak-to-peak over most of the band; sensitivity approximately 20 V/MHz at front-panel connector, approximately 10 V/MHz at rear-panel connector (mating connector supplied); front-panel connector is capacitively coupled to klystron repeller; rear-panel connector is dc-coupled to klystron repeller and is suitable for phase-lock control input.

General

RFI: conducted and radiated leakage limits are below those specified in MIL-I-6181D.

Power source: 115 or 230 volts $\pm 10\%$, 50 to 60 Hz, 230 watts.

Dimensions: cabinet: 17 $\frac{1}{2}$ in. wide, 13 $\frac{7}{8}$ in. high, 20 $\frac{3}{8}$ in. deep behind panel (445 x 353 x 518 mm); rack mount: 19 in. wide, 13 $\frac{31}{32}$ in. high, 19 in. deep behind panel (483 x 355 x 483 mm).

Weight: net, 69 lb (31,1 kg); shipping 90 lb (40,5 kg).

Accessory furnished: 11500A Cable Assembly, 6 feet (1830 mm) of RG-214A/U 50-ohm Coax, terminated on each end by type N male connectors.

Price: Model 618C (cabinet mount), \$2350. Model 618CR (rack mount), \$2390. Model 620B (cabinet mount), \$2350. Model 620 BR (rack mount), \$2390.



SHF SIGNAL GENERATORS

Direct-reading, high power, 10 to 21 GHz

Models 626A, 628A

Advantages:

- Direct-reading frequency control
- Direct-reading output control
- 10 mW output over full range
- CW, FM or pulse modulation
- Internal square-wave modulation
- Broad pulsing capabilities
- Low internal SWR
- High stability
- Operate to 40 GHz with HP 938, 940 Frequency Doubler Sets

Use to measure:

- Receiver sensitivity
- Selectivity or rejection
- Signal-to-noise ratio
- Transmission line characteristics

Here are two HP signal generators which extend the measuring versatility, convenience and accuracy of HP VHF signal generators to 21 GHz. The 626A covers frequencies 10 to 15.5 GHz, and the 628A covers frequencies 15 to 21 GHz. In design and operation, the instruments are similar to HP generators for lower frequency ranges. Operation is very simple. Carrier frequency is set and read directly on the large tuning dial. No voltage adjustment is necessary during tuning because repeller voltage is tracked with frequency changes automatically. Oscillator output also is set and read directly, and no frequency correction is necessary throughout operating range. A frequency logging scale permits frequency to be reset within 0.1%.

The high power output of these signal generators make them ideally suited for driving HP 938A and 940A Frequency Doubler Sets (18 to 26.5 GHz and 26.5 to 40 GHz respectively). These doubler sets retain the modulation and stability of the driving source and have accurate power monitors and attenuators.

Versatile modulation

Both the 626A and 628A offer internal and external pulse modulation, as well as internal square-wave modulation and FM. Pulse repetition rate is continuously variable from 40 to 4000 pps, and pulse width is variable from 0.5 to 10 μ s. Sync out signals are simultaneous with the RF pulse, or in advance of the RF pulse by any time span from 3 to 300 μ s. The pulse generators may be synchronized with an external sine wave and also with positive or negative pulse signals.

For internal FM, both instruments feature a sine-wave sweep at power line frequency. Frequency deviation is variable up to 10 MHz peak-to-peak. For external FM, the generators have capacitive couplings to the klystron oscillator repeller.

Figure 1 shows the basic circuits of the HP signal generators. The reflex klystron oscillator is tuned by a plunger driven by the direct-reading frequency dial and control. Repeller voltage is automatically tracked, so that correct operating potentials are maintained over the entire frequency range. Klystron output is introduced into a power monitoring meter. The directional coupler provides uniform coupling over the entire frequency range. A rotary attenuator which follows the coupler assures high accuracy and stability, because the attenuation is governed by a precise

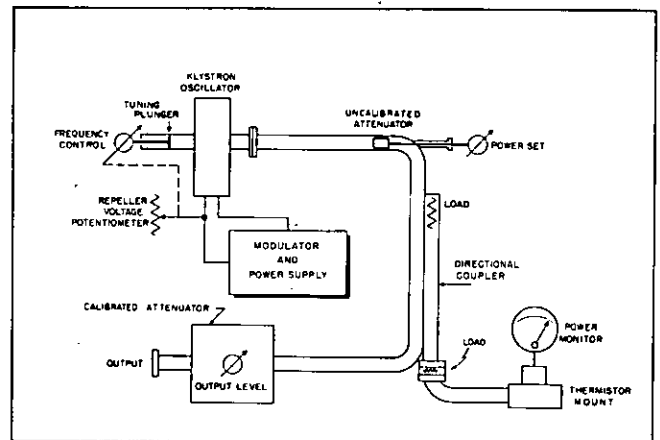


Figure 1. Basic circuit. HP 626A, 628A.

mathematical law related to the angular rotation of the attenuator. The conductivity of the attenuating film does not affect the attenuation; thus, the output of the generator is independent of humidity, temperature or the effect of long-term aging. The attenuator also provides low SWR over the complete frequency range. On both HP 626A and 628A, the output connector is waveguide. Adapters furnished permit the instruments to be connected to WR-42, WR-62 or WR-90 waveguide. Thus, the generators can be employed with all EIA (RETMA) and JAN guides suitable for the 10 to 21 GHz range.

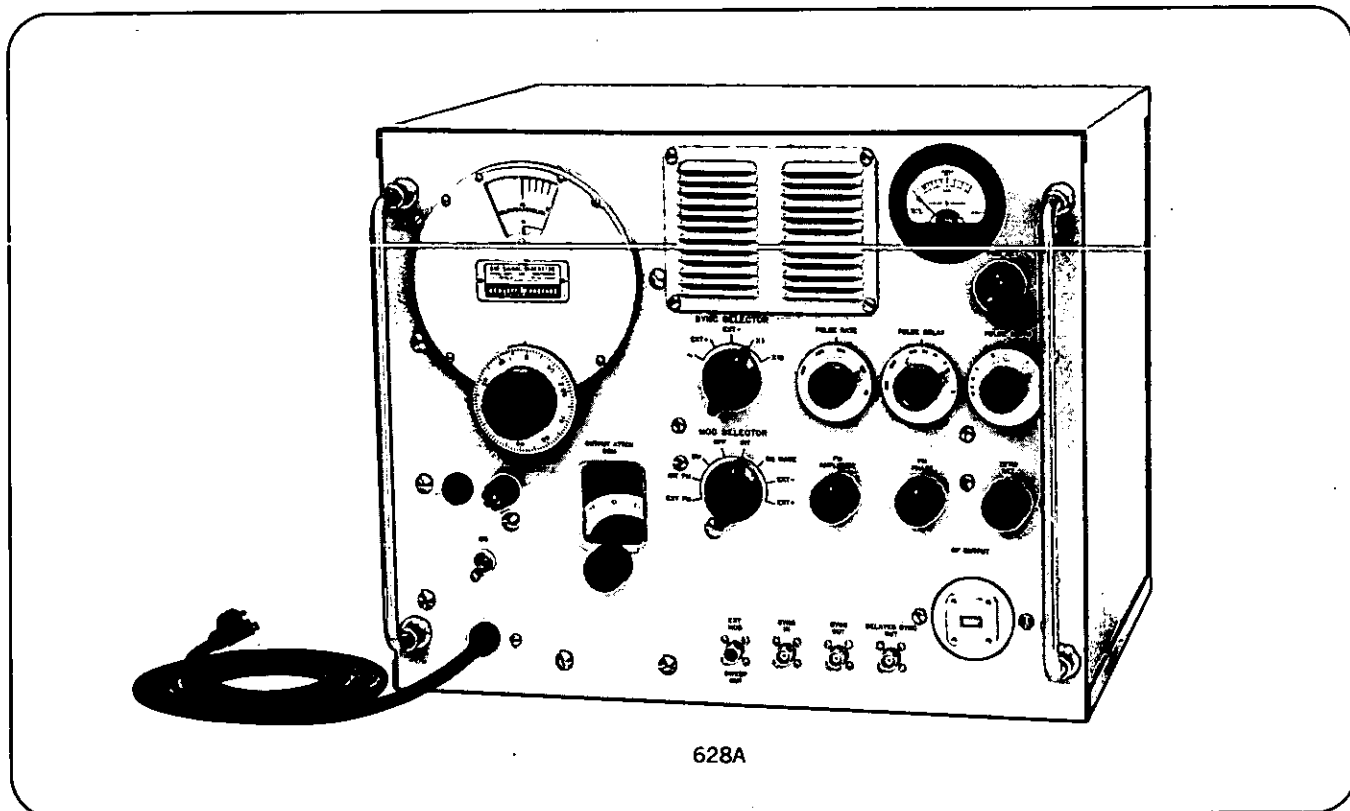
Specifications

Frequency range: 626A, 10 to 15.5 GHz; 628A, 15 to 21 GHz.

Frequency calibration: dial direct-reading in GHz, accuracy better than $\pm 1\%$.

Output range: 10 mW to 1 pW (+10 dBm to -90 dBm, 0 dBm = 1 mW); attenuator dial directly calibrated in output dBm.

Source impedance: 50 ohms nominal; reflection coefficient: 626A, less than 0.43 (2.5 SWR, 7.3 dB return loss) at +10 dBm, 0.15 (1.35 SWR, 16.5 dB return loss) at 0 dBm and below; 628A, less than 0.43 (2.5 SWR, 7.3 dB return loss) at +10 dBm, 0.091 (1.2 SWR, 20.8 dB return loss) at 0 dBm and below.



628A

Output monitor accuracy: better than ± 1 dB; temperature-compensated thermistor bridge circuit monitors RF oscillator power level.

Output connector: 626A: 0.850 x 0.475 in. waveguide, WR75, flat cover flange; 628A: 0.590 x 0.335 in. waveguide, WR51, flat cover flange.

Output attenuator accuracy: better than $\pm 2\%$ of attenuation in dB introduced by output attenuator.

Leakage: less than minimum calibrated signal generator output.

Modulation: internal or external pulsed, FM, or square-wave.

Internal pulse modulation: repetition rate variable from 40 to 4000 pps; pulse width variable 0.5 to 10 μ s.

Internal square-wave modulation: variable 40 to 4000 Hz controlled by "pulse rate" control.

Internal frequency modulation: power line frequency, deviation up to 10 MHz p-p.

External pulse modulation: pulse requirements: amplitude 15 to 70 volts peak positive or negative; width 1 to 2500 μ s.

External frequency modulation: provided by capacitive coupling to repeller of klystron; maximum deviation approximately 10 MHz p-p.

Sync out signals: positive 20 to 50 volts peak into 1000-ohm load; better than 1 μ s rise time; (1) simultaneous with RF pulse, positive; (2) in advance of RF pulse, positive, variable 3 to 300 μ s.

External synchronization: (1) sine wave, 40 to 4000 Hz, amplitude 5 to 50 volts rms; (2) pulse signals 0 to 4000 pps, 5 to 50 volts amplitude, positive or negative; pulse width 0.5 to 5 μ s; rise time 0.1 to 1 μ s.

Power: 115 or 230 volts $\pm 10\%$, 50 to 60 Hz, approx. 200 watts.

Dimensions: cabinet: 17" wide, 14" high, 15" deep (432 x 356 x 381 mm); rack mount: 19" wide, 14" high, 12-13/16" deep behind panel (483 x 356 x 313 mm).

Weight: 626A,AR: net 61 lb (28,1 kg), shipping 76 lb (34,2 kg); 628A,AR: net 58 lb (26,1 kg), shipping 73 lb (32,9 kg).

Accessories furnished: 626A (a) MX 292B Waveguide Adapter, WR-75-to-WR-90 guide; (b) MP 292B Waveguide Adapter, WR-75-to-WR-62 guide; 628A (a) NP 292A Waveguide Adapter, WR-51-to-WR-62 guide; (b) NK 292A Waveguide Adapter, WR-51-to-WR-42 guide.

Accessories available: 10503A Video Cable Assembly for 626A; M362A Low-Pass Filter.

Price: HP 626A or 628A, \$3900 (cabinet); HP 626AR or 628AR, \$3940 (rack mount).

SIGNAL GENERATORS



FREQUENCY DOUBLER SETS

Generate stable signals to 40 GHz

Models 938A, 940A

Hewlett-Packard Model 938A and Model 940A Frequency Doubler Sets bring you low-cost signal-generation capability in K- and R-bands (18 to 40 GHz). Model 938A supplies power from 18 to 26.5 GHz when it is driven by a 9 to 13.25 GHz source; Model 940A supplies power from 26.5 to 40 GHz when it is driven by a 13.25 to 20 GHz source.

These frequency doubler sets consist of broadband crystal harmonic generators suitably mounted in a waveguide section, a power monitor, a broad stopband low-pass filter and a precision attenuator. They may be driven by klystrons, by signal generators such as HP Models 626A and 628A, or by sweep oscillators such as HP Model 8690B with 8694A,B or 8695A RF Units.

Since Model 938A and Model 940A are broadband instruments, the input signal may be CW, pulsed, or swept. Thus, the frequency doubler sets retain all the versatility of the driving source.

Output monitor

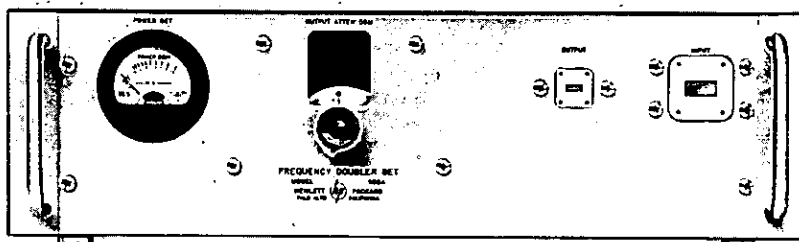
Models 938A and 940A have power monitors and pre-

cision rotary-varie attenuators for accurately setting output level over a range from 0 to -100 dB. Output power depends on input power and is typically 0.5 to 1 mW when a 626A, 628A, or 8690B is used as a driving source. Further, since Models 938A and 940A contain a power monitor, output power is known even though an uncalibrated signal source is used.

Signal generator or swept-frequency operation

Models 938A and 940A have the same output versatility as the driving source. For instance, if you drive Model 938A with Model 626A you may have CW output, pulse-modulated output with a repetition rate from 40 to 4000 pps, square-wave-modulated output with modulation frequencies from 40 to 4000 Hz, or 60 Hz (power line frequency) FM output. In addition, pulsed output may be synchronized with external signals or output may be externally pulse or frequency modulated.

To obtain a swept-frequency output, you simply drive the frequency doubler set from a swept-frequency source such as Model 8690B with 8694A,B or 8695A RF Unit.



938A

Specifications

Frequency range: 938A, 18 to 26.5 GHz; 940A, 26.5 to 40 GHz.

Conversion loss: less than 18 dB at 10 mW input.

Output power: depends on input power supplied; approx. 0.5-1 mW when used with typical 626A, 628A Signal Generators.

Maximum input power: 100 mW.

Output monitor accuracy: ± 2 dB.

Output attenuator accuracy: $\pm 2\%$ of reading or ± 0.2 dB, whichever is greater.

Attenuator range: 100 dB.

Output reflection coefficient: approximately 0.33 (2 SWR, 9.5 dB return loss) at full output; less than 0.2 (1.5 SWR, 14 dB return loss) with attenuator set to 10 dB or more attenuation.

Input flange: 938A, M-band flat cover flange for WR-75 waveguide; 940A, N-band flat cover flange for WR-51 waveguide.

Output flange: 938A, UG-595/U flat cover flange for WR-42 waveguide (K-band); 940A, UG-599/U flat cover flange for WR-28 waveguide (R-band).

Dimensions: cabinet: 19 $\frac{1}{4}$ " wide, 5 $\frac{3}{8}$ " high, 18" deep (489 x 137 x 457 mm).

Weight: net 20 lb (9 kg); shipping 27 lb (12.2 kg).

Accessories available: 938A, X281A Waveguide-to-Coax Adapter, 8.2 to 12.4 gc; MX292B and MP292B Waveguide-to-Waveguide Adapters (1 each furnished with 626A); 11504A X-band Flexible Waveguide; 11503A P-band Flexible Waveguide; 940A, MP292B and NP292A Waveguide-to-Waveguide Adapters, (1 each furnished with 628A); 11503A P-band Flexible Waveguide.

Complementary equipment: 938A, 626A Signal Generator; 8690B Sweep Oscillator with 8694A,B and 8695A RF Unit. 940A, 626A and 628A Signal Generators; 8690B Sweep Oscillator with 8695A RF Unit.

Price: HP 938A or HP 940A, \$2500 (cabinet).

FM SIGNAL GENERATOR

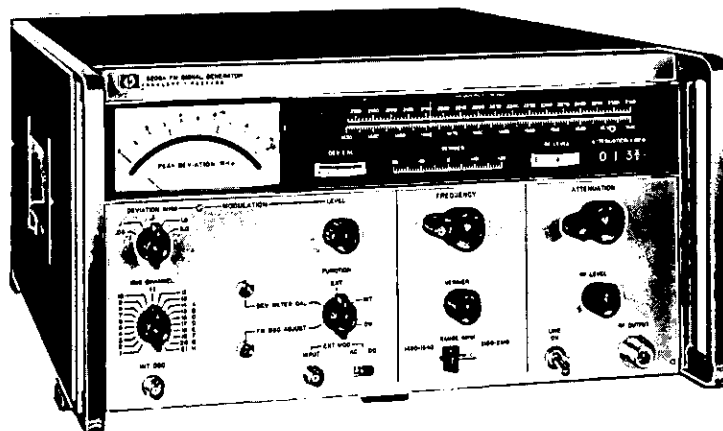
Covers both new telemetry bands
Model 3205A



SIGNAL GENERATORS

The Model 3205A FM Signal Generator is a self-contained, completely solid-state instrument designed for use in the measurement and calibration of FM telemetry receivers in the 1435 to 1540 MHz and 2200 to 2300 MHz frequency bands. Peak FM deviation of the RF output on one of five different ranges is indicated on a calibrated deviation meter. The generator has its own deviation meter calibration system

that does not require external instrumentation. A calibrated RF output level, adjustable from -10 dBm to -127 dBm is also included. An internal modulation oscillator permits selection of channels 1 through 21 of the standard IRIG (Inter-range Instrumentation Group) subcarrier frequencies used for telemetry systems.



3205A

Specifications

RF characteristics

Frequency range: band 1, 1430 to 1540 MHz; band 2, 2150 to 2310 MHz.

Frequency accuracy (main dial): $\pm 0.3\%$.

Vernier: 40 logging divisions, approx. ± 2 MHz.

Frequency stability (after $\frac{1}{2}$ hour warm-up with modulation input ac coupled): short term, 40 PPM per 10 minutes; long term, 150 PPM per hour; temperature coefficient, < 30 PPM per $^{\circ}\text{C}$.

RF output (main): -10 to -127 dBm.

RF output leveling: 1.5 dB pk-pk maximum excursion across each band.

Spurious output: non-harmonically related, > 50 dB below main output on either band; harmonically related, > 20 dB below main output.

Modulation characteristics

FM deviation: ± 3 MHz.

Modulation frequency response: ± 1 dB (referenced to 10 kHz) from dc (dc coupled) or 5 Hz (ac coupled) to 750 kHz; $+2$, -3 dB to 2 MHz.

FM non-linearity:

Band 1:

- $< 0.5\%$ at ± 0.5 MHz deviation (f_{mod} to .5 MHz)
- $< 1.0\%$ at ± 1 MHz deviation (f_{mod} to 1 MHz)
- $< 7.0\%$ at ± 3 MHz deviation (f_{mod} to 2 MHz)

Band 2:

- $< 0.3\%$ at ± 0.5 MHz deviation (f_{mod} to .5 MHz)
- $< 0.7\%$ at ± 1 MHz deviation (f_{mod} to 1 MHz)
- $< 4.0\%$ at ± 3 MHz deviation (f_{mod} to 2 MHz)

FM calibration: 30 kHz to 3 MHz full scale in 5 ranges; accuracy, $\pm 5\%$ of full scale ($f_{\text{mod}} = 5$ Hz to .5 MHz); internal deviation calibrator provides 1% calibrate point at .667 MHz on band 1 and 1.00 MHz on band 2.

Residual FM: less than 1.5 kHz on band 1, 2.0 kHz on band 2, measured in a 1.5 MHz equivalent rectangular bandwidth.

External FM input: impedance: 600 ohms shunted by less than 45 pF (75 pF, option 001); sensitivity: band 1, < 1.5 V rms for 1 MHz deviation; band 2, < 1 V rms for 1 MHz deviation.

Internal modulation oscillator: frequencies: IRIG proportional subcarrier channels 1 through 21; accuracy: $\pm 2\%$; THD: $< 0.5\%$.

Dimensions: 16 $\frac{3}{4}$ " wide, 8 $\frac{3}{4}$ " high, 18 $\frac{3}{8}$ " deep, (425 x 222 x 467 mm).

Weight: net 52 lbs (23,4 kg); shipping 67 lbs (30,2 kg).

Power: 115 or 230 V $\pm 10\%$, 50 to 400 Hz, 50 watts.

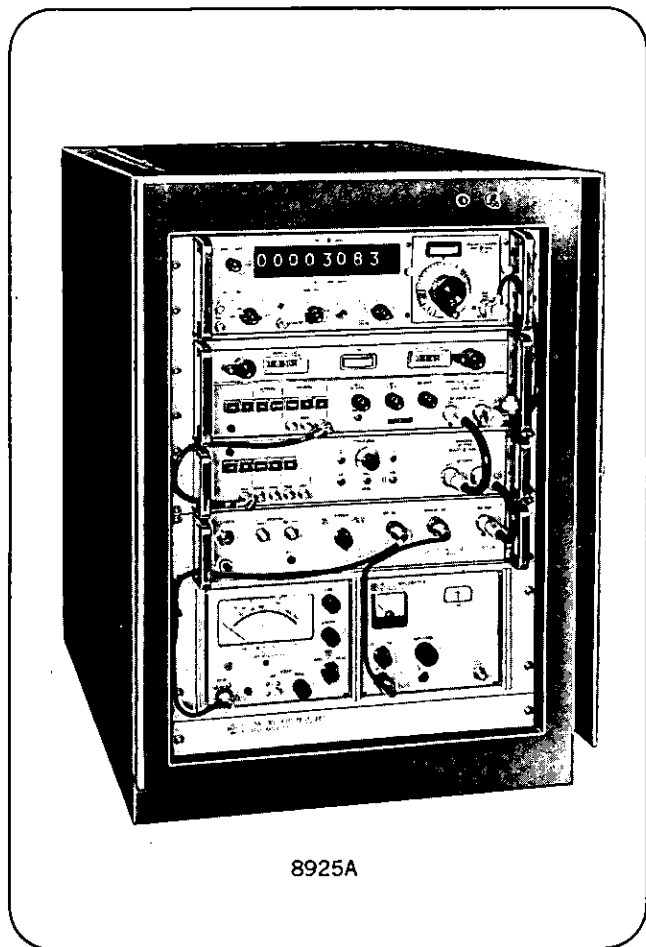
Price: \$5,750.

Option 001: all front panel connectors moved to rear panel. Add \$50.



DME/ATC TEST SET

Calibrates DME and ATC equipment
Model 8925A



8925A

The HP 8925A DME/ATC Test Set is specifically designed for testing and calibrating DME (Distance Measuring Equipment) and ATC (Air Traffic Control) transponder aircraft equipment. When used with suitable modulators, the test set will also simulate some TACAN and IFF signals. Completely self-contained (except for video modulators), the system consists of a continuously tuneable signal generator (HP 8614A option H01), direct-reading frequency counter (HP 5245L), solid-state modulator (HP 8403A option H01), frequency converter (HP 5254A), wavemeter (HP 8905A), peak power measuring system (HP 8900B option 001), and all necessary circuitry for interconnection to the radio set under test (HP 13505A).

Specifications

Radio frequency characteristics

RF range: 962 to 1213 MHz.

RF accuracy: determined by ability to set to desired reading on counter.

RF settability: better than 100 kHz.

RF stability: temperature, approx 0.005% per degree C; line voltage, <0.003% ($\pm 10\%$ line voltage change).

RF output: range: -10 to -100 dBm cross external 50-ohm load at output jack, accuracy:

Attenuator setting	ATC (1015 to 1045 MHz)	DME (962 to 1213 MHz)
-10 to -17 dBm	$+0.7$ to 1.2 dB	$+1.1$ to 1.6 dB
-17 dBm	± 0.6 dB	± 1 dB
-17 to -100 dBm	$\pm(0.8 + 0.06$ per 10 dB) dB	$\pm(1.2 + 0.06$ per 10 dB) dB

Leveled output: (fixed atten. position) ATC, ± 0.2 dB; DME, ± 0.6 dB; impedance: 50 ohms; VSWR: 1.35:1.

Pulse modulation characteristics

PM source: suitable external video modulators.

Pulse shape: with suitable modulators, meets general requirements of DME/ATC.

Side-lobe suppression: the second pulse of a train of 2 (or 3) pulses may be varied $+1$ to -10 dB from the first pulse when its leading edge is ≥ 2 μ s from the first pulse leading edge; calibrated SLS control accurate to ± 0.5 dB.

Simulated bearing input: audio frequency input to BNC jack under TACAN button will simulate bearing modulation to a depth of 55% max. (3.8 dB above pulse tips).

Power measurement characteristics

RF range: 962 to 1213 MHz; RF power range: 100 to 2000 watts peak (ARINC units), 10 to 200/100 to 2000 watts peak (Gen. Aviation and ARINC units) available as factory modification with accessory attenuator; RF power accuracy: ± 1.2 dB from calibration curve).

Frequency measurements characteristics

RF range: 1070 to 1110 MHz; RF accuracy: ± 0.5 MHz; direct meter indication for peak power 250 to 1000 watts at 25°C; video output for external scope indication for input peak power down to approx 10 watts.

Monitor characteristics

Signal generator monitor (Monitor-Sig Gen), heterodyne monitor (Het Mon): frequency range: 1018 to 1032 MHz (for beating oscillator 1025 ± 1 MHz); output level: 0.5 volts peak min at -10 dBm RF level (at IF center frequency); load impedance: 150 ohms nominal; bandwidth: 9 MHz nominal (equivalent low-pass bandwidth 4 MHz); linearity: ± 0.5 dB (-10 to -20 dBm RF level).

Diode monitor (Diode Mon): frequency range: 962 to 1213 MHz; output level: 0.1 V peak min at -10 dBm RF level; low-pass bandwidth: 5 MHz nominal.

Transmitter monitor (Monitor-Xmtr): output level: approx 0.2 V peak for 200 watts peak input (100 to 2000 watts peak power range), 20 watts peak input (10 to 200 watts peak power range); load impedance: 150 ohms nominal; bandwidth: 10 MHz nominal; linearity: ± 1 dB for 200 to 2000/20 to 200 watts peak input; transmitter interlock: terminals are provided for de-energizing the transmitter when the system internal load is removed from the transmitter antenna.

Dimensions: 23" wide, 32 $\frac{1}{4}$ " high, 26" deep (584 x 819 x 660 mm).

Weight: net 310 lbs (139,5 kg); shipping 350 lbs (157,5 kg).

Power: 105 to 125 or 210 to 250 volts, 50 to 60 Hz, 400 W.

Price: HP 8925A, \$12,365.

Options: 001: less 5245L/5254A Counter, \$9,060; 002: less cabinet, \$11,775; 003: dual power range (10 to 200/100 to 2000 watts), add \$100; 004: HP 5246L Counter instead of HP 5245L, \$11,685, specify by option number.

SIGNAL GENERATORS

Test and calibrate aircraft VOR and ILS
Models 211A, 232A



SIGNAL GENERATORS

211A Signal Generator

The HP 211A Crystal-Monitored Signal Generator is specifically designed for the testing and calibrating of aircraft VOR and ILS localizer radio receiving equipment operating within the frequency range from 88 to 140 MHz. It also may be used for laboratory and development work where a precision-type amplitude-modulated RF signal source is required.

232A Signal Generator

The FAA Instrument Landing System for aircraft includes a glide slope receiver for indicating the proper rate of descent. The HP 232A Glide Slope Signal Generator was designed for use in testing and calibrating these glide slope receivers.

Specifications, 211A

Radio frequency characteristics

RF range: master oscillator: 88 to 140 MHz in one range; crystal oscillator: 110.1 and 114.9 MHz.

RF output: range: 0.1 μ V to 0.2 volt (across external 50-ohm load); impedance: 50 ohms; spurious output: all spurious RF output voltages are better than 40 dB below desired output.

Amplitude modulation characteristics: AM range, 0 to 100% in two ranges.

Physical characteristics

Dimensions: 211A and 211AP1 (Power Supply): 19 $\frac{1}{2}$ " wide, 10 $\frac{1}{2}$ " high, 9 $\frac{1}{2}$ " deep (495 x 267 x 241 mm).

Weight: net 63 lbs (28,4 kg); shipping 86 lbs (38,7 kg).

Power: 105 to 125 V, 50 to 60 Hz, 150 W.

Price: HP 211A, 211AP1, \$2900.

Specifications, 232A

Radio frequency characteristics

RF range: (A) 329.3 to 335 MHz in increments of 0.3 MHz; (B) 20.7 MHz; other frequencies between 15 and 30 MHz available on special order.

RF accuracy: $\pm 0.0065\%$ (crystal controlled).

RF output: range: 1 μ V to 0.2 V (across external 50-ohm load); accuracy: $\pm 10\%$ approximately; impedance: 50 ohms.

RF leakage: sufficiently low to permit measurement at 1 μ V.

Amplitude modulation characteristics

Am range: internal: 0 to 100% in two ranges; external: 0 to 100% in two ranges.

AM calibration: increments of 2%, 0 to 50%; increments of 10%, 0 to 100%.

Demodulated output: available at front-panel posts through 2 μ F capacitor.

Modulating oscillator characteristics

OSC frequency: (A) 1000 Hz; (B) 90 and 150 Hz in the following tone ratios: 0 dB, ± 0.5 dB, ± 1 dB, ± 2 dB, ± 3.3 dB, \pm infinite dB (calibrate).

Physical characteristics

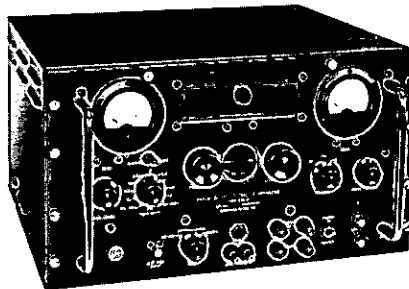
Dimensions: 20 $\frac{7}{8}$ " wide, 10 $\frac{1}{2}$ " high, 12" deep (511 x 267 x 305 mm).

Weight: net 64 lbs (28,8 kg); shipping 75 lbs (33,8 kg).

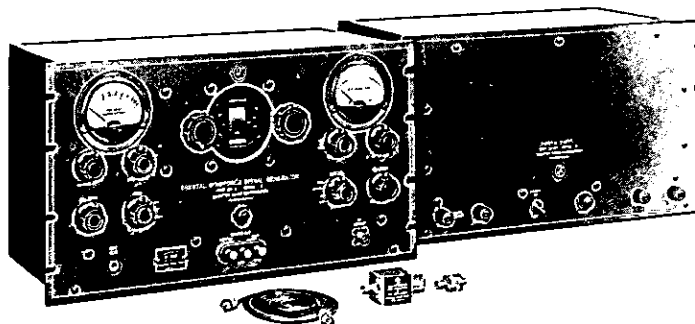
Power: 105 to 125 V, 60 ± 1 Hz, 150 W.

Price: HP 232A, \$3200.

Option 001: 105 to 125 V, 50 Hz, 150 W; add \$50.



232A



211A



8730 PIN Modulators

The Hewlett-Packard 8730 Series PIN Modulators increase the flexibility and performance of signal sources by providing increased modulation capability. With PIN modulators, signal sources, including klystrons, can be pulse-modulated, leveled or amplitude-modulated with sinusoidal and complex waveforms. Incidental FM is virtually eliminated, because modulation is accomplished by absorption of RF power, independent of the signal source, with a nearly constant match presented to both the source and load. Thus, the source can operate continuously at its optimum output level. Extremely fast rise times, typically 30 ns, also result from the absorption type of modulation, which sidesteps the bandwidth limitations imposed by the high-Q RF output circuits.

The 8730 PIN Modulators cover the coaxial range from 0.8 to 12.4 GHz in four overlapping bands, in addition to X-band in waveguide. Two models are available within each band: an "A" model, which provides at least 35 dB of attenuation range, and a "B" model, which provides at least 80 dB.

Physically, the PIN modulator comprises a number of PIN diodes mounted as shunt elements across a transmission line. Since PIN diodes have appreciable storage time, they do not rectify at signal frequencies above 100 MHz. However, when a dc forward bias is applied, the diodes conduct, and their resistance goes down. Thus, the diodes act as low-reactance, variable resistors shunting the transmission line. Their resistance and the degree of attenuation of an RF signal are functions of the modulating current. However, due to the storage time of the diodes, specially shaped modulation signals must be applied to realize the fast RF rise and decay times of which the PIN modulators are capable. The HP Model 8403A Modulator is specifically designed to supply these modulation signals.

8403A Modulator

The Model 8403A provides complete control of the PIN modulators, supplying the appropriate modulation wave shapes and bias levels for fast rise times, rated on/off ratios and amplitude modulation. An internal square-wave and pulse modulator, which can be synchronized with external signals, has a free-running PRF from 50 Hz to 50 kHz. In the pulse-modulation mode both pulse width and pulse delay are adjustable from 0.1 to 100 μ s, and jitter with respect to the sync pulse and pulse width is less than 1 ns. An external AM input permits remote control of attenuation or sinusoidal modulation from dc to 10 MHz.

The Model 8403A also provides square wave and pulses for general pulse applications. Repetition rate, delay and jitter are the same as above. The output signal has an amplitude of 25 to 30 volts.

For situations requiring an absorption-type modulator complete with controls in a single unit, a PIN modulator can be installed in the Model 8403A. This combination is fully portable and convenient for bench use.

Specifications, 8403A

Output characteristics

AM and pulse output for driving 8730 PIN Modulators: pulse output specially shaped for optimum RF rise and decay times.

Pulse output for general pulse applications: positive dc-coupled pulse 25 to 30 volts in amplitude, approximately symmetrical about 0 volt; no AM signal.

Output signals available concurrently from separate front-panel connectors.

Internal modulation

Square wave

Frequency: continuously variable from 50 Hz to 50 kHz, 3 decade ranges.

Symmetry: better than 45/55%.

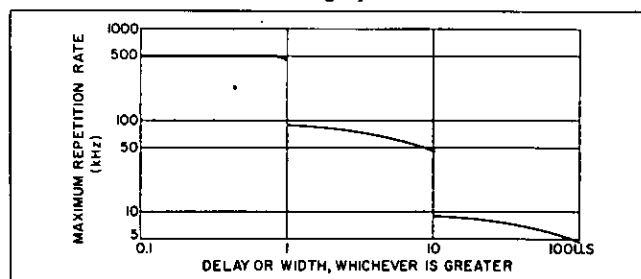
Pulse

Repetition rate: continuously variable from 50 Hz to 50 kHz, 3 decade ranges.

Delay: continuously variable from 0.1 μ s to 100 μ s, in 3 decade ranges, between sync out pulse and RF output pulse.

Width: continuously variable from 0.1 μ s to 100 μ s in 3 decade ranges.

Maximum duty cycle: see graph.



External sync

Amplitude: 5 volts to 20 volts peak.

Waveform: pulse or sine wave.

Polarity: either positive or negative.

Input impedance: approx. 2000 ohms, dc-coupled.

Rate: subject to internal recovery time considerations; see graph.

Trigger out

Sync out: 0.1 to 100 μ s in advance of RF pulse, as set by Delay control (internal pulse mode); simultaneous with RF pulse (internal square wave and external pulse mode).

Delayed sync out: simultaneous with output pulse (internal pulse mode only).

Amplitude: approximately -2 volts.

Source impedance: approximately 330 ohms.

External modulation

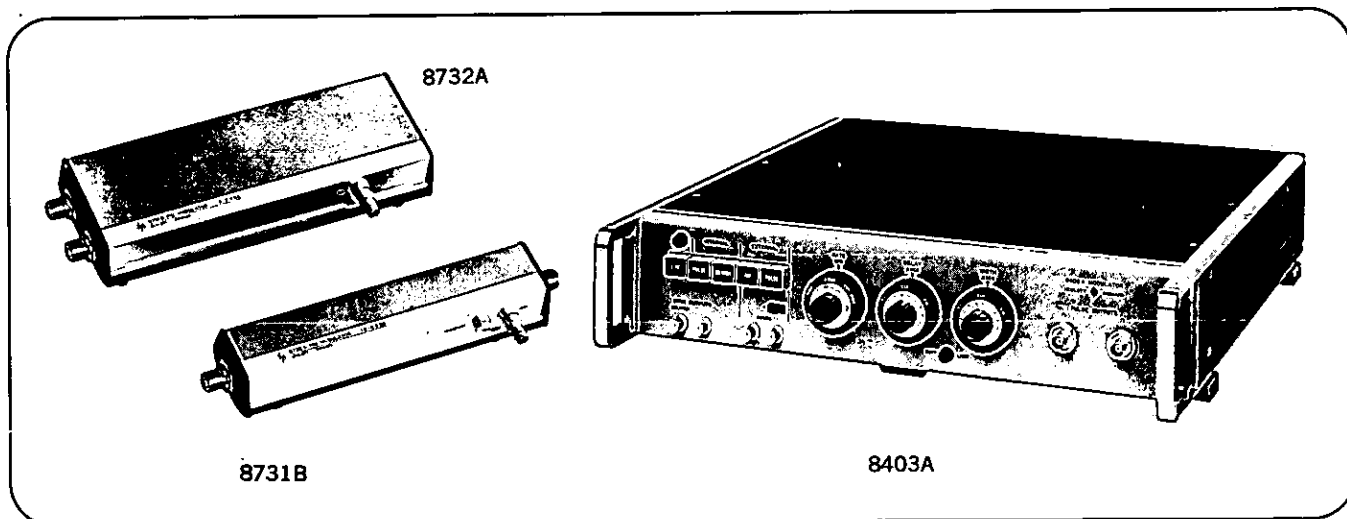
Pulse input

Amplitude and polarity: 5 volts to 20 volts peak, either positive or negative.

Repetition rate: maximum average PRF, 500 kHz.

Input impedance: approx. 2000 ohms, dc-coupled.

Minimum width: 0.1 μ s.



Maximum width: $\frac{1}{\text{PRF}} - 0.4 \mu\text{s}$.

Continuous amplitude modulation (with 8730 Series)

Frequency response: dc to approximately 10 MHz (3 dB).

Sensitivity: approximately 10 dB/volt with HP 8730A Series, approximately 20 dB/volt with HP 8730B Series.

Input impedance: approximately 1000 ohms.

Level control: AM input is dc-coupled, permitting control by bias of AM input; rear-panel control for use with ac-coupled modulation.

General

Power: 115 or 230 volts $\pm 10\%$, 50 to 400 Hz, approximately 10 watts.

Dimensions: 16 $\frac{3}{4}$ " wide, 3 $\frac{3}{4}$ " high, 18 $\frac{3}{8}$ " deep (425 x

96 x 467 mm); hardware furnished for conversion to rack-mount 19" wide, 3-15/32" high, 16 $\frac{3}{8}$ " deep behind panel (483 x 89 x 416 mm).

Weight: net 17 lb (7,7 kg); shipping 21 lb (9,5 kg).

Price: HP 8403A, \$900.

Options

001. HP 8731A PIN Modulator installed, add \$450.
002. HP 8731B PIN Modulator installed, add \$675.
003. HP 8732A PIN Modulator installed, add \$450.
004. HP 8732B PIN Modulator installed, add \$675.
005. HP 8733A PIN Modulator installed, add \$475.
006. HP 8733B PIN Modulator installed, add \$700.
007. HP 8734A PIN Modulator installed, add \$500.
008. HP 8734B PIN Modulator installed, add \$725.
009. Sync output and external modulation input connectors on rear panel in parallel with front-panel connectors; pulse output (or RF input and output) connectors on rear panel only, add \$25.

Specifications, 8730 Series

HP Model	8731A	8731B	8732A	8732B	8733A	8733B	8734A	8734B	8735A	8735B	H10-8731B ⁶
Frequency range (GHz)	0.8-2.4	0.8-2.4	1.8-4.5	1.8-4.5	3.7-8.3	3.7-8.3	7.0-12.4	7.0-12.4	8.2-12.4	8.2-12.4	0.4-0.9
Dynamic range (dB)	35	80	35	80	35	80	35	80	35	80	35
Max. residual atten. (dB) ¹	<1.5	<2.0	<2.0	<3.5 ²	<2.0	<3.0	<4.0	<5.0	<4.0	<5.0	<2.0
Typical rise time (ns) ³	40	30	40	30	30	30	30	30	30	30	40
Typical decay time (ns) ³	30	20	30	20	20	20	20	20	20	20	30
SWR, min. attenuation	1.5	1.6	1.5	1.6 ⁴	1.8	2.0	1.8	2.0	1.7	2.0	1.25 ⁷
SWR, max. attenuation	1.8	2.0	1.8	2.0	2.0	2.2	2.0	2.2	2.0	2.2	1.5 ⁷
Forward bias input resistance (ohms)	300	100	300	100	300	100	300	100	300	100	300
RF connector type	N	N	N	N	N	N	N	N	W/G ⁵	W/G ⁵	N
Weight, net (lb)	3	6	3	6	3	3	3	3	3	3	6
(kg)	1.4	2.7	1.4	2.7	1.4	1.4	1.4	1.4	1.4	1.4	2.7
shipping (lb)	5	8	5	8	4	5	4	5	4	5	8
(kg)	2.2	3.6	2.2	3.6	1.8	2.3	1.8	2.3	1.8	2.3	3.6
Dimensions											
Length (in)	11 $\frac{1}{8}$	11 $\frac{3}{8}$	11 $\frac{1}{8}$	11 $\frac{3}{8}$	8 $\frac{3}{4}$	12 $\frac{1}{4}$	8 $\frac{3}{4}$	12 $\frac{1}{4}$	3 $\frac{1}{4}$	10 $\frac{1}{2}$	11 $\frac{3}{8}$
(mm)	283	289	283	289	213	311	213	311	171	267	289
Width (in)	3 $\frac{1}{4}$	4 $\frac{1}{8}$	3 $\frac{1}{4}$	4 $\frac{1}{8}$	3 $\frac{1}{4}$	3 $\frac{1}{4}$	3 $\frac{1}{4}$	3 $\frac{1}{4}$	3 $\frac{1}{4}$	3 $\frac{1}{4}$	4 $\frac{1}{8}$
(mm)	83	124	83	124	83	83	83	83	83	83	124
Height (in)	2 $\frac{1}{4}$	2 $\frac{1}{4}$	2 $\frac{1}{4}$	2 $\frac{1}{4}$	2 $\frac{1}{4}$	2 $\frac{1}{4}$	2 $\frac{1}{4}$	2 $\frac{1}{4}$	2 $\frac{1}{4}$	2 $\frac{1}{4}$	2 $\frac{1}{4}$
(mm)	57	57	57	57	57	57	57	57	57	57	57
Price	\$350	\$575	\$350	\$575	\$375	\$600	\$400	\$625	\$400	\$625	\$575

Maximum ratings: maximum input power, peak or CW: 1W; bias limits: +20 V, -10 V. Bias polarity: negative voltage increases attenuation.
RFI: radiated leakage limits are below those specified in MIL-I-6181D at input levels less than 1 mW; at all input levels radiated interference is sufficiently low to obtain rated attenuation.
¹With +5 V bias.

²4 dB, 4 to 4.5 GHz.

³Driven by HP 8403A Modulator.

⁴2.0 SWR, 4 to 4.5 GHz.

⁵Fits 1 x 1/2 in. (WR90) waveguide.

⁶External high-pass filters required.

⁷Excluding high-pass filters.

SWEEPERS

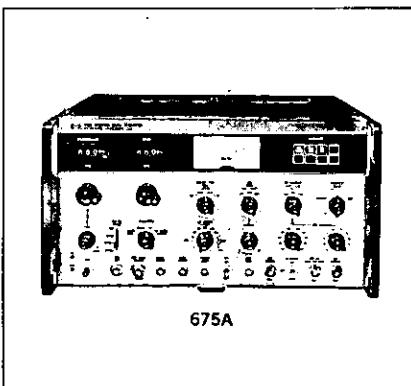


SWEEPERS

The sweeper is a multipurpose test instrument used in the design, manufacture and maintenance of devices, components and systems. Fast and convenient amplitude and phase response characterization of an unknown is possible when a sweeper and detector are used with a CRT display or graphic plotter. Dynamic displays permit on-line adjustment and rapid testing of devices. Depending on the desired display or application, a crystal detector, tracking detector or network analyzer should be used to detect the swept-frequency information.

Hewlett-Packard sweepers cover the entire RF frequency spectrum from 10 kHz to 40 GHz in three broad instrument lines. These instruments feature solid state components to 4 GHz, plug-in versatility for choice of band, sweeper systems for broad band coverage and complete systems compatibility with other Hewlett-Packard instrumentation systems.

Hewlett-Packard solid state sweepers and backward wave oscillator microwave sweepers have superior frequency stability, high power output, external or internal modulation, analog programming capability and systems compatibility. A logical front panel organization for ease and convenience of operation features pushbutton selection of sweep function, modulation and marker selection. Dial resolution is excellent due to the use of digital sweep settings or large 14-inch dial scales. The Hewlett-Packard sweeper family is the nucleus of signal sources for network analyzer systems, transistor S-parameter test systems and high power sweep systems.

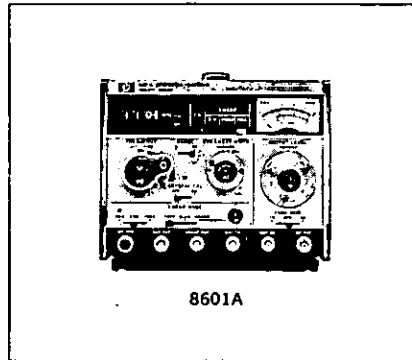


675A
10 kHz to 32 MHz

The HP 675A is a 10 kHz to 32 MHz sweeper with superior frequency stability and extremely level power output. Residual FM of less than 70 Hz peak permits high accuracy measurements of devices with sharp cut-off characteristics. Output amplitude over the 200 kHz—32 MHz range is held constant within ± 0.15 dB (up to 1 V) by an internal automatic leveling control.

The 675A Sweeping Signal Generator is designed to operate with the 676A, tracking detector, and as such serves as a Network Analyzer system. Other features include digital sweep setting, dial accuracy of 0.5%, pushbutton selection of marker function and calibrated power output meter. See page 317 for specifications.

The HP 8601A is a compact, light weight, all solid state sweeper covering the 100 kHz to 110 MHz range in two ranges. Excellent frequency and sweep accuracy are made possible by a frequency control loop, linear tuning dial, and digital readout. Frequency accuracy is nominally 1%, sweep width accuracy is 2% and sweep linearity is 0.5%. With the HP 5321B counter frequency accuracies of 0.001% are achieved.

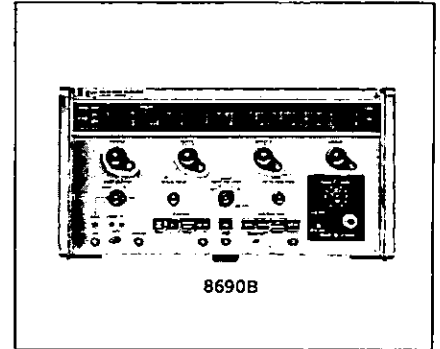


8601A
100 kHz to 110 MHz

The power output range is -110 dBm to $+20$ dBm with low harmonics, spurious and residual FM. The output of the 8601A is monitored with a calibrated output meter (dBm or rms volts) and the output is level within ± 0.25 dB over the full frequency range.

With the frequency accuracy and sweep linearity of the 8601A elaborate marker systems are no longer needed for accurate frequency identification. Calibrated detector-displays such as the HP 8407A Network Analyzer or HP oscilloscopes are compatible without modification to the 8601A. Sweeper systems based on the 8601A offer the user unprecedented accuracy and versatility in a compact solid state unit. See pages 318-319 for specifications.

The HP 8690B Sweep Oscillator with its associated RF Plug-in units offer all the advantages of single-unit sweep oscillators plus economical multiband capability. RF Units combine to provide complete 400 kHz to 40 GHz coverage with a choice of features including PIN diode modulation, grid-modulated BWO units and optional internal leveling. The full-width (14") maximum-resolution dial scale and a carefully designed layout of the front panel controls allow simple, uncomplicated operation. Ease of operation is enhanced by pushbutton function selection and lighted function indicators adjacent to the scale.



8690B
400 kHz to 40 GHz

Frequency accuracy of the 8690B and plug-in RF units is 1% or better from 400 kHz to 40 GHz. Grid modulation and leveling offers high power while PIN modulation and leveling offers excellent source match and extremely low frequency pulling or level variation with load variation. HP 8690B's are compatible without modifications to all Hewlett-Packard sweeper systems.

Coverage from 400 kHz to 4 GHz is available with only two solid state plug-ins. The 8698B covers 400 kHz to 110 MHz in two ranges. Exceptional frequency accuracy and linearity are achieved through use of a frequency controlled feedback loop employing a pulse count discriminator as the frequency sensing element. The 8699B covers more than 5 octaves from 100 MHz to 4 GHz in two ranges. The inherent linearity of a YIG-tuned oscillator produces a very linear swept output. A flat, high gain microcircuit amplifier permits high power output with low spurious and harmonic content. With the Model 8706A/8707A RF Unit Control System programmable selection of multiple RF units is possible by pushbutton or remote contact closure. See pages 320-328 for specifications.



SWEPT MEASUREMENT

Swept frequency measurement is a method of characterizing magnitude and phase parameters as a function of frequency for an unknown device, component or system. A complete swept frequency measurement system has three basic elements: 1) a sweeper which is the signal source, 2) the unknown to be characterized and 3) the detector and display with which to interpret measurement results. Swept frequency measurements evolved as a fast, convenient and accurate method of phase and magnitude characterization replacing the laborious point by point measurement techniques.

The sweeper or signal source in a swept frequency system is a controlled oscillator which is made to vary in frequency between two limits in a pre-prescribed manner, usually linear frequency change with time. The output power of the sweeper should be constant over the range of frequencies swept. Leveled power enables detection and displays to be presented accurately and directly without need for correction due to generator level change during sweep.

The output from the unknown must be detected and displayed in a manner which facilitates easy and accurate identification of sweep frequencies as well as magnitude and phase information. Several types of displays can be used: 1) oscilloscope, 2) X-Y recorder, 3) tracking detector or 4) network analyzer. Accurate frequency identification depends on the sweeper's frequency accuracy, sweep width accuracy, sweep linearity and frequency stability with changes in temperature, load and line. Frequency accuracy is of prime importance in making narrow band measurements accurately and quickly using swept frequency techniques.

Several types of detectors-displays are available depending on application requirements. For fast, inexpensive magnitude-only measurement, a crystal detector and scope, or crystal detector and SWR meter (415E) with scope or X-Y recorder can be used. A bolometer or thermistor detector can also be used with an X-Y recorder for amplitude only measurement. When a wider dynamic range, more accuracy and phase information are needed, the more sophisticated tracking detector or network analyzer is used with CRT displays. Hewlett-Packard CRT displays are available in two configurations; polar or magnitude-phase.

SWEPPER FUNCTIONS, CONTROLS AND OUTPUTS

SWEEP RANGE SELECTION

The sweep frequency limits of the instrument may be set by selecting one of several different sweep modes. Start-stop, Marker, Video, or Full sweep modes begin sweeping at one frequency (independently adjustable except on 8601A) and stop sweeping at a second independently adjustable frequency. With symmetrical or ΔF sweep, the center of the sweep range is first independently selected and then the sweep width is chosen. Manual sweep allows the sweeper to function with operator front panel control, a real convenience for calibration of display devices such as X-Y recorders. External FM can be used for remote, analog programming of frequency.

POWER OUTPUT AND LEVELING

Power out is adjustable at the front panel. On the low frequency sweepers (675A and 8601A) power output is monitored with the output meter. To obtain constant power output and a good source match at microwave frequencies, an automatic leveling loop is employed. The basic external leveling configuration is shown in Figure 1 (internal leveling available as an option on most 8690B series RF plug-ins).

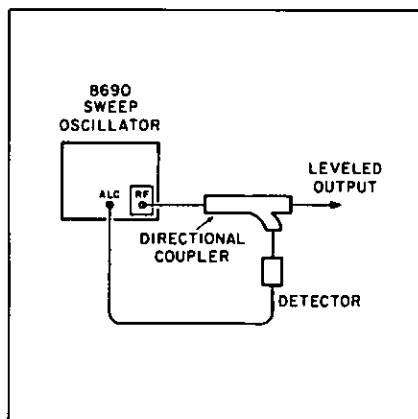


Figure 1. Basic closed-loop leveling system.

For coaxial systems using HP 780 Series Directional Detectors, system flatness of better than ± 0.3 dB over octave bandwidths are typical. When HP 752 Series Waveguide Directional Couplers and 424A Series Waveguide Crystal Detectors are used, excellent source match (nominally 1.02 SWR) and leveled power output (± 0.2 dB) can be achieved.

MODULATION

Modulation capabilities further extend the sweepers usefulness both as a sweeper and as a signal generator for signal simulations. AM modulation is available both internally or externally on all Hewlett-Packard sweepers. AM modulation is useful for testing communication equipment and making microwave measurements (1 kHz modulation is required to drive the 415E SWR Meter). FM modulation allows remote analog programming of frequency (for example, for production testing) or FM signal simulation (for example, in communications).

SWEEP CONTROL

Variable sweep rates are available from 0.01 to 100 seconds to match characteristic detector-display responses. Sweep may be initiated with automatic trigger, external trigger or manual trigger. Frequency changes linearly with sweep time until reaching the end sweep frequency. Blanking and pen lift signals are available at rear output connectors during flyback time when the RF is off.

MARKERS

Hewlett-Packard sweepers are sufficiently accurate to be used without markers but frequency identification can be further improved with the use of markers or a counter with the sweeper in manual control. Refer to Table -1- page 315 for a summary of marker systems offered for use with Hewlett-Packard sweepers.

AVAILABLE OUTPUTS

The flexibility of a swept frequency instrument system depends on the sweeper being compatible and easily connected to other instruments or systems. Hewlett-Packard sweepers have all necessary outputs available for interconnection with Hewlett-Packard instrumentation systems.

The basic sweeper outputs are R.F. output, sweep output, blanking and pen lift. For connection with network analyzer systems, sweep reference outputs and voltage tuned oscillator outputs are also available. The 8601A auxiliary output is divided by a factor of 10 to allow direct connection of an inexpensive low frequency counter. Other connections are available and add to the versatility and convenience of using Hewlett-Packard sweepers with Hewlett-Packard sweep systems.

SWEOPER APPLICATIONS, ACCESSORIES AND SYSTEMS

BASIC APPLICATIONS THEORY

Swept frequency systems are used to characterize an unknown's phase and magnitude characteristics as a function of frequency. Two basic types of measurements are made: transmission characteristics and reflection characteristics. For many transmission type measurements, it is only necessary to know amplitude response and establish that the phase response is linear thereby causing no phase distortion. Reflection measurements are used to optimize device impedance for matching in order to obtain maximum power transfer. Swept frequency techniques can give complete systems characterization with S-parameter techniques for transistors, devices, components or systems (see Application Note 95, "S-Parameters . . . Circuit Analysis and Design"). Sweep techniques also find extensive use in applications where convenience, speed and clarity of display are the prime considerations.

Numerous swept measurement applications and techniques are more fully explained in Hewlett-Packard Application Note 65, "Swept Frequency Techniques."

SWEOPER APPLICATIONS TO 110 MHz

Swept frequency techniques below 110 MHz are desirable for measuring the frequency response of lumped circuits such as filters, broadband amplifiers, antennas, and a wide range of other components and devices.

Such applications require that a swept source cover several decades of frequency with good power output. Frequency accuracy, sweep linearity, low residual FM, harmonics and spurious responses, and a stable, low noise output are necessary for good results.

Hewlett-Packard offers two such sources in this frequency range which meet these requirements and further add some features such as internal AM/FM and calibrated output, not commonly found in sweepers in this frequency range.

The 675A Sweeping Signal Generator covers a range of 10 kHz to 32 MHz in a single band, featuring start-stop and ΔF sweep using a digital frequency settings. All sweeps are accurately calibrated. When used with the 676A Tracking Detector and any Hewlett-Packard oscilloscope, swept displays of magnitude (up to 80 dB dynamic range) and phase are obtained. (See pages 372-373.)

The 8601A Generator/Sweeper covers a frequency range of 100 kHz to 110 MHz in two bands. It features three sweep modes, including calibrated symmetrical sweeps, digital frequency setting, and a small, lightweight (21 lbs.)

package. When used with the new 8407A Network Analyzer and appropriate display, swept plots of amplitude (up to 100 dB range, 0.05 dB resolution) and phase or return loss and complex impedance are possible.

SWEOPER APPLICATIONS TO 40 GHz

Leveled Power Microwave Systems

Leveling has two advantages: 1) leveled power output allows simplified detection and display and 2) the source match at the leveled output is markedly improved. Three methods of leveling can be used with sweepers. A directional coupler with a detector (crystal or power meter) is the simplest system (figure 1-). In coaxial systems a directional detector which contains two back to back direction couplers (compensates for coupling variation with frequency) and a detector provides super leveling. In waveguide systems super leveling is obtained by connecting two directional couplers and a detector as shown in Figure 2.

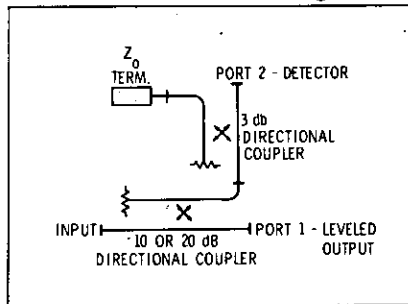


Figure 2. Super leveling with back-to-back waveguide coupler arrangement for extremely flat output.

High Power Systems

Typical backward-wave oscillators supply leveled power outputs in the milliwatt region. Applications such as RFI-susceptibility tests and high attenuation measurements often require 750 mW outputs. The 8690A/B option E15 system which consists of a TWT Amplifier (489A, 491C, 493A, 495A), and other associated passive devices will provide better than 750 mW from 1 to 12.4 GHz. See page 328 for specifications of 8690A/B option E15 systems.

Stabilized Sweep Oscillator System

Applications such as microwave spectroscopy and high-Q swept frequency cavity measurements have brought about the need for phase-locked fixed or swept frequency operation of the 8690B Series Sweep Oscillators. By phase-locking the 8690, excellent stability of microwave signals can be achieved.

Systems are available for swept and CW operation or CW operation only in

coaxial (1 to 12.4 GHz) and waveguide bands (12.4-40 GHz). In these systems the 8690B Sweep Oscillator with appropriate RF unit is phase-locked by the 8709A Synchronizer to a 240-400 MHz reference oscillator (8464A or 8466A). The reference oscillator stability is thereby transferred to the sweep oscillator. The reference oscillator is continuously tunable so the sweep oscillators can be stabilized at any frequency in their respective ranges quickly and easily. See page 327 for specifications of these systems.

Multi-Band Capability

A simple and inexpensive means for achieving broadband sweep capability (more than one octave) is offered by the HP 8707A RF Unit Holder and 8706A Control Unit. The 8706A Control Unit is placed in the sweeper and the RF plug-ins placed in the 8707A RF Unit Holder. Control of up to seven RF plug-ins is possible. See page 327 for specifications.

Microwave Network Analysis

Complete amplitude and phase description of microwave devices is a powerful tool for component and systems design and test. The 8690B Sweeper and 8410A Network Analyzer provide metered or CRT type (polar or magnitude and phase) real time display of this information. Over the 0.1 to 12.4 GHz range, the 8690B/8410A system offers a 60 dB dynamic range with 360° phase display. The 8690B has been designed to be the swept frequency source for the 8410A Network Analysis System and together both provide the most advanced, integrated network analysis instrumentation available. See page 328 for more information on microwave network analysis.

Swept Microwave Transistor Measurement to 2 GHz

Using network analysis techniques and Hewlett-Packard microwave instrumentation, active microwave devices can be accurately characterized and tested. The 8690B and 8699B RF plug-in provide the swept signal source for the Hewlett-Packard pushbutton, S-parameter transistor measurement equipment. The 8690B sweeper system is connected with an 8410A Network Analyzer System, S717A Transistor Bias Supply, 8745A S-Parameter Test Set and 11600A or 11602A transistor fixture. Pushbutton control and CRT display of all four transistor S-parameter characteristics are possible over a 0.1 to 2 GHz range with this system. See page 328 for more information on swept microwave transistor measurement to 2 GHz.

AUDIO FREQUENCY SWEEPERS 3300A Series

Sweep plug-ins which insert directly into the front panel of the HP 3300A Function Generator (see pages 274 and 275) include the HP 3304A Sweep/Offset Plug-in and the HP 3305A Sweep Plug-in.

The 3304A Sweeps up to 1 decade of frequency in 7 ranges from 0.01 Hz to

100 kHz. Sweep time is adjustable from 10 μ s to 100 s. DC Offset voltage is adjustable from 0 to ± 16 volts open circuit with a ± 1 volt vernier control.

The 3305A, a logarithmic sweep plug-in, sweeps up to 4 decades in a single sweep from 0.1 Hz to 100 kHz in three overlapping ranges (0.1 Hz - 1 kHz, 1 Hz - 10 kHz, 10 Hz - 100 kHz). Sweep time varies from 0.01 s to 100 s in 4

decade steps with an adjustable vernier. The start and stop frequencies can be independently adjusted on any one range.

The 3305A has four modes of operation: 1) automatic repetitive sweeps, 2) single sweep per trigger (local or remote), 3) manual sweep, and 4) remotely programmed or swept up to 4 decades by setting the start control and applying an external voltage.

Hewlett-Packard sweepers

HP model	Frequency Range	Max power output	Flatness	Residual FM	Sweep linearity	Sweep time	Sweep modes			Built-in markers	Page
							Auto	Single	Manual		
3304A	0.1 Hz-100 kHz	5 V rms into 600 Ω	$\pm 1\%$ to $\pm 3\%$		1% (linear)	0.01-100 sec	Yes	No	No	No	274 to 275
3305A					logarithmic			Yes	Yes		
675A	10 kHz-32 MHz	1 V rms into 50 Ω	± 0.15 dB to ± 1 dB	70 Hz peak	$\pm 0.5\%$ of sweepwidth	0.01-100 sec	Yes	Yes	Yes	Opt	317
8601A	100 kHz-11 MHz 1 MHz-110 MHz	2.24 V into 50 Ω	± 0.25 dB over full range	<50 Hz peak <500 Hz peak	$\pm 0.5\%$	Fast: 6 to 60 sweep/sec var slow: 8 to 80 sec/sweep var	Yes	Yes	Yes	Yes (at 5 MHz intervals)	318 to 319
8690B	400 kHz-40 GHz		See plug-in table below			0.01-100 sec	Yes	Yes	Yes	Yes 2 var markers	318 to 312

Solid state oscillators 8690B RF plug-ins

Frequency	Model	Leveling control	Max leveled power	Power variation external leveling	Residual FM	Sweep linearity as % of sweepwidth	Page
0.4-11 MHz	8698B	ALC Loop internal leveling	≥ 20 mW	± 0.25 dB	<150 Hz- <500 Hz peak	$\pm 0.5\%$	326
1-110 MHz							
100 MHz-2 GHz	8699B	PIN Diode	$\geq +13$ dBm	± 0.1 dB*	<3 kHz rms in 10 kHz bandwidth	$\pm 0.5\%$	324-325
2 GHz-4 GHz			$\geq +8$ dBm	± 0.1 dB*			
2 GHz-4 GHz	8692C**	PIN Diode	$\geq +8$ dBm	± 0.1 dB*	<3 kHz rms in 10 kHz bandwidth	$\pm 0.5\%$	323

Backward wave oscillators 8690B RF plug-ins

Grid Modulation

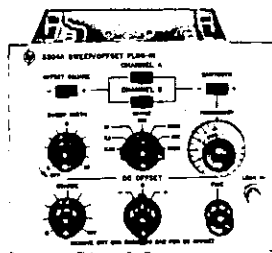
Pin modulation

Frequency	Model	Max leveled power	Power variation external leveling*	Page	Model	Max leveled power	Power variation external leveling	Page
1-2 GHz	8691A	≥ 100 mW	± 0.2 dB	323	8691B	≥ 70 mW	± 0.1 dB	323
1.4-2.5 GHz	8691A-option 200**	≥ 100 mW	± 0.2 dB	323	8691B-option 200**	≥ 70 mW	± 0.1 dB	323
1.7-4.2 GHz	-	-	-	-	8691B-option 100	≥ 15 mW	± 0.1 dB	323
2-4 GHz	8692A	≥ 70 mW	± 0.2 dB	323	8692B	≥ 40 mW	± 0.1 dB	323
3.5-6.75 GHz	8693A-option 200**	≥ 40 mW	± 0.2 dB	323	-	-	-	-
3.7-8.3 GHz	-	-	-	-	8693B-option 100	≥ 5 mW	± 0.1 dB	323
4-8 GHz	8693A	≥ 30 mW	± 0.2 dB	323	8693B	≥ 15 mW	± 0.1 dB	323
7-11 GHz	8694A-option 200	≥ 25 mW	± 0.2 dB	323	8694B-option 200	≥ 15 mW	± 0.1 dB	323
7-12 GHz	8694A-option 100	≥ 25 mW	± 0.2 dB	323	8694B-option 100	≥ 15 mW	± 0.1 dB	323
8-12.4 GHz	8694A	≥ 50 mW	± 0.2 dB	323	8694B	≥ 30 mW	± 0.1 dB	323
10-15.5 GHz	8695A-option 100**	≥ 25 mW	± 0.2 dB	323	8695B-option 100**	≥ 10 mW	± 0.1 dB	323
12.4-18 GHz	8695A	≥ 40 mW	± 0.2 dB	323	8695B**	≥ 10 mW	± 0.1 dB	323
18.0-26.5 GHz	8696A	≥ 10 mW	± 0.2 dB	323	-	-	-	-
26.5-40 GHz	8697A	≥ 5 mW	± 0.2 dB	323	-	-	-	-

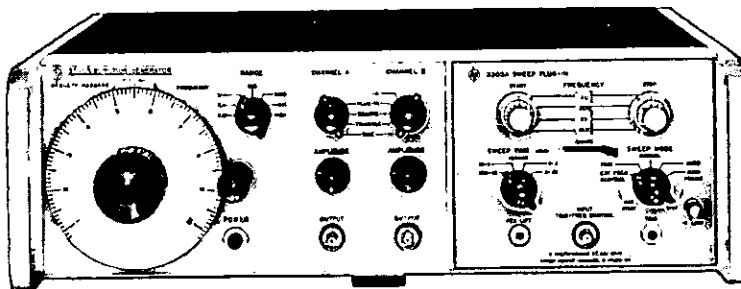
*Excluding coupler & detector variation.

**Tentative specifications.

SWEEPERS


SWEEP PLUG-IN FOR 3300A
 Logarithmic 4-decade or linear 1-decade
 Models 3305A, 3304A


3304A



3305A shown in 3300A

HP 3304A One-Decade Linear Sweep Plug-In

The 3304A plug-in for the 3300A Function Generator provides narrow sweeping or over a decade of sweeping on any one range. A sawtooth output is available for external single direction sweep while internally sweeping the main frame. For more details and specifications, refer to pages 274 and 275.

HP 3305A Four Decade Log Sweep Plug-In

The 3305A Sweep Plug-in combined with the 3300A Function Generator is an automatic, manually, or externally triggered 4-decade sweeper and an external, 4-decade frequency-controlled signal source.

Four Decade Logarithmic Sweep

The 3300A/3305A will sweep logarithmically between any two frequencies in one of the three (4-decade) ranges—0.1 Hz to 1 kHz, 1 Hz to 10 kHz, and 10 Hz to 100 kHz. Calibrated independent start-stop controls greatly simplify setting desired sweep end points. Adjustable sweep time from 0.01 to 100 seconds provides sweep times slow enough for accurate response testing of low-frequency high-Q systems and fast enough for good visual displays of higher frequency responses. A frequency range greater than the audio band can be swept without any range switching or display equipment readjustment.

The manual sweep vernier adjustment of frequency between the start-stop limits allows close observation of a small portion of a response curve. This manual control also permits measurement of a critical frequency with counter accuracy and simple set-ups for oscilloscopes or X-Y recorders.

Programming

For automated testing the 3300A/3305A frequency can be analog programmed over any one of the four decade ranges. Also, a single sweep can be externally triggered.

Sweep Output

X-axis readjustment is eliminated since the sweep output amplitude is independent of start-stop, sweep time and sweep width settings.

Specifications, 3305A*

Frequency range: 0.1 Hz to 100 kHz in 3 overlapping ranges.

Sweep width: limits adjustable 0 to 4 decades in any of three 4-decade bands—0.1 Hz to 1 kHz, 1 Hz to 10 kHz, 10 Hz to 100 kHz.

Start-stop dial accuracy: $\pm 10\%$ of setting.

Sweep modes

Automatic: repetitive logarithmic sweep between start and stop frequency settings.

Manual: vernier adjustment of frequency between start and stop frequency settings.

Trigger: sweep between start and stop frequency settings and retrace with application of external trigger voltage or by depressing front-panel trigger button.

Trigger requirements: ac coupled, positive-going, at least 1 V p with > 2 V per ms rise rate.

Maximum input: ± 90 V p.

Sweep time: 0.01 s to 100 s in 4 decade steps; continuously adjustable vernier.

Retrace time: < 0.003 s for 0.1 to 0.01 s sweep times, < 0.03 s for 1 to 0.1 s sweep times, < 4 s for 100 to 1 s sweep times.

Blanking: oscillator disabled during retrace.

Pen lift: terminals shorted during sweep, open during retrace in auto and trigger modes for 100 to 1 s sweep times.

Sweep output: linear ramp at Channel B output (plug-in); amplitude adjustable independently of sweep width; max. output > 15 V p-p into open circuit, > 7 V p-p into 600 Ω .

External frequency control

Sensitivity: 6 V/decade (referenced to start setting), ± 24 V max.

V-to-F conversion accuracy: for each 6 V change in programming voltage, frequency changes 1 decade $\pm 5\%$ of final frequency.

Input impedance: 400 k Ω $\pm 5\%$.

Maximum rate: 100 Hz.

General

Dimensions: 6 $\frac{1}{16}$ " wide, 4 $\frac{3}{4}$ " high, 10 $\frac{1}{4}$ " deep (154 x 121 x 260 mm).

Weight: net 4 lbs 6 oz (2 kg); shipping 6 lbs 6 oz (2.9 kg).

Price: HP 3305A, \$975; HP 3304A, \$285.

*Refer to pages 274 and 275 for information on the 3300A and other plug-ins.

SWEEP SIGNAL GENERATOR

Analog programmable: frequency 10 kHz-32 MHz
Model 675A



SWEEPERS



675A

Description

The 675A Sweeper has such accuracy and linearity over the 10 kHz to 32 MHz range that it can be used as a sweeper for an overall "look" as well as a CW generator for detailed analysis. Sweep end points and CW frequencies can be set with an accuracy of 0.5% of full scale. The 675A's sweep linearity is better than 0.5% of sweep width, permitting the graticule of a monitoring oscilloscope to be used as a frequency scale for easy location of response points and center frequencies. Counter accuracy can be obtained using the auxiliary output on the rear panel. Manual sweep permits measurement of frequency at important points, such as peaks or 3 dB and 6 dB points.

Frequency stability of the 675A is exceptional. Residual FM is less than 70 Hz peak, important for narrow-band sweeping measurements on devices with sharp cut-off characteristics, such as high-Q filters. This stability, especially important in repetitive production tests, was achieved by housing the RF oscillator in an oven.

Output amplitude over the 200 kHz - 32 MHz range is held constant within ± 0.15 dB (at 1 V) by a sensitive automatic leveling control loop. Output leveling is accomplished either with an internal detector or, if long cables are used between generator and tested device, by an external detector. Because of good leveling and the precision of the frequency sweeps, responses of tested devices can be determined precisely without resorting to point-by-point measurements. Output waveform distortion is low; harmonics are >30 dB below the fundamental, and other frequencies are >50 dB below.

Specifications, 675A

Frequency range: 10 kHz to 32 MHz in one range.

RF output

Level: +13 dBm (1 V rms) to -92 dBm (1.7 μ V rms) into 50 Ω in 10 dB steps with vernier.

Impedance: 50 Ω (75 Ω on request).

Output monitor accuracy: 200 kHz to 32 MHz, ± 0.3 dB.

Attenuator accuracy

+10 dB to -12 dB: ± 0.3 dB.

-13 dB to -89 dB: ± 0.4 dB + 6 μ V.

Flatness (1 V level)

RF output only

	10 kHz	50 kHz	200 kHz	1 MHz	10 MHz	32 MHz
Unleveled:	± 1 dB					
Internally leveled:	± 1 dB		± 0.15 dB			
Externally leveled:	± 0.15 dB					

RF output/internal detector system (1 V level)

	10 kHz	50 kHz	200 kHz	1 MHz	10 MHz	32 MHz
Using internal RF detector, internal leveling:	± 1 dB		± 0.4 dB		± 0.25 dB	
Using external RF detector, external leveling \uparrow	± 0.25 dB					

\uparrow HP 11097A RF Detector \uparrow HP 11098A Leveling Detector

Harmonic distortion: >30 dB below fundamental.

Non-harmonic distortion: >50 dB below fundamental.

AC line-related FM: <70 Hz peak.

Non line-related FM: <60 Hz peak.

Counter output: >300 mV rms.

Vertical (internal detector) output: at least 1.2 V dc for 1 V rms RF input.

Frequency markers: horizontal or vertical oriented birdy bypass markers.

External marker input

Frequency range: 10 kHz to 32 MHz.

Level: 50 mV to 500 mV rms.

Impedance: 50 Ω .

Internal crystal (optional)

Comb markers: 100 kHz and 1 MHz frequency combs.

Fixed-frequency markers: up to 5 fixed frequencies from 100 kHz to 32 MHz (frequency must be specified).

Accuracy: $\pm 0.005\%$ of frequency.

Start-stop frequency accuracy: $\pm 1\%$ of full scale, 20°C to 30°C; $\pm 2\%$ of full scale, 0°C to 50°C.

F/ Δ F (center frequency sweep) accuracy: $\pm 0.5\%$ of full scale.

Sweep width: continuously adjustable from 200 Hz to 10 MHz in 1-2-5 sequence with vernier, 32 MHz max upper frequency.

Sweep width accuracy: $\pm 5\%$ of sweep width ± 100 Hz.

Sweep linearity: $\pm 0.5\%$ of sweep width ± 100 Hz.

Sweep time: 0.01 s/sweep to 100 s/sweep in 4 decade steps with vernier.

Retrace time: 0.01 s fixed for 0.01 s to 1 s sweeps; 1 s fixed for 1 s to 100 s sweeps.

Horizontal (sweep) output: 0 to 5 V dc independent of sweep width.

CW frequency accuracy: $\pm 0.05\%$ of full scale, 20°C to 40°C; $\pm 1\%$ of full scale, 0°C to 50°C.

Amplitude modulation

Internal: 0 to 50%, 1 kHz ± 15 Hz sine wave.

External input

RF leveled: 0 to 50%, dc to 1 kHz.

RF unleveled: 0 to 50%, 50 Hz to 600 kHz.

Sensitivity: at least 50% for 2.5 V rms input.

External FM and frequency control

Sensitivity: 1 MHz/V.

Impedance: 1 M Ω .

Rate: dc to 4 kHz.

Operating temperature: 0°C to 50°C.

Power: 115 V or 230 V $\pm 10\%$, 50 Hz to 400 Hz, 80 W max.

Dimensions: 16 $\frac{3}{4}$ " wide, 8 $\frac{3}{4}$ " high, 18 $\frac{3}{8}$ " deep (425 x 221 x 476 mm).

Weight: net 40 lb (18.1 kg); shipping 57 lb (25.7 kg).

Accessories furnished: HP 11048B 50 Ω feed-thru termination.

Accessories available

HP 11300A single frequency marker above 100 kHz (specify frequency), \$75. For factory installation of one to five markers, add \$25.

HP 11097A RF Detector, \$30.

HP 11098A Leveling Detector, \$30.

HP 675A, \$2300.

HP 675A Option 001 (includes 1 MHz harmonic comb marker), add \$75.

HP 675A Option 002 (includes 100 kHz harmonic comb marker), add \$75.

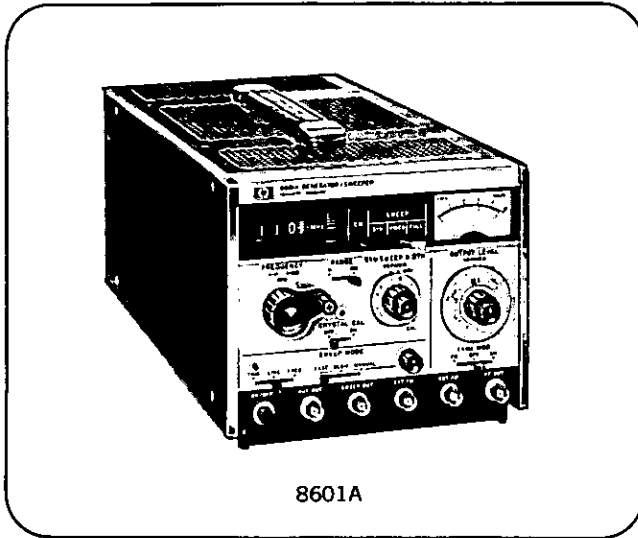
HP 675A Option 003 (includes 1 MHz and 100 kHz harmonic comb markers), add \$125.

SWEEPERS



GENERATOR/SWEEPER

Small, versatile broadband source
Model 8601A



Two instruments in one

Covering 100 kHz to 110 MHz, the 8601A Generator/Sweeper combines the high linearity and flatness of a precision sweeper with a signal generator's frequency accuracy and wide range of calibrated power levels. Though it's small and lightweight, it does the work of two instruments easily and conveniently.

As a signal generator (see page 288), the 8601A output is accurate to ± 1 dB from +13 dBm to -110 dBm. Harmonics and spurious signals are very low. The digital frequency dial is accurate to $\pm 1\%$ of frequency; higher accuracy is achieved with 0.01% crystal checkpoints at 5 MHz intervals. Internal modulation is 1 kHz, AM or FM, or you can modulate externally.

As a sweeper, the 8601A offers a new approach to swept measurements. Elaborate marker systems are no longer needed for accurate frequency identification. The 8601A takes the messy trace and the ambiguity out of swept measurements by substituting linearity and frequency accuracy for markers.

Three convenient sweep modes

The FULL mode sweeps more than a two-decade band from either 0.1 to 11 MHz or 1 to 110 MHz with flatness of ± 0.25 dB, providing a fast look at the complete frequency response of the device under test.

In the VIDEO mode, the 8601A will sweep from the bottom of the band to the frequency selected on the digital readout. This feature is valuable for those who wish to look at the response of a low pass filter or video amplifier.

SYMMETRICAL mode provides five calibrated sweep widths for each band and a vernier for continuous sweep width adjustment. The center frequency is selected on the digital readout. When the sweep width is in a calibrated position, the horizontal gain of an oscilloscope or recorder may be adjusted so that the ends of the sweep coincide with calibrated markings. The sweep can then be defined in MHz/

cm, MHz/inch, etc. The center frequency may be set to counter accuracy by turning the sweep width vernier fully counterclockwise and monitoring the auxiliary output (always 100 kHz to 11 MHz regardless of band) with a low frequency counter. A simple low frequency counter, the HP 5321A Opt. H01, is especially designed to complement the 8601A.

Versatility

All sweep modes may be run in FAST sweep for oscilloscope work, SLOW for recording, or MANUAL. Triggering may be manual, line-synchronized, or free-running. This wide range of sweep modes, rates, and triggering makes the 8601A a truly versatile sweeper, suitable for nearly any 0.1 to 110 MHz sweeper application.

Low residual FM

Frequency-lock circuits lead to low residual FM enabling narrow band measurements previously impossible with conventional low-frequency sweepers.

Applications

The 8601A satisfies a wide range of laboratory and production applications. A partial list is given here.

Filters. Filter testing is easy with the 8601A. Low pass filters are examined rapidly using the VIDEO sweep. Bandpass filters and circuit Q can be measured down to 10-kHz bandwidths on the high range and 1 kHz on low range before residual FM interferes. Calibrated SYMMETRICAL sweep and power output provide fast and accurate identification of center frequency and 3 dB points.

Active circuits. Amplifier bandpass, IF strip response, phase shift, and other frequency-dependent device measurements are no problem for the 8601A due to its excellent flatness, broad range, and frequency accuracy.

Components. Components can be tested with confidence for attenuation, insertion loss, and frequency response. The 8601A is also suitable for use with VSWR bridges and hybrid detectors.

Receiver measurements. Usable sensitivity can be measured down to 1 microvolt due to the 8601A's low leakage. Front-end response of a receiver may be observed with SYMMETRICAL sweep. Discriminator and IF strip alignment is accomplished by using the 8601A as an IF source, or through the front end of a receiver.

The 8601A is an ideal companion for the new 8407A Low Frequency Network Analyzer. This new instrument measures gain/loss, phase, return loss (VSWR), complex impedance, and reflection coefficient on many different components and systems. The 100 dB dynamic range, 360° phase display, and high resolution along with sweep and tracking capabilities over its 0.1 to 110 MHz range all combine to produce a significant advance in the state-of-the-art of RF measurements.

GENERATOR/SWEEPER

Small, versatile broadband source
Model 8601A



SWEEPERS

8601A SPECIFICATIONS

Frequency Characteristics

Coverage: low range, 0.1-11 MHz; high range, 1-110 MHz.

Accuracy: (in CW, stop frequency of VIDEO sweep, and center frequency of SYMMETRICAL sweep.) $\pm 1\%$ of frequency ± 100 kHz, high range; $\pm 1\%$ of frequency ± 10 kHz, low range.

Settability: vernier settability, $\pm 0.01\%$; range, $\pm 0.1\%$; coarse settability using 10 turn pot is 5 kHz, low range; 50 kHz, high range.

Linearity: 0.5% of sweep width.

Stability in CW

0.005% + 500 Hz/5 min., high range. } after 2 hr.

0.005% + 50 Hz/5 min., low range. } warm-up.

0.1%/°C temperature change.

0.001%/V line voltage change.

Harmonics and spurious signals (CW above 250 kHz, output levels below +10 dBm): harmonics at least 35 dB below carrier. Spurious signals at least 40 dB below carrier.

Residual FM: noise in a 10 kHz bandwidth including line related components (dominant component of residual FM is noise).

CW: less than 50 Hz rms, low range; 500 Hz rms high range.

SYM O, sweep: less than 100 Hz rms, low range; 1 kHz rms, high range.

Incidental FM

CW: negligible.

SYM O, sweep: less than 100 Hz peak, low range; 1 kHz peak, high range.

Residual AM: AM noise modulation index (rms, 10 kHz bandwidth) is < -50 dB. (Typically -60 dB at 25°C.)

Incidental AM: incidental AM modulation index is < -55 dB with 75 kHz deviation.

Output Characteristics

Level: +20 to -110 dBm. 10-dB steps and 13-dB vernier provide continuous settings over entire range. Meter monitors output in dBm and rms volts into 50Ω .

Accuracy: ± 1 dB accuracy for any output level from +13 dBm to -110 dBm.

Flatness: ± 0.25 dB over full range, ± 0.1 dB over any 10 MHz portion (+10 dBm step or below).

Impedance: 50Ω , SWR < 1.2 on 0 dBm step and below.

RF leakage: low leakage permits receiver sensitivity measurements down to 1 microvolt.

Sweep Characteristics

Full: approximately 0.1-11 MHz and 1-110 MHz independent of dial setting.

Video: sweep extends from low end of range to frequency dial setting. Start frequency accuracy is $\pm 1\%$ of stop frequency, or ± 100 kHz, high range; ± 10 kHz, low range.

Symmetrical: center frequency may be tuned to any point on either range.

Sweep width: 0-1 MHz low range; 0-10 MHz high range.

There are 5 calibrated sweep width positions as well as an uncalibrated vernier to provide continuous adjustment.

Sweep width accuracy:

$\pm 2\%$ of sweep width or ± 10 kHz, high range.

$\pm 2\%$ of sweep width or ± 1 kHz, low range.

Sweep speeds: fast, typically 3 to 60 sweeps/sec. Slow, typically 3 to 60 seconds/sweep.

Trigger modes: manual trigger with reset, line synchronized, or free-running.

Amplitude Modulation

Internal AM: fixed 30% $\pm 5\%$ at 1 kHz, less than 3% distortion. Typically $< 1\%$ distortion for output readings on upper half of meter scale.

External AM: 0 to 50%, dc to 400 Hz. 0 to 30%, up to 1 kHz. Applied through external AM input on front panel. Sensitivity typically 2 V peak/10% modulation index at 400 Hz (10-50% AM).

Frequency Modulation

Internal FM: 1 kHz rate, fixed 75 kHz $\pm 5\%$ deviation, high range; 7.5 kHz $\pm 5\%$ deviation, low range; less than 3% distortion. Typically $< 1\%$.

External FM: sensitivity: 5 MHz per volt $\pm 5\%$, high range; 0.5 MHz per volt $\pm 5\%$, low range; negative polarity.

Deviations to the band edges are possible for rates to 100 Hz; voltage to frequency linearity is $\pm 0.5\%$, allowing remote frequency programming. FM rates to 10 kHz are obtainable with less linearity and accuracy.

Crystal Calibrator

Internal 5-MHz crystal allows frequency calibration to $\pm 0.01\%$ at any multiple of 5 MHz.

Auxiliary Outputs

Front panel: sweep output: approximately 0 to +7 volts. Auxiliary output: always 0.1-11 MHz for low frequency counter monitoring.

Rear panel: sweep output: approximately 0 to +7 volts. Uncalibrated RF output: -5 dBm minimum, unmodulated. VTO output: 200.1-310 MHz, output level -25 dBm minimum. Blanking: -4 volt pulse concurrent with RF blanking.

Power: 115 or 230 V, $\pm 10\%$, 50-400 Hz, $\pm 10\%$; approximately 50 watts.

Weight: net, 21 lb (9.5 kg); shipping, 27 lb (12.3 kg).

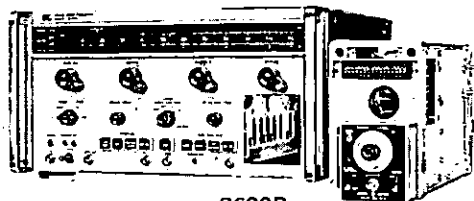
Dimensions: 7-25/32" wide, 6-3/32" high, 16 3/8" deep (190 x 155 x 416 mm).

Price: Model 8601A, \$2250.

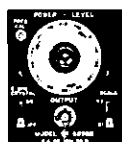


SWEEP OSCILLATOR

Superior performance, 400 kHz through 40 GHz
Series 8690



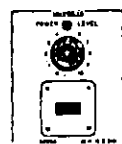
8690B



8698B



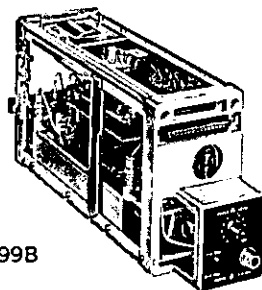
8693A



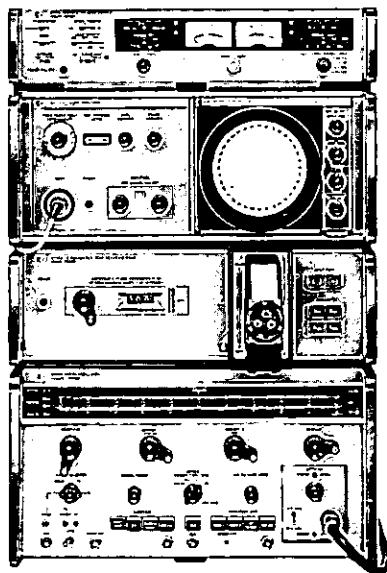
8695A



8706A



8699B



8690B/8699B/8410A/8717A/System

8690B

The 8690B is a mainframe which contains all the sweep and control circuits for 26 different RF plug-ins covering the 400 kHz to 40 GHz spectrum. Interchangeable RF units offer the multiband flexibility of being able to first choose a single band while later being able to expand into any or all bands or a specialized sweep system. With the plug-in flexibility of the 8690B, costs can be minimized by purchasing single band units without sacrificing future expansion needs.

Convenience, ease of application and high accuracy are the prime features of the 8690B. Sweep and modulation functions are selectable by front panel pushbuttons. For positive identification of sweep modes indicator lights opposite dial frequency settings are provided. All outputs are conveniently accessible: frequently used outputs are on the front panel while the rear panel contains all connections needed for systems. Sweep linearity (1%), large high resolution dial (14 inches), excellent frequency accuracy (1% or better), and good frequency stability for changes in line, load, or temperature enable the 8690B to provide convenience while maintaining the high standards of a Hewlett-Packard laboratory instrument.

Solid State to 4 GHz

The 8698B (400 kHz-110 MHz) and the 8699B (100 MHz to 4 GHz) RF plug-ins provide four decades of RF coverage with only two plug-ins. By use of heterodyne techniques, careful filtering and microcircuit technology broadband coverage is achieved without degradation of specifications.

The 8698B utilizes a pulse count discriminator in a frequency control loop to achieve exceptional sweep accuracy and linearity formally unattainable in sweepers in this frequency range. The 8699B, which makes extensive use of thin film microcircuits, provides coverage from 100 MHz to 4 GHz in two ranges with spurious signals more than 30 dB down. The 8692C is an all solid state fundamental oscillator covering the 2-4 GHz band with more than +8 dBm power output. Its design introduces fundamental solid state oscillators to the 8690B series sweepers. Hewlett-Packard solid state 8690B RF plug-ins enable replacement of limited life BWO units up to 4 GHz, while maintaining compatibility with RF plug-ins utilizing BWO oscillators necessary to go to 40 GHz.

Systems Applications

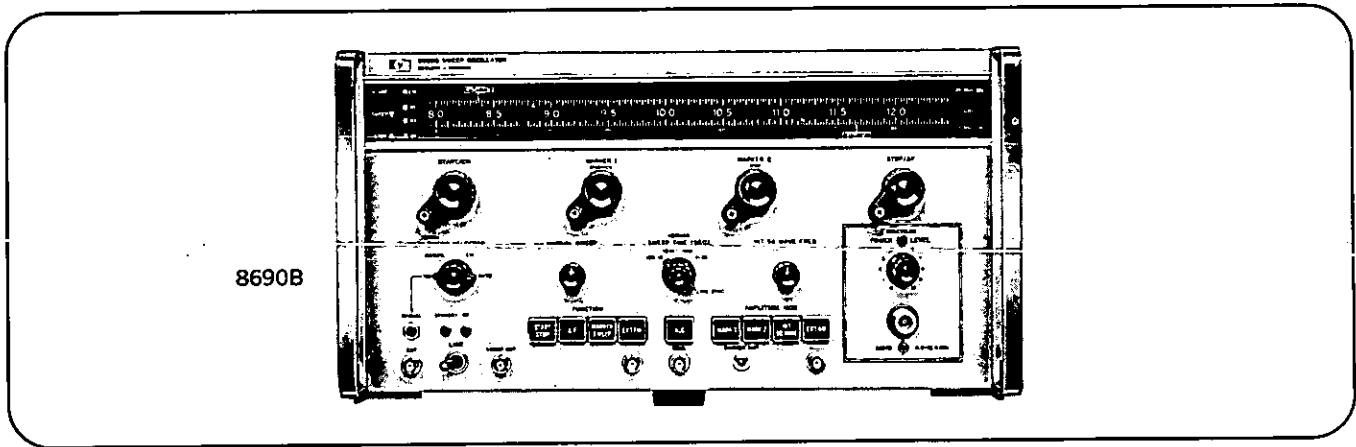
The 8690B with associated RF plug-ins serves as the source for many swept frequency systems used for design, production testing, or field maintenance. These systems include multiband, high power, and phase lock systems as well as network analysis systems for devices, components and operating systems. The 8690B is remotely programmable (analog or digital-option) and is easily integratable into any system without modification. See pages 327 and 328 for specifications.

SWEEP OSCILLATOR

Superior performance, 400 kHz through 40 GHz
Series 8690



SWEEPERS



8690 series sweep oscillators

The HP 8690B Sweep Oscillator and 8690 series RF Units offer you all the advantages of single-unit sweep oscillators plus economical multiband capability. All BWO tubes carry an unconditional 1-year warranty. Careful design of new all-solid-state power supplies results in exceptionally low residual FM and provides rugged protection against system transients. Snap-in scales are keyed for easy changing and accurate positioning.

Sweep oscillator features:

Sweep modes

Automatic, triggered, and manual sweeps are available, in addition to CW operation. Automatic and triggered sweep times are adjustable from 0.01 to 100 seconds, and the triggered sweeps can be synchronized from an external source or started manually from a front panel pushbutton.

To enhance the clarity of oscilloscope presentations, RF power is blanked during retrace to produce a zero base line; however RF is restored before the start of the next sweep to eliminate transients during the early part of the sweep. Oscilloscope photography at slow sweeps is simplified by a front panel sweep indicator that lights automatically during the sweep.

For X-Y recording, an automatic pen lift circuit is provided. During manual sweep, a front panel control varies the RF frequency between the limits set on the selected sweep function. With the use of manual sweep, X-Y recorder setup time is just a few seconds.

Sweep functions and monitors

Two independent frequency markers can be set up separately on the "start-stop" sweep whose end points can be set anywhere in the band. Independent controls set the start and stop frequencies on the scale. Thus, the set frequency range can be swept up or down, depending only on the setting of the start frequency with respect to the stop frequency.

Two independent frequency markers, set separately on the scale and direct-reading in GHz, can be positioned anywhere in the band. The markers amplitude-modulate the RF output, providing triangular markers sharp enough to give high resolution on narrow sweeps, yet broad enough to be

quite visible on the widest sweeps. Marker amplitude can be adjusted from the front panel.

The markers can be used as end points for a second broadband sweep which starts at the Marker 1 frequency and stops at the Marker 2 frequency. Valuable time can be saved by bracketing circuit discontinuities with the markers. By the pressing of the marker sweep button, expanded investigation of the frequency range of interest is immediately available.

The 8690 provides a continuously calibrated narrow band sweep, the ΔF sweep, which is symmetrical about a center frequency. Calibrated directly in MHz, the ΔF sweep width is continuously adjustable from 0 to 10% of the band. Frequency markers can be applied to the ΔF as well as the start-stop sweep.

Leveling

Leveling minimizes the variations in RF output amplitude with frequency. External leveling eliminates the frequency-dependent transmission characteristics of any components between the oscillator and sampling point and also virtually eliminates source mismatch. Thus, leveled power can be established at any point in a system even though it is remote from the source. The degree of leveling is determined primarily by the coupler and detector variation.

Internal leveling is available as an option on most 8690B RF plug-ins. Internally leveled RF units are useful in less critical applications in which transmission variations between oscillator and test point are not significant or when a package free of external elements is desired.

Modulation

All modulation functions are selected by pushbutton, and can be used simultaneously. Included is internal square-wave modulation 950 to 1050 Hz, plus external AM and FM. External FM permits frequency programming, including externally controlled sweeps over all or any part of the band.

Plug-in RF units

Several types of RF units are available permitting selection to meet any application requirement. Table 1 on the following page gives complete 8690B RF plug-in specifications.

SWEEPERS *continued*

Superior performance, 400 kHz through 40 GHz
Series 8690

Specifications, 8690B Sweep Oscillator
(with RF Unit installed)

Frequency range: determined by RF unit.

Sweep functions

Start-stop sweep: sweeps from "start" to "stop" frequency setting.

Range: both settings continuously and independently adjustable over the entire frequency range; can be set to sweep either up or down in frequency.

End-point accuracy: same as RF unit frequency accuracy.

Marker sweep: sweeps from "Marker 1" to "Marker 2" frequency setting.

Range: both settings continuously and independently adjustable over the entire frequency range; can be set to sweep either up or down in frequency.

End-point accuracy: same as RF unit frequency accuracy.

ΔF sweep: sweeps upward in frequency, centered on CW setting.

Width: continuously adjustable from zero to 10% of the frequency band; calibrated directly in MHz.

Width accuracy:* $\pm 10\%$ of ΔF being swept $\pm 1\%$ of maximum ΔF ($\pm 20\%$ $\pm 2\%$ respectively with 8691A/B RF Units).

Center-frequency accuracy: same as RF unit frequency accuracy.

Frequency markers: two frequency markers, independently adjustable over the entire frequency range, amplitude-modulate the RF output; amplitude is adjustable from the front panel; the markers are also available for external use.

Accuracy: 1% of full scale for all RF units.

Resolution: better than 0.05% of RF unit bandwidth.

Marker output: triangular pulse, typically -5 V peak into 1000-ohm load.

CW operation: single-frequency RF output selected by START/CW or MARKER 1 control, depending on sweep function selected.

Accuracy: same as RF unit frequency accuracy.

Preset frequencies: start-stop sweep end points and marker frequencies can be used as four preset CW frequencies.

Sweep mode

Auto: sweep recurs automatically.

Manual: front-panel control provides continuous manual adjustment of frequency between end frequencies set in any of the above sweep functions.

Triggered: sweep is actuated by front-panel pushbutton or by externally applied signal < -25 V peak, > 1 μ s pulse width, and > 0.1 V/ μ s rise.

Sweep time: continuously adjustable in four decade ranges, 0.01 to 100 seconds; can be synchronized with the power line frequency.

Sweep indicator: front-panel indicator lights during the

sweep, providing indication of sweep duration on slower sweep times.

Sweep output: direct-coupled sawtooth, zero to approximately $+15$ V, concurrent with swept RF output; zero at start of sweep, approximately $+15$ V at end of sweep regardless of sweep width or direction; source impedance, 10,000 ohms.

Frequency linearity:*† same as RF unit frequency accuracy.

Blanking: RF automatically turned off during retrace, turned on after completion of retrace. On automatic sweeps, RF is on long enough before sweep starts to stabilize external circuits and equipment whose response is compatible with the selected sweep rate; blanking disable switch provided.

Blanking output: direct-coupled rectangular pulse approximately -4 V coincident with RF blanking; source impedance approximately 3000 ohms.

Pen lift: for use with X-Y graphic recorders; pen lift terminals shorted during sweep, open during retrace.

Power leveling amplifier: internal dc-coupled leveling amplifier provided. (Not used with 8698B.)

Crystal input: approximately -20 to -350 mV for specified leveling at rated output, for use with negative-polarity detectors such as 780 Series Directional Detectors, 423A and 424 Series Crystal Detectors.

Modulation*

Internal AM: square-wave modulation continuously adjustable from 950 to 1050 Hz on all sweep times; on/off ratio greater than 20 dB at rated output.

External AM:

Frequency response: dc to 350 kHz unlevelled, dc to 50 kHz levelled.

Sensitivity: -10 V reduces RF level output at least 30 dB below rated CW output (A Model RF units); 25 dB below rated CW output (B/C Model RF units).

Input impedance: approximately 1000 ohms.

External FM:

Frequency response: dc to 3 kHz.

Sensitivity: deviation from CW setting approximately 6% of the frequency band per volt.

Maximum range: full band for modulation frequencies up to 150 Hz (approximately 17 V p-p input), decreases to about 20% of the band for 3 kHz modulation.

Input impedance: approximately 100,000 ohms.

General

Power: 115 or 230 volts $\pm 10\%$, 50 to 60 Hz, approximately 350 watts.

Dimensions: 16 $\frac{3}{4}$ " wide, 9" high, 18 $\frac{3}{8}$ " deep (426 x 229 x 467 mm); hardware furnished for rack mount 19" wide, 8-23/32" high, 16 $\frac{3}{8}$ " deep behind panel (483 x 221 x 416 mm).

Weight (not including RF unit): net 53 lb (23.9 kg); shipping 71 lb (32 kg).

Furnished: 7 $\frac{1}{2}$ foot (2290 mm) power cable with NEMA plug; rack mounting kit.

Available:

HP 11531A Test Unit (page 328).

HP 8705A Multiplexer (page 327).

HP 8706A Control Unit (page 327).

HP 8707A RF Unit Holder (page 327).

Price: HP 8690B, \$1,600.

*Listed separately for 8698B and 8699B; see pages 324-326.

†Correlation between frequency and both the sweep and reference output.

Specifications, RF units for 8690B

Frequency range	HP model	RF power control	Maximum leveled power	Power variation, external leveling ¹	Frequency accuracy at max leveled power	Frequency stability				Output connector	Price	Option 001 Internal leveling		
						With temperature	With 10% change in line voltage	With power level change	Residual FM			Power variation	Equivalent source match	Price
400 kHz-11 MHz	8698B	ALC loop	≥ +13 dBm	±0.25 dB	±1%	±0.05%/°C	±5 kHz	±50 kHz	<150 Hz peak	BNC	\$1550			
11 MHz-110 MHz									<500 Hz peak					
0.1 GHz-2 GHz	8699B	PIN line	≥ +13 dBm	±0.1 dB	±20 MHz	±750 kHz/°C	<50 kHz	<100 kHz	<3 kHz rms	Type N	\$3600			
2 GHz-4 GHz			≥ +8 dBm						<500 kHz					
1-2 GHz	8691A	BWO grid	≥100 mW	±0.2 dB	±1%	±0.01%/°C	±500 kHz	Typically <20 MHz (for 6 dB) ⁴	<30 kHz peak	Type N	\$2025	±0.4 dB	1.13:1	\$315
	8691B	PIN line	≥70 mW	±0.1 dB	±10 MHz	±0.01%/°C	±500 kHz	±500 kHz	<10 kHz peak	Type N	\$2375			
1.4-2.5 GHz	8691A††	BWO grid	≥100 mW	±0.2 dB	±1%	±0.01%/°C	±500 kHz	Typically <40 MHz (for 6 dB) ⁴	<30 kHz peak	Type N	\$2275			
	8691B††	PIN line	≥70 mW	±0.1 dB	±10 MHz	±0.01%/°C	±500 kHz	±4 MHz (for 10 dB)	<10 kHz peak	Type N	\$2575			
1.7-4.2 GHz	8692B	PIN line	≥15 mW	±0.1 dB	±25 MHz	±0.01%/°C	±500 MHz	±4 MHz (for 10 dB)	<20 kHz peak	Type N	\$2475			
	8692A	BWO grid	≥70 mW	±0.2 dB	±1%	±0.01%/°C	±500 kHz	Typically <40 MHz (for 6 dB) ⁴	<30 kHz peak	Type N	\$1825	±0.4 dB	1.16:1	\$315
2-4 GHz	8692B	PIN line	≥40 mW	±0.1 dB	±20 MHz	±0.01%/°C	±500 kHz	±4 MHz (for 10 dB)	<15 kHz peak	Type N	\$2175			
	8692C††	PIN line	≥ +10 dBm	±0.1 dB	±20 MHz	±750 kHz/°C	<50 kHz	<500 kHz	<3 kHz	Type N	\$1875	±0.5 dB	1.25:1	\$375
3.5-6.75 GHz	8693A††	BWO grid	≥40 mW	±0.2 dB	±1%	±0.01%/°C	±500 kHz	Typically <80 MHz (for 6 dB) ⁴	<50 kHz peak	Type N	\$2125			
	8693B	PIN line	≥5 mW	±0.1 dB	±45 MHz	±0.01%/°C	±1 MHz	±1 MHz (for 10 dB)	<20 kHz peak	Type N	\$2325	±0.4 dB	1.25:1	\$350
4-8 GHz	8693A	BWO grid	≥50 mW	±0.2 dB	±1%	±0.01%/°C	±1 MHz	Typically <80 MHz (for 6 dB) ⁴	<50 kHz peak	Type N	\$1625	±0.5 dB	1.25:1	\$350
	8693B	PIN line	≥15 mW	±0.1 dB	±40 MHz	±0.01%/°C	±1 MHz	±1 MHz (for 10 dB)	<15 kHz peak	Type N	\$2025	±0.4 dB	1.25:1	\$350
7-11 GHz	8694A	BWO grid	≥25 mW	±0.2 dB	±1%	±0.01%/°C	±1 MHz	Typically <160 MHz ¹	<60 kHz peak	Type N	\$1650	±0.75 dB	1.5:1	\$450
	8694B	PIN line	≥15 mW	±0.1 dB	±40 MHz	±0.01%/°C	±1 MHz	±1 MHz ²	<20 kHz peak	Type N	\$2075	±0.75 dB	1.5:1	\$450
7-12.4 GHz	8694A	BWO grid	≥25 mW	±0.2 dB	±1%	±0.01%/°C	±1 MHz	Typically <160 MHz ¹	<60 kHz peak	Type N	\$2000	±0.75 dB	1.5:1	\$450
	8694B	PIN line	≥15 mW	±0.1 dB	±50 MHz	±0.01%/°C	±1 MHz	±1 MHz ²	<20 kHz peak	Type N	\$2325	±0.75 dB	1.5:1	\$450
8-12.4 GHz	8694A	BWO grid	≥50 mW	±0.2 dB	±1%	±0.01%/°C	±1 MHz	Typically <160 MHz ¹	<60 kHz peak	Type N	\$1625	±0.75 dB	1.5:1	\$450
	8694B	PIN line	≥30 mW	±0.1 dB	±40 MHz	±0.01%/°C	±1 MHz	±1 MHz ²	<15 kHz peak	Type N	\$2050	±0.75 dB	1.5:1	\$450
10-15.5 GHz	8695A††	BWO grid	≥25 mW	±0.2 dB	±1%	±0.01%/°C	±10 MHz	<0.25 GHz	<150 kHz	Type N	\$2550			
	8695B††	PIN line	≥10 mW	±0.1 dB	±1%	±0.01%/°C	±10 MHz	<0.25 GHz	<50 kHz	Type N	\$3100			
12.4-18 GHz	8695A	BWO grid	≥40 mW	±0.2 dB	±1% ⁷	±0.01%/°C	±10 MHz	Typically <0.25 GHz ¹	<150 kHz peak	UG-419/U Type N Option 002	\$1800			
	8695B††	PIN line	≥10 mW	±0.2 dB	±1% ⁷	±0.01%/°C	±10 MHz	±1 MHz ²	<50 kHz peak	UG-419/U Type N Option 002	\$2350			
18-26.5 GHz	8696A	BWO grid	≥10 mW	±0.2 dB	±1% ⁷	±0.01%/°C	±15 MHz	Typically <0.36 GHz ¹	<200 kHz peak	UG-595/U	\$2700			
26.5-40 GHz	8697A	BWO grid	≥5 mW	±0.2 dB	±1% ⁷	±0.01%/°C	±20 MHz	Typically <0.53 GHz ¹	<350 kHz peak	UG-599/U	\$4500			

Specifications common to all RF units Output impedance: 50 ohms Prices, rear output connector (Option 004): 8691A/B-8694A/B, add \$75; 8695A/B-8697A, add \$150

††Tentative specifications and price.

Residual FM specifications give peak deviations for modulation components within a 10-kHz bandwidth. Peak deviation may vary ±50% for a 10% line voltage change. Specifications apply for unleveled operation of A Model RF Units and both leveled and unleveled operation in B/C Model RF Units. Specifications for all B/C Model RF Units are typically the same as above when used in an 8707A RF Unit Holder. However, the maximum B/C Model RF Unit specifications are twice the above for use in the 8707A.

¹ Excluding coupler and detector variation

² Down from maximum leveled power

³ With 6-dB power level change down from maximum leveled power

⁴ With 10-dB power level change

⁷ Over a 6-dB range

For all 8691-8697 RF units

Magnetic shielding: all 8692-8697 BWO RF Units except 8691A/B have shielded BWO's (8691A/B not shielded). All BWO's are unconditionally warranted for 1 year.

Residual AM: at least 40 dB below CW output.

Spurious signals: harmonics, at least 20 dB below CW output; nonharmonics, at least 40 dB below CW output.

Reference output: direct-coupled voltage proportional to RF frequency, approximately 0 V at the low end of the band, increasing approximately 40 V/octave; output impedance, 25,000 ohms.

Leveling indicator: front-panel indicator lights when power level set too high to permit leveling over entire selected sweep range or when operating in unleveled mode.

Equivalent source match

Externally leveled: depends on coupler.

Unleveled: less than 2.5:1.

Power variation, unleveled: < 10 dB over the entire band.

Weight

- 8691A, 8692A: 17 lb (7,6 kg); shipping 25 lb (11,3 kg).
- 8691B, 8692B: 20 lb (9 kg); shipping 28 lb (12,6 kg).
- 8693A-8697A: 10 lb (4,5 kg); shipping 18 lb (8,1 kg).
- 8693B, 8694B: 12 lb (5,4 kg); shipping 20 lb (9 kg).

External leveling accessories available

Directional detectors: 780 Series (page 360), 1 to 12.4 GHz.

Directional couplers: coaxial: 790 Series (page 360), 1 to 8 GHz; waveguide: 752 Series (page 362), 2.6 to 40 GHz.

Crystal detectors: coaxial: 423A (page 345), 10 MHz to 12.4 GHz; waveguide: 424A Series (page 345), 2.6 to 18 GHz, and 422A (page 345), 18 to 40 GHz.

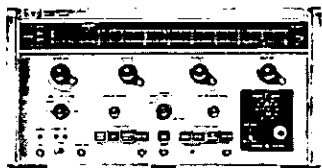
SWEEPERS



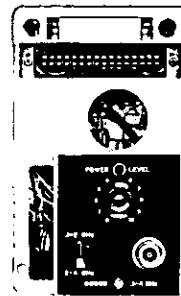
RF UNIT

Cover 5 octaves: 100 MHz to 4 GHz

Model 8699B



- Ultra-Broadband Solid-State Sweeper
- All Solid-State
- Linear YIG Tuning
- PIN Leveled
- Economical and Convenient



8699B

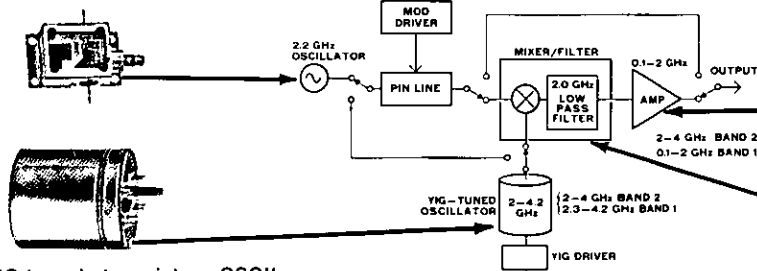
The Hewlett-Packard 8699B RF Unit is a completely solid-state 0.1 to 4 GHz plug-in unit for the HP 8690B Sweep Oscillator. It is extremely versatile and can be used for a wide range of applications requiring an accurate, stable, easy-to-use swept frequency source.

Five octaves of frequency coverage, together with good stability and low residual FM, make the 8699B useful for testing both broadband and narrow-band devices. With this single RF unit, fast and accurate swept measurements can be

made from VHF through S band, bringing convenience and economy to lab and production test applications.

Outstanding performance and high reliability have been achieved through state-of-the-art design and advanced hybrid integrated circuit technology. The result is broad frequency coverage and high output power while frequency stability and low spurious output are maintained. This completely solid-state RF source eliminates the expense of BWO replacement, resulting in additional operational economies.

Thin-film fixed frequency OSCILLATOR provides a low-noise and stable 2.2 GHz signal for the heterodyne mode.



Thin-film YIG-tuned transistor OSCILLATOR provides linear tuning and high output with good stability and excellent spectral purity.

8699B Block Diagram

Thin-film 0.1 to 2 GHz AMPLIFIER, with over 40 dB gain, delivers high output power with low spurious content on the 0.1 to 2 GHz range.

Thin-film MIXER operates at low levels to minimize unwanted mixing products. Thin-film LOW PASS FILTER has low insertion loss to 2.0 GHz and high stop-band rejection.

8699B Description

Broad frequency coverage on the 0.1 to 2 GHz band is achieved with a heterodyne design. The output of a YIG-oscillator, tuned from 2.3 to 4.2 GHz, is mixed with a fixed 2.2 GHz signal. The 0.1 to 2 GHz difference frequency is amplified by a broadband, thin-film amplifier. Undesired higher order signals are eliminated before the amplifier by a low-pass filter having a sharp cutoff and low insertion loss at 2.0 GHz.

The thin-film amplifier is the key element in the heterodyne design. With over 40 db gain, it can deliver high power to the load while maintaining low spurious and harmonic content. Even at maximum leveled power, spurious outputs are below the level where they would affect the accuracy of most measurements.

A PIN modulator is used to control the output of the 2.2 GHz oscillator, thus providing external leveling capability down to 100 MHz. By placing the PIN modulator before the mixer, spurious output is reduced when less than maximum leveled power is required. Frequency pulling with level or load change is low since the PIN modulator presents a constant load to the 2.2 GHz oscillator.

On the 2 to 4 GHz band the mixer and amplifier are switched out of the circuit and the YIG oscillator is tuned from 2 to 4 GHz. The PIN modulator remains in the circuit for leveling and to provide AM modulation capability. The inherent linearity of the YIG oscillator results in a very linear swept output and leads to accurate frequency displays on both bands.

Specifications

(HP 8699B RF Unit Installed in HP 8690B Sweep Oscillator Mainframe)

Frequency Characteristics

Range: 0.1 to 4 GHz in 2 bands (0.1-2 GHz and 2-4 GHz).

Accuracy (at 25°C): CW ± 10 MHz¹. All other modes ± 20 MHz².

Linearity: $\pm 0.5\%$ of sweep width².

Stability

With temperature (from 0 to 55°C): ± 750 kHz/°C.

With 10 dB change from max leveled power: frequency shift is less than 500 kHz.

With 10% line voltage change: less than 50 kHz instantaneous change.

With load impedance change (for any impedance change): 0.1-2 GHz, less than 100 kHz; 2-4 GHz, less than 500 kHz.

With time (after 15 min warm-up): less than 500 kHz/10 min.

Residual FM (in CW): less than 3 kHz rms noise in a 10 kHz bandwidth.

Output Characteristics

Max leveled power (at 25°C): 0.1-2 GHz, at least +13 dBm; 2-4 GHz, at least +8 dBm. The temperature coefficient is typically -0.1 dB/°C.

Flatness

Leveled: ± 0.1 dB plus coupler and detector variation at max leveled power.

Unleveled: 0.1-2 GHz, less than ± 7 dB; and 2-4 GHz, less than ± 3 dB.

Spurious signals

0.1-2 GHz: at rated power, harmonics are more than 25 dB down and nonharmonics, more than 30 dB down (from CW output). At 0 dBm, all spurious signals are typically more than 40 dB down.

2-4 GHz: at max leveled power or below, harmonics are more than 20 dB down and nonharmonics more than 40 dB down (typically nonharmonics are more than 60 dB down since a fundamental oscillator is used).

Residual AM: AM noise modulation index (rms in 10 kHz bandwidth) is less than -40 dB.

Modulation

External FM (through PHASE-LOCK INPUT on 8699B rear panel)

Frequency response: sensitivity of approximately -1 MHz/volt (negative voltage increases frequency) from dc to 500 kHz.

Max deviation: approximately ± 30 MHz from dc to 100 Hz and ± 3 MHz to 200 kHz.

Internal AM (from 8690B mainframe): square wave modulation, continuously adjustable from 950 to 1050 Hz. On/off ratio greater than 20 dB at rated output.

External AM (through 8690B mainframe)

Frequency response: dc to 350 kHz unleveled, dc to 50 kHz leveled.

Sensitivity: -10 V reduces RF output at least 25 dB below rated CW output (unleveled).

Weight: net, 11 lb; shipping, 20 lb.

Price: Model 8699B, \$3600.

Option 004: rear panel RF output. Add \$75.

¹Approach the desired CW frequency from the low-frequency end of the band.
²On the fastest sweep range, there is an added constant frequency offset due to time delay between the SWEEP OUTPUT and the actual RF OUTPUT. The amount of offset depends on both the SWEEP TIME and sweep width:

Max frequency offset = $0.25 \text{ ms} \times \text{sweep width (MHz)}/\text{SWEEP TIME (ms)}$.
This offset affects linearity only on the first 10% of the sweep width.

Operating Features

Remote Programming

For remote programming of CW frequency analog or digital (optional) control is possible. The front panel EXT FM input should be used for remote analogue frequency programming or for modulation at wide deviations and very low rates (< 1 kHz). Digital control is available for 12 line BCD input as 8690B option H26. Remote range switching can be accomplished through connection to a three-prong phone plug on the rear panel.

When the 8699B is installed in an RF Unit Holder (HP 8707A) and the HP 8706A Control Unit is used, the frequency range of operation must be selected manually with the switch on the front panel of the 8699B. To switch ranges remotely, use a modified Control Unit (8706A option H25).

Leveling

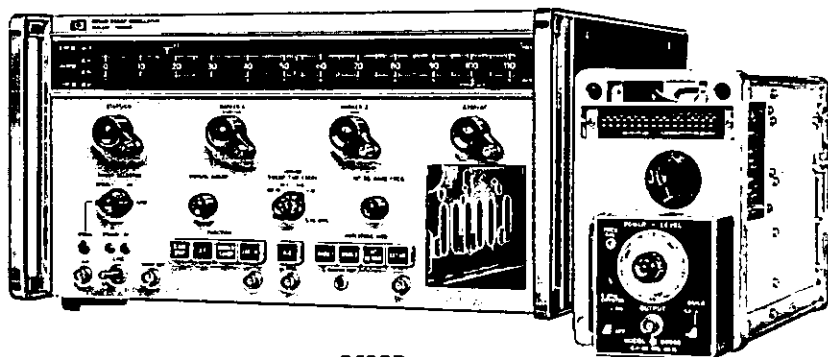
With a directional coupler and crystal detector, the power variations across the frequency band of interest will depend primarily on the frequency response of the coupler and detector used. An alternative scheme, useful in the frequency range of the 8699B, is to use a power splitter instead of a coupler to sample RF power. With this technique, the maximum leveled power available at the output will be lower, but overall flatness will be improved.

Phase-Locking

Input terminals for a phase-locking control voltage (or external FM modulation) are provided on the rear panel of the 8699B. Phase-locking is accomplished by use of the 8709A Synchronizer and a reference oscillator which transfers the inherent stability of the reference oscillator to the 8699B. The input sensitivity of the phase-lock input is 1 MHz/volt.

SWEEPERS**RF UNIT**

**8690B features in a 400 kHz-110 MHz sweeper
Model 8698B**



8698B

The Hewlett-Packard 8698B RF Unit for the HP 8690B Sweep Oscillator covers a frequency range from 400 kHz to 110 MHz in two bands.

Excellent sweep linearity and frequency accuracy assure the user of accurate frequency identification. This permits the use of internal graticule markings on an oscilloscope as a frequency scale.

Calibrated output power, flat output, and low harmonics and spurious responses all assure accurate amplitude measurements over a wide range of device inputs. In addition,

low residual FM permits narrow band characterization while retaining a clean display.

Other significant features are a 0.4-11 MHz auxiliary output which allows the user to monitor frequency up to 110 MHz with an 11 MHz counter (such as the HP 5321), 5 MHz crystal markers, an uncalibrated RF output, a sweep reference output, and a 200.4-300 MHz VTO output.

The all solid-state HP 8698B RF Unit incorporates thin-film microcircuit amplifiers in its design. Reliability is thus high and power consumption low.

8698B Specifications

(Installed in 8690B Sweep Oscillator)

Frequency Characteristics

Range: low range, 0.4-11 MHz; high range, 4-110 MHz.

Accuracy: (CW, ΔF center frequency, end points of start-stop and marker sweep; except when 8690B is in EXT FM mode).

Low range: $\pm 1\%$ of frequency ± 50 kHz.

High range: $\pm 1\%$ of frequency ± 500 kHz.

Linearity: $\pm 0.5\%$ of sweep width.

 ΔF width accuracy

Low range: $\pm 3\%$ of sweep width or ± 20 kHz, whichever is greater.

High range: $\pm 3\%$ of sweep width or 200 kHz, whichever is greater.

Harmonics and spurious responses

Non-harmonics: at least 35 dB below CW output.

Harmonics: (output levels below +10 dBm). At least 30 dB below CW output.

Residual FM: (CW and sweep).

Noise in a 10 kHz bandwidth including line related components: less than 300 Hz rms, low range. Less than 1 kHz rms, high range.

Combined incidental and residual FM with internal square wave modulation: less than 600 Hz rms, low range. Less than 2 kHz rms, high range.

Residual AM: AM noise modulation index (rms, 10 kHz bandwidth) is less than -40 dB.

Output Characteristics

Level: +13 to -110 dBm. Output is calibrated in 10 dB

steps and at +13 dBm. Uncalibrated vernier provides continuous level settings over entire range.

Accuracy: ± 1.5 dB at any calibrated level.

Flatness: ± 0.3 dB over full range.

Impedance: 50 Ω , SWR < 1.2 on 0 dBm step and below.

RF leakage: conducted and radiated leakage limits are below those specified in MIL-1-6181D.

Crystal Calibrator

Internal 5 MHz crystal allows frequency calibration to $\pm 0.01\%$ at any 5 MHz multiple using front panel frequency vernier.

Auxiliary Outputs

(Rear Panel)

Sweep reference output: provides voltage analog to frequency output. Approximately 1 V/MHz on low range, 1 V/10 MHz on high range.

Uncalibrated RF output: -5 dBm minimum.

VTO output: -15 dBm minimum. 200.4-310 MHz.

Auxiliary output: always 0.4-11 MHz, for low frequency counter monitoring.

General

Power supplied by HP 8690B Sweep Oscillator: 115 or 230 V $\pm 10\%$, 50-60 Hz $\pm 10\%$; approximately 350 watts (including 8690B).

Weight: net, 11 lb (5.0 kg); shipping, 18 lb (8.2 kg).

Price: Model 8698B, \$1550.

Options; 001: 75 Ω output, BNC

add \$50

004: Rear-panel RF output

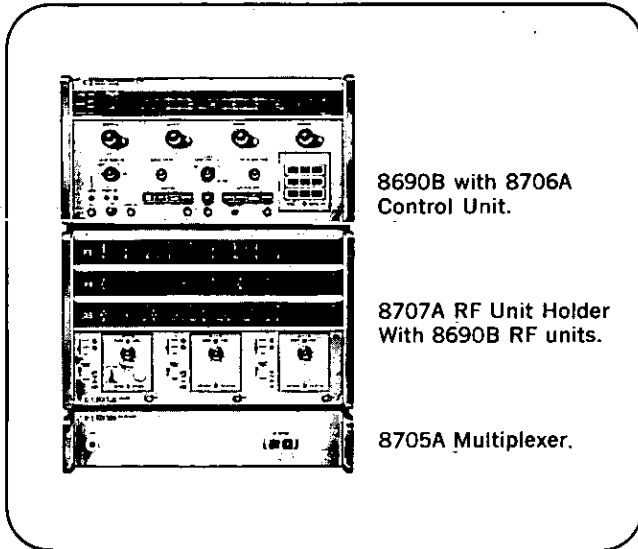
add \$75

ACCESSORIES

Applications and systems
Series 8690B



SWEEPERS



8690B with 8706A
Control Unit.

8707A RF Unit Holder
With 8690B RF units.

8705A Multiplexer.

Multiband Systems

Broadband sweep capability, 400 kHz to 40 GHz, with pushbutton control of frequency range is available with the 8706A Control Unit and the 8707A RF Unit holder. The 8706A Control Unit plugs into the 8690B in place of the normal 8690B RF plug-in and the 8707A RF unit holder accepts the 8690B RF plug-ins which are to be controlled. It is possible to have pushbutton control of from two to seven 8690B RF plug-ins with an 8706A Control Unit and from one to three 8707A Unit Holders.

The 8705A Signal Multiplexer switches RF signals up to 12.4 GHz from three 8690B-series RF units to either of two RF ports. To provide leveled power at the 8705A RF output ports; a detector operating from a wideband coupler in the 8705A provides an ALC signal for the 8690B Sweep Oscillator leveling circuits. For example, with an 8705A, 8706A, 8707A, 8690B, 8699B, 8693A/B and 8694A/B it is possible to have pushbutton control of wideband leveled sweep from 100 MHz to 12.4 GHz at either of two output ports.

Partial Specifications 8705A

Switching time between ports: 40 ms.

Frequency range: dc to 12.4 GHz.

Output port reflection coefficient ≤ 0.25 (VSWR ≤ 1.67).

Input port reflection coefficient ≤ 0.15 (VSWR ≤ 1.35).

Insertion loss: 3 dB.

Weight: approximately 20 lb (9 kg).

Price: \$1950.

Partial Specifications 8706A

Compatibility: the 8706A controls up to three 8707A RF Unit Holders. Option H26 for remote band switching of 8699B.

Switching time between RF Units: 1 second.

Weight: net, 16 lb (7,3 kg); shipping, 22 lb (10 kg).

Price: Model 8706A, \$500.

Partial Specifications 8707A

Capability: accepts up to three 8690B RF units.

Frequency range: 400 kHz to 40 GHz.

Frequency accuracy, maximum leveled power, leveling capability and output impedance: same as RF units.

Sweep functions

Normal: permits all 8690B sweep functions.

Preset: provides start-stop sweep determined by preset adjustments on the 8707A. Sweep end points can be set independently for each RF unit.

Weight: net, 28 lb (12,7 kg); shipping, 34 lb (15,4 kg).

Price: Model 8707A, \$1050.

Stabilized Sweep Oscillator Systems

Stabilized Sweep Oscillator Systems are phase-locked systems which increase the frequency stability of the 8690B sweeper for more sophisticated microwave applications such as narrow-band receiver or filter tests, parametric amplifier pumps or doppler system sources. Other applications include reflectometers, microwave spectroscopy and radio astronomy. CW stabilized systems are available from .1 to 40 GHz.

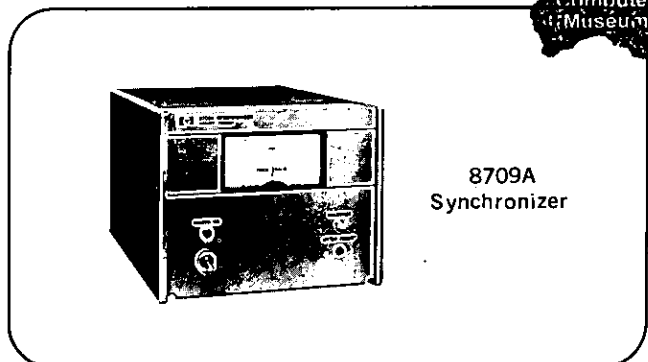
Complete specifications and data on these systems is available on request from Hewlett-Packard. Stabilized swept systems are available on special order.

Partial System Specifications

CW frequency stability in stabilized mode:

With time: $\leq 5 \times 10^{-7}/S$, $\leq 1 \times 10^{-5}/h$.

Residual FM: $\leq 5 \times 10^{-7}$.



8709A
Synchronizer

The 8709A synchronizer features automatic synchronization and side-band cancellation; the lock points are spaced by the reference oscillator frequency (240-400 MHz). This eliminates ambiguities in achieving phase-lock and identifying harmonic lock numbers.

8709A Specifications

Input frequency: 20 MHz.

Sensitivity: -65 dBm.

Minimum output voltage

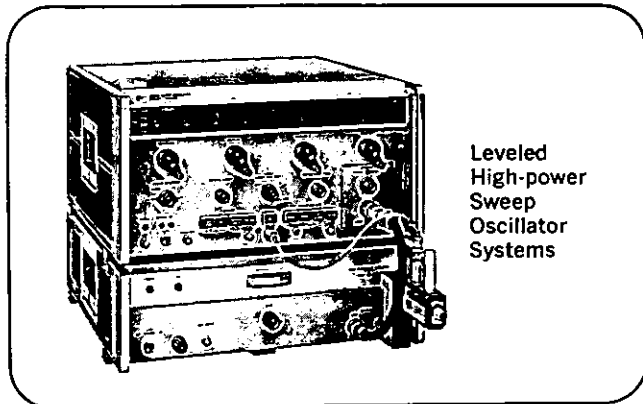
High level: $+12.0$ to -12.0 V dc.

Low level: $+0.8$ to -0.8 V dc.

Weight: net, 10 lb (4,5 kg); shipping, 11 lb 10 oz (5,3 kg).

Price: HP 8709A, \$1300.

SWEEPERS


ACCESSORIES
 Applications and systems
 Series 8690B

 Leveled
 High-power
 Sweep
 Oscillator
 Systems

Leveled High-Power Sweep Oscillators

The 8322A/B series Leveled High-Power Sweep Oscillator Systems provide 750 mW broadband or 1 watt narrow band in four bands from 1 GHz to 12.4 GHz. Flatness is ± 0.3 dB from 1.0 to 8.0 GHz and ± 1.0 dB from 8.0 to 12.4 GHz. These systems are complete with 8690B, 8691A/B-8694A/B RF plug-in (for band specified), HP traveling wave amplifier, bandpass filter (8430A series), directional detector (780 series) and needed cables.

8404A Power Meter Leveling Amplifier

The 8404A Leveling Amplifier is used to level the 8690B sweeper when a power meter is used as the RF detector. When the recorder output of the power meter (431 B/C, 432A or 437A) is connected to the 8404A Leveling Amplifier and the output of the 8404A connected to the external AM input of the 8690B, ± 0.05 dB or less variation in leveled output can be expected.

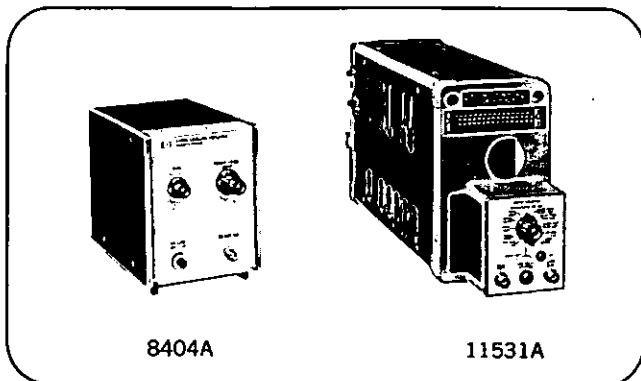
Partial Specifications

Leveling ability: better than ± 0.05 dB (excluding coupler tracking and power meter accuracy).

Compatibility: works with 431B/C, 432A and 437A Power Meters.

Option 100: 4 line BCD power level control—add \$175.

Price: \$295.



8404A

11531A

Model 11531A Test Unit

The Model 1153A Test Unit facilitates 8690B Sweep Oscillator calibration. The unit plugs into the 8690B like

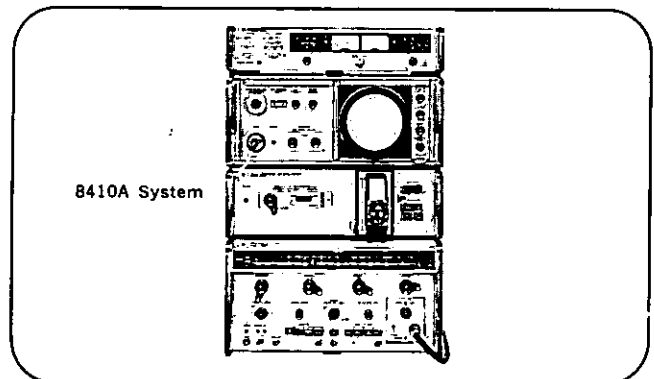
an RF unit. Calibration voltages for sweep range amplitude and end points (all sweep modes) as well as marker calibration, BWO calibration, Blanking and Pen lift are sampled and made available at the Model 11531A front panel output for fast, accurate calibration. Price, Model 11531A: \$350.

Network Analysis

The powerful new tool of network analysis has opened up new methods of design, test and maintenance of electronic equipment. The 8690B is the ideal source for a network analysis system from 400 kHz to 12.4 GHz. For systems operating in the 400 kHz to 110 MHz range the 8407A network analyzer and associated display (8413A Phase-Gain Indicator, 8412A Phase-Magnitude CRT Display or 8414A Polar CRT Display) are used with the 8690B/8698B sweep system. The 8407A which features a frequency tracking system to eliminate detection of spurious responses, requires the input of the voltage tuned oscillator from the 8690B/8698B (or 8601A) sweep system. Refer to page 374 for more information on the 8407A Network Analyzer.

Network analysis at microwave frequencies, 0.11 GHz to 12.4 GHz, is possible with the 8690B/8691A/B-8694A/B or 8699B sweep system and the 8410A Network Analyzer with associated transducers and displays (8413A, 8412A, and 8414A). The feature of interchangeable RF units for the 8690B and interchangeable displays for Hewlett-Packard Network Analyzers makes Hewlett-Packard Sweep/Network Analyzer systems extremely flexible at minimum cost. Refer to page 379 for more information on the 8410A Network Analyzer.

The sophisticated techniques of Network Analysis extend into device design with the HP 8410A systems ability to characterize solid state devices from 0.11-2 GHz. The 8690B/8699B is used as a source and the 8410S option 100 system is augmented by the addition of an 8717A Transistor Bias Supply and 11600B or 11602B Transistor Fixtures.



8410A System

The Hewlett-Packard 8690B series Sweep Oscillator is designed to operate as the swept frequency source for Hewlett-Packard network analyzers. The 8690B series as a sweep instrument source is capable of direct and convenient interface with Hewlett-Packard Network Analyzers. Refer to page 366 for more information on Network Analysis.

BASIC INSTRUMENTS FOR MICROWAVE MEASUREMENTS



MICROWAVE TEST EQUIPMENT

Hewlett-Packard offers a complete line of microwave test equipment from which systems can be assembled for making accurate reflection, transmission, frequency and power measurements. Measurement techniques and equipment functions are discussed briefly in the following paragraphs. More detailed information is available in Application Notes 64, 65, and 84, complimentary copies of which are available from Hewlett-Packard sales offices.

POWER MEASUREMENTS

Power measurements are basic at microwave frequencies. Unlike voltage and current levels along a transmission line, microwave power remains constant with position of measurement in a lossless line and can easily be related to circuit performance.

Hewlett-Packard has a complete line of power meters: thermocouple, thermistor, and calorimetric for power measurement over wide frequency and power ranges. More information about power measurement is contained on pages 389 and 390 of this catalog.

FREQUENCY MEASUREMENTS

There are two general classes of frequency measuring devices—active and passive types. Electronic counters, transfer oscillators, and frequency converters are examples of active types. These instruments measure frequency well into the microwave region with accuracies of a few parts in 10^6 . More information about active frequency-measuring instruments is contained in the frequency counter section of this catalog.

Where the accuracy of active devices is not required, passive devices offer direct readout at a considerable saving in cost. Passive transmission-type frequency meters, such as the HP 532, 536A, and 537A, are two-port devices that absorb part of the input power in a tunable cavity. When the cavity is tuned to resonance, a dip occurs in the transmitted power level. This dip can be observed on a meter or oscilloscope display of the detected RF voltage. Frequency is then read from a calibrated dial driven by the cavity tuning mechanism.

The accuracy of cavity frequency meters depends upon the cavity Q, dial calibration, backlash, and effects of temperature and humidity variations. The Hewlett-Packard waveguide and coaxial passive frequency meters achieve accuracies of a few parts in 10^6 .

IMPEDANCE MEASUREMENTS

Impedance-matching a load to its source is one of the most important considerations in microwave transmission systems. If the load and source are mismatched, part of the power is reflected back along the transmission line toward the source. This reflection not only prevents maximum power transfer, but also can be responsible for erroneous measurements of other parameters or even cause circuit damage in high-power applications.

The power reflected from the load interferes with the incident (forward) power, causing standing waves of voltage and current along the line. The ratio of standing-wave maxima to minima is directly related to the impedance mismatch of the load. The standing-wave ratio (SWR), therefore, provides a valuable means of determining impedance and mismatch.

Slotted line techniques

Standing-wave ratio can be measured

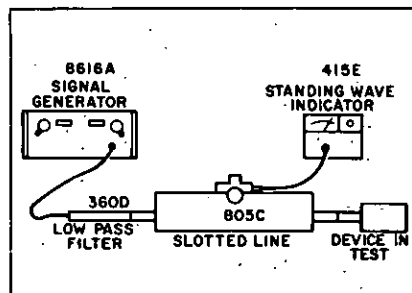


Figure 1. Typical setup for SWR and impedance measurements in coax using HP 805C Slotted Line.

directly with a slotted line in a setup like the one shown in Figure 1. The slotted line is placed immediately ahead of the load in test, and the source is adjusted for 1-kHz amplitude modulation at the desired microwave frequency. The slotted line probe is loosely coupled to the RF field in the line, thus sensing relative amplitudes of the standing-wave pattern as the probe is moved along the line. The ratio of maxima to minima (SWR) is displayed directly on the SWR meter.

While this method works well for single-frequency testing, it is time-consuming for broadband applications. The number of discrete measurements necessary to ensure complete coverage across a frequency range is determined by the degree of confidence required that a sharp resonance or hole does not exist, and for a high confidence factor, the number of measurements must be very high.

The swept slotted line

A measuring system which combines the speed and convenience of swept-frequency measurements and the inherent accuracy of the slotted line can be built around the 817A Slotted Line System (page 352). The 817A consists of an 816A Coaxial Slotted Line, 809C Carriage and 446A Slotted Line Sweep Adapter and can be used throughout the range from 1.8 to 18 GHz. The signal source is a sweep oscillator and the read-out device is an oscilloscope.

The measurement technique is much the same as for fixed-frequency measurements. A detecting probe is moved along the slotted line a distance of at least one half wavelength at the lowest frequency so that both maximum and minimum voltages of the standing waves are sampled. However, instead of the plot being a single vertical line, which would be the case in a fixed-frequency measurement, it is a smear or envelope as shown in Figure 2. At any given frequency, the ratio of the maximum and minimum amplitude of the envelope is the SWR.

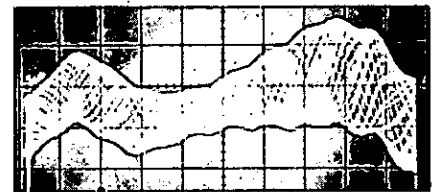


Figure 2. Multi-sweep slotted-line measurement. Vertical scale 0.5 dB/cm (SWR = 1.12/cm).

A storage oscilloscope such as the HP 141A is ideal for these measurements. A plot of SWR can be generated in a few seconds and retained on the CRT for evaluation or photography. The HP 1416A Swept-Frequency Indicator, a plug-in for both the 140A and 141A Oscilloscopes, provides additional convenience with its logarithmic calibration. No zero-level reference is needed, and SWR is indicated directly in dB when the detector is operated in its square-law region.

Accuracy of slotted-line measurements is limited primarily by the residual SWR of the line itself, 1.01 in waveguide and 1.02 to 1.06 in coax depending upon the frequency and type of connector. However, there are other considerations. Penetration of the detector probe into the line should be kept to a minimum to prevent standing waves due to the probe itself. Elimination of harmonics from the signal source is also important. HP 360, 362, and 8430 filters are excellent for this purpose.



Reflectometer techniques

The reflection coefficient (ρ) of a device or system is another useful term in establishing the impedance match of microwave devices. The following relationships of ρ and SWR are frequently used in impedance work:

$$|\rho| = \frac{E_{\text{reflected}}}{E_{\text{incident}}} = \frac{\text{SWR} - 1}{\text{SWR} + 1}$$

The amplitude of reflected voltage with respect to the incident voltage is given in terms of dB *return loss* by the expression: $\text{dB} = -20 \log_{10} |\rho|$. For example, if the reflected signal from a test device is 26 dB below the incident signal level, the reflection coefficient of the device is calculated as 0.05. In a like manner, any reflection coefficient from zero to one can be determined by a measure of the return loss.

The reflection coefficient of a load can be measured by separating the incident and reflected waves propagated in the transmission line connecting the source and load. The reflectometer uses directional couplers to accomplish this separation in both waveguide and coaxial systems. Reflectometers permit continuous oscilloscope displays or permanent X-Y recordings of reflection coefficient across complete operating bands.

Incident power in the improved reflectometer is held constant by the leveling action of the sweep oscillator and crystal detector sampling the incident wave from the forward coupler. With incident power held constant, only the relative amplitude of the reflected wave need be measured to determine reflection coefficient. This technique permits better accuracy than older systems, and fast sweep speeds enabling the use of oscilloscope displays. See Figure 3.

To calibrate the reflectometer, a short circuit is placed at the output port, thus reflecting all of the incident power. The detector in the reverse-arm coupler samples the reflected power and provides a proportional dc voltage for readout. By placing a calibrated attenuator ahead of the detector, specific amounts of return loss may be pre-inserted for calibration of the oscilloscope or recorder gain. The attenuator is then returned to zero, the short removed and the test device connected and measured on the pre-calibrated display.

Calibration also is possible without the pre-insertion attenuator if the detector law is known and the vertical response of the readout device is constant. Calibration levels with this technique are

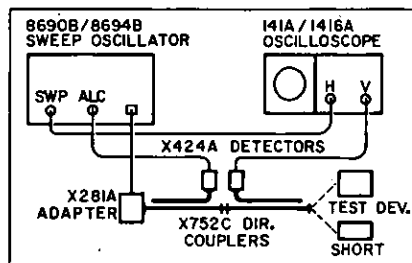


Figure 3. Typical Waveguide Reflectometer.

established with the RF turned off (corresponding to no reflection), then with all of the power reflected by a sliding short. Reflections falling between these limits are then read from the oscilloscope graticule or directly from calibrated transparent overlays such as furnished with Hewlett-Packard Application Note 65. The HP 140A Oscilloscope with its 1416A plug-in eliminates the need for overlays. With logarithmic calibration, the 140A/1416A provides return loss directly in dB.

The overall measurement accuracy of leveled reflectometer systems such as described here may be closely approximated by considering the various sources of error separately, then taking the rms average. These errors may be classified as being due to imperfect components comprising the reflectometer as follows:

- 1) directional couplers
- 2) detectors
- 3) attenuator used in calibration
- 4) display or readout instrument.

One of the primary errors introduced by directional couplers is the directivity signal. Directivity of a coupler refers to its ability to distinguish between forward and reverse power flowing in the main arm. Since reflectometry is based on the separation of incident and reflected power by use of the directional couplers, high directivity is essential to accurate measurements. Any incident power passing to the reverse coupler auxiliary output (because of imperfect directivity) will add in unknown phase with the actual reflected signal from the load in test. The result is an ambiguity in the voltage level at the reverse coupler output. The ambiguity caused by reverse coupler directivity can be determined in terms of reflection coefficient by substituting the directivity (in dB) into the return loss equation given earlier. Thus, for a reverse coupler directivity of 40 dB, the ambiguity in ρ is ± 0.01 .

The ambiguity caused by the *forward* coupler directivity also must be considered, particularly when measuring large reflections. This directivity signal

adds vectorially with the incident signal, producing an ambiguity in the incident power level. The ambiguity is proportional to the magnitude of load reflection and forward coupler directivity and may be calculated as follows:

$$\Delta \rho = \pm \rho \left(\log^{-1} \frac{\text{dB}}{20} \right)$$

where dB = coupler directivity
 ρ = reflection coefficient
of test load.

Primary factors to be considered in the detectors are frequency response, deviation from square law and mismatch. Using HP 423A or 424A Crystal Detectors, frequency response is typically flat to within ± 0.2 dB per octave and deviation from square law less than ± 0.2 dB over a 20 dB dynamic range. These two errors can be evaluated in terms of reflection coefficient ambiguity by alternately adding and subtracting the dB value to the return loss actually measured. The errors caused by these two factors can be eliminated by using the pre-insertion attenuator for initial system calibration. Error due to mismatch between HP 752 Waveguide Couplers and 424A Detectors is typically less than $\pm 3\%$ of the ρ measured.

The use of a pre-insertion attenuator for calibration eliminates some detector errors but introduces error of its own. The dial accuracy of the attenuator and mismatch considerations lead to the following expression for the error introduced in the measured reflection coefficient:

$$\Delta \rho = \rho (1 - \rho^{20.02} \pm 0.015)$$

where ρ = reflection coefficient of the test load.

When the attenuator is not used for calibration, the readout or display device causes error in the measured ρ . When using HP 140A or 180A Oscilloscopes for measuring small ratios (≈ 1), accuracies of 2% are reasonable. Ratios of 30 dB ($\rho \approx 0.03$) can be determined with about 4% accuracy.

The total effects of these errors can be conservatively estimated with the following equations:

1. Using the 382A attenuator pre-insertion technique, $\Delta \rho = \pm (0.01 + 0.05 \rho)$.
2. Using the straightforward oscilloscope technique, $\Delta \rho = \pm (0.01 + 0.07 \rho)$.

A more complete discussion and error analysis of reflectometer systems is included in Hewlett-Packard Application Note 65, "Swept Frequency Techniques."

ATTENUATION MEASUREMENTS



MICROWAVE TEST EQUIPMENT

ATTENUATION MEASUREMENTS

Attenuation is defined as the decrease in power (at the load) caused by inserting a device between a Z_0 source and load. Under this condition, the measured value is a property of the device alone so that this is the "ideal system" in which to make measurements. The term Z_0 is used to describe a unity SWR condition where the load and source impedances equal the transmission line impedance.

There are three common methods for measuring RF attenuation: 1) square-law detection with audio substitution, 2) linear detection with IF substitution, and 3) direct RF substitution using attenuators calibrated by either of the first two methods. Accurate square-law measurements over a range of 30 dB in a single step are possible using modern crystal detectors such as the HP 423A coaxial, and 424A waveguide series. With RF substitution a 45 or 50 dB range is possible using the same detectors without square-law loading. The 423A and 424A detectors are well suited to swept-frequency attenuation tests with either method 1) or method 3) above because of their flat frequency response and low reflection coefficient.

A number of factors affect the range and accuracy of attenuation measurements, each of which must be evaluated for the particular method being used. The measuring system must have low source and load reflections to minimize mismatch error. Pads or isolators can be used to minimize source mismatch, but closed loop leveling is more effective. By leveling the output power of the source at the point of measurement, source impedance is effectively maintained close to Z_0 . With this technique, impedance variations in intervening cables, connectors, and adapters are effectively eliminated since they are within the leveling loop.

Low reflection from the readout crystal detector is important for reducing mismatch error at the load in the measurement system. All Hewlett-Packard detectors are swept-frequency tested to assure low reflection through their frequency ranges.

Square-law detection technique

Figure 4 shows a waveguide system for swept attenuation measurements of 30 to 40 dB. Source power is leveled using a single 752C-series 10-dB directional coupler in the ALC loop. Coupling variation versus frequency in the leveling loop

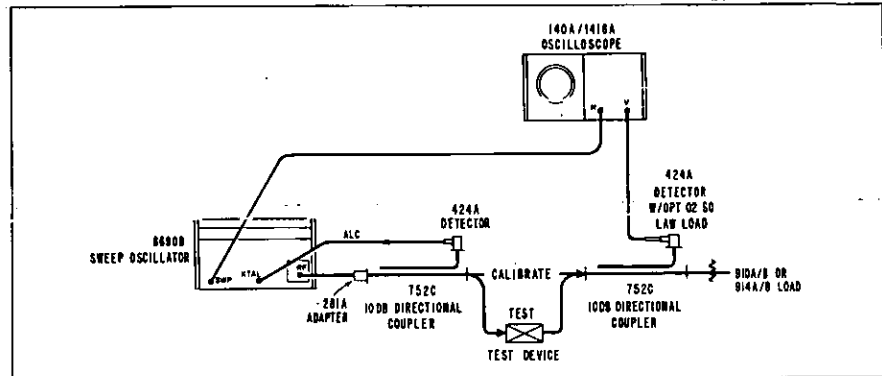


Figure 4. Swept attenuation system for measurements up to 40 dB with oscilloscope.

causes leveled power variation of about 1 dB at the point of test device insertion. This power variation is nearly equal to, but opposite, the coupling variation of the readout coupler. The net variation in readout calibration is therefore mutually compensated to within about 0.3 dB in X-band, depending primarily on coupler tracking.

With the 8690B sweeping the frequency range of interest, a zero-dB reference level is established on the oscilloscope without the test device in the system. The device is then inserted as indicated in Figure 4 and its attenuation versus frequency determined by the amplitude decrease from the CRT reference level previously established.

Figure 5 shows a typical coaxial sys-

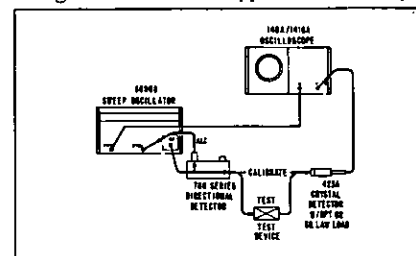


Figure 5. Typical Coaxial Setup for Square-Law Attenuation Measurement.

tem for measuring attenuation by square-law detection. The procedure and dynamic range are the same as for the waveguide system. In the 0.96- to 12.4-GHz range the HP 780 series directional detectors are a convenient means of deriving a leveling signal for the sweep oscillator.

RF substitution technique

Swept attenuation measurements up to 45 or 50 dB can be made using the RF pre-insertion, X-Y recorder system shown in Figure 6. The leveling arrangement is identical to that shown in Figure 4, but coupler tracking and detector errors are

eliminated by plotting a calibration grid on the X-Y recorder prior to the actual measurement. In addition to being leveled, the sweeper is internally amplitude-modulated at 1 kHz to drive the 415E SWR Meter. The 415E, after amplifying the 1-kHz signal, feeds a proportional dc voltage to the recorder Y-input. The dc sweep voltage from the 8690B drives the recorder X-input directly.

Calibration lines are plotted by setting in specific values of attenuation on the 382A near the anticipated test device attenuation and triggering single 30-second sweeps. The 382A is then set to 0 dB and the test device inserted as shown in Figure 6. A final sweep is triggered and attenuation of the test device plotted over the calibration grid.

The system does not rely on square-law performance in the readout detector because of the calibration grid plotted with known attenuation levels set by the 382A. For this reason, the option 002 square-law load is not connected to the 424A readout detector and higher sensitivity is obtained.

IF substitution technique

The IF substitution technique of attenuation measurement involves conversion of the microwave frequency to a constant, much lower frequency for which very accurately calibrated attenuators are available. These are the principles used in the HP 8405A Vector Voltmeter and HP 8410A Network Analyzer. With the vector voltmeter, accurate attenuation measurements can be made over more than 90 dB from 1 to 1000 MHz. The 8410A Network Analyzer has a range of more than 60 dB from 0.1 to 12.4 GHz. For more information about these instruments see the Network Analyzer section of this catalog.

MICROWAVE TEST EQUIPMENT



PASSIVE INSTRUMENTATION

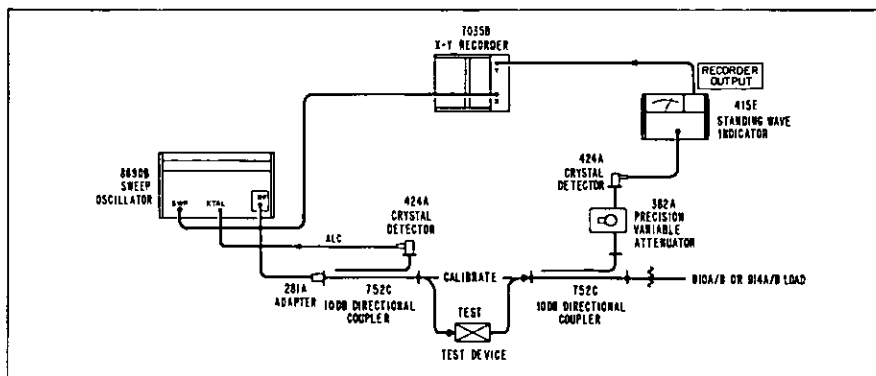


Figure 6. RF pre-insertion technique for swept attenuation measurements.

PASSIVE INSTRUMENTATION

Hewlett-Packard offers a broad line of the coaxial and waveguide accessories required in the measurement of impedance, attenuation, frequency, and other microwave characteristics. Included in the line are directional couplers, thermistor mounts for power meters, frequency meters, slotted lines, detectors, pads, loads, filters, adapters, and other devices and accessories useful in microwave measurements. This instrumentation is tabulated on the following pages for quick and easy reference. Frequency ranges and the page on which each item is described in detail are included in the tables. In the case of waveguide equipment, typical measurement setups are shown with the tables. In general, the setup shown for one band can be duplicated in other bands.

Slotted lines

Slotted lines covering the coaxial and waveguide frequency ranges are available for SWR measurements. Residual SWR is minimal for highest measurement accuracy. Hewlett-Packard SWR meters, probes, and detectors complete the SWR measurement setup.

For coaxial systems, the 817A permits the slotted line technique to be used for swept SWR measurements. This method presents SWR versus frequency directly on an oscilloscope. High measurement accuracy is attainable due to the low residual SWR of the slotted line.

Directional couplers

Hewlett-Packard offers both coaxial and waveguide directional couplers. Coaxial couplers are available in single and dual styles in the 770 and 780 series. The coupler-detector combination of the 780 series gives improved performance to sweep oscillator leveling applications. In the 770 and 780 series, the 779D and the 778D are high performance,

multi-octave couplers that bring convenience and economy to broadband applications.

In waveguide couplers, the 752 series covers the spectrum from 3.95 to 40 GHz in full band models. Available with coupling of 3, 10, or 20 dB, these units are swept-tested for both coupling and directivity. Directivity in most cases exceeds the 40-dB specification by a substantial margin; however, on special order, couplers can be selected to exceed the directivity specification in a particular frequency range. Coupling attenuation is tabulated and supplied with each 752.

Detectors

The 423A, 8470A, and 8472A coaxial crystal detectors, and the 424A series of waveguide detectors, offer the optimum in detectors for swept SWR and attenuation measurements. These detectors are ideal for sweep oscillator leveling applications because of their flat frequency response. Also, the flat frequency response of the individual detector eliminates the need for matched pairs in most applications. Where extremely closely matched frequency response is required, selected pairs can be provided.

Attenuators

Attenuators for a wide variety of functions in microwave measurements are available in both coaxial and waveguide versions. For coaxial systems, the 8490-series provides tested, economical, high-performance fixed attenuators that cover dc to 18 GHz. These attenuators are available in 3-, 6-, 10-, 20-, 30-, 40-, 50-, and 60-dB versions with a choice of Type N, APC-7 and miniature connectors. The 354A is a 0- to 60-dB, dc to 12.4 GHz coaxial step attenuator that uses the simple, effective principles of the fixed attenuators.

Waveguide attenuators are available

in the 375 series of utility variable flap attenuators and the 382 series of precision rotary vane attenuators. The 375 series is useful for controlling power applied to a system or for padding source mismatch, and the 382 attenuators with their accurate calibration and wide range are valuable in calibration and for comparative measurements.

Waveguide construction

Many Hewlett-Packard waveguide instruments are made of die-cast aluminum to attain maximum dimensional and production stability. A broaching technique for cutting the internal waveguide dimensions to very close tolerances can be used on die-cast aluminum. A broach is a long cutting bar similar to a file that is pulled through the casting to cut the interior surfaces. The linear cutting stroke of the broach eliminates minor surface irregularities resulting from use of the milling process. Whereas typical tolerance of milled waveguide tubing is $\pm .003$ inch, precision broaching allows internal dimensions to be controlled to $\pm .001$ inch or less.

The broaching process is very important for instruments such as slotted lines, high directivity directional couplers, sliding loads, and sliding shorts. Smaller tolerances on internal waveguide dimensions provide low SWR so maximum accuracy can be obtained in waveguide setups.

Each flange of a waveguide instrument is machine lapped after initial sanding belt surface preparation. This process, in addition to ensuring smooth surfaces to obtain the best possible mating, provides a slightly convex surface so that only the innermost area of the mating flanges makes contact. Thus, the tightest possible connection is made between waveguide instruments with the result that leakage is minimized.

Reflectometer calculator

Time-consuming calculations of return loss and conversion of ρ to SWR may be eliminated by using an Hewlett-Packard Reflectometer Calculator. This slide-rule-type aid provides continuous scales of ρ , SWR and return loss, which may be positioned under a cursor for instant conversion of terms. Other useful information such as ambiguity in reflectometer measurements, mismatch loss and phase and amplitude mismatch errors are included on the calculator. It may be obtained from your Hewlett-Packard field engineer upon request.

COAXIAL INSTRUMENTATION *continued*
Coaxial Accessories from dc to 18 GHz

Instrument name	Uses	Frequency coverage by model														Page				
		dc	10 MHz	100 MHz	215 MHz	450 MHz	500 MHz	940 MHz	1 GHz	2 GHz	3 GHz	4 GHz	10 GHz	12.4 GHz	18 GHz					
Directional couplers	Power measurements; power leveling; reflection measurements; isolation									796D	779D						360			
Slotted line system Slotted section Swept slotted line system	Measurement of SWR, wavelength, impedance; fixed and swept-frequency slotted line measurements									805C	816A	817A					354 352 352			
Fixed and sliding loads	Fixed loads for terminating 50-ohm systems (908A, 909A) Sliding loads for separating load reflections from other system reflections (905A, 907A, 911A)									908A	909A	905A	907A	911A			356			
PIN modulators	Sinusoidal and complex AM and RF pulsing of microwave sources without incidental FM									8731B, Opt. H10	8731A, B	8732A, B	8733A, B	8734A, B	3300C, D	33008C, D	33001C, D	310 310 310 310 235 235 235		
Mixers	Mixing SHF and VHF signals											934A					355 235 235 235			
Transistor fixtures	Make RF, dc connections to solid state devices																385 385			
Bias networks	Apply dc bias to solid state devices in RF measuring systems															11589A	11590A	385 385		
Coaxial switches	Electrically switch RF signals																8761	(Also see pages 234, 235 for solid state switches)	347	
Air lines	Adapt test equipment port spacing to devices under test																11606A	11588A	347 347	
Shorts	Establish measurement planes, reflection phase and magnitude references																11511A	11512A	11565A	356

WAVEGUIDE INSTRUMENTATION

Quality equipment for microwave measurements
G-band, 3.95 to 5.85 GHz

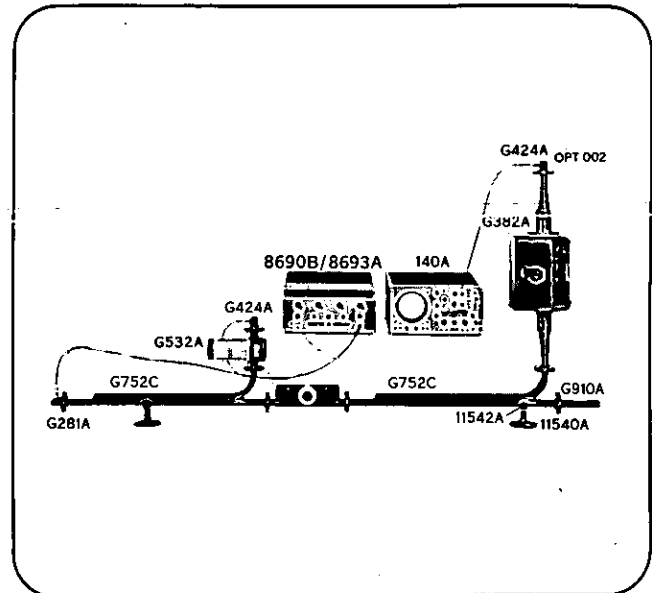


MICROWAVE TEST EQUIPMENT

The swept-frequency system illustrated on the right permits rapid measurement of attenuation (in this example a variable attenuator is being calibrated). The transmission characteristics of the system are accounted for in the initial calibration which is based on the G382A Attenuator.

Complementary equipment

HP Instrument	Frequency Range (GHz)
8616A Signal Generator	1.8 to 4.5
8616B Signal Source	1.8 to 4.5
618C Signal Generator	3.8 to 7.6
8690B Sweep Oscillator	
8693A/B RF Units	4 to 8
8693B Opt. 100 RF Unit	3.7 to 8.3
493A Microwave Amplifiers	4 to 8
8733A/B Pin Modulators	3.7 to 8.3



G-band equipment

HP Model	Description	Accuracy	Range	SWR (max)	Power (watts)	Length		Page Reference	Price
						(in)	(mm)		
G281A	Adapter, waveguide-to-coax			1.25		2 1/4	54	355	\$60
G347A	Noise source, waveguide	± 0.5 dB	15.2 dB	1.2		19	483	350	\$400
G382A	Attenuator, precision variable	$\pm 2\%$ of reading or 0.1 dB, whichever is greater	0 to 50 dB	1.15	15	3 1/8	803	344	\$650
G424A	Crystal detector	response: ± 0.2 dB	sensitivity: 0.4 mV/ μ W	1.35		2-1/16	52	345	\$185
G486A	Thermistor mount, compensated		0.001 to 10 mW	1.5		4	102	396	\$210
G532A	Frequency meter, direct reading	dial: $\pm 0.033\%$ overall: $\pm 0.065\%$				6 1/4	159	346	\$500
G752A G752C G752D	Directional couplers, multi-hole (40-dB directivity)	mean: ± 0.4 dB variation: ± 0.5 dB	3 dB 10 dB 20 dB	1.1 1.05 1.05	2 (in aux. guide)	3 1/2 33 33	876 838 838	362	\$400
G810B (809C) (444A)	Slotted section, waveguide (Carriage for 810B) (Detector probe for 809C)			1.01		10 1/4	260	353 (354) (354)	\$175 (\$225) (\$55)
G910A	Termination, low power			1.04	2	6 3/8	168	357	\$100
G914A	Moving load	load reflection: $< 0.5\%$	$> 1/2$ wavelength	1.01	2	20 1/2	521	357	\$200
G920A	Adjustable short		$> 1/2$ wavelength			7-13/16	199	357	\$200
11540A	Waveguide stand							355	\$5
11542A	G-band waveguide clamp							355	\$5

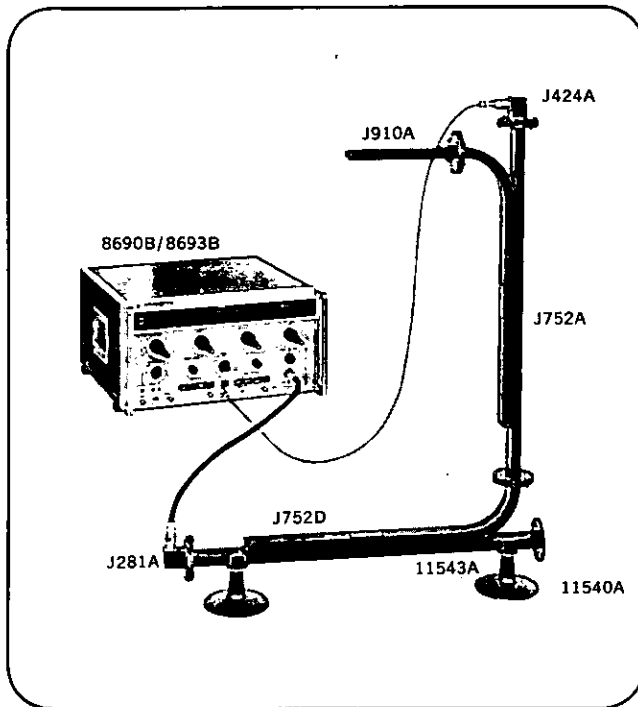
MICROWAVE TEST EQUIPMENT



WAVEGUIDE INSTRUMENTATION

Quality equipment for microwave measurements

J-band, 5.30 to 8.20 GHz



In the illustration leveled output power from the sweep oscillator is obtained through use of the J752 Directional Couplers in the configuration shown. The J424A Crystal Detector, with its extremely flat frequency response, provides the error voltage to the ALC input of the sweep oscillator. The power delivered at the output port of the J752D Coupler is flat to better than $\frac{1}{2}$ dB, and the high directivity of the coupler makes the leveling loop virtually immune to load SWR.

Complementary equipment

HP Instrument	Frequency Range (GHz)
618C Signal Generator	3.8 to 7.6
620B Signal Generator	7 to 11
8690B Sweep Oscillator	—
8693A RF Unit	4 to 8
8693B RF Unit	4 to 8
8693B Opt. 100 RF Unit	3.7 to 8.3
493A Microwave Amplifier	4 to 8
8733A PIN Modulator	3.7 to 8.3
8733B PIN Modulator	3.7 to 8.3

J-band equipment

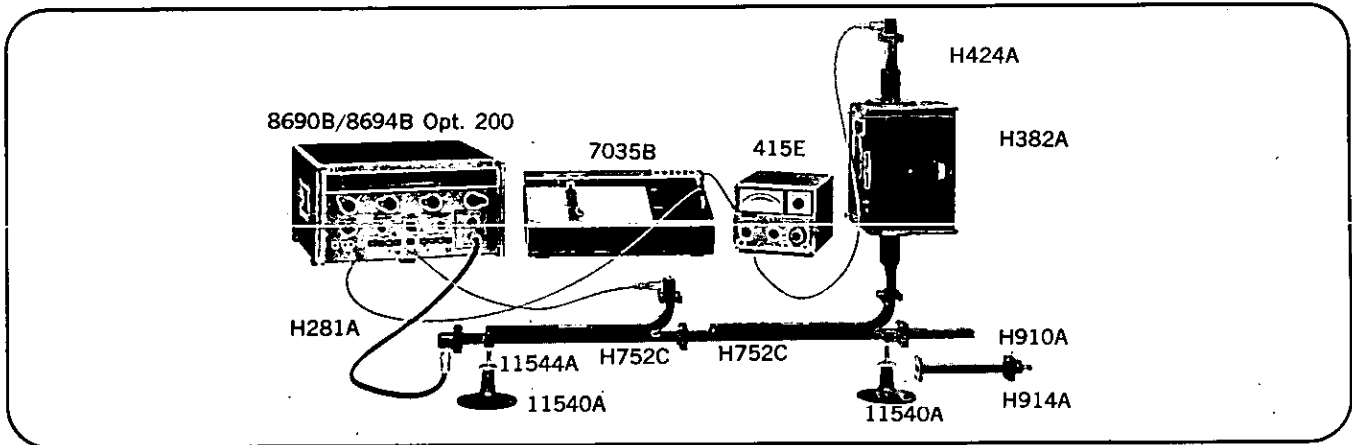
HP Model	Description	Accuracy	Range	SWR (max.)	Power (watts)	Length		Page reference	Price
						(in)	(mm)		
J281A	Adapter, waveguide-to-coax			1.25 (1.3 from 5.3 to 5.5 GHz)		2	51	355	\$55
J347A	Noise source, waveguide	± 0.5 dB	15.2 dB	1.2		19	483	350	\$400
J382A	Attenuator, precision variable	$\pm 2\%$ of reading or 0.1 dB whichever is greater	0 to 50 dB	1.15	10	25	635	344	\$500
J424A	Crystal detector	response: ± 0.2 dB	sensitivity: > 0.4 mV/ μ W	1.35		$1\frac{1}{8}$	48	345	\$185
J486A	Thermistor mount, compensated		0.001 to 10 mW	1.5		$3\frac{3}{8}$	86	396	\$200
J532A	Frequency meter, direct reading	dial: $\pm 0.033\%$ overall: $\pm 0.065\%$				$6\frac{1}{4}$	159	346	\$475
J752A J752C J752D	Directional couplers, multi-hole (40-dB directivity)	mean: ± 0.4 dB variation: ± 0.5 dB (5.85 to 8.2 GHz)	3 dB 10 dB 20 dB	1.1 1.05 1.05	1 (in aux. guide)	$26\frac{1}{2}$ 25-9/16 25-9/16	673 649 649	362	\$275
J810B (809C) (444A)	Slotted section, waveguide (Carriage for 810B) (Detector probe for 809C)			1.01		$10\frac{1}{4}$	260	353 (354) (354)	\$150 (\$225) (\$55)
J885A	Waveguide phase shifter	lesser of 3° or 10%	-360° to $+360^\circ$	1.35	10	$25\frac{1}{8}$	638	358	\$850
J910A	Termination, low power			1.02	1	$8\frac{1}{8}$	206	357	\$75
J914A	Moving load	load reflection: $< 0.5\%$	$> \frac{1}{2}$ wavelength	1.01	2	$15\frac{1}{2}$	394	357	\$200
J920A	Adjustable short		$> \frac{1}{2}$ wavelength			$6\frac{1}{4}$	159	357	\$200
11540A	Waveguide stand							355	\$5
11543A	Waveguide clamp							355	\$5

WAVEGUIDE INSTRUMENTATION

Quality equipment for microwave measurements
H-band, 7.05 to 10 GHz



MICROWAVE TEST EQUIPMENT



The setup shown here is a swept-frequency system for measuring the directivity of a directional coupler. The coupler nearest the 8690B is part of a leveling loop that minimizes test signal amplitude variations. The X-Y recorder plots directivity as a function of frequency. For calibration, the coupler under test is connected as shown with the main line terminated in a low-reflection fixed load, and the 382A is used to simulate values of directivity. For the measurement, the 382A is set to zero, the coupler is reversed, and the fixed load is replaced by a sliding load. With the oscillator sweeping slowly, the load is moved rapidly to phase the load reflection with the directivity signal and thus provide a way of separating the two signals for high-accuracy measurements.

Complementary equipment

HP Instrument	Frequency Range (GHz)
620B Signal Generator	7 to 11
8690B Sweep Oscillator	—
8694A Opt. 200 RF Unit	7 to 11
8694B Opt. 200 RF Unit	7 to 11
495A Microwave Amplifier	7 to 12.4
8734A PIN Modulator	7 to 12.4
8734B PIN Modulator	7 to 12.4

H-band equipment

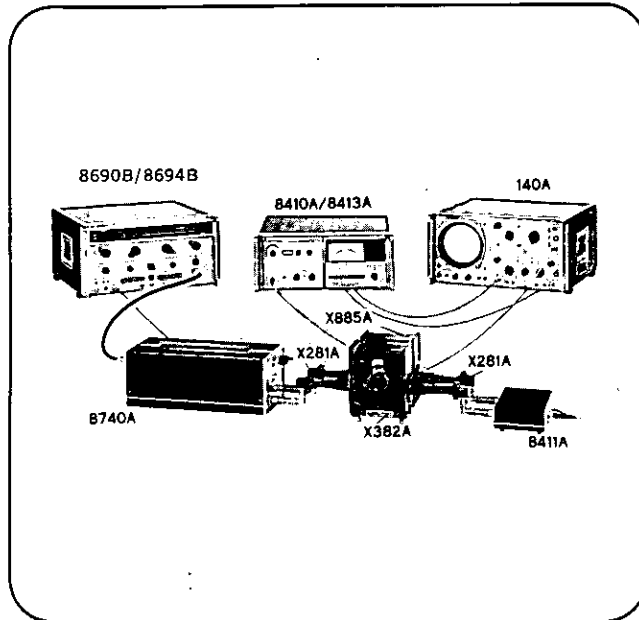
HP Model	Description	Accuracy	Range	SWR (max.)	Power (watts)	Length		Page reference	Price
						(in)	(mm)		
H281A	Adapter, waveguide-to-coax			1.25		1½	41	355	\$50
HX292B	Adapter, waveguide-to-waveguide		8.2 to 10 GHz	1.05		1½	38	355	\$50
H347A	Noise source, waveguide	±0.5 dB	15.6 dB	1.2		16	406	350	\$375
H382A	Attenuator, precision variable	±2% of reading, or 0.1 dB, whichever is greater	0 to 50 dB	1.15	10	20	508	344	\$450
H424A	Crystal detector	response: ±0.2 dB	sensitivity > 0.4 mV/μW	1.35		1-9/16	40	345	\$175
H486A	Thermistor mount, compensated		0.001 to 10 mW	1.5		3¾	86	396	\$195
H532A	Frequency meter, direct reading	dial: ±0.040% overall: ±0.075%				6¾	159	346	\$450
H752A H752C H752D	Directional couplers, multi-hole (40-dB directivity)	mean: ±0.4 dB variation: ±0.5 dB	3 dB 10 dB 20 dB	1.1 1.05 1.05	1 (in aux. guide)	18¾ 17½ 17½	473 445 445	362	\$250
H810B (809C) (444A)	Slotted sections, waveguide (Carriage for 810B) (Detector probe for 809C)			1.01		10¾	260	353 (354) (354)	\$135 (\$225) (\$55)
H910A	Termination, low power			1.02	1	5-9/16	141	357	\$60
H914A	Moving load	load reflection: < 0.5%	> ½ wavelength	1.01	1	11½	267	357	\$160
H920A	Adjustable short		> ½ wavelength			4¾	124	357	\$165
11540A	Waveguide stand							355	\$5
11544A	Waveguide clamp							355	\$5

MICROWAVE TEST EQUIPMENT



WAVEGUIDE INSTRUMENTATION

Quality equipment for microwave measurements
X-band, 8.2 to 12.4 GHz



The variation of phase shift with attenuation of the X382A Precision Variable Attenuator is measured in this setup. The HP 8410A Network Analyzer permits this measurement to be made quickly and easily on a swept-frequency basis.

Complementary equipment

HP Instrument	Frequency range (GHz)
620B Signal Generator	7 to 11
626A Signal Generator	10 to 15.5
8690B Sweep Oscillator	—
8694A RF Unit	8 to 12.4
8694B RF Unit	8 to 12.4
495A Microwave Amplifier	7 to 12.4
8734A PIN Modulator	7 to 12.4
8734B PIN Modulator	7 to 12.4

X-band equipment

HP Model	Description	Accuracy	Range	SWR (max.)	Power (watts)	Length		Page Reference	Price	
						(in)	(mm)			
X281A	Adapter, waveguide-to-coax			1.25		1 3/4	35	355	\$45	
X281B	Adapter, waveguide-to-coax			1.25		1 3/4	35	355	\$80	
HX292B	Adapter, waveguide-to-waveguide		8.2 to 10 GHz	1.05		1 3/4	38	355	\$50	
MX292B	Adapter, waveguide-to-waveguide		10 to 12.4 GHz	1.05		2 3/4	60	355	\$70	
X347A	Noise source, waveguide	± 0.4 dB	15.7 dB	1.2		1 3/4	375	350	\$325	
X362A	Low-pass filter	insertion loss, passband: <10 dB stopband: >40 dB	passband: 8.2 to 12.4 GHz stopband: 16 to 37.5 GHz	passband 1.5		5-11/32	136	348	\$325	
X375A	Attenuator, variable	± 1 dB at <10 dB ± 2 dB at >10 dB	0 to 20 dB	1.15	2	7-3/16	183	344	\$175	
X382A	Attenuator, precision variable	$\pm 2\%$ of reading or 0.1 dB whichever is greater	0 to 50 dB	1.15	10	15 3/4	397	344	\$350	
X424A	Crystal detector	response: ± 0.3 dB	sensitivity >0.4 mV/ μ W	1.35		1 3/4	35	345	\$155	
X485B	Detector mount (less detector)			with barretter 1.25		6-7/16	164	364	\$100	
X486A	Thermistor mount, compensated		0.001 to 10 mW	1.5		2 3/4	54	396	\$165	
X487B	Thermistor mount, broadband		0.01 to 10 mW	1.5		1-3/16	30	397	\$100	
X532B	Frequency meter, direct reading	dial: $\pm 0.05\%$ overall: $\pm 0.08\%$				4 1/2	114	346	\$275	
X752A X752C X752D	Directional couplers, multi-hole (40-dB directivity)	mean: ± 0.4 dB variation: ± 0.5 dB	3 dB 10 dB 20 dB	1.1 1.05 1.05	1 (in aux. guide)	16-11/16 15-11/16 15-11/16	424 399 399	362	\$175	
X810B (809C) (444A)	Slotted section, waveguide (Carriage for 810B) (Detector probe for 809C)			1.01		10 3/4	260	353 (354) (354)	\$125 (\$225) (\$55)	
X870A	Tuner, slide screw	insertion loss: <2 dB at 20:1 SWR	corrects swr of 20			5 1/2	140	358	\$200	
X885A	Waveguide phase shifter	$\pm 2^\circ$ at 8.2 to 10 GHz or 10% $\pm 3^\circ$ at 10 to 12.4 GHz or 10%	-360° to $+360^\circ$	1.35	10	15 3/4	397	358	\$550	
X910B	Termination, low power			1.015	1	6 3/4	168	357	\$45	
X913A	Termination, high power			1.05	500	9 3/4	241	357	\$125	
X914B	Moving load	load reflection: $<0.5\%$	$>1/2$ wavelength	1.005	1	10 3/4	257	357	\$75	
X923A	Sliding short		$>1/2$ wavelength			13	330	357	\$125	
X930A	Waveguide shorting switch	insertion loss "Open": <0.05 dB				3-11/16	94	357	\$260	
8735A	PIN modulator		35 dB							
8735B	PIN modulator		80 dB							
11504A	Flexible waveguide					12	305	—	\$35	
11540A	Waveguide stand							355	\$5	
11545A	Waveguide clamp							355	\$5	
X8747A	Transmission-reflection test unit for 8410A Network Analyzer	Directivity: >40 dB					41	1030	383	\$1600

WAVEGUIDE INSTRUMENTATION

Quality equipment for microwave measurements
P-band, 12.4 to 18 GHz

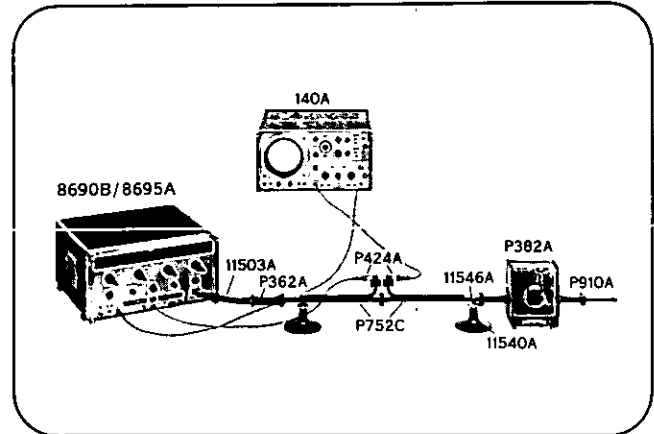


MICROWAVE TEST EQUIPMENT

The conventional swept-frequency reflectometer in the illustration is being used to examine the reflection characteristics of the P382A Attenuator. The flat frequency response and excellent square law characteristics of the P424A Crystal Detectors provide accurate measurement results, with the added advantage that reflection characteristics can be displayed directly on the oscilloscope CRT.

Complementary equipment

HP Instrument	Frequency Range (GHz)
626A Signal Generator	10 to 15.5
628A Signal Generator	15 to 21
8690B Sweep Oscillator	—
8695A RF Unit	12.4 to 18



P-band equipment

HP Model	Description	Accuracy	Range	SWR (max.)	Power (watts)	Length		Page reference	Price
						(in)	(mm)		
P281B	Adapter, waveguide-to-coax		12.4 to 18 GHz	1.25		15/16	24	355	\$95
MP292B	Adapter, waveguide-to-waveguide		12.4 to 15 GHz	1.05		2 3/8	60	355	\$60
NP292A	Adapter, waveguide-to-waveguide		15 to 18 GHz	1.05		2 3/8	60	355	\$60
P347A	Noise source, waveguide	±0.5 dB	15.8 dB	1.2		1 1/4	375	350	\$375
P362A	Low-pass filter	insertion loss, pass-band: <1 dB stopband: >40 dB	pass: 12.4 to 18 GHz stop: 23 to 54 GHz	passband 1.5		3-11/16	94	348	\$350
P375A	Attenuator, variable	±1 dB at <10 dB ±2 dB at >10 dB	0 to 20 dB	1.15	1	7/8	184	344	\$200
P382A	Attenuator, precision variable	±2% of reading or 0.1 dB, whichever is greater	0 to 50 dB	1.15	5	1 1/2	318	344	\$400
P424A	Crystal detector	response: ±0.5 dB	sensitivity >0.3 mV/μW	1.5		15/16	24	345	\$195
P486A	Thermistor mount, compensated		0.001 to 10 mW	1.5		2 1/2	64	396	\$220
P487B	Thermistor mount, broadband		0.01 to 10 mW	1.5		13/16	21	397	\$135
P532A	Frequency meter, direct reading	dial: ±0.068% overall: ±0.1%				4 1/2	114	346	\$300
P752A P752C P752D	Directional couplers, multi-hole (40-dB directivity)	mean: ±0.4 dB variation: ±0.5 dB	3 dB 10 dB 20 dB	1.1 1.05 1.05	1 (in aux. guide)	1 3/8 1 1/4 1 1/4	349 311 311	362	\$190
P810B (809C) (444A)	Slotted section, waveguide (Carriage for 810B) (Detector probe for 809C)			1.01		10/8	260	353 (354) (354)	\$150 (\$225) (\$55)
P870A	Tuner, slide screw	insertion loss: <2 dB at 20:1 SWR	corrects swr of 20			5	127	358	\$225
P885A	Waveguide phase shifter	lesser of ±4° or 10%	-360° to +360°	1.35	5	12-5/16	312	358	\$750
P910A	Termination, low power			1.02	1	4 3/8	111	357	\$50
P914A	Moving load	load reflection: <0.5%	> 1/2 wavelength	1.02	0.5	9/8	248	357	\$125
P920B	Adjustable short		> 1/2 wavelength			5 3/8	146	357	\$175
P932A	Harmonic mixer				0.1			355	\$250
11503A	Flexible waveguide, P-band					12	305	—	\$48
11540A	Waveguide stand							355	\$5
11546A	Waveguide clamp							355	\$5
P8747A	Transmission-reflection test unit for 8410A Network Analyzer	Directivity: >40 dB				33	830	383	\$1700

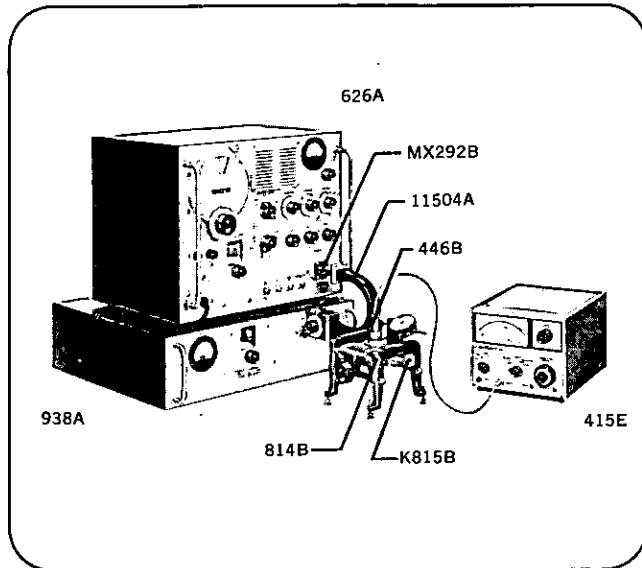
MICROWAVE TEST EQUIPMENT



WAVEGUIDE INSTRUMENTATION

Quality equipment for microwave measurements
K-band, 18 to 26.5 GHz, and R-band, 26.4 to 40 GHz

Illustrated here is a typical system for fixed-frequency measurement of standing wave ratio in K-band.



Complementary equipment

HP Instrument	Frequency Range (GHz)
626A Signal Generator and 938A Frequency Doubler Set	20 to 26.5
626A Signal Generator and 940A Frequency Doubler Set	26.5 to 31
628A Signal Generator and 940A Frequency Doubler Set	30 to 40
8690B Sweep Oscillator	—
8696A RF Unit	18 to 26.5
8697A RF Unit	26.5 to 40

K- and R-band equipment

HP Model*	Description	Accuracy	Range	SWR (max)	Power (watts)	Length		Page Reference	Price	
						(in)	(mm)			
K362A	Low-pass filter	insertion loss, pass-band: <1 dB stopband: >40 dB	pass: 18 to 26.5 GHz stop: 31 to 80 GHz	passband 1.5		2½	64	348	\$385	
R362A		insertion loss, pass-band: <2 dB stopband: >35 dB	pass: 26.5 to 40 GHz stop: 47 to 120 GHz	passband 1.8		1¾	42			
K382A	Attenuator, precision variable	±2% of reading or 0.1 dB, whichever is greater	0 to 50 dB	1.15		2	7½	194	344	\$600
R382A						1	6¾	162	344	\$650
K422A	Crystal detector	freq. resp: ±2 dB sens: 0.3 mV µW		2.5		2	51	345	\$275	
R422A									3	\$630 (matched pair)
K486A	Thermistor mount, compensated		0.001 to 10 mW	2		3	76	396	\$330	
R486A									\$395	
K532A	Frequency meter, direct reading	dial: ±0.077% overall: ±0.11%				4½	114	346	\$450	
R532A		dial: ±0.083% overall: ±0.12%							\$500	
K752A	Directional couplers, multi-hole (40-dB directivity)	mean: ±0.7 dB variation: ±0.5 dB (±0.6 dB, R752D)	3 dB	1.1	.05 (in aux. guide)	10⅞	270	362	\$250	
K752C			10 dB	1.05		9-15/16	252			
K752D			20 dB	1.05		9-15/16	252			
R752A			3 dB	1.1		11⅞	295			
R752C			10 dB	1.05		8⅞	219			
R752D			20 dB	1.05		8¾	222			
K815B	Slotted section, waveguide			1.01		7-9/16	192	353	\$525	
R815B									\$525	
(814B)	(Carriage for 815B)							354	\$525	
(446B)	(Detector probe for 814B)								\$225	
K914B	Moving load	load reflection: <0.5%	>½ wavelength	1.01	0.5	6⅞	156	357	\$275	
R914B						5⅞	130		\$325	
K920B	Adjustable short		>½ wavelength			5½	140	357	\$250	
R920B						4½	114		\$275	
11540A	Waveguide stand							355	\$5	
11547A	K-band Waveguide clamp							355	\$5	
11548A	R-band Waveguide clamp							355	\$5	

* Circular flange adapters 11515A (UG-425/U) for K-band, \$35 each; 11516A (UG-381/U) for R-band, \$40 each.

VARIABLE COAXIAL ATTENUATOR

Versatile application to 2 GHz
Models 355C,D; 393A, 394A



**MICROWAVE
TEST EQUIPMENT**

355C,D VHF Attenuators

Unique design provides accurate attenuation from dc to 1 GHz with the HP 355C (0 to 12 dB in 1-dB steps) and HP 355D (0 to 120 dB in 10-dB steps). Attenuator sections are inserted and removed by cam-driven microswitches. These sections are adjusted by a time-domain reflectometry system to minimize reflections and ensure high accuracy. Insertion loss is low, and using both instruments provides attenuation in 1-dB steps to 132 dB. The units can be connected with either terminal as input or output, and their small size and mounting versatility permit several installation schemes—even within other equipment.

393A, 394A Coaxial Attenuators

Each of these coaxial variable attenuators uses the principle of a directional coupler (see Figure 1) to achieve a wide range of attenuation over a full octave. The HP 393A covers 5 to 120 dB from 500 to 1000 MHz; HP 394A covers 6 to 120 dB from 1 to 2 GHz. With special high-power terminations, they will handle up to 200 watts average.

Since these instruments are variable directional couplers, they are particularly useful for mixing signals while maintaining isolation.

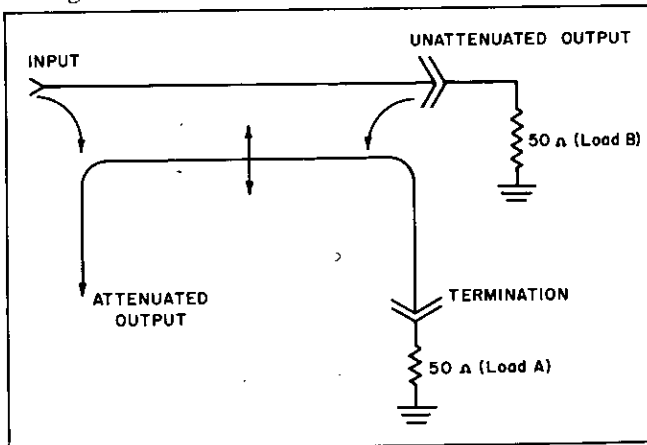
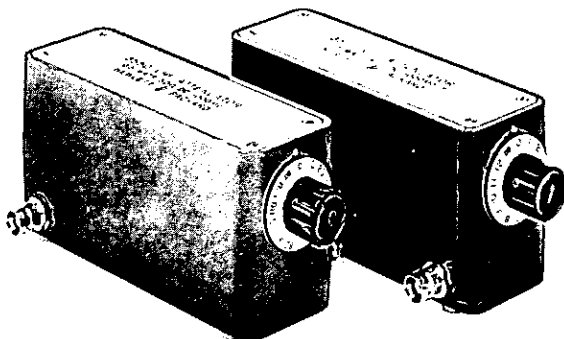


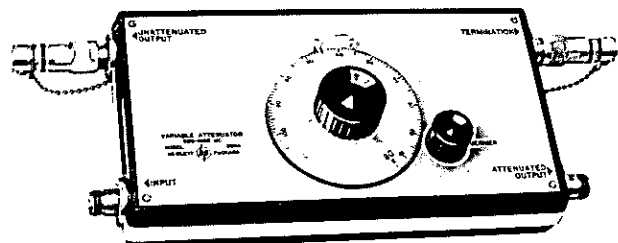
Figure 1. With loads A and B in place the instrument is an attenuator. With load A only, the instrument is a variable directional coupler.

Specifications	355C	355D
Attenuation:	12 dB in 1-dB steps	120 dB in 10-dB steps
Frequency range:	dc to 1 GHz	
Overall accuracy:	± 0.1 dB at 1000 Hz; ± 0.25 dB dc to 500 MHz; ± 0.35 dB dc to 1 GHz	± 0.3 dB to 120 dB at 1000 Hz; ± 1.5 dB to 90 dB below 1 GHz; ± 3 dB to 120 dB below 1 GHz
Impedance:	50 ohms nominal	
Power dissipation:	0.5 watt average, 350 volts peak	
Maximum SWR (input and output):	1.2 below 250 MHz; 1.3 below 500 MHz; 1.5 below 1 GHz	
Maximum insertion loss:	0.25 dB at 100 MHz; 0.75 dB to 500 MHz; 1.5 dB to 1 GHz	
Dimensions (in.):	6 long, 2 1/4 wide, 2 3/4 high (152 x 70 x 67 mm)	
Weight:	net 1 1/2 lb (0.7 kg); shipping 3 lb (1.4 kg)	
Price:	HP 355C, \$160	HP 355D, \$160
Option 001	Type N connectors, add \$25	
Option 003	panel mounting capability, add \$35	
Option 005	Type TNC connectors, add \$10	

Specifications	393A	394A
Frequency range:	500 MHz to 1 GHz	1 to 2 GHz
Attenuation or coupling:	5 to 120 dB, variable	6 to 120 dB, variable
Directivity (with loads less than 1.05 SWR):	typically > 10 dB, 10 to 40 dB attenuation	
Absolute accuracy (between matched generator and load):	± 1.25 dB or $\pm 1.75\%$ of dial reading, whichever is greater	± 1.25 dB or $\pm 2.5\%$ of dial reading, whichever is greater
SWR input:	<2.5, 5 to 15 dB <1.5, 15 to 30 dB <1.2, 30 to 120 dB	<2.5, 6 to 10 dB <1.8, 10 to 15 dB <1.6, 15 to 120 dB
SWR output:	<2.5, 5 to 15 dB <1.5, 15 to 30 dB <1.4, 30 to 120 dB	<2.5, 6 to 10 dB <1.8, 10 to 15 dB <1.6, 15 to 120 dB
Impedance:	50 ohms nominal	
Maximum voltage:	500 volts peak	
Average power:	approx. 200 watts maximum; power rating of terminations must be observed (908A, 0.5 watt terminations furnished)	
Dimensions (in.):	5 1/2 wide, 12 long, 2 3/4 deep (140 x 305 x 70 mm)	
Weight:	net 6 lb (2.7 kg); shipping 13 lb (5.8 kg)	
Price:	HP 393A, \$525	HP 394A, \$550
Option 001	supplied without 908A coaxial terminations, less \$70	



355C,D



393A

MICROWAVE TEST EQUIPMENT



COAXIAL ATTENUATORS

High performance, low cost, dc to 18 GHz
Models 8491A, B; 8492A; 8493A, B



8491A, B



8492A



8493A, B

Hewlett-Packard fixed coaxial attenuators provide precision attenuation, flat frequency response, and low VSWR over broad frequency ranges at low prices. Attenuators are available in nominal attenuations of 3-dB, 6-dB and 10-dB increments from 10 dB to 60 dB.

Each attenuator is swept-frequency tested. Swept-frequency testing to 18-GHz ensures that the attenuator meets specifications at all frequencies in the specified range. Spot frequency testing can easily miss narrow "resonances".

Specifications

Frequency Range	8491A and 8493A		8491B and 8493B			8492A		
	DC to 12.4 GHz		DC to 18 GHz			DC to 18 GHz		
Attenuation Accuracy			DC-12.4 GHz	12.4-18 GHz		DC-12.4 GHz	12.4-18 GHz	
3 dB	±0.3 dB		±0.3 dB			±0.3 dB		
6 dB	±0.3 dB		±0.3 dB	±0.4 dB		±0.3 dB	±0.4 dB	
10 dB	±0.5 dB		±0.5 dB			±0.5 dB		
20 dB	±0.5 dB		±0.5 dB	±1 dB		±0.5 dB	±1 dB	
30 dB	±1 dB		±1 dB			±1 dB		
40 dB ⁴	±1.5 dB		±1.5 dB			±1.5 dB		
50 dB ⁴	±1.5 dB		±1.5 dB			±1.5 dB		
60 dB ⁴	±2 dB		±2 dB			±2 dB		
SWR	DC-8 GHz	8-12.4 GHz	DC-8 GHz	8-12.4 GHz	12.4-18 GHz	DC-8 GHz	8-12.4 GHz	12.4-18 GHz
3 dB	1.25	1.35	1.25	1.35	1.5	1.2	1.3	1.5
6 dB	1.2	1.3	1.2	1.3	1.5	1.2	1.3	1.35
10 dB	1.2	1.3	1.2	1.3	1.5	1.15	1.25	1.3
20 dB	1.2	1.3	1.2	1.3	1.5	1.15	1.25	1.3
30 dB	1.2	1.3	1.2	1.3	1.5	1.15	1.25	1.3
40 dB ⁴	1.2	1.3	1.2	1.3	1.5	1.15	1.25	1.35
50 dB ⁴	1.2	1.3	1.2	1.3	1.5	1.15	1.25	1.35
60 dB ⁴	1.2	1.3	1.2	1.3	1.5	1.15	1.25	1.35
Calibration Frequencies	DC, 4, 8, 12 GHz		DC, 4, 8, 12, 18 GHz			DC, 4, 8, 12, 18 GHz		
Maximum Input Power	2 W avg, 100 W pk		2 W avg, 100 W pk			2 W avg, 100 W pk		
Connectors (50Ω)	8491A: Type N ¹ 8493A: SMA ²		8491B: Type N ¹ 8493B: SMA ²			APC-7 ³		
Dimensions: in. mm	8491A: 2-7/16×13/16 dia. 62×21 8493A: 1-9/16×½ dia. 40×13		8491B: 2-7/16×13/16 dia. 62×21 8493B: 1-9/16×½ dia. 40×13			2¼×13/16 dia. 70×21		
Weight: net shipping	8491A: 4 oz (110 g) 8 oz (220 g) 8493A: 1 oz (30 g) 8 oz (220 g)		8491B: 4 oz (110 g) 8 oz (220 g) 8493B: 1oz (30 g) 8 oz (220 g)			4 oz (110 g) 8 oz (220 g)		
Price: (Give Option Number for desired attenuation) ⁵	8491A	8493A ⁴	8491B	8493B ⁴		8492A		
	3 to 30 dB, \$60 each 40 to 60 dB, \$85 each Qty prices: 5 to 9, deduct \$6 each 10 to 24, deduct \$10 each	3 to 30 dB, \$65 each Qty prices: 5 to 9, deduct \$6 each 10 to 24, deduct \$10 each	3 to 30 dB, \$75 each 40 to 60 dB, \$110 each Qty prices: 5 to 9, deduct \$6 each 10 to 24, deduct \$10 each	3 to 30 dB, \$80 each Qty prices: 5 to 9, deduct \$6 each 10 to 24, deduct \$10 each		3 to 30 dB, \$140 each 40 to 60 dB, \$175 each Qty prices: 5 to 9, deduct \$8 each 10 to 24, deduct \$15 each		

¹ Mate with MIL-C-71 and MIL-C-39012 connectors.

² Miniature 50-ohm, 3-mm type. Mate with OSM, ARM, WPM, BRM, NPM connectors.

³ Amphenol RF Division, Danbury, Connecticut.

⁴ 40, 50, 60-dB attenuation not available in Models 8493A and 8493B.

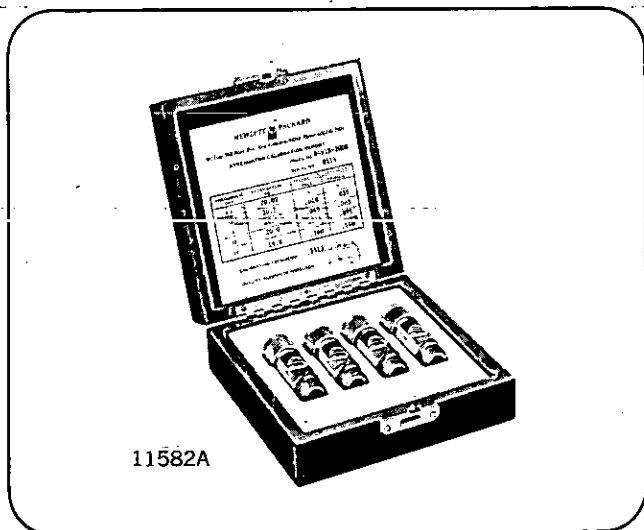
⁵ Option numbers same as attenuation values; e.g., Option 03 for 3 dB, Option 06 for 6 dB, Option 10 for 10 dB, etc.

COAXIAL ATTENUATORS

Step attenuator; 4-pad sets
Models 354A; 11581A, 11582A, 11583A



MICROWAVE
TEST EQUIPMENT



11582A

Attenuator Sets

A set of four Hewlett-Packard attenuators, 3, 6, 10, and 20 dB, are furnished in a handsome walnut accessory case. In addition to protecting the attenuators when not in use, the case is also a convenient storage place for the calibration reports provided with the set of four attenuators. These calibration reports include the accuracy of the measurement and are certified traceable to the National Bureau of Standards.

Attenuation calibrations are stamped on the attenuators at dc, 4, 8, and 12 GHz for the 8491A and at dc, 4, 8, 12, and 18 GHz for the 8491B and 8492A. In addition, the calibration report includes both the reflection coefficient and the attenuation at each port of the attenuator at these frequencies. Calibrations at other frequencies are available on request.

Specifications

Accuracy of insertion loss measurements: (S_{21} , S_{12})

DC	± 0.01 dB
4-18 GHz	± 0.097 dB

Accuracy of reflection coefficient measurements: (S_{11} , S_{22})

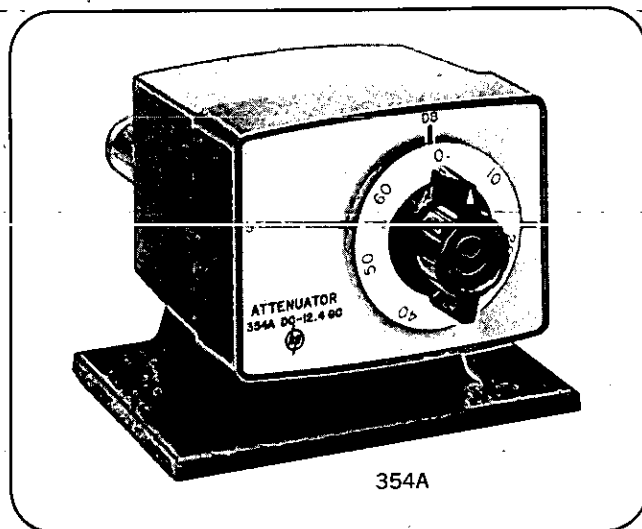
$$4-18 \text{ GHz: } \Delta \Gamma_L \leq 0.035$$

Prices:

11581A (for 8491A) includes 3, 6, 10, 20 dB values, \$250.

11582A (for 8491B) includes 3, 6, 10, 20 dB values, \$310.

11583A (for 8492A) includes 3, 6, 10, 20 dB values, \$575.



354A

354A Attenuator

The Model 354A is a turret-type coaxial attenuator which provides 0 to 60 dB of attenuation in 10-dB steps over the frequency range from dc to 12.4 GHz. Attenuation changes are made with simple knob rotation: no pull-turn-push sequence is required. For bench use the attenuator is supplied with a base; however, the base is removable for easy conversion to rack mount. Input and output connectors, both Type N female, are located on the back panel.

Specifications, 354A

Frequency range: dc to 12.4 GHz.

Incremental attenuation: 0 to 60 dB in 10-dB steps.

Accuracy (including frequency response): ± 2 dB.

Residual attenuation: less than 1.5 dB.

Impedance: 50 ohms.

Reflection coefficient

0 to 8 GHz: less than 0.2 (1.5 SWR, 14 dB return loss).
8 to 12.4 GHz: less than 0.273 (1.75 SWR, 11.3 dB return loss).

Maximum power: 2 W average, 300 W peak.

Connectors: Type N female, stainless steel.

Dimensions (maximum envelope): 4 in. wide, $3\frac{3}{8}$ in. high, $4\frac{1}{2}$ in. deep (102 x 79 x 114 mm); panel mount, $3\frac{1}{16}$ in. wide, $2\frac{5}{16}$ in. high, $3\frac{3}{4}$ in. deep behind panel (78 x 59 x 95 mm).

Weight (with base): net $2\frac{3}{4}$ lb (1.2 kg); shipping 4 lb (1.8 kg).

Price: Model 354A, \$350.

MICROWAVE TEST EQUIPMENT



VARIABLE ATTENUATORS

Frequency coverage to 40 GHz

Models 382A, C and 375A

Precision Variable Attenuators

Operation of these direct-reading, precision attenuators depends on a mathematical law, rather than on the resistivity of the attenuating material. Accurate attenuation from 0 to 50 dB (0 to 60 dB for S382C) is assured regardless of temperature and humidity. The

instruments can handle considerable power and feature large, easily read dials. In addition, the S382C achieves both long electrical length and short physical dimensions through dielectric loading. The result is an S-band attenuator which is only 2 1/4 inches long and yet is more accurate than previously available units.

HP Model	S382C	G382A	J382A	H382A	X382A	P382A	K382A1	R382A1
Frequency range (GHz):	2.6-3.95	3.95 - 5.85	5.3 - 8.2	7.05 - 10.0	8.2 - 12.4	12.4 - 18.0	18.0 - 26.5	26.5 - 40.0
Waveguide size (in): (EIA):	3 x 1 1/2 WR284	2 x 1 WR187	1 1/2 x 3/4 WR137	1 1/4 x 3/8 WR112	1 x 1/2 WR90	.702 x .391 WR62	1/2 x 1/4 WR42	.360 x .220 WR28
Power handling capacity, watts, average continuous duty:	10	15	10	10	10	5	2	1
Size length, in. (mm): height, in. (mm): depth, in. (mm):	25 3/4 (641) 6 (152) 8 (203)	31 3/8 (803) 9 3/4 (245) 7 3/4 (197)	25 (635) 7 1/4 (200) 6-3/16 (157)	20 (508) 7-15/16 (202) 6 1/2 (165)	15 3/8 (397) 7 3/4 (194) 4-11/16 (119)	12 1/2 (318) 7 3/4 (197) 4 3/4 (121)	7 3/8 (194) 6 1/4 (156) 4 3/4 (121)	6 3/8 (162) 6 1/4 (156) 4 3/4 (121)
Weight net, lb (kg): shipping, lb (kg):	18 (8.1) 28 (12.6)	22 (9.9) 32 (14.4)	13 (5.9) 24 (10.9)	10 (4.5) 22 (9.9)	6 (2.7) 8 (3.6)	6 (2.7) 8 (3.6)	4 (1.8) 9 (4.1)	4 (1.8) 9 (4.1)
Price:	\$1300	\$650	\$500	\$450	\$350	\$400	\$600	\$650

For all 382A Models

Incremental attenuation range: 0 to 50 dB.

Residual attenuation: less than 1 dB.

Reflection coefficient: less than 0.07 (1.15 SWR, 23.1 dB return loss).

Accuracy: $\pm 2\%$ of reading in dB, or 0.1 dB, whichever is greater. Includes calibration and frequency error.

For Model S382C

Calibrated attenuation range: 0 to 60 dB (above residual attenuation).

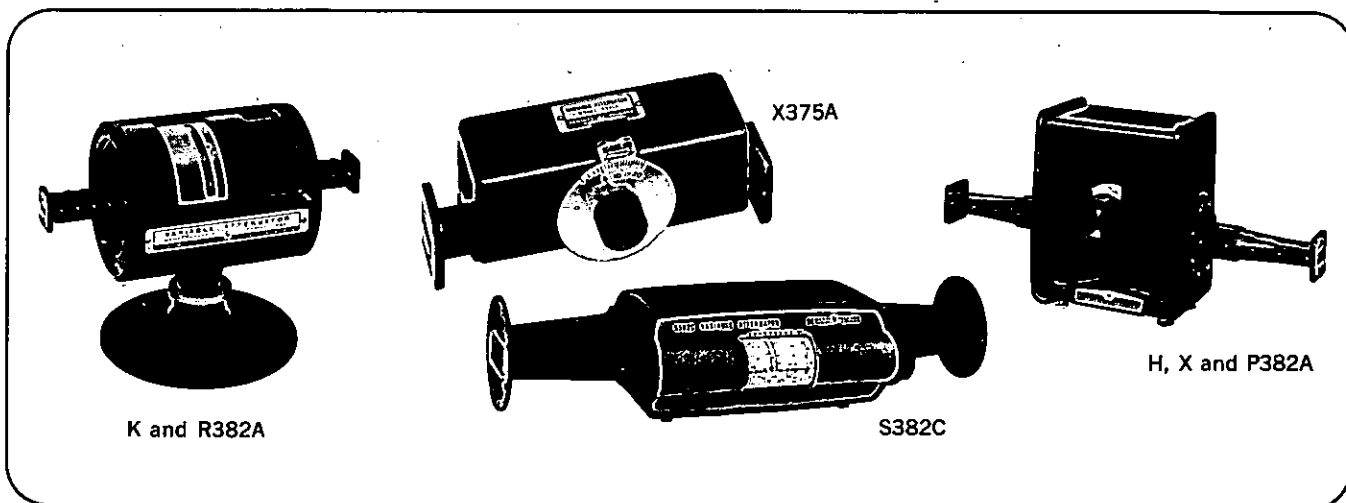
Residual attenuation: less than 1 dB.

Accuracy: $\pm 1\%$ of reading in dB, or 0.1 dB, whichever is greater, from 0 to 50 dB; $\pm 2\%$ of reading above 50 dB; includes calibration and frequency error.

Reflection coefficient: less than 0.091 (1.2 SWR, 20.8 dB return loss), 2.6 to 3 GHz; less than 0.07 (1.15 SWR, 23.1 dB return loss), 3 to 3.95 GHz.

Degree dial: 0 to 90°; calibrated in 0.01° increments.

¹Circular flange adapters: K-band (UG-425/U) 11515A, \$35 each; R-band (UG-381/U) 11516A, \$40 each.



K and R382A

X375A

S382C

H, X and P382A

General-Purpose Attenuators

Variable flap attenuators provide a simple, convenient means of adjusting waveguide power level or isolating source and load. They consist of a slotted section in which a matched resistive strip is inserted. The degree of strip penetration determines attenuation. A dial shows average reading over the frequency band, and a shielded dust cover reduces external radiation and eliminates hand capacity effects. Attenuation is variable from 0 to 20 dB. Dial calibration is accurate within ± 1 dB from 0 to 10 dB, ± 2 dB from 10 to 20

dB. Maximum reflection coefficient is 0.07 (1.15 SWR, 23.1 dB return loss).

Specifications, 375A

HP Model	Frequency (GHz)	Power dissipation (watts)	Length		Fits waveguide size (in.)	Price
			(in.)	(mm)		
X375A	8.2 - 12.4	2.0	7-3/16	183	1 x 1/2	\$175
P375A	12.4 - 18.0	1.0	7 3/4	184	.702 x .391	\$200

CRYSTAL DETECTORS

Flat response, high sensitivity, low SWR

Models 8470A, 8471A, 8472A, 423A, 424A, 420A, B, 422A



MICROWAVE
TEST EQUIPMENT

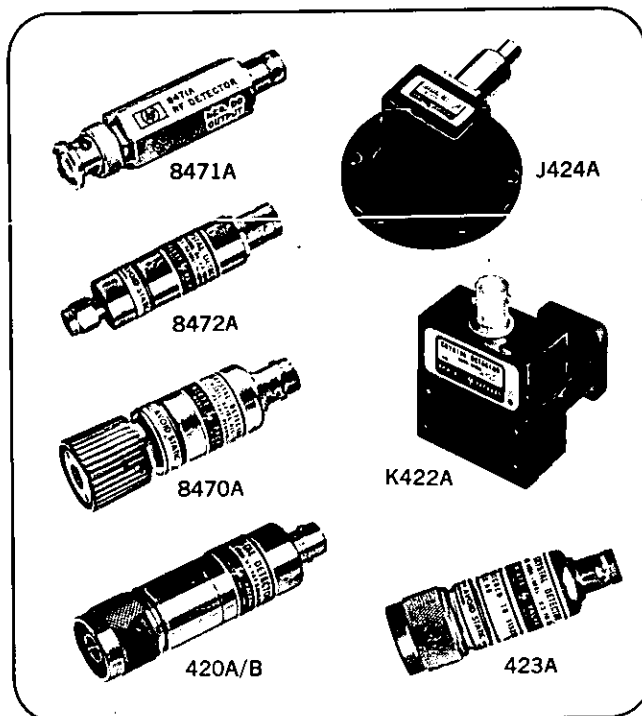
The HP 8470A and 8472A extend the frequency range of coaxial crystal detectors to 18 GHz. Like the 423A and 424A Crystal Detectors, the 8470A and 8472A combine extremely flat frequency response with high sensitivity and low SWR, making them extremely useful as the detecting element in closed-loop leveling systems. Matched pairs are available for applications requiring the utmost in detector tracking, and all but the 8472A can be supplied with video loads for optimum conformance to square law over a range of at least 30 dB.

The 422A Crystal Detectors are convenient waveguide detectors which cover K- and R-bands. They have a dynamic range of 40 dB or more, making them suitable for reflectometer as well as general-purpose applications.

The 420A is a low-cost crystal detector which covers the coaxial range from 10 MHz to 12.4 GHz, making it ideal for general-purpose video detection. The 420B is essentially the same unit as the 420A with the addition of a selected video load for optimum square-law characteristics in the 1 to 4 GHz range. Price: HP 420A, \$65; HP 420B, \$95.

RF Detector

The 8471A is a low-cost RF detector which covers the frequency range from 100 kHz to 1.2 GHz. This unit is a broadband, flat detector with a built-in filter. It is extremely well-suited for use with the HP 8601A Generator/Sweeper (see page 318).



HP Model	Frequency range (GHz)	Frequency resp. ¹ (dB)	Low-level sensitivity (mV/μW)	Maximum SWR	RF Input	Matched pair available	Square-law load available	Length		Shipping weight		Price
								(in.)	(mm)	(lb)	(kg)	
8471A	100 kHz-1.2 GHz	±0.6; typ ±0.1 over 100 MHz	>0.35	typically 1.3	BNC male	no	no	2¾	70	0.5	0.2	8471A, \$ 50
423A	0.01-12.4	±0.2/octave to 8 GHz; ±0.5 overall	>0.4	1.2 to 4.5 GHz; 1.35 to 7 GHz; 1.5 to 12.4 GHz	Type N male	yes ²	yes ³	2-15/32	63	1	0.5	423A, \$135
8470A	0.01-18	±0.2/octave to 8 GHz; ±0.5 to 12.4 GHz; ±1 overall	>0.4	1.2 to 4.5 GHz; 1.35 to 7 GHz; 1.5 to 12.4 GHz; 1.7 to 18 GHz	APC-7	yes ²	yes ³	2½	64	1	0.5	8470A, \$190
8472A	0.01-18	±0.2/octave to 8 GHz; ±0.5 to 12.4 GHz; ±1 overall	>0.4	1.2 to 4.5 GHz; 1.35 to 7 GHz; 1.5 to 12.4 GHz; 1.7 to 18 GHz	SMA type male	yes ²	no	2½	64	0.2	0.1	8472A, \$175
S424A	2.60-3.95	±0.2	>0.4	1.35	Waveguide cover flange	yes ⁴	yes ³	2-7/16	62	2	0.9	S424A, \$195
G424A	3.95-5.85	±0.2	>0.4	1.35		yes ⁴	yes ³	2-1/16	52	1	0.5	G424A, \$185
J424A	5.30-8.20	±0.2	>0.4	1.35		yes ⁴	yes ³	1-7/8	48	0.5	0.2	J424A, \$185
H424A	7.05-10.0	±0.2	>0.4	1.35		yes ⁴	yes ³	1-9/16	40	0.5	0.2	H424A, \$175
X424A	8.20-12.4	±0.3	>0.4	1.35		yes ⁴	yes ³	1-3/8	35	0.5	0.2	X424A, \$155
M424A	10.0-15.0	±0.5	>0.3	1.5		yes ⁴	yes ³	1	25	0.5	0.2	M424A, \$275
P424A	12.4-18.0	±0.5	>0.3	1.5		yes ⁴	yes ³	15/16	24	0.5	0.2	P424A, \$195
K422A ⁶	18.0-26.5	±2	≈0.3	2.5		yes ⁵	yes ³	2	51	1	0.5	K422A, \$275
R422A ⁶	26.5-40.0	±2	≈0.3	3		yes ⁵	yes ³	2	51	1	0.5	R422A, \$275

For all models
Maximum Input: 100 mW peak or average, (8471A: 3 V rms, 4.2 V pk).
Detector element: supplied.

Output polarity: negative (positive output available: for 423A, 8470A, 424A specify Option 003 - no additional charge; for 8471A specify Option 004 - no additional charge; for 8472A by special order only).

Output connector: BNC female (for OSSM on 8472A, specify Option H01 and add \$15/unit).

¹As read on a 416 Ratio Meter or 415 SWR Meter calibrated for square-law detectors.

²Frequency response characteristics (excluding basic sensitivity) track within ±0.2 dB per octave from 10 MHz to 8 GHz, ±0.3 dB from 8 to 12.4 GHz, and (8470A and 8472A) ±0.6 dB from 12.4 to 18 GHz; specify Option 001, add \$20 per unit (\$40 per pair). (8472A, available on special order.)

³<0.5 dB variation from square law up to 50 mV peak output into >75 kΩ; sensitivity typically >0.1 mV/μW; specify Option 002; add \$20.

⁴Frequency response characteristics (excluding basic sensitivity) track within ±0.2 dB for S-, G-, J- and H-band units, ±0.3 dB for X-band units, and ±0.5 dB for M- and P-band units; specify Option 001; add \$20 per unit (\$40 per pair).

⁵Matched pair of units fitted with square-law loads. Frequency response characteristics (excluding basic sensitivity) track within ±1 dB for power levels less than approx. 0.05 mW; specify Option 001; add \$40 per unit (\$80 per pair).

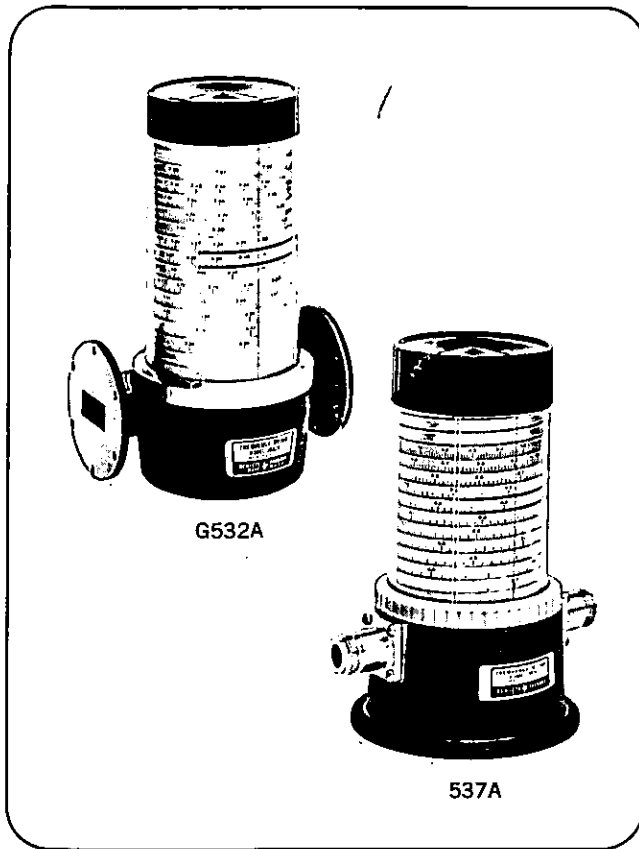
⁶Circular flange adapters: 11515A (UG-425/U) for K-band, \$35 each; 11516A (UG-381/U) for R-band, \$40 each.



FREQUENCY METERS

For general-purpose or lab use

Models 532A/B, 536A, 537A



Advantages

- High resolution, easy-to-read dial
- Direct reading
- Broadband
- Accuracy specified over 20°C and 0 to 100% relative humidity

These direct-reading frequency meters allow you to measure frequencies from 3.95 to 40 GHz in waveguide and from 960 MHz to 12.4 GHz in coax quickly and accurately. Their long scale length and numerous calibration marks provide a high resolution which is particularly useful when measuring frequency differences or small frequency changes. Frequency is read directly in GHz so no interpolation or charts are required.

The instruments comprise a special transmission section with a high-Q resonant cavity which is tuned by a choke plunger. A 1-dB or greater dip in output indicates resonance; virtually full power is transmitted off resonance. Tuning is by a precision lead screw, spring-loaded to eliminate backlash. Resolution is enhanced by a long, spiral scale calibrated in small frequency increments. For example, Model X532B has an effective scale length of 77 inches (1956 mm) and is calibrated in 5-MHz increments. Resettability is extremely good, and all frequency calibrations are visible so you can tell at a glance the specific portion of the band you are measuring. Except for the J532A, there are no spurious modes or resonances. (See note 4 below.)

Specifications, 532A Series, 536A and 537A

Model	Frequency Range (GHz)	Dial Accuracy (%)	Overall Accuracy ¹ (%)	Dip at Resonance	Calibration Increment (MHz)	Fits Waveguide		Equivalent Flange	Size In. (mm)			Weight lb (kg)		Price
						Nom. OD(in)	EIA		Length	Height	Depth	Net	Shipping	
536A	0.96-4.20	0.10 ²	0.17 ³	Note 6	2				6 (152)	9 1/4 (232)	6 (152)	10 (4,5)	13 (5,9)	\$550
537A	3.7-12.4	0.10	0.17	1 dB min	10				4 5/8 (118)	5 1/4 (146)	3 1/2 (89)	3 1/2 (1,6)	5 (2,3)	\$550
G532A	3.95-5.85	0.033	0.065	1 dB min	1	2 x 1	WR187	UG-407/U	6 1/4 (159)	9 1/2 (241)	5 (127)	9 1/4 (4,1)	12 (5,4)	\$500
J532A	5.30-8.20 ⁴	0.033	0.065	1 dB min	2	1 1/2 x 3/4	WR137	UG-441/U	6 1/4 (159)	9 1/4 (232)	4 1/2 (114)	7 1/2 (3,4)	11 (5,0)	\$475
H532A	7.05-10.0	0.040	0.075	1 dB min	2	1 1/4 x 5/8	WR112	UG-138/U	6 1/4 (159)	8 (203)	4 3/8 (111)	6 (2,7)	9 (4,1)	\$450
X532B	8.20-12.4	0.050	0.08	1 dB min	5	1 x 1/2	WR90	UG-39/U	4 1/2 (114)	6 1/8 (156)	2 1/8 (73)	3 1/2 (1,6)	4 (1,8)	\$275
P532A	12.4-18.0	0.068	0.10	1 dB min	5	0.702 x 0.391	WR62	UG-419/U	4 1/2 (114)	6 1/4 (159)	2 3/4 (70)	3 (1,4)	4 (1,8)	\$300
K532A	18.0-26.5	0.077	0.11	1 dB min	10	1/2 x 1/4	WR42	UG-595/U	4 1/2 (114)	5 3/8 (137)	2 1/8 (73)	2 (0,9)	3 (1,8)	\$450
R532A	26.5-40.0	0.083	0.12	1 dB min	10	0.360 x 0.220	WR28	UG-599/U	4 1/2 (114)	5 1/2 (140)	2 3/4 (70)	2 (0,9)	3 (1,8)	\$500

¹ Includes allowance for 0 to 100% relative humidity, temperature variation from 13 to 33°C, and backlash.

² 0.15, 0.96 to 1 GHz.

³ 0.22, 0.96 to 1 GHz.

⁴ Because of the wide frequency range of the J532A, frequencies from 7.6 to 8.2 GHz can excite the TE₁₁₂ mode when the dial is set between 5.3 and 5.6 GHz.

⁵ Circular flange adapters: K-band (UG-425/U) 11515A, \$35 each; R-band (UG-381/U) 11516A, \$40 each.

⁶ 1 dB min., 1-4 GHz; 0.6 dB min., 0.96-1 GHz and 4-4.2 GHz.

COAXIAL SWITCH, AIRLINES

Broadband switches, rotary air lines and joints
Models 8761A,B; 11588A, 11606A



MICROWAVE
TEST EQUIPMENT

8761 Coaxial Switch

The HP 8761 is a single-pole, double-throw coaxial switch with low standing-wave ratio, low insertion loss, and good isolation from dc to 18 GHz. Mechanically, the switch is a break-before-make type controlled by a latching solenoid. Solenoids are available in 12- and 26-volt ratings and can be operated by dc or pulsed signals. Any of seven coaxial connectors, or a 50-ohm termination, may be specified for each port.

Specifications, 8761

Characteristic impedance: 50 ohms.

Frequency range: dc to 18 GHz.

Standing-wave ratio: looking into one of the connected ports with 50 ohms (or built-in termination) on the other, third port open.

Frequency	Connector type		
	7-mm	N	3-mm (SMA)
dc-12.4 GHz	<1.15 (1.20)	<1.20 (1.25)	<1.25 (1.30)
dc-18 GHz	<1.20 (1.25)	<1.25 (1.30)	<1.30 (1.35)

SWR in parenthesis applies to switch with built-in termination.

These specifications apply when connected ports are of the same connector type; for mixed connector types, the larger of the two VSWR's applies. N-connector VSWR specifications apply to Option 4 connectors.

Insertion loss: <0.5 dB, dc-12.4 GHz; <0.8 dB, dc-18 GHz.

Isolation: >50 dB, dc-12.4 GHz; >45 dB, dc-18 GHz.

Power: safety handles 10 W average, 5 kW peak, without built-in termination; built-in termination rated at 2 W average, 100 W peak.

Switching energy: 1.5 W for 20 ms (permanent magnet latching).

Solenoid voltages (dc or pulsed): 12-15 V, 8761A; 24-30 V, 8761B.

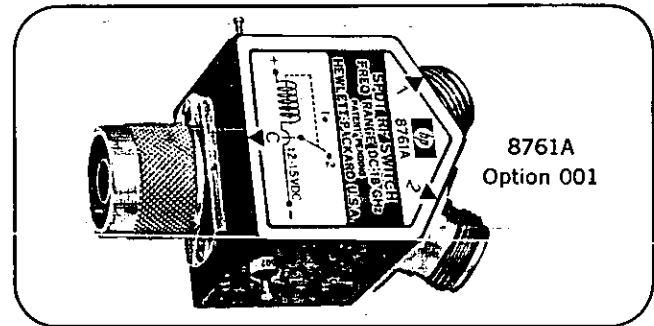
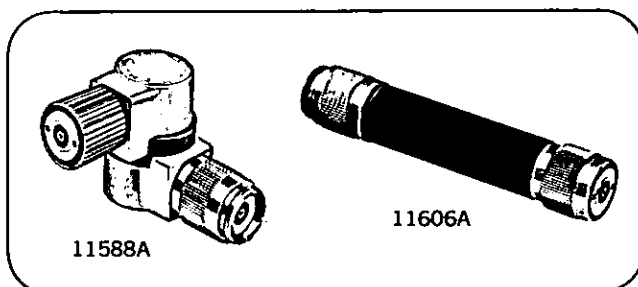
Switching speed: 35-50 ms (includes settling time).

Life: >1,000,000 switchings.

Dimensions: 1.6 x 1.5 x 1.5 in. (41 x 38 x 38 mm), excluding connectors and solenoid terminals.

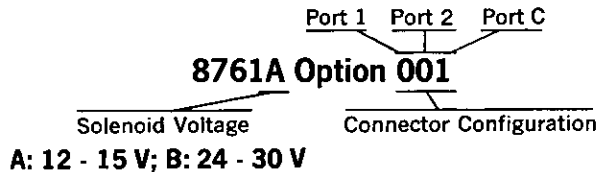
Weight: net, 5-8 oz (140-220 gm); shipping, 8-11 oz (220-300 gm).

Price: Model 8761, \$150 each, 1-9; \$140 each, 10-24. Add \$35 for built-in termination.



Ordering Information, 8761

Specify solenoid voltage and connectors (including built-in 50Ω termination) by the alphabetic suffix on the switch model number and the appropriate three-digit option number.



Option Code	Connector Type	Option Code	Connector Type
0	N Jack	4	7-mm for UT-250 Coax
1	N Plug	5	3-mm Jack
2	7-mm Jack	6	3-mm Plug
3	7-mm Plug	7	50Ω Termination

"Jack" identifies the connector with fixed threads; "plug" identifies the connector with the coupling nut.

11588A Swivel Adapter, 11606A Rotary Air Line

The 11606A Rotary Air Line and the 11588A Swivel Adapter are capable of a full 360° of rotation. A combination of the air line and the adapter permits rigid coax movement in three dimensions. Even the most awkwardly shaped devices can be easily connected or disconnected in a coax system with the aid of these components. Low VSWR and almost negligible uncertainty due to rotation make the 11588A and 11606A ideal for precision measurement systems.

Specifications, 11588A and 11606A

Frequency range: dc to 12.4 GHz.

Reflection coefficient (SWR): 0.048 (1.1). Ambiguity due to rotation 0.003 (-50 dB).

Insertion loss: 0.5 dB.

Connectors: 11588A, one precision 7-mm jack and one APC-7; 11606A, one 7-mm plug and one 7-mm jack. Combinations of APC-7, Type N, and 3-mm type SMA available: prices on request.

Dimensions: 11588A, 1 $\frac{5}{8}$ " x 2-5/16" x 1-3/16" (42 x 59 x 30 mm); 11606A, 3-15/16" x 3/4" x 3/4" (100 x 19 x 19 mm).

Weights: net, 8 oz (220 gm); shipping, 10 oz (280 gm), 11588A; 12 oz (340 gm), 11606A.

Prices: Model 11588A, \$180; Model 11606A, \$115.

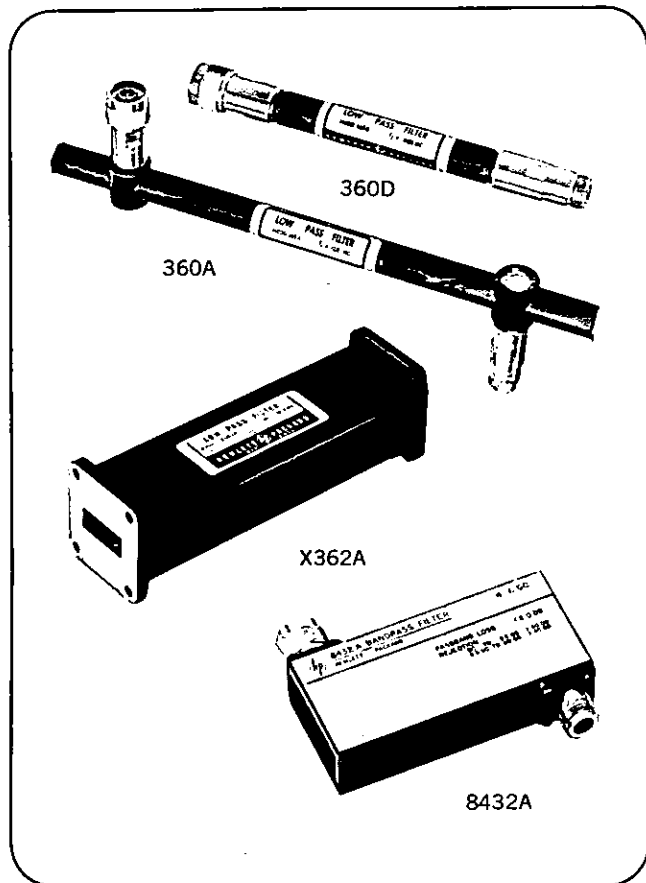
MICROWAVE TEST EQUIPMENT



LOW-PASS; BANDPASS FILTERS

Effective elimination of undesirable signals

Models 360A-D; 362A; 8430A-8436A



These Hewlett-Packard low-pass and bandpass filters facilitate microwave measurements by eliminating undesirable signals (such as harmonics) from the measurement system. Suppression of such signals is particularly important in applications such as slotted-line measurements, where harmonics generated by the signal source could otherwise impair measurement accuracy. These filters also can be used as preselectors for the HP 8551B Spectrum Analyzer. As such, they permit the maximum utilization of the analyzer's broad spectrum-width capability while ensuring virtually spurious-free displays.

Specifications, 360 Series

HP Model	360A	360B	360C	360D
Cut-off frequency	700 MHz	1200 MHz	2200 MHz	4100 MHz
Insertion loss	≤1 dB below 0.9 times cut-off frequency			
Rejection	≥50 dB at 1.25 times cut-off frequency			
Impedance	50 ohms through pass band; should be matched for optimum performance			
SWR	<1.6 to within 100 MHz of cut-off	<1.6 to within 200 MHz of cut-off	<1.6 to within 300 MHz of cut-off	<1.6 to within 300 MHz of cut-off
Connectors	Type N, one male, one female			
Overall length (in.) (mm)	10 ³ / ₈ (276)	7-7/32 (183)	10-25/32 (274)	7 ³ / ₈ (187)
Center line to male end (in.) (mm)	2 ¹ / ₈ (54)	2 ¹ / ₈ (54)	—	—
Center line to female end (in.) (mm)	2 ¹ / ₈ (57)	2 ¹ / ₈ (57)	—	—
Shipping weight (lb) (kg)	2 (0,9)	2 (0,9)	2 (0,9)	1 (0,45)
Price	\$95	\$90	\$85	\$80

Specifications, 362A Series

HP Model	X362A	M362A	P362A	K362A*	R362A*
Passband (GHz)	8.2-12.4	10.0-15.5	12.4-18.0	18.0-26.5	26.5-40.0
Stop band (GHz)	16-37.5	19-47	23-54	31-80	47-120
Passband insertion loss	less than 1 dB	less than 1 dB	less than 1 dB	less than 1 dB	less than 2 dB
Stopband rejection	at least 40 dB	at least 40 dB	at least 40 dB	at least 40 dB	at least 35 dB
SWR	1.5	1.5	1.5	1.5	1.8
Waveguide size, in. (EIA)	1 x 1/2 (WR 90)	0.850 x 0.475 (WR 75)	0.702 x 0.391 (WR 62)	1/2 x 1/4 (WR 42)	0.360 x 0.220 (WR 28)
Length, in. (mm)	5-11/32(136)	4-15/32(114)	3-11/16(94)	2 ¹ / ₂ (64)	1-21/32(42)
Shipping weight, lb (kg)	2(0,9)	1(0,45)	1(0,45)	1/2(0,23)	1/2(0,23)
Price	\$325	\$350	\$350	\$385	\$385

* Circular flange adapters: K-band (UG-425/U), HP 11515A, \$35 each; R-band (UG-381/U), HP 11516A, \$40 each.

Specifications, 8430 Series

HP Model	Passband frequency (GHz)	Max. passband insertion loss	Rejection band attenuation				Dimensions		Shipping weight		Price
			Below passband		Above passband						
			Frequency (GHz)	Attenuation	Frequency (GHz)	Attenuation	(in.)	(mm)	(lb)	(kg)	
8430A	1 to 2	2 dB	≤0.8	≥50 dB	2.2 to 20	≥45 dB	5 ¹ / ₂ x 4 ³ / ₄ x 1	140 x 121 x 25	3	1,4	\$235
8431A	2 to 4	2 dB	≤1.6	≥50 dB	4.4 to 20	≥45 dB	5 ¹ / ₂ x 3 x 1	140 x 76 x 25	3	1,4	\$235
8432A	4 to 6	2 dB	≤3.5	≥50 dB	6.5 to 20	≥45 dB	4 ¹ / ₂ x 2 x 1	114 x 51 x 25	2	0,9	\$300
8433A	6 to 8	2 dB	≤5.5	≥50 dB	8.5 to 20	≥45 dB	4 x 1 ¹ / ₂ x 1	102 x 38 x 25	2	0,9	\$300
8434A	8 to 10	2 dB	≤7.5	≥50 dB	10.5 to 17	≥45 dB	4 ³ / ₈ x 1 x 1	118 x 25 x 25	2	0,9	\$300
8435A	4 to 8	2 dB	≤3.2	≥50 dB	8.8 to 20	≥45 dB	3 ³ / ₈ x 1 ³ / ₄ x 1	92 x 45 x 25	2	0,9	\$235
8436A	8 to 12.4	2 dB	≤6.9	≥50 dB	13.5 to 17	≥45 dB	2 ¹ / ₈ x 1 x 1	73 x 25 x 25	2	0,9	\$235

Connectors: Type N, one male, one female.

KLYSTRON POWER SUPPLIES

Versatile power sources for many klystrons
Models 715A, 716B



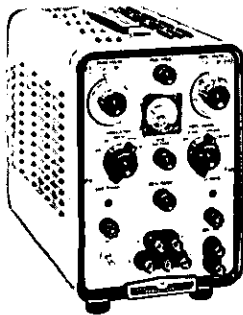
**MICROWAVE
TEST EQUIPMENT**

The HP 716B Supply offers superior regulation, noise, ripple and hum characteristics, plus the broad capability of powering at least 250 types of klystrons. Beam and reflector voltages are closely regulated and continuously adjustable, using calibrated controls accurate to within $\pm 2\%$ on beam voltage and to within $0.5\% \pm 1$ volt on repeller voltage. In addition, a regulated dc filament supply minimizes residual FM and AM from the klystrons.

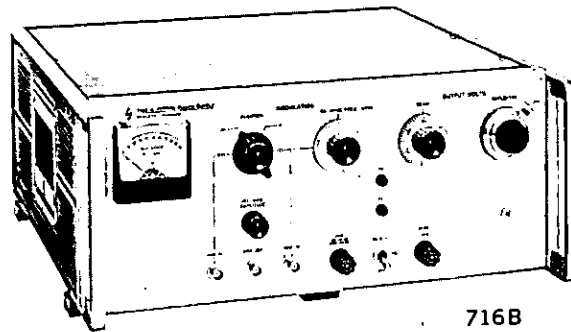
The reflector supply can be internally modulated with a sawtooth for FM or with a square wave for on-off operation. The positive excursion of the square wave is clamped to the reflector voltage, simplifying setup and minimizing double moding. Sawtooth and external modulation are ac-coupled to the reflector. A protective diode prevents the klystron reflector voltage from becoming positive with re-

spect to the cathode. Special circuitry eliminates turn-on transients that could be harmful to the klystron. Relays disconnect the beam supply to prevent klystron failure should the filament voltage drop below 1 volt or rise above 9 volts. The filament circuit in the 716B is protected against voltage surges up to 800 volts. These relays also disconnect the supplies whenever a klystron filament short circuits.

The HP 715A, designed to operate many types of low-power klystrons, offers a regulated 250-to-400 volt beam voltage, a 0-to-900 volt regulated reflector supply and a 6.3 volt ac filament supply. The reflector supply can also be square-wave modulated internally at the nominal frequency of 1000 Hz, externally modulated or sine-wave modulated at the power line frequency. Klystron protection is built in.



715A



716B

Specifications, 715A

Specifications, 716B

Reflector supply	0 to 900 V neg. with respect to beam supply, calibrated voltage controls; regulation within 1% $\pm 10\%$ line voltage variation; ripple < 10 mV; $10 \mu\text{A}$ max.	0 to 800 V neg. with respect to beam supply, accuracy $\pm 0.5\%$ of dial reading ± 1 V, line regulation better than 0.05%; ripple $< 500 \mu\text{V}$
Beam supply	250 to 400 V negative with respect to chassis ground, calibrated voltage controls; current 30 mA max. at 250 V, 50 mA max. at 400 V; regulation better than 1%, no load to full load or for $\pm 10\%$ normal line voltage variation; ripple less than 7 mV	250 to 800 V negative with respect to chassis ground, accuracy $\pm 2\%$ of dial reading; current 100 mA max.; line regulation better than 0.1%; load regulation better than 0.05%; ripple less than 1 mV
Filament supply	6.3 V ac, 1.5 amp maximum	6.3 V dc, adjustable nominally between 5 and 9 volts, isolated from ground; current 0 to 2 amps; 2 amps max. available to 6.5 V, decreasing to approx. 150 mA at 9 V, ripple < 2 mV; line regulation better than 1% with $\pm 10\%$ line change
Internal modulation	square wave: 1000 ± 100 Hz, adjustable; 0 to 110 V p-p, negative from reflector voltage; less than 10 μsec rise and decay times; sinusoidal power line frequency, 0 to 350 V p-p	square wave: 400 Hz to 2.5 kHz; 0.1% short-term stability; 10 to at least 150 V p-p, negative from reflector voltage; 5 μsec rise time; external sync of internal square wave 10 V peak, 500 k Ω nominal input impedance; sawtooth: 75 Hz nominal, 0 to at least 150 V nominal p-p, ac-coupled to reflector
External modulation	terminals provided; input impedance 100 k Ω	max. input 200 V p-p; input impedance 500 k Ω , 100 pF nominal
Oscilloscope output		with internal square-wave modulation: 1 V p-p min. for scope sync, 600 ohms output impedance; with internal sawtooth modulation: 10 V p-p min. for scope sweep, 50 k Ω output impedance
Meter	monitors beam current 0 to 50 mA	monitors beam current 0 to 100 mA
Power	115 V $\pm 10\%$, 50 to 60 Hz, 200 W	115/230 V switch $\pm 10\%$, 50 to 60 Hz, 200 to 350 W
Dimensions	7 $\frac{3}{4}$ " wide, 11 $\frac{1}{2}$ " high, 13 $\frac{3}{4}$ " deep (187 x 292 x 349 mm)	16 $\frac{1}{4}$ " wide, 6-25/32" high, 16 $\frac{1}{4}$ " deep (425 x 172 x 416 mm); hardware furnished for rack mounting
Weight	net 19 lbs (8,6 kg); shipping 24 lbs (10,8 kg)	net 46 lbs (20,7 kg); shipping 62 lbs (28,3 kg)
Accessories furnished	715A-16C shielded output cable, for connection to klystron	6' cable, terminated end mates with 716B (one furnished with instrument) HP Stock No. 00716-61601, \$25
Price	HP 715A, \$400; 50 to 60 Hz input	HP 716B, \$925



NOISE FIGURE METERS; SOURCES

Automatic noise figure measurements to 18 GHz
Models 340B, 342A; 343A, 345B, 347A, 349A

In microwave communications, radar, etc., the weakest signal that can be detected is usually determined by the amount of noise added by the receiving system. Thus, any decrease in the amount of noise generated in the receiving system will produce an increase in the output signal-to-noise ratio equivalent to a corresponding increase in received signal. From a performance standpoint, an increase in the signal-to-noise ratio by reducing the amount of noise in the receiver is more economical than increasing the power of the transmitter.

The quality of a receiver or amplifier is expressed in a figure of merit, or noise figure. Noise figure is the ratio, expressed in dB, of the actual output noise power of the device to the noise power which would be available if the device were perfect and merely amplified the thermal noise of the input termination

rather than contributing any noise of its own.

The Hewlett-Packard system of automatic noise figure measurement depends upon the periodic insertion of a known excess noise power at the input of the device under test. Subsequent detection of noise power results in a pulse train

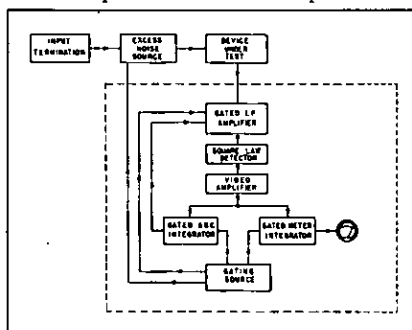


Figure 1. Automatic noise figure measurement system.

of two power levels. The power ratio of these two levels contains the desired noise figure information. Hewlett-Packard noise figure meters automatically measure and present this ratio directly in dB of noise figure.

Noise figure is discussed in detail in Hewlett-Packard Application Note 57, which is available from your local Hewlett-Packard field office upon request. Application Note 57, "Noise Figure Primer," derives noise figure formulas, describes general noise figure measurements and discusses accuracy considerations. One of the measurement systems discussed in Application Note 57 is shown in Figure 1. The portion of the diagram within the dashed box is a simplified block diagram of the HP 340B and 342A Noise Figure Meters, and the excess noise source could be any of the noise sources described on these pages.

Advantages:

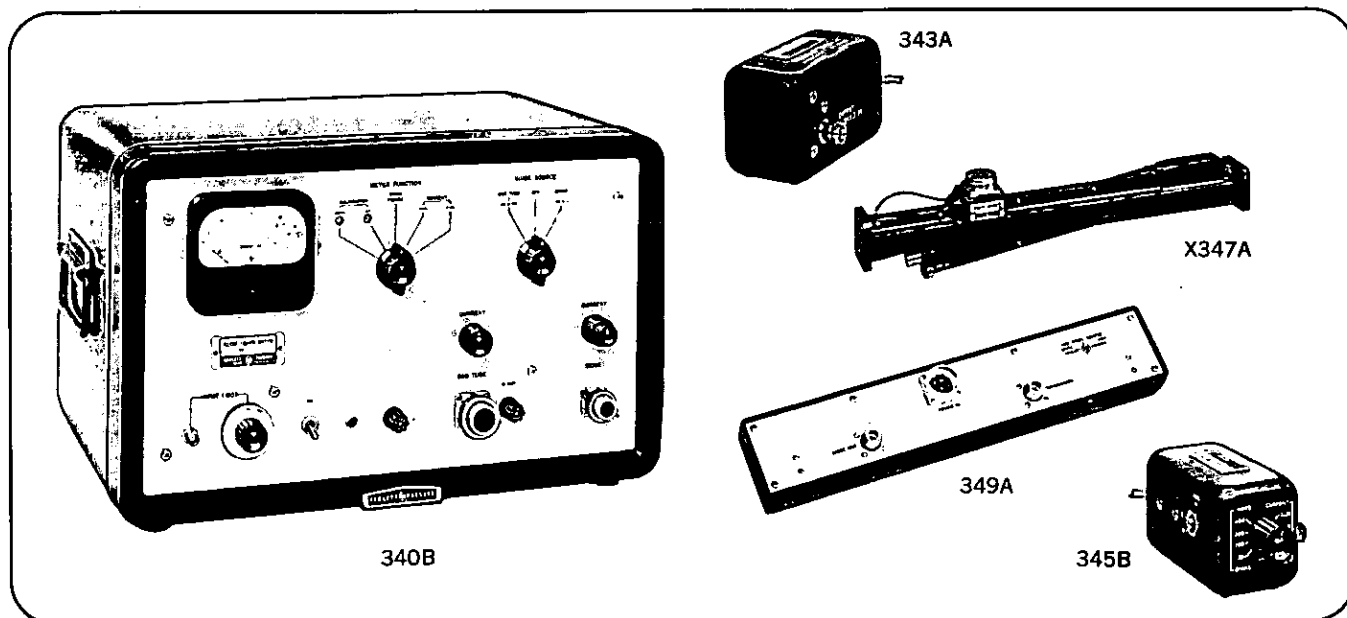
- Reads noise figure directly in dB
- Completely automatic measurement
- Easily used by nontechnical personnel
- No periodic recalibration needed
- Fast response; ideal for recorder operation

Uses:

- Measure noise figure in microwave or radar receivers, RF and IF amplifiers
- Compare unknown noise sources against known noise levels
- Adjust parametric amplifiers for optimum noise figure

HP noise figure meters and noise sources offer time-saving and cost-reducing advantages. Their ease of operation and continuous, automatic metering of noise figure reduce the time required for alignment and adjustment and simplify measurements so that they can be done by nontechnical personnel. No periodic recalibration of the meters is needed, and accurate alignment is easy, so high-level, on-line performance is assured.

In operation, a noise source is connected to the input of the device under test. The IF output of the device is connected to the 340B or 342A. The noise figure meter gates the noise source on and off. When the noise source is on, the noise level is that of the device plus the noise source. When the noise source is off, the noise level is that of the



device and its termination. The noise figure meter automatically compares the two conditions and displays noise figure directly in dB. Power to operate the noise source is supplied by the noise figure meter. Simply connect the noise source, adjust drive current using the controls and meter on the 340B or 342A, and the noise source is ready for operation.

Noise figure meters

Model 340B Noise Figure Meter, when used with an HP noise source, automatically measures and continuously displays noise figure for frequencies of 30 and 60 MHz. On special order up to four custom frequencies between 10 and 70 MHz, and some frequencies outside this range, can be supplied.

Model 342A is similar to Model 340B, except that it operates on five frequencies: 60, 70, 105, 200, and the basic tuned-amplifier frequency of 30 MHz. Up to six custom frequencies between 10 and 200 MHz, including 21.4 MHz, are available on special order.

Noise sources

Hewlett-Packard 343A VHF Noise Source: Specifically for IF and RF amplifier noise measurement, a temperature-limited diode source with broadband noise output from 10 to 600 MHz with 50-ohm source impedance and low SWR.

Hewlett-Packard 345B IF Noise Source: Operates at either 30 or 60 MHz, as selected by a switch; another selector permits matching 50-, 100-, 200-, and 400-ohm impedances.

Hewlett-Packard 347A Waveguide Noise Source: Argon gas discharge tubes mounted in waveguide sections; for waveguide bands 3.95 through 18 GHz, they provide uniform noise throughout the range; maximum SWR is 1.2.

Hewlett-Packard 349A UHF Noise Source: Argon gas discharge tubes in Type N coaxial configuration for automatic noise figure readings, 400 to 4000 MHz.

Specifications, 340B and 342A

Noise figure range: 5.2 dB noise source, 0 to 15 dB, indication to infinity; 15.2 dB noise source, 3 to 30 dB, indication to infinity.

Accuracy (excluding source accuracy): noise diode scale: ± 0.5 dB, 0 to 15 dB; gas tube scale: ± 0.5 dB, 10 to 25 dB; ± 1 dB, 3 to 10 dB and 25 to 30 dB.

Input frequency: 340B; 30 or 60 MHz, selected by switch; 342A: 30, 60, 70, 105, and 200 MHz, selected by switch. Other frequencies available; prices and details on request.

Bandwidth: 1 MHz minimum.

Input requirements: -60 to -10 dBm (noise source on); corresponds to gain between noise source and input of approximately 50 to 100 dB for 5.2 dB noise source and 40 to 90 dB for 15.2 dB noise source.

Input impedance: 50 ohms nominal.

AGC output: nominal 0 to -6 V from rear binding posts.

Recorder output: 1 mA maximum into 2000 ohms maximum.

Power input: 115 or 230 volts $\pm 10\%$, 50 to 60 Hz, 185 to 435 watts, depending on noise source and line voltage.

Power output: sufficient to operate 343A, 345B, 347A or 349A Noise Sources.

Dimensions: cabinet: $20\frac{3}{4}$ " wide, $12\frac{3}{4}$ " high, $14\frac{1}{2}$ " deep (527 x 324 x 368 mm); rack mount: 19" wide, 10-15/32" high, $13\frac{7}{8}$ " deep behind panel (483 x 266 x 353 mm).

Weight: net 44 lb (19.8 kg), shipping 55 lb (24.8 kg) (cabinet); net 37 lb (16.7 kg), shipping 51 lb (22.9 kg) (rack mount).

Accessories furnished: one 340A-16A Cable Assembly, connects noise figure meter to 347A or 349A Noise Source.

Price: HP 340B, \$915 (cabinet); HP 340BR \$900 (rack mount); HP 342A, \$1015 (cabinet); HP 342AR, \$1000 (rack mount); not available in all countries.

Specifications, 343A

Frequency range: 10 to 600 MHz.

Excess noise ratio¹: 10 to 30 MHz, 5.20 dB ± 0.20 dB; 100 MHz, 5.50 dB ± 0.25 dB; 200 MHz, 5.80 dB ± 0.30 dB; 300 MHz, 6.05 dB ± 0.30 dB; 400 MHz, 6.30 dB ± 0.50 dB; 500 MHz, 6.50 dB ± 0.50 dB; 600 MHz, 6.60 dB ± 0.50 dB.

Source impedance: 50 ohms.

Reflection coefficient: < 0.091 (1.2 SWR), 10 to 400 MHz; < 0.13 (1.3 SWR), 400 to 600 MHz.

Noise generator: temperature-limited diode.

Dimensions: $2\frac{3}{4}$ " wide, $2\frac{1}{2}$ " high, 5" deep (70 x 63 x 127 mm).

Weight: net $\frac{3}{4}$ lb (0.34 kg); shipping 2 lbs (0.9 kg).

Price: HP 343A, \$125.

Option 001: spare noise diode(s) calibrated and supplied with instrument, add \$40 each.

Specifications, 345B

(same weight and dimensions as 343A)

Spectrum center: 30 or 60 MHz, selected by switch.

Excess noise ratio¹: 5.2 dB.

Source impedance: 50, 100, 200 or 400 ohms, $\pm 4\%$, as selected by switch; less than 1 pF shunt capacitance.

Noise generator: temperature-limited diode.

Price: HP 345B, \$150 (operation at any two frequencies between 10 and 60 MHz in lieu of 30 and 60 MHz available on special order).

Specifications, 347A

HP Model	Range (GHz)	Excess noise ratio ^{1,2}	Approx. length		Price
			(in.)	(mm)	
G347A	3.95—5.85	15.2 ± 0.5	19	483	\$400
J347A	5.30—8.20	15.2 ± 0.5	19	483	\$400
H347A	7.05—10.0	15.6 ± 0.5	16	406	\$375
X347A	8.20—12.4	15.7 ± 0.4	14 $\frac{1}{4}$	375	\$325
P347A	12.4—18.0	15.8 ± 0.5	14 $\frac{1}{4}$	375	\$375

Reflection coefficient for all models, fired or unfired, 0.091 (SWR 1.2) max. (source terminated in well-matched load).

Specifications, 349A

Frequency range: 400 to 4000 MHz, wider with correction.

Excess noise ratio¹: 15.6 dB ± 0.6 dB; 400 to 1000 MHz; 15.7 dB ± 0.5 dB; 1000 to 4000 MHz.

SWR: < 1.35 (fired), < 1.55 (unfired) up to 2600 MHz; < 1.55 (fired or unfired), 2600 to 3000 MHz; < 2.0 (fired), < 3.0 (unfired) 3000 to 4000 MHz.

Dimensions: 3" wide, 2" high, 15" long (76 x 51 x 381 mm).

Weight: net $3\frac{1}{4}$ lb (1.4 kg); shipping 6 lb (2.7 kg).

Price: HP 349A, \$325.

$$^1 \text{ ENR (dB)} = 10 \log \frac{k(T - T_0)B}{kT_0B}$$

where kTB = available noise power, and kT_0B = available noise power with noise source at 290° K.

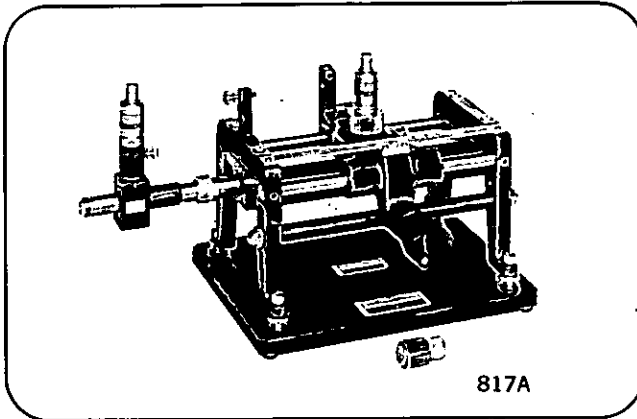
² Includes factor for insertion loss.

MICROWAVE TEST EQUIPMENT



SLOTTED LINES; DETECTORS

Precision tools for measurements to 40 GHz
Models 805C-817A; 440A-447B, 448A



817A

817A Coaxial Swept Slotted Line System

The 817A is a fully tested, complete swept slotted line system that enables you to make accurate swept-frequency SWR measurements in coax from 1.8 to 18 GHz. The 817A system consists of an 816A Coaxial Slotted Line, an 809C Carriage with baseplate, and a 448A Slotted Line Sweep Adapter. These items are discussed individually in the succeeding paragraphs. The 817A is provided with Type N female and APC-7 sexless connectors. On an optional basis, both Type N male and female connectors are available.

Specifications, 817A

(System consists of 816A Slotted Line, 809C Carriage with baseplate, and 448A Slotted Line Sweep Adapter)

Frequency range: 1.8 to 18 GHz.

Impedance: $50\Omega \pm 0.2\Omega$.

Output connector: APC-7 or Type N female, depending upon which end of the 816A is connected to the load (also see option below). Type N connector is stainless steel and mates compatibly with Type N connectors whose dimensions conform to MIL-C-39012 or MIL-C-71.

Residual SWR and (reflection coefficient)

APC-7 connector:

1.8 to 8 GHz: 1.02 (0.01).

8 to 12.4 GHz: 1.03 (0.015).

12.4 to 18 GHz: 1.04 (0.02).

Type N connector:

1.8 to 8 GHz: 1.04 (0.02).

8 to 12.4 GHz: 1.05 (0.024).

12.4 to 18 GHz: 1.06 (0.029).

Maximum power: 2 W average (limited by 6-dB pad in 448A).

Accessories furnished: 11512A N-male short, 11565A APC-7 short.

Dimensions (maximum envelope): 13½ in. long, 7 in. wide, 7 in. high (343 x 178 x 178 mm).

Weight: net 14½ lb (6,5 kg); shipping 19 lb (8,6 kg).

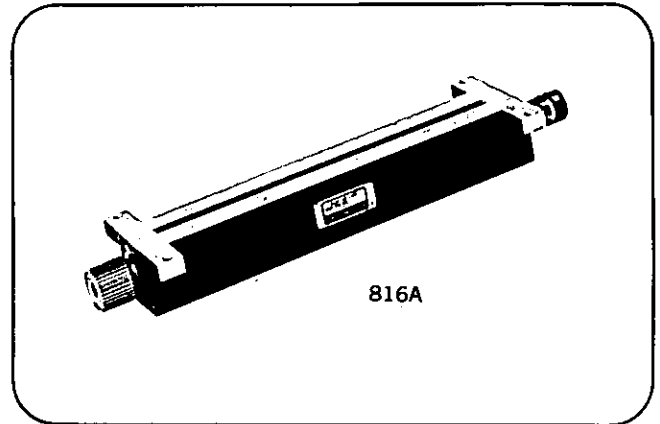
HP 8690B Sweep Oscillator with appropriate RF Unit.
HP 141A Oscilloscope with 1416A Swept-Frequency Indicator plug-in.

HP 905A Sliding Load.

HP 909A Termination.

Price: Model 817A, \$925.

Option 022: Type N male connector in lieu of APC-7, less \$15.



816A

816A Coaxial Slotted Section, 1.8-18 GHz

The 816A enables you to make swept-frequency slotted line measurements from 1.8 to 18 GHz in coaxial systems (HP 448A is required; see below). High accuracy is ensured with the low residual SWR of the 816A. Thus, you can take advantage of the complete coverage offered by the swept-frequency technique. Fixed-frequency measurements from 1.8 to 18 GHz can also be made using HP 447B Probe (see below). With its broad frequency range, the 816A covers the extremely important X-band (8.2 to 12.4 GHz). In addition, it extends the range of coaxial slotted line measurements through P-band (12.4 to 18 GHz), where there is an increasing use of coaxial devices.

Model 816A consists of two parallel planes and a rigid center conductor. This configuration virtually eliminates slot radiation and minimizes the effect of variation in probe penetration and centering. It also provides greater mechanical stability. The 816A is fitted with one APC-7 and one Type N female connector. On an optional basis, the APC-7 can be replaced with a Type N male connector, or both connectors can be APC-7's. Other combinations are available on special order.

Specifications, 816A

Carriage: fits HP 809C Carriage.

Frequency range: 1.8 to 18 GHz with 447B probe.

Impedance: $50\Omega \pm 0.2\Omega$.

Connectors: one APC-7, one Type N female (stainless steel, compatible with connectors conforming to MIL-C-39012 and MIL-C-71); either end can be connected to the load.

Residual SWR and (reflection coefficient): 1.02 (0.01) to 8 GHz, 1.03 (0.015) to 12.4 GHz, 1.04 (0.02) to 18 GHz for APC-7 connector; 1.04 (0.02) to 8 GHz, 1.05 (0.024) to 12.4 GHz, 1.06 (0.029) to 18 GHz for N-female connector.

Slope and irregularities: 0.1 dB per half wavelength, 0.2 dB maximum cumulative when adjusted on 809C Carriage.

Length: 9 $\frac{3}{4}$ in. (248 mm).

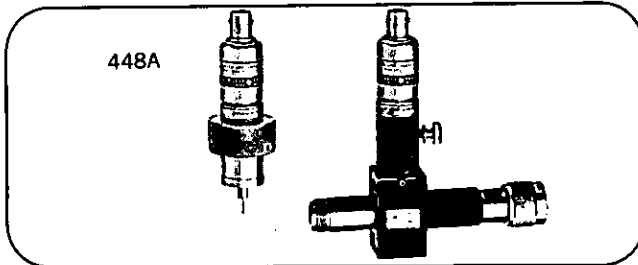
Weight: net 1 $\frac{1}{4}$ lb (0,6 kg); shipping, 3 lb (1,4 kg).

Accessories furnished: 11512A Type N male short; 11565A APC-7 short.

Price: HP 816A, \$250.

Option 011: both connectors APC-7, add \$25.

Option 022: Type N male connector in lieu of APC-7 (11512A N-male, 11511A N-female shorts supplied), less \$15.



448A Slotted Line Sweep Adapter, 1.8-18 GHz

The HP 448A permits accurate swept-frequency SWR measurements in coax from 1.8 to 18 GHz with the 816A Slotted Section. The 448A includes a short slotted line section and two matched detectors with adjustable probes. One detector fits in the slotted section of the 448A, and its output levels the signal source. The other detector monitors the standing waves in the HP 816A Slotted Section.

Specifications, 448A

Frequency range: 1.8 to 18 GHz.

Maximum power: 2 W average (limited by pad in leveling detector).

Equipment supplied: one fixed slotted section, one pair of matched detectors with adjustable probes.

Slotted line connectors: Type N, one male, one female, stainless steel (compatible with connectors conforming to MIL-C-39012 and MIL-C-71).

Detector output connector: BNC female.

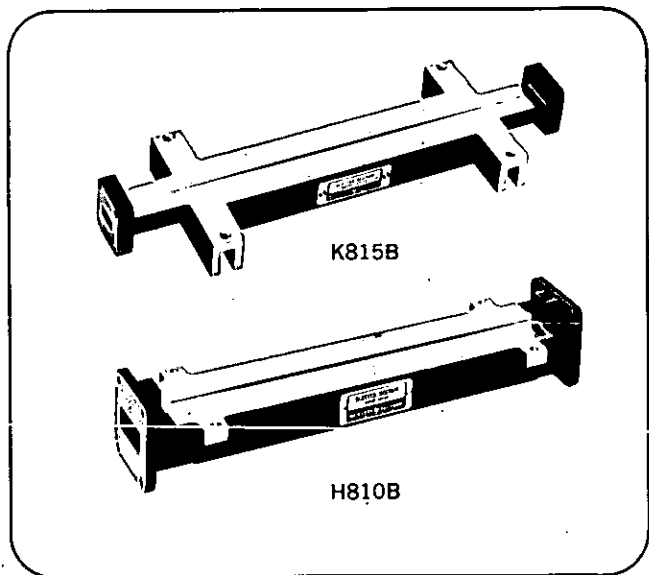
Weight: net 1 lb (0,45 kg); shipping 2 lb (0,9 kg).

Price: HP 448A, \$400.

810B, 815B Slotted Sections, 3.95-40 GHz

The 810B Waveguide Slotted Sections also are designed for use with the 809C Carriage. Each is a precision-manufactured section of waveguide in which a small longitudinal slot is cut. A traveling probe on the 809C Carriage samples the waveguide's electric field along the slot and permits precise plotting of variations along the entire length of probe travel. Ends of the slots are tapered to reduce SWR to less than 1.01. The waveguide sections are broached and checked with precision gauges for careful control of guide wavelength. Broaching is essentially a linear cutting stroke which eliminates even the minor surface irregularities inherent with milling cutters. Five waveguide sizes are available.

The 815B Waveguide Slotted Sections are designed to fit the 814B Carriage. Like the lower-frequency slotted sections, each 815B is precision-manufactured, broached and checked with precision gauges for careful control of guide wavelength. The slot is tapered to insure a low SWR.



Specifications, 810B

HP Model	Frequency range (GHz)	Fits waveguide size		Equivalent flange	Price
		nom. OD (in.)	EIA		
G810B	3.95-5.85	2 x 1	WR187	UG407/U	\$175
J810B	5.30-8.20	1 $\frac{1}{2}$ x $\frac{3}{4}$	WR137	UG441/U	\$150
H810B	7.05-10.0	1 $\frac{1}{4}$ x $\frac{5}{8}$	WR112	UG138/U	\$135
X810B	8.20-12.4	1 x $\frac{1}{2}$	WR90	UG135/U	\$125
P810B	12.4-18.0	0.702 x 0.391	WR62	UG419/U	\$150

Carriage: fits 809C Carriage.

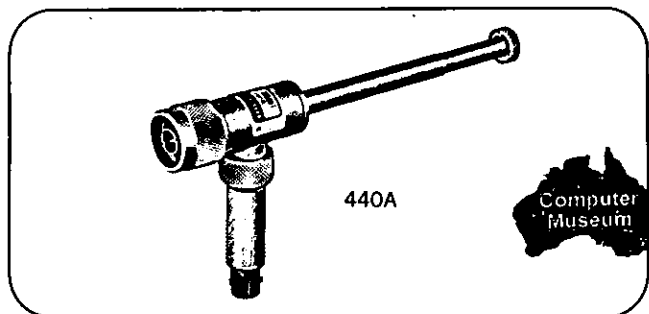
Length of all sections: 10 $\frac{1}{4}$ " (260 mm).

Slope and irregularities: slot discontinuity results in SWR < 1.01.

Specifications, 815B

	K815B	R815B
Frequency range (GHz):	18 to 26.5	26.5 to 40
Residual SWR:	1.01	1.01
Equivalent flange:*	UG595/U	UG599/U
Fits waveguide size:	(in.) 1/2 x 1/4 (EIA) WR42	0.360 x 0.220 WR28
Overall length:	7-9/16" (192 mm)	7-9/16" (192 mm)
Price:	\$525	\$525

*Circular flange adapters: K-band (UG425/U) 11515A, \$35 each; R-band (UG381/U) 11516A, \$40 each.

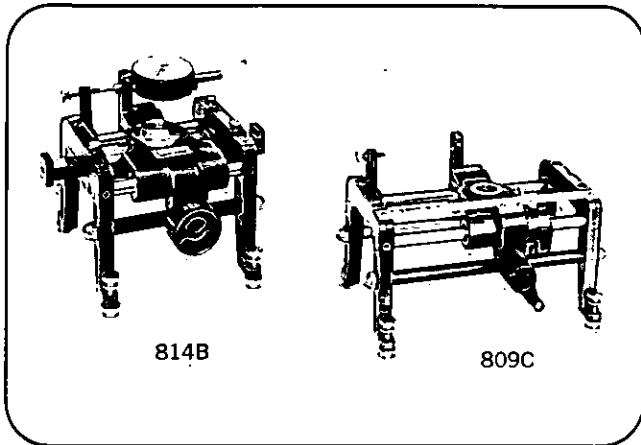


440A Detector Mount

The HP 440A is a tunable, easy-to-use instrument for detecting RF energy in coaxial systems (2.4 to 12.4 GHz) or, in conjunction with the HP 442B, in waveguide or coaxial slotted sections. Just one adjustment is required for tuning. Crystals or bolometers may be used interchangeably in the same holder. A built-in RF bypass is provided. The detector (not supplied) can be a 1N21 or 1N23 Crystal or 821 Series Barretter. Input connector is Type N male; detector output BNC female. Price: HP 440A, \$100.

SLOTTED LINES, DETECTORS *continued*

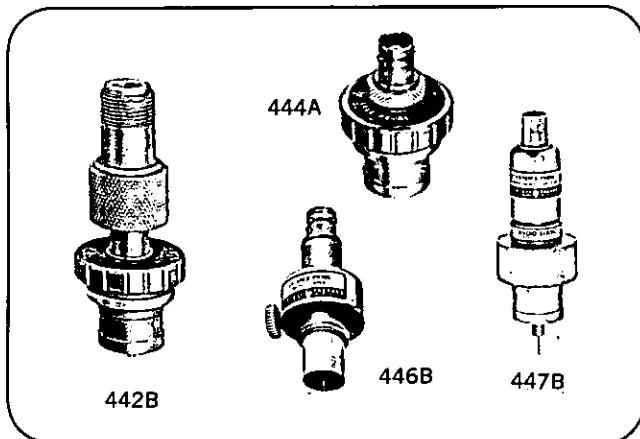
Precision tools for measurements to 40 GHz
Models 805C - 817A; 440A - 447B; 448A



809C, 814B Carriages

The Model 809C Carriage is a precision mechanical assembly which operates with five HP 810B Waveguide Slotted Sections (3.95 to 18 GHz) and with HP 816A Coaxial Slotted Section (1.8 to 18 GHz). The carriage eliminates the cost of a probe carriage for each frequency band. Sections can be interchanged in seconds. The 809C is designed for use with the HP 444A or 447B Untuned Probe, the HP 442B Broadband Probe, or 448A Slotted Line Sweep Adapter. The carriage has a centimeter scale with a vernier reading to 0.1 mm, and provision is made also for mounting a dial gauge if more accurate probe position readings are required. Price: HP 809C, \$225.

The HP 814B Carriage, also a precision assembly, is designed for use with the HP K and R815B Waveguide Slotted Sections (18 to 40 GHz) and HP 446B Untuned Probe. The carriage is equipped with a dial indicator for accurate reading. Slotted sections are easily interchanged. Price: HP 814B, \$525.



442B, 444A, 446B, 447B Probes

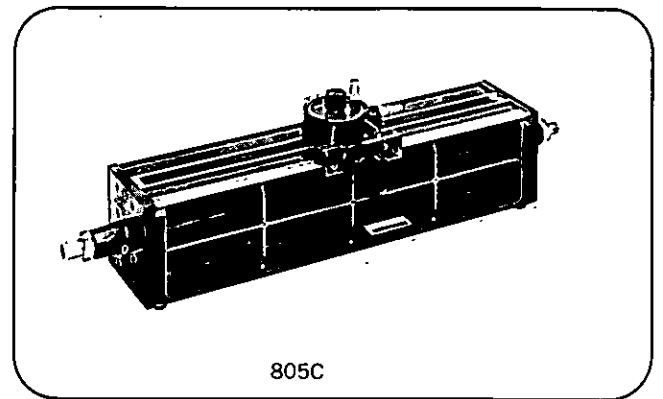
Model 442B is a probe whose depth of penetration into a slotted section is variable. Held in position by friction, it may be fixed in place by a locking ring. Sampled RF appears at a Type N jack. It can be connected to a 440A Detector Mount to form a sensitive and convenient tuned RF detector for HP 810B waveguide slotted sections. The 442B fits the

809C Carriage. Frequency range is 2.6 to 12.4 GHz. Price: HP 442B, \$50.

The 444A Untuned Probe, for use with HP 810B Waveguide Slotted Sections, consists of a crystal, plus a small antenna in a convenient housing. The probe is held in position by friction or may be fixed by a locking ring. No tuning is required, and sensitivity equals or exceeds many elaborate single- and double-tuned probes. The 444A fits the 809C Carriage or other carriages with a $\frac{3}{4}$ in. (19 mm) mounting hole. Frequency range is 2.6 to 18 GHz. Accessory furnished: 11506A Probe Extension Kit. Price: HP 444A, \$55.

The HP 446B is a broadband detector and probe which consists of a modified 1N53 silicon diode in a carefully designed shielded housing. No tuning is required, and probe penetration may be varied quickly and easily. Designed for use with the 814B Carriage, the 446B has a frequency range of 18 to 40 GHz. Price: HP 446B, \$225.

Model 447B consists of a crystal diode detector plus a small antenna probe for sampling energy in HP 816A Coaxial Slotted Lines. The untuned probe is extremely sensitive over its frequency range of 1.8 to 18 GHz. Such performance is achieved through the use of a unique, easily replaced diode package developed by Hewlett-Packard. The 447B fits HP 809C Carriage or other carriages with a $\frac{3}{4}$ in (19 mm) mounting hole. Price: HP 447B, \$125.



805C Slotted Line, 500-4,000 MHz

Model 805C is a coaxial slotted line with an integral probe circuit tunable from 500 to 4,000 MHz. The slotted line consists of two parallel planes and a rigid center conductor. This configuration results in negligible slot radiation, minimum sensitivity to variation in probe depth or centering, and greater structural stability.

Specifications, 805C

Frequency range: 500 to 4,000 MHz; minimum frequency determined by usable length of 14½ in. (368 mm).

Impedance: 50Ω.

Residual SWR: less than 1.04:1.

Slope: 0.2 dB or less.

Connectors: Type N, one male, one female; either end may be connected to the load.

Calibration: metric, cm and mm; vernier reads to 0.1 mm.

Detector probe: tunable; detector may be 1N21B Crystal (supplied) or 821 series barretter or selected 1/100-amp instrument fuse.

Accessories furnished: 11511A Shorting Jack; 11512A Shorting Plug.

Accessory available: 11510A Carrying Case, \$65.

Price: HP 805C, \$750.

MISCELLANEOUS EQUIPMENT

Increase flexibility of microwave measurements
Models 281A/B, 292A/B; P932A, 934A



MICROWAVE TEST EQUIPMENT

281A,B; 292A,B Adapters

HP 281A,B Adapters transform waveguide impedance into 50-ohm coaxial impedance. Power can be transmitted in either direction, and each adapter covers the full frequency range of its waveguide band with SWR less than 1.25. The 281A Adapter is fitted with a cover flange and brass type N female connector; the 281B, with a cover flange and an APC-7 or optional stainless steel type N female connector.

Models 292A,B Waveguide-to-Waveguide Adapters connect two different waveguide sizes with overlapping frequency ranges. The 292A consists of a short tapered section of waveguide. The 292B is broached waveguide with a step transition between waveguide sizes.

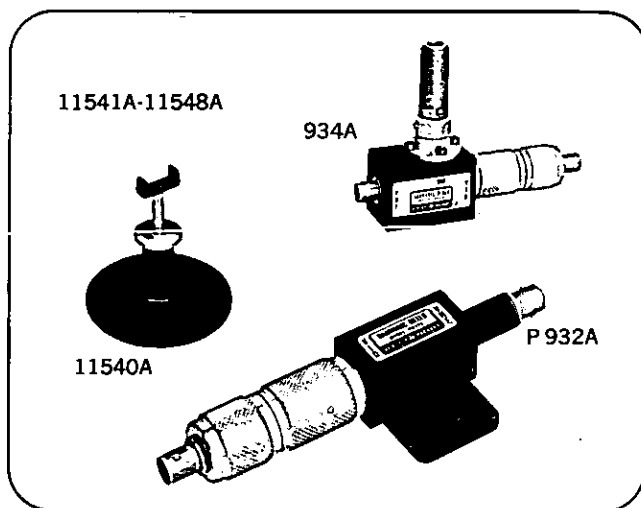
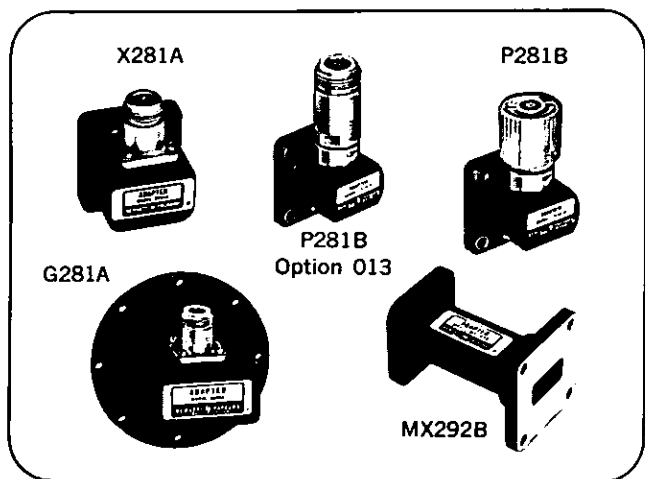
Specifications 281A,B							
HP Model	SWR	Frequency Range (GHz)	Waveguide Size EIA	Coaxial Connector	Length		Price†
					(in.)	(mm)	
S281A	1.25	2.60-3.95	WR284	N Female	2½	64	\$75
G281A	1.25	395-5.85	WR187	N Female	2¾	54	\$60
J281A	1.25*	5.30-8.20	WR137	N Female	2	51	\$55
H281A	1.25	7.05-10.0	WR112	N Female	1¾	41	\$50
X281A	1.25	8.20-12.4	WR90	N Female	1¾	35	\$45
X281B	1.25	8.20-12.4	WR90	APC-7**	1¾	35	\$80
P281B	1.25	12.4-18	WR62	APC-7**	15/16	24	\$95

*1.3 from 5.3 to 5.5 GHz.

**Option 013. Furnished with stainless steel N-female connector, less \$15.

†For quantities 5-9, deduct \$6; 10-24, deduct \$10.

Specifications 292A,B					
HP Model	SWR	Length		Frequency range (GHz)	Price
		(in.)	(mm)		
HX292B	1.05	1½	38	8.20 to 10.0	\$50
MX292B	1.05	2¾	60	10.0 to 12.4	\$70
MP292B	1.05	2¾	60	12.4 to 15.0	\$60
NP292A	1.05	2¾	60	15.0 to 18.0	\$60
NK292A	1.05	2¾	60	18.0 to 22.0	\$60



934A, P932A Harmonic Mixers

HP 934A, P932A speed and simplify frequency measurements from 2 to 18 GHz. They are also excellent as RF mixers in phase-stabilized signal sources. Both feature high sensitivity, yet require no tuning.

Specifications 934A, P932A					
Model	Frequency Range (GHz)	Maximum Input	Typical Sensitivity	Min. video output*	Price
934A	2 to 12.4	100 mW	-48 dBm at 3.5 GHz -25 dBm at 10 GHz	1.4 mV p-p	\$150
P932A	12.4 to 18	100 mW	-10 dBm	0.4 mV p-p	\$250

*With 0 dBm input signal.

Waveguide Stand, Waveguide Clamps

The 11540A Waveguide Stand locks HP Waveguide Clamp at any height from 2¾" to 5¼" (70 to 133 mm). The stand is 2½" (64 mm) high, and the base measures 4¾" (121 mm) in diameter. Price: 11540A, \$5. The Waveguide Clamps are offered in eight sizes to hold waveguide covering frequencies from 2.6 to 40 GHz (see pages 276-281 for individual listings). They consist of a molded plastic cradle with a center rod. Price: 11541A-11548A, \$5 each.

11524A, 11525A; 11533A, 11534A Adapters

These coaxial adapters, not pictured here, permit easy interconnection of 50-ohm precision 7-mm (APC-7) connectors and 50-ohm Type N or SMA (3-mm type) connectors.

HP Model	Description	Shipping Weight	Price
11524A	APC-7 to N female	4 oz (110 gm)	\$55
11525A	APC-7 to N male	5 oz (140 gm)	\$55
11533A	APC-7 to SMA male	5 oz (140 gm)	\$90
11534A	APC-7 to SMA female	5 oz (140 gm)	\$90

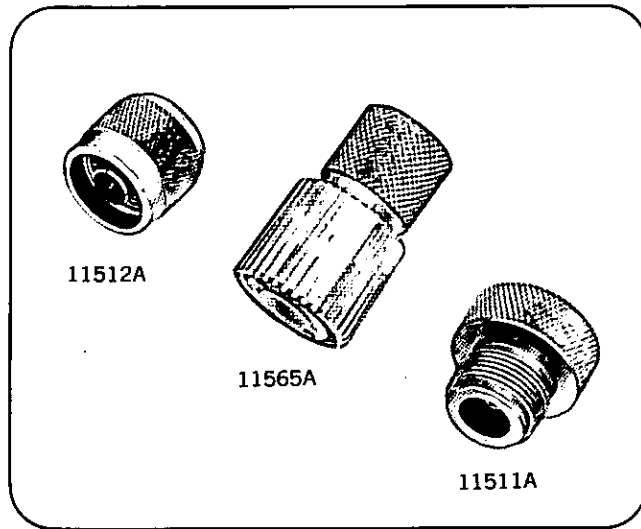
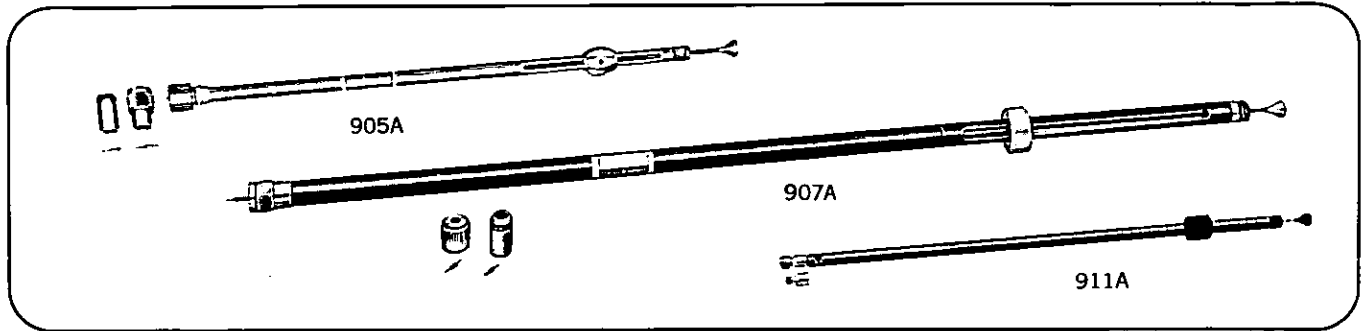
MICROWAVE TEST EQUIPMENT



COAXIAL TERMINATIONS, SHORTS

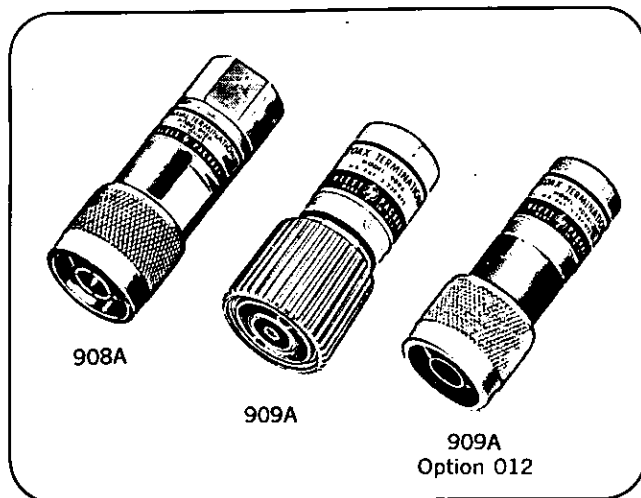
Basic tools for measurements to 18 GHz

Models 905A, 907A, 911A; 908A, 909A; 11511A, 11512A, 11565A



11511A, 11512A, 11565A Shorts

These accessory coaxial shorts are useful for establishing measurement planes and known reflection phase and magnitude in 50-ohm coaxial systems. The 11511A and 11512A are type N female and male shorts and are compatible with connectors conforming to MIL-C-39012. The 11565A has a precision 7-mm (APC-7) connector. Prices: 11511A Type N Female Shorting Jack, \$4; 11512A Type N Male Shorting Plug, \$5; 11565A APC-7 Short, \$25.



These are movable, low-reflection loads for precision microwave measurements. They are ideal for use with the 8410A Network Analyzer for reducing the ambiguity of reflection measurements by directivity signal phasing. The 905A and 907A are supplied with interchangeable Type N (male and female) and precision 7-mm APC-7 connectors: the 911A has male and female SMA connectors. Center conductors have no supporting beads and can be moved to seat accurately with the mating connector for lowest SWR. Load travel is greater than a half wavelength at the lowest frequency. The 905A and 911A feature compact size, light weight, and index marks for accurate, repeatable load positioning. Prices include carrying cases, spare center conductor tips, and wrenches (905A, 907A only) for changing connectors.

905A, 907A, 911A Specifications

HP Model	Frequency range	Load SWR	Power rating	Length in. (mm)	Shipping weight	Price
905A	1.8-18 GHz	1.05	1W avg. 5kW pk	17¼ (440)	2½ lb (1.1 kg)	\$225
907A	1-18 GHz	1.1, 1-1.5 GHz; 1.05, 1.5-18 GHz	1W avg. 5kW pk	30¾ (778)	9 lb (4.1 kg)	\$275
911A	2-18 GHz	1.1, 2-4 GHz; 1.05, 4-18 GHz	1W avg. 5kW pk	14¾ (380)	2 lb (0.9 kg)	\$250

908A, 909A Terminations

The 908A and 909A Terminations are low-reflection loads for terminating 50-ohm coaxial systems in their characteristic impedance. Model 909A is extremely broadband, covering the range from dc to 18 GHz. Combining economy with utility, the 908A covers the range from dc to 4 GHz.

908A, 909A Specifications

HP Model	Frequency Range	Impedance	SWR	Power Rating	Connector	Price
908A	dc-4GHz	50 ohms	1.05	½ W avg. 1kW pk	N male	1 to 4, \$45 ea. 5 to 9, \$39 ea. 10 to 24, \$35 ea.
909A	dc-18GHz	50 ohms	1.05, 0-4GHz. 1.1, 4-12.4GHz. 1.25, 12.4-18GHz.	2W avg. 300W pk	APC-7	1 to 4, \$85 ea. 5 to 9, \$79 ea. 10 to 24, \$75 ea.
909A Option 012 and Option 013	dc-18GHz	50 ohms	1.06, 0-4GHz. 1.11, 4-12.4GHz. 1.3, 12.4-18GHz.	2W avg. 300W pk	Option 012: N male. Option 013: N female	deduct \$15

WAVEGUIDE TERMINATIONS, SHORTS

General-application types
Models 910, X913A, 914, 920, X923A, X930A



MICROWAVE TEST EQUIPMENT

910 Terminations

Model 910 is designed for terminating waveguides systems operating at low average powers. The terminations are carefully designed to absorb virtually all of the applied power and assure a low SWR.

910 Specifications

Model	Frequency Range (GHz)	SWR	Power Ratings	Fits waveguide size OD (in.)	(EIA)	Price
G910A	3.95-5.85	1.04	2 watts	2 x 1	WR 187	\$100
J910A	5.3-8.2	1.02	1 watt	1½ x ¾	WR 137	\$ 75
H910A	7.05-10.0	1.02	1 watt	1½ x ¾	WR 112	\$ 60
X910B	8.2-12.4	1.015	1 watt	1 x ½	WR 90	\$ 45
P910A	12.4-18	1.02	1 watt	0.702 x 0.391	WR 62	\$ 50

914 Moving Loads

Model 914 Moving Load consists of a section of waveguide in which is mounted a sliding tapered low-reflection load. A lockable plunger controls the position of the load, moving it at least ½ wavelength at the lowest waveguide frequency. Seven models cover the frequency range from 3.95 to 40 GHz.

914 Specifications

Model	Frequency Range (GHz)	SWR load	Avg Pwr Rating (watts)	Waveguide Size (EIA)	Price
G914A	3.95-5.85	1.01	2	WR 187	\$200
J914A	5.3-8.2	1.01	2	WR 137	\$200
H914A	7.05-10.0	1.01	1	WR 112	\$160
X914B	8.2-12.4	1.01	1	WR 90	\$ 75
P914A	12.4-18	1.01	½	WR 62	\$125
K914B	18-26.5	1.01	½	WR 42	\$275
R914B	26.5-40	1.01	½	WR 28	\$325

X913A Termination

The X913A is a high-power termination which requires no cumbersome water connections. The unit will dissipate 500 watts average, 100 kW peak, and its SWR over the full 8.2 to 12.4 GHz range is less than 1.05. Price: X913A, \$125.

X923A, 920A,B Waveguide Shorts

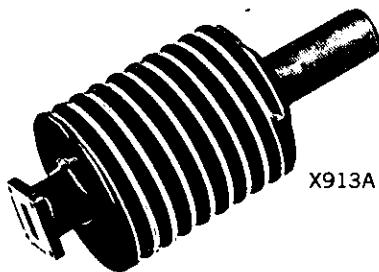
Models X923A and 920A,B are low loss movable shorts. Each of the 920 series is adjustable through at least half a wavelength at the lowest frequency in its band. The X923A is adjustable through about two wavelengths at 8.2 GHz. The 920A features a crank-driven leadscrew that positions a contacting, conducting plane. The 920B uses a choke-type short positioned by a micrometer drive. The X923A employs a non-contacting, conducting plane positioned by a sliding shaft.

X923A, 920A, B Specifications

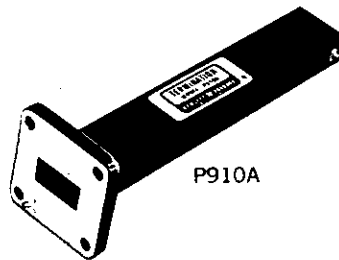
Model	Frequency Range (GHz)	Fits waveguide size OD (in.)	(EIA)	Price
G920A	3.95-5.85	2 x 1	WR 187	\$200
J920A	5.3-8.2	1½ x ¾	WR 137	\$200
H920A	7.05-10.0	1½ x ¾	WR 112	\$165
X923A	8.2-12.4	1 x ½	WR 90	\$125
P920B	12.4-18	0.702 x 0.391	WR 62	\$175
K920B	18.0-26.5	0.500 x 0.250	WR 42	\$250
R920B	26.5-40.0	0.360 x 0.220	WR 28	\$275

X930A Shorting Switch

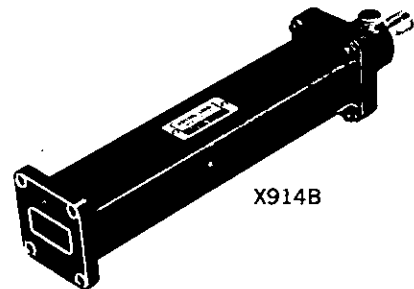
Model X930A, 8.2 to 12.4 GHz, provides a removable short in a waveguide circuit. SWR is less than 1.02 in the "open" position, greater than 125 in the "short" position. Price: HP X930A, \$260.



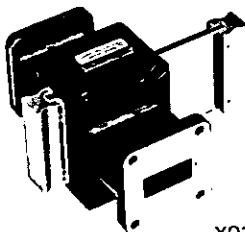
X913A



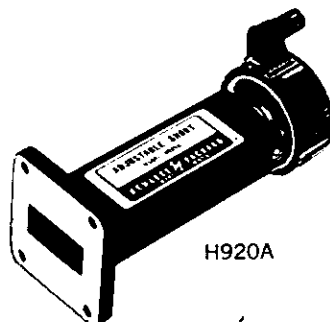
P910A



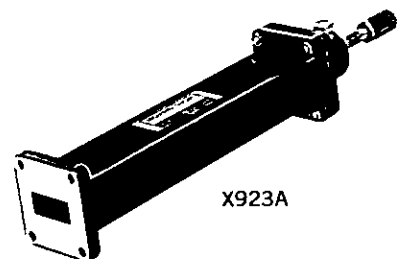
X914B



X930A



H920A



X923A


TUNERS, PHASE SHIFTERS
 Precision instruments for lab or general use
 Models 870A, 885A

885A Waveguide Phase Shifters

HP 885A Phase Shifters provide accurate, controllable phase variation in the J-, X-, and P-band frequency ranges. They are particularly useful in microwave bridge circuits where phase and amplitude must be adjusted independently. They also are used in the study of phased arrays.

The instruments are differential phase devices; that is, they add or subtract a known phase shift from the total phase

shift which a wave undergoes in traveling through the device.

The instruments have high accuracy over their entire phase range, -360 to $+360$ electrical degrees, have low power absorption, are simple to operate, and require no charts or interpolation. They are sturdily built, comprising two rectangular-to-circular waveguide transitions with a dial-driven circular waveguide mid-section. These waveguide phase shifters are housed in cast aluminum containers for extreme rigidity and durability.

Specifications, 885A

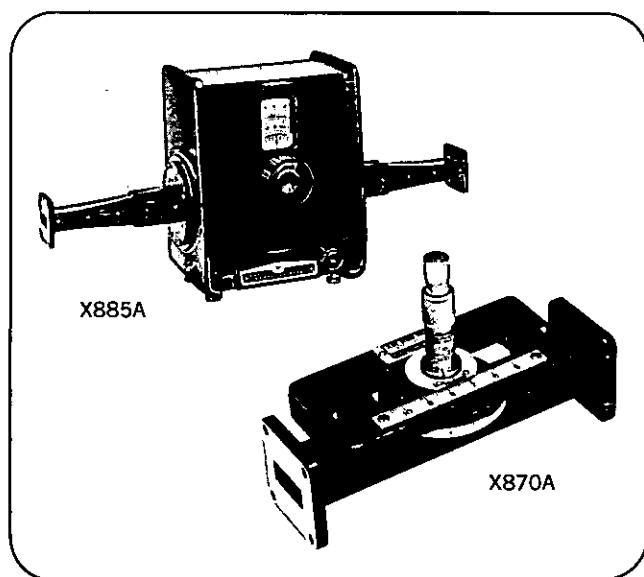
Model	Frequency Range (GHz)	Differential Phase Angle Range ¹	Accuracy ² (The smaller of)	Insertion Loss ³	SWR (max.)	Power Rating (Watts)	Waveguide		Weight				Price
							Size (EIA)	Flange	Net lb	Net kg	Shipping lb	Shipping kg	
J885A	5.3-8.2	-360° to $+360^\circ$	$\pm 3^\circ$ or $0.1 \Delta\phi$	< 2 dB	1.35	10	WR137	UG-344/U	14	6,3	25	11,3	\$850
X885A	8.2-12.4	-360° to $+360^\circ$	$\pm 2^\circ$ ($\pm 3^\circ$, 10-12.4 GHz) or $0.1 \Delta\phi$	< 1 dB, 8.2-10 GHz; < 2 dB, 10-12.4 GHz	1.35	10	WR90	UG-39/U	8	3,6	10	4,5	\$550
P885A	12.4-18	-360° to $+360^\circ$	$\pm 4^\circ$ or $0.1 \Delta\phi$	< 3 dB	1.35	5	WR62	UG-419/U	7	2,5	10	4,5	\$750

¹ Can be shifted continuously through any number of cycles.

² $\Delta\phi$ = phase difference in degrees.

³ Variation with frequency (fixed phase setting): approx. 1 dB.

Variation with phase setting (fixed frequency): < 0.4 dB, J885A; 0.3 dB max. 8.2 to 10 GHz and 0.4 dB max. 10 to 12.4 GHz, X885A; < 0.5 dB, P885A.


870A Slide-Screw Tuners

Waveguide slide-screw tuners are used primarily for correcting discontinuities or for "flattening" waveguide systems. They are also used to match loads, terminations, bolometer mounts, or antennas to the characteristic admittance of the waveguide. They are particularly valuable in determining experimentally the position and magnitude of matching structures required in waveguide systems.

HP 870A tuners consist of a waveguide slotted section with a precision-built carriage on which is mounted an adjustable probe. The position and penetration of the probe is adjusted to set up a reflection which is used to cancel out an existing reflection in a system.

Probe penetration into the guide is varied by a micrometer drive. Position of the probe along the guide is adjusted by a thumb-operated wheel, and position can be read to 0.1 mm on a vernier scale. An SWR of 20 can be corrected to 1.02, and small SWR's can be corrected exactly.

Specifications, 870A

Model	Freq. Range (GHz)	Fits Waveguide Size Nom. OD (in.) (EIA)	Equivalent Flange Type	Length		Net Weight		Shipping Weight		Price
				(in.)	(mm)	(lbs.)	(kg)	(lbs.)	(kg)	
P870A	12.40-18.00	0.702 x 0.391	WR62	5	127	1	0,45	2	0,9	\$225
X870A	8.20-12.40	1 x 1/2	WR90	5 1/2	140	1	0,45	2	0,9	\$200

Correctable SWR: 20.

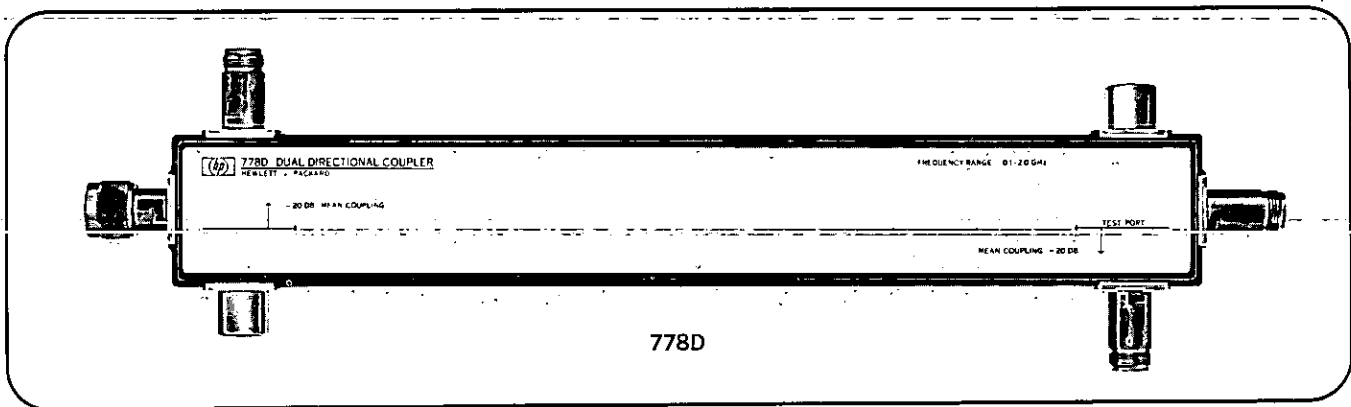
Insertion loss dB at corrected SWR of 20: 2 dB max.

BROADBAND COAX COUPLERS

Multi-Octave coverage with high directivity
778D, 779D



MICROWAVE
TEST EQUIPMENT



778D dual directional coupler

The HP 778D is a 20-dB dual directional coupler with a frequency range of 100 MHz to 2 GHz. High directivity (36 dB below 1 GHz, 32 dB above) and close tracking (typically 0.7 dB and 4°) of the auxiliary arms make it ideal for reflectometer measurements of complex reflection coefficient. Maximum errors in such measurements are:

Freq. Range (GHz)	Maximum Magnitude Error $\Delta\Gamma_L$	
	Swept Frequency	Fixed Frequency
0.1-1	$\pm(0.015 + 0.02 \Gamma_L + 0.05 \Gamma_L ^2)$	$\pm(0.015 + 0.05 \Gamma_L ^2)$
1-2	$\pm(0.025 + 0.02 \Gamma_L + 0.05 \Gamma_L ^2)$	$\pm(0.025 + 0.05 \Gamma_L ^2)$

Maximum phase error $\pm \sin^{-1}(\Delta\Gamma_L/\Gamma_L)$
 $|\Gamma_L|$ = reflection coefficient of unknown.

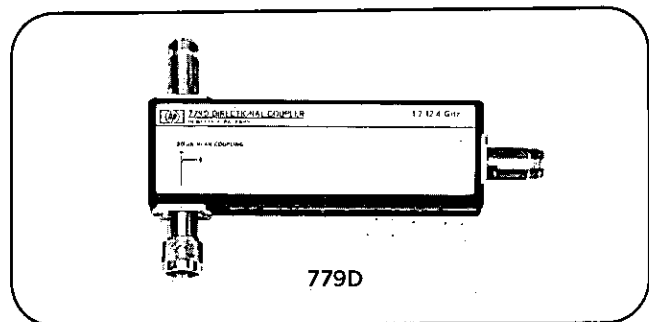
Errors include directivity, source match, and tracking, but do not include any detection errors. They are also based on the following conditions: auxiliary arms terminated in matched loads, the mean of open- and short-circuit readings set to 1.0, and the short-circuit phase measured over a band of frequencies and the mean set to 180°.

Although the coupling factor increases 6 dB/octave below 100 MHz, directivity remains 36 dB. Thus, the coupler can be used below 100 MHz as well as above.

To accommodate test devices with Type N or APC-7 connectors, a choice of TEST PORT (RF output) connectors is available as indicated in the specifications. With an APC-7 TEST PORT connector the coupler can be adapted to other types of connector. Adapters to SMA, TNC, NC, GR900, and others are available.

779D directional coupler

Representing the latest achievement in broadband coaxial couplers, the HP 779D spans more than two octaves from 1.7 to 12.4 GHz with 30-dB directivity below 4 GHz and 26-dB to 12.4 GHz. With increased coupling factor (typically 24 dB) but directivity still 30 dB, the 779D is useful down to 500 MHz. Upper frequency usefulness extends to 18 GHz with a like increase in coupling factor and directivity reduced to about 15 dB.



779D

The 779D is normally supplied with Type N connectors on all ports, as detailed in the table of specifications below. These connectors are stainless steel for long wear and are compatible with all connectors whose dimensions conform to MIL-C-39012 or MIL-C-71. On special order, a precision 7 mm APC-7 connector can be supplied on any, or all, port(s).

778D, 779D Specifications

HP Model	Frequency Range (GHz)	Coupling Attenuation	Coupling Variation	Directivity	SWR	Max Input	Connectors ²	Length in (mm)	Price
778D	0.1-2.0	20 dB nominal	± 1 dB ¹	Inc. port: 36 dB, 0.1-1GHz, 32 dB, 1-2GHz Refl. port: 30 dB, 0.1-2GHz	1.1 all ports	50 W avg, 10 kW pk	Pri line ³ : N-male input, N-female output Aux arms: N-female	16 $\frac{3}{4}$ (425)	\$450 Opt 011: add \$25 Opt 012: no extra charge
779D	1.7-12.4	20 dB ± 0.5 dB	$\leq \pm 0.75$ dB	30 dB min, 1.7-4 GHz; 26 dB min, 4-12.4 GHz	<1.2 all ports	50 W	Pri line ⁴ : N-male input N-female output Aux arm: N-female	7 $\frac{3}{4}$ max (196)	\$550 Opt 010: no extra charge

¹ Auxiliary outputs typically track within 0.7 dB and 4°.

² All Type N connectors stainless steel, compatible with MIL-C-39012 and MIL-C-71.

³ Option 011: APC-7 output, N-female input.

Option 012: N-male output, N-female input.

⁴ Option 010: N-female input, N-male output. Also, APC-7 on any or all port(s) on special order.



DIRECTIONAL COUPLERS

High directivity—low SWR

770, 780, 790 Series

770 Dual Directional Couplers

The economical HP 774D-777D Couplers cover frequency spreads of more than two-to-one, each centered on one of the important VHF/UHF bands. With their high directivity, these couplers are ideal for reflectometer applications. Reflectometers can save appreciable time in the design and manufacture of broadband antennas, ECM equipment, television receivers and transmitters, etc. The close tracking of the auxiliary arms makes these couplers particularly useful for reflectometers driven by externally-leveled sweep oscillators such as the HP 8690 series. The forward signal is detected and used to level the output of the sweep oscillator while the reflected signal, after detection, is applied to a display device such as an oscilloscope or graphic recorder. Changes in the leveled power due to the coupling variation in the forward arm are virtually cancelled by a similar coupling variation in the reverse arm.

The couplers are also capable of materially improving the speed and accuracy of power measurements because of their accurate coupling and low SWR. The units are capable of handling fairly high amounts of power and have low insertion loss so they can be permanently installed in coaxial lines for continuous monitoring. Also, a power meter can be alternately connected to the "incident" and "reflected" ports to aid in adjusting for maximum forward power.

780 Directional Detectors

The HP 780-series Directional Detectors are directional couplers with built-in crystal detectors. The couplers have flat

frequency response and good directivity, while the detectors also have good frequency response plus high sensitivity. The configuration of the directional detector reduces the number of ambiguities over the standard system of separate coupler and detector and makes possible tighter correlation between main-arm power and detected signal.

The directional detector is well-suited to closed-loop leveling applications, for it permits establishment of a leveled-power point anywhere in a system irrespective of the characteristics of intervening cables, connectors, etc.

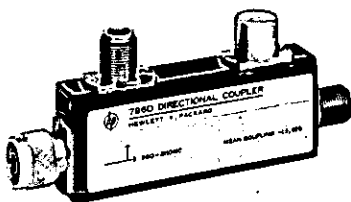
These directional detectors can also be used to monitor power, with a voltmeter or oscilloscope indicating detected output. For applications where conformance to square law is important, factory-selected load resistors can be supplied.

The 786D, 787D, 788C, and 789C are strictly coaxial devices, both RF connectors being Type N.

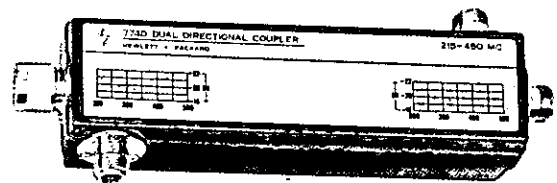
Detector elements can be replaced without special tools or procedures. Type N connectors are stainless steel for long wear.

790 Directional Couplers

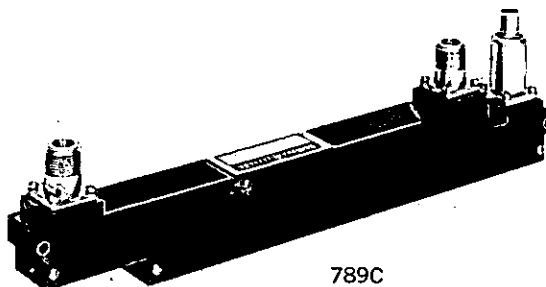
The 790 Directional Couplers are ultra-flat, high directivity couplers which are ideal for power-monitoring applications in coaxial systems. Output coupling (ratio of output power from main and auxiliary arms) is specified rather than coupling factor. Thus, no correction factor is required to account for insertion and coupling losses in the main arm.



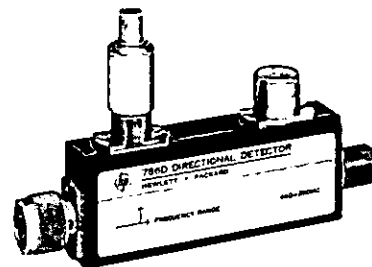
796D



774D



789C



786D

Specifications, 774D — 777D

HP Model	774D	775D	776D	777D
Frequency range	215 to 450 MHz	450 to 940 MHz	940 to 1900 MHz	1900 to 4000 MHz
Minimum directivity ¹	40 dB	40 dB	40 dB	30 dB
Coupling attenuation (each auxiliary arm)	20 dB	20 dB	20 dB	20 dB
Accuracy of coupling (each auxiliary arm)	mean coupling level within 0.5 dB of specified values			
Max. coupling variation (50-ohm terminations)	±1 dB	±1 dB	±1 dB	±0.4 dB
Auxiliary arm tracking ²	—	—	≤0.3 dB	≤0.5 dB
Max. primary line SWR ¹ (50-ohm terminations)	1.15	1.15	1.15	1.2
Max. auxiliary arm SWR (50-ohm terminations)	1.2	1.2	1.2	1.3
Primary line power-handling capacity	50 watts avg. 10 kW peak	50 watts avg. 10 kW peak	50 watts avg. 10 kW peak	50 watts avg. 10 kW peak
Primary line insertion loss	0.3 dB max.	0.4 dB max.	0.35 dB max.	0.75 dB max.
Primary line connectors	Type N, one male, one female ³			
Auxiliary arm connectors	Type N, female ³			
Accessories available	11511A Type N Female Shorting Jack, \$4; 11512A Type N Male Shorting Plug, \$5			
Length	9-1/16" (230 mm)	9-1/16" (230 mm)	6-5/16" (161 mm)	8-7/8" (225 mm)
Shipping weight	4 lb (1,8 kg)	4 lb (1,8 kg)	3 lb (1,4 kg)	3 lb (1,4 kg)
Price	\$250	\$250	\$250	\$275

¹ Measured with HP 907A Sliding Termination or H02-909A (male), H03-909A (female) Load.

² Maximum change in the coupling curve of one auxiliary arm relative to the other.

³ Compatible with connectors whose dimensions conform to MIL-C-39012 or MIL-C-71.

Specifications, 780 Series

HP Model	Frequency range (GHz)	Freq. resp. (dB) ¹	Low-level sens. (μV/μW)	Directivity (dB)	Equiv. source SWR ²	Max. SWR	Max. input (W, peak or avg.)	Max. insertion loss (dB)	Length		Shipping weight		Price
									(in)	(mm)	(lb)	(kg)	
786D	0.96 to 2.11	±0.2	>4	30	1.13	1.15	10	0.4	6	152	2	0,9	\$300
787D	1.9 to 4.1	±0.2	>4	26	1.16	1.15	10	0.5	4 7/8	124	2	0,9	\$300
788C	3.7 to 8.3	±0.3	>40	20	1.25	1.20	1	0.8	4 7/8	124	2	0,9	\$325
789C	8.0 to 12.4	±0.5	>20	17	1.25	1.40	1	1.2	11 1/8	295	2	0,9	\$550

For all models

Detector output impedance: 15 kΩ max. shunted by approx. 10 pF.

Detector element: supplied.

Noise: < 200 μV peak-to-peak with CW power applied to produce 100 mV output.

Detector output polarity: negative.

Detector output connector: BNC female.

RF connectors:³ Type N, one male (input), one female (789C: both female).

Options

002. Furnished with load resistor for optimum square law characteristics at 24°C (75°F), < ±0.5 dB variation from square law over a range of at least 30 dB from low level up to 50 mV peak output (working into external load > 75 kΩ); sensitivity typically one-fourth of unloaded sensitivity; add \$20.

003. Positive polarity detector output; no additional charge.

¹ Includes coupler and detector variation with frequency as read on a meter calibrated for square-law detectors (e.g., HP 415E SWR Meter).

² The apparent reflection coefficient at the output of an RF generating system, using a directional detector in a closed-loop leveling system.

³ Type N connectors mate compatibly with connectors whose dimensions conform to MIL-C-39012 or MIL-C-71.

Specifications, 790 Series

HP Model	Frequency range (GHz)	Mean output coupling (dB) ¹	Output coupling variation (dB) ²	Directivity (dB) ²	Equiv. source match ^{2,3}	Max. primary line SWR	Max. aux. arm SWR	Max. input (W)	Max. insertion loss (dB) ⁴	Length		Shipping weight		Price
										(in)	(mm)	(lb)	(kg)	
796D	0.96 to 2.11	20 ±0.5	±0.2	30	1.13	1.15 ²	1.20 ²	50	0.4	6	152	2	0,9	\$200
797D	1.9 to 4.1	20 ±0.5	±0.2	26	1.16	1.15 ²	1.25 ²	50	0.5	4 7/8	124	2	0,9	\$200
798C	3.7 to 8.3	10 ±0.3	±0.3	20	1.25	1.20	1.20	10	0.8	4 7/8	124	2	0,9	\$225

For all models: RF connectors: primary line: type N, one male (input), one female; auxiliary arm: type N female.⁵

¹ Difference in dB between power out of primary line and auxiliary arm.

² Swept-frequency tested.

³ The apparent SWR at the output port of a directional coupler when it is used in a closed-loop leveling system.

⁴ Includes loss due to coupling.

⁵ Type N connectors mate compatibly with connectors whose dimensions conform to MIL-C-39012 or MIL-C-71.

MICROWAVE TEST EQUIPMENT



DIRECTIONAL COUPLERS

Easy-to-use, precision instruments

Model 752A,C,D

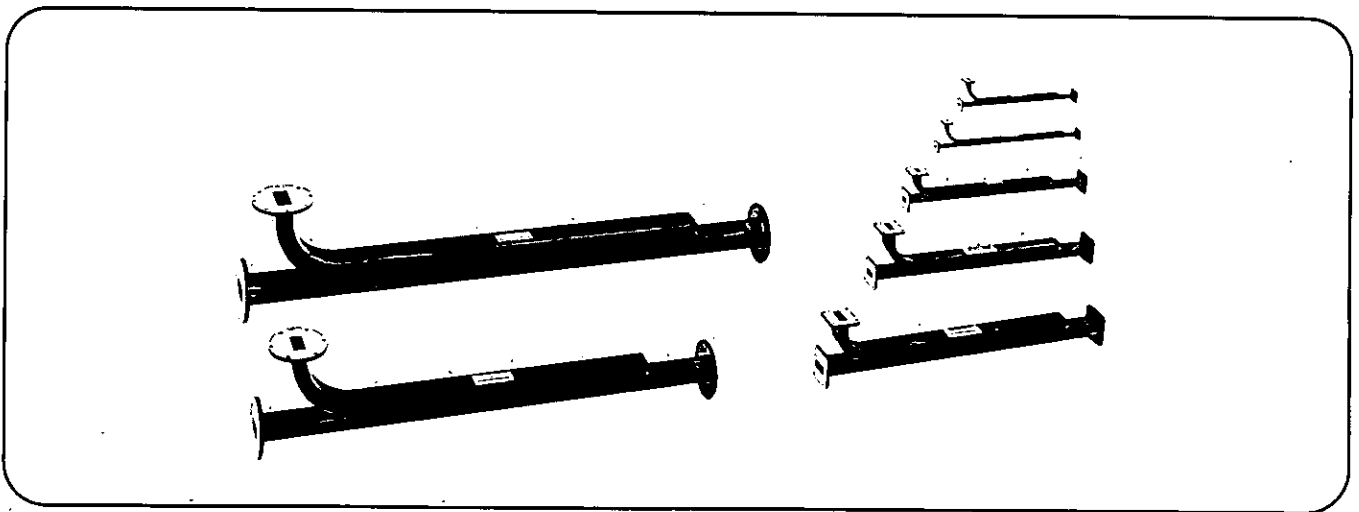
The HP 752 Directional Couplers are important tools in waveguide measurements. They can be used to monitor power, measure reflections, mix signals, or isolate signal sources or wavemeters.

Each coupler has an overall directivity of better than 40 dB (including reflection from built-in termination and flange) over its entire range. Performance characteristics are unaffected by humidity, temperature or time, thus making these units especially useful in microwave "standards" measurements. Coupling factors are 3, 10 and 20 dB; mean coupling accuracy is ± 0.4 dB (± 0.7 dB for K- and R-bands); and coupling variation vs frequency is ± 0.5 dB (± 0.6 dB for R752D).

Used together and connected back to back, two couplers are most useful with the HP 8690B Sweep Oscillator (see Signal Sources) in broadband reflection and SWR measurements. One directional coupler samples power traveling toward the load, and the detected sample can be used to

maintain a constant forward power. The output of the auxiliary arm of the second coupler, which samples power reflected from the load, is then a direct indication of reflection coefficient and swr. After detection, this signal can be viewed on an oscilloscope or permanently recorded on an x-y recorder. The HP 424A Series Crystal Detectors are ideal for use with the 752 couplers.

In the system described above, the variation in coupling with frequency of the two couplers tends to cancel. This cancellation effectively improves the leveling of the signal source and increases the accuracy of the measurement. For applications in which the actual variations in source output must be minimized, matched pairs of couplers for the leveling loop are available on special order. The pair comprises a 3- and 10- or 20-dB coupler. The 3-dB coupler is connected to the auxiliary arm of the 10- or 20-dB coupler, reducing coupling variation to less than ± 0.2 dB. Swept-frequency techniques are described in detail in Application Note 65, available from any HP field office.



Specifications, 752 Series

Band ^{1,2} (prefix)	Frequency (GHz)	Fits waveguide size (in)	Mean coupling accuracy (dB) ^{3,4}	SWR ^{5,6} main guide		Average power aux. guide load (W)	Length (in)			Shipping weight		Price
				752A	752C,D		A	C	D	(lbs)	(kg)	
G	3.95-5.85	2 x 1	± 0.4	1.1	1.05	2	34½	33	33	16	7.4	\$400
J*	5.85-8.2	1½ x ¾	± 0.4	1.1	1.05	1	26½	25-9/16	25-9/16	13	5.8	\$275
H	7.05-10	1¼ x ¾	± 0.4	1.1	1.05	1	18½	17½	17½	4	1.8	\$250
X	8.2-12.4	1 x ½	± 0.4	1.1	1.05	1	16-11/16	15-11/16	15-11/16	3	1.4	\$175
P	12.4-18	.702 x .391	± 0.4	1.1	1.05	1	13¾	12¼	12¼	2	0.9	\$190
K†	18-26.5	½ x ¼	± 0.7	1.1	1.05	½	10½	9-15/16	9-15/16	1	0.45	\$250
R†	26.5-40	.360 x .220	± 0.7	1.1	1.05	½	11½	8½	8-23/32	1	0.45	\$275

¹When ordering, specify suffix letter to indicate nominal coupling: A for 3 dB, C for 10 dB, D for 20 dB (example: G-band, 3 dB coupling, Model G752A).

²Directivity is at least 40 dB; swept-frequency tested.

³Mean coupling is the average of the maximum and minimum coupling values in the rated frequency range.

⁴Coupling variation over rated frequency range is not more than ± 0.5 dB about mean coupling (± 0.6 dB for R752D).

⁵Auxiliary arm swr is 1.15 (1.2 for P-, K- and R-band units).

⁶Swept-frequency tested.

⁷J752 Couplers operate to 5.3 GHz with reduced performance.

†Circular flange adapters: K-band (UG425/U), HP 11515A, \$35 each; R-band (UG-381/U), HP 11516A, \$40 each.

SWR METER

Reduced noise for greater usable range
Model 415E



MICROWAVE
TEST EQUIPMENT

The Hewlett-Packard Model 415E SWR Meter is a low-noise tuned amplifier-voltmeter calibrated in dB and SWR for use with square-law detectors. It is an extremely useful and versatile instrument, measuring SWR, attenuation, gain, or any other parameter determined by the ratio of two signal levels. The standard tuned frequency is 1000 Hz and is adjustable over a range of about 7% for exact matching to the source modulation frequency. Amplifier bandwidth is also adjustable, from 15 to 130 Hz. The narrow bandwidth facilitates single-frequency measurements by reducing noise, while the widest setting accommodates a sweep rate fast enough for oscilloscope presentation.

The 415E has a very low noise figure, less than 4 dB. This represents a 6 to 10 dB improvement over other SWR meters. Equally significant is the fact that the noise figure has been optimized for source impedances presented by detectors most often used with SWR meters. As a result the 415E has greater measurement range because the reduction in noise permits the measurement of lower-level signals for a given signal-to-noise ratio.

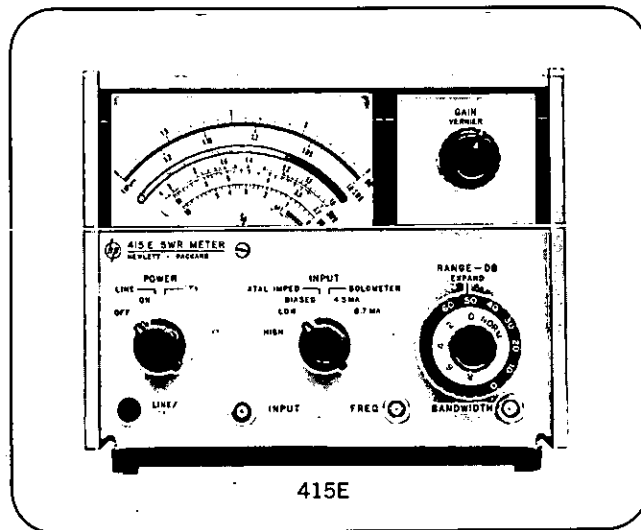
A precision 60-dB attenuator with an accuracy of 0.05 dB/10 dB assures high accuracy in attenuation measurements. In addition, an expand-offset feature allows any 2-dB range to be expanded to full scale for maximum resolution. Linearity on the expanded ranges is ± 0.02 dB, permitting full utilization of the increased resolution; high accuracy is possible on the normal scales as well, for linearity is limited only by meter resolution. The meter itself has individually calibrated, mirror-backed scales plus a rugged taut-band movement for full realization of the inherently high accuracy, resolution, and linearity of the instrument.

The Model 415E operates with either crystal or bolometer detectors. Both high- and low-impedance inputs are available for crystal detectors (see page 345), optimum crystal source impedances being 50 to 200 and 2500 to 10,000 ohms respectively. For operation with bolometers, the 415E provides precise bias currents of 4.5 and 8.7 mA into 200 ohms, as selected at the front panel. This bias is peak-limited for positive bolometer protection.

Both ac and dc outputs are provided for use of the 415E as a high-gain tuned amplifier and with recorders. The solid-state 415E can be operated with an internally mounted battery pack (optional extra) for completely portable use or to eliminate ground loops.

Specifications

- Sensitivity:** 0.15 μ V rms for full-scale deflection at maximum bandwidth (1 μ V rms on high impedance crystal input).
- Noise:** at least 7.5 dB below full scale at rated sensitivity and 130 Hz bandwidth with input terminated in 100 or 5000 Ω ; noise figure less than 4 dB.
- Range:** 70 dB in 10- and 2-dB steps.
- Accuracy:** ± 0.05 dB/10-dB step; maximum cumulative error between any two 10-dB steps, ± 0.10 dB; maximum cumulative error between any two 2-dB steps, ± 0.05 dB; linearity, ± 0.02 dB on expand scales, determined by inherent meter resolution on normal scales.



- Input:** unbiased low and high impedance crystal (50-200 and 2500-10,000 Ω optimum source impedance respectively for low noise); biased crystal (1 V into 1 k Ω); low and high current bolometer (4.5 and 8.7 mA $\pm 3\%$ into 200 Ω), positive bolometer protection; input connector, BNC female.
- Input frequency:** 1000 Hz adjustable 7%; other frequencies between 400 and 2500 Hz available on special order.
- Bandwidth:** variable, 15-130 Hz; typically less than 0.5 dB change in gain from minimum to maximum bandwidth.
- Recorder output:** 0-1 V dc into an open circuit from 1000 Ω source impedance for ungrounded recorders; output connector, BNC female.
- Amplifier output:** 0-0.3 V rms (Norm), 0-0.8 V rms (Expand) into at least 10,000 Ω for ungrounded equipment; output connector, dual banana jacks.
- Meter scales:** calibrated for square-law detectors; SWR: 1-4, 3.2-10 (Norm); 1-1.25 (Expand). dB: 0-10 (Norm); 0-2.0 (Expand); battery: charge state.
- Meter movement:** taut-band suspension, individually calibrated mirror-backed scales; expanded dB and SWR scales greater than $4\frac{1}{4}$ in. (108 mm) long.
- RFI:** conducted and radiated leakage limits are below those specified in MIL-I-6181D.
- Power:** 115-230 V $\pm 10\%$, 50-400 Hz, 1 W; optional rechargeable battery provides up to 36 hr continuous operation.
- Dimensions:** $7\frac{1}{2}$ in. wide, $6\frac{3}{8}$ in. high, 11 in. deep from panel (190 x 155 x 279 mm).
- Weight:** net, 9 lb (4 kg), 11 lb (5 kg) with battery; shipping, 10 lb (4.5 kg), 13 lb (6.3 kg) with battery.
- Accessory available:** 11057A Handle, fits across top of instrument for carrying convenience.
- Combining cases:** 1051A, $11\frac{1}{4}$ in. (286 mm) deep. 1052A, $16\frac{3}{8}$ in. (416 mm) deep.
- Price:** HP Model 415E, \$400.
- Options:** 001. rechargeable battery installed, add \$100; 002. rear-panel input connector in parallel with front-panel connector, add \$25.

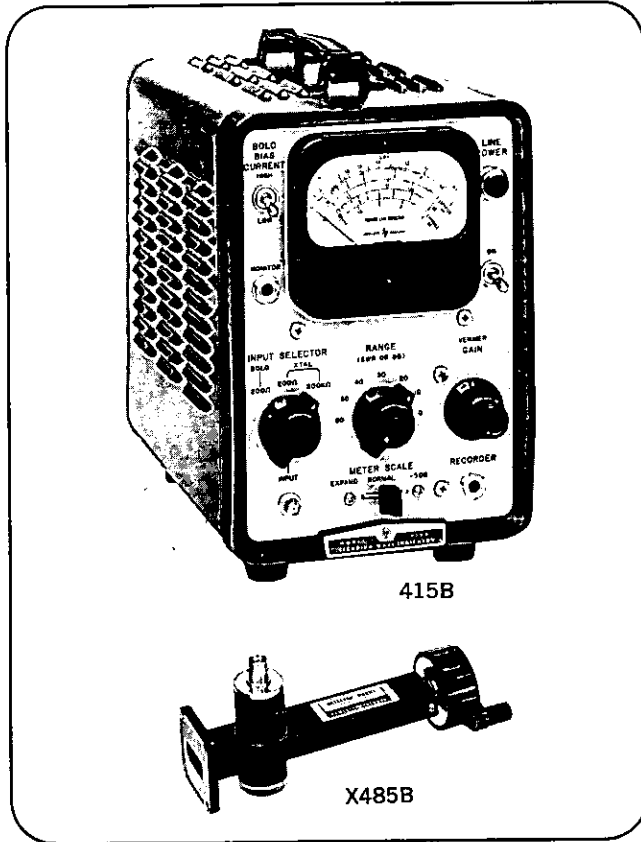
MICROWAVE TEST EQUIPMENT



SWR METER, DETECTOR MOUNT

For convenient SWR measurements

Models 415B, X485B



415B Standing Wave Indicator

Similar to the HP 415E, this meter is a tuned voltmeter for SWR measurements with HP slotted lines and detector mounts. It also is useful as a null indicator for bridge measurements, with a 200 k Ω input circuit for this use.

A 60-dB attenuator adjustable in 10-dB range steps provides a calibrated range of 70 dB. An output is provided for use with a recording milliammeter, and a special 5-dB attenuator is incorporated to increase resolution through use of the upper portion of the logarithmic meter scale.

Inputs include a 200-ohm termination with bias of 4.3 or 8.7 mA for bolometers, unbiased for crystals, or a 200 k Ω load for null measurements. A jack and monitor cable are provided for connecting an external milliammeter to measure bolometer current.

Specifications, 415B

Input: "Bolo" (200 ohms), bias provided for 8.7 or 4.3 mA bolometer or 1/100 amp fuse; "Crystal" (200 ohms) for crystal rectifier; "Crystal" (200 k Ω) high impedance for crystal rectifier as null detector; BNC connector.

Sensitivity: 0.1 μ V at 200 ohms for full-scale deflection.

Noise: at least 5 dB below full scale when operated from 200-ohm resistor at room temperature.

Frequency: 1000 Hz \pm 2%; other frequencies, 315 to 2020 Hz, available on special order; should not be harmonically related to power line frequency.

Bandwidth: 30 Hz (nominal).

Range: 70 dB; input attenuator provides 60 dB in 10-dB steps, accuracy \pm 0.1 dB per 10-dB step; maximum accumulative error, \pm 0.2 dB.

Calibration: square law; meter reads SWR, dB.

Scale selector: "Normal", "Expand" and "-5 dB".

Recorder output: jack provided for recording milliammeter having 1 mA full-scale deflection and internal resistance of 1500 ohms or less.

Meter scales: SWR 1 to 4, SWR 3 to 10, expanded SWR 1 to 1.3; dB 0 to 10, expanded dB 0 to 2.

Gain control: adjusts to convenient reference level; range at least 10 dB.

Power: 115 or 230 volts \pm 10%, 50 to 60 Hz, 55 watts.

Dimensions: cabinet: 7 $\frac{1}{2}$ " wide, 11 $\frac{3}{4}$ " high, 12 $\frac{1}{2}$ " deep (191 x 299 x 318 mm); rack mount: 19" wide, 6-31/32" high, 10 $\frac{7}{8}$ " deep behind front panel (483 x 177 x 276 mm).

Weight: net 14 lb (6,3 kg), shipping 15 lb (6,8 kg) (cabinet); net 17 lb (7,7 kg), shipping 27 lb (12,2 kg) (rack mount).

Accessory furnished: 415B-16E cable assembly.

Accessories available: plug-in filters (specify frequency): 415B-42B (315 to 699 Hz), \$60, and 415B-42C (700 to 2000 Hz), \$50; 10501A Cable Assembly; 10503A Cable Assembly.

Price: HP 415B, \$400 (cabinet); HP 415BR, \$410 (rack mount).

X485B Detector Mount

The X485B Detector Mount permits the accurate matching of waveguide sections to a bolometer element. The mount is tuned by a variable short, and can be used with a barretter or, where SWR is not critical, with a silicon crystal.

Specifications, X485B¹

HP Model	Frequency range (GHz)	Maximum SWR ²	Fits waveguide size		Length		Price
			(in.)	(EIA)	(in.)	(mm)	
X485B ³	8.2 - 12.4	1.25	1 x 1/2	WR90	6-7/16	163	\$100

¹Detector elements are not supplied

²With Weinschel 1180P-8 barretter

³May use 1N21 or 1N23 crystal for maximum detection sensitivity where SWR is not critical

RATIO METER

Simplified reflection coefficient measurements
Model 416B



**MICROWAVE
TEST EQUIPMENT**

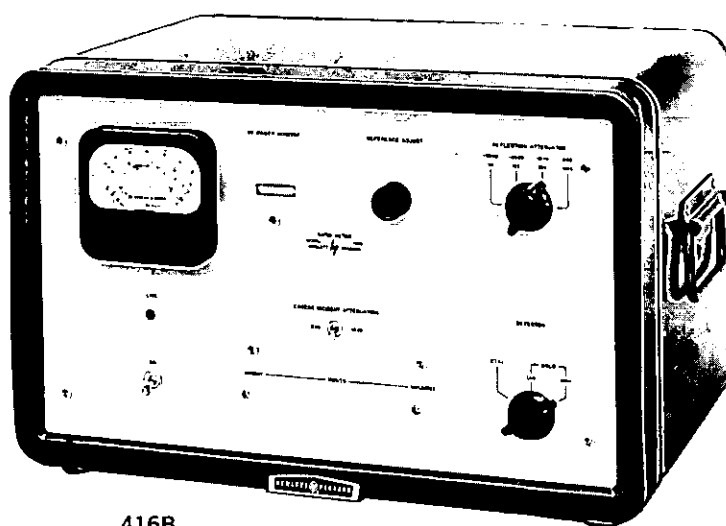
Eliminates amplitude-variation error
Operates accurately over 20:1 incident power range

Reflection coefficient measurements over broad
frequency range, independent of RF power level

The HP 416B is designed for use with unlevelled sweep oscillators and signal sources in the measurement of reflection coefficient. The ratio meter provides valid results inde-

pendent of incident power variations as high as 20:1. Either swept- or fixed-frequency measurements can be made using the Model 416B, and a high-impedance output on the rear of the instrument permits swept-frequency measurements to be presented on an oscilloscope or preserved on a graphic recorder. The panel meter is calibrated in percent reflection and equivalent SWR.

The 416B operates with either crystals or bolometers, and a panel switch permits selection of 4.3 or 8.7 mA bias for bolometers. Positive bolometer protection is provided.



416B

Specifications

Meter presentation

Reflection coefficient (%): four ranges, 100%, 30%, 10% and 3% reflection, equivalent to reflection coefficients of 1, 0.3, 0.1 and 0.03.

Equivalent SWR: two ranges, 1.06 to 1.22 and 1.2 to 1.9.

DB: for use with both reflection coefficient and equivalent SWR scales; scale calibrated 0 to -10 dB; with ranging, spans 0 to -40 dB in four 10-dB steps.

Accuracy: crystal, $\pm 3\%$ of full scale; bolometer, same as crystal except $\pm 5\%$ for incident input voltage below 1 mV.

Calibration: square law for use with crystal detectors or barretters.

Frequency: 1000 Hz ± 40 Hz (± 20 Hz for bolometer detectors when incident input voltage is < 1 mV rms).

Input voltage (for full-scale deflection):

	Crystal	Bolometer
Incident channel	3 to 100 mV rms	0.3 to 10 mV rms
Reflected channel	$3 \mu\text{v}$ to 100 mV rms	$0.3 \mu\text{v}$ to 10 mV rms

Input impedance (both channels): crystal, approximately 75 k Ω ; bolometer, approximately 500 Ω (High Bolo) or 1000 Ω (Low Bolo).

Excess incident attenuation: provision for 10 dB increase of incident channel sensitivity for reflectometers using couplers with different coefficients; under certain circumstances, accuracies can be improved by this procedure.

Output

Open circuit voltage: approx. 10 V dc at full scale.

Source impedance: 100 k Ω ; BNC type connector.

Bolo bias: high range, 8.7 mA; low range, 4.3 mA; bias variable approximately 10% by means of rear-panel control; positive bolometer protection.

RF power monitor: level indicator monitors input amplitude (and frequency, indirectly) to ensure proper operating range for the instrument and for crystal detectors.

Power: 115 or 230 volts $\pm 10\%$, 50 to 60 Hz, 115 watts.

Dimensions: cabinet: 20 $\frac{3}{4}$ " wide, 12 $\frac{3}{4}$ " high, 14 $\frac{7}{8}$ " deep (527 x 324 x 378 mm); rack mount: 19" wide, 10 $\frac{1}{2}$ " high, 14" deep behind panel (483 x 267 x 356 mm).

Weight: net 34 lb (15.3 kg), shipping 45 lb (20.3 kg) (cabinet); net 27 lb (12.2 kg), shipping 41 lb (18.5 kg) (rack mount).

Accessories available: 10503A Cable Assembly, \$7; 11001A Cable Assembly, \$6.

Price: HP 416B, \$850 (cabinet); HP 416BR, \$835 (rack mount).

NETWORK ANALYZERS



MEASURING TRANSMISSION AND REFLECTION MAGNITUDE AND PHASE

RF and microwave measurements are, of necessity, becoming more complex. Engineers today want a more complete characterization of components and devices to speed and improve their measurements.

The network analyzer represents a significant step in this direction by measuring amplitude and phase over a wide dynamic range. This opens up a whole new field of CW and swept measurements to the user—analysis of filter skirts, feedback amplifiers, and other components' transfer frequency response as well as return loss, VSWR, complex impedance and reflection coefficient.

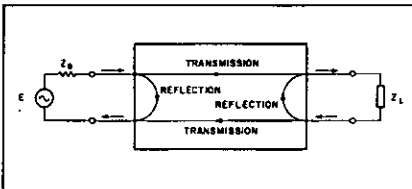


Figure 1. Simple flow graph representation of a component or device.

Any device may be characterized using the simple flow graph of Figure 1. By characterizing components in a system for both magnitude and phase, these can be cascaded into a system with optimum match and performance.

Hewlett-Packard offers complete network analysis instrumentation throughout the frequency range of 10 kHz to 12.4 GHz. This equipment is described in the following two sections: *RF Network Analysis* (10 kHz to 1000 MHz) and *Microwave Network Analysis* (110 MHz to 12.4 GHz).

RF NETWORK ANALYSIS—10 kHz to 1000 MHz

There is a tremendous array of components, devices, and systems that are being designed and tested in the <1000 MHz range. Thus, a network analysis system must be flexible (adaptable to many different power levels, have wide dynamic range and high resolution) and cover a broad frequency range. Swept displays are becoming very important by increasing measurement speed and preventing oversights due to point-by-point techniques.

Tracking Network Analyzers

These devices take advantage of the heterodyne technique (beating together of two high frequency oscillators, one fixed and one variable) commonly employed in swept sources in this frequency range. By taking the source's variable oscillator to the network analyzer, one can construct a tracking receiver that detects the device's response at a fixed, narrowband IF frequency. The benefit of such a scheme is that sensitive, low-noise detection—free from responses of the device to source harmonics and spurious signals—is possible. Broadband voltmeters, log amplifiers, and crystal detectors fail in this task; moreover, they lack the important phase information.

Hewlett-Packard offers two such tracking network analyzers in this range. The 676A Tracking Detector tracks the 675A Sweeping Signal Generator from 10 kHz to 32 MHz. It features 80 dB dynamic range and 360° of phase. Displays of both narrowband and broadband devices

come out clean and accurate. The 8470A Network Analyzer operates from 100 kHz to 110 MHz and tracks either the 8601A Generator/Sweeper or the 8690B/8698B Sweeper. A choice of rectangular or polar displays complements its 100 dB dynamic range and phase capability.

Vector Voltmeter

The 8405A Vector Voltmeter operates from 1 to 1000 MHz. A CW instrument, it employs a sampling, phase-lock technique to achieve its narrowband IF detection. Dynamic range of 90 dB and 360° of phase is featured. The 8405A also doubles as an extremely accurate RF voltmeter.

676A Tracking Detector 10 kHz - 32 MHz

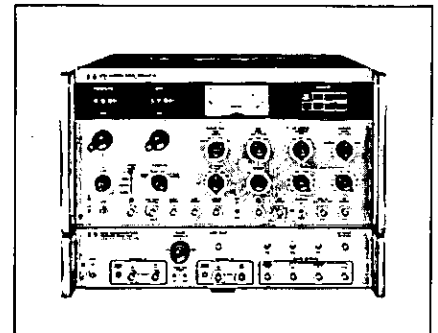


Figure 2. 676A/675A Tracking Detector and Source.

The 676A Phase/Amplitude Tracking Detector, used with the 675A Sweeping Signal Generator and either an oscilloscope or X-Y recorder, will display log amplitude (80 dB range) and phase response of devices from 10 kHz to 32 MHz.

The 676A is capable of measuring: 1) transmission (the transfer frequency response of a device), 2) complex impedance when used with the 11138A Impedance Adapter, or 3) the amplitude and phase difference between two similar devices (e.g., a standard and a test device).

Transmission measurements such as filter response, amplifier gain, insertion loss, and the phase shift that accompanies them can be made over an 80-dB range and 360° of phase. Figure 3, page 367, illustrates the phase and amplitude response of an LC filter. Sweep widths up to 32 MHz and as narrow as 1 kHz (in the case of narrow IF filters) are possible with similar results.

NETWORK ANALYZER SUMMARY

Frequency Range	Source	
10 kHz-32 MHz	676A (page 426)	675A (page 425)
100 kHz-110 MHz	8407A 8412A 8414A (pages 429-431)	8601A (page 300) or 8690B/8698B (pages 302-305, 308, 310)
1-1000 MHz	8405A (page 427)	608E/F (pages 277) or 612A (page 282) or 3200A (page 281)
0.11-12.4 GHz	8410A 8412A 8411A 8413A 8414A (pages 432-436)	8690B & RF units (pages 302-310)

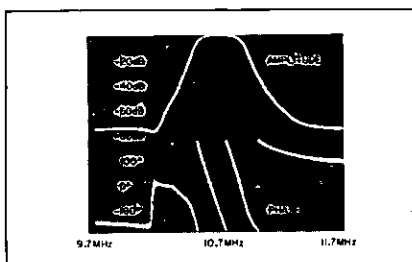


Figure 3. Phase and amplitude response of an LC filter displayed on an oscilloscope.

Complex impedance is an important quantity to measure on antennas and for matching networks for maximum power transfer. When used with the 11138A Impedance Adapter, the 676A can measure Z and phase of Z from 0.3 to 3000 ohms.

Comparison of two devices is also possible because of the two input channels. This is particularly valuable in production line applications for comparing a test device to a known standard.

Further applications are detailed in Hewlett-Packard's AN112-1, including techniques for getting extremely high resolution (0.01 dB and 0.01°) and Bode (log-log) plots.

**8407A Network Analyzer System—
100 kHz to 110 MHz**

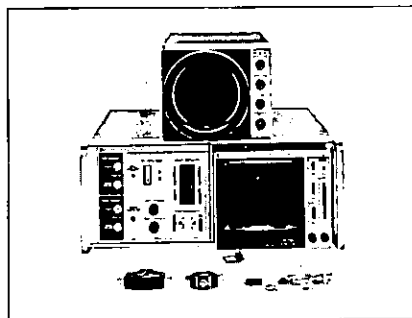


Figure 4. 8407A shown with 8412A Phase Magnitude Display, 8414A Polar Display, and transducer accessories.

The 8407A Network Analyzer Mainframe, along with a rectangular or polar display, appropriate transducer and source (it tracks the 8601A Generator/Sweeper or the 8690B/8698B Sweeper) is capable of measuring: 1) transmission (gain/loss, phase); 2) reflection (return loss, VSWR, complex impedance/reflection coefficient); and 3) probed circuit voltage and current transfer functions.

Transmission

A simple transmission measurement setup is shown in Figure 5. The power splitter and matched, low-leakage cables are provided in the 11651A Transmission kit.

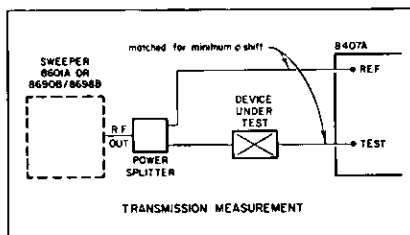


Figure 5. Transmission Measurement.

Some common transmission measurements are shown below in Figures 6 and 7.

Low Pass Filter—This 4-pole Chebyshev (Figures 6a & 6b) begins to roll off around 50 MHz. Note the notch at 60 dB below the passband. Neither crystal detector nor broadband log detector could faithfully measure it.

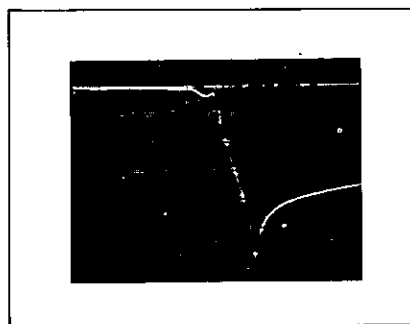


Figure 6a. Sweep is 1 - 100 MHz (display calibrated for 10 MHz/div.) and the amplitude axis is 10 dB/div. Zero-dB reference level is solid trace above filter response. Trace is clean, unambiguous, and noise-free.

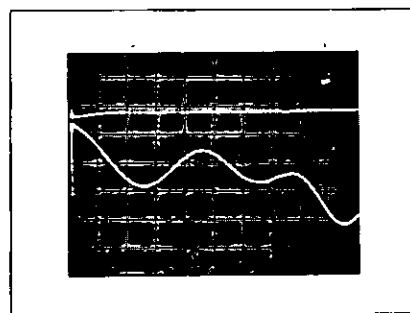


Figure 6b. Sweep is 1 - 40 MHz (4 MHz/div.) and amplitude resolution is 0.25 dB/div. Insertion loss and passband ripple are measured to an accuracy of several hundredths of dB.

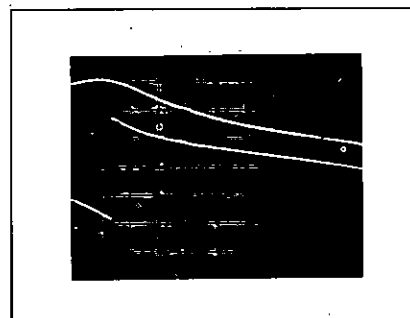


Figure 7. Amplifier Voltage Gain—This open-loop video amplifier can be analyzed for gain, bandwidth, and distortion (phase shift) while still in the breadboard stage with the passive voltage probes. Gain is 50 dB at low frequencies, dropping down to about 27 dB at 50 MHz. Amplitude is 10 dB/division; phase 100°/division. Phase shift is quite linear above 20 MHz.

Reflection

A reflection measurement setup is shown in Figure 8. All components shown plus a precision termination and a calibrating short are included in the 11652A Reflection-Transmission Kit.

Some common reflection measurements are shown below in Figures 9 and 10.

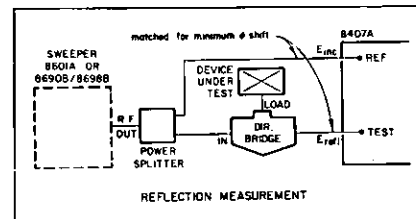


Figure 8. Reflection Measurement.

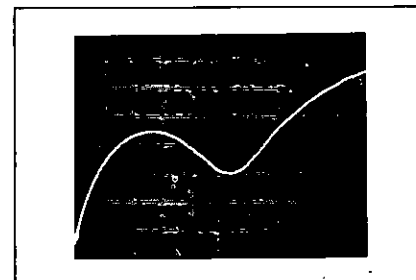


Figure 9. Cable Return Loss—A length of cable is seldom a perfect 50-ohm transmission line. This one varies from return losses of 40 dB at 1 MHz to 25.5 dB at 110 MHz. Corresponding VSWR can be calculated. Other passive and active devices can be measured just as quickly and accurately.

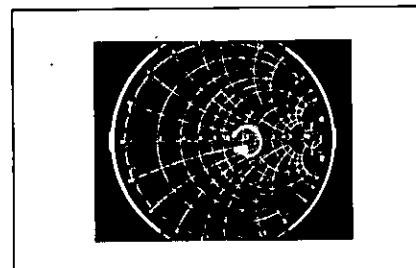


Figure 10. Antenna Complex Impedance—An FM antenna was swept over its usable range of 88 to 108 MHz, using the 8414A display with Smith chart overlay. 50-ohm input Z is desired (the exact center of the display) but the antenna varies from inductive to capacitive over the sweep range. Values of complex impedance can be read directly off the Smith chart.

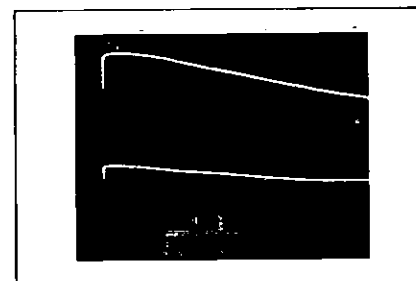


Figure 11. Transistor Current Gain—Current gain (B) may be measured using the current probes. This is a power transistor whose gain is 33 dB at 1 MHz (sweep is 1 to 10 MHz to 1 MHz per division). Amplitude is 10 dB/division, phase 100°/division, showing 16 dB gain at 10 MHz and a flat phase response (about 45° from 1 to 10 MHz). Center of graticule is 0 dB and 0° phase reference.

Often when a circuit is still in the breadboard stage or one wishes to measure the current or voltage gain of a transistor, probes are convenient to use. The 11654A Passive Probe Kit contains two sets of voltage and current probes for these applications. Figure 11 shows a typical measurement.

Comparison Measurements

Like the 676A, the 8407A is a two-input ratiometer, allowing a test device to be compared to a standard in the reference channel.

8405A Vector Voltmeter— 1 to 1000 MHz

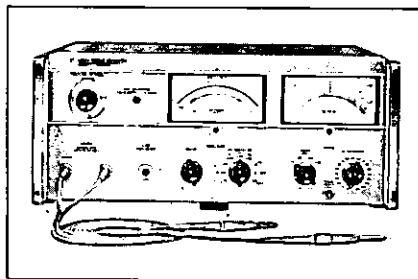


Figure 12. HP 8405A Vector Voltmeter.

The Model 8405A Vector Voltmeter is a dual-channel RF millivoltmeter and phasemeter. It reads the absolute voltages on either of two channels and simultaneously determines the phase relationship between them.

CW measurements over this frequency range are made by means of sampling circuitry which converts the RF frequency to a 20-kHz IF frequency for processing.

To measure the transmission characteristics of a device fully, the A channel probe on the 8405A must be sampling an unchanging reference signal. By sampling this same signal with the B channel probe, an amplitude and phase reference calibration may be obtained. A 10° /step phase offset and continuous vernier allow the phase calibration between A and B to be conveniently set at zero on the phase meter on the $\pm 6^\circ$ range. A range switch allows full-scale ranges of ± 6 , ± 18 , ± 180 degrees. The amplitude meter range begins at 1 volt full scale and ranges in 10-dB steps down to 100 microvolts full scale.

Figure 13 shows a typical setup for measuring the transmission characteristics of an unknown device. Note the inclusion of the power splitter to provide A and B channels, the probe tees to provide isolation of the probe from the measurement, and the 50-ohm terminations to eliminate reflections in the system.

The vector voltmeter does not need a highly stable source because any drift in

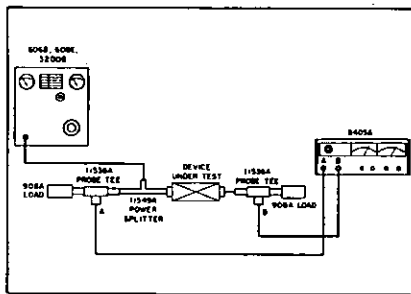


Figure 13. Transmission tests for phase and amplitude response (attenuation or gain) of a test device can be made over a dynamic range greater than 90 dB.

frequency is compensated for by the automatic tuning circuitry.

The signal source may have harmonics present which will be converted, through the sampling process, to harmonics of the IF frequency. A 1-kHz passband in the IF stage eliminates these harmonics and the voltage and phase of only the fundamental are read out.

Circuits may be probed in much the same manner as is done with oscilloscopes. The absolute voltages at the points of contact of both probes with the circuit and the phase difference of the signals at those points may be read without loading the circuit because of the high impedance of the probes. However, as frequency increases, even the small shunt capacitance of the probes becomes a factor and the probe tees must be used.

Reflectometer systems may be used to determine the reflection coefficient of a device. Figure 14 shows a reflectometer setup using the vector voltmeter. The system is calibrated with a short circuit at the test port of the coupler which gives a reflection coefficient of $1/180^\circ$. This is referenced on the meters of the 8405A and the device is then connected. The reflection coefficient is the ratio of the reflected voltage read with the device

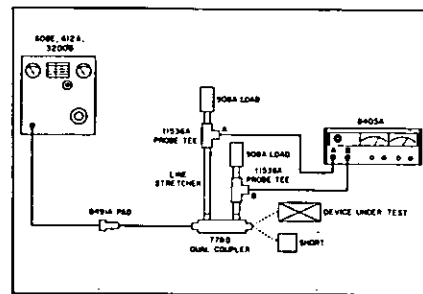


Figure 14. Amplitude and phase of reflected signal from test device can be measured directly using a dual directional coupler.

connected to the reflected voltage read with the short connected. The phase may be read directly if the phase meter is referenced correctly.

MICROWAVE NETWORK ANALYSIS 0.11 to 12.4 GHz

The HP Model 8410A Network Analyzer (Figure 15) is a unique instrument which covers the frequency range of 110 MHz through 12.4 GHz. It is capable of measuring the amplitude and phase relationships between two signals in both coaxial and wave-guide transmission line. The network analyzer is capable of sweeping octave bands throughout its full frequency range. Here, as in the case of the 8405A Vector Voltmeter, harmonic frequency conversion from RF to IF is used. For swept-frequency measurements, this frequency conversion is accomplished in the 8411A Harmonic Frequency Converter by means of an automatic phase-lock loop between the 8410A and the 8411A. The harmonic sampling technique allows the IF frequency to be held constant. Any deviation from this constant IF is then detected and a signal proportional to the difference is used to tune a voltage-tuned oscillator so that a constant IF frequency is preserved.

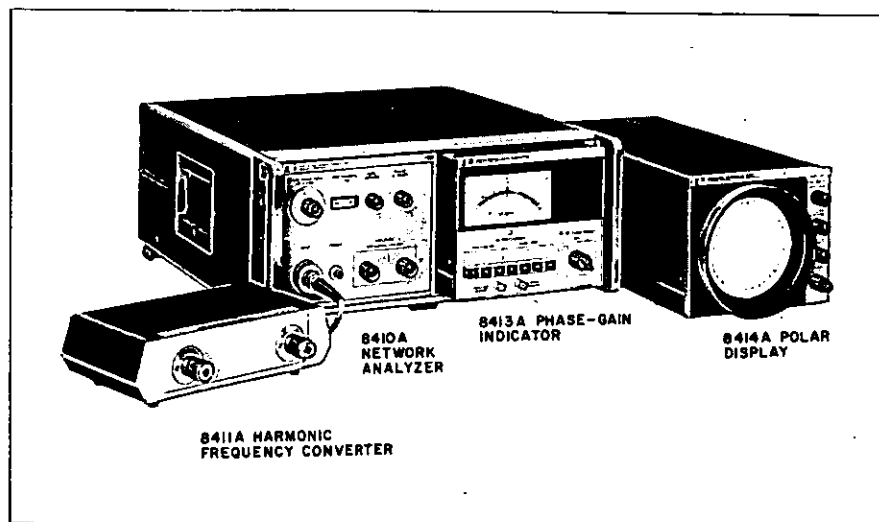


Figure 15. Hewlett-Packard Model 8410A Network Analyzer.

The network analyzer must have some means by which the power can be split into reference and test channels. There are a variety of methods for splitting power (Figure 16). The simplest is the type of power splitter used with the Vector Voltmeter. The electrical lengths of the two channels are approximately equal. The critical factors with such a power splitter are frequency response and relative tracking of the two channels. The power splitter can be used for transmission gain/attenuation tests.

Another method of splitting RF power for the network analyzer is two directional couplers as in Figure 16c. The first

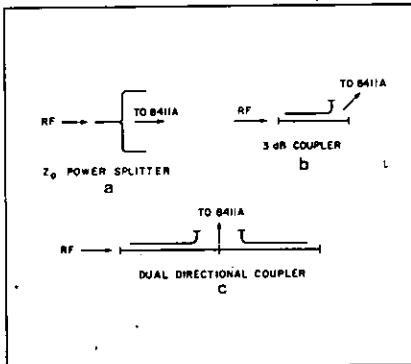


Figure 16. Reference and test channels for the network analyzer may be obtained using various methods such as a) power splitters, b) 3-dB couplers, c) dual directional or back-to-back couplers. The second coupler in c would be turned around for transmission measurements.

coupler obtains incident power for the reference channel, the second obtains power for the test channel. Orientation of the second coupler for reflection tests of transmission tests would be chosen by the user. The electrical lengths of the two channels are unequal. The coupler outputs must track with frequency, and the couplers must be wide band with high directivity. The coupling coefficient of the two couplers should be the same.

Assuming good tracking, wide band frequency coverage, and reasonable frequency response characteristics, it is still necessary to equalize the lengths of the two channels to allow swept phase measurements. By adding a line stretcher in one of the channels, it is possible to equalize the lengths and, in some cases, measure the actual length of devices by observing the swept phase shift as the line stretcher is adjusted. No linear phase shift as a function of frequency is indicative of equal path lengths between reference and test channels.

Once this power split is accomplished, all measurements can be made using the

network analyzer in terms of a set reference in the reference channel. The reference channel is also used to regulate any common-mode variations in power. An AGC amplifier in the reference channel, in conjunction with its feedback circuitry, compensates for as much as 20-dB variation in the input power. The correction signal is also fed to a matched AGC amplifier in the test channel. Any common-mode variations will thus be compensated and a leveled signal source is unnecessary.

With the common-mode variations in RF power compensated by the AGC amplifiers in the network analyzer, it is now possible to measure the ratio of the test channel signal to the reference channel signal directly. Any deviation in the test channel can now be read directly from one of the modules which plugs directly into the 8410A mainframe.

Display Units

The 8413A Phase-Gain Indicator has a meter readout for CW measurements or analog outputs at 50 millivolts/dB and 10 millivolts/degree for swept-frequency readout on an oscilloscope or an X-Y recorder. The 8413A also has a rear-panel output which is linear 0-1 volt proportional to the ratio between the reference and test channels. The data can also be read on a linear polar readout, the 8414A Polar Display Unit, with linear radial scale for ratio of test to reference channel at the input ports of the 8411A. This display is a CRT display capable of making either swept-frequency or CW measurements. The use of the 8413A plug-in module allows direct linear readout of both amplitude in dB and phase in degrees as a function of frequency. This type of readout is useful for the conventional method of displaying the amplitude and phase response of such devices as filters, amplifiers, and attenuators. The 8414A lends itself more readily to the measurement of amplitude and phase of reflected signals when measuring impedance. This becomes useful for direct impedance readout when a Smith Chart overlay is placed on the CRT face.

The network analyzer can be tuned very simply for swept-frequency measurement. A front panel dial indicates the proper position of the coarse frequency control for bracketing the range of frequencies to be swept. Once the frequency range to be swept has been bracketed on the dial, a sweep stability

control is adjusted to maintain phase lock across the full range of frequencies. This tuning is done simply and quickly by watching the trace of amplitude or phase on an oscilloscope. A swept-frequency display of the response of an unknown device allows tuning of the device under test to get the proper response at a particular frequency and still allows the effect of that tuning to be observed at other frequencies in the band of interest. Swept-frequency measurements also allow rapid viewing of amplitude and phase response of devices over wide frequency ranges.

With the broad frequency range of the 8410A Network Analyzer, it is possible to observe several octave bands in minutes by merely switching the coarse frequency control knob on the system.

Transmission Measurements

Measuring the amplitude response of a device to be inserted in a transmission line generally involves two important considerations. The first is the wide dynamic response of the device under test and the second is the wide scale blowup of some particular part of that wide dynamic range, even at an attenuation level of 50 dB or at a gain of 40 dB.

Wide Dynamic Range

The 8410A Network Analyzer will measure more than 60 dB of attenuation or 40 dB of gain in a single measurement. The swept-frequency measurement of a bandpass filter with at least 60 dB of rejection may be viewed with completely flicker-free display as in Figure 17. Due to the harmonic sampling technique and the fast response time of the AGC and phase-lock circuitry, the sweep oscillator can sweep at least 150 GHz/s and remain phase-locked. A sweep reference connection from the rear of an HP 8690B sweeper to the rear of the 8410A

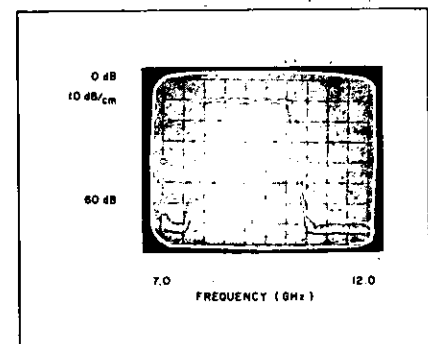


Figure 17. Swept-frequency display of an 8-10 GHz bandpass filter. Scale: 10 dB/cm vertical; 500 MHz/cm horizontal. Sweep speed: 0.01 second.

allows phase-lock at sweep speeds exceeding 600 GHz/s.

A typical transmission test setup is shown in Figure 18. The 8740A Transmission Test Unit is a combination pow-

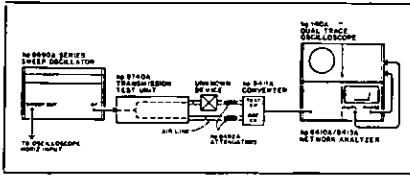


Figure 18. Typical test setup for measuring swept or CW phase shift and attenuation (gain) through a device.

er splitter and line stretcher which operates from dc through 12.4 GHz and is usable to 18 GHz. The line stretcher allows electrical length adjustments between channels of up to 30 cm for phase-balancing the two channels. A 10-cm mechanical extension allows compensation for the physical length of a device: Additional sections of rigid 10- or 20-cm air line may be added to the reference channel to compensate for any extra physical length. Hence, the response of a test device with more than 60 dB of insertion attenuation may be viewed. The test channel gain on the network analyzer mainframe may be adjusted to allow increased resolution about any point in the 60-dB "window" of the system. A device having 60 dB of attenuation may be viewed about the 0-dB reference line.

High Resolution Measurements

For a device such as the filter of Figure 17, the wide variation in response due to signal rejection is very important. Equally important, however, is the small insertion loss (residual attenuation) present in the passband. The high resolution readout of non-linear phase shift as

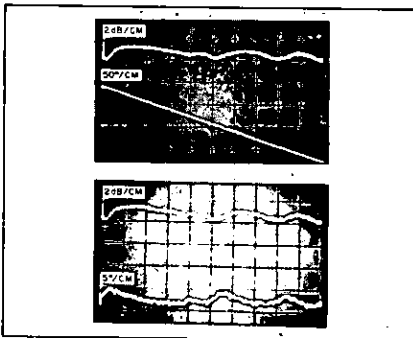


Figure 19a. Insertion phase and attenuation of a PIN modulator showing both amplitude frequency response and the linear phase shift due to excess electrical length.

Figure 19b. The excess electrical length of the PIN modulator of Figure 12a has been compensated by the transmission unit line stretcher. The phase display now shows the "nonlinear" portion of the phase transmission. Note the phase scale change to 5°/cm. The excess electrical length over coaxial air line is read from the transmission unit directly as 6.0 cm.

a function of frequency is also important. Figure 19a shows the insertion phase and attenuation of a PIN modulator. Figure 19b shows the same response with the linear phase shift compensated by the calibrated line stretcher allowing a scale change of 10:1 for high resolution.

Reflection Measurements

All methods for measuring the mismatch of a device when it is placed in a perfect transmission line must, in some manner, detect the signal reflected from the device with respect to the signal incident upon the device. Detecting probes or point contact diodes can detect the amplitude of such a signal but they do not respond to phase information. By using a high directivity reflectometer system, such as the HP 8741A (0.11 to 2.0 GHz) or HP 8742A (2.0 to 12.4 GHz) in conjunction with the 8410A Network Analyzer, the phase and amplitude of that reflected signal can be measured. Figure 20 shows a reflection test setup for measuring the reflection coefficient magnitude and phase by means of wideband reflectometers. A line stretcher allows for phase-balancing of the reference and test channels. The line stretcher compensates for as much as 15 cm of reference plane extension from the plane of connection on the reflection unit test port.

If one were interested only in the amplitude of the reflected signal, the 8413A Phase-Gain Indicator and an oscilloscope would allow swept or CW readout of return loss in dB. The phase information is also available if desired. A reflectometer calculator is available from Hewlett-Packard for making rapid conversions between return loss, VSWR, and reflection coefficient magnitudes.

By measuring the reflection coefficient of a device, its impedance may be read as the reflection is plotted on a Smith Chart. If only the magnitude of the reflection is known, the plot of reflection coefficient would be a circle on the Smith Chart centered at unity with a radius proportional to the magnitude of the reflection coefficient. By referring the measurement to a short

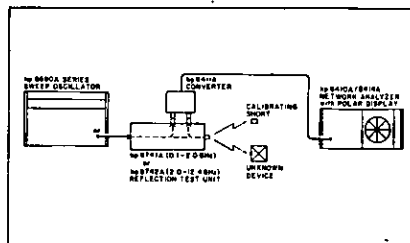


Figure 20. Reflectometer setup for Smith Chart impedance measurements. Readout of both the reflection coefficient magnitude and angle can also be made directly from polar display unit.

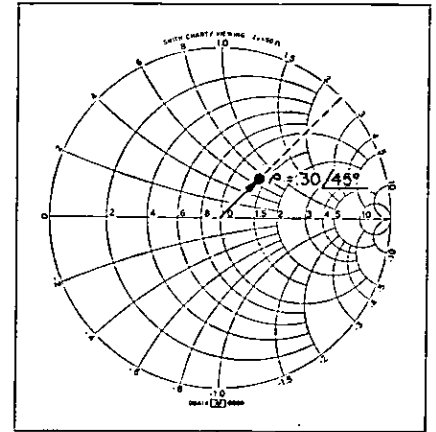


Figure 21. Plot of the impedance for a reflection coefficient of known magnitude and phase $\rho = 0.30/45^\circ$.

circuit with a reflection coefficient $\rho=1/180^\circ$, and measuring the magnitude and phase shift of the reflected signal, impedance can be read as a single value because the reflection coefficient is now a point as shown in Figure 21.

Using reflectometer systems 8741A and 8742A, the reflection coefficient (magnitude and phase), can be measured and read out in polar coordinates on the 8414A Polar Display Unit. A Smith Chart overlay can then be placed on the CRT face and normalized impedance can be read directly as a function of frequency. Using the 8741A and 8742A broadband reflectometers, which cover frequency ranges of 0.11 GHz through 2.0 GHz and 2.0 GHz through 12.4 GHz respectively, it is possible to characterize a device through 7 octaves with only one minor change of equipment.

The step attenuator on the 8410A mainframe allows the test channel gain to be varied for high resolution readout of low reflection coefficients. By decreasing the test channel gain, the output reflection of an active device, such as a tunnel diode (Figure 22), can be measured. The compressed Smith Chart overlay used in Figure 22 provides for direct readout of negative impedance.

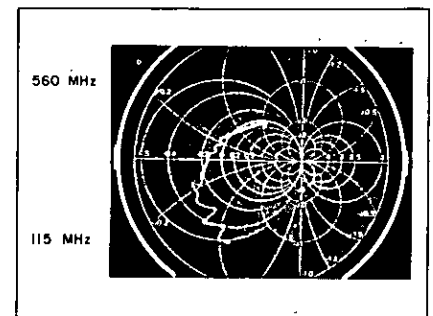


Figure 22. Swept-frequency display of impedance of a tunnel diode when it is biased in the negative impedance region.

Reflection and Transmission Measurements

The introduction of reliable, high quality, wide-band coaxial switches, such as the HP 8761A, brought about an arrangement of wide-band directional couplers such as the HP 778D and 779D, which allows reflection and transmission tests of an unknown device. The ability to measure both the input impedance and the transmission properties of a device using the same transducer saves time and money for the user. If the transmission and reflection characteristics can be measured with only one instrument setup, measurement accuracy will also be improved. A new measurement capability is achieved in determining the transmission and reflection characteristics of a two-port device at both ports with only one setup. The Hewlett-Packard Model 8743A Reflection/Transmission Test Unit in Figure 23 is capable of measuring the input impedance of a device and, by simply pushing a button, the transmission coefficient of that device from input to output. The 8745A S-Parameter Test Set in Figure 24 measures the input and output impedance and the forward and reverse transmission coefficients of a device with pushbutton ease.

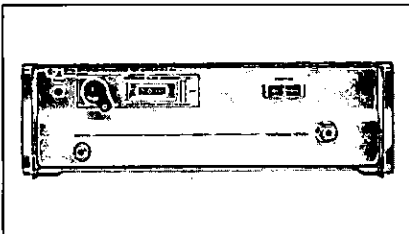


Figure 23. Hewlett-Packard Model 8743A Reflection/Transmission Test Unit.

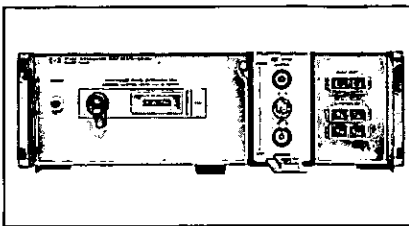


Figure 24. Hewlett-Packard Model 8745A S-Parameter Test Set.

To speed the overall measurement-design process, it is necessary to define components in terms of some universally accepted language. Networks have been characterized for many years in terms of z , y , and h parameters. At frequencies above 100 MHz, currents and a defined reference plane for an open circuit are difficult to measure. For these reasons, the microwave industry has found it necessary to define a set of descriptive network parameters which could be measured at very high frequencies.

Transmission and reflection coefficients of devices in terms of incident and re-

flected voltages are parameters measured by all microwave engineers. If these coefficients are defined in general terms and are measured in a system with a known characteristic impedance, they are given the title "scattering parameters." In Figure 25 (compare with Figure 1) the s parameters of a two-port device are named. They are like h , y , and z parameters because they describe the inputs and outputs of a black box. S-parameters have the inherent advantage of being measured while the device is terminated in its characteristic impedance or, more correctly, the characteristic impedance of the measuring system (50 ohms).

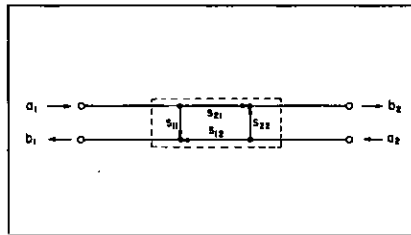


Figure 25. S-parameter representation of a two-port microwave device.

The outputs in Figure 25 can be related to the inputs by the equations:

$$b_1 = s_{11}a_1 + s_{12}a_2$$

$$b_2 = s_{21}a_1 + s_{22}a_2$$

$$\text{When } a_2 = 0, s_{11} = \frac{b_1}{a_1}, s_{21} = \frac{b_2}{a_1}$$

$$\text{And when } a_1 = 0, s_{12} = \frac{b_1}{a_2} \text{ and } s_{22} = \frac{b_2}{a_2}$$

where a_1 and a_2 are the square root of the incident power and b_1 and b_2 are the square root of the reflected power at ports 1 and 2 respectively. (For more details see "Two-Port Power Flow Analysis Using Generalized Scattering Parameters" by George Bodway, Microwave Journal, May 1967, and HP Application Note 95.)

The characteristic impedance termination has the following advantages:

1. the termination is accurate at high frequencies.
2. No tuning is required to terminate a device in the characteristic impedance.
3. Broadband swept-frequency measurements are possible because the device will remain terminated in the characteristic impedance as frequency changes.
4. The termination enhances stability providing a resistive termination that stabilizes many negative resistance devices, which might otherwise tend to oscillate.

An advantage due to the inherent nature of s parameters is:

5. Different devices can be measured

with one setup because probes do not have to be located right at the test device.

A typical display of s_{11} for a transistor is shown in Figure 26. The Smith Chart overlay allows direct impedance readout for the input of the transistor.

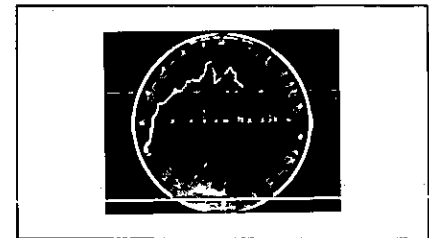


Figure 26. Swept-frequency display of s_{11} of a transistor with Smith Chart overlay for direct impedance readout. Frequency range: 300 MHz to 700 MHz.

Fixtures which are capable of accepting various lengths of leads make characterization of transistors and diodes for any lead length relatively simple. The Hewlett-Packard transistor fixtures allow s-parameter measurement on transistors, diodes, and FET's at frequencies up to 2.0 GHz.

If the rate of change of the phase of s_{11} or s_{12} is constant with respect to frequency for a given device, the ability of that device to pass a pulsed signal undistorted can be predicted. A linear phase shift as a function of frequency denotes constant "group delay." Group delay is defined as:

$$t_d = \frac{d\theta}{d\omega} = \frac{1}{2\pi} \cdot \frac{d\theta}{df}$$

where θ is the phase shift and ω is the radian frequency. A low-value, constant group delay is important in communication systems where several channels are carried on one link. If the group delay is not constant for all frequencies of interest, distorted information at the receiving end of the link is obtained. This is especially true of any pulse-coded communication system. Group delay can be read quickly and accurately from the swept display of phase when a test device is connected to the 8743A or 8745A. A typical display is shown in Figure 27.

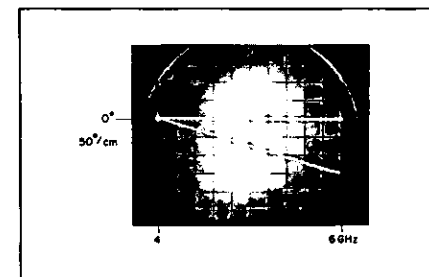
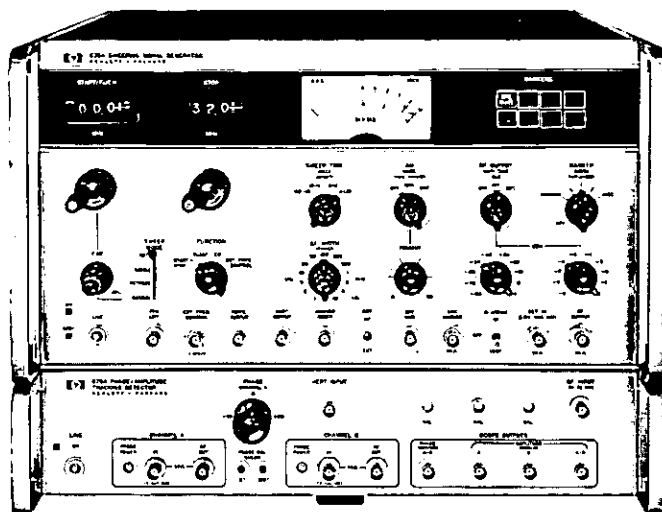


Figure 27. Linear phase shift indicates constant group delay for frequencies between 4 and 6 GHz. 150° phase shift in 2 GHz gives group delay of 11.9 nanoseconds.

NETWORK ANALYZERS



NETWORK ANALYZER
80 dB amplitude response/360° phase
Models 675A/676A



Network Analyzer (675A/676A)

Network Analyzer, 675A & 676A

This network analyzer provides swept phase and amplitude information over the 10 kHz to 32 MHz frequency range. Both laboratory and production oriented, the 675A Sweeping Signal Generator and 676A Phase/Amplitude Tracking Detector system provides an amplitude response with 80 dB dynamic range, accompanied by 360° (or multiples of) phase measurement capability. The swept frequency can be chosen anywhere in the prescribed range, making this technique amenable to both narrow and broadband frequency sweeps for amplitude and phase.

Some of the more common types of measurements made practical by phase and amplitude information obtained through a swept technique are transfer characteristics, impedance plots, dynamic input and output impedance, system flatness, return loss, time delay, and open and closed loop response.

Frequency

The 675A frequency can be manually positioned, automatically swept between two preset limits, or swept about a center frequency in calibrated increments. A bypass marker system superimposes markers on all phase and amplitude channels for easy frequency identification and calibration. 100 kHz and 1 MHz comb markers and up to five individual single frequency markers are available in the 100 kHz to 32 MHz range. In addition, an external marker can be used to further extend frequency identity.

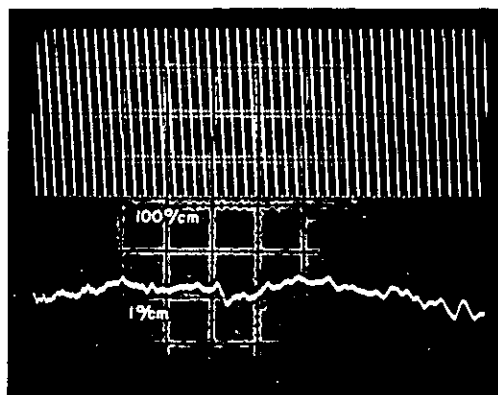
When used with a low frequency oscilloscope or X-Y recorder, the network analyzer presents displays that can be calibrated in frequency, phase, and amplitude. Along with the low residual FM (<70 Hz peak), low spurious response and low noise (-85 dB), these capabilities permit accurate measurements of devices with steep responses. A wide range of sweep times insures display accuracy regardless of the bandwidth of the circuit under test.

Amplitude and Phase

The 676A is a dual channel detector synchronously tuned to the sweep frequency. Four scope outputs (A, B, A-B,

PHASE A-B) are located on the front panel of the detector. A and B provide 80 dB of log amplitude dynamic range (50 mV/dB) for each channel, and A-B is the log difference between the two channels. All three present information in linear dB. PHASE A-B is a dc voltage that is linearly proportional (10 mV/degree) to the phase difference between channels from 0° to 360°.

The RF output of the 675A is divided in the 676A so that an equal and in-phase voltage appears at the "RF OUT" connectors of both channels A and B (+2 dBm max. into 50Ω). Typically, the device under test is connected between the "RF OUT" and "IN" connectors of one channel, and a short jumper is placed across the other channel. The amplitudes of both channels are simultaneously adjusted over a 99 dB range in 10 dB and 1 dB steps, plus vernier. To make using an oscilloscope or recorder more convenient, a "CAL" is provided for the scope outputs to allow fine adjustment of the display. Phase is also conveniently calibrated using the 5° or 100°



The top trace is the phase shift through 1000 ft. of coaxial cable. The bottom trace shows the phase shift match between two identical 1000 ft. pieces of cable. Cables, filters, multi-couplers, and other devices can be easily phase matched using the dual-channel capability of the network analyzer.

"PHASE CAL CHECK" buttons. Either pushbutton supplies a calibrated dc offset to the vertical input of the oscilloscope allowing a quick check of phase and calibration of the display. With the "PHASE CHANNEL A" control, continuous 0° to 360° phase shift is provided in channel A.

The dual channel technique used in the network analyzer is particularly useful when a device under test is compared to a "standard" device. Both PHASE A-B and amplitude difference (A-B) are available for time saving and convenient comparison testing.

Specifications, Network Analyzer (675A and 676A)

Frequency range: 10 kHz to 32 MHz in one range with Start-Stop, Manual, Center Frequency Sweep, and CW control. Digital drum readout, 1 kHz settability, 20 kHz resolution.

RF output (Channels A and B): two equal-amplitude, in-phase outputs derived from 675A output through resistive power divider.

Level: +2 dBm (0.28 V rms) into 50Ω with 675A set to +13 dBm. Adjustable with 675A attenuator.

Impedance: 50Ω (75Ω on request). NOTE: impedance independent of 675A. Impedance of 675A must match impedance of 676A.

Output isolation: 16 dB between channels.

RF input (Channels A and B): identical inputs synchronously tuned to 675A output frequency.

Level: +2 dBm max. (not to exceed +13 dBm or 1 V rms).

Impedance: same as RF output.

Crosstalk: >84 dB between channels.

Amplitude Function

Range: 0 to -80 dBm.

Dynamic display range: 25 kHz to 32 MHz, 80 dB; decreases linearly below 25 kHz to 45 dB at 10 kHz.

Accuracy

Using Channel A or B: output proportional to log of input ± 1.5 dB over 80 dB dynamic range.

Using A-B comparison: can be adjusted for identical Channel A and B performance at any one frequency and amplitude for A-B comparison measurements using external attenuator or other devices.

System flatness

Using Channel A or B: ± 0.8 dB, 10 kHz to 200 kHz, 675A unlevelled; ± 0.8 dB, 200 kHz to 32 MHz, 675A internally levelled.

Using A-B comparison: ± 0.2 dB, 10 kHz to 32 MHz, equal channel levels.

Noise: < -85 dB (50Ω source impedance).

Spurious responses: < -85 dB (50Ω source impedance).

Channel A and B scope output: 50 mV/dB ($+4.2$ V dc for +2 dBm input level) adjustable with CAL control.

A-B scope output: 50 mV/dB (± 4.2 V dc for 80 dB channel level difference) adjustable with CAL control.

Phase Function

Range: 0° to 360°. Display recycles every 360°, internal phase shifter allows 0° to 360° continuous phase offset.

Accuracy

As a function of frequency: 100 kHz to 32 MHz, $\pm 1^\circ$; 10 kHz to 100 kHz, $\pm 2^\circ$.

As a function of amplitude: $\pm 5^\circ$ over entire 80 dB dynamic range.

Calibrator accuracy: $100^\circ \pm 1.0^\circ$, $5^\circ \pm 0.2^\circ$.

Phase scope output: 10 mV/° (1.80 V dc ± 1.80 V dc for 180° with phase control set to 0°). Adjustable with CAL control.

General

Operating temperature: 0°C to 50°C.

Power: 115 V or 230 V $\pm 10\%$, 50 Hz to 400 Hz, 30 W max.

Weight: net 18 lb (8,2 kg); shipping 25 lb (11,3 kg).

Accessories furnished

5 ea. 10502-6001 interconnecting cables, 5060-0216 joining brackets.

11048B 50Ω feed-thru termination.

Dimensions (676A): 16 $\frac{3}{4}$ " wide, 3 $\frac{1}{2}$ " high, 18 $\frac{3}{8}$ " deep (425 x 88 x 467 mm).

Total system weight: net 58 lb (26,3 kg); shipping 84 lb (37,8 kg).

Total system power: 110 W max.

Price (must order 676A and 675A for network analyzer system)

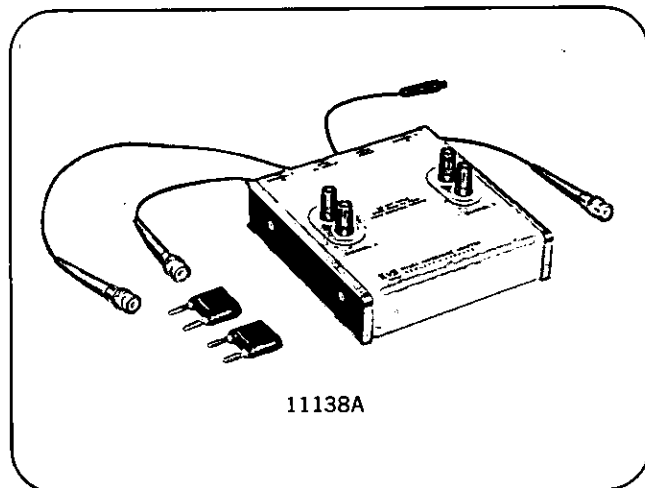
HP 676A, \$1375.

HP 675A, \$2300.

HP 675A Option 001 (includes 1 MHz harmonic comb marker), add \$75.

HP 675A Option 002 (includes 100 kHz harmonic comb marker), add \$75.

HP 675A Option 003 (includes 1 MHz and 100 kHz harmonic comb markers), add \$125.



11138A Impedance Adapter

The 11138A Impedance Adapter extends the capabilities of the network analyzer (675A and 676A) to include driving point impedance measurements. The 11138A allows the user to make swept measurements of antenna driving point impedance, network input or output impedance, transmission line sending end impedance, and any other impedance over the 10 kHz to 32 MHz frequency range. Impedance magnitudes from 0.3Ω to 3 kΩ can be displayed on an oscilloscope or X-Y recorder in dB above or below a reference magnitude and in degrees positive or negative with respect to zero degrees.

Included with the impedance adapter are two 100Ω calibrating resistors and the necessary cabling for connection to the 675A and 676A Network Analyzer.

Specifications, 11138A

Frequency range: 10 kHz to 32 MHz.

Magnitude range: 0.3Ω to 3 kΩ.

Phase range: -180° to +180°.

Flatness

Magnitude flatness at 100Ω over frequency range: ± 8 dB.

Phase flatness at 100Ω over frequency range: $\pm 5^\circ$.

Accuracy

Magnitude (log): ± 1.5 dB.

Phase: $\pm 10^\circ$.

Terminal parasitic: < 50 nH series.

Reactance: < 8 pF shunt.

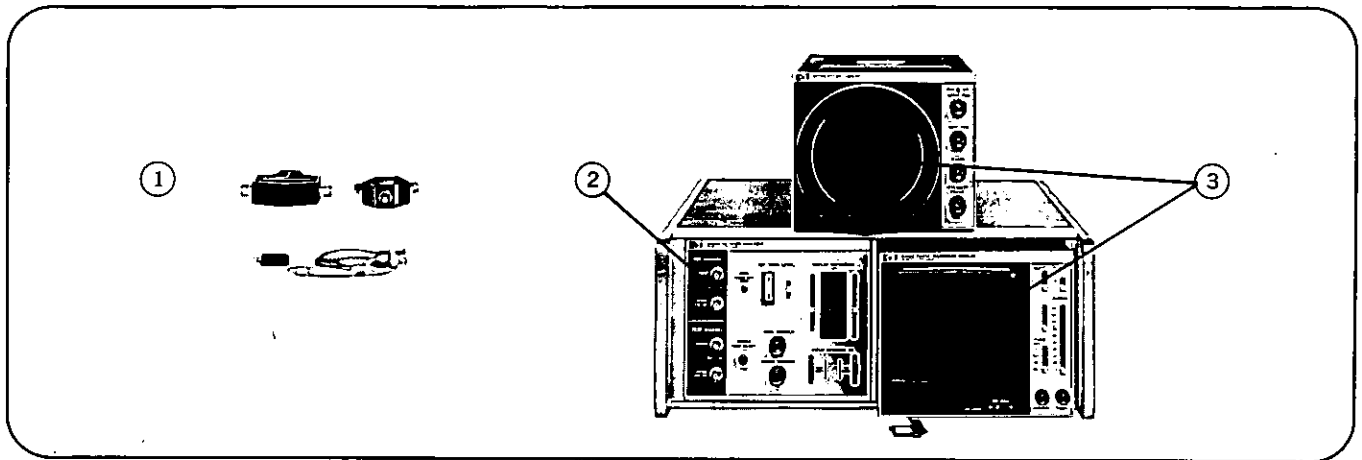
Price: HP 11138A, \$175.



NETWORK ANALYZER

Accurate measurement of amplitude & phase

Models 8407A, 8412A, 8414A, 11651A, 11652A, 11654A



8407A Network Analyzer System

The 8407A system accurately measures amplitude ratio and phase difference between two signals on a swept basis from 100 kHz to 110 MHz. A wide variety of transducers and displays offers the ideal solution to practically any application in this frequency range. The system, shown above, consists of:

Transducers—process your device's response for accurate measurement.

The 11651A Transmission kit allows accurate transmission measurements. A power splitter splits the source's output to provide both TEST and REFERENCE signals. The kit includes three matched low-leakage cables for wide dynamic range measurements.

The 11652A Reflection-Transmission Kit allows you to measure return loss, VSWR, complex impedance and reflection coefficient, as well as transmission. Included are a directional bridge, precision terminations, and cable.

If you prefer to probe circuits directly, the 11654A Passive Probe Kit allows minimum disturbance voltage and current measurements.

8407A Mainframe—the heart of the system. The 8407A accepts signals from the transducers and processes them for convenient display.

Since the 8407A is a ratiometer, it requires both a TEST and REFERENCE channel. The reference signal is held constant within the instrument and the test signal compared to it. These signals then go to the display where both amplitude and phase are measured.

The DIRECT input operates at levels of -10 to -90 dBm. For high gain measurements, the ATTENUATED input accepts signals ranging from $+20$ to -50 dBm. By using the two in combination, ratios to $+90$ and -100 dB can be measured with no additional accessories (up to 80 dB range is possible on each input separately).

The 8407A tracks two Hewlett-Packard sources: the 8601A, 0.1 to 110 MHz Generator/Sweeper, and the 8690B/8698B, 0.4 to 110 MHz Sweeper. Their 0.5% linearity and accurate sweep widths en-

hance 8407A capability. Tracking eliminates unwanted responses from source harmonics and spurious signals and allows extremely sensitive, low noise detection.

A warning light on the front panel tells you if an improper TEST/REF ratio is applied. This prevents erroneous measurements.

Another convenience is the DISPLAY REFERENCE. It allows you to read directly off the front panel the number of dB measured without having to mentally add or subtract values.

The 8407A has 50-ohm BNC inputs. Thus, you use only BNC cable or detachable probes simply by connecting them to the inputs. Probe power is also supplied at the front panel.

Displays—to see best what your device is doing.

The 8412A Phase-Magnitude Display is an accurate oscilloscope readout. It displays amplitude and phase vs. frequency. It has 80 dB $\pm 180^\circ$ display range with selectable resolutions up to 0.25 dB and 1° per division, allowing resolution of 0.05 dB and 0.2° .

The 8412A is ideal for making transmission measurements of gain or attenuation and phase shift or for measuring return loss (VSWR).

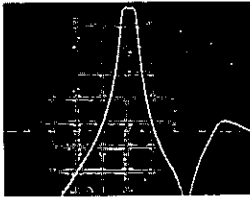
Amplitude and phase may be displayed either separately or simultaneously.

The 8414A is a polar display having 30 dB and 360° range. If you want Smith Chart displays of complex impedance or reflection coefficient, the 8414A is a natural. The 8414A includes Smith Chart overlays with full scale values of 0.2, 1.0, and 3.16.

Transmission Measurements

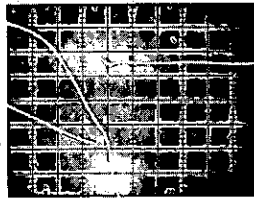
The 11651A Transmission Kit provides you with all the equipment necessary to make accurate transmission measurements from 0.1 to 110 MHz. A power splitter and matched, low-leakage cables assure you of phase matching (so you don't need a line stretcher) and negligible crosstalk.

Some common applications are shown on the next page. Others include measuring cable loss, attenuator accuracy, feedback amplifiers, coupler flatness and directivity. The ability to measure phase greatly enhances the power of your measurement—now you can design and test your devices for linear phase shift (constant group delay) to reduce signal distortion through the device.



Bandpass Filter—This tunable bandpass filter has a skirt that disappears below the -80 dB line, clearly seen on the 8412A display.

60 dB points are measured at 35 and 63 MHz off the calibrated 10 MHz/div. graticule. The trace could be raised by another 20 dB, identifying the -100 dB point on the lower skirt.



Feedback Amplifier—Plotting the open-loop phase-gain margin of a feedback amplifier results in optimizing amplifier stability vs. gain.

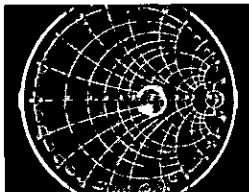
Adjustment while sweeping yields nearly instantaneous results. Shown is the open-loop feedback response of the amplifier. Amplitude is 2.5 dB/div., phase is 100° /div. Sweep is 1-50 MHz (5 MHz/div.).

Reflection-Transmission Measurements

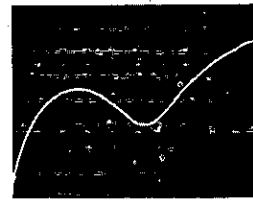
The 11652A Reflection-Transmission Kit does everything that the 11651A can and further adds the capability of swept return-loss (VSWR) and complex impedance (reflection coefficient) measurements. In addition to the power splitter and matched, low-leakage cables, the kit includes a directional bridge, two precision 50-ohm terminations, and a calibrating short.

The system is calibrated by placing the short on the LOAD port of the bridge, adjusting the display to a 0 dB, -180° reference. By replacing the short with the test device, return loss and phase are measured directly on the 8412A CRT display; complex impedance is measured directly on the 8414A Polar Display with a Smith Chart overlay.

In addition to the applications show, the Reflection-Transmission Kit is useful for matching networks, designing low VSWR devices, and measuring S-parameters on active components and circuits.



Antenna Complex Impedance—An FM antenna was swept over its usable range of 88 to 108 MHz, using the 8414A display with Smith Chart overlay. 300-ohm input Z is desired (the exact center of the display) but the antenna varies from inductive to capacitive over the sweep range. Values of complex impedance can be read directly off the Smith Chart.



Cable Return Loss—A length of cable is seldom a perfect 50-ohm transmission line. This one varies from return losses of 40 dB at 1 MHz to 25.5 dB at 110 MHz. Other passive and active devices can be measured just as quickly and accurately.

Passive Probe Measurements 11654A

The 11654A Passive Probe Kit is the answer for probing circuits still in the breadboard stage or which are not characterized by 50 ohms impedance.

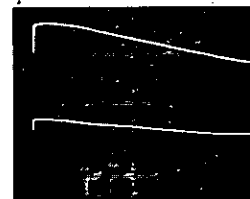
The kit includes two each of probe cables, current probe tips, six different voltage probe tips (1:1, 5:1, 10:1, 20:1, 50:1, and 100:1) and a wide variety of accessories for grounding and getting at those "difficult to measure" circuits.

Voltage and current transfer functions can be easily measured using two sets of voltage and current probes.

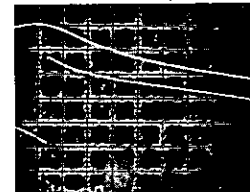
Calibration is accomplished by touching both voltage probes to a single point of RF voltage in the circuit or by placing the current probes around the same circuit lead at the point of interest.

A. (Transistor Current Gain—Current gain (β) may be measured using the current probes. This is a power transistor whose gain is 33 dB at 1 MHz (sweep is 1 to 10 MHz or 1 MHz per division). Amplitude is 10 dB/division, phase 100° /division, showing 16 dB gain at 10 MHz and a flat phase response (about 45° from 1 to 10 MHz). Center of graticule is 0 dB and 0° phase.)

B. (Amplifier Voltage Gain—This open-loop, video amplifier can be analyzed for gain, bandwidth, and phase shift while still in the breadboard stage. Gain is 50 dB at low frequencies, dropping down to about 27 dB at 50 MHz. Amplitude is 10 dB/division; phase 100° /division.



Transistor Current Gain—Current gain (β) may be measured using the current probes. This is a power transistor whose gain is 33 dB at 1 MHz (sweep is 1 to 10 MHz or 1 MHz per division). Amplitude is 10 dB/division, phase 100° /division, showing 16 dB gain at 10 MHz and a flat phase response (about 45° from 1 to 10 MHz). Center of graticule is 0 dB and 0° phase reference.



Amplifier Voltage Gain—This open-loop, video amplifier can be analyzed for gain, bandwidth, and distortion (phase shift) while still in the breadboard stage with the passive voltage probes. Gain is 50 dB at low frequencies, dropping down to about 27 dB at 50 MHz. Amplitude is 10 dB/division; phase 100° /division. Phase shift is quite linear above 20 MHz.

NETWORK ANALYZERS *continued*
Mainframe, display plug-ins, accessories

Models 8407A, 8412A, 8414A, 11651A, 11652A, 11654A

Specifications
8407A
Test input:
Direct: -10 to -90 dBm.

Attenuated: +20 to -50 dBm.

Impedance: 50Ω, VSWR <1.08.

Reference input:
Direct: level required is -10 to -60 dBm.

Attenuated: level required is +20 to -30 dBm.

Impedance: 50Ω, VSWR <1.08.

Amplitude accuracy:
Frequency response (may be calibrated out): ±0.3 dB, 0.1 to 116 MHz; ±0.1 dB over any 10 MHz portion.

Display reference: <0.05 dB/1 dB step, total error does not exceed 0.1 dB; <0.1 dB/10 dB step, total error does not exceed 0.25 dB.

Reference channel level variation: <0.5 dB/10 dB over 30 dB operating range. For minor source and transducer variations (<0.5 dB), this error is negligible.

Phase accuracy (amplitude reading must be on-scale at the 10 dB/division setting):
Frequency response (may be calibrated out): ±5° 0.1 to 116 MHz; ±2° over any 10 MHz portion.

Display reference: <0.1°/1 dB step, total error does not exceed 0.2°; <0.5°/10 dB step, total error does not exceed 1°.

Reference channel level variation: <0.4°/10 dB, <1° total error over 40 dB operating range. Negligible for minor source and transducer variations.

Power: 64 watts, 50-60 Hz, 115/230 ±10% Vac.

Weight: net, 32 lb (14.6 kg). Shipping, 39 lb (17.8 kg).

Dimensions: 7¼" high, 18¾" deep, 16¾" wide.

Price: 8407A, \$2,950.00.

8412A
Amplitude accuracy:
Display: 0.08 dB/dB.

Rear output: 0.03 dB/dB.

Temperature coefficient: typically <0.05 dB/°C at midscreen.

Phase accuracy:
Display: 0.065°/degree.

Rear output: 0.015°/degree.

Phase offset: 0.3°/20 degree step, not to exceed total error of 3° for 360° of change, positive or negative direction.

Vs. displayed amplitude: <1°/10 dB, 4° total error for 80 dB.

Temperature coefficient: typically <0.1°/°C.

Power: 23 watts, supplied by 8407A.

Weight: net, 17 lb (7.8 kg). Shipping, 22 lb (10 kg).

Dimensions: 6" high, 15-9/16" deep, 7-9/32" wide.

Price: 8412A, \$1,575.00.

8414A
General: normalized polar coordinate display: Magnitude calibration is in 0.2 of full scale gradations, full scale determined by DISPLAY REFERENCE setting on 8407A. Phase calibration is in 10° increments over a 360° range.

Accuracy: all errors in amplitude and phase due to the display are contained within a circle of 3 mm about the measurement point.

Power: 35 watts, supplied by 8407A.

Weight: net, 13 lb (5.9 kg). Shipping, 17½ lb (7.8 kg).

Dimensions: 6" high, 15-9/16" deep, 7-9/32" wide.

Price: 8414A, \$1,250.00.

11651A
General: Transmission Kit, contains power splitter (6 dB loss through each arm) and matched, low-leakage cables.

Weight: net, 1.5 lb (0.7 kg). Shipping, 2.5 lb (1.2 kg).

Dimensions: 3" high, 8" deep, 10½" wide.

Price: 11651A, \$80.00.

11652A
General: Reflection-Transmission Kit, contains power splitter, directional bridge, two precision 50Ω terminations, calibrating short, BNC adapters and matched, low-leakage cables.

Directional bridge: 6 dB coupling in main and auxiliary arm. Frequency response is ±0.5 dB, 0.1 to 110 MHz (may be calibrated out). Directivity is >40 dB, 1 to 110 MHz. Return loss at LOAD port is >30 dB (ρ <0.03).

Power splitter: 6 dB loss through each arm.

50Ω termination: return loss is >43 dB.

Weight: net, 1.5 lb (0.7 kg). Shipping, 2.5 lb (1.2 kg).

Dimensions: 3" high, 8" deep, 10½" wide.

Price: 11652A, \$300.00.

11654A
General: Passive Probe Kit, contains a pair each of six resistive divider probes (1:1, 5:1, 10:1, 20:1, 50:1, 100:1) current probes, and variety of adapters.

Weight: net, 2 lb (0.9 kg). Shipping, 3 lb (1.4 kg).

Dimensions: 3" high, 8" deep, 10½" wide.

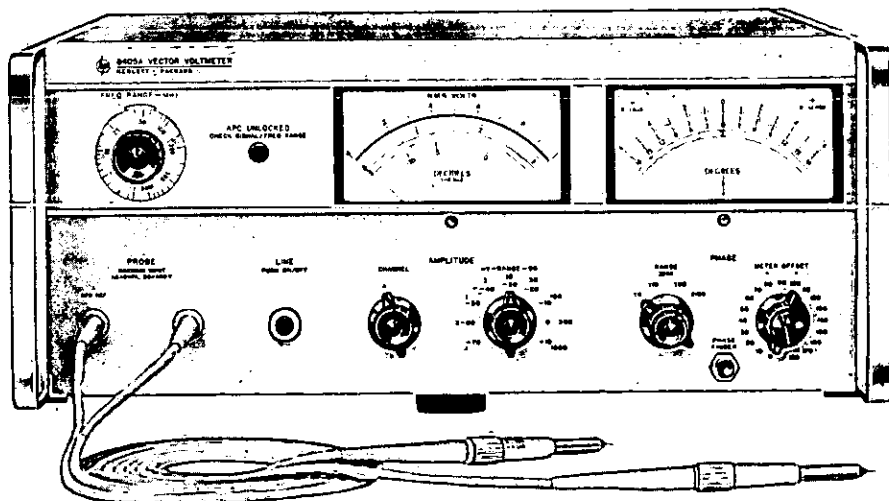
Price: 11654A, \$225.00.

VECTOR VOLTMETER

Accurate voltage and phase measurements,
1-1000 MHz — Model 8405A



NETWORK ANALYZERS



8405A

The HP 8405A Vector Voltmeter measures the magnitude of and the phase difference between two voltage vectors from 1 to 1000 MHz. Since RF voltages have both magnitude and phase, simple voltage measurements tell only half the story. Much circuit design is virtually impossible without phase information; both magnitude and phase data are required to optimize circuit design.

The HP 8405A provides high accuracy and resolution; direct readout, and operating convenience, features which enable you to make RF voltage and phase measurements more easily than ever before. It reduces costs by minimizing equipment requirements, saves time by simplifying measurements, and increases effectiveness by extending capability in the RF range.

1-1000 MHz frequency range

The instrument uses phase-locked coherent sampling to translate 1- to 1000-MHz RF signals to 20-kHz IF signals. The IF signals retain the same wave shapes and the same amplitude and phase relationships as the original RF. Thus, the vector voltmeter's performance is related to what you might expect from a precision laboratory receiver.

Automatic tuning over an octave

You simply rotate a front-panel switch to select any of the 21 overlapping octave ranges which include the input signal frequency, and the automatic phase-locked tuning does the rest. To eliminate guesswork, a front-panel light tells you when the voltmeter is properly tuned. It can then follow slowly drifting signals automatically.

100 μ V F.S. sensitivity, >90 dB dynamic range

Voltages from less than 100 microvolts to 1 volt can be measured on channel B of the 8405A, from less than 500 microvolts to 1 volt on channel A. (Channel A requires the

higher input to operate the automatic tuning). External 10:1 dividers extend channel A and B measurements to 10 volts. Thus, readings can be taken over a 90- to 100-dB range. Either channel A or B voltages are read on a single front-panel meter by simply setting a switch. Both voltage and phase meters have rugged, reliable taut-band suspensions with mirror-backed scales individually calibrated to the meter movement.

The input signals are applied through convenient ac-coupled probes that are permanently attached to the instrument. These probes present a high input impedance (0.1 megohm shunted by 2.5 picofarads) for minimum loading effects when probing. The 10:1 dividers increase input impedance to 1 megohm shunted by 2 picofarads. The ac-coupling in the probes permits you to measure signals as much as 50 volts off ground. Output signals include the 20-kHz signals from each channel plus recorder outputs proportional to phase and amplitude.

360° phase range, 0.1° resolution

Phase is read on a zero-center meter with end-scale ranges of $\pm 180^\circ$, $\pm 60^\circ$, $\pm 18^\circ$, and $\pm 6^\circ$. The $\pm 6^\circ$ scale provides 0.1° resolution, and a meter offset selectable in precise 10° increments permits this resolution to be realized anywhere in the 360° range. Phase accuracy is $\pm 1.5^\circ$ at fixed frequencies and equal signal levels in channels A and B.

High selectivity, 1-kHz bandwidth

Although the sampling system employed in the 8405A results in wide frequency coverage, the actual measurement bandwidth in the 20-kHz IF preceding the voltage and phase measuring sections is only about 1 kHz, affording high selectivity. As a result, measurements are free from errors that might be encountered with a wideband system if signal harmonics or other spurious outputs were present.

NETWORK ANALYZERS *continued*

360° phase range, 100 μ V sensitivity
8405A Vector Voltmeter

Specifications

Instrument type: two-channel sampling RF millivoltmeter-phase-meter, which measures voltage of two signals and simultaneously displays the phase angle between the two signals.

Frequency range: 1 MHz to 1 GHz in 21 overlapping octave bands (lowest band covers two octaves).

Tuning: automatic within each band. Automatic phase control (APC) circuit responds to the Channel A input signal. Search and lock time, approximately 10 ms.

Isolation between channels:

1 to 300 MHz: greater than 100 dB.

300 to 1,000 MHz: greater than 80 dB.

Maximum ac input: 2 V peak.

Maximum dc input: ± 50 V.

Voltage range (rms):

Channel	1 - 10 MHz	10 - 500 MHz	500 - 1000 MHz
A	1.5 mV - 1.0 V	300 μ V - 1.0 V	500 μ V - 1.0 V
B	< 20 μ V - 1.0 V	< 20 μ V - 1.0 V	< 20 μ V - 1.0 V

Range of each channel is extended to 10 V with 11576A 10:1 Divider.

Voltmeter characteristics:

Meter ranges: 100 μ V to 1 V rms full scale is 10-dB steps.

Meter indicates amplitude of the fundamental component of the input signal.

Voltage ratio accuracy:

1 - 200 MHz:

0.2 dB for -60 to 0 dB ranges,

0.5 dB for -70 to +10 dB ranges.

200 - 1000 MHz:

0.2 dB for -60 to -10 dB ranges,

0.5 dB for -70 to 0 dB ranges,

1.5 dB for +10 dB ranges.

Phasemeter characteristics:

Phase range: 360° indicated on zero-center meter with end-scale ranges of ± 180 , ± 60 , ± 18 , and ± 6 °.

Meter indicates phase difference between the fundamental components of the input signals.

Resolution: 0.1° at any phase angle.

Meter offset: ± 180 ° in 10° steps.

Phase accuracy: at single frequency ± 1.5 ° (equal voltages at Channel A and B).

Phase jitter vs. Channel B input level

Greater than 700 μ V: typically less than 0.1° p-p.

125 to 700 μ V: typically less than 0.5° p-p.

20 to 125 μ V: typically less than 2° p-p.

Accessories furnished: two 11576A 10:1 Dividers to reduce voltage input 10 to 1; two 10216A Isolators to eliminate errors due to the effects of changing test point impedance; two 10218A BNC Adapters to convert probe tip to male BNC connector; six ground clips for 11576A or 10216A; six replacement probe tips.

Input impedance (nominal): 0.1 M Ω shunted by approximately 2.5 pF; 1 M Ω shunted by approximately 2 pF when 11576A 10:1 Divider is used; 0.1 M Ω shunted by approximately 5 pF when 10216A Isolator is used. AC-coupled.

Residual noise: less than 10 μ V as indicated on the meter.

Bandwidth: 1 kHz.

RFI: conducted and radiated leakage limits are below those specified in MIL-1-6181D and MIL-1-16910C except for pulses emitted from probes. Spectral intensity of these pulses is approximately 60 μ V/MHz; spectrum extends to approximately 2 GHz. Pulse rate varies from 1 to 2 MHz.

20-kHz IF output (each channel): reconstructed signals, with 20-kHz fundamental components, having the same amplitude, waveform, and phase relationship as the input signals. Output impedance, 1000 Ω in series with 2000 pF; BNC female connectors.

Recorder output:

Amplitude: 0 to approx. +1 V dc, open circuit, proportional to voltmeter reading in volts. Output tracks voltage reading within $\pm 0.5\%$ of full scale. Output impedance, 1000 Ω ; BNC female connector.

Phase: 0 to approx. ± 0.5 V dc, open circuit, proportional to phasemeter reading. External load greater than 10,000 Ω affects recorder output and meter reading less than 1%. Output tracks meter reading within $\pm 1.5\%$ of end scale; BNC female connector.

Power: 115 or 230 V $\pm 10\%$, 50 to 400 Hz, 35 W.

Weight: net, 30 lb (13.5 kg). Shipping, 35 lb (15.8 kg).

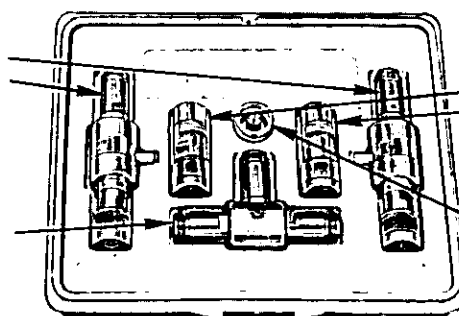
Dimensions: 18 $\frac{3}{8}$ " x 7" x 16 $\frac{3}{4}$ " (467 x 177 x 425 mm).

Price: Model 8405A, \$2850.

Option 02. Linear dB scale uppermost on voltmeter. Add \$25.00.

11536A 50 Ω Tee, with Type N RF fittings, for monitoring signals in 50 Ω transmission line without terminating the line. \$75

11549A Power Splitter, all connectors Type N female (UG-28A/U). \$85



908A Termination, for terminating 50 Ω coaxial systems in their characteristic impedance.

11512A Shorting Plug, Type N male.

11570A Accessory Kit, required for measurements in 50 Ω systems. \$340

MICROWAVE NETWORK ANALYZER

0.11 to 12.4 GHz
Model 8410S



NETWORK ANALYZERS

- ATTENUATION • PHASE • GAIN • IMPEDANCE • ADMITTANCE • COMPLEX REFLECTION COEFFICIENT

Choice of Three Complete Systems

All three systems measure transmission and reflection parameters of coaxial microwave components in the form of gain, attenuation, phase; reflection coefficient or impedance. The 8410S Option 100 System operates from 0.1 to 2 GHz. The 8410S Option 200 System operates from 2 to 12.4 GHz. The 8410S Option 300 System covers the complete frequency range from 0.1 to 12.4 GHz. All systems come complete with necessary accessories and interconnecting cables. Overall system accuracy is specified for easier error analysis. Individual instruments which make up the system can be ordered separately for updating existing Network Analyzer equipment or for specific applications only. Additional accessories for making transistor S-parameter measurements and waveguide measurements are also described.

Direct Readout with Choice of Display

Plug-in meter indicates magnitude and phase at spot frequencies. Wideband auxiliary outputs for swept displays on oscilloscope or X-Y recorder.

Plug-in CRT display for swept polar and Smith Chart readout. Auxiliary outputs for higher resolution X-Y plots. Add display versatility with future plug-ins.

Fast Sweeps over Octave Bands

Swept displays for fast testing over full band. Rapid sweep for dynamic CRT display—make adjustments to devices while viewing overall effects.

Wide Dynamic Range—High Resolution

60 dB amplitude and 360° phase displays. Use precise offset controls to read amplitude and phase to 0.1 dB and 0.1 degree resolution. No phase ambiguity—meter indicates phase sense directly.

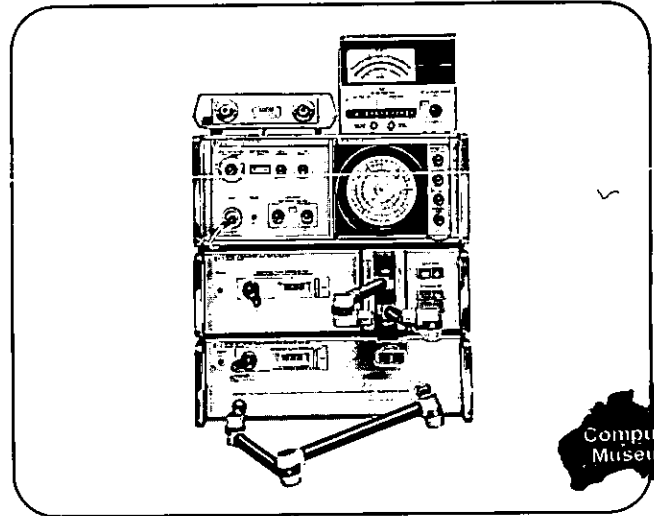
Easy Setup

All RF hardware is connected and pre-calibrated inside convenient modules. They provide:

- A calibrated variable measurement plane (line stretcher) to determine electrical and physical length of unknown devices in transmission tests, and to eliminate graphical Smith Chart transformations in reflection tests.
- Specified overall system accuracy for easier error analysis.
- Pushbutton selection of device parameters.
- Swivel joints and air lines for connection to any geometrical configuration.

System Description

The Hewlett-Packard Network Analyzer System includes the 8410A mainframe, 8411A Harmonic Frequency Converter, 8413A Phase-Gain Indicator and 8414A Polar Display Unit plug-in modules. The 8410A/8411A provide



8410S Opt 300 Measures all Network Parameters from 110 MHz to 12.4 GHz

automatic RF tuning and IF conversion to 20 MHz over frequencies from 100 MHz through 12.4 GHz for swept or CW measurements. The phase and amplitude relationships of the RF are preserved in the IF. The 8410A/8411A include sampling and automatic tuning circuitry, IF amplifiers, precision IF gain control, amplitude and phase verniers, and frequency range selection.

The 8413A includes phase and amplitude circuitry, meter readout, log converter circuitry, and calibrated analog outputs at 50 mV/dB and 10 mV/deg. Expansion of the meter scale is accomplished with pushbutton ease in ranges of ± 3 , ± 10 , ± 30 dB and ± 6 , ± 18 , ± 60 , ± 180 degrees full scale. Phase offset in 10-degree steps allows higher resolution for phase readout. The 8414A includes polar conversion circuitry for direct polar readout of ratio coefficient and phase shift. Full scale ratio is dependent upon the gain setting on the 8410A mainframe.

The 8412A Phase-Magnitude Display which is described in the RF Microwave Network Analysis section (page 374) can also be used with the 8410S Network Analyzer systems. The 8412A combines the circuitry of the 8413A and a CRT to give direct phase and amplitude vs. frequency plots. The 8412A eliminates the need for an external oscilloscope when making swept frequency measurements.

The 8745A S-parameter Test Set and/or 8743A Transmission/Reflection Test Unit completes the systems. The 8745A and 8743A contain the necessary broadband directional couplers, line stretchers and RF switches necessary for separating the test signals for measurement. Both test units will make transmission and reflection measurements. The 8745A covers the frequency range of 0.1 to 2 GHz and the 8743A covers the range of 2 to 12.4 GHz. Other test units for measuring only transmission or reflection parameters are available and described in the individual instrument listing.


**Specifications Common to
 8410S Option 100, 200, 300 Systems**
Function

All systems measure transmission and reflection parameters on a swept-frequency or CW basis in the form of attenuation, gain, phase shift, reflection coefficient, return loss, impedance, depending on readout display.

Display Units**8413A Phase-Gain Indicator:**

Meter readout of amplitude in dB and phase in degrees.

Amplitude ranges: ± 3 , ± 10 , ± 30 dB full scale.

Phase ranges: ± 6 , ± 18 , ± 60 , ± 180 degrees full scale.

Resolution: 0.1 dB, 0.1 degree.

Swept-frequency readout with oscilloscope or X-Y recorder.

Amplitude: Front-panel analog output at 50 mV/dB, 10 kHz bandwidth. Also, rear output 0-1 volt linear, proportional to ratio of test and reference signals.

Phase: Front-panel analog output at 10 mV/degree, 10 kHz bandwidth.

8414A Polar Display:

Polar coordinate CRT with magnitude calibration divisions at 20, 40, 60, 80, and 100% of full scale. Outer range settable by IF Gain Control and amplitude vernier. Accepts marker signals from Hewlett-Packard sweep oscillators, -5 V peak, which appear as intensified dot on CRT face. Accepts blanking pulse, -4 V, from Hewlett-Packard sweep oscillators to blank retrace during swept operation.

Connectors:

RF Input, Type N female, stainless steel; Measurement Ports, APC-7 precision 7-mm connectors.

Transmission Measurement Accuracy:

Accuracy curves below show overall system uncertainty when measuring amplitude and phase. Sources of error included are IF gain control, meter accuracy, phase offset, system noise, and crosstalk. System frequency response is specified separately and is not included in accuracy curves.

Amplitude accuracy (using 8413A):

Range: full 60 dB dynamic range.

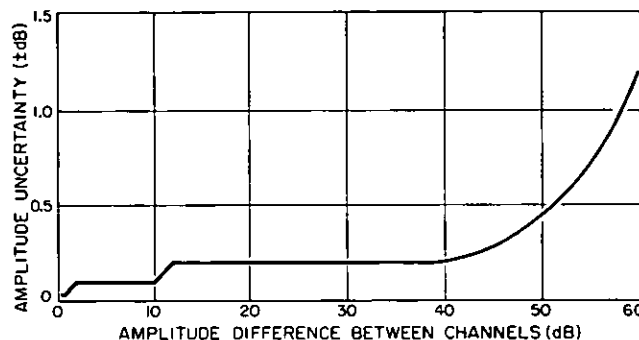
IF gain control:

60 dB in 10 dB and 1 dB steps.

± 0.1 dB/10 dB	} ± 0.2 dB maximum
± 0.05 dB/1 dB	

Amplitude vernier: 2 dB range.

Meter: $\pm 3\%$ of full scale, ± 0.05 dB for readings between 0 and 0.5 dB only.



Amplitude uncertainty for transmission measurements as a function of amplitude measured.

Phase accuracy:**Phase offset:**

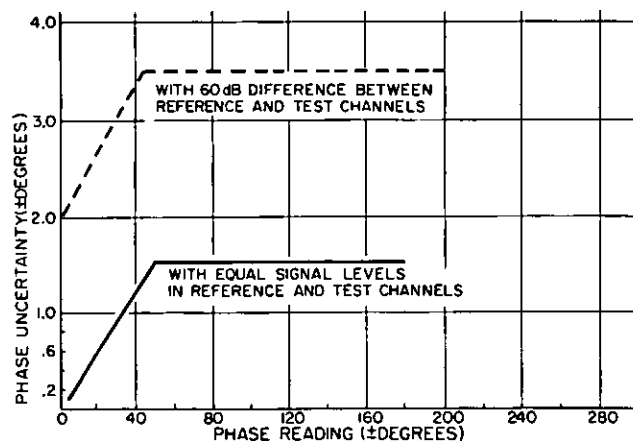
Range: $\pm 180^\circ$ in 10° steps.

Accuracy: $\pm 0.3^\circ/10^\circ$ step, $\pm 1.5^\circ$ maximum cumulative for equal signal levels in reference and test channels. Add $\pm 2^\circ$ maximum to above for 60 dB difference between reference and test channels.

Meter: $\pm 2\%$ of full scale.

Phase vernier: 90° range.

Reference plane extension: 0 to 15 cm for reflection; 0 to 30 cm for transmission; calibrated by digital dial indicator. Indicator is adjustable for initial calibration.



Phase uncertainty for transmission measurements as a function of phase shift measured.

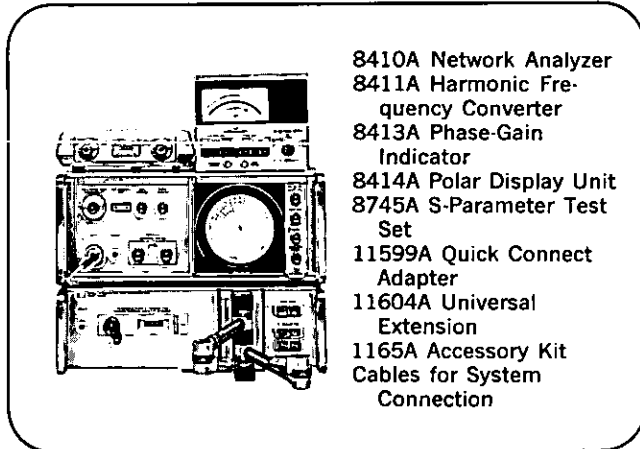
MICROWAVE SYSTEMS

Swept Measurements 0.11 to 2 GHz
8410S Option 100 System



NETWORK ANALYZERS

Specifications 8410S Option 100 System



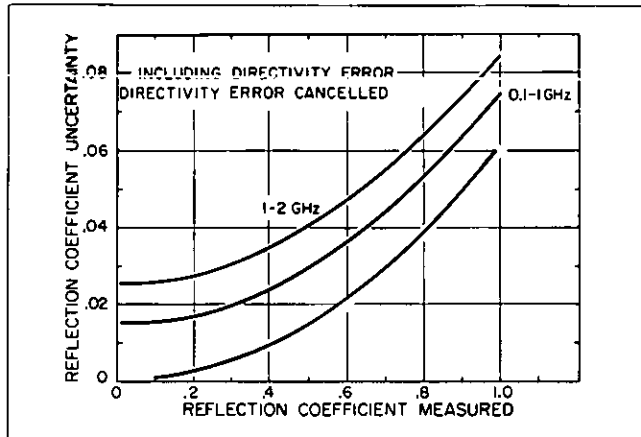
8410A Network Analyzer
8411A Harmonic Frequency Converter
8413A Phase-Gain Indicator
8414A Polar Display Unit
8745A S-Parameter Test Set
11599A Quick Connect Adapter
11604A Universal Extension
1165A Accessory Kit
Cables for System Connection

Magnitude accuracy:

$$\rho_u = \pm(0.015 + 0.06 \rho_L^2) \quad 0.11 - 1.0 \text{ GHz}$$

$$\rho_u = \pm(0.025 + 0.06 \rho_L^2) \quad 1.0 - 2.0 \text{ GHz}$$

ρ_u = magnitude uncertainty
 ρ_L = measured reflection coefficient magnitude

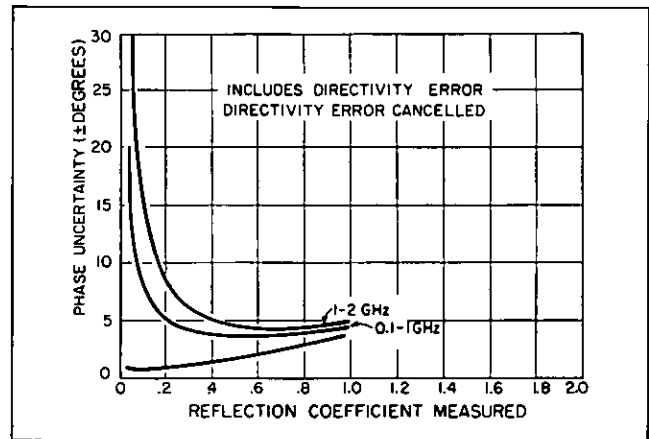


Reflection coefficient magnitude uncertainty including coupler directivity and when directivity is cancelled using a low VSWR load.

Phase accuracy:

$$\phi_u = \sin^{-1} \frac{\rho_u}{\rho_L} \text{ for } \phi_u < 90^\circ$$

ϕ_u = phase uncertainty
(See Magnitude above for ρ_u, ρ_L terms)



Phase uncertainty including coupler directivity and when directivity is cancelled using a low VSWR load.

Weight and dimensions: instruments shipped separately. (See individual instrument listing.)

Price: Model 8410S Option 100, \$11,470.

¹Source Reflection Coefficient: Reflection coefficient of the port used to supply incident signal to the device under test.

²Termination Reflection Coefficient: Reflection coefficient of port connected to output of test device when transmission or reflection measurement is being made.

Frequency range: 0.11 to 2.0 GHz.

Transmission-reflection selection: manual by front panel, lighted pushbuttons; remote by contact closure or saturated transistors through 36-pin connector contacts. Short circuit current, 12 mA; open circuit voltage, 12 V dc.

RF input: 20 dB range between -21 dBm and $+7$ dBm. 20 dB variation causes less than 1.5 dB and 4° change in amplitude and phase readings.

Source reflection coefficient:¹

$$\leq 0.09 (\leq 1.2 \text{ SWR}), 0.11 - 2.0 \text{ GHz.}$$

Termination reflection coefficient:²

$$\leq 0.11 (< 1.25 \text{ SWR}), 100 - 200 \text{ MHz.}$$

$$\leq 0.09 (< 1.20 \text{ SWR}), 200 - 2000 \text{ MHz.}$$

Directivity:

$$> 36 \text{ dB (typically } > 39 \text{ dB)} \quad 0.11 - 1.0 \text{ GHz.}$$

$$> 32 \text{ dB (typically } > 36 \text{ dB)} \quad 1.0 - 2.0 \text{ GHz.}$$

Insertion loss, RF input to test port: 4 dB nominal.

Frequency response

Transmission: typically $< \pm 0.35$ dB amplitude and $< \pm 30$ phase.

Reflection: typically $< \pm 0.06$ magnitude and $\pm 5^\circ$ phase as read on the 8414A polar display with a short on the test port.

Transmission measurement accuracy

(see common specifications).

Reflection measurement accuracy

Accuracy curves show overall system uncertainty when measuring reflection coefficient. Sources of error included are directivity, source match, and polar display accuracy. System frequency response is specified separately and is not included in the accuracy curves.

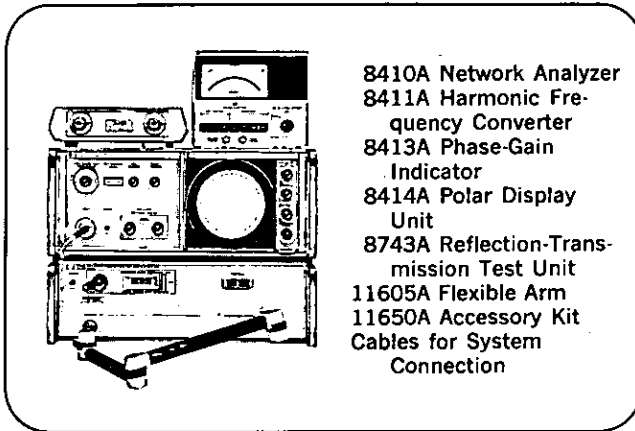
NETWORK ANALYZERS



MICROWAVE SYSTEMS

Swept Measurements 2 to 12.4 GHz
8410S Option 200 System

Specifications 8410S Option 200 System



8410A Network Analyzer
8411A Harmonic Frequency Converter
8413A Phase-Gain Indicator
8414A Polar Display Unit
8743A Reflection-Transmission Test Unit
11605A Flexible Arm
11650A Accessory Kit
Cables for System Connection

Frequency range: 2.0 to 12.4 GHz.

Transmission-reflection selection: manual, by front-panel, lighted pushbuttons; remote, by contact closure or saturated transistors through 36-pin connector contacts. Short circuit current, 12 mA; open circuit voltage, 12 V dc.

RF input: 20-dB range between -14 dBm and $+14$ dBm, 20-dB variation causes less than 1.5 dB and 4° change in amplitude and phase readings.

Source reflection coefficient:¹

≤ 0.09 (1.2 SWR), 2-8 GHz
 ≤ 0.13 (1.3 SWR), 8-12.4 GHz

Termination Reflection Coefficient:²

≤ 0.09 (1.2 SWR), 2 - 8 GHz
 ≤ 0.13 (1.3 SWR), 8 - 12.4 GHz

Directivity: ≥ 30 dB, 2-12.4 GHz.

Insertion loss, RF input to test port: 20 dB nominal.

Frequency response

Transmission: typically $< \pm 0.5$ dB amplitude $< \pm 5^\circ$ phase.

Reflection: typically $< \pm 0.06$ magnitude and $< \pm 7^\circ$ phase, as read on the 8414A with a short on the unknown port.

Transmission measurement accuracy

(See common performance specifications.)

Reflection measurement accuracy

Accuracy curves show overall system uncertainty when measuring reflection coefficient. Sources of error included are directivity, source match, and polar display accuracy. System frequency response is specified separately and is not included in the accuracy curves.

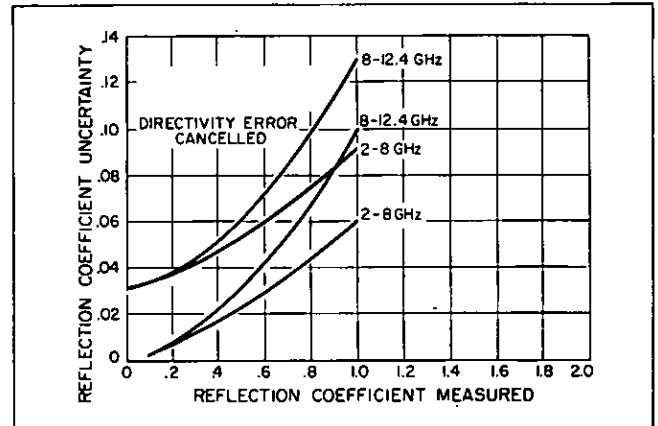
Magnitude accuracy:

$$\rho_u = \pm(0.032 + 0.03 \rho_L + 0.03 \rho_L^2) \text{ 2-8 GHz}$$

$$\rho_u = \pm(0.032 + 0.04 \rho_L + 0.04 \rho_L^2) \text{ 8-12.4 GHz}$$

ρ_L = magnitude uncertainty

ρ_L = measured reflection coefficient magnitude



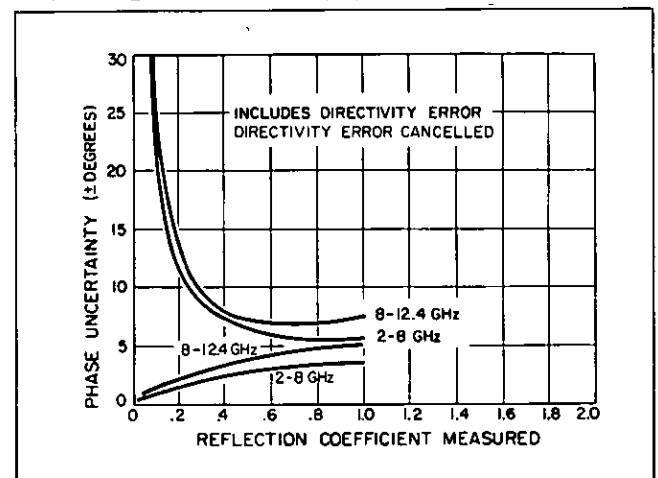
Reflection coefficient uncertainty including coupler directivity and when directivity is cancelled using a sliding load.

Phase accuracy:

$$\phi_u = \sin^{-1} \frac{\rho_u}{\rho_L} \text{ for } \phi_u < \pm 90^\circ$$

ϕ_u = phase uncertainty

(See magnitude above for ρ_u, ρ_L terms)



Phase uncertainty including coupler directivity and when directivity is cancelled using a sliding load.

Weight and dimensions: instruments shipped separately. See individual instrument listing.)

Price: Model 8410S Option 200, \$10,595.

¹Source Reflection Coefficient: Reflection coefficient of the port used to supply incident signal to the device under test.

²Termination Reflection Coefficient: Reflection coefficient of port connected to output of test device when transmission or reflection measurement is being made.

MICROWAVE SYSTEMS

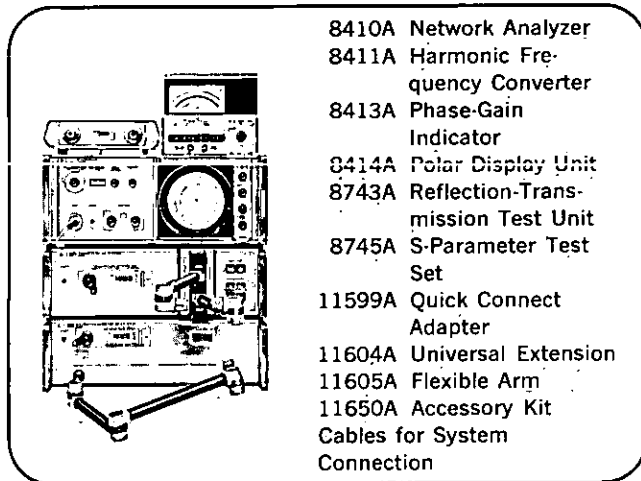
Swept measurements 0.11 to 12.4 GHz

8410S Option 300; 8410A, 8411A, 8413A, 8414A, 8740A-8742A



NETWORK ANALYZERS

Specifications 8410S Option 300 System



8410A Network Analyzer
8411A Harmonic Frequency Converter
8413A Phase-Gain Indicator
8414A Polar Display Unit
8743A Reflection-Transmission Test Unit
8745A S-Parameter Test Set
11599A Quick Connect Adapter
11604A Universal Extension
11605A Flexible Arm
11650A Accessory Kit
Cables for System Connection

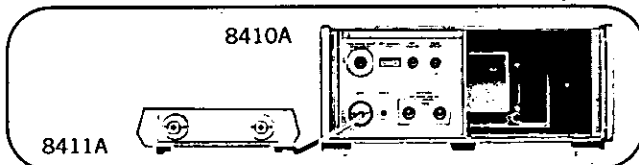
Frequency range: 0.11 to 12.4 GHz.

Specifications for Model 8410S-300 are a combination of Models 8410S-100 and 8410S-200. All specifications for those models pertain directly to the 8410S-300 at the frequencies of interest.

Weight and dimensions: instruments shipped separately. (See individual instrument listing.)

Price: Model 8410S Option 300, \$14,470.

INDIVIDUAL INSTRUMENT LIST



NETWORK ANALYZER

8410A Network Analyzer, 8411A Frequency Converter Function: 8411A Harmonic Frequency Converter converts RF signals to IF signals for processing in 8410A Mainframe. 8410A is the mainframe for display plug-in units. Mainframe includes tuning circuits. IF amplifiers and precision IF attenuator.

Dimensions

8410A: 7" high, 8 $\frac{3}{8}$ " deep, 16 $\frac{3}{4}$ " wide (17,8 x 21,3 x 42,5 cm).

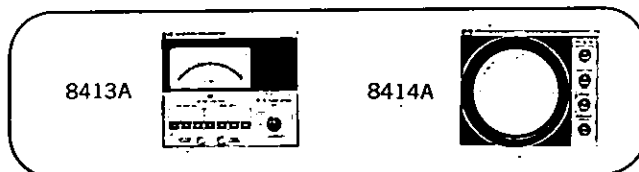
8411A: 2 $\frac{3}{8}$ " high, 5 $\frac{5}{8}$ " deep, 9" wide (6,8 x 14,3 x 22,9 cm), exclusive of connectors. 5-ft cable permanently attached for connection to 8410A.

Price

Model 8410A, \$2000.

Option 005: (compatible with 8418A), add \$100.

Model 8411A, \$2500.



DISPLAY UNITS

8414A Polar Display

Function: plug-in CRT display unit for 8410A or 8407A. Displays amplitude and phase data in polar coordinates on 5" cathode ray tube.

Weight: net, 13 lb (5,8 kg); shipping, 17 $\frac{1}{2}$ lb (7,8 kg).

Dimensions: 6" high, 15-9/16" deep, 7-9/32" wide (15,2 x 39,5 x 18,6 cm), excluding front panel knobs.

Price: Model 8414A, \$1250.

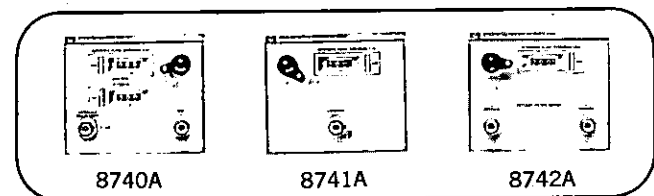
8413A Phase-Gain Indicator

Function: plug-in meter display unit for 8410A or 8407A. Displays relative amplitude in dB between reference and test channel inputs or relative phase in degrees. Pushbutton selection of meter function and range.

Weight: net, 11 lb (4,9 kg); shipping, 15 lb (6,7 kg).

Dimensions: 6" high, 15-9/16" deep, 7-9/32" wide (15,2 x 39 x 18,6 cm), excluding front panel knobs.

Price: Model 8413A, \$1050.



TEST UNITS

8740A Transmission Test Unit

Function: RF power splitter and calibrated line stretcher for transmission measurement with Network Analyzer.

Frequency range: dc-12.4 GHz.

Weight: net, 16 lb (7,1 kg); shipping, 21 lb (9,4 kg).

Dimensions: 6" high, 16-3/16" deep, 7-9/32" wide (15,2 x 41 x 18,6 cm), excluding knobs and connectors.

Price: Model 8740A, \$1300.

8741A & 8742A Reflection Test Units

Function: wideband reflectometer, phase-balanced for swept or single frequency impedance tests with 8410A. Calibrated adjustable reference plane.

Frequency range: 0.11-2.0 GHz (8741A); 2.0-12.4 GHz (8742A).

Weight: net, 15 lb (6,7 kg); shipping, 20 lb (8,9 kg).

Dimensions: 6" high, 16-3/16" deep, 7-9/32" wide (15,2 x 41 x 18,6 cm), excluding connectors and knobs.

Price

Model 8741A, \$1500.

Model 8742A, \$1500.

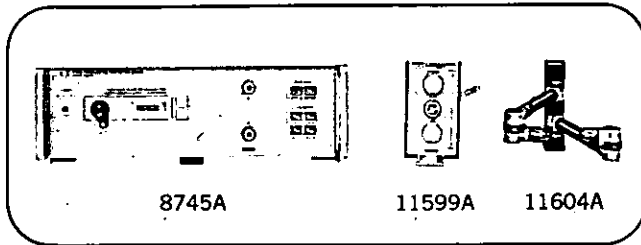
NETWORK ANALYZERS



MICROWAVE SYSTEMS

Individual Instruments

8418A, 8743A, 8745A, 8747A & Accessories



8745A S-Parameter Test Set

Function: wideband RF power splitter and reflectometer with calibrated line stretcher. Pushbutton operated for either transmission or reflection measurements with network analyzer.

Frequency range: 0.1-2 GHz.

Weight: net, 34¼ lb (15,9 kg); shipping, 39¼ lb (17,5 kg).

Dimensions: 5½" x 16¾" x 25¾" (139 x 423 x 650 mm).

Price: Model 8745A, \$3000. Option 001 (Type N female connectors on outputs to 8411A), no additional charge.

11604A Universal Extension

Function: mounts on front of 8745A; connects to device under test. Rotary air lines and rotary joints connect to any two-port geometry.

Weight: net, 4 lb (1,8 kg); shipping, 5 lb (2,2 kg).

Dimensions: 10½" x 5" x 1¼" (267 x 127 x 31,6 mm).

Price: Model 11604A, \$800.

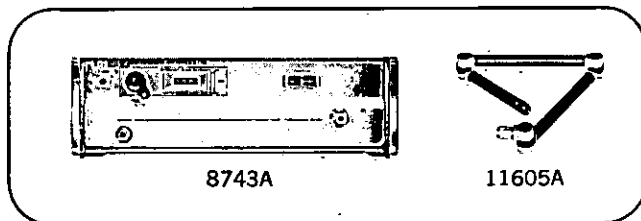
11599A Quick Connect Adapter

Function: quickly connects and disconnects the 8745A and the transistor fixtures or 11604A Universal Extension.

Dimensions: 3" x 5" x 4¼" (76 x 127 x 108 mm).

Weight: net, 12 oz (21 gm); shipping, 1 lb (28 gm).

Price: Model 11599A, \$75.



8743A Reflection/Transmission Test Unit

Function: wideband RF power splitter and reflectometer with calibrated line stretcher. Pushbutton operated for either transmission or reflection measurements with network analyzer.

Frequency range: 2-12.4 GHz.

Weight: net, 27 lb (12,4 kg); shipping, 34 lb (15,2 kg).

Dimensions: 5½" high, 16¾" wide, 18¾" deep (140 x 426 x 467 mm).

Price: Model 8743A, \$2450.

11605A Flexible Arm

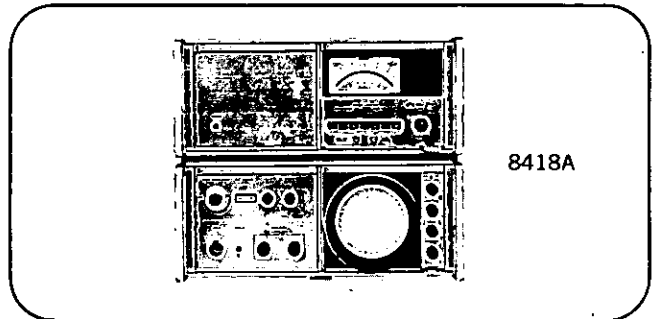
Function: mounts on front of 8743A; connects to device under test. Rotary air lines and rotary joints connect any two-port geometry.

Weight: net, 4 lb (1,8 kg); shipping, 6 lb (2,7 kg).

Length: 10.1" (256,5 mm) closed, 25.5" (647,7 mm) extended.

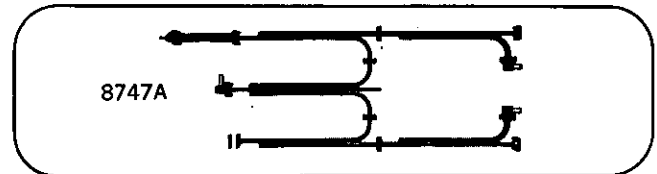
Price: Model 11605A, \$550.

8418A Auxiliary Power Supply



Function: the 8418A Power Supply Unit provides power for operation of either the 8413A Phase-Gain Indicator or the 8414A Polar Display Unit. Used in conjunction with the 8410A Opt 005 Network Analyzer, it provides the capability of viewing amplitude and phase readout in both rectangular and polar coordinates simultaneously.

Price: Model 8418A, \$500.



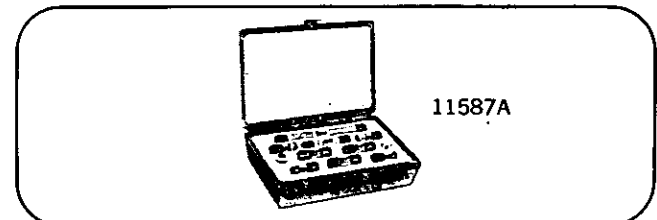
8747A Waveguide Reflection/Transmission Test Units

Function: waveguide setup for measuring reflection and transmission parameters of waveguide devices with the network analyzer.

Dimensions: X8747A, 14" x 41" (350 x 1030 mm); P8747A, 12" x 33" (300 x 830 mm).

Weight: X8747A, 11 lb (5 kg) net, 15½ lb (7 kg) shipping. P8747A, 7 lb (3,2 kg) net, 12½ lb (5,6 kg) shipping.

Price: Model X8747A, \$1600; P8747A, \$1700.



11587A, 11650A Accessory Kits

Function: 11650A contains accessories normally used for transmission and reflection tests with the 8745A and 8743A. 11587A contains accessories normally used for transmission and reflection measurements with the 8740A, 8741A and 8742A.

Weight: net, 3 lb (1,34 kg); shipping, 5 lb (2,2 kg).

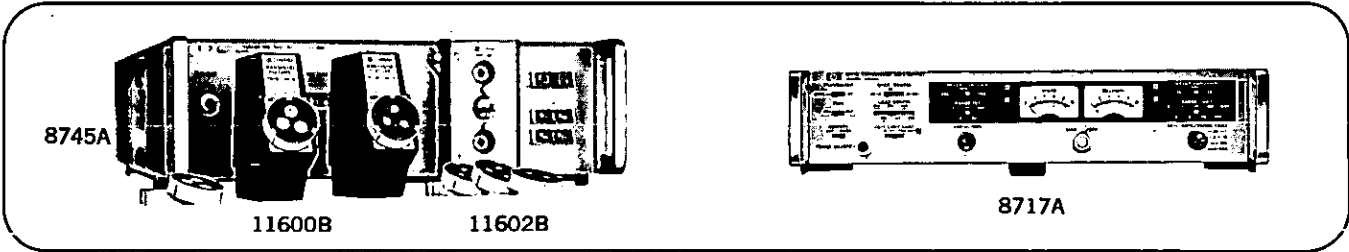
Price: 11587A, \$840; 11650A, \$740.

TRANSISTOR S-PARAMETERS

Two-port reflection and transmission, 0.1 - 2 GHz
Models 8717A, 11600B, 11602B, 11589A, 11590A



NETWORK ANALYZERS



Transistor S-Parameter Measurements

The 8745A S-parameter Test Set combined with the 11600B or 11602B Transistor Fixtures make accurate transistor characterization as easy as pushing a button. After one simple calibration all four S-parameters can be made. A rear panel connector on the 8745A allows bias and bias sensing connectors to be made to biasing networks built into the 8745A. The 8717A Transistor Bias Supply is designed for use with the 8745A. Front panel switches on the 8717A makes it easy to set up the desired transistor bias. The 8745A, 8717A, 11600B and 11602B can be used with either the 8405A Vector Voltmeter or 8410A Network Analyzer when making transistor S-parameter measurements.

Models 11600B and 11602B Transistor Fixtures

Function: used with or without the 8745A to measure transistors and other semiconductor devices. Mount directly on the 8745A and provide common emitter-base-collector and common source-gate-drain connections. A calibration short and thru are included with the fixtures.

Model 11600B: for TO-18/TO-72 or similar transistor packages. Has four snap-on dials, two for bipolars and two for FET's.

Model 11602B: for TO-5/TO-12 or similar transistor packages. It has two snap-on dials for bipolars.

Frequency: dc to 2 GHz.

Lead lengths: accepts leads up to 1.5 inches long.

Lead diameters: 0.016 to 0.019 inch.

Impedance: 50Ω ± 2Ω.

Connectors: APC-7* precision connectors for input and output.

Option 001: precision type N connectors for input and output.

Maximum power: 10 W including RF signals.

Dimensions: 4 7/8" x 6" x 1 1/2" (119 x 152 x 38 mm).

Weight: 38 oz (1,1 kg).

Price: 11600B, \$600; 11602B, \$525.

Option 010: includes 50 ohm calibration load, add \$50.

8717A Transistor Bias Supply

The 8717A can be digitally programmed through an optional D/A converter Fixtures. It is an accurate, stable, manual and/or digitally programmable transistor bias supply. It features switching for convenience in test setups and provides metering for accurate voltage/current settings and readings. Front panel switches on the 8717A quickly establish stable bias conditions for all transistor configurations used in the 11600B/11602B transistor fixtures. This eliminates the need for external wiring changes for each new configuration, i.e., common emitter-base-collector or common source-gate-drain. The transistor under test is biased in a feedback circuit which maintains a highly accurate collector-emitter voltage and emitter current every time a different transistor is biased, when a common lead configuration is changed, or when temperature changes. Two meters independently measure one of the voltages and one of the currents on any of the three leads of the transistor under test. Transistors are protected by an emitter current limit shutdown circuit which removes biasing when the preset limit is exceeded.

The 8717A can be digitally programmed through an optional D/A converter plug-in with which the two internal supplies can be switched into an independent constant voltage supply and an independent constant current supply. All the features otherwise remain the same as above.

Specifications, 8717A

Outputs:	Manual control	Programmed control
Normal Mode { V _{CE} (V _{DS}): 0-31.75 V I _E (I _S): 0-500mA	continuously variable continuously variable (4 ranges) 0.01-1; 0.1-10; 1-100; 10-1000 mA	min. step size: 0.25 V min. step size: 3.2% of full range
Independent Mode { Voltage supply: 0 to ±31.75V @ 0.5 A Current supply: 0 to 100 mA @ ±10 V	continuously variable continuously variable (3 ranges) 0.01-1; 0.1-10; 1-100 mA	min. step size: 0.25 V min. step size: 3.2% of full range
Normal or Independent {	Voltage accuracy Current accuracy	4% of meter full scale 4% of meter full scale
		0.2 V + 2% of normal 2% of programmed value

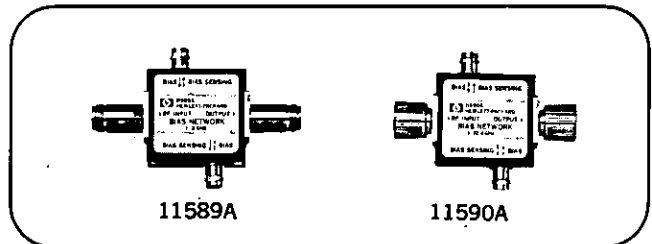
Meters:	Volts	Milliamps
Meter functions Full scale ranges	V _{CE} , V _{BE} , V _{CB} or V _{DS} , V _{DG} , V _{GS} 1, 3, 10, 30, 100 V	I _E , I _C , I _B or I _S , I _G , I _D 0.1, 0.3, 1, 3, 10, 30, 100, 300, 1000 mA

Dimensions: 16 3/4" x 3 3/8" x 13 1/2" (425 x 86 x 336 mm).

Weight: 17.75 lb (8,0 kg).

Price: HP 8717A, \$1295.

Option 001: programmable A-D Converter, \$500.

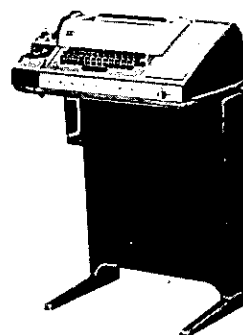
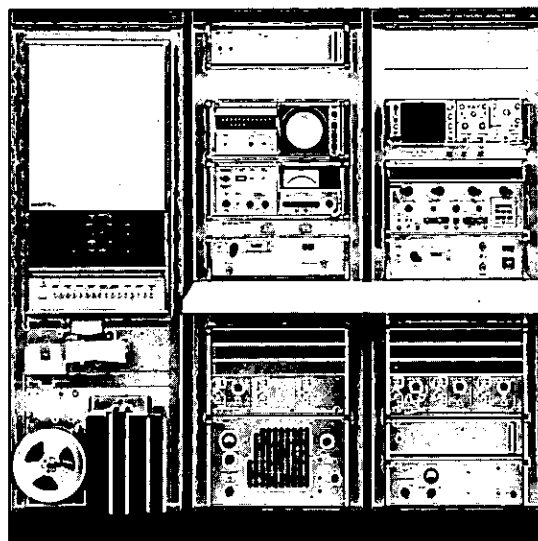


11589A and 11590A Bias Networks

Function: provides dc bias and bias sensing on 50Ω systems. Compatible with bias supplies using sensing like the 8717A, but can be used without bias sensing.

Specifications, 11589A, 11590A

	11589A	11590A
Frequency range:	100 MHz-3 GHz	1 GHz-12.4 GHz
VSWR	<1.2 5/5	<1.2 5/5
Insertion loss	<0.8 dB	<0.8 dB
Max bias voltage	100 V	100 V
Max RF	50 watts	50 watts
Max bias current	1 A	0.5 A
RF connectors	Type N	Type N
Price Option 001 APC-7 connectors	\$250 add \$30	\$250 add \$30



8542A

General Description

The HP 8542A Automatic Network Analyzer is a computer-controlled microwave measurement system which provides complete characterization of microwave devices by a self-calibration and error correction technique. Measured data can be presented in numerous forms including VSWR, return loss, impedance, gain or loss, non-linear phase shift, group delay, and h-, y-, z-, or s-parameters. Either active or passive devices may be completely characterized by phase and amplitude measurements of the test device's reflection and transmission characteristics over the frequency range from 110 MHz to 18.0 GHz.

The 8542A system provides a great many advantages over conventional measurement systems because of the system's ability to make very accurate measurements at high speed. By coupling the 8410A Network Analyzer's ability to completely characterize a device in terms of magnitude and phase angle with a computer's ability to store data and solve complex mathematics, the system can perform sophisticated error-correction procedures that are difficult or impossible to perform manually. In addition, the direct coupling between the Network Analyzer and the computer allows data to be gathered at a far more rapid rate than possible in any manual measurement scheme.

Principles of Operation

The 8542A Automatic Network Analyzer System consists of three essential sub-systems: a programmable signal source, a programmable network analyzer, and a small instrumentation computer. Operation of each of these subsystems is outlined briefly below. Figure 1 is a simplified block diagram of the measurement system.

Programmable Signal Source. This subsystem consists of a sweep oscillator modified for digital programming of frequency, one or more RF units, a computer interface, and RF leveling circuitry. In multiband systems, a RF unit holder and a signal multiplexer is also provided. While under computer control, the RF signal is set by first programming the desired frequency band and then selecting the correct frequency within this band. All band and frequency selection is done by the computer while in the AUTOMATIC mode of operation. Table 1 describes the frequency range options available.

The desired test unit is selected manually from the system control panel; the signal multiplexer then switches the RF signal from the signal source to this test unit automatically. A portion of the RF signal is detected in the multiplexing unit, permitting automatic level control (ALC).

Programmable Network Analyzer. This subsystem measures both magnitude and phase angle of the transmission and reflection coefficients of the device under test over 360° of phase shift and 80 dB of dynamic amplitude range. The RF signal entering the subsystem is routed through a test unit which converts transmission and reflection measurements into a test and reference signal for the network analyzer. Table 2 describes the test unit options available for use with an 8542A system.

In the test unit, the RF is split into two signals. One is connected to the reference channel of the frequency converter; the other goes to the device under test. For transmission measurements, the signal through the device is connected to the test channel of the frequency converter. For reflection measurements, the signal reflected from the test device is coupled to the test channel via a directional coupler.

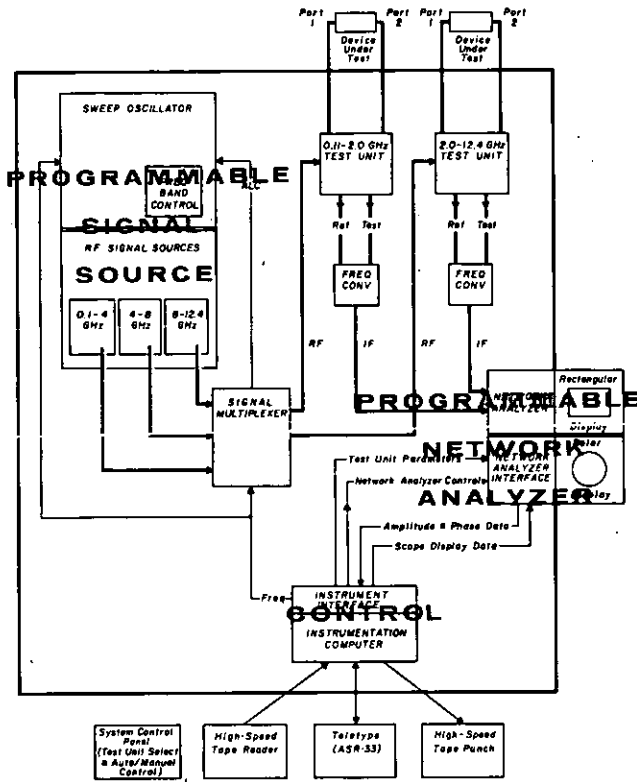


Figure 1. Complete multiband system.

In both types of measurements, the network analyzer measures the magnitude ratio and phase difference between the test and reference signals. These ratios are then converted from analog to digital information for processing by the computer.

Computer Subsystem. This subsystem consists of a small instrumentation computer and its associated peripheral devices such as a teletypewriter, high-speed tape reader, and a high-speed tape punch. The control subsystem performs the following functions:

- Controls all instruments in the system
- Stores the calibration and measurement data
- Performs programmed calculations
- Displays data in the desired form on either an oscilloscope or teletypewriter

Table 1. Frequency range options available for either single-band or multi-band programmable signal sources.

RF Source Frequency Range ¹	Number of Programmable Steps over Frequency Range
{ 110 MHz-2.0 GHz ² 2.0 GHz-4.0 GHz }	{ 1000 steps: 110 MHz-2.0 GHz 1000 steps: 2.0 GHz-4.0 GHz }
1.0 GHz-2.0 GHz	1000 steps
2.0 GHz-4.0 GHz	1000 steps
4.0 GHz-8.0 GHz	1000 steps
8.0 GHz-12.4 GHz	1000 steps
12.4 GHz-18.0 GHz	1000 steps

¹ Other frequency ranges are available on special order — for example: 1.4 GHz - 2.9 GHz, 1.7 GHz - 3.4 GHz, and 7.0 GHz - 12.4 GHz.

² The two bands in this option are selected manually in the single-band configurations and automatically in the multiband configurations.

Table 2. Test unit options

Test Unit Options Available for Programmable Network Analyzers				
Frequency Range (GHz)	Type of Measurements Possible	Nominal Input Power To Device Under Test ¹	Precision Flexible Extension	Transistor Fixtures
2.0-18.0	Transmission (s ₂₁) and Reflection (s ₁₁). For all four s parameters, the device under test must be turned around.	-25 dBm	Yes	No
0.5-18.0	Transmission and Reflection for up to four-port devices—sixteen s parameters maximum	-5 dBm ²	Yes	No
0.11-2.0	Transmission (s ₂₁ and s ₁₂) and Reflection (s ₁₁ and s ₂₂) with one connection of the device under test.	-5 dBm	Yes	Yes

¹This level can be reduced by inserting attenuators at the input port. All power levels shown are approximate and can be adjusted or will vary about 10 dB from the nominal.

²This power level can be reduced in 10-dB steps from -5 dBm to -75 dBm under computer control.

Three input/output peripheral devices are included with the system. The teletypewriter is used for programming and command and provides readout of data in "hardcopy" form. The teletypewriter can also be used to generate a paper tape copy of a computer program.

The tape reader is used for high-speed entry of the punched paper tape programs into the computer. A high-speed tape punch is used for punching paper tapes for data outputs, edited versions of computer program tapes, or for the output of the FORTRAN or BASIC compilers. This peripheral device is especially useful in writing and compiling special computer programs since it is capable of punching tapes twelve times faster than the teletypewriter. Optional peripheral devices available include:

- Heavy-duty Teletypewriter (Modified ASR-35)
- Disc Memory (and Direct Memory Access)
- X-Y Plotter
- Large Screen Oscilloscope Display
- Programmable Power Supplies

Calibration and Measurement Procedure

Measurement of a device using an 8540 series system typically follows a two part sequence: calibration of the system and a measurement sequence using stored calibration data. For reflection measurements, the system is calibrated by measuring three precision standards: a sliding load, a short and an offset short (a short located a precise distance along a precision air line). These three standards have highly predictable behaviors based upon precise physical dimensions. The system's reflection errors are computed from the difference between the standards' measured and theoretical values. For transmission measurements, the test ports are connected together and the transmission errors are determined from the measurement data with the reflection errors subtracted.

All of the calibration data is stored for later correction of test data.

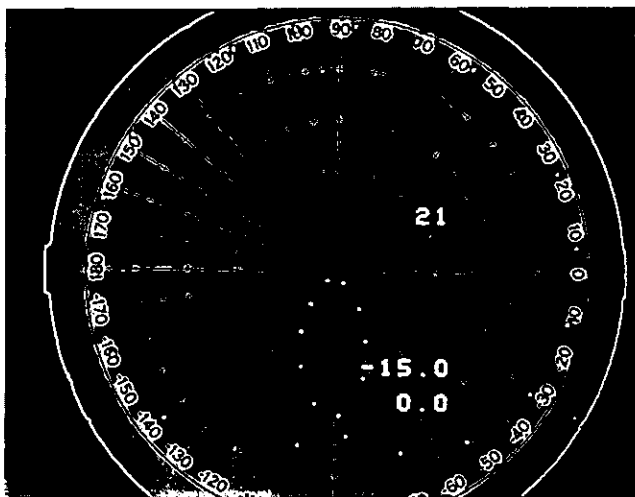
The calibration sequence is spelled out step-by-step on the teletype. Therefore, there is no need to remember a complicated procedure. After the system types each instruction, such as "connect short", the teletype waits for the operator to perform the operation and answer. The system then measures the standard at all frequencies requested, performs any mathematics necessary, and goes to the next instruction in the procedure.

This calibration procedure is supplied ready to use with enough options to cover a wide variety of test situations: fixed or sliding load, coaxial line or waveguide, single or multiband tests. This calibration procedure is followed by one of several standard measurement tapes designed to perform the most commonly needed measurements or by a special program written by the operator in either FORTRAN or BASIC. The standard measurement tapes contain a step by step sequence which provides a consistent and repeatable measurement procedure. Figures 2 and 3 illustrate some of the data displays possible using an 8542A system.

Although the standard software supplied makes most of the commonly needed tests, the need to tailor a program to a specific engineering or production test also arises. Since the 8542A series hardware is general-purpose, its character is largely determined by the software, giving the user a high degree of flexibility in designing special procedures. Two computer languages are available: BASIC and FORTRAN. Both are supplied with standard, corrected-measurement subroutines using data stored by the programmed calibration routines. Thus, a minimum of programming effort is required of the user. BASIC is an easy-to-learn, conversational computer language; the program can be typed into the teletype and executed immediately. A combination of key words and instant feedback makes it possible to teach any engineer how to use the BASIC language within a few hours.

For users familiar with FORTRAN, a compiler comparable to FORTRAN 2 is supplied with a complete library of measurement, complex math, and display subroutines.

For measurements requiring hardware not normally pro-



FREQ	REPL	ANGLE	RTN LS	VSWR	GAIN	PHASE	DELAY
3390.000	.949	86.9	.5	37.955	-14.20	-45.1	2.382
3310.000	.936	78.8	.6	38.183	-12.30	-53.3	2.711
3320.000	.916	69.2	.8	22.939	-10.50	-63.1	3.008
3330.000	.887	58.2	1.0	16.777	-8.55	-73.9	3.536
3340.000	.840	45.8	1.5	11.530	-6.59	-84.7	4.150
3350.000	.769	29.3	2.3	7.661	-4.68	-101.6	4.926
3360.000	.662	11.0	3.6	4.926	-3.04	-119.3	5.472
3370.000	.525	-9.5	5.6	3.208	-1.78	-139.0	5.635
3380.000	.372	-31.3	8.6	2.185	-1.01	-159.3	5.385
3390.000	.237	-53.5	12.5	1.620	-.59	-178.7	5.049
3400.000	.134	-78.0	17.5	1.389	-.40	-193.1	4.652
3410.000	.071	-106.9	23.0	1.153	-.26	-194.4	4.428
3420.000	.043	-140.8	27.3	1.009	-.27	-130.5	4.226
3430.000	.034	-177.5	28.8	1.075	-.27	-115.0	4.156
3440.000	.036	-172.1	28.8	1.075	-.26	-100.3	4.099
3450.000	.040	-169.4	28.0	1.083	-.27	-85.5	4.083
3460.000	.042	-162.3	27.5	1.088	-.29	-70.8	4.150
3470.000	.036	-144.3	26.9	1.074	-.31	-55.9	4.293
3480.000	.021	-81.6	33.4	1.044	-.32	-40.4	4.506
3490.000	.057	-5.8	24.8	1.121	-.36	-24.2	4.845
3500.000	-1.44	-35.5	16.8	1.327	-.44	6.8	5.152
3510.000	.060	-57.0	11.4	1.733	-.70	-11.8	5.340
3520.000	.422	-70.0	7.5	2.459	-1.26	-31.6	5.340
3530.000	.579	-97.0	4.0	3.745	-2.23	-50.2	5.093
3540.000	.710	-116.3	3.0	5.905	-3.63	-68.6	4.455
3550.000	.809	-132.7	1.8	9.406	-5.39	-84.6	3.031
3560.000	.671	-146.4	1.2	14.478	-7.27	-98.4	3.252
3570.000	.910	-158.2	.8	21.173	-9.16	-110.1	2.787
3580.000	.933	-168.2	.6	28.793	-10.90	-120.8	2.420
3590.000	.949	-176.7	.5	38.066	-12.72	-128.9	2.151
3599.999	.957	-175.8	.4	45.121	-14.40	-136.6	2.151

Figure 3. Forward printout of coaxial bandpass filter displayed in Figure 2.

vided with an 8542A system, special systems can be provided. Among the types of measurements which can be provided are frequency (using a counter), power, and thermistor mount calibration.

Pricing

This advanced microwave measurement system can be tailored to meet your individual needs. The following four systems are representative of the types of systems and range of prices available. Included in the price of each system is installation and on-site training of factory personnel and 90 days of preventative maintenance.

1. Frequency range .11-2.5 GHz, manual band select, standard signal source, calibration standards, and 2114A-8K Core computer. Price \$68,355.
2. Frequency range .11-12.4 GHz, automatic band select standard signal source, calibration standards, and 2114A-8K Core computer. Price \$84,230.
3. Frequency range .11-2.5 GHz, manual band select, frequency stabilized signal source, calibration standards, and 2114A-8K Core computer. Price \$93,660.
4. Frequency range .11-12.4 GHz, automatic band select, frequency stabilized signal source, calibration standards, and 2114A-8K Core computer. Price \$108,630.

Leasing

8542A systems are also available on a four-year lease contract. To provide maximum on-site system support, a Hewlett-Packard Customer Assistance Agreement may be obtained.

For complete system information or a quotation on a system designed to meet your needs, call your Hewlett-Packard field engineer.

POWER MEASUREMENTS



POWER METERS

Power measurements

At microwave frequencies power is the basic measure of signal amplitude. Unlike voltage and current, microwave power remains constant along a loss-less transmission line. Thermocouple, Thermistor and Calorimetric power meters are the three most common type of instruments used to measure microwave power.

Thermocouple power meters

The use of thermocouples as a sensing element is the most recent development in microwave power measurement. Wide range, low drift and simple operation are the major advantages of thermocouples over other detectors. A thermocouple measurement system consists of a mount which produces a dc output voltage proportional to the power dissipated within it and a power meter which measures the voltage and displays it in units of power. The mount provides a match between the thermocouple sensor elements, Figure 1, and the microwave transmission line. Thin-films of antimony and bismuth form the sensor elements which are bonded to a gold film deposited on a sapphire substrate. Gold offers a low thermal resistance between the ends of the sensor elements and the ambient temperature sink of the mount. Dissipation of microwave energy in the resistive thermocouple elements causes the temperature of the Sb-Bi junctions to rise above the temperature of the Sb-Au and Bi-Au reference junctions. This temperature differential and the resulting thermocouple voltage are proportional to the applied power. The mount has been designed such that changes in ambient temperature affect all junctions equally; maintaining nearly the same temperature gradient between the two junctions. This insensitivity to zero-drift allows the full dynamic range of the thermocouple to be exploited. A cable delivers the dc output of the mount to the power meter for measurement and display. The power meter is basically a low noise, chopper stabilized dc amplifier with the appro-

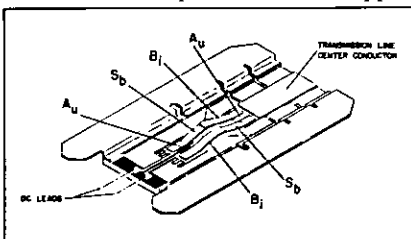


Figure 1. Thermocouple Sensor Elements and Substrate.

appropriate gain to drive a panel meter calibrated in units of power.

With thermocouple type power meters, accuracy is fundamentally dependent on the instrument's gain being matched to the mount's sensitivity. Since thermocouple sensitivity is subject to change with variations in temperature, overload and aging, a convenient means of calibration is vital.

The Hewlett-Packard 437A Power Meter provides internal calibration. Controlled by a front panel switch, the circuit illustrated in Figure 2 automatically compensates for variations in thermocouple sensitivity. With the 8485A Thermocouple Mount, the 437A measures power from 0.3 μ W to 100 mW at frequencies from 10 MHz to 18 GHz.

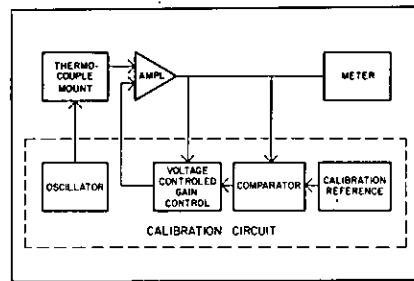


Figure 2. 437A Calibration Circuit. An audio oscillator delivers a precise 10 kHz signal to the mount. The amplified output voltage is then compared to a calibration reference. Any difference appears as an error signal which actuates a voltage controlled gain control to compensate the instrument gain.

Thermistor power meters

Thermistors offer an alternative means to measure microwave power. A thermistor is a resistive element whose resistance decreases with increasing temperature. In a thermistor type instrument the sensor elements are contained in a mount but form one leg of a Wheatstone bridge through a bias connection to the power meter. Dc or ac excitation biases the thermistor elements to balance the bridge. When microwave power is applied to the sensor elements, the resulting temperature rise causes the element's resistance to fall, unbalancing the bridge. Withdrawing an equal amount of bias power from the thermistors rebalances the bridge. The change in bias power is then measured and displayed on a meter.

Automatic thermistor bridges

There are a number of thermistor bridge designs which provide various degrees of accuracy, speed, and convenience.

The Hewlett-Packard Model 432A

Power Meter is a temperature-compensated, automatically balanced thermistor bridge of versatile design. Operating with any of the Hewlett-Packard temperature-compensated thermistor mounts, the 432A automatically maintains bridge balance and reads substituted bias power over ranges of 10 microwatts to 10 milliwatts (full scale).

Since thermistor elements are temperature-sensing devices, they are unable to distinguish between applied power level changes and environmental temperature changes. As thermistor bridge sensitivity is increased, even minute temperature variations can unbalance the bridge. This results, if uncompensated, in "zero drift" of the power meter and erroneous power measurements.

A dual bridge arrangement, as shown in Figure 3 is used in the 432A to compensate for variations in temperature at the thermistor mount. The thermistor mounts used with the 432A have two thermistor elements. The two are in close thermal proximity and are affected equally by changes in ambient temperature. Thus R_p responds to both ambient temperature and applied RF power; R_c , isolated from the RF power, responds only to ambient temperature. Each element is connected to its own bridge circuit in the power meter, which automatically controls bias power. This arrangement compensates for temperature changes, thus reducing zero drift in the 432A by a factor of 100 over uncompensated thermistor meters. Another advantage of the 432A design is that when zeroed on the most sensitive range, the meter may be switched to any other power range without re-zeroing (zero-carryover is within 1% on all ranges). A dc output proportional to the meter deflection is available for recording purposes or control of external circuits such as power meter leveling of microwave sweep oscillators and signal generators.

Compensated thermistor mounts available for the 432A include the 478A (10 MHz to 10 GHz) and the 8478B (10 MHz to 18 GHz) Coaxial Mounts. The 486A Waveguide Series collectively cover the waveguide bands from 2.6 to 40 GHz. All mounts have low SWR over their frequency ranges without tuning.

Calorimetric power meters

Above 100 mW accurate power measurements can be achieved using calorimetric techniques.

Calorimetric power meters dissipate the unknown power in a resistive termi-

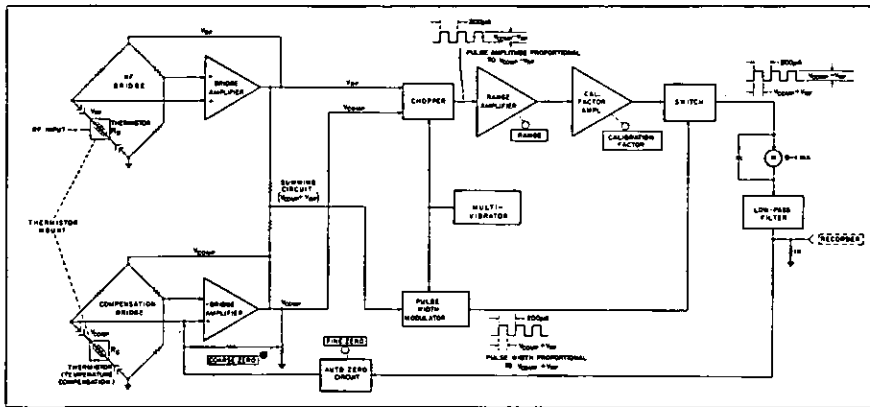


Figure 3. Block diagram of HP 432A Power Meter. Dual bridge provides proper bias to thermistor mount to correct for temperature variation and reduce zero drift.

nation that is matched to the transmission line or source impedance. The temperature rise caused by the power dissipation is then measured by a temperature sensor which is calibrated against known amounts of dc power. Calorimetric power meters fall into two categories—dry and fluid. Dry calorimeters depend upon a static thermal path between the dissipative load and the temperature sensor. This arrangement often requires several minutes for the termination and sensor to reach equilibrium, making measurements time-consuming and too sluggish for tuning circuit parameters for optimum output.

Fluid calorimeters such as the HP 434A utilize a moving stream of oil to transfer heat quickly to the sensing element. An amplifier-feedback arrangement, in conjunction with the series oil flow system, reduces measurement time in the 434A to less than 5 seconds for full-scale response. The physical size of the termination and the flow rate of liquid passing over the termination are primary factors which determine the maximum power that may be dissipated by a fluid calorimeter. The HP 434A covers the important range of 10 mW to 10 watts from dc to 12.4 GHz.

Peak power measurement

A frequent requirement in microwave work is the measurement of peak power in a periodic pulse. This may be done by various indirect techniques using thermocouples, thermistors or calorimeters. Hewlett-Packard produces a versatile instrument that conveniently measures peak power directly in the 50 MHz to 2 GHz region. This instrument (the 8900B) utilizes a video comparator technique to bring a known dc voltage, supplied by the 8900B, in a known impedance to a level which is equal to the pulse being measured. This allows simple measurements of peak pulse power with a basic accuracy of 1.5 db even when the waveform is not rectangular. A custom calibration chart increases accuracy to 0.6 db for critical applications.

Applications

Information on virtually all aspects of microwave power measurement, including detailed descriptions and illustrations of instruments, measurement techniques, error analysis and applications, is contained in Application Note 64. Sources of measurement error and systematic methods for error-reduction allow selection of the best procedure for specific applications. Application Note 64, entitled "Microwave Power Measurement," is available on request through your Hewlett-Packard Sales Office.

Steps toward better accuracy

The fundamental standards of microwave power lie in dc or low-frequency ac voltage and resistance standards which may be accurately measured and used for comparison or substitution. Other factors, such as impedance matching and efficiency of the sensing device, also play an important role in overall measurement accuracy.

The basic accuracy of Hewlett-Packard power measuring equipment satisfies the requirements of most applications without complicated setups requiring extensive manual operations and calculation. Should greater accuracy be required, the versatility and stability of Hewlett-Packard equipment allows easy enhancement of its basic accuracy in a step-by-step manner until the degree of accuracy needed is achieved.

Effective Efficiency and Calibration Factor: A power meter can only be responsive to the power which is actually dissipated within its sensor elements. Power which is dissipated elsewhere in the mount or reflected by it will not be indicated. Furthermore, the spatial distribution of current and resistance within the sensor elements differs for power at microwave frequencies and the dc or audio power used for reference or substitution. The effects of these sources of error are measured at a number of frequencies for all Hewlett-Packard Thermocouple Mounts and HP Models 478A,

8478B, and 486A Thermistor Mounts, and presented on their nameplates as Effective Efficiency and Calibration Factor. For thermocouple mounts Effective Efficiency is defined as the ratio of audio reference power to microwave power absorbed by the mount for the same dc output voltage. Effective Efficiency accounts for all losses except the reflection due to impedance mismatch. Calibration Factor is defined as the ratio of audio reference power to microwave power incident on the mount for the same dc output voltage. Calibration Factor, therefore, accounts for all losses. In the case of thermistor mounts, the same concepts apply, but the definitions differ slightly. Effective Efficiency is the ratio of substituted bias power in the power meter to the microwave power absorbed by the mount and Calibration Factor is the ratio of substituted bias power in the meter to the microwave power incident on the mount. Although direct traceability to NBS is not yet available in certain bands, the extensive tests and crosschecks conducted by Hewlett-Packard on literally thousands of mounts assure a high level of confidence in the calibration of all mounts. In addition, the mounts are swept-frequency tested, to reveal any "holes" in their response.

Tuners: In most applications it is sufficient to correct for the various losses associated with the mount by using Calibration Factor data. Source mismatch (SWR) is also a factor in any power measurement and the combination of source and load SWR can result in serious mismatch errors. Uncertainty can be significantly reduced by using an HP 870A Slidescrew Tuner ahead of the mount. When a tuner is used only corrections for Effective Efficiency are necessary.

Instrumentation: Maximum instrumentation uncertainty of the 437A Power Meter is $\pm 1\%$ of full-scale on all ranges. This uncertainty can be reduced by directly measuring the voltage at the recorder output. Use of a digital voltmeter, such as the HP 3440A, reduces instrumentation uncertainty to $\pm 0.6\%$.

The 432A Power Meter provides instrumentation accuracy of $\pm 1\%$ in measuring the substituted power to the thermistor. Rear panel connectors allow direct measurement of the bridge voltages and computation of substituted dc power to within $\pm 0.2\% + 0.5 \mu\text{W}$.

Basic accuracy of the 434A Calorimetric Power Meter is $\pm 5\%$. Instrumentation uncertainty can be substantially reduced by calibrating the 434A on the range to be used with a dc test set. The HP 11550A dc Test Set provides calibration power levels in convenient steps from 2 mW to 10 W, accurate to $\pm 0.5\%$ of output.

PEAK POWER CALIBRATOR

Power measurements, 50 to 2000 MHz, to ± 0.6 dB
Model 8900B



POWER METERS

Features

- Measures true peak power ± 0.6 dB absolute
- Measurement completely independent of repetition rate and pulse width (> 0.25 μ sec)
- Readily standardized against external bolometer or calorimeter
- Incorporates wide-band (7 MHz) detector output for pulse monitoring

The HP 8900B Peak Power Calibrator provides a convenient means for measuring the peak RF power of pulses in the range from 50 to 2000 MHz. The power level is read out directly on the panel meter and is completely independent of repetition rate and pulse width (> 0.25 μ sec). The instrument consists basically of a precision terminated input circuit, diode detector, dc reference supply, meter and a chopped video output system.

In operation, the RF signal is applied to the input circuit, which, through a power splitter, feeds the diode detector. The demodulated diode output and the output of the dc reference supply are simultaneously fed to the video output through a mechanical chopper. In making a measurement, a suitable external oscilloscope is connected to the video output, and the dc reference voltage is adjusted so that it is exactly equal to the peak value of the demodulated pulse.

Panel meter readout

The level of the required dc reference voltage is then indicated on the panel meter, calibrated to read peak RF power. The diode is operated in a biased condition for maximum stability of calibration. Provision is made, how-

ever, for readily standardizing the instrument against an external bolometer or calorimeter by simply connecting to a rear-panel output in place of a standard termination.

Specifications

Radio frequency measurement characteristics

- RF range:** 50 to 2000 MHz.
- RF power range:** 200 mW peak full scale (may be readily increased through use of external attenuators or directional couplers).
- RF power accuracy:** ± 1.5 dB (± 0.6 dB with custom calibration curve furnished with instrument).
- RF power precision:** 0.1 dB.
- RF pulse width:** > 0.25 μ s.
- RF repetition rate:** 1.5 MHz maximum.
- RF impedance:** 50 ohms.
- RF vswr:** < 1.25 .

Monitor output

- Level:** > 0.2 volt for 20 mW input (nominal).
- Impedance:** 150 ohms nominal.
- Bandwidth:** > 7 MHz.

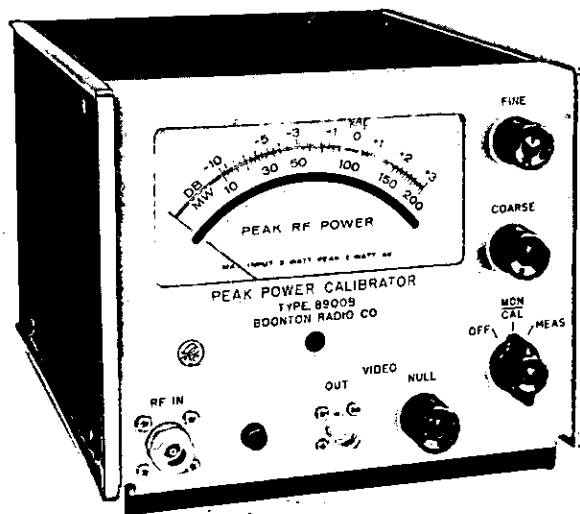
Physical characteristics

- Dimensions:** 7 $\frac{3}{4}$ " wide, 6 $\frac{1}{8}$ " high, 11" deep (197 x 156 x 279 mm).
- Weight:** net 10 lbs (4,5 kg); shipping 13 lbs (5,9 kg).

Power: 105 to 125 or 210 to 250 volts, 50 to 60 Hz.

Price: HP 8900B, \$625 (includes calibration curve).

Option 001: calibrated and offset for use with 8925A DME/ATC Test Set; no additional charge.

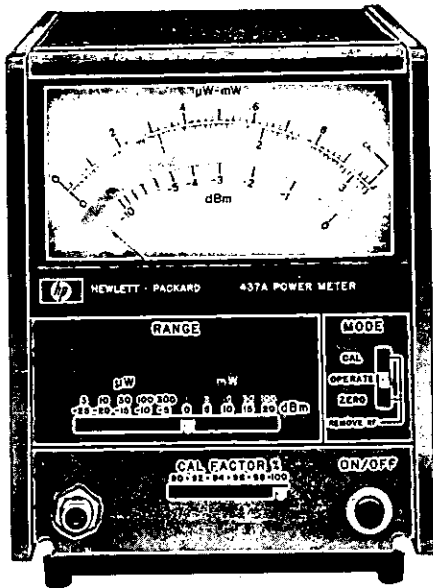


8900B

POWER METERS

POWER METER;
THERMOCOUPLE MOUNT

Models 437A, 8485A



437A



8485A

Features:

- Measurements from $0.3 \mu\text{W}$ to 100 mW with a single mount
- Frequency coverage from 10 MHz to 18 GHz
- Low noise and drift
- Internal Calibration
- Auto-zero

Description

The 437A Power Meter and 8485A Thermocouple Mount. Combine several unique features to form a system for measuring RF and microwave power over a wide range of amplitude and frequency. Consideration of all sources of error and attention to design details result in exceptionally high system accuracy without sacrificing broadband capability and convenient operation.

Internal Calibration

The foundation of the 437A/8485A system accuracy is the power meter's internal calibrator. Calibration is vital in thermocouple type power meters because accuracy depends on the instrument gain being matched to the mount sensitivity. Experience shows that thermocouple sensitivity can change due to variations in temperature, overload, and even aging. Without calibration there is no way of detecting the change and resulting measurement error. The 437A's internal calibrator allows the instrument to be matched to the mount by simply depressing a front panel switch.

*Effective Efficiency is the ratio of audio reference power to RF power dissipated within the mount for the same dc output voltage.

**Calibration Factor is the ratio of audio reference power to RF power incident on the mount for the same dc output voltage.

Instrumentation Accuracy

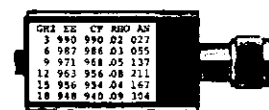
Complementing the confidence provided by internal calibration is the instrument's ability to measure the dc output voltage of the mount and convert it to a power reading accurately. Instrumentation uncertainty is less than $\pm 1\%$ from 0° to 55°C .

Low SWR

To further enhance system accuracy, variations in mount impedance have been reduced, resulting in a SWR less than 1.35. This is achieved by precise control of thermocouple film thickness for proper load resistance and use of a micro-circuit for the high frequency matching network. Low SWR not only reduces simple mismatch loss, but also reduces the mismatch uncertainty due to re-reflection from the source. This uncertainty cannot be specified here because of its dependence on source impedance, but it is often the single largest source of error.

Mount Calibration

Each 8485A Thermocouple Mount is individually calibrated for Effective Efficiency* Calibration Factor,** and magnitude and phase of the reflection coefficient. Calibra-



8485A Calibration

tion is obtained using a Hewlett-Packard Automatic Network Analyzer resulting in increased transfer accuracy and is traceable to the National Bureau of Standards.

Wide Power Range

Broadband capability of the 8485A makes it possible to measure power over a 55 dB range from 0.3 μ W to 100 mW without switching mounts. An additional benefit of the wide range is protection against burn-out to 150 mW.

Low Noise and Drift

High sensitivity requires that meter indications be free from excessive noise and drift. A low noise, chopper-stabilized dc amplifier holds short-term noise and drift to a maximum of 2% peak on the 3 μ W range. Long term drift is typically less than 0.3 μ W peak.

Broad Frequency Coverage

The 8485A coax mount covers the RF and microwave spectrum from 10 MHz to 18 GHz. This extended range makes measurements possible at higher frequencies where the use of coax devices is becoming widespread.

Automatic Zeroing

On the most sensitive ranges where it may be necessary, zeroing can be accomplished in a few seconds by simply pressing a front panel switch. Zero carry-over of only 0.2% means that any range may be selected after zeroing with virtually no loss of accuracy.

Specifications

Frequency range: 10 MHz to 18 GHz.

Power range: 55 dB with 10 full-scale ranges of 3, 10, 30, 100, and 300 μ W, 1, 3, 10, 30, and 100 mW; also calibrated in dB from -35 dBm to +20 dBm.

System accuracy:

Instrumentation uncertainty: $\pm 1\%$ of full scale $\pm 0.03 \mu$ W on all ranges (0° to 55°C).

Calibration uncertainty: $\pm 0.7\%$ of full scale at room temperature $\pm 0.02\%$ per °C.

Zero uncertainty: $\pm 0.2\%$ of full scale $\pm 0.03 \mu$ W on all ranges.

High-power uncertainty: $\pm 0.6\%$ of reading on 100 mW range, $\pm 0.25\%$ of reading on 30 mW range, and $\pm 0.1\%$ of reading on 10 mW range when correction curves provided in operating and service manual are used. (Not a factor on lower ranges.)

Noise and Drift: $< 2\%$ of full scale, on 3 μ W range declining to $\pm 0.01\%$ on 100 mW range, (at constant temperature).

Response time: 2.7 seconds on 3 and 10 μ W ranges, 0.5 s on 30, 100, and 300 μ W ranges, and 70 ms on higher ranges.

Power Meter

Calibrator: automatic, operated by front panel switch.

Zero: automatic, operated by front panel switch.

Calibration factor control: 11 position switch normalizes meter reading to account for Calibration Factor or Effective Efficiency. Range 90% to 100% in 1% steps.

Recorder output: proportional to indicated power with 1 volt corresponding to full-scale; 1000 Ω output impedance, BNC connector.

RF blanking output: provides a short when auto-calibrate or auto-zero mode is engaged.

Power: 115 or 230 V ac $\pm 10\%$, 50 to 400 Hz, 2½ watts.

Weight: net, 6 lb 10 oz (3 kg). Shipping, 9 lb 8 oz (4.3 kg).

Dimensions: 6-3/32 in high, 5½ in wide, and 11 in deep (155 x 130 x 279 mm).

Accessories furnished: 7½ ft (2.29 m) power cable, NEMA plug.

Price: Model 437A, \$625.00.

Thermocouple Mount

RF impedance: 50 Ω nominal.

Reflection coefficient: < 0.15 (SWR 1.35) from 20 MHz to 18 GHz, reaches maximum of 0.23 (SWR 1.6) at 10 MHz.

Thermocouple temperature coefficient: -0.1% per °C. (Compensated for by internal calibrator).

Maximum average power: 150 mW.

Maximum peak power: 100 W.

Maximum energy per pulse: 200 W μ s.

RF connector: Type N male, compatible with female connectors whose dimensions conform to MIL-C-71 or MIL-C-39012.

Mount calibration: Calibration Factor, Effective Efficiency, and magnitude and phase of the reflection coefficient are furnished at 3, 6, 9, 12, 15, and 18 GHz.

Weight: net, 8 oz (227 g). Shipping, 1 lb (454 g).

Dimensions: 1½ in high, 1-9/16 in wide, 3¾ in long (39 x 41 x 96 mm).

Price: Model 8485A, \$300.00.

Option 001: APC-7 connector, add \$25.00.

11532A Range Calibrator

Verification of full-scale readings on all ranges, performance testing and maintenance adjustments require the 11532A Range Calibrator. This accessory is a battery-operated precision voltage source packaged in a compact case.



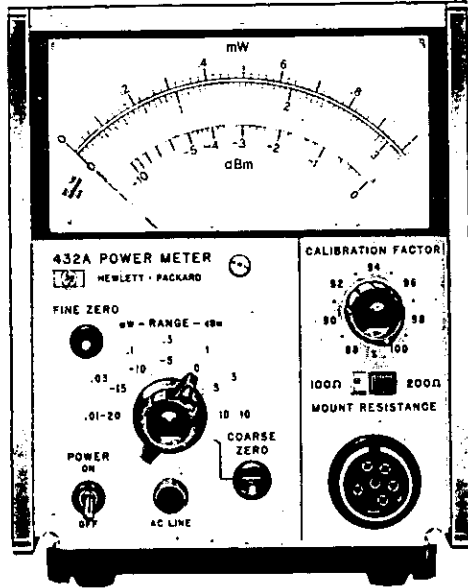
11532A Range Calibrator



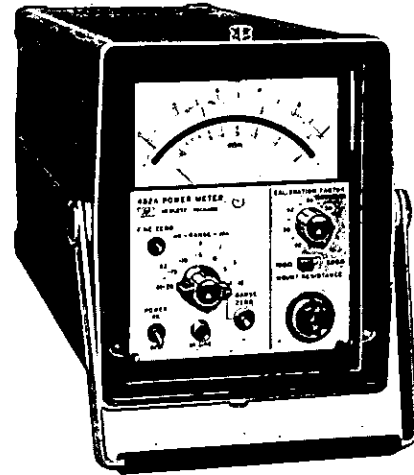
POWER METER; CALIBRATOR

Automatic zero; high accuracy

Models 432A, 8477A



432A



432A in 11076A Carrying Case

The 432A Power Meter, together with the 478A, 8478B and 486A Thermistor Mounts, enables you to conveniently make routine microwave power measurements with standards lab accuracy from 10 MHz to 40 GHz. The 432A has 1% instrumentation accuracy on all ranges, a dc bridge circuit, and an automatic zero feature that brings time-saving convenience to otherwise tedious power meter measurements.

The 432A was designed to operate with thermistor mounts already in use in many installations—the same mounts designed for use with the 431C Power Meter. Therefore, you can incorporate this meter, with all its advantages, directly into these applications without costly mount replacement.

With this power meter you can measure power levels from -30 dBm to $+10$ dBm ($1 \mu\text{W}$ to 10 mW). This 40-dB measurement range is covered in seven 5-dB steps. The meter face is calibrated in both milliwatts and dBm with a 10-dB full scale dynamic range.

Automatic zeroing: a unique circuit allows you to zero the 432A by merely depressing a toggle switch. The time required is so short that the meter can be zeroed easily before each reading if desired, eliminating possible inaccuracy caused by thermistor drift. This feature offers advantages not found in other thermistor instruments.

DC bridge circuit: four notable advantages stem from the use of dc rather than the conventional 10 kHz bias current in the bridge circuits:

First, because there is no signal emission from the cable or mount, you can make measurements in extremely sensitive circuits without affecting their operation;

Second, meter zeroing is independent of the impedance connected to the RF terminal of the thermistor mount. The mount need not be connected to the signal source during the meter zeroing process;

Third, measurements are not affected by capacitive changes caused by movement of the thermistor mount cable; and,

Fourth, the specified accuracy of 1% is maintained even on the most sensitive range ($10 \mu\text{W}$ or -20 dBm full scale) because the error due to thermoelectric effect is reduced to a negligible level.

Higher accuracy: the 432A offers you 1% instrumentation accuracy on all power ranges over a wide temperature range, 0° to 55°C . Even higher accuracy, $0.2\% \pm 0.5 \mu\text{W}$, can be attained by measuring the output voltage of the thermistor bridges (test points are available on the rear panel of the 432A) with a digital voltmeter and computing the corresponding RF power.

System accuracy is improved through the utilization of the Effective Efficiency and Calibration Factor* data on each thermistor mount. A front panel control on the 432A is set to the required Calibration Factor or Effective Efficiency to automatically account for the losses introduced in the mount.

More flexibility: the 432A is truly portable because it is small ($1/3$ module), light, and can be battery-operated. With the optional battery installed, you can operate the 432A for 24 hours without recharging. A built-in power supply makes recharging easy. A carrying case is available as an accessory.

You can use optional thermistor mount cables up to

20 feet long and still maintain 1% accuracy without special matching of the bridge circuit. Cables up to 200 feet long can be used if the cable is matched to the bridge circuit.

Due to the exceptional temperature stability of the power meter/thermistor mount, operation over extended time periods is practical without resetting the meter to zero. Thus, long term power level recording is possible. This temperature stability results from the use of dual self-balancing bridges (of which the thermistor mount is a part) in a dc feedback amplifier. One bridge senses the RF power and the other corrects the meter for changes in ambient temperature.

Specifications

Instrument type: automatic, self-balancing power meter for use with temperature-compensated thermistor mount.

Power range: 7 ranges with full-scale readings of 10, 30, 100, and 300 μ W, 1, 3, and 10 mW; also calibrated in dBm from -20 dBm to +10 dBm full scale in 5-dB steps.

Instrumentation accuracy: $\pm 1\%$ of full scale on all ranges ($+0^\circ$ to $+55^\circ\text{C}$).

Calibration factor control: 13-position switch normalizes meter reading to account for thermistor mount Calibration Factor*. Range 100% to 88% in 1% steps.

Thermistor mount: external temperature-compensated thermistor mounts required for operation (HP 486A, 8478B, and 478A series; mount resistance 100 or 200 ohms).

Meter: taut-band suspension, individually computer-calibrated, mirror-backed scales. Milliwatt scale more than $4\frac{1}{4}$ " (108 mm) long.

Zero carryover: less than 0.5% of full scale when zeroed on most sensitive range.

Meter noise: less than 0.5% peak-to-peak.

Fine zero: automatic, operated by toggle switch.

Recorder output: 1.000 volt into $>100\ \text{k}\Omega$ corresponds to full-scale meter deflection (1.0 on 0-1 scale) $\pm 0.5\%$; 1000-ohm output impedance, BNC connector.

RFI: meets all conditions specified in MIL-I-6181D.

Power: 115 or 230 V ac $\pm 10\%$, 50 to 400 Hz, $2\frac{1}{2}$ watts. Optional rechargeable battery provides up to 24 hours continuous operation. Automatic battery recharge.

Weight: net, 7 lb 14 oz (3,6 kg). Shipping, 11 lb 9 oz (5,2 kg).

Weight with optional battery pack: net, $9\frac{1}{4}$ lb (4,2 kg). Shipping, 12 lb (5,5 kg).

Dimensions: $5\frac{1}{8}$ " wide, $6\text{-}3/32$ " high, 11" deep (130 x 155 x 279 mm).

Accessories furnished: 5-ft (1,42-m) cable for Hewlett-Packard temperature-compensated thermistor mounts; $7\frac{1}{2}$ ft (2,29 m) power cable, NEMA plug.

Accessories available:

5060-0797 Rack Adapter Frame (holds three instruments the size of the 432A).

11076A, Carrying Case.

Combining cases:

1051A, $11\frac{1}{4}$ " (286 mm) deep.

1052A, $16\frac{3}{8}$ " (416 mm) deep.

Options

001: Rechargeable battery installed, provides up to 24 hours continuous operation, add \$100.

002: Input connector placed on rear panel in parallel with front, add \$25.

003: Input connector on rear panel only, add \$10.

Note: For cables over 10 feet long the bridge is matched to specific cable options, so the various cables should not be interchanged.

009: 10-foot (3,5 m) cable only for 100-ohm or 200-ohm mounts, add \$25.

010: 20-foot (6,10 m) add \$50.

011: 50-foot (15,24m) add \$100.

012: 100-foot (30,48 m) add \$150.

013: 200-foot (60,96 m) add \$250.

Price: Model 432A, \$495.

8477A Power Meter Calibrator

The 8477A Calibrator is specifically designed for use with the 432A Power Meter. It allows you to verify full-scale meter readings on all ranges, and meter tracking. Simply connect three cables between the power meter and calibrator; no charts or additional instruments are required.

8477A Specifications

Calibration points: outputs corresponding to meter readings of: 0.01, 0.03, 0.1, 0.3, 1.0, 3.0, and 10 mW (for mount resistance switch settings of both 100 and 200 ohms).

Calibration uncertainty: $\pm 0.2\%$ on the top five ranges, and $\pm 0.5\%$ on the 0.01 and 0.03 mW ranges from $+20^\circ$ to $+30^\circ\text{C}$.

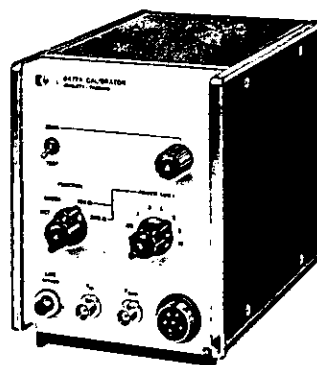
RFI: meets all conditions specified in MIL-I-6181D.

Power: 115 or 230 Volts $\pm 10\%$, 50-400 Hz, approximately 2 W.

Weight: net $4\frac{1}{2}$ lbs (2,0 kg); shipping $6\frac{1}{4}$ lbs (2,9 kg).

Dimensions: $6\text{-}3/32$ " high, $5\frac{1}{8}$ " wide, 8" deep (155 x 130 x 203 mm).

Price: Model 8477A, \$450.



8477A

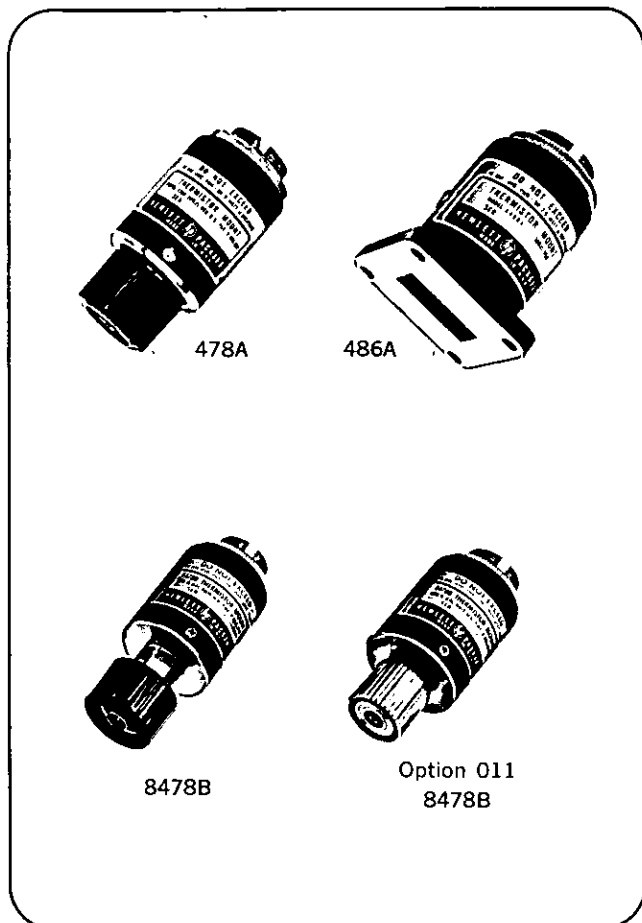
*"Calibration Factor" and "Effective Efficiency" are figures of merit expressing the ratio of the substituted signal measured by the power meter to the microwave power incident on and absorbed by the mount, respectively. The data supplied with each thermistor mount are traceable to the National Bureau of Standards.



THERMISTOR MOUNTS

Compensated mounts reduce drift

Models 478A, 8478B and 486A



With Hewlett-Packard 478A, 8478B, and 486A Thermistor Mounts and a 432A Power Meter, you can make microwave power measurements with extreme accuracy. Each mount is supplied with Calibration Factor and Effective Efficiency data to eliminate errors due to mismatch and RF losses. The data, provided at several points across each band, are traceable to National Bureau of Standards to the extent allowed by the Bureau's facilities.

The calibration data at points not yet on the NBS schedule are based on interim standards established at Hewlett-Packard after years of designing, manufacturing, and testing thermistor mounts. Literally thousands of tests and measurements have gone into the development of these standards, including cross-checks against NBS-calibrated mounts wherever possible. Thus efficiency data are provided at many points in addition to those on the NBS schedule to facilitate interpolation and help you to make more accurate power measurements more easily. For easy access, these data are affixed directly to each mount.

Both Calibration Factor and Effective Efficiency Data are furnished to provide complete measurement flexibility. Calibration Factor is used as the correction factor for general applications when a tuner is not used; Effective Efficiency is used whenever a tuner is part of the measurement system.

These mounts are temperature-compensated for low drift, permitting measurement of microwave power as low as one microwatt. Thus, the 432A can be zeroed with the mount disconnected from the RF system if the RF power cannot be turned off.

Models 478A and 8478B are designed for 50-ohm coaxial systems. They operate over frequencies from 10 MHz to 10 and 18 GHz respectively. Each presents a good 50-ohm match over its frequency range, and no tuning is required.

The subject of power measurements is covered in detail in Hewlett-Packard Application Note 64, "Microwave Power Measurement." This comprehensive note discusses principles of operation, techniques of measurement, interpretation of results, and accuracy considerations. Application Note 64 is available upon request from any Hewlett-Packard Field Office.

Specifications

HP Model ¹	Frequency range, GHz	Maximum SWR	Operating resistance (ohms)	Price
478A	10 MHz to 10 GHz	1.75, 10 to 25 MHz 1.3, 25 MHz to 7 GHz 1.5, 7 to 10 GHz	200	\$165
8478B ²	10 MHz to 18 GHz	1.75, 10 to 30 MHz 1.35, 30 to 100 MHz 1.1, 0.1 to 1 GHz 1.35, 1 to 12.4 GHz 1.6, 12.4 to 18 GHz	200	\$300 ⁴
S486A	2.60 to 3.95	1.35	100	\$240
G486A	3.95 to 5.85	1.5	100	\$210
J486A	5.30 to 8.20	1.5	100	\$200
H486A	7.05 to 10.0	1.5	100	\$195
X486A	8.20 to 12.4	1.5	100	\$165
M486A	10.0 to 15.0	1.5	100	\$250
P486A	12.4 to 18.0	1.5	100	\$220
K486A ³	18.0 to 26.5	2.0	200	\$330
R486A ³	26.5 to 40.0	2.0	200	\$395

¹ 11528A Adapter adapts mount to 430 Series Power Meter (thermistor circuit unbalanced, no temperature compensation), \$10.

² 11527A Adapter adapts 8478B to 431A/B Power Meters (thermistor circuit unbalanced), \$25.

³ Circular flange adapters: K-band (UG-425/U) HP 11515A, \$35 each; R-band UG-381/U) HP 11516A, \$40 each.

⁴ Option 011, furnished with APC-7 RF connector, add \$25.

POWER METER

Works with positive or negative bolometers
Models 430C; 477B, 487 Thermistor Mounts



POWER METERS

The HP 430C reads RF power directly in dBm or mW—and completely eliminates tedious computation and troublesome adjustments during operation. The instrument may be used at any frequency for which there are bolometer mounts—and measurements are entirely automatic.

In measuring power, HP 430C uses a bolometer at either 100- or 200-ohm levels. Power is read directly in milliwatts, 0.01 to 10 mW, or in dBm from -20 to +10. Higher powers may be measured by adding attenuators to the system. Directional couplers also may be used to sample energy.

When used in an appropriate bolometer mount, instrument fuses are generally satisfactory for measuring power at frequencies up to 4 GHz. Barretters and thermistors can be used for measurements at much higher frequencies, up to 12.4 GHz for barretters (in HP mounts) and up to 18 GHz for certain thermistors.

Hewlett-Packard waveguide mounts for the 430C are available covering 2.6 to 40 GHz in bands. In addition, the Model 477B coaxial mount covers 10 MHz to 10 GHz.

Specifications, 430C

Power range: 5 ranges, front-panel selector; full-scale readings of 0.1, 0.3, 1, 3, and 10 mW; also calibrated in dB from -20 to +10 dBm.

External bolometer: frequency range depends on bolometer mount; bolometers can operate at resistance levels of 100 or 200 ohms and can have positive or negative temperature coefficients; any dc bias current up to 16 mA is available for biasing bolometers; dc bias current is continuously adjustable and independent of bolometer resistance and power level range.

Accuracy: $\pm 5\%$ of full scale.

Power: 115 or 230 V $\pm 10\%$, 50 to 400 Hz, approximately 90 W.

Dimensions: cabinet: 7 $\frac{1}{2}$ " wide, 11 $\frac{1}{2}$ " high, 14 $\frac{1}{4}$ " deep (191 x 292 x 362 mm); rack mount: 19" wide, 7" high, 13 $\frac{1}{8}$ " deep behind panel (483 x 178 x 333 mm).

Weight: net 14 lb (6.3 kg), shipping 16 lb (7.2 kg) cabinet; net 18 lb (8.1 kg); shipping 27 lb (12.2 kg) (rack mount).

Accessory available: 11528A Adapter, adapts HP 478A, 486A, 8478B Thermistor Mounts for use with 430C, \$10.

Price: HP 430C, \$395 (cabinet); HP 430CR, \$405 (rack mount).

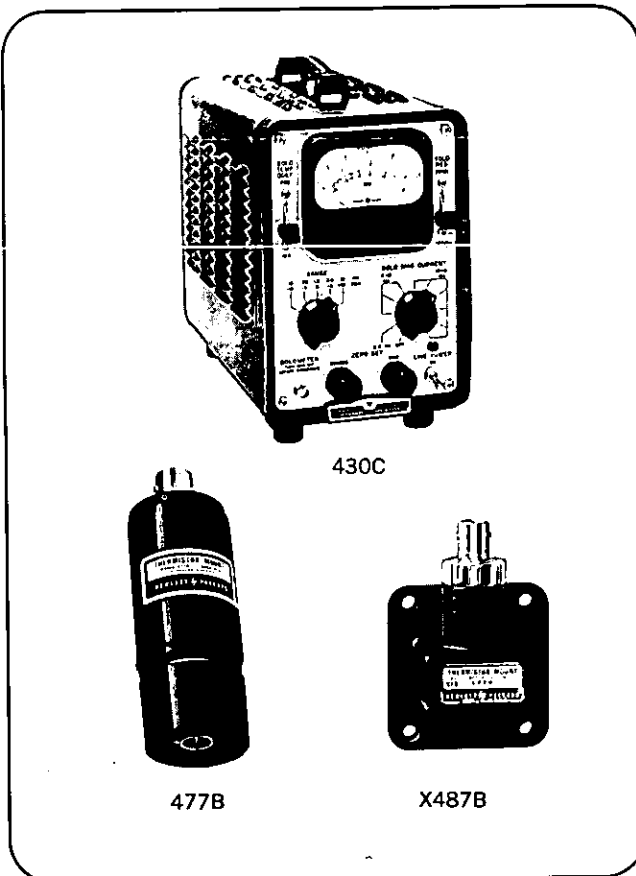
477B Thermistor Mount

This coaxial thermistor mount, designed for use in 50-ohm systems with the HP 430C, covers 10 MHz to 10 GHz with a SWR of less than 1.5. It requires no tuning and employs long-time-constant elements that ensure measurement accuracy—even for low duty cycle pulses. In addition, it is not susceptible to burnout even at 1 watt peak power at a 1000:1 duty cycle.

Specifications, 477B

Frequency range: 10 MHz to 10 GHz.

Reflection coefficient: full range, < 0.2 (1.5 SWR, 14 dB return loss); 50 MHz to 7 GHz, < 0.13 (1.3 SWR, 17.7 dB return loss).



Power range: 0.01 to 10 mW (with HP 430C) 10 mW maximum average power; 1 Watt maximum peak power.

Element: 200-ohm, negative temperature coefficient thermistor included; approx. 13 mA bias required.

RF connector: Type N male.

Price: HP 477B, \$95.

487 Waveguide Thermistor Mounts

Hewlett-Packard Series 487 thermistor mounts, for use with HP 430C Power Meters, collectively cover frequencies from 8.2 to 18 GHz. Each 487 series mount covers the full frequency range of its waveguide band and requires no tuning. The long time constant of the mount makes it ideal for measuring average power of low duty cycle pulses. Burnouts are virtually impossible. All models may be used to measure a maximum average power of 10 mW with 430C Microwave Power Meter.

Specifications, 487

HP Model	Maximum SWR	Frequency range* GHz	Price
X487B	1.5	8.2 - 12.4	\$100
P487B	1.5	12.4 - 18.0	\$135

*HP 486A Waveguide Thermistor Mounts are available in S- through R-band (2.6 to 40 GHz); 11528A Adapter required.



CALORIMETRIC POWER METER

Just connect, read power 10 mW to 10 watts
Model 434A

With the 434A, measurement is literally as simple as connecting to a 50-ohm Type N front-panel terminal and reading power directly. The instrument has only two simple front-panel controls and is ideal for use by nontechnical personnel.

Model 434A fills the important range between microwave power meters such as the HP 437A and 432A, and conventional calorimeters whose lower range is approximately 10 watts. But, unlike previous cumbersome and costly equipment suggested for this range, the HP 434A is completely self-contained and requires no external detectors. In addition, the wider frequency response permits the unit to be conveniently calibrated by the application of a known dc power.

Rapid response time

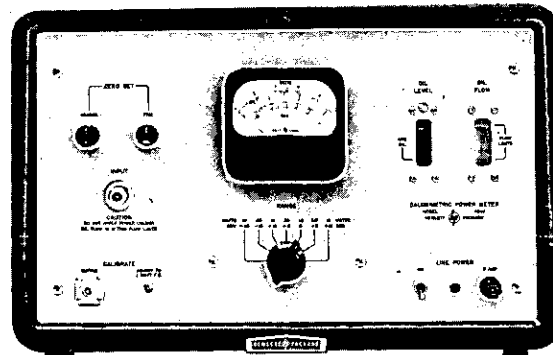
Model 434A employs a self-balancing bridge and a high-efficiency heat transfer system to and from an oil stream to provide a full-scale response time of 5 seconds or less. This fast reaction, a fraction of the response time needed by ordinary calorimeters, means the 434A quickly follows small power changes, such as may be encountered in tuning.

Basically, the Model 434A consists of a self-balancing bridge which has identical temperature-sensitive resistors (gauges) in

two legs, an indicating meter and two load resistors, one for the unknown input power and one for the comparison power. The input load resistor and one gauge are in close thermal proximity so that heat generated in the input load resistor heats the gauge and unbalances the bridge. The unbalance signal is amplified and applied to the comparison load resistor which is in close thermal proximity to the other gauge so that the heat generated in the comparison load resistor is transferred to its gauge and nearly rebalances the bridge.

The meter measures the power supplied to the comparison load to rebalance the bridge. The characteristics of the gauges are the same, and the heat transfer characteristics from each load are the same, so the power dissipated in each load is the same, and the meter may be calibrated directly in input power.

The power measurement is accurate because the flow rates through the two heads are the same and the oil enters the heads at nearly the same temperature. To ensure constant temperature and to bring the streams to nearly the same temperature, they are passed through a parallel-flow heat exchanger just before entering the heads. Identical flow rates are obtained by placing all elements of the oil system in series.



434A

Specifications

Input power range: seven meter ranges; full-scale readings of 0.01, 0.03, 0.1, 0.3, 1, 3 and 10 watts; meter scale also calibrated from -10 to 0 dBW, providing continuous readings from -30 to +10 dBW; power range can be extended upward with attenuators or directional couplers.

Maximum input power: 1 kW peak; 10 watts average.

Frequency range: dc to 12.4 GHz.

Accuracy: within $\pm 5\%$ of full scale; includes dc calibration and RF termination efficiency but not mismatch loss; greater accuracy can be achieved through appropriate techniques.

Estimated attainable accuracy

	Upper ranges	Two lowest ranges
DC	0.5%	2%
0 to 1 GHz	1%	3%
1 to 4 GHz	2%	4%
4 to 10 GHz	3%	5%
10 to 12.4 GHz	4%	5%

DC input impedance: 50 ± 5 ohms at Type N input jack.

Reflection coefficient: dc to 5 GHz, < 0.13 (1.3 SWR, 17.7 dB return loss); 5 to 11 GHz, < 0.2 (1.5 SWR, 14 dB return loss); 11 to 12.4 GHz, < 0.26 (1.7 SWR, 11.7 dB return loss).

Meter response time: less than 5 seconds for full-scale deflection.

Internal calibrator: 100 mW dc $\pm 1\%$ into 45 to 55 ohms.

Power: 115 or 230 volts (specify) $\pm 10\%$, 50 to 60 Hz approximately 180 watts with no input, 200 watts with 10 watts input.

Dimensions: cabinet: $20\frac{3}{4}$ " wide, $12\frac{3}{4}$ " high, 14" deep (527 x 324 x 356 mm); rack mount: 19" wide, 10-15/32" high, $13\frac{1}{2}$ " deep behind panel (483 x 266 x 343 mm).

Weight: net 49 lb (22.2 kg), shipping 59 lb (26.8 kg) (cabinet); net 43 lb (19.4 kg), shipping 56 lb (25.2 kg) (rack mount).

Accessories available: 281A,B Waveguide-to-Coax Adapters; 11550A (formerly K02-434A) DC Test Set (for more accurate power measurements), \$1025.

Price: Hp 434A, \$1950 (cabinet); HP 434R, \$1935 (rack mount).

FREQUENCY DOMAIN MEASUREMENT



SIGNAL ANALYZERS

Modern Spectrum Analyzers

Modern spectrum analyzers are finding new and different applications. They are being recognized as the general-purpose instruments that they are, providing scope access to the frequency domain. Anyone interested in amplitude versus frequency measurements will find spectrum analyzer applications limited only by the imagination.

Basically a spectrum analyzer is a swept receiver that provides a CRT display of amplitude versus frequency. It shows how energy is distributed as a function of frequency, displaying the Fourier components of a given waveform. With it you can measure frequency response; characterize mixers, doublers, and other frequency conversion devices. You can measure signal purity or see directly the bandwidth needed to pass a given signal.

The first spectrum analyzers were difficult to operate and interpret, but still they were adequate tools for looking at the spectra of radar pulses or looking at the signals in a microwave carrier system. As analyzers evolved it became apparent that they were not special purpose devices but general purpose instruments with a variety of applications. Modern spectrum analyzers are smaller in size and lower in cost. They are easier to use and interpret. The addition of absolute calibration meant signal levels could be accurately measured.

In many cases a modern spectrum analyzer can make the same measurements as an RF volt meter, a power meter, a wave analyzer, or a distortion meter. More importantly, since the analyzer presents frequency and amplitude information on a swept basis, it is often more useful than a collection of those other instruments.

HP Spectrum Analyzers

Hewlett-Packard makes three analyzers covering different frequency ranges. The HP 8553B and 8554L are plug-in RF sections designed for use with an 8552A IF section. The combined RF and IF sections are installed in a 140S or 141S display section to form a complete analyzer. The 8551B RF section is a self-contained unit designed for use with an 851B or 852A display section.

The frequency ranges of the analyzers are as follows:

8553B	1 kHz to 110 MHz
8554L	500 kHz to 1250 MHz
8551B	10.1 MHz to 40 GHz

Additional information about the HP 8553B and 8554L can be found on pages 403 to 408; information on the HP 8551B is on pages 409 to 414.

Series 63 Application Notes

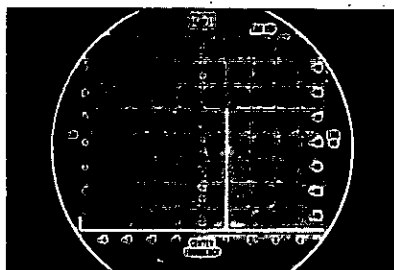
A series of application notes containing detailed information concerning spectrum analysis are available on request through your Hewlett-Packard Sales Office.

Application Note 63 contains an introduction to spectrum analysis which explains the basic principles of frequency domain measurements. Illustrations of spectral displays and examples of their interpretation form a considerable portion of the text. An appendix provides a rigorous treatment of Fourier analysis as applied to spectrum analyzer displays.

AN63A through AN63E detail measurement techniques with Hewlett-Packard spectrum analyzers. For example, AN63B discusses the use of the 8441A Preselector, AN63C describes the measurement of white noise power density, AN63D describes accurate frequency calibration (typically to 0.01%) of spectrum analyzers using the HP 8406A Frequency Comb Generator, and AN63E discusses using spectrum analyzers for EMI measurements.

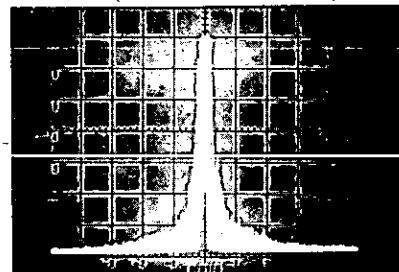
A manual, "EMI Measurement Procedure," describes RFI/EMI measurements with the 851B/8551B to satisfy requirements of MIL-STD-826A, including details of test setups and procedures. A slide rule for simplifying calibration of the analyzer is included with the manual.

Applications

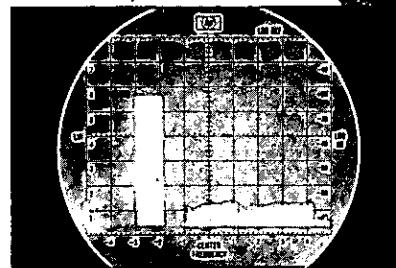


CW Signal. This is an 8552A/8553B calibrated display of a -30 dBm CW signal at 60 MHz. The zero frequency indicator appears at the far left of the display; the horizontal scan is 10 MHz/cm. The log reference level (top graticule line of the display) is 0 dBm.

Oscillators

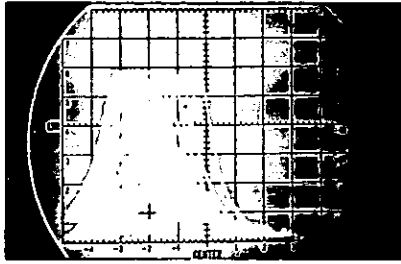


Oscillator Spectral Purity. Here the spectral purity of an oscillator is viewed using a spectrum analyzer; the major noise sidebands are about 65 dB below the carrier. Low frequency residual FM is also evident. The sidebands are not resolved by the 0.3 kHz IF bandwidth, however the deviation rate is low enough so that you actually see the back-and-forth movement of the CW signal. The peak-to-peak frequency deviation is about 4 kHz (10 kHz per division) since the center frequency is 100 MHz, stability is 4 parts in 10^5 . The log reference level is -10 dBm.



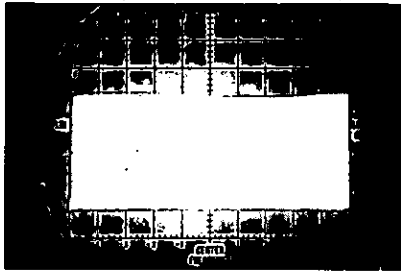
Spectrum from a Tunable Oscillator. The output of a practical oscillator contains harmonics as well as the fundamental frequency. As the oscillator is tuned, the amplitude of each harmonic can vary independently. This signal generator, tuned from 20 to 30 MHz, has a flat fundamental frequency output, but its 2nd and 3rd harmonics vary 2 or 3 dB with frequency. The frequency scan is 10 MHz per division with the center frequency at 50 MHz. The reference level is $+10$ dBm. This is a stored display on the 141S Variable Persistence Display Section.

Computer
Museum

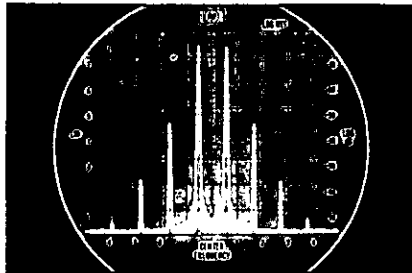


Frequency drift. The frequency drift of an oscillator during warm-up is measured here. Scans are independently triggered 5 seconds apart and are stored on the 141S Display Section CRT. The frequency scale is 0.3 kHz per division with the center frequency at 20 MHz. The initial drift rate is 600 Hz in 80 seconds.

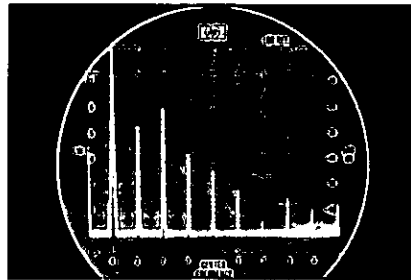
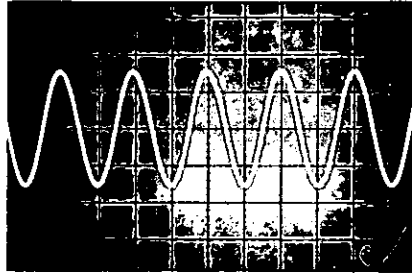
Amplifiers



Amplifier Frequency Response. Amplifier frequency response from 2 MHz to 100 MHz is measured and recorded on the 141S Variable Persistence Display Section. The Log Reference Level is +10 dBm. Since the signal generator input is -60 dBm, the amplifier gain is 40 dB ± 1 dB over the entire range.



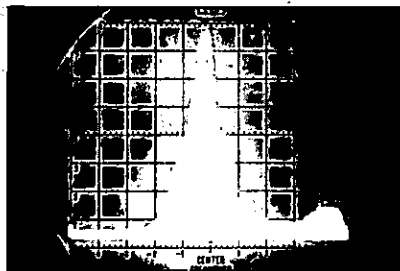
Im Distortion. A two-tone intermodulation test (similar to the CCIF method) is performed on a 40 dB gain amplifier with signal frequencies of 9.95 MHz and 10.05 MHz. The signal levels at the amplifier's input are each -35 dBm. The third order sidebands ($2f_2 - f_1$ and $2f_1 - f_2$) due to the amplifier nonlinearity, are 31 dB down. Higher order harmonic distortion levels can also be measured. The log reference level is +10 dBm, the horizontal scale is 0.1 MHz/division centered at 10 MHz.



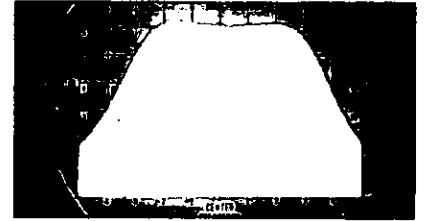
Harmonic Distortion. The top figure shows a conventional oscilloscope display of what looks like a fairly good sine wave. Scope calibration is 1 volt/division vertical, 0.05 μ sec/division horizontal.

In the lower figure the spectrum analyzer easily gives quantitative information about distortion. The frequency scale is 10 MHz/division centered at 50 MHz and the reference level is +10 dBm. (The response at the far left is the zero frequency indicator.) The 10 MHz signal input to the amplifier is at -30 dBm so the amplifier has a gain of 40 dB. Second harmonic distortion is 30 dB down and other harmonics are easily measured.)

Filters

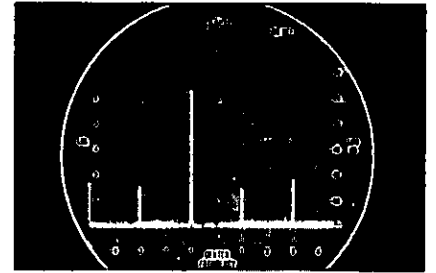


Filter Frequency Response. Using a signal generator and the 141S Variable Persistence Display Section, filter responses are easily measured and recorded with the spectrum analyzer. The filter input and the log reference level are both -20 dBm. Therefore, insertion loss is 3.5 dB. Scan width is 10 MHz/division centered at 50 MHz. The 3 dB bandwidth is approximately 4 MHz and the 60 dB bandwidth is 24 MHz, a ratio of 6 to 1. Stop band rejection is greater than 70 dB throughout most of the frequency range, but at 90 MHz the stop band is only 66 dB down.

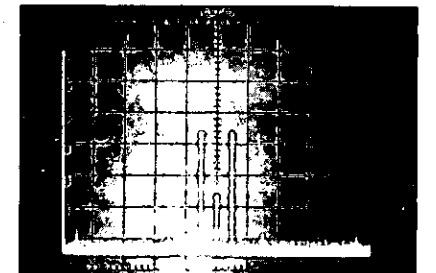


Filter Passband. Setting the analyzer to LINEAR, the passband of the filter is examined in greater detail. The 3 dB points ($E_1/E_2 = 2$) are 3.5 MHz apart (scan width 0.5 MHz/division centered at 48 MHz). Insertion loss, using the IF substitution technique at the center frequency, was 3.6 dB.

Frequency Converters

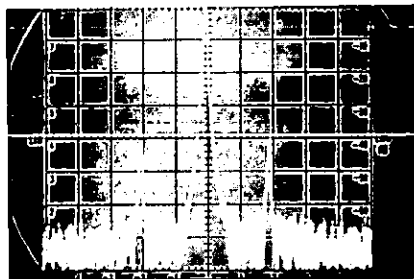
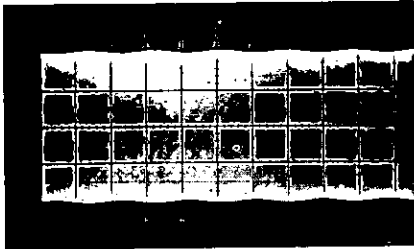


Frequency Doubler. A doubler is driven at 20 MHz and +2 dBm, producing a 40 MHz signal at -10 dBm (log reference level = +10 dBb). Conversion loss, then, is 12 dB. The 3rd and 4th harmonics are greater than 35 dB below the desired 2nd harmonic output, and the 20 MHz feedthrough is 38 dB down. The input power was easily adjusted for optimum doubler performance. The spectrum analyzer scan is 10 MHz/division centered at 50 MHz. At the left-hand edge of the display is the zero frequency indicator.

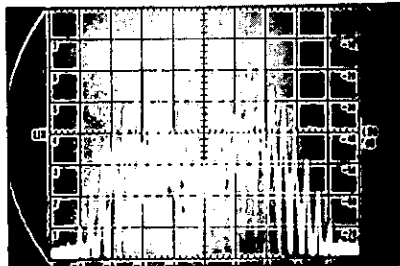


Mixer. Driving a double balanced mixer with an L.O. of 50 MHz at 0 dBm and with a 5 MHz, -30 dBm signal, results in the output shown. The reference level is 0 dBm and the frequency scan is 10 MHz/division centered at 50 MHz. The two sidebands at 45 MHz and 55 MHz have a conversion loss of 6 dB (6 dB below the -30 dBm graticule line). The local oscillator (50 MHz signal) has 56 dB isolation. 5 MHz signal leak through is at -65 dBm, i.e., 35 dB isolation. Third harmonic distortion products at 35 and 65 MHz are 32 dB down.

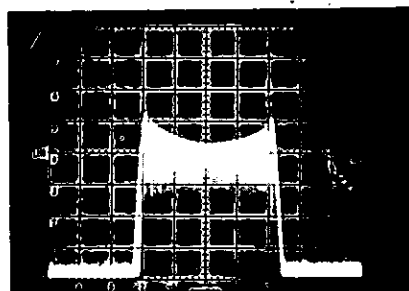
Modulation



It is difficult to measure the modulation envelope on a conventional oscilloscope. (Top figure . . . scope calibration 50 μ sec/division, 5 mV/division. In the frequency domain, however, the measurement can still be made quite accurately . . . Since the sidebands are 40 dB down, $M = 2\%$. Sidebands as much as 70 dB down ($M = 0.06\%$) can be measured with the spectrum analyzer.

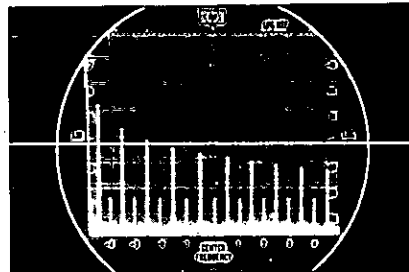
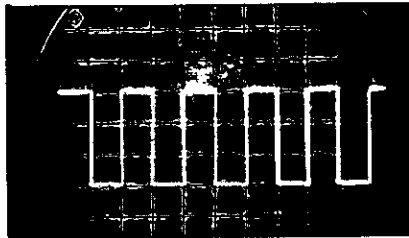


Low Deviation FM. This is the spectrum for an FM signal at 10 MHz. The deviation has been adjusted for the second carrier null ($M_f = 5.6$). The sideband spacing is 20 kHz, the modulation frequency; therefore, $\Delta f_{peak} = 5.6 \times 20 \text{ kHz} = 112 \text{ kHz}$. (50 kHz/division at 10 MHz, LOG REF = 0 dBm.)

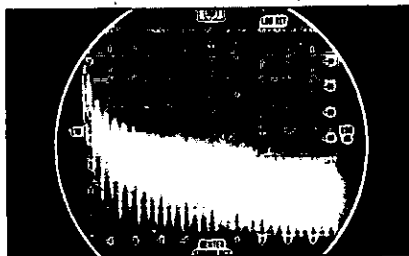


High Deviation FM. The transmission bandwidth required for this FM signal is 2.5 MHz (0.5 MHz/division, LOG REF = 0 dBm). Expanding the scale reveals a sideband spacing of 10 kHz, the modulation frequency.

Digital Circuits



Square Wave. A 1 MHz square wave is adjusted for best symmetry by nulling the even harmonics. Some even harmonic content is still present, indicating that further adjustment of the square wave generator is required. Frequency scan is 2 MHz/division centered at 10 MHz and the log reference level is +10 dBm. For the time domain photograph the scale factors are 0.2 volts/division and 0.5 μ sec/division.



Pulse Bandwidth. To pass 99% (40 dB) of this pulse adequately, a bandwidth of at least 70 MHz is required. Frequency scan is 10 MHz/div. This pulse has a repetition rate of 2.9 μ s and a width of 0.54 μ s. A 50-MHz oscilloscope could not measure the rise time (about 5 ns) accurately nor could it measure overshoot and ringing.

A Simple Spectrum Analyzer

A spectrum analyzer looks at an electrical signal, sorts out the various frequency components, and displays their amplitudes on a CRT. The display, in effect, is the Fourier spectrum of the original signal.

Figure 1 is a simplified block diagram of a spectrum analyzer; it is essentially a "swept receiver" whose detected output is applied to the vertical deflection plates of a CRT. When a signal is received, a vertical deflection proportional to the amplitude of the signal is produced. The receiver is electronically tuned by a linear ramp voltage. This tuning voltage is also applied to the horizontal deflection plates of the CRT so that the horizontal position of the CRT spot is proportional to frequency, and a plot of frequency versus amplitude is displayed on the CRT.

Practical Spectrum Analyzers

To be versatile and effective, the spectrum analyzer should have: 1) the ability to locate and identify signals over a wide frequency range, 2) the ability to magnify portions of the spectrum for detailed analysis with stable, calibrated sweeps and resolution, 3) minimum display clutter from spurious responses in the analyzer, and 4) wide dynamic range and flat frequency response.

Spectrum analyzers usually contain more than one mixer and IF stage. Either the first or second local oscillator (LO) of the receiver can be swept. Sweeping the first LO (Figure 2a) has the advantages of providing very good frequency response flatness, wide spectrum widths, and generally lower distortion.

In the swept-second-LO type of analyzer (Figure 2b) a portion of the spectrum is heterodyned to a broadband first IF where it is scanned by the swept second LO. Thus in this type of analyzer, maximum spectrum width is limited by the bandwidth of the first IF. Frequency response flatness and distortion charac-

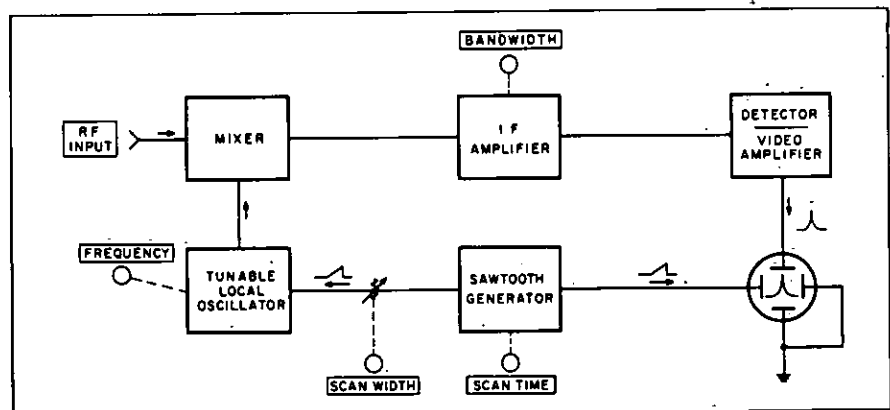


Figure 1. Simplified Spectrum Analyzer of the Swept-Receiver Design.

teristics of the analyzer now depend on the first IF and second mixer as well as the first mixer.

Frequently, the two types of analyzers are combined, as in the HP 8553B or 8554L. Here the first LO is swept for the wide scans, and the third LO is swept for the narrower scans. This approach combines the wide sweep capabilities of swept-first-LO analyzers with excellent stability in the narrow scans since the first LO is phase-locked to a stable crystal oscillator when the third LO is being swept.

Harmonic Mixing

A spectrum analyzer can also respond to RF signals that mix with harmonics of the first LO (as well as the fundamental). Harmonic mixing is generally used in microwave spectrum analyzers to economically extend the frequency range of the analyzer. For example, the 8551B uses harmonics as high as $n = 10$ to extend its frequency range to 40 GHz.

Resolution

Resolution is the ability of the analyzer to separate signals closely spaced in frequency. Since the response of the analyzer to a CW signal is a plot of the passband of the IF, the width and shape of the pass band are major limitations on resolution. If two CW signals simultaneously appear in the pass band they cannot be separated. Thus, the narrower the bandwidth and the steeper the skirts of the pass band, the better the resolution.

Analyzer frequency stability also limits resolution. The residual FM (short term stability) must be less than the narrowest IF bandwidth. If not, the response in the IF to an RF input would drift in and out of the IF pass band. On the CRT it would look like the RF signal itself had this residual FM, and would consequently affect the ability to resolve two signals very close in frequency.

In order to utilize the resolution of these narrow IF bandwidths the analyzer must have compatible sweep speeds. The narrower the pass band and the steeper the skirts, the more time it takes the IF

amplifier to respond. Consequently the sweep rate must be slow so that a signal remains in the IF pass band long enough for the amplifier to fully respond. A special logic circuit in the 8553B and the 8554L lights a front panel warning lamp when the sweep rate is too fast for the selected bandwidth. The AUTO Bandwidth Select mode of the 8551B automatically chooses the minimum IF bandwidth compatible with the sweep rate.

Sensitivity

Sensitivity is a measure of an analyzer's ability to detect small signals, and is often defined as the point where the signal level is equal to the noise level. Since noise level decreases as the bandwidth is decreased, sensitivity is a function of bandwidth.

Specified sensitivity is for a stable CW signal. The apparent sensitivity is reduced when signal power is distributed in sidebands as well as the carrier. For example, a very unstable or an FM signal has appreciable energy in the sidebands. If enough sidebands fall outside the IF passband, a significant amount of signal power is lost, and the apparent sensitivity is reduced.

Need for Variable Persistence

High resolution and sensitivity both require narrow bandwidths and consequently slow sweep rates. Because of these slow sweeps, variable persistence is virtually indispensable in providing a bright, steady, flicker-free trace. (In effect, variable persistence allows one to vary the length of time a trace remains on the CRT.) For example, persistence is necessary for analysis of low-repetition rate phenomena such as radar pulses and modulation spectra.

Spurious Responses

Negligible spurious responses are generated when the total power of the RF input signals is small so that the analyzer is operating linearly. When the total power is not small, the analyzer is overloaded and generates harmonic and intermodulation distortion products of the RF input signals; these products appear on the CRT as spurious responses.

The RF input attenuators of Hewlett-Packard spectrum analyzers allow the operator to check to be sure that the analyzer is not being over driven. They also increase the analyzer's measurement range by the amount of attenuation available, thus increasing the versatility.

The Need for Tracking Preselection

We have seen that spurious responses are generated when the analyzer is overdriven. In addition if an analyzer utilizes harmonic mixing, other unwanted responses can occur. For example, a single RF signal can produce more than one response on the CRT (multiple responses), or several RF signals can produce only one CRT response (harmonic and image responses).

A partial solution is to use fixed bandpass filters as preselectors. Though usually less expensive than tracking preselection, this method is not a total solution. It does prevent most harmonic and image responses. However, it does almost nothing for spurious, and does not avoid inband multiple responses.

The only way to simultaneously avoid spurious, multiple, harmonic and image responses, is to filter the RF signal through a tracking preselector. This is an electronically tuned bandpass filter that automatically tracks the analyzer's tuning.

Strong signals, such as may be received when the analyzer is connected to an antenna, may cause inter-modulation distortion products. However, the narrow-band preselector lets the analyzer look at these signals one-at-a-time preventing interacting, thus reducing spurious responses.

Low-Frequency, Narrow-Band Analyzer

Wave analyzers offer another method of measuring both the amplitude and frequency of an input signal's components. They have higher sensitivity and better frequency resolution than spectrum analyzers. However, they are generally used for low frequency, narrow band applications.

The electronic sweeping and amplitude autoranging of the new HP 3590A Wave Analyzer permit X-Y and strip chart plots of amplitude versus frequency over a frequency range of 20 Hz to 620 kHz and a dynamic range of more than 85 dB. For additional information, see pages 448 to 457.

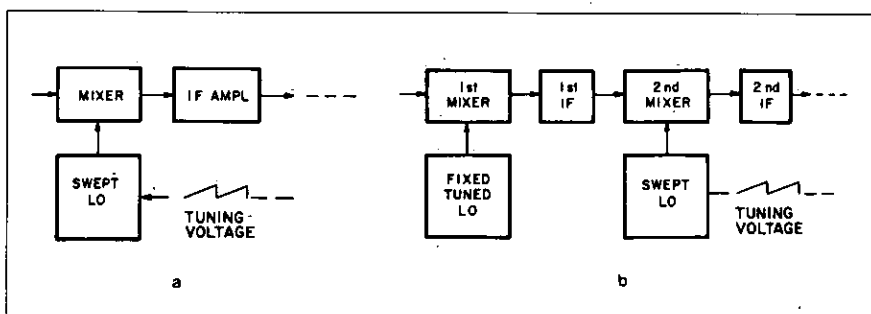


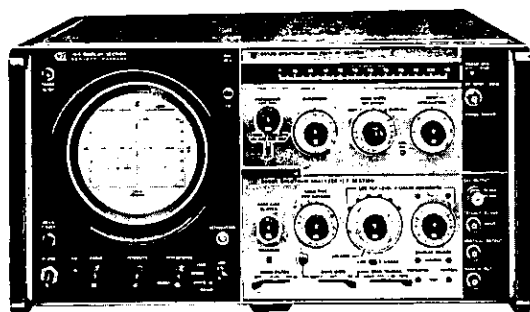
Figure 2. Two Methods of Obtaining Swept-Frequency Capability. a. Spectrum Analyzer using swept first LO. b. Spectrum Analyzer using swept second LO.

ABSOLUTE CALIBRATION

Spectrum analyzer system
Models 8553B/8552A, 8554L/8552A

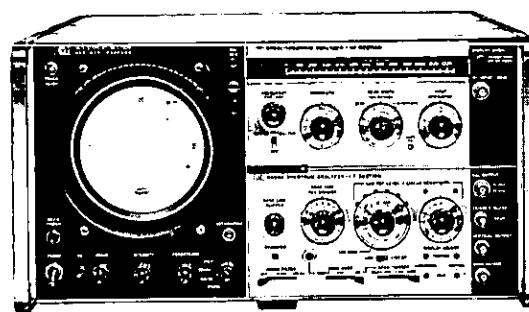
**SIGNAL ANALYZERS**

1 kHz to 110 MHz



8553B/8552A
(In 141S Display Section)

500 kHz to 1250 MHz



8554L/8552A
(In 141S Display Section)

These Hewlett-Packard Spectrum Analyzer systems offer absolute amplitude calibration over a wide frequency range. The 8553B/8552A coverage extends from 1 kHz to 110 MHz, the 8554L/8552A from 500 kHz to 1250 MHz. Both are designed as general purpose instruments to make circuit design and systems evaluation easier. Absolute amplitude calibration, exceptional flatness and wide dynamic range set these new analyzer systems apart from other spectrum analyzers. Simple, easy-to-use controls and a calibrated display eliminate tedious substitution measurements and calculations to save you measurement time.

Each analyzer system is composed of either the 8553B or 8554L RF Section in the frequency range of your choice, an 8552A IF Section, and a 140 series display section. The 141S, a variable-persistence/storage display, provides a flicker-free display for high resolution or transient measurements. Fixed persistence displays are also available; the 140S for bench use or the 143S, an 8 x 10 inch display for improved visual resolution or classroom/group viewing. All display sections have an internal, parallax-free graticule with special log and linear scale calibrations.

70 dB Distortion-free Display

Up to 70 dB of dynamic range can be viewed, free of any distortion. All image responses, out-of-band mixing responses, harmonic and intermodulation distortion products are at least 70 dB below the input signal. Figure 1 shows the output of a comb generator spread across the calibrated frequency range of the analyzer. Signals differing by more than 70 dB can be quickly identified and measured with precision on the clean, distortion-free display.

Calibrated Scan Widths—Preset and Selectable

The analyzer provides three calibrated scan modes; preset scan, selectable PER DIVISION scan and ZERO scan. Preset scan displays essentially the entire swept frequency range of the analyzer on a single scale. You can view the broadband effects of circuit adjustments and refinements as they are made. The FREQUENCY tuning knob moves the dial pointer on the frequency dial and a corresponding frequency marker on the CRT display. Each response can be identified by reading frequency directly from the calibrated CRT or by tuning the frequency marker to the signal and reading the frequency dial.

Once the frequency marker selects a signal, you can switch to PER DIVISION scan and place the selected spectra at the CRT center, Figure 2. In this mode the analyzer scans symmetrically about this frequency in selectable frequency spans. Locate RF circuit harmonics and spurious responses in preset scan; then switch to PER DIVISION scan for detailed examination of sidebands and signal purity. System parameters such as baseband frequencies and carrier separation are easy to identify and measure using the calibrated scan widths. Selectable scan widths and narrow bandwidths make it easy to resolve and measure signals regardless of spacing.

In the third scan mode, ZERO scan, the analyzer becomes a fixed frequency, selectable bandwidth receiver, manually tuned by the FREQUENCY control. The CRT displays the demodulated amplitude information in the time domain; the scan time control provides a calibrated time base.

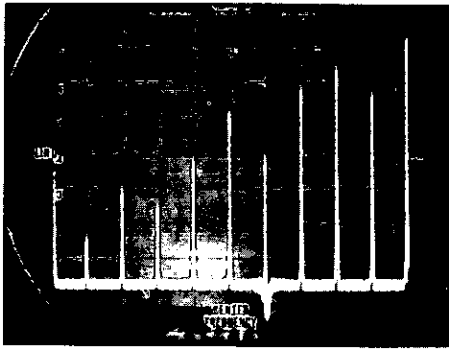
70 dB Dynamic Range
Models 8553B/8554L


Figure 1. Preset SCAN displays output (fundamental through 10th harmonic) of comb generator. Highly linear scan makes it simple to measure the frequency of any component accurately. Note inverted scan marker beneath 6th harmonic; switching to SCAN WIDTH PER DIVISION expands the spectral display symmetrically about the frequency the marker identifies.

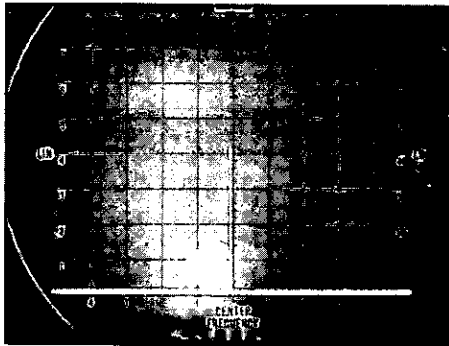


Figure 2. Signal selected by the marker from the comb of Figure 1. Signal amplitude is 38 dB below REF, and the display is LOG (power). The LOG REFERENCE LEVEL (from fig. 3) is -30 dBm, therefore amplitude is -68 dBm.

Absolute Amplitude Calibration

Signal amplitudes are measured directly in μV or dBm with absolute vertical calibration. The LOG REFERENCE or LINEAR SENSITIVITY controls determine the display calibration, Figures 3, 4. With the exceptional flatness of these analyzers, it is only necessary to calibrate at a single frequency using the internal calibrator. External generators and calibration curves are eliminated; absolute amplitude measurements are made with confidence directly from the CRT display. Less time is required to make measurements and the possibility of error is reduced.

Resolution—Automatic Stabilization

Resolution, the ability to separate closely-spaced signals, is determined largely by the IF bandwidth of a spectrum analyzer. Resolution increases as narrow IF filters are selected, but filter response time also increases. If the filter does not fully respond in the scan time selected, inaccurate measurements result. A red UNCAL light warns if a combination of control settings (scan, bandwidths, etc.) affects the absolute calibration. The slow scan time required for full filter response and highest resolution produces a slow-

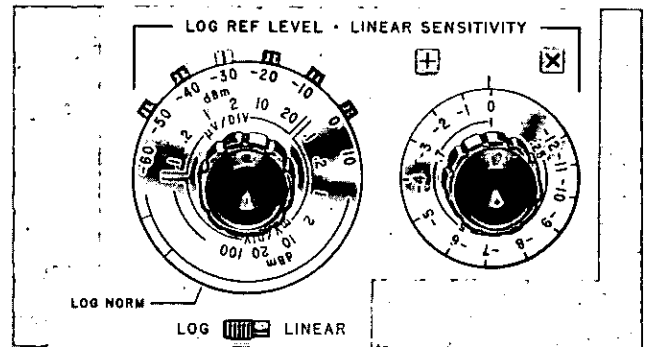


Figure 3. Settings of the INPUT ATTENUATOR and LOG REFERENCE LEVEL controls determine the scale factor for absolute amplitude calibration. Here, LOG is selected and the "+" lamp lights to indicate that LOG REFERENCE LEVEL is the sum of the black color-coded dial readings; i.e., LOG REF = -30 dBm + 0 dBm = -30 dBm.

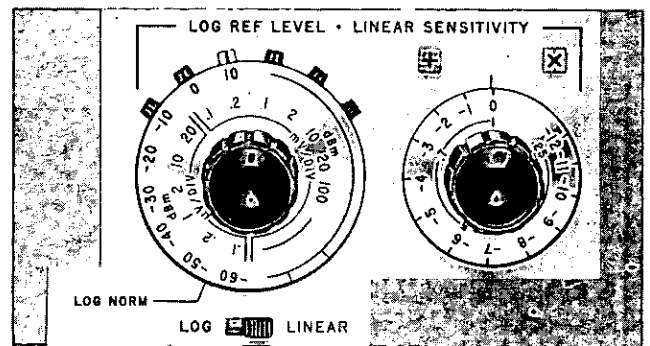


Figure 4. Settings of INPUT ATTENUATOR and LINEAR SENSITIVITY analyzer controls determine scale factor for absolute voltage calibration. The "X" lamp indicates that the scale factor is the product of the LINEAR SENSITIVITY dial readings (blue color-coded): $0.2 \text{ mV/div} \times 1 = 0.2 \text{ mV/div}$.

moving CRT spot. Although suitable for making photo or recorder records, the slow-moving spot makes direct measurements difficult. The 141S variable persistence display makes direct viewing of such signals easy and practical; simply adjust the display persistence to match the sweep speed for a flicker-free display.

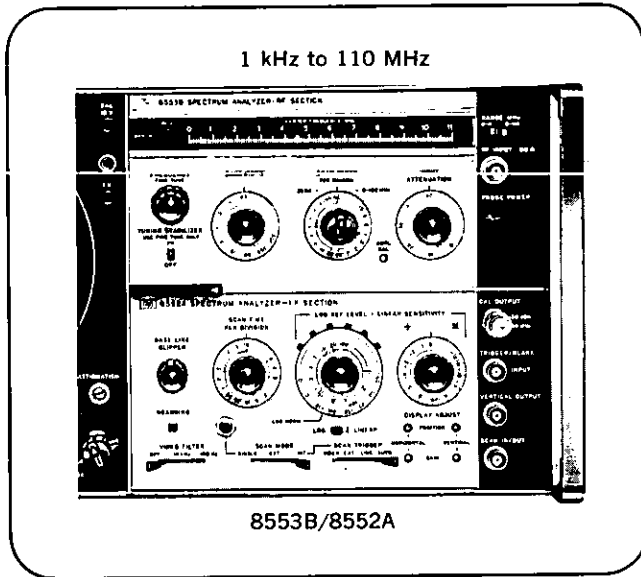
An automatic stabilization system phase-locks the first local oscillator to a stable crystal reference. High stability and excellent resolution make it easy to measure signal generator residual FM and frequency drift.

Single Instrument—Wide Application

These highly sensitive, calibrated analyzers can be used as RF voltmeters or power meters. You can measure signal purity in an amplifier or oscillator as a function of output level and check output levels of sources and generators. Field intensity measurements are easy to make using a calibrated antenna. A video filter is provided to smooth the detected signal before it is displayed and extract small signals from the residual noise. This is especially useful for averaging noise as when making broadband power density measurements.

Highest resolution

8553B/8552A

8553B/8552A Spectrum Analyzer 1 kHz - 110 MHz

The 8553B/8552A Spectrum Analyzer has fully calibrated swept coverage from 1 kHz to 110 MHz. This single instrument can be used over many decades of frequency to examine audio spectra, baseband modulation, system IF's, and modulated RF carriers into the VHF region. System performance tests for absolute levels of power, distortion or spurious radiation are easy to perform using this analyzer. New features such as absolute amplitude calibration are made possible by flat frequency response and highly stable instrument gain. These features simplify tedious measurements in RF circuit design and system analysis. The spurious free instrument response and absolute amplitude calibration make it easy to make unambiguous, accurate measurements over a wide frequency range. The completely calibrated instrument controls are simple to operate and the display is easy to interpret.

Wide frequency range—expanded dial

With the flat 1 kHz to 110 MHz frequency coverage you can optimize RF circuit designs across the entire frequency range. Only signals in this frequency range are viewed; a low-pass filter rejects all out-of-band signals giving an unambiguous display. Both tuning resolution and dial readability are extremely important in a low-frequency analyzer. A unique feature to increase the 8553B low-frequency dial

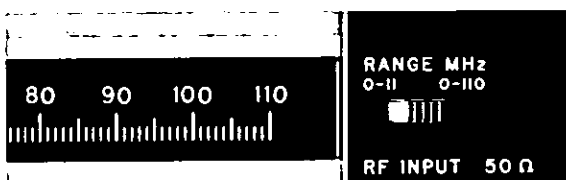


Figure 1. Expanded Dial Scale. When the Expanded Dial Scale is selected the 0 - 110 MHz dial becomes 0 - 11 MHz. Dial resolution is 200 kHz; tuning resolution much easier.

readability is an expanded dial scale. When the low-frequency expand position is selected, Figure 1, the 0 - 110 MHz frequency dial becomes 0 to 11 MHz. In this range tuning dial resolution is improved to 200 kHz making low-frequency measurements easy. A ten-turn fine-tuning knob provides better tuning resolution making it easy to select individual sidebands and spectral lines in high resolution measurements. System subcarriers are simple to identify and measure.

Calibrated scan widths—0 - 100 MHz

A preset 0 - 100 MHz scan is provided, as well as selectable, calibrated scan widths. In preset scan a frequency marker identifies the center frequency selected by the tuning control. Switching to PER DIVISION scan provides ten division symmetrical scan from 10 MHz/div. to 20 Hz/div. about the center frequency selected by the frequency marker. Calibrated scan widths and narrow bandwidths make it easy to resolve and measure signals regardless of spacing, see Figure 2.

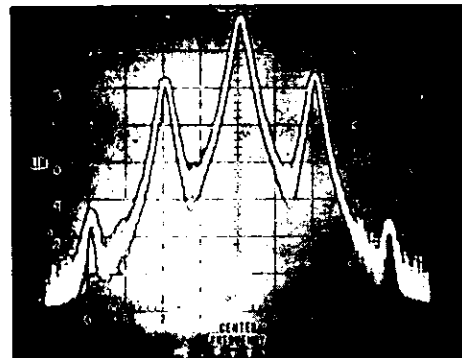


Figure 2. LOG Display of Amplitude Modulated Carrier. SCAN WIDTH is 200 Hz/div; IF BANDWIDTH is 50 Hz. The modulation frequency is measured directly from the display as 400 Hz (2 division spacing of carrier and sidebands). The modulation percentage is measured from the 16 dB amplitude ratio of the carrier and sidebands . . . modulation percentage is 30%. It is easy to measure the modulation distortion from the display; the 800 Hz second harmonic distortion products are 40 dB below the fundamental, indicating 1% distortion. LOG REFERENCE is -30 dBm . . . with absolute calibration carrier is -31 dBm.

Excellent resolution

The resolving capability of a spectrum analyzer is largely determined by its IF bandwidth and frequency stability. The highly selective IF filters of the 8553B/8552A have 3 db bandwidths as narrow as 50 Hz with a shape factor better than 25:1. Sidebands on a carrier 30% amplitude modulated by 400 Hz are resolved easily. These sidebands appear 16 db below the carrier and 400 Hz away, Figure 2. Second harmonic modulation distortion products of only 1% appear 40 db below the fundamental sidebands. Select the optimum bandwidth for your measurements, 50 Hz for highest resolution to 300 kHz for rapid wideband analysis.

Stability

For critical examination of individual spectral lines, the analyzer must be very stable. A completely automatic fre-

Absolute amplitude calibration Model 8553B/8552A

quency stabilization system provides a display free of drift and jitter. This system phase-locks the first local oscillator to a crystal reference to provide crystal-solid stability over the entire frequency range. Stabilized operation automatically reduces residual FM to less than 20 Hz peak-to-peak for scan widths less than 50 kHz/div. Signal generator residual FM and frequency drift is easy to check because virtually no drift or jitter is contributed by the analyzer; all analyzer noise sidebands are more than 70 dB down.

Absolute amplitude calibration—highest sensitivity

With the analyzer's absolute amplitude calibration you can measure signal amplitudes directly in microvolts (0.07 μV to .8 V) or dBm (-130 dBm to $+10$ dBm). The ex-

treme sensitivity of 0.07 μV (-130 dBm) ensures that even very small signals can be measured. With ± 0.5 dB flatness, signals widely spaced in frequency can be compared and their amplitudes read directly from the CRT.

Distortion-free 70 dB display

The full 70 dB analyzer display range is free of distortion products. With the INPUT ATTENUATOR you can check for input mixer overload. The full 0-50 dB range of attenuation prevents input mixer overload and keeps analyzer distortion products 70 dB below any signal input level to $+10$ dBm. With this clean display you can measure distortion levels as low as 0.03% in the output of oscillators, amplifiers and other active devices.

Partial Specifications 8553B/8552A RF and IF Sections

(refer to Technical Data Sheet for complete specifications)
RF input and tuning characteristics

Frequency range: 1 kHz to 110 MHz. Tuning dials calibrated for 0-110, 0-11 MHz.

Frequency response: ± 0.5 dB, 1 kHz to 110 MHz (for attenuator settings ≥ 10 dB). Typical fine grain flatness, ≤ 0.1 dB per MHz.

Input impedance: 50 Ω nominal. Reflection coefficient ≤ 0.13 . (1.3 SWR) for input attenuator setting ≥ 10 dB.

Maximum input level: peak or average power to input mixer $< +13$ dBm (1.4 V ac peak; ± 50 V dc).

Noise level: the average noise level of the analyzer depends on IF bandwidth and determines its sensitivity for small signals, see Figure 3.

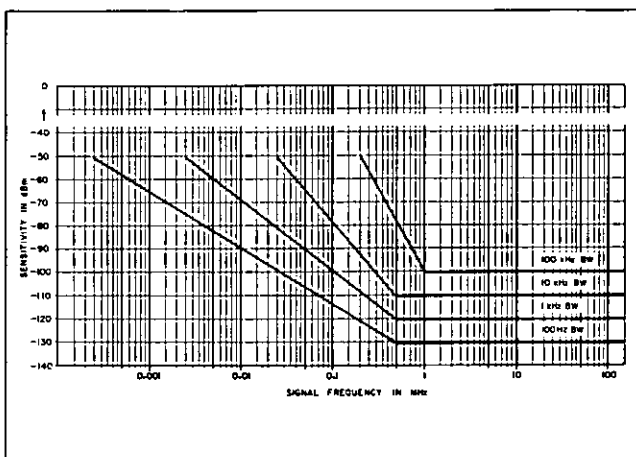


Figure 3. Noise level vs. Input Frequency.

Amplitude characteristics

Vertical display calibration (8 divisions full-scale deflection)

Logarithmic: calibrated directly in dBm over 140-dB range from -130 dBm to $+10$ dBm, 10 dB/div on

0 to -70 dB CRT display. Measurement accuracy at least ± 1.5 dB using suitable measurement techniques.

Linear: calibrated directly in V/div from 0.1 $\mu\text{V}/\text{div}$ to 100 mV/div in a 1, 2, 10 sequence.

Calibrator: 30-MHz signal, -30 dBm ± 0.3 dB.

Spectral resolution

IF bandwidth: 3-dB bandwidths of 50, 100, 300 Hz, and 1, 3, 10, 30, 100, and 300 kHz can be selected.

IF bandwidth selectivity: 60 dB/3 dB bandwidth ratio less than 20:1 for IF bandwidths from 1 kHz to 300 kHz. 60 dB/3 dB bandwidths ratio less than 25:1 for IF bandwidths from 50 Hz to 300 Hz.

Video filter bandwidths: 10 kHz and 100 Hz.

Spectral purity

Stabilization: automatic phase-lock reduces residual FM to less than 20 Hz peak-to-peak for scans 20 kHz/div or less.

Noise sidebands: more than 70 dB below CW signal 50 kHz or more away from signal, with a 1-kHz IF BANDWIDTH setting.

Spurious responses: for -40 dBm signal level to input mixer: image responses, out-of-band mixing responses, harmonic and intermodulation distortion products, and IF feedthrough responses, all more than 70 dB below the Signal Level at Input Mixer. (Signal Level at RF INPUT — INPUT ATTENUATOR).

Residual responses: 200 kHz to 110 MHz: < -110 dBm. 20 kHz to 200 kHz: < -95 dBm.

Scan characteristics

Scan width: 20 Hz/div to 10 MHz/div in a 1, 2, 5, sequence plus ZERO and preset 0-100 MHz scan.

Scan time: 0.1 ms/div to 10 s/div in a 1, 2, 5, sequence.

General

Price: 8553B, \$2050; 8552A, \$2050.

For accessories and required display see page 408.

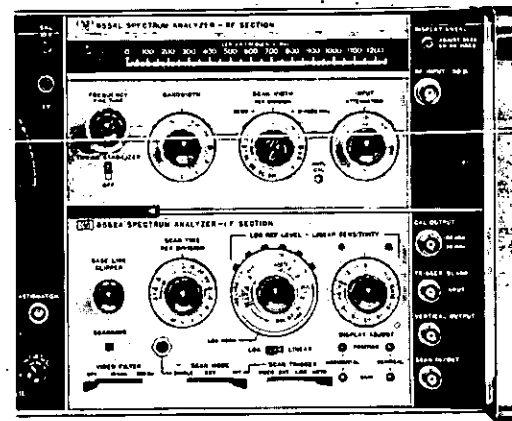
SPECTRUM ANALYZERS *continued*

Wide range
8554L/8552A

8554L/8552A Spectrum Analyzer
500 kHz - 1250 MHz

The 8554L/8552A Spectrum Analyzer has fully calibrated swept coverage from 500 kHz to 1250 MHz. This range represents over three decades of frequency from most common IF and broadcast frequencies to HF and VHF communications; navigation and radar IF frequencies. System performance tests for absolute levels of power, distortion or spurious radiation are easy to perform using this analyzer. New features such as absolute amplitude calibration are made possible by flat frequency response and highly stable instrument gain. These features simplify tedious measurements in RF circuit design and system analysis. The spurious free instrument response and absolute amplitude calibration make it easy to make unambiguous, accurate measurements over a wide frequency range. The completely calibrated instrument controls are simple to operate and the display is easy to interpret.

500 kHz to 1250 MHz



8554L/8552A

Wide frequency coverage—calibrated scan widths

With the flat 500 kHz to 1250 MHz frequency coverage you can optimize RF circuit designs across the entire frequency range. Only signals in this frequency range are viewed; a low-pass filter rejects all out-of-band signals giving an unambiguous display.

A preset 0-1250 MHz scan is provided, as well as selectable, calibrated scan widths. In preset scan, a frequency marker identifies the center frequency selected by the tuning control. Switching to PER DIVISION scan provides ten division symmetrical scan from 100 MHz/div to 2 kHz/div about the center frequency selected by the frequency marker. Calibrated scan widths and narrow bandwidths make it easy to resolve and measure signals regardless of spacing.

Resolution

The resolving capability of a spectrum analyzer is largely determined by its IF bandwidth and frequency stability. For fast, broadband analysis, a 300 kHz bandwidth is available which can be reduced to as narrow as 300 Hz for critical examination of individual spectra. Resolution of two signals differing by 60 dB and 20 kHz apart is easy with the 8554L/8552A narrow bandwidths.

High stability

To effectively use narrow bandwidths in this frequency range, the analyzer must be very stable. A high order of stability is provided by the automatic stabilization system. This fully automatic phase-lock system reduces residual FM to less than 300 Hz peak-to-peak for scan widths less than 500 kHz/div. High stability makes it easy to measure oscillator frequency drift, phase noise and adjust FM deviation using the Bessel null technique.

With the analyzer's absolute amplitude calibration you can measure signal amplitudes directly in microvolts (0.4 μ V to .8 V) or dBm (-117 dBm to +10 dBm). The extreme sensitivity of 0.4 μ V (-117 dBm) ensures that even very small signals can be measured. With ± 1 dB flatness, signals widely spaced in frequency can be compared and their amplitudes read directly from the CRT.

70 dB distortion free display

A full 70 dB of display range is provided with up to 70 dB of freedom from distortion products. With the 0 - 20 dB INPUT ATTENUATOR you can check for input mixer overload and maintain a distortion-free display. With this clean display you can measure distortion levels as low as 0.1% in amplifiers, oscillators and active networks.

Partial Specifications 8554L/8552A
RF and IF Sections

(Refer to Technical Data Sheet for complete specifications)
RF input and tuning characteristics.

Frequency range: 500 kHz to 1250 MHz.

Frequency response: ± 1 dB 500 kHz to 1250 MHz (for attenuator settings ≥ 10 dB).

Input impedance: 50 Ω nominal.

Reflection coefficient: ≤ 0.3 (1.85 SWR) for input attenuator settings ≥ 10 dB.

Maximum input level: peak or average power to input mixer $< +13$ dBm (1.4 V ac peak; ± 50 V dc).

Noise level: the average noise level of the analyzer depends on IF bandwidth and determines its sensitivity for small signals, see Figure 1.

Amplitude characteristics

Vertical display calibration: (8 divisions full-scale deflection).

Logarithmic: calibrated directly in dBm over 130 dB range from -120 dBm to +10 dBm, 10 dB/div on 0 to 70 dB CRT display. Measurement accuracy at least ± 2.0 dB using suitable measurement techniques.

Linear: calibrated directly in V/div from 0.1 μ V/div to 100 mV/div in a 1, 2, 10 sequence.

Calibrator: 30 MHz signal, -30 dBm ± 0.3 dB.

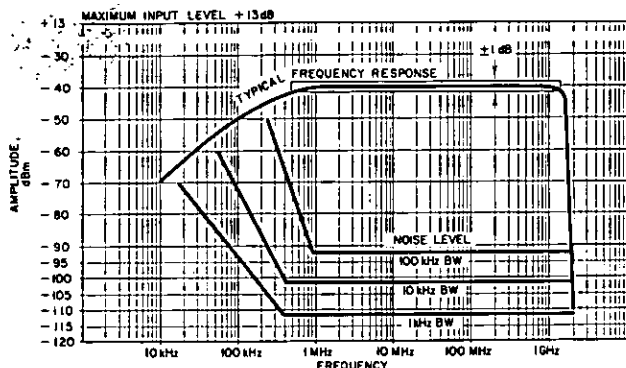
SPECTRUM ANALYZERS *continued***Multipurpose Display**
141S/140S/143S

Figure 1. Noise level vs. Input Frequency.

Spectral resolution

IF bandwidth: 3 dB bandwidths of 300 Hz, and 1, 3, 10, 30, 100, and 300 kHz can be selected.

IF bandwidth selectivity: 60 dB/3 dB bandwidth ratio less than 20:1 for IF bandwidths from 1 kHz to 300 kHz. 60 dB/3 dB bandwidth ratio less than 25:1 for IF bandwidth of 300 Hz.

Video filter bandwidths: 10 kHz and 100 Hz.

Spectral purity

Stabilization: automatic phase-lock reduces residual FM to less than 300 Hz peak-to-peak for scans 200 kHz/div or less.

Noise sidebands: more than 70 dB below CW signal, 30 kHz or more away from signal, with a 1 kHz IF BANDWIDTH setting.

Spurious responses: for -40 dBm signal level to input mixer; image responses, out-of-band mixing responses, harmonic and intermodulation distortion, are all more than 65 dB below the Signal Level at Input Mixer (Signal Level at RF INPUT - INPUT ATTENUATOR).

Residual responses: < -100 dBm.

Scan characteristics

Scan width: 100 MHz/div to 2 kHz/div in a 1, 2, 5, sequence plus ZERO and preset 0-1250 MHz SCAN.

Scan time: 0.1 ms/div to 10 s/div in a 1, 2, 5, sequence.

General

Price: Model 8554L, \$3300., Model 8552A, \$2050.

DISPLAY SPECIFICATIONS

Model 141S Variable Persistence Display (for additional information, see Model 141A/B, Page 517).

Cathode-ray tube:

Type: aluminized P31 phosphor; etched safety glass face plate reduces glare.

Graticule: 8 x 10 divisions (approximately 6,6 x 8,2 cm).

Persistence: . .

Normal: P31 phosphor (approximately 0.1 second).

Variable: continuously adjustable from less than 0.2 second to more than one minute depending on writing rate mode.

Model 140S Fixed Persistence Display (for additional information, see Model 140A/B Page 517).

Cathode-ray tube:

Type: etched safety glass face plate reduces glare; Transparent coating reduces RFI. P7, long persistence phosphor.

Graticule: 8 x 10 division (approximately 7,2 x 9,0 cm).

Model 143S Large Screen Display 8 x 10 Division, 1 inch/div. See 143A Page 517, for additional information.

General Specifications

CRT base line clipper: adjusts blanking of CRT trace base line to allow more detailed analysis.

RFI: conducted and radiated interference is within requirements of MIL-I-16910C, MIL-I-6181D and methods E03 and RE02 of MIL-STD-461 (above 40 kHz) when 8553B or 8554L is combined with 8552A in a 140S or 141S Display Section. For EMI performance below 40 kHz refer to Technical Data Sheet for details.

Temperature range: operating, 0° to +55°C.

Power requirements: 115 or 230 volts $\pm 10\%$, 50 to 60 Hz, normally less than 225 watts (varies with plug-in units used).

Weight: Model 8552A IF Section: net, 9 lb (4,1 kg). Shipping, 14 lb (6,4 kg).

Model 8553B RF Section: net, 12 lb (5,5 kg): Shipping, 17 lb (7,8 kg).

Model 8554L RF Section: net, 10 lb 4 oz (4,7 kg). Shipping, 17 lb (7,8 kg).

Model 140S Display Section: net, 37 lb (16,8 kg). Shipping, 45 lb (20 kg).

Model 141S Display Section: net, 40 lb (18 kg). Shipping, 51 lb (23 kg).

Model 143S Display Section: net, 63 lb (28,6 kg). Shipping, 80 lb (36,3 kg).

Dimensions: 140S or 141S, 9-1/16" high (including height of feet) x 16 3/4" wide x 18 3/8" deep (229 x 425 x 467 mm). 143S, 21" x 16 3/4" x 18 3/8" (533 x 425 x 467 mm).

Accessory required for service: 11592A Service Kit, \$185. Includes extender cables, connector adapters, etc.

Accessories available: Model 8406A Frequency Comb Generator for precise frequency calibration of analyzer. Frequency accuracy is $\pm 0.01\%$. See Page 414.

Price: Model 8552A IF Section, \$2050.

Model 8553B RF Section, \$2050.

Model 8554L RF Section, \$3300.

Model 140S Display Section, \$800.

Model 141S Variable Persistence Display Section, \$1600.

Model 143S Display Section, \$1500.

10 MHz—40 GHz
Fully calibrated, 2 GHz spectrum width
Models 8551B/851B, 8551B/852A



SPECTRUM ANALYZERS

Description

The Hewlett-Packard 8551B Spectrum Analyzer System is a fully calibrated, highly versatile analyzer which covers the range from 10.1 MHz to 40 GHz. The accuracy and flexibility of the instrument make it suitable for many applications beyond the capability of other spectrum analyzers. These include wideband yet rapid RFI measurements, spectrum surveillance and spectrum signature work, and semiconductor evaluations embracing such tests as fast pulsing viewed in the frequency domain.

The analyzer consists of two units, the 8551B RF Section and either the 851B or 852A Display Section, comprising a triple-conversion superheterodyne receiver with swept first local oscillator and oscilloscope readout. The 851B Display Section has a standard persistence CRT; the 852A Display Section offers variable persistence and storage as well as normal persistence. In the 852A Display Section the persistence of the CRT can be adjusted to match the sweep speed, thus obtaining a flicker-free display even at slow sweep rates.

Maximum RF input flexibility

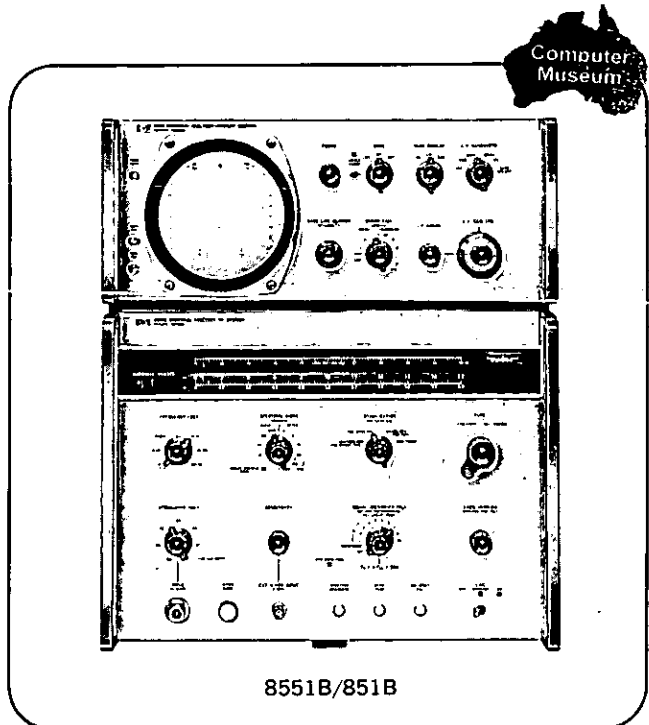
The extremely wideband coaxial input system (10.1 MHz to 12 GHz) permits simultaneous observation of widely spaced signals. Testing of parametric amplifiers is a typical example; here you can observe the signal, pump, and idler frequencies on a single display.

External preselectors, such as filters, isolators, and tuned amplifiers, can be used to limit the input frequency range for specific applications. Both in-band and out-of-band image and multiple responses of the analyzer in the 1.8 - 12.4 GHz signal frequency range are eliminated by the 8441A Preselector (page 413). Fixed bandpass filters (8430A series, page 414) and low pass filters (360 and 362 series, page 348) are also available.

Additional input system flexibility and convenience are afforded by the inclusion of a high performance RF attenuator for use with the coaxial inputs when higher level signals are to be examined. Signal levels as high as 1 watt can be viewed without jeopardizing the input mixer. The attenuator has 60-dB range in 10-dB steps, and because its residual attenuation is very small (less than 2 dB at 10 GHz), it can remain an integral part of the input system, thereby eliminating any need for cable patching. In addition, the attenuator provides a well-matched input for the analyzer. The match on the straight-through or 0-dB position of the attenuator is also good with a maximum reflection coefficient of 0.5 (SWR of 3).

Flat response, high sensitivity

The broadband coaxial input mixer provides the analyzer with extremely flat frequency response. Over full 2-GHz spectrum widths, response is ± 2 dB on fundamental mixing, ± 2 to ± 3.5 dB on harmonic mixing to 12 GHz. Over spectrum widths of 100 MHz, frequency response is somewhat better. Response over the 4- to 6-GHz range is shown in Figure 1. Such flat frequency response permits reliable quantitative measurements where amplitude comparisons of signals at different frequencies can be made (such as in mea-



suring the harmonic content of signals). Very low-level harmonic and intermodulation products are generated within the mixer. For example, with a -30 dBm input level to the mixer, harmonic and intermodulation products are typically > 50 dB below the signal level when fundamental mixing is employed. An additional feature of the input mixer is that the diode is a standard, readily available item easily replaceable from the front panel.

The 8551B has high sensitivity as well as flat frequency response. Sensitivity (10 kHz BW) ranges from -100 dBm in the lower coaxial ranges (where fundamental mixing is employed) to -65 dBm in the highest waveguide band (using harmonic mixing). This sensitivity plus the 60 dB range of the input attenuator enables the analyzer to handle an extremely broad range of signal levels.

The discussion above deals primarily with the coaxial input system of the analyzer. Analysis of signals at higher frequencies where waveguide systems are employed can also be performed. External waveguide mixers covering 8.2 to 40 GHz are used, with a simple coaxial cable serving as the link between the mixer and the 8551B. The single cable delivers local oscillator power to the mixer and returns the mixing products to the analyzer. Thus there is no need to use cumbersome flexguide or resort to awkward handling merely to observe signals in waveguide systems. External waveguide attenuators, such as the HP 382 series, can be used to control the input signal level.

2-GHz spectrum width with clutter-free display

A fresh approach to spectrum analyzer design has resulted in the 8551B offering up to 2 GHz of calibrated spectrum width with a display that is free from the spurious responses and images which historically have made interpretation of spectral displays very difficult. This is achieved through the use of a 2-4 GHz backward-wave oscillator as the first swept

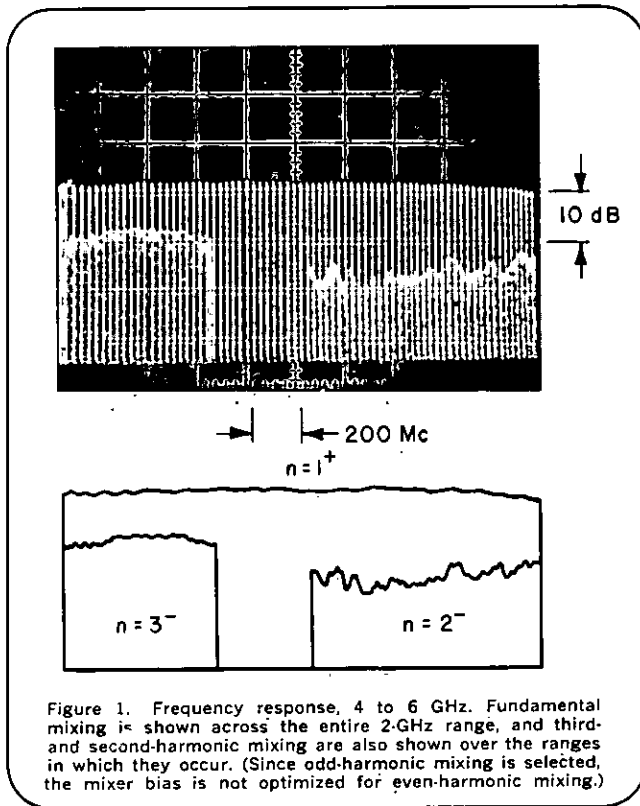


Figure 1. Frequency response, 4 to 6 GHz. Fundamental mixing is shown across the entire 2-GHz range, and third- and second-harmonic mixing are also shown over the ranges in which they occur. (Since odd-harmonic mixing is selected, the mixer bias is not optimized for even-harmonic mixing.)

local oscillator (LO) followed by a 2-GHz first IF amplifier. Sweeping the first local oscillator allows use of fixed tuned, narrow-band IF amplifiers throughout the analyzer, eliminating the sources of spurious signals found in other spectrum analyzers. The high frequency first IF spaces images 4 GHz apart and therefore image signals do not clutter the display. Figure 2 illustrates the use of the 2-GHz spectrum width in the evaluation of a frequency doubler. The combination of a 2-4 GHz swept LO and a 2-GHz first IF provides low frequency coverage down to 10.1 MHz. When the LO is set to 2 GHz, the LO feeds directly through the IF and can serve as a signal source to perform self-checks on the analyzer's performance and calibration.

When viewing signals very close to 2 GHz in frequency, a separate first IF of 200 MHz can be switch-selected. The 200-MHz first IF mode can be used to observe signals from 1.8 to 4.2 GHz; sensitivity exceeds -100 dBm and images are 400 MHz apart. Flatness of response and freedom from internally generated spurious signals are also characteristic of this mode.

In addition to its wide sweep capability, the 8551B Spectrum Analyzer also excels in the presentation of narrow frequency sweeps. Spectrum widths as narrow as 100 kHz can be selected for detailed examination of individual signals, distortion products, etc. Figure 3 is the spectrum of an amplitude-modulated signal in the VHF region. The narrow sweep capability of the analyzer is made possible by a self-contained phase-lock system which reduces residual FM in the first local oscillator to less than 1 kHz. Stabilization of the local oscillator by means of phase-lock is possible for spectrum widths up to $(10/n)$ MHz (where n is the harmonic number of the LO); this is well beyond the point where residual FM of the unstabilized LO could be detected on the display. For operator convenience, a front panel warning light indicates spectrum width too great for use of phase-lock stabilization.

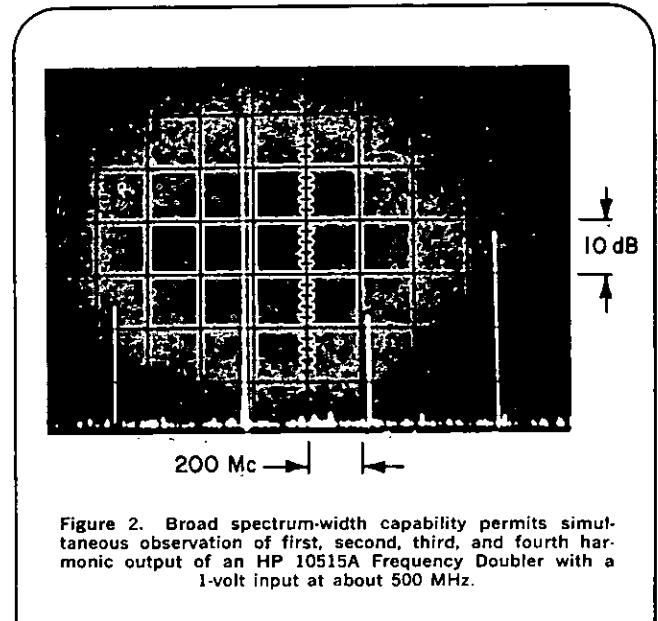


Figure 2. Broad spectrum-width capability permits simultaneous observation of first, second, third, and fourth harmonic output of an HP 10515A Frequency Doubler with a 1-volt input at about 500 MHz.

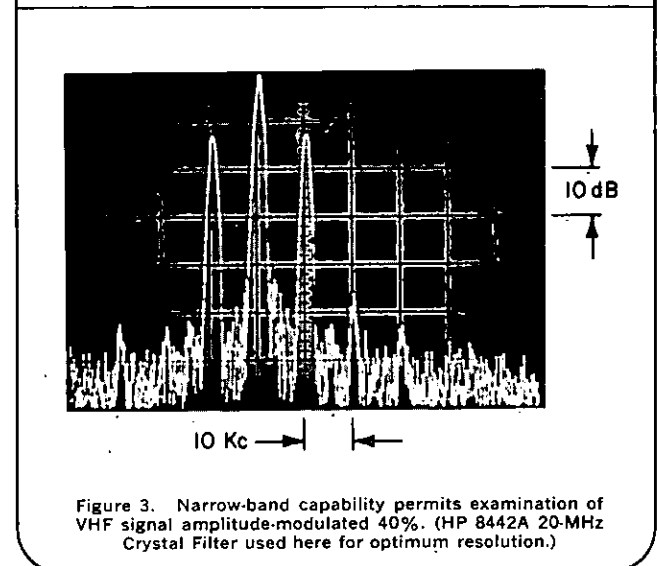


Figure 3. Narrow-band capability permits examination of VHF signal amplitude-modulated 40%. (HP 8442A 20-MHz Crystal Filter used here for optimum resolution.)

The 8551B provides simplicity of tuning, particularly when the unit is operated with the LO stabilized. The phase-lock system itself tracks with tuning so the LO remains stabilized while it is sweeping and also when its center frequency is changed. Thus, there is no need to re-establish phase-lock with every change of frequency, so the operator can continue to tune the analyzer with a single knob.

Two tuning speeds are available. The shift between coarse and fine tuning is accomplished by a pull-push selector on the tuning control. An ultra-fine vernier is also available during stabilized operation for precise positioning of the display.

Positive signal identification

Measurements with the 8551B are simplified by the fact that all displayed signals are easily and positively identifiable. Factors contributing to the ease of signal identification are the 4-GHz image separation and almost total absence of spurious signals which otherwise clutter the display and mask real signals. Actual identification is straightforward. A front-panel control permits rapid determination of the LO mixing harmonic and identification of the signal as an upper or lower mixing product.

Specifications 8551B RF SECTION

(When connected to display section)

Coaxial input characteristics

Frequency range: 10.1 MHz to 12 GHz. Input connector, Type N female.

Sensitivity

$$\left(\frac{\text{signal power} + \text{noise power}}{\text{noise power}} = 2; 10\text{-kHz IF bandwidth} \right):$$

- 10.1 MHz to 100 MHz, -98 dBm, fundamental mixing
 - 100 MHz to 1.8 GHz, -100 dBm, fundamental mixing
 - 1.8 to 4.2 GHz, -100 dBm, fundamental mixing (using 200 MHz 1st IF)
 - 2.4 to 4.1 GHz, -90 dBm, second harmonic mixing
 - 4.1 to 6 GHz, -100 dBm, fundamental mixing
 - 6 to 8 GHz, -88 dBm, third harmonic mixing
 - 8 to 10 GHz, -91 dBm, second harmonic mixing
 - 10 to 12.0 GHz, -85 dBm, third harmonic mixing
- With source stability better than 1 kHz, greater sensitivity can be achieved using narrower IF bandwidth.

Image separation: 4 GHz, (2 GHz First IF); 400 MHz separation when using 200 MHz IF.

Maximum input power (for 1 dB signal compression):

Input Atten Setting	Typical Max Input (peak or average)
0 dB	-10 dBm
10 dB	0 dBm
20 dB	+10 dBm
30 dB	+20 dBm
40 - 60 dB	+30 dBm

Mixer diode: standard 1N4603 replaceable from the front panel.

Residual responses, 10.1 MHz-12 GHz (no input signal): less than -90 dBm referred to signal input on fundamental mixing (-85 dBm when LO is within 60 MHz of 2 or 4 GHz).

RF input attenuator: 0 to 60 dB in 10-dB steps (attenuator residual loss and flatness characteristics included in sensitivity and frequency response specifications). Input ac-coupled; maximum dc voltage: 50 V on 0-dB setting, 7 V on all others.

Waveguide input characteristics

Frequency range: 8.2 to 40 GHz (accessory mixers and adapters required).

Sensitivity

$$\left(\frac{\text{signal power} + \text{noise power}}{\text{noise power}} = 2; 10\text{-kHz IF bandwidth} \right):$$

- 8.2 to 18 GHz, -80 dBm
- 18 to 26.5 GHz, -75 dBm
- 26.5 to 40 GHz, -65 dBm

Maximum input power (for 1 dB signal compression):

- 8.2 to 12.4 GHz (using 11521A Mixer) typically -15 dBm peak or average.
- 12.4 to 40 GHz (using 11517A Mixer) typically -15 dBm peak or average.

External mixer input connector: BNC female; LO power to mixer and 2-GHz IF signal from mixer use this connector.

SPECTRUM ANALYZERS *continued*

8551B RF Section

RF sweep, first local oscillator (LO), and RF tuning characteristics

Spectrum width: 10 calibrated spectrum widths from 100 kHz to 2 GHz in a 1, 3, 10 sequence to 1 GHz. Vernier allows continuous adjustment between calibrated ranges and can be used to reduce width to 0. Displayed over 10-div horizontal span on display section CRT.

Swept frequency linearity: spectrum widths 200 MHz/div to 3 MHz/div: Frequency error between two points on the display is less than $\pm 10\% \pm 3$ MHz of the indicated frequency separation between the two points.

Spectrum widths 1 MHz/div to 10 kHz/div (stabilized tuning mode): Frequency error between two points on the display is less than $\pm 5\%$ of the indicated frequency separation between the two points.

First local oscillator: 2 to 4 GHz backward-wave oscillator.

Tuning accuracy: $\pm 1\%$ of first LO fundamental or harmonic.

Tuning modes: selectable continuous coarse, fine, and stabilized (phase-locked) tuning determines center frequency about which first local oscillator (LO) is swept. Tuning accomplished with single front panel TUNE control (with FREQUENCY VERNIER control for increased settability when in stabilized tuning mode; vernier tuning range 100 kHz).

Frequency change of LO fundamental is 200 MHz per revolution of TUNE control for COARSE, 10 MHz per revolution for FINE.

LO stabilization range: first LO can be phase-locked to internal voltage-tuned reference oscillator. LO sweep tracks reference oscillator sweep for spectrum widths up to $(n) \times (10 \text{ MHz})$; $(n = \text{LO harmonic number})$.

Stabilized tuning: internal reference oscillator automatically tracks with TUNE control over full LO range to retain stabilization at any LO frequency. Frequency change of LO fundamental is 10 MHz per revolution of the TUNE control. FREQUENCY VERNIER control (100 kHz tuning range) permits precise settability.

LO characteristics

Residual FM: less than 1 kHz (p-p) when first LO stabilized; typically less than 40 kHz (p-p) when LO not stabilized.

Noise sidebands: more than 60 dB below CW signal level 90 kHz or more away from signal, using fundamental mixing.

Auxiliary RF output: approximately 20 mW available at rear panel Type N female connector for use with other equipment (e.g. frequency counter, wavemeter). Requires nominal 50-ohm load impedance; HP 908A termination furnished.

Frequency response, Coaxial input

(includes mixer and RF attenuator response with attenuator setting ≥ 10 dB):

Frequency range	n*	Mixing mode IF (GHz)	Relative gain** (dB)	Flatness, full range (dB)	Flatness, 100 MHz (dB)
10.1 to 1.8 GHz	1-	2	0	± 2.0	± 2.0
(100 MHz to 1.8 GHz)	1-	2	0	± 1.5	± 1.0
1.8 to 4.2 GHz	1=	0.2	0	± 3.5	± 2.0
2.4 to 4.1 GHz	2-	2	-7	± 2.5	± 2.0
4.1 to 6 GHz	1+	2	0	± 1.5	± 1.0
6 to 8 GHz	3-	2	-11	± 2.0	± 1.5
8 to 10 GHz	2+	2	-7	± 2.0	± 1.5
10 to 12 GHz	3+	2	-12	± 3.5	± 2.0

* n = LO harmonic. Normal operating range specified; full range approximately same performance.

** The approximate relative displayed amplitudes of equal-amplitude input signals for the various harmonic mixing modes.

851B, 852A display section

Signal identification and self-check characteristics

Signal identifier: front panel switch introduces precise frequency offsets to permit exact determination of LO harmonic number used for mixing. Direction of display shift indicates whether signal frequency is higher or lower than LO harmonic. Concentric push button switch permits reestablishment of reference position to facilitate identification of drifting signals.

Self-check: first IF of 2 GHz permits use of swept LO (tuned to 2 GHz) for calibration, alignment, and general performance checks. Stabilized LO provides swept RF signal with very high linearity over 10-MHz range for IF bandwidth calibrations.

General

IF output center frequency: 20 MHz (at rear panel BNC female connector for use with 851B or 852A Display Section).

RFI: conducted and radiated leakage are below requirements of MIL-I-16910C when the RF and display sections are fastened together with the bracket kit supplied.

Power: 115 or 230 V $\pm 10\%$, 50 to 60 Hz, less than 275 W (less than 330 W, total, when display section power supplied through 8551B rear panel switched line output).

Weight: net 88 lb (39,6 kg); shipping 134 lb (60,3 kg).

Dimensions: 16 $\frac{3}{4}$ " wide, 12 $\frac{7}{32}$ " high, 18 $\frac{3}{8}$ " deep (425 x 310 x 467 mm).

Accessory items furnished: 7 $\frac{1}{2}$ ft (2290 mm) power cable; rack mounting kit; cables to connect 8551B RF section to display section; 908A Termination for rear panel auxiliary LO output.

Price: Model 8551B, \$7950.

Specifications

851B, 852A DISPLAY SECTIONS

Vertical display (7 div full scale deflection):

Mode	Scale Factor	Accuracy**
LINEAR	Relative voltage/div	$\pm 3\%$ full scale
SQUARE	Relative power/div	$\pm 5\%$ full scale*
LOGARITHMIC	10 dB/div calibrated over 0 to 60 dB on CRT display	$< \pm 0.2$ dB/dB but not more than ± 2 dB over full calibrated 60 dB CRT display range*

*Except pulse spectra on 1 MHz IF bandwidth.

**0 to 40°C.

IF characteristics

IF input center frequency: 20 MHz (accepts 20-MHz output from 8551B RF Section).

IF bandwidth: manual: bandwidths of 1, 3, 10, 100 kHz, and 1 MHz can be selected; AUTO SELECT: one of the above bandwidths automatically selected for best resolution of a CW signal for each combination of Spectrum Width and Sweep Time; Bandwidth Accuracy: individual bandwidths are calibrated within $\pm 20\%$, bandwidth repeatability and stability typically better than $\pm 3\%$.

IF gain set: 2-section attenuator provides 0 to 80 dB attenuation in 1-dB steps; one section provides 0 to 70 dB attenuation in 10-dB steps; the other 0 to 10 dB in 1-dB steps; IF Vernier provides continuous adjustment between 1-dB steps.

IF gain set accuracy: 70-dB section, ± 0.5 dB; 10-dB section, ± 0.1 dB.

Sweep characteristics

Sweep time: six calibrated rates from 3 ms/div to 1 s/div in a 1, 3, 10 sequence; Vernier provides continuous adjustment between calibrated rates and extends slowest rate to at least 3 s/div.

Sweep time accuracy: $\pm 3\%$.

Sweep synchronization: INTERNAL: sweep free-runs; LINE: sweep synchronized with power-line frequency; EXTERNAL: sweep synchronized with externally applied signal of +3 to +15 volts peak amplitude/BNC female input connector on rear panel/SINGLE SWEEP: sweep actuated by front panel pushbutton; panel light signifies duration of single sweep.

External sweep: input: 0 to +15 volt external signal (from 10 k ohm source impedance) results in full horizontal trace; BNC female connector on rear panel, direct-coupled; blanking: -5 volt external blanking signal required to blank retrace; BNC female connector on rear panel.

General

CRT base line clipper: front panel control permits blanking of CRT trace base line to allow more detailed analysis of low repetition rate signals.

Output signals: vertical and horizontal signals applied to CRT are available for external applications; rear panel BNC female connectors; vertical: 0 to approximately -4 volts, open circuit, 4700 ohms source impedance; horizontal: 10 volts p-p ± 0.3 volt, open circuit, sweep approximately symmetrical about 0 volts, source impedance 4700 ohms, IF test point (20 MHz) also provided, rear panel BNC female connector.

RFI: conducted and radiated leakage are below the requirements of MIL-I-16910C when the RF and display section are fastened together with the bracket kit supplied.

Dimensions: 16 $\frac{3}{4}$ " wide, 6-21/32" high, 16 $\frac{3}{8}$ " deep behind panel (425 x 177 x 416 mm).

Accessory items furnished: 7 $\frac{1}{2}$ ft (2290 mm) power cable; rack mounting kit; joining bracket kit to attach display section to 8551B.

Accessory items available: 8442A 20-MHz Crystal Filter for increased resolution on 1-kHz IF bandwidth. 197A Oscilloscope Camera.

851B Display Section

Display characteristics

Vertical display (7 cm full scale deflection):

Cathode-ray tube: 7.5 kV post-accelerator tube with P2 medium persistence phosphor (other optional) and internal graticule; light blue filter supplied; light-proof CRT bezel provides firm mount for oscilloscope camera.

CRT internal graticule: parallax-free 7 x 10 cm, marked in centimeter squares with 2-mm subdivisions on major horizontal and vertical axes.

Power: 115 or 230 V $\pm 10\%$, 50 to 400 Hz, < 55 W.

Weight: net 34 lb (15,2 kg); shipping 38 lb (17,1 kg).

Price: Model 851B, \$2475.

852A Display Section

Display characteristics

Cathode-ray tube:

Type: post-accelerator storage tube, 7300-volt accelerating potential; aluminized P31 phosphor; etched safety glass face plate reduces glare.

Graticule: 7 x 10 divisions (approximately 8.5 x 5.9 cm) parallax-free internal graticule; 5 subdivisions per major division on major horizontal and vertical axes.

Persistence:

Short: natural persistence of P31 phosphor (approximately 0.2 second).

Variable:

Normal writing rate mode: continuously variable from less than 0.2 sec to more than 1 min, typically to 2 or 3 min).

Max. writing rate mode: typically variable from 0.2 to 15 s.

Erase: manual; erasure takes approximately 0.5 s; CRT ready to record immediately after erasure.

Brightness: greater than 100 footlamberts in NORMAL or VIEW; typically 5 footlamberts in STORE.

Power: 115 or 230 volts $\pm 10\%$, 50 to 400 Hz, 75 W.

Weight: net 36 lb (16,1 kg); shipping 40 lb (18 kg).

Price: Model 852A, \$3475.

Accessories

Description

The HP 8441A Preselector is a voltage-tunable bandpass filter designed primarily as an accessory instrument for the HP 8551B Spectrum Analyzer. The 8441A uses an yttrium-iron-garnet (YIG) filter as the tunable element. The YIG sphere is tuned by a current-controlled magnetic field. Passband of the filter is about 30 MHz; frequency range is from 1.8 to 12.4 GHz. When used with the 8551B, the preselector tracks the RF input frequency of the analyzer to reject all signals other than those desired. By automatically tracking the analyzer tuning the 8441A Preselector virtually eliminates multiple responses, image responses and spurious responses. The display on the CRT is greatly simplified as only the band of frequencies desired is present on the display. The center frequency of the display may be read directly on the 8551B tuning dial, eliminating the need for signal identification.

The 8441A can be used as a manually tuned narrow-band microwave filter anywhere in the 1.8 to 12.4 GHz frequency range. Continuous tuning is controlled by one dial on the front panel. Also, the filter may be tuned across its range by an internal sweep oscillator. Center frequency and sweep limits are front panel selected. When internally swept, the 8441A plus a broadband crystal detector and a sensitive oscilloscope form a simple spectrum analyzer.

Specifications, as preselector for 8551B

Frequency range: 1.8 to 12.4 GHz. Input connector, Type N female.

Insertion loss: insertion loss in the passband is less than 5 dB; minimum VSWR in the passband is less than 2:1. The filter reflects applied signals at frequencies other than the passband, so the VSWR is very high outside the passband.

Undesired response reduction: (reduction of responses of the 8551 to harmonic mixing modes other than the one preselected) At least 35 dB.

Contribution to 8551B frequency response:

Preselector Harmonic Mixing Mode	Addition to 8551B Variation
1±; 200 MHz IF	±2.5 dB over 2 GHz range
1+; 2 GHz IF	±2.5 dB over 2 GHz range
2±; 2 GHz IF	±3.5 dB over 2 GHz range
3±; 2 GHz IF	±4.5 dB over 2 GHz range

Limiting level: (maximum input level for <2 dB signal compression).

- 20 dBm, 1.8 GHz to 2 GHz.
- +10 dBm, 2 GHz to 12.4 GHz.

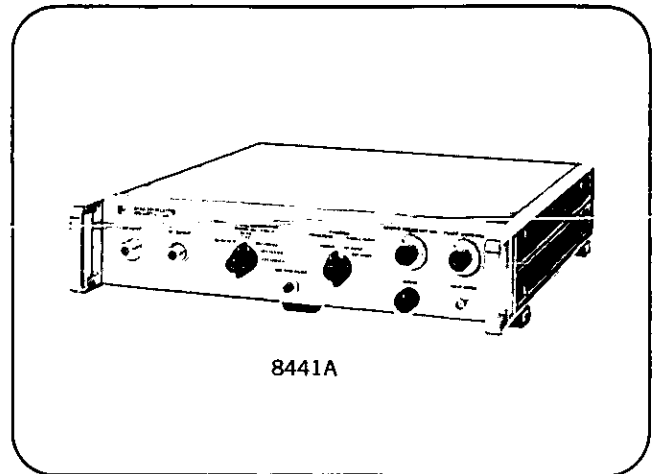
Absolute maximum input level: +30 dBm; 8551B Input Attenuator must be set to keep power to analyzer input mixer below 0 dBm to prevent damage to the mixer.

Reduction in 8551B local oscillator emission: (LO emission is 2 GHz to 4 GHz; level is typically 0 dBm).

2 GHz IF input: 50 dB (except when preselecting 2nd harmonic mixing mode from 2 GHz to 4 GHz).

200 MHz IF input: 33 dB (1st harmonic mixing mode).
40 dB (1st harmonic mixing mode).

Dimensions: 16¾" wide, 3¼" high, 19" deep (425 x 83 x



8441A

483 mm).

Maximum 851 or 852 sweep rate: 10 milliseconds/div.

Connections to 8551B:

- 851B/852A Horizontal Output, BNC female.
- 8551B Preselector Drive Output, BNC female.
- 8551B RF Input, Type N female.

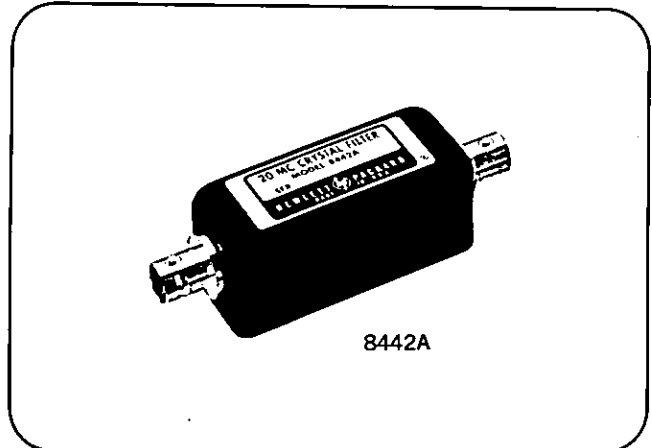
RFI: conducted and radiated leakage are below those specified in MIL-I-6181D and MIL-I-16910C.

Power: 115 or 230 volts ±10%, 50 to 400 Hz.

Weight: net 19 lb (8,6 kg); shipping 23 lb (10,5 kg).

Accessory items furnished: 7½-foot power cable, rack mounting kit; cables to connect preselector to 8551B; joining bracket kit to attach 8441A to 8551B/851B.

Price: Model 8441A, \$2,950.

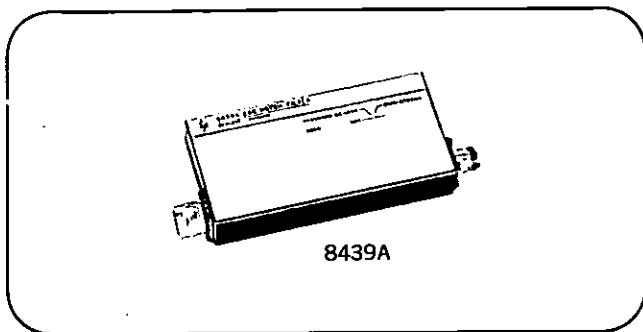


8442A

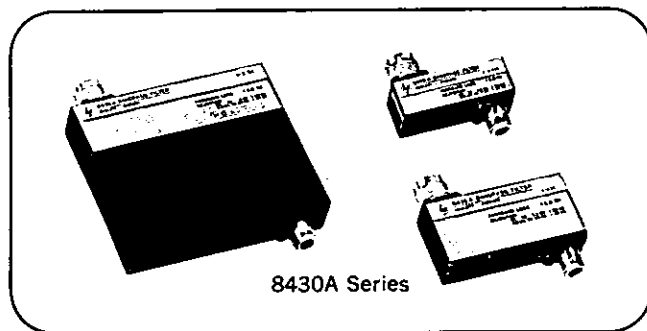
The HP 8442A 20-MHz Crystal Filter is a bandpass filter with a 20-MHz center frequency for use with the HP 8551B Spectrum Analyzer. The filter, which has a 2-kHz passband, improves the skirt characteristics of the 851/852 display section of the analyzer for greater resolution of closely spaced signals. Filter bandwidth at the 60-dB points is less than 10 kHz. Small in size, the filter is easily connected in the 20-MHz line between the 8551B and the display section of the analyzer.

Price: HP 8442A, \$250.

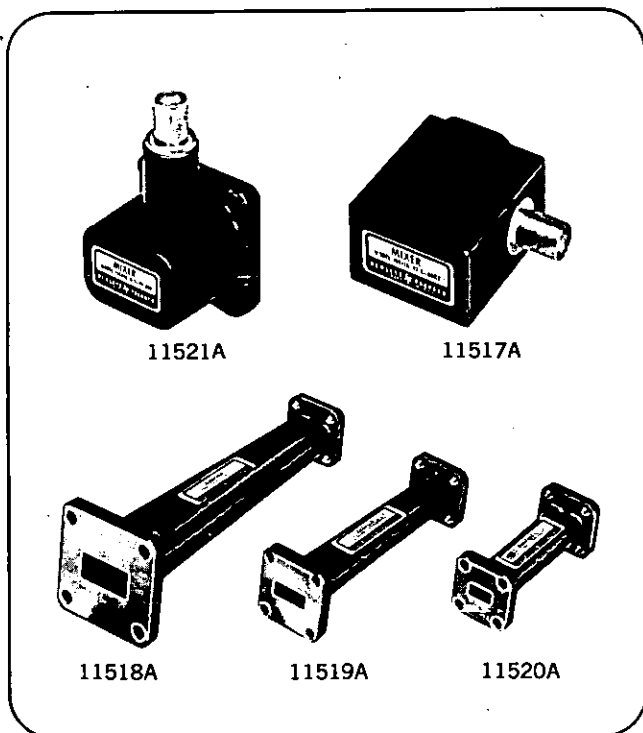
Accessories

**8439A 2-GHz notch filter**

Model 8439A has an extremely narrow rejection notch (2 MHz at 60 dB down) at 2 GHz, thereby permitting observation of broadband signals without interference from signals at the 2-GHz IF (evidenced by the raising of the entire base line on the CRT). Price: HP 8439A, \$275.

**Preselection filters**

Series 8430A bandpass filters are coaxial preselectors for the spectrum analyzer. They limit the input of the analyzer to a specific frequency range, minimizing interference from signals outside the range of interest. Low pass filters (coaxial series 360 and waveguide series 362) are also useful for preselection.



11521A

11517A

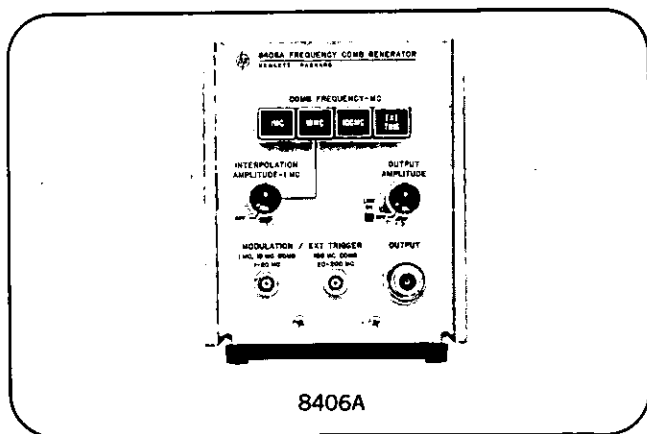
11518A

11519A

11520A

External waveguide mixers, adapters

External waveguide mixers 11517A and 11521A permit direct observation of signals in waveguide systems. The 11517A covers 12.4 to 40 GHz and requires adapters 11518A, 11519A, 11520A as transitions to P-, K-, R-band waveguide respectively. The 11521A Mixer covers X-band (8.2 to 12.4 GHz). Price: HP 11517A Mixer (12.4-40 GHz), \$200, 11518A Adapter (12.4-18 GHz), \$75; HP 11519A Adapter (18-26.5 GHz), \$75; HP 11520A Adapter (26.5-40 GHz), \$75; HP 11521A Mixer (8.2-12.4 GHz), \$75.

**8406A frequency comb generator**

Model 8406A provides frequency markers spaced 1, 10, and 100 MHz apart for frequency calibration of the spectrum analyzer. Because the markers are harmonics derived from 0.01% crystal oscillators, accurate determination of absolute as well as relative frequencies is possible. An external oscillator can be used to produce a comb with different spacing; or each of the output combs can be phase-modulated with external oscillators to produce sidebands about each comb signal, thereby facilitating interpolation measurements. The combs are useable from the fundamental to beyond 5 GHz. Price: HP 8406A, \$575.

Model	Pass Band (GHz)	Price
8430A	1-2	\$235.00
8431A	2-4	235.00
8432A	4-6	300.00
8433A	6-8	300.00
8434A	8-10	300.00
8435A	4-8	235.00
8436A	8-12.4	235.00



NEW MEASUREMENT TECHNIQUES

Analytical methods currently used in all branches of engineering are based, almost exclusively, on well defined forms of test signal such as the sine wave and square wave. Testing with these simple deterministic signals has been accepted practice for many years; results are seldom difficult to obtain, and well-established methods exist for their analysis.

Suppose we wished to measure the dynamic characteristics of a control system: one method would be to measure gain and phase shift at a number of frequencies. Alternatively, we might choose to observe the system's transient response to a step or impulse test signal; again, the results can be interpreted to give a complete description of system behavior. In short, practical tests using sine waves, steps and impulses are a firmly established part of the engineering scene.

We should pause here, however, to question whether they are in fact the most satisfactory methods available to us. How many engineering systems are subject, in their normal operating environment, to perturbations like the signals we use to test them? Real-life systems, almost without exception, experience *random* disturbances. Examples of this are: temperature control systems (random temperature fluctuations about the desired value), aircraft guidance systems (random disturbances due to air turbulence) and communications channels (speech, music and telegraph are effectively random signals).

Since random disturbances are the norm, it seems reasonable to use random signals (that is, noise) for test purposes in preference to sine waves or other simple functions. Perhaps as important as the use of noise in systems testing is the analysis of noise itself, and the use of averaging methods to detect periodic signals buried in noise . . . all of which point to the need for new measurement techniques.

Noise Parameters

Noise, by definition, is non-periodic; it contains many frequencies, and it cannot be synchronized, nor analyzed by conventional means. Like any other random phenomena, noise can be characterized only in terms of its *average* behavior, that

is, its *statistical* properties. Some of these properties will be familiar. . . .

ROOT MEAN SQUARE (RMS): a measure of the total power contained in the signal.

MEAN VALUE: the dc component of the signal.

POWER DENSITY SPECTRUM: shows how each frequency present in the signal contributes to the total power.

Some properties will perhaps be less familiar. . . .

PROBABILITY DENSITY FUNCTION (PDF): a histogram-type plot showing the proportion of time spent by the signal at each amplitude level.

AUTOCORRELATION FUNCTION: a graph of the average similarity between a signal and a time-shifted version of itself, expressed as a function of this time-shift. The amplitude of a signal at one instant in time is likely to be related to the amplitude immediately before and after; but the likelihood of any dependency decreases as the time between amplitude samples increases. The autocorrelation function shows the *average* dependence of amplitude for all values of time-shift.

Autocorrelation

In practice, the process of establishing correlation, or similarity, involves four operations . . . sampling, delay, multiplication and averaging.

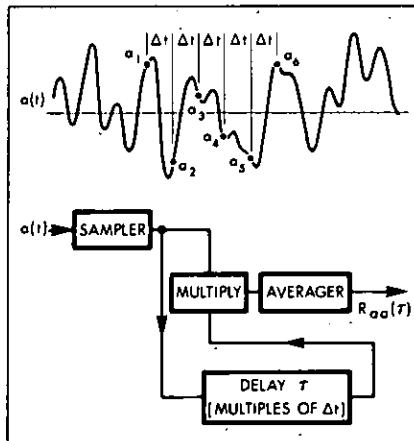


Figure 1. Computing autocorrelation function.

For example, the first step in computing the autocorrelation function $R_{aa}(\tau)$ for the waveform in Figure 1 would be to sample the signal at intervals of Δt . Sample a_1 would be delayed by a time-

shift Δt and then multiplied by a_2 , a_2 would be delayed and multiplied by a_3 , and so on. The average of many such products would be the value of the autocorrelation function at time-shift Δt : in other words, the value of $R_{aa}(\Delta t)$. Clearly, a single value is not sufficient description of the signal: the same basic method, however, is easily extendable for other values of time-shift. $R_{aa}(2\Delta t)$, for example, would be computed by increasing the delay τ shown in the Figure 1 schematic to $2\Delta t$: a_1 is now multiplied by a_3 , a_2 by a_4 , and so on. Model 3721A Correlator has a 100-stage delay register arranged so that 99 previous values of the signal can be multiplied by the most recent value each time a sample is taken: this means that the Correlator can compute and display, in real time, the correlation function for 100 values of delay *simultaneously*.

Consider now some of the things autocorrelation can do for us. Figure 2 shows the autocorrelation function of one kind of random signal. Note that the function is symmetrical for positive and negative time-shifts: in practice we display only one direction of shift.

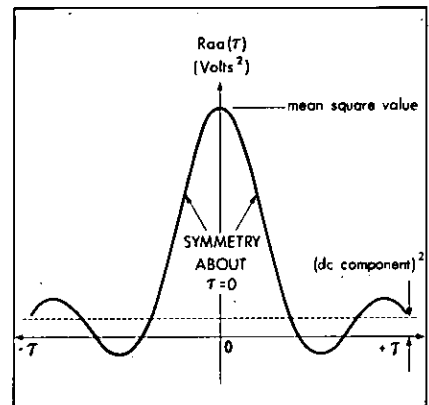


Figure 2. Autocorrelation function of random signal.

General properties of autocorrelation functions are:

- symmetry about $\tau = 0$.
- a positive maximum at $\tau = 0$, equal to the mean square value of the signal (to get $R_{aa}(0)$ we simply square the samples).
- level of the "tail" is equal to the square of the signal's dc component.

The sharpness, or width of the function tells us the bandwidth of the signal. Intuitively, this is not difficult to appreciate. A low frequency signal changes

slowly, so samples a small interval Δt apart must be very similar—that is, dependent: a signal of higher bandwidth fluctuates more in the same time, so the interdependence of samples Δt apart is less. It follows that the higher the bandwidth the more rapidly does the autocorrelation function decay with increasing time-shift.

So autocorrelation can give us an indication of signal bandwidth . . . but more than that, there is a precise relationship between autocorrelation function and power density spectrum: they are a *Fourier Transform Pair*. This opens up new possibilities in low frequency spectrum analysis: even the lowest frequency signals can be autocorrelated, but there is a definite lower limit below which direct spectrum analysis isn't practicable. Fourier transformation is a computer operation, greatly facilitated by the Correlator's data output capability. The optional computer interface makes possible direct transfer of data from the Model 3721A Correlator to any computer in the Hewlett-Packard range.

In routine work with the Correlator it is often sufficient to analyze correlation functions by simple rule-of-thumb methods, rather than resort to rigorous Fourier transformation. For example, a "ringing" type autocorrelation function (as in Figure 2) implies a sharp-cornered power density spectrum (the transform of a $\sin x/x$ shaped time function): the sharper the roll-off, the greater the tendency to oscillatory tails on the autocorrelation function. A smoother decay in the autocorrelation function implies a more gentle roll-off with frequency.

There is no unique correspondence between the shape of a correlation function and the shape of the time waveform from which it was obtained . . . an infinity of different time waveforms could produce the same autocorrelation function. There is, however, one important general characteristic: the autocorrelation function of a *random* signal *decays* with increasing time-shift, whereas the autocorrelation function of a *periodic* signal is *itself periodic*—it has the same period as the waveform from which it was derived, and does not decay with increasing time-shift.

This characteristic leads to a powerful technique for detecting periodic signals hidden in large amounts of random noise. The autocorrelation function of such a signal shows the presence of both noise and periodic waveform at small values of time-shift, but the noise component decays with increasing time-shift to leave only the periodic component in the tail of the function.

Crosscorrelation

Autocorrelation is, in fact, a special case of *crosscorrelation*, the process of comparing two *non-identical* waveforms. A crosscorrelation function, $R_{ba}(\tau)$, is a graph of the average similarity between two waveforms $a(t)$ and $b(t)$ as a function of the time-shift between them. The process is illustrated in Figure 3. Both waveforms are sampled simultaneously at intervals of Δt , corresponding samples (a_1 and b_1 , a_2 and b_2 , etc.) being multiplied together and averaged to give the value of the crosscorrelation function at zero time-shift, that is, $R_{ba}(0)$. To calculate $R_{ba}(\tau)$ for other values of τ , the sampled values of $b(t)$ are delayed with respect to $a(t)$.

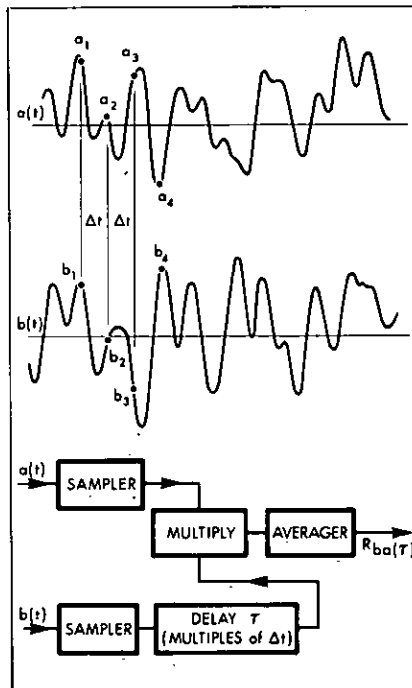


Figure 3. Computing crosscorrelation function.

Apart from its other more sophisticated applications, crosscorrelation has immediate usefulness as a means of detecting and measuring time delay in a signal transmission path . . . for example, the delay between a transmitted and received signal in a ranging system. In this application, the transmitted signal would be progressively delayed until it "finds itself" in the received signal. Similarity between transmitted and received signals would appear as a peak on the Model 3721A display. The time-shift at which the similarity occurs is easily calculated from the position of the peak along the horizontal (delay) axis.

Probability

The autocorrelation function describes a signal's frequency content, but gives no indication of its amplitude characteristics . . . that is, how big is it, for how

long? For this purpose we determine the *proportion* of time spent by the signal at all possible amplitudes during a finite period of time (Figure 4). In practical terms, this means totalizing the time spent by the signal in a selection of narrow (δx) amplitude windows, and then dividing the total for each window by the measurement time.

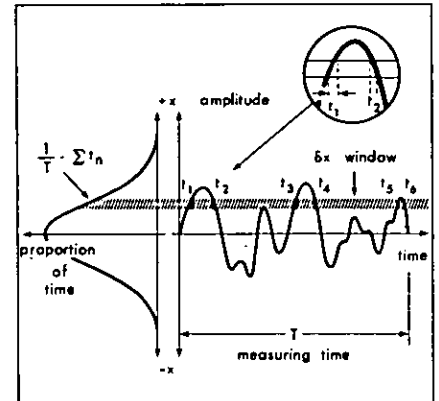


Figure 4. Measuring pdf of random signal.

The curve obtained by plotting the window totals against amplitude is known as the *probability density function* (pdf) of the signal. Assuming that the behavior of the signal during the measuring time was truly representative of its behavior at all other times, we now have a *statistical* measure of the signal's amplitude characteristics. The Model 3721A Correlator uses 100 amplitude windows to display the amplitude probability of any kind of input signal. Also displayed by the Model 3721A is the *cumulative probability distribution function* (cdf), the *integral* of the pdf. The cdf represents the probability that a signal will be *at or below* a certain amplitude, and is sometimes a more convenient function than the pdf for a clear description of a signal's amplitude properties.

Statistical Measurements in Practice

Rigorous analysis of the random signals encountered in all fields of engineering and fundamental research has long been held to be vitally important . . . but has rarely been achieved in practice owing to the lack of suitable hardware. Statistical signal analysis has hitherto involved two discrete operations . . . first, data recording and second, off-line analysis by computer. Now, however, with very fast processing—as in the Model 3721A Correlator—statistical analysis in *real time* is entirely practicable. Furthermore, with increased processing capability has come more compact hardware, and hence the new generation of sophisticated, yet truly portable instruments.

The following list, though not ex-

haustive, indicates some of the fields in which statistical signal analysis is particularly useful.

- Aerodynamics
- Vibration analysis
- Hydro dynamics
- Underwater sound
- Acoustics
- Structural engineering
- Geophysics
- Radio astronomy
- Communications
- Medical physics

Aside from the general applications listed above, correlation techniques provide a revolutionary answer to a specific, age-old problem . . . dynamic response measurements, or system identification. This particular application—certainly one for which the Model 3721A Correlator is ideally suited—is discussed in the following section.

Dynamic Response Measurement by Crosscorrelation

In one form or another, "modeling" is a technique used by all engineers. A model is a replica of the real system, and may take the form of a physical object, a set of differential equations, a transient response, a frequency response . . . something which describes—or even duplicates—the real system's behavior. A model enables us to *predict* how the real system will behave without involving hardware: with a mathematical model we can make adjustments simply by changing numbers in equations. In no field of engineering is modeling more essential than in process control work: hardware is expensive, and mistakes catastrophic. Characteristically, it is also one of the most intractable areas so far as modeling is concerned: we must be able to put the right numbers in an equation, and to do this we have to collect experimental data from a working system. None of the traditional methods—

using sine wave, step or pulse—is suited to experiments with large systems. The measurements must be made under working conditions (implying large background disturbances), and the response is difficult to detect unless large test signals are applied—which could lead to gross disturbances in magnitude or quality of the system's end-product. Another disadvantage of the sinusoidal test is that, particularly with large slow-to-respond systems, it can be very time consuming . . . requiring frequencies measured in, say, hours per cycle rather than cycles per second.

Ideally the method used to identify the system should employ a test signal smaller in amplitude than the existing background disturbances, thus avoiding fluctuations in the end product, and yet should be capable of extracting the response to the test signal from the background noise. The technique of crosscorrelation provides the answer: an approximation to the *impulse response* of a linear system can be determined by applying a suitable *noise* signal to the system, then crosscorrelating the noise signal with the system's output. This technique overcomes the main disadvantage of conventional test methods—the need to apply a large test signal to obtain a measureable output. The noise test signal can be applied at a *very low level*, resulting in very small additional perturbations at the output. Crosscorrelation, essentially a process of accumulation, builds up the result over a period of time. Hence, although the perturbations may be very small, a measurable result can be obtained provided that the accumulation time is sufficiently long. Background disturbances in the system will be uncorrelated with the random test signal and will therefore be effectively ignored by the correlation process.

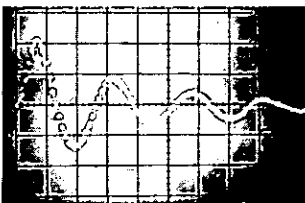
This technique has been in use for some time, but its acceptance has been

slowed by the lack of suitable hardware. Typically, system data would be collected on paper tape and correlation would be performed, off-line, by general purpose computer. The delay between data collection and interpretation thus introduced is frustrating to the experimenter wishing to repeat experiments, or check the effect of parameter adjustments. On-line correlation, with special purpose equipment, clearly answers this problem. The Model 3721A Correlator, with its digital processor, is particularly suited to systems identification work: unlike other real-time correlators, using analog stores, the 3721A is not limited in length of time constant (switch selectable up to 10^7 seconds), and is not subject to drift problems.

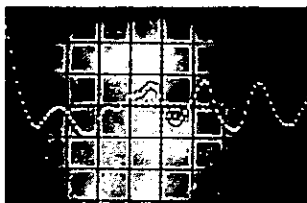
Complete Systems Test Set

Noise used as the test signal in system identification work should ideally have a well-defined power spectrum—hence the need for a precision noise generator such as the 3722A, described on page 264. This instrument generates both random and pseudo-random noise, the latter being particularly well suited to system testing. BINARY and GAUSSIAN outputs are provided, both having constant power, independent of bandwidth selected. Like the 3721A Correlator, the 3722A Noise Generator has an excellent low frequency performance, and is thus of particular interest to those concerned with large systems.

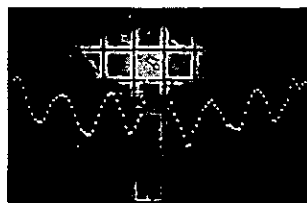
The optional computer interface greatly extends the data analysis capability of the Model 3721A. For example, from an impulse response computed by the Model 3721A, the corresponding system frequency response can be derived by Fourier Transform techniques. Even more exciting possibilities in systems analysis arise from the rapidly developing Z Transform methods.



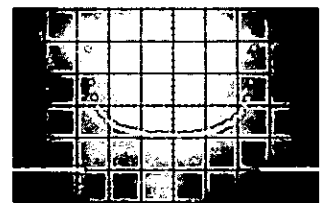
Impulse response of under-damped servo, obtained by crosscorrelation method.



Autocorrelation of background noise in office area. Shows periodic component due to ventilation fan, normally inaudible. Timescale 1 ms/mm.



Crosscorrelation between noise in machine shop and noise from ventilation fan. Timescale 1 ms/mm. Peak centered on 47 ms shows propagation delay between microphone at fan and microphone in machine shop (approximately 50 ft separation).

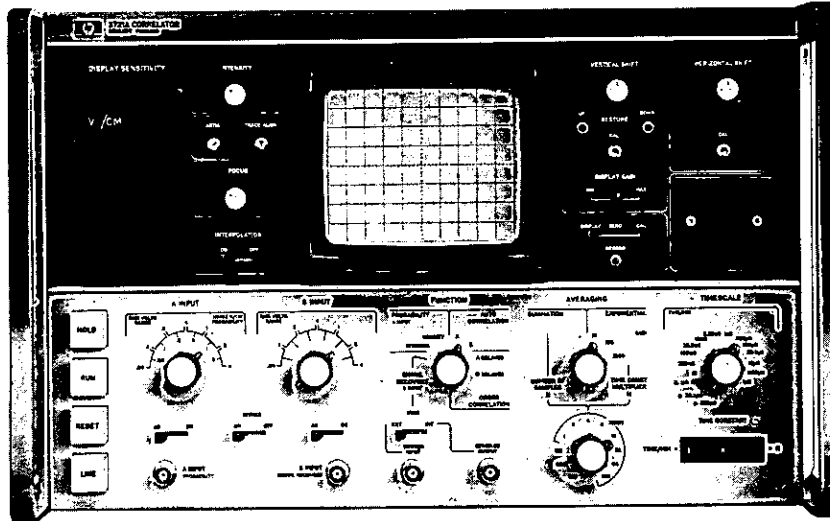


PDF of sine wave.



CORRELATOR

Real-time signal analysis
Model 3721A



3721A

Description

Model 3721A Correlator is an all-digital, dc-to-250 kHz signal analyzer which combines four major measurement capabilities in one instrument. It measures autocorrelation, crosscorrelation, probability distributions, and signal averaging (signal recovery), the process of recovering the wave-shape of repetitive signals buried in noise (described, with reference to the Model 5480A Signal Analyzer, on page 42). All results are displayed on built-in CRT.

In general, using the 3721A Correlator is similar to using an oscilloscope. Essentially an "on-line" instrument, it can easily be carried from place to place, yet has the flexibility of much larger data processing systems . . . for example, a selection of averaging time constants from a few milliseconds to many days. With the 3721A Correlator comes the ability to *observe* statistical behavior in real time, and to monitor changing phenomena continuously.

The computed function is displayed using 100 points; however, if more resolution is required in correlation measurements, Option series 01 provides additional delay in batches of 100 points, up to a maximum of 900 points. This pre-computational delay gives an effective resolution of 1 point in 1000 over a selected portion of the display.

The major axis of the display is scaled five points to each centimeter and is calibrated in time per millimeter: this applies to all displays other than probability, for which the horizontal axis is calibrated in volts per centimeter. (Note that for correlation functions the horizontal axis represents time *shift* between input signals rather than real time.) The time per millimeter can be switched from 1 μ s to 1 second; other, intermediate, sweep rates may be obtained using an external timebase (the time/mm can be increased without limit).

Being a digital instrument, the Correlator is easily interfaced with a computer: Option 020 provides interface hardware for reading out displayed data in 16 bit parallel binary form to any computer in the Hewlett-Packard range. Analog outputs are provided, as standard features, for both X-Y recorder and external oscilloscope.

Digital Averaging

Correlation, signal recovery and probability measurements are all processes in which the end result is the average of many samples. In the Model 3721A Correlator averaging is performed by two methods: SUMMATION and EXPONENTIAL, one or the other being selected by a front panel switch. In the summation mode, the computed function is averaged by summing N samples and then dividing the total by N : N is selectable (front panel control) from 2^7 to 2^{17} . Summation averaging anticipates the number of samples contributing to the computed function's final value, and is therefore a process of pre-established length: it is particularly useful for the analysis of a limited quantity of data.

The second averaging mode, exponential averaging, is a continuous filtering process which forgets old information and thus follows changing phenomena. If A_{p-1} is the current value of the running average and a new sample I_p arrives, the new average would be $A_p = A_{p-1} + (I_p - A_{p-1})/N$, where N is a number selectable from 2^7 to 2^{17} in binary steps. This running average algorithm is the digital equivalent of an RC smoothing filter, but with greater stability and flexibility. *Stable* because it is not subject to the drift normally associated with long time constant analog circuits, and *flexible* because changing of the time constant entails not a change of physical components, but a changed divisor, N , in the averaging algorithm. Digital averaging has the

added advantage that it makes possible very long time constants, and hence low frequency analysis, without physically large components.

The easily variable time constant is used with great effect to provide a *quick-look* facility. A long averaging time constant, essential for accurate statistical measurements, normally means a long wait before the computed function

arrives at its final value . . . and hence the possibility of an abortive experiment being discovered only after a lengthy time interval. The quick-look facility in the 3721A, however, gives an immediate approximation to the final value, regardless of the length of time constant selected; and the approximation is progressively refined as the experiment proceeds.

Specifications

Input Characteristics

Two separate input channels, A and B, with identical amplifiers.

Bandwidth: dc to 250 kHz nominal. Lower cut-off frequency selectable, dc or 1 Hz.

Input range: accepts signals from 40 mV rms to 4 V rms over six ranges.

Analog-to-digital conversion: fine quantizer; 7 bits. Coarse quantizer (feeds delayed channel); 3 bits. Coarse quantizer linearized by internally-generated wideband noise (dither).

Overload: maximum permissible voltage at input; dc coupled 120 V peak, ac coupled 400 V = dc + peak ac.

Input impedance: nominally 100 pF to ground, shunted by 1 M Ω .

Correlation Mode

Computes the following functions:

Autocorrelation of A input.

Autocorrelation of B input.

Crosscorrelation of A and B inputs, A delayed.

Crosscorrelation of A and B inputs, B delayed.

Simultaneous computation and display of 100 values of auto or crosscorrelation function. Display sensitivity indicated directly in V²/cm on illuminated panel. Non-destructive readout; computed function can be displayed for an unlimited period without deterioration. (Non-permanent storage; data cleared on switch-off.)

Timescale: (time/mm = delay increment Δt) 1 μ s to 1 second (total delay span 100 μ s to 100 seconds) in 1, 3.33, 10 sequence, plus external clock; minimum increment 1 μ s (1 MHz), no upper limit.

Delay offset: option series 01 provides delay offset (precomputation delay) facility. Without offset, first point on display represents zero delay; with offset, delay represented by first point is selectable from 100 Δt to 900 Δt in multiples of 100 Δt .

Display sensitivity: 5 x 10⁻⁴ V²/cm to 5 V²/cm. Calibration automatically displayed by illuminated panel.

Vertical resolution: depends on display sensitivity. Minimum resolution is 25 levels/cm. Interpolation facility connects points on display.

Averaging: two modes are provided: Summation (true averaging) and Exponential.

1. Summation Mode

Computation automatically stopped after N process cycles, at which time each point on the display represents the average of N products. N is selectable from 128 to 128 x 1024 (2⁷ to 2¹⁷ in binary steps). Display calibration automatically normalized for all values of N. Summation time indicated by illuminated panel.

2. Exponential Mode

Digital equivalent of RC averaging, with time constant selectable from 36 ms to over 10⁷ seconds. Approximate time constant indicated by illuminated panel. Display correctly calibrated at all times during the averaging process.

Signal Recovery Mode (Channel B Only)

Detects coherence in repeated events, when each event is marked by a synchronizing pulse. After each sync pulse, a series of 100 samples of channel B input is taken, and corresponding samples from each series are averaged. The 100 averaged samples are displayed simultaneously. Display sensitivity is indicated directly in V/cm on illuminated panel.

Synchronization: an averaging sweep is initiated either by a pulse (TRIGGER) from an external source (EXT) or, in internally triggered mode (INT), by a pulse derived from the internal clock. In the INT mode, the start of each sweep is marked by an output pulse (STIMULUS) used to synchronize some external event.

Trigger input: ac coupled. Averaging sweep initiated by negative-going edge; minimum swing 5 volts, maximum 12 volts; maximum fall time 2 μ s; minimum pulse width 0.5 μ s; maximum dc voltage 200 volts.

Stimulus output: negative-going pulse at start of averaging sweep, +12 V to 0 V, duration >0.5 μ s; interval between stimulus output pulses equals 100 x time/mm, plus up to 270 μ s.

Timescale: (time/mm = interval between samples) 1 μ s to 1 second (total display width 100 μ s to 100 seconds) in 1, 3.33, 10 sequence with internal clock. Other intervals (hence other display widths) with external clock; minimum interval 1 μ s (1 MHz), no upper limit.

Display sensitivity: 50 μ V/cm to 1 V/cm. Calibration automatically displayed by illuminated panel.

Vertical resolution: depends on display sensitivity. Minimum resolution is 25 levels/cm. Interpolation facility connects points on display.

Averaging: two modes are provided: Summation (true averaging) and Exponential.

1. Summation Mode

Process automatically stopped after N averaging sweeps, at which time each point on the display represents the average of N samples of the input, taken at a particular displacement from the sync pulse. N is selectable from 128 to 128 x 1024 (2⁷ to 2¹⁷ in binary steps). Summation time indicated by illuminated panel.

2. Exponential Mode

Digital equivalent of RC averaging, with time constant selectable from 36 ms to over 10⁷ seconds. Approximate time constant indicated by illuminated panel.

Probability Mode (Channel A Only)

Displays either (1) amplitude probability density function (pdf) or (2) integral of the pdf of channel A input. Signal amplitude represented by horizontal displacement on display, with zero volts at center; vertical displacement represents amplitude probability.

Display sensitivity: horizontal sensitivity 0.05 V/cm to 2 V/cm in 5, 10, 20 sequence.

Horizontal resolution: 100 discrete levels in 10 cm wide display = 10 levels/cm.

CORRELATOR *continued***Four instruments in one
Model 3721A**

Vertical resolution: 256 discrete levels in 8 cm high display = 32 levels/cm.

Vertical scaling: depends on averaging method used (summation or exponential).

1. Summation Averaging

Process automatically stopped by the first point to reach 8 cm displacement from the baseline. In the pdf mode, 8 cm vertical displacement represents approximately N occurrences of a particular signal level, N being selectable from 128 to 131,072 (2^7 to 2^{17} in binary steps). Area under pdf curve may be obtained by counting cycles of process clock.

2. Exponential Averaging

Continuous updating of display, with time constant as given for correlation and signal recovery mode.

Sampling rate: 1 Hz to 3 kHz in 1, 3, 10 sequence with internal clock. Other sampling rates with external clock; maximum frequency 3 kHz, no lower frequency limit.

Interfacing

X-Y recorder: separate analog outputs corresponding to horizontal and vertical co-ordinates of the CRT display.

X drive: nominal 12.5 V staircase, 270 ms dwell per step. Alternative dwell 1.35 seconds.

Y drive: nominal 1.25 V for each centimeter deflection on 3721A CRT display.

Pen control: 2 modes controlled by toggle switch on rear panel.

- a. Pen lowered for entire sweep.
- b. Pen plots series of 100 points per sweep.

Pen lift signal: short-circuit to ground for pen down. Maximum sink current 150 mA. In the pen-up condition, voltage from recorder must not exceed +40 V.

Recorder calibration: ZERO on DISPLAY/CAL switch puts pen to center of paper. CAL puts pen to lower left. Depressing the RECORD pushbutton gives a single sweep output to the X-Y recorder.

Oscilloscope: separate analog outputs corresponding to the horizontal and vertical co-ordinates of the CRT display.

Noise Generator Model 3722A: control of the Correlator from the Model 3722A Noise Generator. The gate signal from the 3722A is used to set the Correlator into RUN state. On termination of the gate signal, Correlator will go into HOLD state.

Gate Signal 3722A*: +1.5 V when gate open sets Correlator into RUN state; on rising to +12.5 V (gate closed), sets Correlator into HOLD state.

Digital computer: Option 020 provides interface hardware (buffer card) for reading out displayed data to any Hewlett-Packard digital computer.

Data output*: signals containing VERTICAL ordinate information transmitted to the computer. The 100 displayed points are scanned in sequence on command from the computer. Each point is represented by 16 bits parallel binary information comprising 10 bits amplitude data, 2 bits sign, 2 bits range factor, and 2 bits command information, one denoting instrument in HOLD state and the other "time constant reached" condition. Ordinates are presented, to the computer, for a period of approximately 130 μ s and a *data ready* signal marks the changeover from one to the next. The data ready signal can be used to initiate a computer interrupt.

Computer commands*

Run: signal from computer which sets Correlator into RUN state.

Hold: signal from computer which sets Correlator into HOLD state.

Reset: signal from computer which sets Correlator into RESET state.

Data: signal from computer which commands Correlator to output a series of 100 data words, if Correlator is in HOLD state.

Clock*

Internal clock: all timing signals derived from crystal-controlled oscillator: stability 40 ppm over specified ambient temperature range. Internal clock output: train of negative-going pulses, +12 V to 0 V, >0.5 μ s wide, period as indicated by TIMESCALE switch.

External clock: maximum frequency 1 MHz. Negative-going level change, minimum transition +5.5 V to +2.8 V, initiates clock pulse. Minimum dwell at lower level 0.5 μ s. Maximum permissible levels +13.5 V to -8 V.

Process clock: 135 μ s wide negative-going pulse. Normally 0 V, rises to +12 V at start of each process cycle and returns to 0 V after 135 μ s.

Remote Control and Indication*

Control: remote control inputs for RUN, HOLD and RESET functions are connected to DATA INTERFACE socket on rear panel. Command represented by negative-going level change, minimum transition +5.5 V to +2.8 V. Minimum dwell at lower level 1.5 μ s. Maximum permissible levels +13.5 V to -8 V.

Indication: remote indication of Correlator RUN, HOLD or RESET states is available at the DATA INTERFACE socket on rear panel. A condition will be indicated as true when signal is at 0 V.

Display

Mono-accelerator tube, 3 kV accelerating potential; aluminum P31 phosphor; etched safety glass faceplate reduces glare, 8 x 10 cm parallax-free internal graticule marked in cm squares, 2 mm sub-divisions on major axes.

General

Ambient temperature range: 0° to 50°C.

Power: 115 or 230 V \pm 10%, 50 to 400 Hz, 150 W.

Dimensions: 16 $\frac{3}{4}$ " wide, 10 $\frac{3}{4}$ " high, 18 $\frac{3}{4}$ " deep overall (426 x 272 x 476 mm).

Weight: 45 lb (20.5 kg) net.

Accessories furnished: detachable power cord, rack mounting kit, trimming tool, circuit extender boards (2 supplied), special-purpose coax extender lead, 50-contact male cable plug.

Price: Model 3721A \$8300 (\$7600 at factory in Scotland).

Options

Delay offset: option series 01. Full details to be announced.

Data interface: option series 02. Option 020 Correlator with interface for data output to computer.

*** Denotes signals specified as follows:**

Correlator output signals

TRUE or low state -1 V to +1.5 V, sinking up to 12 mA.
FALSE or high state +12 V, output impedance 12 k Ω .

Correlator input signals

TRUE or low state -1 V to +2.8 V.

FALSE or high state +5.5 V to 12 V.

TRANSISTOR NOISE ANALYSIS



SIGNAL ANALYZERS

Transistor noise is a complex, randomly varying signal generated within bipolar and field-effect transistors. Known noise sources for bipolar transistors are thermal noise generated in the emitter-base diode and base resistance, shot noise at the junctions and partition noise in the base region. Although field-effect devices are not as clearly understood as bipolars, they are noted for considerable "excess noise" particularly at low frequencies. This excess noise is referred to as "1/f" noise.

The actual noise performance of a transistor in a practical circuit will depend on the noise generated within the device itself and the noise contributed by the effective source resistance at the transistor input. This overall noise performance can be described in terms of Noise Figure (NF). NF expresses the increase in noise (over that due to source resistance only) added by the transistor, and is expressed in decibels. Zero dB is defined as the level of source resistance thermal noise. The noise contribution of the transistor itself is of much greater interest. This contribution is described in terms of two noise generators " e_n " and " i_n ".

e_n , a "noise voltage" generator and i_n , a "noise current" generator are fictitious sources which if connected to the input of a noiseless, ideal transistor would give the same overall noise performance as a given actual transistor. (See Figure 1.)

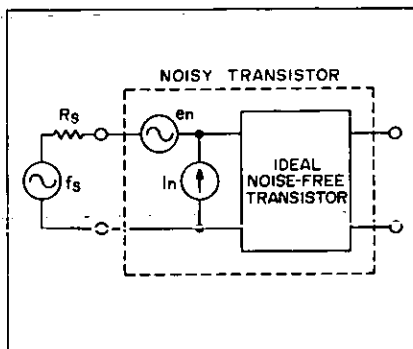


Figure 1. Transistor Noise Model

Knowledge of e_n and i_n can be used to completely characterize the noise performance of any transistor, including prediction of Noise Figure for any value of source resistance, and optimum selection of bias and gain parameters for best low-noise performance. Figure 2 illustrates the approximate theoretical variation of the e_n , i_n amplitudes as a function of emitter current in bipolar devices.

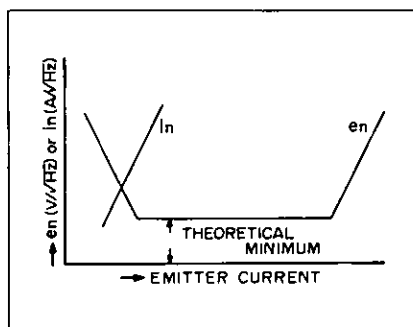


Figure 2. Theoretical Variation Of e_n, i_n

Measurement of e_n and i_n requires very stringent transistor input circuit impedances—a short circuit for e_n and

an open circuit for i_n . Applying bias control, variable-frequency input signals and gain control under these conditions in a measuring instrument designed to provide NF, e_n and i_n is one of the benefits of the HP 4470A Transistor Noise Analyzer.

The Model 4470A makes all three measurements under a wide variety of transistor test conditions. Since noise is primarily determined by current and frequency, a wide range of these two parameters is provided. A variable voltage source, independent of current is also built in. For Noise Figure testing, an array of common source resistance values are internally selectable, with other values applicable externally in a special guarded holder.

Measurements may be made in both FETs and bipolar devices, of either polarity and in six different transistor lead configurations. Use of the analyzer is further simplified through the addition of automatic range, scale and multiplier indicators.

The diagram in figure 3 illustrates the fundamentals of Transistor Noise Analysis, as accomplished by the 4470A. Pilot signals are applied to the device under test through the appropriate input network. Biasing is controlled as a function of device gain and the selected collector/drain current and voltage values. The combined noise and pilot signal is separated by the noise detection system using zero-beat mixing. Gain control is established at the input by monitoring the pilot signal level after noise detection. After the separation process, the noise signal is converted to dc and passed directly to the display circuits.

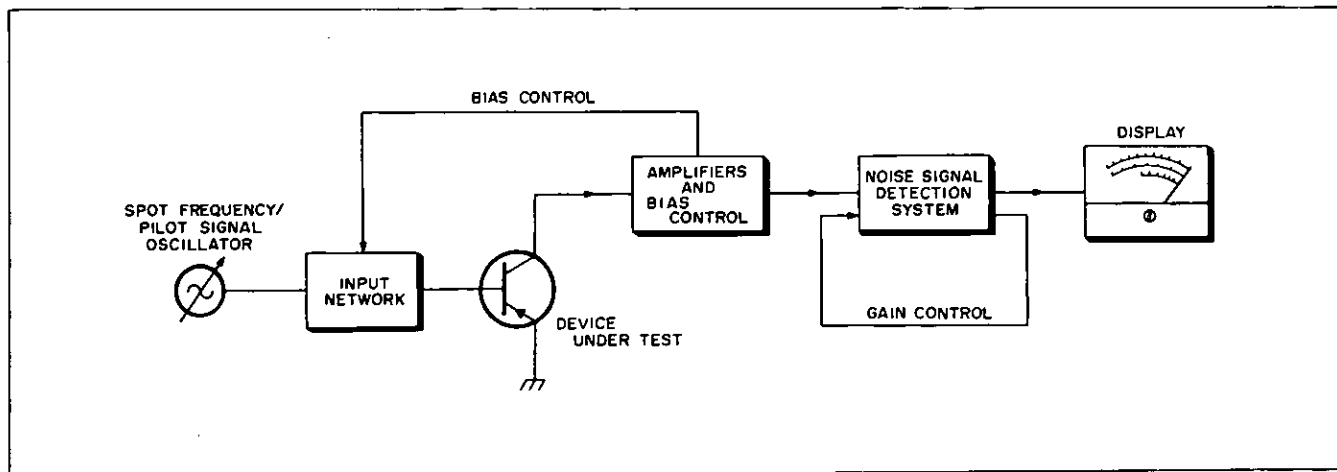


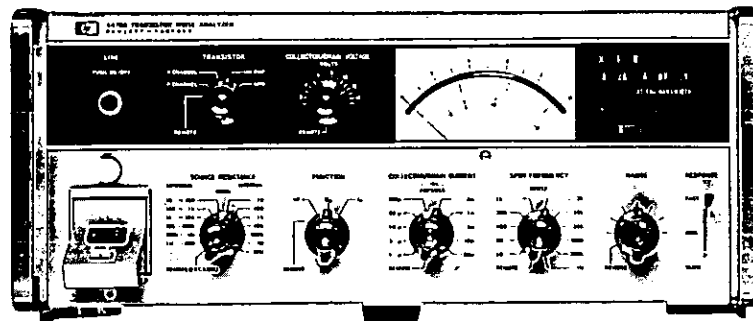
Figure 3. 4470A Basic Block Diagram



NOISE ANALYZER

Complete analysis of transistor noise
Model 4470A

4470A



Transistor Noise Analyzer HP Model 4470A

Complete transistor noise performance, of greatest interest to circuit designers and transistor developers, until recently has been measurable only through the application of complex, time-consuming laboratory test set-ups. Some instrumentation has provided Noise Figure or noise voltage information directly. The 4470A now makes available a wide range of transistor noise evaluation measurements in a single instrument. Providing narrow-band data at 11 frequencies from 10 Hz to 1 MHz, the 4470A measures Noise Figure (NF), noise voltage (e_n) and noise current (i_n). Complete flexibility is provided for the measurement of all three functions including application to both bipolar and field-effect transistors, a wide range of current control, and internal source resistances. Provision is made for the use of external source resistors where specific values are not included internally. Bias values of interest (base/gate voltage, collector/drain current, collector/drain voltage) may be monitored at rear-panel outputs. Programming for remote control of complex or sequential testing is provided, contact closures or analog resistance control being used to switch functions and to control settings from the rear panel. A recorder output is built-in, giving an output voltage proportional to meter deflection. Readings are simplified through automatically illuminating function and meter scale indicators.

Noise parameters measured

Voltage noise: (e_n) referred to the input of the transistor under test, in bipolar and field-effect transistors.

Current noise: (i_n) referred to input of transistor under test, in bipolar transistors.

Spot noise figure: (NF) for both bipolar and field-effect transistors.

Spot frequencies: 10 Hz, 30 Hz, 100 Hz, 300 Hz, 1 kHz, 3 kHz, 10 kHz, 30 kHz, 100 kHz, 300 kHz, and 1 MHz.

Response: determined by 4 Hz noise bandwidth used in noise-signal extraction and selectable averaging times. (Fast, Medium and Slow.)

Collector/drain power supplies: collector/drain currents of 1, 3, 10, 30, 100 μ A, .3, 1, 3, 10 and 30 mA are provided; vernier provides continuous adjustment between these values; current monitoring output on rear panel.

Collector/drain voltages of 0 to 15 V dc, continuously variable at front-panel, monitored at rear-panel jack. Both supplies are independently controlled, changes in one supply will not affect the other. Current control is derived from base/gate control. Current supply seeks desired setting irrespective of type of FET tested. (i.e. MOSFET etc.)

Accuracies

Collector/drain voltage: $\pm 3\%$ at monitor jack; $\pm 10\%$ at front panel.

Collector/drain current: $\pm 3\%$ at monitor jack; $\pm 3\%$ at calibrated front panel settings.

Spot frequency: $\pm 2\%$.

Noise bandwidth: $\pm 3\%$.

Total measurement accuracy: determined by above plus accuracy of internal circuitry plus averaging of meter or analog output. Better than ± 1 dB.

Transistor types: bipolar NPN and PNP, P-channel or N-channel FET noise may be analyzed.

Source resistance

Internal: values provided for use when measuring Noise Figure are 10, 100, 1K, 10K, 100K and 1M. Other values from 10 to 10M may be applied at EXT RES holder on front panel.

Remote programming: seven front-panel functions may be remotely controlled by external contact closure between pins of rear-panel connectors. Programmable functions are FUNCTION, FREQUENCY, CURRENT, VOLTAGE, METER RANGE, SOURCE RESISTANCE, TRANSISTOR. (Pilot signal level, collector/drain current vernier are programmable by external resistance.)

Transistor socket configurations: six modular sockets provided have the following lead configurations:

2	3	3	2	4	2	2	4	3	4	4	3
1	4	1	4	1	3	1	3	1	2	1	2

Where 1-ground, 2-base or gate, 3-collector or drain, and 4-emitter or source.

Power required: 115/230 V ac, $\pm 10\%$, 50 or 60 Hz, 60 W.
Weight: 32 lb (14,5 kg).

Accessories provided: power cord, external resistor holder, (fitted with typical resistor), six modular sockets.

Price: \$4450.

FAULT LOCATORS/ ULTRASONIC DETECTORS

Locate buried shorts, grounds - 4900 Series



FAULT ANALYZERS

Special ordering information

U.S.A. Customers: The Delcon Division products listed on this page are sold directly to the customer from the manufacturing division. Please direct all orders and inquiries to:

DELCON DIVISION
333 Logue Avenue
Mountain View, California 94040
Telephone (415) 969-0880

Customers Outside the U.S.A.: Orders should be directed to your local Hewlett-Packard distributor or representative.

Cable Fault Locators Model 4904A

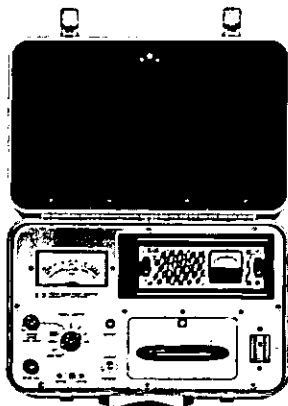
Pulsed tone system for locating shorts, crosses and grounds in direct buried, underground (ducted) and aerial utilities cable. Also, accurately locate path and determine depth of buried cables and pipes. Sensitive narrow bandwidth receiver rejects ac hum and permits locating high resistance faults. Tone transmitter unit also has built-in ohmmeter for analyzing faults. Complete with transmitter, receiver, search wand, cables and ground rod. \$995.

Model 4901A

Similar to Model 4904A except limited to locating path, depth and low resistance faults. Built-in ohmmeter. \$765.

Model 4900A

Identical to Model 4901A except without ohmmeter. \$655.

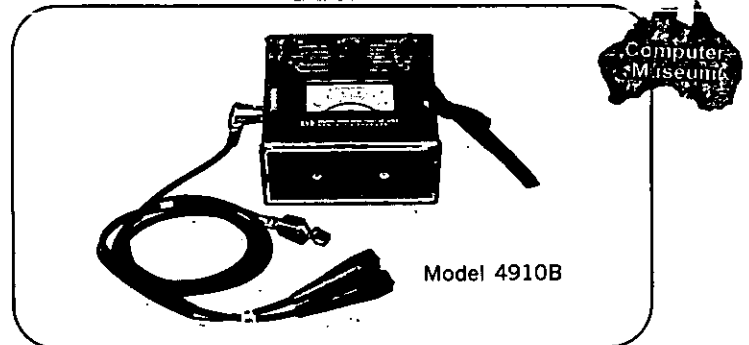


Model 4904A

Model 4910B

Locates opens in telephone exchange cable, coaxial cable and other cable types having constant mutual capacitance. Reads distance to fault directly in feet* by sampling mutual capacitance. \$635.

*Metric calibration available on special order.



Model 4910B

Ultrasonic Translator Detectors Model 4905A

Locates leaks in pressurized communication cable and other pressure and vacuum vessels by detecting release of ultrasonic energy. Also detects friction in moving machinery and electrical corona. Special accessory for detecting leaks in cable ducts available. Self-contained speaker and logging meter. Provision for headphones (not included). \$595.

Model 4916A

Identical to Model 4905A, except without speaker and meter. Includes headphones. \$525.

Model 4917A

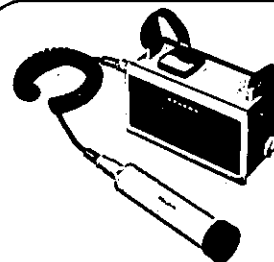
Identical to Model 4905A, except without speaker. Includes headphones. \$575.

Model 4918A

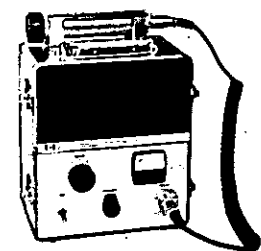
Industrial Ultrasonic Translator Detector. Listed under Re-examination Service of Underwriters Laboratories, Inc. as intrinsically safe for use in hazardous locations, Class I, Group D. \$850.

Model 4950A

Embodies special alarm circuitry to actuate relay whenever ultrasonic intensity exceeds preset limits. Can be used on bench or rack mounted. Self contained speaker and level meter; oscilloscope and recorder output jacks. AC powered. \$1475.



Model 4905A

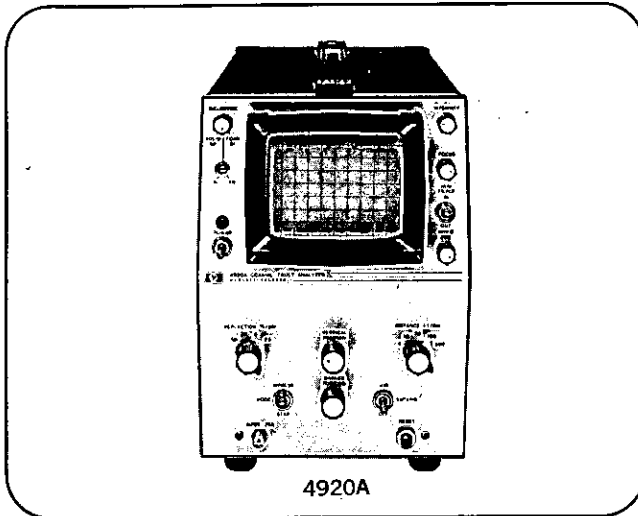


Model 4918A



COAXIAL FAULT ANALYZER

Line or battery power + automatic input protection
Model 4920A



General

Basically, Time Domain Reflectometry is nothing more than a "closed-circuit" radar system with the capability of locating and analyzing faults in a coaxial cable system. In TDR measurements a pulse is sent down a cable and it and any reflections are then observed on a cathode-ray tube. The resulting waveform corresponds to an "electrical x-ray" of the cable quick, accurate, repeatable, and indisputable all money-saving prerequisites in cable maintenance.

Description

The HP 4920A COAXIAL FAULT ANALYZER is a light-weight (24 lbs) portable instrument that combines basic TDR principles with easy-to-operate controls and an easy-to-interpret display. The Fault Analyzer is specifically designed to locate both resistive and reactive faults in 75-ohm coaxial cables up to 5000 feet in length. Operation of the 4920A is simple, fast, and reliable. Technicians, craftsmen, and even those personnel with minimum experience will have no trouble using the instrument, because it puts the TDR technology behind the front panel and only the results up front.

Automatic input protection

A reed relay and voltage detector are part of the input circuitry; the relay contacts are in series with the input transmission line. The voltage detector continuously monitors the cable under test and if the input level exceeds 5 volts, the relay contacts open within 100 microseconds. A red panel lamp lights when the contacts open and, once the over-voltage is removed, input continuity can be restored at the press of a button. Another useful feature is the hum filter which immunizes the instrument against the degrading effects of 60-cycle pickup.

Step/impulse mode

For the greatest flexibility in locating and analyzing complex faults, the incident energy can be selected as a step or impulse function. Both operating modes cover the VHF bandwidth and both provide one or more unique features. The step function is traditionally used in a TDR display. In this mode, impedance measurements can readily be made in terms of the reflection coefficient; the coefficient is easily obtained from the display graticule. In the impulse mode, low frequency information is attenuated; thus, the cable system can be evaluated, even in the presence of capacitive coupling or transformer-coupled taps. Calculation of relative line loss is also easier and quicker in the impulse mode.

Calibrated expansion

Any one-tenth part of the basic 10 cm trace can be selected by a fixed-width marker and expanded to a full-screen display. The marker-and-expansion capability provides the resolution required to examine input/output connectors of in-line components or other cable hardware with close physical spacing.

Dielectric selection

The 4920A is calibrated to measure cables with either foam or solid-polyethylene dielectric; selection is made by a front-panel switch. A variable control, also on the front-panel, permits quick calibration to cables with other velocity constants, such as air-disc, or future cable types. A short length of test cable can be used for precise calibration to any velocity constant between 0.6 and 1.0.

Performance data

Vertical (% reflection) scale

Calibrated to indicate percentage of incident pulse reflected back to input. Four sensitivity ranges 50%/DIV, 25%/DIV, 5%/DIV, and 2.5%/DIV. Faults that reflect as little as 0.5% of the input incident energy can be resolved over the effective VHF bandwidth; vertical accuracy is better than 5%. Instrument is calibrated for 75-ohm cable systems. Built-in hum filter has nominally 40 dB rejection at 60 Hz.

Horizontal (distance) scale

Calibrated to indicate distance to impedance discontinuity in feet. Five distance ranges: 5 Ft/DIV, 10 Ft/DIV, 50 Ft/DIV, 100 Ft/DIV, and 500 Ft/DIV. Maximum range 5000 Ft. Distances can be resolved to within 2% of full screen and distance accuracy is better than 5%. Instrument is calibrated to propagation velocities of cables with solid ($V_c = .66$) and foam ($V_c = .81$) dielectrics. Velocity constant can also be calibrated to other types of cable with panel adjustment ($V_c = .6$ to 1.0). Marker window permits x10 expansion of any centimeter wide portion of trace.

Display

Display is on cathode-ray tube with P31 phosphor, having a natural persistence of approximately 0.1 second. 8 x 10 centimeter graticule is divided into five subdivisions per major division on horizontal and vertical axes. Graticule permanently etched into CRT screen to prevent parallax errors.

General

Connector: type F (other types available on special order).

Automatic input protection: nominally 5 V required to open the input circuit; component damage may occur if input exceeds 60-volts.

Operating temperature range: 0°C to 55°C (32°F to 131°F).

Power requirements:

AC—115 or 230 Vac ($\pm 10\%$ in each case); 47 to 440 Hz; approximately 66 watts.

DC—11 to 15 Vdc; 6.3 A at 12 V; nominally 76 watts.

Dimensions: 11" high; 8-5/16" wide; 18 1/4" deep (279,4 x 210,8 x 463,6 mm).

Weight: net 24 lbs (10,9 kg); shipping 33 lbs (15,0 kg).

Price: \$1825.

Accessories furnished: 10169A Front Cover; 10179A Contrast Filter.

Accessories available: 10176A Viewing Hood, \$7.

Complimentary equipment available: 197A Oscilloscope Camera, \$540.



The telegraph was the first method of electrical communication. In 1844 the first message was sent over a circuit; shortly after this, the telephone was invented. Since then, electrical communications have been changed to electronic communications. Hewlett-Packard has designed equipment specifically for testing communication systems. The following information pertains only to test equipment designed to simplify and expedite communications service.

These objectives have been accomplished several ways: 1) One instrument, or combination of instruments in one carrying case, will perform the duties of several previous instruments. 2) One function may be transferred to another by merely changing a switch position. 3) Battery-operated test equipment permits operation in the field. 4) A number of standard Western Electric terminals connected in parallel permit connection to different types of line equipment.

Generally, in the United States subscribers' loops are of nominal 900-ohm impedance. 600 ohms is an accepted trunk and tollboard impedance and is found in the many miles of open-wire carrier still in use. The CCITT* does not recognize 900 ohms as a subscriber-loop impedance but recommends 600 ohms. Wire-cable carrier, typically short-haul, uses 135-ohm cable. Many higher capacity systems use 135 ohms as an interface impedance on a group or super-group basis. The CCITT equivalent of this impedance is 150 ohms. Long-haul coaxial-cable carrier systems use 75 ohms in the United States and in the CCITT recommended systems.

Since a holding function is desirable in many measurements, a holding coil is provided which may be switched into the circuit on voice measurements. This provides an off-hook condition to hold the dialed line.

Connections are provided for attaching a lineman's handset for dialing. Once the connection has been established, the test instrument may be switched to Hold. This will maintain the dialed connection but will remove the talking function and substitute the measuring circuit. The input and output jacks accept standard 241, 289, 309, 310 and 347 Western Electric plugs, as well as the special connectors to receive the lineman's handset and dual banana binding posts for attaching wires.

The theory of message-circuit noise measurement is based on a relative inter-

fering effect of the noise on the subscriber's hearing. Because of the frequency response of the telephone subset and the fact that the human ear responds differently to noise of various frequencies, a weighting function is assigned to each frequency in proportion to its contribution to the interfering effect.

The weighting curve currently accepted as a U.S. standard is the Bell System C-Message weighting (see Figure 1). The unit used to define noise measured in this manner is dBRNC, meaning decibels above Reference Noise, C-Message weighted. Reference noise is -90 dBm at 1 kHz. The CCITT recommendation is psophometric weighting, which has a slightly different curve and is referenced to 800 Hz. The measuring units for this weighting are picowatts psophometric, or pWp. A flat weighting refers to the broadband or flat voltmeter function, and a 3 kHz flat weighting provides for

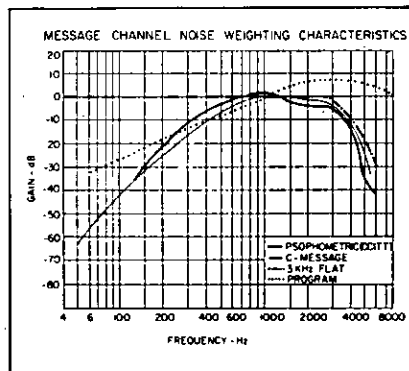


Figure 1. Noise weighting curves.

weighting over the range of voice frequencies only. Radio and television studio-transmitter and studio-remote audio links require a different weighting known as program weighting because of the different sending and receiving equipment characteristics. This program weighting curve is also shown in Figure 1.

Since noise measuring sets are designed to duplicate the response of the ear, the dynamic response time and the law of combination of tones should be the same. This requires a 200 ms meter-response time and rms response. Average-responding meters will read 1.05 dB low compared to an rms meter on Gaussian noise (providing no overload occurs on the peaks).

The CCITT recommendation specifies rms response for noise measurements and calls out a method for testing meters for rms response.

In addition to the quantitative measurement of noise, it is important to identify

the source of the noise. Some indication of this can be obtained by noting the difference in noise on the 3 kHz flat and the C-Message weighting functions. A substantially higher reading in the 3 kHz flat mode usually indicates excessive power-line noise. Aural monitoring of the noise using a headphone is also used.

The noise meter should also be a level meter, as these two measurements are most frequently made. Since field use accounts for a major part of the service of such a device, portability and battery operation are essential. Rugged case construction able to withstand the rigors of outside operation is desired. Monitor and recorder outputs for aural monitoring and long-term recording of noise and level should be provided along with a damping switch to lengthen the integrating time constant of the meter for rapidly fluctuating noise.

The Hewlett-Packard Transmission and Noise Measuring Set incorporates these important features.

3555B Transmission and Noise Measuring Set

The HP Model 3555B Transmission and Noise Measuring Set combines the functions of a broadband level meter and a message-circuit noise meter. As a broadband rms-level meter, it covers a frequency range of 20 Hz to 3 MHz with a maximum sensitivity of 0 dBm and -90 dBm. It is fully balanced with impedances of 75 ohms unbalanced, 135 or 150, 600, and 900 ohms balanced, both bridging and terminated (Figure 2). The balanced input impedances are accomplished by a high impedance repeat coil. This technique gives impedances of over 100 k Ω bridging with less than 0.05 dB bridging loss. Provisions are made for dial-through and hold.

As a noise-measuring set, the 3555B contains filters which perform the C-Message, 3 kHz Flat, 15 kHz Flat and Program weighting functions. The meter circuit contains an rms detector which adds the noise voltages on a power basis. Indication of noise levels down to 0 dBm as well as noise-to-ground and noise-metallic measurements can easily be made. The amplifier output may be connected to a recorder for long-term noise records or will allow aural monitoring of the character of the noise.

This instrument in a rugged, portable carrying case features internal battery operation as well as CO battery or ac power. It operates reliably over a 0°F to +120°F temperature range at humidity

*Consultative Committee on International Telephone and Telegraph.

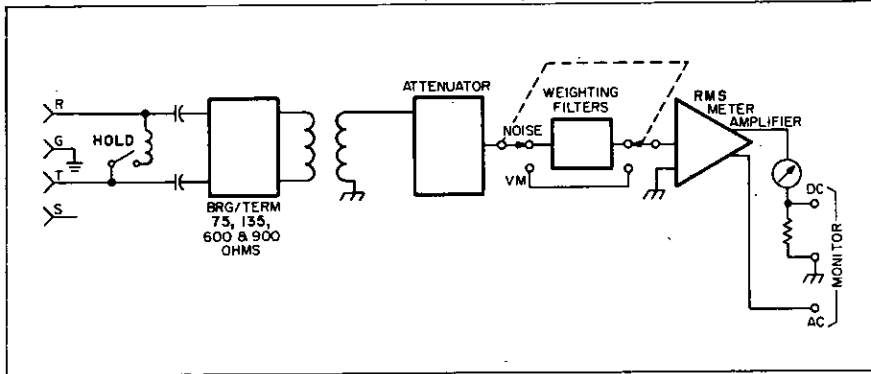


Figure 2. 3555B simplified block diagram.

ties up to 95% R.H. An interlock turns the power switch off when the cover is replaced.

Using the 3555B Transmission and Noise Measuring Set in conjunction with the HP 236A Telephone Test Oscillator makes a universal transmission test set that can be used for all types of telephone equipment.

236A Telephone Oscillator

The HP Model 236A Telephone Oscillator has all of the above-mentioned Western Electric connectors for dialing and output. It incorporates the holding function for 600 and 900-ohm impedances. It provides a 50 Hz to 20 kHz frequency range in the 600 and 900-ohm balanced output and a 5 kHz to 560 kHz frequency range on the 135-ohm balanced output. Its power source may be a 115/230 V $\pm 10\%$, 50 to 400 Hz external source, or a 45 V dry cell internal battery.

An interlock turns the power switch off when the cover is replaced. The oscillator's output level is adjustable from +10 to -31 dBm in 0.1 dB steps. The attenuator precedes the output transformer so the output impedance is not affected by the attenuation.

The HP 236A consists of an oscillator-amplifier, attenuator, power supply, meter circuit, and a selective output circuit. Figure 3 shows the block diagram of this instrument.

The oscillator-amplifier operates as a typical solid-state HP RC oscillator (refer to page 270 of the oscillator section of this catalog). The front-panel output calibrator adjustment controls the output

amplitude. Accurate metal film resistors are used to insure exact attenuations.

The output circuitry consists of a low- and a high-frequency output transformer, a holding coil, and parallel Western Electric output and dial connectors to insure a proper connection to any line equipment.

3550B Portable Test Set

The HP 3550B Portable Test Set was designed specifically for transmission-line testing and for such applications as alignment and maintenance of multi-channel communication systems. The test set consists of a wide-range oscillator, an electronic voltmeter and a patch panel containing attenuators and line-matching transformers. The instruments are operated from a rechargeable battery power source, making it usable in the field.

The heart of this test set is the 353A Patch Panel which adapts the oscillator and voltmeter to specific telephone usage. The patch panel has input and output sections acting as a source and receiver for the transmission line. The output section has an attenuator, and both sections have an impedance-matching device which matches the oscillator and voltmeter 600-ohm impedance to 135, 600 and 900 transmission-line impedances. The center-tapped transformers give balanced outputs and inputs with bridging or terminated capabilities. The accurate attenuator gives 110dB attenuation in 1dB steps.

The 204C option H20, option 002 Oscillator frequency is 5 Hz to 1.2 MHz in six ranges, and the 403B option 001 Voltmeter has ranges from 0.001 to 300

V full scale in 12 ranges. Thus, a complete telephone measuring set is contained in one portable package.

The 353A option H02 Patch Panel has special telephone jacks which will accommodate Western Electric 309 and 310 plugs. The Hold function is included along with a selectable 23 dB attenuation position.

The 353A option H03 Patch Panel will accommodate Western Electric 309, 310 and 241 plugs and a lineman's handset. The Hold function is included along with a 23 dB attenuator.

Analyzers

The 332A option H05 and 334A option H05 are standard HP Models 332A and 334A Distortion Analyzers modified for use in the broadcast industry. The front-panel voltmeter reading is in dBm, and a switchable low-pass 30 kHz filter is added.

312A/313A Selective Voltmeter

The low noise and wide dynamic range of the 312A Selective Voltmeter make it useful for many telephone applications including measurement of system flatness, analysis of distortion and intermodulation (cross-talk) in carrier systems, and measurement of noise levels. Input impedances of 50, 60, 75, 124, 135, 150, and 600 ohms or bridging, balanced or unbalanced, are selectable at the front panel. Amplitude response vs. frequency can be measured when using the Model 313A Tracking Oscillator. Semi-automatic plots of amplitude vs. frequency can be made using the Model 297A Sweep Drive and an X-Y recorder.

Noise on coaxial telephone lines restricts dynamic range, which often must be as high as 70 to 90 dB. The measurements are usually made with a selective voltmeter that has a 200 Hz window. This reading is normalized to that of a 3 kHz window, which covers the standard voice-channel width, adding a complicated correction factor to compensate for the difference in bandwidths, weighting factors, and rms response.

A selective voltmeter with a 3 kHz bandwidth would be better to measure noise. Until recently, the shape factor of the 3 kHz bandwidth was such that the carrier frequencies were only partially suppressed.

The HP 312A option 001 provides carrier system operators with a filter that allows channel noise measurements with a 3 kHz bandwidth. Two notches are superimposed 2 kHz away from the center frequency. Better carrier rejection is obtained, as can be seen in Figure 4. If the carrier frequency is known, the HP 312A option 001 need only be tuned to 2 kHz above or below the carrier frequency, and the carrier frequencies adjacent to the voice channel are attenuated 45 dB before they are detected.

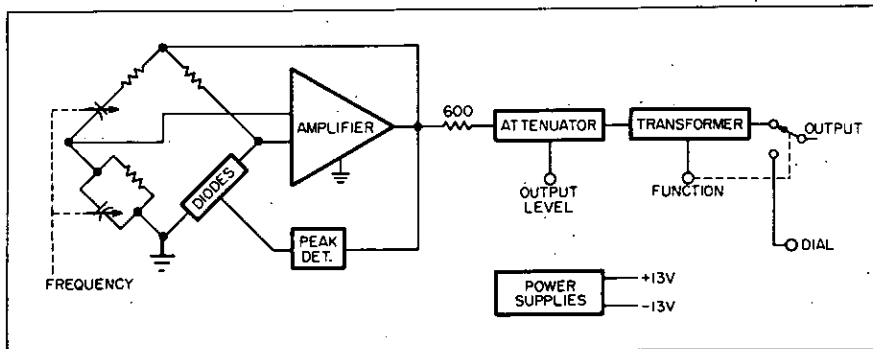


Figure 3. 236A block diagram.

The indication is a much truer representation of channel noise. Refer to pages 460 and 461 for additional information.

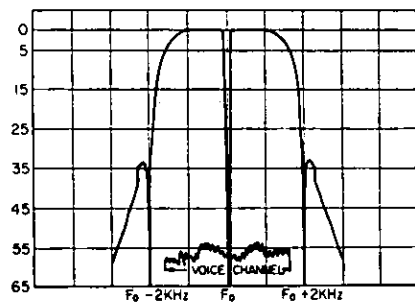


Figure 4. Bandpass for the 312A Selective Voltmeter.

3591A Selective Voltmeter

The HP 3591A Selective Voltmeter with a Sweeping Local Oscillator Plug-in is a modified 3590A Wave Analyzer that is specialized for communication testing.

The balanced input impedances are 75, 135, 150, 600 ohms, and 100 k-ohms bridging. The meter has an illuminated scale with high resolution.

The input functions selected by the function switch are: 1) "dBm," with levels calibrated in dBm for each of the selected input impedances. 2) "ABS VM," which is the absolute value calibrated in volts. 3) "Rel," which is relative values in 10 dB steps with an adjustable reference level for an arbitrary starting point for relative measurement. 4) "Cal," which gives a 100 kHz full scale calibration signal.

The outstanding dynamic range of this instrument is shown in Figure 5. For additional information refer to the 3590A technical pages 451 to 454, and for plug-in information, refer to page 457. The 3591A specifications are given on page 432.

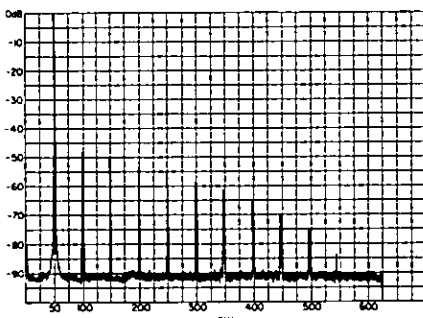


Figure 5. HP 3591A/3594A sweeps a signal showing the dynamic range of the instrument.

Alignment in Local Video Loops

Equalizer alignment in local video loops has typically been a complicated procedure requiring considerable time and effort on the part of the technician or craftsman. He has had to carry four bulky pieces of test equipment to the site,

interconnect them with seemingly endless patch cords, and then become a nimble-fingered wizard adjusting a myriad of controls to produce a flat video response. A frequency range of more than 5 decades is required to faithfully transmit television signals. This necessitates an impressive array of equipment to maintain the required response.

The classical test equipment used at the sending end for setting the receive equalizers consists of a Western Electric 61C Signal Generator supplying test frequencies from 300 kHz to 10 MHz and a Hewlett-Packard 200CD Oscillator for supplying the 300 kHz reference. For test frequencies below 300 kHz, the 200CD is used as the test frequency generator and the 61C supplies the reference. Since neither generator is capable of supplying accurate amplitude signals with a flat frequency response over the wide range required, a Western Electric 70B Power Meter is used to monitor the generator outputs. The 70B is a highly accurate thermocouple-type meter and consequently is subject to burnout or error when overloaded. Its time constant is slow, making rapid amplitude adjustments difficult. A Western Electric 1AP Comparing Set is used to switch between the test and reference frequencies and contains a power splitter arrangement to allow the 70B to monitor the power level simultaneously while transmitting the signal. The receiving level indicator is also a 70B Power Meter.

There are several sources of error to be considered in making these accurate measurements. Since the 70B Power Meter responds to the total power generated by the test oscillator, any oscillator distortion generated will also be measured. If the distortion is not constant, the total power indicated will vary. Near the high frequency end of the system response, the oscillator distortion products will fall outside the band resulting in an apparent change in total power. Impedance accuracy is important, as mismatches will cause part of the power to be reflected and consequently change the total level. Thus, the return loss of the test equipment, which is a measure of its impedance accuracy, must be high. Amplitude transients occurring when the test frequency is changed must be minimized to avoid damage to the thermocouple in the 70B Power Meter. The oscillator frequency must be accurate since the loss of the equalizers varies with frequency. Frequency inaccuracy would result in the equalizer being set improperly.

In some installations the 1AP Comparing Set and 70B Power Meter are replaced with a Western Electric 38A Transmission Measuring Set which automatically performs the switching and

comparing function. These 4 classical pieces of test equipment represent a cost of about \$5000, weigh 100 lbs., and are rather laborious to carry to remote sites as well as to operate.

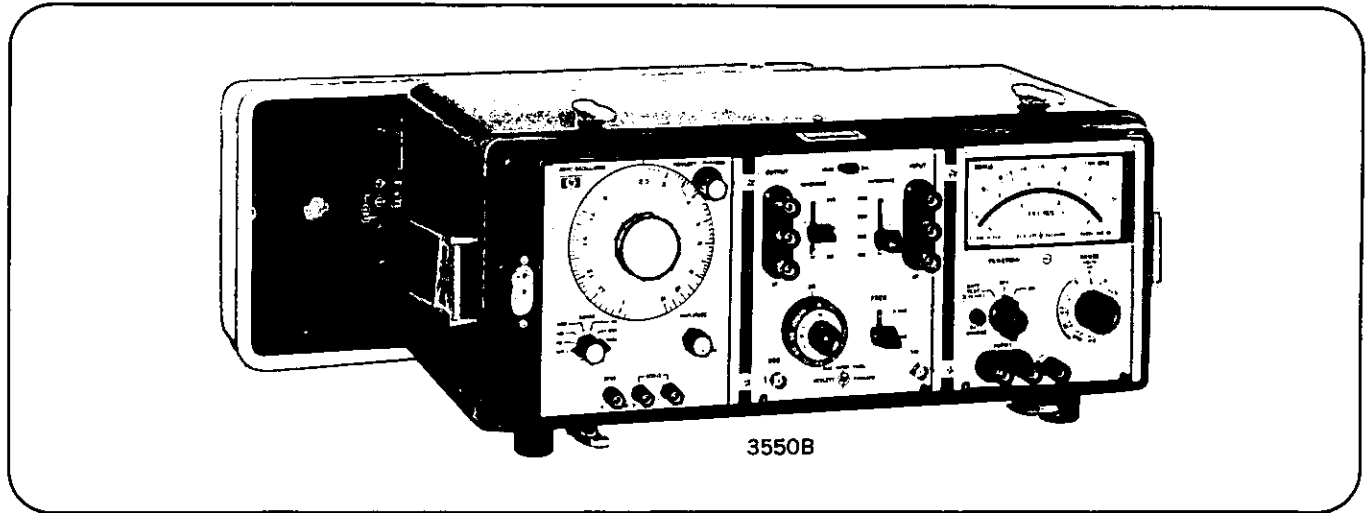
Hewlett-Packard has recently introduced the Model 653A Test Oscillator shown on page 435 which combines into one 21 lb. package costing \$990 all the functions previously requiring 4 test sets. The oscillator covers a test frequency range of 10 Hz to 10 MHz and contains a built-in 300 kHz reference oscillator. The output can be switched between the test and reference frequency at any time. The output circuitry supplies a balanced 124Ω or unbalanced 75Ω output flat to within ±0.05 dB over the entire 10 Hz to 10 MHz frequency range. An accurate 1 and 10 dB step attenuator together with an output meter capable of 0.02 dB resolution allows output levels from +10 dBV to -99 dBV to be accurately set. To avoid accidentally applying the +10 dBV power output causing possible damage to the system under test, a locking switch is used which must be purposely depressed and turned to the +10 dBV position.

The operation of the 653A is simple. The reference frequency is switched on and the system gain is adjusted. Then the switch is set to the test frequency position, and the equalizer frequency is set on a large, easy-to-read dial. Once the amplitude of the test frequency is adjusted to equal the reference level on the oscillator output meter, no further adjustments are necessary, since the oscillator is extremely flat over the entire range. The reference test switch is spring-loaded for momentary reference level checks or can be locked in the reference position. The indicating meter used at the receiving end is a 70B Power Meter.

The 653A is equipped with a front cover with carrying handle for protection of the panel controls and a rear cover providing storage space. For additional information refer to Application Note 114.

The 653A represents a modern test set for television system maintenance with unparalleled speed and accuracy. The broadcast technician can make rapid and accurate alignments with this inexpensive, lightweight, and portable piece of test equipment. Refer to page 435 for specifications. For theory of operation refer to the 654A description page 271. The 654A oscillator is similar to the 653A, omitting the 300 kHz reference oscillator and adding a different output circuit calibration in dBm for impedances of 50Ω, 75Ω unbalanced and 135Ω, 150Ω, and 600Ω balanced.

Other instruments which can be used in the communications industry are found in the oscillator and voltmeter sections of this catalog.


PORTABLE TEST SET
 Measures transmission line characteristics
 Model 3550B

Features

- Oscillator—battery or ac operated; 5 Hz to 1.2 MHz.
Amplitude variation within $\pm 0.5\%$ 100 Hz to 300 kHz; $\pm 1\%$ 5 Hz to 100 Hz and 300 kHz to 1.2 MHz.
- Voltmeter—battery or ac operated.
5 Hz to 2 MHz; reads in volts and dBm from -72 to $+52$ dBm.
- Patch Panel (353A)—Matches both oscillator and voltmeter to 135, 600, and 900 Ω systems; provides 110 dB attenuation in 10-dB and 1-dB steps.
(353A option H02 or H03) Holding coils provided.
23 dB Attenuator to conform to standard telephone levels of $+7$ and -16 dBm.
135, 600, 900 Ω Balanced Input and Output impedances.
Dial/Talk function switch for use in active telephone circuits.
Better than 60 dB balanced at 1 kHz for 600 ohm and 900 ohm impedances. Better than 40 dB balance over entire frequency range for 135, 600 and 900 ohms.
Measure-calibrate switch eliminates insertion loss.
Accepts standard telephone plugs.
Hand set may be used in conjunction with Patch Panel.

Uses

- Align and maintain multichannel communications systems.
- Align and maintain long distance and local telephone circuits, both wet and dry.
- Measure gain, attenuation, and frequency response.
- Measure amplifier characteristics without ground loops.
- Source of balanced μ V signals for testing differential amplifiers.

Description

The HP Model 3550B Portable Test Set is designed specifically to measure transmission line and system characteristics such as attenuation, frequency response, or gain. It is particularly useful for lineup and maintenance of multichannel communication systems. Model 3550B contains a wide range oscillator, a voltmeter, and a patch panel to match both the oscillator and the voltmeter to 135, 600, and 900 ohm lines. These instruments are mounted in a combining case which is

equipped with a splash-proof cover. In addition, the oscillator, voltmeter, and patch panel may be used separately whether they are in or removed from the combining case.

Both the oscillator and voltmeter are transistorized and operate from their internal rechargeable batteries or from the ac line. The batteries provide 40 hours of operation between charges and are recharged automatically during operation from the ac line.

Oscillator

The oscillator of the Portable Test Set is an HP Model 204C option H20 and has a frequency range of 5 Hz to 1.2 MHz. Its output is fully floating, isolated from the instrument case and powerline ground. Flat frequency response, excellent amplitude and frequency stability, and balanced output further enhance its ease of operation.

Voltmeter

The HP Model 403B-option 001 Voltmeter, which is part of the Model 3550B Portable Test Set, is a versatile general purpose voltmeter for measurements both in the laboratory and in the field. Its most sensitive range, 1 mV full scale, allows measurement of voltage as small as 100 μ V rms from 5 Hz to 2 MHz and a dB scale allows measurement in dBm from -72 dBm to $+52$ dBm. Accuracy is within 2% of full scale over a temperature range of 0°C to $+50$ °C for frequencies from 10 Hz to 1 MHz. The dB scale is placed at the top of the meter scale to provide increased resolution for dB measurements.

Patch Panel

HP Model 353A Patch Panel contains a precision attenuator, variable in 1-dB steps to 110 dB, and two sets of impedance matching transformers.

The calibrate position of the Meas-Cal switch connects the output of the oscillator to the voltmeter via the attenuator and both sets of transformers to calibrate out the insertion loss of the impedance matching transformers when making loop-back measurements. Insertion loss should be considered when making single-ended or straightaway measurements.

One set of transformers matches the oscillator to 900-ohms, 600-ohms, or 135-ohms lines. The other set of transformers

terminates the line in 900 ohms, 600 ohms, 135 ohms or in 10 kilohms for bridging measurements. In all positions except Bridging, the voltmeter reads dBm directly. Bridging is on a 1:1 impedance and voltage basis.

Available telephone patch panels

The 353A op H02 has jacks for Western Electric 309 and 310 plugs which may be switched to either the input or output function of the patch panel. Special clip posts accept a Western Electric 1011B lineman's handset for the dial and talk function. A single-step 23-dB attenuator is provided to facilitate setting standard levels of +7 and -16 dbm.

The 353A op H03 has jacks for Western Electric 241, 309, 310 and 347 plugs at both input and output permitting loop-back measurements. The dial/talk and hold functions along with the 23 dB attenuator are identical to the 353A op. H02.

Specifications

Oscillator 204C Op H20, 002

Frequency range: 5 Hz to 1.2 MHz in 6 ranges. Vernier.

Dial accuracy: $\pm 3\%$ of setting.

Frequency response: +5% -1% 5 Hz to 30 Hz. $\pm 0.5\%$ 30 Hz to 300 kHz. $\pm 1\%$ 300 kHz to 1.2 MHz.

Output impedance: 600 Ω .

Output: 10 mW (2.5 V rms) into 600 Ω ; 5 V rms open circuit. Completely floating (isolated).

Output control: continuously adjustable bridged "T" attenuator with 20 dB minimum range.

Distortion: $< 1\%$ -5°F to +120°F; $< 0.1\%$ 30 Hz to 200 kHz 32°F to 120°F.

Hum and noise: $< 0.01\%$.

Power supply: 4 rechargeable batteries (furnished). 40 hr. operation per recharge (20 hr. at -20°C), up to 500 recharging cycles (expected battery life of 20,000 hr. Recharging circuit is self-contained and functions automatically when instrument is connected to ac line (115 or 230 V $\pm 10\%$, 50 to 400 Hz, approximately 3 W).

Temperature range: -5°F to +120°F.

Dimensions: (Std. 1/3 module) 6-3/32" high, 5 1/8" wide, 8" deep (155 x 130 x 203 mm).

Voltmeter 403B op 001

Range: 0.001 to 300 V rms full scale (12 ranges).

Frequency range: 5 Hz to 2 MHz.

Accuracy: within ± 0.2 dB of full scale from 10 Hz to 1 MHz; within ± 0.4 dB of full scale from 5 Hz to 10 Hz and 1 MHz to 2 MHz, except ± 0.8 dB 1 to 2 MHz on the 300 V range (0°C to +50°C).

Meter: individually calibrated, taut band. Responds to average value of input waveform and is calibrated in the rms value of a sine wave.

Nominal input impedance: 2 M Ω ; shunted by 50 pF on 0.001 V to 0.03 V ranges, 25 pF on 0.1 V to 300 V ranges.

DC isolation: signal grd. may be ± 500 V dc from chassis grd.

Price: HP 403B op. 001 \$365 when purchased separately.

Patch panel, 353A (apply with oscillator and voltmeter)

Input (receiver)

Frequency range: 50 Hz to 560 kHz.

Frequency response: ± 0.5 dB, 50 Hz to 560 kHz.

Balance: better than 70 dB at 60 Hz for 600 Ω and 900 Ω ; better than 60 dB at 1 kHz for 600 and 900 Ω ; better than 40 dB over entire frequency range for 135,600 and 900 Ω .

Impedance: 135,600,900 Ω and Bridging (10 k Ω); center-tapped.

Insertion loss: < 0.75 dB at 1 kHz.

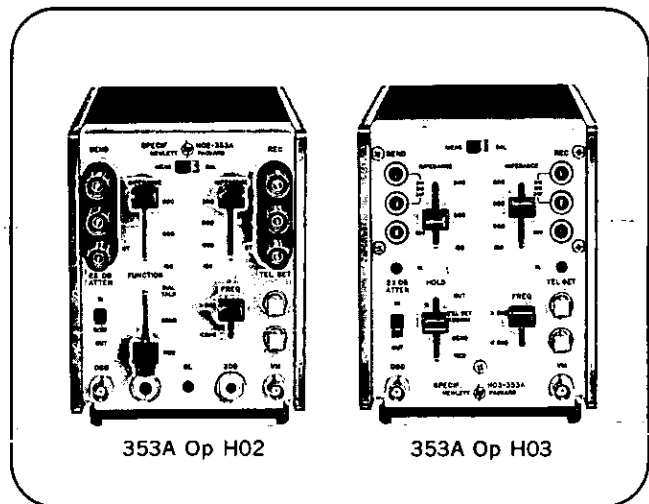
Maximum level: +22 dBm (10 V rms at 600 Ω).

Output (source) includes all receiver specifications and Attenuation: 110 dB in 1 dB steps.

Accuracy: 10 dB section $< \pm 0.25$ dB per step. 100 dB section, $< \pm 0.5$ dB per step.

Accessories available: 11075A Carrying Case (page 636), \$45.

Price: HP 353A, \$280 when purchased separately.



Available Telephone Patch Panels

Patch Panel 353A op. H02 (same as Model 353A except as indicated).

Attenuator: 23 dB ± 0.5 dB (1-step slide switch).

Hold circuit (send terminals)

Frequency response: 300 Hz to 3 kHz ± 0.5 dB, 1 kHz refer.

DC resistance: 240 Ω NOMINAL.

Maximum dc current: 100 mA.

Maximum dc voltage: 150 V.

Connectors: special telephone jacks to accept Western Electric No. 309 and 310 plugs. Sleeve jack is connected to sleeve of jacks 309 and 310.

Price: 353A op. H02, \$400 when purchased separately.

Patch Panel 353A op. H03 (same as Model 353A except as indicated).

Hold circuit (receive terminals)

Frequency response: 300 Hz to 3 kHz ± 0.5 dB, 1 kHz ref.

DC resistance: 240 Ω NOMINAL.

Maximum dc current: 100 mA.

Maximum dc voltage: 150 V.

Attenuation: 23 dB ± 0.5 dB (1-step slide switch).

Hold circuit (send terminals)

Frequency response: 300 Hz to 3 kHz ± 0.5 dB, 1 kHz ref.

DC resistance: 240 Ω NOMINAL.

Maximum dc current: 100 mA.

Maximum dc voltage: 150 V.

Connectors: special telephone jacks to accept Western Electric No. 309, 310 and 241 at Send and Rec terminals. Sleeve jack is connected to sleeve of jacks 309 and 310.

Price: 353A op. H03, \$400 when purchased separately.

General

Power: (identical specifications in both voltmeter and oscillator): 4 rechargeable batteries (furnished); 40 hr. operation per recharge, up to 500 recharging cycles; recharging circuit is self-contained and functions automatically when instrument is operated from ac line (115 or 230 V $\pm 10\%$, 50 to 400 Hz approx. 3 W).

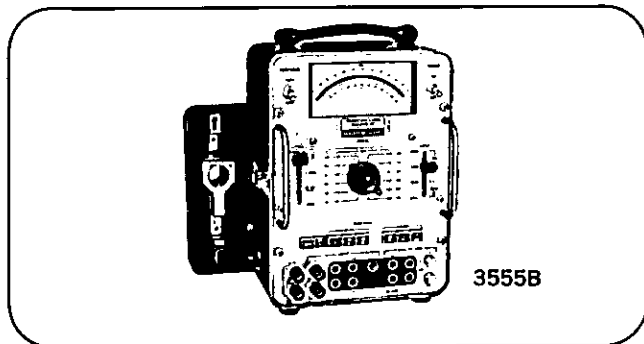
Dimensions: 8 3/8" high, 19 1/4" wide, 13 1/4" deep (with cover installed) (213 x 489 x 367 mm).

Weight: net 30 lbs (13.5 kg); shipping 40 lbs (18 kg).

Accessories furnished: detachable power cord; two 11035A Cables (1 foot long, dual banana-plug-to-BNC); the three instruments are enclosed in a 11046A Combining Case with a splash-proof cover.

Accessories available: 10503A Cable, BNC-to-BNC, \$7; 11002A Test Leads, banana-plug-to-alligator clip, \$8.

Price: HP 3550B (204C op. H20, 002, 353A and 403B op. 001) \$1200. HP 3550B op. H02 (204C op. H20, op. 353A op. H02 and 403 op. 001). HP 3550B op. H03 (204C op. H20, 002, 353A op. H03 and 403B op. 001).


TRANSMISSION/NOISE TEST SET
 Companion to 236A Telephone Test Oscillator
 Model 3555B


The HP Model 3555B Transmission and Noise Measuring Set is designed especially for telephone plant maintenance. Its wide range of sensitivity, selection of balanced input impedances, and variety of weighting filters make it a universal tool for virtually all telephone level and noise measurements.

RMS Responding

In order to add noise voltages on a power basis as does the human ear, the 3555B employs a 200 ms integrating time constant rms meter detector.

Weighting Filters

Front-panel selection of C-message, 3 kHz Flat, Program, and 15 kHz Flat noise weighting filters allows the 3555B to make a variety of noise measurements. Both noise-to-ground and noise-metallic can be measured, facilitating the calculation of line balance.

Wide-Band Level Measurements

As a transmission measuring set, the Model 3555B has a wide 3 MHz bandwidth, making it a multi-purpose tool for voice, program, carrier, and video measurements. It can be combined with the HP Model 236A Telephone Test Oscillator for complete transmission measurement capability.

Dial-Through and Hold

A convenient set of clip posts allows the lineman to connect his handset directly to the line and dial a connection. In the terminating modes, holding coils can be switched in to hold the dialed connection. After the connection is dialed, these terminals can be used as a convenient monitor output to listen to noise characteristics with the handset or an earphone. Since this output is amplified by the 3555B, very low-level noise can easily be monitored without loading the circuit under test.

Specifications

Voice Frequency (20 Hz to 20 kHz) Level Measurements

Range: -91 dBm to +31 dBm.

Level accuracy: ± 0.5 dB; ± 0.2 dB 40 Hz to 15 kHz, level > 60 dBm.

Note: for levels greater than +1 dBm, level accuracy spec. applies only for frequencies above 100 Hz.

Input: will terminate or bridge 600 Ω or 900 Ω balanced.

Bridging loss: < 0.3 dB at 1 kHz; return loss: 30 dB min. (30 Hz to 20 kHz); balance: > 80 dB at 60 Hz, > 70 dB to 6 kHz; > 60 dB to 20 kHz.

Holding circuit: 700 Ω dc resistance, 60 mA max. loop current at 300 Hz. With holding circuit in, above specs apply from 300 Hz to 4 kHz.

Noise Measurements

Range: -1 dBm to +121 dBm.

Weighting filters 3 kHz flat, 15 kHz flat, C-message, and program. Meets joint requirements of Edison Electric Institute and Bell Telephone System.

Input: same as for level measurements.

Noise to ground: 80 k Ω across line, 100 k Ω to ground, -40 dB relative to 600 Ω noise metallic at 1 kHz.

Meter response: normal, 200 ms to indicate a reading to 0 dBm on meter; damp, 500 ms to indicate a reading to 0 dBm on meter.

Carrier Frequency (30 Hz to 3 MHz) Level Measurements

Range: -50 dBm to +10 dBm (reads from -61 dBm to +11 dBm).

Level accuracy

600 Ω balanced: 1 kHz to 150 kHz, ± 0.5 dB; 10 kHz to 100 kHz, ± 0.2 dB.

135 Ω balanced (or 150 Ω balanced): 1 kHz to 600 kHz; ± 0.5 dB; 10 kHz to 300 kHz, ± 0.2 dB.

75 Ω unbalanced: 100 Hz to 600 kHz, ± 0.2 dB; 30 Hz to 1 MHz, ± 0.5 dB; 1 MHz to 3 MHz, ± 0.5 dB +10% of meter reading.

Input: will terminate or bridge 600 Ω or 135 Ω balanced and 75 Ω unbalanced.

Return loss: 600 Ω , 26 dB min 3 kHz to 150 kHz; 135 Ω , 26 dB min 1 kHz to 600 kHz; 75 Ω , 30 dB min to 3 MHz.

Bridging loss: < 0.05 dB at 10 kHz.

Balance: > 70 dB to 10 kHz, > 60 dB to 100 kHz, > 40 dB to 600 kHz.

General

Temperature range: 0 $^{\circ}$ F to 120 $^{\circ}$ F to 95% relative humidity. The 3555B will operate at -40 $^{\circ}$ F under reduced specifications. At this temperature, attention should be given to noting condition of battery as indicated on Battery Test (DIAL/BAT).

Meter: linear dB scale indicates rms value of input signal; 12 dB range.

Maximum input voltage: tip to ring, 150 V p; tip or ring to ground, 500 V p. (This is maximum instantaneous voltage. Input circuit will stand 48 V dc CO battery with superimposed 90 V rms 20 Hz ringing voltage or ± 130 V carrier supply.)

Maximum longitudinal voltage: 200 V rms at 60 Hz.

AC monitor: 0.27 V rms for 0 dBm on meter. R out = 8 k Ω . Available at Dial/AC Monitor jacks. Sufficient to drive Western Electric (WE) 1011B or 52 type headset.

DC monitor: 1 V for 0 dBm on meter. R out = 2 k Ω . Jack accepts 310 plug (tip negative).

Input jacks: will accept WE 241, 309, 310, 358 plugs. Binding posts accept banana plugs, spade lugs, phone tips, or bare wires. Removable shorting bar between sleeve and ground binding posts.

Dial/AC monitor jacks: will accept WE 289, 310, 347 plugs. Accepts WE 1011B lineman's handset or 52 type headset.

Power requirements

Internal battery: single NEDA 202 45 V "B" battery included. Expected battery life, 180 hours at 4 hours per day.

External battery: 24 V or 48 V office battery; jack accepts 310 plug (tip negative) < 15 mA. AC: 115 V or 230 V (must be specified), 50 to 400 Hz, < 1 W.

Dimensions: 7 $\frac{3}{4}$ " wide, 10 $\frac{1}{2}$ " high, 8 $\frac{1}{8}$ " deep (197 x 267 x 206 mm).

Weight: net 15 lbs (6.8 kg); shipping 17 lbs (7.5 kg).

Complementary equipment available: HP Model 236A Telephone Test Oscillator, \$600 (refer to page 431).

Price: HP Model 3555B, \$625.

TELEPHONE OSCILLATOR

Wide range telephone test oscillator
Model 236A



COMMUNICATIONS
TEST EQUIPMENT

General

The solid-state HP 236A Telephone Test Oscillator is designed specifically to deliver transmission test signals. It is particularly useful for lineup and maintenance of telephone voice and carrier systems.

Any frequency between 50 Hz and 560 kHz may be selected in four ranges to an accuracy of $\pm 3\%$. Frequency response is flat over the entire range at any attenuator setting. The oscillator is fully transistorized, and internal heat production is small, resulting in unusually low warmup drift. Advanced feedback techniques insure excellent frequency and amplitude stability even under temperature extremes. Its output is fully floating and balanced, isolated from power-line ground and instrument case. Low current drain from the solid-state circuitry results in exceptionally long battery life with hum and noise 65 dB below total output.

Output jacks are standard telephone types to facilitate patching into standard test boards. A front-panel switch selects 135, 600 or 900-ohm output impedance. These outputs are balanced to ground, and the impedance of each is controlled over the specified frequency range. The phase angle of the output impedance is low to maintain a true resistive source.

The output circuit includes two transformers preceded by step attenuators which, together, adjust output power over a 41 dB range (+10 to -31 dBm), in 10 dBm, 1 dBm, and 0.1 dBm steps having an overall accuracy of 0.1 dB over the entire range.

A front-panel control permits calibration of the output power level. Frequency response of the instrument is better than ± 0.3 dB.

A front-panel meter monitors the 45 volt dry cell battery or the 115/230 V ac regulated power supply. The dry cell will provide in excess of 180 hours of operation of the oscillator on a 3 hr/day discharge cycle at 70°F.

Uses

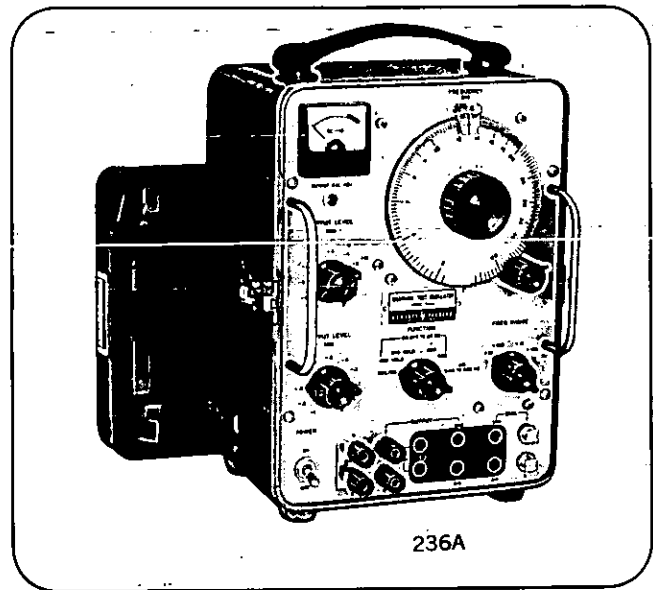
- Align, test, and maintain telephone circuits, both wet and dry
- Align, test, and maintain carrier systems
- Test manual switchboards and PBX systems
- Make accurate and reliable measurements even at temperature and humidity extremes
- Balanced signal source for bridges

Features

- Flat frequency response 50 Hz to 560 kHz
- Calibrated -31 to +10 dBm output in .1 dBm steps
- Balanced 135, 600 and 900 Ω outputs
- Standard telephone output jacks
- Dial and hold provisions
- Operates from battery or ac line

Specifications

Frequency range: 50 Hz to 560 kHz.
Frequency dial accuracy: $\pm 3\%$ of setting.



Frequency response (60°F to 80°F operating temperature):*

50 Hz		20 kHz
600 Ω & 900 Ω outputs	± 0.3 dB*	
5 kHz		560 kHz
135 Ω output	± 0.3 dB*	

*Response is ± 0.5 dB from 32°F to 60°F and 80°F to 120°F.

Output level: -31 to +10 dBm in 0.1 dBm steps.

Output level accuracy: ± 0.2 dBm from -31 to +10 dBm (1 kHz reference) when operating into selected output impedance.

Distortion: at least 40 dB below fundamental output.

Noise: at least 65 dB below total output or -90 dBm, whichever noise is greater.

Output circuit: balanced and floating. Can be operated up to ± 500 V dc above case (earth) ground.

Output impedance: 600 and 900 Ω $\pm 5\%$; 135 Ω $\pm 10\%$.

Output balance: 70 dB at 100 Hz (600 and 900 Ω outputs). 55 dB at 3 kHz (600 and 900 Ω outputs); 50 dB at 5 kHz (135 Ω output); 30 dB at 560 kHz (135 Ω output).

Output jacks: accepts Western Electric 241, 309 and 310 plugs. Binding posts accept banana plugs, spade lugs, phone tips or bare wires. Removable shorting bar between sleeve and ground binding posts.

Dial jacks: accepts Western Electric 309 and 310 plugs. Clip posts accept Western Electric 1011B lineman's handset clips.

DC holding coil: 700 Ω $\pm 10\%$ dc resistance; 60 mA maximum loop current at 100 Hz (600 and 900 Ω outputs only).

Power requirements: line: 115 or (230 V must be specified) $\pm 10\%$ ac, 50 to 400 Hz, 1 W.

Internal battery: single NEDA 202 45 V "B" battery (included).

Battery life: 180 hr on a 3 hr/day duty cycle at 70°F.

Dimensions: 7 $\frac{3}{4}$ " wide, 10 $\frac{1}{2}$ " high, 8 $\frac{1}{8}$ " deep (197 x 267 x 205 mm).

Weight: net 13.5 lbs (6.1 kg); shipping 16 lbs (7.2 kg).

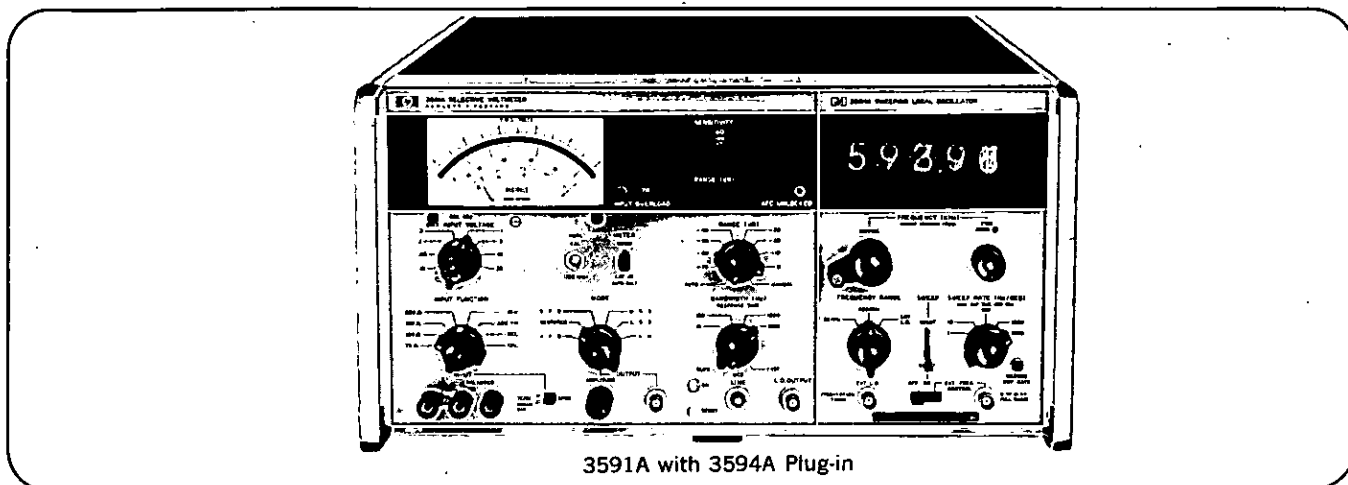
Complementary equipment available: HP Model 3555B Transmission and Noise Measuring Set, \$625.

Price: HP 236A, \$600.



PLUG-IN SELECTIVE VOLTMETER

Balanced inputs of 75 Ω to 600 Ω and bridging
HP 3591A/3594A



3591A with 3594A Plug-in

The HP Model 3591A Plug-in Selective Voltmeter is designed specifically for communications systems. The input balanced impedances and the input functions, in addition to all of the features of the 3590A, make it outstanding as a communications test instrument.

Specifications†

Frequency range: 20 Hz to 620 kHz.

Amplitude ranges: 3 μ V to 30 V full scale in 15 ranges.

Amplitude accuracy with input terminated

Meter switch in normal position: overall accuracy: ± 0.43 dB to ± 0.67 dB of reading depending on frequency, including:

Frequency response flatness, total deviation: 600 ohm: 20 Hz to 100 Hz ± 0.53 dB ($\pm 5\%$); 100 Hz to 620 kHz ± 0.26 dB.

All other terminations: 5 kHz to 620 kHz ± 0.26 dB.

Meter tracking: ± 0.1 dB or $\pm 1\%$ of reading, 0 dB to -10 dB.

Meter switch in linear dB position: overall accuracy: ± 1 dB.

Internal calibrator: frequency, 100 kHz ± 10 Hz; Amplitude, full scale on 0 dB range in CAL mode: accuracy, ± 0.1 dB.

Dynamic range: (IM and harmonic distortion products).

>85 dB below zero dB reference level when ABSOLUTE measurements are being made (>70 dB 20 Hz 50 Hz).

>80 dB below zero dB reference level when RELATIVE adjustment is used (>70 dB for 20 Hz to 50 Hz).

Residual responses

>80 dB below zero reference (>70 dB for 20 Hz to 50 Hz).

Return loss: 100 Hz to 620 kHz, 600 Ω >30 dB; 5 kHz to 620 kHz, 150 Ω , 135 Ω , 75 Ω , >35 dB.

Noise level:

Bandwidths	Input noise level (600 Ω input impedance)
10 Hz and 100 Hz	< -125 dBm or 0.44 μ V
1 kHz and 3.1 kHz	< -115 dBm or 1.38 μ V

Selectivity:

Rejection	Bandwidths			
	10 Hz	100 Hz	1 kHz	3.1 kHz
3 dB	10 Hz	100 Hz	1 kHz	3.1 kHz
60 dB	35 Hz	320 Hz	3.1 kHz	9.6 kHz

(Frequency accuracy $\approx 10\%$)

Automatic frequency control

Capture threshold: 75 dB below 0 dB reference.

Dynamic hold-in range: >3 bandwidths.

Tracking rate proportional to bandwidth.

Inputs: balanced or single-ended, not floating; term. or brdg.

Input functions

dBm: levels calibrated in dBm for impedances selected.

Abs Vm: level calibrated in volts.

Rel: input level can be set arbitrarily to 0 dB Ref. (10 dB set level range).

Cal: internal level calibrator.

Input impedances*

Resistances: 75 Ω , 135 Ω , 150 Ω , 600 Ω terminated; 50 k Ω (single ended bridging) and 100 k Ω (balanced bridging).

Capacitance (each terminal to ground): 10 mV, 30 mV ranges <55 pF; 100 mV to 30 V ranges <40 pF.

Common mode rejection: 20 Hz to 620 kHz, >40 dB.

Automatic ranging: 8 ranges, 0 dB to -70 dB. Ranging rate proportional to bandwidth.

Output: amplitude: adjustable 0 to 1 V rms open circuit.

BFO frequency response flatness: ± 0.2 dB or $\pm 2\%$.

Resistance: 600 Ω .

L.O. output: frequency, 1.28 MHz to 1.90 MHz (1.28 MHz + tuned frequency); amplitude, 0.65 V rms $\pm 20\%$ open circuit; resistance, 250 Ω .

Recorder outputs:

X-Axis (3593A/3594A only)	Plug-in Frequency Ranges	
	62 kHz	620 kHz
X-axis linear output: (1 k Ω source resistance)	0 to -12.4 V (200 mV/kHz $\pm 5\%$)	0 to -12.4 V (20 mV/kHz $\pm 5\%$)
X-axis log output: (1 k Ω source resistance)	5 V/decade $\pm 5\%$ (50 Hz - 62 kHz)	5 V/decade $\pm 5\%$ (500 Hz - 620 kHz)

* Y-Axis:

Linear Y axis output: $+10$ V dc $\pm 2\%$ for full scale meter indication, 1 k Ω source resistance.

Log Y axis output: $+1$ V to $+10$ V dc, proportional to linear dB meter indication (-90 to 0 dB, 0.1 V/dB) 1 k Ω source resistance.

Power: 115 V or 230 V $\pm 10\%$, 50 Hz to 400 Hz, <70 W.

Dimensions: 16 $\frac{3}{4}$ " wide, 8 $\frac{1}{4}$ " high (without removable feet), 16 $\frac{3}{8}$ " deep (425 x 210 x 416 mm).

Weight: net 37 lbs (16.8 kg); shipping 47 lbs (21.3 kg).

Accessories furnished: rack mounting kit for 19" rack. (Refer to page 457 for plug-in information. The 3591A must have a plug-in to operate.)

Price: HP 3591A, \$3350.

Plug-ins: HP 3592A, \$80; HP 3593A, \$1100; HP 3594A, \$1600.

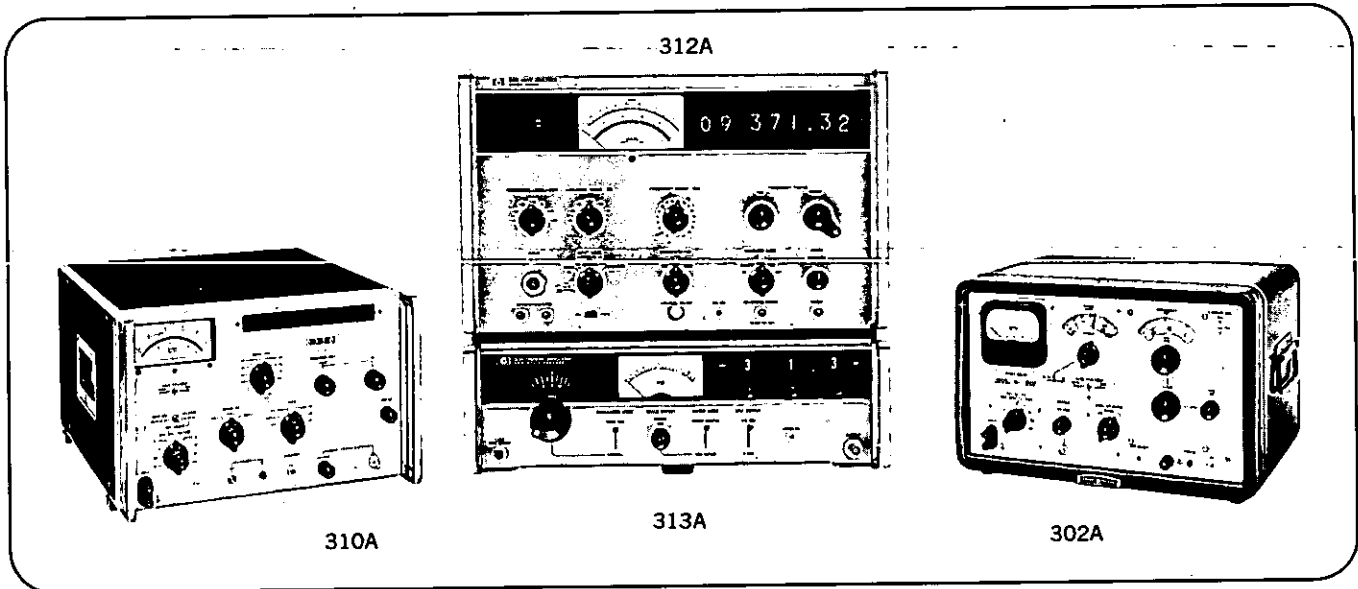
*Other terminations available on special order.
†For complete specifications refer to data sheet.

SELECTIVE VOLTMETERS

Choice of frequencies and bandwidths
Models 302A, 310A, 312A/313A



COMMUNICATIONS
TEST EQUIPMENT



Description

These Hewlett-Packard Selective Voltmeters are particularly useful for testing multiplex communications systems. The 302A with its narrow (7 Hz) bandwidth is particularly useful for measuring power-line frequency noise components and narrow-spaced, voice-band telegraph and telemetry signals. The 310A is useful in multiplex systems up to about 300 channels. The 312A is useful in multiplex systems up to about 3600 channels. The 312A is a versatile measuring set with time-saving features (special 312A instruments are listed in the table below).

Specifications, 302A

Frequency range: 20 Hz to 50 kHz.
Level ranges: -120 dB to +50 dB full scale (15 ranges).
Dynamic range: >75 dB below 0 dB ref.
Selectivity (bandwidth): 7 Hz; >80 dB down at ± 70 Hz.
Input impedance: 100 k Ω / <100 pF to 1 M Ω / <20 pF (unbalanced).
BFO output: adj 0 to 2 V rms open circuit. Tracks tuned frequency. (For complete specifications, refer to page 458.)
Price: HP 302A (cabinet) \$2000; (rack mount) \$1985.

Specifications, 310A

Frequency range: 1 kHz to 1.5 MHz (200 Hz bandwidth), 5 kHz to 1.5 MHz (1000 Hz bandwidth), 10 kHz to 1.5 MHz (3000 Hz bandwidth).
Voltage range: -130 dB to +40 dB V full scale in 10 dB steps.
Noise and spurious response: at least 75 dB below a full scale reference on 0 dB position of range switch.
Selectivity (3 IF bandwidths): 200 Hz, 1000 Hz and 3000 Hz.
Input impedance: 10 k Ω /100 pF to 100 k Ω /50 pF unbalanced.
Restored-frequency output: 0.25 V across 135 Ω unbalanced (FS). (For complete specifications, refer to page 459.)
Price: HP 310A, \$2600.

Specifications, 312A/313A

Frequency range: 1 kHz to 18 MHz in 18 overlapping bands.

Amplitude range: -97 to +23 dBm FS (-107 to +13 dBm for 600 Ω impedance), 3 μ V to 3 V FS; selected in steps of 10 dB or 3, 1 V sequence.

Noise level, referred to input: 50 to 150 Ω , -120 dBm (200 Hz bandwidth); 600 Ω , -130 dBm (200 Hz bandwidth).

Selectivity (3 IF bandwidths): 200 Hz, 1000 Hz and 3000 Hz.

Input impedances: 50, 60, 75, 124, 135, 150, 600 Ω or bridging; input capacitance <18 pF balanced, <35 pF unbalanced.

Automatic frequency control

Dynamic hold-in range: ± 3 kHz. Tracking speed: 100 Hz/s.

Frequency readout: 7 digits with 10 Hz resolution.

Frequency range: (313A Tracking Oscillator): usable to 3 kHz; tracks 312A tuning or 10 kHz to 22 MHz in one band.

Output: 0 or +10 dBm max.; attenuator, 0 to 99.9 dB in 0.1 dB steps. (For complete specifications, refer to pages 460 and 461.)

Price: HP 312A, \$4100; HP 313A, \$1350.

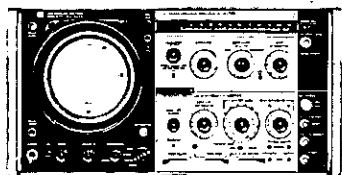
HP 312A, Option 001 (measurement of channel noise in C message units "dBrc" at carrier frequencies), add \$100.

Special *312A Instruments for Communications

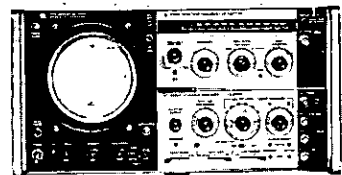
312A Option	Frequency Range	Input Z	Connectors	
			Input	Output
C01	10 kHz to 18 MHz 18 bands	Same as Std. 312A	WE-465C	WE-477B
H01	10 kHz to 22 MHz, 22 bands	75 Ω or 10 k Ω bridging (unbalanced)	WE-477B	2 Std. Phone-jacks
H05	10 kHz to 22 MHz 22 bands	50 Ω or 10 k Ω bridging (unbalanced)	female BNC	female BNC
H10	10 kHz to 22 MHz, 22 bands	75 Ω or 10 k Ω bridging (unbalanced)	female BNC	female BNC

*Same as standard instrument except as designated.

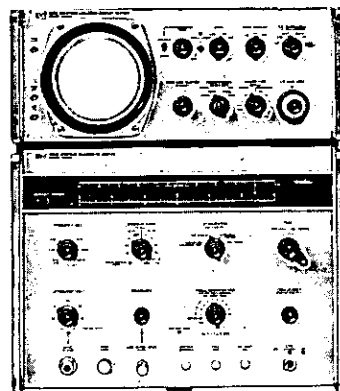

SPECTRUM ANALYZERS

 Models 8553B/8552A/141S/8554L/
8552A/141S/8551B/851B


8553B/8552A/141S



8554L/8552A/141S



8551B/851B

Spectrum analysis provides a rapid means of evaluating the performance of communications systems; the spectrum analyzer is useful for monitoring, as well as testing and alignment. Important measurements such as distortion, percent amplitude modulation, carrier and sideband suppression in SSB systems, carrier and pilot levels, and calibration of FM deviation meters by the carrier null technique are easily made. Other uses include equalization and distortion adjustments of the tape recorder systems used in telemetry systems.

Hewlett-Packard spectrum analyzers provide frequency coverage from 1 kHz to 40 GHz—measurement capability from baseband through microwave. Variable persistence/storage display units are available for all Hewlett-Packard spectrum analyzers for flicker-free spectral display even with high resolution, slow sweep rates.

For complete specifications and information on these spectrum analyzers and accessories refer to pages 399 through 414.

Model 8553B/8552A/141S - 1 kHz to 110 MHz

This spectrum analyzer provides high resolution coverage from 1 kHz to 110 MHz, a range covering baseband, commercial and military communications broadcast, as well as navigation systems and the common IF's. All functions are calibrated: scan widths from 200 Hz for modulation and stability analysis to 100 MHz for monitoring out-of-band signals such as RFI or carrier distortion components.

Outstanding features of the 8553B/8552A/141S are:

Absolute amplitude calibration/high sensitivity: -130 dBm ($0.07 \mu\text{V}$) to $+10$ dBm (0.8 V).

70-dB display range: free of internal distortion products.

Frequency response flatness: ± 0.5 dB.

50-Hz resolution: to separate closely spaced signals.

Automatic stabilization: for scan widths of 20 kHz or less, automatic phase-locking reduces residual FM to less than 20 Hz peak-to-peak.

Variable persistence display: a necessity for low-frequency, high-resolution, flicker-free displays. This is the break-

Model 8554L/8552A/141S - 500 kHz to 1.25 GHz

The broad frequency range of this spectrum analyzer covers broadcast, military, and navigational aid bands with absolute amplitude and frequency calibration. For spectrum monitoring or specific signal analysis, scan widths from 1.25 GHz to 20 kHz are selectable. Automatic phase-locking and simplified controls allow easy operation.

Outstanding features of the 8554L/8552A/141S are:

Absolute amplitude calibration/high sensitivity: -117 dBm ($0.4 \mu\text{V}$) to $+10$ dBm (0.8 V).

70 dB display range: 65 dB range free of internal distortion products.

Frequency response flatness: ± 1 dB.

300 Hz resolution: to separate closely spaced signals.

Automatic stabilization: for scan widths of 200 kHz or less, automatic phase-locking reduces residual FM to less than 300 Hz peak-to-peak.

Variable persistence display: a necessity for flicker-free, slow sweep time, high resolution displays.

through that makes low-frequency spectrum analysis practical; the spectrum, instead of a slowly moving CRT spot, can be seen.

Model 8551B/851B - 10.1 MHz to 40 GHz

RF and microwave frequency coverage with the 8551B/851B allows easy measurement of system power, flatness, gain, and spurious emissions. This spectrum analyzer can display as much as 2 GHz of any portion of the spectrum from 10.1 MHz to 40 GHz.

Outstanding features of this analyzer are:

2-GHz spectrum width: a wide, easy-to-interpret display.

60-dB display range: for signals differing widely in amplitude.

Flat frequency response: ± 2 dB to 1.8 GHz, ± 3.5 dB to 12 GHz, a "must" for accurate comparison of signals of different frequencies.

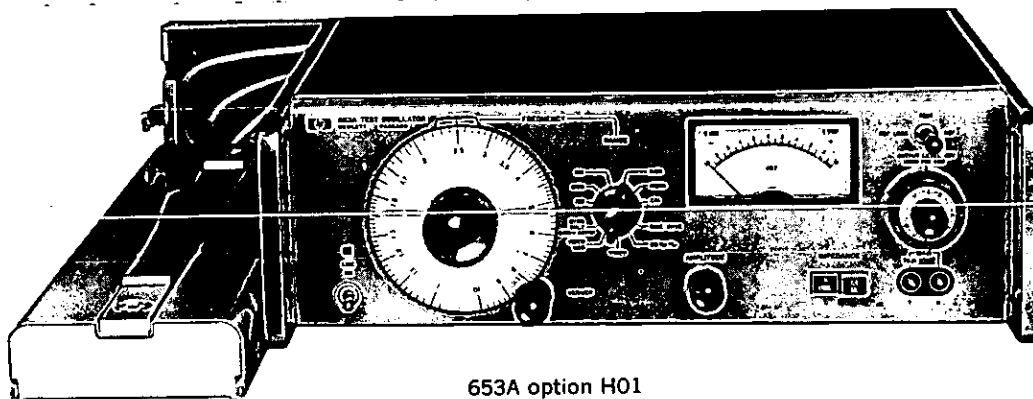
High sensitivity: to -100 dBm (10 kHz bandwidth).

VIDEO TEST OSCILLATOR

Balanced, unbalanced, auto leveled outputs
Models 653A, 653A option H01



COMMUNICATIONS
TEST EQUIPMENT



653A option H01

The 653A Test Oscillator is a lightweight, portable, solid-state signal source primarily used in the adjustment of transmission characteristics of television video loops. For this adjustment, the HP 653A Test Oscillator replaces the Western Electric 61C Signal Generator, HP 200CD Reference Oscillator, Western Electric 70B Power Meter at the sending end, and the Western Electric 1AP or 38A Transmission Comparing Set and associated cabling.

Adjustable test frequencies from 10 Hz to 10 MHz cover the complete video frequency range. The internal 300 kHz reference oscillator, conveniently selected by a front-panel switch for comparison measurements, eliminates the need for a separate reference oscillator. Amplitude stability, accuracy, and frequency response, good for 90 days from calibration, eliminate the need for the power meter at the sending end.

Front and rear covers provide protection and convenient cable storage space during transportation and periods when the instrument is not in use. The test set can be operated vertically on the floor or ground.

In addition to the features of the standard, the 653A option H01 includes a 60 Hz square wave, a simulated video signal, a modulated video signal, and a separate sync-only pulse. The simulated video signal, useful for qualitative monitoring, contains a blanking pulse, sync pulse, and white window. For video measurements and adjustments, the 653A option H01 can replace the Western Electric 61C Signal Generator, 70B Power Meter, 1AP or 38A Transmission Comparing Set, HP 200CD Reference Oscillator, and much associated cabling.

The 654A Test Oscillator is similar to the 653A except it is a general purpose test oscillator. The internal 300 kHz reference oscillator is deleted. It has BNC output connectors, and the meter is calibrated in dBm. Output impedances of 50 and 75 ohms unbalanced and 135, 150, and 600 ohms balanced are selected by a pushbutton switch. For additional technical information, refer to pages 271 and 282.

Specifications, 653A

Frequency range: 10 Hz to 10 MHz in 6 bands.

Test frequency accuracy: $\pm 1\%$ at 4.5 MHz \ddagger ; $\pm 2\%$, 100 Hz to 5 MHz; $\pm 3\%$, 10 Hz to 5 MHz; $\pm 4\%$, 10 Hz to 10 MHz.

Reference accuracy (0 dBV): frequency, 300 kHz $\pm 2\%$; level, ± 0.1 dB for 90 days.

Output impedance: 75 Ω unbalanced, 124 Ω balanced.

Return loss (on 0 dB range and below): >40 dB to 5 MHz;

>30 dB, 5 MHz to 10 MHz.

Output level: +11 dBV max to -90 dBV, 10 dB and 1 dB steps with adjustable ± 1 dB vernier into 75 Ω unbalanced or 124 Ω balanced.

Overall attenuator accuracy: ± 0.15 dB (± 1 dB at output levels below -60 dB at frequencies >300 kHz).

Meter range: ± 1 dBV full scale.

Meter resolution: 0.02 dB.

Meter tracking accuracy: ± 0.05 dB.

Frequency response (0 dBV, at end of recommended 6-ft cables): ± 0.05 dB, 10 Hz to 10 MHz.

Balance: >50 dB, 10 Hz to 1 MHz; >40 dB, 1 MHz to 10 MHz.

Distortion (THD): >40 dB below fundamental, 10 Hz to 5 MHz; >34 dB, 5 MHz to 10 MHz.

Hum and noise: >70 dB below full output.

Output jacks: accepts WE 358A and 408A plugs; max dc voltage which can be applied to the output jacks, $< \pm 3$ V p.

Counter output: >0.1 rms into 50 Ω , BNC connector.

Specifications, 653A option H01

(in addition to the 653A specifications)

Functions*

Sine wave (standard operation).

60 Hz square wave 0 dBV = 1 V p-p, risetime 2T (T = 125 ns).

Simulated video signal with sync pulse, blanking pulse and white window, 0 dBV = 1 V p-p, risetime 150 ns.

Video signal modulated by 60 Hz square wave, 0 dBV = 1 V p-p, risetime 150 ns.

Sync pulse only, 0 dBV = 0.25 V p-p, width 12.7 μ s, risetime 150 ns.

Output amplitude accuracy: $\pm 5\%$ all signals except sine wave.

General

Operating temperature: 32°F to 130°F.

Power: 115 V or 230 V $\pm 10\%$, 50 Hz to 400 Hz, 30 W nominal, 35 W max.

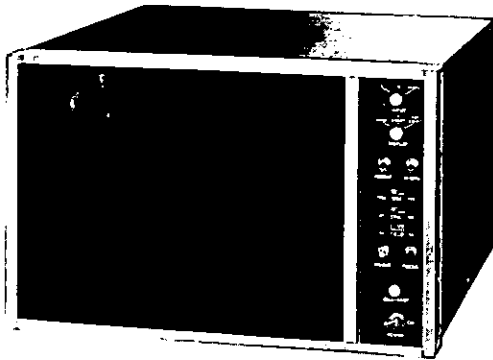
Dimensions (covers installed): 16 $\frac{3}{4}$ " wide, 5" high, 16" deep (425 x 127 x 406 mm).

Weight: net 21 lb (9.5 kg); shipping 28 lb (12.6 kg).

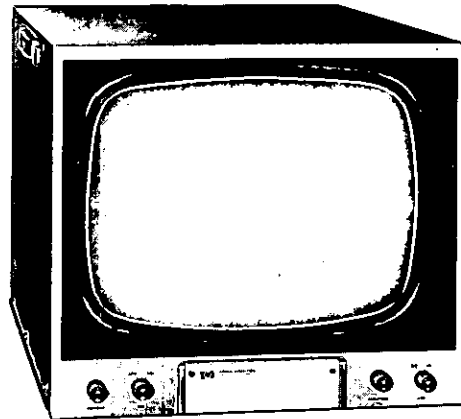
Accessories furnished: rack mount kit, front cover, rear cover, 7.5-ft yellow power cord.

Price: HP 653A, \$990.

*Waveforms conform to EIA Spec. RS170.
 \ddagger Accuracy for temperatures from 20°C to 30°C.


PRECISION RASTER DISPLAYS
Unexcelled picture quality
Models 6946A, 6947A


6947A



6946A

Description

Hewlett-Packard Models 6946A and 6947A are monochrome precision raster displays that employ circuit concepts and techniques new to the industry. Several of the circuits are already patented with patents pending on other portions of this unique design. Special consideration was given to the display's resolution, frequency and phase response, sweep linearity, and stability. Because of the extensive and unique use of feedback throughout its circuitry, the display has a high degree of performance stability under a wide range of environmental conditions.

Resolution for the Most Critical Application

Frequency and phase responses of the video amplifier are carefully controlled, and are feedback-stabilized to make them virtually independent of signal level and of temperature-sensitive circuit elements. The resulting accuracy and stability make the video amplifier capable of producing a high-resolution display. To complement the video amplifier, a high-resolution 14" tube is used in the HP 6947A (optional high-resolution 17" tube available for the HP 6946A) which makes full use of the video amplifier characteristic. The spot size of this high-resolution tube is 0.010", measured at a brightness level of 30 foot lamberts.

Unexcelled Stability and Linearity

Horizontal and vertical deflection circuits employ feedback to improve and stabilize sweep linearity, thereby keeping the overall geometric distortion of the picture under 1.5%. No linearity adjustments are needed over the life of the instrument. Of special significance is the use of feedback in the horizontal sweep circuit, along with the usual energy-conserving technique. This circuit concept provides a highly efficient and linear deflection system and it is the first time such a

technique has been used in a commercially available raster display. The feedback technique employed in the sweep circuits allows size adjustment to obtain any size format without degrading linearity.

No Hold Controls—Perfect Interlace

Novel synchronizing circuits regenerate the sync pulse train to ensure stability of the raster, even in the presence of transmission noise. Optimum interlacing of the lines which make up the raster pattern is achieved by synchronizing the vertical and horizontal sweeps. No manual hold controls are required for either U.S. or CCIR (International Radio Consultative Committee) scanning standards.

All Solid State—Including High Voltage Circuit

High voltage and the lower accelerating potentials required by the picture tube are derived from an all-solid-state high-voltage power supply. This supply is highly regulated so that the size of the raster is not measurably affected by changes in the picture tube current demand. The high-voltage supply is protected by use of a pulse width limiting circuit that allows the supply to maintain a fixed power output level under varying overload conditions. The picture tube is protected by cutting off the high voltage when there is no horizontal deflection signal and by the use of a phosphor protection circuit in the grid of the tube.

Raster Display Kit

A complete kit on Raster Displays including technical data sheets and an in-depth discussion of state-of-the-art circuitry in Hewlett-Packard displays, is available upon request to your local Hewlett-Packard sales representative.

Specifications

Models 6946A and 6947A conform to EIA standards RS-170, RS-330, and RS-343.

Video Circuits

Input circuit: 75 ohms unbalanced to ground; 124 ohms balanced. Return loss greater than 40 dB from dc to 4.5 MHz. Protection for up to 100 V peak transients appearing on the input balanced line. Input impedance (unterminated): 12K ohms. 6946A: UHF connectors with loop-through facility; 6947A: BNC connectors with loop-through facility.

Input level: 0.5 to 4 V p-p for 85-volt signal at kinescope.

Rise time: less than 40 nanoseconds for a step change input viewed at the picture tube modulating grid.

Input polarity: differential input; black can be positive or negative.

Common mode rejection (longitudinal balance): 46 dB from 0 to 2 MHz; decreasing at 6 dB/oct from 2 MHz to 20 MHz.

Frequency response: flat up to 8 MHz (± 0.25 dB); less than -1 dB at 10 MHz decreasing smoothly to -3 dB at 18 MHz. Low frequency tilt is less than 2% for a 60 Hz squarewave.

Signal-to-noise ratio: rms visible noise is greater than 50 dB below p-p signal present at picture tube when a 0.5 V sinusoid is applied to the input.

Sine-squared response: overshoot symmetry is better than 1% on a 62.5 nanosecond input pulse appearing on the picture tube control grid. Maximum overshoot is less than 3% of pulse amplitude.

Differential gain: less than 3% over specified input level (0.5 to 4 V p-p).

DC restoration: keyed back-porch clamp; black level shift: less than 1% for a full change in input signal level.

Horizontal Deflection Circuits

Horizontal AFC: standard unit locks on either EIA 525/60 Hz or CCIR 625/50 Hz line systems. Horizontal sync is maintained with a composite picture signal-to-noise ratio of 24 dB.

Horizontal width: more than 5% overscan of the usable visible area of the kinescope. Horizontal width control range is 25% of horizontal dimension.

Vertical Deflection Circuits

Field rate: vertical lock and interlace is automatic. Front panel switch maintains the picture aspect ratio for either 50 or 60 Hz field rate. Vertical sync is maintained with a composite picture signal-to-noise ratio of 12 dB.

Vertical height: more than 5% overscan of the usable visible area of the kinescope. Vertical height control range is 25% of vertical dimension.

Display

Display size: 6946A, 14"; 6947A, 17" diagonal. Both models can be switched between full and reduced size.

Full size mode: vertical and horizontal independently adjustable between +10% and -15% of normal raster size.

Reduced size mode: vertical and horizontal independently adjustable between -15% and -30% of normal raster size.

Geometric raster distortion: less than 1.5% overall; less than 1% in safe title area (80% of full picture size).

Interlace: 2:1.

Interlace factor: unity (equal spacing between raster lines), maintained with a signal-to-noise ratio of 24 dB.

Pulse cross display: enables inspection of the relative phasing and duration of the synchronizing information transmitted with the video signal. The vertical interval is expanded so that the individual scanning lines may be observed and measured easily. A front panel switch activates the pulse cross circuit located within the monitor. Standard on all units.

Spot size: 6946A: less than .018 (18 mils) at 30 ft lamberts; 6947A: less than .010 (10 mils) at 30 ft lamberts. Higher resolution tubes available; consult Hewlett-Packard, Berkeley Heights, N.J.

Picture tube and safety glass: standard unit has clear safety glass and rectangular tube with medium short persistence P-4 phosphor, aluminized. Other phosphors and bonded faceplate tubes are also available; consult Hewlett-Packard, Berkeley Heights, N.J.

General

External sync inputs: sync switch selects the external sync input (rear panel jack) or internal sync input. Sync input range is -1 V to -8 V.

Temperature ratings: operating, 0°C to $+55^{\circ}\text{C}$; storage, -40°C to $+75^{\circ}\text{C}$.

Altitude: operating, up to 15,000 ft; storage, up to 50,000 ft.

Controls: front-panel off-on ac switch, contrast, brightness, focus, height, width, sync, 50/60 Hz field rate switch, size switch, pulse cross display switch (optional on Model 6946A), video input selector switch on Model 6947A only.

Input power: 6946A: 115 V ac $\pm 10\%$, 48-440 Hz, 75 W at 115 V ac; 6947A: switchable between 115 and 230 V ac $\pm 10\%$, 48-440 Hz, 75 W at 115 V ac.

Weight: 6946A: net, 63.5 lbs (30.6 kg); shipping, 100 lbs (45.3 kg); 6947A: net, 43.8 lbs (19.8 kg); shipping, 64.5 lbs (29.2 kg).

Rack mounting: rack mounting kit, consisting of two angle brackets, provided with each unit.

Dimensions: 6946A: 17 $\frac{1}{2}$ " (44.5 cm) W x 15 $\frac{3}{4}$ " (40 cm) H x 21 $\frac{1}{8}$ " (53.7 cm) D; 6947A: 17-1/16" (43.3 cm) W x 10 $\frac{1}{2}$ " (26.6 cm) H x 20-9/16" (52.2 cm) D.

Price: \$1050.

Options

028: 230 V ac $\pm 10\%$, single phase input; 034: circularly polarized laminated safety glass. See page 571 for details.

High line rate options: the standard display will operate at either 525/60 or 625/50 line rates. Models can be ordered with optional higher line rates from 675 to 1029. The field rate for these higher line rates is 60 Hz, and the CRT spot size is compatible with the number of lines. Price, \$200.

Option:	001	002	003	004	005
Lines:	675	729	875	945	1029

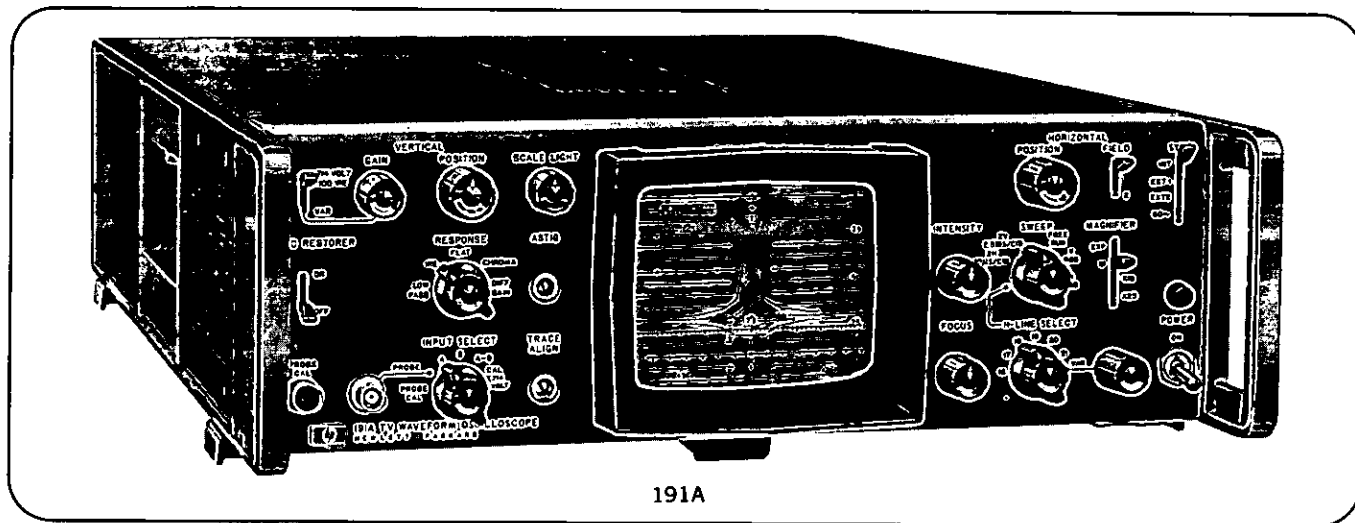


TV WAVEFORM OSCILLOSCOPE

Precision Measurement of VITS and Video Signals
Model 191A

Displaying the TV video waveform and the new test signals, and making accurate measurements of them, calls for an oscilloscope with special capabilities, plus unusual accuracy and

stability. These requirements are met by the HP Model 191A Television Waveform Oscilloscope which displays and measures black-and-white and color TV video signals and VITS.



191A

Specifications

Vertical amplifier

Input circuit: loop through type.

Terminated: 75 ohms unbalanced; 124 ohms balanced.

Unterminated: 12.5 k ohms unbalanced; 25 k ohms balanced.

Power off-on transient: less than 5 mV.

Transient protection: 100 V, risetime no less than 1 μ s.

Common mode rejection: -40 dB from 0 to 2 MHz; decreasing at 6 dB/octave from 2 MHz to 20 MHz.

Gain control: selectable, fixed or variable; variable provides 140 IRE deflection for composite TV video signal from 0.2 V to over 2 V pk-pk amplitude.

DC restorer: On, restores to the back porch, color burst effect on the display will be less than 2 IRE; Off, restores to the average value of the input signal.

Calibrator: with input switch set to Cal, automatically switches vertical channel to flat filter mode, horizontal sweep to 2 V mode, and applies a 120 Hz, 0.714 volt \pm 1% signal to the vertical amplifier.

Probe input: input RC, 1 megohm shunted by 25 pF; with X10 attenuation probe, 10 megohms shunted by 10 pF.

Filters

Flat: +15°C to +35°C: \pm 0.05 dB from 100 Hz to 1.5 MHz decreasing to -0.05 \pm 0.05 dB at 4.5 MHz; -20°C to +65°C: decreasing to \pm 0.15 dB from 100 Hz to 1.5 MHz, -0.1 \pm 0.2 dB at 4.5 MHz, -3 dB at 10.5 MHz, and -20 dB at 20 MHz; risetime less than 50 ns; less than 1% tilt on 60-Hz square-wave with dc restorer off.

IRE: standard roll-off as specified by IRE (1958 IRE Journal, page 23.S1); 20 dB down at 3.58 MHz.

Chrominance: band-pass filter with Q of 4 and center frequency of 3.58 MHz.

Differential gain: same response as Chrominance with 14 dB additional gain.

Low pass: more than 30 dB down at 0.500 MHz \pm 0.015 MHz; 40 dB down at 1.5, 2.0, 3.0, 3.6, and 4.2 MHz; less than 2 dB down at 0.15 MHz.

Horizontal sweep

Internal sweep:

2V (2.5 ms/cm): \pm 5% for X1, X10, and X25 magnification.

2H (10 μ s/cm): \pm 3% for X1 and X10; \pm 5% for X25 magnification.

H-Line select (10 μ s/cm): discrete line selection for lines 16

through 21; variable line selection for all lines in the entire field.

Free run (10 μ s/cm): envelope display for video setup.

External inputs: two inputs to sync oscilloscope to external TV sync generators; staircase input accepts 4-step staircase for WRGB (may be modified for 3-step staircase).

RGB operation:

H-RGB: displays 3 or 4 line parade.

V-RGB: displays 3 or 4 field parade.

Expand mode allows 10-cm overlay display.

Field select: positive selection of either field; circuit is insensitive to noise pulses.

Blanking: decoupled to remove trace with no signal input.

Linearity: \pm 1.0% of full scale.

CRT display

Cathode-ray tube: post-accelerator, 20 kV accelerating potential; aluminized P31 phosphor; high writing rate for viewing of sine-squared T/2 pulse.

Graticule: 8 cm x 10 cm parallax-free internal graticule; 140 IRE units = 7 cm; vertical and horizontal trace alignment controls; external graticules available for sine-squared pulse-and-bar, video modulation, etc.

Bezel: provision for external transparent plate with graticule markings; provision for illuminating both internal and external graticules.

General

Design: solid-state on plug-in PC boards.

Power: 115/230 volts \pm 10%, 50 to 400 Hz; approx 70 W.

Temperature: operating range from -20°C to +65°C unless otherwise noted.

Environmental: meets Bell Telephone Laboratories KS-19763 environmental specifications.

Altitude: operates to 15,000 feet above sea level.

Line bright output: supplies both video and line bright gate to the associated picture monitor; line bright gate pulse is supplied in variable H-line select only.

Accessories supplied: two plug-in extender boards for servicing, and rack-mount kit.

Dimensions: 16 $\frac{3}{4}$ " wide, 5 $\frac{1}{4}$ " high, 21 $\frac{1}{2}$ " deep over-all (426 x 133 x 546 mm); hardware furnished for quick conversion to 5" x 19" (127 x 483 mm) rack mount.

Price: HP Model 191A, \$1775.

Accessories: refer to page 534.

CUT COST ON CABLE INSTALLATION AND MAINTENANCE



COMMUNICATIONS TEST EQUIPMENT

Quick location of faults

Time domain reflectometry (TDR) speeds maintenance by locating faults such as shorts, opens, loose connectors, troublesome tap-offs, mismatched terminations, and poor cable splices. The information is presented on a cathode-ray tube and discloses both the location and nature of each discontinuity. Problems of locating smashed or water damaged sections of underground cable are quickly resolved. Troubles are isolated to specific locations in the line.

Improve picture quality

TDR reveals the quality of the transmission system by directly measuring reflection. Since reflection ghosts are an even greater annoyance to color TV viewers than to monochrome viewers, color transmission requires a higher degree of precision. CATV transmission is subject to reflection anywhere along the cable, at connectors, tap-offs, and terminations. The high sensitivity of the TDR plug-in can locate even the smallest ghost-causing reflection.

Time domain reflectometry principle

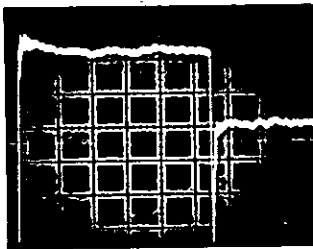
TDR employs a closed loop radar method to examine cables. Cables can be easily tested in the same way a transmitted signal would see it. By sending a step voltage through the cable and measuring the reflected voltage with a high-speed sampling oscilloscope, a time profile is obtained revealing the characteristics of each point along the cable.



Wet Connector: Highly magnified display of a wet connector. Multiple reflections from the faulty connector cause a reflection coefficient of -0.4 .

Checks cables to 10,000 feet

The plug-in controls are calibrated directly in distance for air and polyethylene dielectric cables.

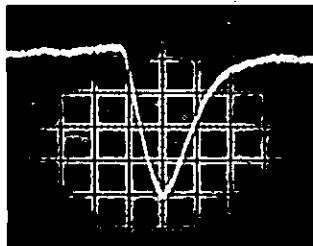


Impedance Mismatch: Reflection caused by cables of different impedance. With the vertical calibrated in $.02 \rho/\text{div}$ and the first cable known to be 75Ω , the second cable is quickly found to be 69Ω using the TDR slide rule. From scope readout, the mismatch is located 55 ft down the 75Ω cable.

The Model 1815A can test polyethylene cable to 10,000 feet with 5% accuracy. A variable adjustment is furnished to convert the distance scale to other dielectrics. Special techniques can double the range and pinpoint discontinuities at long distances. If both ends are accessible, measurements can be taken at each end permitting 20,000 feet to be checked. Accuracy can be improved two ways. The first is to close in on the fault by measuring at successively closer connections. The other is to compare distances to a standard cable connected in parallel. With these techniques, faults can be isolated within inches of the trouble spot. The 28 ps ($1 \text{ ps} = 10^{-12} \text{ s}$) step risetime of the Model 1817A is great enough to resolve nearby discontinuities that are less than 0.25 inch apart. The high resolution is useful to examine faulty connectors.

50 ohm system TDR plug-in

Distance scale is calibrated to relate centimeters of CRT display to centimeters of transmission cable. For polyethylene line for example with a dielectric constant of 2.25, the CRT is calibrated to represent 200, 500, 1000... up to 1000 cm line/div display.



Pinched Cable: Magnified display of a pinched cable resulting from sharp radius of curvature. The calibrated CRT indicates a reflection coefficient of -0.04 .

75 ohm system

The Model 1570A option 002 is a special system for checking and analyzing 75 ohm coaxial cable systems. This system uses a 1415A option H08 plug-in which is calibrated to read directly in feet of polyethylene or polyfoam coaxial cable. This system includes a 140A Oscilloscope mainframe with P7 phosphor. This phosphor has a long persistence that is quite useful in reducing flicker when scanning a line in detail. This system includes a 50 to 75 ohm adapter and is calibrated at the factory for 75-ohm systems. Also included in this system are: an application note about TDR measurements; 75 ohm overlays for direct reading of different resistance cables; and a TDR slide-rule for rapid conversion to distance in different dielectric cables.

Models 10452A through 10456A Rise-Time Converters slow down the step from the Model 1415A in order to eliminate reflections caused by frequencies beyond the bandwidth of interest. Rise-times are 0.5, 1, 2, 5, and 10 ns.

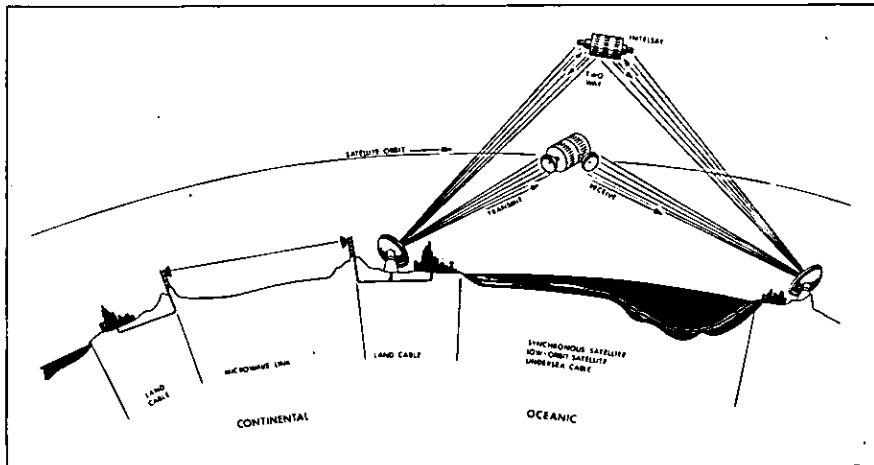


System Profile: Reflection pattern as seen by looking down a transmission system. The pattern reveals a low impedance cable (off screen) connected to a 69Ω cable. 27 ft from the connector is an inductive defect; 20 ft farther along is a capacitive defect from a pinched cable; 8 ft from the pinch is a 67Ω termination.

1815A TDR system

The 1815A TDR is a high resolution system designed to be easy to use. The fast risetime provides resolution necessary for connector design and a signal averaging technique reduces noise and improves accuracy.

Indicator lights show vertical and horizontal calibration units. The horizontal scale switch incorporates a direct reading magnifier which eliminates the need for dividing to determine the horizontal calibration and eliminates a possible source of error. The direct reading marker position dial allows the user to set his zero reference anywhere on the trace and take only one reading for a differential measurement.



The seventh decade

Communication systems have been planned, and are being commissioned now which will make multi-national communications in the 1970's the most rapid and of the highest quality ever achieved. Hewlett-Packard recognizes the vital role that the complex communication systems of the seventies will play in the continuing endeavor for better understanding between nations and ultimate World peace.

Increasing complexity

These communication systems encompass every possible means of communication and embrace many fields of technology. Typically these systems include

telephone and telegraph equipment, multiplex and data-handling racks, overland and undersea cables, microwave links, broadcast radio and VHF, and special active communication satellites. Many different branches of information are passed by communication systems including telephony, datel, monochrome and color TV, Press Wire Photo, and international news messages. For example, during the Olympic Games in Mexico City in the late summer 1968, continuous daily Radio and TV broadcasts were relayed live to many countries throughout the World. Sportsmen throughout the World could follow their country's progress at the Games, with TV and up-to-date sports news services far in excess

of the coverage available four years before at the Tokyo Olympics.

Accepted as the leading supplier, and famous in the design of electronic measuring instruments for the engineer, Hewlett-Packard has more recently become an important source of microwave link test equipment.

International standards

With improvements in solid-state electronics, and microwave equipment in particular, coupled with the rising costs of cable-laying and maintenance, the Microwave Link has gradually yet successfully replaced the use of cable for long-haul overland communications. Development and maintenance of these microwave links requires specialized equipment. Hewlett-Packard recognizes this need and developed the Microwave Link Analyzer, Models 3701A, 3702A, 3703A, to meet this need. The Analyzer is designed to the CCIR recommendations on international standards for radio relay equipment, which includes 70 MHz IF, 75 ohms standard impedance, and standardized test deviations and baseband sensitivity.

Standard link equipment

Microwave Link equipment embraces three main areas of electronics, each very much different from the other and requiring specialized test equipment. These areas are (1) Multiplex at 600 kHz to 9 MHz, (2) FM modulators, demodula-

Table 1. Communications Test Equipment

Type	Description	Range	Models
Transmission test set	Transmission line and system characteristics: attenuation, gain, frequency response, line-up; patch-panel 135, 600, 900 Ω lines	5 Hz to 560 kHz	3550B/353A 204C/403B
Cable network leak detector	Ultrasonic translator detector which translates detected leaks of ultrasonic energy in cables to audio frequency	36 kHz to 44 kHz	4916A 4905A
Cable shorts, grounds, crosses	Operating on principle of electromagnetic induction and earth voltage gradients with inductive and conductive loops	990 Hz Pulsed 7 pps	4900A 4901A
Cable resistance	Resistance measurement for fault location in telephone cable pairs to 30,000 meters	0-3 kHz	4910B/C
Telephony oscillator	R-C oscillator with all Western Electric connectors for dialling and output. Holding functions for 600, 900 Ω outputs.	50 Hz-20 kHz 5-560 kHz	236A
Telephony analyzer	Selective voltmeter, 7 Hz bandwidth, meter scale in dB, working range -120 to +50 full scale. High impedance.	20 Hz to 50 kHz	302A
Multiplex oscillator	Linear sweeping oscillator, 10 Hz to 32 MHz in one range, 0.15 dB flatness, AM to 1 kHz, FM to 4 kHz, +13 dBm/50 Ω	10 kHz to 32 MHz	675A
Multiplex analyzer	Selective voltmeter, digital frequency readout, bandwidth 200 Hz, 1 kHz, 3 kHz, sensitivity -97 dBm to +23 dBm, 75 Ω	10 kHz to 22 MHz	312A
Microwave link IF analyzer	Transmission generator provides 45-95 MHz swept IF with baseband FM. Output range +10 dBm to -89 dBm. IF flatness \pm 0.1 dB. Demodulator display extracts FM from 45-95 MHz IF, will display IF flatness, linearity, group delay, Bessel Zero, TVSC differential phase and gain at 3.50 and 4.50 MHz, return loss. 75 Ω system	IF 45-95 MHz BB 83.3-500 kHz TVSC 3.5-4.5 MHz	3701A 3702A 3703A
TV waveform oscilloscope	Displays of TV test signals are multiburst frequencies, sine-squared pulse and bar, modulated staircase. Checks quality of monochrome or color TV signal channel in routing equipment or Microwave links. 75 Ω input. Chrominance filters at 3.58 MHz.	Monochrome and Color TV	191A 193A
Attenuator	75 Ω push-button unbalanced impedance. 0-99 dB in 1 dB steps. Insertion loss less than 0.6 dB. Accuracy \pm 0.5 dB to 79 dB, \pm 1 dB to 89 dB, \pm 2 dB to 99 dB	DC- to 100-MHz to 200 MHz	3750A
Accessories	75 Ω impedance, 6 dB Hybrid Accessory kit includes 75 Ω loads, cables, 17 dB standard mismatch	DC- to 100 MHz	15520A 15526A



tors and IF- at 70 MHz, (3) Up- or down- converters at 3-10 GHz. The Microwave Link Analyzer is specially designed for analyzing IF equipment, but can do a number of tests at baseband (BB). Figure 1 shows how typical telephone signals get transferred by frequency division multiplex (FDM) into the multiplex band. 1800 telephone channels, each allocated 4 kHz, occupy about 8.4 MHz, with spacing for test frequencies.

Figure 2 shows in simplified form the concept of a microwave link. The BB signals are applied to an FM modulator centered at 70 MHz. Frequency modulation is used because it offers a significant improvement in signal/noise ratio and is more resistant to fading effects than

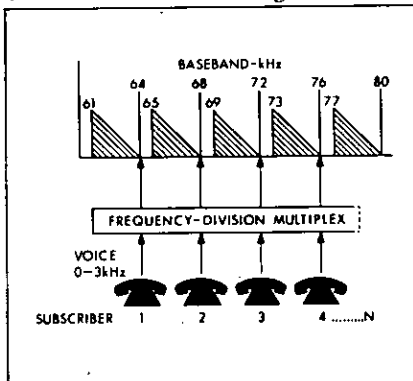


Figure 1. Voice channels are shown conventionally as triangles stacked by the multiplex (FDM) in the frequency spectrum. Each channel is 3 kHz-wide lower sideband (LSB) amplitude modulation on the appropriate multiplex carrier.

amplitude modulation.

The modulator is followed by an up-converter where the 70 MHz band signals are converted to the GHz band, generally around 3-10 GHz. The same parabolic dish and aerial system is used for both the EASTBOUND and WESTBOUND carriers which are separated slightly in frequency; for example A speech at 7070 MHz, B speech at 6930 MHz. A simple 'hop' like the one shown can span a maximum of about 30 miles.

Figure 3 shows in simplified form the basic microwave link terminal. The input signals (BB) at A are applied to an FM modulator centered at 70 MHz. The input frequencies extend up to 8.4 MHz and the deviation rates generally used create sidebands which extend from about 55 MHz to 85 MHz. This 30 MHz band IF is amplified and filtered before being applied to the up-converter where it is converted to, typically, 7070 MHz. The incoming signal is at some different frequency, say 6930 MHz, and the use of

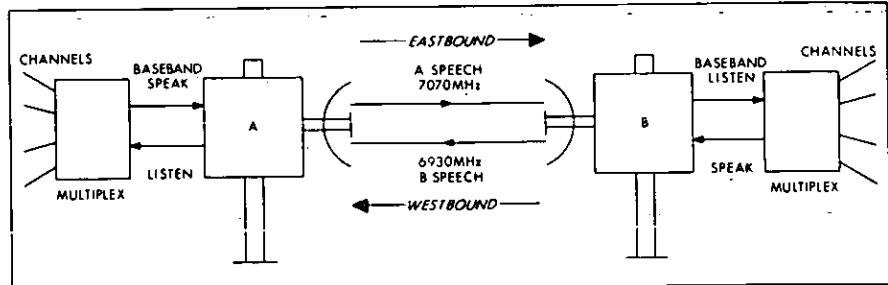


Figure 2. Simple microwave link, like the one above, can provide two-way communication for up to 1800 voice channels over a 'hop' of less than 30 miles. Most links employ the system shown where a common aerial system is used to transmit and receive simultaneously the two microwave carriers at different frequencies.

ferrite circulators and waveguide filters prevents breakthrough of the 7070 MHz and 6930 MHz signals into unwanted channels.

Distortion problems

Principal causes of distortion in the handling of the baseband input to the modulator arise at the IF sections. The IF signal for an 1800 channel telephony system extends from about 55 MHz to 85 MHz and is densely packed with channel information. All these channels are in particular amplitude and phase relationship to each other and any changes in amplitude sensitivity or phase are evident as distortion, crosstalk and intermodulation.

Distortion at IF is caused by the inability of modulators, IF amplifiers, filters, attenuators and demodulators to handle the IF with constant sensitivity, group delay and return loss across the

IF band. The Microwave Link Analyzer measures IF sensitivity, FM linearity, group delay and return loss of any BB/IF, IF/IF or IF/BB item. For checking IF sections, the Analyzer provides a swept IF output from 45 MHz to 95 MHz flat to within ± 0.2 dB. A special feature about this IF is that the sweep is sinusoidal at 70 Hz (Figure 5) with distortion products better than 30 dB down on sweep level. The general measurements required by link engineers are shown in Figure 4.

Sinusoidal sweep

Hewlett-Packard employs classical methods of sweep-testing with pure sinusoidal sweep-envelopes because these methods are inherently noise-free and offer the most accurate and reliable solutions to the problems of distortion measurement.

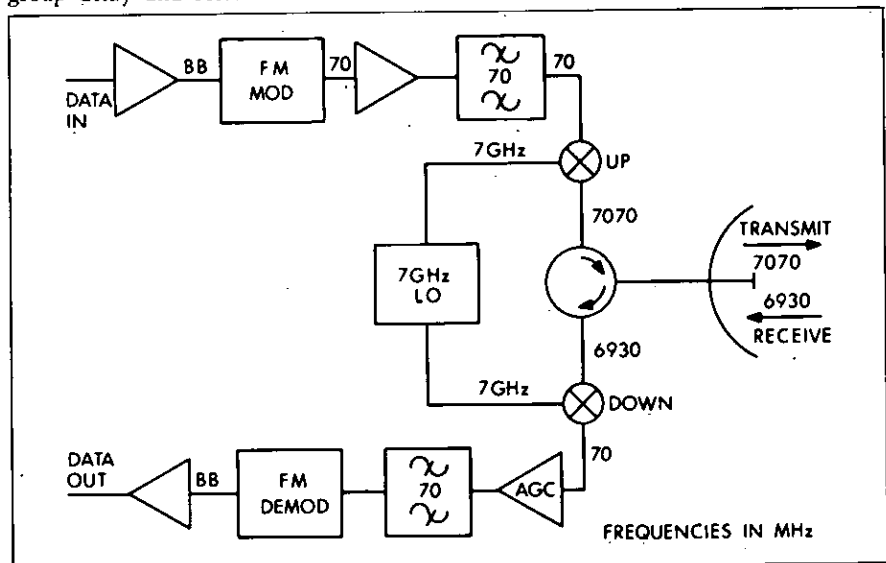


Figure 3. Simplified concept of a microwave link terminal. The main information encoder is the frequency modulator where input data is modulated by FM onto a 70 MHz carrier. This carrier, or IF, is up-converted to frequencies 3-10 GHz. In-coming transmissions are down-converted to 70 MHz and the data extracted in a frequency demodulator. Many links now in service have entirely solid-state electronics.

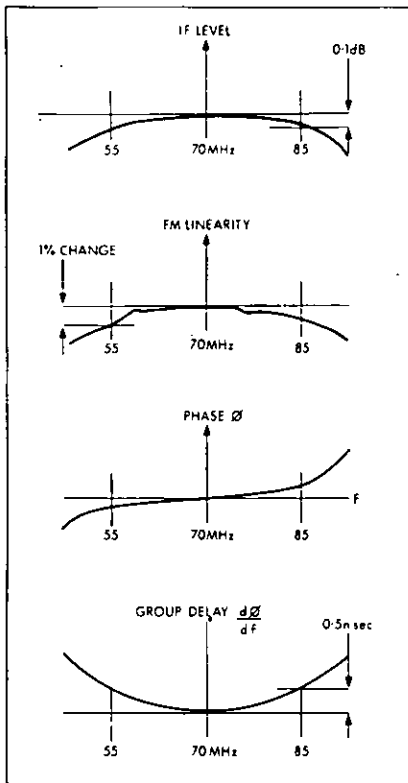


Figure 4. General measurements required at IF. Phase/frequency is not displayed directly, but the effects, mainly of envelope delay on the IF carrier are measured as group delay, the derivative of phase/frequency.

IF level, FM linearity

The IF level sensitivity is detected from the signal IF in a linear detector and displayed as level (dB) against a base of swept frequency. For the measurement of FM linearity on modulators, a modulation frequency is added to the sweep frequency and the resultant IF with FM is demodulated in an FM demodulator. The resultant demodulated frequency is detected and the level measured. This level is displayed (% change in level) against a base of swept frequency. For measurement of group delay, the phase of the detected modulation, which contains the

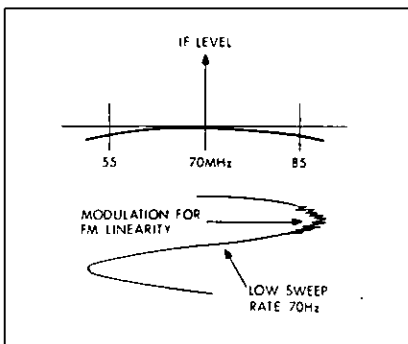


Figure 5. Sinusoidal sweep methods are inherently noise-free and simple in operation. Baseband modulation frequencies are added to sweep so that modulators can be swept-tested over the working band at constant modulation level. For checking IF sections and demodulators an IF in the band 45-95 MHz is available, modulated with the same baseband + sweep.

information on envelope delay, is extracted in a phase detector, converted to dc and displayed (nsec delay change) against a base of frequency.

Simultaneous display

These bandwidth measurements of IF level, FM linearity and group delay are fundamental to the continued operation and acceptability of the link. To aid setting-up commissioning procedures, the display of IF level and group delay, two quantities which can be mutually interfering, can be viewed simultaneously; group delay can also be viewed simultaneously with FM linearity and return loss. Other measurements performed include BB gain, insertion loss, IF gain, insertion loss and return loss at IF.

Return loss

The return loss, or impedance match, of all connectors and cables at IF is critical. Poor impedance matching results in high VSWR (greater than 1.10:1 is not acceptable) with consequent distortion caused by the standing wave ripple at IF level, and the classic phase ripple on IF group delay. Hewlett-Packard provides two fundamentally different methods of measuring return loss, each with its own advantages and disadvantages. 1) Hybrid method using hybrid power divider and sensitive IF detector to measure return loss power 2) Long cable method where incident power is compared to return loss power by relative attenuation and a long cable.

1) The Hybrid method has the advantage that actual return loss can be seen across the band and compensated for at frequencies where it is excessive. Hewlett-Packard provides a direct-coupled display calibrated at 1 dB/cm so that the threshold can be set, and return loss better than this can be seen. Initial calibration and matching of the hybrid to the measurement system is achieved using the HP Model 15521A 17 dB Standard Mismatch.

2) The long cable method compares the return loss power with the incident power by means of an accurate attenuator. Principal requirement is that IF is detected to display VSWR ripple, and ripple with cable open-ended is attenuated to match ripple with cable terminated. Twice the attenuation applied is the return loss figure.

Calibration

An important feature of the Analyzer is the calibration facilities offered. For relative amplitude of IF, including return loss, a 0.1, 0.3 or 1 dB setting can be used where the calibration selected is the spacing between the double lines on the display. Also, for linearity measurements, where percentage change in modulation level is required, 1, 3 or 10% setting can

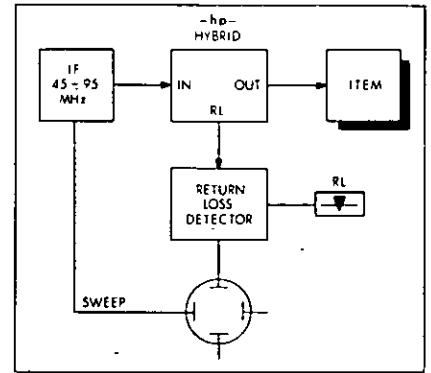


Figure 6. Hybrid method of return loss measurement has return loss detector with -54 dBm IF sensitivity. Initial calibration requires HP Model 15521A Standard Mismatch 17 dB and simple setting-up.

be selected between the double lines. Similarly, for group delay measurements, 1, 3 or 10 nsec can be selected between the double lines. Guaranteed sensitivities are 0.1 dB/cm, 0.25%/cm and 0.33 nsec/cm.

Accurate pin-pointing of non-linearities, relative to the IF band 45-95 MHz, is possible by means of the MARKER OFFSET dial which positions two sliding markers, one each side of 70 MHz, at a spacing up to 26 MHz offset from 70 MHz. These markers are generated by a highly-linear voltage-tuned oscillator output mixing with a stable, accurate crystal reference to produce a center marker at 70 MHz and two sliding markers. For accurate interpolation, offset frequency up to 26 MHz is available at rear panel for digital display.

A further refinement on the Analyzer is a simple Spectrum Analyzer function where the frequency band 67-73 MHz can be investigated for the analysis of deviation. Bessel Zero's, with FM at 83.3 kHz and deviation of 141 kHz rms, are easily displayed, allowing deviation measurement to 1 kHz. The Spectrum Analysis function has a sweep rate of 70 Hz and a separate crystal-derived marker at 70 MHz.

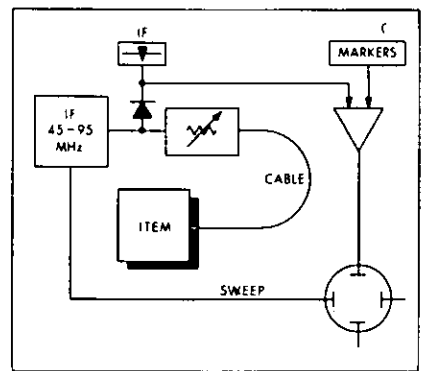


Figure 7. Long cable method of return loss measurement has IF level second-harmonic balanced detector, two-way attenuator and 15 ft. or more of 75 ohm cable. Ripples caused by VSWR of item are noted on display, the item is disconnected, and ripples caused by open-ended cable are attenuated to match the previous ripples. Twice the attenuation applied is the return loss figure.

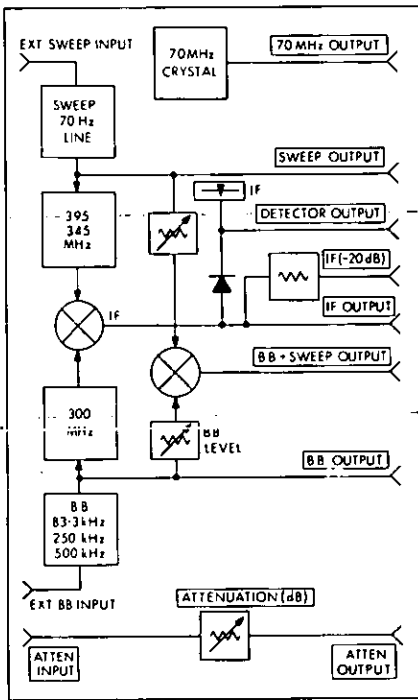


Figure 8. 3701A block diagram.

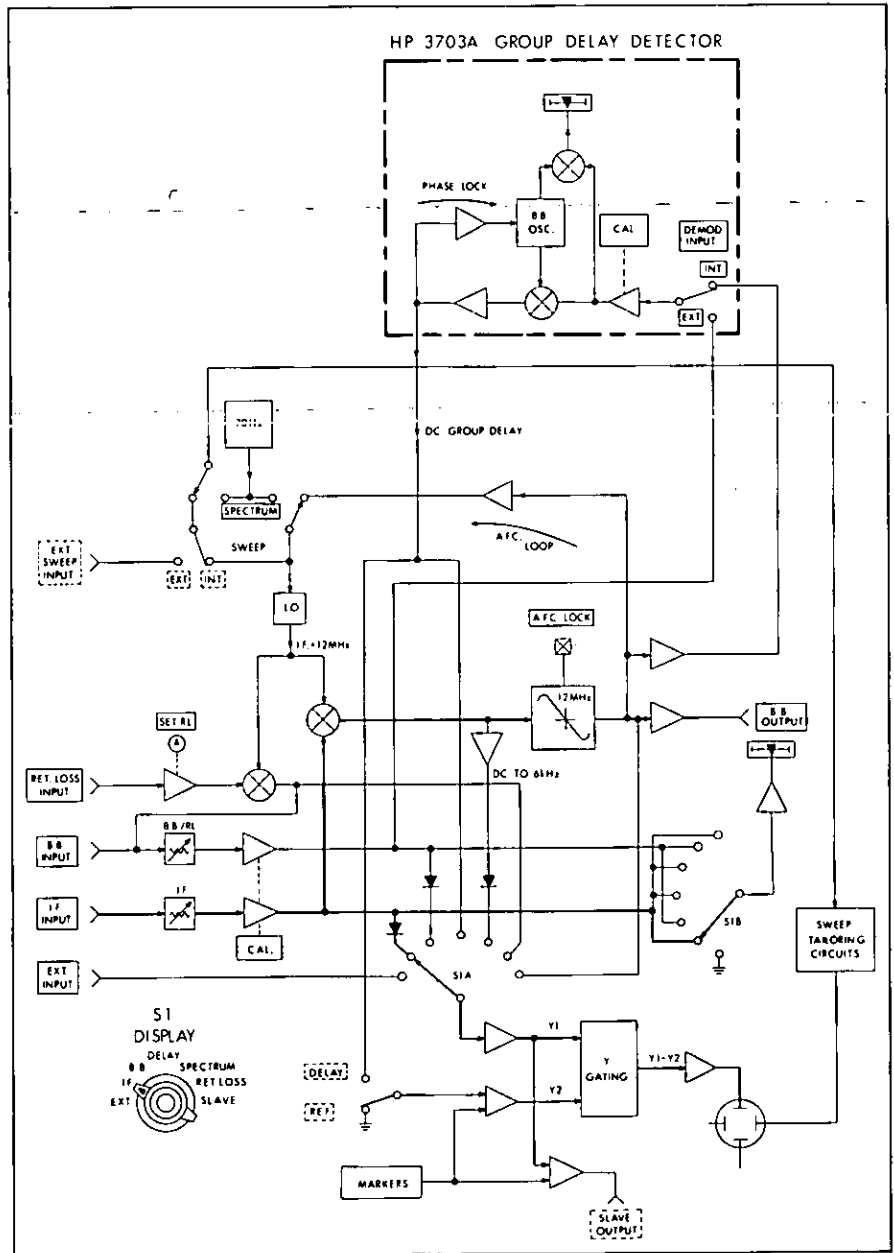
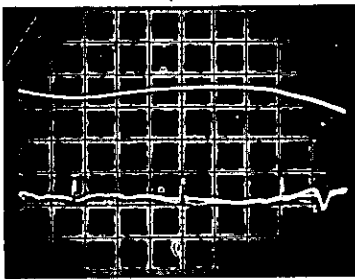


Figure 9. 3702A/3703A block diagram.

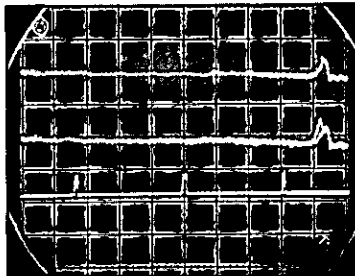
Options

One option offered gives adjustment of phase on the IF sweep, a valuable feature during thru-link tests with slaving for a remote display. Also available as an option, are extra baseband frequencies

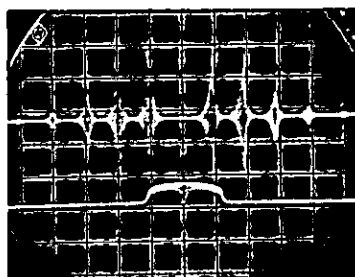
namely the chrominance sub-carriers for color TV transmission testing, 3.50 MHz or 4.50 MHz. With these frequencies using sinewave methods, the critical measurements of differential gain and phase can be made.



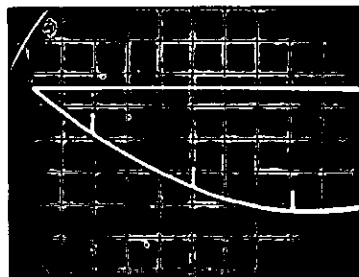
Simultaneous IF response (top) and group delay 0.1 dB/cm and 0.5 nsec/cm



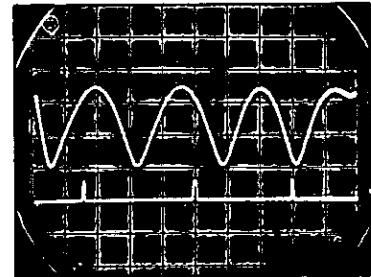
BB linearity. Calibration is at 1% between traces. Lower trace is flatness reference.



Spectrum display of Bessel Zero 2.4, deviation 423 kHz rms. Center marker is 70 MHz.

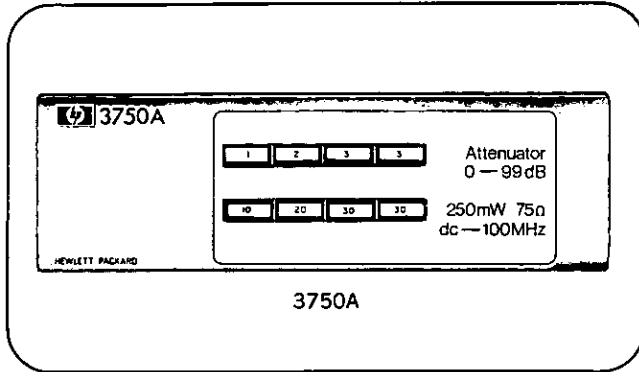


DC-coupled return loss 1 dB/cm. Horizontal line is 30 dB limit. Trace below this line is better than 30 dB.



VSWR ripples with long line. Ripples with long cable open-ended are attenuated to match this.

Oscillograms made with the Microwave Link Analyzer Models 3701A/3702A/3703A show performance over 45-95 MHz swept band with 250 kHz FM, deviation 200 kHz rms, outer markers at 55 and 85 MHz.


ATTENUATORS, ACCESSORIES
Model 3750A, 15526A


DC to 400 MHz
0 to 99 dB by 1 dB steps
VSWR better than 1.1:1
Up to +24 dBm input
75 ohms impedance

Description

The Model 3750A Attenuator is ideally suited for use as a reliable, accurate general-purpose attenuator operating in the communications bands, dc to 400 MHz. It is particularly suited to large-value attenuation of RF signals during receiver and amplifier design.

A controlled-dielectric strip-line attenuator operated by push-buttons in 1, 2, 3, 3, 10, 20, 30, 30 dB steps forms the basis for the Model 3750A. Connectors are 75 BNC female with outer grounded. Insertion loss is less than 0.6 dB. Input powers up to +24 dBm can be accepted, and

either connector can be used as input or output; small size and mounting versatility allows various installation arrangements including stacking, even within other equipments.

Specifications
Attenuation performance

	DC - 100 MHz	100 - 200 MHz	200 - 400 MHz
Units	±0.1 dB	±0.2 dB	±0.2 dB
Tens	±0.2 dB	±1.0 dB	±1.0 dB
Cumulative	±0.5 dB to 79 dB	±2.0 dB to 89 dB	±2.0 dB to 79 dB
	±1.0 dB to 89 dB	±2.0 dB to 89 dB	Not usable
	±2.0 dB to 99 dB	Not usable	

Impedance: 75Ω

Power dissipation: +24 dBm (250 mW).

Maximum SWR: below 1.1:1.

Maximum insertion loss: 0.1 dB at 10 MHz; 0.4 dB at 50 MHz; 0.6 dB at 100 MHz.

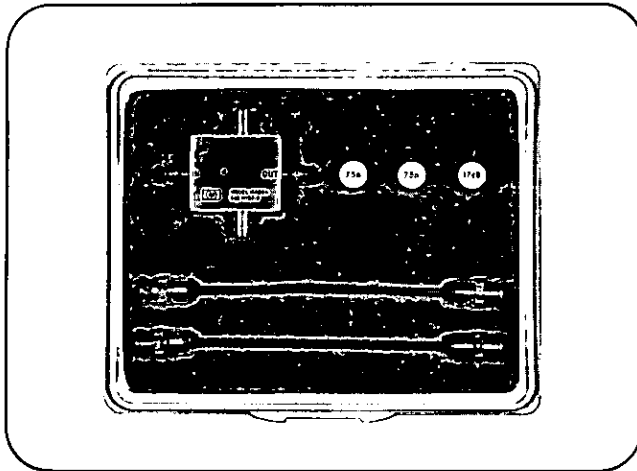
Maximum leakage at 99 dB (100 MHz) is 2 dB.

Dimensions: 8" long x 4" wide x 2¾" high (203 mm x 102 mm x 70 mm).

Weight: 2.8 lb (1,27 kg).

Temperatures: operating 0°C to +50°C; storage -40°C to +65°C.

Price: \$95 (\$80 at factory in Scotland).

Communications Accessories

15525A cable
Description

Constructed from best-quality 75Ω low-loss cable, these cables provide a high standard of connection at nominal cost. Standard cable is 48" (1220 mm) long with BNC male ends.

Prices

Standard BNC, \$8.

Option 002, Siemens 2.5 mm, \$10.

Option 003, Siemens 1.6 mm, \$10.

15526A accessory kit
Description

Developed for use with HP 3701A/2A/3A, these accessories are supplied standard 75Ω BNC with return loss better than 32 dB, except for Model 15521A 17 dB Standard Mismatch. They are supplied in a useful grey molded PVC case which serves for storage and protection. Options offered include Siemens 75Ω connectors, both large and small types.

Contents

Model 15520A, 6 dB Hybrid.

Model 15521A, 17 dB Standard Mismatch.

Model 15522A, 75Ω Termination (two supplied).

Model 15524A, 75Ω Coupler (two supplied).

Prices

Standard BNC, \$140 (\$130 at factory in Scotland).

Option 002, Siemens 2.5 mm, add \$35.

Option 003, Siemens 1.6 mm, add \$35.

MICROWAVE LINK ANALYZER

Checkout 1800 channel systems at IF
Models 3701A, 3702A, 3703A



COMMUNICATIONS
TEST EQUIPMENT

Description

The Microwave Link Analyzer, Models 3701A, 3702A, 3703A, is an integrated system package which offers a wide range of measurements at both baseband (BB) and 70 MHz IF for BB and IF equipment in Microwave Links. It satisfies the needs of engineers involved in development, commissioning and on-site measurements of Microwave Link equipment.

With the Analyzer comes the ability to performance-check 1800 channel systems through a series of realistic measurements, such as group delay and IF band flatness simultaneously with modulation linearity over the 45-95 MHz band. Sensitivity, group delay and modulation linearity of modulators and demodulators can be measured separately. A special SPECTRUM mode allows analysis of modulation index and hence accurate measurement of deviation (± 1 kHz at 83.3 kHz FM) for sensitivity of modulators and demodulators.

Based on CCIR and CCITT recommendations for international standards for Radio Systems, the Analyzer is available as a standard model with 75 ohm BNC connectors. Options offered give differential gain and phase measurements at either 3.50 or 4.50 MHz color TV chrominance sub-carrier frequencies using the Link demodulator; other options give different connectors, including Siemens large and small types.

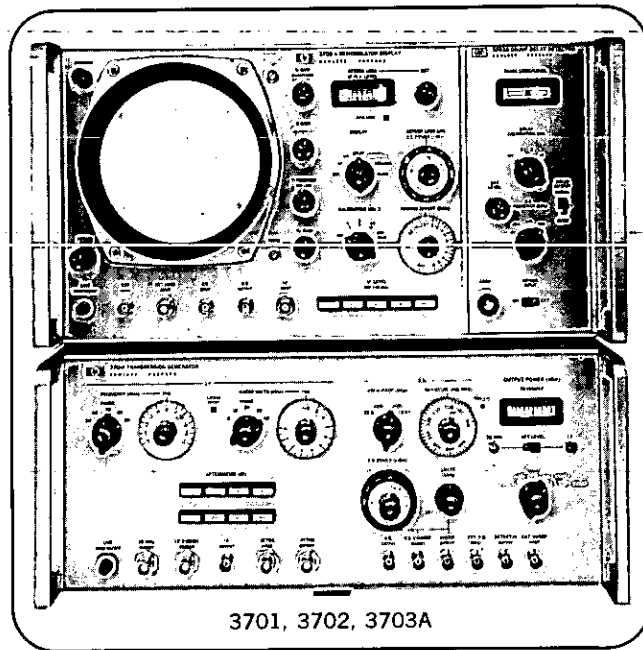
Except for the CRT, the Analyzer is entirely solid-state, having short warm-up and stabilization times, and few regular maintenance requirements. A compatible range of 75 ohm accessories, including a 6 dB Hybrid, are supplied (for further details see page 444).

Operation

The Microwave Link Analyzer is simple to operate. Particular care has been given to logical panel layout and simple cabling set-ups. The Analyzer consists of two principal instruments; Model 3701A Transmission Generator and Model 3702A Demodulator Display. A third instrument, Model 3703A Group Delay Detector is a plug-in for the 3702A and is used in group delay measurements. Figures 8 and 9 (page 443) show the block diagrams of these instruments.

Model 3701A is a BB and IF generator. The highly stable IF is produced by a twin UHF oscillator design, one oscillator fixed at 300 MHz and has FM, the other swept in 70 Hz sinusoidal envelope from 345-395 MHz. Mixing of these two quantities produces a stable 45-95 MHz IF, internally levelled to better than ± 0.2 dB, all housed in the same thermal environment to minimize temperature drift. Sweep width is selectable 0-50 MHz continuous, and FM is superimposed at 83.3, 250 and 500 kHz, as selected, with deviation controllable 100 kHz to 500 kHz rms. Options extend the FM to 3.50 or 4.50 MHz. IF output is +10 dBm direct, can be varied in 1 dB steps down to -89 dBm with 99 dB built-in attenuator.

Model 3702A is a 70 MHz demodulator, with automatic frequency lock (AFC) capabilities; the Model 3702A can thus lock and follow swept IF in the range 45-95 MHz, and



3701, 3702, 3703A

recover frequency modulation up to 1 MHz, deviations up to 500 kHz rms. IF sensitivity of the 3702A is -10 dBm.

Display modes of the Model 3702A Demodulator Display are selected by the DISPLAY switch as follows:

1. EXT. (input at EXT. INPUT)
2. I.F. (display is IF level)
3. B.B. (display is BB level)
4. DELAY (display is group delay)
5. SPECTRUM (display is sidebands above and below carrier)
6. RET. LOSS (direct hybrid measurement at swept frequencies with marker offset frequency 0-26 MHz available for readout)
7. SLAVE (do test on transmit path, playback display on receive path)

Simultaneous display of IF level, BB linearity, or direct-coupled return loss with group delay is one of the valuable features which speeds-up and simplifies on-site Link performance checks. Other features include a calibration facility where IF, BB and group delay displays can be separately calibrated in dB, % and nanoseconds, and frequency markers are available (with marker offset frequency for digital display) to define both specific non-linearity points and IF frequency band.

Model 3702A has Y1 and Y2 channels operating on a time-sharing basis, with Y1 being the continuous signal channel and Y2 being grounded reference channel with frequency markers, except during simultaneous display, when both channels are used. Particularly useful time-saving features include a 70 MHz crystal-controlled output for checking demodulator crossover and a balanced detector at the IF output which gives a detected IF output including VSWR. This latter feature is invaluable for performing return loss measurements by the 'long cable' method.

Checkout 1800 channel systems at IF
Models 3701A, 3702A, 3703A

System Specifications

1 Swept frequency

Measurement	Back-to-back Swept band at 70 MHz			Test Sensitivity
	30 MHz	40 MHz	50 MHz	
IF flatness	±0.1 dB	±0.1 dB	±0.1 dB	0.1 dB/cm
IF group delay	±0.2 nsec	±0.3 nsec	±0.5 nsec	0.33 nsec/cm
Mod/demod group delay	±0.05 nsec	±0.05 nsec	±0.05 nsec	0.33 nsec/cm
Mod group delay	±0.15 nsec	±0.2 nsec	±0.3 nsec	0.33 nsec/cm
Demod group delay	±0.15 nsec	±0.2 nsec	±0.3 nsec	0.33 nsec/cm
Mod/demod linearity	±0.1%	±0.1%	±0.2%	0.25%/cm
Mod linearity	±0.1%	±0.1%	±0.2%	0.25%/cm
Demod linearity	±0.05%	±0.05%	±0.05%	0.25%/cm

2 Fixed frequency

Measurement	Max	Min	Accuracy	Frequency band
BB power	-10 dBm	-32 dBm	±0.5 dB	50 kHz to 12 MHz
BB gain	39 dB	0 dB	±0.5 dB	83.3, 250 and 500 kHz
BB insertion loss	43 dB	0 dB	±0.5 dB	83.3, 250 and 500 kHz
IF power	+12 dBm	-10 dBm	±0.5 dB	67 MHz to 73 MHz
IF gain	101 dB	0 dB	±0.5 dB	
IF insertion loss	22 dB	0 dB	±0.5 dB	
Mod sensitivity	-49 dBm 141 kHz	-10 dBm 141 kHz	±0.5 dB ±1 kHz	45 MHz to 95 MHz
Demod. sensitivity	-10 dBm 141 kHz	-32 dBm 141 kHz	±0.5 dB ±1 kHz	45 MHz to 95 MHz
Klystron mod. Linearity Mode center	— — —	— — —	±0.2% ±1 MHz	All bands

3 Return loss

Method	Max.	Min.	Accuracy	Frequency band
Hybrid	10 dB	32 dB	±2.5 dB at 32 dB	45 MHz to 95 MHz
Long cable	0	46 dB	±1 dB	45 MHz to 95 MHz

3701A Transmission generator

Description

Mode switch controls baseband modulation and sweep applied to IF.

Setting	Sweep rate	Baseband (kHz)
Manual	Use I.F. Fine	83.3/250/500/ext.
Auto	70 Hz	—
Line	Line	83.3/250/500/ext.
B.B. +sweep	70 Hz	83.3/250/500/ext.
B.B. +ext. sweep	External	83.3/250/500/ext.

Specifications

IF range: 50, 60, 70, 80, 90 MHz with ±5 MHz on vernier; accuracy ±0.5%, ±0.5 MHz at +25°C, ±1 MHz from 0°C to +50°C.

IF output: +8 dBm to +12 dBm with SET LEVEL; accuracy ±0.5 dB levelled to better than ±0.1 dB over 45 to 95 MHz, return loss 30 dB with ±15 MHz sweep, 28 dB with ±25 MHz sweep.

70 MHz output: 10 dBm, adjustable with SET LEVEL; crystal-derived for accurate frequency checking, ±0.01%.

Meter: reads IF or 70 MHz OUTPUT, +8 dBm to +12 dBm, 0.5 dB sub-divisions.

IF sweep rates: power line, 70 Hz, manual (IF FINE) or external; sweep harmonics better than 30 dB down on 70 Hz; internal sweep widths 0 to 50 MHz with step and vernier, centered on IF, accuracy ±2 MHz for internal 70 Hz, ±20% for line sweep 50/60 Hz; external sweep: frequencies 40 Hz to 500 Hz; 5 V peak-peak into 7 kΩ at EXT. SWEEP INPUT maintains sweep calibration.

Baseband: frequencies 83.3, 250, 500 kHz or external; output: +11 dBm ±0.5 dB, return loss 26 dB 50 kHz to 1 MHz; frequency stability: ±5 ppm, 0°C to +50°C; aging rate: ±0.2 ppm per month; external baseband 10 kHz to 12 MHz.

Modulator: sensitivity, -36 dBm ±1 dB/200 kHz rms; constant to ±0.1% over IF band.

Deviation: range 100 kHz to 500 kHz rms with internal baseband, accuracy ±5 kHz up to 430 kHz; ±20 kHz above 430 kHz.

BB + sweep output: baseband frequencies combined with sweep frequency of power line, 70 Hz, or external (40-500 Hz); sweep output variable 0 to 5 V p-p continuous, baseband output variable -49 dBm to -10 dBm stepped at 1 dB.

Attenuator: range 99 dB in 1 dB steps; accuracy ±0.1 dB units, ±0.2 dB tens, ±0.5 dB any combination; insertion loss 0.4 dB at 50 MHz, 0.6 dB at 100 MHz; frequency range dc to 100 MHz; maximum input +24 dBm.

Detector output: detected level of IF is available for displaying return loss on 3702A Demodulator Display, using 'long cable' method of measurement.

Price: \$2700 (\$2450 at factory in Scotland).

Options

001: variable phase and amplitude facility on rear panel.

Phase: 0° ±120°, 180° ±120° continuous.

Output: 0 to 6 V peak-peak at 75Ω.

Price: add \$100.

002: Siemens 2.5 mm large connectors, 75Ω.

Price: add \$75.

003: Siemens 1.6 mm small connectors, 75Ω.

Price: add \$95.

004: not assigned.

005: TV color sub-carrier 4.50 MHz.

Price: add \$300.

006: TV color sub-carrier 3.50 MHz.

Price: add \$300.

3702A demodulator display

Description

Display mode: two channels are displayed on a CRT. In most measurements one channel is the reference channel. Guaranteed CRT sensitivities are 0.1 dB/cm, 0.25%/cm and 0.33 nsec/cm. Signal channel is switched to display seven functions as follows:

Setting	Function Y1	Calibration traces
Ext.	External	50 mV
I.F.	IF amplitude	0.1, 0.3, 1 dB
B.B.	BB amplitude	1, 3, 10%
Delay	Group delay	1, 3, 10 nsec
Spectrum	Spectrum	—
Ret. loss	Return loss	0.1, 0.3, 1 dB
Slave	Slaving	dB, % or nsec

Specifications

X phase shift: adjusts symmetry of recovered X-axis sweep.

IF range: 45 to 95 MHz at IF INPUT; sensitivity -10 dBm to $+12$ dBm; 22 dB step attenuator (± 0.3 dB) compensates for powers greater than -10 dBm; return loss 30 dB over ± 15 MHz sweep, 28 dB over ± 25 MHz sweep.

Automatic frequency control: ± 1 MHz captive range at 70 MHz; 45 to 95 MHz dynamic hold-in range; sweep rates at 45-85 Hz can be followed.

BB input: feeds detector and meter through 22 dB attenuator; basic sensitivity is -32 dBm, accuracy of power measurement ± 0.5 dB; frequency response 80 kHz to 12 MHz.

BB output: baseband frequencies demodulated from IF; internally coupled to 3703A for group delay measurements.

Demodulator: sensitivity -15.5 dBm ± 2 dB/200 kHz rms at 83.3 kHz rate. Response < 0.5 dB down at 700 kHz rms deviation with rates, 50 kHz to 600 kHz. Useable bandwidth 3 MHz max.

Meter: center zero, calibrated -0.5 to $+0.5$ dB with 0.25 dB graduations; when set to read zero by IF ATTENUATOR or BB LEVEL or RETURN LOSS controls, the input power can be read off the control.

Return loss: direct-coupled return loss on Y2 display, gives return loss simultaneously with IF level, using the HP 15520A Hybrid. Initial calibration is achieved with HP 15521A 17 dB Standard Mismatch, using the RET. LOSS INPUT; display sensitivity can be calibrated to 1 dB/cm; frequency range 45 to 95 MHz, sensitivity -54 dBm, flatness ± 0.5 dB.

Spectrum: display of fixed IF and sidebands, maximum display 67-73 MHz; spectrum sweep is 70 ± 5 Hz; minimum width is 1 MHz, with SPECTRUM WIDTH control.

Ext. input (Y1): frequency 5 Hz to 70 kHz (3 dB) on Y1 GAIN; sensitivity 5 to 600 mV/cm (Y GAIN), input impedance 1 M Ω in parallel with < 50 pf, max. input 6 V peak-peak.

Calibration: amplitude: 0.1, 0.3, 1.0 dB (at IF); 1, 3, 10% (at BB) selected by CALIBRATION control, accuracy $\pm 10\%$; frequency: selected by MARKER OFFSET, on center marker at 70 MHz ($\pm 0.01\%$) and two sliding markers up to 52 MHz separation; for accurate interpolation, the frequency is available on the rear panel at MARKER OFFSET connector as a clipped sine wave, frequency 0.26 MHz, amplitude 0.5 V peak-peak minimum into 75 Ω .

Price: \$3750 (\$3400 at factory in Scotland).

Options:

001: not assigned.

002: Siemens 2.5 mm large connectors, 75 Ω .

Price: add \$100.

003: Siemens 1.6 mm small connectors, 75 Ω .

Price: add \$110.

3703A group delay detector

Description

Output (internally connected to display channel of 3702A) is dc voltage proportional to instantaneous value of group delay on baseband frequencies of 83.3, 250, 500 kHz and 3.50 and 4.50 MHz added by Option 005, which for measurements at IF requires use of external demodulator.

Specifications

Group delay: maximum resolution at 500 kHz: 0.1 nsec, 250 kHz: 0.2 nsec, 83.3 kHz: 0.6 nsec. Resolution limits set by system noise. Above noise is obtained with back-to-back IF tests, 200 kHz rms deviation; minimum measureable phase difference is 0.01° .

Display: total of 80 nsec on Y1 channel, 40 nsec on Y2.

Calibration: 1, 3 or 10 nsec on display, accuracy $\pm 10\%$.

Phase detector: mean-phase tracking between reference baseband of the 3703A and group delay baseband is achieved by means of a phase-lock loop. The display can be inverted with the NORMAL/INVERT switch. INT/EXT switch gives internal baseband demodulated from IF (INT) in 3702A or requires baseband demodulated externally to be applied to BB INPUT.

Reference baseband: frequency, 83.3, 250 or 500 kHz, crystal-derived, stability and aging same as 3701A baseband.

Meter: indicates phase lock and correct phase detector input level.

Price: \$750 (\$650 at factory in Scotland).

Options:

001 thru 004: not assigned.

005: modified to measure group delay on TV color sub-carriers 3.50/4.50 MHz.

Price: add \$100.

General System Specifications

Connectors: all impedances are 75 Ω BNC unless otherwise stated.

Temperatures: operating, 0°C to $+50^\circ\text{C}$.
storage, -40°C to $+65^\circ\text{C}$.

Weights:	net		Shipping
	lb.	(kg)	
3701A	31.5	(14.2)	40 (18)
3702A	44	(20)	55 (25)
3703A	3	(1.4)	4 (1.8)

Power:	Volts		Hz		Watts
	3701A	3702A	3701A	3702A	
3701A	115/230 ($\pm 10\%$)	115/230 ($\pm 10\%$)	45-100	45-100	80
3702A	115/230 ($\pm 10\%$)	115/230 ($\pm 10\%$)	45-100	45-100	100
3703A	3702A	3702A	3702A	3702A	3

Dimensions:	wide (mm)		high (mm)		deep (mm)
	3701A	3702A	3701A	3702A	
3701A	16 $\frac{3}{4}$ " (425)	16 $\frac{3}{4}$ " (425)	6 $\frac{7}{8}$ " (177)	6 $\frac{7}{8}$ " (177)	18 $\frac{3}{8}$ " (467)
3702A	16 $\frac{3}{4}$ " (425)	16 $\frac{3}{4}$ " (425)	8 $\frac{3}{8}$ " (221)	8 $\frac{3}{8}$ " (221)	18 $\frac{3}{8}$ " (467)
3703A	3 $\frac{3}{8}$ " (92)	3 $\frac{3}{8}$ " (92)	8 $\frac{1}{4}$ " (210)	8 $\frac{1}{4}$ " (210)	10 $\frac{5}{8}$ " (270)

Accessories furnished:	3701A	3702A	3703A
15520A	—	1*	—
15521A	—	1*	—
15522A	1*	1*	—
15524A	1*	1*	—
15525A	1	2	—
PVC Box	—	1*	—

*Items comprise accessory Kit 15526A. For description see page 444. When system is ordered, 15526A Kit plus three 15525A are supplied.



The goal of audio and communications equipment is to reproduce input signals faithfully at the output. System nonlinearity distorts the waveshape of the signals. Poor reproduction brought about by distortion will appear to the user of audio equipment as a change in the quality or as noise; to the user of communications gear, it appears as channel crosstalk.

Distortion in amplifiers, created by non-linear circuits, consists of components present in the output that are not contained in the input signal. Distortion in a sine-wave signal source consists of frequency components that exist in the output in addition to the fundamental frequency. An ac signal that appears to be a pure sine wave as viewed on an oscilloscope (Figure 1) may have some harmonic distortion. The total of these frequency components present in the signal in addition to the fundamental frequency can be measured quickly and easily with Hewlett-Packard distortion analyzers.

One type of distortion analyzer contains a narrow-band rejection filter which, when properly tuned, removes the fundamental frequency so that the amplitude of the remaining components can be measured simultaneously. HP distortion analyzers are used for fast quantitative measurements of total harmonic distortion and noise.

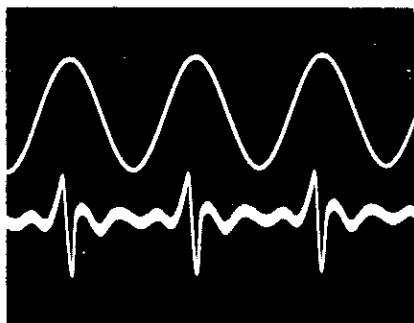


Figure 1. Output signal of nonlinear system, with the fundamental filtered out, is the lower trace on the oscilloscope screen. The residual output shows that a seemingly pure sine wave does in fact contain harmonics.

Total Harmonic Distortion Analysis

This measurement technique compares the amplitude of the harmonics to that of the original signal at the output where the original signal becomes the fundamental frequency of the harmonics. The defining equation is:

$$(1) \text{ total harmonic distortion} = \frac{\sqrt{\sum(\text{harmonics})^2}}{\text{fundamental}}$$

A frequency-selective voltmeter is needed to measure the fundamental, and either a selective voltmeter with a wide dynamic

range or a frequency rejection circuit with a true rms detector is needed to measure the harmonics. The frequency rejection circuit nulls the fundamental and passes its harmonics to the detector with no attenuation so that the ratio between the fundamental and harmonics can be determined.

A less expensive way to measure the total harmonic distortion, however, is to use a rejection filter and a broadband detector. Since the fundamental is not directly measured, the equation becomes

$$(2) \text{ THD} = \frac{\sqrt{\sum(\text{harmonics})^2}}{\sqrt{(\text{fundamental})^2 + (\text{harmonics})^2}}$$

If the distortion is less than 10%, the denominator of equation 2 will be within 1/2% of the denominator in equation 1, which is as accurate as any frequency selective voltmeter.

Another approximation usually made for economy is average measurement instead of rms measurement indicated in (2).

There are two difficulties in making total harmonic distortion measurements. First, to get a measurement within the desired accuracy, the harmonic content of the test signal must not be more than a third of the distortion expected to be caused by the system. Second, the chore of nulling the fundamental can be time consuming. Oscillators that meet the distortion requirements and automatic nulling equipment, which has recently become available, can overcome the difficulties.

Automatic Null

Since the nulling of the fundamental is normally the time-consuming portion of total harmonic distortion measurement, great savings can be realized, especially in production line testing with an analyzer which automatically rejects the fundamental. The time saved is as much as 25 seconds of a 30-second measurement. With automatic nulling, the accuracy of the null achieved is no longer a function of operator training, manual dexterity, or signal source frequency drift.

Automatic nulling circuitry in Hewlett-Packard distortion analyzers, the HP 333A and 334A, operates on the principle that the fundamental at either side of a Wien bridge off null follows well-known phase relationships.

In this instrument (Figure 2), phase-sensitive feedback loops are employed which drive photocells in parallel with the resistances on either side of the bridge. These loops reject the fundamental and are not critical to adjust, since any imbalance on one side of the bridge is automatically compensated for on the other. Imbalances on either side cause phase errors in the fundamental which are in quadrature, so the phase-sensitive feedback loops are independent of each other.

The analyzer will maintain a null even

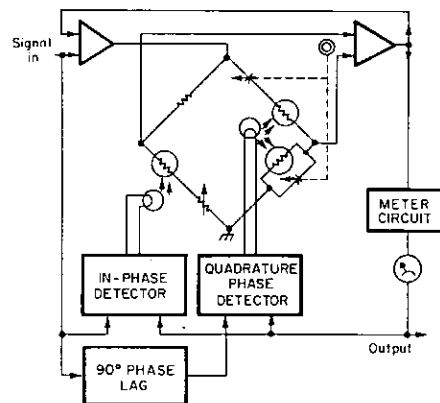


Figure 2. Rejection amplifier with automatic nulling circuitry. Phase detectors sense bridge unbalance and control intensity of lamps to change resistance of photoconductors, thus adjusting bridge to reject fundamental frequency of input signal.

though there is a slow drift in the input frequency. This ability to "pull" the null has opened the door to a number of applications where the total harmonic distortion measurements were not readily applied in the past. Among them are:

1. Single-frequency production line testing of such components as integrated-circuit amplifiers or transformers. As long as the long-term drift of the signal source is less than $\pm 1\%$, a good null will be achieved.
2. Optimizing the performance of an oscillator. Here, any variation in the parameters causes the frequency to shift slightly. The automatic nulling of the analyzer allows the oscillator performance to be improved on a continuous basis rather than by relying on a point-to-point check which may or may not find the optimum point.
3. Correcting distortion in signal generators which produce sine waves by mixing or by non-linear shaping. The small frequency shifts would cause the loss of the null if it were not for the automatic null feature.

Selecting an Analyzer

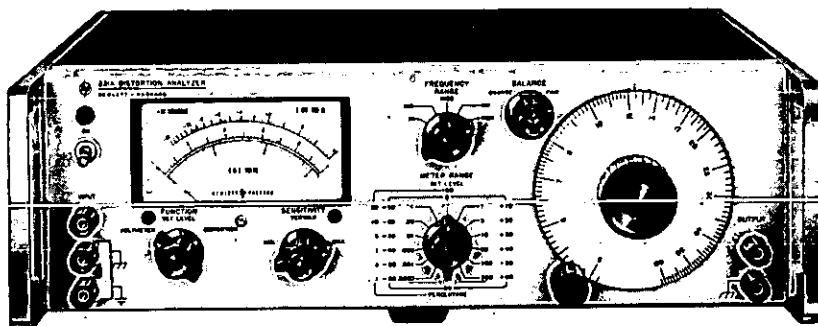
Distortion analyzers may be regarded as the inverse of wave analyzers. Distortion analyzers *remove* any signal component to which they are tuned, having the rest of the signal for measurement. In practice, distortion analyzers are tuned to the fundamental frequency and, by measuring the amplitude of the remaining harmonic components all at once, they provide an indication of percentage total harmonic distortion. Distortion analyzers do not provide information about individual distortion products—wave analyzers (See page 451) and spectrum analyzers (See page 399) do this job, but they do not provide fast readings of the signal's total departure from sine wave purity.

DISTORTION ANALYZERS

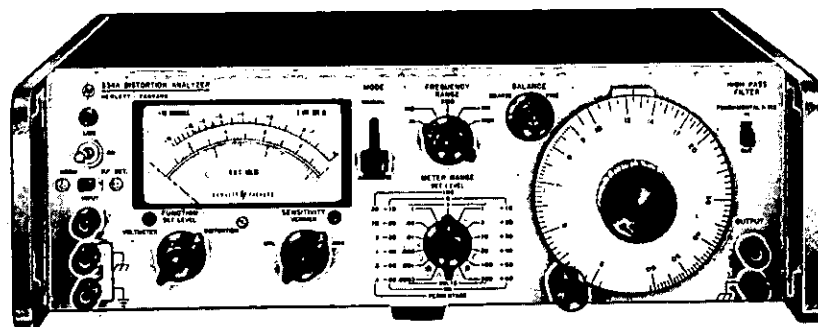
Manual or auto tuned; FCC approved
Models 331A, 332A, 333A, 334A



DISTORTION ANALYZERS



331A



334A

Description

Distortion Analyzers have gone solid-state, offering extended tuning range, greater set-level sensitivity, improved selectivity, and greater overall accuracy. The Model 331A, 332A, 333A and 334A Distortion Analyzers measure total distortion down to 0.1% full scale at any frequency between 5 Hz to 600 kHz; harmonics are indicated up to 3 MHz. These instruments measure noise as low as 50 microvolts and measure voltages over a wide range of level and frequency. All four models may be used as sensitive wide-range transistorized voltmeters for general-purpose voltage and gain measurements. The transistorized ac voltmeter provides 13 ranges from 300 μ V to 300 V rms full scale.

Automatic Fundamental Nulling

Automatic fundamental nulling (available in HP Models 333A and 334A) speeds up the normally time-consuming portion of the measurement. This is done by manually nulling with the coarse tuning and balance controls to less than 10% of the Set-Level Reference. The automatic mode is used to complete rejection of the fundamental on more sensitive ranges without any further manual tuning.

Amplitude Modulation Detector

The HP Models 332A, 332A option H05, 334A and 334A option H05 Analyzers are provided with an amplitude modulation detector having a frequency range from 550 kHz to greater than 65 MHz.

The high-impedance dc restoring peak detector which utilizes a semiconductor diode measures distortion at carrier levels as low as 1 V. The input to the detector is located

on the rear of the instrument. The Model 334A is similar to Model 332A, but is provided with Automatic Fundamental Nulling and a High-Pass Filter.

The 332A option H05 and 334A option H05 meet FCC requirements on broadcast distortion levels. Both models measure total distortion down to 0.1% full scale. The Model 334A option H05 features automatic fundamental nulling. The 332A option H05 and 334A have a switchable low pass filter to reduce the effect of unwanted high frequencies (noise, etc.) when measuring lower frequency signals with high accuracy.

High-Pass Filter

In order to reduce the effect of hum components, a high-pass filter is provided which attenuates frequencies below 400 Hz. The filter may be activated by a front-panel switch when measuring distortion of signals greater than 1 kHz in frequency.

Models And Available Features

Model No.	Automatic Fundamental Nulling	Hi-Pass Filter	Lo-Pass Filter	AM Detector	Gear Reduction Tuning
331A					X
332A				X	X
332A op. H05			X	X	X
333A	X	X			
334A	X	X		X	
334A op. H05	X		X	X	

Optional, for each model, features VU meter characteristics conforming to FCC requirements.

Option 001, for each model, features VU meter characteristics conforming to FCC requirements.

Specifications

Model 331A

Distortion measurement range: any fundamental frequency, 5 Hz to 600 kHz. Distortion levels of 0.1%-100% are measured full scale in 7 ranges.

Distortion measurement accuracy

Harmonic measurement accuracy (full scale)

Fundamental Input Less Than 30 V

Range	±3%	±6%	±12%
100%-0.3%	10 Hz-1 MHz	10 Hz-3 MHz	
0.1%	30 Hz-300 kHz	20 Hz-500 kHz	10 Hz-1.2 MHz
Fundamental Input Greater Than 30 V			
Range	±3%	±6%	±12%
100%-0.3%	10 Hz-300 kHz	10 Hz-500 kHz	10 Hz-3 MHz
0.1%	30 Hz-300 kHz	20 Hz-500 kHz	10 Hz-1.2 MHz

Elimination characteristics

Fundamental rejection >80 dB.

Second harmonic accuracy for a fundamental of:

- 5 to 20 Hz: better than +1 dB.
- 20 Hz to 20 kHz: better than ±0.6 dB.
- 20 kHz to 100 kHz: better than -1 dB.
- 100 kHz to 300 kHz: better than -2 dB.
- 300 kHz to 600 kHz: better than -3 dB.

Distortion introduced by instrument: <0.03% from 5 Hz to 200 kHz; <0.06% from 200 kHz to 600 kHz.

Meter indication is proportional to the average value of a sine wave.

Frequency calibration accuracy

- Better than ±5% from 5 Hz to 300 kHz.
- Better than ±10% from 300 kHz to 600 kHz.

Input impedance: distortion mode: 1 MΩ ±5% shunted by less than 70 (*90) pF (10 MΩ shunted by <10 pF with HP 10001A 10:1 Divider Probe).

Voltmeter mode: 1 MΩ ±5% shunted by <35 pF 1 to 300 V rms; 1 MΩ ±5% shunted by <70 pF, 300 μV to 0.3 V rms.

Input level for distortion measurements: 0.3 V rms for 100% set level or 0.245 V for 0 dB set level (up to 300 V may be attenuated to set-level reference).

DC isolation: signal ground may be ±400 V dc from external chassis.

Voltmeter range: 300 μV to 300 V rms full scale (13 ranges) 10 dB per range.

Voltmeter accuracy (using front panel input terminals)

Range	±2%	±5%
300 μV	30 Hz-300 kHz	20 Hz-500 kHz
1 mV-30 V	10 Hz-1 MHz	5 Hz-3 MHz
100 V-300 V	10 Hz-300 kHz	5 Hz-500 kHz

Noise measurements: voltmeter residual noise on the 300 μV range: <25 μV rms, when terminated in 600Ω (shielded), <30 μV rms terminated with a shielded 100 kΩ resistor.

Output: 0.1 ±0.01 V rms open circuit and 0.05 ±0.005 V rms into 2 kΩ for full scale meter deflection.

Output impedance: 2 kΩ.

Power supply: 115 or 230 V ±10%, 50 to 400 Hz, approximately 4 W. Terminals are provided for external battery supply. Positive and negative voltages between 30 V and 50 V are required. Current drain from each supply is 40 mA.

Model 332A

Same as Model 331A except as indicated below:

AM detector: high impedance dc restoring peak detector with semiconductor diode operates from 550 kHz to greater than 65 MHz. Broadband input, no tuning is required.

Maximum input: 40 V p-p ac or 40 V peak transient.

Distortion introduced by detector: carrier frequency: 550 kHz-1.6 MHz: <50 dB (0.3%) for 3-8 V rms carriers modulated 30%. 1.6 MHz-65 MHz: <40 dB (1%) for 3-8 V rms carriers modulated 30%.

NOTE: distortion introduced at carrier levels as low as 1 V is normally <40 dB (1%) 550 kHz to 65 MHz for carriers modulated 30%.

332A option H05: same as 332A except low-pass filter is added (4 pole, 3 dB down at 30 kHz); meter reads in dBm.

Model 333A

Same as Model 331A except as indicated below:

Automatic nulling mode

Set level: at least 0.2 V rms.

Frequency ranges: X1, manual null tuned to <3% of set level; total frequency hold-in ±0.5% about true manual null. X10 through X10 k, manual null tuned to <10% of set level; total frequency hold-in ±1% about true manual null.

Automatic null accuracy

5 Hz to 100 Hz; meter reading within 0 to +3 dB of manual null. 100 Hz to 600 kHz; meter reading within 0 to +1.5 dB of manual null.

High-pass filter: 3 dB point at 400 Hz with 18 dB per octave roll off. 60 Hz rejection >40 dB. Normally used only with fundamental frequencies greater than 1 kHz.

Power supply: same as Model 331A except current drain from each supply is 80 mA.

Model 334A

Same as Model 333A except includes AM Detector described under Model 332A.

334A option H05: same as 334A except a low-pass filter is substituted for the high-pass filter; meter reads in dBm.

General

Weight: net 17¼ lbs (8 kg); shipping 26 lbs (11.8 kg).

Dimensions: 16¾" wide, 5" high (without removable feet), 13¼" deep (426 x 126 x 337 mm).

Accessories furnished: rack mounting kit for 19" rack.

Price: HP 331A, \$650; HP 332A, \$680; HP 333A, \$895; HP 334A, \$925. 332A option H05, add \$110; 334A option H05, add \$85; option 001, indicating meter has VU characteristics conforming to FCC requirements for AM/FM and TV broadcasting; add \$15.



What Is a Wave Analyzer?

A wave analyzer can be thought of as a finite bandwidth window filter which can be tuned throughout a particular frequency range.

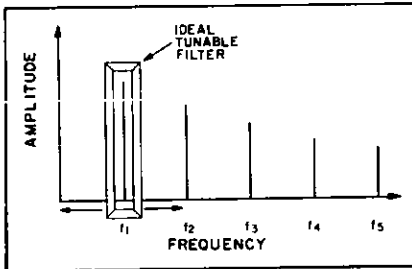


Figure 1. Wave Analyzer Tunable Filter.

Signals located on the frequency spectrum will be selectively measured as they are framed by the window. Thus, for a particular signal, the wave analyzer can indicate its frequency (window position) and amplitude. Amplitude is read on an analog meter; frequency is read on either a mechanical or electronic readout.

Wave analysis measurement techniques were introduced some twenty-five years ago and are used more today than ever before. Continued improvement in sensitivity and dynamic range along with frequency resolution has opened many new application areas.

Today's wave analyzer measurements can be divided into three broad areas:

1. Selective measurements of signals with large differences in level. Examples are distortion analysis, measurements of low level signals very close in frequency to much larger signals, or identification of low level signals obscured by broadband noise.
2. Determination of noise characteristics (noise/ $\sqrt{\text{Hz}}$) by utilizing the well-defined bandwidth of a wave analyzer. Noise power spectral density can also be measured over the entire frequency range of the instrument.
3. Frequency response testing, using the tracking output as an excitation source to make tests at ultra-low threshold levels. The wave analyzer's high sensitivity eliminates harmonics, spurious responses and ground loop effects.

Each generation of wave analyzers has seen increasingly useful improvements. First, there was the basic tunable filter and broadband voltmeter. Now there are features such as autoranging, automatic frequency control (AFC), electronic sweeping, counter digital readout, select-

able bandwidths, and recorder outputs. These convenience and performance features make the instrument easy to use, but they are not the only considerations in selecting a wave analyzer.

The selectivity of a wave analyzer is its greatest asset and a most important specification. Selectivity is defined by the 3 dB bandwidth and the shape factor of the bandpass. The smaller the shape factor number, the more selective the instrument will be. Note the passband (dotted line) in Figure 2. Specifying just the 3 dB bandwidth (bandwidth C) can be misleading—but specifying the ratio of two selected bandwidths (usually —3 or —6 dB and the —60 dB points) provides further definition of the sharpness of the skirt (solid line in the diagram).

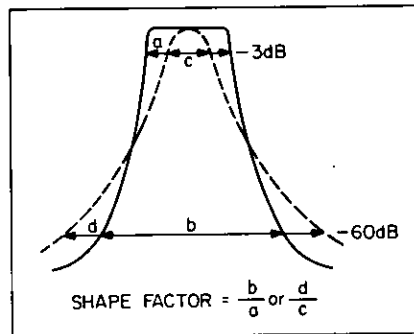


Figure 2. Shape factors for different wave analyzers.

A shape factor so defined gives a true picture of the bandpass. Today's wave analyzers have shape factors as low as 2:1. These are especially useful in making critical frequency measurements where signal density is high.

Dynamic range is an important wave analyzer characteristic. It defines the range of the smallest to the largest signal the instrument can accommodate simultaneously. Some wave analyzers are capable of an 85 dB range. The relationship between dynamic range and attenuator range is shown in Figure 3. The top end of the attenuator range is limited by the amount of attenuation built in and

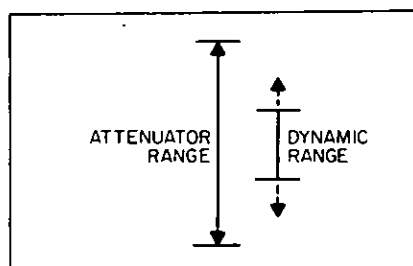


Figure 3. Relationship between attenuation and dynamic range.

the bottom end by the instrument's sensitivity. Dynamic range is limited by nonlinearities and noise.

Wave analyzers designed with two attenuators allow tracking of the dynamic range of the input. This helps to avoid input overloading that causes measurement inaccuracies. Autoranging further extends the capability of a wave analyzer to track the dynamic range of the input.

To obtain high sensitivity measurements without loading a low-level circuit under test, a wave analyzer with high input impedance is necessary. There is always a trade-off between high sensitivity and high input impedance. Trade-off optimization depends on the application. Input impedances range from 10 k Ω to 1 M Ω while full scale sensitivities range from 3 μV to 50 μV .

Hewlett-Packard wave analyzers cover a broad frequency range from 20 Hz up to 22 MHz. The 3590A covers the audio range plus the RF range to 620 kHz. The 302A covers the audio range and frequencies to 50 kHz. The 310A provides coverage in the video range, 1 kHz to 1.5 MHz. The 312A extends the coverage to 18 MHz in 18 overlapping bands (22 MHz with the 312A option H01). This analyzer is useful for testing multiplex communications systems, IF and video amplifiers, filters, and attenuators. Each Hewlett-Packard wave analyzer contains special features which adapt it to specific uses. Many features are included for ease of operation, accuracy of readings and ability to compare signals of great variation in amplitude. The selective bandwidths, the shape factor of these bandwidths, and the dynamic range (from 72 dB to greater than 85 dB) enhance the use of these wave analyzers. The following individual description of each instrument enlarges upon the features contained by each model.

Model 3590A

The 3590A Wave Analyzer measures the frequency components of simple or complex signals over an extremely wide amplitude range—more than 85 dB—without manual range switching. Automatic ranging makes successive measurements of all signal components quick and easy. It also gives the instrument ability to make linear dB recordings over the full 85 dB dynamic range. No time is lost making the many up-and-down range changes usually required with wave analyzers when signal components have widely differing amplitudes.

The 3590A also has a wide frequency range; it tunes from 20 Hz to 620 kHz in two overlapping ranges (20 Hz to 62 kHz and 500 Hz to 620 kHz).



Figure 4. Recording shows the intermodulation distortion products of an amplifier driven by signal f_1 and f_2 .

Wide Range Recorder Outputs

Of particular importance, the new Wave Analyzer has both logarithmic and linear dc outputs to drive the X and Y axes of recorders. One Y-axis output is linearly proportional to the measured voltage amplitude, and the second output is proportional to the logarithm of the measured amplitude (linear dB). This voltage spans the instrument's more-than-85 dB dynamic range, making this the first wave analyzer to provide a wide-range output suitable for driving all kinds of recorders. With the built-in electronic sweep tuning, a full frequency range plot is easily made of the spectral frequency distribution. Also, frequency response recordings can be made over the entire 85 dB dynamic amplitude range. In addition, the front-panel meter can be switched to read the logarithmic Y-axis voltage, thus displaying amplitude over the full dynamic range on a single, linear, 0 to -90 dB scale. This simplifies reading interpretation when many different amplitude levels are involved.

For driving the X-axis of recorders, another output supplies a voltage proportional to the instrument's tuning. This output can be linearly proportional to frequency, generating X-Y recordings with a linear frequency scale on which harmonic relationships are determined easily. Alternatively, the output can be switched to make the output voltage logarithmically proportional to frequency. With the logarithmic X and Y outputs, wide-range frequency response measurements can be made on the familiar semilog paper (see Figure 5), enabling Bode plots of amplifier or filter frequency response to be made directly. If one wishes, recordings can be made with any combination of linear and logarithmic axes (log-log, lin-log, log-lin, lin-lin).*

*Lin-lin or log-lin plots can also be made with a strip-chart recorder, which supplies a linear X-axis.

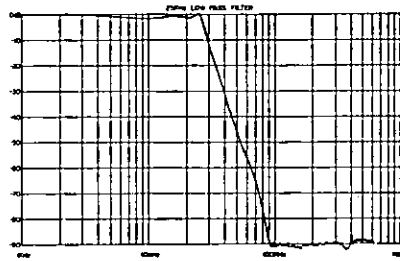


Figure 5. Bode plots can be recorded directly by sweeping and stimulating the device under test with the 3590's internal tracking output (BFO) and using the log-log recorder outputs.

The New Generation

The new Hewlett-Packard Model 3590A Wave Analyzer is easier to use than previous instruments. Annunciator lights show overall sensitivity in response to settings of both the interstage range switch and the input attenuator. In the automatic mode, the interstage ranges are switched automatically with the annunciator lights showing the selected interstage dB range and the overall voltage sensitivity. Meter scales are backlighted to show which scale is in use.

Frequency is likewise easy to read on this new instrument. Frequency readout is in plug-ins, one of which contains a 5-digit electronic counter. The counter measures the tuning frequency with an accuracy of better than 0.001% with 10 Hz resolution on the 200 Hz-to-620 kHz frequency range and with 1 Hz resolution on the 20 Hz-to-62 kHz range. The counter also supplies instantaneous readings of frequency as the instrument sweeps.

Where 5-digit resolution is not required in frequency measurements, a second plug-in has a mechanical 3-digit-plus-vernier readout. This gives frequency readout with 1% accuracy and with 100 Hz resolution on the high range and 10 Hz resolution on the low range. Should higher resolution and accuracy be desired on some occasion, an external electronic counter can be used to read the "restored frequency" output, an amplified replica of the selected input signal component available at a front-panel connector.

The instrument tunes easily. It is only necessary to approach the correct tuning, and an automatic frequency control (AFC) circuit then "pulls in" the selected component. The AFC circuit slaves the instrument's tuning to any signal component within the passband, making it possible to use very selective filters without danger of signals drifting out of the tuning "window" before an accurate amplitude measurement can be made. Should the AFC circuit become unlocked,

a front panel lamp alerts the operator that his reading may not be valid.

Selectable Bandwidths

The instrument has four selectable bandwidths. The 10 Hz bandwidth for use on the 20 Hz-62 kHz range separates closely-spaced frequency components but requires more careful tuning of the instrument. A 100 Hz bandwidth allows easier tuning where selectivity is not so important, and a 1000 Hz bandwidth permits wide range sweeps at faster rates. The fourth bandwidth is 3100 Hz, useful when one wishes to measure a complete multiplexed telephone voice channel or other similar communications channels.

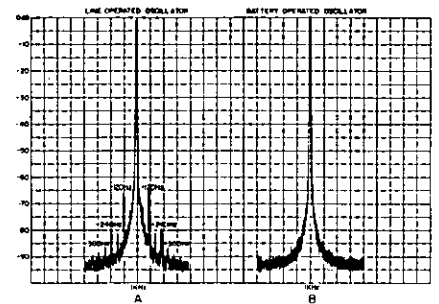


Figure 6. Line-frequency related FM sideband detection is accomplished by using the 3590A's 10 Hz bandwidth. Note that no sidebands are generated by the analyzer.

Bandwidth shape factor (ratio of bandwidth at -60 dB to bandwidth at -3 dB) is a very low 3.5:1, indicating that the analyzer's passband has very steep skirts. Bandwidth shape factor is more important for highly selective measurements than a simple expression of 3 dB bandwidth. Crystal filters, for instance, typically have shape factors of 10:1 or greater, making separation of closely-spaced frequencies more difficult.

Electronic Tuning

The instrument is tuned electronically, simplifying frequency sweeping. Five sweep rates (1, 10, 100, 1000, and 3100 Hz/s) are provided, so the operator can select the optimum trade-off between sweep rate and bandwidth. A front-panel indicator lights if the sweep rate is too fast for the bandwidth selected (narrow-band filters do not respond quickly enough if the sweep rate is too fast). The instrument sweeps upward to the top of the range from the start frequency selected by the tuning control.

Programmed tuning by an externally-supplied dc voltage is possible because of the electronic tuning. And where extreme precision is desired, another input allows a frequency synthesizer or other frequency source to serve as the Wave

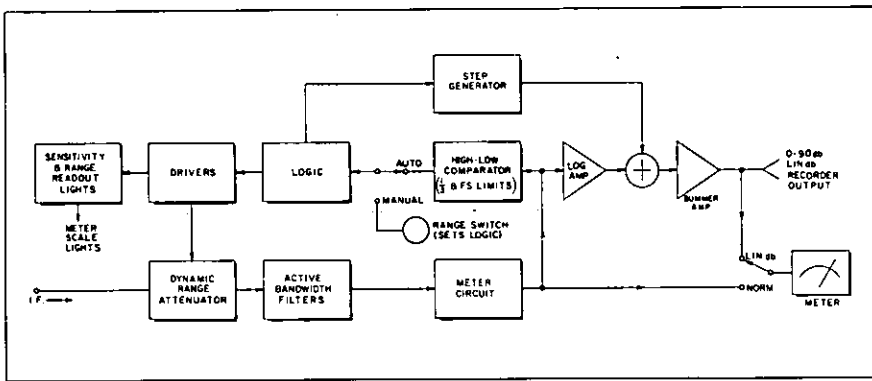


Figure 7. The HP 3590A Wave Analyzer provides automatic ranging of the signal amplitude and allows 0 to -90 dB meter display and recorder output.

Analyzer's local oscillator. (The 3592A, a low-cost plug-in without a local oscillator, is available if the analyzer is to be used only with an external oscillator or as a frequency slave to another analyzer.)

Automatic Ranging

The input to the autoranging circuit originates from the output of the meter circuit. When autoranging is turned on, the signal goes to the high-low comparator which samples the signal to determine if its level is between 1/3 and full scale (Figure 7). If the signal is too high or too low, the comparator sends a digital command to the logic circuit which in turn triggers the drivers. The drivers are responsible for switching the dynamic range attenuator reed relays and driving the readout lights on the front panel.

Linear DB Output

As a by-product of the autoranging, linear dB outputs to the meter and recorder log output have been made possible. The entire dynamic range can be presented linearly from 0 dB to -90 dB on one scale.

Information in the form of a dc analog signal is taken from the meter circuit output and supplied to the log amplifier. The amplifier logarithmically shapes the linear volts signal into a linear dB signal from 1/3 scale to full scale (10 dB) and -70 dB to -90 dB on the -70 dB range. When autoranging is on, the log amplifier output has ranging discontinuities due to switching of the attenuator reed relays. To avoid the range discontinuities, a step generator triggered by the autoranging logic circuit is used to supply a dc step offset to compensate for the range change at the output of the log amplifier.

Special Outputs

As in other Hewlett-Packard wave analyzers, the new Model 3590A has a

"BFO" output. This is a constant level signal which tracks with and is controlled by the instrument's tuning. The BFO output is useful as a test stimulus, enabling the wave analyzer to serve as both the signal generator and the measuring voltmeter in frequency response measurements on amplifiers, filters, and the like. The advantage of this arrangement is that the narrowband response of the wave analyzer removes any noise and distortion products from the measurement, products which could affect accuracy if a separate broadband voltmeter were used. Furthermore, the "voltmeter" tuning always tracks the "generator" frequency since both are tuned by the same control.

Other modes of operation in the new Wave Analyzer are slanted toward communications usage. There is a carrier reinsertion oscillator to detect either upper sideband (USB) or lower sideband (LSB) single-sideband signals. There is also an AM detector.

Another version of the new Wave Analyzer is identical to the Model 3590A except that the input is designed for communications system test and analysis. The input of this one (Model 3591A) can bridge a communication line or it can terminate it. A front panel switch selects the input impedance, — 75, 135, 150, or 600 Ω terminated or 100 kilohms bridged. In addition, the impedance selector switch adjusts the instrument's gain so that amplitude can be read in dBm directly, regardless of the input impedance selected.

Model 302A

The 302A Wave Analyzer is a tunable voltmeter covering the frequency range of 20 Hz to 50 kHz. The frequency scale is linear throughout the band with a constant resolution of a division per 10 Hz. It can be used as a tuned voltmeter which will read absolute or relative levels. The 7 Hz bandwidth permits the separation of closely spaced signals.

The automatic frequency control used in all Hewlett-Packard wave analyzers greatly facilitates wave analysis. With the 7 Hz passband of the 302A, a slightly unstable input signal could easily drift out of the passband during measurement. The automatic frequency control locks the analyzer's tuning to the frequency of the signal component so that measurements are not affected by drift in the source signal.

Semi-automatic plots of amplitude vs frequency can be made with the 302A or 310A in the BFO operation by using the 297A Sweep Drive unit and an X-Y recorder.

Model 310A

The 310A Wave Analyzer is a tunable voltmeter covering the frequency range of 1 kHz to 1.5 MHz. This wave analyzer offers a front panel selection of three bandwidths: 200 Hz for maximum resolution, 1000 Hz to simplify calculations of noise power/Hz measurements, and 3000 Hz for operation of the wave analyzer as a receiver. In this mode IF bandwidth is sufficient to recover voice modulation from either standard AM or single sideband systems (a carrier reinsertion oscillator is provided to permit detection of either normal or inverted single sideband transmissions).

The 310A Wave Analyzer features a wide dynamic range (-75 dB) over the entire frequency band, automatic frequency control, high sensitivity and a restored frequency output.

Models 312A/313A

The 312A Selective Voltmeter is a tuned voltmeter with selectable bandwidths of 200 Hz, 1000 Hz, and 3100 Hz. The operating frequency range is 10 kHz to 18 MHz in 18 overlapping bands (to 22 MHz with the 312A option H01). Using the narrowest bandwidth, the instrument will function down to 1 kHz. With these bandwidths and frequencies, the 312A can be used for communication system measurements including long haul coaxial cable carriers. The 312A can be used for measurements of harmonics, intermodulation distortion, and crosstalk. It is a sensitive detector for bridge measurements; and with the use of the 313A Tracking Oscillator, it will measure frequency vs amplitude for response curves of IF amplifiers, attenuators, and crystal-filter circuits.

In addition, the operation of the 312A is simple and is enhanced by logical panel layout. The digital readout indicates the frequency of the center of the passband with 10 Hz resolution.

For maximum flexibility the 312A input may be operated either balanced or unbalanced. In the terminated mode, the

input signal is terminated in a selectable impedance of 50, 60, 75, 124, 135, 150, or 600 ohms. The meter indicates power in dBm absorbed by the selected impedance. In the bridged mode, the input impedance is 20 k Ω balanced and 10 k Ω unbalanced. In the bridging mode, the meter can indicate dBm according to the impedance selected, or it can indicate voltage by selecting the volts calibrated position of the impedance selector switch.

The high impedance 11530A Probe also can be used for bridging measurements to eliminate the loading effects.

The input signal enters the instrument through either the bridged-terminated connector or the probe connector. The probe contains a unity-gain isolation amplifier at the end of a cable. The BAL/UNBAL switch grounds one end of the input terminal in the unbalanced position.

In the heterodyning process of the 312A, the local oscillator uses a synthesis technique stabilized by a 1 MHz crystal timebase oscillator. The output of this local oscillator is mixed with the input frequency to form a 30 MHz intermediate frequency for uniform amplification. The signal is then divided into two channels, shifted in phase and mixed with a 30 MHz crystal oscillator

input resulting in information centered on a zero frequency. Both of these quadrature channels contain three cascaded lowpass filter-amplifiers which produce a flat response within the passband with symmetrical slopes of 72 dB per octave beyond cutoff. These two channels are mixed with two 250 kHz carriers and phased so that the difference frequency is obtained. The resultant is amplified and detected to drive the meter. The AFC circuit keeps the input frequency centered in the passband, and a decade counter is designed to read the center frequency of the passband.

The single sideband detector circuit consists of an upper sideband carrier reinsertion crystal oscillator which operates at 248.2 kHz and a lower sideband oscillator which operates at 251.8 kHz. A product detector and appropriate switching provide for the demodulation of upper and lower sidebands when using the 3 kHz bandwidth for both aural and recorder purposes. The analyzer also detects AM signals.

The 313A Tracking Oscillator complements the 312A Wave Analyzer in making distortion checks and loop gain measurements and analyzing frequency response characteristics. The 313A has two modes of operation: a track 312A

mode and a free-running internal mode. In the track 312A mode of operation, the 313A utilizes the 30 MHz crystal oscillator and the local oscillator from the 312A to obtain a beat frequency at the tuned frequency of the 312A. In the internal mode of operation, the 313A uses its own internal local oscillator and 30 MHz crystal oscillator for adjustable frequencies from 10 kHz to 22 MHz in one single band. Any 313A Tracking Oscillator can be used with any 312A Analyzer. Output levels from +10 dBm to -99.9 dBm are available adjustable in 10, 1 and 0.1 dB steps.

An important feature of the 313A Tracking Oscillator is its meter expand function. Any 2 dB range of the 312A meter indication from -7 to +3 dB can be expanded for full-scale coverage. This is accomplished by using the 312A recorder output and placing the 313A meter mode switch to 312A expand position.

The standard 312A and 313A have a high frequency of 18 MHz while the 312A option H01 and 313A have a high frequency of 22 MHz. Specifications for special instruments, page 433, give differences in connectors and impedance. Table 1 summarizes the basic specifications of HP wave analyzers.

Table 1. HP wave analyzers.

HP wave analyzers	Frequency range	Selective bandpasses	Dynamic range		Freq readouts	Type of inputs	Type of outputs	Modes of operation
			Absolute	Relative				
302A (p. 458)	20 Hz to 50 kHz	7 Hz	30 μ V-300 V full scale	>75 dB	dial	banana jacks	rec: 1 mA dc into 1500 Ω full scale BFO: 2 V open circuit, meter at full scale	AFC, normal, BFO
3590A/ 3594A (p. 455)	20 Hz to 620 kHz	10 Hz 100 Hz 1000 Hz 3100 Hz	3 μ V-30 V full scale	>85 dB	5-place digital	BNC un- balanced	rec: X and Y axes log and linear. BFO: to 1 V rms. L.O.: (1.28 MHz-1.9 MHz) 0.65 V rms.	AFC, restored, BFO, USB, LSB, AM sweep
310A (p. 459)	1 kHz to 1.5 MHz	200 Hz 1000 Hz 3000 Hz	10 μ V-100 V full scale	>75 dB	dial	banana jacks	rec: 1 mA dc into 1500 Ω full scale BFO: 0.5 V open circuit, meter at full scale output impedance 135 Ω	AFC, normal BFO, USB, LSB AM
312A/ 313* (p. 460)	10 kHz to 18 MHz 18 ranges	200 Hz 1000 Hz 3000 Hz	3 μ V-3 V full scale or -97 to +23 dBm -107 to +13 dBm (600 Ω only)	>72 dB	7-place decade counter	probe 11530A bridged/ terminated balanced or unbalanced	rec: 1 V dc full scale 1 k Ω source aux: 1 MHz (1 V p-p) 30 MHz (40-60 mV) rms L.O. (30-48 MHz) 60 to 80 mV rms audio: -5 V into 10 k Ω 313A: Track or tuned 75 Ω unbalanced, -99.9 to +10 dBm	AFC, AM, beat LSB, USB
3591A/3594A (p. 432)	Same as 3590A/3594A except input bridged/terminated bal. or unbal. and modified input circuitry.							
312A/313A Op. H01 (p. 433)	Same as 312A except 10 kHz to 22 MHz and WE-477B input unbalanced.							
312A/313A Op. H05 (p. 433)	Same as 312A Option H01 except 50 Ω unbalanced input with BNC connector.							

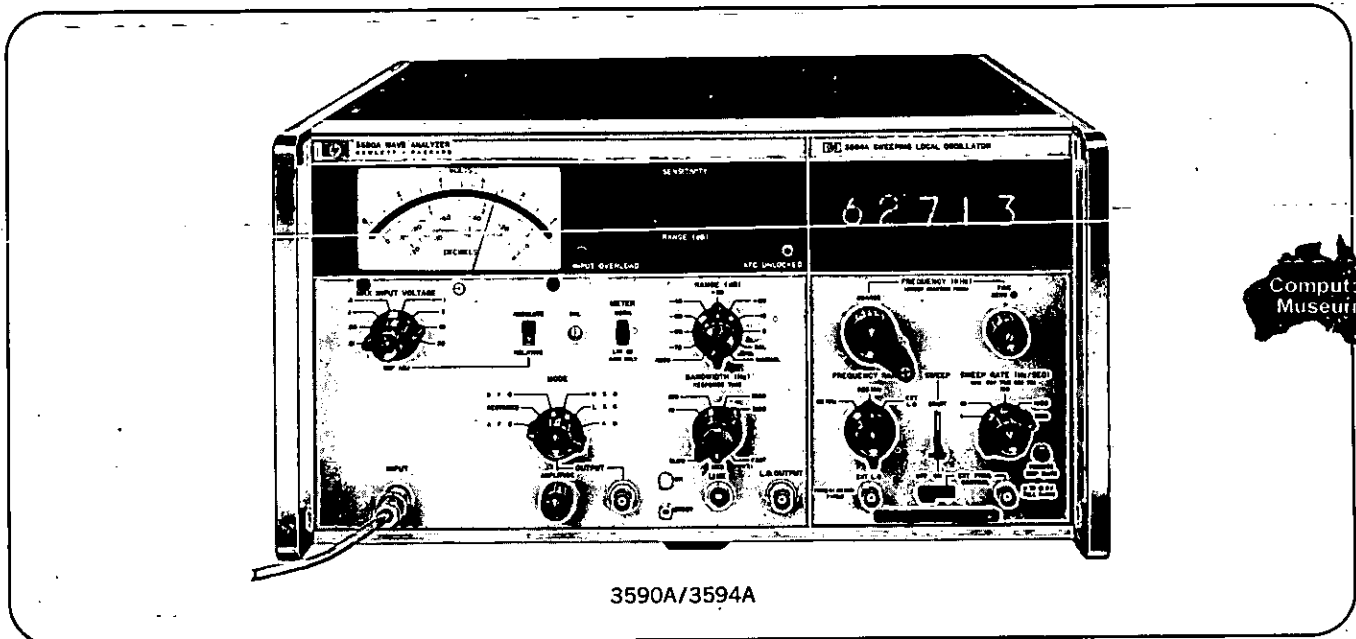
*313A option 001, 50 Ω unbalanced output.

PLUG-IN WAVE ANALYZER

85 dB dynamic range; electronic sweeping
Model 3590A



WAVE ANALYZERS



Description

The Hewlett-Packard Model 3590A Wave Analyzer offers automatic, state-of-the-art detection of signal amplitude and frequency information. Over a frequency range of 20 Hz to 620 kHz, the analyzer can separate frequency components of an input signal to locate the fundamental, harmonics, inter-modulation products, or any other signals present in the spectrum. Selectable bandwidths of 10, 100, 1000 and 3100 Hz permit easy location of signals and separation of closely spaced components. Operation has been greatly simplified by automatic amplitude ranging and electronic sweeping. X-Y recorder outputs permit frequency spectrum recordings to be made covering the entire frequency range with a linear dB amplitude display of 90 dB.

Automatic Operation

The 3590A features automatic amplitude ranging and electronic sweeping. During autoranging, the analyzer maintains a meter indication between one-third and full scale, except on the lowest range where the meter can go to zero. Once the input voltage level is adjusted for a proper input level, the autoranging will step through the entire dynamic range in eight 10 dB steps.

Electronic sweeping is simple to use and permits X-Y recordings to be made quickly and easily. Operation involves selecting one of five sweep rates, tuning to a start frequency, and starting the sweep. Maximum sweep time is 620 s or until the end of the frequency range is reached.

Measurement Performance

The key measurement characteristics of the 3590A are 85 dB of dynamic range, $3 \mu\text{V}$ full-scale sensitivity, 10 Hz to 3.1 kHz bandwidths with a constant factor of 3.5, and 1 Hz frequency resolution. Significant features include warning lights, direct range readout, automatic ranging, electronic sweep, remote tuning, linear 0 to 90 dB meter display, and meter scale lights.

High performance combined with maximum operational ease enables the analyzer to make distortion, filter, noise, side band, and spectrum measurements previously unattainable.

Generator-Receiver

Besides being a waveform analyzer, the 3590A is also extremely effective as an oscillator-tracking detector combination. By using the BFO output, an operator can stimulate a device under test and detect responses at the analyzer input over a 20 Hz to 620 kHz range. The BFO output and the analyzer input track together and follow the frequency setting. This feature is particularly useful for measuring transmission and rejection characteristics of systems and filters. Because the analyzer selectively measures only the fundamental of the input signal, distortion products and noise will have negligible effect on the reading accuracy.

Dynamic Range

The 3590A's >85 dB of dynamic range can be referenced to 0 dB from 30 V to 10 mV. 86 dB below 10 mV corresponds to $.5 \mu\text{V}$. Presentation of the dynamic range up to 90 dB can be displayed in linear dB on the third meter scale. Lights behind the meter face indicate the proper scale to be read to help eliminate erroneous scale readings.

Selectable Bandwidths

Bandwidths of 10, 100, 1000 and 3100 Hz can be selected from the front panel. Active filtering is used to provide flat passbands with steep skirts. All bandwidths have a 1 Hz rejection notch at midpoint for precise frequency determination. The shape factor is a constant 3.5/1 at -60 dB/ -3 dB. Because of the high selectivity and narrow 10 Hz bandwidth, line frequency side bands can be measured as well as other closely spaced signals. Other bandwidths provide useful flexibility for easy location of signals. The 3100 Hz bandwidth is also useful for detection of line communication channels.

WAVE ANALYZERS *continued*

85 dB dynamic range; electronic sweeping
Model 3590A

Recorder Outputs

Both X and Y recorder outputs are available at the rear panel of the 3590A. These outputs produce either logarithmically or linear varying dc voltages. Any combination of X and Y log or linear outputs (lin-lin, lin-log, log-lin, log-log) can be chosen to provide maximum flexibility. For example, the operator can make recordings with a linear decibel amplitude scale including the full dynamic range. Recordings can also be made on standard semi-log graph paper to produce direct Bode plots.

Y-axis log and linear outputs occur simultaneously, but the X-axis output is switched to choose the output function. When the switch is in Linear (ramp only), the dc offset produced by the start frequency location is blocked out. This permits wide expansion of a narrow sweep segment without having to buck out the offset voltage.

The pen lift operates by dropping the open (contact closure) during the sweep. During retrace and standby, the pen is lifted.

Low Frequency Spectrum Analyzer

All low-frequency sweeping analyzers must sweep slowly to allow their high-resolution, narrow filters time to fully respond to input signals. For this reason, the 3590A employs an X-Y recorder as a display device. Refer to page 399.

Specifications

3590A Wave Analyzer

Frequency range: 20 Hz to 620 kHz.

Amplitude ranges: 3 μ V to 30 V full scale in 15 ranges.

Amplitude accuracy (meter switch in normal position)

Overall accuracy: ± 0.5 dB or $\pm 5\%$ of reading, including the following:

Frequency response flatness: ± 0.2 dB or $\pm 2\%$.

Meter tracking: ± 0.1 dB or $\pm 1\%$ of reading, 0 dB to -10 dB indication.

Amplitude accuracy (meter switch in linear dB position)

Overall accuracy: ± 1 dB.

Internal calibrator

Frequency: 100 kHz ± 10 Hz.

Amplitude: full scale on 0 dB range in CAL mode.

Amplitude accuracy: ± 0.1 dB.

Dynamic range (IM and harmonic distortion products)

>85 dB below zero dB reference level when ABSOLUTE measurements are being made (>70 dB for 20 Hz to 50 Hz).

>80 dB below zero dB reference level when RELATIVE adjustment is used (>70 dB for 20 Hz to 50 Hz).

Dynamic range (residual responses)

>80 dB below zero reference (>70 dB for 20 Hz to 50 Hz).

Noise level

Bandwidths	Input Noise Level (600 Ω Source Impedance)
10 Hz and 100 Hz	<0.3 μ V or at least 90 dB below 0 dB reference
1 kHz and 3.1 kHz	<1.0 μ V or at least 80 dB below 0 dB reference

Selectivity:

Rejection	Bandwidths			
	10 Hz	100 Hz	1 kHz	3.1 kHz
3 dB	10 Hz	100 Hz	1 kHz	3.1 kHz
60 dB	35 Hz	320 Hz	3.1 kHz	9.6 kHz

(Frequency accuracy = 10%)

Automatic frequency control

Capture threshold: 75 dB below 0 dB reference.

Dynamic hold-in range: >3 bandwidths.

Tracking rate proportional to bandwidth.

Input impedance

Resistance: 100 k Ω all ranges.

Capacitance: <50 pF for 10 mV, 30 mV, input ranges; <30 pF for 100 mV to 30 V input ranges.

Automatic ranging: 8 ranges, 0 dB to -70 dB. Ranging rate proportional to bandwidth.

Output

Amplitude: adjustable 0 to 1 V rms open circuit.

BFO frequency response flatness: ± 0.2 dB or $\pm 2\%$.

Resistance: 600 Ω .

L.O. output

Frequency: 1.28 MHz to 1.90 MHz (1.28 MHz + tuned frequency).

Amplitude: 0.65 V rms $\pm 20\%$ open circuit.

Resistance: 250 Ω .

Recorder outputs

X-Axis (3593A/3594A only)	Plug-in Frequency Ranges	
	62 kHz	620 kHz
X-axis linear output: (1 k Ω source resistance)	0 to -12.4 V (200 mV/kHz $\pm 5\%$)	0 to -12.4 V (20 mV/kHz $\pm 5\%$)
X-axis log output: (1 k Ω source resistance)	5 V/decade $\pm 5\%$ (50 Hz - 62 kHz)	5 V/decade $\pm 5\%$ (500 Hz - 620 kHz)

Y-axis

Linear Y axis output: +10 V dc $\pm 2\%$ for full scale meter indication, 1 k Ω source resistance.

Log Y axis output: +1 V to +10 V dc, proportional to linear dB meter indication (-90 to 0 dB, 0.1 V/dB) ± 1 dB, 1 k Ω source resistance.

Pen lift: contact closure during sweep, open during reset (3593A/3594A only).

Power: 115 V or 230 V $\pm 10\%$, 50 Hz to 400 Hz, <70 W (includes plug-in).

Dimensions: 16 $\frac{3}{4}$ " wide, 8 $\frac{3}{4}$ " high, 16 $\frac{3}{8}$ " deep (425 x 221 x 416 mm).

Weight: net 37 lb (16.8 kg); shipping 47 lb (21.3 kg).

Accessories furnished: rack mounting kit for 19" rack.

Available Companion X-Y Recorders

The HP 7005B has an 11" x 17" recording area giving high resolution and 0.2% accuracy. This recorder is well suited for 3590A applications and features a low price, \$1195. See page 113.

The HP 7004A also has an 11" x 17" recording area, but has higher performance specifications. Plug-in capability, greater acceleration and higher sensitivity allow an extremely wide range of applications. The 7004A is recommended where the 3590A will not be the recorder's only application, \$1395. See page 117.

The HP 7035B is a compact, lightweight recorder with an 8 $\frac{1}{2}$ " x 11" recording area.* Where transportability and low cost are prime concerns, the 7035B is recommended for use with the 3590A, \$985. See page 113.

The HP 7030A is a high performance 8 $\frac{1}{2}$ " x 11" recorder.* Its high sensitivity, acceleration and versatility suggest that the 7030A is a good all-around recorder for many applications besides being a 3590A companion, \$1895. See page 116.

Price: HP 3590A, \$3200.

HP 3592A Auxiliary Plug-in

The 3592A Auxiliary Plug-in for the 3590A Wave Analyzer was especially designed as a slave unit where the cost was kept to a minimum. The 3592A plug-in must be controlled by an external oscillator. The input filter switch on the front panel charges the 3590A input filter depending upon which frequency range is being used. Any of the three plug-ins for the 3590A Wave Analyzer can be used in a slave unit when the tuning of two or more 3590A's is accomplished by one master unit. However, the 3592A is the most economical.

Specifications

3592A Auxiliary Plug-in

External L.O. input: 0.65 V ± 0.2 V rms, 1.28 to 1.90 MHz (1.28 MHz + tuned frequency).

Input impedance: 10 k Ω in parallel with <100 pF.

Weight: net 2 lb (.9 kg); shipping 3 lb (1.4 kg).

Dimensions: 4 $\frac{1}{2}$ " wide, 8" high, 11" deep (11 x 20 x 28 cm).

Price: HP 3592A, \$80.

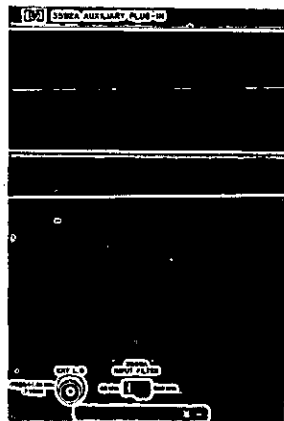
*Special recording paper is available for 8 $\frac{1}{2}$ " x 11" recorders. The paper is specially designed for optimizing display area for linear decibel amplitude and full range sweeping.

PLUG-INS FOR THE 3590A

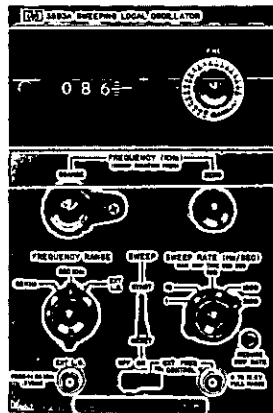
Versatility with the choice of three plug-ins
Models 3592A, 3593A, 3594A



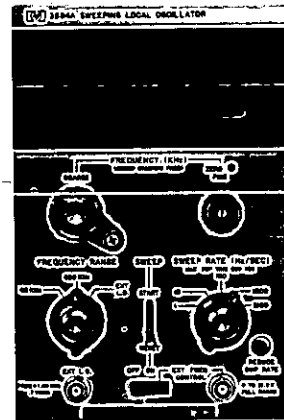
WAVE ANALYZERS



3592A



3593A



3594A

3593A Sweeping Local Oscillator

The 3593A Sweeping Local Oscillator Plug-in for the 3590A Wave Analyzer contains a 3 digit mechanical frequency display. Coarse and fine frequency controls are for two selectable frequency ranges: 500 Hz to 620 kHz and a range of 20 Hz to 62 kHz to provide 10 times the resolution and stability for low frequency applications. Remote tuning can be accomplished in the Ext. L.O. position of the Frequency Range switch by applying a 0.65 rms external frequency source from 1.28 MHz to 1.90 MHz.

One of 5 sweep rates can be selected. If the rate is excessive, the Reduce Sweep Rate light will go on indicating that the sweep rate should be lowered or the bandwidth increased. Sweep circuits are placed in standby when the Sweep switch is turned on. DC programming or sweeping can be accomplished by applying a dc voltage to the BNC connect designated when the slide switch is in External position. For internal sweeping the base or start frequency is set by the coarse frequency control and the level switch placed in the start position. The recorder pen is dropped and the sweep begins. At the end of the sweep time, the pen will lift and travel to the Y axis zero. During reset, the pen will return to the start position.

Specifications

3593A Sweeping Local Oscillator

	Frequency Ranges	
	20 Hz to 62 kHz	500 Hz to 620 kHz
Frequency accuracy:	$\pm(1\% + 20 \text{ Hz})$ of dial setting	$\pm(1\% + 200 \text{ Hz})$ of dial setting
Frequency resolution:	10 Hz/minor div.	100 Hz/minor div.
Ext. frequency control:	0 to 15.5 V (250 mV/kHz $\pm 5\%$)	0 to 15.5 V (25 mV/kHz $\pm 5\%$)
Bandwidth specified:	10, 100, 1000, 3100 Hz	100, 1000, 3100 Hz

Sweep rates: 1 Hz/s, 10 Hz/s, 100 Hz/s, 1000 Hz/s, 3100 Hz/s.

Sweep linearity: $\pm 1\%$ of final value.

Maximum sweep time: 620 s $\pm 15\%$.

Start frequency: determine by frequency control setting.

Pen lift: contact closure during sweep, open during reset.

External L.O. input: 0.65 V ± 0.2 V rms, 1.28 to 1.90 MHz (1.28 MHz + tuned frequency).

Weight: net 7.5 lb (3,4 kg); shipping 12 lb (5,5 kg).

Dimensions: 8" high, 4½" wide, 11" deep (20 x 11 x 28 cm).

Price: HP 3593A, \$1100.

3594A Sweeping Local Oscillator

The 3594A Sweeping Local Oscillator Plug-in for the 3590A Analyzer has all of the features of the 3593A Plug-in with the addition of a 5 digit electronic frequency counter to replace the 3 digit mechanical counter. The 3594A features frequency accuracy and resolution plus the ability to track and display sweeping frequencies.

Specifications

3594A Sweeping Local Oscillator

	Frequency Ranges	
	20 Hz to 62 kHz	500 Hz to 620 kHz
Frequency accuracy:	$\pm(1 \text{ Hz} + \text{time base accuracy})$	$\pm(10 \text{ Hz} + \text{time base accuracy})$
Frequency resolution:	1 Hz	10 Hz
Ext. frequency control:	0 to 15.5 V (250 mV/kHz $\pm 2\%$)	0 to 15.5 V (25 mV/kHz $\pm 2\%$)
Bandwidth specified:	10, 100, 1000, 3100 Hz	100, 1000, 3100 Hz

Time base accuracy: temperature coefficient: +15° to +35°C ± 1 ppm/°C (+25°C ref). Aging rate: ± 3 ppm per month.

Sweep rates: 1 Hz/s, 10 Hz/s, 100 Hz/s, 1000 Hz/s, 3100 Hz/s.

Sweep linearity: $\pm 1\%$ of final value.

Maximum sweep time: 620 s $\pm 15\%$.

Start frequency: determined by frequency setting.

Pen lift: contact closure during sweep, open during reset.

External L.O. input: 0.65 V ± 0.2 V rms, 1.28 to 1.90 MHz (1.28 MHz + tuned frequency).

Weight: net 7.5 lb (3,4 kg); shipping 12 lb (5,5 kg).

Dimensions: 8" high, 4½" wide, 11" deep (20 x 11 x 28 cm).

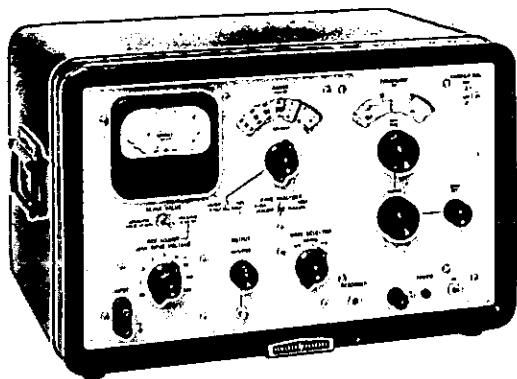
Price: HP 3594A, \$1600.

WAVE ANALYZERS

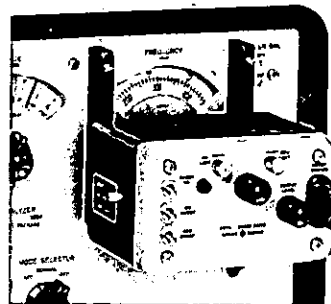


WAVE ANALYZER, SWEEP DRIVE

Measures wave components with narrow B.W.
Models 302A, 297A



302A



297A mounted on 302A

Description

The HP Model 302A Wave Analyzer is a tunable voltmeter of high selectivity and high sensitivity covering the frequency range of 20 Hz to 50 kHz. The frequency scale is linear throughout the band with a constant resolution of one division per 10 Hz.

The instrument separates an input signal into its individual frequency components so that fundamental harmonic and intermodulation products may be separately measured and evaluated. It may also be used as a narrow-band selective voltmeter which will read absolute or relative levels.

An automatic frequency control (AFC) circuit locks the measuring system to the frequency of the incoming signal, eliminating any need for frequency tracking while making a measurement.

Besides its primary function as a waveform analyzer, the 302A can be operated as an oscillator-selective voltmeter combination. In BFO operation, an oscillator and the tuned voltmeter track together over the entire frequency range (20 Hz to 50 kHz) of the Model 302A. One control tunes both the oscillator and the voltmeter simultaneously, making filter and amplifier response measurements easy.

Specifications, 302A

- Frequency range:** 20 Hz to 50 kHz.
- Frequency accuracy:** $\pm(1\% + 5 \text{ Hz})$.
- Frequency resolution:** 10 Hz per division.
- Amplitude ranges:** 30 μV to 300 V full scale in 15 ranges.
- Amplitude accuracy:** $\pm 5\%$ of full scale.
- Internal level calibrator**
 - Amplitude accuracy:** $\pm 2\%$.
 - Amplitude:** 1 V full scale.
 - Frequency:** 5 kHz ± 1 kHz.
- Dynamic range**
 - IM and harmonic distortion products:** >75 dB below 0 dB refer.
 - Residual responses:** >75 dB below 0 dB reference.
- Selectivity**

Rejection	Bandwidth
0.1 dB	$>2\text{Hz}$
3 dB	7 Hz $\pm 10\%$
60 dB	60 Hz $\pm 10\%$
80 dB	140 Hz $\pm 10\%$

Input impedance

Resistance: 30 μV to 1 mV input ranges, 100 k Ω ; 3 mV to 300 V input ranges, 1 M Ω .

Capacitance: 30 μV to 1 mV input ranges, <100 pF; 3 mV to 300 V input ranges, <20 pF.

Mode outputs

AFC and NORMAL outputs: 0 to 2 V rms open circuit proportional to meter deflection. Frequency is exactly the same as the measured component's frequency.

AFC hold-in range: $> \pm 100$ Hz.

BFO: constant-level amplitude, adjustable 0 to 2 V rms open circuit. Output frequency tracks the tuned frequency.

Frequency response flatness: $\pm 2\%$.

Source resistance: 600 Ω .

Recorder output: 1 V open circuit; source resistance, 1 k Ω .

Power: 115 or 230 V $\pm 10\%$, 50 to 400 Hz, approx. 3 W; terminals are provided for powering instrument from external battery source; battery supply range, 28 V to 18 V.

Dimensions: cabinet 20 $\frac{3}{4}$ " wide, 12 $\frac{1}{2}$ " high, 14 $\frac{1}{2}$ " deep behind panel (527 x 318 x 368 mm).

Weight: cabinet net 43 lbs (19.5 kg), shipping 51 lbs (23 kg); rack mount net 35 lbs (16 kg), shipping 49 lbs (22.1 kg).

Price: HP 302A, \$2000 (cabinet); HP 302AR, \$1985 (rack mount).

297A Sweep Drive

The 297A is a motor-drive unit designed to enhance the usefulness of the HP 302A, 310A or 312A Wave Analyzers. With the 297A you may sweep through all or any part of the 302A range. Because the 297A produces an X-axis output, you may easily make semi-automatic plots of harmonics, intermodulation products and response characteristics with an X-Y recorder such as Model 7035A.

The 297A may also be used to drive other tunable devices through their ranges. A stand (HP 11505A) allows the shaft height to be adjusted from 4 to 12 inches (102 to 305 mm).

Specifications, 297A

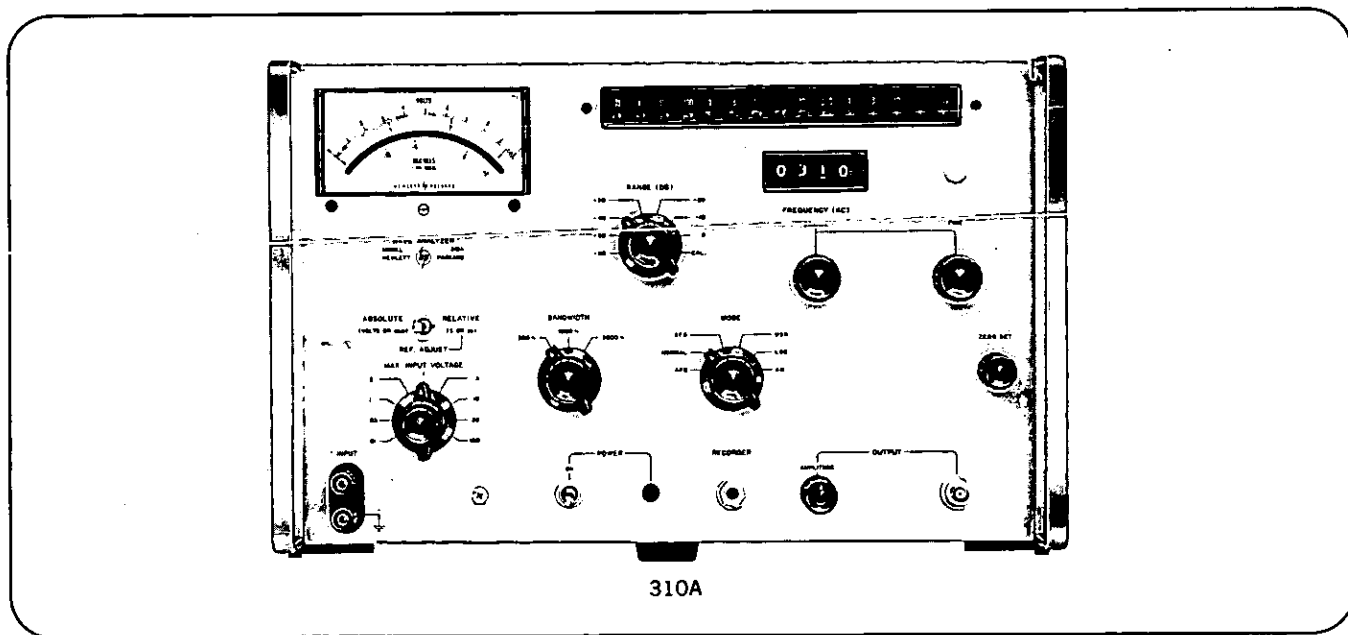
- Sweep limits:** any interval from 64 revolutions to 10 $^\circ$.
- Sweep speed with 302A:** 170 and 17 Hz/s.
- Shaft speed:** 10 rpm, 1 rpm, and neutral; other shaft speeds available on special order; neutral permits manual operation.
- Sweep voltage output:** at least 12 V maximum; full output is obtained with either 2.1 or 50 rpm of the shaft.
- Torque:** 9 in/oz at 10 rpm (approx. 22 in/oz max. at 1 rpm).
- Power:** 115 V $\pm 10\%$, 60 Hz, 12 W running or stalled.
- Weight:** net 4 $\frac{1}{4}$ lbs (1.9 kg); shipping 7 lbs (3.2 kg).
- Price:** HP 297A, \$425.
- HP 297A option H03, power: 230 V, 50 Hz.

WAVE ANALYZER

Measure harmonics, intermodulation products
Model 310A



WAVE ANALYZERS



Description

The HP 310A High-Frequency Wave Analyzer is a narrow-band selective voltmeter. Selectivity allows analysis of closely spaced fundamental signals, harmonics, and intermodulation products. Signal components between 1 kHz and 1.5 MHz may be measured in both relative and absolute terms. Absolute readouts in volts and dBm, and relative readings in percent and dB are easily made. BFO operation allows use of the 310A as a signal generator and response meter suitable for measuring both amplifier and passive element characteristics. Also, provisions have been made for detecting and monitoring single side-band and AM signals.

Specifications

Frequency range: 1 kHz to 1.5 MHz (200 Hz bandwidth); 5 kHz to 1.5 MHz (1000 Hz bandwidth); 10 kHz to 1.5 MHz (3000 Hz bandwidth).

Frequency accuracy: $\pm(1\% + 300 \text{ Hz})$.

Frequency scale: linear graduation, 1 div per 200 Hz.

Selectivity: 3 IF bandwidths, 200 Hz, 1000 Hz and 3000 Hz; mid-point of the passband (f_0) is readily distinguished by a rejection region 1 Hz wide between the 3 dB points.

	200 Hz bandwidth	1000 Hz bandwidth	3000 Hz bandwidth
Rejection*	frequency (Hz)	frequency (Hz)	frequency (Hz)
$\geq 3 \text{ dB}$	$f_0 \pm 108$	$f_0 \pm 540$	$f_0 \pm 1550$
$\geq 50 \text{ dB}$	$f_0 \pm 500$	$f_0 \pm 2400$	$f_0 \pm 7000$
$\geq 75 \text{ dB}$	$f_0 \pm 1000$	$f_0 \pm 5000$	$f_0 \pm 17000$

*Rejection increases smoothly beyond the -75 dB points.

Voltage range: 10 μV to 100 V full scale, ranges provided by input attenuator and meter range switch in steps of 1:3 or 10 dB.

Voltage accuracy: $\pm 6\%$ of full scale.

Internal calibrator stability: $\pm 1\%$ of full scale.

Dynamic range: $> 75 \text{ dB}$.

Noise and spurious response: at least 75 dB below a full-scale reference set on the 0 dB position of Range switch.

Input resistance: determined by input attenuator; 10 $\text{k}\Omega$ on most sensitive range, 30 $\text{k}\Omega$ on next range, 100 $\text{k}\Omega$ on other ranges; shunt capacitance $< 100 \text{ pF}$ on three most sensitive ranges, $< 50 \text{ pF}$ on other ranges.

Automatic frequency control: dynamic hold-in range is $\pm 3 \text{ kHz}$ minimum at 100 kHz; tracking speed is approximately 100 Hz/s; locks on signal as low as 70 dB below a full-scale reference set on the 0 dB position of the Range switch.

Restored-frequency output: restored signal frequency maximum output is at least 0.25 V (meter at full scale) across 135 Ω , with approximately 30 dB of level control provided; output impedance approximately 135 Ω .

BFO output: 0.5 V across 135 Ω with approx. 30 dB of level control provided; output impedance approx. 135 Ω .

Recorder output: 1 V dc into an open circuit from 1000 Ω source impedance for single-ended recorders; output of 1 mA dc into 1500 Ω or less available on special order.

Receiver function (Aural or Recording provision): internal carrier reinsertion oscillator is provided for demodulation of either normal or inverted single sideband signals; AM signal also can be detected.

RFI: conducted and radiated leakage limits are below those specified in MIL-I-6181D.

Power: 115 or 230 V $\pm 10\%$, 50 to 400 Hz; 20.5 W max.

Dimensions: 16 $\frac{3}{4}$ " wide, 10 $\frac{3}{4}$ " high, 18 $\frac{3}{8}$ " deep (426 x 274 x 467 mm); hardware furnished for conversion to rack mount 19" wide, 10-15/32" high, 16 $\frac{3}{8}$ " deep behind panel (483 x 266 x 416 mm).

Weight: net 45 lbs (20.3 kg); shipping 52 lbs (23.4 kg).

Accessories available: 11001A Cable Assembly, \$6; 10503A Cable Assembly, \$7; 10111A Adapter, \$7; 297A Sweep Drive, \$425. 11505A Bench Stand for 297A, \$25.

Price: HP 310A, \$2600.

Options

001: internal frequency calibrator providing check points every 100 kHz; interpolation accuracy (between check points): $\pm 2 \text{ kHz}$ up to 1.4 MHz, $\pm 3 \text{ kHz}$ between 1.4 and 1.5 MHz; add \$105.

002: dB scale uppermost on meter face and extended to -25 dB ; add \$25.



SELECTIVE VM; OSCILLATOR

Signal analysis to 22 MHz; tracking oscillator
Models 312A; 313A



312A; 313A

Description

The Hewlett-Packard Model 312A/313A is a frequency selective voltmeter/tracking oscillator set operating in the frequency range of all commercially available carrier and radio systems including the Western Electric L4 system. The set is capable of making transmission and noise measurements with an unparalleled speed and accuracy resulting in a substantial time saving even when operated by inexperienced craftsmen.

The 312A uses a frequency synthesizer for tuning that is automatically phase locked in 1 MHz steps with no tuning clicking relays or flashing lights necessary to achieve lock. Tuning between lock points is indicated on a 7-place indicator tube readout with 10 Hz plus time-base accuracy. The frequency is unambiguous and can be set up easily by inexperienced craftsmen. Coupled with this digital indication of frequency is an automatic tuning aid known as automatic frequency control (AFC). The AFC will automatically fine tune the frequency to the center of the set's passband, eliminating the need for time consuming peaking of the meter indication. It will automatically correct for any relative frequency drift between the set and the signal being measured. Long term monitoring of pilots is possible without periodic readjustment. The high frequency accuracy coupled with AFC gives clear, instantaneous tuning with complete operator confidence and eliminates the need to search for signals or bump tones for identification.

Input and IF attenuators allow a maximum of dynamic range without concern for overloading the set. The attenuators can be easily set for maximum distortion or noise performance. Attenuator settings are indicated clearly on a lighted annunciator which, when added to the meter indication, gives a fast, error-free indication of input level. An accessory expanded scale meter allows 0.02 dB resolution of input level for accurate measurements.

The set is equipped with both balanced and unbalanced inputs to fit any measuring situation without the need for external accessory transformers. A wide selection of input impedances, either bridging or terminated, is provided along with provisions

for an accessory high impedance, balanced bridging probe to eliminate measurement errors. The set always indicates directly in dBm or volts for any impedance without the need for time consuming calculations or conversion charts.

Three selectable bandwidths are provided for all measurement situations. A narrow 200 Hz bandwidth is used for highly selective measurements, a 1000 Hz bandwidth for general measurements, and a 3100 Hz bandwidth for noise measurements. The Model 312A Option 001 provides for channel noise measurements in dBm at carrier frequencies on operating systems similar to the Western Electric 7A. This allows easy troubleshooting of tough noise problems by making possible noise measurements of a noisy channel anywhere in the baseband spectrum.

Demodulation of upper or lower sideband channels with an audio output is provided for monitoring of noise, traffic, or tones in any channel. The inherent accuracy of the digital frequency readout requires only a quick reference to the system frequency charts to determine frequency for perfect demodulation—no tuning around for natural sounding demodulation is required. In this respect the Model 312A can be thought of as a single-channel, tuneable, multiplex, receive terminal.

The Model 313A Tracking Oscillator provides an accurate, flat output at the frequency to which the 312A is tuned for frequency response measurements. The output frequency is quickly and easily set by the digital tuning indicator on the selective voltmeter.

Output level is easily set by a 3-digit presentation with 0.1 dB resolution. Output level is also easily read and remains constant with changes in frequency requiring no time consuming resetting of level at each new frequency.

A built-in meter provides an expanded scale display of the 312A's meter indication with 0.02 dB resolution of input level.

Specifications, 312A*

Tuning characteristics

Frequency range: 1 kHz to 18 MHz in 18 overlapping bands, 200 kHz overlap between bands.

Frequency accuracy: $\pm(10 \text{ Hz} + \text{time-base accuracy})$. Frequency indicated on in-line digital readout with $\pm 10 \text{ Hz}$ resolution.

Time-base stability

Aging rate: $\pm 2 \text{ ppm}$ per week.

As a function of ambient temperature: $\pm 15^\circ$ to $+35^\circ\text{C}$, $\pm 20 \text{ ppm}$; 0° to $+55^\circ\text{C}$, $\pm 100 \text{ ppm}$.

As a function of line voltage: $\pm 0.1 \text{ ppm}$ for changes of $\pm 10\%$.

Selectivity

Rejection	200 Hz bandwidth	1000 Hz bandwidth	3100 Hz bandwidth
3 dB	200 Hz $\pm 10\%$	1 kHz $\pm 10\%$	3 kHz $\pm 10\%$
60 dB	<470 Hz	<2350 Hz	<6680 Hz

(Midpoint of the band is marked by rejection notch 3Hz wide.)

Automatic frequency control

Dynamic hold-in range: $\pm 3 \text{ kHz}$ at 3.1 kHz bandwidth (0 dB ref.).

Tracking speed: 100 Hz/s; locks on to signals as low as 60 dB below zero reference. Zero reference level set with Amplitude Range switch set to 0 dB.

*Refer to page 433 for special options for the 312A.

Amplitude characteristics

Amplitude range: 50 to 150 Ω , -97 dBm to +23 dBm full scale; 600 Ω , -107 to +13 dBm.

Voltage: 3 μ V to 3 V full scale (50 Ω reference).

Amplitude accuracy

Amplitude range: attenuator: ± 0.1 dB (1% of reading).

Reference level attenuator: at 1 MHz, ± 0.2 dB.

Frequency response (bridging input with external termination of 50 Ω $\pm 1\%$): 1 kHz to 10 kHz, ± 0.5 dB (5% of reading); 10 kHz to 10 MHz, ± 0.2 dB (2% of reading) 10 MHz to 18 MHz, ± 0.5 dB (5% of reading).

Meter tracking: ± 0.1 dB to -10 dB (1% of reading).

Internal calibrator output

Frequency: 1 MHz square wave (derived from time base).

Amplitude: -40 dBm into 75 Ω termination.

Amplitude stability: ± 0.1 dB.

Output connector: BNC female.

Matching impedance: 50, 60, 75, 124, 135, 150 or 600 Ω , balanced or unbalanced.

Bridging impedance: 20 k Ω $\pm 3\%$ shunted by <30 pF (balanced); 10 k Ω $\pm 3\%$ shunted by <60 pF, reference level attenuator at -40 dB (unbalanced).

Common-mode rejection (balanced input): 10 kHz to 5 MHz, >40 dB; 5 MHz to 18 MHz, >30 dB.

Input connector: BNC female (2).

Harmonic distortion: 1 kHz to 1 MHz, >55 dB below zero reference with Amplitude Range switch set at 0 dB; 1 MHz to 18 MHz, >65 dB below zero reference with Amplitude Range switch set at 0 dB.

Residual responses: 72 dB below zero reference with no input and reference level in any position.

Noise level, referred to input: 50 to 150 Ω , -120 dBm (200 Hz bandwidth); 600 Ω , -130 dBm (200 Hz bandwidth). Ref. level at 0.

Receiver characteristics**Receiver mode outputs:**

AM and AM/AFC: diode-demodulated audio.

Beat: beat frequency audio center at f_c .

LSB: product-demodulated audio, carrier reinserted at $f_c + 1.8$ kHz.

USB: product-demodulated audio, carrier reinserted at $f_c - 1.8$ kHz.

Output connector: BNC female.

Audio output level: >0.5 V rms into 10 k Ω with full scale meter deflection.

Recorder output level: 1 V ± 0.1 V with full-scale meter deflection across open circuit. Output connector, BNC female. Tracking accuracy, better than ± 0.1 dB to 20 dB below full-scale reference on 0 dB position of Amplitude Range switch; better than ± 0.2 dB to 30 dB below full-scale reference. Output resistance, 1 k Ω .

Auxiliary outputs

1 MHz: 1 V p-p sine wave into 1 k Ω ; output connector, BNC female.

30 MHz: 40 mV to 70 mV rms into 50 Ω ; output connector, BNC female.

Local oscillator (30 to 48 MHz): 60 mV to 90 mV rms into 50 Ω ; output connector, BNC female.

Power: 115 or 230 V $\pm 10\%$, 50 to 400 Hz, 90 W.

Dimensions: 16 $\frac{3}{4}$ " wide, 10 $\frac{3}{4}$ " high, 18 $\frac{3}{8}$ " deep (426 x 274 x 467 mm); hardware furnished for conversion to rack mount 19" wide, 10 15/32" high, 16 $\frac{3}{8}$ " deep behind panel (483 x 266 x 416 mm).

Weight: net 46 lbs (20.7 kg); shipping 59 lbs (26.6 kg).

Accessory available: 11530A Probe provides amplitude accuracy (probe and divider only) of ± 0.5 dB; \$200.

Probe input impedance (at 1 MHz)

Probe divider	Input impedance	
	Unbalanced	Balanced
1:1 (0 dB)	20 k Ω shunted by <20 pF	40 k Ω shunted by <10 pF
10:1 (20 dB)	20 k Ω shunted by <12 pF	40 k Ω shunted by < 6 pF
100:1 (40 dB)	20 k Ω shunted by < 7 pF	40 k Ω shunted by < 4 pF

5060-0216 Joining Bracket Kit for joining two full-module instruments, \$25.

Price: HP 312A, \$4100.

Specifications for 312A, Option 001*

(Same as Standard Model 312A with following exceptions)

Bandpass: 3100 Hz with carrier rejection notched at ± 2 kHz from the center of passband.

Rejection notches: down >55 dB at 2 kHz above and below center of passband; down >45 dB at ± 7.5 Hz from center of rejection notch.

Price: 312A Option 001, add \$100.

Specifications, 313A**Frequency range**

As tracking oscillator: same as 312A (18 MHz) or (22 MHz). Refer to page 460.

As signal source: 1 kHz to 22 MHz in one band, continuous tuning.

Frequency accuracy

As tracking oscillator: 35 Hz ± 4 Hz above 312A tuning.

As signal source: $\pm 1\%$ of maximum dial setting from 10 kHz to 2 MHz; $\pm 3\%$ of maximum dial setting from 2 to 8 MHz; $\pm 5\%$ of maximum dial setting from 8 to 22 MHz.

Frequency stability

As tracking oscillator: same as 312A time base ± 100 Hz/ $^{\circ}$ C.

As signal source: short term (5 min) drift <1 kHz in stable environment after warmup.

Frequency response: ± 0.1 dB, 10 kHz to 22 MHz.

Amplitude stability: ± 0.1 dB for 90 days (0 to +55 $^{\circ}$ C).

Meter mode

312A Expand: meter expands any 2 dB range of 312A meter indication from -7 to +3 dB using 312A recorder output. Meter range, -1 to +1 dB; tracking error, ± 0.05 dB over full 2 dB range (operates with any 1 V, 1 k Ω recorder output).

Output monitor: meter indicates voltage level at the input of the attenuator and can be calibrated from the front panel.

Maximum output: 0 or +10 dBm ± 0.1 dB, selectable at front panel.

Output attenuator: 3-section attenuator provides 0 to 99.9 dB attenuation in 0.1 dB steps.

Attenuator accuracy: 0.9 dB section (0.1 dB steps), ± 0.02 dB; 9 dB section (1 dB steps), ± 0.1 dB; 90 dB section (10 dB steps), ± 0.1 dB to 50 dB, ± 0.2 dB to 90 dB.

Output impedance: 75 Ω unbalanced (50 Ω optional, see Option 001 below).

Output connector: BNC female.

Harmonic distortion: >34 dB below fundamental.

Non-harmonic distortion

As tracking oscillator: >40 dB below fundamental.

As signal source: >50 dB below fundamental.

Recorder output: +0.3 V for full-scale deflection. Output impedance 1 k Ω , BNC female connector.

Power: 115 or 230 V $\pm 10\%$, 50 to 400 Hz, 30 W maximum.

Dimensions: 16 $\frac{3}{4}$ " wide, 5 $\frac{1}{2}$ " high, 18 $\frac{3}{8}$ " deep (426 x 141 x 467 mm).

Weight: net 25 lbs (11.3 kg); shipping 29 lbs (13.1 kg).

Accessories furnished: 11086A interconnecting cables for use with HP 312A, each cable 2 ft (610 mm) long with BNC male connectors (3).

Price: HP 313A, \$1350.

Option 001: output impedance 50 Ω unbalanced; no additional charge.

*For other special 312A's, refer to page 433.



Amplifiers

Amplifiers have two basic functions in instrumentation: 1) to amplify signals that are too low in level for intended applications and 2) to isolate circuits.

General-purpose amplifiers

A typical general-purpose ac amplifier is the HP 465A. Designed to amplify low-level signals, it has a noise level of 25 μ V and a bandwidth of 1 MHz.

This solid-state amplifier is ideal for increasing the power output of transistorized oscillators or amplifiers. Output power of HP oscillators can be increased 14 times into a 600 Ω load with the 465A, or by a factor of 180 into a 50 Ω load.

The HP 467A Power Amplifier has an average ac power capability of 5 watts over a frequency range from dc to beyond 1 MHz, (10-watt peak-power output). It has an output impedance that is virtually zero (<0.005 Ω in series with 1 μ H).

If signals >40 volts p-p are needed, two power amplifiers, driven from a differential source such as the HP 200CD Oscillator, may be connected in a push-pull arrangement. This combination will develop 80 volts p-p at 1 ampere.

When the 465A Amplifier is cascaded with the 467A Power Amplifier, Figure 1, the combination achieves 10-watt peak-power output, an overall stable gain of 60 dB and a 1 MHz frequency response.

The 467A also serves as a power supply with an adjustable control that can

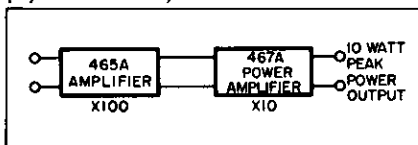


Figure 1. Cascading the HP 467A Power Amplifier with the HP 465A Amplifier results in a stable 60 dB amplifier with 10 M Ω input impedance and 10 W peak-power output.

provide maximum-negative to maximum-positive output voltage. The output voltage polarity may thus be changed without switching or lead changing, a useful feature in diode testing, where both reverse and forward bias are required.

Precision ac amplifier

The HP 463A is a precision, all solid-state amplifier delivering 100 volts rms at 5 watts. Augmenting these features is the ultra-low distortion specification and three fixed-gain ranges (10, 100 and 1000) with a continuously-adjustable gain capability from 0 to 1000.

The 463A is valuable not only in precision measurements and calibration set-

ups, but as a general-purpose amplifier. It is ideal for amplifying the output of stable solid-state oscillators, or to isolate thermocouple transfer measurements.

High-frequency ac amplifiers

The HP Models 461A and 462A Amplifiers have wide bandwidths plus input and output emitter-followers to match 50 Ω coaxial lines. The 461A frequency response extends to 150 MHz. The 462A is rolled off along a Gaussian curve to preserve the wave-shapes of complex waveforms.

Sources of radio frequency interference generated by high-frequency or fast-pulse circuits can be located and identified by combining the HP Model 140A/1410A/1425A Sampling Oscilloscope with a 461A/462A Amplifier. An exploring loop of two or three turns of wire attached to the amplifier input cable serves as a convenient probe as shown in Figure 2.

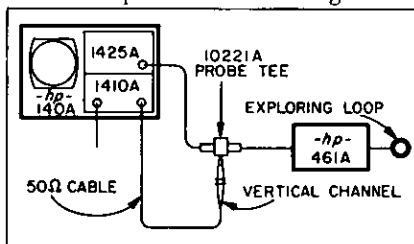


Figure 2. Block diagram shows use of amplifier with search exploring loop and oscilloscope to probe for RF radiation sources.

Power amplifier

An increasing demand has developed for higher RF power output levels for the testing of communications systems and for general laboratory measurements. The need for higher power signal sources stems mainly from the strong signal and cross modulation requirements of certain receiver tests and the large input signal requirements of bridge-type devices. Because of the large number of existing signal generators in the 0 dBm maximum output category, HP developed the Model 230A tunable Power Amplifier for use as an accessory to amplify the RF output power of these instruments. Consisting essentially of three tracked-tuned, cascaded stages of grounded-grid amplification, the 230A is capable of providing up to 30 dB RF gain and 4.5 watts of power over a 10 to 500 MHz frequency range.

DC amplifiers

A widely-used technique for circumventing the drift problems of direct-coupled amplifiers is to convert the dc to an equivalent ac (modulation). The ac is amplified in a gain-stable ac amplifier and reconverted to dc (demodula-

tion). During amplification, the signal is represented by the difference between the maximum and minimum excursions of the ac waveform and is not affected by drift in the absolute voltage levels within the amplifier.

One method of converting the dc to ac is to switch the amplifier input alternately to both sides of a transformer, as shown in Figure 3. This periodically inverts the

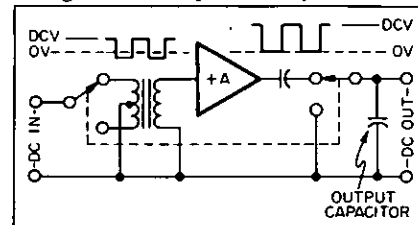


Figure 3. Modulated amplifier.

polarity of the signal applied to the amplifier. The switches illustrated may be mechanical, transistor or photoconductive. Another pair of contacts at the output establishes the ground level for a storage capacitor in series with the output. The output storage capacitor becomes charged to a level corresponding to the amplitude of the output square wave. Synchronous detection preserves the polarity of the input voltage and recovers both positive and negative voltages with the correct polarity.

The dc amplifiers just described offer drift-free amplification of low-level signals in the microvolt region. Another modulation technique uses two photoconductors—one in series with, and one parallel to the amplifier input, shown in Figure 4.

Photoconductors' resistance is proportional to their illumination. By illuminating the photoconductors alternately, the amplifier input is connected to the signal

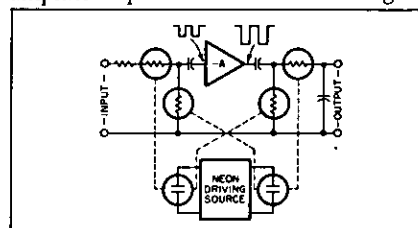


Figure 4. Amplifier with photoconductive modulator.

and to ground. Photoconductors perform well as modulators at microvolt levels. They can be isolated from the driving signal and designed with very low offset voltages.

Differential amplifiers

Differential data amplifiers have two identical input channels that function in push-pull fashion. The output generally

is single-ended and represents the amplified difference between the two input channels. This arrangement cancels hum or other interference picked up on the signal leads which appear in phase to the amplifier inputs (referred to as common-mode signals). Examples are the HP Models 2470A, 2471A and 8875A.

Since a differential amplifier is sensitive only to the difference between the two input signals, the transducer or other signal source need not be grounded. Therefore, differential amplifiers allow a bridge-type transducer to be used with a grounded power supply.

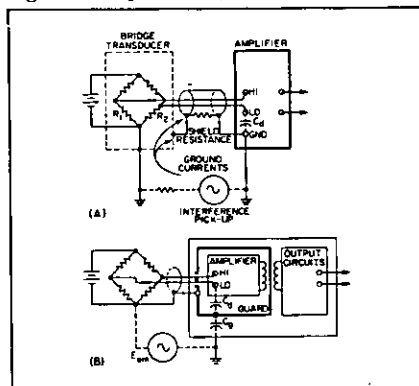


Figure 5. Guard reduces capacitance between signal leads and ground.

The differential amplifier configuration also allows injection of a fixed dc voltage into either channel to permit establishment of a new voltage-reference level at the output (zero suppression).

When the input is floating, cable shielding may be connected to chassis ground rather than to signal ground. However, both ac and dc potentials can exist between two widely-separated earth grounds, and common-mode currents may circulate. The signal leads and the internal capacitances are shown lumped as C_a in Figure 5. Consequently, a ground loop may inject interference into the signal path. A guard shield (Figure 5) providing an electrostatic shield around the input circuitry breaks the stray capacitance into two series capacitances, C_a and C_e . A much higher impedance is then presented to the flow of common-mode signals. This type is termed a floated and guarded amplifier.

DC amplifiers using choppers are able to couple the signal information out of the guard shield by means of transformers. No dc connection between the output and input grounds is necessary; and no ground loops are formed between the input circuits and equipment connected to the output.

Amplifiers designed for use with guarded digital voltmeters or other guarded equipment (Model 860-4300) continue the guard shield through the output.

Microwave amplifiers

There often are applications requiring

high-quality microwave signals, such as those obtained from precision signal generators where the magnitude of signal power needed is greater than that available directly from the signal generator. Amplification of the signal generator output will fill this requirement. At frequencies from 1 to 12.4 GHz this is accomplished by HP microwave amplifiers. Four broadband amplifiers are available, each using a traveling-wave tube that delivers at least one watt output with one milliwatt or less input. Excellent stability is achieved through the use of highly regulated power supplies for all elements of the TWT, including the filament. The amplifiers have provision for amplitude modulation and since the internal modulation amplifier is dc-coupled, remote programming and power leveling are possible. Sensitivity is high for large output power changes from relatively small modulation signals, obviating the need for an external modulation amplifier.

Selecting an amplifier

Stability, noise and input-output impedances, as well as cost, are basic considerations. If an amplifier is to be used for general-purpose applications, low distortion and preservation of magnitude relations are essential. When selecting an amplifier for pulse applications, low rise times and low sag are of prime importance. The differential amplifier is the most logical choice when interference from other connecting equipment is likely. To preserve guarding features of voltmeters or other connecting equipment, or to suppress common-mode noise, a floated and guarded amplifier is essential.

All the Hewlett-Packard amplifiers described have been designed to maximize performance for specific applications while minimizing cost. A Hewlett-Packard amplifier is available to meet your specific requirements. Refer to tables for relative functions and features.

General-purpose amplifiers

Model	Frequency response	Gain	Input Z	Noise (max)	Output (max)	See page
450A	± 0.5 dB, 10 Hz - 1 MHz ± 1 dB, 5 - 10 Hz and 1 - 2 MHz ± 0.5 dB, 5 Hz - 1 MHz ± 1 dB, 2 - 5 Hz and 1 - 1.2 MHz	40 dB 20 dB	1 M Ω /15 pF	250 μ V (referred to input)	10 V into 3000 Ω	467
461A/462A	± 1 dB, 1 kHz - 150 MHz into 50 Ω load	40 dB 20 dB	50 Ω	< 40 μ V at 40 dB	0.5 V into 50 Ω load	470
465A	± 0.1 dB, 100 Hz - 50 kHz < 2 dB, at 5 Hz and 1 MHz	40 dB 20 dB	10 M Ω /20 pF	25 μ V referred to input	5 V rms into 50 Ω 10 V open circuit	468
466A	± 0.5 dB, 10 Hz - 1 MHz < 3 dB at 5 Hz and 2 MHz	40 dB 20 dB	1 M Ω /25 pF	75 μ V rms	1.5 V rms into 1500 Ω	467
467A	$\pm 0.3\%$, dc - 10 kHz $\pm 1\%$, 10 kHz - 100 kHz $\pm 10\%$, 100 kHz - 1 MHz	X1, X2, X5, X10	50 K Ω / 100 pF	< 5 mV p - p	± 20 V peak at 0.5 A peak	468
463A	$\leq \pm 0.01\%$, 10 Hz - 10 kHz $\leq \pm 0.1\%$, 10 kHz - 100 kHz $\leq \pm 0.1\%$, 10 Hz - 20 kHz $\leq \pm 1\%$, 20 kHz - 100 kHz $\leq \pm 0.3\%$, 10 Hz - 20 kHz $\leq \pm 3\%$, 20 kHz - 100 kHz	X10 X100 X1000	100K Ω / < 35 pF (fixed gain) 50 k Ω / < 200 pF (Adj. gain)	(rms referred to input) 1.5 mV 150 μ V 50 μ V	100 V rms (5 W continuous)	469

Power and voltage amplifiers

Model	Instrument	Frequency response	Gain	Output	See Page
467A	Power amplifier is also ± 1 V to ± 20 V $\frac{1}{2}$ amp power supply, input Z 50 k Ω /100 pF, noise < 5 mV p-p.	dc - 1MHz	X1, X2, X5, X10	20 V peak-0.5 A peak	468
230A	Tunable Power Amplifier, source of high-level rf power when used with signal generators.	10-500 MHz	30, 27, 24 dB, depending on frequency	0-15 V into 50 Ω	471
489A	Microwave power amplifiers; TWT devices; amplitude modulation capability with internal 20 dB, 500kHz modulation amplifier.	1-2 GHz	30 dB	1 W	
491C		2-4 GHz	30 dB	1 W	
493A		4-8 GHz	30 dB	1 W	
495A		7-12.4 GHz	30 dB	1 W	

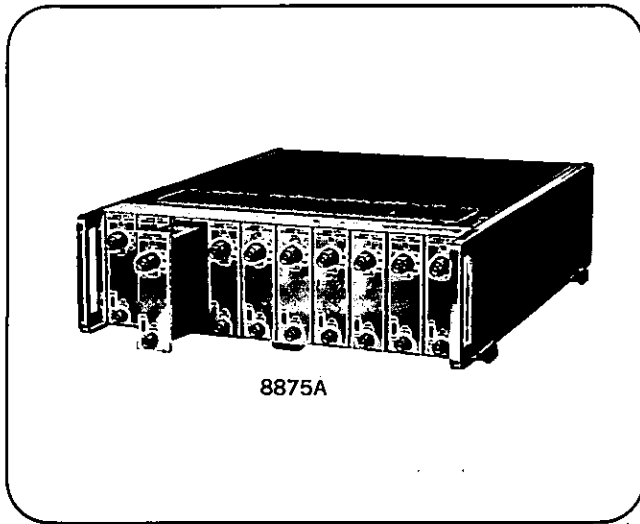
Data amplifiers

Model	Instrument	Frequency response	Gain	Noise (max)	Output	See Page
2470A	Differential data amplifier (with internal power supply)	dc-50 kHz	1, 10, 30, 100, 300, 1000	5 μ V rms rti	± 10 V	469
2471A	Differential data amplifier (with internal power supply)	dc-50 kHz	1, 10, 30, 100, 1,000	5 μ V rms rti	± 10 V	470



DIFFERENTIAL AMPLIFIER

Wideband amplifier for data acquisition systems
Model 8875A



8875A

The Model 8875A is a differential dc amplifier that provides high gain (up to 3000) and wide bandwidth. It features low drift for reliable, long term measurements, a common mode rejection of at least 120 dB at 60 Hz (500 ohm source unbalance, gain of 1000) and a common mode tolerance of ± 20 V. Intermodulation distortion is avoided by use of direct-coupled input circuits (no choppers or modulators are used). An output having a capability of ± 10 V at ± 100 mA is standard, with a second independent output of ± 10 V at ± 10 mA optional. The 8875A is available as a single unit, in banks of up to 10 channels for rack mounting or in portable cases.

The 8875A is ideal for use with thermocouples, dc excited strain gages and other low level sources, with read out to devices such as digital voltmeters, oscillographs, analog-digital converters and similar units. Applications include space vehicle checkout, monitoring of physical variables, wind tunnel tests and arrangements with either input or output multiplexers.

Performance Specifications

Bandwidth: dc to 75 Hz within 3 dB, at fixed gain steps. Can be narrowed to as low as dc to 2 Hz with optional switch-selectable filter.

Gain: fixed steps of 1, 3, 10, 30, 100, 300, 1000 plus OFF; on any range, variable gain potentiometer may be switched to provide uncalibrated gain up to 3X gain switch setting. Gain accuracy $\pm 0.1\%$; gain vernier allows setting any one fixed gain to an accuracy of 0.01%.

Input circuit: differential, active guarded; will accept floating input without ground return; may be used single-ended.

Input impedance: differential, 20 M Ω ($\pm 5\%$) with less than 0.001 μ F shunt; common mode (guarded), greater than 2000 M Ω with less than 2 pF shunt.

Common mode rejection: at least 120 dB from dc to 60 Hz for up to 500 Ω source impedance either side of input at gain of 1000; 66 dB minimum at gain of 1.

Common mode tolerance: ± 20 V.

Input overload tolerance: ± 30 V differential; ± 70 V common mode will not damage the amplifier.

Output circuit: ± 10 V across 100 Ω (100 mA), output impedance (dc) 0.2 Ω max. Short circuit proof; current limited to approx 150 mA. Will not oscillate with any value of capacity load.

Zero drift: ± 3 μ V referred to input, ± 0.2 mV referred to output, at constant ambient temperature for 30 days. ± 1 μ V/ $^{\circ}$ C referred to input, ± 0.2 mV/ $^{\circ}$ C referred to output. ± 2 mV referred to output for $\pm 10\%$ change in line voltage.

Gain stability: $\pm 0.01\%$ at constant ambient temperature for 30 days, $\pm 0.005\%/^{\circ}$ C (fixed gain steps only). $\pm 0.01\%$ for $\pm 10\%$ change in line voltage.

Nonlinearity: less than 0.01% of full scale 10 V output (zero based terminal linearity).

Current feed to source: 0.001 μ A max at constant ambient temperature; ± 0.001 μ A/ $^{\circ}$ C.

Settling time: 100 μ s to 99.9% of final value for step input.

Overload recovery time: from differential overload signal of ± 10 V at gains of 300 to 1000, recovery in 10 ms to within 10 μ V, referred to input plus 10 mV referred to output: for gains of 1 to 100, recovery in 1 ms. For a 10X full scale overload of any duration, recovery in 2 ms for gains of 300 to 100, and 100 μ s for gains of 1 to 100.

Noise: measured at gain of 1000 with respect to input, 1000 Ω source impedance:

Bandwidth	Noise	Bandwidth	Noise
dc-10 Hz	1 μ V pp	dc-10 kHz	3 μ V rms
dc-100 Hz	3 μ V pp	dc-50 kHz	4 μ V rms
dc-1 kHz	6 μ V pp	dc-250 kHz	5 μ V rms

Slewing: gain of 1 or 3, 0.7 μ V/s; gain greater than 3, 1 μ V/s referred to output, for 10 mV dc offset at output with resistive load of 100 Ω or greater.

Input-output isolation: greater than 200 M Ω shunted by less than 2 pF.

Temperature range: 0 $^{\circ}$ C to 55 $^{\circ}$ C.

General Specifications

Power: 115/230 V $\pm 10\%$, 50 to 400 Hz, 6 VA.

Dimensions: 4 $\frac{3}{4}$ " high, 1-9/16" wide, 15" deep (121 x 40 x 381 mm).

Weight: 3.5 lb (1.6 kg).

Prices: 8875A Differential Amplifier, \$495.

Option 01: dual outputs (10 mA and 100 mA capability; short on one has negligible effect on other), add \$75.

Option 02: switch selected filters (single-pole, low pass, with corner frequencies of 2, 200, 2000 and 20,000 Hz), add \$75.

Option 03: gain ranges of 10, 20, 50, 100, 200, 500 and 1000, add \$25.

Option 04: 14010A Cord Connector Set for bench-top use (required for single-channel operation), add \$65.

Option 05: combines Option 01 and 02 (filters on 10 mA output only), add \$150.

Option 06: combines Option 02 and 03, add \$100.

Note: must order 1069-01A case for multichannel banks of 10 or less, \$365. Sufficient blank panels (01069-61069) to fill case are required to maintain temperature stability specifications, \$10 each.

DATA AMPLIFIER

Solid-state, wideband differential amplifier
Model 2470A



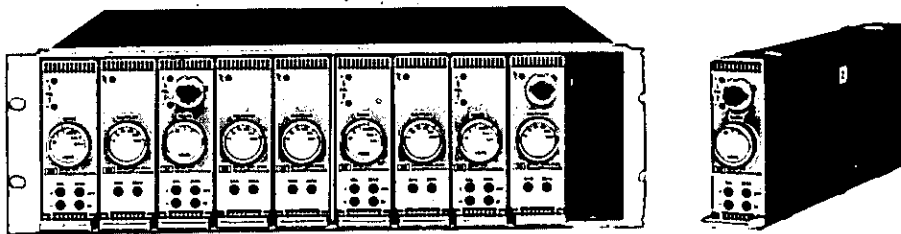
AMPLIFIERS

The HP 2470A Amplifier is a flexible wideband differential amplifier exhibiting low drift and noise, achieved without the use of a chopper. The instrument will supply up to 1 watt output to a resistive or reactive load. Exceptionally high reliability and accuracy are achieved by the use of silicon semiconductors.

Applications include amplification of strain gage bridge, thermocouple and other low-impedance sensors. Amplifier provides an output suitable for data acquisition devices, in-

cluding recording galvanometers and oscillographs, analog recorders, servo control systems. Low instrument cost keeps per-channel price to the minimum. The 2470A also applies directly to many general-purpose laboratory uses, both differential and single-ended.

The amplifier with its power supply is packaged compactly. Ten instruments fit side-by-side in 5¼" of standard 19" rack space, or two instruments may be installed in a portable case.



2470A Amplifiers shown in combining case.

Specifications

Specifications include $\pm 10\%$ line voltage variation, hold for 1K max. source resistance, any unbalance, and assume calibration after specified warmup.

DC gain: 6 fixed steps of x1, x10, x30, x100, x300, x1000. Optional vernier (10-turn potentiometer) extends gain to x3.5.

DC gain accuracy: calibrated gain: .01% of output; other gains: .03%, consisting of .02% gain-to-gain accuracy and .01% gain trim resolution.

Gain stability: dc: $\pm .005\%$ of output per month; ac: $\pm .1\%$ per month, for ac to 2 kHz; temp. coeff: $\pm .001\%$ per °C.

Linearity: dc: $\pm .002\%$ of full scale, referred to straight line through zero and full scale output. AC: $\pm .01\%$ of full scale; inputs to 2 kHz.

Zero drift (offset): per day: $\pm 5 \mu\text{V}$ rti (referred to input) $\pm 200 \mu\text{V}$ rto (referred to output); per month: $\pm 25 \mu\text{V}$ rti $\pm 500 \mu\text{V}$ rto; temp. coeff: $\pm 1 \mu\text{V} \pm .5 \text{ namp}$ rti $\pm 40 \mu\text{V}$ rto per °C.

Maximum input signal: $\pm 11 \text{ V}$, differential plus common mode.

Differential input impedance: 10^8 ohms shunted by .001 μF .

Common mode rejection: 120 dB at 60 Hz for gains of x30 and higher.

Common mode return: from input common to output common; 1 megohm, max.

Noise: 0 to 10 Hz: $1 \mu\text{V}$ p-p rti and $10 \mu\text{V}$ p-p rto; to 50 kHz: $5 \mu\text{V}$ rms rti and $500 \mu\text{V}$ rms rto.

Output: $\pm 10 \text{ V}$ max, 0 to 100 mA. Self-limits.

Output impedance: 0.1 ohm in series with 10 μH max.

Load capability: 100 ohms or .01 μF for full output.

Slewing: 10^6 V/sec at gain of 1; $5 \times 10^6 \text{ V/sec}$ at gain of 1000.

Bandwidth: for any gain step, 0 to 50 kHz $\pm 3 \text{ dB}$; 0 to 15 kHz $\pm 1 \text{ dB}$; 0 to 5 kHz $\pm 1\%$; 0 to 1.5 kHz $\pm .1\%$; 0 to 500 Hz $\pm .01\%$.

Settling time: 100 μs to .01% of final value.

Overload recovery: 200 μs to .01% of final value for signal of 10 times full scale, but less than 10 V; less than 5 ms for signal plus common mode up to 20 V.

Overload signal: -17.5 to -19.5 V with no overload, 0 to -1 V in overload; 5 mA drive capability; front panel lamp indication.

Operating conditions: ambient temperatures 0 to 55°C; relative humidity to 95% at 40°C.

Warmup: operates immediately after turn-on, but requires 3 hours in free air, 30 minutes in Portable Case or Combining Case (plus 1 hour additional warmup for each 10°C difference between storage temperature and operating ambient) for specified accuracy and zero drift.

Reliability: predicted MTBF (90% confidence) 20,000 hours when operated at 25°C ambient.

Power: 115 or 230 V $\pm 10\%$, 50 to 400 Hz, 10 W max.

Dimensions: 1-9/16" wide, 4/8" high, 15" deep (39.7 x 123.9 x 381 mm).

Weight: net 4 lbs (1.8 kg); shipping 6½ lbs (2.9 kg).

Accessories available: mating rear connector; mating rear connector with power cord, input/output cables; combining case: holds up to 10 instruments in 5¼" of standard 19" rack space (mating connectors furnished) includes power cord and fan; portable case: holds two amplifiers (mating connectors furnished) and includes power switch, pilot light, power cord and fan.

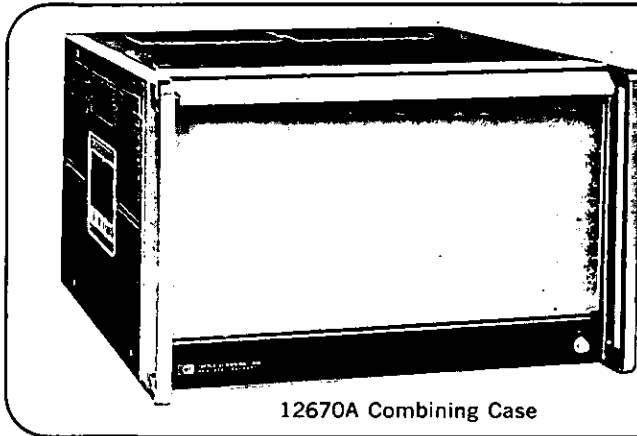
Price: HP 2470A Data Amplifier, \$660.



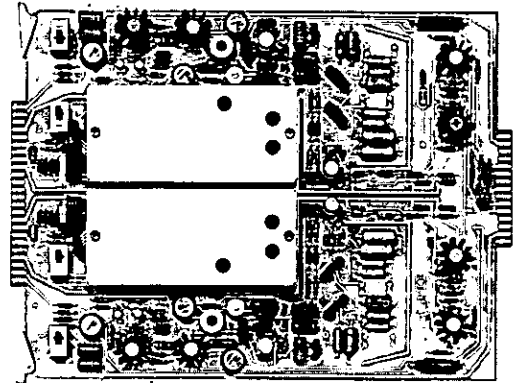
SYSTEM DATA AMPLIFIER

Excellent performance at lower cost

Model 2471A



12670A Combining Case



2471A System Data Amplifier

The new HP 2471A System Data Amplifier is a wide-band, differential-input amplifier featuring excellent system performance at low per-channel cost through extensive use of integrated circuits and modern plug-in-design packaging techniques.

The 2471A is a single plug-in circuit board which consists of two identical and independent amplifier channels, each providing up to ± 10 V, 50 mA full-scale output. Each channel has four switch-selectable calibrated gains from 1 to 1000 in decade multiple steps. Bandwidths are also selectable for each channel by plug-in jumpers with a choice of 10 Hz, 100 Hz, 1 kHz, and 10 kHz controlled bandwidths with 12 dB-per-octave rolloff, and full bandwidth (greater than 50 kHz). Common mode rejection is > 80 dB at the

two lowest gains and > 120 dB at the highest gain.

Up to 10 amplifier boards (20 channels) may be installed in a model 12670A Combining Case which includes power supplies and connectors for all boards. The case occupies only $10\frac{1}{2}$ inches of rack space. A pull-down front panel allows direct access to the boards. The amplifier boards are furnished with mating connectors, simplifying installation where the combining case is not used.

The system data amplifier is ideally suited for amplification of strain gage bridge, thermocouple and other low-impedance sources. The amplifier output is compatible with high-speed analog-to-digital converters such as used in computerized data acquisition systems.

Specifications, 2471A

DC gain: selectable in 4 fixed steps of $\times 1$, $\times 10$, $\times 100$, $\times 1000$.

DC gain accuracy: $\pm 0.01\%$.

DC gain stability: $\pm 0.02\%$ of output for 6 months; temp. coeff. $\pm 0.005\%$ per $^{\circ}\text{C}$.

DC linearity: $\pm 0.01\%$ of full scale, referred to straight line through zero and full scale output.

Zero drift: per day: ± 10 μV rti (referred to input); ± 1.0 mV rto (referred to output). Temp. coeff.: ± 1 μV ± 0.5 namp rti per $^{\circ}\text{C}$; ± 0.2 mV rto per $^{\circ}\text{C}$.

Maximum input signal: ± 11 V differential plus common mode; combined input of ± 20 V will not damage the amplifier.

Common mode rejection (CMR): dc to 60 Hz, up to 1 K Ω line unbalance:

Gain	CMR
1000	> 120 dB
100	> 100 dB
10,1	> 80 dB

Common mode return: from input common to output common: 10 megohms max.

Noise:

(with source resistance ≤ 1 K Ω)	Bandwidth	Noise
	0 - 10 Hz	3 μV peak-to-peak
	0 - 50 kHz	< 5 μV rms rti, < 0.5 mV rms rto

Output: ± 10 V max. 0 to 50 mA. Short-circuit proof.

Output impedance: < 0.1 ohm in series with 10 μH .

Load capability: 200 ohms resistive. Capacitive load up to 0.01 μF will not cause instability.

Slewing rate: > 1 V per μsec .

Bandwidth: selectable in 5 steps: 10 Hz, 100 Hz, 1 kHz, 10 kHz with 12 dB-per-octave rolloff and max. amplifier bandwidth of > 50 kHz.

Operating conditions: ambient temperature 0 to 55°C ; relative humidity to 95% at 40°C .

Power required: +30 V @ 50 mA, -30 V @ 50 mA, ± 15 V @ 60 mA plus 50 mA max. load current, -15 V @ 60 mA plus 50 mA max. load current.

Power supply immunity: ± 30 V, > 120 dB rti; ± 15 V, > 60 dB rto.

Dimensions: $7\frac{3}{4}$ " H (197 mm), 1" W (25.4 mm), 10" D (254 mm).

Weight: net 1 lb (454 gm); shipping 4 lb (1.8 kg).

HP 12670A Combining Case: (includes integral power supply and holds up to ten 2471A Amplifiers (20 channels).

Power: 115 or 230 V $\pm 10\%$, 50-400 Hz, 110 watts (for full complement of 20 channels).

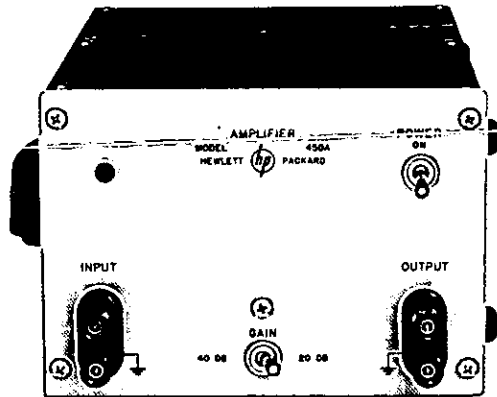
Dimensions: $10\frac{1}{2}$ " H (267 mm), 19" W (483 mm), 20" D (508 mm).

AMPLIFIERS

Offer 20 or 40 dB gain
Models 450A, 466A



AMPLIFIERS



450A

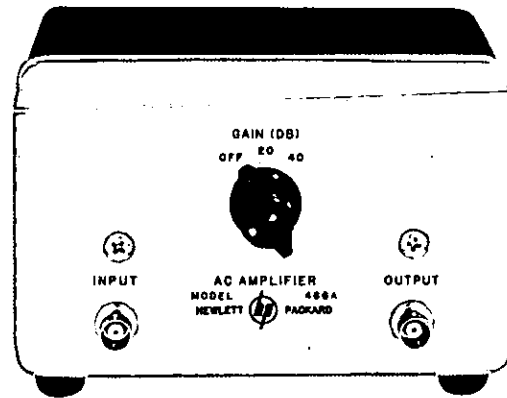
450A Stabilized Amplifier

The HP Model 450A is ideal as a general purpose instrument wherever wide frequency range and stable gain are essential. The instrument has an extremely stable 20 dB or 40 dB gain over a continuous frequency range of 10 Hz to 1 MHz. Either gain may be selected quickly with a toggle switch on the front panel.

The amplifier is resistance coupled and does not use peaking or compensating networks. Optimum performance is obtained entirely from a straightforward amplifier design in combination with inverse feedback.

Specifications, 450A

- Gain:** 20 dB (X10) or 40 dB (X100) ± 0.125 dB at 1000 Hz.
- Frequency response:** 40 dB gain: ± 0.5 dB, 10 Hz to 1 MHz; ± 1 dB, 5 Hz to 2 MHz; 20 dB gain: ± 0.5 dB, 5 Hz to 1 MHz; ± 1 dB, 2 Hz to 1.2 MHz (open circuit).
- Stability:** $\pm 2\%$, includes line voltage variation 115 or 230 V $\pm 10\%$.
- Impedance:** input, 1 M Ω , 15 pF shunt; internal, $< 150\Omega$.
- Distortion:** $< 1\%$, 2 Hz to 100 kHz at maximum output and rated load; 2% above 100 kHz.
- Output:** 10 V maximum into 3000 Ω or greater load.
- Noise referred to input:** 40 dB gain, 40 μ V; 20 dB gain, 250 μ V.
- Power:** 115 or (230 V must be specified) $\pm 10\%$, 50 to 400 Hz, 50 W.
- Dimensions:** cabinet: 8 $\frac{3}{8}$ " wide, 5 $\frac{1}{2}$ " high, 10 $\frac{3}{4}$ " deep (219 x 140 x 273 mm); rack mount: 19" wide, 5 $\frac{1}{4}$ " high, 10 $\frac{3}{8}$ " deep behind panel (483 x 133 x 270 mm).
- Weight:** net 10 lbs (4.5 kg), shipping 15 lbs (6.8 kg) (cabinet); net 11 lbs (5 kg), shipping 23 lbs (10.4 kg) (rack mount).
- Price:** HP 450A, \$220 (cabinet); HP 450AR, \$225 (rack mount).



466A

466A AC Amplifier

The HP Model 466A AC Amplifier is ideal wherever low distortion, stability, wide frequency range, and portability are desirable; and it may be used to increase the sensitivity of voltmeters and oscilloscopes, since its gain is accurate and stable.

Model 466A is normally furnished with a plug-in supply for ac operation. For portable operation or for isolation from power lines, the supply may be quickly removed and replaced with batteries. If desired, specify batteries in lieu of the plug-in supply (Option 001).

Specifications, 466A

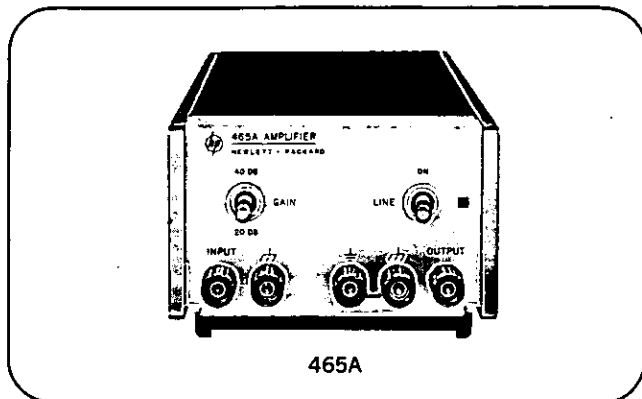
- Gain:** 20 dB (X10) or 40 dB (X100) ± 0.2 dB at 1000 Hz.
- Frequency response:** ± 0.5 dB, 10 Hz to 1-MHz down 3 dB, or less at 5 Hz and 2 MHz.
- Output voltage:** 1.5 V rms across 1500 Ω .
- Output current:** 1 mA rms maximum.
- Noise:** 75 μ V rms referred to input, 100,000 Ω source.
- Impedance:** input, 1 M Ω , 25 pF shunt; output, 50 Ω in series with 100 μ F.
- Distortion:** $< 1\%$, 10 Hz to 100 kHz; $< 5\%$ to 1 MHz.
- Power:** 115 or (230 V must be specified) $\pm 10\%$, 50 to 400 Hz, 1 W (supply normally furnished); battery operation optional: radio-type mercury batteries, TR234-316649 or equivalent, 3 required (HP #1420-0006); battery life, 150 hours.
- Dimensions:** 6 $\frac{1}{4}$ " wide, 4" high, 6 $\frac{1}{4}$ " deep (159 x 102 x 159 mm).
- Weight:** net 2 $\frac{1}{2}$ lbs (1.13 kg); shipping 3 $\frac{1}{2}$ lbs (1.58 kg).
- Price:** HP 466A, \$195, ac operation.
- HP 466A Option 001:** batteries in lieu of ac supply, deduct \$15.

AMPLIFIERS



SOLID-STATE AMPLIFIERS

Precision general-purpose amplifiers
Models 465A, 467A



HP 465A Amplifier

The HP Model 465A is a general purpose amplifier and an excellent impedance converter (10 megohms to 50 ohms). This amplifier has extremely stable 20 dB or 40 dB gain over a continuous frequency range of 5 Hz to 1 MHz. Either gain may be selected rapidly with a switch on the front panel.

This solid-state amplifier is ideal for increasing the power output of solid-state oscillators or amplifiers. The output stage

provides low output impedance and wide dynamic range. The HP 465A is a three-terminal device isolated from chassis and may be floated up to 500 volts dc above chassis ground.

465A Specifications

- Voltage gain:** 20 dB (X10) or 40 dB (X100), open circuit.
- Gain accuracy:** ± 0.1 dB ($\pm 1\%$) at 1000 Hz.
- Frequency response:** ± 0.1 dB, 100 Hz to 50 kHz < 2 dB down at 5 Hz and 1 MHz.
- Output:** > 10 V rms open circuit; > 5 V rms into 50 Ω (0.5 W).
- Distortion:** $< 1\%$, 10 Hz to 100 kHz; $< 2\%$, 5 Hz to 10 Hz and 100 kHz to 1 MHz.
- Input impedance:** 10 M Ω shunted by < 20 pF.
- Output impedance:** 50 Ω .
- Noise:** < 25 μ V rms referred to input (with 1 M Ω source resistance).
- Temperature range:** 0°C to +50°C.
- Power:** 115 or 230 V $\pm 10\%$, 50 to 400 Hz, 10 W at full load.
- Dimensions:** 5 $\frac{1}{8}$ " wide, 3" high (without removable feet), 11" deep (130 x 76 x 279 mm).
- Weight:** net: 4 lbs (1,8 kg) shipping: 6 lbs (2,7 kg).
- Price:** HP 465A, \$235.

HP 467A Amplifier/Power Supply

The solid-state HP 467A Power Amplifier/Supply is a 10-watt peak power amplifier and -20 to $+20$ volt dc power supply. The power amplifier has a wide bandwidth and low dc drift, suitable for many applications wherever a power source is required. Unique features are low distortion ($< 0.01\%$), low drift and high-gain accuracy.

An output greater than ± 20 volts peak and ± 0.5 A peak is available from dc up to 1 MHz. At full output the distortion of the 467A is less than 3% up to 1 MHz. The amplifier is a three-terminal device isolated from chassis and may be floated up to 200 volts dc above chassis ground.

467A Specifications

Power amplifier

Voltage gain (non-inverting): fixed steps: X1, X2, X5, X10.

Variable: 0-10 resolution is better than 0.1% of full output.

Accuracy: $\pm 0.3\%$ from dc to 10 kHz; $\pm 1.0\%$ from 10 kHz to 100 kHz; $\pm 10\%$ from 100 kHz to 1 MHz with load of $> 40\Omega$.

Output: ± 20 V p at 0.5 A p.

Distortion: $< 0.01\%$ at 1 kHz; $< 1\%$ at 100 kHz; $< 3\%$ at 1 MHz.

Input impedance: 50 k Ω shunted by 100 pF.

DC power supply

Voltage range: $> \pm 20$ V, ± 10 V, ± 4 V, ± 2 V, ± 1 V; with adjustable vernier. Resolution: better than 0.1% of full output.

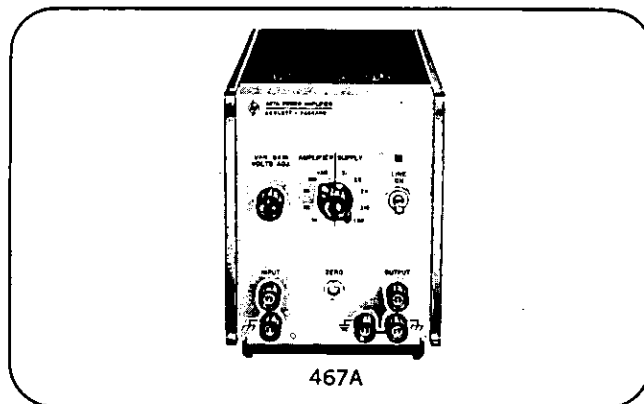
Current: ± 0.5 A p.

Load regulation: (front panel) < 10 mV, no load to full load.

Line regulation: < 10 mV for a $\pm 10\%$ change in line voltage.

General

Output impedance: (front panel): 5 m Ω in series with 1 μ H.



Capacitance load: 0.01 μ F or less does not cause instability.

Ripple and noise: < 5 mV p-p (referred to output) for amplifier and power supply.

Current limit: < 800 mA.

Temperature coefficient: $< \pm 0.05\%/^{\circ}\text{C}$ of output or ± 2 mV/ $^{\circ}\text{C}$ at output, whichever is greater.

Input-output terminals: front panel: $\frac{3}{4}$ " spaced banana terminals for input, output, and chassis. Rear panel: BNC terminals. Circuit ground can be floated 200 V dc above chassis ground.

Operating temperature range: 0°C to +50°C.

Power required: 115 or 230 V $\pm 10\%$, 50-400 Hz; < 35 W, full load.

Dimensions: 5 $\frac{1}{8}$ " wide, 6 $\frac{1}{4}$ " high (without removable feet), 11" deep (130 x 159 x 279 mm).

Weight: net: 10 lbs (4,5 kg); shipping: 14 lbs (6,4 kg).

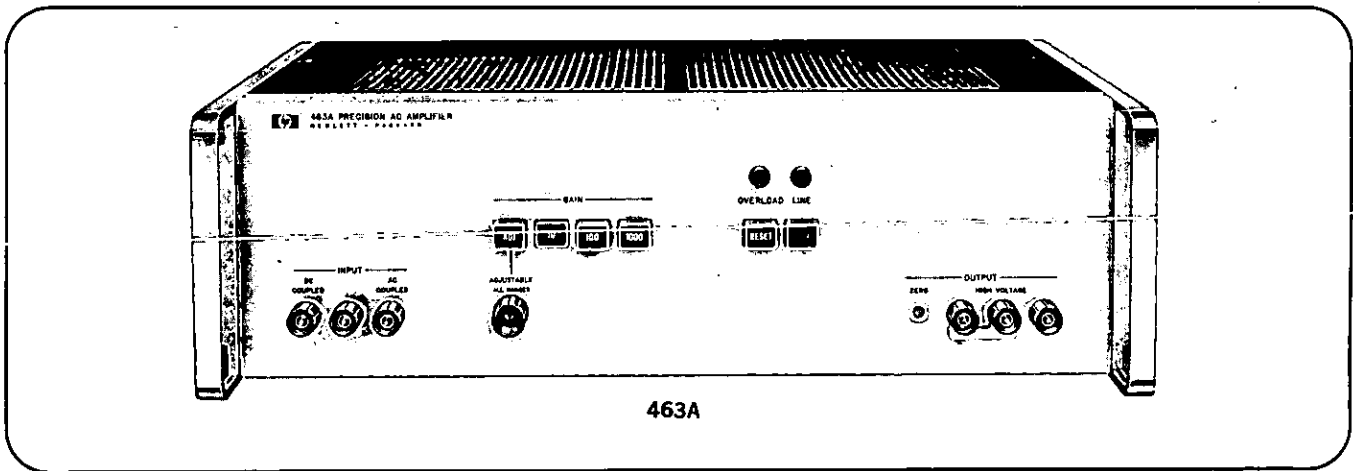
Price: HP 467A, \$595.

PRECISION AC AMPLIFIER

Low level measurements; precision application
Model 463A



AMPLIFIERS



Description

A precision ac amplifier, the solid-state HP 463A has gain accuracy better than 0.01% with long-term stability of 100 ppm/yr., distortion below 0.01%, and output capability up to 100 volts rms at 5 watts continuous. The 463A has a bandwidth from dc to 100 kHz offering use in many applications. Unusual precision in the performance of the 463A Amplifier suggests its usefulness in ac calibration procedures; an example is calibrating precision attenuators. The 100-volt output capability makes it practical to measure as much as 110 dB of attenuation. It is ideal for amplification of the output of stable solid-state oscillators or for use as an isolator for thermocouple transfer measurements. The Hewlett-Packard Model 463A Precision AC Amplifier was designed to meet the most critical requirements for wide-range, low-distortion applications.

Specifications*

Fixed Gain (DC Coupled)

X10 Range

Accuracy: dc to 10 Hz, $< \pm 0.3\%^{**}$; 10 Hz to 10 kHz, $< \pm 0.01\%$; 10 kHz to 100 kHz, $< \pm 0.1\%$.

Distortion (100 V output, full load): 10 Hz to 10 kHz, $< 0.01\%$; 10 kHz to 100 kHz, $< 0.1\%$.

X100 Range

Accuracy: dc to 10 Hz, $< \pm 3\%^{**}$; 10 Hz to 20 kHz, $< \pm 0.1\%$; 20 kHz to 100 kHz, $< \pm 1.0\%$.

Distortion (100 V output, full load): 10 Hz to 10 kHz, $< 0.03\%$; 10 kHz to 100 kHz, $< 0.1\%$.

X1000 Range

Accuracy: dc to 10 Hz, $< \pm 30\%^{**}$; 10 Hz to 20 kHz, $< \pm 0.3\%$; 20 kHz to 100 kHz, $< \pm 3.0\%$.

Distortion (100 V output, full load): 10 Hz to 10 kHz, $< 0.1\%$; 10 kHz to 100 kHz, $< 0.5\%$.

Fixed gain (ac coupled): identical to dc coupled except coupling capacitor causes 0.01% error at 250 Hz to 3 dB error at 3.5 Hz.

Adjustable gain (ac or dc coupled): gain may be adjusted from 0 to 100% of the fixed gain range.

Distortion: same as fixed gain range.

Long term stability (Fixed Gain):

Frequency	X10	Gain, X100	X1000
10 Hz to 10 kHz	0.003%/mo or 0.01%/yr	0.03%/mo or 0.1%/yr	0.3%/mo or 1%/yr
10 kHz to 100 kHz	0.03%/mo	0.3%/mo	3%/mo

Temperature coefficient: X10 (10 Hz to 10 kHz) 10 ppm/°C, (10 kHz to 100 kHz) 50 ppm/°C; X100 (10 Hz to 10 kHz) 50 ppm/°C, (10 kHz to 100 kHz) 250 ppm/°C; X1000 (10 Hz to 10 kHz) 100 ppm/°C, (10 kHz to 100 kHz) 500 ppm/°C (deviation from Cal. Temp. for fixed gain).

DC zero stability

Short term: (23°C \pm 1°C)	Gain range	V/hr (output)
	X10	0.05
	X100	0.5
	X1000	5.0

Input impedance: fixed gain, 100 k Ω , < 35 pF; adjustable gain, 50 k Ω , < 200 pF.

Maximum input voltage: protected to ± 150 V. AC coupling capacitor ± 500 V p.

Noise (rms referred to input)

Gain range	< 1 k Ω source	> 1 k Ω source \ddagger
X10	1.5 mV	1.5 mV
X100	150 μ V	300 μ V
X1000	50 μ V	200 μ V

\ddagger with input shielded

Output characteristics

Voltage: dc: 100 V, 20 mA; ac: 100 V rms, 50 mA. \dagger

Power: 5 W continuous.

Impedance: from 0.05 Ω to 20 Ω .

Minimum resistive load: 100 Ω .

Maximum capacitive load: capacitive drive increased with a resistor in series with the output.

General

Temperature range: 0°C to +50°C.

Power: 115 or 230 V $\pm 10\%$, 50 to 400 Hz, 60 W full load.

Dimensions: 16 $\frac{3}{4}$ " wide, 5" high (without removable feet), 13 $\frac{1}{4}$ " deep (426 x 127 x 337 mm).

Weight: net 19 lbs. (8.6 kg); shipping 25 lbs (11.3 kg).

Accessories furnished: rack mounting kit for 19" rack.

Price: HP 463A, \$715.

*For complete data refer to Technical Data Sheet.

**Includes temperature coefficient and short term stability.

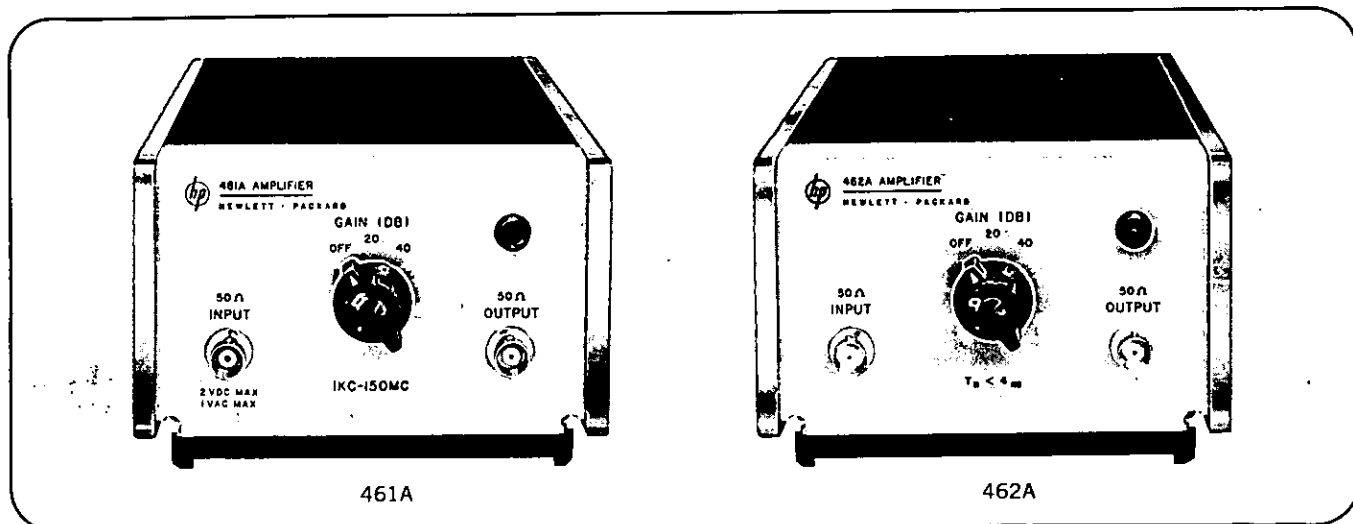
\dagger From 11 Hz to 50 kHz.



SOLID STATE AMPLIFIERS

Wide band, 40 dB solid-state amplifiers

Models 461A, 462A



The solid-state HP 461A and 462A Amplifiers are excellent wherever wide frequency range, low distortion, and portability are desired.

The 461A Amplifier is a general purpose instrument designed to deliver stable gain over a wide frequency range. Either 20 dB or 40 dB gain may be selected with a front-panel switch. Figure 1 illustrates the typical frequency response of the 461A. Both input and output impedances are matched to 50 ohms. Maximum output is $\frac{1}{2}$ volt rms.

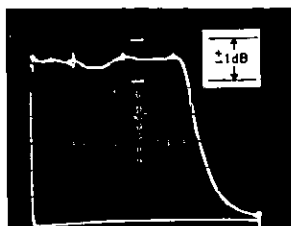


Figure 1. Frequency response curve of HP 461A. Markers shown from left to right are: 50, 100, 150 and 200 MHz. Gain control is set in 20 or 40 dB position.

The ability of the 462A to amplify very fast pulses can be seen in Figure 2. The upper trace (A) shows a 20 ns pulse applied to the input of the 462A Amplifier. The lower trace shows the same pulse amplified at 40 dB as viewed on the HP Sampling Oscilloscope.

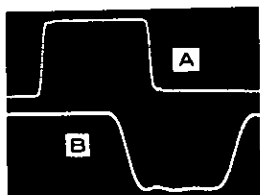


Figure 2. (A) Input Pulse to HP 462A (5 mV peak to peak). (B) Output Pulse of HP 462A (500 mV peak to peak). Gain control is set in 40 dB position. Sweep speed is 5 ns/cm.

This amplifier gives maximum usefulness for fast-pulse applications, television, and vhf work.

Specifications, 461A

Frequency range: 1 kHz to 150 MHz.

Frequency response: ± 1 dB, 1 kHz to 150 MHz when operating into a 50 Ω resistive load (500 kHz reference).

Gain at 500 kHz: 40 dB ± 0.5 dB or 20 dB ± 1.0 dB, selected by front-panel switch (inverting).

Input impedance: nominal 50 Ω .

Maximum input: 1 V rms or 2 V p-p pulse.

Maximum dc input: ± 2 V.*

Maximum Output: 0.5 V rms into 50 Ω resistive load.

Equivalent wideband input noise level: < 40 μ V in 40 dB position when loaded with 50 Ω .

Distortion: $< 5\%$ at maximum output and rated load.

Overload recovery: < 1 μ s for 10 times overload.

Specifications, 462A

Pulse response: leading edge and trailing edge: rise time, < 4 ns; overshoot, $< 5\%$.

Pulse overload recovery: < 1 μ s for 10 times overload.

Pulse duration for 10% droop: 30 μ s.

Equivalent input noise level: < 40 μ V in 40 dB position (50 Ω load).

Input impedance: nominal 50 Ω .

Maximum input: 1 V rms or 2 V p-p pulse.

Maximum dc input: ± 2 V.*

Gain: 20 or 40 dB selected by front-panel switch (inverting).

Output: 1 V p-p into 50 Ω resistive load.

Delay: nominally 12 to 14 ns.

General Specifications

Dimensions: $5\frac{1}{8}$ " wide, 3" high (without removable feet), 11" deep (130 x 76 x 279 mm).

Weight: net 4 lbs (1,8 kg); shipping 6 lbs (2,7 kg).

Power: 115 or 230 V $\pm 10\%$, 50 to 400 Hz, 5 W.

Connectors: BNC female.

Accessories available: 11048B 50 Ω Feed-thru Termination, \$10; Combining Cases: 1051A, \$110, or 1052A \$120, (each holds six HP 461A Amplifiers).

Price: HP 461A, \$350; HP 462A, \$350.

*For the protection of the input circuitry.

POWER AMPLIFIER

Provides more than 4.5 watts, 10 to 500 MHz
Model 230B



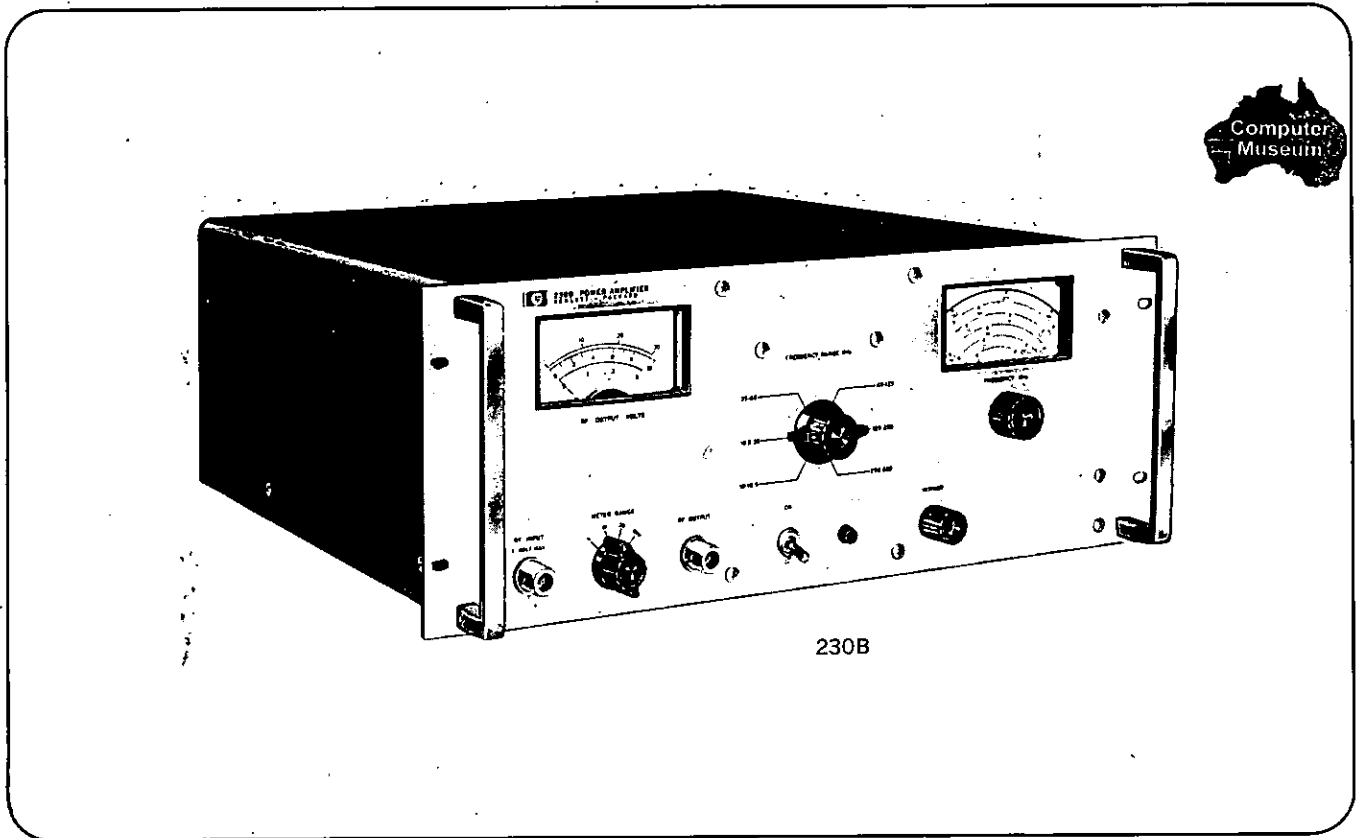
AMPLIFIERS

The HP 230B is a tuned RF power amplifier covering 10 to 500 MHz in six continuous ranges. It provides up to 30 dB of gain, and has a maximum rated power output of 4.5 watts. With a typical noise figure of 6 to 9 dB, it is also suitable for low-level applications.

The 230B consists of a three-stage, grounded-grid amplifier powered from a regulated supply. A broad-band, rms cali-

brated, peak-reading voltmeter monitors the output level. In addition, a maximum level limit circuit reduces the amplifier gain when the output reaches a fixed 30-volt level. This protects the amplifier from accidental overload and possible damage from improper output termination.

High and low-level applications of the power amplifier are discussed in Application Note 76. Copies are available from any Hewlett-Packard field office.



Specifications

Frequency range: 10 to 500 MHz in six bands: 10 to 18.5 MHz, 18.5 to 35 MHz, 35 to 65 MHz, 65 to 125 MHz, 125 to 250 MHz, 250 to 500 MHz.

Frequency calibration: increments of approximately 10%, accurate to $\pm 10\%$.

RF gain: 30 dB (10 to 125 MHz), 27 dB (125 to 250 MHz), 24 dB (250 to 500 MHz), with 10 volts output into 50 ohms.

RF bandwidth: >700 kHz (10 to 150 MHz), >1.4 MHz (150 to 500 MHz), with 10 volts output into 50 ohms.

RF output:

Level: up to 15 volts across external 50-ohm load (4.5 watts).

Level monitor: full scale ranges of 3, 10, and 30 volts, accurate to 10% from 10 to 500 MHz.

AM range: reproduces 0 to 100% modulation of driving source.

AM distortion: $<10\%$ added to distortion of driving source, up to 5 volts maximum carrier output for up to 100% AM.

FM range: reproduces modulation of driving source, except as limited by RF bandwidth.

Incidental AM: $<10\%$ added to modulation of driving signal source at 150 kHz deviation.

FM distortion: negligible distortion added to distortion of driving source for <150 kHz deviations and modulation frequencies.

Connectors: Type N female.

Power: 105 to 125 volts or 210 to 250 volts, 50 or 60 Hz, 150 watts.

Dimensions: $16\frac{3}{4}$ " wide, $7\text{-}3/16$ " high, $18\text{-}1/16$ " deep (425 x 183 x 459 mm).

Weight: net 35 lbs (15,8 kg), shipping 52 lbs (23,4 kg).

Price: \$1190.

AMPLIFIERS



MICROWAVE AMPLIFIERS

Broadband, high-gain, high-power amplification

Models 489A, 491C, 493A, 495A

Advantages:

DC-coupled modulation circuitry allows power leveling and remote programming
PPM focusing means fewer alignment problems

Uses:

Antenna efficiency and pattern measurements
Extends attenuation measuring systems capability by at least 30 dB.

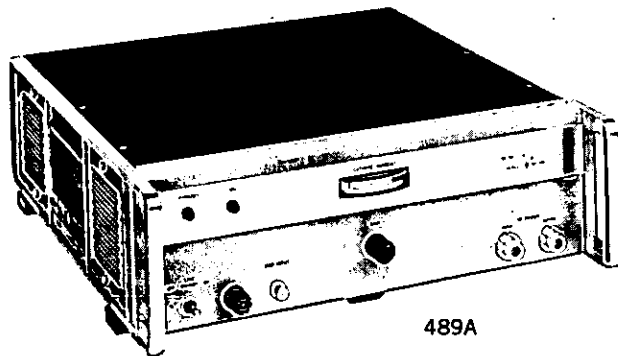
Description

Amplification of frequencies from 1 to 12.4 GHz is accomplished in four ranges by the Hewlett-Packard microwave amplifiers. Each delivers at least 1 watt with an input of 1 mW or less, a gain of at least 30 dB.

Amplitude modulation circuitry has been designed for wide bandwidth (down to dc) and with internal amplification, so that small modulation signals cause a large output power change. This unique modulation circuitry also per-

mits power leveling with external elements, plus remote programming. Spurious phase modulation of 0.1° or less and residual AM at least 45 dB below carrier are assured by regulation of the filament, anode, and helix power supplies. TWT cathode current is monitored by a front-panel meter and can be controlled by the gain adjustment for rated power output or for reducing tube current to extend tube life when full output power is not required. Helix, collector, and anode current can be measured at an easily accessible test point board.

Periodic permanent magnet focusing reduces weight, size, and power consumption and at the same time alleviates alignment problems. Protective features incorporated to prevent TWT failure include an overload relay on the helix power supply, a three-minute time delay on the beam supply, and a fail-safe circuit that disconnects ac power whenever the regulated filament supply voltage exceeds a predetermined level.



489A

Specifications

	489A	491C	493A	495A
Frequency range (GHz)	1-2	2-4	4-8	7-12.4
Power output (with 1 mW or less input)	1 W	1 W	1 W	1 W
Gain at rated output	30 dB	30 dB	30 dB	30 dB
Gain variation with freq. at rated output small signal across any 10% of band	≤ 6 dB	≤ 6 dB	≤ 6 dB	≤ 6 dB
across full band	≤ 5 dB	≤ 5 dB	≤ 5 dB	≤ 5 dB <small>(for 300 MHz)</small>
Gain variation with $\pm 10\%$ variation from rated line voltage	≤ 12 dB	≤ 12 dB	≤ 12 dB	≤ 10 dB
Gain variation with $\pm 10\%$ variation from rated line voltage	≤ 1 dB	≤ 1 dB	≤ 1 dB	≤ 1 dB
Noise max. noise figure typ. noise power out	30 dB -10 dBm	30 dB -10 dBm	30 dB 0 dBm	30 dB 0 dBm
Price	\$2350	\$2350	\$2700	\$2700

For all models

Maximum RF input: 100 mW.

Input/output characteristics: impedance, 50 Ω ; reflection coefficient (cold), ≤ 0.43 (2.5 SWR, 7.3 dB return loss); connectors, type N female.

Amplitude modulation

Sensitivity: a modulation input of -20 V peak or more reduces the RF output by more than 20 dB from dc to 50 kHz. Above 50 kHz modulation decreases approximately 6 dB per octave.

Frequency response: dc to 500 kHz (3 dB).

Input impedance: 100 k Ω shunted by approx. 50 pF.

Pulse response: < 1 μ s rise and fall times.

Residual AM: at least 45 dB below carrier.

Dimensions: 16 $\frac{3}{4}$ " wide, 5 $\frac{1}{2}$ " high, 18 $\frac{3}{8}$ " deep (426 x 140 x 467 mm); hardware furnished for conversion to rack mount 19" wide, 5-7/32" high, 16 $\frac{3}{8}$ " deep behind panel (483 x 133 x 416 mm).

Weight: net 39 lb (17,6 kg); shipping 43 lb (19,4 kg).

Power: 115 or 230 volts $\pm 10\%$, 50 to 60 Hz, approx. 225 watts.

Accessories available: 11500A Cable Assembly; 11501A Cable Assembly.

GENERAL INFORMATION



OSCILLOSCOPES

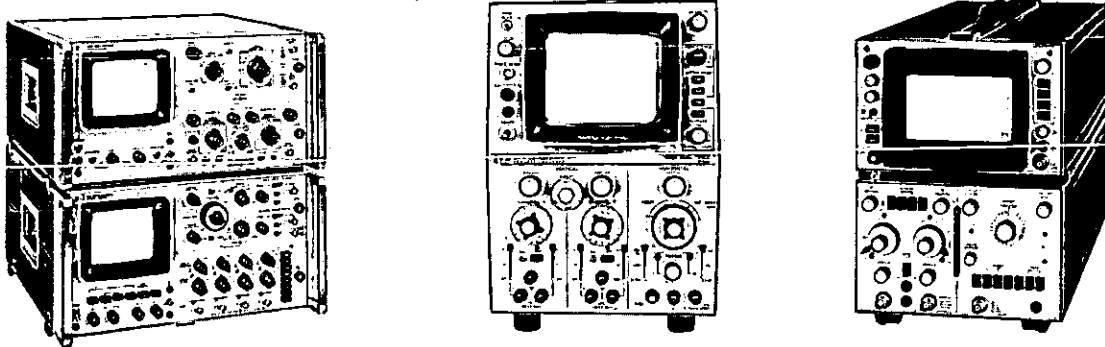


Figure 1. A few Hewlett-Packard Oscilloscopes.

The oscilloscope is an extremely fast X-Y plotter which displays one input signal versus another signal, or versus time. The variations are displayed on the face of the cathode-ray tube. The "stylus" is a luminous spot which moves over the CRT in response to input voltages. In the usual scope application the X axis represents time. To do this a linear ramp of voltage is generated internally which moves the spot uniformly from left to right across the face of the CRT. The voltage being examined is applied to the Y axis input, moving the spot up or down in accordance with its instantaneous value. The spot then traces a curve that shows how the input voltage varies as a function of time.

Because the oscilloscope can display time varying voltages, it has become a universal tool in all kinds of electronic investigations. In addition, the oscilloscope can present a visual display of a variety of dynamic phenomena by the use of transducers which convert current, strain, acceleration, pressure, sound, and other physical quantities into voltages.

The primary sub-systems of an oscilloscope are the vertical deflection system, horizontal deflection system, power supplies, and the cathode-ray tube. The vertical deflection system processes the Y axis input signal to control the up and down movement of the CRT spot. The horizontal deflection system either generates the sweep to move the spot across the CRT or processes an external signal to control the horizontal movement of the spot. The low voltage power supply provides power for the scope circuits and the high voltage power supply provides power for the cathode-ray tube. The CRT is the readout device that displays the plot of Y versus X or Y versus time.

Cathode-ray Tube

The cathode-ray tube is the heart of the oscilloscope, with the rest of the instrument consisting of circuits for operating the CRT. As is commonly known, the tube has an electron gun at one end and a phosphor display screen at the other end. The electron gun is made up of a thermionic cathode, various accelerating electrodes for directing emitted electrons toward the display screen, and controls necessary for focus and intensity. The resulting narrow beam of electrons from the gun strikes the phosphor in a small spot with enough energy to cause fluorescence.

After leaving the gun, the electron stream passes between each of two pairs of deflection electrodes. Voltages applied to these electrodes bend the beam. Voltages on one pair of electrodes move the beam up and down and voltages on the other pair move it from side to side. The electrodes that move the beam up and down are the vertical deflection plates

and the pair that moves the spot side-ways are the horizontal deflection plates. These movements are independent of each other so that the spot may be positioned anywhere on the phosphor screen by the appropriate input voltages.

The accuracy with which the viewed waveform corresponds to the deflection voltages depends to a large measure on the performance of the cathode-ray tube. Careful design of the electron gun structure and precision manufacturing techniques of the Hewlett-Packard cathode-ray tube facility ensure that the beam moves linearly with respect to the deflection voltages. Precision CRT's make it possible to measure accurately the input voltage amplitude at any point on the waveform by measuring the amount of deflection of the fluorescent spot.

In order to make measurements of the spot deflection, a rectangular grid (called a graticule) is scribed on transparent material and attached to the face plate

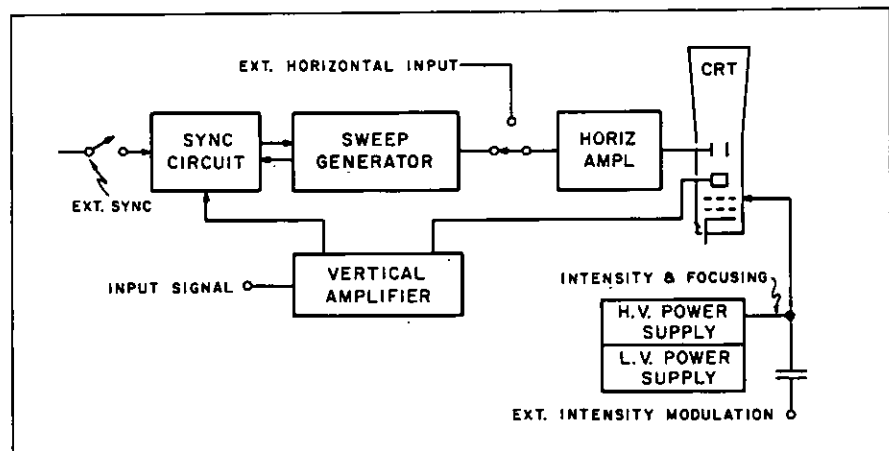


Figure 2. Oscilloscope block diagram.

of the CRT. All Hewlett-Packard CRT's however, incorporate an internal graticule. This type of graticule consists of lines placed in the same plane as the phosphor. The internal graticule avoids errors caused by parallax which exists when the graticule is external to the tube, separated from the phosphor by the thickness of a glass face plate.

Storage and variable persistence

The Hewlett-Packard Models 141B, 181A/AR, 1201A/B, 1207A/B oscilloscopes are effectively three scopes in one. They are first of all, a normal oscilloscope; secondly, a storage scope capable of storing traces for periods of hours; and thirdly, a variable persistence oscilloscope. By persistence, we mean the time it takes for the trace to fade to 10% of its original brightness. The persistence of these scopes is continuously variable from 0.2 seconds to more than a minute. These versatile oscilloscopes were made possible by uniquely designed CRT's and persistence control circuits.

Large screen displays

Another area in which Hewlett-Packard is advancing the technology is that of cathode-ray tube design. The ideal oscilloscope would have a very large viewing area in a very short tube. However, since the electron beam is initially deflected at the gun structure and continues at a given deflection angle, the displacement depends on the distance from the gun to the screen. To get a larger display in a shorter tube, the electron beam must be re-deflected between the gun and screen. The Model 140A CRT was the first in which a wire expansion mesh was used, placing a voltage on the mesh to create an electrostatic field to further bend the beam. The next step in the expansion-mesh technology was to change the radius of the mesh, thereby obtaining greater magnification. This resulted in the 180A CRT which has 30% more viewing area in a tube that is four inches shorter than previous high frequency tubes. A recent development is the 8 inch by 10 inch CRT display in the 1300A and 143A. This is the first time that a tube with this size display area has been designed into an 18" long tube with a deflection factor of only 14 volts for 1 inch of display.

High frequency CRT

A new Hewlett-Packard designed CRT, in Model 183A/B mainframe, with distributed deflection plates extends CRT

operation to greater than 500 MHz. The two helical transmission line vertical deflection plates provide distributed deflection of the electron beam which provides high-frequency response and deflection factors that are compatible with transistor amplifiers.

Vertical deflection system

The vertical deflection system is made up of an input attenuator and an amplifier chain. Since the CRT is limited as to the range of voltage that can be applied to deflection plates, considerations must be made to handle signals outside this range. For signal amplitudes below this range the amplifier chain is used to increase the amplitude. If the signal is too large, the attenuator reduces the signal so that it can be displayed. By calibrating the attenuator and amplifiers the deflection factor is known for each setting of the attenuator. That is, the graticule is calibrated in so many volts/div depending on the attenuator setting.

The amplifiers in Hewlett-Packard oscilloscopes are stable enough to permit voltage measurements with confidence to at least $\pm 3\%$ accuracy. To verify amplifier accuracy, all Hewlett-Packard scopes have built-in calibrators which supply precisely controlled signals for use as calibrating test signals.

High amplifier gain, with minimum drift and noise, is obtained in Hewlett-Packard scopes by careful circuit design. This allows scopes to be built with high sensitivity. Large amounts of negative feedback, aided by the use of regulated power supplies, achieve gain stability for measurement accuracy.

DC coupling preserves the waveform of slowly varying signals and also permits a dc reference line to be established on the display, facilitating precise amplitude measurements. DC coupling is not desirable when a small ac component on a relatively large dc voltage is examined. All Hewlett-Packard scopes have provision for switching decoupling capacitors into the signal line when dc coupling is not desired.

Horizontal deflection system

The horizontal deflection system supplies drive voltages for moving the electron beam horizontally. Since so many measurements are concerned with plotting voltages versus time, the horizontal deflection system also includes sawtooth waveform generators for sweeping the beam horizontally at a uniform rate.

Since the rate of sweep is uniform, the scope can be calibrated for so many s/div of horizontal display. To accept signals that vary over a wide range of frequencies, a switch is used to vary the sweep rate. Each position of the switch is calibrated so that the time scale can be varied from s/div to ms/div to $\mu\text{s}/\text{div}$.

Also necessary are synchronizing circuits for starting the horizontal sweep at a specific instant with respect to the measured waveform. Starting the sweep (triggering) is quick and easy with Hewlett-Packard scopes through the use of automatic triggering. Preset adjustments produce synchronized sweeps with little or no adjustment of the front-panel controls. An automatic baseline, present on many Hewlett-Packard scopes, facilitates setting up the display in the absence of an input signal. The sweep magnifier feature is valuable for close examination of trace segments which occur too late in time after the start of the trace to be examined with faster sweeps.

The horizontal amplifiers of most Hewlett-Packard scopes may be used separately from the sweep generating circuits for deflecting the horizontal beam in response to external waveforms, a useful technique for making X-Y plots. Phase shift measurements can also be made in this mode of operation by selecting a scope that has horizontal and vertical amplifiers with identical characteristics.

Probes

A probe is used to transfer the signal from the circuit under test to the vertical amplifier of the oscilloscope. The characteristics of a probe should be such

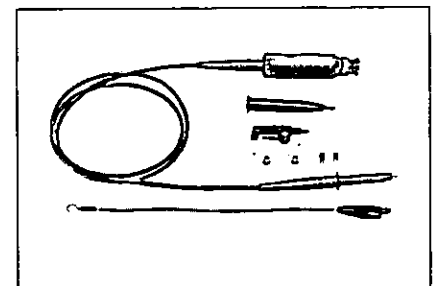


Figure 3. One type of probe used to transfer the signal from the test circuit to the scope.

that it does not disturb, in any way, the circuit that is being tested or the performance of the oscilloscope. To accomplish this the probe has a very high impedance, say $10\text{ M}\Omega$, and a variable

capacitor to adjust for high frequency components of the signal. Most probes are of the voltage divider type which reduce the signal amplitude. The typical division ratio is 10:1. There are types of probes other than voltage divider, such as active probes, current probes and sampling probes. Each of these types of probes performs the same basic function, that is, to get the signal from the circuit under test, to the input of the oscilloscope with little or no distortion.

Sampling oscilloscopes

Conventional or "real time" oscilloscopes are limited in bandwidth to frequencies in the megahertz region. Sampling scopes, however, have bandwidths to 12.4 GHz, (12.4×10^9 hertz). This type of oscilloscope uses a stroboscopic approach to reconstruct the input waveform from samples taken during many recurrences of the waveform. This technique is illustrated by the waveforms of Figure 4. In reconstructing a waveform, the sampling pulse "turns on" the sampling circuit for an extremely short interval and the waveform voltage at that instant is measured. The CRT spot is positioned vertically to correspond to this voltage amplitude.

The next sample is taken during a subsequent cycle at a slightly later point on the input waveform. The CRT spot moves horizontally a short distance and is repositioned vertically to the new voltage. In this way, the scope plots the waveform point by point, as many as 1000 samples being used to reconstruct the waveform.

Selecting an oscilloscope

Choice of an oscilloscope is based largely on considerations of both performance capabilities and versatility. However the complexity of the plug-in scope necessitates higher costs. Non-plug-in scopes that are designed to meet specific needs can be produced at lower costs.

Bandwidth and deflection factor of the vertical amplifiers are the primary characteristics which describe an oscillo-

scope's performance capabilities. Wide bandwidth is obtained at the expense of more complicated circuits and more expensive cathode-ray tubes. A low deflection factor requires more amplifier stages and added refinements for minimizing dc drift and noise. In addition to these two primary considerations and the question of plug-ins or not, there are special requirements and features that can dictate which scope is selected. Refer to page 543 for a glossary of oscilloscope terminology and information on CRT phosphors.

Non-plug-in oscilloscopes

Hewlett-Packard's non-plug-in oscilloscopes make accurate voltage and time measurements on a wide variety of waveforms in the subsonic, audio, ultrasonic,

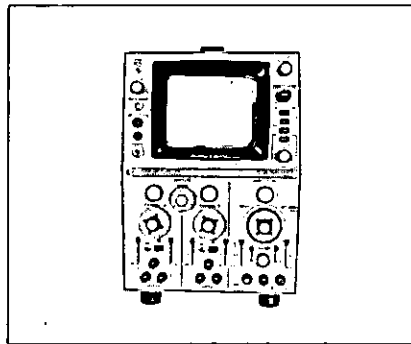


Figure 5. Model 1201A/B 500 kHz bandwidth oscilloscope is all solid-state non-plug-in instrument. This is one in 1200-series scopes offering wide selection of specifications and configurations.

and low frequency ranges. These scopes are intended for analysis of waveforms in which little importance is attached to frequency components beyond 500 kHz. The dc amplifiers and long sweep rates are suitable for medical and mechanical observations, as well as for low-frequency electrical work. At the same time, faster sweep speeds are provided in these instruments for detailed studies of transient phenomena, vibration effects, audio analysis, and other medium frequency events.

Since these instruments have relatively simple circuits and construction they are the most economical type of oscilloscope.

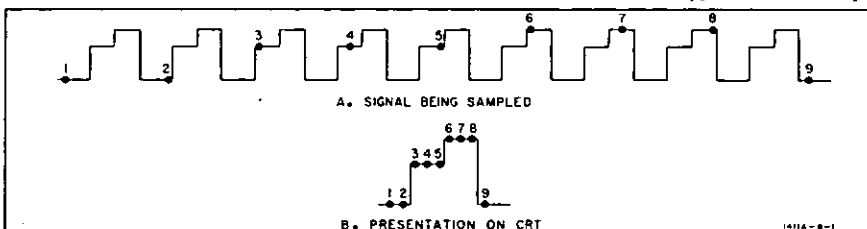


Figure 4. The sampling oscilloscope reconstructs the test signal by taking up to 1000 samples.

In applications, such as systems, where the scope performs a limited number of functions and the added expense of plug-in flexibility is not needed, the non-plug-in oscilloscope provides maximum economy.

Plug-in oscilloscopes

Hewlett-Packard plug-in oscilloscopes enable the user to make a very wide

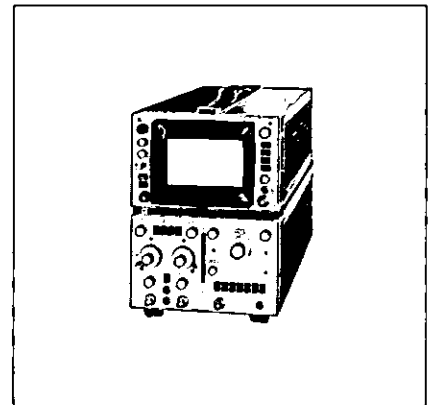


Figure 6. The Model 183A plug-in oscilloscope features aircraft type frame construction for maximum ruggedness with minimum weight.

variety of measurements with just one oscilloscope. The instrument characteristics can be altered by simply changing the vertical and horizontal plug-ins. Bandwidth, deflection factor, number of channels, and time base can all be tailored to exact needs. Other features such as sampling or TDR can be added at will. Plug-in capability also enables a scope's performance to be updated as new plug-ins become available.

In determining which scope to buy, the considerations are: Will the needs change in the future?—if so, a plug-in scope would be the best buy; is cost a major consideration?—if so, then a non-plug-in scope might fill the bill; or is there a special function that is desired?—this then dictates the type of scope. A general rule for selection would be to determine the basic requirements of the oscilloscope based on the intended application and then use the Selection Charts to determine the one best suited for the task.

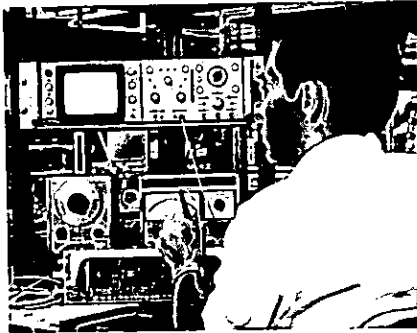
If there is any question as to which oscilloscope to choose, it is recommended that the customer consult with the local Hewlett-Packard field engineer. Hewlett-Packard field engineers are trained in the use and applications of all Hewlett-Packard instruments and can assist in solving the particular applications problem in the most economical way.

OSCILLOSCOPES

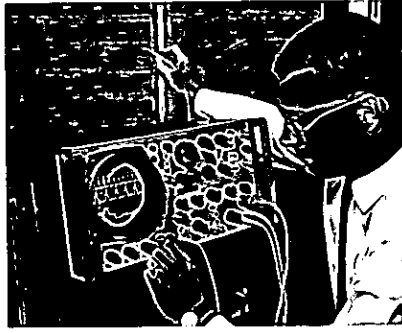


SELECTION CHART

Choose the oscilloscope for the application



180AR



141A



1202A

Type	Non plug-in										X-Y displays		Plug-in systems	
	120B	122A/AR	130C	132A	1200A/B	1201A/B	1202A/B	1205A/B	1206A/B	1207A/B	1208A/B	1300A	140-series	180-series
Model no.	120B	122A/AR	130C	132A	1200A/B	1201A/B	1202A/B	1205A/B	1206A/B	1207A/B	1208A/B	1300A	140-series	180-series
Realtime bandwidth	450 kHz	200 kHz	500 kHz	500 kHz	500 kHz	500 kHz	500 kHz	500 kHz	500 kHz	500 kHz	600 kHz	20 MHz	20 MHz	250 MHz
Minimum deflection factor	10 mV/cm	10 mV/cm	200 μ V/cm	100 μ V/cm	100 μ V/div	100 μ V/div	100 μ V/div	5 mV/div	5 mV/div	5 mV/div	100 mV/div	0.1 V/in.	10 μ V/div	1 mV/div
Sampling bandwidth													12.4 GHz	12.4 GHz
Variable persistence/storage						•				•			•	•
Differential input	•	•	•	•	•	•	•	•	•	•	•		•	•
8 in. x 10 in. CRT												•	•	
Number of channels	1	2	1	2	2	2	1	2	1	1	1	2	4	4
TDR													•	•
DC offset													•	•
Swept frequency													•	
Delayed sweep													•	•
Price	\$560	\$850	\$790	\$1475	\$990	\$1900	\$790	\$875	\$715	\$1500	\$540	\$2000	\$1220 and up	\$2065 and up
Page	477	478	479	480	482-483	482-483	484	485	486-487	486-487	488	489-490	491-516	518-533

450 kHz OSCILLOSCOPE

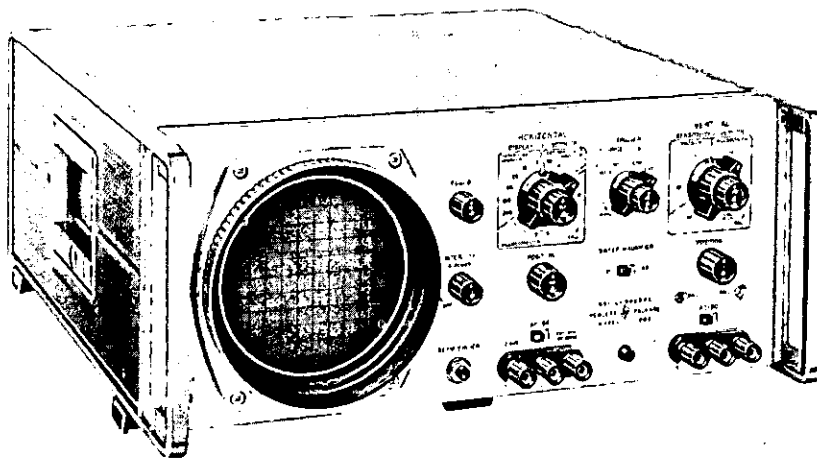
Easy-to-use, general-purpose 10 mV/cm scope
Model 120B



OSCILLOSCOPES

The HP Model 120B Oscilloscope is an easy-to-use, general-purpose oscilloscope for both laboratory and industrial applications. It combines accurately calibrated horizontal sweep times and vertical deflection sensitivities with an internal graticule CRT that eliminates parallax error. In addition, the front panel controls are logically grouped by function to simplify operation. The automatic triggering feature synchronizes the sweep circuits with the displayed

waveform, eliminating time-consuming trigger adjustments. The Hewlett-Packard modular enclosure is equally well suited for bench use or for rack mounting with the hardware provided with each instrument. Moreover, the removable top and bottom covers of the modular enclosure permit access to all components and adjustments within the instrument for easy routine maintenance. Several instrument options are available as indicated in the Specifications.



120B

Specifications

Time base

Range: 5 μ s/cm to 200 ms/cm, 15 ranges in a 1, 2, 5, sequence; accuracy $\pm 5\%$; vernier provides continuous adjustment between steps and extends the 200 ms/cm step to at least 0.5 s/cm.

Magnifier: X5 sweep expansion may be used on all ranges and expands the fastest sweep to 1 μ s/cm; expanded sweep accuracy is $\pm 10\%$.

Automatic triggering (baseline displayed in the absence of an input signal):

Internal: 50 Hz to 450 kHz for most signals causing 1.0 cm or more vertical deflection; also from line voltage.

External: 50 to 450 kHz for most signals at least 1.5 volts peak-to-peak.

Trigger slope: positive or negative slope of vertical deflection signal; or negative slope of external sync signal.

Amplitude selection triggering:

Internal: 10 Hz to 450 kHz for signals causing 0.5 cm or more vertical deflection.

External: 10 Hz to 450 kHz for signals at least 1.5 volts, peak-to-peak.

Trigger point and slope: from any point on the vertical waveform presented on CRT; or continuously variable from -7 to $+7$ volts on the negative slope of external sync signal.

Vertical amplifier

Bandwidth: dc coupled, dc to 450 kHz; ac coupled, 2 Hz to 450 kHz.

Deflection factor (sensitivity): 10 mV/cm to 10 volts/cm in 4 calibrated steps; accuracy $\pm 3\%$; vernier provides continuous adjustment between steps and extends 10 V/cm step to at least 100 V/cm.

Maximum input: 500 V peak (dc + ac).

Internal calibrator: calibrating signal automatically connected to vertical amplifier for setting amplifier gain, accuracy $\pm 2\%$.

Input RC: 1 megohm shunted by approximately 50 pF.

Balanced input: on 10 mV/cm range; input RC, 2 megohms shunted by approximately 25 pF; common mode rejection at least 40 dB; common mode signal must not exceed ± 3 volts peak.

Phase shift: vertical and horizontal amplifiers have same phase characteristics within $\pm 2^\circ$ to 100 kHz (with verniers in Cal).

Horizontal amplifier

Bandwidth: dc coupled, dc to 300 kHz; ac coupled, 2 Hz to 300 kHz.

Deflection factor (sensitivity): 0.1 volt/cm to 10 volts/cm in 3 calibrated

steps; accuracy $\pm 5\%$; vernier provides continuous adjustment between steps and extends 10 V/cm step to at least 100 V/cm.

Input RC: 1 megohm, nominal, shunted by approximately 100 pF.

General

Cathode-ray tube: mono-accelerator, 2700-volt accelerating potential; aluminized P31 phosphor (other phosphors available, see modifications); etched safety glass face plate reduces glare.

Graticule: 10 cm x 10 cm parallax-free internal graticule marked in cm squares; major horizontal and vertical axes have 2 mm sub-divisions.

Beam finder: pressing beam finder control brings trace on CRT screen, regardless of settings of horizontal, vertical, or intensity controls.

Intensity modulation: +20 volt pulse will blank trace of normal intensity; input terminals on front panel.

Dimensions: 16 $\frac{1}{4}$ " wide, 7 $\frac{1}{2}$ " high, 18 $\frac{3}{8}$ " deep overall (425 x 191 x 467 mm); hardware furnished for quick conversion to 7" x 19" (178 x 483 mm) rack mount.

Weight: net 29 lbs (13 kg); shipping 35 lbs (16.9 kg).

Power: 115 or 230 volts $\pm 10\%$; 50 to 400 Hz; approximately 95 W.

Price: HP Model 120B, \$360.

Options (specify by option number):

001: factory wired for 230 V operation, no charge.

002: P2 phosphor, no charge.

005: external graticule CRT with P31 phosphor in lieu of standard internal graticule, add \$40; includes edge-lighting of external graticule.

006: rear terminals in parallel with front panel terminals; two 3-pin AN connectors for horizontal, vertical, and trigger inputs, add \$40; mating AN connectors supplied.

007: P7 phosphor, no charge.

010: provision for single-sweep operation, as well as conventional triggered sweep, add \$35.

011: P11 phosphor, no charge.

013: Plain 3/16" x 7" x 19" front panel for rack mounting only; suitable for installing special handles to match existing equipment in system or console, add \$20.

Accessories: refer to page 534.

OSCILLOSCOPES



DUAL-TRACE OSCILLOSCOPE

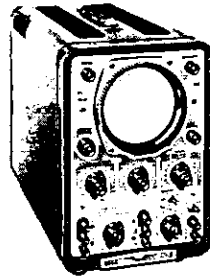
Economical versatility—200 kHz 10 mV/cm
Models 122A, 122AR

The Model 122A/AR is a dual trace, 200 kHz bandwidth oscilloscope which simplifies observation and measurement of electrical and mechanical equipment performance.

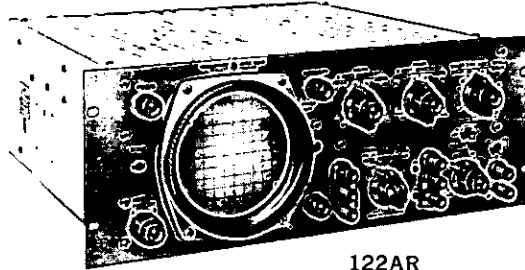
Personnel quickly learn the operation of this instrument and can use it with confidence since it has guaranteed calibration on time

base and voltage amplitude measurements.

Signals may be compared simultaneously and directly due to the twin vertical amplifiers which may be used separately or automatically switched. Input and output signals of amplifiers, filters, and other networks may be viewed simultaneously and transmission or rejection characteristics seen immediately.



122A



122AR

Specifications

Time base

Range: 5 μ s/cm to 200 ms/cm, 15 ranges in a 1, 2, 5 sequence; accuracy $\pm 5\%$; vernier provides continuous adjustment between steps, and extends 200 ms/cm step to at least 0.5 s/cm.

Magnifier: X5 sweep expansion may be used on all ranges and expands the fastest sweep to 1 μ s/cm; $\pm 10\%$.

Automatic triggering (baseline displayed in the absence of an input signal):

Internal: 50 Hz to 250 kHz for signals causing 0.5 cm or more vertical deflection; also from line voltage.

External: 50 Hz to 250 kHz for signals at least 2.5 pk-pk.

Trigger slope: positive or negative slope of vertical deflection signals; or negative slope of external sync signals.

Amplitude selection triggering:

Internal: 10 Hz to 250 kHz for signals causing 0.5 cm or more vertical deflection.

External: 10 Hz to 250 kHz for signals at least 2.5 pk-pk.

Trigger point and slope: from any point on the vertical waveform presented on CRT; or continuously variable from -10 to $+10$ volts on negative slope of external sync signal.

Vertical amplifiers

Bandwidth: dc coupled, dc to 200 kHz; ac coupled, 2 Hz to 200 kHz.

Deflection factor (sensitivity): 10 mV/cm to 10 V/cm in 4 calibrated steps; $\pm 3\%$; vernier provides continuous adjustment between steps and extends 10 V/cm step to at least 100 V/cm.

Maximum input: 500 V peak (dc + ac).

Internal calibrator: calibrating signal automatically connected to vertical amplifier for setting amplifier gain, $\pm 2\%$.

Input RC: 1 megohm shunted by approximately 50 pF.

Balanced input: on 10 mV/cm range; input RC, 2 megohms shunted by approximately 25 pF; CMRR, at least 40 dB; common mode signal must not exceed ± 3 pk.

Phase shift: vertical and horizontal amplifiers have same phase characteristics within $\pm 2^\circ$ to 100 kHz (with verniers in Cal).

Isolation: greater than 80 dB between Channels A and B from dc to 200 kHz.

Difference input: both input signals may be switched to one channel to give differential input on all sensitivity ranges; the sensitivity controls may be set separately to allow mixing signals of different levels; CMRR is at least 40 dB with both controls in most sensitive range, 30 dB on other ranges.

Vertical presentation: A only, B only, B-A, Alternate, or Chopped.

Horizontal amplifier

Bandwidth: dc coupled, dc to 200 kHz; ac coupled, 2 Hz to 200 kHz.

Deflection factor (sensitivity): 0.1 V/cm to 10 V/cm in 3 calibrated steps; $\pm 5\%$; vernier provides continuous adjustment between steps and extends 10 V/cm step to at least 100 V/cm.

Input RC: 1 megohm, nominal, shunted by approximately 100 pF.

General

Cathode-ray tube: mono-accelerator, 3000-volt accelerating potential; aluminumized P31 phosphor (other phosphors available, see options); etched safety glass face plate reduces glare.

Graticule: 10 cm x 10 cm internal graticule marked in cm squares; major horizontal and vertical axes have 2 mm sub-divisions.

CRT plates: direct connection to CRT deflection plates via terminals on rear panel; deflection factor approximately 20 V/cm.

Intensity modulation: +20 volt pulse blanks trace of normal intensity; input terminals on rear panel.

Dimensions: cabinet: 9 $\frac{3}{4}$ " wide, 15" high, 21 $\frac{1}{4}$ " deep over-all (248 x 381 x 540 mm); rack mount: 19" wide, 7" high, 19 $\frac{1}{2}$ " deep behind panel (483 x 178 x 495 mm).

Weight: cabinet: net, 35 lbs (16,9 kg); shipping, 45 lbs (21,7 kg); rack mount net, 34 lbs (16,4 kg); shipping, 49 lbs (23,6 kg).

Power: 115 or 230 volts $\pm 10\%$; 50 to 400 Hz; approx. 150 W.

Price: HP Model 122A (cabinet), \$850; HP Model 122AR (rack mount), \$850; for single sweep operation specify 122A Opt. H15 or 122AR Opt. H15, \$950.

Options (specify by option number):

001: factory wired for 230 V operation, no charge.

002: P2 phosphor, no charge.

005: external graticule CRT with P31 phosphor in lieu of standard internal graticule, add \$40; includes external graticule edge lighting.

006: rear terminals in parallel with front panel terminals; three 3-pin AN connectors for horizontal, vertical, and trigger inputs, add \$60; mating AN connectors supplied.

007: P7 phosphor, no charge.

011: P11 phosphor, no charge.

631: non internal graticule with P31 phosphor, no charge.

Accessories: refer to page 534.

200 μ V/CM OSCILLOSCOPE

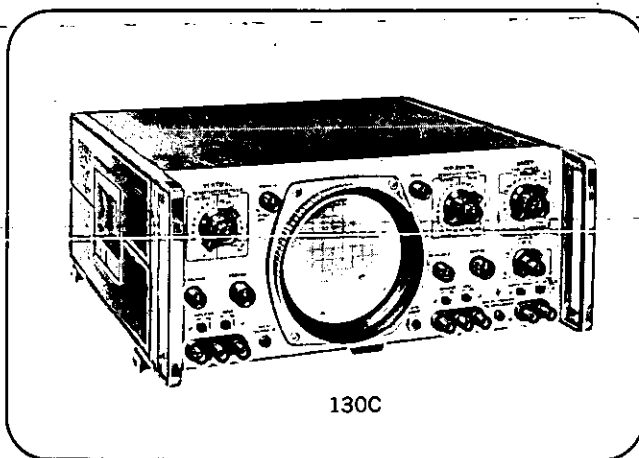
Features identical amplifiers for x-y plots
Model 130C



OSCILLOSCOPES

The HP Model 130C Oscilloscope is a versatile all-purpose instrument for laboratory, production line, industrial process measurements and medical applications. The outputs of rf detectors, strain gauges, transducers, and other low-level devices may be viewed directly without preamplification. Calibrated sweeps allow accurate time measurements, and the identical horizontal and vertical amplifiers permit simple and precise measurement of phase shifts within $\pm 1^\circ$ up to 100 kHz.

The Model 130C is easy to operate even by inexperienced personnel. Controls are color coded to front-panel markings and are logically arranged by function. An internal-graticule CRT provides a bright, clear, non-glare display without parallax. Automatic triggering minimizes adjustments. Positive pushbutton beam finder immediately locates an off-screen trace.



Specifications

Time base

Range: 1 μ s/cm to 5 s/cm, 21 ranges in a 1, 2, 5 sequence; accuracy $\pm 3\%$; vernier provides continuous adjustment between steps and extends the 5 s/cm step to at least 12.5 s/cm.

Magnifier: X2, X5, X10, X20, X50; over-all sweep accuracy within $\pm 5\%$ for sweep rates which do not exceed a maximum rate of 0.2 μ s/cm.

Automatic triggering (baseline displayed in the absence of an input signal):

Internal: 50 Hz to 500 kHz for signals causing 0.5 cm or more vertical deflection; also from line voltage.

External: 50 Hz to 500 kHz for signals at least 0.5 volt peak-to-peak.

Trigger slope: positive or negative slope of external sync signal or internal vertical deflection signal.

Amplitude selection triggering:

Internal: 10 Hz to 500 kHz for signals causing 0.5 cm or more vertical deflection.

External: for signals at least 0.5 volt peak-to-peak; dc coupled, dc to 500 kHz; ac coupled, 20 Hz to 500 kHz.

Trigger point and slope: from any point on the displayed vertical waveform; or continuously variable from -10 to $+10$ volts on either positive or negative slope of external sync signal.

Single sweep: front panel switch permits single sweep operation.

Vertical and horizontal amplifiers

Bandwidth: dc coupled, dc to 500 kHz; ac coupled (input), 2 Hz to 500 kHz; ac coupled (amplifier), 25 Hz to 500 kHz at 0.2 mV/cm deflection factor; lower cut-off frequency (f_{co}) is reduced as deflection factor is increased; at 20 mV/cm, f_{co} is 0.25 Hz; on less sensitive ranges, response extends to dc.

Deflection factor (sensitivity): 0.2 mV/cm to 20 volts/cm, 16 ranges in a 1, 2, 5 sequence; accuracy $\pm 3\%$; vernier provides continuous adjustment between steps and extends 20 V/cm step to at least 50 V/cm.

Maximum input: 500 V peak (dc + ac).

Internal calibrator: calibrating signal (line frequency square wave, 5 cm $\pm 3\%$) for setting amplifier gain, is automatically connected to amplifier when sensitivity vernier is set to Cal.

Input RC: 1 megohm shunted by approximately 45 pF; constant on all ranges.

Balanced inputs: on all sensitivity ranges.

Common mode rejection (dc to 50 kHz): at least 40 dB from 0.2 mV/cm to 0.1 V/cm sensitivities, common mode signal maximum 4 V pk-pk; at least 30 dB from 0.2 V/cm to 20 V/cm sensitivities, common mode signal maximum 4 V pk-pk on 0.2 V/cm range, 40 V pk-pk on 0.5 V/cm to 2 V/cm ranges, or 400 V pk-pk on 5 V/cm to 20 V/cm ranges.

Phase shift: $\pm 1^\circ$ to 100 kHz (verniers in Cal, and equal input sensitivities).

General

Calibrator: line frequency square wave, 500 mV $\pm 2\%$ provided through jack on front panel.

Cathode-ray tube: mono-accelerator, 3000-volt accelerating potential; aluminized P31 phosphor (other phosphors available, see options); etched safety glass face plate reduces glare.

Graticule: 10 cm x 10 cm parallax-free internal graticule marked in cm squares; major horizontal and vertical axes have 2 mm sub-divisions.

Beam finder: returns trace to CRT screen, regardless of setting of horizontal, vertical, or intensity controls.

Intensity modulation: +20 volt pulse blanks trace of normal intensity; input terminals on rear panel.

Dimensions: 16 $\frac{3}{4}$ " wide, 7 $\frac{1}{2}$ " high, 18 $\frac{3}{8}$ " deep over-all (426 x 191 x 467 mm); hardware furnished for quick conversion to 7" x 19" (178 x 843 mm) rack mount.

Weight: net, 31 lbs (15 kg); shipping, 38 lbs (18 kg).

Power: 115 or 230 volts $\pm 10\%$; 50 to 400 Hz; approximately 90 W.

Price: HP Model 130C, \$790.

Options (specify by option number):

002: P2 CRT phosphor, no charge.

005: external graticule CRT with P31 phosphor in lieu of internal graticule, add \$40; includes edge-lighting of external graticule.

006: rear terminals in parallel with front panel terminals; two 3-pin AN connectors for horizontal and vertical inputs, BNC for trigger input, add \$60; mating AN connectors supplied.

007: P7 CRT phosphor, no charge.

011: P11 CRT phosphor, no charge.

013: rack mount panel (3 $\frac{1}{16}$ " x 7" x 19"); suitable for installing special handles to match existing system equipment, add \$20.

Accessories: refer to page 534.

OSCILLOSCOPES

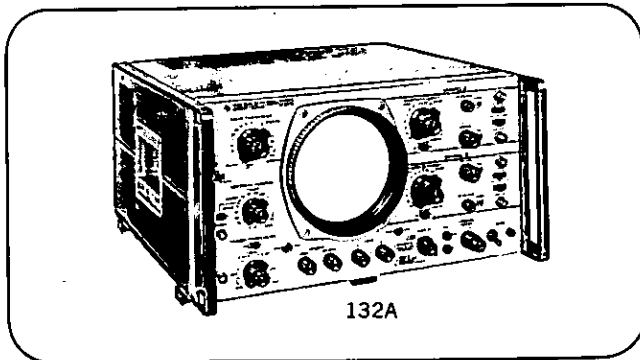


DUAL BEAM OSCILLOSCOPE

Two completely independent beams

Model 132A

The HP Model 132A Dual Beam Oscilloscope is designed to perform many electronic, scientific, bio-medical and mechanical measurements. Its 100 $\mu\text{V}/\text{cm}$ sensitivity, 500 kHz band-



Specifications

Time base

Range: may be selected for both beams, or one beam only with the other driven externally; 1 $\mu\text{s}/\text{cm}$ to 5 s/cm, 21 ranges in a 1, 2, 5 sequence $\pm 3\%$; vernier provides continuous adjustment between steps, and extends 5 s/cm step to at least 12.5 s/cm.

Magnifier: X2, X5, X10, X20, X50; may be selected for both channels together, or Channel B only $\pm 5\%$; vernier provides continuous adjustment between steps; with same vertical input applied to both channels, any portion of the display may be magnified on Channel B and the magnified portion will be intensified on Channel A display.

Automatic triggering (baseline displayed in the absence of an input signal):

Internal: 50 Hz to 500 kHz for signals causing 0.5 cm or more vertical deflection; selected from either channel input, or from line voltage.

External: 50 Hz to 500 kHz, for signals at least 0.5 V pk-pk.

Trigger slope: positive or negative slope of external sync signal of internal vertical deflection signals.

Amplitude selection triggering:

Internal: for signals causing 0.5 volt or more vertical deflection; dc-coupled, dc to 500 kHz; ac-coupled, 20 Hz to 500 kHz; selected from either channel signal, or from line voltage.

External: for signals at least 0.5 V pk-pk; dc-coupled, dc to 500 kHz; ac-coupled, 20 Hz to 500 kHz.

Trigger point and slope: from any point on displayed vertical waveform or continuously variable from -10 to +10 volts on either positive or negative slope of external signal.

External trigger input RC: ac-coupled, 0.01 μF in series with 1 megohm; dc-coupled, 1 megohm.

Sweep delay time: a pretrigger of approximately 1 μs allows the leading edge of non-recurrent waveform to be visible.

Single sweep: front panel switch and pushbutton.

Identical vertical amplifiers

Deflection factor (sensitivity): 100 $\mu\text{V}/\text{cm}$ to 20 V/cm; 17 ranges in a 1, 2, 5 sequence; accuracy $\pm 3\%$; verniers provide continuous adjustment between steps, and extend 20 V/cm steps to at least 50 V/cm.

Bandwidth: dc to >500 kHz (10% to 90% risetime $<0.7 \mu\text{s}$) on ranges 20 V/cm through 1 mV/cm, decreasing to >150 kHz at 100 $\mu\text{V}/\text{cm}$; input may be ac-coupled with 2 Hz lower cutoff; amplifier may be ac-coupled (to eliminate drift) with 2.5 Hz lower cutoff at 100 $\mu\text{V}/\text{cm}$, decreasing to 0.1 Hz at 20 mV/cm.

Differential input: differential input may be selected on all attenuator ranges; common mode rejection ratio (dc to 50 kHz) at least 74 dB on 0.1 mV/cm range, 66 dB on 1 mV/cm range, 40 dB on 0.2 V/cm and 30 dB on 0.5 V to 20 V/cm

width, two completely independent beams, and low microphonics and drift assure ease and accuracy in a wide variety of applications.

ranges. Max. CMRR 86 dB on 0.1 mV/cm range at 60 cps (60 dB with amp ac coupled). Maximum CM signal ± 2 V pk on 0.1 mV to 0.2 V/cm ranges, ± 20 V pk-pk on 0.5 V to 2 V ranges and ± 200 V pk on 5 V to 20 V ranges.

Inputs: AC, DC, or Off may be selected for each input; input RC is 1 megohm shunted by 50 pF, constant on all ranges; max. input voltage is ± 500 V peak (dc + ac).

Amplifier outputs: output is approx 2 V/cm from a 2 k ohm source impedance; is approx 500 kHz BW single ended on rear panel.

External horizontal amplifier

Functions: may be used on both beams simultaneously, or on one beam only while the other is sweeping unmagnified.

Deflection factor (sensitivity): 5 mV/cm to 2 V/cm; 9 ranges in a 1, 2, 5 sequence; accuracy $\pm 3\%$; vernier provides continuous adjustment between steps and extends 2 V/cm step to at least 5 V/cm.

Bandwidth: dc to >300 kHz (with vernier in Cal); ac-coupled, lower limit is 2 Hz.

Input: 1 megohm shunted by 50 pF, constant on all ranges; max. input voltage, ± 500 volts peak (dc + ac).

X-Y operation A vert - B Horiz

Single beam: relative phase shift between + inputs is within $\pm 2^\circ$ up to 50 kHz with verniers in Cal and equal input sensitivities.

Dual-beam: dual plots can be made using the external horizontal amplifier driving both beams; relative phase shift is normally within $\pm 2^\circ$ up to 10 kHz with vernier in Cal and equal input sensitivities.

General

Calibrator: approximately 350 Hz square wave, 0.5 V and 0.5 mV, provided through jacks on front panel; accuracy $\pm 2\%$.

Cathode-ray tube: mono-accelerator, 3500-volt accelerating potential; aluminized P2 phosphor (other phosphors available, see options); dual gun and two independent sets of vertical and horizontal deflection plates; etched safety glass face plate reduces glare.

Graticule: 10 cm x 10 cm parallax-free internal graticule marked in cm squares; display area for each beam is 8 cm x 10 cm, with 6 cm vertical overlap in center; vertical and horizontal axes for each beam have 2 mm subdivisions.

Beam finder: returns both traces to CRT screen, regardless of vertical, horizontal, or intensity control settings.

Intensity modulation: +20 volt pulse will blank traces of normal intensity; input terminals on rear panel; input time constant is approximately 125 μs (9400 pF and 13.5 k ohms).

Dimensions: 16 $\frac{3}{4}$ " wide, 9" high, 18 $\frac{3}{8}$ " deep over-all (426 x 229 x 466 mm); hardware furnished for quick conversion to 19" x 8 $\frac{3}{4}$ " x 16 $\frac{3}{8}$ " behind panel (483 x 222 x 416 mm) rack mount.

Weight: net 43 lbs (19.4 kg); shipping 55 lbs (24.8 kg).

Power: 115 or 230 V $\pm 10\%$; 50 to 400 Hz; approx 130 W.

Price: HP Model 132A, \$1475.

Options (specify by option number):

005: external graticule CRT with P2 phosphor in lieu of standard internal graticule, includes edge-lighting of external graticule, add \$40.

006: rear terminals in parallel with front panel terminals; 3-pin AN connectors for vertical inputs; BNC for horizontal and trigger inputs, mating AN connectors supplied, add \$60.

007: P7 phosphor, no charge.

011: P11 phosphor, no charge.

031: P31 phosphor, no charge.

602: non internal graticule with P2 phosphor, no charge.

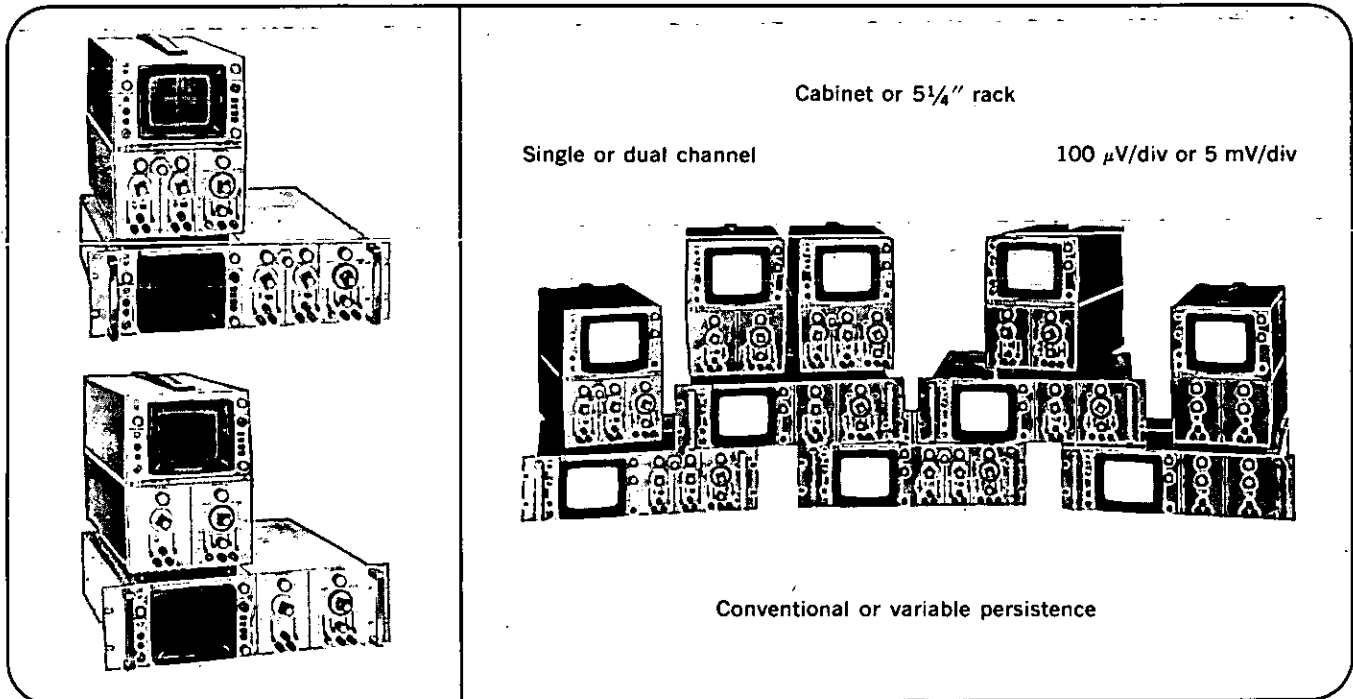
Accessories: refer to page 534.

500 kHz OSCILLOSCOPES

Solid-state, low drift, 100 $\mu\text{V}/\text{div}$
Model 1200-series



OSCILLOSCOPES



The all solid-state, low frequency 1200-series oscilloscopes offer advanced performance with operating features previously available only in much wider bandwidth, more expensive instruments. A wide variety of operating characteristics allows you to select the right instrument for your exact need. Bandwidth for the basic instruments is 500 kHz; 600 kHz for X-Y version. (Refer to selection chart below.)

Solid-state circuit design throughout the 1200-series oscilloscopes provides portable, reliable, stable, and versatile operation in a variety of measurements. Typical applications include:

- R & D laboratory design
- Production line testing
- Scientific research
- Systems instrumentation
- Information display
- Educational laboratories



Testmobiles, probes, cameras, and other accessories for use with the 1200-series are shown on pages 534 through 538.

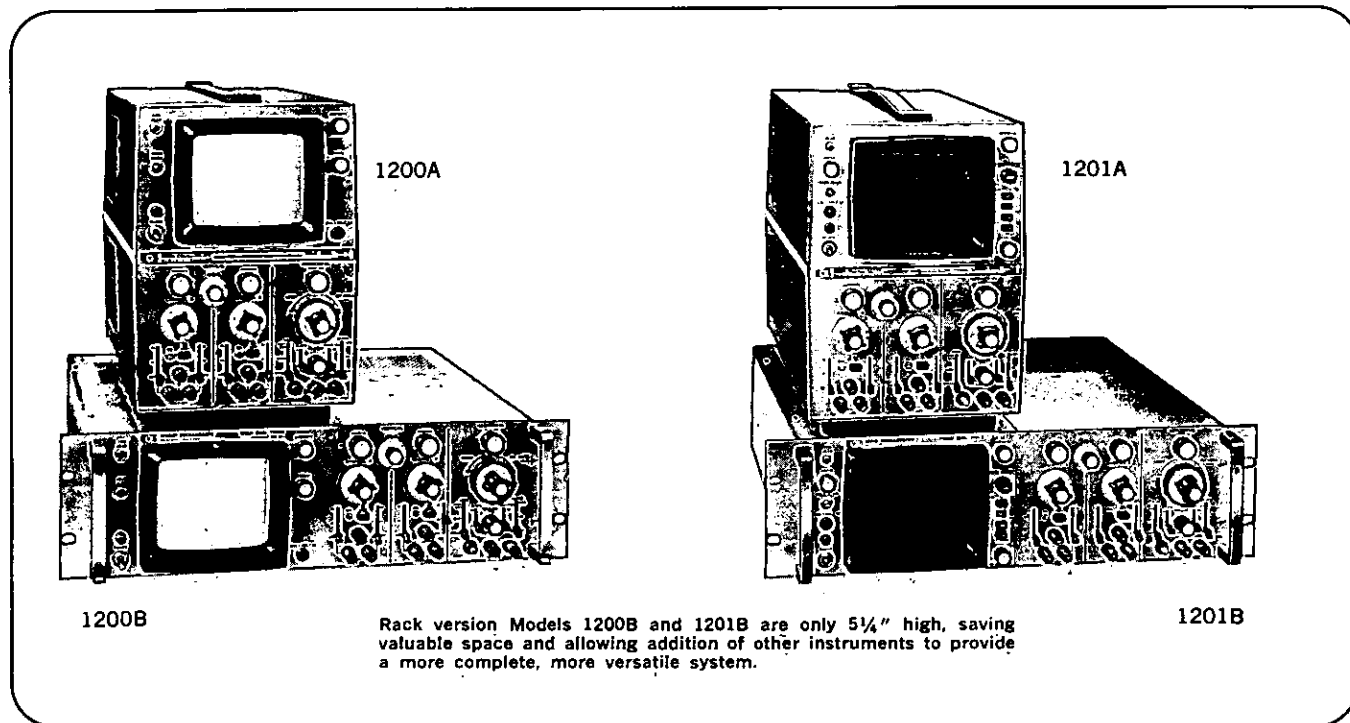
Instrument selection chart

Feature	1200A/B*	1201A/B*	1202A/B*	1205A/B*	1206A/B*	1207A/B*	1208A/B*
Deflection Factor	0.1 mV/div to 20 V/div	0.1 mV/div to 20 V/div	0.1 mV/div to 20 V/div	5 mV/div to 20 V/div	5 mV/div to 20 V/div	5 mV/div to 20 V/div	100 mV/div to 1 V/div
Bandwidth	500 kHz	500 kHz	500 kHz	500 kHz	500 kHz	500 kHz	600 kHz
Number of Traces	2	2	1	2	1	1	1
Differential Input	all ranges	all ranges	all ranges	all ranges	all ranges	all ranges	all ranges
CMRR	100 dB	100 dB	100 dB	50 dB	50 dB	50 dB	40 dB
Common-mode Signal Maximum	± 10 V	± 10 V	± 10 V	± 3 V	± 3 V	± 3 V	± 4 V
Phase Shift	1° to 100 kHz	1° to 100 kHz	—	1° to 100 kHz	—	—	1° to 500 kHz
Sweep Speeds	1 $\mu\text{s}/\text{div}$ to 5 s/div	1 $\mu\text{s}/\text{div}$ to 5 s/div	1 $\mu\text{s}/\text{div}$ to 5 s/div	1 $\mu\text{s}/\text{div}$ to 5 s/div	1 $\mu\text{s}/\text{div}$ to 5 s/div	1 $\mu\text{s}/\text{div}$ to 5 s/div	X-Y only
Ext. Horiz. Input	yes	yes	yes	yes	yes	yes	X-axis
DC-coupled Z-axis	yes	yes	yes	yes	yes	yes	yes
Variable Persistence and storage	no	yes	no	no	no	yes	no (see Specials & Options)
Page	482 and 483	482 and 483	484	485	486 and 487	486 and 487	488
Price	\$990	\$1900	\$790	\$875	\$715	\$1500	\$540

*"A" denotes standard bench model, e.g. 1200A. "B" denotes standard rack model, e.g. 1200B.

OSCILLOSCOPES 1200 SERIES *continued*

Dual channel, 100 $\mu\text{V}/\text{div}$, variable persistence and storage
Models 1200A/B, 1201A/B



Models 1200A/B and 1201A/B Dual Trace Oscilloscopes are versatile, easy-to-use, all-purpose instruments for 500 kHz bandwidth applications requiring 100 $\mu\text{V}/\text{div}$ deflection factors.

The Model 1201A/B has the added capability of variable persistence and variable storage time that makes low frequency measurements easier and more accurate. Variable persistence allows you to view a slow moving sweep as a complete trace rather than a moving dot. You can integrate fast risetime signals to full brightness, eliminate confusing displays by adjusting trace persistence so that one trace is fading as the next trace is being written, and adjust persistence to view several traces that makes circuit adjustments easier and quicker. Persistence can be continuously varied from 0.2 second to 1 minute in standard mode, or to 15 seconds in fast mode.

Variable storage time allows you to select a storage time and brightness combination that best solves your measurement problem. With the wide range of storage times available, up to 8 hours, you can store a trace, change circuit components, and store another trace to see how circuit operation changed. Traces can also be intensity modulated to provide a stored trace that has several gray shades. Stored traces have a brightness of at least 100 foot-lamberts, which allows viewing in bright ambient light environments.

Both the Model 1200A/B and the Model 1201A/B include many improved operating features which are standard in the 1200-series oscilloscopes. These include: 500 kHz bandwidth, all-range differential inputs, dc-coupled Z-axis, single-sweep, auto and amplitude selection triggering, external horizontal input, and all solid-state circuits.

Two signals can be compared simultaneously and directly by automatic switching between traces in either Chop or Alternate modes. In Chop operation, switching occurs at approximately 100 kHz between traces during the sweep; either internal time base or an external horizontal input signal can be used. In Alternate operation, switching occurs alternately between channels at the end of each sweep.

In Chop or Alternate operation, internal triggering of the start of the sweep is always derived from the signal on Channel A. This technique maintains the time relationship between the two vertical input signals.

Dual trace displays are useful for viewing both the input and output signals of amplifier, filters, and other networks to determine transmission or rejection characteristics. In vibration studies a rapid analysis is possible since the vibration pattern and the driving source waveform can be displayed at the same time.

The Channel A vs. B mode, selected by a front panel control, provides convenient X-Y displays of two variables. The two vertical amplifiers are identical, with less than 1° phase shift up to 100 kHz.

These instruments provide the capability to accurately measure and analyze low level signals. In addition to 100 $\mu\text{V}/\text{div}$ deflection factor, both vertical amplifiers have very low drift of typically less than 50 μV per hour and low noise of less than 50 μV pk-pk.

The low drift, very stable characteristics result in simpler operation and in less frequent circuit calibration. Operation is so stable that the balance control requires only infrequent adjustment. AC-coupling in the amplifier is no longer necessary as a means of eliminating drift, again simplifying operating controls.

The common-mode rejection ratio is 100,000 to 1 (100 dB) on the lowest deflection factor of .1 mV/div, over a dc to 10 kHz frequency range. This high CMRR is made even more useful by the ± 10 volts common-mode signal maximum on the lower deflection factors, a combination not previously available in low frequency oscilloscopes.

There are many measurement areas for which the instruments are well-suited. These include: audio systems, biological research, circuit design, drift measurement, filter design, phase measurement, servo design, strain gage and transducer monitoring, educational instruction, and X-Y displays.

Specifications, 1200A/B, 1201A/B

Vertical amplifiers

Deflection factor

Ranges: from 0.1 mV/div to 20 V/div (17 positions) in 1, 2, 5 sequence. $\pm 3\%$ accuracy with vernier in calibrated position.

Vernier: continuously variable between all ranges; extends -maximum deflection factor to at least 50 V/div.

Bandwidth: dc to 500 kHz with a maximum risetime of 0.7 μ s. 2 Hz to 500 kHz when ac-coupled. Front panel switch reduces upper frequency limit to approx 50 kHz.

Noise: less than 50 μ V peak-to-peak at full bandwidth.

Input: differential or single-ended on all ranges, selectable by front panel control.

Common-mode:

Frequency: dc to 10 kHz on all ranges.

Rejection ratio: at least 100 dB (100,000 to 1) on 0.1 mV/div range, decreasing by less than 20 dB per decade of deflection factor to at least 40 dB on the 0.2 V/div range; CMRR at least 30 dB on 0.5 V/div to 20 V/div ranges.

Signal maximum: ± 10 V (dc + peak ac) on 0.1 mV/div to 0.2 V/div ranges; ± 400 V (dc + peak ac) other ranges.

Input coupling: front panel selection of dc, ac, or off for both + and - inputs.

Input RC: 1 megohm shunted by 45 pF; constant on all ranges.

Maximum input: ± 400 volts (dc + peak ac).

Display: (1) Channel A, (2) Channel B, (3) Channels A and B, (4) Channels A and B vs. horizontal input (Chop only), (5) Channel A vs. B (A-vertical, B-horizontal). Chop display frequency is approx 100 kHz.

Internal trigger: by Channel A signal for A, Chop, and Alternate displays. By Channel B signal for B display.

Isolation: greater than 80 dB between channels at 500 kHz, with input connectors shielded.

Phase shift: (for Channel A vs. B) less than 1° , to 100 kHz (Verniers in calibrated position).

Time base

Sweep

Ranges: 1 μ s/div to 5 s/div (21 positions) in 1, 2, 5 sequence. $\pm 3\%$ accuracy with vernier in calibrated position.

Vernier: continuously variable between ranges; extends slowest sweep to at least 12.5 s/div.

X10 magnifier: indicates magnified sweep directly with $\pm 5\%$ accuracy.

Automatic triggering: baseline is displayed in absence of an input signal.

Internal: 50 Hz to above 500 kHz on most signals causing 0.5 division or more vertical deflection. Triggering on line frequency also selectable.

External: 50 Hz to above 1 MHz on most signals at least 0.2 volt peak-to-peak.

Trigger slope: positive or negative slope on internal, external or line trigger signals.

Amplitude selection triggering

Internal: dc to above 500 kHz on signals causing 0.5 division or more vertical deflection.

External: dc to 1 MHz on signals at least 0.2 volt peak-to-peak. Input impedance is 1 megohm shunted by approx 20 pF.

Trigger level and slope: internal, at any point on vertical waveform displayed; or continuously variable from +100 V to -100 V on either slope of the external trigger signal.

Trigger coupling: dc or ac for external, line, or internal triggering. Lower ac cut-off is 1.6 Hz for external; 5 Hz for internal.

Single sweep: selectable by front panel switch. Reset switch and armed indicator light.

Free run: selectable by front panel switch.

Maximum input: ± 350 volts (dc + peak ac).

Horizontal amplifier

Bandwidth: dc to 300 kHz. With input ac-coupled, low frequency cut-off is 1.6 Hz.

Deflection factor

Ranges: 0.1 V/div, 0.2 V/div, 0.5 V/div, and 1 V/div.

Vernier: continuously variable between ranges; extends maximum deflection factor to at least 2.5 V/div.

Input: single-ended.

Input RC: 1 megohm shunted by approx 20 pF.

Maximum input: ± 350 volts (dc + peak ac).

General

Cathode-ray tube (1200A/B)

Type: mono-accelerator, 3,000-volt accelerating potential; P31 phosphor standard (see options for other phosphors); etched safety glass faceplate reduces glare.

Graticule: 8 x 10 divisions; parallax-free internal graticule; 0.2-div subdivision markings on horizontal and vertical major axes. 1 div = 1 cm. Front panel screwdriver adjust aligns trace with graticule.

Intensity modulation: +2-volt signal blanks trace of normal intensity; +8-volt signal blanks any intensity. DC-coupled rear panel input; amplifier risetime approx 200 ns; input resistance is 5 k ohms.

Cathode-ray tube (1201A/B)

Type: post-accelerator, variable persistence storage tube; 10.5 kV accelerating potential; aluminized P31 phosphor.

Graticule: 8 x 10 divisions; parallax-free internal graticule; 0.2-div subdivision markings on horizontal and vertical major axes. 1 div = 0.95 cm. Front panel screwdriver adjust aligns trace with graticule.

Intensity modulation: +2-volt signal blanks trace of normal intensity; +8-volt signal blanks any intensity. DC-coupled rear panel input; amplifier risetime approx 200 ns; input resistance, 5 k ohms.

Persistence: conventional, natural persistence of P31 phosphor (approx 40 μ s). Variable, continuously variable from 0.2 s to 1 minute or longer in STD mode; and from 0.2 s to 15 s in FAST mode.*

Storage writing speed: STD mode, 20 cm/ms or greater; FAST mode, 0.5 cm/ μ s or greater.

Brightness: measured with entire screen faded positive, 100 foot-lamberts or greater.*

Storage time: STD writing speed, continuously variable from 1 minute to 8 hours or longer. FAST writing speed, continuously variable from 15 seconds to 1 hour or longer.

Erase: manual pushbutton erasure takes approx 1 s. Write gun is blanked and sweep is reset until erasure is complete.

Calibrator

Type: line frequency square wave.

Output: 1 volt $\pm 1.5\%$, front panel connector.

Beam finder (1200A/B): returns beam to CRT regardless of setting of vertical, horizontal, and intensity controls.

Beam finder (1201A/B): returns beam to CRT regardless of settings of vertical and horizontal controls.

Dimensions

Cabinet: 8-5/16" wide x 11 3/4" high x 18-11/16" deep (211,1 x 298,5 x 474,7 mm).

Rack: 19" wide x 5 1/4" high x 15 3/8" deep behind panel (483 x 133,4 x 390,5 mm).

Weight (1200A/B)

Cabinet: net, 25 lb (11,3 kg); shipping, 34 1/2 lb (15,6 kg).

Rack: net, 22 1/2 lb (10,2 kg); shipping, 35 lb (15,8 kg).

Weight (1201A/B)

Cabinet: net, 30 lb (13,6 kg); shipping, 39 1/2 lb (17,9 kg).

Rack: net, 27 1/2 lb (12,5 kg); shipping, 40 lb (18,2 kg).

Power (1200A/B): 115 or 230 V $\pm 10\%$, 50 to 400 Hz; approx 50 watts.

Power (1201A/B): 115 or 230 V $\pm 10\%$, 50 to 400 Hz; approx 60 watts.

Options (specify by option number)

001: factory wired for 230 V operation, no charge.

002 (1200A/B): P2 phosphor, no charge.

006 (1200B and 1201B): rear terminals wired in parallel with front panel input terminals, add \$55.

007 (1200A/B): P7 phosphor, no charge.

009 (1201A/B): remote erase function through rear panel banana jack, add \$25.

011 (1200A/B): P11 phosphor, no charge.

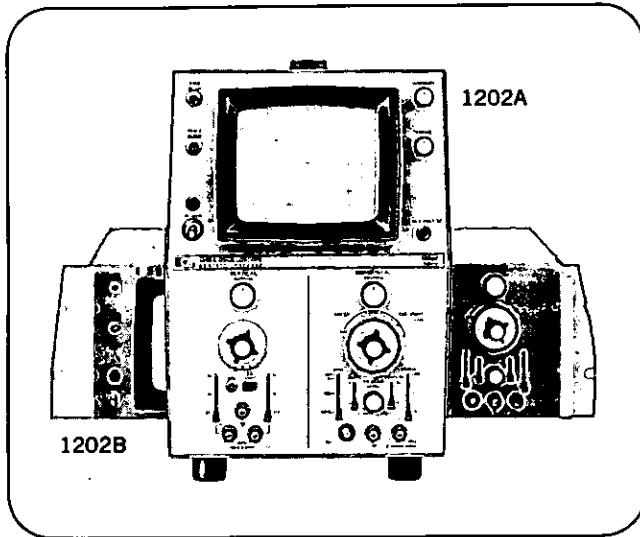
Accessories: refer to page 534.

Price: HP Model 1200A/B, \$990; HP Model 1201A/B, \$1900.

*Persistence and storage characteristics referenced to a centered 7 x 9 division area.

OSCILLOSCOPES 1200 SERIES *continued*

Single channel, 100 μ V/div, versatile sweep
Model 1202A/B



Model 1202A/B provides the capability to accurately measure and analyze, 500 kHz bandwidth, low level signals. Its 100 μ V/div vertical amplifier has very low drift of typically less than 50 μ V per hour and low noise of less than 50 μ V pk-pk.

Specifications

Vertical amplifier

Deflection factor

Ranges: from 0.1 mV/div to 20 V/div (17 positions) in 1, 2, 5 sequence. $\pm 3\%$ accuracy with vernier in calibrated position.

Vernier: continuously variable between all ranges; extends maximum deflection factor to at least 50 V/div.

Bandwidth: dc to 500 kHz with a maximum risetime of 0.7 μ s. 2 Hz to 500 kHz when ac-coupled. Front panel control provided to reduce upper frequency limit to approx 50 kHz.

Noise: less than 50 μ V peak-to-peak at full bandwidth.

Input: differential or single-ended on all ranges, selected by front panel control.

Common-mode

Frequency: dc to 10 kHz on all ranges.

Rejection ratio: at least 100 dB (100,000 to 1) on 0.1 mV/div range, decreasing by less than 20 dB per decade of deflection factor to at least 40 dB on the 0.2 V/div range; CMRR at least 30 dB on 0.5 V/div to 20 V/div ranges.

Signal maximum: ± 10 V (dc + peak ac) on 0.1 mV/div to 0.2 V/div ranges; ± 400 V (dc + peak ac) other ranges.

Input coupling: front panel selection of dc, ac, or off for both + and - inputs.

Input RC: 1 megohm shunted by 45 pF; constant on all ranges.

Maximum input: ± 400 volts (dc + peak ac).

Time base

Sweep

Ranges: from 1 μ s/div to 5 s/div (21 positions) in 1, 2, 5 sequence. $\pm 3\%$ accuracy with Vernier in calibrated position.

Vernier: continuously variable between ranges; extends slowest sweep to at least 12.5 s/div.

X10 magnifier: indicates magnified sweep directly with $\pm 5\%$ accuracy.

Automatic triggering: baseline is displayed in absence of an input signal.

Internal: 50 Hz to above 500 kHz on most signals causing 0.5 division or more vertical deflection. Triggering on line frequency also selectable.

External: 50 Hz to above 1 MHz on most signals at least 0.2 volt peak-to-peak.

Trigger slope: positive or negative slope on internal, external, or line trigger signals.

Amplitude selection triggering

Internal: dc to above 500 kHz on signals causing 0.5 division or more vertical deflection.

External: dc to 1 MHz on signals at least 0.2 volt peak-to-peak. Input impedance is 1 megohm shunted by approx 20 pF.

Trigger level and slope: internal, at any point on vertical waveform displayed; or continuously variable from +100 V to -100 V on either slope of the external trigger signal.

Trigger coupling: dc or ac for external, line, or internal triggering. Lower ac cut-off is 1.6 Hz for external; 5 Hz for internal.

Single sweep: selectable by front panel switch. Reset switch and armed indicator light.

Free run: selectable by front panel switch.

Maximum input: ± 350 volts (dc + peak ac).

Horizontal amplifier

Bandwidth: dc to 300 kHz. With input ac-coupled, low frequency cut-off is 1.6 Hz.

Deflection factor

Ranges: 0.1 V/div, 0.2 V/div, 0.5 V/div, and 1 V/div.

Vernier: continuously variable between ranges; extends maximum deflection factor to at least 2.5 V/div.

Input: single-ended.

Input RC: 1 megohm shunted by approx 20 pF.

Maximum input: +350 volts (dc + peak ac).

General

Cathode-ray tube

Type: mono-accelerator, 3,000-volt accelerating potential; P31 phosphor standard (see options for other phosphors); etched safety glass faceplate reduces glare.

Graticule: 8 x 10 divisions; parallax-free internal graticule; 0.2-div subdivision markings on horizontal and vertical major axes. 1 div = 1 cm. Front panel screwdriver adjust aligns trace with graticule.

Intensity modulation: +2-volt signal blanks trace of normal intensity; +8-volt signal blanks any intensity. DC-coupled input on rear panel; amplifier risetime approx 200 ns; input resistance is 5 k ohms.

Calibrator

Type: line frequency square wave.

Output: 1 volt $\pm 1.5\%$, front panel connector.

Beam finder: return beam to CRT screen regardless of setting of vertical, horizontal, and intensity controls.

Dimensions

Cabinet: 8-5/16" wide x 11 3/4" high x 18-11/16" deep (211,1 x 298,5 x 474,4 mm).

Rack: 19" wide x 5 1/4" high x 15 3/8" deep behind panel (483 x 133,4 x 390,5 mm).

Weight

Cabinet: net, 23 1/2 lbs (10,6 kg); shipping, 33 lbs (15,0 kg).

Rack: net, 21 lbs (9,5 kg); shipping 33 1/2 lbs (15,2 kg).

Power: 115 or 230 volts $\pm 10\%$; 50 to 400 Hz; approx 40 watts.

Options:

001: factory wired for 230 V operation, no charge.

002: P2 phosphor, no charge.

006 (1202B): rear terminals wired in parallel with front panel input terminals, add \$35.

007: P7 phosphor, no charge.

011: P11 phosphor, no charge.

631: non-internal graticule CRT, no charge.

Accessories available: refer to page 534.

Price: HP Model 1202A/B, \$790.

Model 1205A/B is a portable, reliable dual trace, 5 mV/div, oscilloscope for low frequency applications. Some operating features are: 500 kHz bandwidth, all-range differential outputs, dc-coupled Z-axis, single sweep, auto, and amplitude selection triggering, external horizontal input, and all solid-state circuits.

Specifications, 1205A/B

Vertical amplifiers

Deflection factor...

Ranges: from 5 mV/div to 20 V/div (12 positions) in 1, 2, 5 sequence. $\pm 3\%$ accuracy with vernier in calibrated position.

Vernier: continuously variable between all ranges; extends maximum deflection factor to at least 50 V/div.

Bandwidth: dc to 500 kHz with a maximum risetime of 0.7 μ s. 2 Hz to 500 kHz when ac-coupled.

Input: differential or single-ended on all ranges, selectable by front panel control.

Common mode:

Frequency: dc to 10 kHz on all ranges.

Rejection ratio: at least 50 dB on 5 mV/div to 0.2 V/div ranges; CMRR is at least 30 dB on 0.5 V/div to 20 V/div ranges.

Signal maximum: ± 3 V (dc + peak ac) on 5 mV/div to 0.2 V/div ranges; ± 300 V (dc + peak ac) on all other ranges.

Input coupling: front panel selection of dc, ac, or off for both + and - inputs.

Input RC: 1 megohm shunted by 45 pF; constant on all ranges.

Maximum input: ± 400 volts (dc + peak ac).

Display: (1) Channel A, (2) Channel B, (3) Channels A and B (either Chop or Alternate), (4) Channels A and B vs. horizontal input (Chop only), (5) Channel A vs. B (A-vertical, B-horizontal). Chop frequency is approx 100 kHz.

Internal trigger: by Channel A signal for A, Chop, and Alternate displays. By Channel B signal for B display.

Isolation: greater than 80 dB between channels at 500 kHz, with input connectors shielded.

Phase shift: (for Channel A vs. B) less than 1° , to 100 kHz (Verniers in calibrated position).

Time base

Sweep

Ranges: 1 μ s/div to 5 s/div (21 positions) in 1, 2, 5 sequence. $\pm 3\%$ accuracy with vernier in calibrated position.

Vernier: continuously variable between ranges; extends slowest sweep to at least 12.5 s/div.

X10 magnifier: indicates magnified sweep directly with $\pm 5\%$ accuracy.

Automatic triggering: baseline is displayed in absence of an input signal.

Internal: 50 Hz to above 500 kHz on most signals causing 0.5 division or more vertical deflection. Triggering on line frequency also selectable.

External: 50 Hz to above 1 MHz on most signals at least 0.2 volt peak-to-peak.

Trigger slope: positive or negative slope on internal, external, or line trigger signals.

Amplitude selection triggering

Internal: dc to above 500 kHz on signals causing 0.5 division or more vertical deflection.

External: dc to 1 MHz on signals at least 0.2 volt peak-to-peak. Input impedance is 1 megohm shunted by approx 20 pF.

Trigger level and slope: internal, at any point on vertical waveform displayed; or continuously variable from +100 V to -100 V on either slope of the external trigger signal.

Trigger coupling: dc or ac for external, line, or internal triggering. Lower ac cut-off is 1.6 Hz for external, 5 Hz for internal.

Single sweep: selectable by front panel switch. Reset switch and armed indicator light.

Free run: selectable by front panel switch.

Maximum input: ± 350 volts (dc + peak ac).

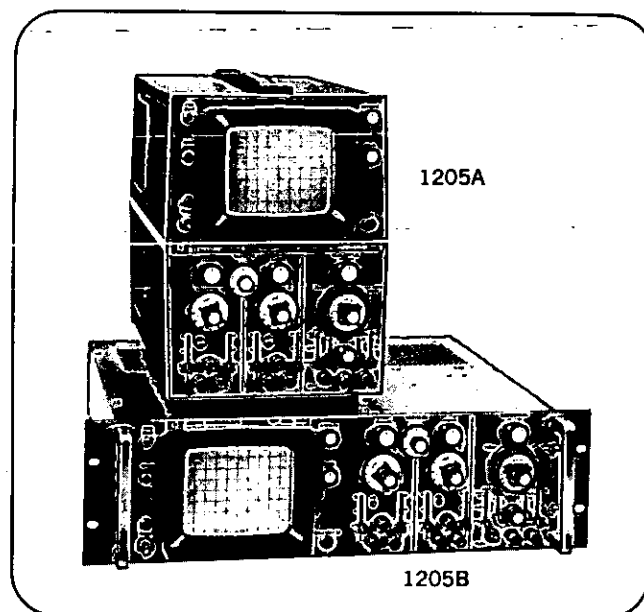
Horizontal amplifier

Bandwidth: dc to 300 kHz. With input ac-coupled, low frequency cut-off is 1.6 Hz.

OSCILLOSCOPES 1200 SERIES *continued*

Dual channel, solid-state, versatile sweep

Model 1205A/B



Deflection factor

Ranges: 0.1 V/div, 0.2 V/div, 0.5 V/div, and 1 V/div.

Vernier: continuously variable between ranges; extends maximum deflection factor to at least 2.5 V/div.

Input: single-ended.

Input RC: 1 megohm shunted by approx 20 pF.

Maximum input: ± 350 volts (dc + peak ac).

General

Cathode-ray tube

Type: mono-accelerator, 3,000-volt accelerating potential; P31 phosphor standard (see options for other phosphors); etched safety glass faceplate reduces glare.

Graticule: 8 x 10 divisions; parallax-free internal graticule; 0.2-div subdivision markings on horizontal and vertical major axes. 1 div = 1 cm. Front panel screwdriver adjust aligns trace with graticule.

Intensity modulation: +2-volt signal blanks trace of normal intensity; +8-volt signal blanks any intensity. DC-coupled input on rear panel; amplifier risetime approx 200 ns; input resistance is 5 k ohms.

Calibrator

Type: line frequency square wave.

Output: 1 volt $\pm 1.5\%$, front panel connector.

Beam finder: returns beam to CRT screen regardless of setting of vertical, horizontal, or intensity controls.

Dimensions

Cabinet: 8-5/16" wide x 11 3/4" high x 18-11/16" deep (211,1 x 298,5 x 474,5 mm).

Rack: 19" wide x 5 1/4" high x 15 3/8" deep behind panel (483 x 133,4 x 390,5 mm).

Weight

Cabinet: net, 25 lbs (11,3 kg); shipping, 34 1/2 lbs (15,6 kg).

Rack: net, 22 1/2 lbs (10,2 kg); shipping, 35 lbs (15,8 kg).

Power: 115 or 230 volts $\pm 10\%$; 50 to 400 Hz; approx 45 watts.

Options

001: factory wired for 230 V operation, no charge.

002: P2 phosphor, no charge.

006: (1205B): rear terminals wired in parallel with front panel input terminals, add \$55.

007: P7 phosphor, no charge.

011: P11 phosphor, no charge.

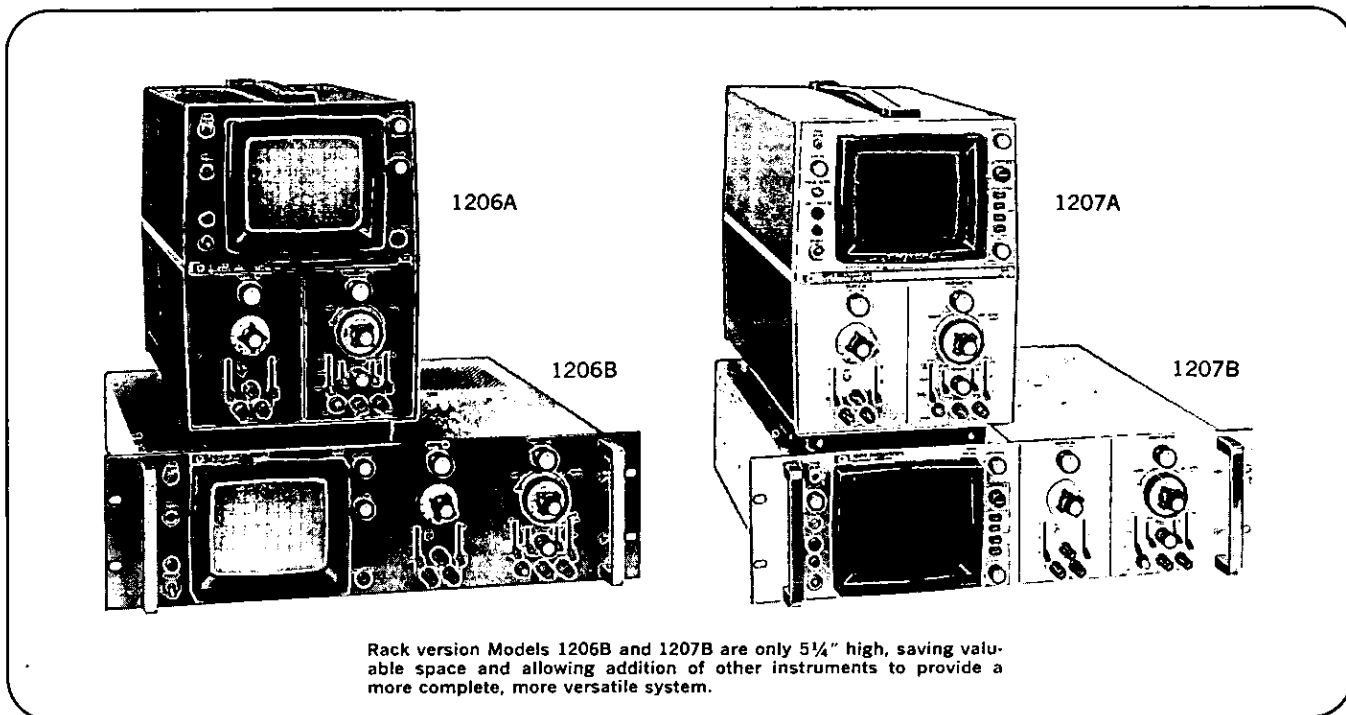
014: non internal graticule CRT, no charge.

Accessories available: refer to page 534.

Price: HP Model 1205A/B, \$875.

OSCILLOSCOPES 1200 SERIES *continued*

Single channel, 5 mV/div, variable persistence and storage
Models 1206A/B, 1207A/B



Rack version Models 1206B and 1207B are only 5 1/4" high, saving valuable space and allowing addition of other instruments to provide a more complete, more versatile system.

Single trace Models 1206A/B and 1207A/B are versatile, easy-to-use, all-purpose instruments for 500 kHz bandwidth applications requiring 5 mV/div deflection factors.

The Model 1207A/B has the added capability of variable persistence and variable storage time that makes low frequency measurements easier and more accurate. Variable persistence allows you to view a slow moving sweep as a complete trace rather than a moving dot. You can integrate fast risetime signals to full brightness, eliminate confusing displays by adjusting trace persistence so that one trace is fading as the next trace is being written, and adjust persistence to view several traces that makes circuit adjustments easier and quicker. Persistence can be continuously varied from 0.2 second to 1 minute in standard mode, or to 15 seconds in fast mode.

Variable storage time allows you to select a storage time and brightness combination that best solves your measurement problem. With the wide storage times available, up to 8 hours, you can store a trace, change circuit components, and store another trace to see how circuit operation changed.

Traces can also be intensity modulated to provide a stored trace that has several gray shades. Stored traces have a brightness of at least 100 foot-lamberts, which allows viewing in bright ambient light environments.

Models 1206A/B and 1207A/B have 500 kHz bandwidth, all range differential input, dc-coupled Z-axis, single sweep, auto and amplitude selection triggering, external horizontal input, and all solid-state circuits.

X-Y displays of two variables can be obtained by use of the external horizontal input. Bandwidth for the horizontal amplifier is 300 kHz. There are four horizontal deflection factors: .1 V/div, .2 V/div, .5 V/div, and 1 V/div. A ver-

system monitoring, research and educational laboratories, timing measurements, and ultrasonic systems. vernier extends the maximum deflection factor to 2.5 V/div.

The horizontal deflection system time base provides a wide range of sweep speeds from 1 μ s/div to 5 s/div. The vernier provides continuous coverage between ranges and extends the slowest sweep speed to 12.5 s/div.

With solid-state portability, reliability, and stability, Models 1206A/B and 1207A/B can fulfill any low frequency measurement application requiring only single trace capability.

These instruments are highly portable, reliable general purpose oscilloscopes. They are versatile instruments for single channel applications. Many systems applications are met satisfactorily by the size, economy, and versatility offered by Models 1206A/B and 1207A/B.

Deflection factors are provided from 5 mV/div to 20 V/div with a vernier extending maximum deflection factor to 50 V/div. At least 50 dB common-mode rejection ratio with a ± 3 volt common-mode signal maximum is specified for the six lowest deflection factors.

Measurement applications include: audio systems, circuit design, component testing, computer information display,

Specifications, 1206A/B, 1207A/B

Vertical amplifier

Deflection factor

Ranges: from 5 mV/div to 20 V/div (12 positions) in 1, 2, 5 sequence. $\pm 3\%$ accuracy with vernier in calibrated position.

Vernier: continuously variable between all ranges; extends maximum deflection factor to at least 50 V/div.

Bandwidth: dc to 500 kHz with a maximum risetime of 0.7 μ s. 2 Hz to 500 kHz when ac-coupled.

Input: differential or single-ended on all ranges, selectable by front panel control.

Common-mode

Frequency: dc to 10 kHz on all ranges.

Rejection ratio: at least 50 dB on 5 mV/div to 0.2 V/div ranges; CMRR is at least 30 dB on 0.5 V/div to 20 V/div ranges.

Signal maximum: ± 3 V (dc + peak ac) on 5 mV/div to 0.2 V/div ranges; ± 300 V (dc + peak ac) on all other ranges.

Input coupling: front panel selection of dc, ac, or off for both + and - inputs.

Input RC: 1 megohm shunted by 45 pF; constant on all ranges.

Maximum input: ± 400 volts (dc + peak ac).

Time base

Sweep

Ranges: from 1 μ s/div to 5 s/div (21 positions) in 1, 2, 5 sequence. $\pm 3\%$ accuracy with vernier in calibrated position.

Vernier: continuously variable between ranges; extends slowest sweep to at least 12.5 s/div.

X10 magnifier: indicates magnified sweep directly with $\pm 5\%$ accuracy.

Automatic triggering: baseline is displayed in absence of an input signal.

Internal: 50 Hz to above 500 kHz on most signals causing 0.5 division or more vertical deflection. Triggering on line frequency also selectable.

External: 50 Hz to above 1 MHz on most signals at least 0.2 volt peak-to-peak.

Trigger slope: positive or negative slope on internal, external or line trigger signals.

Amplitude selection triggering

Internal: dc to above 500 kHz on signals causing 0.5 division or more vertical deflection.

External: dc to 1 MHz on signals at least 0.2 volt peak-to-peak. Input impedance is 1 megohm shunted by approx 20 pF.

Trigger level and slope: internal, at any point on vertical waveform displayed; or continuously variable from +100 V to -100 V on either slope of the external trigger signal.

Trigger coupling: dc or ac for external, line, or internal triggering. Lower ac cut-off is 1.6 Hz for external; 5 Hz for internal.

Single sweep: selectable by front panel switch. Reset switch and armed indicator light.

Free run: selectable by front panel switch.

Maximum input: ± 350 volts (dc + peak ac).

Horizontal amplifier

Bandwidth: dc to 300 kHz. With input ac-coupled, low frequency cut-off is 1.6 Hz.

Deflection factor

Ranges: 0.1 V/div, 0.2 V/div, 0.5 V/div, and 1 V/div.

Vernier: continuously variable between ranges; extends maximum deflection factor to at least 2.5 V/div.

Input: single-ended.

Input RC: 1 megohm shunted by approx 20 pF.

Maximum input: ± 350 volts (dc + peak ac).

General

Cathode-ray tube (1206A/B)

Type: mono-accelerator, 3,000-volt accelerating potential; P31 phosphor standard (see options for other phosphors); etched safety glass faceplate reduces glare.

Graticule: 8 x 10 divisions; parallax-free internal graticule; 0.2-div subdivision markings on horizontal and vertical major axes. 1 div = 1 cm. Front panel screwdriver adjust aligns trace with graticule.

Intensity modulation: +2-volt signal blanks trace of normal intensity; +8-volt signal blanks any intensity. DC-coupled rear panel input; amplifier risetime approx 200 ns; input resistance, 5 k ohms.

Cathode-ray tube (1207A/B)

Type: post-accelerator, variable persistence storage tube; 10.5 kV accelerating potential; aluminized P31 phosphor.

Graticule: 8 x 10 divisions; parallax-free internal graticule; 0.2-div subdivision markings on horizontal and vertical major axes. 1 div = 0.95 cm. Front panel screwdriver adjust aligns trace with graticule.

Intensity modulation: +2-volt signal blanks trace of normal intensity; +8-volt signal blanks any intensity. DC-coupled rear panel input; amplifier risetime approx 200 ns; input resistance, 5 k ohm.

Persistence: conventional, natural persistence of P31 phosphor (approx 40 μ s). Variable, continuously variable from 0.2 s to 1 minute or longer in STD mode; and from 0.2 s to 15 s in FAST mode.*

Storage writing speed: STD mode, 20 cm/ms or greater; FAST mode, 0.5 cm/ μ s or greater.*

Brightness: measured with entire screen faded positive, 100 foot-lamberts or greater.

Storage time: STD writing speed, continuously variable from 1 minute to 8 hours or longer. FAST writing speed, continuously variable from 15 seconds to 1 hour or longer.

Erase: manual pushbutton erasure takes approx 1 s. Write gun is blanked and sweep is reset until erasure is complete.

Calibrator

Type: line frequency square wave.

Output: 1 volt $\pm 1.5\%$, front panel connector.

Beam finder (1206A/B): returns beam to CRT regardless of setting of vertical, horizontal, and intensity controls.

Beam finder (1207A/B): returns beam to CRT regardless of settings of vertical and horizontal controls.

Dimensions

Cabinet: 8-5/16" wide x 11 3/4" high x 18-11/16" deep (211,1 x 298,5 x 474,7 mm).

Rack: 19" wide x 5 1/4" high x 15 3/8" deep behind panel (483 x 133,4 x 390,5 mm).

Weight (1206A/B)

Cabinet: net, 23 1/2 lb (10,6 kg); shipping, 33 lb (15,0 kg).

Rack: net, 21 lb (9,5 kg); shipping 33 1/2 lb (15,2 kg).

Weight (1207A/B)

Cabinet: net, 28 lb (12,7 kg); shipping, 37 1/2 lb (17 kg).

Rack: net, 26 lb (11,8 kg); shipping, 38 1/2 lb (17,5 kg).

Power (1206A/B): 115 $\pm 10\%$; 50 to 400 Hz; approx 40 W.

Power (1207A/B): 115 $\pm 10\%$; 50 to 400 Hz; approx 55 W.

Options (specify by option number)

001: factory wired for 250 V operation, no charge.

002 (1206A/B): P2 phosphor, no charge.

006 (1206B and 1207B): rear terminals wired in parallel with front panel input terminals, add \$35.

007 (1206A/B): P7 phosphor, no charge.

009 (1207A/B): remote erase function through rear panel banana jack, add \$25.

011 (1206A/B): P11 phosphor, no charge.

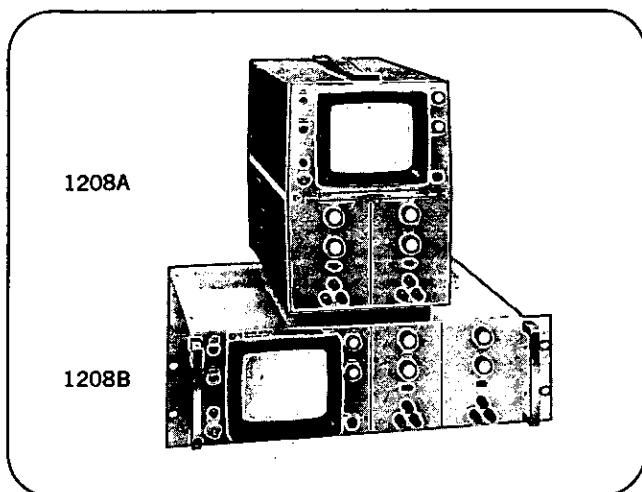
Accessories: refer to page 534.

Price: HP Model 1206A/B, \$715; HP Model 1207A/B, \$1550.

*Persistence and storage characteristics referenced to a centered 7 x 9 division area.

OSCILLOSCOPES 1200 SERIES *continued*

System display, solid-state X-Y display Model 1208A/B



Rack version Model 1208B is only 5¼" high, saving valuable space and allowing addition of other instruments to provide a more complete, more versatile system.

Low frequency X-Y displays are obtained easily and accurately with the Model 1208A (cabinet) or Model 1208B (rack) Display. Horizontal and vertical amplifiers are identical, each with a bandwidth of dc to 600 kHz.

All solid-state circuits have been used by Hewlett-Packard in the Model 1208A/B, bringing low power portability and reliability to X-Y display instrumentation.

Selection of deflection factor for each amplifier is continuously variable from less than 100 mV/div to greater than 1 V/div. Provision has been made to modify internal circuits to permit use of any larger deflection factor.

Specifications, 1208A/B

Vertical and horizontal amplifiers

Bandwidth: dc to 600 kHz when dc-coupled; 20 Hz to 600 kHz when ac-coupled. (3 dB down from 8-div reference signal.)

Deflection factor: continuously variable from <0.1 V/div to >1 V/div.

Input: differential or single-ended.

Input coupling: front panel selection of ac or dc.

Input RC: 100 k ohms shunted by approx 70 pF.

Maximum input: ±200 V (dc + peak ac).

Common-mode

Rejection ratio: 40 dB (100:1).

Signal maximum: up to ±4 V (dc + peak ac).

Frequency: dc to 10 kHz.

Phase shift

Same X and Y deflection factor: <1°, to 500 kHz for deflection factors below 0.2 V/div. <1°, to 100 kHz for deflection factors above 0.2 V/div.

Different X and Y deflection factors: <3°, to 100 kHz.

Cathode-ray tube and controls

Type: monoaccelerator, 3 kV accelerating potential; P31 phosphor standard (see options for other phosphors); etched safety glass faceplate reduces glare.

Graticule: 8 x 10 divisions, parallax-free internal graticule. 0.2-div subdivision markings on major axes. 1 div = 1 cm. Front panel screwdriver adjust aligns trace with graticule.

Beam finder: returns trace to CRT screen regardless of setting of horizontal, vertical, or intensity controls.

Intensity modulation: +2-volt signal blanks trace of normal intensity; +8-volt signal blanks any intensity. DC-coupled

Model 1208A/B exhibits less than 1° phase shift up to 500 kHz for equal X and Y deflection factors below 0.2 V/div, and up to 100 kHz for equal X and Y deflection factors above 0.2 V/div. For any combination of X and Y deflection factors, phase shift is less than 3°, up to 100 kHz.

The dc-coupled Z-axis amplifier, well-suited for computer information displays, allows CRT intensity modulation, with signals of +2 volts blanking a display of normal intensity. A +8 V signal will blank a display of any intensity. Amplifier risetime is approximately 200 nanoseconds.

Applications for X-Y displays

Model 1208A/B can be used to display an X-Y plot of one input versus the other for a wide variety of signals. It is a useful measurement tool in such applications as the following:

- Pressure vs. volume diagrams.
- Component testing to determine characteristics such as voltage or temperature coefficients.
- Semiconductor diode characteristic V vs. I curves.
- Determine characteristics of ferromagnetic materials.
- Measure performance of limiting- or expanding-amplifiers.
- Measurement of distortion in linear amplifiers.
- Function generator, obtaining $y = f(x)$.
- Performance evaluation of various modulator and demodulator systems such as AM, FM, PTM, PAM, and suppressed carrier.

X-Y displays in systems

Solid-state circuits in the Model 1208B results in direct benefits of special importance for systems applications:

- Lower maintenance costs, due to better component reliability and longer time between calibrations.
- No waiting for warm-up before measurements can be made and recorded.
- Low power (35 watts) eliminates need for fan, cuts system cooling requirements, and minimizes heat-related component failures.

input on rear panel; amplifier risetime approx. 200 ns; input R is 5 k ohms.

Calibrator

Type: line frequency square wave.

Output: 1 volt ±1.5%, front panel connector (banana plug).

General

Weight

Cabinet: net, 21½ lbs (9,8 kg); shipping, 31 lbs (14,7 kg).

Rack: net, 20½ lbs (9,3 kg); shipping, 33 lbs (15,0 kg).

Power: 115 or 230 volts ±10%, 50 to 400 Hz, approx 35 watts.

Dimensions

Cabinet: 8-5/16" wide x 11¾" high x 18½" deep (211,1 x 298,5 x 474,4 mm).

Rack: 19" wide x 5¼" high x 15⅝" deep behind panel (483 x 132,5 x 390,5 mm).

Options (specify by option number):

001: factory wired for 230 V operation, no charge.

002: P2 phosphor, no charge.

004: P4 phosphor, no charge.

006: rear terminals in parallel with front panel terminals, add \$55.

007: P7 phosphor, no charge.

011: P11 phosphor, no charge.

631: Non internal graticule CRT with P31 phosphor, no charge.

Specials: available with 5 mV/div or 100 μV/div deflection factors and/or variable persistence and storage. Contact your Hewlett-Packard field engineer for latest information.

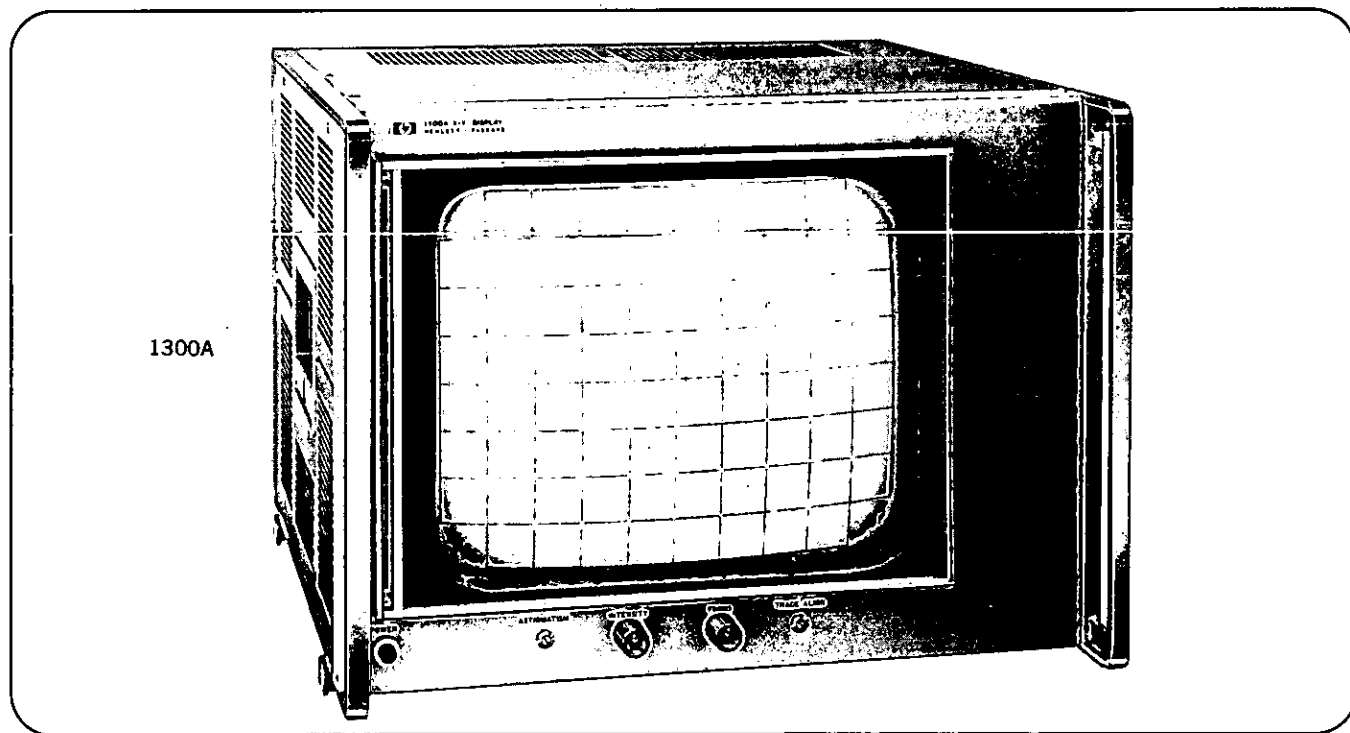
Accessories: refer to page 534.

Price: HP Model 1208A or HP Model 1208B, \$540.

X-Y DISPLAY
20 MHz Monitor with 8 by 10 in screen
Model 1300A



OSCILLOSCOPES



The extremely wide dc-20 MHz bandwidth of the Model 1300A X-Y Display provides capabilities not found in any other large screen display. The fast 20 nanoseconds rise-time and 200 nanoseconds settling time allow rapid switching between several input waveforms without flicker. The 1300A CRT writes at better than 20 inches/ μ s for bright displays of low rep rate signals. The 8 inch x 10 inch viewing area provides the high resolution readout needed for many measurements. Some of these include swept frequency, spectrum analysis, and time domain reflectometry. The 1300A's 20 kV display is easy to see even from long distances making it especially suited for system applications as well as production testing or class room demonstrations. Added versatility in a large screen display is also available in the HP Model 143A which is a plug-in type oscilloscope. Model 143A accepts all standard HP Model 1400-series plug-ins. Control and amplifier options are available for increased versatility. Contact your local Hewlett-Packard field engineer for your special requirements.

Applications

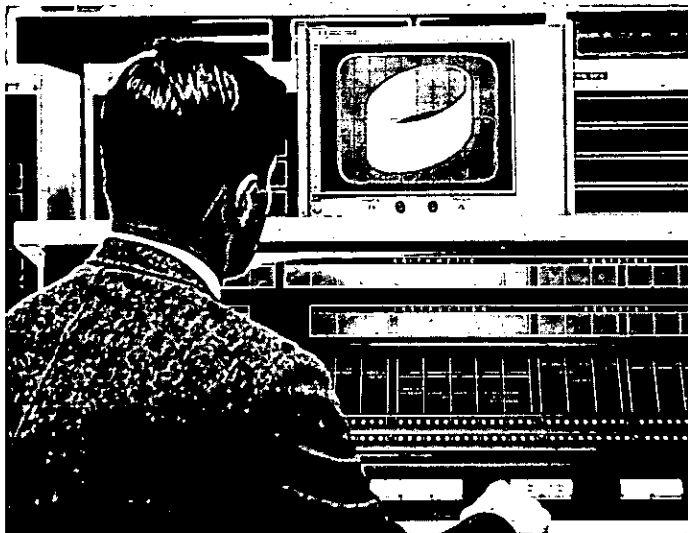
Swept frequency measurements are especially suited for a large screen readout. The 1300A Opt H09 is a special model of the 1300A X-Y Display that has been modified to be directly compatible with the Model 674A Sweeping Signal Generator. These two instruments when used together, provide an easy to read, easy to use, high resolution display of swept frequency measurements. Extended vertical dynamic range in the 1300A Opt H09 allows high sensitivity measurements at any point on the 1.5 volt output of the Model 675A Sweeping Signal Generator. The 1300A

Opt H09 vertical position control provides the dc offset required to look at any point on the incoming signal while at deflection factors as low as 10 mV/in.

Another important application for the 1300A is analog computer readout. The 1300A provides a significant increase in useful resolution over the conventional 5-inch oscilloscope, without sacrificing useful bandwidth for displays such as analog computers, bar graphs, and the like. Increased resolution coupled with 1% linearity provides an accurate display of even high frequency phenomena and stable dc amplifiers provide excellent repeatability. The all solid-state circuits of the Model 1300A provide a very reliable instrument that will be free from maintenance and service requirements.

Another application of the 1300A is in the Hewlett-Packard Model 2331A X-Y Display Subsystem which equips Hewlett-Packard computer systems for graphical presentation of computer-processed information. Visual presentation of the magnitude and shape of data speeds the refinement of computer test, data acquisition, and control techniques because results are interpreted more easily and rapidly than they could be from a set of alphanumeric listings.

The range of display applications is virtually unlimited. For example, it can provide a 'quick look' at computer-processed multi-channel inputs from a data acquisition subsystem. The display-computer combination can be used to assist design of mechanical or electrical devices. Reflection coefficients produced by Hewlett-Packard Network Analyzer and nuclear spectra determined by a Hewlett-Packard Multi-Channel Analyzer are examples of data that may be more



Model 1300A displaying a computer readout. X-Y-Z information provides an easy to read three dimensional display.

easily interpreted by large-format display with the 2331A subsystem.

Many other applications could be mentioned, but the basic principle is clear: graphic display of data can intensify and accelerate understanding of the relationships you are exploring in your application.

Specifications

X-Y amplifiers

Deflection factor: at least 0.1 V/inch; vernier provides 2.5:1 reduction.

Drift: <0.1 inch/hr after 1/2-hr warmup; <0.2 inch/8 hr.

Bandwidth: dc-coupled, dc to 20 MHz; ac-coupled 2 Hz to 20 MHz (8-inch reference at 50 kHz).

Risetime: <20 ns (10% to 90% points).

Settling time: <200 ns to within a trace width of final value.

Repeatability: less than 0.15% error for re-addressing a point from any direction; source impedance <4 k Ω .

Input RC: 1 megohm shunted by approximately 20 pF.

Input: single ended; BNC connector, maximum input ± 500 V (dc + peak ac).

Linearity: over 8 x 10-inch screen $\pm 1\%$ of full screen; any inch with respect to any other inch, within 10%.

Phase shift: 0.1° to 50 kHz, up to 100-inch signal; 1° to 1 MHz, up to 10-inch signal.

Z amplifier

Analog input: dc to 20 MHz bandwidth over the 0 to +1 V range; +1 V gives full blanking, -1 V gives full intensity; vernier gives 2.5:1 reduction, balance allows intensity adjustment of ± 1 V, maximum input ± 500 V (dc + peak ac).

Risetime: <20 ns (10% to 90% points).

Sweep blank input: digital dc blanking with <1 k Ω and -0.7 V to +5 V; unblanking with >20 k Ω and 0 V to -5 V. Repetition rates to 1 MHz.

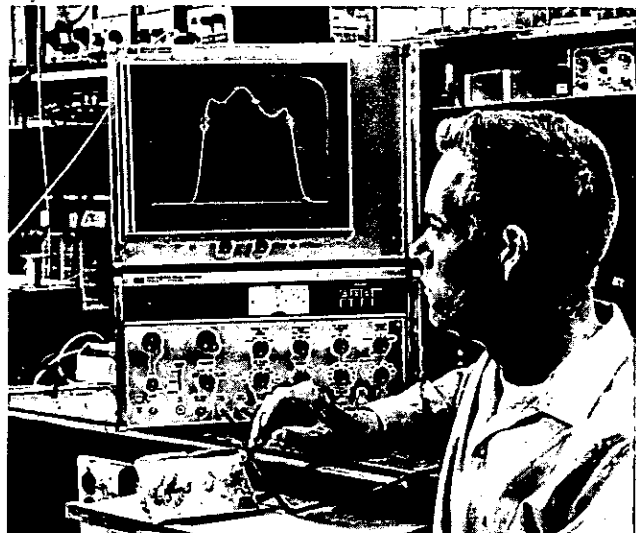
Chop blank input: ac-coupled blanking, +50 V blanks CRT. Input grounded when not in use.

Calibrator

0.5 V $\pm 2\%$, line frequency square wave.

CRT

Accelerating potential: 20 kV.



Model 1300A displaying filter response in conjunction with Model 675A Sweeping Signal Generator.

Writing rate: >20 inches/ μ s.

Spot size: less than 30 mils throughout 8 x 10-inch screen at 100 ft lamberts light output; nominally 20 mils at center screen (shrinking raster).

Phosphor and graticule: aluminized P31 phosphor with 1-inch grid and 0.2-inch subdivisions on major axis. Other phosphors available, see options; other graticules available on special order. Amber face plate filter supplied with P7 phosphor instead of standard blue-green.

Controls: X-Y-Z inputs, ac-dc input switches, calibrator, X-Y gain verniers and position, Z axis vernier and balance on rear panel. Intensity, astigmatism, trace align, and focus on front panel.

General

Size: 12 $\frac{3}{4}$ " high, 16 $\frac{3}{4}$ " wide, 19 $\frac{7}{8}$ " deep, 18 $\frac{1}{2}$ " behind front panel (311 x 425 x 505 x 470 mm). Rack mount hardware supplied.

Weight: net, 47 lb (21.4 kg); shipping 64 lb (29.1 kg).

Power: 115 or 230 volts $\pm 10\%$; 50 to 400 Hz; approximately 175 W.

Price: Model 1300A, \$2000.

Special order: a number of special modifications are available. They include: front panel X and Y inputs and controls, X10 pre-amplifier for 10 mV/in X and Y deflection factor, Z axis to provide eight gray scales; attenuators for X and Y amplifiers. Contact your local Hewlett-Packard Field Engineer for details on these and other special requirements.

Model 1300A Opt H09: specially modified 1300A to be directly compatible with Model 675A Sweeping Signal Generator. Includes 10 mV/inch vertical deflection factor and attenuator. All X and Y inputs and controls on front panel. Price: \$2275.

Options:

001: Gray CRT filter, add \$15.

002: P2 phosphor, no charge.

004: P4 phosphor, no charge.

007: P7 phosphor, no charge.

011: P11 phosphor, no charge.

631: No internal graticule CRT with P31 phosphor, no charge.

Accessories: refer to page 534.

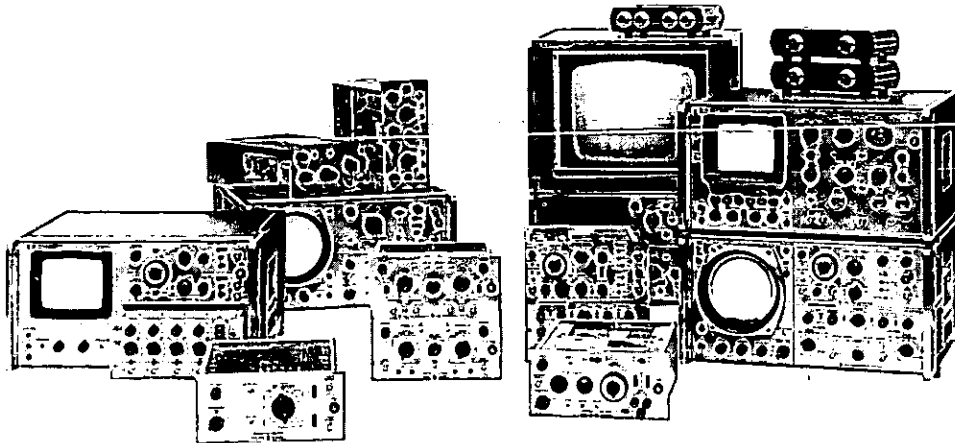
PLUG-IN OSCILLOSCOPE

One scope to do nearly any measurement task

Model 140 system



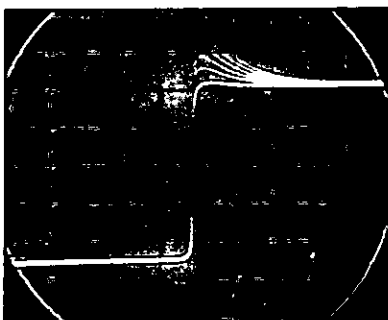
OSCILLOSCOPES



140 System

The Hewlett-Packard 140 Oscilloscope System, which consists of the 140A, 140B, 141A, 141B, or 143A mainframes and the 1400-series or 8550-series plug-ins, provides the versatility you need for measurements over the entire oscilloscope spectrum. With 22 high performance vertical and horizontal plug-ins to choose from, you can head in any measurement direction: wide-band sampling, high-sensitivity, delayed sweep, or measurements such as time domain reflectometry, swept frequency, or spectrum analysis . . . all with variable persistence and storage or large screen display if you like.

Hewlett-Packard's 140 system offers these capabilities: an oscilloscope system that gives you sampling bandwidth to 12.4 GHz . . . sampling delayed sweep time base . . . 50 $\mu\text{V}/\text{div}$ sensitivity with no dc drift . . . versatile single or double-size plug-in capability . . . direct readout TDR . . . swept frequency and spectrum analyzer plug-ins to convert the 140 system to a frequency-domain oscilloscope. In addition, it is the only oscilloscope system to offer standard CRT persistence in either the 140A, 140B, or 143A mainframes; or variable persistence and storage in the 141A and 141B mainframes. Select from these unique measurement capabilities, or choose from the general purpose plug-ins available.



See signal trends while making circuit adjustments by simply making persistence long enough so that several traces appear on screen simultaneously.

12.4 GHz sampling with delayed sweep

You can see through X band, observe CW signals to 12.4 GHz and beyond, and see fast pulses with a 28 ps risetime capability. You can also use TDR measurements to resolve discontinuities down to less than 1 cm in the design of cables, coaxial components, connectors and strip lines. In addition, you can utilize delayed sweep through the full bandwidth to get displays of pulse segments that leave conventional sampling scopes blurred. You also get less than 20 ps jitter to ensure steady, clear displays.

Two vertical amplifiers are available. Model 1411A provides dc to 12.4 GHz at 1 mV/div, dual-channel performance with remote samplers featuring feed-through inputs for minimum signal disturbance. The other sampling vertical amplifier, Model 1410A, gives performance to 1 GHz, with both high-Z probes and 50 ohm inputs—and internal triggering. Model 1425A Sampling Time Base plug-in provides delayed sweep, automatic triggering, and a movable intensified dot that makes it easy to set up the point of magnification.

50 $\mu\text{V}/\text{div}$ zero drift

The versatile HP 140 Scope System gives you six high-sensitivity plug-ins specifically designed for measurement of low-level signals. For example, the 1406A vertical plug-in offers high 50 $\mu\text{V}/\text{div}$ sensitivity with no dc drift—plus precision calibrated dc offset for extreme magnification.

With the HP calibrated offset feature, the 1406A gives you the advantages of a dc and ac voltmeter—four-digit readout, auto decimal placement, better than 0.5% measurement accuracy. As a dc voltmeter, the 1406A offers you the additional advantages of no drift in the measurement instrument, and the ability to observe and measure any ac riding on the dc voltage. With these capabilities you can make measurements never before possible. For example, you can simultaneously display a 10 V dc signal at 50 $\mu\text{V}/\text{div}$ (giving a magnification of

OSCILLOSCOPES 140 SERIES *continued***One scope to do nearly any measurement task**

200,000), measure dc level accurately to four digits, see short term dc drift with microvolt resolution, and view and measure all ac ripple—an impossible measurement with a meter. The HP 1406A plug-in also operates as a dc-coupled, no drift differential amplifier with 80 dB common mode rejection ratio.

Get 20 MHz bandwidth, 4-channel displays to 15 MHz, and delayed sweep readability

If you need wideband performance, for example, you can use the dual-trace 1402A vertical amplifier and get dc to 20 MHz (15 MHz with Model 143A) at 5 mV/div, algebraic addition, built-in delay line for viewing the leading edge of fast-rise pulses, full 6 div deflection and a wide dynamic range. An internal sync amplifier triggers on Channel A in dual trace mode of operation—gives stable traces and accurate time measurements without external triggering.

When you need to display four channels of information, you can use the 4-trace 1404A vertical amplifier and get dc to 15 MHz at 10 mV/div or 1 mV/div to 10 MHz, algebraic addition, and built-in delay line for viewing the leading edge of fast-rise pulses. Internal trigger circuits allow you to trigger on channel A, B, C, or D or you may select composite triggering, which triggers each channel individually.

For easy readability of complex waveforms and accurate time interval measurements, Model 1421A Time Base & Delay Generator provides extreme magnification—calibrated time delays from 10 seconds to 0.5 μ s, calibrated sweep speeds from 1 s/div to 20 ns/div. The 1421A also offers the additional advantage of exclusive HP mixed sweep. This feature combines display of the first portion of a trace at normal sweep speeds, and simultaneously expands the trailing portion of the trace at faster delayed sweep speeds to allow step-by-step magnified examination.

Spectrum analyzer plug-ins for measurement in the frequency domain

By a simple addition of Spectrum Analyzer plug-ins, you can convert your time-domain oscilloscope into a frequency-domain instrument. These spectrum analyzer plug-ins have a frequency range of 1 kHz-1250 MHz, absolute amplitude calibration, high sensitivity, low distortion, wide dynamic range, and flat frequency response.

Choose from HP high-performance mainframes

The advanced 140A, 140B, 141A, 141B, and 143A mainframes give you a choice between conventional (fixed) CRT persistence, variable persistence and storage, and 8" x 10" CRT display. As a result, the 140 system gives you not only an extensive plug-in capability, but also, the CRT versatility you need to meet the requirements of any measurement problem today—six months from now—or at any future time.

These HP 140 system mainframes are specifically designed to give you both high-frequency and high-sensitivity performance. They consist of the essential functional blocks for low and high frequency applications—plus sampling. Included are a post-accelerator CRT, associated control circuits, power supplies, and the plug-in power supplies.

This true building-block arrangement assures that you can use existing and future plug-ins without modification to the mainframe. You pay only for the circuitry you actually need to make your particular measurements.

Because all deflection circuits are contained in the plug-ins, you get exclusive capabilities in mixing plug-ins. You can not only select the amplifier you need for the vertical axis, but also, you can select the particular time base generator needed for the horizontal axis.

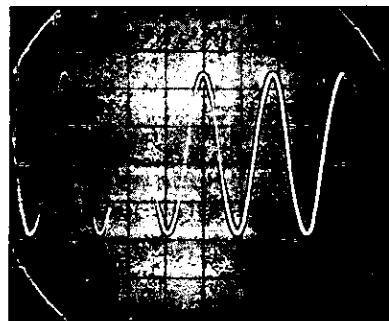
Further, since the 140 system CRT's have identical horizontal and vertical amplifiers for an X-Y display . . . or one single-channel amplifier and one dual-channel amplifier to plot two variables against a third . . . or two identical dual-channel amplifiers for a pair of simultaneous X-Y displays.

All 140 series mainframes are equipped with a convenient beam finder which quickly locates a trace and puts it on screen for fast trouble-free set-up.

Variable persistence and storage

The 141A and 141B mainframes give you all the advantages of the 140A mainframe—plus the exclusive benefits of HP variable persistence and storage.

The HP 141A/B, have post accelerator CRT's—with unique mesh storage. At the twist of a knob, you can adjust trace persistence from 0.2 seconds to a minute . . . to hours . . . to days. This exclusive HP variable persistence allows you to adjust the CRT persistence to match the changing characteristics of a signal—any necessary number of traces can be held for trend comparisons, or for flicker free displays. With a bi-stable storage tube, all information is stored, often creating jumbled displays—or you have flickering "full" erase and no retained information.



Exclusive Hewlett-Packard variable persistence enables you to match the persistence of your CRT screen to any signal—eliminating annoying flicker on slow signals such as swept frequency and sampling waveforms, transducer signals, and low-frequency displays.

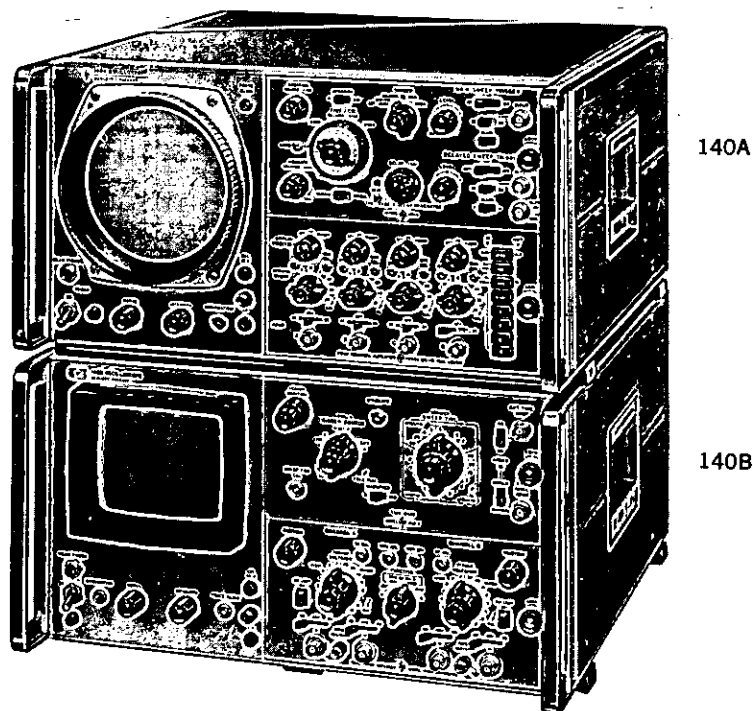
The HP mesh storage tube offers many advantages. With the 141A/B CRT's, the stored trace has the same high contrast as a conventional CRT. Intermediate trace values stand out clearly, you can easily distinguish between four or five separate trace intensities—as opposed to the limiting black-and-white-only displays of ordinary bi-stable storage. Intensity of the CRT can be varied by a front panel control, or modulated externally for X-Y-Z presentations. Maximum viewing intensity in store/view mode is 200 foot lamberts—25 times brighter than bi-stable tubes. With the HP storage mesh CRT, trace brightness and writing speed are maintained over the entire life of the tube—specified performance is warranted for one year.

OSCILLOSCOPES 140 SERIES *continued*

Accepts all 1400-Series Plug-ins
Mainframes Models 140A and 140B

Model 140A and 140B mainframes contain the basic functional circuits for both low and high frequency applications, as well as those for sampling. Each contains a post-accelerator CRT with its associated power supplies and control circuits,

and the dc supplies required to power the Model 1400-series plug-ins. The plug-ins contain all of the circuits necessary to produce beam deflection, and operate directly into the CRT.



Specifications, 140A, 140B

Plug-ins: Model 1400-series and Model 8550-series plug-ins; upper compartment for horizontal axis and lower compartment for vertical axis; removable divider shield may be removed to accommodate a single dual-axis Model 1400-series unit.

Cathode-ray tube

Type: post-accelerator, 7300-volt accelerating potential; aluminized P31 phosphor (other phosphors available, see options); etched safety glass face plate reduces glare.

140A Graticule: 10 div x 10 div parallax-free internal graticule marked in 1 cm squares; major horizontal and vertical axes, and second and tenth horizontal graticule lines have 2 mm subdivisions.

140B Graticule: 8 div x 10 div parallax-free internal graticule marked in 1 cm squares; subdivisions of 2 mm on major horizontal and vertical axes, and 10 — 90% lines for 6 and 8 cm display.

Intensity modulation: ac-coupled, +20 volt pulse blanks trace of normal intensity; rear panel input terminals.

Warranty: CRT warranted for one year.

Writing speed: (using HP Model 197A Camera with f/1.9 lens and Polaroid® 3000 speed film).

P31 Phosphor: 250 cm/μs.

P11 Phosphor: 430 cm/μs.

Calibrator

Type: line-frequency rectangular signal, approximately 0.5 μs risetime.

Voltage: two outputs: 1 volt and 10 volts peak-to-peak, ±1% from 15°C to 35°C, ±3% from 0°C to 55°C.

Beam finder: returns trace to CRT screen regardless of settings of horizontal, vertical, or intensity controls.

Power requirements: 115 or 230 volts ±10%, 50 to 60 Hz, normally less than 285 watts (varies with plug-in units used).

Dimensions: 16¾" wide, 9" high, 18⅞" deep over-all (426 x 229 x 466 mm); hardware furnished for conversion to 19" x 8¾" x 16⅞" (483 x 222 x 416 mm) behind panel rack mount.

Weight: net, 37 lbs (16,7 kg); shipping, 45 lbs (21 kg).

Options (specify by option number):

002: P2 phosphor, no charge.

007: P7 phosphor, no charge.

011: P11 phosphor, no charge.

Accessories: refer to page 534.

Price: HP Model 140A (without plug-ins), \$695.

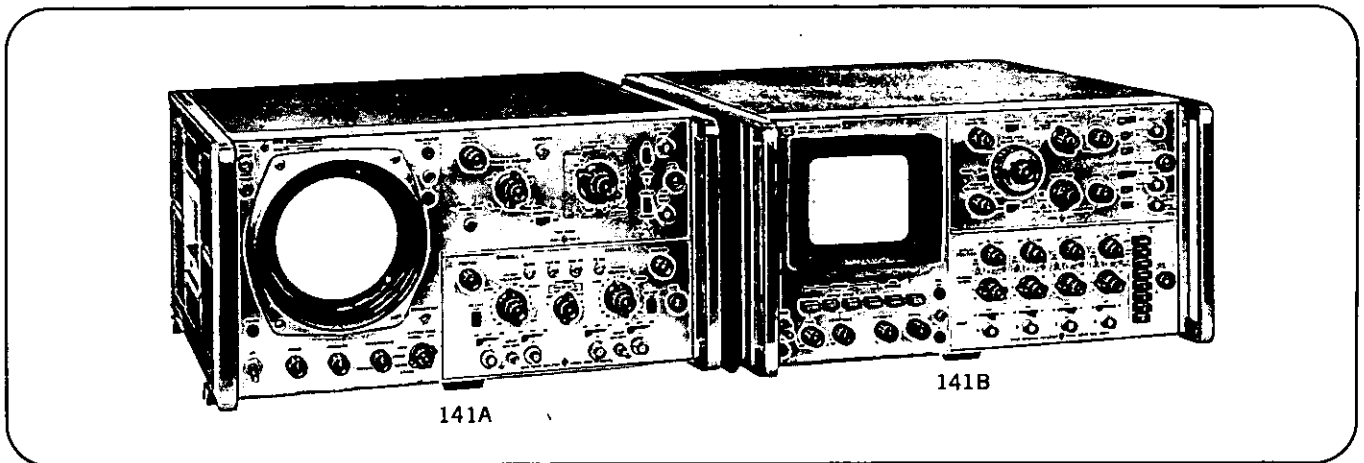
HP Model 140B (without plug-ins), \$695.

OSCILLOSCOPES 140 SERIES *continued*

Accepts all 1400-Series Plug-ins
Mainframes Models 141A, 141B

Model 141A and 141B mainframes contain the basic circuits for low-frequency, high frequency, TDR, and sampling applications. They also accept all of the 1400-series plug-ins. In addition the mainframes contain the cathode-ray tube and associated circuits for the unique variable persistence and storage capabilities.

The 141A/B give you storage for side-by-side comparison of waveforms. In this mode, traces can be held intact for hours (days, in fact, with the scope turned off). Fast $1\text{ cm}/\mu\text{s}$ storage writing rate enables you to capture single-shot transients. Variable persistence allows adjustments to match changing signal characteristics.



Specifications

Plug-ins: Model 1400-series plug-ins; upper compartment for horizontal and lower compartment for vertical; divider shield may be removed for double size plug-ins.

Cathode-ray tube

Type: post-accelerator storage tube, 9000-volt (7300 volts in 141A) accelerating potential; aluminized P-31 phosphor; etched safety glass face plate reduces glare.

141A Graticule: 10 x 10 divisions (approximately 9.4 x 9.4 cm parallax-free internal graticule; 5 subdivisions per major division on major horizontal and vertical axes, and on second and tenth horizontal graticule lines).

141B Graticule: 8 x 10 divisions (approximately 7.5 x 9.4 cm) parallax-free internal graticule including 10% to 90% lines for 6 and 8 division reference; 5 subdivisions per major division on major horizontal and vertical axes.

Intensity modulation: ac-coupled, +20 volt pulse blanks trace of normal intensity; input terminals on rear panel.

Warranty: CRT specifications (persistence, writing rate, brightness, storage time) warranted for one year.

Persistence

Conventional: natural persistence of P31 phosphor (approximately 40 microseconds).

Variable

Standard writing speed mode: continuously variable from less than 0.2 second to more than one minute (typically to two or three minutes).

Fast writing speed mode: typically variable from 0.2 seconds to 15 seconds.

Erase: manual or optional remote (see options); erasure takes approximately 350 ms; scope ready to record immediately after erasure.

Writing speed photographic (conventional operation): (using HP Model 197A camera with f/1.9 lens and ASA 3000 speed film): $100\text{ cm}/\mu\text{s}$.

Writing speed (storage):

Standard mode: $20\text{ cm}/\text{ms}$.

Fast mode: $1\text{ cm}/\mu\text{s}$.

141A storage time: from Normal Writing Rate mode to Store, traces may be stored for 1 hour. To View mode, traces may be viewed at normal intensity for up to 1 minute. From Max. Writing Rate mode to Store, traces may be stored at reduced intensity for more than 15 minutes. To View mode, traces may be stored at normal intensity for more than 15 seconds.

141B storage time: standard writing speed; up to 8 hours at reduced brightness. Traces may be viewed at maximum brightness for up to one minute. Fast writing speed: traces may be stored at reduced brightness for more than 1 hour or stored at maximum brightness for more than 15 seconds.

Brightness: 100 foot-lamberts in standard mode.

Calibrator

Type: line-frequency rectangular signal, approximately 0.5 ms risetime.

Voltage: two outputs; 1 volt and 10 volts peak-to-peak, $\pm 1\%$ from 15°C to 35°C , $\pm 3\%$ from 0°C to 55°C .

Beam finder: returns trace to CRT screen regardless of settings of horizontal or vertical controls.

Power requirements: 115 or 230 volts $\pm 10\%$, 50 to 60 Hz, normally less than 285 watts (varies with plug-in units used).

Dimensions: $16\frac{3}{4}$ " wide, 9" high, $18\frac{3}{8}$ " deep over-all (425 x 229 x 467 mm); hardware furnished for quick conversion to 19 " x $8\frac{3}{4}$ " x $16\frac{3}{8}$ " (483 x 222 x 416 mm) behind panel rack mount.

Weight: net, 40 lb (18 kg); shipping, 51 lb (23 kg).

Options: (specify by option number).

009: remote erase. BNC input on rear panel; shorting to ground for at least 50 ms erases screen, with scope ready to use 350 ms after ground is removed; input draws 20 mA from ground through a 600-ohm impedance to a -12 volt supply, add \$25.

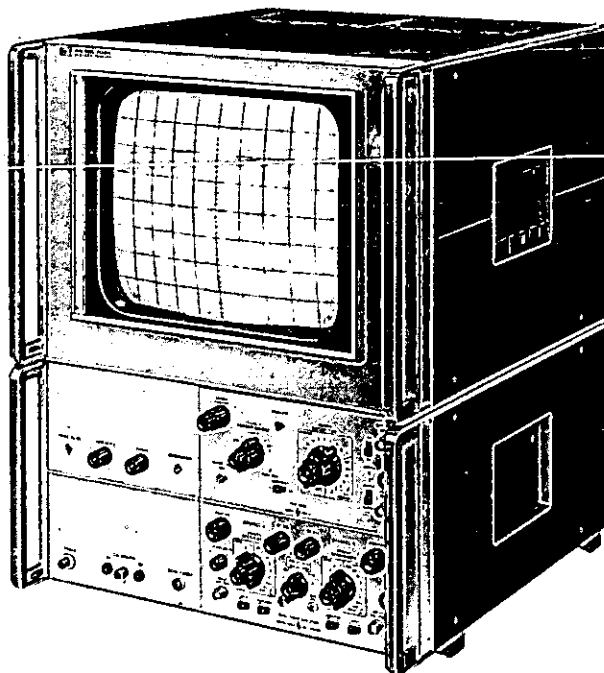
Price: HP Model 141A, \$1395; HP Model 141B, \$1500.

Accessories: refer to page 534.

OSCILLOSCOPES 140 SERIES *continued*

8" x 10" CRT display
Mainframe Model 143A

- 8" x 10" CRT display
- Accepts HP 1400 and 8550 Series plug-ins
- Parallax-free internal graticule



The HP Model 143A Oscilloscope mainframe provides the extreme versatility of a dual-axis plug-in oscilloscope, and in addition has a very large 8-inch by 10-inch viewing area. The large display is useful wherever the readout is to be viewed from a distance or by several people at one time.

The Model 143A provides higher resolution displays throughout the oscilloscope measuring spectrum with the same accuracy and linearity normally associated with a conventional 5" display.

This large-screen oscilloscope is specifically designed to give you both high-frequency and high-sensitivity performance. It consists of the essential functional blocks for low and high frequency applications—plus sampling. Included are an advanced-design post accelerator CRT, associated control circuitry, and the power supplies required for the HP 1400-series plug-ins.

Specifications, 143A

Plug-ins: accepts standard Model 1400-series plug-ins; upper compartment for horizontal axis and lower compartment for vertical axis (all plug-in specifications are same except bandwidth is 15 MHz with Model 1402A); center shield may be removed to accommodate a single dual axis Model 1400-series unit. Plug-in panel nomenclature of centimeter divisions translates directly to inch divisions on the Model 143A display. For example, 5 V/cm deflection factor is displayed as 5 V/inch on the Model 143A.

Cathode-ray tube

Type: post-accelerator, 20 kV accelerating potential; aluminized P31 phosphor (other phosphors available on order).

Graticule: 8-inch by 10-inch parallax-free internal graticule marked in one inch squares; major vertical and horizontal axes have 0.2-inch subdivisions (other graticules available on order).

Intensity modulation: ac-coupled (down 3 dB at 4 kHz), +20 volt pulse will blank trace of normal intensity; input on rear panel.

Warranty: CRT warranted for one year.

Calibrator

Type: line-frequency rectangular signal, approximately 0.5 μ s risetime.

Voltage: two outputs; 1 volt and 10 volts peak-to-peak \pm 1% from 15°C to 35°C, \pm 3% from 0° to +55°C.

Beam finder: returns trace to CRT screen regardless of vertical, horizontal or intensity control settings.

Power requirements: 115 or 230 volts \pm 10%, 50 to 60 Hz, normally less than 235 watts (varies with plug-in units used).

Weight: without plug-ins, net 62 lbs (28.1 kg); shipping 81 lbs (36.7 kg).

Dimensions: 16 $\frac{3}{4}$ " wide, 21" high, 18 $\frac{3}{8}$ " deep over-all (426 x 533 x 466 mm); hardware furnished for quick conversion to 19" x 20 $\frac{3}{4}$ " x 16 $\frac{3}{8}$ " (483 x 527 x 416 mm) behind panel rack mount.

Accessories furnished: rack mounting hardware for conversion to a standard EIA rack configuration.

Price: HP Model 143A, \$1500.

Accessories available

Anti-reflection filter: nylon mesh attached to contrast filter to reduce reflections. Model 10181A, amber for P7 phosphor; Model 10182A, green for standard phosphors. Price: Model 10181A, \$30; Model 10182A, \$30.

Chassis slides and adapters: fixed slides, order HP Part No. 1490-0714, \$32.50; pivot slides, order HP Part No. 1490-0718, \$40; slide adapter kit for mounting slides, order HP Part No. 1490-0721, \$40. Note: one adapter kit required for mounting one pair of chassis slides.

Selection chart
1400 series plug-ins

1400-SERIES PLUG-IN SELECTION CHART

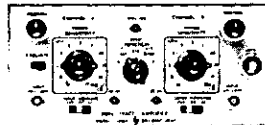
VERTICAL PLUG-IN Capabilities	REAL TIME									SAMPLING				DOUBLE SIZE	
	1400B	1401A	1402A	1403A	1404A	1405A	1406A	1407A	1408A	1410A	1411A/1430A	1411A/1431A	1411A/1432A	1416A	1418A
Bandwidth	500 kHz	450 kHz	20 MHz	400 kHz	15 MHz	5 MHz	400 kHz	400 kHz	500 kHz	1 GHz	12.4 GHz	12.4 GHz	4 GHz		
Deflection Factor/div	100 μ V	1 mV	5 mV	10 μ V	10 mV	5 mV	50 μ V	50 μ V	100 μ V	1 mV	1 mV	1 mV	1 mV		
Number of traces	1	2	2	1	4	2	1	1	2	2	2	2	2		
X-Y	x	x	x	x	x	x	x	x	x	x	x	x	x		
Delayed Sweep	1421A for Realtime									1425A for Sampling					
No drift							x	x							
Max CMRR in dB	100	40	40	106	40	40	60	80	100						
Algebraic Addition		x	x		x	x			x	x	x	x	x		
TDR															x
Wide Band TDR											x				
Swept Frequency												x			x
Recommended time bases															
1420A	x	x		x		x	x	x	x						
1421A	x	x	x	x	x	x	x	x	x						
1422A	x	x		x			x	x	x						
1423A	x	x	x	x	x	x	x	x	x						
1424A										x	x	x	x		
1425A										x	x	x	x		
Spectrum analyzer system plug-ins															
8553B/8552A	1 kHz to 110 MHz Spectrum analysis														
8554L/8552A	500 kHz to 1250 MHz Spectrum analysis														



1400B

- 100 μ V/div
- dc to 500 kHz
- Differential on all ranges
- 100 dB CMRR

Price: \$275 Page 501



1402A

- 5 mV/div
- dc to 20 MHz-dual trace
- Signal delay for fast rise viewing

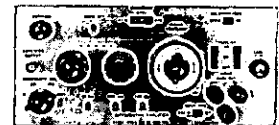
Price: \$575 Page 498



1404A

- 10 mV/div to 15 MHz
- 1 mV/div to 10 MHz
- Selectable triggering

Price: \$975 Page 504



1406A

- 50 μ V/div-dc to 400 kHz
- No drift
- Calibrated offset for accurate ac and dc measurements

Price: \$950 Page 500



1401A

- 1 mV/div-dual trace
- dc to 450 kHz
- Convenient dual trace triggering

Price: \$450 Page 501



1403A

- 10 μ V/div
- 0.1 Hz to 400 kHz
- 106 dB CMRR

Price: \$575 Page 503



1405A

- 5 mV/div-dual trace
- dc to 5 MHz
- Algebraic addition

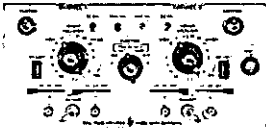
Price: \$350 Page 499



1407A

- 50 μ V/div
- No drift
- 80 dB CMRR

Price: \$725 Page 503



1408A

- 100 μ V/div-dual channel
 - dc to 500 kHz
 - 100 dB CMRR
 - Alternate or chopped sweeps
- Price: \$575 Page 502



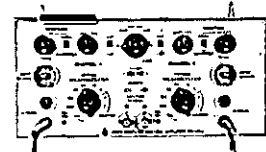
1420A

- 10 MHz triggering
 - Sweeps to 50 ns/div
 - Auto triggering
- Price: \$375 Page 505



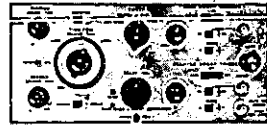
1425A

- Delayed sweep
 - Sweeps to 10 ps/div
 - Triggering to 1 GHz
- Price: \$1900 Page 512



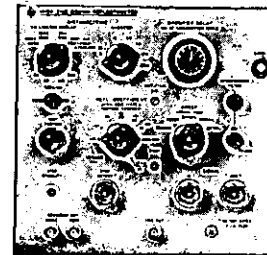
1410A

- 1 mV/div at 1 GHz dual trace
 - Internal triggering
 - High impedance probes and 50 Ω inputs
- Price: \$1700 Page 507



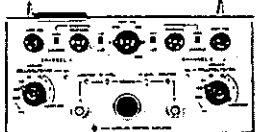
1421A

- 20 MHz triggering
 - Delayed sweep
 - Sweeps to 20 ns/div
- Price: \$675 Page 506



1415A

- Complete TDR system for testing cables, connectors, striplines
 - Determines location, meaning, and nature of each discontinuity—an inch apart
 - Easy to operate
- Price: \$1200 Page 515



1411A

- 1 mV/div-dual trace
 - Bandwidths to 12.4 GHz
 - Remote samplers
- Price: \$700 Page 509



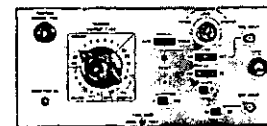
1422A

- 500 kHz triggering
 - Sweeps to 200 ns/div
 - Auto triggering
- Price: \$250 Page 505



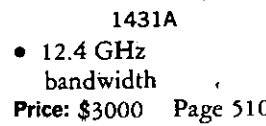
1430A

- 28 ps risetime—
- Price: \$3000 Page 510



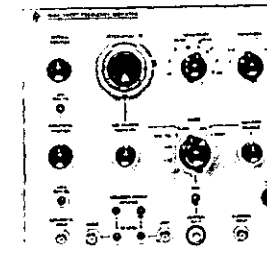
1423A

- 20 MHz triggering
 - Sweeps to 20 ns/div
 - Trigger hold-off
- Price: \$490 Page 505



1431A

- 12.4 GHz bandwidth
- Price: \$3000 Page 510



1416A

- Speeds and simplifies swept frequency measurements
 - High resolution direct readout in dB
 - Low drift
 - X-Y recorder outputs
- Price: \$725 Page 514



1432A

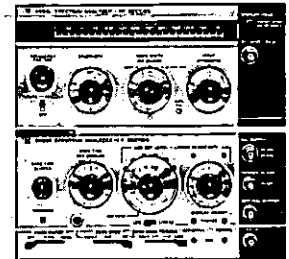
- 90 ps risetime—
- Price: \$1000 Page 509



1424A

- Triggering to 5 GHz
 - Sweeps to 10 ps/div
 - Direct readout on all sweeps
- Price: \$1400 Page 511

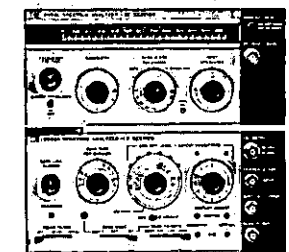
Spectrum Analyzer Plug-ins



8552A/8553B

- 1 kHz to 110 MHz
- Presents amplitude as frequency over >70 dB dynamic range
- Absolute amplitude measurement from -130 dBm to +10 dBm (0.07 μ V to 0.8 V)

Price: 8552A, \$2050
8553B, \$2050
Page 517



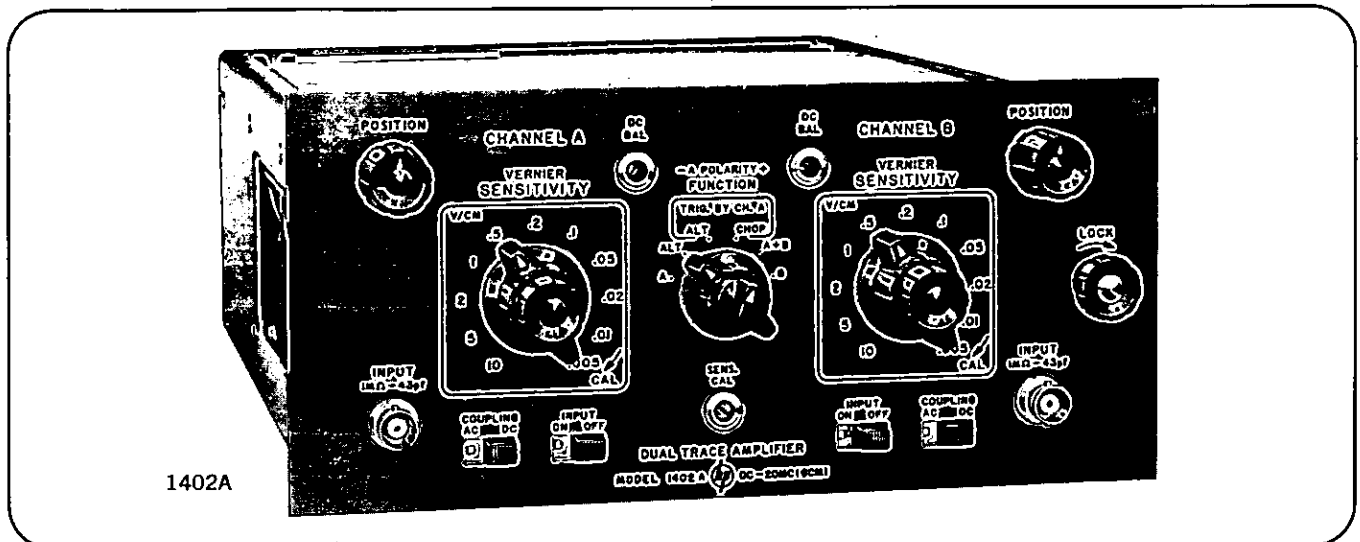
8552A/8554L

- 500 kHz to 1250 MHz
- Presents amplitude as frequency up to 70 dB dynamic range
- Absolute amplitude measurement from -117 dBm to +10 dBm (0.5 μ V to 0.8 V)

Price: 8552A, \$2050
8554L, \$3300
Page 517

OSCILLOSCOPES 140 SERIES *continued*

20 MHz With Signal Delay Dual Trace Amplifier Model 1402A



The 1402A Dual Trace Amplifier provides greater than 20 MHz bandwidth plus 5 mV/div sensitivity on each channel for accurate analysis of high frequency low level signals. Rise times of signals can be easily measured because the 1402A has a built-in delay line in the vertical amplifier following the trigger take-off.

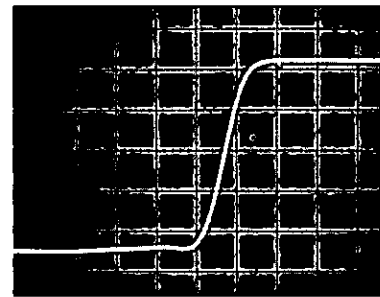
Two signals can be displayed with the 1402A in each of two modes. Slow signals can be viewed in the chopped mode, since the input to the CRT is switched between Channel A and Channel B at a high rate during each sweep. Fast signals can be viewed in the alternate mode since the input to the CRT is switched at the end of each sweep, with Channel A displayed during one sweep and Channel B on the following sweep.

Accurate time difference measurements are possible because the sync amplifier in the 1402A can be switched to Channel A alone. This feature is useful when dual traces are displayed on alternate sweeps; switching the sync to Channel A preserves the time relationship between the two signals, because the sweep always triggers on the same point on Channel A. Also, syncing to Channel A when in the chopped dual trace mode assures triggering on the displayed waveform rather than the chopper. Two unrelated signals can be displayed by triggering on the composite waveform. This feature

avoids resorting to external triggering for either of these dual trace presentations.

Single-channel displays are also possible for either input A or B. The two channels may also be displayed algebraically added, and a polarity reversal switch on Channel A allows the differential signal, $B - A$, to be displayed.

Although maximum bandwidth is obtained from the 1402A with 6 div or less deflection, larger amplitude signals can be displayed without distortion and with only a small sacrifice in bandwidth. For example, the bandwidth when using a full 10-div deflection is greater than 15 MHz.



Above photo demonstrates bandwidth and excellent transient response of 1402A Dual Trace Amplifier. Sweep time is 20 ns/div; sensitivity is 5 mV/div.

Specifications

Mode of operation: (1) Channel A alone, (2) Channel B alone, (3) Channel A and Channel B displayed on alternate sweeps, (4) Channel A and Channel B displayed by switching at approx. 100 kHz, with trace blanking during switching, (5) Channel A and Channel B added algebraically, polarity of Channel A may be inverted to obtain differential operation.

Bandwidth: (6 div reference signal) dc coupled, dc to 20 MHz; ac coupled, 2 Hz to 20 MHz.

Risetime: less than 20 ns with 6 div step input.

Deflection factor (sensitivity): each channel; 5 mV/div to 10 V/div, 11 ranges in a 1, 2, 5 sequence; accuracy $\pm 3\%$; vernier provides continuous adjustment between steps and

extends 10 V/div step to at least 25 V/div.

Signal delay: signal is delayed so that leading edge of fast-rise signals is visible at start of sweep.

Common mode rejection: (in B-A mode) at least 40 dB on 5, 10 and 20 mV/div ranges, at least 30 dB on 50 mV/div to 10 V/div ranges; common mode signal not to exceed 150 div (e.g., 150 volts on 1 V/div range) or a frequency of 500 kHz.

Input RC: 1 megohm shunted by 43 pF.

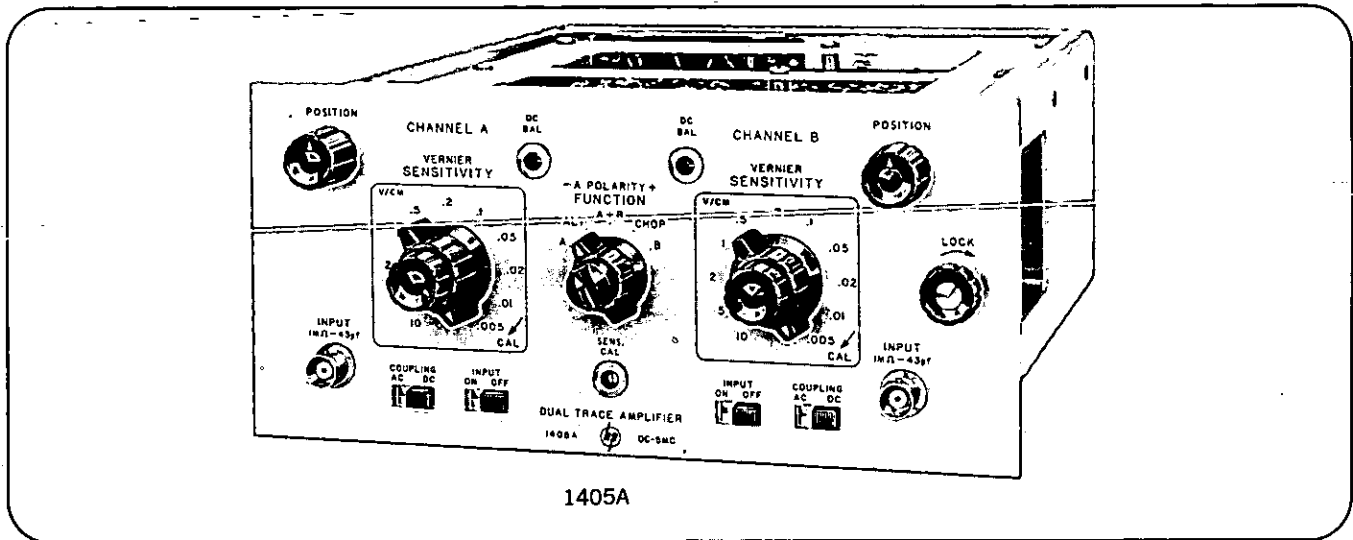
Maximum input: 600 volts peak (dc + ac).

Weight: net, 7 lbs (3,2 kg); shipping, 13 lbs (5,9 kg).

Price: HP Model 1402A, \$575.

Option 090: includes two 10012A Probes, add \$60.

Dual Trace Amplifier Model 1405A

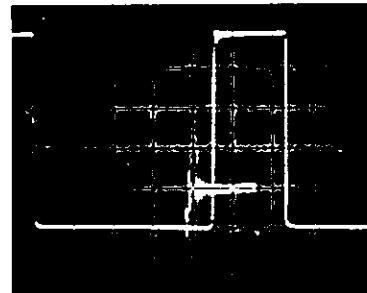


The wide dynamic range of the 1405A permits a 50 div width at 5 mV/div sensitivity. Dual trace presentations can be displayed on alternate sweeps or by chopping between the two input signals on the same sweep at a 100 kHz rate. In addition to single-trace presentations of Channel A or B, the two channels may be algebraically added or, by a reversal of the Channel A polarity switch, the differential signal may be viewed. The full 5 MHz frequency response is achieved in every operating mode, and when operating in any sensitivity position.

In all operating modes each channel has independent positioning and sensitivity controls, permitting the comparison of signals with widely differing amplitudes. When used as a differential amplifier, a common-mode rejection of better than 40 dB in the higher sensitivity positions permits the display of low-level signals while attenuating undesirable components such as hum.

The 1405A Dual Trace Amplifier provides 5 MHz bandwidth peak-to-peak signal to be displayed without significant distortion. Using A + B mode and a variable dc voltage source such as the 723A power supply applied to the second channel, any 10-div segment of the 50-div trace can be

positioned on screen and analyzed. The 1405A is an ideal tool for video waveforms when used with the 1421A Time Base and Delay Generator, since any single line of a television frame may be isolated and displayed. The 5 mV/div sensitivity permits the display of signals in low-level stages, or permits the use of attenuator probes to prevent circuit loading. For X-Y measurements, such as phase shift or Lissajous patterns, the 1405A may be used with any other 1400 series plug-in (including another 1405A) for either vertical or horizontal deflection.



Double exposure showing 5-div pulse on upper waveform, and the same pulse expanded 10 X to view small perturbation on the top.

Specifications

Modes of operation: (1) Channel A alone, (2) Channel B alone, (3) Channel A and Channel B displayed in alternate sweeps (4) Channel A and Channel B displayed by switching at approx 100 kHz, with trace blanking during switching, (5) Channel A and Channel B added algebraically, polarity of Channel A may be inverted to obtain differential operation.

Bandwidth: dc coupled, dc to 5 MHz (70 ns risetime; ac coupled, 2 Hz to 5 MHz (the lower limit is extended to approx 0.2 Hz with a X10 probe).

Deflection factor (sensitivity): each channel; 5 mV/div to 10 V/div, 11 ranges in a 1, 2, 5 sequence; accuracy $\pm 3\%$;

vernier provides continuous adjustment between steps and extends 10 V/div step to at least 25 V/div.

Common mode rejection: at least 40 dB on 5, 10, and 20 mV/div ranges, at least 30 dB on 50 mV/div to 10 V/div ranges; common mode signal not to exceed 50 div (e.g., 0.5 volt on 10 mV/div range) or a frequency of 50 kHz.

Input RC: 1 megohm shunted by 43 pF.

Maximum input: 600 volts peak (dc + ac).

Weight: net, 4 lbs (1,8 kg); shipping, 10 lbs (4,5 kg).

Price: HP Model 1405A, \$350.

OSCILLOSCOPES 140 SERIES *continued***Differential amplifier with calibrated offset**
Precision amplifier Model 1406A

1406A

Specifications

Deflection factor: 50 $\mu\text{V}/\text{div}$ to 20 V/div in a 1, 2, 5 sequence; vernier provides continuous adjustment between ranges and extends highest deflection factor to at least 50 V/div; attenuator accuracy is $\pm 3\%$.

Amplified output: approx 1 V/div, dc coupled, single ended, dc level approx 0 volts, output impedance less than 100 ohms, dynamic range ± 5 V.

Bandwidth**Upper limit:**

20 V/div to 100 $\mu\text{V}/\text{div}$ -400 kHz (0.9 μs risetime); or 50 $\mu\text{V}/\text{div}$ -300 kHz.

Upper limits of max, 100, 25, and 5 kHz selectable with front panel switch on all deflection factors.

Lower limit: dc with input dc coupled, 2 Hz with input ac coupled.

Drift

Long-term drift: less than ± 0.2 div or less than ± 20 μV per 200 hrs, whichever is greater.

Temperature drift: less than ± 0.2 div or less than ± 50 μV , whichever is greater over a temperature range of 0°C to 55°C.

Drift correction occurs at 3 Hz for 50 ms/div sweeps and faster, and 1.5 Hz on 0.1 s/div sweeps and slower.

Range to range shift: dc stabilization maintains a fixed baseline reference within ± 1 div on CRT over entire range of deflection factors after a 3-minute warmup.

Positioning: baseline can be positioned ± 10 div by continuous position.

DC offset: offset is applied to the B (—) input.

Readout: 4-digit resolution, with lighted decimal indicators.

Ranges: ± 0.1 V, ± 1 V, ± 10 V, ± 100 V, ± 1000 V.

Up to ± 10 V offset can be used on all deflection factor ranges; an equivalent ± 100 V range can be used from 0.5 mV/div through 20 V/div, and an equivalent ± 1000 V range from 5 mV/div through 20 V/div.

Accuracy: $\pm 0.15\%$ of indicated value plus 0.05% of full

In addition to 50 $\mu\text{V}/\text{div}$ deflection factor, no drift dc stabilization, and wide dynamic range, the 1406A offers a calibrated dc offset for better than 0.5% accurate ac and dc voltage measurements.

Accurate measurements are accomplished by inserting the test signal into one side of a high common mode rejection differential amplifier and a very accurate (0.15%) dc level into the other side. The top of the waveform is then positioned to center screen with the offset controls and the offset reading noted. This is then repeated for the bottom of the waveform. The difference between the two offset readings is the ac amplitude. When measuring a dc level only one reading is required; zero volts is already established because the stabilizer eliminates drift.

The range switching is interlocked with the deflection factor switching so that the direct reading offset does not change when changing the deflection factor. There are ten offset ranges providing ± 0.1 V to ± 1000 V in decade steps.

scale offset range, on ± 0.1 V, ± 1 V, and ± 10 V ranges. $\pm 0.4\%$ of indicated value plus 0.05% of full scale offset range, on ± 100 V and ± 1000 V ranges.

Differential input: may be selected on all deflection factor ranges. Single-ended operation is used when employing offset.

Common mode rejection ratio: ± 5 V (dc + pk ac) or ± 10 V dc, dc coupled, 50 $\mu\text{V}/\text{div}$ to 20 mV/div; dc to 60 Hz, 80 dB; 60 Hz to 10 kHz, 60 dB.

Maximum input without overload

50 $\mu\text{V}/\text{div}$ to 20 mV/div — ± 10 V pk-pk.

50 mV/div to 2 V/div — ± 100 V pk-pk.

5 V/div to 20 V/div — ± 600 V pk-pk.

Dynamic range: dynamic signals of at least ± 50 div of deflection can be displayed without distortion.

Input impedance: 1 megohm shunted by 100 pF, constant on all attenuator ranges.

Max input

V_0 range: 0.1 to 10.

15 V (dc + peak ac), 0.05 mV/div to 20 mV/div;

150, 50 mV/div to 0.2 V/div; 600 V, 0.5 V/div to 20 V/div.

V_0 range: 100.

150 V (dc + peak ac).

V_0 range: 1000.

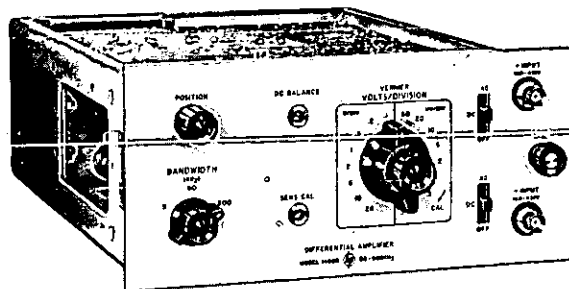
600 V (dc + peak ac).

X-Y operation: two 1406A's or 1406A and a 1407A can be used to give stabilized X-Y presentation. Models 1406A and 1407A are not compatible with other 1400-series vertical plug-ins for X-Y displays.

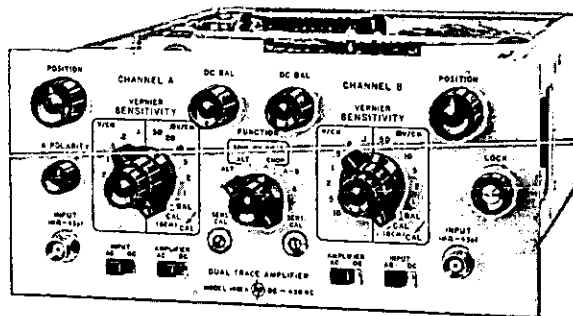
Time base compatibility: the 1406A and 1407A can be used directly with the 1422A and 1423A; 1420A's below serial 441-01326 and 1421A's below serial 545-00651 must be modified. (Order kits 01420-69502 for the 1420A, 01421-69501 for the 1421A.)

Weight: net 6 lbs (2,7 kg); shipping 12 lbs (5,4 kg).

Price: HP Model 1406A, \$950.

OSCILLOSCOPES 140 SERIES *continued*
Measure microvolt signals
 High sensitivity amplifiers Models 1400B, 1401A


1400B



1401A

Get 100 $\mu\text{V}/\text{cm}$ sensitivity and selectable bandwidth from dc to 400 kHz with low drift differential amplifiers in the 1400B.

The 1401A is a dual trace amplifier with 1 mV/cm sensitivity and a 450 kHz bandwidth.

Specifications, 1400B
Deflector factor

Ranges: from 0.1 mV/div to 20 V/div (17 positions) in 1, 2, 5 sequence. $\pm 3\%$ accuracy with vernier in calibrated position.

Vernier: continuously adjustable between all ranges; extends maximum deflection factor to at least 50 V/div.

Bandwidth: dc to 500 kHz with a maximum risetime of 0.7 μs . 2 Hz to 500 kHz when ac-coupled. Front panel control reduces upper frequency limit to 50 kHz $\pm 20\%$ and 5 kHz $\pm 20\%$.

Noise: tangential noise is $< 25 \mu\text{V}$ at full bandwidth (which is approximately 50 μV pk-pk).

Input: differential or single-ended on all ranges, selectable by front panel control.

Common mode characteristics (dc-coupled)

Frequency: dc to 10 kHz on all ranges.

Rejection ratio: 100 dB (100,000 to 1) on 0.1 mV/div range, decreasing by less than 20 dB per decade of deflection factor to at least 40 dB on the 0.2 V/div range; CMRR is at least 30 dB on the 0.5 V/div to 20 V/div ranges.

Signal maximum: ± 10 V (dc + peak ac) on 0.1 mV/div to 0.2 V/div ranges; ± 400 V (dc + peak ac) on all other ranges.

Input coupling: front panel selection of DC, AC, or OFF for both + and - inputs.

Input RC: 1 megohm shunted by approximately 45 pF; constant on all ranges.

Maximum input: ± 400 volts (dc + peak ac).

Weight: net 4 lb (1,8 kg); shipping 10 lb (4,5 kg).

Price: HP Model 1400B, \$275.

Specifications, 1401A

Bandwidth: input and amplifier coupling set to dc, dc to 450 kHz (0.8 μs risetime); input set to dc and amplifier set to ac, dc to 450 kHz for deflection factors from 50 mV/div to 10 V/div; from 1 mV/div to 20 V/div, lower cutoff depends on the deflection factor: approx 0.5 Hz (to 450 kHz) at 20 mV/div and 10 Hz (to 450 kHz) at 1 mV/div; input set to ac and amplifier set to dc, 2 Hz to 450 kHz.

Deflection factor (sensitivity): each channel; 1 mV/div to 10 V/div, 14 ranges in a 1, 2, 5 sequence; accuracy $\pm 3\%$; vernier provides continuous adjustment between steps and extends 10 V/div step to at least 25 V/div.

Phase shift: when used with another Model 1401A, less than 2° relative phase shift up to 50 kHz with X and Y deflection factors the same, and verniers in Cal.

Common mode rejection ratio: both inputs may be switched to one channel to give differential input; cmrr at least 40 dB on 1 mV/div to 0.1 V/div ranges, signal not to exceed 4 V pk-pk; at least 30 dB on 0.2 V/div to 10 V/div ranges, signal not to exceed 40 V pk-pk on 0.2, 0.5, and 1 V/div ranges or 400 V pk-pk on 2, 5, and 10 V/div ranges; measured with 1 kHz sine wave.

Input RC: 1 megohm shunted by 45 pF.

Maximum input: 60 volts peak (dc + ac).

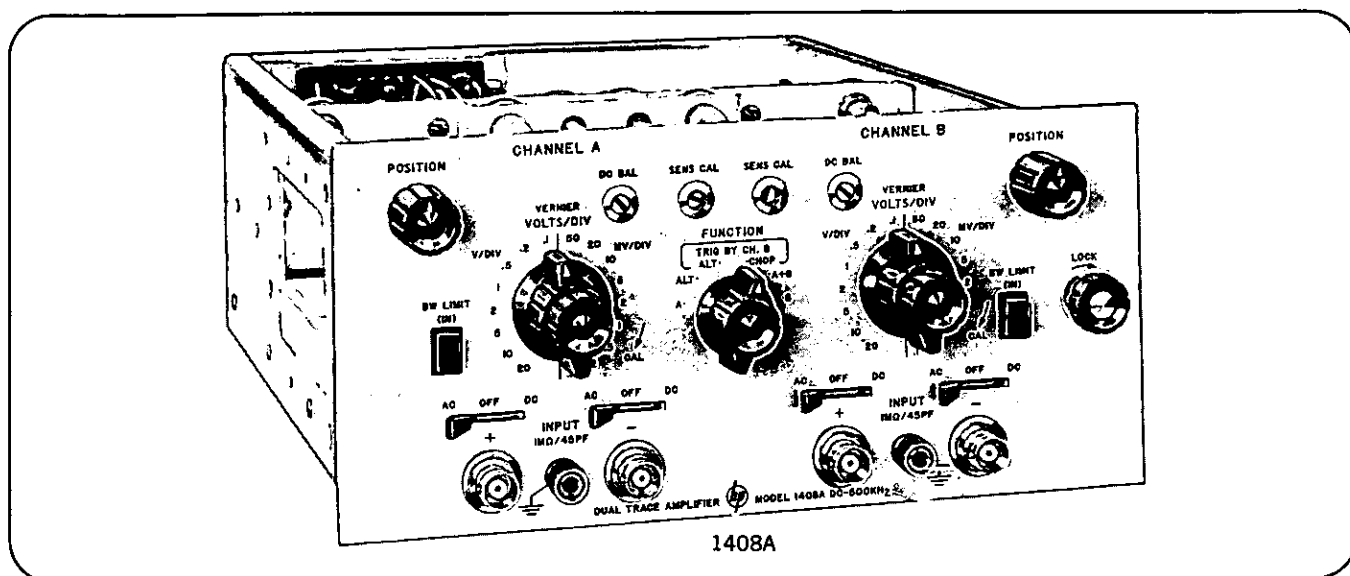
Internal calibrator: line frequency square wave, 6 div pk-pk; displayed when vernier is set to Cal; accuracy $\pm 3\%$.

Mode of operation: (1) channel A alone, (2) channel B alone, (3) channel A and channel B displayed on alternate sweeps, (4) channel A and channel B displayed by switching at approx 100 kHz, with trace blanking during switching, (5) channel A minus channel B.

Display polarity: + up or - up, selectable.

Weight: net 5 lbs (2,3 kg); shipping, 11 lbs (5,3 kg).

Price: HP Model 1401A, \$425.

OSCILLOSCOPES 140 SERIES *continued***Measure microvolt signals****High sensitivity amplifier Model 1408A**

Model 1408A Dual Trace Amplifier provides 500 kHz bandwidth at 100 $\mu\text{V}/\text{div}$ sensitivity. Dual trace presentations can be displayed on alternate sweeps or by chopping between the two input signals, during the same sweep, at a 100 kHz rate. In addition to single-trace presentations of Channel A or B, the channels may be algebraically added or, by reversing the polarity of the input signal, the differential signal may be viewed. Two 2-position bandwidth limit switches (50 and 500 kHz) improve resolution of low level signals by eliminating noise from the unused portion of the bandwidth.

Solid-state circuits throughout the instrument provide stable operation and less frequent calibration. The 100 $\mu\text{V}/\text{div}$ vertical amplifier exhibits very low drift (typically

less than 50 μV per hour) and tangential noise of less than 25 μV .

Model 1408A has a common mode rejection ratio of 100,000 to 1 (100 dB) in the most sensitive deflection factor of 100 $\mu\text{V}/\text{div}$, over a dc to 10 kHz frequency range. This high CMRR is made even more useful by the ± 10 volts common mode signal specification in the more sensitive deflection factor settings, a combination not previously available in low frequency plug-in oscilloscopes. High CMRR eliminates concern about inaccuracies caused by induced voltage in differential signal leads. For example, a common mode signal of 10 volts would be reduced to only 100 microvolts. And, no time-consuming front panel adjustments are required.

Specifications, 1408A**Deflection factor**

Ranges: from 100 $\mu\text{V}/\text{div}$ to 20 V/div (17 positions) in 1, 2, 5 sequence. $\pm 3\%$ accuracy.

Vernier: continuously adjustable between all ranges; extends maximum deflection factor to at least 50 V/div.

Bandwidth

DC to 500 kHz with a maximum risetime of 0.7 μs . 2 Hz to 500 kHz when ac-coupled. Front panel control reduces upper frequency limit to 50 kHz $\pm 20\%$.

Noise: tangential noise is $< 25 \mu\text{V}$ at full bandwidth (which is approximately 50 μV pk-pk).

Input

Differential or single-ended on all ranges, selectable by front panel control.

Common mode characteristics (dc-coupled)

Frequency: DC to 10 kHz on all ranges.

Rejection ratio: 100 dB (100,000 to 1) on 0.1 mV/div range, decreasing by less than 20 dB per decade of deflection factor to at least 40 dB on the 0.2 V/div range; CMRR is at least 30 dB on the 0.5 V/div to 20 V/div ranges.

Signal maximum: ± 10 V (dc + peak ac) on 0.1 mV/div

to 0.2 V/div range; ± 400 V (dc + peak ac) on all other ranges.

Input coupling

Front panel selection of AC, OFF, or DC for both + and - inputs.

Input RC

1 megohm shunted by approximately 45 pF; constant on all ranges.

Maximum input

± 400 volts (dc + peak ac).

Modes of operation: (1) Channel A alone, (2) Channel B alone, (3) Channels A and B displayed on alternate sweeps with composite triggering, (4) Channels A and B displayed on alternate sweeps with Channel B triggering, (5) Channels A and B displayed by switching between channels at approximately 100 kHz with trace blanking during switching and trigger signal from Channel B, (6) Channel A plus Channel B.

Display polarity: + up or - up, selectable.

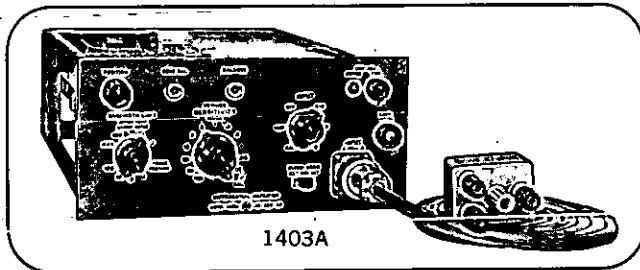
Weight: net 4 $\frac{1}{2}$ lb (2 kg); shipping 10 $\frac{1}{2}$ lb (4.8 kg).

Price: HP Model 1408A, \$575.

OSCILLOSCOPES 140 SERIES *continued*

High common mode rejection

High sensitivity amplifiers Models 1403A, 1407A



1403A

The Model 1403A Amplifier features 106 dB of common mode rejection with guarded input and 10 $\mu\text{V}/\text{div}$ sensitivity.

Specifications, 1403A

Input modes: (1) input A single-ended, (2) input B single-ended and inverted, (3) A-B differential, (4) off disconnects inputs and grounds input amplifier, (5) cmr, and (6) Cal for calibrating the instrument; A and B inputs, guard, and chassis ground are brought out through a special guarded connector; guard is normally driven by internal common mode signal amplifier; with unbalanced source impedances, the guard may be driven externally, preserving high cmr.

Bandwidth: 0.1 Hz to 400 kHz (0.9 μs risetime) (to 200 kHz at 10 $\mu\text{V}/\text{div}$ and to 300 kHz at 20 $\mu\text{V}/\text{div}$); upper and lower limits may be independently selected; lower: 0.1, 1, 10, and 100 Hz; upper: max (greater than 400 kHz), 100, 10, 1, and 0.1 kHz.

Deflection factor (sensitivity): 0.01 mV/div to 100 mV/div, 13 ranges in a 1, 2, 5 sequence; accuracy $\pm 3\%$; vernier provides continuous adjustment between steps and extends 100 mV/div step to at least 125 mV/div.

Phase shift: when used with another Model 1403A, less than 2° relative phase shift up to 50 kHz with X and Y deflection factors the same, and verniers in Cal.

Common mode rejection ratio: differential input may be selected on all ranges; with a balanced input impedance and the guard drive in external, cmr may be adjusted to the values below for up to 5 V pk-pk, 45 Hz to 3 kHz (for internal, cmr is 6 dB less than shown below).

Deflection factor (mV/div)	Common mode rejection ratio (dB)
0.01 to 0.2	106
0.5, 1, 2	86
5, 10, 20	66
50, 100	46

Typical CMRR with an unbalanced source impedance when using Guard Drive Ext on most sensitive ranges:

Unbalance	60 Hz	120 Hz	1 kHz	10 kHz
100 ohms	100 dB	100 dB	100 dB	90 dB
1 k ohms	100 dB	100 dB	90 dB	70 dB
10 k ohms	80 dB	80 dB	70 dB	50 dB

Input RC: 10 megohms shunted by approx. 60 pF.

Maximum input: 600 volts peak (dc + ac) on A and B inputs, 10 volts on Guard input.

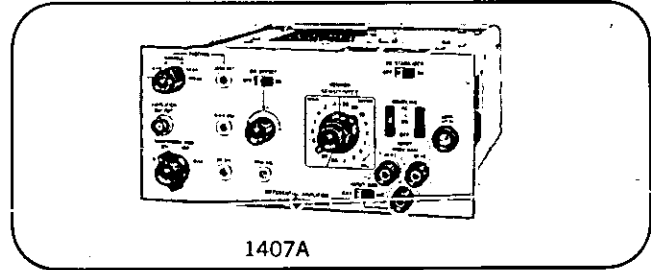
Noise: 20 μV pk-pk at 100 kHz, noise is reduced as bandwidth is reduced.

Internal calibrator: line frequency square wave, 100 mV pk-pk; displayed when input selector is set to Cal; accuracy $\pm 3\%$.

Weight: net 5 lbs (2.3 kg); shipping 11 lbs (5.2 kg).

Accessories furnished: 6-ft double-shielded extension cable (01403-61602), and a 4-terminal binding post adapter (1251-1888).

Price: HP Model 1403A, \$575.



1407A

The Model 1407A has 50 $\mu\text{V}/\text{div}$ sensitivity, 80 dB of common mode rejection, and no dc drift.

Specifications, 1407A

Bandwidth

Upper limit: selectable; 5, 25, 100 kHz, and max (400 kHz for 20 V/div to 100 $\mu\text{V}/\text{div}$ ranges, 0.9 μs risetime; or 300 kHz for 50 $\mu\text{V}/\text{div}$ range).

Lower limit: dc coupled input, dc; ac coupled input, 2 Hz.

Deflection factor (sensitivity): 50 $\mu\text{V}/\text{div}$ to 20 V/div, 17 ranges in a 1, 2, 5 sequence; accuracy $\pm 3\%$; vernier provides continuous adjustment between steps and extends 20 V/div step to at least 50 V/div.

Amplifier output: approx 1 V/cm, dc coupled, single-ended, dc level approx 0 V, output impedance ≤ 100 ohms, dynamic range ± 5 V.

Drift: drift correction occurs at 3 Hz for 50 ms/div speeds and faster, 1.4 Hz on 0.1 s/div speeds and slower.

Long term drift: less than ± 0.2 div or $\leq \pm 20$ $\mu\text{V}/200$ hours, whichever is greater.

Temperature drift: less than ± 0.2 div or $\leq \pm 50$ μV , whichever is greater, over a temperature range of 0°C to 55°C .

Range to range shift: dc stabilization maintains a fixed baseline reference within ± 1 div on CRT over entire deflection factor range, after a 3-minute warmup.

Positioning: baseline can be positioned continuously or in calibrated steps of 0, ± 5 div; and ± 10 div; accuracy $\pm 3\%$.

DC offset: uncalibrated dc offset is provided in both single-ended and differential operation; the max amount of offset obtainable, referenced to the input, varies with deflection factor approx as follows: 0.2 V at 50 $\mu\text{V}/\text{div}$, increasing to 0.5 V at 10 mV/div, 5 V at 100 mV/div, 50 V at 1 V/div, and 600 V at 20 V/div; offset dc drift is ≤ 20 $\mu\text{V}/\text{hr}$ at constant ambient temperature, or $\leq \pm 100$ μV for ambient temperature change of 0°C to 50°C .

Differential input: may be selected on all ranges; offset capability is maintained in differential operation.

Common mode rejection: ± 5 V (dc + pk ac) or ± 10 V dc, dc coupled, 50 $\mu\text{V}/\text{div}$ to 20 mV/div; dc to 60 Hz, 80 dB; 60 Hz to 10 kHz, 60 dB; max. input without overload: 50 $\mu\text{V}/\text{div}$ to 20 mV/div, ± 10 V pk-pk; 50 mV/div to 2 V/div, ± 100 V pk-pk; 5 V/div to 20 V/div, ± 600 V pk-pk.

Dynamic range: dynamic signals of less than ± 50 div of deflection can be displayed without distortion.

Input RC: 1 megohm shunted by 90 pF.

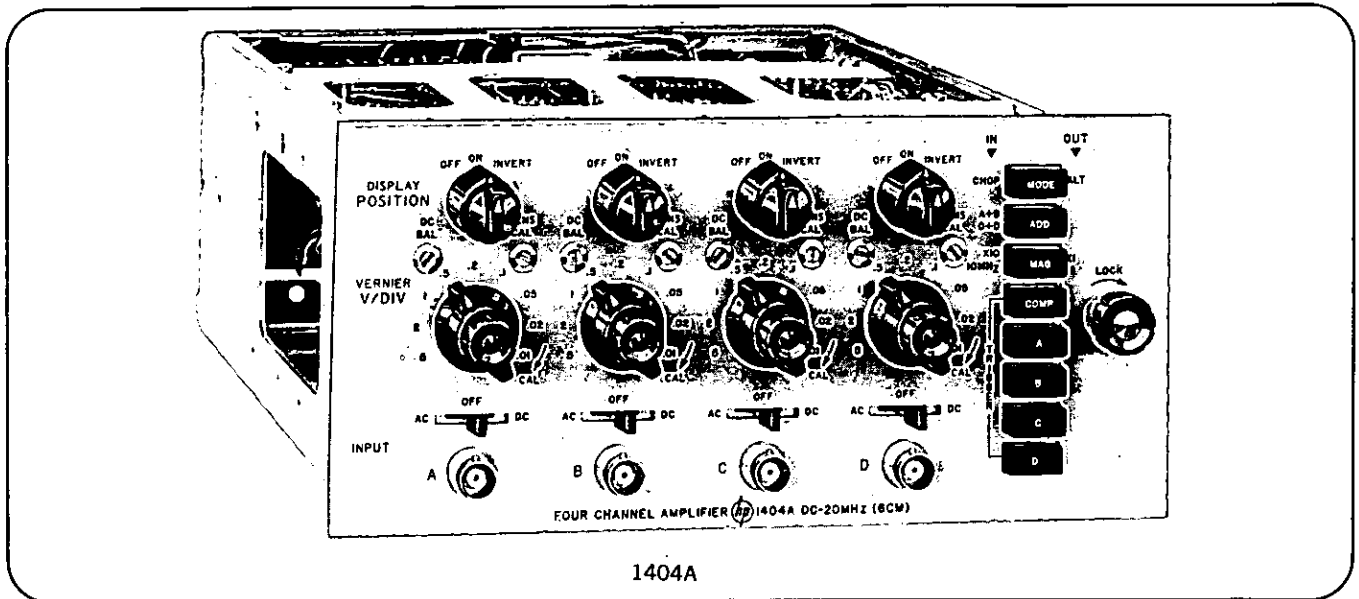
Maximum input: 100 volts peak (dc + ac) for 0.05 mV/div to 20 mV/div ranges, 600 volts peak (dc + ac) for 50 mV/div to 20 V/div ranges.

X-Y operation: two 1407A's or 1407A and a 1406A can be used to provide stabilized X-Y presentations. Models 1406A and 1407A are not compatible with other 1400-series vertical plug-ins for X-Y displays.

Time base compatibility: the Model 1407A may be used directly with Models 1422A and 1423A; Model 1420A's below serial 441-01326, and Model 1421A's below serial 545-00651 must be modified for use with the Model 1407A (order kits 01420-69502 for the Model 1420A, \$12.50; or 01421-69501 for the Model 1421A, \$20).

Weight: net 5 lbs (2.3 kg); shipping 11 lbs (5 kg).

Price: HP Model 1407A, \$725.

OSCILLOSCOPES 140 SERIES *continued***15 MHz with 10 mV/div deflection factor****4-channel vertical amplifier Model 1404A**

1404A

Description

When you need to display four channels of information, the HP Model 1404A Four Channel Vertical Amplifier plug-in provides twice the measurement capability of a two-channel scope. As part of the 140 series scope system the 1404A gives you 15 MHz, 10 mV/div deflection factor or 1 mV/div to 10 MHz with a x10 magnifier, in your lab or production area.

This amplifier allows you to measure relationships or make timing comparisons of two to four inputs. It is ideal for designing logic circuits, or for checking time relationships of digital logic pulse trains.

Channels A + B and channels C + D may be displayed, algebraically added, and a polarity reversal switch position on each channel allows the differential of either pair of inputs to be displayed.

The 1404A amplifier offers a choice of selectable or composite triggering. When Channel A, B, C, or D trigger pushbutton is pressed, you trigger on the selected channel and see the time relationship with each of the other channels. Composite triggering, which triggers each sweep individually, is also provided.

The 1404A is fully compatible with any of the 140-Series mainframes. When used in a 140A or B Oscilloscope, the 1404A adds the versatility of four channel displays. In a 141A or B Oscilloscope, you can display four traces simultaneously, vary the persistence to view four simultaneous slow sweeps without flicker, or store them. When used in a 143A Oscilloscope four well-defined traces can be clearly observed, from a distance, on the large 8 x 10 inch CRT.

Specifications

Modes of Operations: Any channel or combination of channels may be displayed. The display may be selected to be on alternate sweeps or switched between four channels at approximately 200 kHz rate with blanking during switching. Algebraic addition is provided for Channels A + B and Channels C + D in alternate or chopped modes. An invert switch on each channel allows signal summing or difference with either polarity result displayed.

Each channel

Bandwidth: (Referenced to a 6 division 50 kHz signal)
dc coupled; x1 mag 0 to 15 MHz, x10 mag 0 to 10 MHz.
ac coupled; x1 mag 2 Hz to 15 MHz, x 10 mag 2 Hz to 10 MHz.

Risetime: referenced to a 6 division high step input, less than 25 ns in x1 mag and less than 40 ns in x10 mag.

Deflection factor: 0.01 v/div to 5 v/div; 9 ranges in a 1,2,5,10 sequence; attenuator accuracy $\pm 3\%$; vernier provides continuous adjustment between ranges and extends maximum deflection factor to approximately 12.5 v/div x

10 mag changes deflection factor to 1 mV/div to 0.5 v/div.

Input RC: 1 megohm shunted by approximately 30 pF.

Maximum input: 600 volts (dc + peak ac).

Triggering: in alternate mode, by any one of the four channels (A,B,C, or D) or by the composite signal (COMP). Any channel turned off is skipped by composite triggering. In alternate mode x1 mag, $\frac{1}{2}$ division of deflection will trigger to 1 MHz increasing to 1 div at 15 MHz (2 div for COMP). In x10 mag, 1 div to 10 MHz.

Triggering frequency is limited to 200 kHz in chopped mode.

Signal delay: signal is delayed 250 ns so that leading edge of fast risetime signals are visible at start of sweep.

Common-mode rejection ratio: 40 dB minimum in 0.01 to 0.05 v/div and less than 30 dB in 0.1 to 5 v/div. Maximum sinewave common-mode signal 100 divisions or 500 kHz.

Weight: net 6 lbs (2.7 kg); shipping 8 lbs (3.6 kg).

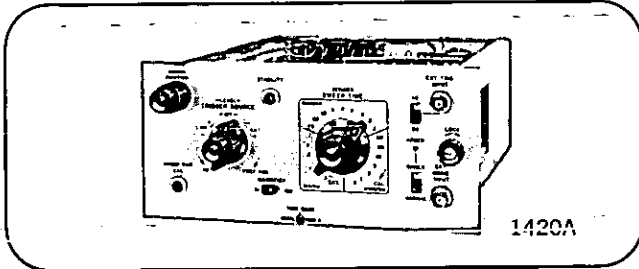
Power: supplied by mainframe.

Price: Model 1404A, \$975.

Option 090: includes four 10012A probes, add \$120.



Sweeps to 20 ns/div Time bases Models 1420A, 1422A, 1423A



5 MHz triggering with sweeps to 50 ns/div and automatic triggering.

Specifications, 1420A

Range: 0.5 μ s/div to 5 s/div, 22 ranges in a 1, 2, 5 sequence; accuracy $\pm 3\%$; vernier provides continuous adjustment between steps and extends the 5 s/div step to at least 12.5 s/div.

Magnifier: X10, over-all accuracy $\pm 5\%$; expands 0.5 μ s/div speed to 50 ns/div.

Automatic triggering: (baseline displayed in the absence of an input signal).

Internal: 40 Hz to 500 kHz for signals causing 0.5 div or more vertical deflection; also from line signal.

External: 40 Hz to 500 kHz for signals at least 0.5 V pk-pk.

Trigger slope: positive or negative slope of external sync signal or internal vertical deflection signal.

Amplitude selection triggering

Internal: 10 Hz to 5 MHz for signals causing 0.5 div or more vertical deflection.

External: for signals at least 0.5 V pk-pk; dc coupled, dc to 5 MHz; ac coupled, 10 Hz to 5 MHz; max input, 600 V pk (dc + ac).

Trigger point and slope: from any point on the vertical waveform presented on crt; or continuously variable from -7 to +7 volts on external sync signal; positive or negative slope.

Single sweep: front panel switch permits single sweep operation.

Horizontal input

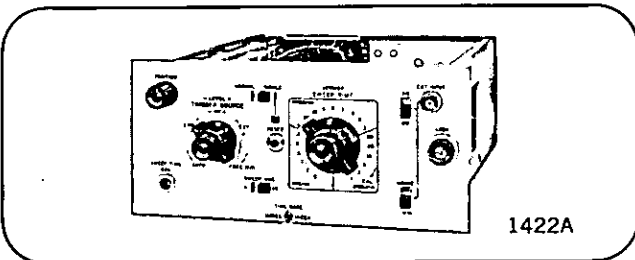
Bandwidth: dc to better than 1.5 MHz (typically).

Deflection factor: vernier permits continuous adjustment from approx 50 mV/div to 5 V/div.

Input RC: 1 megohm shunted by approximately 50 pF.

Weight: net 5 lbs (2.3 kg); shipping 10 lbs (4.5 kg).

Price: HP Model 1420A, \$375.



500 kHz triggering with sweeps to 200 ns/div and automatic triggering.

Specifications, 1422A

Range: 1 μ s/div to 5 s/div, 21 ranges in a 1, 2, 5 sequence; accuracy $\pm 3\%$; vernier provides continuous adjustment between steps and extends the 5 s/div step to at least 12.5 s/div.

Magnifier: X5, over-all accuracy $\pm 5\%$; expands 1 μ s/div speed to 200 ns/div.

Automatic triggering: (baseline displayed in the absence of an input signal).

Internal: 50 Hz to 500 kHz for signals causing 0.5 div or more vertical deflection; also from line signal.

External: 50 Hz to 500 kHz for signals at least 0.5 V pk-pk.

Trigger slope: positive or negative slope of external sync signal or internal vertical deflection signal.

Amplitude selection triggering

Internal: dc or 10 Hz to 500 kHz (depending on vertical system) for signals causing 0.5 div or more vertical deflection.

External: for signals at least 0.5 V pk-pk; dc coupled, dc to 500 kHz; ac coupled, 10 Hz to 500 kHz; max. input, 600 V pk (dc + ac).

Trigger point and slope: from any point on the vertical waveform presented on crt; or continuously variable from -10 to +10 volts on external sync signal; positive or negative slope.

Single sweep: front panel switch permits single sweep operation.

Horizontal input

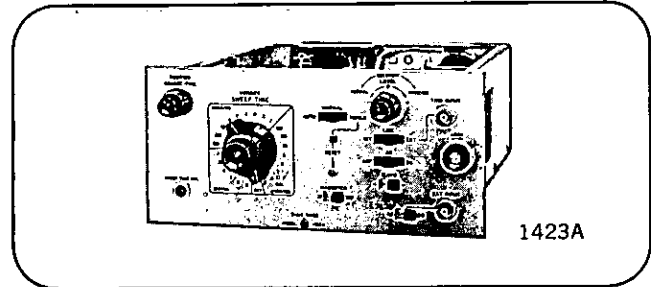
Bandwidth: dc coupled, dc to 400 kHz; ac coupled, 20 Hz to 400 kHz.

Deflection factor: vernier permits continuous adjustment from approx 0.8 V/div to 2.5 V/div.

Input RC: 1 megohm shunted by approx 150 pF.

Weight: net 5 lbs (2.3 kg); shipping 9 lbs (4.1 kg).

Price: HP Model 1422A, \$250.



20 MHz triggering with sweeps to 20 ns/div and trigger hold-off.

Specifications, 1423A

Range: 0.2 μ s/div to 5 s/div, 23 ranges in a 1, 2, 5 sequence; accuracy $\pm 3\%$; vernier provides continuous adjustment between steps and extends the 5 s/div step to at least 12.5 s/div.

Magnifier: X10, over-all accuracy $\pm 5\%$; expands 0.2 μ s/div speed to 20 ns/div.

Automatic triggering: (baseline displayed in the absence of an input signal) same as normal, except lower limit is 40 Hz for both ac and dc coupling.

Normal triggering

Internal: dc coupled: dc (with Models 1406A/1407A) to 15 MHz for signals causing 0.5 div or more vertical deflection, to 20 MHz for 1 div signals; ac coupled: 10 Hz to 15 MHz for 0.5 div signals, to 20 MHz for 1 div signals; ACF: approx 2 kHz to 15 MHz for 0.5 cm signals, to 20 MHz for 1 div signals.

External: for signals at least 0.5 V pk-pk; dc coupled, dc to 20 MHz; ac coupled, 10 Hz to 20 MHz; ACF, approx 2 kHz to 20 MHz; max input, 600 V pk (dc + ac).

Line: triggering from line frequency also selectable.

Trigger point and slope: selectable in both normal and automatic; from any point on the vertical waveform presented on crt, or continuously variable from -5 to +5 volts on external sync signal; positive or negative slope.

Trigger hold-off: time continuously variable, exceeding one full sweep at 50 ms/div and faster, prevents multiple triggering on signals that have desired triggering level and slope appearing more than once per cycle.

Trigger input RC: dc and ac, approx 1 megohm shunted by 50 pF; acf, approx 120 k ohms shunted by 50 pF.

Single sweep: front panel switch permits single sweep operation.

Horizontal input

Bandwidth: dc to 500 kHz.

Deflection factor: vernier and X10 magnifier permit continuous adjustment from approx 300 mV/div to 30 V/div.

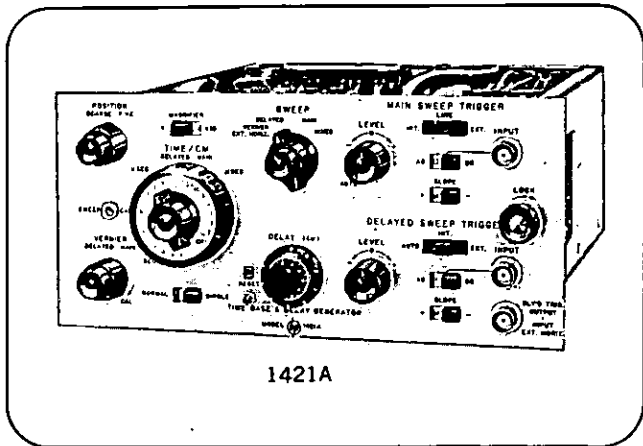
Input RC: 1 megohm shunted by approx 50 pF.

Weight: net 5 lbs (2.3 kg); shipping 11 lbs (5 kg).

Price: HP Model 1423A, \$490.

OSCILLOSCOPES 140 SERIES *continued*

Delayed sweep to 20 MHz Time base Model 1421A



- 20 MHz triggering
- Delayed sweep
- Sweeps to 20 ns/div

Specifications

Main sweep: for displaying signals vs time where sweep delay is not required; employs the main time base only.

Range: 0.2 μ s/div to 1 s/div, 21 ranges in a 1, 2, 5 sequence; accuracy $\pm 3\%$; vernier provides continuous adjustment between steps and extends 1 s/div step to at least 2.5 s/div.

Triggering: (when used with Model 1402A).

Amplitude selection:

Internal: approx 10 Hz to 15 MHz for signals causing 0.5 div or more vertical deflection, to 20 MHz for 1 div signals; also from line signal.

External: for signals at least 0.5 V pk-pk; dc coupled, dc to 20 MHz; ac coupled, approx 5 Hz to 20 MHz.

Trigger point and slope: controls allow selection of level and positive or negative slope; trigger level of external sync signal is continuously variable from -5 to $+5$ volts.

Automatic: baseline displayed in the absence of an input signal; internally down to 40 Hz on signals causing 1 div or more vertical deflection, also on line signal; externally down to 40 Hz on signals at least 1 V pk-pk; trigger slope, positive or negative.

Trace intensification: used for setting up delayed or mixed sweep modes by increasing brightness of portion of main sweep which will be expanded to full screen in delayed sweep, or magnified portion of display in mixed sweep; rotating delayed sweep time switch out of off position activates intensified mode.

Delayed sweep: delayed time base sweeps after a time delay set by main sweep and delay controls.

Range: 0.2 μ s/div to 50 ms/div, 17 ranges in a 1, 2, 5 sequence; accuracy $\pm 3\%$; vernier provides continuous adjustment between steps and extends 50 ms/div step to at least 125 ms/div.

Delay (before start of delayed sweep):

Time: continuously variable from 0.5 μ s to 10 s.

The 1421A Time Base and Delay Generator provides sweep speeds to 20 ns/div with stable triggering to 20 MHz and beyond.

The delayed sweep feature of the 1421A permits detailed examination of any portion of a complex signal or pulse train by generating an accurately controlled delay time, at the end of which, a second sweep in the 1421A provides the deflection signal to the crt. The 1421A has provision to trigger the deflection sweep at the end of the delay interval either automatically, on the vertical deflection signal (internal), or on an external signal. In the automatic mode, the delayed sweep is immediately triggered at the end of the delay interval, thereby permitting accurate measurements of the time jitter in the input waveform. In the internal and external modes, the delayed sweep is armed at the end of the delay interval and the signal triggers the delayed sweep. Thus the rise time and amplitude can be accurately measured without jitter.

Accuracy: $\pm 1\%$; linearity, $\pm 0.2\%$; time jitter less than 0.005% of max delay of each range (1 part in 20,000).

Trigger output: (at end of delay time) approx +4 V with less than 150 ns risetime, from 1 k ohms output impedance.

Triggering: (applies to intensified main, delayed, and mixed sweep modes).

Automatic: delayed sweep starts precisely at end of delay period.

Internal: delayed sweep triggered by vertical waveform presented on crt after end of delay period; approx 10 Hz to 15 MHz for signals causing 0.5 div or more vertical deflection, or to 20 MHz for 1 div signals.

External: delayed sweep triggered by external signal after end of delay period; for signals at least 0.5 V pk-pk; dc coupled, dc to 20 MHz; ac coupled, approx 5 Hz to 20 MHz.

Trigger point and slope: (internal and external) same as main sweep.

Mixed sweep: dual sweep-speed display in which main sweep drives first portion of display, and delayed sweep completes the display at sweep speeds up to 100 times faster; changeover point determined approx by delay setting.

Triggering: same as for delayed sweep.

Magnifier: X10; any display; overall accuracy $\pm 5\%$; expands 0.2 μ s/div speed to 20 ns/div.

Single sweep: any display can be operated in single sweep.

Horizontal input

Bandwidth: dc to typically better than 500 kHz.

Deflection factor: vernier and X10 magnifier permit continuous adjustment from approx 0.3 V/div to 30 V/div.

Input RC: 1 megohm shunted by less than 20 pF.

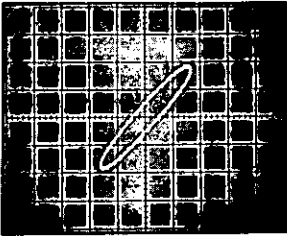
Weight: net 6 lbs (2.7 kg); shipping 11 lbs (5 kg).

Price: HP Model 1421A, \$675.

Sampling vertical amplifier Model 1410A

The versatile 1410A Sampling Vertical Amplifier provides 1 mV/div deflection factor at 1 GHz. Optimum compromise among risetime, overshoot, and noise can be easily and quickly made with the front-panel risetime and smoothing controls.

Front-panel recorder outputs with both dc level and amplitude adjustments simplify your X-Y or strip chart recorder setup and enable permanent recording of crt traces.



The A vs B mode of the 1410A permits X-Y measurements to 1 GHz and above.

Specifications

Mode of operation

1. channel A only.
2. channel B only.
3. channel A and channel B.
4. channel A and channel B added algebraically.
5. channel A vs channel B.

Polarity: either channel may be displayed either positive or negative up in any mode.

Risetime: less than 350 ps.

Bandwidth: dc to 1 GHz.

Overshoot: less than 5%.

Deflection factor: calibrated ranges from 1 mV/div to 200 mV/div in a 1, 2, 5 sequence; vernier control provides continuous adjustment between ranges and extends deflection factor to less than 0.4 mV/div.

Attenuator accuracy: $\pm 3\%$.

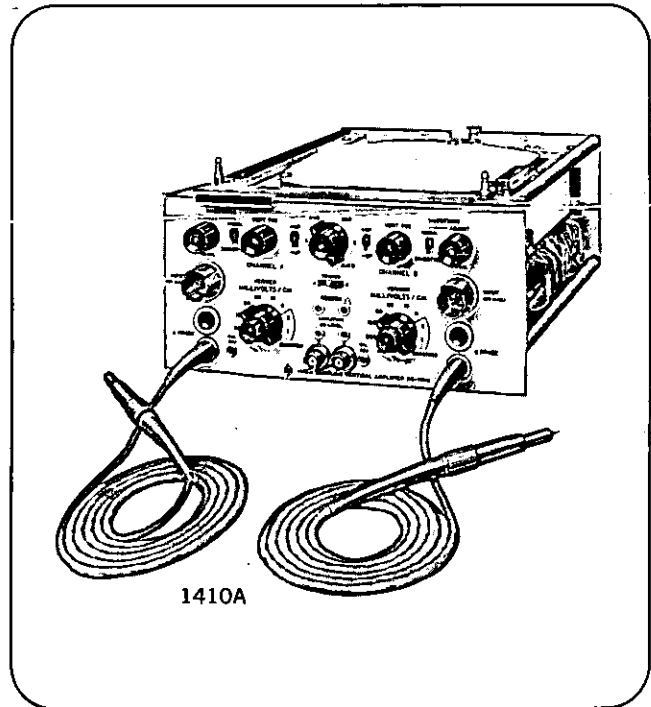
Isolation between channels: greater than 40 dB to 1 GHz.

Input impedance

Probes: 100 K ohms shunted by 2 pF nominal.

GR type 874 inputs: 50 ohms $\pm 2\%$ with 57 ns internal delay lines for viewing leading edge of fast rise signals. Reflection from input connector is approx 10%, using a 150 ps TDR system.

Noise: approximately 1 mV observed noise on crt excluding 10% of random dots; noise decreases on automatically smoothed ranges and 2 and 1 mV/div; smoothed position of smoothing switch reduces noise and jitter approximately 4:1; vernier control provides continuous adjustment between the normal and smoother modes.



Dynamic range: ± 2 volts.

Drift: less than 3 mV/hr after warmup.

Maximum safe input

Probes: ± 50 volts.

50 Ω inputs: ± 5 volts.

Triggering: internal or external when using 50 Ω inputs; internal triggering selectable from channels A or B; external triggering necessary when using probes.

Time difference between channels (for probes or 50 Ω inputs): less than 100 ps.

Recorder outputs: front panel outputs provide 0.1 V/div from a 500 Ω source; gain adjustable from approximately 0.05 V/div to 0.2 V/div; dc level adjustable from approx -1.5 V to $+0.5$ V.

Accessories provided

HP Model	Quantity	Description
10214A	2	10:1 divider
10216A	2	Isolator
10217A	2	0.001 μ F blocking capacitor
10218A	2	BNC adapter
10219A	1	GR adapter
10220A	2	Microdot adapter
10221A	1	50-ohm T-connector
10213-62102	6	Ground clip
5020-0457	6	Probe tip
—	1	Accessory box

Weight: net 12 lbs (5,4 kg); shipping 19 lbs (8,6 kg).

Price: HP Model 1410A, \$1700.

OSCILLOSCOPES 140 SERIES *continued*

Accessories

1410A Accessories (Separately Available)



10214A

10214A 10:1 divider: permits accurate measurement of signals as large as 20 volts peak-to-peak and increases the impedance of the probe to 1 megohm shunted by 2.5 pF. Price, \$30.



10216A

10216A isolator: increases convenience and accuracy when probing by reducing baseline shift and transient response changes caused by changes in the circuit source impedance. 1410A rise-time is increased to approximately 0.6 ns and probe input capacitance is increased by less than 3 pF. Price, \$25.



10217A

10217A blocking capacitor: this blocking capacitor (0.001 μ F) permits measurements of signals that are ± 50 volts from ground (to ± 200 V when used with 10214A 10:1 Divider). The blocking capacitor contributes only 1% sag when used with the 10:1 divider. No more than 2.5 pF shunt capacitance is added to the input by the blocking capacitor. Price, \$20.



10218A

10218A BNC adapter: converts probe tip into a male BNC connector. Price, \$7.



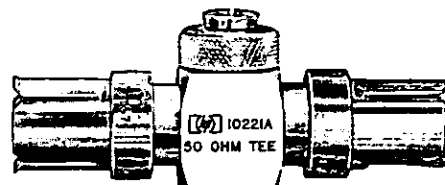
10219A

10219A GR adapter: converts probe tip into a GR type 874 connector. Price, \$15.



10220A

10220A microdot screw-on adapter: allows easy connection to coaxial connectors and also provides a solid ground reference. 10220A adapts to connectors similar to Microdot series 31-50. Price, \$4.



10221A

10221A 50-ohm T connector: permits monitoring of signals in 50 ohm transmission lines with the 1410A without terminating the line or disturbing the signal. Mismatch is low; the reflection from a step input is no greater than 20% of the input step height. Price, \$50.

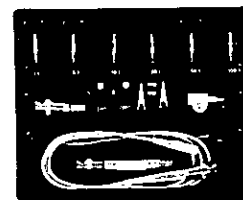
Additional accessories

(Not supplied with 1410A.)



10215A

10215A 100:1 divider: this 100:1 divider may be used to reduce levels as high as 200 V to the ± 2 V dynamic range of the 1410A. The 10215A offers less than 3 pF shunt capacitance and 1 megohm shunt resistance to the circuit under test. Price, \$50.



10020A

10020A Miniature Resistive Dividers

Division Ratio	Input R* (ohms)	Division Accuracy	Max. V† (rms)	Input C (pF)
1:1	50		6	
5:1	250	$\pm 3\%$	9	0.7
10:1	500	$\pm 3\%$	12	0.7
20:1	1000	$\pm 3\%$	15	0.7
50:1	2500	$\pm 3\%$	25	0.7
100:1	5000	$\pm 3\%$	35	0.7

*When terminated in 50 ohms.

†Limited by power dissipation of resistive element.

Accessories furnished

Included are: HP Model 10218A BNC Adapter Tip, 4-ft cable, a 6-32 adapter tip, ground leads, and Model 10240B Blocking Capacitor.

Weight: net, 1 lb (0.5 kg); shipping 3 lb (1.4 kg).

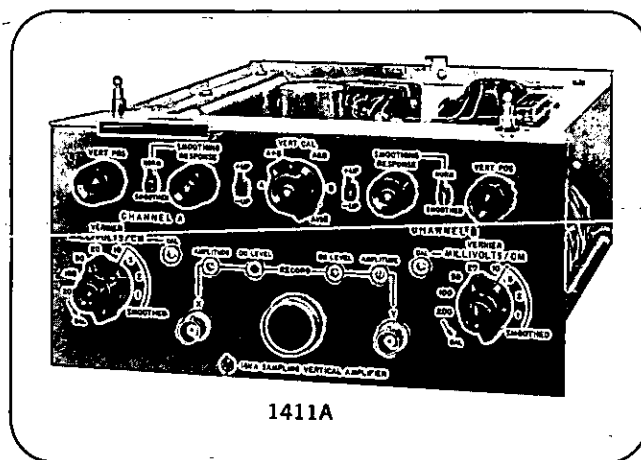
Price: Model 10020A, \$100.

OSCILLOSCOPES 140 SERIES *continued***Bandwidth to 12.4 GHz at 1 mV/div****1411A Sampling Amplifier, 12.4 GHz**

The 1411A Sampling Vertical Amplifier is a basic vertical plug-in that accepts a series of wide band samplers. All three samplers have 1 mV/div deflection factor. Feedthrough inputs are also featured, for monitoring signals without terminating them and for precise Time Domain Reflectometry measurements.

The remote samplers, connected to the oscilloscope by a five-foot cable, can be placed right at the signal source, eliminating lossy lines.

Risetime is set with a front panel knob, allowing convenient adjustment of risetime and bandwidth to the ultimate when needed, at the sacrifice of increased noise. Front panel recorder outputs and an X-Y mode for wideband phase measurements add to the 1411A's measurement capability.

**Specifications, 1411A**

(When used with 1430A, 1431A, or 1432A)

Mode of operation

(1) channel A only, (2) channel B only, (3) channel A and channel B, (4) channel A and channel B added algebraically, (5) channel A vs channel B.

Polarity: either channel may be displayed either positive or negative up in any mode.

Deflection factor: calibrated ranges from 1 mV/div to 200 mV/div in a 1, 2, 5 sequence; vernier control provides continuous adjustment between ranges and extends deflection factor to less than 0.4 mV/div.

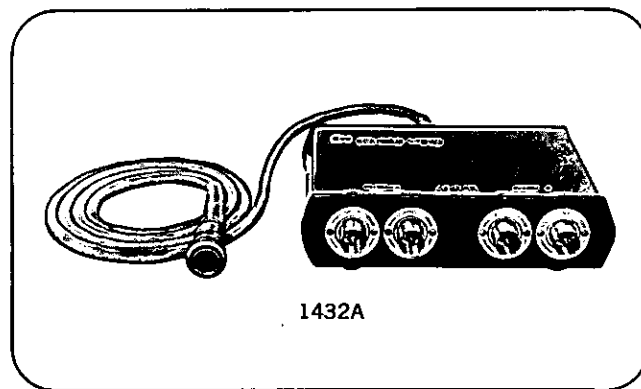
Attenuator accuracy: $\pm 3\%$.

Isolation between channels: greater than 40 dB over bandwidth of sampler.

Recorder outputs: front panel outputs provide 0.1 V/div from a 500 ohm source; gain adjustable from approximately 0.05 V/div to 0.2 V/div; dc level adjustable from approximately -1.5 V to +0.5 V.

Weight: net 5 lbs (2,3 kg); shipping 12 lbs (5,4 kg).**Price:** HP Model 1411A, \$700.**1432A Sampler, 90 ps**

The 1432A is a lower-priced version of the 1430A and 1431A. Its 90 ps risetime (dc to 4 GHz bandwidth), 1 mV/div deflection factor and feedthrough inputs permit many accurate measurements involving CW, fast pulses, and TDR.

**Specifications, 1432A**

(When used with 1411A)

Risetime: less than 90 ps.**Bandwidth:** dc to 4 GHz.**Overshoot:** less than $\pm 5\%$.**Noise:** same as 1430A, except approx 3 mV observed noise.**Dynamic range:** ± 1 volt.**Low frequency distortion:** less than $\pm 3\%$.**Maximum safe input:** ± 5 volts.**Input characteristics**

Mechanical: GR type 874 connectors used on input and output.

Electrical: 50 ohm feedthrough, dc-coupled; reflection from

sampler is approximately 15% using a 90 ps TDR system; pulses emitted from sampler input are approx 50 mV in amplitude and 10 ns wide.

Time difference between channels: less than 25 ps.

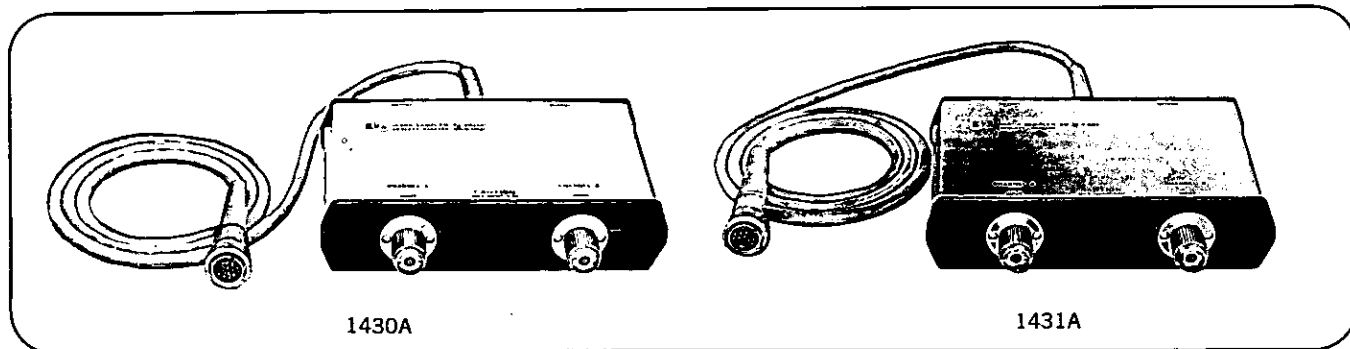
Connecting cable length: 5 ft (for longer cable, see special order below).

Weight: net 4 lbs (1,8 kg); shipping 9 lbs (4,1 kg).**Accessories provided:** two GR Model 874-W50 50 ohm loads.**Price:** HP Model 1432A, \$1000.

Special order: 10-ft connecting cable (5-ft is standard), order C01-1432A. Price, \$1035.

OSCILLOSCOPES 140 SERIES *continued*

Sampler with 28 psec risetime
12.4 GHz samplers Models 1430A, 1431A



Model 1430A provides 28 ps risetime with minimal overshoot for accurate measurements on fast-rise pulses. Used with the 1105A/1106A 20 ps pulse generator, its response and feedthrough inputs make it ideal for TDR measurements.

Specifications, 1430A
(When used with 1411A)

Risetime: approx 28 ps (less than 35 ps observed with 1105A/1106A pulser and 909A 50-ohm load).

Bandwidth: dc to approx 12.4 GHz.

Overshoot: less than $\pm 5\%$.

Noise: approximately 8 mV observed noise on CRT excluding 10% of random dots. Noise decreases on automatically smoothed ranges 5, 2, and 1 mV/div. Smoothed position of smoothing switch reduces noise and jitter approximately 4:1. Vernier control provides continuous adjustment between the normal and smoothed modes.

Dynamic range: ± 1 volt.

Low frequency distortion: less than $\pm 3\%$.

Maximum safe input: ± 3 volts.

Input characteristics

Mechanical: Amphenol APC-7 precision 7 mm connectors on input and output.

Electrical: 50 ohm feedthrough, dc-coupled. Reflection from sampler is approx 10%, using a 40 ps TDR system. Pulses emitted from sampler input are approximately 10 mV in amplitude and 5 ns in duration. Vswr less than 3:1 at 12.4 GHz.

Time difference between channels: less than 5 ps.

Connecting cable length: 5 ft.

Weight: net 4 lb (1.8 kg); shipping 9 lb (4.1 kg).

Accessories provided: two Amphenol APC-7 to female Type N adapters (HP 11524A); two 50-ohm loads (HP 909A).

Price: HP Model 1430A, \$3000.

Special order: 10-ft connecting cable (5-ft is standard), order 1430A Opt C01. Price, \$3035.

The 1431A allows viewing of CW signals from dc to beyond 12.4 GHz at 1 mV/div deflection factor. It differs slightly from the 1430A, having a very flat bandwidth and low vswr at the sacrifice of increased overshoot.

Specifications, 1431A
(When used with 1411A)

Bandwidth: dc to greater than 12.4 GHz (less than 3 dB down from a 10 div dc reference).

Risetime: approx 28 ps.

Vswr: dc to 8 GHz, 1.4:1

8 to 10 GHz, 1.6:1

10 to 12.4 GHz, 2.0:1

Noise: same as 1430A.

Dynamic range: ± 1 volt.

Low frequency distortion: less than $\pm 3\%$.

Maximum safe input: ± 3 volts.

Input characteristics

Mechanical: amphenol APC-7 precision 7 mm connector used on input and output.

Electrical: 50-ohm feedthrough, dc-coupled. Reflection from sampler is approx 5%, using a 40 ps TDR system. Pulses emitted from sampler input are approx 10 mV in amplitude and 5 ns in duration.

Phase shift between channels: less than 10° at 5 GHz, typically less than 2° at 1 GHz.

Connecting cable length: 5 ft.

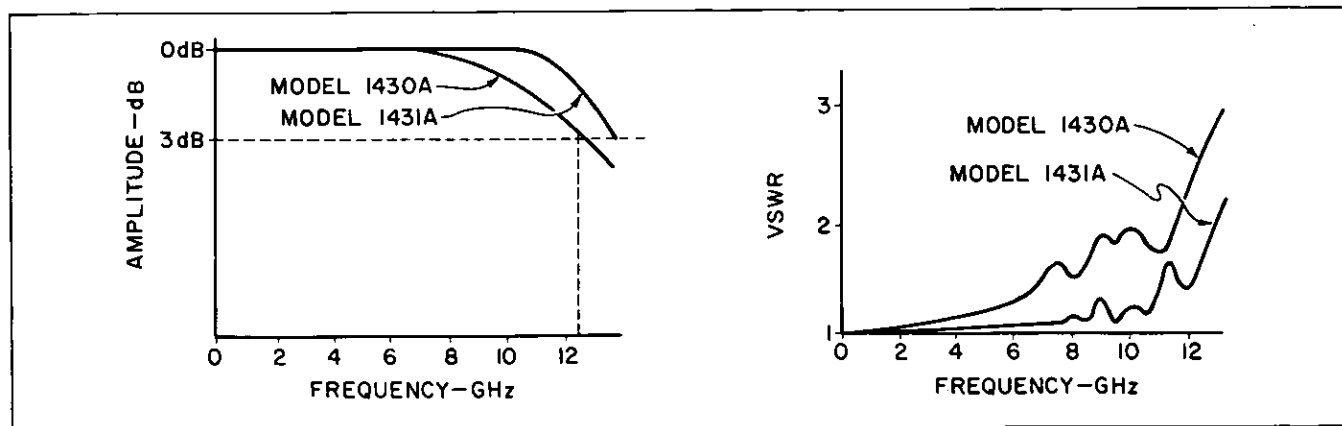
Weight: net 4 lb (1.8 kg); shipping 9 lb (4.1 kg).

Accessories provided: two Amphenol APC-7 to female Type N adapters (HP 11524A); two 50-ohm loads (HP 909A).

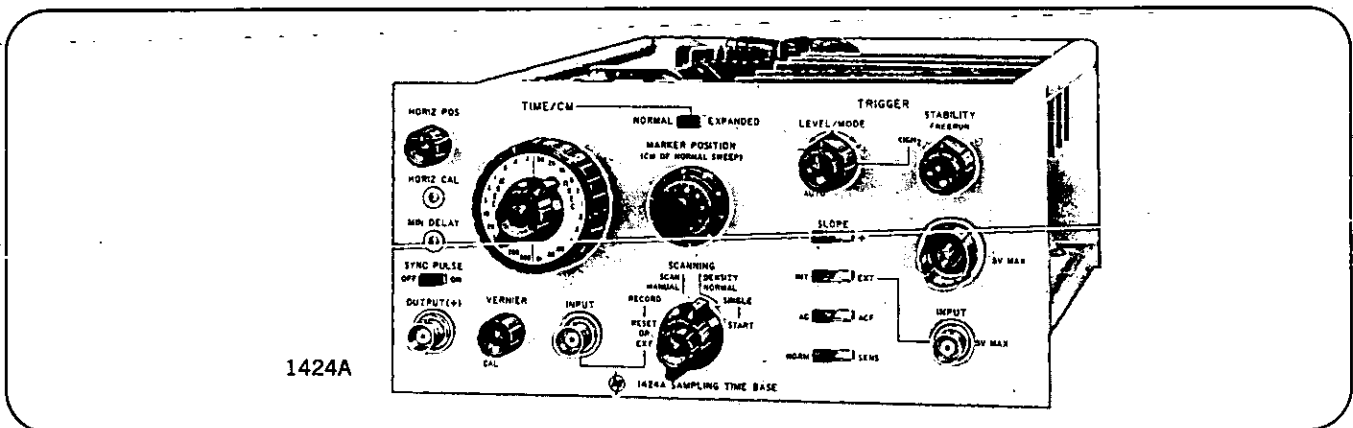
Price: HP Model 1431A, \$3000.

Special order: 10-ft connecting cable (5-ft is standard), order 1431A Opt C01. Price, \$3035.

Recommended accessory: HP Model 1109A High Pass Filter.

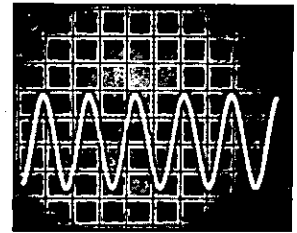


Sampling time base Model 1424A



Model 1424A is an easy-to-operate time base for use with the 1410A and 1411A plug-ins. Convenient and more meaningful measurements are made possible through features such as: direct sweep readout, calibrated marker position control (which positions an intensified marker), and automatic triggering (which locks in on a wide range of signals). A single scan feature helps provide clearer photos and stored traces of drifting or changing signals.

Solid triggering to 5 GHz without external count down box.



Specifications, 1424A

Sweep range: 24 ranges, 10 ps/div to 500 μ s/div in a 1, 2, 5 sequence. Sweeps from 1 ns/div to 500 μ s/div may be expanded up to 100 times and read out directly. Sweeps from 10 ps/div to 500 ps/div are obtained by expansion and also read out directly. Accuracy $\pm 3\%$ except for time represented by approx first $\frac{1}{4}$ div of unexpanded sweep. Vernier provides continuous adjustment between ranges and increases max sweep speed to faster than 4 ps/div.

Marker position: intensified marker indicates point about which sweep is expanded; 10-turn calibrated control. Accuracy, ± 1.5 mm.

Minimum delay: less than 55 ns.

Triggering (less than 1 GHz)

Internal (with Model 1410A)

Automatic: baseline displayed in the absence of an input signal.

Pulses: at least 50 mV amplitude required of pulses 2 ns or wider for jitter less than 30 ps.

Sine waves: signals from 200 Hz to 150 MHz require 25 mV amplitude for jitter less than 10% of input signal period (usable to 1 GHz with increased jitter).

Level select

Pulses: at least 50 mV amplitude required for pulses 2 ns or wider for jitter less than 20 ps.

Sine waves: signals require from 200 Hz to 150 MHz 25 mV amplitude (increasing to 400 mV at 1 GHz) for jitter less than 1.5% of input signal period $+10$ ps.

External

Automatic: baseline displayed in the absence of an input signal.

Pulses: at least 100 mV amplitude required of fast rise pulses 2 ns or wider for jitter less than 20 ps.

Sine waves: signals from 200 Hz to 500 MHz require 50 mV for jitter less than 10% of input signal period (usable to 1 GHz with increased jitter).

Level select

Pulses: at least 50 mV amplitude required of fast rise pulses 2 ns or wider for jitter less than 20 ps.

Sine waves: signals from 200 Hz to 1 GHz require 50 mV for jitter less than 1.5% of input signal period $+10$ ps; jitter is less than 50 ps for signals of 10 mV at 1 GHz.

Dynamic range: 100 mV in sensitive; 1.0 V in normal.

Trigger input: 50-ohm, ac, or ac fast; signal output, <10 mV in sensitive and <5 mV in normal.

Maximum safe input: sensitive, 5 V rms or peak transient; normal, 5 V rms (50 V peak transient); internal, 5 V rms or peak transient.

Jitter (with 500 mV pulses having 1 ns or faster risetimes): less than 10 ps plus 0.2% of unexpanded sweep time per cm.

Slope: positive or negative.

Sensitivity: jitter specifications above are for sensitive mode; normal mode reduces sensitivity by approx. 10:1.

Triggering (greater than 1 GHz): jitter is less than 30 ps for 25 mV input from 1 GHz to 4 GHz, and for 50 mV input from 4 to 5 GHz.

Scanning

Internal: X axis driven from internal source; scan density continuously variable.

Manual: X axis driven by manual scan control knob.

Record: X axis driven by internal slow ramp; approx 60 seconds for one scan.

External: 0 to $+15$ V required for scan; input impedance, 10 k ohms.

Single scan: one scan per actuation; scan density continuously variable.

Sync pulse output

Amplitude: greater than 1.5 V into 50 ohm.

Risetime: approx 1 ns.

Overshoot: less than 5%.

Width: approx 1 μ s.

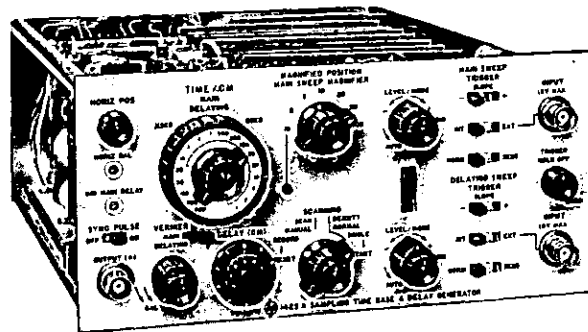
Relative jitter: less than 10 ps.

Repetition rate: one pulse per sample.

Weight: net 5 lbs (2.3 kg); shipping 11 lbs (5 kg).

Price: HP Model 1424A, \$1400.

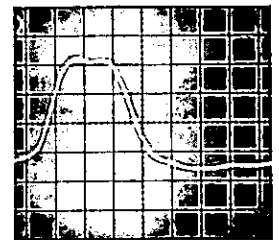
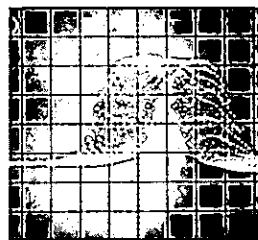
Triggering to 1 GHz with delayed sweep Sampling time base Model 1425A



1425A

Model 1425A is a delaying sweep time base for use with the 1410A and 1411A sampling plugs-ins.

The delaying sweep feature permits detailed examination of any portion of a complex signal or pulse train by generating an accurately controlled delay time, and then, enabling a sweep which provides timing signals to the 1410A or 1411A and deflection signals to the CRT. This delayed sweep may be set to begin automatically at the end of the delay period (for accurate drift or time-jitter measurements) or may be armed at the end of the delay period and retriggered on an internal signal (1410A only) or external signal (1410A or 1411A); thus eliminating signal jitter from the display.



Jitter on delayed pulse in left photo eliminated at right by retriggering the delayed sweep. Sweep speed, 1 ns/div; delay, 5 μ s.

Specifications, 1425A

Main Sweep

Range: 1 ns/div to 10 μ s/div, 13 ranges in a 1, 2, 5 sequence; accuracy $\pm 3\%$, except for time represented by approx first $\frac{1}{4}$ div of unexpanded sweep. Vernier provides continuous adjustment between steps and extends max magnified speed to at least 4 ps/div.

Magnifier: X1 to X100 in 7 calibrated steps; increases 1 ns/div sweep to 10 ps/div; pushbutton returns magnified to X1.

Marker position: intensified marker indicates point about which sweep is expanded; 10-turn control.

Minimum delay: main sweep, less than 55 ns; main delayed sweep, less than 105 ns.

Triggering (for both main and delaying sweeps)

Internal (with Model 1410A)

Automatic: baseline displayed in the absence of an input signal.

Pulses: at least 75 mV amplitude required of pulses 2 ns or wider for jitter less than 30 ps.

Sine waves: signals from 200 Hz to 150 MHz require 50 mV amplitude for jitter less than 10% of input signal period (usable to 1 GHz with increased jitter).

Level select

Pulses: at least 100 mV amplitude required for fast rise pulses 2 ns or wider for jitter less than 20 ps.

Sine waves: signals from 200 Hz to 150 MHz require 50 mV amplitude (increasing to 400 mV at 1 GHz) for jitter less than 1.5% of input signal period ± 10 ps.

External

Automatic: baseline displayed in the absence of an input signal.

Pulses: at least 100 mV amplitude required of fast-rise pulses 2 ns or wider for jitter less than 20 ps.

Sine waves: signals from 200 Hz to 500 MHz require 50 mV amplitude for jitter less than 10% of input signal period (usable to 1 GHz with increased jitter).

Level select

Pulses: at least 50 mV amplitude required for fast-rise pulses 2 ns or wider for jitter less than 20 ps.

Sine waves: signals from 200 Hz to 1 GHz require 50 mV for jitter less than 1.5% of input signal period ± 10 ps; jitter is less than 50 ps for signals of 10 mV amplitude at 1 GHz.

Dynamic range: 100 mV in sensitive; 1.0 V in normal.

Trigger input: 50 ohms, ac-coupled (2.2 μ F); signal output, < 10 mV in sensitive and < 5 mV in normal.

Maximum safe input: sensitive, 5 V rms or peak transient; normal, 5 V rms (50 V peak transient); internal, 5 V rms or peak transient.

Jitter (with 500 mV pulses having 1 ns or faster risetimes): less than 10 ps on 1 ns/div range and less than 20 ps (or 0.2% of unexpected sweep time per div, whichever is larger) at 2 ns/div and slower.

Slope: positive or negative.

Sensitivity: jitter specifications above are for sensitive mode; normal mode reduces sensitivity by approx. 10:1.

Delaying sweep

Range: 10 ns/div to 500 μ s/div, 15 ranges in a 1, 2, 5 sequence; accuracy $\pm 3\%$, except for slight nonlinearity at start of sweep, $\pm 5\%$, on 200 μ s/div and 500 μ s/div ranges; vernier provides continuous adjustment between steps and increases 10 ns/div step to at least 4 ns/div.

Delay time: continuously variable from 50 ns to 5 ms.

Accuracy: $\pm 3\%$; linearity 0.5%; jitter time is less than 1 part in 20,000 or 20 ps, whichever is greater.

Sweep functions: main, delaying, and main delayed.

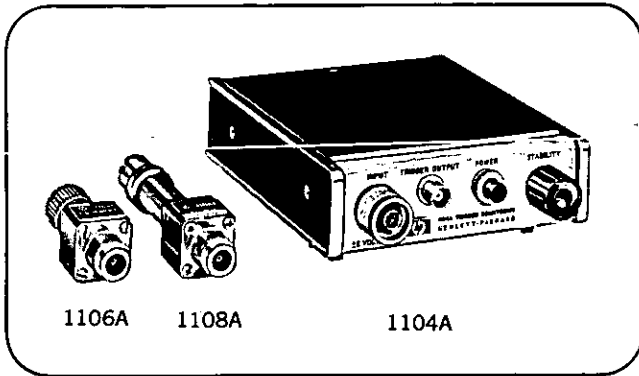
Scanning: same as 1424A except no external scan input.

Sync pulse output: same as 1424A. Pulse always synchronized to main sweep trigger circuit; pulse delay and rate are variable.

Weight: net 7 lbs (3.2 kg); shipping 13 lbs (5.9 kg).

Price: HP Model 1425A, \$1900.

Sampling accessories

1104A/1106A 18 GHz trigger countdown
1104A/1108A 10 GHz trigger countdown

Specifications, 1104A, 1106A, 1108A
Input

Frequency range: (1106A) 1 GHz to 18 GHz. (1108A) 1 GHz to 10 GHz.

Sensitivity: (1106A) signals 100 mV or larger and up to 12.4 GHz, produce <20 ps of jitter (200 mV required to 18 GHz). (1108A) signals up to 50 mV or larger and up to 10 GHz, produce <20 ps of jitter.

Maximum safe input: ± 1 V.

Input impedance: (1106A) 50-ohm Amphenol APC-7 input connector. (1108A) 50-ohm GR-874 input connector. Reflection from input connector is <10% using a 40 ps TDR system.

Signal appearing at input connector: approximately 250 mV.

Output

Center frequency: approximately 100 MHz.

Amplitude: typically 150 mV.

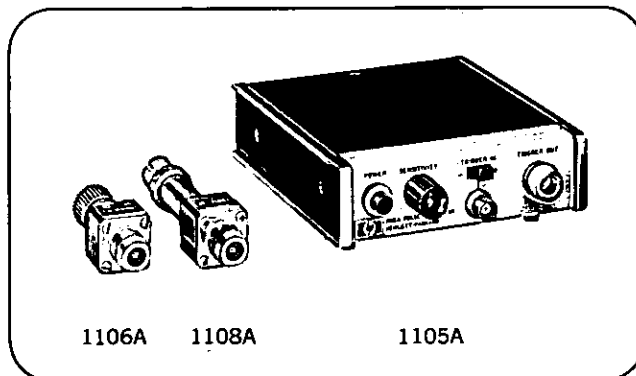
Weight

1104A: net 2 lbs (0,9 kg); shipping 4 lbs (1,8 kg).

1106A or 1108A: net 1 lb (0,5 kg); shipping 2 lbs (1 kg).

Price: HP Model 1104A, \$200. HP Model 1106A, \$550. HP Model 1108A, \$175.

Recommended accessory: HP Model 1109A/1129A High Pass Filter.

1105A/1106A 20 ps pulse generator
1105A/1108A 60 ps pulse generator

Specifications, 1105A, 1106A, 1108A
Output

Risetime: approx 20 ps with 1106A, (<60 ps with 1108A). <35 ps observed with HP Model 1411A/1430A 28 ps

Sampler and HP Model 909A 50 ohm termination.

Overshoot: $< \pm 5\%$ as observed on 1411A/1430A with 909A.

Droop: less than 3% in first 100 ns.

Width: approximately 3 μ s.

Amplitude: greater than +200 mV into 50 ohms.

Output characteristics (1106A/1108A):

Mechanical: (1106A) Amphenol APC-7 connector. (1108A) GR-874 connector.

Electrical: dc resistance —50 ohm $\pm 2\%$. Source reflection—less than 10%, using a 40 ps TDR system. DC offset voltage—approximately 0.1 V.

Triggering

Amplitude: at least ± 0.5 V peak required.

Risetime: less than 20 ns required. Jitter less than 15 ps when triggered by 1 ns risetime sync pulse from 1424A or 1425A Sampling Time Base.

Width: greater than 2 ns.

Maximum safe input: 10 volts.

Input impedance: 200 ohms, ac-coupled through 20 pF.

Repetition rate: 0 to 100 kHz; free runs at 100 kHz.

Accessories provided (with Model 1105A): one 6-ft 50 ohm cable with Type N connectors, HP Model No. 10132A.

Weight

1105A: net 2 lb (1 kg); shipping 4 lb (1,8 kg).

1106A or 1108A: net 1 lb (0,5 kg); shipping 2 lb (1 kg).

Price: HP Model 1105A, \$200. HP Model 1106A, \$550. HP Model 1108A, \$175.

1109A/1129A High-Pass Filters

The 1109A and 1129A High Pass Filters transmit only frequencies above 1 GHz. They are useful for blocking the 100 MHz "kickout" encountered when using a tunnel diode countdown to view high frequency signals on a sampling oscilloscope. The 1109A is designed for use with the Model 1104A/1106A Trigger Countdown, and the 1129A mates with the Model 1104A/1108A.

Specifications, 1109A

Lower bandwidth limit: 3 dB down at 3 GHz, nominal.

Input characteristics

Mechanical: amphenol APC-7 precision 7 mm connector.

Electrical (with output terminated in 50 ohms):

Reflection: less than 10% using 40 ps TDR system.

VSWR: typically 1.1:1 up to 10 GHz increasing to 2:1 at 15 GHz.

DC resistance: 50 ohms $\pm 2\%$ shunted across line.

Weight: net, 5 oz (0,14 kg).

Price: \$250.

Specifications, 1129A

Lower bandwidth limit: 3 dB down at 3 GHz, nominal.

Input characteristics

Mechanical: GR-874 connector.

Electrical (with output terminated in 50 ohms):

Reflection: less than 3% using 150 ps TDR system.

DC resistance: 50 ohms $\pm 2\%$ shunted across line.

Weight: net, 4 oz (0,11 kg).

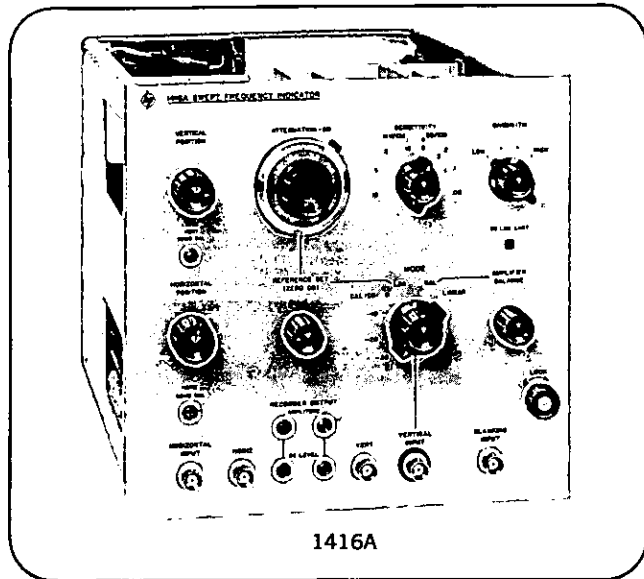
Price: \$150.

Other Sampling Accessories

50-ohm loads: Models 908A and 909A. See index.

50-ohm adapter: Model 11524A; has type N female and APC-7 connectors. Price, \$55.

Air line extensions: Model 11566A; 10 cm, APC-7 connector. Model 11567A; 20 cm, APC-7 connector. Price, \$100 each.

OSCILLOSCOPES 140 SERIES *continued*
Make microwave swept frequency measurements
 Swept frequency indicator Model 1416A


Model 1416A Swept Frequency Indicator transforms Model 140-series into an X-Y oscilloscope which speeds and simplifies microwave swept frequency measurements. Insertion loss vs frequency measurements on attenuators, filters, ferrite isolators, and return loss measurements on all types of loads can be made with ease and accuracy.

Model 1416A incorporates a number of features which

provide convenience and accuracy not available with the usually used conventional X-Y scope. Readouts directly in dB are provided by Model 1416A's logarithmic amplifier. The attenuation-dB control allows a calibrated dB offset to be applied to an offscreen trace, providing high resolution readings when trace returns to reference. A linear mode of operation is also provided. A chopper stabilized input amplifier minimizes drift, and a front-panel adjustable bandwidth switch allows the operator to select a bandwidth just wide enough to present the signal with a minimum amount of noise. An internal dB calibrator, accurate to 3%, allows a quick check of amplifier accuracy. Also provided on the front panel are outputs for driving an X-Y recorder. Thus, you can now achieve speed, convenience, and accuracy with all types of swept frequency measurements by using the Model 140-series/1416A combination and appropriate auxiliary equipment. Sweep oscillators and associated instruments are available for testing both coaxial and waveguide microwave components from 1 to 40 GHz. Such items as adapters, impedance transformers, tuners, loads, filters, detectors, couplers, and attenuators can be measured or adjusted. Swept frequency techniques are also useful for over-all system analysis.

Swept frequency techniques are not only helpful design aids, but can be used as maintenance tools as well. They provide fast routine maintenance checks on laboratory instruments. Hours and sometimes days of tedious precise measurements can often be completed within minutes.

Specifications, 1416A

Mode of operation: linear or logarithmic.

Bandwidth

Linear: variable from approx 1 kHz to 30 kHz in four steps.

Logarithmic: varies with input level.

Deflection factor (sensitivity):

Linear: 50 μ V/div to 10 mV/div, 8 ranges in a 1, 2, 5 sequence; accuracy $\pm 3\%$.

Logarithmic: 0.5 dB/div to 10 dB/div (referred to RF input into crystal detector) in 5 ranges; accuracy (after 30-min warmup), ± 0.02 dB/dB (0 to -25 dB) and ± 0.03 dB/dB (-25 to -30 dB).

Noise: typical observed values on crt:

Mode	Noise at low bandwidth	Noise at high bandwidth
Linear	40 μ V pk-pk	200 μ V pk-pk
Logarithmic: input signal level		
0 dB	0.05 dB	0.1 dB
-10 dB	0.05 dB	0.2 dB
-20 dB	0.3 dB	0.4 dB
-25 dB	1 dB	1 dB
-30 dB	4 dB	4 dB

Maximum measured noise at recorder output: (measured with a true rms voltmeter, and recorder output deflection factor set to 200 mV/div).

Linear: less than 120 mV; Model 1416A deflection factor set to 0.05 mV/div and input shorted.

Logarithmic: less than 50 mV/div; Model 1416A deflection factor set to 5 dB/div and input signal of -30 μ V (-30 dB).

Internal calibrator: four positions: 0, 10, 20, and 30 dB below approx 50 mV; accuracy ± 0.01 dB/dB.

Sweep and blanking: supplied by Model 690 Series Sweep Oscillator.

Recorder outputs:

Vertical: gain adjustable from 0 to approx 200 mV/div; dc level adjustable over approx ± 1.5 volts.

Horizontal: gain adjustable from 0 to approx 100 mV/div; dc level adjustable over approx ± 1 volt.

Inputs

Vertical: input impedance, 75 k ohms; dynamic range: logarithmic, -50 μ V to -100 mV; linear 0 to -100 mV; BNC connector receives output from Models 423A or 424A Crystal Detectors, or Models 786D or 787D Directional Detectors (all Option 002).

Horizontal: ramp required: amplitude between 7.5 and 20 volts; some part of ramp must be at 0 volts.

Blanking: 0 to -5 V gate (supplied by Model 690 Series Sweep Oscillator; early models require slight modification).

Power: supplied by oscilloscope.

Weight: net 7 lbs (3.2 kg); shipping 13 lbs (5.9 kg).

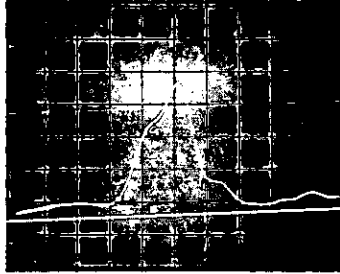
Price: HP Model 1416A, \$725.

OSCILLOSCOPES 140 SERIES *continued*

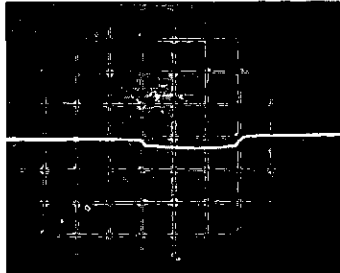
Complete cable testing system Time domain reflectometer Model 1415A

Computer
Museum

Magnified display of a BNC connector joining two 50-ohm cables. The horizontal axis is set at 2 cm/div. Multiplying the 3.5 cm deflection by the reflection coefficient sensitivity of 0.01/cm, one can determine the connector has a ρ of 0.035.



TDR display of a section of unknown cable spliced into a length of 50-ohm cable. Noting the distance setting of 40 cm/div, and reflection coefficient sensitivity of 0.2/cm, one can determine the unknown cable is 120 cm long and has a Z_0 of 44 ohms.



The Model 1415A Time Domain Reflectometer in a 140 system Oscilloscope represents a completely integrated broadband system for testing cables, transmission lines, strip lines, connectors, and other types of high frequency devices.

You can quickly determine the magnitude and nature of each resistive or reactive discontinuity in coaxial components such as attenuators, cables, connectors and delay lines used in microwave and pulse circuit design. Or you can locate and identify cable faults such as shorts, opens, loose connectors, defective tap offs, splices, and mismatches in signal transmission cables. Whatever your application the 1415A can save you time and money by minimizing guesswork and indecision.

Specifications, 1415A

System (in reflectometer configuration)

- Risetime:** less than 150 ps.
- Overshoot:** 5% or less overshoot and ringing ($1/2\%$ in 2 ns).
- Internal reflections:** less than 10%.
- Reflectometer sensitivity:** reflection coefficients as small as 0.001 can be observed.
- Rep. rate:** 150 kHz nominal.

Signal channel

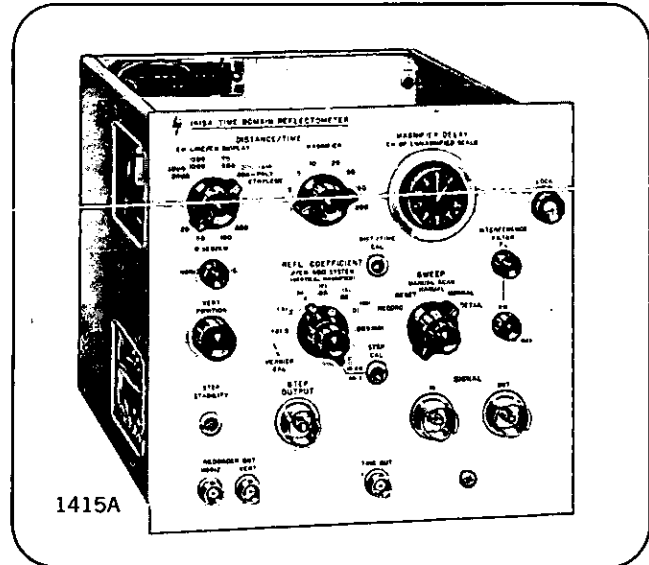
- Risetime:** approximately 110 ps.
- Reflection coefficient:** 0.5/div to 0.005/div in 1, 2, 5 sequence.
- Input:** 50 ohms, feedthrough type.
- Noise and internal pickup, peak:** less than 0.2 div on 0.005/div range, with step disconnected and input terminated in 50 ohms.
- Dynamic range:** ± 0.5 volt.
- External signal level:** up to 1 V p-p may be safely applied to the signal out connector.
- Attenuator accuracy:** $\pm 3\%$.

Step generator

- Amplitude:** approx 0.25 V into 50 ohms (0.5 V open circuit).
- Risetime:** approximately 50 ps.
- Output impedance:** 50 ohms ± 1 ohm.
- Droop:** less than 1%.

Distance/time scale

- Distance scale (cm line/div display) accuracy:** 5%.
- Polyethylene line ($\epsilon=2.25$):** 200 to 2000 cm/div.
- Air line ($\epsilon=1$):** 300 to 3000 cm/div (0.19 mi.).
- Time scale:** 20 to 200 ns/div, $\pm 5\%$ accuracy.
- Magnification:** X1 to X200 in 1, 2, 5 sequence; accuracy of basic



Model 1415A Opt H08 is a 3000-foot version of Model 1415A, with the horizontal scale calibrated in ft/div and vertical scale calibrated in % reflection. 1415A Opt H08 specifications follow 1415A specifications below.

Also available is a complete 75-ohm, factory-calibrated TDR system, 1570A Opt 002. This system includes: 1415A Opt H08 Time Domain Reflectometer plug-in; a standard Model 140A Oscilloscope with P7 phosphor CRT; a Model 10458A 50-ohm to 75-ohm adapter (includes operating instructions and 75-ohm impedance overlays for CRT); Application Note 67 on cable testing (contains TDR slide rule for quick conversion to different dielectrics). Price: 1570A Opt 002 \$2160.

sweep maintained at all magnifier settings with exception of time represented by first 0.1 div of unmagnified step.

Delay control: 0 to 10 div of unmagnified sweep, calibrated.

Jitter: less than 20 ps.

Power: supplied by oscilloscope.

Weight: net 7 lb (3.2 kg); shipping 13 lb (5.9 kg).

Accessories furnished: 2 GR elbows (HP Part No. 1250-0239).

1 GR to Type N adapter (1250-0240), and 1 Type N to BNC adapter (1250-0067).

Price: HP Model 1415A, \$1200.

Option 014: long-line TDR for cables up to 1500 meters (0.62 mile); P7 phosphor recommended for CRT, no extra charge; specifications same as for 1415A except as follows:

System risetime: less than 200 ps.

Rep rate: 30 kHz, nominal.

Noise and internal pickup: 0.25% of step.

Droop: 2%.

Time scale: 20 ns/div to 1 μ s/div.

Air line: 300 cm/div to 150 m/div.

Polyethylene: 200 cm/div to 100 m/div.

Price: HP Model 1415A Option 014, \$1300.

1415A Opt H08: calibrated to read distance in feet of polyethylene or polyfoam dielectric cables; vertical scale calibrated in % reflection. 1415A Opt H08 same as Option 014 except as follows:

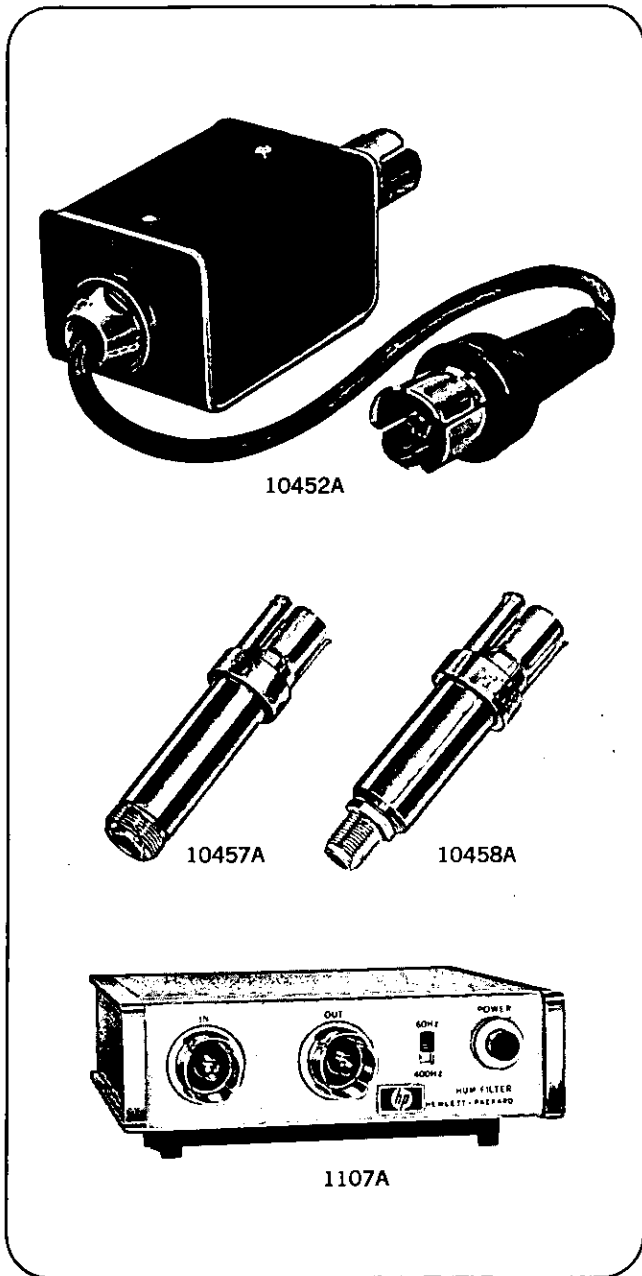
Reflection coefficient: 50, 20, 10, 5, 2, 1, and 0.5%/div.

Distance scale: maximum range 3000 ft in 300, 100, 50, 20, and 10 ft/div for polyfoam and polyethylene dielectric cables.

Time scale: 900, 300, 150, 60, and 30 ns/div.

Price: HP Model 1415A Opt H08, \$1430.

TDR Accessories

**Models 10452A-10456A**

Model 10452A through 10456A Rise Time Converters slow down the step from the 1415A in order to eliminate reflections caused by frequencies beyond the bandwidth of interest.

Specifications

Rise times: (10-90% points as measured in 150 ps risetime system.)

10452A: 0.5 ns. 10453A: 1 ns. 10454A: 2 ns. 10455A: 5 ns. 10456A: 10 ns.

Rise time accuracy: better than $\pm 5\%$.

Overshoot: less than $\pm 3\%$.

Output impedance (dc): 50 ohms (accuracy determined by output impedance of generator).

Output mismatch: less than $\pm 5\%$ reflection to output rise time.

Allowable input voltage: up to 50 volts, open circuit (from a 50-ohm source).

Connectors: GR Type 874.

Price: \$95 each.

Models 10457A-10458A

Adapters convert 1415A 50 ohm output to 75 ohm systems.

Model 10457A: converts 50 ohm GR to 75 ohm Type N.
Price: \$45.

Model 10458A: converts 50 ohm GR to 75 ohm Type F (CATV).

Price: \$25.

Model 1107A

Power line interference can be reduced with the 1107A Hum Filter when used with Time Domain Reflectometers such as the HP Model 1415A. A front panel switch allows you to select either 60 Hz or 400 Hz filtering.

Specifications**Hum rejection**

In a 50 ohm hum source

50-120 Hz, 40 dB; 400 Hz, 35 dB.

Introduced reflection: less than 5%. Using a 150 ps TDR system.

Step distortion (droop): less than 3%.

Power

115-230 volts ac; 50-400 Hz; 1 watt.

Price: \$325.

TDR Application Notes

The following application notes about TDR measurements are available, at no charge, from your local Hewlett-Packard field engineering office, or write Hewlett-Packard Co., 1501 Page Mill Road, Palo Alto, California 94304.

AN 67

Cable Testing with Time Domain Reflectometry: A summary of cable-testing techniques using TDR. Discusses ways of simplifying cable measurements when multiple reflections or spurious signals are present. Includes a slide rule for quick measurements of distance and impedance.

AN 75

Selected Articles on TDR Applications: Includes (1) TDR-Theory and Applications, (2) Transmission Line Pulse Reflectometry, (3) Mechanical Scaling Enhances TDR Use, (4) Some Uses of TDR in the Design of Broadband UHF Components, (5) Thermocouple Fault Location by TDR.

AN 94

Connector Design Employing TDR Techniques: Describes techniques and results of 28 pico second risetime TDR examination of physical parts of the connector and relating this data to mechanical contact configuration and the theoretical design.

SPECTRUM ANALYZERS

An oscilloscope in the frequency domain
Models 8554L/8553B/8552A and 8551B/851B



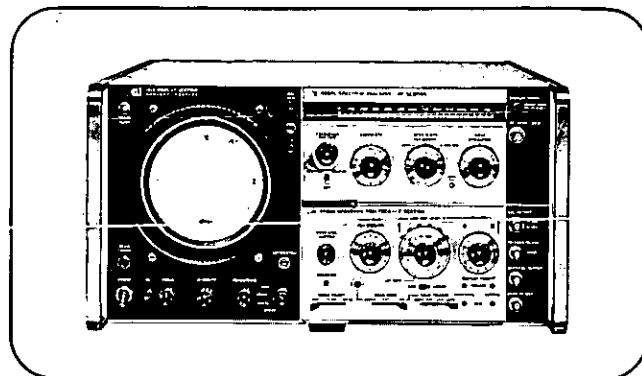
OSCILLOSCOPES

General

Oscilloscopes display the amplitude of electrical signals as a function of time, combining all frequency components into the composite time-domain waveform. Spectrum analyzers separate the frequency components, displaying the amplitude of each as a function of its frequency. Both time and frequency-domain analysis are indispensable for the rapid analysis of signals in circuit characterization.

Common Frequency Domain Applications

Many measurements commonly made on circuits such as oscillators, amplifiers, mixers, and filters must be made in the frequency domain. Such measurements include frequency response, harmonic and intermodulation distortion, spurious oscillations, frequency stability, spectral purity, modulation index, and attenuation. Because you rapidly plot the frequency domain picture on a CRT, you gain insight from a spectrum analyzer that is often not possible from other instruments. For more complete information on spectrum analysis, see pages 399 through 414.



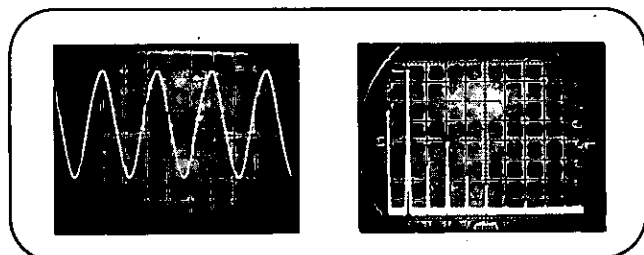
8553B/8552A Spectrum Analyzer Plug-ins in 141S Oscilloscope Mainframe

scanning speeds. The entire spectrum may be viewed, rather than a slowly moving CRT spot.

Automatic stabilization: featured on both spectrum analyzers. No complicated phase-locking procedure on narrow scan widths.

8553B/8552A Features

- 1 kHz to 110 MHz frequency range:** from baseband through FM.
- Flatness:** ± 0.5 dB.
- 70 dB display dynamic range:** free of internal distortion products.
- High sensitivity:** to -130 dBm ($0.07 \mu\text{V}$).
- 50 Hz resolution:** to separate closely-spaced signals.
- High stability:** residual FM less than 20 Hz peak-to-peak when stabilized.



Harmonic Distortion in Time-Domain—Hardly Visible

Harmonic Distortion in Frequency Domain—Easily Seen

8554L/8552A and 8553B/8552A Spectrum Analyzers

These spectrum analyzers bring the power of complete frequency domain analytical capabilities to the design engineer, the system engineer, and the EMC engineer. For the first time absolute amplitude calibration is combined with broad sweep capabilities, high sensitivity, low distortion, wide dynamic range, and flat frequency response, to produce a truly general-purpose frequency domain instrument.

The 8554L/8552A and 8553B/8552A are invaluable, not only in basic circuit design, but also in system evaluation. These spectrum analyzers provide frequency coverage from 1 kHz to 1.25 GHz allowing measurement from baseband through military and navigational aid bands with absolute amplitude calibration.

The 8554L/8552A and 8553B/8552A are designed for use with a 140S or 141S display section. The 140S CRT is of the fixed-persistence/non-storage type; the 141S offers the additional benefits of variable persistence and storage. The spectrum analyzer plug-ins work equally well in a 140A/B and 141A/B oscilloscope mainframes.

Variable persistence display: the 141S display unit gives high-resolution, flicker-free displays at even the slowest

8554L/8552A Features

- 500 kHz to 1.25 GHz frequency range:** for broad coverage.
- Flatness:** ± 1 dB.
- 65 dB display dynamic range:** free of internal distortion products.
- High sensitivity:** to -117 dBm ($0.33 \mu\text{V}$).
- 300 Hz resolution:** to separate closely-spaced signals.
- High stability:** residual FM less than 300 Hz peak-to-peak when stabilized.

For complete specifications and additional information, refer to pages 403 through 408.

8551B/851B and 8551B/852A Spectrum Analyzer

The 8551B RF Section with either the 851B or 852A Display Section makes a spectrum analyzer that is a versatile, fully calibrated instrument over the 10.1 MHz to 40 GHz frequency range. Accuracy and flexibility of the 8551B make it suitable for many applications, such as rapid, wide-band EMC measurements, spectrum surveillance, spectrum signature recording, and general signal analysis—all in the frequency domain.

Complete specifications and accessory information for this instrument are given on pages 409 through 414.

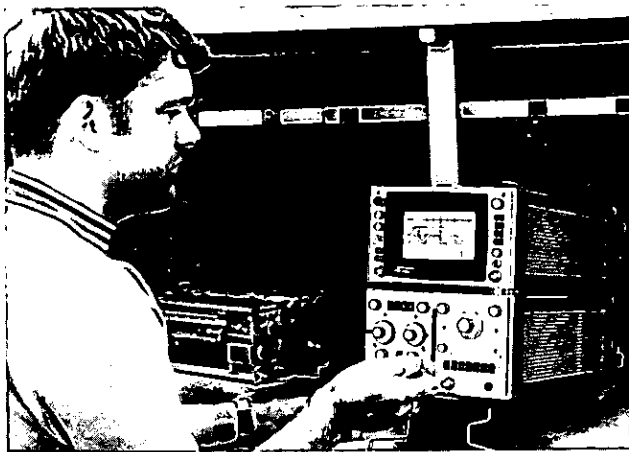


SOLID-STATE OSCILLOSCOPES

dc to 250 MHz bandwidth plug-in system
Models 180A, 181A, 183A

NEW STANDARD FOR OSCILLOSCOPE MEASUREMENTS

The growing 180 Oscilloscope System establishes a new standard for high-performance, high-frequency, general-purpose oscilloscope design. This modern plug-in system allows you to match your oscilloscope capability to your particular application. These small all solid-state scopes are ideal for all types of high frequency measurements. This reliable, accurate performance has been proven in applications varying from shipboard testing, to flight-line checkout, to exacting measurements of computer memories. This system is designed to meet today's requirements and still provide capabilities for future growth.



COMPLETE SELECTION FOR ANY MEASUREMENT NEED

Realtime measurements to 250 MHz

With the introduction of the new 183A/B mainframes, 1830A dual channel vertical amplifier, and 1840A time base real time measurements to 250 MHz are now possible. With this instrument you can make repetitive and single-shot real-time measurements that were previously possible only with sampling oscilloscopes or special purpose low-sensitivity scopes designed for display of single-shot transients. Model 183 is a new generation laboratory oscilloscope mainframe that will operate beyond 500 MHz. As the integrated state-of-the-art increases, new vertical plug-ins will provide bandwidths beyond the present 250 MHz. This high frequency performance is obtained without restricting general purpose applications, since all 1800-series plug-ins will operate in the 183 mainframe.

Precision measurements to 100 MHz

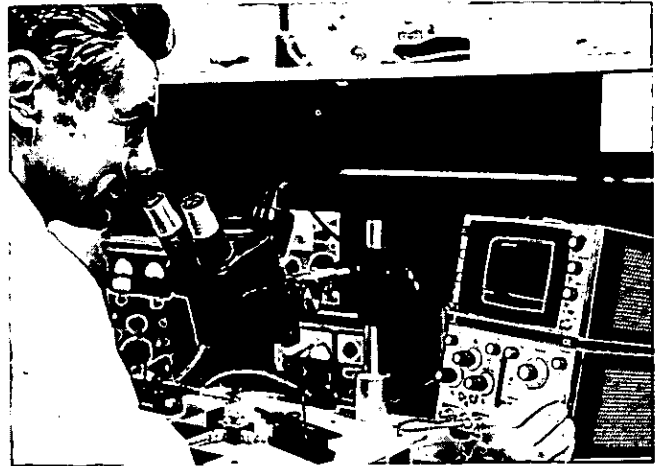
With the 1802A vertical plug-in, dual-channel measurements to 100 MHz have reached a high level of quality. Using transmission line techniques, this 50 ohm input plug-in provides the ideal termination for measurements in a 50-ohm system, and with active and passive probes you get the impedance multiplication when you need it for probing applications.

Differential/DC Offset Measurements

Easy and precise measurements can be made with the 1803A differential dc offset plug-in in the low dc drift 180 system. For example, offset voltages can be measured with a comparison accuracy of less than 0.5% and in the differential mode, the high common mode rejection ratio of 86 dB will withstand a 10 volt common mode signal.

General-purpose engineering and development

For versatility combined with accuracy, choose the 50 MHz dual channel plug-in with either standard or delayed sweep time base. Plug these into the variable persistence and storage mainframe for a truly general-purpose scope. This mainframe features conventional oscilloscope operation with variable persistence and storage available at the push of a button. The cabinet version requires little of that valuable workbench space or, if you prefer, the rack version is a real space-saver (5¼" high) in a portable test console.



Field and Service

The over-all 180 system design concept results in features especially suited for field and service applications. All solid-state circuits, small package, with accessories such as front panel covers and light weight testmobiles, make this system ideal for field location work. The plug-in design lets you take a mainframe and only the plug-ins necessary for the job, not a second oscilloscope. Broad environmental specifications and rugged construction assure you accurate laboratory performance in field applications.



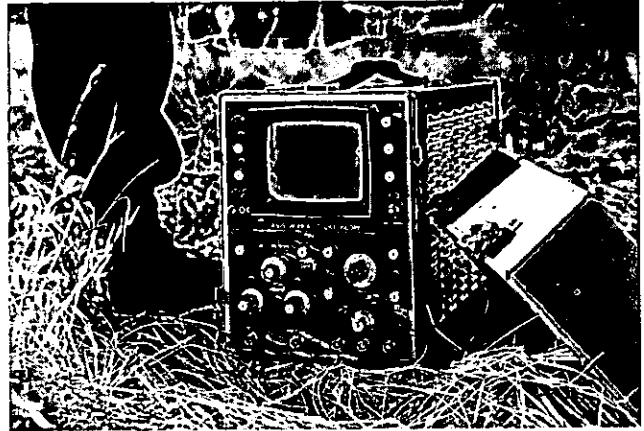
Systems and Manufacturing

The 180 system design also makes it ideal for instrument systems and manufacturing applications. The rack-mount mainframe versions are only 5¼-inches high, which saves valuable space, and the wide selection of plug-ins allows you to easily tailor the system to fit the application. The variable persistence and storage oscilloscope lets you control CRT persistence to eliminate flicker or integrate dim signals for a display of full brightness. Storage provides side-by-side trace comparison and single-shot occurrences and, with the Hewlett-Packard mesh storage tube, you can intensity modulate the trace and store the gray shades.

A typical system application is shown with a special Model 181AR mounted in a HP Model 5406A Multiparameter Analyzer System. Logical arrangement of controls makes these instruments easy to operate even for those not familiar with an oscilloscope and the internal graticule eliminates parallax errors.

Operation in Extreme Environments

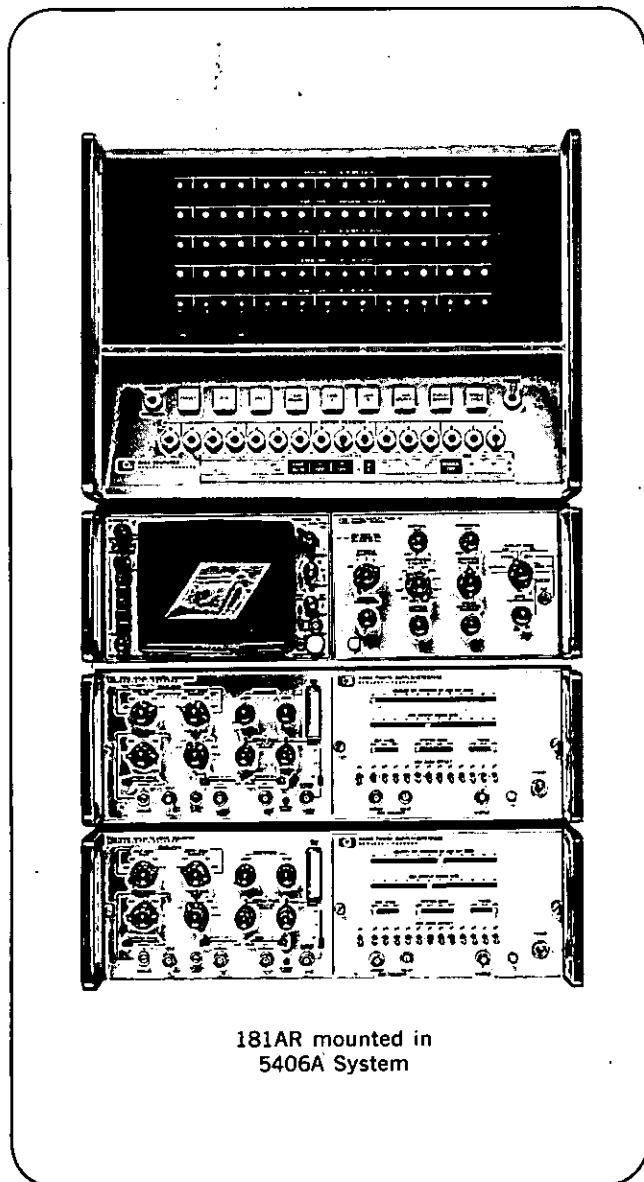
A 180 system has been developed to meet the extreme environmental requirements of the military. This system, which includes plug-ins and front panel cover with accessories, is available as an AN/USM-281A. The same ruggedized system can also be obtained as a 180F mainframe and with 1801F and 1821F plug-ins or as a rack mount model in the 180ER.



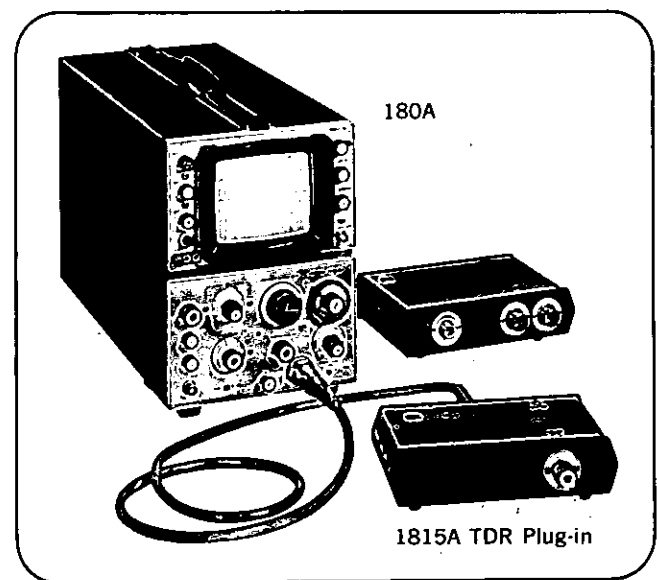
TDR/Sampling

With the 1815A/B plug-in and remote sampling heads, any 180-System oscilloscope can be used for direct readout TDR and 12.4 GHz Sampling. Time Domain Reflectometry (TDR) is a fast convenient technique for measuring the electrical characteristics of transmission systems. In a TDR system, a pulse is repetitively injected into the line, and the reflection caused by a mismatch results in a CRT trace that displays an impedance profile showing magnitude, nature, and distance from the test point.

This plug-in with its fast risetime is calibrated and easy to use. With calibrated controls there is direct readout of distance to the mismatch and distance between points on the trace. With signal to noise ratio improvement of better than 2:1 (made possible by signal averaging techniques), very small discontinuities can be measured.



181AR mounted in
5406A System



180A

1815A TDR Plug-in

Selection chart

180 System Selection Chart

MAINFRAMES			
Model	Description	Price	Page
180A	Cabinet style	\$ 895	521
180AR	5¼-inch high rack/bench style	\$ 995	521
181A	Cabinet style, variable persistence and storage CRT	\$1850	522
181AR	5¼-inch high rack/bench style, variable persistence and storage CRT	\$1925	522
183A	Cabinet style, >500 MHz bandwidth	\$1750	530
183B	5¼-inch high rack/bench style, >500 MHz bandwidth	\$1825	530
AN/USM-281A (180F)	Militarized (cabinet style)	\$1215	533
180ER	Militarized rack/bench style, meets AN/USM-281A specifications with exception of drip-proofing. (The 180ER is not specifically mentioned on page 533.)	\$1205	533

VERTICAL PLUG-INS						
Model No.	1801A	1802A	1803A	1804A	1830A*	1801F
Bandwidth MHz	50	100 (75 cascaded)	40 MHz (30 MHz)	50	250	50 (20)
Min. deflection factor/div	5 mV	10 mV (1 mV cascaded)	5 mV (1 mV)	20 mV	10 mV	5 mV (1 mV)
Channels	2	2 (1 cascaded)	1	4	2	2
Differential input	•	•	• (with dc offset)		•	•
Price	\$695	\$1200	\$950	\$1050	\$850	\$800
Page	523	526	523	524	532	533

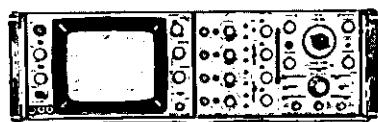
TIME BASE PLUG-INS								TDR/SAMPLING
Model No.	1820A	1820B	1821A	1822A	1840A*	1820E**	1821F	1815A
Ext trig	100 MHz	150 MHz	100 MHz	150 MHz	>500 MHz	100 MHz	100 MHz	35 ps calibrated TDR and 12.4 GHz sampling
Int trig	75 MHz	120 MHz	75 MHz	120 MHz	250 MHz	75 MHz	75 MHz	
Sweep Speeds/div	5 ns- 2 s	5 ns- 2 s	10 ns- 1 s	5 ns- 1 s	1 ns- .1 s	5 ns- 2 s	10 ns- 2 s	
Delayed and mixed sweep			•	•			•	
Price	\$475	\$525	\$800	\$900	\$550	\$570	\$920	\$2075-3150
Page	525	527	525	527	532	525	533	528

*Only operates in 183 Mainframe.

**Ruggedized version of the 1820A.

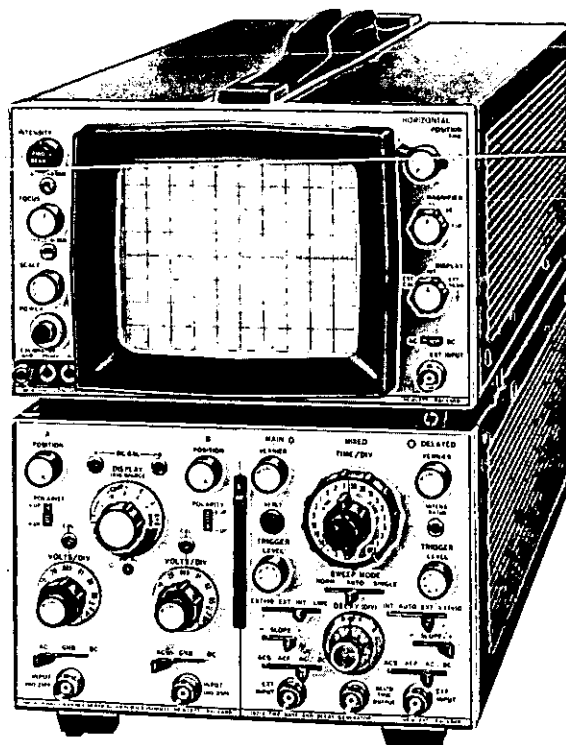
OSCILLOSCOPES 180 SERIES *continued*

8 x 10 cm display, solid-state, 30 pounds
Models 180A, 180AR mainframes



180AR

The 180AR is housed in the Hewlett-Packard modular cabinet, suitable for either bench or rack mount. As a rack mounted unit, the 180AR requires only 5¼ inches of vertical rack space, with no clearance requirements at top or bottom of the unit. Fixed pivoted slides are described on page 536.



180A

Specifications, 180A/180AR
Cathode-ray tube and controls

Type: post accelerator, 12 kV accelerating potential; aluminized P31 phosphor (other phosphors available, see options); safety glass faceplate.

Graticule: 8 x 10 div parallax-free internal graticule. 0.2-div sub-divisions on major axes. 1 div = 1 cm. Front panel recessed screwdriver adjustment aligns trace with graticule. Scale control illuminates CRT phosphor for viewing with hood or taking photographs.

Beam finder: returns trace to CRT screen regardless of setting of horizontal, vertical, or intensity controls.

Intensity modulation: approx +2 V, ≥ 50 ns pulse width (≤ 10 MHz cw) blanks trace of normal intensity. Input R, 5100 ohms.

Calibrator

Type: approximately 1 kHz square wave, 3 μs risetime.

Voltage: two outputs, 250 mV pk-pk and 10 V pk-pk; accuracy, ±1%.

Horizontal amplifier

Bandwidth: dc to 5 MHz when dc-coupled; 5 Hz to 5 MHz when ac-coupled.

Deflection factor: 1 V/div, X1; 0.2 V/div, X5; 0.1 V/div, X10. Vernier provides continuous adjustment between ranges.

Dynamic range: ±20 V.

Maximum input: 600 V dc (ac-coupled input).

Input RC: 1 megohm shunted by approximately 30 pF.

Sweep magnifier: X5, X10; accuracy, ±5%.

Outputs: four emitter follower outputs on rear for main and delayed gates, main and delayed sweeps or vertical and horizontal

outputs when used with sampling plug-ins; maximum current available, ±3 mA; outputs will drive impedances down to 1000 ohms without distortion.

General

Weight: (without plug-ins) Model 180A, net, 24 lb (11,6 kg); shipping, 36 lb (17,4 kg). Model 180AR (rack), net, 26 lb (12,5 kg); shipping, 40 lb (19,3 kg).

Environment: 180A/AR scope operates within specifications over the following ranges:

Temperature: -28°C to +65°C.

Humidity: to 95% relative humidity to 40°C.

Altitude: to 15,000 ft.

Vibration: vibrated in three planes for 15 min. each with 0.010 inch excursion, 10 to 55 Hz.

Power: 115 or 230 V ±10%, 50 to 400 Hz, less than 110 watts with plug-ins at normal line, convection cooled.

Dimensions:

Cabinet: 7⅞" wide, 11⅜" high, 21¼" deep behind panel (200 x 289 x 540 mm).

Rack: 19" wide, 5¼" high, 19½" deep behind panel (482 x 133 x 495 mm); 21⅜" deep over-all.

Accessories furnished: mesh contrast filter; rack mounting hardware (180AR only).

Price: HP Model 180A (cabinet), \$895; HP Model 180AR (modular rack), \$995.

Options (specify by option number):

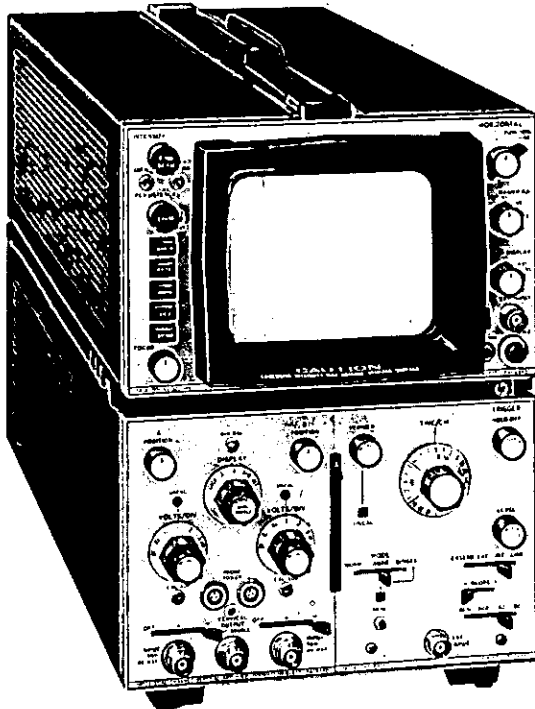
002: P2 phosphor, no charge.

007: P7 phosphor, no charge.

011: P11 phosphor, no charge.

OSCILLOSCOPES 180 SERIES *continued*

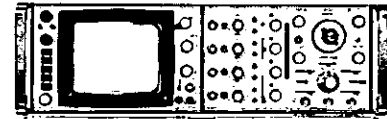
Storage, variable persistence, solid-state
Models 181A, 181AR mainframes



181A

Features

Vary persistence to view slow signals
"Develop" fast, low repetition rate pulses
Bright, high-contrast storage up to 1 hour
Rugged construction for field use
Scope with plug-ins weighs only 30-32 pounds
Pushbutton erase and mode controls



181AR

The 181AR is housed in the Hewlett-Packard modular cabinet, suitable for either bench or rack mount. As a rack mounted unit, the 181AR requires only 5¼ inches of vertical rack space, with no clearance requirements at top or bottom of the unit. Fixed pivoted slides are described on page 536.

Specifications, 181A/AR**Cathode-ray tube and controls**

Type: post accelerator storage tube; 8.5 kV accelerating potential; aluminized P31 phosphor.

Graticule: 8 x 10 div parallax-free internal graticule, 0.2-div subdivisions on major axes. 1 div = 0.95 cm. Front panel recessed screwdriver adjustment aligns trace with graticule.

Beam finder: returns trace to CRT screen regardless of setting of horizontal or vertical controls.

Intensity modulation: approximately +2 V, ≥ 50 ns pulse width (≤ 10 MHz cw) blanks trace of normal intensity. Input R, 5100 ohms.

Persistence: normal, natural persistence of P31 phosphor (approx 40 μs). Variable, continuously variable from less than 0.2 second to more than 1 minute.

Storage writing speed:

Write mode: greater than 20 div/ms.

Max. write mode: greater than 1000 div/ms.

Brightness: measured with entire screen faded positive, greater than 200 footlamberts.

Storage time: from Write mode to Store, traces may be stored at reduced intensity for more than one hour. To View mode, traces may be viewed at normal intensity for more than one minute. From Max. Write mode to Store, traces may be stored at reduced intensity for more than 5 minutes. To View mode, traces may be stored at normal intensity for more than 15 seconds.

Erase: manual, pushbutton erasure takes approximately 300 ms.

Calibrator

Type: approximately 1 kHz square wave, 3 μs risetime.

Voltage: 10 V pk-pk; accuracy, ±1%.

Horizontal amplifier

Bandwidth: dc to 5 MHz when dc-coupled; 5 Hz to 5 MHz when ac-coupled.

Deflection factor: 1 V/div, X1; 0.2 V/div, X5; 0.1 V/div,

X10. Vernier provides continuous adjustment between ranges.

Dynamic range: ±20 V.

Maximum input: 600 V dc (ac-coupled input).

Input RC: 1 megohm shunted by approximately 30 pF.

Sweep magnifier: X5, X10; accuracy, ±5%.

Outputs: four emitter follower outputs on rear for main and delayed gates, main and delayed sweeps; or vertical and horizontal outputs when used with sampling plug-ins; maximum current available, ±3 mA; outputs will drive impedances down to 1000 ohms without distortion.

General

Weight: (without plug-ins) Model 181A, net 24 lbs (11,6 kg); shipping, 36 lbs (17,4 kg). Model 181AR (rack), net, 26 lbs (12,5 kg); shipping, 40 lbs (19,3 kg).

Environment: same as Model 180A/AR except for temperature which is 0°C to +55°C.

Power: 115 or 230 volts ±10%, 50 to 400 Hz, less than 115 watts, at normal line, with plug-ins, convection cooled.

Dimensions:

Cabinet: same as Model 180A.

Rack: same as Model 180AR.

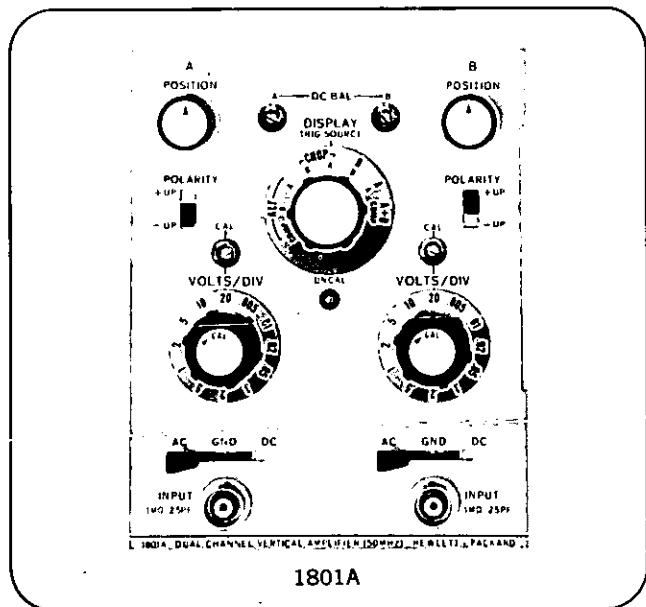
Accessories furnished: mesh contrast filter; rack mounting hardware (181AR only).

Special order: modified Model 181A/AR with remote programming capability for Write, Max Write, Normal, Store, View, and Erase functions. Programming accomplished through contact closures, DTL or TTL logic sources. Order as 181A option H49 (cabinet) or 181AR option H49 (modular rack).

Price: HP Model 181A (cabinet), \$1850; HP Model 181AR (modular rack), \$1925; 181A option H49 (cabinet), \$2350; 181AR option H49 (modular rack), \$2425.

OSCILLOSCOPES 180 SERIES *continued*

50 MHz amplifier, differential/dc offset amplifier Models 1801A, 1803A



This dual channel amplifier is ideal for general-purpose use in the 180 Oscilloscope System. Its high sensitivity of 5 mV/div provides the extra gain needed when divider probes are used. (Also note 1 mV/div Model available; see 1801F.) The 1801A has FET inputs for low drift and quick warm-up, plus a virtual absence of microphonics. All attenuation, which sets deflection factor, occurs prior to any active component—eliminating trace shift with range changes and also assuring constant bandwidth in excess of 50 MHz on all ranges. Internal triggering on either A or B channel signals assures time correlation between traces in either chopped or alternate operation.

Specifications, 1801A

Modes of operation: channel A alone; channel B alone; channels A and B displayed alternately on successive sweeps (ALT); channels A and B displayed by switching between channels at approx 400 kHz rate (CHOP), with blanking during switching; channel A plus channel B (algebraic addition).

Each channel

Bandwidth: dc to 50 MHz (3 dB down). Lower 3 dB limit is approx 8 Hz with input ac-coupled. (Measured with or without 10004A probe; 8 div reference signal from a 25 Ω source. Lower limit is approx 0.8 Hz with 10004A probe.)

Risetime: less than 7 ns. (Measured with or without 10004A probe; 10% to 90% of 8-div input step from a 25-ohm source.)

Deflection factor:

Ranges: from 0.005 V/div to 20 V/div (12 calibrated positions) in 1, 2, 5 sequence.

Attenuator accuracy: $\pm 3\%$.

Vernier: provides continuous adjustment between deflection factor ranges; extends maximum deflection factor to at least 50 V/div.

Polarity: + UP or - UP, selectable.

Signal delay: input signals are delayed sufficiently to view leading edge of input pulse without advance external trigger.

Input coupling: front panel selection of AC, DC, or Ground; Ground position disconnects signal input and grounds amplifier input for reference.

Input RC: 1 megohm shunted by approx 25 pF; constant on all ranges.

Maximum input:

DC-coupled: ± 350 V (dc + peak ac); ± 150 V (dc + peak ac) on 5 mV/div at 10 kHz or less.

AC-coupled: ± 600 V dc.

A + B operation

Amplifier: bandwidth and deflection factor are unchanged; either channel may be inverted to give $\pm A \pm B$ operation.

Differential input (A-B) common mode: for frequencies from dc to 1 MHz, common mode rejection ratio is at least 40 dB on 5 mV/div deflection factor, at least 20 dB on other ranges; for common mode signals of 24-div or less.

Triggering

Source:

A, B, A + B mode: on the signal displayed.

Chop mode: on chan A signal or chan B signal.

Alternate mode: on chan A signal, chan B signal, or successively from the displayed signal on each channel.

Frequency: dc to 50 MHz on signals causing 0.5 division or more vertical deflection in all display modes except Chop; dc to 100 kHz for Chop mode.

General

Weight: net, 4 lbs (1.8 kg); shipping, 7 lbs (3 kg).

Environment: same as Model 180A/AR.

Accessories furnished: two Model 10004A 10:1 Voltage Divider probes.

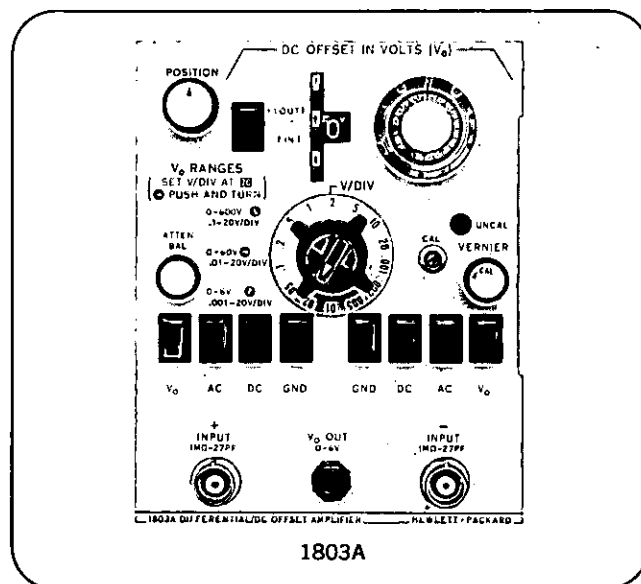
Price: Model 1801A, \$695.

Options:

090: two 10006A probes (6-ft cable) instead of 10004A probes. Add \$10.

091: two 10005A probes (10-ft cable) instead of 10004A probes. Add \$20.

Differential/DC Offset Preamp



The Model 1803A Differential/DC Offset Amplifier uses the slideback technique to achieve greater measurement accuracy. The plug-in generates a very stable, precise dc voltage which may be read to four-digit resolution. This voltage is then compared to the input signal. If the input signal is expanded to many screen diameters, the dc offset permits any part of the input signal to be displayed on screen and measured accurately. Fool-proof, interlocked controls prevent unwanted off-set changes as sensitivity is changed.

Used as a differential amplifier, the 1803A has high common-mode rejection and will withstand a 10 V common-mode signal on the most sensitive range of 1 mV/div. Even higher common-mode signals may be applied on the less sensitive ranges.

Specifications, 1803A

Bandwidth: dc to 40 MHz (3 dB down) for deflection factors of 0.005 V/div to 20 V/div; dc to 30 MHz (3 dB down) on 0.001 V/div and 0.002 V/div. Lower 3 dB limit is approx 2 Hz with input ac-coupled. (Measured with or without 10004A probe; 8 div reference signal from a 25 Ω source. Lower limit is approx .2 Hz with probe.)

(cont.)

OSCILLOSCOPES 180 SERIES *continued***50 MHz 4-channel amplifier****Model 1804A**

Risetime: 10 ns for deflection factors of 0.005 V/div to 20 V/div; <12 ns on 0.001 V/div and 0.002 V/div. (Measured with or without 10004A probe; 10% to 90% of 8 div input step from 25Ω source.)

Deflection factors

Ranges: from 0.001 V/div to 20 V/div (14 calibrated positions) in 1, 2, 5 sequence.

Attenuator accuracy: ±3%.

Vernier: provides continuous adjustment between deflection factor ranges; extends maximum deflection factor to at least 50 V/div.

Input RC: 1 megohm shunted by approx 26 pF; constant on all ranges.

Input coupling: front panel selection of AC, DC, Ground, or V_0 for both + and - inputs. Ground disconnects signal input and grounds amplifier input for reference.

Maximum input

V_0 Range	Deflection Factor	Maximum Input (DC + Peak AC)
0 to 6 V	0.001 V/div to 0.02 V/div	±15 V
0 to 6 V	0.05 V/div to 0.2 V/div	±150 V
0 to 6 V	0.5 V/div to 20 V/div	±600 V
0 to 60 V	0.01 V/div to 0.2 V/div	±150 V
0 to 60 V	0.5 V/div to 20 V/div	±600 V
0 to 600 V	0.1 V/div to 20 V/div	±600 V

Common mode rejection: measured at a deflection factor of 0.001 V/div. (CMRR decreases with increasing deflection factor.)

Frequency Range	CMRR	Common Mode Input Sinewave (Max Peak-to-Peak)
DC to <100 kHz	≥20,000:1 (≥86 dB)	10 V
100 kHz to <1 MHz	≥10,000:1 (≥80 dB)	10 V
1 MHz to <10 MHz	≥5,000:1*	10 V*
20 MHz	Freq. in MHz ≥50:1 (≥34 dB)	Freq. in MHz 1 V
60 Hz	≥2,000:1 (≥66 dB)**	10 V

*Divide CMRR and Voltage by Frequency in MHz.

**AC-coupled (all others dc-coupled).

Overload recovery

6 V overload: within ±10 mV of final signal value in 0.3 μs or less; within ±5 mV in 1 μs or less; and within 1 mV in 1 ms or less.

60 V overload: with ±100 mV of final signal value in 0.3 μs or less; within ±50 mV in 1 μs or less; and within 10 mV in 1 ms or less.

600 V overload: within ±1 V of final signal value in 0.3 μs or less; within ±0.5 V in 1 μs or less; and within ±100 mV in 1 ms or less.

Triggering: dc to 40 MHz on signals causing 0.5 division or more vertical deflection.

V_0 output: calibrated dc offset voltage available at front panel connector, continuously variable from 0 to ±0.006 V, 0 to ±0.06 V, 0 to ±0.6 V or 0 to ±6 V. Accuracy of the ±6 V range is ±0.15% of reading ±8 mV when driving a resistance of 10 megohms or higher.

DC offset

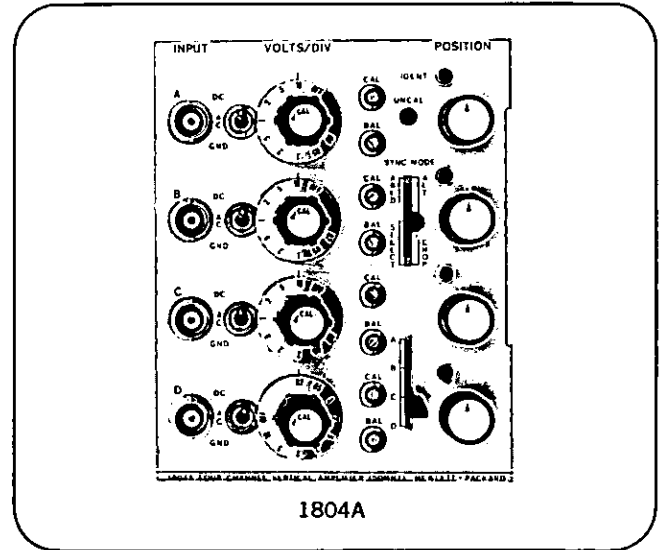
V_0 Range	Deflection Factor	Comparison Accuracy
0 to ±6 V	0.001 V/div to 0.02 V/div	±(0.15% + 8 mV)
	0.05 V/div to 0.2 V/div	±(0.75% + 8 mV)
	0.5 V/div to 2 V/div	±1%
	5 V/div to 20 V/div	±3%
0 to ±60 V	0.01 V/div to 0.2 V/div	±(0.4% + 80 mV)
	0.5 V/div to 2 V/div	±(0.75% + 80 mV)
	5 V/div to 20 V/div	±3%
0 to ±600 V	0.1 V/div to 2 V/div	±(0.65% + 0.8 V)
	5 V/div to 20 V/div	±3%

General

Weight: net, 5 lbs (2,4 kg); shipping, 8 lbs (3,9 kg).

Environment: same as Model 180A/AR except temperature which is 0°C to +55°C.

Price: HP Model 1803A, \$950.



The 1804A Four Channel Amplifier permits direct comparison of four signals simultaneously. Each of the four channels has 50 MHz bandwidth, 20 mV/div sensitivity. Ideal for logic circuit testing, the 1804A may be operated to trigger on each channel individually for asynchronous signals or for direct comparison of input/output pulses in spite of time delays. Or, the triggering may be set for one channel only for time correlation measurements.

Specifications, 1804A

Modes of operation: channels A, B, C, and D or any combination displayed alternately on successive sweeps (ALT); channels A, B, C, and D or any combination displayed by switching between channels at approx 1 MHz rate (CHOP), with blanking during switching.

Each channel (4)

Bandwidth: dc to 50 MHz (3 dB down). Lower 3 dB limit is approx 10 Hz with input ac-coupled. (Measured with or without 10004A probe; 8-div reference signal from a 25-ohm source. Lower limit is approx 1 Hz with probe.)

Risetime: <7 ns. (Measured with or without 10004A probe; 10% to 90% of 8-div input step from a 25-ohm source.)

Deflection factor

Ranges: from 0.02 V/div to 10 V/div (9 calibrated positions) in 1, 2, 5 sequence.

Attenuator accuracy: ±3%.

Vernier: provides continuous adjustment between all deflection factor ranges; extends maximum deflection factor to at least 25 V/div.

Signal delay: input signals are delayed sufficiently to view leading edge of input pulse without advance external trigger.

Input coupling: front panel selection of AC, DC, or Ground; ground position disconnects signal input and grounds amplifier for reference.

Input RC: 1 megohm shunted by approximately 25 pF; constant on all ranges.

Maximum input

DC-coupled: ±350 V (dc + peak ac); ±150 V (dc + peak ac) on 20 mV/div at 10 kHz or less.

AC-coupled: ±400 V dc.

Trace identification: pushbutton displaces respective trace approx 0.5 div.

Triggering

Source: selectable on signal from any channel in either chop or alternate mode, or successively from the displayed signal on each channel in alternate mode.

Frequency: dc to 50 MHz on signals causing 0.5 div or more vertical deflection in all display modes except Chop; dc to 200 kHz for Chop mode.

General

Weight: net, 5 lbs (2,4 kg); shipping, 8 lbs (3,9 kg).

Environment: same as Model 180A/AR except temperature which is 0°C to +55°C.

Price: HP Model 1804A, \$1050.

General-purpose time bases Models 1820A, 1821A

Time base plug-ins

The Model 1820A Time Base provides sweep speeds from 2 s/div to 50 ns/div, 5 ns/div when using Model 180A/181A X10 horizontal amplifier magnifier. Positive triggering is assured to 100 MHz and a front panel trigger holdoff control locks in complex waveforms. Automatic triggering provides a bright baseline in the absence of an input signal, and syncs on the input waveform when a vertical input signal is applied.

Model 1821A Time Base and Delay Generator provides from 1 s/div to 100 ns/div, 10 ns/div when using Model 180A/181A magnifier. It also features easy-to-use delayed sweeps. Exclusive Hewlett-Packard mixed sweep combines display of first portion of trace at normal sweep speeds, and simultaneously expands trailing portion of trace at faster delayed sweep speeds to allow magnified examination. Functional groupings of all controls simplifies operation. The internally generated delay trigger is available for external syncing.

Specifications, 1820A

Same as Model 1820B (see page 527) except for following:

Internal triggering: see Model 1802A Vertical Amplifier plug-in specifications for specific difference.

External triggering: dc to 50 MHz on signals 0.5 V pk-pk or more, increasing to 100 MHz on 1 V pk-pk or more.

Price: HP Model 1820A, \$475.

Specifications, 1821A

Main time base

Sweep

Ranges: from 0.1 μ s/div to 1 s/div (22 positions) in 1, 2, 5 sequence. $\pm 3\%$ accuracy with Vernier in calibrated position.

Vernier: continuously variable between all ranges; extends slowest sweep to at least 2.5 s/div.

Magnifier: mainframe magnifier expands fastest sweep to 10 ns/div.

Sweep mode

Normal: sweep is triggered by an internal, external, or power line signal.

Automatic: bright baseline displayed in absence of input signal. Triggering same as Normal except low frequency limit is 40 Hz for internal and external.

Single: sweep occurs once with same triggering as Normal; reset push button with indicator light.

Triggering

Internal: see vertical amplifier plug-in specifications.

External: from dc to 50 MHz on signals 0.5 V pk-pk or more, increasing to 100 MHz on 1 V pk-pk or more.

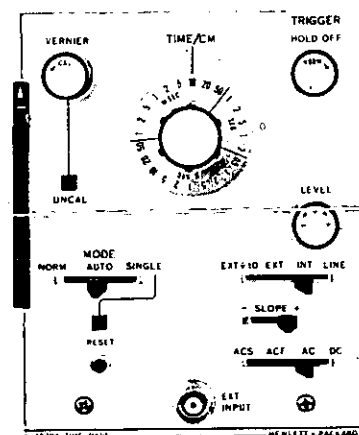
Line: selectable on power line frequency signal.

Level and slope: internal, at any point on the vertical waveform displayed. External, continuously variable from +3 V to -3 V on either slope of the sync signal; from +30 V to -30 V in $\div 10$ setting.

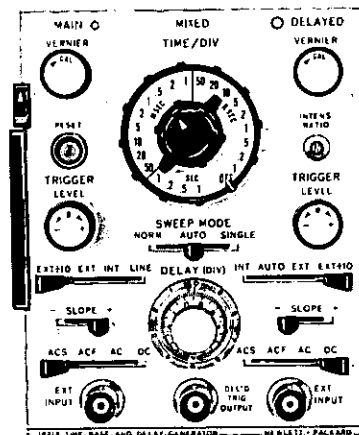
Coupling: front panel selection of ac, dc, ac fast (ACF), or ac slow (ACS). AC attenuates signals below approx. 20 Hz; ACF attenuates signals below approx. 15 kHz; ACS attenuates signals above approx. 30 kHz.

Trace intensification: used for setting up Delayed or Mixed time base. Intensifies that part of Main time base to be expanded to full screen on Delayed time base. Rotating Delayed time base sweep switch from Off position activates intensified mode. Front panel screwdriver adjust sets relative intensity of brightened segment.

Delayed time base: delayed time base sweeps after a time delay set by Main time base and Delay controls.



1820A



1821A

Sweep

Ranges: from 0.1 μ s/div to 50 ms/div (18 positions) in 1, 2, 5 sequence. $\pm 3\%$ accuracy with Vernier in calibrated position.

Vernier: continuously variable between all ranges; extends slowest sweep to at least 125 ms/div.

Triggering: applies to intensified Main, Delayed, and Mixed time base triggering.

Internal: same as Main time base triggering.

Automatic: delayed sweep is automatically triggered at end of set delay time.

External: same as Main time base triggering.

Level and slope: same as Main time base triggering.

Coupling: same as Main time base triggering.

Delay (before start of Delayed time base)

Time: continuously variable from 0.1 μ s to 10 s.

Accuracy: $\pm 1\%$. Linearity, $\pm 0.2\%$. Time jitter is less than 0.005% (1 part in 20,000) of maximum delay of each step.

Trigger output: (at end of Delay time) approximately 1.5 V with less than 50 ns risetime from 1000-ohm source resistance.

Mixed time base: dual time base in which Main time base drives first portion of display and delayed time base completes sweep at up to 1000 times faster. May be operated in single sweep mode.

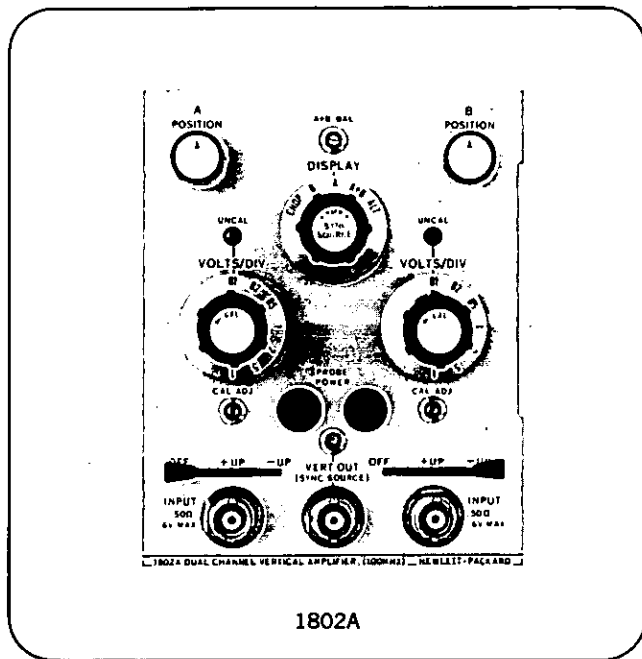
General

Weight: net, 4 lbs (1.8 kg); shipping, 7 lbs (3.2 kg).

Environment: same as Model 180A/AR.

Active components: all solid-state.

Price: HP Model 1821A, \$800.

OSCILLOSCOPES 180 SERIES *continued***Dual channel vertical amplifier**
Model 1802A

1802A

Model 1802A Dual Channel Vertical Amplifier extends precision high frequency measurements to greater than 100 MHz, when used in the 180 scope system.

Standard deflection factor for each channel is 10 mV/div. Channels may be cascaded to provide 1 mV/div deflection factor, single channel operation.

High frequency work with 50-ohm systems is simplified and accurate with the 1802A. The plug-in input has been designed to terminate a 50-ohm system. It is also ideal for probing applications since it minimizes capacitance, an obstacle to accuracy in most high frequency measurements. Capacitance reduces signal amplitude, introduces phase shift, limits risetime in circuit and in measurement, and causes a time delay.

Resistive divider probes (refer to page 508 for specifications) for Model 1802A add less than 0.7 pF. The basic 50-ohm input can be multiplied to 250, 500, 1 k, 2.5 k, or 5 k ohms, to reduce the dc loading. When a measurement requires a higher input resistance the Model 1120A Active Probe (powered by Model 1802A) can be used. (Refer to page 534 for specifications.)

Specifications, 1802A

Modes of operation: channel A alone; channel B alone; channels A and B displayed alternately on successive sweeps (ALT); channels A and B displayed by switching between channels at approx 400 kHz rate (CHOP), with blanking during switching; channel A plus channel B (algebraic addition). Vertical output allows cascading of channels.

Each channel**Bandwidth***

dc to greater than 100 MHz; with channels cascaded, dc to greater than 75 MHz. (3 dB down from 8-div reference signal from a 50Ω source.)

Risetime*

less than 3.5 ns; with channels cascaded, less than 4.5 ns. (10% to 90% of 6-div input step from a 50Ω source.)

*With Model 1120A active probe: same for source resistances from 0 to 150 ohms.

*With Model 10020A resistive divider probes; same for source resistances from 0 to 750 ohms.

Pulse response: (6 div reference at 25°C) overshoot, <3%; perturbations, <3%; tilt, <2%. With channels cascaded: overshoot, <5%; perturbations, <5%; tilt, <3%.

Deflection factor

Ranges: from 0.01 V/div to 1 V/div (7 calibrated positions) in 1, 2, 5 sequence. Channels may be cascaded using vertical output to obtain 1, 2, or 5 mV/div.

Attenuator accuracy: ±3%.

Vernier: provides continuous adjustment between all deflection factor ranges; extends maximum deflection factor to at least 2.5 V/div.

Polarity: + UP or - UP, selectable; OFF position disconnects signal input from amplifier, terminates input signal in 50 ohms and grounds amplifier input for reference.

Signal delay: input signals are delayed sufficiently to view leading edge of input pulse without advance external trigger.

Dynamic range: on screen display 6 divisions for signals to 100 MHz, increasing to 8 div at 50 MHz.

Positioning range: ±4 div.

Drift: less than ±1 div over environmental temperature range (except for cascaded operation).

Input impedance: 50 ohms ±2 ohms.

Maximum input: 0.72 watts (6 V rms).

VSWR: less than 1.35:1 at 100 MHz on 0.01 V/div; less than 1.1:1 at 100 MHz on all other deflection factors.

Reflection coefficient: less than 15% at 100 MHz on 0.01 V/div; less than 5% at 100 MHz on all other deflection factors.

Probe power: provides power to operate Model 1120A Active Probe (one each channel).

A + B operation

Amplifier: bandwidth and deflection factor are unchanged; either channel may be inverted to give ± A ± B operation.

Differential input (A - B): common mode rejection ratio greater than 40 dB for frequencies to 1 MHz, greater than 20 dB to 100 MHz; maximum common mode signal, equivalent to 6-div deflection.

Triggering

Source: selectable from chan A, chan B, or composite signal in any display mode.

Frequency: dc to greater than 120 MHz on 1 div pk-pk signals for Models 1820B or 1822A time base plug-ins; or from dc to greater than 75 MHz on 1 div pk-pk signal for Models 1820A or 1821A time base plug-ins.

Vertical signal output

Amplitude: 100 mV/div of displayed signal into 50-ohm load, adjustable with front panel control; useable amplitude, 600 mV pk-pk.

Bandwidth: dc to greater than 100 MHz.

Risetime: less than 3.5 ns.

General

Weight: net, 5 lbs (2,4 kg); shipping 8 lbs (3,9 kg).

Environment: same as Model 180A/AR except temperature which is 0°C to +55°C.

Accessories furnished: calibrator adapter (HP Part No. 01802-63201).

Price: HP Model 1802A, \$1,200.

Options: 090, two 10020A resistive divider probe sets; add \$175.

OSCILLOSCOPES 180 SERIES *continued*

Time base triggering to 150 MHz Models 1820B, 1822A

multiple triggering on signals that have desired triggering level and slope occurring more than once per cycle.

Weight: net, 3 lbs (1,4 kg); shipping, 6 lbs (2,7 kg).

Price: HP Model 1820B, \$525.

Specifications, 1822A

Main time base

Sweep

Ranges: 0.05 μ s/div to 1 s/div (23 positions) in 1, 2, 5 sequence. $\pm 3\%$ accuracy with Vernier in calibrated position.

Vernier: with uncalibrated light; continuously variable between ranges; extends slowest sweep to at least 2.5 s/div.

Magnifier: (on mainframe) expands fastest sweep to 5 ns/div.

Sweep mode

Normal: sweep is triggered by an internal, external, or power line signal.

Automatic: bright baseline displayed in absence of input signal. Same as Normal except low frequency limit is 40 Hz.

Single: sweep occurs once with same triggering as Normal; reset spring-return switch with indicator light.

Triggering

Internal: see vertical amplifier plug-in specifications.

External: from dc to 100 MHz on signals 250 mV pk-pk or more, increasing to 150 MHz on 350 mV pk-pk or more.

Line: selectable on power line frequency signal.

Level and slope: internal, at any point on the vertical waveform displayed. External, continuously variable from +3 V to -3 V on either slope of the sync signal; from +30 V to -30 V in $\div 10$ setting.

Coupling: front panel selection of ac, dc, ac fast (ACF), or ac slow (ACS). AC attenuates signals below approx. 20 Hz; ACF attenuates signals below approx. 15 kHz; ACS attenuates signals above approx. 30 kHz.

Variable hold off: time between sweeps continuously variable, exceeding one full sweep at 50 ms/div and faster. Prevents multiple triggering on signals that have desired triggering level and slope occurring more than once per cycle.

Trace intensification: used to set up Delayed or Mixed time base. Intensifies that part of Main time base to be expanded to full screen on Delayed time base. Moving Delayed sweep switch from Off position activates intensified mode. Front panel adjust sets relative intensity of brightened segment.

Delayed time base: delayed time base sweeps after a time delay set by Main time base and Delay controls.

Sweep

Ranges: 0.05 μ s/div to 50 ms/div (19 positions) in 1, 2, 5 sequence. $\pm 3\%$ accuracy with Vernier in calibrated position.

Vernier: with uncalibrated light; continuously variable between ranges; extends slowest sweep to at least 125 ms/div.

Triggering: applies to intensified Main, Delayed, and Mixed time base triggering.

Internal: same as Main time base triggering.

Automatic: delayed sweep is automatically triggered at end of set delay time.

External: same as Main time base triggering.

Level and slope: same as Main time base triggering.

Coupling: same as Main time base triggering.

Delay (before start of Delayed time base)

Time: continuously variable from 0.05 μ s to 10 s.

Accuracy: $\pm 1\%$. Linearity, $\pm 0.2\%$. Time jitter is less than 0.005% (1 part in 20,000) of maximum delay of each step.

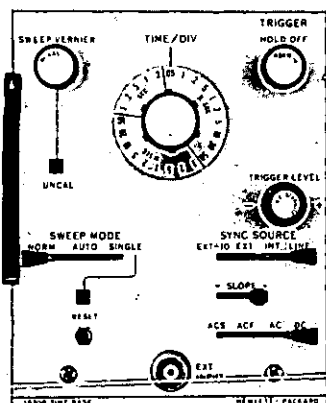
Trigger output: (at end of Delay time) approximately 1 V with less than 50 ns risetime from 1000-ohm source resistance.

Mixed time base: dual time base in which Main time base drives first portion of display and delayed time base completes sweep at up to 1000 times faster. May be operated in single sweep mode.

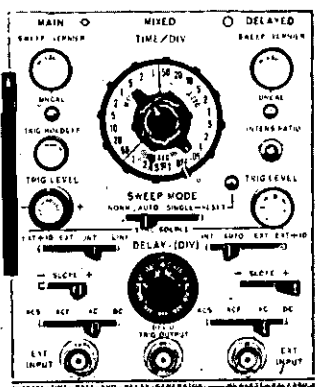
Weight: net, 4 lbs (1,8 kg); shipping, 7 lbs (3,1 kg).

Price: HP Model 1822A, \$900.

1820B



1822A



Model 1820B Time Base has sweep speeds to 5 ns/div (using mainframe magnifier) and triggering capability to 150 MHz. A trigger hold-off control allows easy triggering on complex waveforms.

Model 1822A has the same basic features as the 1820B, i.e., 5 ns sweep, 150 MHz triggering, and trigger hold off. In addition, it provides a delayed sweep to allow viewing of a waveform at a faster sweep speed.

Specifications, 1820B

Sweep

Ranges: 0.05 μ s/div to 2 s/div (24 positions) in 1, 2, 5 sequence. $\pm 3\%$ accuracy with Vernier in calibrated position.

Vernier: with uncalibrated light; continuously variable between ranges; extends slowest sweep to at least 5 s/div.

Magnifier: (on mainframe) expands fastest sweep to 5 ns/div.

Triggering

Normal

Internal: see vertical amplifier plug-in specifications.

External: dc to 100 MHz on signals 250 mV pk-pk or more, increasing to 150 MHz on 350 mV pk-pk or more.

Line: selectable, from line frequency.

Automatic: bright baseline displayed in absence of input signal. Same as Normal except low frequency limit is 40 Hz.

Single sweep: selectable by front panel switch; reset push button with armed indicator light.

Trigger level and slope

Internal: at any point on the vertical waveform displayed.

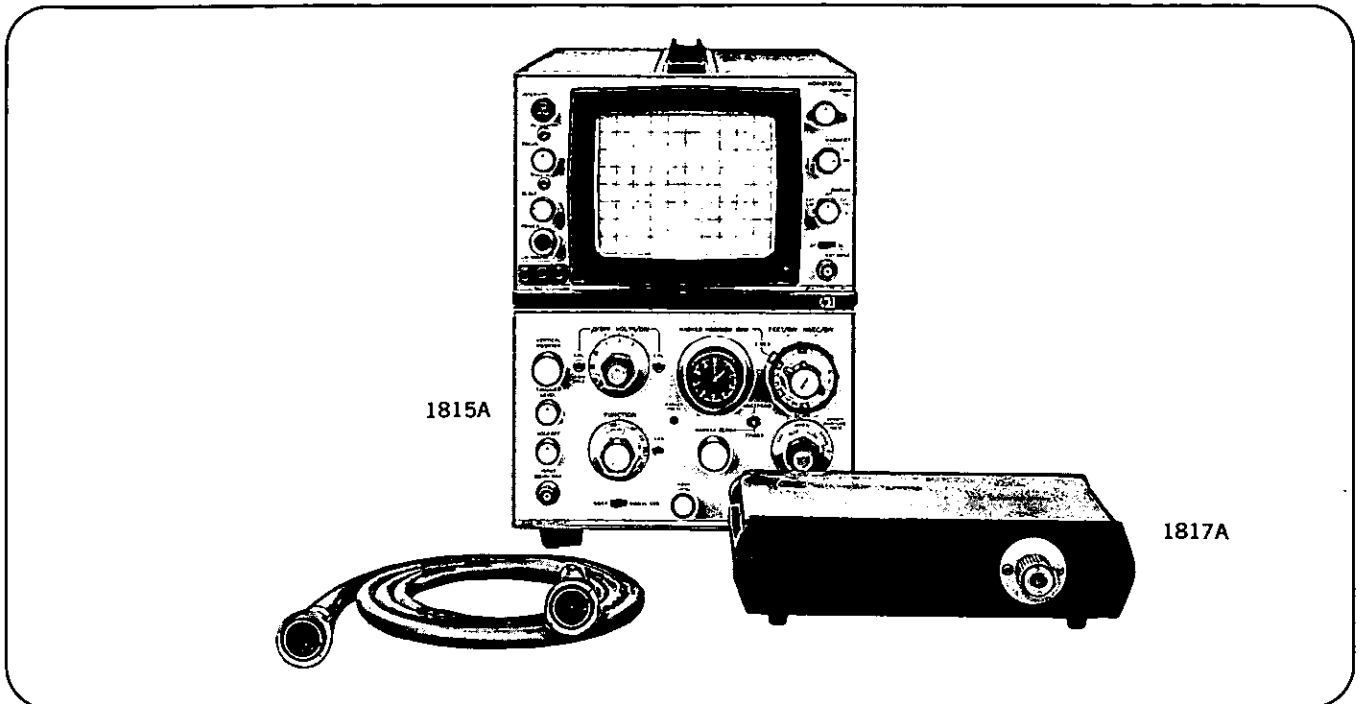
External: continuously variable from +3 V to -3 V on either slope of the sync signal; from +30 V to -30 V in $\div 10$ setting.

Coupling: front panel selection of ac, dc, ac fast (ACF), or ac slow (ACS). AC attenuates signals below approx. 20 Hz; ACF attenuates signals below approx. 15 kHz; ACS attenuates signals above approx. 30 kHz.

Variable hold off: time between sweeps continuously variable, exceeding one full sweep at 50 ms/div and faster. Prevents

OSCILLOSCOPES 180 SERIES *continued*

35 ps TDR/12.4 GHz sampling
Models 1815A,B; 1816A; 1817A



Calibrated 35 ps risetime time domain reflectometry and 12.4 GHz (28 ps risetime) sampling capabilities are now available as part of the versatile 180 system oscilloscope.

The Model 1815A TDR/Sampler plug-in, a double-sized plug-in for the 180 system, can be combined with appropriate remote sampler head and tunnel diode mount to obtain a calibrated TDR system which is three times faster than was previously available, providing considerably greater resolution. Direct readout in feet along the line is obtained from the 1815A; Model 1815B is calibrated in meters. Either Model 1106A (20 ps) or Model 1108A (60 ps) tunnel diode mount is compatible for TDR with the plug-in and samplers.

These same plug-in and sampler heads used for TDR measurements also serve as either a 4 GHz or 12.4 GHz sampling system with a direct readout in time. For sampling use, there is direct triggering to 500 MHz and to 18 GHz with Model 1104A/1106A trigger countdown.

Sampling heads, Model 1816A (90 ps risetime) and Model 1817A (28 ps risetime), are detachable, remote, single channel, feed-through samplers for convenient use in 50-ohm transmission systems. The plug-in and sampler heads provide the circuitry for operating the tunnel diode pulse generators.

Several new circuit techniques contribute to this new standard of versatility and accuracy. These include:

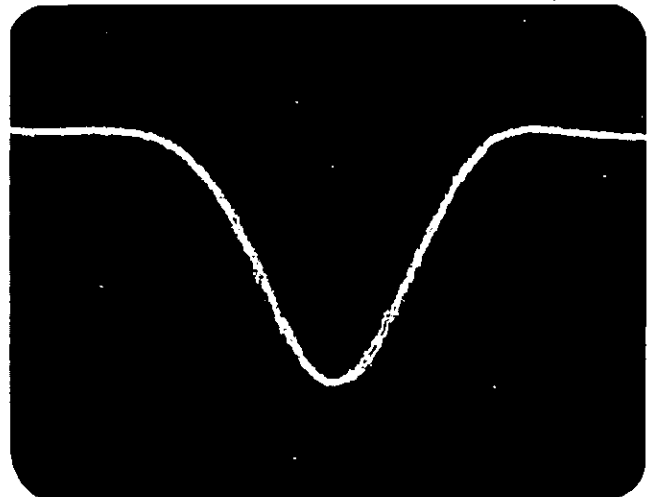
1. A new circuit for generating the sampling pulses, which is inherently far more stable with temperature variations.

2. A signal-averaging circuit (superseding the previous smoothing technique) which reduces noise and jitter by a ratio of 2:1 or more. This technique does not degrade risetime performance, with only a slight decrease in display rate. Performance can be fully optimized even with slow display rates by use of the Model 181A/AR variable persistence and storage mainframe.

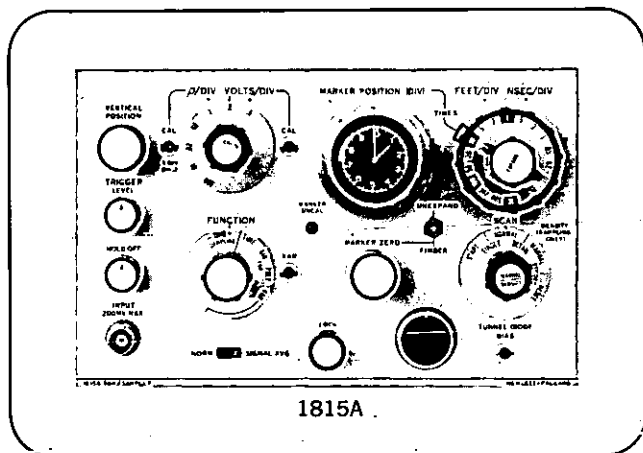
3. Unique marker zero which shifts reference of calibrated marker position to any point on the display. This permits direct read-out of differential time or distance measurements.

4. Electronic delay circuit which keeps the leading edge of a step function on-screen over all sweep speeds and for a wide ambient temperature range.

This calibrated TDR system allows analysis of coaxial microwave components, identifying discontinuities on the order of 0.25 inch apart. Typical components that can be analyzed are connectors, adapters, coaxial-to-circuit board transitions, loads, etc. Direct read-out in reflection coefficient, feet, or meters (optional) makes measurements faster and easier to interpret. Front panel calibration for air and polyethylene dielectrics is standard. In addition, the control allows variable calibration for different dielectrics from $\epsilon = 1$ to $\epsilon = \text{approx. } 4$.



CRT display using Model 1815A/1817A/1106A TDR system slows the reflection from HP Model 874B Susceptance Standard set at 1 pF equivalent capacitive discontinuity. Scale: 20 ps/div horizontal, 0.1 p/div vertical.



Specifications, 1815A TDR/sampler plug-in

Unless indicated otherwise, TDR and sampling performance specifications are same. Where applicable, TDR specification is given first, followed by Sampler specification in parentheses.

Vertical

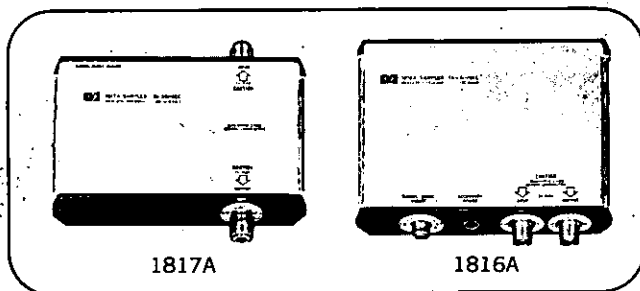
Scale: reflection coefficient ρ (volts) from 0.005/div to 0.5/div in 7 calibrated ranges; 1, 2, 5 sequence.

Accuracy: $\pm 3\%$; TDR only, $\pm 5\%$ on 0.01/div and 0.005/div in signal average mode.

Vernier: provides continuous adjustment between ranges; extends scale to greater than 0.002/div.

Signal average: reduces noise and jitter approx. 2:1.

Samplers and tunnel diodes



Specifications, 1817A and 1816A 28 ps and 90 ps samplers

Unless indicated otherwise, Model 1817A and Model 1816A specifications are same. Where applicable, Model 1817A specification used with Model 1106A tunnel diode mount is given first, followed by Model 1816A specification (in parentheses) used with Model 1108A tunnel diode mount.

TDR system

System risetime: less than 35 ps (110 ps) incident as measured with Model 1106A (Model 1108A). Less than 45 ps (145 ps) reflected at shorted output connector.

Overshoot: less than $\pm 5\%$.

Internal reflections: less than 10% with 45 ps (145 ps) TDR; use reflected pulse from shorted output.

Jitter: less than 15 ps; with signal averaging, typically 5 ps.

Internal pickup: $\rho \leq 0.01$.

Noise: measured tangentially as a percentage of the incident pulse when terminated in 50 Ω and operated in signal averaging mode. Less than 1% (0.5%) on 0.005/div to 0.02/div; less than 3% (1%) on 0.05/div to 0.5/div.

Low frequency distortion: $\leq \pm 3\%$.

Maximum safe input: 1 volt.

Sampler system

Risetime: less than 28 ps (90 ps).

Input: 50 Ω feed-through.

Dynamic range: 1 volt.

Horizontal

Scale: round-trip time or distance (time) in four calibrated decade ranges of 1/div, 10/div, 100/div, and 1000/div. Concentric expand control provides direct read-out in 28 calibrated steps in 1, 2, 5 sequence from 0.01 ns/div to 1000 ns/div or from 0.01 feet/div to 1000 feet/div (0.01 ns/div to 1000 ns/div).

Accuracy: time, $\pm 3\%$; distance, TDR only, $\pm 3\%$ \pm variations in propagation velocity.

Marker position: ten-turn dial, calibrated in divisions; provides direct read-out of round-trip time or distance (time), number of divisions X decade range in units/div.

Marker zero: ten-turn control provides variable reference for marker position dial; allows direct read-out of round-trip time or distance (time) between two or more displayed events.

Zero finder: permits instant location of marker reference.

Dielectric, TDR only: calibrated for air, $\epsilon = 1$, and for polyethylene, $\epsilon = 2.25$. Also provides variable settings for dielectric constants from $\epsilon = 1$ to $\epsilon =$ approx 4.

Triggering, sampling only:

Pulses: less than 50 mV for pulses 5 ns or wider for jitter < 20 ps.

CW: signals from 500 kHz to 500 MHz require at least 80 mV for jitter less than 2% of signal period plus 10 ps; usable to 1 GHz. CW triggering may be extended to 18 GHz with HP Models 1104A/1106A trigger countdown.

Recorder outputs: approx. 100 mV/div; vertical and horizontal outputs at BNC connectors on rear panel of mainframe.

Display modes: repetitive scan, normal or detail; single scan; manual scan; record.

Weight: net, 5 lbs (2,3 kg); shipping, 10 lbs (4,5 kg).

Model 1815B: distance calibrated in meters instead of feet.

Price: HP Model 1815A or 1815B, \$1100.

Maximum safe input: 3 volts (5 volts).

Low frequency distortion: $\leq \pm 3\%$.

Noise:

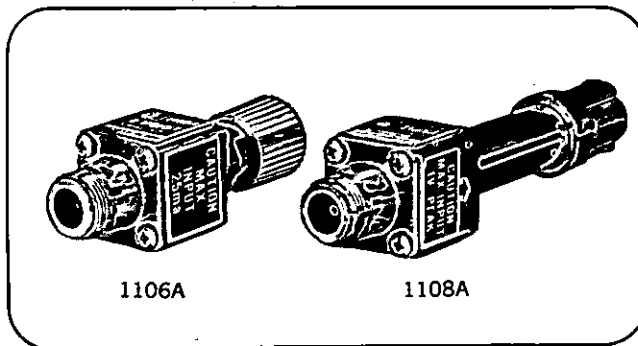
Normal: less than 8 mV (3 mV) tangential noise on 0.01 V/div to 0.5 V/div. Noise decreases automatically on 0.005 V/div.

Signal average: reduces noise and jitter approx. 2:1.

Tunnel diode mount: direct connection for either Model 1106A or Model 1108A tunnel diode mount for TDR system.

Weight: net, 3 lbs (1,4 kg); shipping, 7 lbs (3,2 kg).

Price: HP Model 1816A, \$850; HP Model 1817A, \$1500.



Specifications, 1106A and 1108A 20 ps and 60 ps tunnel diode mounts

Tunnel diode mount connects directly to sampler head for TDR system.

Amplitude (both): greater than 200 mV into 50 Ω .

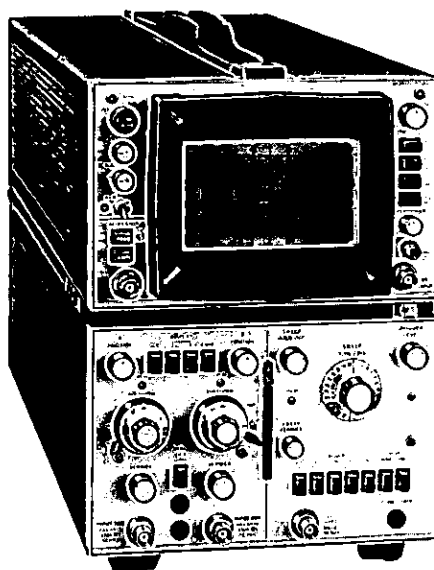
Risetime: Model 1106A, approx. 20 ps; Model 1108A, less than 60 ps.

Output impedance: 50 $\Omega \pm 2\%$.

Source reflection: Model 1106A, less than 10% with 45 ps TDR; Model 1108A, less than 10% with 145 ps TDR.

Weight (both): net, 1 lb (0,5 kg); shipping, 3 lbs (1,4 kg).

Price: HP Model 1106A, \$550; HP Model 1108A, \$175.

OSCILLOSCOPES 180 SERIES *continued***250 MHz Real-time Bandwidth
Model 183A/B**

183A

A new member of the Hewlett-Packard 180 series Oscilloscope family, Model 183A/B with 1830A and 1840A plug-ins, brings you realtime frequency response from dc to 250 MHz with the same operating ease, serviceability, and plug-in versatility found in the 180 series. Now you can make repetitive and single-shot realtime measurements that were previously possible only with sampling Oscilloscopes or special purpose low-sensitivity scopes designed for display of single-shot transients.

Fast risetimes are necessary when viewing digital words or groups of short-duration, fast-rise pulses from computers and high-speed digital systems. When a word rate is too slow for sampling scope display, this realtime scope clearly displays every word bit. The 250 MHz response also makes possible distortion free RF carrier modulation envelope displays.

High frequency performance and fast risetime (<1.5 ns), are essential when photographing fast, single-shot signals, as in nuclear and high-energy experiments. As an aid in capturing single-shot signals, Model 183 CRT has an internal pulsed flood-gun that illuminates the phosphor to increase film sensitivity. The pulsed flood-gun increases single-shot photographic writing speed (4 cm/ns*) and provides a neutral gray background with a well defined black CRT graticule. The CRT potential of 20 kV gives you the fast writing speed necessary for high frequency realtime displays.

The 183A/B is a new generation laboratory oscilloscope mainframe, which will operate beyond 500 MHz. The 1830A vertical amplifier allows you to measure from dc to 250 MHz. As the integrated circuit state-of-the-art increases, you will only need a new vertical amplifier plug-in for wider bandwidth—not a new mainframe. The 183 distributed deflection plate CRT has a deflection factor of 3 V/cm which is compatible

with solid-state circuits. The calibrator has a completely specified output that allows you to validate both vertical and horizontal plug-in performance.

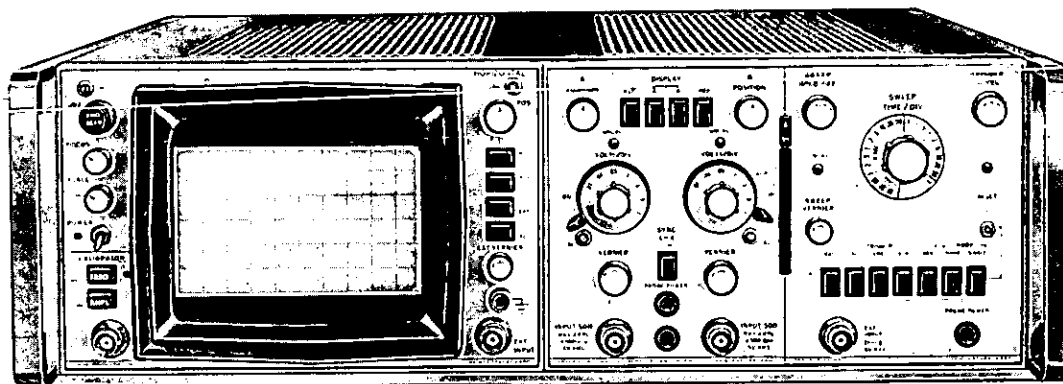
High-frequency performance is obtained without restricting other general purpose applications. The mainframe works with all 1800 series plug-ins (minor modification is required because of different CRT capacitance of the 180 and 181 Oscilloscopes). These include: a 4 channel 50 MHz amplifier, dc offset plug-in, delaying sweep time base, and a 12.4 GHz sampling and time-domain reflectometer plug-ins.

With the present 1830A vertical amplifier plug-in, the Model 183A/B is a 250 MHz bandwidth dual-trace instrument that clearly displays, on a 6 cm by 10 cm internal graticule, two input signals in single, alternate, or chopped (time shared) modes. The plug-in input has a 50 ohm impedance that terminates a 50 ohm system and keeps VSWR to a minimum. This 50 ohm system provides a constant load impedance, and allows direct probing of high frequency signals with minimum signal degradation from capacitive loading. If higher probe resistances are desired, passive resistive-divider probes with a slight capacitive increase (0.7 pF) are available. Or, the 1:1, 500 MHz bandwidth, active probe Model 1120A, translates the 50 ohm input impedance to 100 k ohm/3 pF at the probe tip (<1 pF at $\div 10$).

The Model 1840A Time Base sweep circuits trigger reliably to 250 MHz by synchronizing signals which are generated in the 1830A. External input signals of 20 mV peak-to-peak will trigger Model 1840A to 250 MHz, increasing to 500 MHz triggering with 50 mV peak-to-peak signals. The time base provides sweep speeds of 0.01 μ s/div and by using the mainframe X10 multiplier sweep speed increases to 1 ns/div.

*With 10,000 ASA films, P31 phosphor, f/1.3 lens, 1:0.5 object to image ratio, and pulsed flood gun fogging.

250 MHz Real-time Bandwidth
Model 183A/B



183B

Specifications, 183A/B

Cathode-ray tube and controls

Type: post accelerator, 20 kV accelerating potential; aluminized P31 phosphor (other phosphors available, see options); safety glass faceplate.

Graticule: 6 x 10 division parallax-free internal graticule. 0.2 division subdivisions on major axes. 1 div = 1 cm. SCALE control adjusts flood gun that illuminates CRT phosphor for viewing with a hood and controls the pulsed flood gun that increases photographic writing speed. Normal or pulsed mode flood gun operation selected by rear panel switch.

Beam finder: returns trace to CRT screen regardless of horizontal, or vertical position control settings, which allows easy positioning of off-screen traces.

Intensity modulation: approximately +2 V dc to 15 MHz; blanks trace of normal intensity. Input R, 4.7 k ohms. (+15 V blanks any intensity trace.)

Calibrator

Pulse timing: ($\pm 0.5\%$ 10°C to 40°C, $\pm 1.0\%$ 0°C to +55°C).

Mode 1: Rep-rate; 2 kHz (0.5 ms period), Pulse Width; 50 μ s.

Mode 2: Rep-rate; 1 MHz (1 μ s period), Pulse Width; 100 ns.

Amplitude: selectable 50 mV and 500 mV, $\pm 1\%$ into 50 $\pm 0.5\%$ ohms.

Source impedance: 50 ohms.

Pulse shape: (measured with 1 GHz bandwidth).

Risetime (Neg): < 1 ns.

Overshoot and ringing: $\pm 3\%$ max.

Flatness (pulse top & baseline with perturbations averaged): $\pm 0.5\%$ after 5 ns.

External calibrator input: rear panel input selectable with rear panel switch. Front panel light indicates when switch is in EXT position. The calibrator shaper network shapes an external negative input which exceeds -0.5 V peak. Rep-rate extends to >10 MHz. Input impedance approximately 10 k Ω .

Horizontal amplifier

Bandwidth: dc-coupled; dc to 8 MHz. ac-coupled; 2 Hz to 8 MHz.

Deflector factor: 1.0 V/div in X1, 0.1 V/div in X10; $\pm 3\%$

with VERNIER in CAL position. Vernier provides continuous adjustment between ranges extends deflection factor to 10 V/div. Dynamic range, ± 20 V.

Input RC: approximately 1 megohm shunted by approximately 20 pF.

Maximum input: 350 V (dc + peak ac).

Sweep magnifier: X1, and X10; magnified sweep accuracy, $\pm 5\%$ (with $\pm 3\%$ accuracy time base plug-in). Allows 1 ns/div with 1840A.

Outputs: two emitter follower outputs on rear panel for main and delayed gates or Vertical and Horizontal outputs when used with sampling plug-ins. Approximately 0.75 V with 1840A; outputs will drive impedances down to 1000 ohms without distortion.

General

Weight: (without plug-ins) Model 183A, net 33 lb (15 kg); shipping 46 lb (20.9 kg). Model 183B, net 35 lb (15.9 kg); shipping 48 lb (21.8 kg).

Environment: 183A/B operates within specifications over the following ranges:

Temperature: 0°C to +45°C.

Humidity: to 95% relative humidity to 40°C.

Altitude: to 15,000 feet.

Vibration: vibrated in three planes for 15 minutes each with 0.010 inch excursion, 10 to 55 Hz.

Power: 115 or 230 V $\pm 10\%$, 50 to 400 Hz, less than 170 watts at normal line with plug-ins.

Dimensions:

Cabinet: 7 $\frac{7}{8}$ " wide, 11 $\frac{3}{8}$ " high, 23 $\frac{3}{8}$ " deep behind panel (200 x 289 x 594 mm).

Rack: 19" wide, 5 $\frac{1}{4}$ " high, 21 $\frac{3}{8}$ " deep behind panel (483 x 133 x 543 mm); 23 $\frac{3}{8}$ " deep over-all.

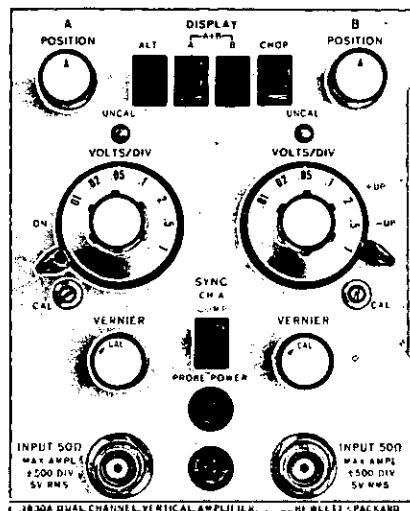
Options: CRT phosphor (specify by option number); P31 standard, P2, option 002; P7, option 007; P11, option 011, no extra charge.

Price: HP Model 183A (cabinet), \$1750. HP Model 183B (rack), \$1825.

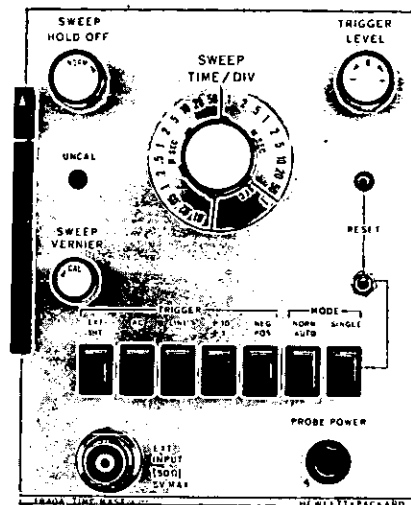
Accessories: refer to page 534.

OSCILLOSCOPES 180 SERIES *continued*

Dual channel vertical amplifier, time base Models 1830A, 1840A



1830A



1840A

Specifications, 1830A

Modes of operation: Channel A alone; Channel B alone; Channels A and B displayed alternately on successive sweeps (ALT); Channels A and B displayed by switching (time shared) between channels, chop frequency of approx 250 kHz; Channel A plus Channel B; Channel A minus Channel B.

Each channel

Bandwidth: dc to 250 MHz, 3 dB down from 6 div reference signal, 50-ohm source.

Risetime: ≤ 1.5 ns, 10% to 90% with 6 div input step, 50 ohm source.

Deflection factor

Ranges: from 0.01 V/div to 1 V/div (7 positions) in 1, 2, 5 sequence. $\pm 3\%$ accuracy; calibration adjust on front panel. Maximum input, 0.5 watts.

Vernier: continuously variable between all ranges, extends deflection factor to 2.5 V/div vernier UNCAL (uncalibrated) light indicates when vernier is not in the calibrated position.

Signal delay: > 55 ns to allow viewing the leading edge of a pulse without external delay.

Input characteristics

Reflection coefficient: (measured with 1 ns TDR risetime) $\leq 10\%$ on 10 mV/div and $\leq 5\%$ from 20 mV/div to 1.0 V/div.

VSWR: ≤ 1.30 on 10 mV/div and ≤ 1.20 from 20 mV/div to 1.0 V/div at 250 MHz.

Maximum input: 5 volts rms or ± 500 div peak, whichever is less.

Polarity: selectable + up or - up on Channel B.

Probe power: provides power for operating two Model 1120A probes.

DC drift: short term drift/min and long term drift/hr ≤ 0.05 div after $\frac{1}{2}$ hr from turn-on at constant ambient temperature.

A + B operation

Amplifier: meets independent channel specifications for risetime and bandwidth. B channel may be inverted for A-B operation.

Triggering:

Channel A or composite (on displayed signal).

Frequency: dc to > 250 MHz on signals causing 1 division or more vertical deflection in all modes.

General

Weight: net, 5 lb (2,3 kg); shipping, 8 lb (3,6 kg).

Environment: same as Model 183A/B.

Price: HP Model 1830A, \$850.

Specifications, 1840A

Sweep

Ranges: from 10 ns/div to 0.1 s/div in 1, 2, 5 sequence; $\pm 3\%$ accuracy with vernier in calibrated position. Mainframe magnifier extends fastest speed to 1 ns/div with $\pm 5\%$ accuracy.

Vernier: continuously variable between all ranges, extends slowest sweep to at least 0.25 s/div.

Triggering

Normal

Internal: dc to > 250 MHz with 1830A plug-in and signals producing 1.0 div or more vertical deflection.

External: dc to > 250 MHz with signals of 20 mV peak-to-peak or more, increasing to 50 mV at 500 MHz. Input impedance 50 ohms ± 10 trigger attenuator allows wider dynamic range of INT and EXT trigger input.

Automatic: bright baseline displayed in absence of trigger signal. Triggering is same as normal except low frequency limit is 50 Hz for internal and external triggering.

Single sweep: selectable with front panel switch; reset push-button with armed indicator light. Rear panel input provides remote arming.

Trigger level and slope

Internal: any point on the vertical waveform displayed.

External: trigger level continuously variable from +0.1 V to -0.1 V on either slope of sync signal; from +1.0 V to -1.0 V in ± 10 setting.

Coupling: front panel selection of ac or dc. AC attenuates signals below approximately 5 kHz.

Variable hold off: time between sweeps continuously variable, exceeding one full sweep on all ranges. Prevents multiple triggering on signals that have desired triggering level and slope occurring more than once per cycle.

General

Weight: net, 3 lb (1,4 kg); shipping 6 lb (2,7 kg).

Environment: same as Model 183A/B.

Price: HP Model 1840A, \$550.

RUGGEDIZED OSCILLOSCOPES

Designed to meet military requirements
AN/USM-281A



OSCILLOSCOPES

Model AN/USM-281A

The AN/USM-281A (1551A Opt 021 system) is an accurate, versatile, lightweight, general purpose oscilloscope that meets the rugged requirements of military environmental and electrical specifications. The complete AN/USM-281A system includes mainframe, dual channel vertical amplifier, time base and delay generator, and a front panel cover with probes and accessories.

Specifications

Mainframe, vertical amplifier, and time base and delay generator specifications are the same as the Model 180A, 1801A, and 1821A specifications except as noted below:

Mainframe OS-189A(P)/USM-281 (180F Opt 021)

Cathode-ray tube

Type: post accelerator, 12 kV accelerating potential; aluminumized P31 phosphor, NESA coated safety glass face plate.

Display area: meets MIL-O-24311(EC) for 10 cm horizontal and 6 cm vertical display area, ± 3 cm about the center horizontal graticule line.

General

Weight: 28 lb (12.7 kg); shipping 43 lb (19.5 kg).

Case: instrument is enclosed in a removable, louvered, drip-proof combination cover and case.

Price: OS-189A(P)/USM-281 (180F Opt 021), \$1215.

Vertical Amplifier PL-1186A/USM (1801F Opt 021)

Each channel

Bandwidth: dc to 50 MHz dc-coupled; 2 Hz to 50 MHz ac-coupled; direct or with 10003A probe; 3 dB down from 6 div reference signal from 25 ohm source.

Risetime: < 7 ns. Direct or with probe; 10% to 90% with 6 div input step from 25 ohm source.

Magnifier: X5 magnifier provides 1 mV/div deflection factor to 20 MHz.

Triggering

Mode: A, B, or A + B; on displayed signal.

Chop: on channel B signal.

Alternate: on channel B signal or the signal displayed by each channel.

Price: PL-1186A/USM (1801F Opt 021), \$800.

Time Base and Delay Generator PL-1187A/USM (1821F Opt 021)

Main time base

Sweep range: 23 ranges, 0.1 μ s/div to 2 s/div in 1, 2, 5 sequence, $\pm 3\%$.

Vernier: provides continuous adjustment between steps; extends slowest sweep to at least 5 s/div.

Price: PL-1187A/USM (1821F Opt 021), \$920.

Accessory Cover CW-1082/USM-281A (10164B Opt 021)

The accessory cover protects the instrument front panel and contains the following accessories: two Model 10003A/B high impedance probes; two rf cables, four 0.6 amp fuses; 8 adapters, and 12 probe tips.

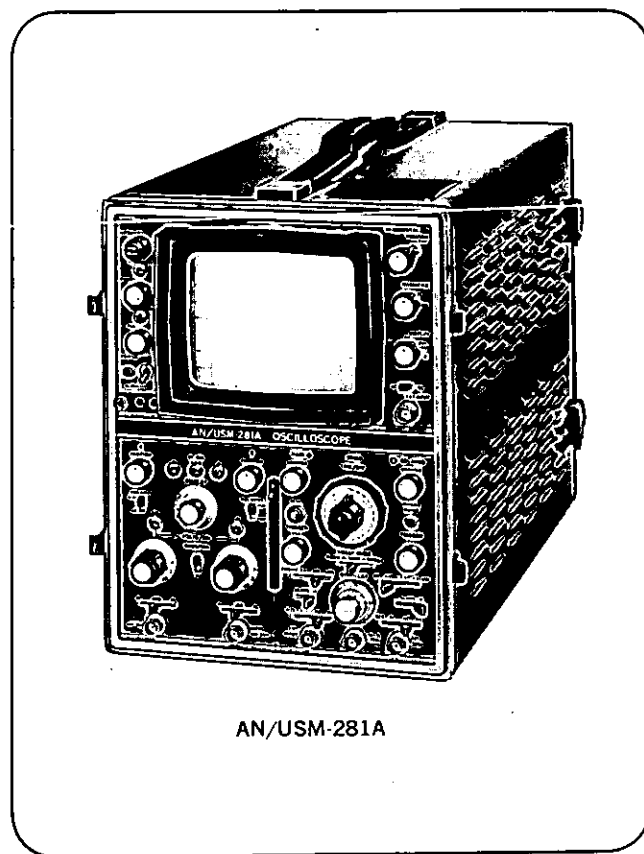
Price: CW-1082/USM-281A (10164B Opt 021) \$165.

System Environmental Specifications

Meets all environmental requirements of MIL-O-24311(EC)

Temperature: non-operating -62°C to $+75^{\circ}\text{C}$ (storage).

Operating -28°C to $+65^{\circ}\text{C}$.



AN/USM-281A

Humidity: operating 0 to 95% RH over entire specified temperature range. Non-operating—same as above.

Altitude: non-operating—sea level to 50,000 ft. Operating—sea level to 25,000 ft.

Vibration: operating—5 Hz to 15 Hz .030 \pm 0.006 inches, 16 Hz to 25 Hz .020 \pm 0.004 inches, 26 Hz to 33 Hz 0.10 \pm 0.002 inches.

Shock: operating 1 ft, 3 ft, and 5 ft. 400 pound hammer blows in vertical, horizontal and longitudinal axis. Per MIL-STD-901, Grade A, Class 1, Type A for lightweight equipment.

Inclination: operating—per MIL-E-16400.

Dripproof: non-operating—per MIL-STD-198.

Salt spray: non-operating—per MIL-E-16400.

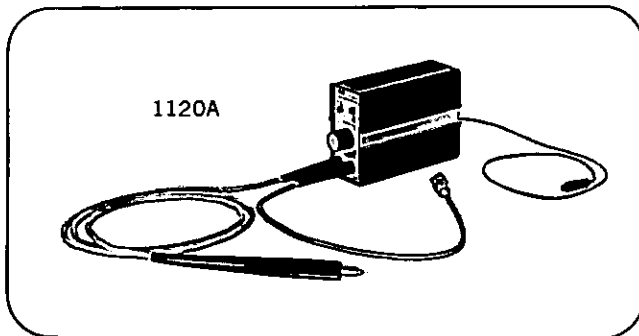
Electromagnetic interference: per MIL-STD-462 performed by MIL-STD-461 for the following test:

- a. CE01 30 Hz to 20 kHz power leads.
- b. CE03 0.02 Hz to 50 MHz power leads.
- c. CS01 0.03 Hz to 50 kHz power leads.
- d. CS02 0.05 Hz to 400 MHz power leads.
- e. CS06 Spike Power leads.
- f. RE01 0.03 Hz to 30 kHz, Mag. Field.
- g. RE02 14 kHz to 10 GHz, Elect. Field.
- h. RS01 0.03 Hz to 30 kHz, Mag. Field.
- j. RS03 14 kHz to 10 GHz, Elect. Field.

Reliability: tested per MIL-O-24311(EC). 8 instruments operated for total of 2630 operating hours at 40°C and vibrated at 25 Hz with an amplitude of 0.020 inch for 10 minutes of each hour of "on" time during each day of the 8 hour manned cycle. The input power was removed for 10 minutes of each 4 hours during the same manned test schedule. Proven MTBF of 600 hours with 99% confidence level.



For probing high source impedances at high frequencies, the 500 MHz bandwidth Model 1120A, 1:1 active probe provides a probe tip impedance of 100 k ohms shunted by <3 pF with a 50 ohm output impedance for the Models 1802A (100 MHz) and 1830A (250 MHz) plug-ins. This active probe has very low drift and noise, and when used with the 10:1 or 100:1 dividers the shunt capacitance is <1 pF.



Specifications, 1120A

Bandwidth

DC-coupled: dc to >500 MHz.

AC-coupled: <1.5 kHz to >500 MHz.

Pulse response: risetime, <0.75 ns; perturbations, $<\pm 5\%$ measured with 1 GHz sampler.

Gain: 1:1, $\pm 5\%$.

Dynamic range: ± 0.5 V with ± 5 V dc offset.

Noise: approximately 1.5 mV (measured tangentially with 1 GHz sampler); approximately 0.8 mV (measured tangentially) with Model 1830A.

Drift: probe tip; $<\pm 100$ μ V/ $^{\circ}$ C; amplifier, $<\pm 200$ μ V/ $^{\circ}$ C.

Input impedance: 100 k ohms; shunt capacitance <3 pF at 100 MHz, with 10:1 divider shunt capacitance is <1 pF.

Maximum input: ± 100 V.

Weight: net, $2\frac{1}{4}$ lb (1,0 kg); shipping, $4\frac{1}{4}$ lb (1,9 kg).

Power: supplied by 1802A, 1830A, or 1840A plug-ins or Model 1122A probe power supply. $+15$ V $\pm 2\%$, 110 mA; -12.6 V $\pm 2\%$, 70 mA.

Length: over-all, 4 ft; with option 006, 6 ft.

Accessories furnished

Model 10241A 10:1 divider: increases input impedance to approximately 1 megohm; shunt capacitance <1 pF at 100 MHz; increases dynamic range to ± 50 V, offset range to ± 350 V, maximum input to ± 350 V. Pulse response: perturbations within $\pm 5\%$ measured with 1 GHz sampler.

Model 10243A 100:1 divider: increases input impedance to approximately 1 megohm; shunt capacitance <1 pF at 100 MHz; increases dynamic range to ± 50 V, offset range to 350 V, and maximum input to ± 350 V. Pulse response: perturbations within $\pm 5\%$ measured with 1 GHz sampler.

Model 10242A bandwidth limiter: reduces bandwidth to approximately 27 MHz shunted by approximately 6 pF and reduces gain $<2\%$.

Also included: a Model 10229A hook tip, 2.5-inch ground lead, spare probe tips and a BNC probe adapter.

Price: Model 1120A, \$350. Model 1120A option 006, add \$25.

Model 1122A Probe power supply

Model 1122A power supply can power up to four Model 1120A or 1123A Active Probes.

Specifications, 1122A

Probe-driving capability: up to four Model 1120A or 1123A Active Probes.

Dimensions: $5\frac{1}{2}$ " wide, $3\text{-}7/16$ " high, $1\frac{1}{8}$ " deep (140 x 87 x 295 mm).

Power: 115 V or 230 V $\pm 10\%$, 50 to 400 Hz.

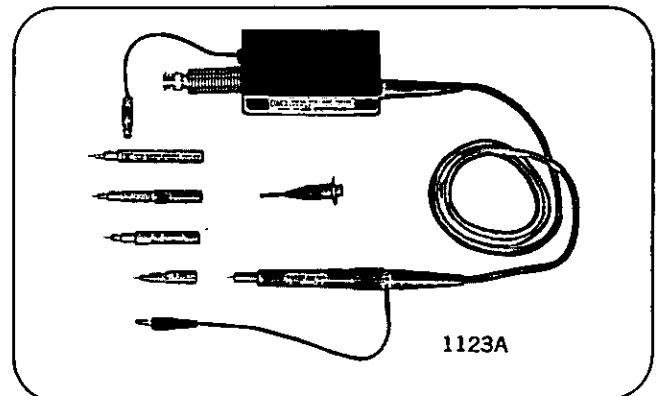
Weight: net, 6 lb (2,7 kg); shipping, 8 lb (3,6 kg).

Price: HP Model 1122A, \$225.

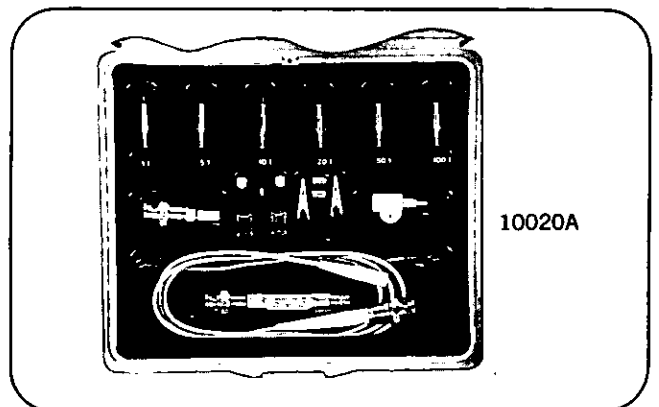
Model 1123A Active Probe

When probing high source impedances, the Model 1123A may be used to apply input signals to the Model 1802A 100 MHz plug-in. This 1:1 active probe has an input impedance of 100 k ohms shunted by <3.5 pF, 1.6 ns risetime, 220 MHz bandwidth, at a maximum input of ± 50 V. Divider tips, blocking capacitors, and other convenient accessories are supplied. This active probe may be powered by either Model 1802A plug-in or Model 1122A power supply.

Price: Model 1123A, \$350.

**Resistive dividers**

Model 10020A miniature resistive dividers facilitate signal measurements with instruments that have 50 ohm inputs. Dividers allow probing various source impedances, all with just 0.7 pF of shunt capacitance. For specifications, refer to page 508.

**Special purpose probes****Current probe**

With the HP Model 1110A Current Probe you can observe fast-rise, ac current waveforms on any wideband oscilloscope. The following specifications include Model 1110A specifications when using a Model 10100B 100 ohm feed-through termination.

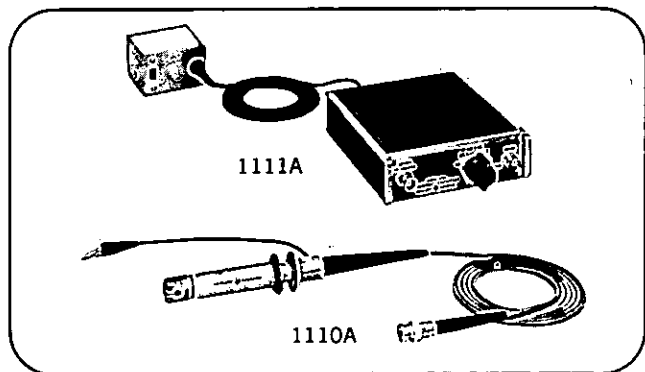
Specifications, 1110A/10100B

Sensitivity: 1 mV/mA without 10100B, 0.5 mV/mA with 10100B.
Accuracy: ±3%.
Bandwidth: lower limit; 1700 Hz without 10100B, 850 Hz with 10100B.
Upper limit: inversely proportional to capacitance of load; 4 pF load, 45 MHz, 7 ns risetime; 30 pF load; 35 MHz, 9 ns risetime.
Maximum dc current: 0.5 ampere.
Maximum ac current: 15 amperes pk-pk above 4 kHz; decreasing below 4 kHz at the rate of 3.8 A/kHz (30 A pk-pk max with Model 10100B).
Insertion impedance: approximately 0.01 ohm, shunted by 1 μH; capacitance to ground is less than 3 pF.
Dimensions: aperture 5/32" (4 mm) dia; 5 ft cable.
Price: HP Model 1110A, \$100. HP Model 10100B, \$18.
Current probe amplifier

The Model 1111A Amplifier increases the 1110A Probe sensitivity and extends low frequency response. When used with a 50 mV/div sensitivity oscilloscope, the Model 1111A attenuator indicates directly in mA/div on the CRT and eliminates cumbersome conversion factors.

Specifications, 1110A with 1111A

Sensitivity: 1 mA/div to 50 mA/div in X1, and 100 mA/div to 5 A/div in X100 (1, 2, 5 sequence when used with an oscilloscope at 50 mV/div sensitivity).
Accuracy: ±3% on 50 mA/div sensitivity and below; ±4% on 100 mA/div sensitivity and above (when Models 1110A and 1111A are calibrated together).
Bandwidth: 50 Hz to 20 MHz (18 ns risetime).
Noise: less than 100 μA pk-pk, referred to input.
Maximum ac current: 50 A pk-pk above 700 Hz decreasing below 700 Hz at the rate of 1.4 A/20 Hz.
Output impedance: 50 ohms.
Dimensions: amplifier: 1 1/2" high, 5 1/8" wide, 6" deep (38 x 130 x 152 mm).
Weight: Model 1111A: net, 2 lb (0.9 kg); shipping, 3 lb (1.4 kg).
Power: 115 or 230 V ±10%, 50 to 1000 Hz, approx 1.5 W.
Price: Model 1111A, \$160.



Probe accessories

Probe tips

For probes 10001A-10003A: Model 10035A kit contains pincer jaw, banana tip, pin tip, hook tip, and spring tip.
Price: Model 10035A, \$5. Model 10010C BNC adapter tip.
Price: Model 10010C, \$10.
For probes 10004A-10006A and 10012A: furnished with each probe are: slip-on pincer tip, spanner tip, and ground lead.
 Model 10036A, kit contains spring tips for 0.08 inch jack; 0.025 and 0.045 inch square pin; 0.040 and 0.062 inch dia pin, and a long pin tip. **Price:** Model 10036A, \$20.
 Model 10037A, kit contains six spring tips for 0.025 inch square pins. **Price:** Model 10037A, \$15.

Model 10011A BNC adapter tip. **Price:** Model 10011A, \$8.

Terminations

Model 10100A, 50 ohm feed-through, \$15.
 Model 10100B, 100 ohm (±2 ohm) feed-through for 1110A current probe. **Price:** Model 10100B, \$18.

Adapters

Model 10110A, Male BNC to dual female banana post. **Price:** Model 10110A, \$5.
 Model 10111A, female BNC to shielded banana post. **Price:** HP Model 10111A, \$7.

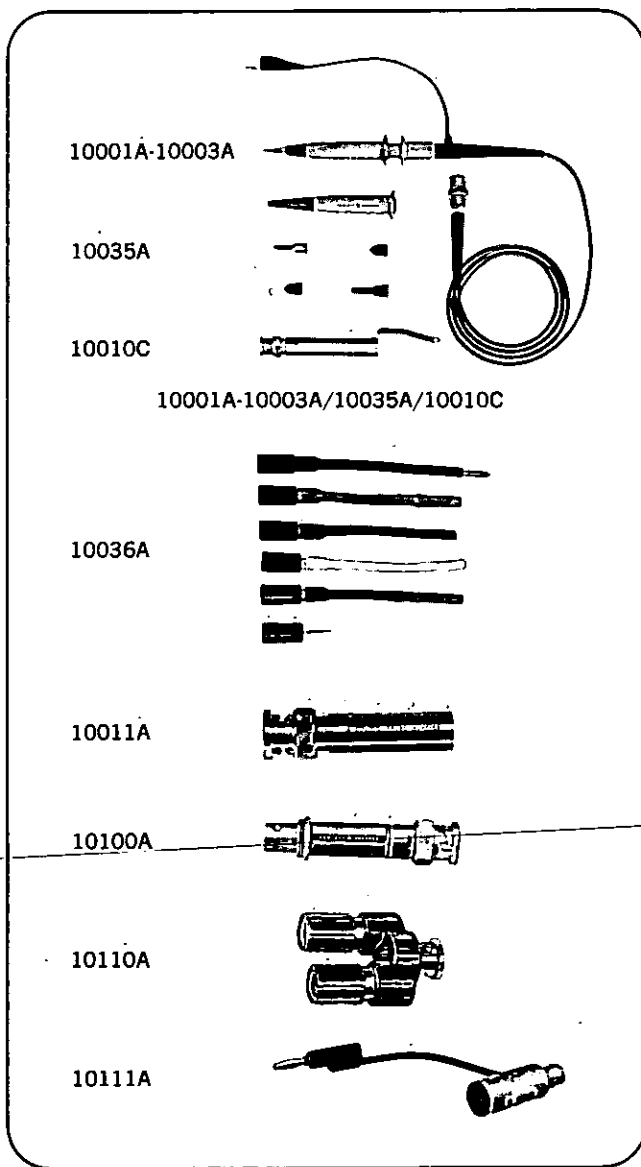
BNC tip

Model 10011A BNC tip for Models 10004A, 10005A, 10006A probes.

Price: \$8.

Probe tip kits

Probe tip kits, Models 10036A and 10037A, extend usefulness of 10004A, 10005A, and 10006A probes. Model 10036A consists of an assortment including tips for the following: 0.08-inch jack; 0.025- and 0.045-inch square pin; 0.040- and 0.062-inch dia pin; and a long pin tip. Model 10037A contains six 0.025-inch square-pin tips. **Price:** Model 10036A, \$20; Model 10037A, \$15.



OSCILLOSCOPES *continued*

Probes and Accessories

Probes

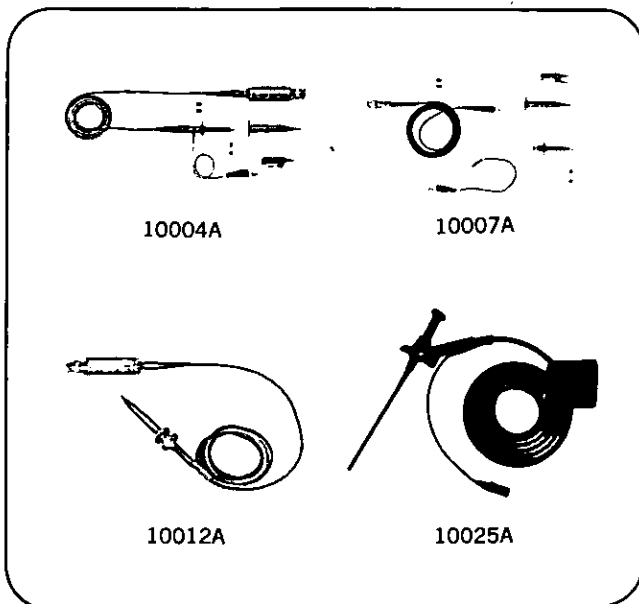
(Versatile line of probes for all applications)

When used with the following instruments, these Hewlett-Packard probes do not degrade the specified performance of the oscilloscope or plug-in. These probes may be quickly and accurately compensated for optimum step response.

	120B	122A/AR	130C	132A	1200 Series	140 System	180 system (except 50Ω inputs)
10001A	●	●	●	●	●	●	
10002A	●	●	●	●	●	●	
10003A	●	●	●	●	●	●	●
10004A							●
10005A							●
10006A							●
10007A	●	●	●	●	●	●	●
10008A	●	●	●	●	●	●	●
10012A	●	●	●	●	●	●	
10025A	●	●	●	●	●	500 kHz	

Voltage divider probe specifications

Model No.	Over-all Length	Divider Atten.	Resistance M Ω	Capacitance	Compensation Range(pF)	Peak Volts	Division Accuracy	Price
10001A	5'	10:1	10	10 pF	15-55	600	2%	\$30
10001B	10'	10:1	10	20 pF	15-45	600	2%	\$35
10002A	5'	50:1	9	2.5 pF	15-55	1000	3%	\$40
10002B	10'	50:1	9	5 pF	15-55	1000	3%	\$40
10003A	4'	10:1	10	10 pF	15-55	600	2%	\$35
10004A	3.5'	10:1	10	10 pF	15-30	500	3%	\$40
10005A	10'	10:1	10	17 pF	15-30	500	3%	\$40
10006A	6'	10:1	10	14 pF	15-30	500	3%	\$40
10007A	3.5'	1:1	—	30 pF	—	600	—	\$20
10008A	6'	1:1	—	60 pF	—	600	—	\$20
10012A	6'	10:1	10	16 pF	30-55	500	3%	\$40
10025A	6'	1:1	—	150 pF	—	600	—	\$15



CRT filters

5-inch rectangular CRT oscilloscopes

Model 10178A, wire contrast filter. Price: \$15.

Model 10179A, nylon contrast filter. Price: \$7.

Amber plastic filter, HP Part Number 5020-0530. Price: \$2.50.

Blue plastic filter, HP Part Number 5020-0554. Price: \$2.50.

5-inch round CRT oscilloscopes

Model 10180A nylon mesh. Price: \$7.

Model 120A-83A amber plastic filter. Price: \$6.50.

Model 120A-83B blue plastic filter. Price: \$6.50.

Model 120A-83G green plastic filter. Price: \$3.50.

Large screen CRT (1300A and 143A)

Green plastic filter HP Part Number 01300-02701. Price: \$4.

Amber plastic filter HP Part Number 01300-02702. Price: \$4.

Gray plastic filter HP Part Number 01300-02703. Price: \$4.

Anti-reflection filter: nylon mesh attached to contrast filter to reduce reflections.

Model 10181A amber filter for P7 phosphor, price: \$30.

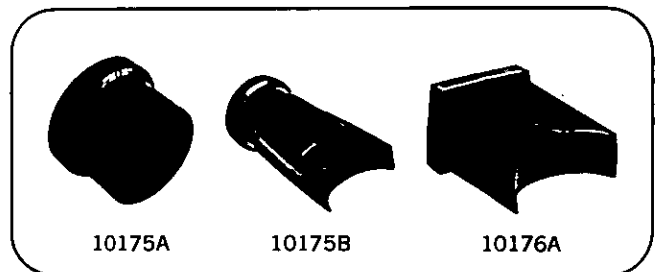
Model 10182A green filter for other phosphors, price: \$30.

Viewing hoods

Model 10175A polarizer hood increases contrast and reduces glare when viewing dim traces under ambient light; price: \$20.

Model 10175B hood with removable vinyl face mask designed for use on Hewlett-Packard 5-inch round CRT bezels; price: \$20.

Model 10176A flexible viewing hood is for Hewlett-Packard 5-inch rectangular CRT bezels; price: \$10.



Slides and slide adapters

Both fixed and pivoted 22-inch slides are available for slide mounting Hewlett-Packard oscilloscopes. A slide adapter kit is required for either type slide.

120B through 140 series modular instruments

Slide adapter: HP Part Number 1490-0721, price: \$40.

Fixed slides: HP Part Number 1490-0714, price: \$32.50.

Pivot slides: HP Part Number 1490-0718, price: \$40.

180AR and 181AR slide adapter, HP Part Number 1490-0768, price: \$22.50.

180AR and 181AR pivot slides: HP Part Number 1490-0719, price: \$37.50.

180 AR and 181AR fixed slides: HP Part Number 1490-0714, price: \$32.50.

Blank plug-ins

Blank plug-ins are available for either 140 and 180 system vertical and horizontal mainframe compartments or a double-size is also available.

140-system blank plug-ins

Vertical or horizontal: Model 10477A, price: \$25.

Double-size: Model 10478A, price: \$30.

180-system blank plug-ins

Vertical: Model 1801A Opt K01, price: \$65.

Horizontal: Model 1821A Opt K01, price: \$65.

Double size: 180A Opt K53, price, \$65.

Probes and Accessories

**Plug-in extenders**

Plug-in extenders allow calibration and maintenance while a unit is operating.

140 system extender cable Model 10406A (one required for each plug-in) price: \$40.

180 system extender (metal frame extends both plug-ins) Model 10407A, price: \$75.

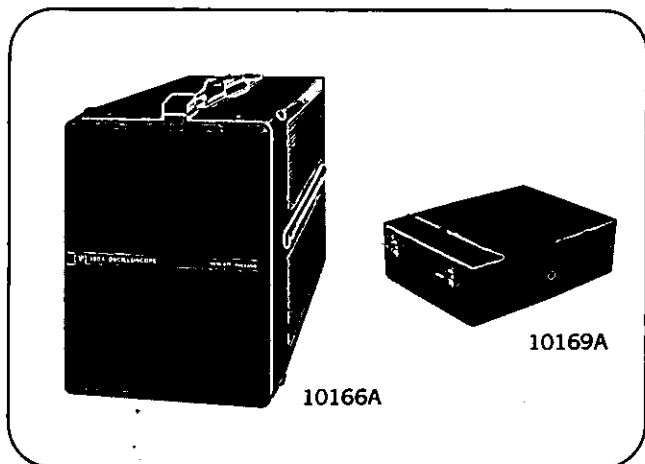
Panel covers

Models 10166A and 10169A panel covers provide front panel protection and space for probe and accessory storage for 180-series and 1200-series cabinet instruments.

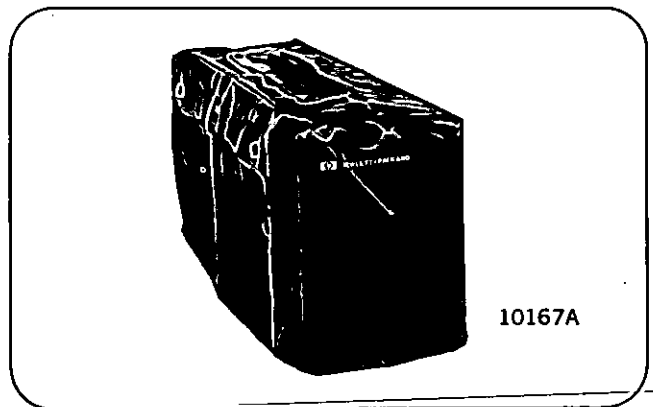
180-system cabinet instruments, HP Model 10166A, price: \$25.

1200-system cabinet instruments, HP Model 10169A, price: \$25.

For 180-system and 191A TV waveform oscilloscope rack model instrument panel cover, order HP Part Number 5060-0437, \$39.50.

**Model 10167A Cover**

Model 10167A Cover, made of flexible vinyl material, fits over the Model 180A or 181A. The cover top is slotted for access to the instrument carrying handle. Price: \$20.

**Accessory Cover Model 10164B**

Model 10164B is a front panel cover and accessory compartment containing the following accessories:

RF probes: two high impedance probes (HP Model 10003A), each with an over-all length of 48-inches constructed of non-ringing low noise cable with a male BNC connector on one end and at the other end a probe presenting an impedance of 10 megohms \pm 2% shunted by 10 pF or less.

RF cables: two 8 ft rf cables.

Fuses: four 0.6 amp, slow-blow.

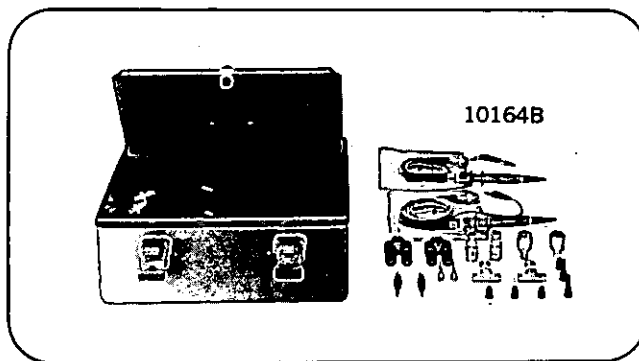
Adapters: (1) two BNC receptacle to UHF plug, Type UG-255/U. (2) two BNC plug to UHF receptacle, Type UG-273/U. (3) two adapters, Type UG-1044/U or UG-1035/U, consisting of binding posts connected to a BNC male connector. (4) two BNC tee connectors, Type UG-274B/U.

Probe tips: (1) two flattened alligator jaw. (2) two pincer (retractable hook tip). (3) two pin tip. (4) two hook tip. (5) two banana tip. (6) two spring tip.

General

Weight: 3 lbs 14 ounces (1,8 kg); shipping, 6 lbs (2,7 kg).

Price: HP Model 10164B, \$165.

**191A TV Waveform Oscilloscope Accessories**

Calibration kit: consists of four printed circuit boards for calibrating the Model 191A vertical amplifier HP Part Number 00191-69508, price: \$195.

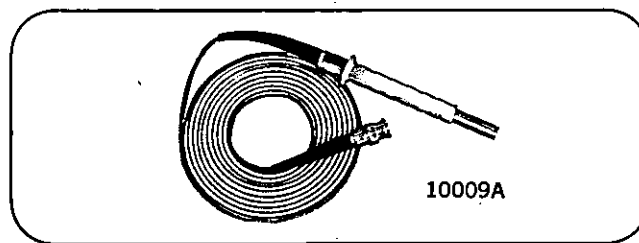
Model 10009A probe: probe tip is WECO type 477B connector: input RC, 10 megohms shunted by 10 pF; when connected to Model 191A Probe Input, input signal from 0.2 V to 4 V provides 140 IRE display; probe combined with 191A X10 magnifier has unity gain \pm 10%; price, Model 10009A, \$60.

External graticules

2T 4MHz, HP Part No. 00191-62801, price: \$10.

2T 8MHz, HP Part No. 00191-62802, price: \$10.

Dual (combined 2T 4 and 2T 8MHz, HP Part No. 00191-62803, price: \$10.

**Coaxial cables**

Hewlett-Packard 50-ohm coaxial cables insure faithful transmission of fast-rise, high frequency signals. Mismatch loss is reduced to a minimum by using close tolerance 50-ohm-cable-and high-quality connectors.

Cable Specifications

HP Model	Length	Description	Price
10120A	3' (91 cm)	male BNC-to-male BNC	\$10
10121A	8' (20,3 cm)	male BNC-to-male BNC	\$10
10122A	3' (91 cm)	male BNC-to-male type N	\$10
10123A	6' (183 cm)	male BNC-to-male BNC	\$11
10124A	9' (274 cm)	male BNC-to-male BNC	\$12
10127A	1' (30,5 cm)	GR-to-male BNC	\$16
10128A	1' (30,5 cm)	GR-to-female BNC	\$16

OSCILLOSCOPES



TESTMOBILES

Store, transport test equipment

Models 1116A, 1117B, 1118A, 1119A/B/C/D

Hewlett-Packard Testmobiles provide easy, convenient portability of test equipment to multiple test locations. These testmobiles can also be equipped to provide extra storage space for equipment and accessories which increase test bench working area.

Model 1116A Testmobile

The Model 1116A can be tilted from horizontal to 30° above horizontal, and can also be folded for transportation to the test site or for convenient storage.

Dimensions: 40" high, 20" wide, 24" deep (1016 x 508 x 610 mm).

Weight: net, 32 lb (14,5 kg); shipping 47 lb (21,3 kg).

Price: HP Model 1116A, \$95.

Model 1117B Testmobile

The Model 1117B can be equipped as a complete, portable test center. The top instrument tray can be tilted. The front or rear frame can accommodate standard 19 inch RETMA rack panels, with central power distribution to the instruments provided by four standard NEMA receptacles on the back panel.

Dimensions: 39" high, 20" wide, 24" deep (991 x 508 x 610 mm).

Weight: net, 91 lb (41,3 kg); shipping, 109 lb (49,4 kg).

Price: HP Model 1117B (without drawers), \$200. Model 10475A 3-inch drawer for 1117B.

Weight: net, 9 lb (4,1 kg); shipping, 13 lb (5,9 kg).

Price: HP Model 10475A, \$40. Model 10476A 8-inch drawer for 1117B.

Weight: net, 11 lb (5 kg); shipping, 25 lb (11,3 kg).

Price: HP Model 10476A, \$45.

Model 1118A Testmobile

The Model 1118A is designed for cabinet models of the 180 system or the 1200 series oscilloscopes only. Instrument height may be adjusted from 32 to 42 inches. The legs may be folded for easy carrying or storage.

Dimensions: 33" to 43" high (838 mm to 1092 mm).

Weight: net, 13 lb (5,9 kg); shipping 17 lb (7,7 kg).

Price: HP Model 1118A, \$120.

Model 1119A Testmobile

The Model 1119A, for standard Hewlett-Packard modular instruments.

Dimensions: 38" high, 19¼" wide, 23½" deep (965 x 489 x 597 mm).

Weight: net, 34 lb (15,4 kg); shipping, 44 lb (20 kg).

Price: HP Model 1119A, \$110.

Model 10479A tilt tray for 1119A or 1119B

For use with instruments other than standard Hewlett-Packard modular size.

Dimensions: 17¼" wide, 23" deep (438 x 584 mm).

Weight: net, 12 lb (5,4 kg); shipping, 18 lb (8,2 kg).

Price: HP Model 10479A, \$35.

Model 10480A storage cabinet for 1119A

Contains 1½" drawer for cables and accessories; mounts in place of lateral brace.

Dimensions: 11¼" high, 18¼" wide, 15" deep (286 x 464 x 381 mm).

Weight: net, 20 lb (9,1 kg); shipping, 23 lb (10,4 kg).

Price: HP Model 10480A, \$35.

Model 1119B Testmobile

Model 1119B is the same as Model 1119A except that the Model 10480A Storage Cabinet is factory-installed in place of the lateral brace.

Dimensions: same as 1119A Testmobile.

Weight: net, 46 lb (20,9 kg); shipping, 60 lb (27,2 kg).

Price: HP Model 1119B, \$145.

Model 1119C Testmobile

Model 1119C is designed for use with cabinet models of the 180 system and 1200 series, which attach to a pivotable support bracket. The lateral brace contains storage space for small accessories.

Dimensions: 38" high, 13¼" wide, 23½" deep (965 x 337 x 597 mm).

Weight: net, 32 lb (14,5 kg); shipping, 43 lb (19,5 kg).

Price: HP Model 1119C, \$110.

Model 10479AB tilt tray for 1119C and 1119D

For use with equipment other than Hewlett-Packard 180 system or 1200 series oscilloscopes.

Dimensions: 11¼" wide, 23" deep (286 x 584 mm).

Weight: net, 8 lb (3,6 kg); shipping, 12 lb (5,4 kg).

Price: HP Model 10479B, \$35.

Model 10480B storage cabinet for 1119C

Contains 1½" drawer for cables and accessories; mounts in place of lateral brace.

Dimensions: 11¼" high, 12¼" wide, 15" deep (286 x 311 x 381 mm).

Weight: net, 11 lb (5 kg); shipping, 16 lb (7,3 kg).

Price: HP Model 10480B, \$35.

Model 1119D Testmobile

Model 1119D is same as Model 1119C except that the Model 10480B Storage Cabinet is factory-installed in place of the lateral brace.

Dimensions: same as 1119C Testmobile.

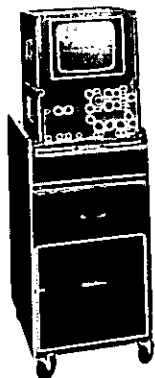
Weight: net, 43 lb (19,5 kg); shipping, 54 lb (24,5 kg).

Price: HP Model 1119D, \$135.

1116A



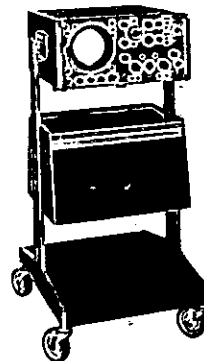
1117B



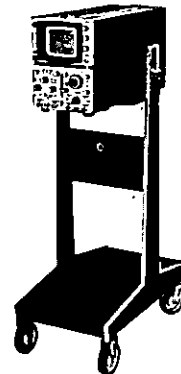
1118A



1119B



1119C

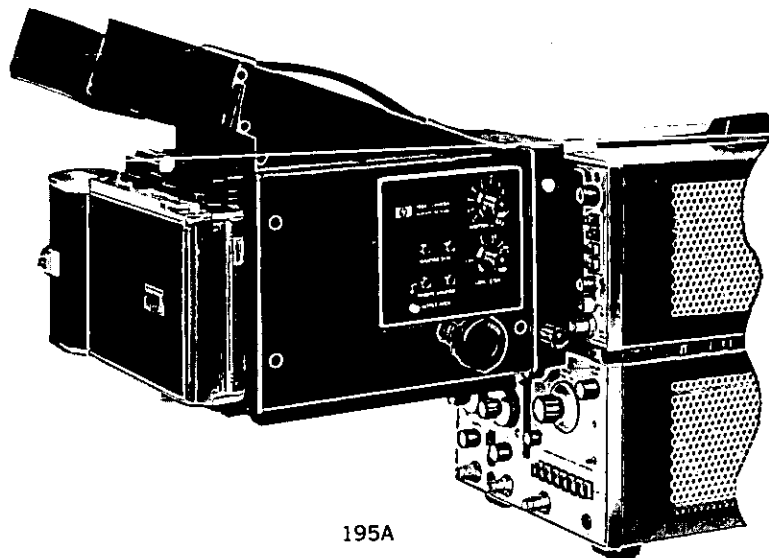


OSCILLOSCOPE CAMERA

High speed single-shot photography
Model 195A



OSCILLOSCOPES



195A

The HP Model 195A is a versatile, easy-to-use oscilloscope camera for high-speed single-shot photography. The 1:0.5 object-to-image ratio and a 80 mm f/1.3 lens allows maximum light transmission for photographing fast traces.

All 195A controls are located outside the camera. Shutter speed and f-stop controls are color coded to provide a good starting point for the photographer.

The electronic shutter employed in the 195A provides accurate exposure times from 1/30 to 4 seconds, and all solid-state circuits insure reliable operation. The shutter may be operated remotely by providing a closure to ground, and a contact closure is provided when the shutter is open to provide synchronization of other equipment with the camera.

The ultraviolet light option provides a two-fold increase in film speed when used with an oscilloscope that does not have a pulsed flood gun. The UV light generates an effect equivalent to "post-fogging" of the film at the same time that the picture is taken. Ordinarily, a single, faint trace may not expose the film sufficiently to bring the density level above the brightness threshold level. The gray background, provided by the UV light, moves the trace's "zero" exposure level into the gray region, where a slight increase in exposure, caused by the trace, becomes visible.

The 195A mounts directly to 5-inch rectangular or round Hewlett-Packard Oscilloscopes without requiring a bezel adapter and also swings away from the CRT-face for easy viewing.

The 195A camera back may be rotated from the normal horizontal position to a vertical position, allowing a 90° rotation of the film format. The back can also be moved through 11 detented positions for multiple exposures. The camera back may also be removed and replaced with a 4 x 5 Graflok® back which allows use of cut or roll film or a Polaroid® Pack Film back.

Specifications, 195A

Object-to-image ratio: 1:0.5.

Lens: 80 mm, f/1.3 high transmission lens; aperture ranges from f/1.3 to f/11.

Shutter: electronically operated and timed shutter, with all solid-state circuits; shutter speeds are 1/30, 1/15, 1/8, 1/4, 1/2, 1, 2, 4 seconds, Time, and Bulb; shutter has a sync contact closure output for triggering external equipment and input jack for remote operation. Shutter-Open Light: provides visual indication when shutter is open and shutter speed control is set to: T, B, and all other shutter speeds except 1/15 and 1/30 second.

Camera back: Polaroid® roll film holder standard; Polaroid® pack film holder or Graflok® backs available (see options); backs may be interchanged without refocusing and may be rotated in 90-degree increments.

Mounting: quick lift on-off mounting with positive lock; swing away to left. Fits on Hewlett-Packard 5-inch rectangular and round oscilloscopes.

Viewing: low-angle, direct viewing flexible face-mask.

Multiple exposure: back moves vertically through 11 detented positions.

Focus: adjustable focusing with lock; split image focusing plate provided.

Dimensions: 14½" long, 9¾" wide, 10½" high (368 x 248 x 267 mm) with hood.

Weight: net, 12-lb (5.4 kg); shipping, 18-lb (8.2 kg).

Power: 115 V ±10%, 50 to 400 Hz, 6 watts.

Accessories furnished: combination split image focusing plate and reduction ratio scale. HP Part No. 1000-0226.

Price: HP Model 195A, \$975.

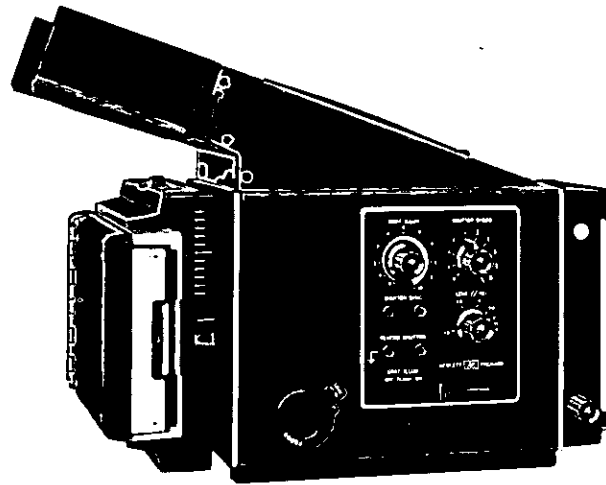
Options:

- 001: with ultra violet light, add \$50.
 - 002: Graflok® back instead of roll back, no charge.
 - 003: Polaroid® pack back instead of roll back, no charge.
 - 004: modified for 230 V operation, no charge.
- "Polaroid"® by Polaroid, Corp.
"Graflok"® by Graflex, Inc.



OSCILLOSCOPE CAMERA

Permanent record of oscilloscope traces
Model 197A



197A

The Model 197A Oscilloscope Camera provides an accurate, convenient way of recording oscilloscope displays. It is a precision instrument, designed for long hard use.

Model 197A electronic shutter provides accurate exposure times from 1/30 s to 4 s. The shutter may be tripped electrically from a remote source and a "x" sync output provides a contact closure when the shutter is opened, allowing synchronizing of other equipment with the camera.

An ultra-violet light in the Model 197A for illuminating the internal graticule used in Hewlett-Packard oscilloscopes. The adjustable intensity "black" light excites the CRT phosphor and it photographs as an intermediate gray background, which clearly contrasts with the black graticule lines. This black light has the additional advantage of sensitizing the film at the same time that the photograph is taken. The uniform glow of the CRT face lowers the threshold sensitivity of the film, enabling it to record dimmer traces and makes clear, sharp photographs of both repetitive and single-shot phenomena. In addition to continuously adjustable ultraviolet intensity, the Model 197A also has a "flash" feature which automatically turns the UV light on and off. The "flash" permits recording

of slow single-shot events and complete graticule information in a single exposure. In other cameras, a double exposure is usually required.

All Model 197A controls are located outside the camera with shutter speed, f-stop, and UV light brightness color coded to provide a good starting point for the photographer. The lightweight Model 197A mounts on any 5-inch round or rectangular Hewlett-Packard oscilloscope, and swings away from the CRT face when not needed. The face-fitting, flexible hood has a low viewing angle for easy direct viewing of the CRT display.

The Model 197A film back may be rotated from the normal horizontal position to a vertical position, allowing two smaller pictures to be taken on one polaroid print. The back also can be moved through 11 detented positions for multiple exposures (see Figure 1) or it can be removed and replaced with a 4 x 5 inch Graflok® back or a Polaroid® roll film back. The Model 197A's continuous reduction ratio feature allows the entire film area of the back to be used. The camera may then be quickly refocused with a simple knob adjustment, using the furnished split image focusing plate stored in the camera.

Specifications, 197A

Reduction ratio: continuously adjustable from 1:1 to 1:0.7; reference scale provided on focus plate.

Lens: 75 mm, f/1.9 high transmission lens; aperture ranges f/1.9 to f/16.

Shutter: electronically operated and timed shutter, with solid-state circuits; shutter speeds are 1/30, 1/15, 1/8, 1/4, 1/2, 1, 2, 4 s, Time, and Bulb; shutter has an "x" sync contact closure output for triggering external equipment and an input jack for remote operation.

Camera back: Polaroid® Land Camera using pack film Type 107 supplied; Graflok® back and Polaroid® Roll Film back available (see Options); backs may be interchanged without refocusing and may be rotated in 90-degree increments.

Mounting: quick lift on-off mounting with positive lock; swing away to left.

Viewing: low-angle, direct viewing flexible face mask.

Multiple exposure: back moves vertically through 11 detented positions; 1/2 cm per detent at 1:0.9 object-to-image ratio.

Focus: adjustable focusing with lock; split image focusing plate provided.

Dimensions: 14" long, 10 1/2" high, 7 3/8" wide (356 x 267 x 193 mm) with hood.

Weight: net, 10 lb (4,5 kg); shipping 19 lb (8,6 kg).

Power: 115 V \pm 10%, 50 to 1000 Hz, 6 W.

Accessories furnished: combination split image focusing plate and reduction ratio scale.

Price: HP Model 197A, \$575.

Option 001: without ultraviolet light, deduct \$50.

Option 003: Graflok® back in place of Polaroid® back; no charge.

Option 004: Polaroid® Roll back in place of Polaroid® Flat pack back; no charge.

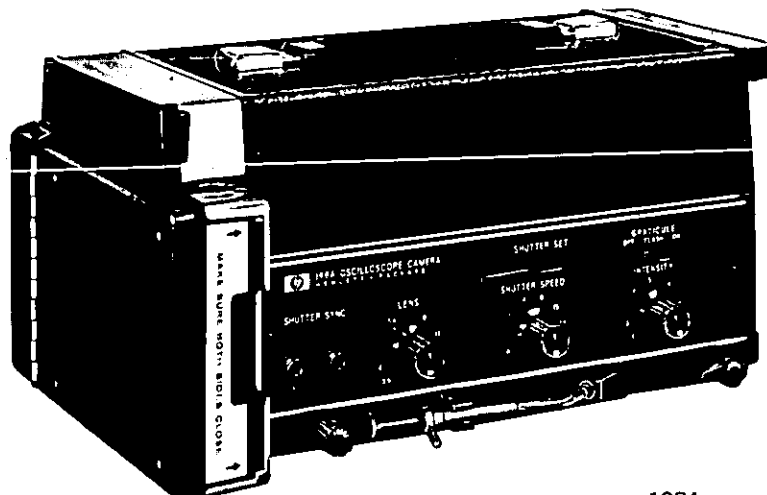
Option 012: modified for 230 V operation; no charge.

OSCILLOSCOPE CAMERA

Battery-powered, low cost
Model 198A



OSCILLOSCOPES



198A

The HP model 198A is an economical camera for general-purpose oscilloscope photography. In addition, the new camera may be conveniently applied to normal photography of objects or surfaces which can be placed in the camera focal plane.

The camera features a Polaroid® back using the standard flat-pack self-processing film, for rapid, on-the-spot results. The new focusing system eliminates focus-plates and wasted film. Graticule (scale) illumination consists of two mirrors that reflect twin curtains of light onto the surface to be photographed. The mirror system is interlocked with lens focal distance and the mechanical focusing system. When the curtains of light just meet, the CRT graticule is evenly illuminated and the camera is focused. Thus, one simple adjustment allows convenient, rapid set-up.

Graticule illumination can be set to ON, FLASH or OFF. When in ON or FLASH, the illumination intensity is variable. Focusing, graticule illumination and the CRT display may be seen through a viewing port at the rear of the camera.

Model 198A is easily and directly mounted on 5-inch rectangular or round Hewlett-Packard oscilloscopes by an adjustable clamp that locks the 198A securely in place. Bezel adapters are available for most other oscilloscopes.

An "x" synchronized contact closure is provided to trigger external circuits or synchronize other equipment with shutter release.

All operating controls are located outside the camera housing.

Specifications, 198A

Film type: Polaroid® 107 Black and White ASA 3000 8-pack; Polaroid® 108 Color ASA 75 8-pack. (73 x 96 mm). Type 107 (black and white) development time: 15 seconds. Type 108 (color) development time: 60 seconds.

Object-to-image ratio: 1:0.85.

Lens: 75 mm, f/3.5.

Shutter:

Speeds: -B, -1s, -1/2s, -1/8s, -1/15s, -1/30s, -1/60s. Cable release; cable has thumbscrew lock for time exposures.

Apertures: F/3.5, 4, 5.6, 8, 11, 16, 22.

Focus: directly adjustable with camera-back closed or open. Coincidence of vertical light patterns on CRT face indicates correct focus; 15 mm lens movement, relative to camera body and oscilloscope face.

Graticule illumination: provided internally. Incandescent lamp and projector/mirror system, with variable intensity control, OFF, FLASH, and ON.

Power required: 4 ea Type-C, 1.5 V dry cells. (graticule illumination and focus system).

Synchronization: X-type contacts provided to trigger or synchronize other equipment with shutter release.

Compatibility:

Direct: Hewlett-Packard 5-inch rectangular and round bezels. 140, 180, 1200 series oscilloscopes; 8550 series spectrum analyzers, 780 series monitoring oscilloscopes, 8540, 8410 network analyzers, and all other Hewlett-Packard instrumentation having a 5-inch CRT display.

Adapters for other Oscilloscopes: see camera accessories.
Dimensions: 7-9/16" x 12-3/16" x 5-13/16" (192 mm x 310 mm x 148 mm).

Weight: approximately 6⁵/₈ lb, (3 kg).

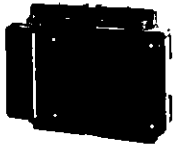
Price: HP Model 198A, \$350.

Option 001: 1:0.7 object-to-image ratio, allows entire 5-inch round CRT to be photographed, add \$50.

"Polaroid"® by Polaroid Corp.



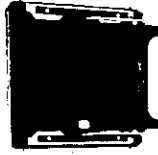
Camera Backs



10353A



10365A

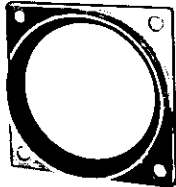


10352A

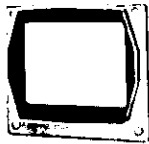
Model 195A is supplied with a Polaroid® Roll Film back and Model 197A is supplied with a Polaroid® Pack Film back. Either back may be ordered initially as options at no extra charge (refer to specifications), or the backs may be ordered separately. Polaroid® Pack Film back, Model 10353A, \$85. Polaroid® Roll Film back, Model 10365A, \$85. Graflex® back, Model 10352A, \$85.

Note: these backs will not fit on the HP Model 198A camera.

Oscilloscope Bezel Adapters



10355A



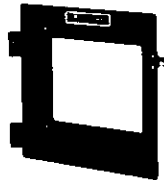
10356A



10357A



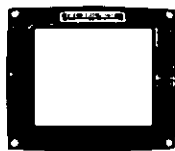
10360A



10361A



10362A



10363A

Models 195A, 197A, and 198A fit HP 5-inch rectangular and round CRT oscilloscopes and can easily be fitted to other oscilloscopes by means of bezel adapters. Model 10355A adapts to Tektronix and Fairchild 5-inch round bezels, \$15. Model 10356A adapts to Tektronix 560 Series rectangular bezels, \$15. Model 10357A adapts to Tektronix 640 Series rectangular bezels, \$15. Model 10360A adapts Model 196A/B camera to the Hewlett-Packard rectangular bezel, \$15. Model 10361A adapts Tektronix C12 camera to Hewlett-Packard rectangular bezel, \$15. Model 10362A adapts Tektronix C27 camera to Hewlett-Packard rectangular bezel, \$15. Model 10363A adapts Tektronix C30 or C40 cameras to Hewlett-Packard rectangular bezel, \$15.

Camera Accessories

Carrying Case

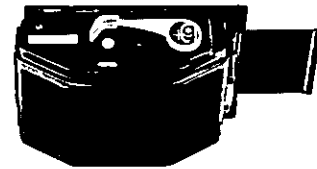


10358B

The Model 10358B carrying case is constructed of fiberglass and aluminum with foam padding to protect the Model 195A, 197A, and 198A cameras in transit or storage. Price: \$70.

Other Accessories

When the 4 x 5 Graflex back is used, various film packs and adapters (readily available from local camera shops) may be used, some of which are shown below. Order these film packs from the manufacturer or your local camera dealer.



Model RH/50 70mm roll film holder.

50 exposures without reloading.

Graflex catalog No. 1240.

Approximate price: \$150.

Beattie-Coleman 70mm roll film holder available (type 45R).

Approximate price: \$150.



Graphic film pack adapter.

Daylight load—16-exposure film packs.

Graflex catalog No. 1234.

Approximate price: \$16.



Polaroid Land 4 x 5 film holder No. 545.

Makes both print and negative in 20 seconds—outside the dark room.

Approximate price: \$50.

Glossary of oscilloscope terminology

Accelerating Voltage—The cathode-to-viewing-screen voltage applied to a cathode-ray tube for the purpose of accelerating the electron beam.

Alternate Mode—A means of displaying output signals of two or more channels by switching the channels, in sequence, after each sweep.

Automatic Triggering—A mode of triggering in which one or more of the triggering circuit controls are preset to conditions suitable for automatically displaying repetitive waveforms. The automatic mode may also provide a recurrent trigger or recurrent sweep in the absence of triggering signals.

Bandwidth—A statement of the frequencies defining the upper and lower limits of a frequency spectrum where the amplitude response of an amplifier to a sinusoidal waveform becomes .707 (−3db) of the amplitude of a reference frequency. When only one number appears, it is taken as the upper limit.

Chopped Mode—A time sharing method of displaying output signals of two or more channels with a single cathode-ray tube gun, in sequence, at a rate not referenced to the sweep.

Common Mode Rejection Ratio (CMRR)—Ratio of the deflection factor for a common-mode signal to the deflection factor for a differential signal.

Common-Mode Signal—The instantaneous algebraic average of two signals applied to a balanced circuit, all signals referred to a common reference.

Common-Mode Signal Maximum—The largest common-mode signal at which the specified common-mode rejection ratio is valid.

DC Balance—An adjustment of circuitry to avoid a change in dc level when changing gain.

DC Drift (Stability)—Property of retaining defined electrical characteristics for a prescribed period.

DC Shift—An error in transient response with a time constant approaching several seconds.

Deflection Axis—The major coordinates passing through the center of the viewing area.

Deflection Factor—The ratio of the input signal amplitude to the resultant displacement of the indicating spot (e.g., volts/division).

Delayed Sweep—A sweep that has been delayed either by a predetermined period or by a period determined by an additional independent variable.

Differential Amplifier—An amplifier whose output signal is proportional to the algebraic difference between two input signals.

Dual-Beam Oscilloscope—An oscilloscope in which the cathode-ray tube produces two separate electron beams that may be individually or jointly controlled.

Dual Trace—A mode of operation in which a single beam in a cathode-ray tube is shared by two signal channels. See Alternate Mode and Chopped Mode.

Free-Running Sweep—A sweep that runs without being triggered and is not synchronized by any applied signal.

Guarded Input—Means of connecting an input signal so as to prevent any common mode signal from causing current to flow in the input, thus differences of source impedance do not cause conversion of the common mode signal into a differential signal.

Input RC Characteristics—The dc resistance and capacitance to ground present at the input of an oscilloscope.

Internal Graticule—A scale for measurement of quantities displayed on the crt whose rulings are a permanent part of the inner surface of the cathode-ray tube faceplate.

Jitter—An aberration of a repetitive display indicating instability of the signal or of the oscilloscope. May be random or periodic, and is usually associated with the time axis.

Magnified Sweep—A sweep whose time per division has been decreased by amplification of the sweep waveform rather than by changing the time constants used to generate it.

Mixed Sweep—In a system having both a delaying sweep and a delayed sweep, a means of displaying the delaying sweep to the delaying pickoff and the delayed sweep beyond that point.

Risetime—The interval between the instants at which the pulse amplitude first reaches specified lower and upper limits. Unless otherwise stated, these limits shall be 10% and 90% of the pulse's amplitude.

Single Sweep—Operating mode for a triggered-sweep oscilloscope in which the sweep must be reset for each operation, thus preventing unwanted multiple displays.

Sweep—An independent variable of a display; unless otherwise specified, this variable is a linear function of time, but may be any quantity that varies in a definable manner.

Sweep Holdoff—The interval between sweeps during which the sweep and/or trigger circuits are inhibited.

Time Base—The sweep generator in an oscilloscope that generates the time function, which is usually linear and expressed in s/cm.

Time Base Accuracy—Accuracy of the time base usually expressed in terms of average rate error as a percent of full scale.

Trigger—A pulse used to initiate some function.

Triggering Level—The instantaneous level of a triggering signal at which a trigger is to be generated.

Triggering Slope—The positive going (+ slope) or negative slope (− slope) portion of a triggering signal from which a trigger is to be derived.

Cathode-ray tube phosphor characteristics

Phosphor	Trace Color		Persistence	Relative Burn Resistance	Relative Visual Brightness
	Under Excitation	After-Glow			
P2	yellowish-green	yellowish-green	medium short	6	6.5
P4	white	white	medium	8	5
P7	white	yellowish-green	long	3	4.5
P11	blue	blue	medium short	3	2.5
P31	green	green	medium short	10	10
Description of Persistence			Time to Decay to 10% of Initial Brightness		
medium short			10 μs to 1 ms		
medium			1 ms to 100 ms		
long			100 ms to 1 s		
Phosphor	Application				
P2	Persistence useful for observing low rep rate phenomena.				
P4	White trace; high contrast display.				
P7	Longer persistence for low speed occurrences. Used primarily in medical application.				
P11	Highest writing rate; used in photographic applications.				
P31	Standard HP phosphor because of its high visual brightness and high burn resistance.				



The following is a step-by-step procedure which, when used with the Condensed Listing on the following pages, will be helpful in choosing the right power supply.

(1) Determine dc output voltage rating

A dc voltage requirement is often expressed as a nominal rating, but power supplies are rated in terms of maximum output under worst operating conditions. For example, if the dc voltage required is nominally 32 volts, adjustable $\pm 10\%$, a 36 volt supply (not 32 volts) should be obtained, provided operation is actually desired at 110% of nominal (35.2 volts). This can be important if "marginal checking" of a system or a load circuit is to be accomplished by varying the dc power supply feeding it.

(2) Determine dc output current rating

The output current rating of a power supply must be selected on the basis of the peak current requirement, not the average current requirement; this results from the fact that the current limiting protection circuitry internal to the supply is extremely fast in order to protect the series power transistors. The current limit circuit is normally adjustable to between 105 and 110% of the nominal current rating of the power supply. If inverse current loading is involved, the power supply must have a current rating equal to or greater than the sum of peak current delivered and peak current absorbed.

(3) Consult condensed listing

Enter the Condensed Listing at the voltage rating found from (1). Supplies above this point are eliminated from consideration because of insufficient output voltage. Many supplies below this point are also eliminated because of a current rating too small compared with (2). If the desired output voltage-current combination does not appear in the Condensed Listing, consider series and parallel combinations of power supplies; Hewlett-Packard's Auto-Series and Auto-Parallel feature permits one knob control and equal voltage and current sharing.

(4) Constant voltage and/or constant current output

Most applications require constant voltage power supplies. However, some load devices require a constant current source of dc power. Still other applications (e.g. battery charging and electrolytic capacitor forming) call for supplies which have automatic crossover between constant voltage and constant current operation.

If the requirement involves constant current performance, then the Condensed Listing should be used to determine which supplies remaining from (3) are capable of

constant current operation. Remember that all Remote Programming constant voltage supplies can also be converted to constant current use with one external resistor.

(5) Specifications for load regulation, line regulation, ripple and transient response

Generally speaking, a Hewlett-Packard power supply employs one of two basic circuit technique — (1) a transistor regulator, or (2) an SCR regulator. (In the case of high power output rating, the transistor regulator is preceded by an SCR preregulator.) All low output power supplies use circuit technique (1), since this results in both lower cost and better performance. Either circuit technique (1) or (2) may be utilized in a supply of moderate output power capability. Power supplies of very high output power employ circuit technique (2).

These two circuit techniques result in distinctly different performance characteristics — particularly with regard to regulation, ripple and transient response.

Specification	Transistor Regulated	SCR Regulated
Load Regulation	0.001% to 0.05%	0.1% to 1%
Line Regulation	0.001% to 0.05%	0.1% to 1%
Ripple and Noise	50 μ v to 1 mv	0.1% to 1%
Transient Response	Less than 50 μ sec.	Less than 50-200 msec.

(6) Is remote programming required?

If it is desired to control the output of the power supply remotely using switched or variable values of resistance, or if the supply is to be controlled by means of a voltage input, then look on the Condensed Listing for those power supplies with a check under "Remote Programming."

(7) Physical configuration

Power supplies are available in three basic packages — rack mounting (standard 19" RETMA), bench, and modular. For high output ratings, rack mounting is the only practical configuration. All supplies which are not normally rack mounting are easily adapted to rack applications using standard hardware available from Hewlett-Packard. Reference to the appropriate catalog pages will indicate the nature and cost of this rack mounting adapting hardware.

(8) Miscellaneous requirements

Depending on the particular application, check also for remote error sensing, permissible values of input line voltage and frequency, front and/or rear output terminals, meters, etc. Many of these miscellaneous requirements can be checked directly on the Condensed Listing. In other cases it will be necessary to refer to the more de-

tailed information on the catalog pages referenced by the Condensed Listing.

A spec sheet can be obtained from any Hewlett-Packard sales office.

Power supply series designations

Series designations identify groupings of Hewlett-Packard power supplies that have similar circuit techniques and operating characteristics.

The model numbers assigned to each Series can be determined from the Product Category Index on next page.

Note that each multiple letter Series designation (1) suggests the general type of power supply in a given category and (2) indicates (in the third letter) the nature of the power supply case and its "normal" mode of installation. A final "B" indicates Bench supplies and a final "R" applies to units which are Rack mounted. Absence of a "B" or an "R" as the final letter means that the supplies have not been designed primarily for either Bench or Rack use, or that the series includes both full rack width and half rack width instruments.

Notice that these designations are not part of the model number. They do not appear on the instrument and should not be used when ordering.

Series	Description
BENCH	Small Laboratory Bench
CCB	Constant-Current, Bench
DPR	Dual Power Rack
DPB	Dual Power Bench
HVB	High Voltage Bench
HVR	High Voltage Rack
ICS	Low Voltage for Integrated Circuits
LAB	Laboratory Bench
LVR	Low Voltage Rack
MPB-3	3½" -High Medium Power Bench
MPB-5	5¼" -High Medium Power Bench
MPM	Medium Power Modular
MVR	Medium Voltage Rack
PS/A	Power Supply/Amplifier
SCR-1P	Primary SCR Regulated, Output Ratings — 300 and 900 Watts
SCR-3	SCR Regulated, Output Ratings up to 3 KW
SCR-10	SCR Regulated, Output Ratings up to 10 KW
SLOT	Fixed Output Modules
STB	High Stability Supply/Calibrator

Digitally controlled power

For information on digitally controlled power sources, see page 86.

CONDENSED LISTING



POWER SUPPLIES

Output (volts)	Output (amperes)	Model	Series	Catalog page	Load regulation (mV)	Line regulation (mV)	RMS ripple & noise (mV)	Input line voltage (Vac)	Input line frequency	Remote programming	Bench or Rack*	CV/CC**	Price
0-4	0-2000	6463A	SCR-10	565	50 mV combined		280	3 ϕ 208/460	57-63	✓	R	✓	\$3500
4-5.5	0-8	6384A	ICS	569	1 mV	1 mV	1 mV	115 \pm 10%	48-63		B		220
5.8 \pm 20%	0-1.5	60063A	SLOT	566	0.05%	0.05%	1 mV	115 \pm 10%	48-440		R		See p. 566
5.8 \pm 20%	0-3	60065A	SLOT	566	0.05%	0.05%	1 mV	115 \pm 10%	48-440		R		See p. 566
5.8 \pm 20%	0-8	60066A	SLOT	566	0.05%	0.05%	1 mV	115 \pm 10%	48-440		R		See p. 566
0-7.5	0-3	6203B	LAB	556	5 mV	3 mV	0.2	115 \pm 10%	48-440	✓	B	✓	169
0-7.5	0-5	6281A	MPB-3	559	5 mV	2 mV + 0.01%	0.2	115 \pm 10%	50-400	✓	B	✓	210
0-8	0-1000	6464A	SCR-10	565	25 mV combined		80	3 ϕ 208/460	57-63	✓	R	✓	3300
0-10	0-1	6213A	BENCH	555	.01% + 4 mV	.01% + 4 mV	0.2	115 \pm 10%	48-440		B		90
0-10	0-1	6214A	BENCH	555	.01% + 4 mV	.01% + 4 mV	0.2	115 \pm 10%	48-440		B	✓	115
0-10	0-2	6113A	STB	548	0.001% + 1.1 mV	0.001%	0.04	115 \pm 10%	48-63	✓	B		375
0-10	0-10	6282A	MPB-5	558	1 mV + 0.01%	1 mV + 0.01%	0.5	115 \pm 10%	50-60	✓	B	✓	350
0-10	0-20	6256B	LVR-B	560	200 μ V + 0.01%	200 μ V + 0.01%	0.2	115 \pm 10%	57-63	✓	R	✓	450
0-10	0-50	6259B	LVR-B	560	200 μ V + 0.01%	200 μ V + 0.01%	0.5	115 \pm 10%	57-63	✓	R	✓	650
0-10	0-100	6260A	LVR-B	560	200 μ V + 0.01%	200 μ V + 0.01%	0.5	210 - 250	57-63	✓	R	✓	825
13 \pm 20%	0-0.5	60122B	SLOT	566	0.05%	0.05%	1 mV	115 \pm 10%	48-440		R		See p. 566
13 \pm 20%	0-1	60123B	SLOT	566	0.05%	0.05%	1 mV	115 \pm 10%	48-440		R		See p. 566
13 \pm 20%	0-2.2	60125B	SLOT	566	0.05%	0.05%	1 mV	115 \pm 10%	48-440		R		See p. 566
13 \pm 20%	0-6	60126B	SLOT	566	0.05%	0.05%	1 mV	115 \pm 10%	48-440		R		See p. 566
\pm 15 \pm 20%	0-0.2 A	60153D	SLOT	567	0.03%	0.03%	0.3	115 \pm 10%	48-440		R		See p. 567
\pm 15 \pm 20%	0-0.75	60155C	SLOT	566	0.03%	0.01%	0.3	115 \pm 10%	48-440		R		See p. 567
0-15	0-200	6453A	SCR-3	564	10 mV + 0.2% combined		150	3 ϕ 208/230/460	57-63	✓	R	✓	1375
0-16 or 0-18	0-600 or 0-500	6466A	SCR-10	565	10 mV + 0.2% combined		160 or 180	3 ϕ 208-460	57-63	✓	R	✓	2600
-20 to +20	0-0.5	6823A	PS/A	568	5 mV + 0.02%	5 mV + 0.02%	2	115 \pm 10%	50-440	✓	B	✓	194
0-20	0-0.6	6204B	LAB	557	4 mV + 0.01%	4 mV + 0.01%	0.2	115 \pm 10%	48-440	✓	B		144
0-20 and 0-40	0-0.6 and 0-0.3	6205B	LAB	557	4 mV + 0.01%	4 mV + 0.01%	0.2	115 \pm 10%	48-440	✓	B		235
0-20	0-1	6101A	STB	548	600 μ V + 0.001%	0.001%	0.04	115 \pm 10%	48-63	✓	B		265
0-20	0-1	6111A	STB	548	600 μ V + 0.001%	0.001%	0.04	115 \pm 10%	48-63	✓	B		375
0-20	0-1.5	6200B	LAB	556	4 mV + 0.01%	4 mV + 0.01%	0.2	115 \pm 10%	48-440	✓	B	✓	189
0-20	0-1.5	6201B	LAB	556	4 mV + 0.01%	4 mV + 0.01%	0.2	115 \pm 10%	48-440	✓	B	✓	169
0-20 Dual	0-3	6253A	DPR	559	4 mV + 0.01%	2 mV + 0.01%	0.2	115 \pm 10%	48-440	✓	R	✓	445
0-20	0-3	6284A	MPB-3	559	4 mV + 0.01%	2 mV \pm 0.01%	0.2	115 \pm 10%	48-440	✓	B	✓	210
0-20	0-5	6285A	MPB-5	558	1 mV + 0.01%	1 mV + 0.01%	0.5	115 \pm 10%	50-60	✓	B	✓	350
0-20	0-10	6263B	LVR-B	560	200 μ V + 0.01%	200 μ V + 0.01%	0.2	115 Vac \pm 10%	57-63	✓	R	✓	435
0-20	0-10	6286A	MPB-5	558	1 mV + 0.01%	1 mV + 0.01%	0.5	115 \pm 10%	50-60	✓	B	✓	395
0-20	0-15	6427B	SCR-1P	563	20 mV	10 mV	40	115 \pm 10%	57-63	✓	R	✓	380
0-20	0-20	6264B	LVR-B	561	200 μ V + 0.01%	200 μ V + 0.01%	0.2	115 Vac \pm 10%	57-63	✓	R	✓	525

B Indicates bench type and **R** indicates full rack width type supplies. All bench supplies (except Models 721A, 712C and 715A) can be rack mounted using accessory rack mounting hardware.

**Automatic crossover between constant voltage (cv) and constant current (cc) operation.

additional listings on next page

CONDENSED LISTING *continued***Condensed listing**

Output (volts)	Output (amperes)	Model	Series	Catalog page	Load regulation (mV)	Line regulation (mV)	RMS ripple & noise (mV)	Input line voltage (Vac)	Input line frequency	Remote programming	Bench or Rack*	CY/CC**	Price
0-20	0-45	6428B	SCR-1P	563	40 mV	20 mV	40	115 ± 10%	57-63	✓	R	✓	\$550
0-20	0-50	6261B	LVR-B	561	200 μV ± 0.01%	200 μV ± 0.01%	0.5	115 ± 10%	57-63	✓	R	✓	775
0-24	0-3	6224B	MPM	552	.01% + 4 mV	.01% + 2 mV	0.2	115 ± 10%	50-60	✓	B	✓	325
0-25	0-0.4	6215A	BENCH	555	.01% + 4 mV	.01% + 4 mV	0.2	115 ± 10%	48-440		B		90
0-25	0-0.4	6216A	BENCH	554	.01% + 4 mV	.01% + 4 mV	0.2	115 ± 10%	48-440		B	✓	115
0-25	0-1	6220B	MPM	552	.01% + 2 mV	.01% + 2 mV	0.2	115 ± 10%	50-400	✓	B	✓	250
0-25 Dual	0-2	6227B	DPB	553	.01% + 1 mV	1 mV	0.25	115/230 ± 10%	48-63	✓	B	✓	450
26 ± 20%	0-0.25	60242B	SLOT	566	0.05%	0.05%	1 mV	115 ± 10%	48-440		R		See p. 566
26 ± 20%	0-0.5	60243B	SLOT	566	0.05%	0.05%	1 mV	115 ± 10%	48-440		R		See p. 566
26 ± 20%	0-1	60244B	SLOT	566	0.05%	0.05%	1 mV	115 ± 10%	48-440		R		See p. 566
26 ± 20%	0-1.5	60245B	SLOT	566	0.05%	0.05%	1 mV	115 ± 10%	48-440		R		See p. 566
26 ± 20%	0-3.5	60246B	SLOT	566	0.05%	0.05%	1 mV	115 ± 10%	48-440		R		See p. 566
0-30	0-0.15	721A	—	555	30 mV	± 15 mV	0.15	115 ± 10%	50-60		B		145
0-30	0-1	6206B	LAB	557	4 mV + 0.01%	4 mV + 0.01%	0.2	115 ± 10%	48-440	✓	B		169
0-36	0-10	6433B	SCR-1P	563	36 mV	18 mV	36	115 ± 10%	57-63	✓	R	✓	370
0-36	0-100	6456B	SCR-3	564	10 mV + 0.2% combined		160	3φ 208/230/460	57-63	✓	R	✓	1275
0-36	0-300	6469A	SCR-10	565	10 mV + 0.2%		180	3φ 208/230/460	57-63	✓	R	✓	2300
0-40	0-0.3	6204B	LAB	557	4 mV + 0.01%	4 mV + 0.01%	0.2	115 ± 10%	48-440	✓	B		144
0-40 and 0-20	0.03 and 0-0.6	6205B	LAB	557	4 mV + 0.01%	4 mV + 0.01%	0.2	115 ± 10%	48-440	✓	B		235
0-40	0-0.5	6102A	STB	548	350 μV + 0.001%	0.001%	0.04	115 ± 10%	48-63	✓	B		265
0-40	0-0.5	6112A	STB	548	350 μV + 0.001%	0.001%	0.04	115 ± 10%	48-63	✓	B		375
0-40	0-0.75	6200B	LAB	556	4 mV + 0.01%	4 mV + 0.01%	0.2	115 ± 10%	48-440	✓	B	✓	189
0-40	0-0.75	6202B	LAB	556	4 mV + 0.01%	4 mV + 0.01%	0.2	115 ± 10%	48-440	✓	B	✓	169
0-40 Dual	0-1.5	6255A	DPR	559	2 mV + 0.01%	2 mV + 0.01%	0.2	115 ± 10%	48-440	✓	R	✓	445
0-40	0-1.5	6289A	MPB-3	559	2 mV + 0.01%	2 mV + 0.01%	0.2	115 ± 10%	48-440	✓	B	✓	210
0-40	0-3	6265B	LVR-B	561	200 μV + 0.01%	200 μV + 0.01%	0.2	115 Vac ± 10%	57-63	✓	R	✓	350
0-40	0-3	6290A	MPB-5	558	1 mV + 0.01%	1 mV + 0.01%	0.5	115 Vac ± 10%	50-60	✓	B	✓	350
0-40	0-5	6266B	LVR-B	561	200 μV + 0.01%	200 μV + 0.01%	0.2	115 Vac ± 10%	57-63	✓	R	✓	435
0-40	0-5	6291A	MPB-5	558	1 mV + 0.01%	1 mV + 0.01%	0.5	115 ± 10%	50-60	✓	B	✓	395
0-40	0-10	6267B	LVR-B	561	200 μV + 0.01%	200 μV + 0.01%	0.2	115 Vac ± 10%	57-63	✓	R	✓	525
0-40	0-25	6434B	SCR-1P	563	40 mV	18 mV	40	115 ± 10%	57-63	✓	R	✓	550
0-40	0-30	6268A	LVR-B	561	200 μV + 0.01%	200 μV + 0.01%	1	210-250	57-63	✓	R	✓	695
0-40	0-50	6269A	LVR-B	561	200 μV + 0.01%	200 μV + 0.01%	1 mV	210-250	57-63	✓	R	✓	875
-50 to +50	0-1	6824A	PS/A	568	5 mV + 0.02%	5 mV + 0.02%	10	115 ± 10%	50-60	✓	B	✓	350
0-±50	0-1	6130B	DVS	86	2 mV	2 mV	1 mV	115 ± 10%	48-440	✓	B		1500
0-50	0-0.2	6217A	BENCH	555	.01% + 1 mV	0.1% + 4 mV	0.2	115 ± 10%	48-440		B		90
0-50	0-0.2	6218A	BENCH	555	.01% + 1 mV	.01% + 4 mV	0.2	115 ± 10%	48-440		B	✓	115
0-50	0-0.5	6177B	CCB	551	25ppm	25ppm	40 μA	115 ± 10%	48-63	✓	B		425
0-50	0-0.5	6220B	MPM	552	2 mV + .01%	2 mV + .01%	0.2	115 ± 10%	50-400	✓	B	✓	250
0-50	0-1.5	6226B	MPM	552	2 mV + .01%	2 mV + .01%	0.2	115 ± 10%	50-60	✓	B	✓	325
0-50 Dual	0-1	6228B	DPB	553	.01% + 1 mV	1 mV	0.25	115/230 ± 10%	48-63	✓	B	✓	450
0-60	0-0.5	6206B	LAB	557	4 mV + 0.01%	4 mV + 0.01%	0.2	115 ± 10%	48-440	✓	B		169

additional listings on next page



Output (volts)	Output (amperes)	Model	Series	Catalog page	Load regulation (mV)	Line regulation (mV)	RMS ripple & noise (mV)	Input line voltage (Vac)	Input line frequency	Remote programming	Bench or Rack*	CV/CC**	Price
0-60	0-1	6294A	MPB-3	559	2 mV + 0.01%	2 mV + 0.01%	0.2	115 ± 10%	48-440	✓	B	✓	\$210
0-60	0-3	6296A	MPB-5	558	1 mV + 0.01%	1 mV + 0.01%	0.5	115 ± 10%	50-60	✓	B	✓	395
0-60	0-3	6271B	LVR-B	561	200 μV + 0.01%	200 μV + 0.01%	0.2	115 V ac ± 10%	57-63	✓	R	✓	435
0-60	0-5	6438B	SCR-1P	563	60 mV	30 mV	120	115 ± 10%	57-63	✓	R	✓	360
0-60	0-15	6439B	SCR-1P	563	120 mV	60 mV	60	115 ± 10%	57-63	✓	R	✓	550
0-60	0-15	6274A	LVR-B	561	0.2 mV + 0.01%	0.2 mV + 0.01%	0.5	115 ± 10%	57-63	✓	R	✓	695
0-64	0-50	6459A	SCR-3	564	10 mV + 0.2% combined		160	3φ 208/230/460	57-63	✓	R	✓	1275
0-64	0-150	6472A	SCR-10	565	100 mV + 0.2% combined		160	3φ 208/230/460	57-63	✓	R	✓	2600
0-100	0-0.2	6106A	STB	548	200 μV + 0.001%	0.001%	0.04	115 ± 10%	48-63	✓	B		265
0-100	0-0.2	6116A	STB	548	200 μV + 0.001%	0.001%	0.04	115 ± 10%	48-63	✓	B		375
0-100	0-0.25	6181B	CCB	550	25 ppm	25 ppm	20 μA	115 Vac ± 10%	48-63	✓	B		425
0-100	0-0.5	6131B	DVS	86	2 mV	2 mV	5.0	115 Vac ± 10%	48-440	✓	R		1500
0-100	0-0.75	6299A	MPB-3	559	2 mV + 0.01%	2 mV + 0.01%	0.2	115 ± 10%	48-440	✓	B	✓	225
0-110	0-100	6475A	SCR-10	565	100 mV + 0.2% combined		220	3φ 208/230/460	57-63	✓	R	✓	2600
0-120	0-2.5	6443B	SCR-1P	563	120 mV	60 mV	240	115 ± 10%	57-63	✓	R	✓	360
0-160	0-0.2	6207B	LAB	557	2 mV + 0.02%	2 mV + 0.02%	0.5	115 ± 10%	48-63	✓	B	✓	235
0-220	0-50	6477A	SCR-10	565	100 mV + 0.2% combined		330	3φ 208/230/460	57-63	✓	R	✓	2600
0-300	0-35	6479A	SCR-10	565	100 mV + 0.2% combined		300	3φ 208/230/460	57-63	✓	R	✓	2600
0-300	0-0.1	6186B	CCB	551	25 ppm	25 ppm	5 μA	115 ± 10%	48-63	✓	B		475
0-320	0-0.1	6209B	LAB	557	2 mV + 0.02%	2 mV + 0.02%	1.0	115 ± 10%	48-63	✓	B	✓	235
0-320	0-0.6	890A	MVR	562	10 mV or 0.007%	10 mV or 0.007%	1.0	115 ± 10%	57-63	✓	R		445
0-320	0-1.5	895A	MVR	562	10 mV or 0.007%	10 mV or 0.007%	1.0	115 ± 10%	57-63	✓	R		625
-250 to -400 0 to -900	.03-.05 0-10 μA	715A†	—	349	1% 1%	1% 1%	7 10	115/230 ± 10%	50-60		B		400
0 to +500 -300 0 to -150	0-0.2 0-0.05 0-0.005	712C†	—	562	0.01% + 5 mV 50 mV 50 mV	0.01% + 50 mV 50 mV 50 mV	0.5 30 15	115 ± 10%	50-60	✓	B	✓	490
0-440 or 0-500 or 0-600	0-25 or 0-20 or 0-15	6483B	SCR-10	565	100 mV + 0.5% combined		440 500 600	3φ 208/230/460	57-63	✓	R	✓	2600
1-600	0-1.5	6448B	SCR-1P	563	600 mV	600 mV	600 mV	115 V ac ± 10%	57-63	✓	R	✓	550
-250 to -800 0 to -800 6.3 V (ADJ)	0-2.0	716B†	—	349	0.05% — —	0.05% 0.05% 1%	1 0.5 2	115/230 ± 10%	50-60		B		925
0-1000	0-0.2	6521A	HVR	570	20 mV or 0.005%	20 mV or 0.005%	1.0	115 ± 10%	48-440		R	✓	750
0-1600	0-0.005	6515A	HVB	570	16 mV or 0.01%	16 mV or 0.01%	2.0	115 ± 10%	57-63		B		235
0-2000	0-0.1	6522A	HVR	570	20 mV or 0.005%	20 mV or 0.005%	1.0	115 ± 10%	48-440		R	✓	750
0-3000	0-0.006	6110A	STB	548	100 μV + 0.001%	0.001%	0.4	115 ± 10%	57-63		B		495
0-3000	0-0.006	6516A	HVB	570	16 mV or 0.01%	16 mV or 0.01%	2.0	115 ± 10%	57-63		B		295
0-4000	0-0.05	6525A	HVR	570	20 mV or 0.005%	20 mV or 0.005%	1.0	115 ± 10%	48-440		R	✓	750

All Supplies: 50°C maximum ambient temperature rating. Floating output (ground either side), continuously variable output, low output impedance at all frequencies, 3-wire input, computer-quality electrolytics, 1 year warranty. No turn-on, turn-off overshoot; short-circuit-proof, all semiconductor except as noted by †.

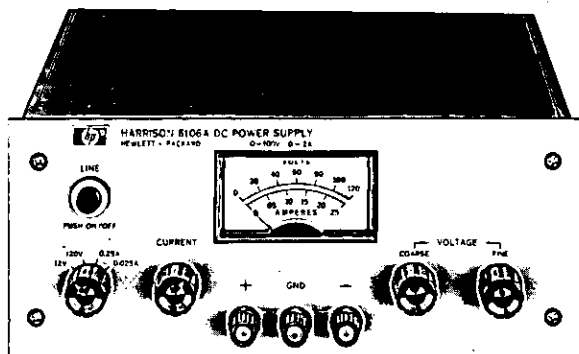
Transistor Supplies: Glass-epoxy printed circuit board construction, fully automatic overload protection — short-circuit-proof.



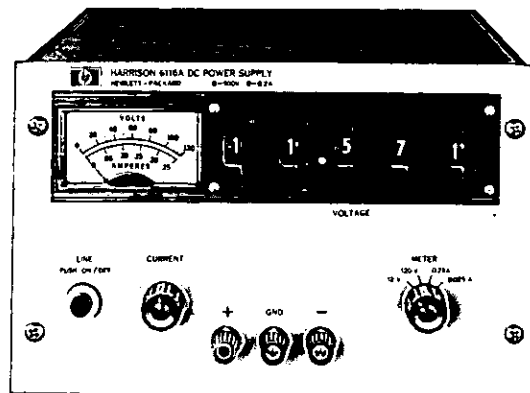
HIGH STABILITY SUPPLY/CALIBRATOR

STB series

Models 6101A—6116A



Models 6101A - 6106A



Models 6110A - 6116A

Model	6101A	6102A	6106A	6110A	6111A	6112A	6113A	6116A	
DC output	0-20V 0-1A	0-40V 0-500mA	0-100V 0-200mA	0-3000V 0-6mA	0-20V 0-1A	0-40V 0-500mA	0-10V 0-2A	0-100V 0-200mA	
Load regulation: For full rated output current change	Front terminals	0.001% (10ppm) plus 600 μ V	0.001% (10ppm) plus 350 μ V	0.001% (10ppm) plus 200 μ V	0.001% (10ppm) plus 100 μ V	0.001% (10ppm) plus 600 μ V	0.001% (10ppm) plus 350 μ V	0.001% (10ppm) plus 1.1 mV	0.001% (10ppm) plus 200 μ V
	Rear terminals	0.001% (10ppm) + 100 μ V			—	0.001% (10ppm) + 100 μ V			
Line regulation: For a 10% change in the nominal line voltage	0.001% (10ppm)			0.001% (10ppm)		0.001% (10ppm)			
Ripple and noise	40 μ V RMS 100 μ V P-P		40 μ V RMS 100 μ V P-P	2 mV RMS 5 mV P-P	40 μ V RMS 100 μ V P-P				
Temperature coefficient: Output voltage change per °C after 30 minute warm-up.	Front panel control	0.005% (50ppm) plus 30 μ V	0.005% (50ppm) plus 50 μ V	0.005% (50ppm) plus 100 μ V	0.001% (10ppm) plus 50 μ V	0.001% (10ppm) + 10 μ V			
	Remote programming	0.001% (10ppm) plus 10 μ V	0.001% (10ppm) plus 10 μ V	0.001% (10ppm) plus 50 μ V	—				
Stability: Total drift after 30 minute warm-up and with 3°C ambient variation.	Front panel control	For 8 hrs. 0.01% + 300 μ V	For 8 hrs. 0.01% + 500 μ V	For 8 hrs. 0.01% + 1 mV	For 8 hrs. 0.01% + 500 μ V For 1 month 0.012% + 600 μ V	For 8 hours: 0.01% + 100 μ V For 1 month: 0.012% + 120 μ V Controlled Environment **for 8 hours: (0.0005%) + 10 μ V			
	Remote programming	For 8 hrs. — 0.10% + 100 μ V For 1 month — 0.012% + 120 μ V							
Resolution	100 μ V + 0.002% of setting			20 mV	200 μ V	20 μ V	200 μ V		
Accuracy	—			0.1% +100 mV	0.1% + 1 mV				
Output impedance	DC — 100 Hz; <0.002 Ω 100 Hz — 1 kHz; <0.02 Ω 1 kHz — 100 kHz; <0.5 Ω 100 kHz — 1 MHz; <3 Ω			At 3000 V DC — 1000 Hz; <50 Ω At 3 V DC — 100 Hz; <0.05 Ω	DC — 100 Hz; <0.002 Ω 100 Hz — 1 kHz; <0.02 Ω 1 kHz — 100 kHz; <0.5 Ω 100 kHz — 1 MHz; <3 Ω				
Remote programming: All programming terminals are located on rear barrier strip	Coefficient — 1000 ohms per volt Accuracy — 0.1% plus 1 mV			—	Coefficient — 1000 ohms per volt Accuracy — 0.1% plus 1 mV Resettability — 0.01% + 200 μ V				
Meters ranges Single meter with switch to select scale	0-2.4V/0-24V 0-120mA/0-1.2A	0-5V/0-50V 0-60mA/0-600mA	0-12V/0-120V 0-25mA/0-250mA	0-3500V 0-7mA	0-2.4V/0-24V 0-120mA/0-1.2A	0-5V/0-50V 0-60mA/0-600mA	0-1.2V/0-12V 0-250mA/0-2.5A	0-12V/0-120V 0-25mA/0-250mA	
Size	Inches	8½ W × 3½ H × 12¾ D			8½ W × 5½ H × 16 D	8½ W × 5½ H × 12¾ D			
	Centimeters	21.6W × 8.9H × 32D			21.6W × 14H × 40.6D	21.6W × 14H × 32D			
Weight: Net/Shipping (lb.)	Pounds	10/13	10/13	10/13	19/23	11/14	11/15	11/15	
	Kilograms	4.5/5.9	4.5/5.9	4.5/5.9	7.7/10.4	5.0/6.8	5.0/6.8	5.0/6.8	
Price	\$265	\$265	\$265	\$495	\$375	\$375	\$375	\$375	
Options: Refer to p. 571 for description.	011 — \$50 028 — \$10	011 — \$50 028 — \$10	011 — \$50 028 — \$10	*005 — \$50 018 — \$50	011 — \$50 028 — \$10	011 — \$50 028 — \$10	011 — \$50 028 — \$10	011 — \$50 028 — \$10	

*No charge if ordered with option 018

**Constant load current, line voltage, and ambient temperature

Advantages

- Low output drift and temperature coefficient.
- Low output ripple
- Low output impedance
- High-accuracy remote programming (except 6110A)
- Remote error sensing (except 6110A)
- No overshoot on turn-on, turn-off, or power removal
- Output continuously adjustable to zero volts
- High output voltage resolution — ten-turn coarse and one-turn fine control (6101A, 6102A and 6106A)
- In-line 5-digit thumb-wheel voltage programmer (6110A, 6111A, 6112A, 6113A, 6116A)
- All silicon design
- Positive or negative output
- Short circuit proof
- Continuously variable current limit control
- Output voltage and current metering
- Easily rack mounted for systems applications
- Auto-series and auto-tracking operation
- Multiple range meter
- Resettability — 0.01% + 200 μ V

Description

The STB Series of high stability dc bench supplies has been designed for those applications requiring performance an order of magnitude better than well-regulated laboratory supplies. The performance advantages of the STB Series exist with regard to virtually every important aspect of power supply performance — ripple, stability, temperature coefficient, output resolution, programming accuracy, load and line regulation.

The all-silicon circuit uses as its reference element a temperature-compensated zener diode having a temperature coefficient of 20 ppm/°C. A high gain feedback amplifier employing a "diff-amp" (matched silicon differential amplifier package) monitors and controls the output voltage. Critical components, including the zener reference diode and low level portions of the feedback amplifier, are enclosed in an oven which is temperature-controlled entirely with solid-state components — no moving parts to wear out.

Models 6111A, 6112A, 6113A, and 6116A are similar to models 6101A, 6102A and 6106A except for the built-in 5-digit thumb-wheel voltage programmer.

Model 6110A is a high-voltage high-stability supply that is all silicon (no tubes) and also can provide a positive or negative output. The 6110A is ideally suited for high-voltage photomultipliers requiring an exceptionally stable power source. It can also be used as a 0-3000 volt calibrator.

Specifications

AC input: Model 6110A—115 Vac \pm 10%, 57-63 Hz, 1A, 50 W. Other Models—115 Vac \pm 10%, 48-63 Hz, 0.5A, 52 W.

Temperature ranges: operating: 0 to 50°C.
storage: -20°C to +85°C.

Transient recovery time: less than 50 μ s is required for output voltage to recover to within 10 millivolts of the nominal output voltage following a full load change in output current.

Less than 100 μ s is required for output voltage recovery to within the load regulation specification.

The nominal output voltage is defined as the mean between the no load and full load voltage.

Controls: 6101A, 6102A & 6106A—A 10 turn pot permits continuous adjustment of the output voltage over its entire range. A single-turn pot allows fine trimming of the output voltage. A single-turn front-panel pot permits the current limit setting to be varied continuously from zero to a value slightly in excess of the full current rating.

6110A, 6111A, 6112A, 6113A & 6116A—An in-line 5-digit (thumb-wheel) voltage programmer permits control of the output voltage. The 6111A, 6112A, 6113A & 6116A have a single-turn front panel pot that permits the current limit setting to be varied continuously from zero to a value slightly in excess of the full current rating. The 6110A has a fixed current limit built-in to the supply.

Overload protection: an all electronic, continuously acting current limit protects the power supply for all overloads regardless of how long imposed, including a direct short circuit across the output terminals.

Output terminals: The dc output of the supply is floating; thus, the supply can be used as either a positive or negative source. Terminals for +OUT, -OUT, and GND are provided on both the front and back of the supply (except 6110A which has front terminals only). In addition, the rear barrier strip includes terminals for remote programming, remote sensing, Auto-Series, and Auto-Tracking operation (except 6110A).

Cooling: convection cooling is employed. The supply has no moving parts.

Finish: light gray front panel with dark gray case.

Power cord: a 3-wire 5-foot power cord is provided with each unit.

Accessories: see rack kits on page 571.



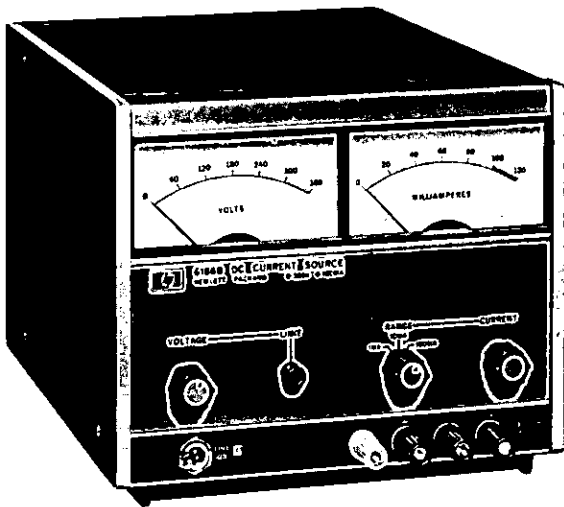
CONSTANT CURRENT SUPPLIES

CCB Series

Models 6177B-6186B

Advantages:

- Output useful to μA region
- High output impedance—no output capacitor
- 200 μs load transient recovery
- Rapid programming with external resistance or voltage
- All semiconductor circuitry
- Driven guard—no output current degradation due to voltmeter
- Continuously variable voltage limit
- Floating output—useful as positive or negative source



6186B



6177B

6181B

Description

Precision performance, low price, small size, and light-weight combine to make the new solid-state CCB Series supplies useful as general purpose laboratory constant current sources for semiconductor circuit development and component evaluation. Excellent ripple, regulation, drift, and output impedance satisfy the most critical constant-current demands.

The unique high-speed remote programming characteristics lend these constant current supplies to diverse applications, such as testing and sorting of semiconductors, resistors, relays, meters, etc., and also precision electroplating and electromagnetics. The capability of superimposing output ac modulation permits CCB supplies to be used for measurement of dynamic or incremental impedance of circuit components.

Special attention has been given to circuit details so that well regulated performance is maintained down to very low output currents ($1 \mu\text{A}$). Other design precautions contribute to the dc isolation and ac shielding properties which are necessary for a high performance constant current supply.

Specifications

Load regulation: less than 25 ppm of output ± 5 ppm of range switch setting for a load change which causes the output voltage to vary from zero to maximum.

Line regulation: less than 25 ppm for a change in the line voltage from 103.5 to 126.5 V ac (or 126.5 to 103.5 V ac) at any output current and voltage within rating.

Load transient recovery time: less than 200 μ s for output current recovery to within 1% of the nominal output current following a full load change in output voltage.

Temperature coefficient: output change per degree C is less than 75 ppm of output current + 5 ppm of range switch setting.

Stability: less than 100 ppm of output current + 25 ppm of range switch setting. Stability is measured for 8 hours after 1 hour warm-up under conditions of constant line, load, temperature, and output setting.

Resolution: 0.02% of range switch setting.

Temperature rating: operating, 0 to 55°C; storage, -40 to +75°C.

Controls: 3-position output current range switch, 10-turn output current control, 1-turn voltage limit control and indicator, meter switch (6177B and 6181B only), and power switch.

Output terminals: a positive and negative output terminal are included on the front panel, as well as plus meter and ground terminals. Either output terminal may be grounded or the supply may be floated at up to 300 V off ground. A rear panel barrier strip includes output, plus meter, and other terminals necessary for remote programming, ac modulation, and other control functions.

Size: 6186B: 6½" (16,5 cm) H x 7¾" (19,7 cm) W x 12¾" (30,9 cm) D; 6177B, 6181B: same except 3½" (8,9 cm) H.

Weight: 6177B, 6181B: 10 lbs (4,5 kg) net, 13 lbs (5,9 kg) shipping; 6186B: 13 lbs (5,9 kg) net, 17 lbs (7,7 kg) shipping.

Options: 014, three digit graduated decadal current control; 028, 230 V ac, single phase input (required for 6177B and 6181B only). See page 571 for details.

Model		6177B	6181B	6186B	
Output current		0-500 mA	0-250 mA	0-100 mA	
Voltage compliance		0-50 Vdc	0-100 Vdc	0-300 Vdc	
Output ranges	A	0-5 mA	0-2.5 mA	0-1 mA	
	B	0-50 mA	0-25 mA	0-10 mA	
	C	0-500 mA	0-250 mA	0-100 mA	
AC input:		115 Vac $\pm 10\%$, 48-63 Hz; 0.6A, 55 W @ 115 Vac For 230 Vac see Option 028		115/230 Vac, 48-63 Hz 0.9A, 90W @ 115 Vac 115/230 Vac Switch	
Constant current Remote Programming	Voltage Control (Accuracy: 0.5% of output current, .04% of range)	Range A	200 mV/mA	1 V/mA	10 V/mA
		Range B	20 mV/mA	100 mV/mA	1V/mA
		Range C	2 mV/mA	10 mV/mA	100 mV/mA
	Resistance Control (Accuracy: 1% of output current .04% of range)	Range A	400 Ω /mA	2 k Ω /mA	10 k Ω /mA
		Range B	40 Ω /mA	200 Ω /mA	1 k Ω /mA
		Range C	4 Ω /mA	20 Ω /mA	100 Ω /mA
Voltage limit Remote Programming	Voltage Control (Accuracy: 20%)	1 V/V	1 V/V	1 V/V	
	Resistance Control	870 Ω /V	440 Ω /V	820 Ω /V	
	Accuracy	20%	20%	10%	
Output impedance (R in parallel with C)*	Range A	R=330 Meg, C=500 pf	R=1330 Meg, C=10 pf	R=10,000 Meg.	
	Range B	R=33 Meg, C=0.005 μ f	R=133 Meg, C=100 pf	R=1,000 Meg.	
	Range C	R=3.3 Meg, C=0.05 μ f	R=13.3 Meg, C=1000 pf	R=100 Meg.	
Ripple and noise: rms/p-p (dc-20 MHz) Either output terminal can be grounded	Range A	0.40 μ A rms/5 μ A p-p	0.20 μ A rms/0.5 μ A p-p	50 nA rms/-	
	Range B	4.0 μ A rms/40 μ A p-p	2.0 μ A rms/7.5 μ A p-p	0.5 μ A rms/-	
	Range C	40 μ A rms/250 μ A p-p	20 μ A rms/100 μ A p-p	5 μ A rms/-	
Programming Speed From zero to 99% of programmed output current, with a resistive load		500 μ sec	500 μ sec	1 msec	
Meter Ranges (Accuracy 2% of full scale)		6, 60, 600 mA; 60 Vdc	3, 30, 300 mA; 120 Vdc	1.2, 12, 120 mA; 360 V	
Price		\$425	\$425	\$475	

*This network is a simplified representation of a complex network. The formula $Z = R X_c / \sqrt{R^2 + X_c^2}$ is used for frequencies up to 1 MHz by substituting the values given for R and C. Above 1 MHz the output impedance is greater than the formula would indicate—load transient overshoots are less than 20% of range setting for a full load change with a 1 μ sec rise time.

POWER SUPPLIES



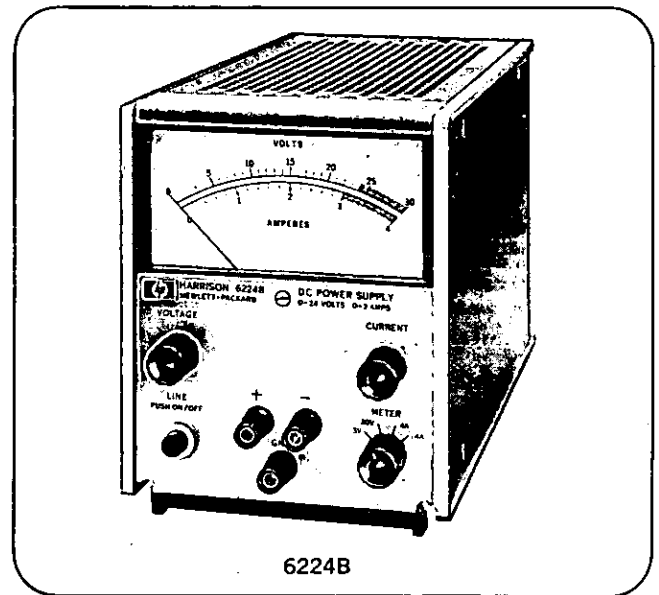
MEDIUM POWER MODULAR MPM series Models 6220B-6226B

The MPM Series consists of compact constant voltage/constant current dc power supplies suitable for either bench or rack operation. They are packaged in one-third rack width modules for use in the modular enclosure system, described on page 636. MPM supplies are designed to satisfy the need for a general purpose and reliable source of power for engineers experimenting with transistor circuit design.

Models 6224B and 6226B possess all of the advantages of the preceding "A" versions of these models plus the following improvements:

- Increased output voltage.
- Ten-turn voltage and current controls for better output settability.
- Multiple range meter for increased bench utility.
- Special circuitry for faster programming.
- All silicon semiconductors for greater reliability.

In addition a dual range supply, Model 6220B has been added to the series. This supply can be used as a 0-25 volt source at 0-1 A or a 0-50 volt source at 0-0.5 A.



Specifications

Model		6220B		6224B	6226B
Output	DC voltage	0-25 V	Dual range	0-24 V	0-50 V
	DC current	0-1 A	0-50 V 0-0.5 A	0-3 A	0-1.5 A
Input: 115 V ac $\pm 10\%$			50-400 Hz 0.5A, 44W	50-60 Hz 1.8 A, 164 W	50-60 Hz 1.8 A, 164 W
Load regulation: the constant voltage load regulation is given for a load current change equal to the current rating of the supply. The constant current load regulation is given for a load voltage change equal to the voltage rating of the supply.	CV		0.01% plus 2 mV	0.01% plus 4 mV	0.01% plus 2 mV
	CC		0.01% plus 250 μ A	0.01% plus 250 μ A	0.01% plus 250 μ A
Line regulation: for a change in the nominal line voltage from 103.5 to 126.5 V at any output voltage and current within rating.	CV		0.01% plus 2 mV	0.01% plus 2 mV	0.01% plus 2 mV
	CC		0.01% plus 250 μ A	0.01% plus 250 μ A	0.01% plus 250 μ A
Ripple and noise: at any line voltage and under any load condition within rating.	CV		200 μ V rms/1 mV p-p (dc to 20 MHz)		
	CC		200 μ A rms/1 mA p-p (dc to 20 MHz)		
Temperature coefficient: output change per degree centigrade change in ambient following 30 minutes warm-up.	CV		0.02% plus 1 mV	0.02% plus 500 μ V	0.02% plus 500 μ V
	CC		0.02% plus 1 mA 0.02% plus 0.5 mA	0.02% plus 1.5 mA	0.02% plus 0.8 mA
Stability: under constant ambient conditions, total drift for 8 hours following 30 minutes warm-up.	CV		0.1% plus 5 mV	0.1% plus 2.5 mV	0.1% plus 2.5 mV
	CC		0.1% plus 5 mA 0.1% plus 2.5 mA	0.1% plus 7.5 mA	0.1% plus 4 mA
Remote programming: all programming terminals are located on rear barrier strips.	CV		200 ohms per volt	200 ohms per volt	200 ohms per volt
	CC		1000 ohms per amp 2000 ohms per amp	500 ohms per amp	500 ohms per amp
Meter ranges:			0-6 V, 0-60 V, 0-0.12 A, 0-1.2 A	0-3 V, 0-30 V, 0-0.4 A, 0-4 A	0-6 V, 0-60 V, 0-0.18 A, 0-1.8 A
Weight: (net/shipping)	lbs. kg		16/20 7,25/9	16/20 7,25/9	16/20 7,25/9
Price:			\$250	\$325	\$325
Options: refer to page 571 for description			013—\$35 014—\$35 028—\$10		

CV = Constant Voltage CC = Constant Current

Output impedance

DC to 1 kHz—less than 0.01 ohm, 1 kHz to 10 kHz—less than 0.05 ohm, 10 kHz to 100 kHz—less than 0.5 ohm, 100 kHz to 1 MHz—less than 5 ohms.

Transient recovery time: less than 50 μ seconds is required for output voltage recovery in constant voltage operation to within 10 millivolts of the nominal output voltage following a change in output current equal to the current rating of the supply. The nominal output voltage is defined as the mean between the no load and full load voltages.

Temperature ratings: operating: 0-55°C (consult factory for derating information for operation between 50°C and 71°C); storage: -40°C to +85°C.

Controls: ten-turn output voltage and current controls permit continuous adjustment over entire output span. Switch selects front panel meter voltage or current scale. Model 6220B includes range switch for selecting 0-25 V or 0-50 V output.

Size: 6 1/4" H x 5 1/8" W x 11" D (15,9 cm H x 13 cm W x 28 cm D).

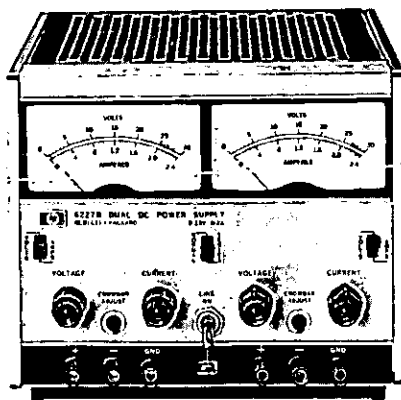
DUAL POWER SUPPLY

DPB Series

Models 6227B, 6228B



POWER SUPPLIES



6227B

Description

Hewlett-Packard offers two new dual output supplies with tracking operation for powering operational amplifiers, push-pull stages, deflection systems, and any application where plus and minus voltages are required to track with an insignificant error.

Each unit houses two identical independently adjustable dc power supplies. In the normal mode, the output voltage and current are metered and controlled separately, and each supply is isolated at up to 300 V from output to chassis or output to output. A convenient front panel switch selects either normal or tracking operation.

These supplies offer advantages not previously available at this price range.

1. Two 50-watt power supplies for independent or tracking operation in a half-rack case.
2. Constant current in addition to constant voltage outputs.
3. Built-in overvoltage protection crowbars.
4. Low peak-to-peak ripple and noise.
5. Large meters for current and voltage.

Specifications

DC output: Model 6227B: two 0-25 V supplies @ 0-2A. Model 6228B: two 0-50 V supplies @ 0-1A.

AC input: 115 V ac $\pm 10\%$ or 210-250 V ac, selected by rear panel switch, 48-63 Hz.

Constant voltage load regulation: less than 0.01% +1 mV for a load current change equal to the current rating of the supply.

Constant current load regulation: less than 0.01% +250 μ A for a load voltage change equal to the voltage rating of the supply.

Line regulation: less than 1 mV (constant voltage) or 100 μ A (constant current) for any change in line voltage between -103.5 and +126.5 V ac or 210 and 250 V ac at any output voltage and current within rating.

Ripple and noise at any line voltage and under any load condition within rating

Constant voltage: 250 μ V rms and 1.5 mV p-p (dc to 20 MHz).

Constant current: 250 μ A rms and 2 mA p-p (dc to 20 MHz).

Temperature coefficient: output change per degree Centigrade change in ambient following 30 minutes warmup.

Constant voltage: 0.02% +200 μ V.

Constant current: 6227B, 0.02% +300 μ A; 6228B, 0.02% +150 μ A.

Remote resistance programming

Constant voltage: 200 Ω /V.

Constant current: 6227B, 500 Ω /A; 6228B, 1 K Ω /A.

Remote voltage programming

Constant voltage: 1 V/V.

Constant current: 6227B, 0.5 A/V; 6228B, 1 A/V.

Voltage resolution (fine control): 6227B, 5 mV; 6228B, 10 mV.

Current resolution (fine control): 6227B, 1 mA; 6228B, 0.5 mA.

Load transient recovery time: less than 50 μ seconds is required for output voltage recovery in constant voltage operation to within 10 mV of the nominal output voltage following a change in output current equal to the current rating of the supply. The nominal output voltage is the mean between the no-load and full-load voltages.

Temperature ratings

Operating: 0-55°C.

Storage: -40 to +75°C.

Controls: single-turn concentric coarse and fine controls are used for voltage and current, slide switch selects voltage or current meter readings. Normal/tracking switch for selecting either two independently isolated supplies or auto-tracking operation.

Meters: two meters, one for each supply, can be switched to either voltage or current. Meter accuracy is 2% of full scale.

6227B, 30 V/2.4A; 6228B, 60 V/1.2A

Weight: net, 24 lbs (11 kg); shipping, 28 lbs (12.9 kg).

Size: 6-3/32" H (15,48 cm) x 7-25/32" W (19,76 cm) x 12 1/4" D (31,12 cm).

Internal overvoltage crowbar: protects delicate loads by monitoring the output voltage and firing an SCR that effectively shorts the output when the preset trip voltage is exceeded.

Trip voltage range: 6227B, 5 to 28 V dc; 6228B, 5 to 55 V dc.

Trip voltage margin: the minimum trip voltage above the operating output voltage of the supply to prevent false crowbar tripping: 7% of the output voltage + 1.5 V.

Tracking error: in Auto-Tracking mode, both supplies are matched to within 0.2% ± 2 mV.

Price: \$450.

Options (refer to page 571 for descriptions): 07-\$25, 08-\$25, 13-\$60, 14-\$60.

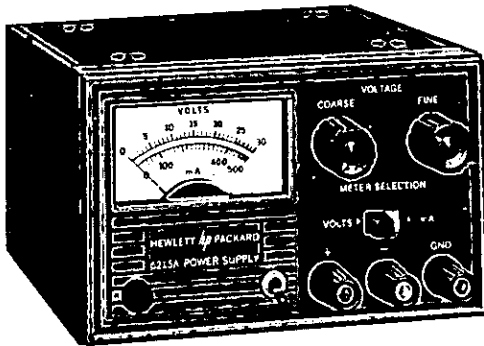
Accessories: both supplies are packaged in the one-half rack width modules for use in the modular enclosure system described on page 636.



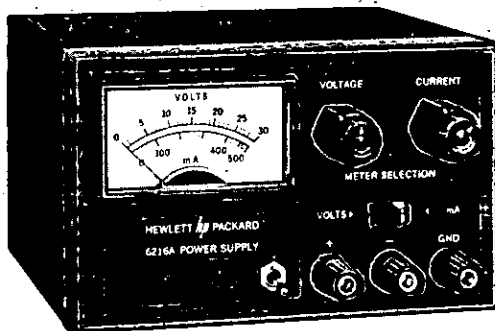
SMALL LABORATORY SUPPLIES

BENCH Series

Models 721A, 6213A-6218A



Constant Voltage/Current Limiting



Constant Voltage/Constant Current

Common Specifications

Load transient recovery time: less than 50 μ seconds is required for output voltage recovery in constant voltage operation to within 15 millivolts of the nominal output voltage following a change in output current equal to the current rating of the supply; the nominal output voltage is defined as the mean between the no load and full load voltages.

Output impedance:

Less than 0.03 ohm from DC to 1 kHz.
Less than 0.5 ohm from 1 kHz to 100 kHz.
Less than 3 ohms from 100 kHz to 1 MHz.

Temperature ratings:

Operating: 0 to 55°C (consult factory for derating information for operation over 55°C).
Storage: -40°C to +75°C.

Size: - 3¼" H x 5¼" W x 7" D.

- 8,26 cm H x 13,34 cm W x 17,78 cm D.

Output terminals: either positive or negative output terminal may be connected to ground through a separate terminal provided for that purpose, or the supply may be operated floating at up to 300 volts off ground.

Accessories: See page 571.

Option 028 - 230 vac, single phase input: factory modification consists of reconnecting the multitap input power transformer for 230-volt operation;
Price \$10.

Advantages:

High quality—low cost

Short circuit-proof—current limit circuit protects the supply against any overload, including a direct short circuit across the output terminals, for any time interval without damage

Compact—impact-resistant case

Floating output—supply can be operated as a positive or negative source

Silicon differential amplifiers compare the output voltage with a stable reference voltage; provide improved stability

No turn-on, turn-off, or power removal overshoot

Coarse and fine controls

Low output ripple and drift

Rack mounting hardware available

Fully serviceable

Description

Six extremely compact well-regulated dc power supplies, designed especially for bench use, comprise the BENCH series. New fabrication techniques employed minimize manufacturing costs while retaining component and circuit quality. Reliable, yet low cost, these "hand-size" battery substitutes have overall performance features ideal for circuit development, component evaluation, and other laboratory applications.

The all-silicon circuit uses an input differential amplifier to compare the output voltage with reference voltage derived from a temperature-compensated zener diode. These stable input and reference circuits are combined with a high gain feedback amplifier to achieve low-noise drift-free performance. Output voltage is fully adjustable to zero. Special design precautions prevent output overshoot during turn-on or turn-off, or when ac power is suddenly removed.

The front panel meter can be switched to monitor output voltage or current. Constant voltage/constant current or constant voltage/current limiting insures short-circuit proof operation, and permits series and parallel connection of two or more supplies when greater voltage or current is desired.

The molded, impact-resistant case includes an interlocking feature for stacking several units vertically, thus minimizing bench space required for multiple supplies. Alternatively, up to three units can be mounted side by side in a 19" rack using a special Rack Mounting Kit. See page 571.

Specifications

Model	Constant voltage/current limiting			Constant voltage/constant current			
	6213A	6215A	6217A	6214A	6216A	6218A	
Output DC voltage DC current	0-10 V 0-1 A	0-25 V 0-400 mA	0-50 V 0-200 mA	0-10 V 0-1 A	0-25 V 400 mA	0-50 V 0-200 mA	
Input: 115 V ac \pm 10%, 48-440 Hz	0.29 A, 28 W	0.25 A, 25 W	0.25 A, 25 W	0.29 A, 28 W	0.25 A, 26 W	0.25 A, 26 W	
Load regulation: the constant voltage load regulation is given for a load current change equal to the current rating of the supply; the Constant Current load regulation is given for a load voltage change equal to the voltage rating of the supply.	C V	4 mV			4 mV		
	C C	-	-	-	500 μ A		
Line regulation: for a change in line voltage from 103.5 to 126.5 (or 126.5 to 103.5) at any output voltage and current within rating.	C V	4 mV			4 mV		
	C C	-	-	-	750 μ A	500 μ A	500 μ A
Ripple and noise: at any line voltage and load condition within rating.	C V	200 μ V rms/1 mV p-p (dc to 20 MHz)			200 μ V rms/1 mV p-p (dc to 20 MHz)		
	C C	-	-	-	150 μ A rms/500 μ A p-p (dc to 20 MHz)		
Temperature coefficient: output change per degree centigrade change in ambient following 30 minutes warm-up.	C V	(0.02% +1 mV) per $^{\circ}$ C			(0.02% +1 mV) per $^{\circ}$ C		
	C C	-	-	-	6 mA per $^{\circ}$ C	2 mA per $^{\circ}$ C	1 mA per $^{\circ}$ C
Stability: under constant ambient conditions, total drift for 8 hours following 30 minutes warm-up.	C V	0.1% +5 mV			0.1% +5 mV		
	C C	-	-	-	15 mA	5 mA	2.5 mA
Resolution:	C V	<5 mV	<5 mV	<10 mV	<5 mV	<5 mV	10 mV
	C C	-	-	-	<75 μ A	<20 μ A	10 μ A
Controls:	On-off switch and separate pilot light; one-turn coarse and fine voltage controls; meter switch selects volts or mA			On-off switch and separate pilot light; concentric coarse and fine voltage control; concentric coarse and fine current control; meter range switch			
Meter ranges: accuracy is 3% of full scale.	0-12 V, 0-1.2 A	0-30 V, 0-500 mA	0-60 V, 0-250 mA	0-12 V, 0-1.2 A	0-30 V, 0-500 mA	0-60 V, 0-250 mA	
Weight: (net/shipping)	lbs. kg.	4.5/6.5 2,0/2,9	4.5/6.5 2,0/2,9	4.5/6.5 2,0/2,9	4.75/6.75 2,2/3,1	4.75/6.75 2,2/3,1	
Price		\$90	\$90	\$90	\$115	\$115	\$115

Model 721A Specifications

DC output: 0-30 V dc, 0-150 mA.

AC input: 105-125/210-250 volts, 50 to 60 Hz, 16 W.

Load regulation: less than 0.3% or 30 mV (whichever is greater) output voltage change from no load to full load.

Line regulation: less than 0.3% or \pm 15 mV (whichever is greater) output voltage change for a 10% change in nominal line voltage.

Ripple and noise: less than 150 μ V rms at any line voltage and under any load condition within rating.

Temperature ratings: operating: 0 to 50 $^{\circ}$ C; storage: -20 to +85 $^{\circ}$ C.

Output impedance: less than 0.2 ohm in series with less than 30 μ H; meter range switch in 10 or 30 V dc position.

Overload protection: automatically limits peak output current to selected values (25, 50, 100, or 225 mA)—regardless of the load resistance.

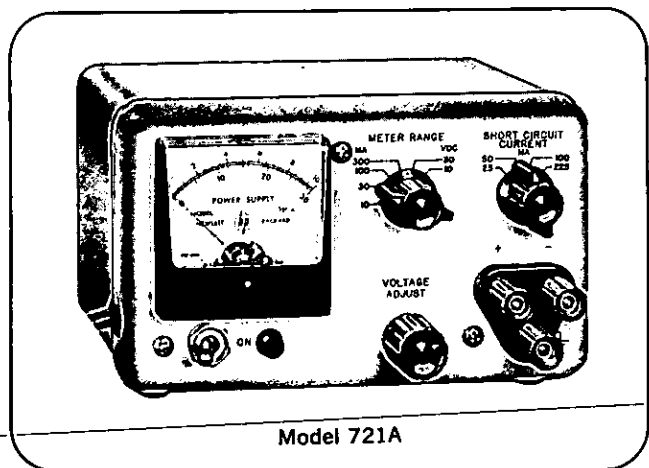
Controls: 6-position rotary switch selects current or voltage meter ranges; 4-position rotary switch selects maximum output current, 25, 50, 100, or 225 mA.

Output terminals: three banana jacks spaced $\frac{3}{4}$ " apart. Positive and negative terminals are isolated from chassis; supply can be operated floating up to 400 volts off ground.

Weight: net, 4 lbs (1,81 kg); shipping, 7 lbs (3,17 kg).

Size: 7" (1,8 cm) W x 4 $\frac{3}{8}$ " (11,1 cm) H x 5 $\frac{1}{4}$ " (13,3 cm) D.

Price: \$145.



Model 721A

The forerunner of the BENCH Series, the Model 721A Power Supply was designed to produce dc voltages for transistor investigation, and its reliability has made it a popular reorder item. Its fully regulated output voltage range of 0 to 30 volts is sufficient for most types of transistors in use today. It has a three terminal output so that either the positive or negative terminal may be grounded. Particularly useful are 4 choices of current limit values, and multiple range metering.

POWER SUPPLIES



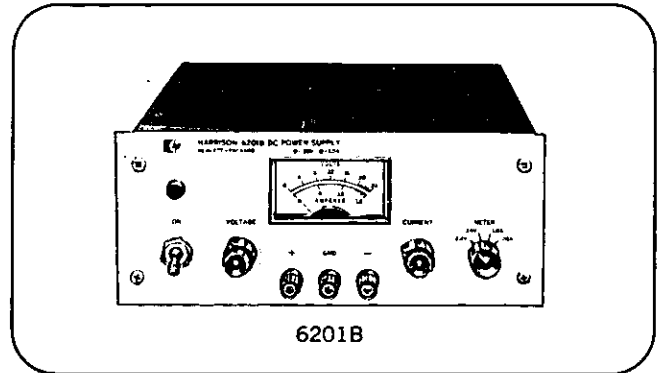
LABORATORY BENCH SERIES

LAB Series

Models 6200B - 6209B

Advantages

- Multiple range meter
- Remote programming and sensing
- High-speed programming
- Auto-series, auto-parallel, auto-tracking
- Short circuit proof
- Front and rear output terminals
- Floating output
- RFI-conformance to MIL-I-6181D



Model		6200B†	6201B†	6202B†	6203B
CONSTANT VOLTAGE/CONSTANT CURRENT					
Output	DC Voltage	0-20 V	0-40 V	0-20 V	0-40 V
	DC Current	0-1.5 A	0-0.75 A	0-1.5 A	0-0.75 A
Input		115 V ac \pm 10%, 48-440 Hz, 0.9 A, 70 W	115 V ac \pm 10%, 48-440 Hz, 0.8 A, 66 W	115 V ac \pm 10%, 48-440 Hz, 0.8 A, 66 W	115 V ac \pm 10%, 48-440 Hz, 0.9 A, 70 W
Load regulation	Constant Voltage	0.01% plus 4 mV	0.01% plus 4 mV	0.01% plus 4 mV	5 mV
	Constant Current	0.03% plus 250 μ A	0.03% plus 250 μ A	0.03% plus 250 μ A	0.03% plus 250 μ A
Line regulation	Constant Voltage	0.01% plus 4 mV	0.01% plus 4 mV	0.01% plus 4 mV	3 mV
	Constant Current	0.01% plus 250 μ A	0.01% plus 250 μ A	0.01% plus 250 μ A	0.01% plus 250 μ A
Ripple and noise	Constant Voltage	200 μ V rms/ 1mV p-p (DC-20 Mhz)	200 μ V rms/ 1mV p-p (DC-20 Mhz)	200 μ V rms/ 1mV p-p (DC-20 Mhz)	200 μ V rms/ 1mV p-p (DC-20 Mhz)
	Constant Current	500 μ A rms	500 μ A rms	500 μ A rms	500 μ A rms
Remote resistance programming	Constant Voltage*	200 ohms per volt	200 ohms per volt	200 ohms per volt	200 ohms per volt
	Constant Current†	500 ohms per amp	1000 ohms per amp	1000 ohms per amp	1000 ohms per amp
Remote voltage programming	CV (Accur. 1%)	1 V/V	1 V/V	1 V/V	1 V/V
	CC (Accur. 10%)	1 V/A	2 V/A	1 V/V	0.5 V/A
Voltage resolution		10 mV	5 mV	10 mV	5 mV
Current resolution		2 mA	1 mA	1 mA	2 mA
Overload protection		Constant voltage/constant current circuit provides complete protection for the power supply for any overload condition. In addition, continuously adjustable current limiting in constant voltage operation and continuously adjustable voltage limiting in constant current operation provides optimum protection for the load device.			
Controls		Off-On Switch, Pilot Light, Concentric Coarse and Fine Voltage Control, Concentric Coarse and Fine Current Control, Concentric Meter Range and Output Range Switch.	Off-On Switch, Pilot Light, Concentric Coarse and Fine Voltage Control, Concentric Coarse and Fine Current Control, Meter Range Switch.	Off-On Switch, Pilot Light, Concentric Coarse and Fine Voltage Control, Concentric Coarse and Fine Current Control, Meter Range Switch.	Off-On Switch, Pilot Light, Concentric Coarse and Fine Voltage Control, Concentric Coarse and Fine Current Control, Meter Range Switch.
Meter ranges: Accuracy is 3%		0-5 V, 0-50 V, 0-1.8 A, 0-1.8 A	0-2.4 V, 0-24 V, 0-1.8 A, 0-1.8 A	0-5 V, 0-50 V, 0-0.09 A, 0-0.9 A	0-9 V, 0-9 V, 0-4 A, 0-4 A
Weight (Net/Shipping)		14/19 lbs. (6.34/8.60 kg)	14/19 lbs. (6.34/8.60 kg)	14/19 lbs. (6.34/8.60 kg)	14/19 lbs. (6.34/8.60 kg)
Price		\$189	\$169	\$169	\$169
Options Refer to page 571 for descriptions		007—\$25	008—\$25 009—\$45 011—\$50	013—\$60 014—\$60	028—\$10

*Voltage programming coefficient accuracy 100mv plus 2% of output voltage setting. †Similar Models are manufactured in Western Europe.

Lab Specifications

Load transient recovery time: less than 50μs for output recovery to within 10 mV following a full load current change in output.

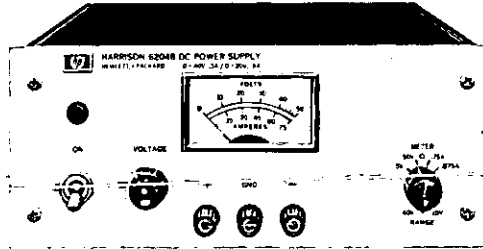
Internal impedance: less than 0.02 ohm from dc to 1 kHz;

less than 0.5 ohm from 1 kHz to 100 kHz; less than 3.0 ohms from 100 kHz to 1 MHz.

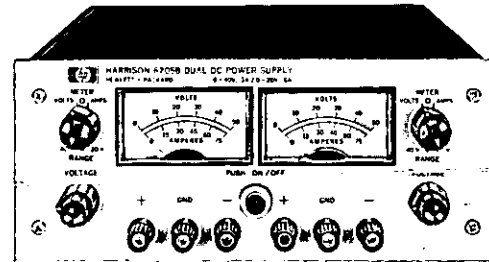
Size: 3½" (8,9 cm) H x 12½" (32 cm) D x 8½" (21,6 cm) W—half rack width.

Accessories: refer to page 571.

Maximum ambient operating temperature: +50°C.



6204B DUAL RANGE



6205B DUAL OUTPUT

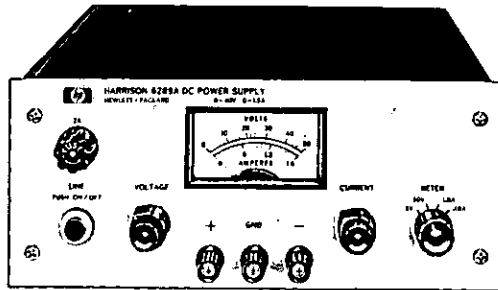
6204B†			6205B			6206B			6207B		6209B	
CONSTANT VOLTAGE/CURRENT LIMITING									CV/CC			
0-20 V	DUAL RANGE	0-40 V	0-20 V	TWO DUAL RANGE	0-40 V	0-30 V	DUAL RANGE	0-60 V	0-160 V	0-320 V		
0-0.6 A		0-0.3 A	0-0.6 A	OUTPUTS	0-0.3 A	0-1 A		0-0.5 A	0-0.2 A	0-0.1 A		
115 V ac ±10%, 48-440 Hz, 0.4 A, 24 W			115 V ac ±10%, 48-440 Hz, 0.5 A, 50 W			115 V ac ±10%, 48-440 Hz, 1.0 A, 66 W			115 V ac ±10%, 48-63 Hz, 1.0 A, 60 W		115 V ac ±10%, 48-63 Hz, 1.0 A, 60 W	
0.01% plus 4 mV			0.01% plus 4 mV			0.01% plus 4 mV			0.02% plus 2 mV		0.02% plus 2 mV	
0.01% plus 4 mV			0.01% plus 4 mV			0.01% plus 4 mV			200 μA		200 μA	
0.01% plus 4 mV			0.01% plus 4 mV			0.01% plus 4 mV			0.02% plus 2 mV		0.02% plus 2 mV	
200 μV rms/1mV p-p (DC-20 Mhz)			200 μV rms/1mV p-p (DC-20 Mhz)			200 μV rms/1mV p-p (DC-20 Mhz)			500 μV rms/40 mV p-p		1 mV rms/40 mV p-p	
200 ohms per volt			200 ohms per volt			300 ohms per volt			200 μA rms		200 μA rms	
200 ohms per volt			200 ohms per volt			300 ohms per volt			300 ohms per volt		300 ohms per volt	
1 V/V			1 V/V			1 V/V			75 K ohms per amp		150 K ohms per amp	
1 V/V			1 V/V			1 V/V			1 V/V		1 V/V	
10 mV			10 mV			10 mV			0.75 V/0.1 A		1.5 V/0.1 A	
10 mV			10 mV			10 mV			25 mV		40 mV	
500 μA			500 μA			500 μA			500 μA		200 μA	
Fixed current limit provides complete protection for any overload condition. This limit is set at approximately 700 mA for the 20 volt range and 350 mA for the 40 volt range.			Fixed current limit provides complete protection for any overload condition. This limit is set at approximately 700 mA for the 20 volt range and 350 mA for the 40 volt range.			Fixed current limit provides complete protection for any overload condition. This limit is set for approximately 1.2 A for the 30 volt range and 600 mA for the 60 volt range.			Same as 6200B			
Off-On Switch, Pilot Light, Concentric Coarse and Fine Voltage Control, Concentric Meter Range and Output Range Switch.			Combined Pilot Light and On-Off Button, Two Concentric Coarse and Fine Voltage Controls, Two Concentric Meter Range and Output Range Switches.			Off-On Switch, Pilot Light, Concentric Coarse and Fine Voltage Control, Concentric Meter Range and Output Range Switch.			Off-On Switch, Pilot Light, 10-turn Voltage Control, Concentric Coarse and Fine Current Control, Meter Range Switch.		Off-On Switch, Pilot Light, 10-turn Voltage Control, Concentric Coarse and Fine Current Control, Meter Range-Switch.	
0-5 V, 0-50 V, 0-0.75 A, 0-.75 A			0-5 V, 0-50 V, 0-0.75A, 0-.75A			0-7 V, 0-70 V, 0-.12 A, 0-1.2 A			0-20 V, 0-200 V, 0-24 mA, 0-240 mA		0-40 V, 0-400 V, 0-12 mA, 0-120 mA	
10/13 lbs. (4,53/5,89 kg)			10/13 lbs. (4,53/5,89 kg)			12/17 lbs. (5,43/7,70 kg)			13/18 lbs. (5,89/8,15 kg)		13/18 lbs. (5,89/8,15 kg)	
\$144			\$235			\$169			\$235		\$235	
007-\$25 013-\$60 011-\$50 028-\$10			007-\$50 013-\$140 011-\$90 028-\$10			007-\$25 013-\$60 011-\$50 028-\$10			008-\$25 013-\$35 014-\$60 028-\$10		008-\$25 028-\$10 013-\$35 014-\$60	

†Current programming coefficient accuracy 6% of current rating plus 10% of output current setting.

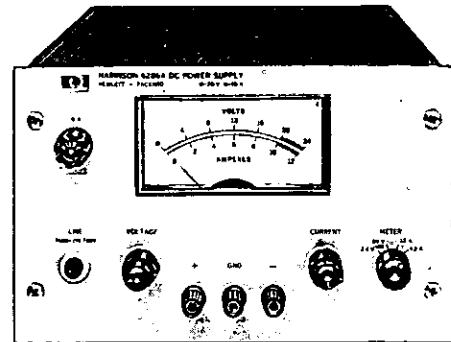
POWER SUPPLIES



MEDIUM & DUAL POWER SUPPLIES MPB-3, MPB-5, & DPR series Models 6281A-6299A, 6253A, 6255A



MPB-3



MPB-5

The MPB-3 and MPB-5 Series of dc power supplies are highly regulated, medium power, constant voltage/constant current bench models. All include multiple range meters and provision for remote sensing, remote programming, auto-series, auto-parallel, and auto-tracking operation.

The DPR models contain two identical MPB-3 supplies mounted in a full rack-width chassis. All DPR features and specifications are identical to the MPB-3 with the exceptions listed on the following page.

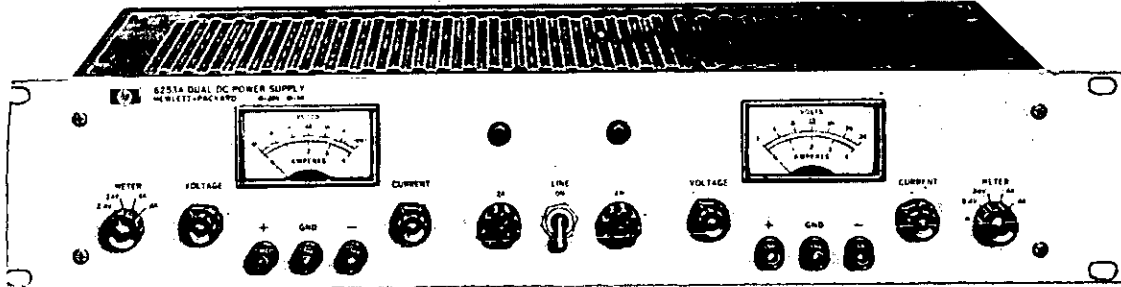
Advantages:

- Short circuit proof
- Constant voltage/constant current operation with automatic crossover
- Multiple range meters
- Floating output
- All silicon circuitry
- Front and rear output terminals
- No overshoot on turn-on, turn-off, or power removal
- Easily rack mounted
- Internal overvoltage protection "crowbar" option
- Auto-series, auto-parallel, auto-tracking

MPB-5 Specifications

Model		6282A	6285A	6286A	6290A	6291A	6296A
Output	DC Voltage	0-10V	0-20V	0-20V	0-40V	0-40V	0-60V
	DC Current	0-10A	0-5A	0-10A	0-3A	0-5A	0-3A
Input: 115 V ac \pm 10%, 50-60 Hz		3.5A, 200W	3.5A, 160W	5.5A, 320W	3.5A, 170W	5.5A, 280W	4.5A, 250W
*Load regulation: The Constant Voltage Load Regulation specification is given for a load current change equal to the current rating of the supply. The Constant Current Load Regulation specification is given for a load voltage change equal to the voltage rating of the supply.	C V	0.01% plus 1 mV	0.01% plus 1 mV	0.01% plus 1 mV	0.01% plus 1 mV	0.01% plus 1 mV	0.01% plus 1 mV
	C C	0.05% plus 1 mA	0.05% plus 1 mA	0.05% plus 1 mA	0.05% plus 1 mA	0.05% plus 1 mA	0.05% plus 1 mA
Line regulation: For a change in line voltage from 103.5 to 126.5 V ac.	C V	0.01% plus 1 mV	0.01% plus 1 mV	0.01% plus 1 mV	0.01% plus 1 mV	0.01% plus 1 mV	0.01% plus 1 mV
	C C	0.05% plus 1 mA	0.05% plus 1 mA	0.05% plus 1 mA	0.05% plus 1 mA	0.05% plus 1 mA	0.05% plus 1 mA
Ripple and noise: At any line voltage and under any load condition within rating.	C V	500 μ V RMS (25 mV peak to peak DC to 20 MHz)					
	C C	5 mA RMS	3 mA RMS	5 mA RMS	3 mA RMS	3 mA RMS	3 mA RMS
Remote programming: All Programming terminals are located on rear barrier strips.	C V	200 ohms per volt	200 ohms per volt	200 ohms per volt	200 ohms per volt	200 ohms per volt	300 ohms per volt
	C C	100 ohms per amp	200 ohms per amp	100 ohms per amp	500 ohms per amp	200 ohms per amp	500 ohms per amp
Meter ranges: (Accuracy : 3%)		0-1.2 V, 0-12 V, 0-1.2 A, 0-12 A	0-2.4 V, 0-24 V, 0-6 A, 0-6 A	0-2.4 V, 0-24 V, 0-1.2 A, 0-12 A	0-5 V, 0-50 V, 0-4 A, 0-4 A	0-5 V, 0-50 V, 0-6 A, 0-6 A	0-7 V, 0-70 V, 0-4 A, 0-4 A
Weight: (Net/Shipping)	lbs	25/32	25/32	30/40	26/33	30/40	29/38
	kg	11,3/14,5	11,3/14,5	13,6/14,1	11,8/15,0	13,6/14,1	13,1/12,7
Price		\$350	\$350	\$395	\$350	\$395	\$395
Options: Refer to page 571 for description		005-\$10 008-\$25	(no charge if ordered with Option 018) 009-\$45	011-\$55	007-\$25 013-\$60	014-\$60	018-\$50

*CV load regulation given for rear terminals only. At front terminals CV load regulation is 0.5 mv per amp greater due to front terminal resistance.



6253A

Output impedance: MPB-5 series: 0.001Ω series with $1\mu\text{H}$. For other models, see table below.

Controls: Concentric coarse and fine output voltage and current controls permit continuous adjustment over entire output span. Models 6294A and 6299A incorporates a 10-turn front panel voltage control in lieu of the concentric coarse and fine voltage controls. Switch selects front panel meter voltage or current scale.

Finish: Light gray panel with dark gray case.

Accessories: Rack Kits 14513A and 14523A. See page 571.

Load transient recovery time: less than $50\mu\text{s}$ is required for output voltage recovery in constant voltage operation to within 15 millivolts of the nominal output voltage following a change in output current equal to the current rating of the

supply or 5 amperes, whichever is smaller. The nominal output voltage is defined as the mean between the no load and full load voltages.

Temperature ratings:

Operating: $0-50^\circ\text{C}$ (consult factory for derating information for operation between 50°C and 71°C)

Storage -20°C to $+85^\circ\text{C}$

Size:

MPB-3 — $3\frac{1}{2}''$ H x $8\frac{1}{2}''$ W x $14\frac{1}{2}''$ D
— 8,9 cm H x 21,8 cm W x 36,8 cm D

MPB-5 — $5\frac{1}{4}''$ H x $8\frac{1}{2}''$ W x $16''$ D
— 13,3 cm H x 21,8 cm W x 40,7 cm D

DPR — $3\frac{1}{2}''$ H x $14\frac{1}{2}''$ D x $19''$ W
— 8,9 cm H x 36,8 cm D x 48,3 cm W

Specifications

Model		MPB-3 6281A	MPB-3 6284A	DPR 6263A	MPB-3 6289A	DPR 6255A	MPB-3 6294A	MPB-3 6299A
Output	DC Voltage	0-7.5V	0-20V		0-40V		0-60V	0-100V
	DC Current	0-5A	0-3A		0-1.5A		0-1A	0-750 mA
Input: 115 V ac $\pm 10\%$, 48-440 Hz		1.3 A 118 W	1.5 A 128 W	3 A 256 W	1.3 A 110 W	2.6 A 220 W	1.3 A 114 W	1.5 A 135 W
*Load regulation: The Constant Voltage Load Regulation is given for a load current change equal to the current rating of the supply. The Constant Current Load regulation is given for a load voltage change equal to the voltage rating of the supply.	C V	5 mV	0.01% plus 4 mV		0.01% plus 2 mV		0.01% plus 2 mV	0.01% plus 2 mV
	C C	0.01% plus 250 μA	0.01% plus 250 μA		0.01% plus 250 μA		0.01% plus 250 μA	0.01% plus 250 μA
Line regulation: For a change in line voltage from 103.5 to 126.5 V ac.	C V	0.01% plus 2 mV	0.01% plus 2 mV		0.01% plus 2 mV		0.01% plus 2 mV	0.01% plus 2 mV
	C C	0.01% plus 250 μA	0.01% plus 250 μA		0.01% plus 250 μA		0.01% plus 250 μA	0.01% plus 250 μA
Ripple and noise: At any line voltage and under any load condition within rating.	C V	200 μV RMS/1 mV p-p (dc to 20 MHz)						
	C C	4 mA RMS	2 mA RMS		500 μA RMS		500 μA RMS	500 μA RMS
Remote programming: All Programming terminals are located on rear barrier strips.	C V	200 ohms per volt	200 ohms per volt		200 ohms per volt		300 ohms per volt	300 ohms per volt
	C C	200 ohms per amp	500 ohms per amp		500 ohms per amp		1000 ohms per amp	1000 ohms per amp
Output impedance:		1 m Ω + 1 μH	2 m Ω + 1 μH		4 m Ω + 1 μH		8 m Ω + 1 μH	16 m Ω + 1 μH
Meter ranges (Accuracy: 3%)		0-9 V, 0-9 V, 0-6 A, 0-6 A	0-2.4 V, 0-24 V, 0-4 A, 0-4 A		0-5 V, 0-50 V, 0-18 A, 0-1.8 A		0-7 V, 0-70 V, 0-12 A, 0-1.2 A	0-12 V, 0-120 V, 0-1 A, 0-1 A
Weight: (Net/Shipping)	lbs. kg	14/19 6,4/8,6	14/19 6,4/8,6		28/35 12,7/15,8		14/19 6,4/8,6	15/20 6,8/9,1
Price		\$210	\$210		\$445		\$210	\$225
Options: Refer to page 571 for details		MPB-3 007—\$25	008—\$25	009—\$45		011—\$50	013—\$60	014—\$60
		DPR 007—\$50	008—\$50	009—\$90	010—\$125	011—\$100	013—\$120	014—\$120
								028—\$10
								028—\$10

CC indicates constant current.

CV indicates constant voltage.

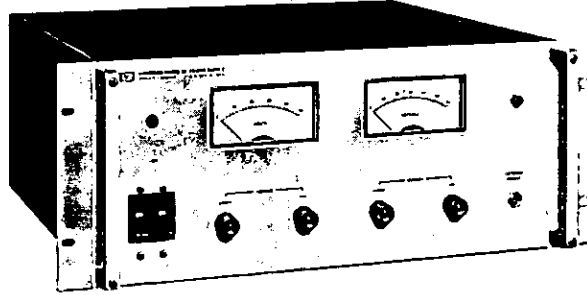
POWER SUPPLIES



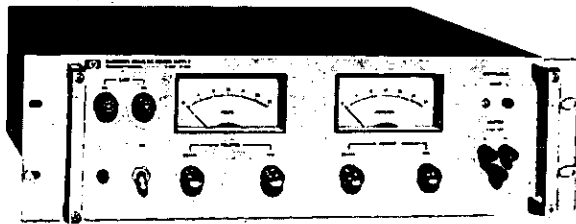
LOW VOLTAGE RACK SUPPLIES

LVR-B Series

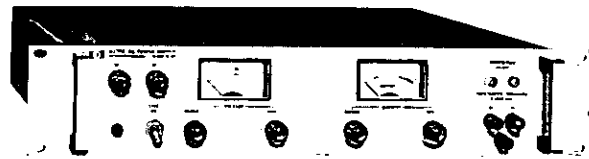
Models 6256B-6274A



6259B, 6260B, 6261B, 6268B, 6269B



6256B, 6264B, 6267B, 6274B



6263B, 6265B, 6266B, 6271B

Model		6256B	6259B	6260B	6261B	6268B
DC output:		0-10 Volts @ 0-20 Amps	0-10 Volts @ 0-50 Amps	0-10 Volts @ 0-100 Amps	0-20 Volts @ 0-50 Amps	0-20 Volts @ 0-10 Amps
AC Input: (see options available)		115 Vac \pm 10%, 1 ϕ 57-63 Hz, 5 A, 375 W @ 115 V	210-250 Vac, 1 ϕ 57-63 Hz, 6 A, 850 W @ 230 V	210-250 Vac, 1 ϕ 57-63 Hz, 12 A, 1600 W @ 230 V	210-250 Vac, 1 ϕ 57-63 Hz, 11 A, 1500 W @ 230 V	115 Vac \pm 10%, 1 ϕ 57-63 Hz, 4 A, 350 W @ 115 V
Load regulation: The Constant Voltage Load Regulation specification is given for a load current change equal to the current rating of the supply. The Constant Current Load Regulation specification is given for a load voltage change equal to the voltage rating of the supply.	CV	0.01% plus 200 μ V	0.01% plus 200 μ V	0.01% plus 200 μ V	0.01% plus 200 μ V	0.01% plus 200 μ V
	CC	0.02% plus 500 μ A	0.02% plus 1 mA	0.02% plus 2 mA	0.02% plus 1 mA	0.02% plus 500 μ A
Line regulation: For a change in line voltage from 103.5 to 126.5 at any output voltage and current within rating.	CV	0.01% plus 200 μ V	0.01% plus 200 μ V	0.01% plus 200 μ V	0.01% plus 200 μ V	0.01% plus 200 μ V
	CC	0.02% plus 500 μ A	0.02% plus 1 mA	0.02% plus 1 mA	0.02% plus 1 mA	0.02% plus 500 μ A
Ripple and noise: rms/p-p (dc to 20 MHz). At any line voltage and under any load condition within rating.	CV	200 μ V/10 mV	500 μ V rms/5 mV p-p	500 μ V rms/5 mV p-p	500 μ V rms/5 mV p-p	200 μ V/10 mV
	CC	5 mA rms	25 mA rms	50 mA rms	25 mA rms	3 mA rms
Temperature coefficient: Output change per degree centigrade change in ambient following 30 minutes warm-up.	CV	0.01% plus 200 μ V	0.01% plus 200 μ V	0.01% plus 200 μ V	0.01% plus 200 μ V	0.01% plus 200 μ V
	CC	0.01% plus 2 mA	0.01% plus 4 mA	0.01% plus 8 mA	0.01% plus 4 mA	0.01% plus 2 mA
Stability: Under constant ambient conditions, total drift for 8 hours following 30 minutes warm-up.	CV	0.03% plus 500 μ V	0.03% plus 2 mV	0.03% plus 2 mV	0.03% plus 2 mV	0.03% plus 500 μ V
	CC	0.03% plus 6 mA	0.03% plus 10 mA	0.03% plus 20 mA	0.03% plus 10 mA	0.03% plus 6 mA
Voltage resolution: Fine control.		1 mV	1 mV	1 mV	2 mV	2 mV
Remote resistance programming: All programming terminals on rear barrier strips.	CV (accuracy: 1%)	200 ohms/Volt	200 ohms/Volt	200 ohms/Volt	200 ohms/Volt	200 ohms/Volt
	CC (accuracy: 10%)	10 ohms/Amp	4 ohms/Amp	2 ohms/Amp	4 ohms/Amp	100 ohms/Amp
Remote voltage programming:	CV (accuracy: 1%)	1 V/Volt	1 V/Volt	1 V/Volt	1 V/Volt	1 V/Volt
	CC (accuracy: 10%)	25 mV/Amp	10 mV/Amp	5 mV/Amp	10 mV/Amp	50 mV/Amp
Current resolution: Fine control.		20 mA	50 mA	100 mA	50 mA	10 mA
Overvoltage protection "crowbar" — Trip voltage range: Front panel control.		2 to 12 Vdc	2 to 12 Vdc	2 to 12 Vdc	2 to 23 Vdc	2 to 24 Vdc
Trip voltage margin: The minimum crowbar trip setting above the desired operating output voltage to prevent false crowbar tripping.		5% output voltage setting +1 V	5% output voltage setting +2 V	5% output voltage setting +2 V	5% output voltage setting +2 V	5% output voltage setting +1 V
Meters:	Accuracy: 2%	0-12 V & 0-24 A	0-12 V & 0-60 A	0-12 V & 0-120 A	0-24 V & 0-60 A	0-24 V & 0-12 A
Weight	Net	42 lbs. (19.1 kg)	80 lbs. (36.2 kg)	90 lbs. (40.8 kg)	80 lbs. (36.2 kg)	34 lbs. (15.4 kg)
	Shipping	57 lbs. (25.9 kg)	105 lbs. (47.7 kg)	115 lbs. (52.2 kg)	105 lbs. (47.7 kg)	48 lbs. (21.7 kg)
Price		\$450.00	\$650.00	\$825.00	\$775.00	\$435.00
Options available (see description on page 571).		005, 007, 008, 009, 010, 013, 014, 027, 028	005, 007, 008, 009, 010, 013, 014, 026, 027	005, 007, 008, 009, 010, 013, 014, 016, 027	005, 007, 008, 009, 010, 013, 014, 026, 027	005, 007, 008, 009, 010, 013, 014, 027, 028

CV indicates Constant Voltage

CC indicates Constant Current

Advantages

Low peak-to-peak ripple
 Built-in overvoltage protection "crowbar"
 Remote programming: voltage and current can be controlled by external resistance or voltage
 Remote error sensing
 Low output impedance
 Rapid load transient recovery time
 Continuously variable output voltage and current: no range switching

Automatic crossover between constant voltage and constant current

Fully protected against any overload condition including continuous short circuit

Both voltage comparison and current comparison amplifiers employ "dif-amps" (matched silicon differential amplifier package) for improved performance

Front panel voltmeter and ammeter

Specifications

Controls: single-turn coarse and fine voltage and current controls are included on the front panel.

Temperature ratings: operating, 0 to 55°C; storage, -40 to +75°C.

Load transient recovery time: less than 50 μ s is required for output voltage recovery (in constant voltage operation) to within 10 mV of the nominal output voltage following a 5 A change in output current.

Output terminals: an output terminal strip is located on the rear of the chassis. All power supply terminals are isolated from the chassis and either the positive or negative terminal may be connected to the chassis through a separate ground

terminal located adjacent to the output terminals. Models 6256B, 6263B, 6264B, 6265B, 6266B, 6267B, 6271B, and 6274A include front panel terminals for monitoring the output voltage. These banana jack type terminals are rated at 3 A maximum current output.

Size

Models 6256B, 6264B, 6267B, 6274A: 5¼" (14 cm) H x 17½" (44,4 cm) D x 19" (48,3 cm) W.

Models 6263B, 6265B, 6266B, 6271B: 3½" (8,9 cm) H x 17½" (44,4 cm) D x 19" (48,3 cm) W.

Models 6259B, 6260B, 6261B, 6268B, 6269B: 7" (17,8 cm) H x 17½" (44,4 cm) D x 19" (48,3 cm) W.

6264B	6265B	6266B	6267B	6268B	6269B	6271B	6274A
0-20 Volts @ 0-20 Amps	0-40 Volts @ 0-3 Amps	0-40 Volts @ 0-5 Amps	0-40 Volts @ 0-10 Amps	0-40 Volts @ 0-30 Amps	0-40 Volts @ 0-50 Amps	0-60 Volts @ 0-3 Amps	0-60 Volts @ 0-15 Amps
115 Vac \pm 10%, 1 Φ 57-63 Hz, 8 A, 600 W @ 115 V	115 Vac \pm 10%, 1 Φ 57-63 Hz, 3 A, 180 W @ 115 V	115 Vac \pm 10%, 1 Φ 57-63 Hz, 4 A, 325 W @ 115 V	115 Vac \pm 10%, 1 Φ 57-63 Hz, 8 A, 550 W @ 115 V	210-250 Vac, 1 Φ 57-63 Hz, 11 A, 1600 W @ 230 V	210-250 Vac, 1 Φ 57-63 Hz, 18 A, 2500 W @ 230 V	115 Vac \pm 10%, 1 Φ 57-63 Hz, 4 A, 300 W @ 115 V	115 Vac \pm 10%, 1 Φ 57-63 Hz, 16 A, 1200 W @ 115 V
	0.01% plus 200 μ V		0.01% plus 200 μ V	0.01% plus 200 μ V	0.01% plus 200 μ V	0.01% plus 200 μ V	0.01% plus 200 μ V
	0.02% plus 500 μ A		0.02% plus 500 μ A	0.02% plus 2 mA	0.02% plus 2 mA	0.02% plus 500 μ A	0.02% plus 2 mA
	0.01% plus 200 μ V		0.01% plus 200 μ V	0.01% plus 200 μ V	0.01% plus 200 μ V	0.01% plus 200 μ V	0.01% plus 200 μ V
	0.02% plus 500 μ A		0.02% plus 500 μ A	0.02% plus 2 mA	0.02% plus 2 mA	0.02% plus 500 μ A	0.02% plus 2 mA
	200 μ V/10 mV		200 μ V/10 mV	1 mV/5 mV	1 mV/5 mV	200 μ V/10 mV	500 μ V rms
5 mA rms	3 mA rms		3 mA rms	20 mA rms	25 mA rms	3 mA rms	10 mA rms
	0.01% plus 200 μ V		0.01% plus 200 μ V	0.01% plus 200 μ V	0.01% plus 200 μ V	0.01% plus 200 μ V	0.01% plus 200 μ V
0.01% plus 2 mA	0.01% plus 1 mA	0.01% plus 1 mA	0.01% plus 1 mA	0.01% plus 2 mA	0.01% plus 4 mA	0.01% plus 1 mA	0.01% plus 2 mA
	0.03% plus 500 μ V		0.03% plus 2 mV	0.03% plus 2 mV	0.03% plus 2 mV	0.03% plus 500 μ V	0.03% plus 2 mV
0.03% plus 6 mA	0.03% plus 3 mA	0.03% plus 3 mA	0.03% plus 3 mA	0.03% plus 5 mA	0.03% plus 10 mA	0.03% plus 3 mA	0.03% plus 5 mA
2 mV	5 mV	5 mV	5 mV	3 mV	3 mV	15 mV	10 mV
200 ohms/Volt	200 ohms/Volt	200 ohms/Volt	200 ohms/Volt	200 ohms/Volt	200 ohms/Volt	300 ohms/Volt	300 ohms/Volt
10 ohms/Amp	300 ohms/Amp	200 ohms/Amp	100 ohms/Amp	6 ohms/Amp	4 ohms/Amp	300 ohms/Amp	62 ohms/Amp
1 V/Volt	1 V/Volt	1 V/Volt	1 V/Volt	1 V/Volt	1 V/Volt	1 V/Volt	1 V/Volt
25 mV/Amp	167 mV/Amp	100 mV/Amp	50 mV/Amp	16.7 mV/Amp	10 mV/Amp	167 mV/Amp	33.3 mV/Amp
20 mA	3 mA	5 mA	10 mA	30 mA	50 mA	3 mA	15 mA
2.5 to 23 Vdc	2.5 to 45 Vdc	2.5 to 45 Vdc	2.5 to 45 Vdc	4 to 45 Vdc	4 to 45 Vdc	6 to 66 Vdc	—
	5% output voltage setting +1 V		5% output voltage setting +1 V	5% output voltage setting +2 V	5% output voltage setting +2 V	5% output voltage setting +1 V	—
0-24 V & 0-24 A	0-50 V & 0-4 A	0-50 V & 0-6 A	0-50 V & 0-12 A	0-50 V & 0-35 A	0-50 V & 0-60 A	0-70 V & 0-4 A	0-70 V & 0-18 A
42 lbs. (19.1 kg) 57 lbs. (25.9 kg)	34 lbs. (15.4 kg) 48 lbs. (21.7 kg)	34 lbs. (15.4 kg) 48 lbs. (21.7 kg)	42 lbs. (19.1 kg) 57 lbs. (25.9 kg)	85 lbs. (38.6 kg) 110 lbs. (50 kg)	95 lbs. (43 kg) 120 lbs. (54.5 kg)	34 lbs. (15.4 kg) 48 lbs. (21.7 kg)	75 lbs. (34 kg) 95 lbs. (43.1 kg)
\$525	\$350	\$435	\$525	\$695	\$875	\$435	\$695
	005, 007, 008, 009, 010, 013, 014, 027, 028		005, 007, 008, 009, 010, 013, 014, 027, 028	005, 007, 008, 009, 010, 013, 014, 026, 027	005, 007, 008, 009, 010, 031, 014, 027	005, 007, 008, 009, 010, 013, 014, 027, 028	005, 010, 011, 013, 014, 017, 018

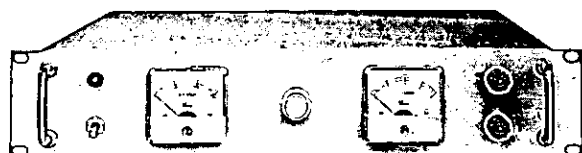
POWER SUPPLIES



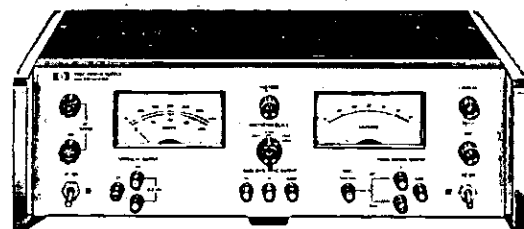
MEDIUM VOLTAGE SUPPLIES

MVR Series

712C, 890A, 895A



Model 890A



Model 712C

Advantages, MVR Series:

- All solid-state
- Short-circuit proof
- Remote programming, remote error sensing

The MVR Series features a unique "piggy-back" circuit; low voltage series power transistors, which are required to dissipate only a fraction of their power rating, provide high regulation

All MVR models are short circuit proof. An all-electronic, continuously acting current limit circuit protects the supply for all overloads, including a direct short placed across the output terminals.

Model 712C

This easy-to-use general purpose, low-power, medium-voltage, laboratory supply is particularly suitable for experimental setups and other medium voltage bench applications. All solid state, the supply is designed for high regulation and low ripple. Model 712C provides four outputs: 0 to 500 V at 0 to 200 mA, 0 to -150 V at 5 mA, -300 V at 50 mA, and an unregulated ac filament source.

MVR Specifications

Outputs: 890A: 0 to 320 V, 0 to 600 mA; 895A: 0 to 320 V, 0 to 1.5 A.

Line regulation: less than 0.007% or 10 mV change (whichever is greater) in output voltage for a 10% change in the nominal line voltage.

Load regulation: less than 0.007% or 10 mV change (whichever is greater) in output voltage for an output current change from no load to full load.

Ripple and noise (rms maximum): less than 1 mV for both models.

Meters: 890A: 320 V and 0.8 A; 895A: 320 V and 1.5 A.

Dimensions: 890A: 3½" H x 16¾" D x 19" W (88 x 425 x 483 mm); 895A: 5¼" H x 16¾" D x 19" W (133 x 425 x 483 mm).

Maximum operating temperature: 50°C.

Temperature coefficient: less than 0.03%, plus 1.5 mV/°C.

Stability: total drift for 8 hours (after 30 minutes warm-up) at a constant ambient is less than 0.1% plus 5 mV.

Transient recovery time: less than 100 μs is required for output voltage recovery to within 20 mV of the nominal output following a full load change in output current.

Output terminals: output terminal strip is located on the rear of the chassis.

Input ac: 115 V ac ±10%, 57 to 63 Hz.

Weight (net/shipping): 890A: 35/43 lbs (15,8/9,4 kg); 895A: 50/66 lbs (22,5/29,7 kg).

Price: 890A: \$445; 895A: \$625.

712C Specifications

Output:

DC main (cv/cc): 0 to 500 V at 0 to 200 mA.

DC fixed bias: -300 V at 0 to 50 mA.

DC variable bias: 0 to 150 V at 5 mA.

AC unregulated: 6.3 V ct at 10 A.

Input: 115 V ac ±10%, 57-63 Hz, 2.5 A at 115 V ac.

Load regulation: the constant voltage load regulation is given for a load current change equal to the current rating of the supply.

DC main: 0.01% +5 mV.

DC fixed bias: 50 mV.

DC variable bias is tied to fixed bias, hence source regulation is same as for fixed bias. Internal impedance is 0 to 10,000 ohms, depending on bias control setting.

Line regulation: for a change in line voltage from 103.5 to 126.5 V at any output voltage and current within rating.

DC main: cv-0.01% +5 mV, cc-100 μA.

DC fixed bias: 50 mV.

Ripple and noise: at any line voltage and under any load condition within rating.

DC main: cv-500 μV rms, 15 mV p-p (dc-20 MHz); cc-0.1 mA rms.

DC fixed and variable bias: cv-0.01% rms, 0.03% p-p.

Load transient recovery time: less than 50 μs is required for output voltage recovery (in constant voltage operation) to within 125 mV of the nominal output voltage following a full output current change.

Dimensions: 5-7/32" H x 16¾" W x 11⅛" D (139 x 425 x 281 mm).

Weight: net 22 lbs (10 kg); shipping 26 lbs (11,8 kg).

Price: \$490.

COMPACT SCR REGULATED

SCR-1P Series

Models 6427B-6448B

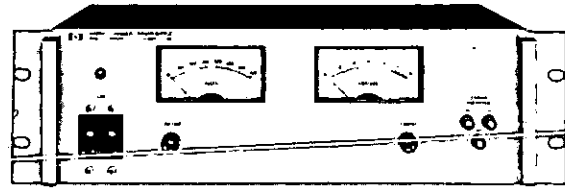


POWER SUPPLIES

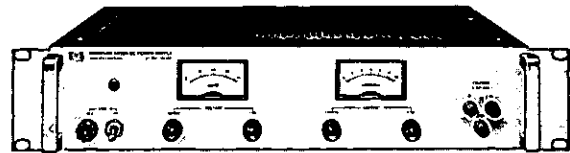
The SCR-1P Series consists of eight regulated dc power supplies utilizing silicon-controlled rectifiers in series with the transformer primary. Controlled by the output voltage and current settings, these supplies accomplish the desired regulation using HP's unique phase control circuit. This circuit technique permits a reduction in the overall size and weight of the power supply and results in up to 75% efficiency at full output. Four models with output ratings of approximately 300 watts are packaged in a 3½" high rack mounting cabinet, while the four models with approximately 900 watt output power capability are 5¼" high. All supplies may also be used on the bench (attachable rubber feet for bench use available on request). These second generation SCR regulated power supplies also feature lower output ripple, tighter load and line regulation, and Constant Voltage/Constant Current operation with automatic crossover, and all-silicon circuitry.

Advantages:

- Output continuously variable to zero in either voltage or current mode
- Efficiency up to 75% at full output
- Excellent line transient immunity



Models 6428B, 6434B, 6439B, 6448B



Models 6427B, 6433B, 6438B, 6443B

Specifications

Model		6427B	6428B	6433B	6434B	6438B	6439B	6443B	6448B
DC output	volts	0-20	0-20	0-36	0-40	0-60	0-60	0-120	1-600
	amps	0-15	0-45	0-10	0-25	0-5	0-15	0-2.5	0-1.5
AC power in	volts	115 V ac ± 10%, 57-63 Hz							
	amps	6.5	17	7	19	6.5	17	6.5	16
	watts	450	1200	450	1300	400	1200	400	1200
Line regulation: For a 10% change in the nominal ac line voltage.	constant voltage	10 mV	20 mV	18 mV	18 mV	30 mV	60 mV	60 mV	600 mV
	constant current	150 mA	450 mA	100 mA	200 mA	50 mA	150 mA	25 mA	15 mA
Constant voltage load regulation: for a change in output current from no load to full load or full load to no load.		20 mV	40 mV	36 mV	40 mV	60 mV	120 mV	120 mV	600 mV
Constant current load regulation: for a change in output voltage from no load to full load or full load to no load.		150 mA	450 mA	100 mA	200 mA	50 mA	150 mA	25 mA	15 mA
Full scale meter readings: meters have 2% accuracy; all units have meter calibrating potentiometers.		24 V & 18 A	24 V & 50 A	40 V & 12 A	50 V & 30 A	70 V & 6 A	70 V & 18 A	150 V & 3 A	700 V & 1.8 A
*Transient recovery time: <200 ms for output recovery to within "A" mV; transient amplitude less than "B" volts/amp for any load change between 20% and 100% of rated output current.		A = 200 B = 0.35	A = 200 B = 0.15	A = 200 B = 0.5	A = 200 B = 0.3	A = 300 B = 1.0	A = 600 B = 0.4	A = 600 B = 4.0	A = 3000 B = 20
*Ripple and noise: rms/P-P		40/400 mV	40/500 mV	36/400 mV	40/500 mV	120/400 mV	60/500 mV	240/400 mV	600 mV/2 V
Remote programming	constant voltage	200 ohms/volt	200 ohms/volt	200 ohms/volt	200 ohms/volt	300 ohms/volt	300 ohms/volt	300 ohms/volt	300 ohms/volt
	constant current	15 ohms/amp	6 ohms/amp	25 ohms/amp	10 ohms/amp	50 ohms/amp	15 ohms/amp	100 ohms/amp	600 ohms/amp
Size: W x H x D	inches	19 x 3½ x 17	19 x 5¼ x 17¼	19 x 3½ x 17½	19 x 5¼ x 16¾	19 x 3½ x 17½	19 x 5¼ x 17¼	19 x 3½ x 17½	19 x 5¼ x 17¼
	centimeters	48,3 x 8,9 x 44	48,3 x 14 x 43,8	48,3 x 8,9 x 44,4	48,3 x 14 x 43,7	48,3 x 8,9 x 44,4	48,3 x 14 x 43,8	48,3 x 8,9 x 44,4	48,3 x 14 x 43,8
Weight (net/shipping)	pounds	36/51	67/76	33/48	67/76	31/46	61/70	31/46	61/70
	kilograms	16,3/23,1	30,4/34,4	14,9/21,7	30,4/34,4	14/20,8	27,6/31,7	14/20,8	27,6/31,7
Price		\$380	\$550	\$370	\$550	\$360	\$550	\$360	\$550
Options: refer to page 571 for descriptions		005 010	005, 010 017, 018	005 010	005, 010 017, 018	005 010	005, 010 017, 018	005 010	005, 010 017, 018

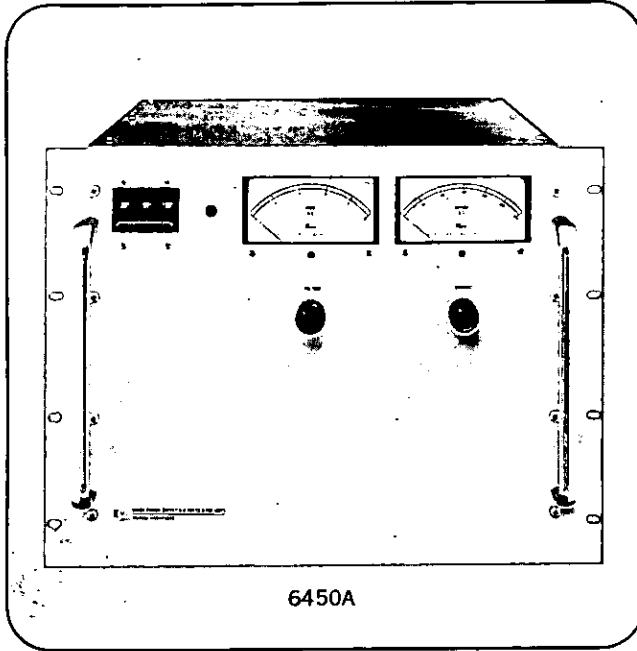
*Use of supply at 50 Hz input (possible only with option 005) results in a 50% increase in the values given.



3 KW REGULATED SUPPLIES

SCR-3 series

Models 6453A, 6456B, 6459A



Description

The SCR-3 Series of regulated supplies are suitable for high-power applications which require up to 200 amps output current and up to 3.6 kilowatts output power. In this series of supplies, silicon-controlled rectifiers perform simultaneously the rectifying and regulating functions with resulting voltage regulation of less than 0.3%.

Advantages:

- Constant voltage/constant current
- Minimum size, reduced weight
- Continuously variable to zero volts
- Excellent line transient immunity
- 50 millisecond recovery for load current changes
- Short-circuit-proof
- Remote programming
- Remote error sensing
- 75% efficiency at full load

Specifications

Model	6453A	6456B	6459A
DC volts out	0 to 15 V	0 to 36 V	0 to 64 V
DC amps out	0 to 200 A	0 to 100 A	0 to 50 A
AC power in	208/230/460 ± 10%, 3 phase, 57 to 63 Hz; 14 amps per phase		
Combined load and line regulation	cv	0.2% + 10 mV	0.2% + 10 mV
	cc	1% or 2 A	1% or 1 A
†Ripple and noise (rms max., specified as percent of max. output voltage)	1%	0.5%	0.25%
Remote programming (all programming terminals located on rear barrier strips)	cv	200 ohms/volt	200 ohms/volt
	cc	1 ohm/amp	2 ohms/amp
†Transient recovery time (less than 50 ms required for output voltage recovery to within A mV of nominal output voltage following a load change from full load to half load or half load to full load)	A = 150	A = 300	A = 600
Meters	20 V and 200 A	40 V and 100 A	80 V and 50 A
Input terminals	4-terminal twist lock connector		
Output terminals	tapped rectangular bus bars		
Cooling	internal fan		
Dimensions	19" W, 14" H, 18 1/4" D (48,3 x 35,6 x 46,4 cm)		
Weight (net/shipping)	275/299 lbs (124/135 kg)	275/299 lbs (124/135 kg)	275/299 lbs (124/135 kg)
Price: Option 001, 002, or 003 must be specified when ordering	\$1375	\$1275	\$1275
Options: Refer to page 571 for description	006-\$350	006-\$300	006-\$300
	001-208 V ac input—no charge, 002-230 V ac input—no charge, 003-460 V ac input—no charge.		
	005-\$25, 010-\$195, 031-\$40, 032-\$40		

cc = constant current, cv = constant voltage

†Use of supply at 50 Hz input (possible only with option 005) results in a 50% increase in the values given.

10 KW REGULATED SUPPLIES

SCR-10 Series

Models 6463A—6483B



POWER SUPPLIES

The SCR-10 Series of all silicon, 10 kilowatt regulated supplies are intended for high power applications which require a fixed or variable dc source with a moderate degree of regulation. Silicon-controlled rectifiers in series with the transformer primary, and controlled by the output voltage and current settings, accomplish the desired regulation using Hewlett-Packard's phase control circuit. This circuit technique permits a reduction in the overall size and weight of the power supply and results in up to 75% efficiency at full output. All features of the SCR-10 Series are the same as given for the SCR-5 Series.

Specifications

Controls: a single control allows continuous adjustment of output voltage over the entire output range. A single control allows continuous adjustment of output current. Models 6475A, 6477A, 6479A, and 6483B have 10-turn voltage controls.

Input terminals: a 4-pin jack and mating connector are supplied.

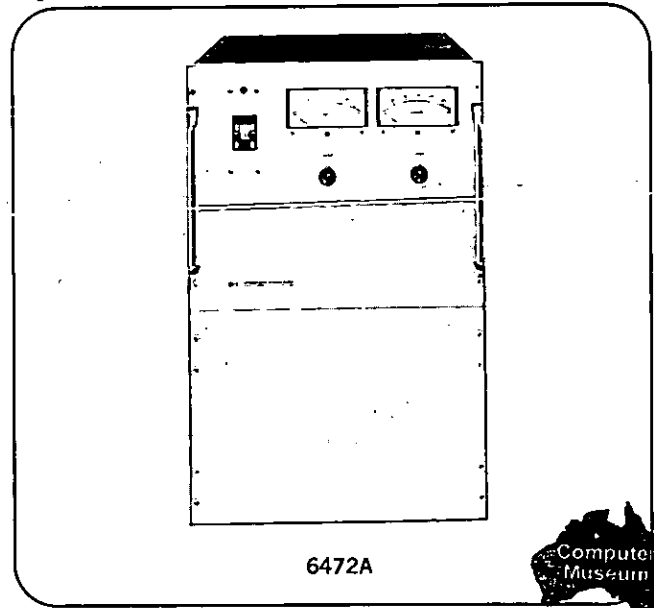
Output terminals: tapped rectangular bus bars.

Cooling: internal fan.

Size: standard 19 inch (483 mm) relay rack mounting, 26¼ inches (669 mm) and 22½ inches (572 mm) deep.

Weight: 420 lbs (191 kg) net, 500 lbs (227 kg) shipping weight.

Finish: light gray front panel with dark gray case.



6472A



Model	6463A	6464A	6466A	6469A	6472A	6475A	6477A	6479A	6483B	
DC output	volts	0-4	0-8	0-16 or 0-18	0-36	0-64	0-110	0-220	0-300	0-440 or 0-500 or 0-600
	amps	0-2000	0-1000	0-600 or 0-500	0-300	0-150	0-100	0-50	0-35	0-15 or 0-20 or 0-25
AC input	volts	208/230/380/400/460 ±10% 3 Phase 57-63 Hz Specify by option number. See below								
	amps	less than 50 amps per phase at 230 V ac								
Combined line and regulation constant voltage: for a change in output current from no load to full load or full load to no load combined with a ±10% change in line voltage.	50 mV	25 mV	0.2% plus 10 mV	0.2% plus 10 mV	0.2% plus 100 mV	0.2% plus 100 mV	0.2% plus 100 mV	0.2% plus 100 mV	0.5% plus 100 mV	
Combined line and load regulation constant current: for a change in output voltage from no load to full load or full load to no load combined with a ±10% change in line voltage.	20 A	10 A	6 A	3 A	1.5 A	1 A	0.5 A	0.3 A	0.2 A	
Full scale meter readings: meters have 2% accuracy; all units have meter calibrating potentiometers.	5 V & 2400 A	10 V & 1200 A	18 V & 700 A	40 V & 350 A	80 V & 180 A	125 V & 120 A	250 V & 60 A	350 V & 40 A	600 V & 25 A	
†Transient recovery time: less than 50 milliseconds is required for output voltage recovery to within A millivolts of the nominal output voltage following a load change from full load to half load or half load to full load, or a change of 100 amperes, whichever is less.	—	A = 150	A = 150	A = 500	A = 600	A = 1 V	A = 2 V	A = 3 V	A = 5 V	
‡Ripple and noise: rms/p-p (dc to 20 MHz); at any line voltage and load condition within rating	280 mV/1V	80 mV/1V	180 mV/1V	180 mV/1V	160 mV/2V	220 mV/2V	330 mV/2V	300 mV/2V	600 mV/2V	
Temperature coefficient: output change per degree centigrade change in ambient following 30 minutes warmup.	cv	0.05% plus 2 mV								
	cc	12 A	6.0 A	3.6 A	1.8 A	0.9 A	0.6 A	0.3 A	0.2 A	0.1 A
Stability: under constant ambient conditions, total drift for 8 hours following 30 minutes warmup.	cv	0.25% plus 10 mV								
	cc	60 A	30 A	18 A	9 A	4.5 A	3 A	1.5 A	1 A	0.6 A
Remote programming	(Accuracy 1%) cv	200Ω/V	200Ω/V	200Ω/V	200Ω/V	300Ω/V	300Ω/V	300Ω/V	300Ω/V	300Ω/V
	(Accuracy 10%) cc	0.1Ω/A	1/5Ω/A	1/3Ω/A	1/2Ω/A	1.5Ω/A	2Ω/A	4Ω/A	6Ω/A	10Ω/A
Price: Option 001, 002, 003, 031 or 032 must be specified when ordering.		\$3500	\$3300	\$2600	\$2300	\$2600	\$2600	\$2600	\$2600	\$2600
Options: refer to page 571 for description.	06	—	—	\$500	\$450	\$400	\$400	\$300	\$300	\$300
		001-208 V ac input-no charge, 002-230 V ac input-no charge, 003-460 V ac input-\$200, 004-\$85, 005-\$25,* 010-\$225 031-380 V ac input-\$275, 032-400 V ac input-\$275.								

cv = constant voltage cc = constant current

†Use of supply at 50 Hz input (possible only with option 005) results in a 50% increase in the values given.
*Not available on 6463A, 6464A, and 6466A.



MODULAR SLOT SUPPLIES

Adjustable within $\pm 20\%$ band

Models 60063A - 60246B

SINGLE OUTPUT SLOT SUPPLIES

The SLOT series of modular power supplies is intended for applications requiring a fixed constant voltage source of dc.

The output voltage can be selected by adjusting the rear panel screwdriver control. The nominal output voltage is offset from the design center, used in the output rating charts at right, by up to 2 volts. The output voltage can be varied $\pm 10\%$ of the design center without derating the output current; above $\pm 10\%$, the output current is derated as illustrated in the graphs below.

The mechanical and electrical design have been accomplished with a view toward simplicity, without any compromise in component quality or manufacturing technique. The result is a low cost, yet reliable power supply which can be bolted directly to standard rack panels (with only four screws) or included as a

power module in a larger chassis. All supplies are fully rated to 55°C , and require no additional heat sinks.

A temperature compensated zener diode is employed as the reference element in an all-silicon series regulator feedback circuit which monitors and controls the output voltage. The resulting low ripple and low output impedance permit these supplies to be used in critical applications where less well regulated supplies are not suited.

All supplies are short circuit proof and will not be damaged by any overload regardless of how long imposed. If the output current exceeds the rated value, the cut back circuit is triggered and reduces the output current to a safe limit. When the overload is removed, the supply returns to normal operation.

The output is floating—thus any supply can be used as either a positive or negative source.

Specifications

MODEL	DC OUTPUT (Refer to Derating Charts)		AC INPUT			RIPPLE & NOISE		SIZE	PRICE		
	NOMINAL VOLTS	AMPS	VOLTS	AMPS	WATTS	RMS	P-P (mV) dc to 20 MHz		1-9	10-19	20-49
60063A	6	1.5	115 V ac $\pm 10\%$; 48-440 Hz	0.3	26	1 mV or 0.006%, whichever is greater	3	3	\$ 87	\$ 85	\$ 81
60065A	6	3		0.75	63		3	5	\$110	\$107	\$103
60066A	6	8		1.5	150		6	6	\$197	\$191	\$186
60122B	12	0.5		0.16	15.7		3	2	\$ 72	\$ 70	\$ 68
60123B	12	1		0.3	26		3	3	\$ 79	\$ 77	\$ 74
60125B	12	2.2		0.75	62		4	5	\$100	\$ 97	\$ 94
60126B	12	6		1.75	153		6	6	\$179	\$174	\$169
60242B	24	0.25		1.5	15.5		3	2	\$ 72	\$ 70	\$ 68
60243B	24	0.5		0.3	26		3	3	\$ 79	\$ 77	\$ 74
60244B	24	1		0.5	45		3	4	\$ 88	\$ 85	\$ 83
60245B	24	1.5		0.75	65		9	5	\$100	\$ 97	\$ 94
60246B	24	3.5		2	160		12	6	\$179	\$174	\$169

If chart does not include a SLOT supply to fill your needs, ask your HP Sales Engineer for the Custom SLOT Series data sheet.

Load regulation: less than 0.05% from no load to full load.

Line regulation: less than 0.05% from 103.5 to 126.5 V ac.

Temperature coefficient: output voltage change per $^\circ\text{C}$ is less than 0.025% after 30-minute warmup.

Stability: the total drift for eight hours (after 30 minutes warmup) at a constant ambient is less than 0.1%.

Temperature rating: operating: 0 to 55°C ; storage: -40 to $+85^\circ\text{C}$.

Output impedance: less than 0.3 ohms to 100 kHz; less than 3 ohms to 1 MHz.

Load transient recovery time: less than 25 μs for output voltage recovery to within 10 mV of the nominal output voltage following a full load or 5 amp load change, whichever is less.

Overload protection: the output is current limited (non-adjustable) and is fully rated for operation under any overload condition including a direct short circuit, regardless of how long maintained. Supply will automatically restore to normal operation upon overload removal.

Terminals: a rear barrier strip includes AC, ACC, GND, + Out, - Out, + Sensing, and - Sensing terminals. Either side of the supply may be grounded or the output may be operated floating at potentials of up to 300 V off ground.

Output control: screwdriver adjust, accessible through hole in end plate.

Mounting: four 8-32 threaded nuts embedded in mounting end plate facilitate assembly of modules to rack panels, chassis, etc.

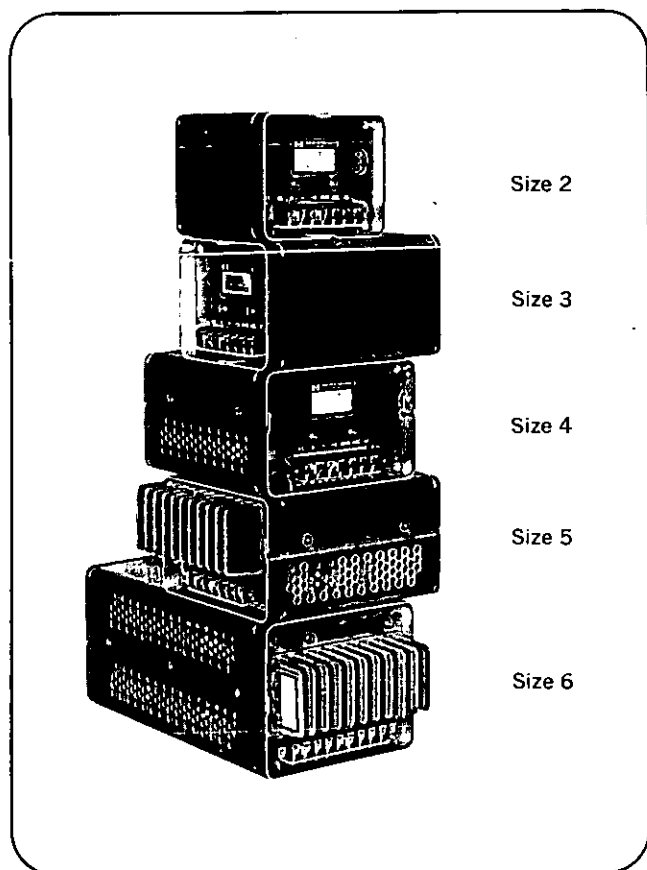
Overall dimensions:

	Mounting face	Module length
Size 2:	3 $\frac{1}{4}$ " (8.6 cm) x 4 $\frac{1}{4}$ " (10.5 cm)	4 $\frac{1}{4}$ " (10.5 cm)
Size 3:	3 $\frac{1}{4}$ " (8.6 cm) x 4 $\frac{1}{4}$ " (10.5 cm)	6" (15.2 cm)
Size 4:	3 $\frac{1}{4}$ " (8.6 cm) x 5 $\frac{1}{4}$ " (13 cm)	6" (15.2 cm)
Size 5:	3 $\frac{1}{4}$ " (8.6 cm) x 5 $\frac{1}{4}$ " (13 cm)	7-5/16" (18.6 cm)
Size 6:	4 $\frac{1}{4}$ " (10.8 cm) x 5 $\frac{1}{4}$ " (13 cm)	11" (27.9 cm)

Weight:

	Net	Shipping
Size 2:	2.1 lbs (0.95 kg)	3.5 lbs (1.6 kg)
Size 3:	2.5 lbs (1.1 kg)	4.0 lbs (1.8 kg)
Size 4:	4.5 lbs (2 kg)	6.5 lbs (2.9 kg)
Size 5:	6.0 lbs (2.7 kg)	8.0 lbs (3.6 kg)
Size 6:	13 lbs (5.9 kg)	15 lbs (6.8 kg)

Options: 006, 017, 018. See page 571 for descriptions.



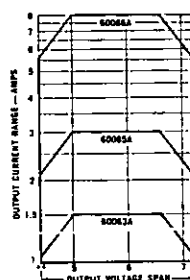
Size 2

Size 3

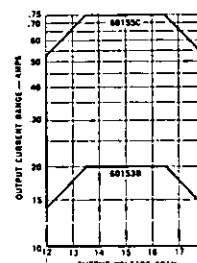
Size 4

Size 5

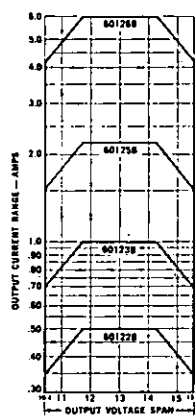
Size 6



6 V

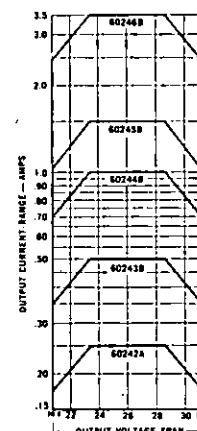


±15 V



12 V

Output Ratings



24V

DUAL OUTPUT SLOT SUPPLIES

Model 60155C and 60153D are dual output SLOT supplies ideal for powering operational amplifiers. These new supplies provide a positive and negative 15 V dc output referenced to a common terminal and are internally connected for auto-tracking "rubber-band" operation. With the slave (−) supply tracking the master (+) supply, any change of the internal reference source (e.g. drift, ripple) will cause an equal percentage change in the outputs of both the master and slave supplies.

The degree by which the slave supply varies as a percentage from the master supply is defined as "tracking error." The tracking error is less than 30 mV for each 1 V change in the master. For example, if the master supply output voltage drifted more negative by 0.5 V, the slave supply output voltage would become more positive by 0.5 V ±15 mV.

The features are identical to the standard units in the SLOT Series as listed on page 566.

Specifications

Unless otherwise indicated, the specifications are identical to the single output SLOT power supplies on the preceding page.

Dual output: 60155C: ±15 V dc, 0 - 0.75 A; 60153D: ±15 V dc, 0 - 0.2 A.

Output current capability: as illustrated, the output voltage can be varied from 12 to 18 volts; but with output current rated according to chart above.

Input: 115-V ac ±10%; 48-440 Hz.

Load regulation: less than 0.03% output voltage change for a load current change equal to the rating of the supply.

Line regulation: less than 0.01% for 60155C, 0.03% for 60153D for a change in line voltage from 103.5 to 126.5 V ac.

Ripple and noise: less than 300 μV rms, 2 mV p-p (dc to 20 MHz).

Temperature coefficient: output voltage change per degree centigrade after 30-minute warmup.

Master supply: less than 0.015%.

Slave supply: less than 0.015%.

Stability: total drift for 8 hours (after 30-minute warmup) at a constant ambient temperature.

Master supply: less than 0.1%.

Slave supply: less than 0.06%.

Slave tracking error: less than 30 mV for each 1V change in the master output voltage.

Terminals: a rear barrier strip includes AC, ACC, +, −, common, + sensing, − sensing, and common sensing terminals. Either side of the supply may be grounded or the output may be operated floating at potentials 300 V off ground.

Weight: (net/shipping) 60155C: 5.25 lbs (2,4 kg), 7.25 lbs (3,2 kg); 60153D: 2.5 lbs (1,1 kg), 4.0 lbs (1,8 kg).

Size: 60155C, size 5; 60153D, size 3. Refer to dimensions under single SLOT specifications.

Price:	1-9	10-19	20-49
60155C	\$133	\$129	\$125
60153D	97	93	91

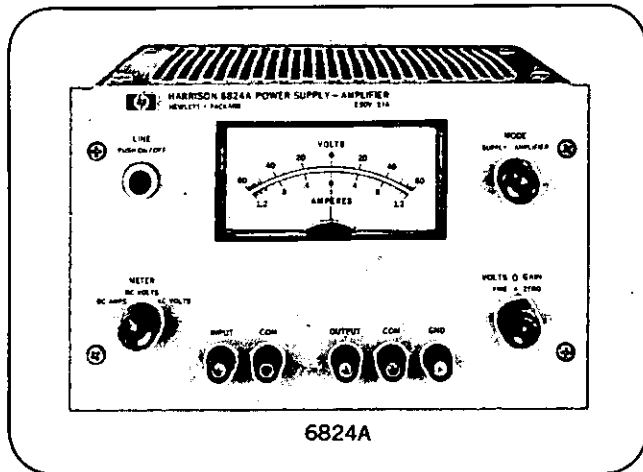
POWER SUPPLIES



DC POWER SUPPLY/AMPLIFIER

PS/A series

Models 6823A, 6824A



Models 6823A and 6824A are dual-purpose dc regulated power supplies and direct-coupled amplifiers. Two or more of these units can be connected in Auto-Series to obtain greater voltage capability. High speed constant current operation can be obtained by simply adding an external resistor in series with the load and making minor changes in the rear barrier strapping.

Two temperature-compensated zener diodes are employed as reference elements in a series regulator feedback circuit which monitors and controls the output voltage. The resulting low ripple and low output impedance permit these instruments to be used in critical power supply applications. Low internal dissipation assures reliability.

As a power amplifier, both instruments offer a signal-to-noise ratio of 80 dB at full output with low distortion and 20 dB gain from dc-20 kHz; making them useful in a wide variety of applications. The output is inverted. Rack mounting hardware is available for mounting singly or in pairs in 3½" or 5¼" of rack height.

Advantages:

Power supply

- Output adjustable through zero
- High-speed programming
- Short-circuit proof
- Low ripple and noise
- Fast transient recovery
- No overshoot for turn-on, turn-off, or power removal

Power amplifier

- Variable gain
- High signal-to-noise ratio
- Low distortion
- Frequency response — dc to 20 kHz

Applications

As a dc Power Supply, Models 6823A or 6824A can be controlled from the front panel, or remotely programmed with resistance or voltage. The low output drift and noise combined with high speed programming adapt this supply to a wide variety of laboratory and production testing applications.

As a dc coupled Power Amplifier, the unusually low output impedance, distortion, ripple and noise make the 6823A or 6824A useful in servo system, as a pulse or oscillator amplifier, and for motor control. Constant current output is readily achieved by connecting a current monitoring resistor to the rear terminal barrier strip—makes an ideal driver-amplifier for deflection coils.

For more information, refer to Application Note 82, Power Supply/Amplifier Concepts and Modes of Operation, available free of charge from your local Hewlett-Packard field sales office.

Specifications

MODEL 6823A	
High speed programming dc power supply	10 watt peak output dc power amplifier
Output: -20 to +20 V dc @ 0-0.5 A	Output: 40 volts p-p @0-0.5 A
Load regulation: 0.02% +5 mV	Voltage gain: Variable 0-10 (20 dB) output inverted.
Line regulation: 0.02% +5 mV	Frequency response: at full output, \pm 3 dB from dc to 20 kHz.
Ripple & noise: 2 mV rms	Max. phase shift: dc -180° 100 Hz -181° 1 kHz -183° 10 kHz -205° 20 kHz -225°
Load transient recovery time: less than 100 μ s to within 5 mV +0.02% of the nominal output.	Distortion: <0.02% at 1 kHz and full output.
Remote programming: 500 ohms/V. Also voltage programming.	Input impedance: 2k ohms approx.
Programming speed: less than 50 μ s are required for programming between -20 V and +20 V. Typically the programming time between 0 and 90% of the maximum voltage span is 20 μ s.	Input terminals: front and rear.
AC input: 115 V ac \pm 10%, single phase, 50-440 Hz; 0.33 amp, 24 watts max. Meter: Dual purpose with selector switch; -24 to +24 volts, -0.6 to +0.6 amps. Size: 3½" H x 8¼" W x 13" D (8.9 cm H x 21.8 cm W x 33 cm D). Weight: 16 pounds (7.26 kg) net, 20 pounds (9.07 kg) shipping. Price: \$194. Rack mounting kits: refer to page 571. 14513A: mounts one 3½" high unit—add \$20.00 14523A: mounts two 3½" high units—add \$10.00	

MODEL 6824A	
High speed programming dc power supply	50 watt peak output dc power amplifier
Output: -50 to +50 V DC @ 0-1.0 A	Output: 100 volts p-p @ 0-1.0 A
Load regulation: 0.02% +5 mV	Voltage gain: variable, 0-10 (20 dB), output inverted.
Line regulation: 0.02% +5 mV	Frequency response: At full output, \pm 3 dB from dc to 20 kHz
Ripple & noise: 10 mV rms.	Max. phase shift: dc -180° 100 Hz -180.7°, 1 kHz -182.9° 10 kHz -205°, 20 kHz -225°
Transient recovery time: less than 100 μ s to within 5 mV +0.02% of the nominal output.	Distortion: <0.02% at 1 kHz and full output
Remote programming: 500 ohms/V. Also voltage programming.	Input impedance: 2k ohms approx.
Programming speed: less than 50 μ s are required for programming between -50 V and +50 V. Typically, the programming time between 0 and 90% of the maximum voltage span is 20 μ s.	Input terminals: front and rear.
AC input: 115 V ac \pm 10%, single phase, 50-60 Hz, 1.3 amps, 96 watts max. Meter: triple purpose with selector switch; -60 to +60 volts, -1.2 to +1.2 amps, 0 to 60 V rms Size: 5¼" H x 8¼" W x 13" D (14 cm H x 21.8 cm W x 33 cm D). Weight: 17 pounds (7.7 kg) net, 21 pounds (9.55 kg) shipping. Price: \$350 Rack mounting kits: refer to page 571. 14515A: mounts one 5¼" high unit—add \$23.00 14525A: mounts two 5¼" high units—add \$13.00	

Other specifications for both models

Temperature ratings: operating: 0 to 55°C. Storage -40 to +75°C.

Temperature coefficient: 0.015% +1 mV per °C.

Stability: 0.075% +5 mV for 8 hrs. (after ½ hr. warm-up); ambient temperature variation held to 3°C.

Overload protection: the unit is completely protected for all overload conditions including a short circuit applied directly across the output terminals.

Output terminals: both front and rear terminals are provided.

Option 007: ten turn volt/gain control for Model 6824A. Price: \$35.

Option 028: 230 V ac, single phase input. Factory modification consists of reconnecting the multi-tap input power transformer for 230-volt operation. See page 571.

INTEGRATED CIRCUIT SUPPLY

ICS model
Model 6384A



POWER SUPPLIES

Model 6384A is a well-regulated dc constant voltage/current limit power supply specifically designed for use with integrated circuits, micro-modular circuits, and other low voltage semiconductor circuitry. Included is an overvoltage "crowbar" protection circuit. If for any reason an overvoltage condition occurs, this completely independent circuit shorts the power supply output with an SCR "crowbar" within 10 μ s.

A temperature compensated zener diode is employed as the reference element in the all-silicon series regulator feedback circuit which monitors and controls the output voltage. The resulting low ripple and low output impedance permit this supply to be used in critical applications where less well regulated supplies are not suited.

This supply is short-circuit proof and will not be damaged by any overload regardless of how long imposed. The output is floating—thus the supply can be used as either a positive or negative source.

Advantages:

Built-in overvoltage protection "crowbar"

Specifications

AC input: 115 Vac \pm 10%, 48-63 Hz, 1.35 A, 120 W at 115 Vac.

Output: 4 to 5.5 Vdc, 0 to 8 A.

Load regulation: less than 1 mV from no load to full load.

Line regulation: less than 1 mV for a change in line voltage from 103.5 to 126.5.

Ripple and noise: 5 mV p-p (dc to 20 MHz), 1 mV rms at any line voltage and any load condition within rating.

Load transient recovery time: less than 50 μ s is required for output voltage recovery in constant voltage operation to within 10 mV of the nominal output voltage following a change in output current equal to the current rating of the supply. The nominal output voltage is defined as the mean between the no load and full load voltages.

Voltage resolution: 15 mV.

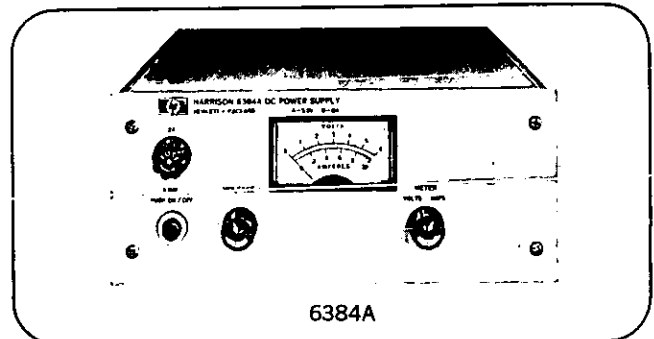
Temperature coefficient: output change per degree centigrade change in ambient following 30 minutes warm-up is 3 mV.

Stability: under constant ambient conditions, total drift for 8 hrs. following 2 hrs. warm-up is 0.3% plus 10 mV.

Temperature rating: operating, 0 to 55°C; storage, -40 to +75°C.

Protection:

Short circuit protection: the output is current limited and fully rated for operation under any overload condition including a direct short circuit, regardless of how long



Low output drift

Fully rated for any overload condition including continuous short circuit operation

Automatic restoration of normal operation following removal of overload

No overshoot for turn-on, turn-off, or power removal

Low peak-to-peak ripple and noise

Remote error sensing

Less than 50 μ s load transient recovery

maintained. Supply will automatically restore to normal operation upon overload removal.

Over-voltage protection: an independent built-in overvoltage "crowbar" circuit prevents the output voltage from exceeding a preset voltage under any failure condition. This crowbar circuit shorts the output within 10 μ s following the onset of the over-voltage condition. The "crowbar" threshold voltage is variable between 4.5 and 5.6 V by monitoring rear terminals while substituting a selected resistor.

Controls: single-turn output voltage control, combined off-on switch and pilot light, and switch that selects voltage or current meter.

Output terminals: rear barrier strip includes +OUT, -OUT, GND, +SENSING, and -SENSING. Either output terminal can be grounded or the output may be operated floating up to 300 V off ground.

Output impedance: 1 megohm resistance in series with 1 μ H inductance.

Meter ranges: 0 to 6 V, 0 to 10 A.

Meter accuracy: 3% of full scale.

Weight: (net/shipping) 12 lbs (5,4 kg)/15 lbs (6,8 kg).

Size: 8 $\frac{1}{4}$ " W x 3 $\frac{1}{2}$ " H x 13 $\frac{1}{4}$ " D (209,5 x 88,9 x 336,6 mm).

Price: \$220.

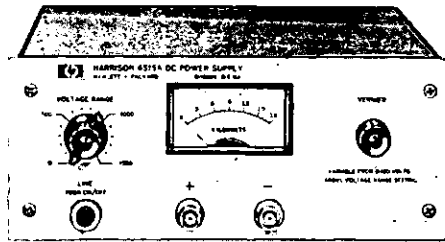
Option 028: 230 Vac, single phase input. Factory modification consists of reconnecting the multi-tap input power transformer for 230 V operation. Price: \$10.



HIGH VOLTAGE SUPPLIES

HVB, HVR Series

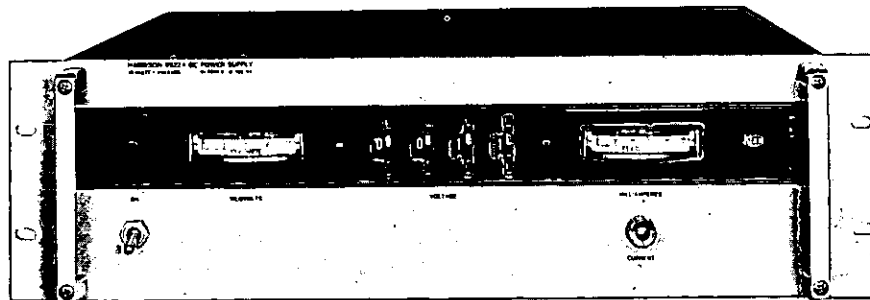
Models 6515A—6525A



6515A



6516A



HVR Series

HVB SERIES—This series has two compact, dc regulated bench supplies offering up to 3 KV in moderate currents. These high-voltage supplies offer low cost, portability, and high performance for experimenting and circuit developing at the bench. Low ripple and impedance are achieved by a series regulator feedback circuit using a temperature-compensated zener diode for reference. The design also includes short-circuit protection and current-limiting. Output is floating, giving choice of negative or positive voltages up to 1 KV off ground. High performance design makes these supplies particularly suited for photomultiplier application, as well as for TWT's, CRT's, gas flow tubes, proportional counter tubes, and rapid high-voltage single-trip electrophoresis. Circuits are all solid-state.

HVR SERIES—These three supplies are all tightly regulated (0.005%) and provide sufficient output current for many devices not capable of being powered from conventional low current, high voltage supplies. Such devices include power TWT's, Klystrons, continuous wave magnetrons, power gas lasers, and electron beam welding devices. Circuitry includes constant voltage/constant current operation with automatic crossover. Thumbwheel voltage controls give you 0.002% resolution. Two meters—one for voltage, one for current—are standard with each model. As in the HVB Series, these supplies are short-circuit proof. With floating output, you have the option of negative or positive voltages up to 2 KV off ground. Circuits are all solid-state.

HVB SERIES

HVR SERIES

Model		6515A	6516A	6521A	6522A	6525A
DC output*	voltage	0-1600 V	0-3000 V	0-1000 V	0-2000 V	0-4000 V
	current	0-5 mA	0-6 mA	0-200 mA	0-100 mA	0-50 mA
AC input		115 V \pm 10%, 57-63 Hz	115 V \pm 10%, 57-63 Hz	115 V ac \pm 10%, 48-440 Hz		
Load regulation	constant voltage	0.01% \pm 16 mV			0.005% or 20 mV	
	constant current	—			2% or 1 mA	
Line regulation	constant voltage	0.01% \pm 16 mV			0.005% or 20 mV	
	constant current	—			1 mA	
Ripple and noise	constant voltage	2 mV rms/5 mV p-p			1 mV rms	
	constant current	—			2 mA rms	500 μ A rms
Temperature coefficient	constant voltage	0.02% \pm 2 mV			0.012% \pm 1 mV	
	constant current	—			0.2% \pm 0.2 mA	0.2% \pm 0.05 mA
Stability	constant voltage	0.05% \pm 5 mV			0.036% \pm 3 mV	
	constant current	—			0.25% \pm 0.5 mA	0.25% \pm 0.12 mA
Meters		0-1800 V	0-3500 V	0-1 kV and 0-200 mA	0-2 kV and 0-100 mA	0-4 kV and 0-50 mA
Controls		100 V steps with intermediate vernier for 100 mV resolution.	4-digit thumbwheel, to 1-Volt resolution.	voltage control—3 decade thumbwheel switches plus thumbwheel vernier with 0.002% resolution, current control—single-turn potentiometer.		
Dimensions		3½" (8.9 cm) H x 8½" (21.6 cm) W x 11-13/16" (30 cm) D.	5½" (12.7 cm) H x 8½" (21.6 cm) W x 16" (40.6 cm) D.	5½" H x 18" D x 19" W (13.3 x 45.7 x 48.3 cm)		
Options: See page 571.		013	005, 018			
Weight (net/shipping)		12/15 lbs (5.44/6.8 kg)	17/20 lbs (7.71/9.07 kg)	50/60 lbs (22.5/27 kg)		
Price		\$235	\$295	\$750	\$750	\$750

*Note: See Model 6110A on p. 548.

Options

Options are mechanical and/or electrical modifications to standard instruments performed at the factory. A list of all options available on Hewlett-Packard DC Power Supplies is given below. To determine which options are available for a particular supply, refer to the appropriate product page (548 to 570).

No.	Description
001	208 $\pm 10\%$ V ac, 3-phase input, 57-63 Hz. Input is factory wired for 208 V ac.
002	230 $\pm 10\%$ V ac, 3-phase input, 57-63 Hz. Input is factory wired for 230 V ac.
003	460 $\pm 10\%$ V ac, 3-phase input, 57-63 Hz. Input is factory wired for 460 V ac.
004	Casters. Factory mounts 4 casters on base of standard instrument.
005	50 Hz ac input. Standard instrument is wired for 60 Hz ac. Option 005 includes alignment and in some cases internal rewiring.
006	Overvoltage "crowbar" protector. Protects delicate loads against power supply failure or operator error. Compact, inexpensive; can be factory installed at rear of power supply. Virtual short circuit (SCR crowbar) is placed across load within 10 μ s after trip voltage is

exceeded. For complete specifications, refer to appropriate data sheet.

007	Ten-turn output voltage control. Replaces concentric coarse and fine voltage control.
008	Ten-turn output current control. Replaces concentric coarse and fine current control.
009	Ten-turn output voltage and current controls. Same as options 007 and 008 on same instrument.
010	Chassis slides. Enables convenient access to power supply interior for maintenance. Chassis slides are attached to supply at factory.
011	Internal overvoltage protection "crowbar." Protects delicate loads by monitoring the output voltage and firing an SCR that shorts the output when the preset value is exceeded.
013	Three-digit graduated decadal voltage control. Includes 10-turn control replacing coarse and fine voltage control.
014	Three-digit graduated decadal current control. Includes 10-turn control replacing coarse and fine current control.
016	115 V ac $\pm 10\%$, single phase input. Factory modification includes the installation of a 115 V input power transformer to replace the standard 230 V transformer.

017	208 V ac $\pm 10\%$, single phase input. Factory modification includes the installation of a 208 V input power transformer to replace the standard 115 or 230 V transformer.
018	230 V ac $\pm 10\%$, single phase input. Factory modification includes the installation of a 230 V input power transformer to replace the standard 115 V transformer.
026	115 V ac $\pm 10\%$, single phase input. Factory modification consists of reconnecting the multi-tap input power transformer for 115 V operation.
027	208 V ac $\pm 10\%$, single phase input. Factory modification consists of reconnecting the multi-tap input power and bias transformers for 208 V operation.
028	230 V ac $\pm 10\%$, single phase input. Factory modification consists of reconnecting the multi-tap input power transformer for 230 V operation.
031	380 V ac $\pm 10\%$, 57-63 Hz, 3-phase input.
032	400 V ac $\pm 10\%$, 57-63 Hz, 3-phase input.
033	UHF connectors installed instead of standard BNC connectors.
034	Circularly polarized laminated safety glass. Increases reproduced picture contrast, but reduces light transmission by 65%.

Accessories

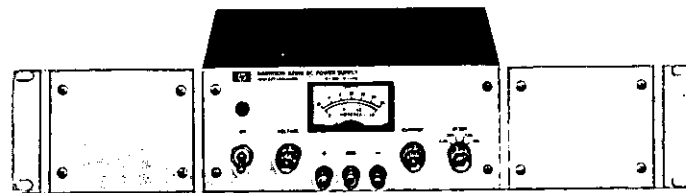
15 1/2" high tilt rack mounting tray and brackets for Model 6946A-14526A...\$55

15 1/2" high flush rack mounting brackets for Model 6946A-14528A\$10

15 1/2" high tilt rack mounting brackets—14529A\$10

Dual Rack Adapter Kit for rack mounting one or two CCB Series. Models 6177B, 6181B, HP part number 5060-0808; Model 6186B, HP part number 5060-0797 ...\$25

Blank filler panel to block unused half of rack when mounting only one CCB Series supply. Models 6177B, 6181B, HP part number 5060-0097; Model 6186B, HP part number 5060-0794\$5



14513A, 14515A

Rack kit for mounting one 3 1/2" high HVB, LAB, MPB-3, or STB series supply.....\$20

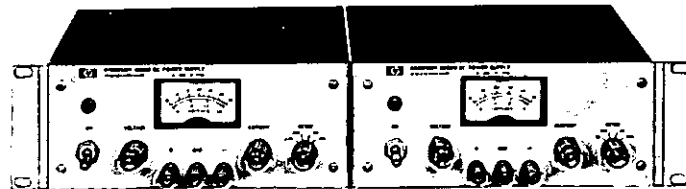
14513A.....\$20

Rack kit for mounting one 5 1/4" high MPB-5 or STB series supply.....\$25



14521A

Rack kit for mounting up to three BENCH series supplies.....\$25



14523A, 14525A

Rack kit for mounting two 5 1/4" high MPB-5 or STB series supplies.....\$12

Rack kit for mounting two 3 1/2" high HVB, LAB, MPB-3 or STB series supplies.....\$10



Electronic counters have proven to be the most accurate, flexible, and convenient instruments available for making both frequency and time interval measurements. Since the introduction of the first high-speed counter (the 10 MHz HP Model 524A) more than 17 years ago, Hewlett-Packard has developed a broad range of counters to permit selecting the proper instrument for virtually any application. In 1969, introduction of the HP 5360A Computing Counter brought about a revolutionary increase in counter performance and versatility, and also offered real time solution to equations whose variables are the counter's measurements. Thus, with the accessory Model 5375A Keyboard, one effectively now has a combination counter-computer with interface problems solved.

To go with this complete line of electronic counters Hewlett-Packard also offers many input and output accessories: equipment for measuring frequencies from dc to 40 GHz and time intervals from 100 picoseconds to more than 100 days; digital recorders for automatic recording of measurements; digital clocks which control measurement intervals and supply time information for simultaneous recording; digital-to-analog converters for high resolution analog records of digital measurements (e.g. Models 580/581); and scanners which can receive the outputs from several electronic counters for entry into a single recording device. Hewlett-Packard also manufactures magnetic and optical tachometers for rps measure-

ment inputs to counters, and accurate analog frequency meters which also serve as highly linear, wide-band, FM discriminators.

Conventional counters

Data on these first four pages apply mainly to conventional instruments that can only count signals from the input or the internal time base cycle-by-cycle. Operating principles of the HP 5323A Automatic Counter and HP 5360A Computing Counter differ considerably from conventional cycle-counting instruments and are described on the fifth page of this section.

Counter elements

Electronic counters in essence compare an unknown frequency or time interval to a known frequency or a known time interval and present this information in an easy-to-read, non-ambiguous, numerical display. Counters have several basic functional sections in common. These are interconnected in a variety of ways to perform the different counter functions. The most important components are: (1) the decade counting assemblies (DCA's) with visual numerical readouts to totalize and display the count; (2) the main gate, which controls count start and stop with respect to time, (3) the time base, which supplies the precise increment of time to control the gate for a frequency or pulse train measurement and (4) decade divider assemblies (DDA's) which allow variation of gate time. Other sections

include: Schmitt trigger for signal shaping, display control, and logic control. The logic control interconnects the proper circuits for the desired measurement, selects the appropriate measurement units for display and initiates the measurement cycle.

Totalizing

In the totalizing mode the main gate flip-flop is controlled remotely or by a manual start-stop switch (Figure 1). With the switch in Start (gate open), the decimal counter assemblies totalize input pulses until the main gate is closed. The counter display then represents the input pulses received during the interval between Start and Stop. For reversible totalizing see Model 5280A.

Frequency measurements

For direct frequency measurements (Figure 2) the input signal is first converted to uniform pulses by the Schmitt signal shaper. These pulses are then routed through the main gate and into the decade counting assemblies (DCA's) where the pulses are totaled. The number of pulses totaled during the "gate open" interval is a measure of the average input frequency for that interval. The count obtained, with the correct decimal point, is displayed and retained until a new sample is ready to be shown. The Sample Rate Control determines the time between samples, resets the counter and initiates the next measurement cycle.

The time base selector switch selects the gating interval, positions the decimal point and selects the appropriate measurement units.

For measurement of low level signals (down to 1 mV rms), HP manufactures the Model 5261A Video Amplifier and 5258A Sensitive Prescaler for HP plug-in counters. When using these on their most sensitive ranges, precaution should be taken to exclude the presence of stray radiation from the immediate measurement area because of the instrument's high sensitivity.

Period measurements.

Period is the inverse of frequency ($P = 1/f$). Therefore period measurements are made with the input and time base connections reversed. This is shown in Figure 3. The unknown input signal controls the main gate time, and the time base frequency is counted in the DCA's. The input shaping circuit selects the positive-going zero axis crossing of successive cycles of the unknown as trigger points for opening and closing the gate.

Low frequencies may be determined more accurately by measuring period rather than frequency directly. This is true because the

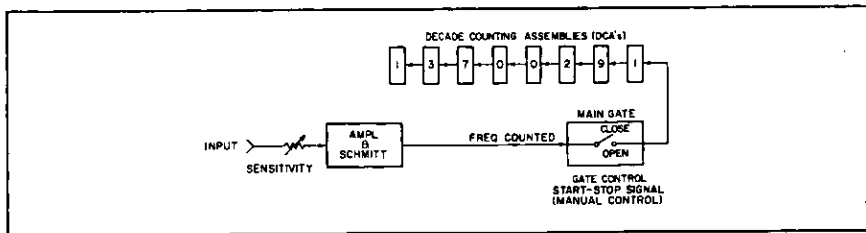


Figure 1. Function switch set to manual Start and Stop for totalizing.

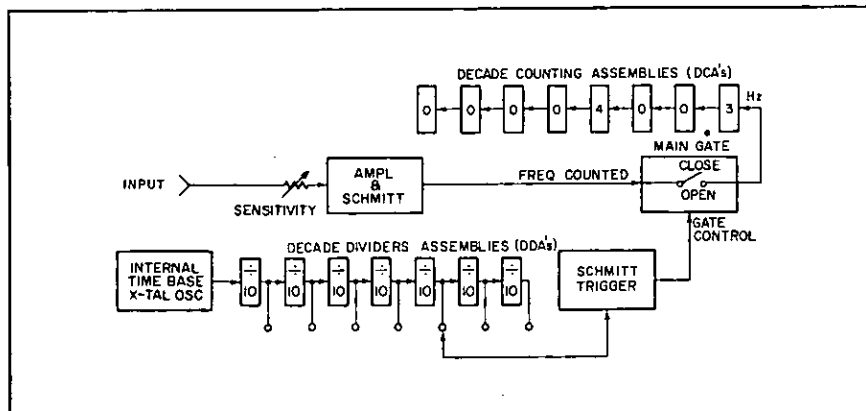


Figure 2. Function switch set to Frequency and gate time selected by time base switch.

longer period of a low frequency allows more counts to accumulate in a period measurement; therefore, resolution and accuracy are both improved (see Figure 9). For example, a frequency measurement of 100 Hz on the 8-digit 5248L Counter with a 10-second gate time will be displayed as 0000.1000 kHz. A 10 period average measurement of 100 Hz on an HP 5248L with 100 MHz as the counted frequency, would be displayed as 100000.00 μ s. Thus, resolution is increased by a factor of 10^4 and measurement time decreased by 100.

The accuracy-speed benefit of period measurements and the convenience of direct readout in frequency are offered by the Models 5323A and 5360A.

Multiple period averaging

Multiple period averaging is a simple method for reducing error and improving resolution in period measurements, more periods over which a signal is averaged, the better the accuracy.

The number of periods of the unknown to be averaged is selected by a front panel switch. The HP 5325B can average up to 10^8 periods and several other HP counters can average up to 10^9 periods. In the low-frequency measurement example above, the counter would display 10000.000 μ s for a 10 period average. (The selector switch automatically shifts the decimal point in the display to show the correct reading for a single period.)

Ratio measurements

The ratio of two frequencies is determined by using the one signal for the gate control while the other signal is counted (Figure 5). With proper transducers, ratio measurements may be applied to any phenomenon which may be represented by pulses or sine waves. Gear ratios and clutch slippage, as well as frequency divider or multiplier operation, are some of the measurements which can be made using this technique.

Accuracy is improved by the multiple period averaging technique by counting for 10^N cycles of the gate control signal.

Rate measurements

With a preset counter or a counter with a preset plug-in, frequency measurements can be normalized automatically to rate measurements by appropriate selection of the

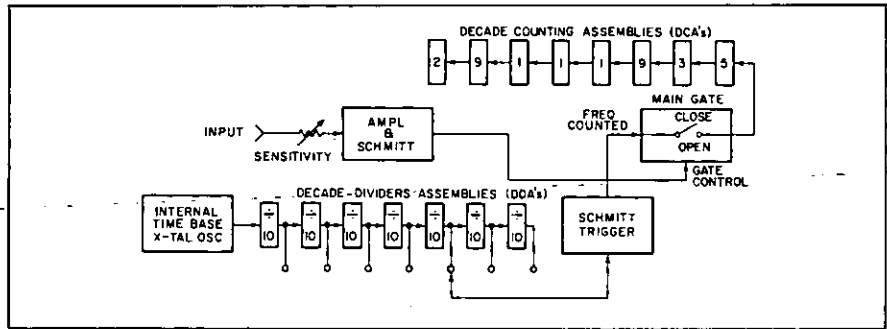


Figure 3. Function switch set to Period and counted frequency selected by time base switch.

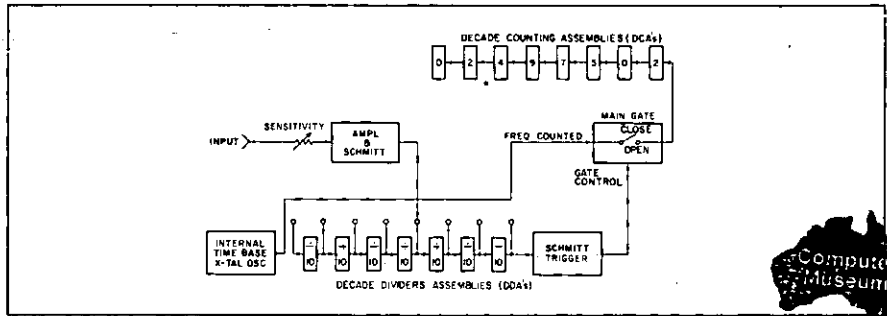


Figure 4. Function switch set to Period Average. Input signal controls gate for counting time base frequency.

gate time. The counter will then display a readout in the desired unit of measurement. For example: the HP 5330A/B Preset Counters or the HP 5248L Counter with the 5264A Preset Plug-in can be set to a gate time of 600 milliseconds to cause the input from a 100-pulse-per-revolution tachometer to be displayed directly in revolutions per minute.

Scaling

Several HP counters can scale (divide) an input by powers of 10 up to 10^9 . The scaled output is available from the rear of the counter.

Time interval measurements

Counters vary greatly in their time interval measuring capability. Some counters only measure the duration of an electrical event, others measure the interval between the start of two pulses, but the most versatile models, known as "universal counters," have separate inputs for the start and stop commands and have separate trigger controls which permit setting the trigger level amplitude, polarity, slope and type of input coupling (ac or dc) for the start and stop channel. Since stop

and start commands can originate from common or separate sources, this type of instrument can measure the interval from one point on a waveform to another point on the same waveform. Examples of universal counters are the HP 5325B, 5326A/B and 5267A Time Interval Plug-in in an HP 5245, 5246, or 5248 Counter. Time is displayed in μ s, ms or s. Accuracy is affected by the same factors which affect period measurements.

Measurement of the time required for a number of random events to occur is possible with 5330A/B Preset Counters. The decade dividers may be preset to close the gate on the Nth input pulse, where N is any number from 1 to 100,000.

Measurements with 1 nanosecond accuracy, 0.1 ns resolution, and of both "+" and "-" intervals (where "stop" signal arrives before "start") are unique features of the HP 5360A Computing Counter.

High-frequency measurements

Heterodyne converters measure the average frequency of CW signals (even when FM'd) and give the greatest resolution for a given counter gate time of any frequency extension technique. Resolution is 1 Hz in 1 s, 10 Hz in 0.1 s, 100 Hz in 0.01 s, etc. (exception: Models 5255A and 5256A require four times longer).—Hewlett-Packard manufactures a series of heterodyne converter plug-in units which convert the unknown high frequency to a related frequency which is within the counter's basic range. Measurements to 18 GHz are possible.

As an example we shall refer to the HP 5255A Plug-in Unit (see Figure 6). The tuning cavity selects the 200 MHz harmonic that gives a beat frequency output. After pre-scaling by a factor of four, the difference frequency is within the 50 MHz counting capability of the 5245M. At the same time the 5245M gate time is automatically ex-

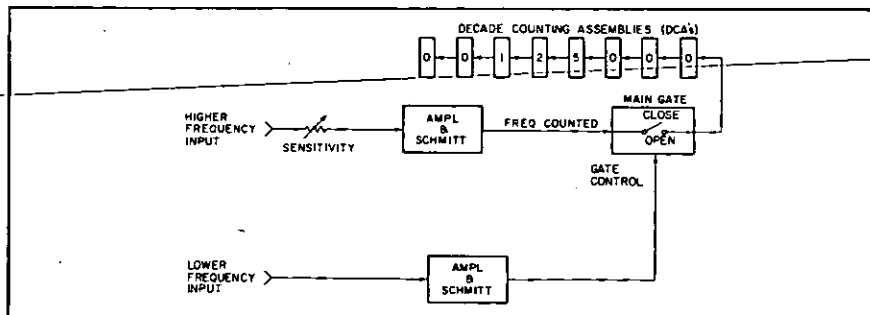


Figure 5. Ratio measurement. Function switch set to Period and time base switch to Ext. Lower frequency controls gate, while higher frequency replaces time base as counted frequency.

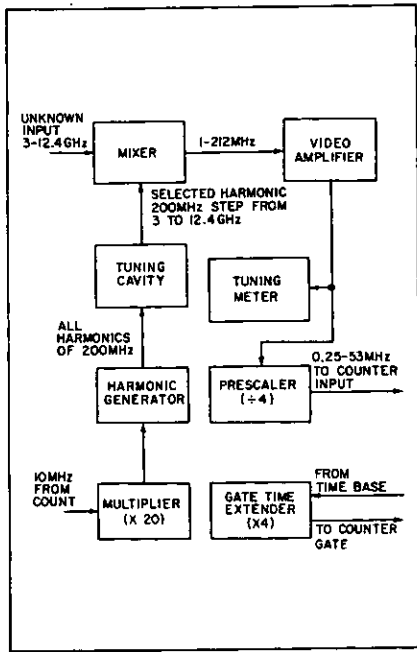


Figure 6. Frequency measurement with heterodyne converter; counter measures difference frequency (diagram is of HP 5255A Converter).

tended by a factor of 4 so that direct readout on the 5245M is achieved. The frequency reading on the counter is then added to the setting on the tuning dial to give the unknown frequency.

Transfer oscillators, on the other hand, can measure pulsed signals as well as CW signals. They also have a wider bandwidth than heterodyne converters. Possible drawbacks of transfer oscillators, when compared to converters, are that they require more operator skill and time for initial set-up (because calculations of harmonic number might be needed), and a longer gate time is needed for equivalent resolution.

The model 5257A is HP's newest transfer oscillator. It plugs into the front panel of the HP 5245, 5246, 5247, and 5248 Counters and extends counter range so that continuous coverage from 50 MHz to 18 GHz is achieved in a very compact, convenient, easy-to-use package. It is a new concept in frequency extension using a broadband sampler in place of both the harmonic mixer and phase detector of conventional units. It operates without an offset frequency; thus, once the harmonic number has been dialed into the 5257A thumbwheel switches and the VFO tuned for phase-lock, frequency is read directly from the counter with no further calculation. It also measures pulsed RF frequencies. A simple tuning meter replaces the conventional "zero beat" oscilloscope with no sacrifice in accuracy. The broadband sampler offers high sensitivity over the entire 50 MHz to 18 GHz range and permits tuning by a single knob.

The 5257A operates in a manner analogous to a stroboscope which uses a flashing lamp for measuring vibrational or rotary speeds. That is, if the 5257A variable frequency oscillator output frequency (Figure 7) is set to any sub-harmonic (N) of the unknown input frequency f_x , then V_1 will be

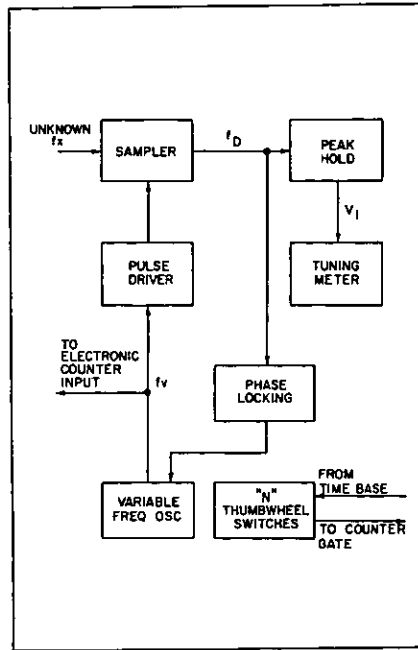


Figure 7. Frequency measurement with HP 5257A Transfer Oscillator using new transfer oscillator principle; counter measures sampling frequency of sampler.

a dc voltage (otherwise it's ac) because the input waveform will be sampled at the same point each time the sampler is gated open. Thus, if we manually tune the VFO until $f_D = 0$ (indicated by tuning meter) and measure f_v with an electronic counter, the counter reading will be the frequency of some subharmonic of f_x . The frequency of f_x can then be determined by multiplying the counter reading by the harmonic number N . Dialing the number N into the thumbwheel switches on the 5257A performs this multiplication by extending the counter gate time by a factor of N . Since there is no offset frequency to add or subtract from the reading, the counter displays f_x directly. "Zero beats" occur at intervals of $N f_v$ across the VFO dial. The VFO dial need only be used as an approximate indicator of VFO frequency since the electronic counter rapidly measures VFO frequency and displays up to 8 significant figures.

Tuning the 5257A is an uncritical operation. For CW signals, once the VFO is tuned through the proper frequency, it becomes automatically and securely phase-locked to it. Phase-locking does not occur for pulsed RF signals. Therefore, as in all transfer oscillators, accuracy is not as great when measuring the frequency of pulsed carriers as it is for CW signals. Tuning is also simple for pulsed carriers because zero beat is indicated by a maximum reading on the front panel meter.

In all transfer oscillators, harmonic number is calculated from the VFO frequency measured at two adjacent lock-points ("zero beat"). If the transfer oscillator operates with an offset (IF frequency), calculation is lengthier. See HP Journal, Feb. '68.

Without using a transfer oscillator, Models 5323A and 5360A can measure even a single burst of signal up to 20 MHz and 320 MHz, respectively. Unlike other counters, the 5360A can measure pulsed rf signals with heterodyne converters.

Automatic frequency dividers provide automatic measurement and direct readout of a wide range of CW frequencies, and furnish 1000 Hz resolution in 1 s. Some FM can be tolerated. Measurements from 0.3 GHz to 12.4 GHz can be achieved using the HP 5240A Frequency Meter. The 5240A and 5260A zero beat with the input automatically and without offset and then provide a frequency input to the counter equal to exactly 1/100 or 1/1000 of the unknown frequency depending upon the division ratio switch setting. See HP Journal, April '67.

Prescaling is accomplished by means of frequency division of the input signal. If the gate time is extended with the scale factor, the correct frequency will appear on the counter readout. The HP Model 5252A Prescaler plug-in unit has three selectable scale factors: $\div 8$, $\div 4$, and $\div 2$ and is dc coupled which makes it very useful for counting of random pulses or events. Because the Prescaler is a wideband instrument, it is more susceptible to noise than tuned instruments like the heterodyne converters. An adjustable trigger-level control on the Prescaler can be used to discriminate against unwanted signals. The accuracy of the Prescaler is the same as that of the counter although the measurement takes 2, 4, or 8 times as long time, depending on the scale factor.

For very low signal levels, HP manufactures a Sensitive Prescaler (Model 5258A) with a maximum sensitivity of 1 mV rms and a frequency range of 1 MHz to 200 MHz. The scale factor is fixed at $\div 4$. For simplicity of operation, a meter indicates the input signal level.

Counter accuracy

There are 3 main sources of error in counter measurements: ± 1 count ambiguity, time base instability, and trigger error. The causes and the effects of these errors are discussed below.

± 1 COUNT AMBIGUITY. The ± 1 count ambiguity is inherent in conventional electronic counter measurements because the input signal and the time base are normally not synchronized. As shown in Figure 8, the count registered during the gating time t_g may be either 6 or 7 depending on the moment at which t_g begins. Thus, in any measurement, the counter's display may be incorrect by one count.

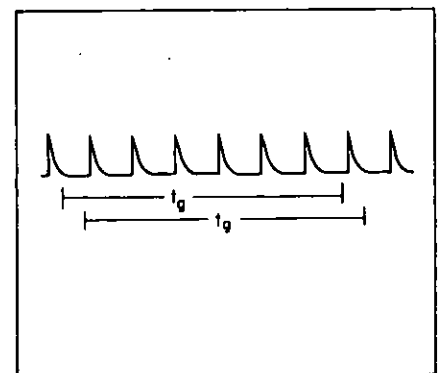


Figure 8. An error of ± 1 count can occur because gate may open and close between input pulses. With gate open for upper t_g interval, 6 counts occur; 7 counts occur for lower interval.

The fractional effect of the ± 1 count ambiguity is:

$$\frac{1}{\text{total events counted}}$$

Obviously, the more events counted, the smaller this error becomes. This explains why long gate times result in better accuracy in frequency measurements. Interpolating circuits unique to the HP 5360A Computing Counters reduce the ± 1 count ambiguity by a factor of 1000 times.

TIME BASE STABILITY. When the crystal is in a precision oven, Hewlett-Packard separately specifies crystal aging rate, short-term stability, temperature change and line voltage change as sources of time base error.

Crystal aging rate (also called long-term stability or drift rate) refers to slow, but predictable, variation in average oscillator frequency with time due to changes occurring in the quartz crystal itself. After an initial period of rapid change when the oscillator is turned on, aging in a good crystal becomes quite slow and assumes a predictable linear characteristic. The slope of this line is the aging rate of the oscillator.

Since aging is cumulative, it is necessary to periodically calibrate the oscillator. Calibration methods are discussed in HP Application Note 52 which is available upon request.

Short-term stability specifications indicate the effects of noise generated internally in the time base oscillator on the average frequency over a short time, usually one second.

Short-term effects are so small that the spec is listed for only the very most stable time base oscillators in precision ovens. In the less stable oscillators, other errors make the short-term spec insignificant.

When comparing short-term stability specifications, it is important to remember that the averaging time used will determine how good the spec *appears* to be. A long averaging time will hide large frequency

variations. Hewlett-Packard always specifies rms short-term stability over the realistically short period of 1 second.

Line voltage and temperature specifications should be self-explanatory. The total inaccuracy due to the time base is the sum of the aging, short-term, line voltage, and temperature errors.

TRIGGER ERROR. Trigger error arises from noise on the gate-control signal. This noise causes the gate to open or close at incorrect times and results in an erroneous count.

Significant trigger error can occur only when an external signal controls the gate; that is, when period, ratio, and time interval measurements are being made.

Absolute trigger error is stated in time units and the fractional effect is given by:

$$\frac{\text{error in time}}{\text{total time gate is open}}$$

This equation explains why multiple period averaging is such a good method for reducing period measurement error (because it extends the gate time). As more periods are averaged, the effect of both trigger error and the 1 count ambiguity are reduced proportionally.

For the best HP counters, trigger error is $<0.3\%$ for one period if the signal is a sine wave with 40 dB signal-to-noise ratio, and if triggering occurs at zero volts on the signal, and if the signal amplitude is at the specified sensitivity limit of the counter (generally 100 mV rms). Trigger error is less than 0.3% if signal-to-noise ratio is improved, or if the input amplitude or rise time increased. For clean, fast rise time pulses, trigger error can be very low.

TOTAL MEASUREMENT ERROR. To calculate the error in any counter measurement, simply sum the individual errors discussed above.

In frequency measurements trigger error is zero, so the total error equation becomes:

$$\text{error}_{\text{req}} = S_{LT} + S_{ST} + T_e + V + C,$$

where S_{LT} = long-term instability,

S_{ST} = short-term instability,

T_e = temperature variation error,

V = line voltage error,

and $C = \pm 1$ count error = $1/\text{total events counted}$.

For Period, Ratio, and Time Interval measurements trigger error must be included and the error equation is: $\text{error}_{\text{period, ratio, ti}} = S_{LT} + S_{ST} + T_e + V + C + Tr$, where $Tr = \text{trigger error in time/total gate time}$.

Figure 9 presents a good summary of this accuracy discussion. Notice how error decreases as frequency is measured over longer gate times and also how multiple period averaging is used to increase period accuracy. The minimum error in the figure, 2×10^{-7} , is equal to the total time base instability.

In the section titled "Period Measurements" it was mentioned that low frequencies are determined more accurately by measuring period than frequency directly. This is shown in Figure 9. The intersection points of the frequency and period error curves indicate the frequency below which better accuracy is obtained by the Multiple Period Average technique.

Counter display

If a long gate time is used when a high frequency is counted, the entire answer will not be seen on the counter because the readout capacity will be exceeded. To determine what part of the answer will be visible, one must realize that counting starts with the rightmost digit in the readout, progresses to the next digit to the left after a count of 9 has been reached, and so forth until all digits read 9. Next, account for the effect of gate time: if .9 MHz is counted for 1 s, a total of 900,000 counts will be gated into the counting circuits and a 6-digit counter will display 900,000 but a 5-digit counter will display 00000. In the most versatile 8 digit counters having gate times from 1 μ s to 10 s, the entire answer can always be made visible by suitable gate time selection. The convenient table below shows the maximum readout capacity (counting rate can be much greater) for low cost counters having fewer digits and a more limited gate time selection than more expensive units.

Gate	4-digit	5-digit	6-digit
.01 s	.9999 MHz	9.9999 MHz	99.9999 MHz
.1 s	99.99 kHz	.99999 MHz	9.99999 MHz
1 s	9.999 kHz	99.999 kHz	.999999 MHz
10 s	.9999 kHz	9.9999 kHz	99.9999 kHz

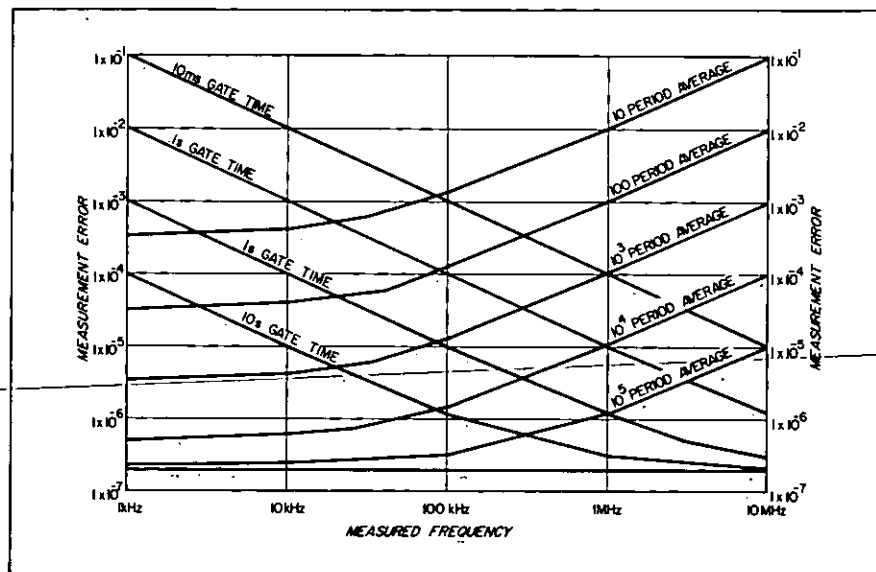


Figure 9. Comparison of error vs measured frequency for frequency measurements (plots labeled "gate time") and period measurements. Example is for HP 5325B Counter. Total time base error assumed to be 2×10^{-7} . Note that low frequencies are best measured by multiple period averaging.

Lowest frequency measured

Counters can have ac or dc coupled inputs or both, the desired input coupling being selected by a front panel switch. As the name implies, dc coupled inputs will pass input waveforms regardless of rise time. Ac coupled inputs discriminate against slow rise times; the frequency range specified defines sine wave frequencies for which the sensitivity specification will be met (typically, 100 mV rms for frequencies down to several Hz). Most ac coupled counters will count sine waves below the minimum frequency specified but a higher input amplitude will be needed; they will count events of extremely low repetition rate if the input waveshape counted has a fast rise time. Where contact closures are being counted beware of spurious counts caused by contact bounce.

COMPUTING COUNTERS

The newest generation of Hewlett-Packard counters add a new dimension to counter measurements — computing capability. The Model 5323A Automatic Counter measures frequency only, while the Model 5360A Computing Counter provides a host of measurement functions.

5323A Automatic Counter

The 5323A actually measures period, then inverts it to get frequency. Thus, it combines direct readout in Hz or RPM with the speed and accuracy advantages of multi-

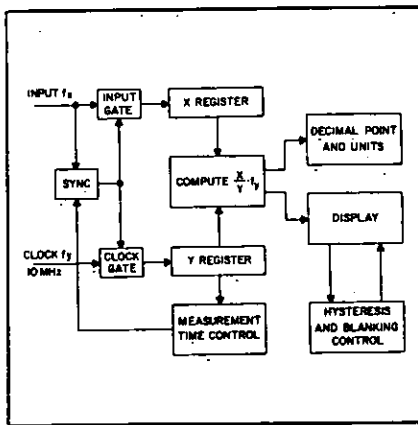


Figure 10. 5323A Automatic Counter. Computing circuits divide the number of input cycles (X) by the number of clock periods (Y) and multiply by $f_y = 10^7$ to find the unknown frequency f_x . Other IC's determine the measurement units, position the decimal point, blank insignificant digits, and apply hysteresis to prevent display jitter.

ple period measurement (see previous discussion, Period Measurements, and Figure 1, 5323A pages farther on in catalog).

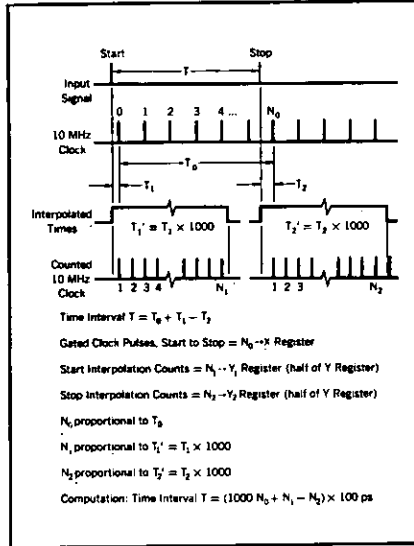


Figure 11. Time intervals measured by 5360A Computing Counter.

The automatic counter operates by counting precise 10 MHz clock pulses during the gate interval over which a number of complete periods of the input signal are counted. Each of these numbers is in a separate register (see Figure 10). The frequency of the unknown input is then computed by dividing the number of input periods by the number of clock pulses and then multiplying by the clock frequency. Approximately 1 ms is needed to compute and display the result.

Ranging (gate time selection) is automatic; the computer fills the entire 7 digit readout for any frequency, 0.125 Hz-20 MHz. If measurement time selected is too short, the computer will blank the insignificant data, giving a 5 or 6-digit reading.

Due to a unique "arming" concept (see 5323A catalog pages) pulsed signals (bursts) can be measured conveniently.

5360A Computing Counter

The Model 5360A Computing Counter is truly a revolutionary type of digital instrument that makes computation an integral, indispensable part of the measurement process. Unique advantages accrue in speed, accuracy, ability to measure pulsed RF and time intervals to 100 ps, and computing capability that solves equations whose variables are the counter's measurements.

Time interval is the basic measurement of the computing counter. In Figure 11, the small times T_1 and T_2 represent the phase difference between the internal clock and the input start/stop signals (which signals are the zero crossings of a waveform whose frequency or period are being measured, or the beginning and end of any time interval measured). In an ordinary counter, T_1 and T_2 account for the ± 1 count uncertainty. In the 5360A, interpolators stretch T_1 and

T_2 1000 times, giving a time-interval resolution of 0.1 ns although the clock rate is only 10 MHz. Notice that computational capability is needed to make such measurements.

By itself, the 5360A arithmetic unit can be thought of as a desk calculator without a keyboard. In place of a keyboard, it is told what mathematical operations to perform by short programs wired into the counter mainframe, the input module, the plug-in, or external units such as read-only diode matrices plugged into the rear panel of the counter. It can also be controlled by the accessory keyboard, in which case it is similar to a programmable desk calculator.

The Arithmetic Processor. The programming circuits read the operation-code requests from various programs in the counter and create a set of five binary signal lines. The processor reads the operation code on these lines and performs the corresponding sequence of operations on the contents of three registers (X, Y, and Z). There are many data routes by which register contents can be interchanged or passed through the adder. The arithmetic operations—add, subtract, multiply, and divide—are accomplished by repetitive shifts and passes through the adder. An exponent manipulation is associated with each operation; for example, during multiplication the exponents are added.

The table below shows arithmetic operations accessible by external programs and is an indication of the computing power of this unique instrument. Even greater computing power is expected to be available in accessories now under development.

Code	Name	Description	Register Contents After Operation*
16 8 4 2 1			X Y Z
0 0 0 0 0			
0 0 0 0 1			
0 0 0 1 0	MODULE	Call Module Subprogram	
0 0 0 1 1	PLUG-IN	Call Plug-in Subprogram	
0 0 1 0 0			
0 0 1 0 1	\sqrt{x}	Square-Root Subroutine	\sqrt{x}
0 0 1 1 0	CHECK	Call Check Subprogram	
0 0 1 1 1	CAL	Call Calibrate Subprogram	
0 1 0 0 0	DISPLAY X	Display contents of X register	a b c
0 1 0 0 1	10 X	Multiply X by 10	10a b c
0 1 0 1 0	ADD	Add X to Y	a+b c
0 1 0 1 1	SUBTRACT	Subtract X from Y	b-a c
0 1 1 0 0	1/X	Reciprocal of X	1/a b c
0 1 1 0 1	LOAD	Enter New Number	a' b c
0 1 1 1 0	DIVIDE	Divide Y by X	b/a a c
0 1 1 1 1	MULTIPLY	Multiply Y by X	ab a c
1 0 0 0 0			
1 0 0 0 1	X \leftrightarrow A	Interchange X and A**	B, b c
1 0 0 1 0			
1 0 0 1 1	A \leftrightarrow X-Y	Copy A into X and X into Y	B, a c
1 0 1 0 0	2 X	Add X to X	2a b c
1 0 1 0 1	X \leftrightarrow Y	Interchange X and Y	b a c
1 0 1 1 0	CLEAR X	Reset X to Zero	0 b c
1 0 1 1 1	X \leftrightarrow Y	Copy X into Y	a b c
1 1 0 0 0			
1 1 0 0 1	X \leftrightarrow B	Interchange X and B**	B, b c
1 1 0 1 0			
1 1 0 1 1	B \leftrightarrow X-Y	Copy B into X and X into Y	B, a c
1 1 1 0 0	X/10	Divide X by 10	a/10 b c
1 1 1 0 1	X \leftrightarrow Z	Interchange X and Z	c b a
1 1 1 1 0	CLEAR X Y Z	Reset X, Y, and Z to Zero	0 0 0
1 1 1 1 1	Z \leftrightarrow X-Y	Copy Z into X and X into Y	c a c

*Contents before operations: X = a, Y = b, Z = c
 **A is a storage register in the mainframe. Contents: S_a
 B is a storage register that can be provided in an external device. Contents: S_b

NEW 320-MHZ COUNTER

High Speed, Resolution
Model 5360A



FREQUENCY COUNTERS



5360A

Advantages:

Greatest accuracy per unit time of any counter—up to 1 part in 10^9 per μsec . Resolves 1 millihertz in a 1 MHz measurement in 1 second and 100 picosecond time interval resolution (see 5379A).

Computing capabilities offer (via accessory keyboard), direct display of processed answers such as: phase directly in degrees from time interval measurements, $\Delta f/f$, averaging, unit conversions, differential measurements and standard deviation.

Measures single and repetitive burst of Pulsed RF directly and automatically.

Makes accurate sampled frequency measurements up to 300 times/sec.

.01 Hz to 320 MHz basic range—to 18 GHz with existing conventional counter plug-ins.

11 digit maximum display about a fixed decimal point.

Ultra-stable time base.

± 1 count ambiguity is 1/1000 that of conventional counters.

Dual plug-in compartments.

Automatic operation.

Measurement Capability

The 5360A with the 5365A Input Module is an 11-digit (maximum) counter with a 320 MHz basic frequency range, 3 to 100 times more accurate at any frequency than other counters. It is capable of sampled frequency and pulsed-carrier ("tone burst") measurements, has time interval and period measurement accuracy that in a conventional counter would require a clock rate greater than 1 GHz.

Frequency

Basic range is 0.01 Hz to 320 MHz, and is extended to 18 GHz using heterodyne converter plug-ins now in use with HP Models 5245-46-48 Counters.

Low frequencies (down to 0.01 Hz) are accurately and rapidly measured since, in frequency mode, the 5360A measures the waveform's period (or multiple period average), then computes and displays the reciprocal, which is frequency. Compared to conventional counters, for equal measuring speed and ignoring noise considerations, the 5360A is 10 times more accurate in measuring 100 MHz and 10^9 times more accurate in measuring 1 Hz.

Sampled Frequency and Pulsed Signals

The 5360A samples, measures, and can display at rates greater than 300 times/s for frequency and period measurements and automatically measures the frequency of pulsed signals with direct read out in frequency.

Display and Printer Output

Measurements are displayed around a fixed decimal point. Insignificant digits are automatically blanked. The number of digits desired (3 to 11 digits) can also be selected manually.

The computer applies range change hysteresis to eliminate readout jitter at range change points such as that between 999 kHz and 1.00 MHz. The printer output format is identical and the 5050B Option 001 Printer accepts the output directly.

Accuracy

The 5360A is more rapid and accurate than conventional counters or those that measure waveform period for improved accuracy at low frequencies, inverting the answer for direct readout in frequency. The accuracy-speed benefits are due to interpolators and computing circuits that reduce the ± 1 count ambiguity by three orders of magnitude and supply direct readout in units desired.

Accuracy to 1 part in 10^3 per μsec

Specifications

5360A with 5365A Input Module

Input Channel B

Range: 1 kHz to 320 MHz, ac coupled.**Impedance:** 50 ohms nominal, VSWR, 1.3 or less.**Maximum sensitivity:** 20 mV rms. Stepped SENSITIVITY MULTIPLIER: X1, X10, X100.**Level control:** continuously adjustable. PRESET position automatically centers trigger level about 0 V.**Pulse measurement:** LEVEL control permits counting pulses of any duty cycle or amplitude from 42 mV to overload level, and of either polarity.**Overload protection:** diodes protect input for up to 3.5 V rms in X1 SENSITIVITY POSITION, 35 V rms in X10, and 70 V rms in X100.

Input Channel A

Range: 0.01 Hz to 10 MHz, dc coupled. 100 Hz to 10 MHz, ac coupled.**Impedance:** 1 M Ω shunted by 20 pF.**Sensitivity:** 100 mV rms sine wave. Stepped SENSITIVITY MULTIPLIER: X1, X10, X100.**Level control:** adjustable over ± 3 V dc multiplied by SENSITIVITY MULTIPLIER position. PRESET position centers trigger level about 0 V.**Overload protection:** diodes protect input for up to: 120 V rms in X1 SENSITIVITY MULTIPLIER position, 250 V rms in X10, 500 V rms in X100.**Channel selection:** Channel A or B can be selected for measurement by a switch on the Model 5365A Input Module.**Accuracy:** $\frac{1 \times 10^{-3}}{\text{Counting Start/Stop time}} \pm \text{trigger* error} \pm \text{time base error. Applies for both Channel A and B.}$

Remote Control of Module Channel

In center position (dot) of 5365A FUNCTION switch, measurement from Module Channel A or Channel B can be controlled from 5375A Keyboard.

Measurement Speed

Cycle time: the overall time (cycle time) required for a measurement is: Counting Time + Compute Time + Recycle Time.**Counting time:** Measurement Time + Interpolating Time.**Measurement time:** (MEASUREMENT TIME controls) 1 μs to 10 s in decade steps multiplied by integers from 1 to 9 selected by the MULTIPLIER. In MIN position measurement time is one period of the input to Channel A, 32 periods of the input to Channel B.**Interpolating time:** 200 μs max.**Compute time:** <3 ms for frequency and period measurements, <1 ms for time interval.**Recycle time:** the time remaining between completion of all other steps and the end of CYCLE TIME, with CYCLE RATE control at MAX, there is no delay.

Time Interval Measurements

Interval between two like polarity events on the same input channel can be measured in Period Mode with same accuracy as period measurements. For highly versatile interval measurements, use Model 5379A Time Interval Plug-in.

Scaling

Channel A

Frequency range: .01 Hz to 10 MHz.*For a signal with S/N ratio of 40 dB, and amplitude equal to the rated sensitivity of the input, trigger error is $< \frac{3 \times 10^{-3}}{n}$ where n is the number of measurement periods of the input signal. Trigger error is inversely proportional to signal amplitude and is negligible except for the noisiest or lowest frequency signals.**Factor:** by decades to 10^3 ; switch selected on rear panel. Scaled output from rear panel BNC.

Channel B

Frequency range: 1 kHz to 320 MHz.**Factor:** by 32 x decades to 10^3 ; switch selected on rear panel. Scaled output from rear panel BNC.**Scaled output:** 1 V p-p into 50 Ω .

General

Display: 12 digits, in-line, Nixie[®] digital readout. Measurements are displayed to 11 digits max., about a fixed decimal point with illuminated units annunciator.**Display storage:** previous reading is held constant till completion of compute time when new reading becomes available.**Blanking:** in AUTO position of DIGITS DISPLAYED selector, only the number of digits within the counter accuracy capability are displayed.**Cycle rate controls:** three ranges. In FAST and NORMAL, continuously adjustable control set from 20 ms to 0.9 s and from 75 ms to 6 s, respectively; the HOLD position holds the last reading until a manual or external reset signal is applied. In MAX, delay time is zero and repetitive measurements are made at maximum rate.**Measurement selectors:** front panel pushbuttons select: measurement from plug-in or input module; external control through rear panel connector, self-check.**External trigger:** with MEASUREMENT TIME selector at EXT, an external control signal will arm the counter and the ARMING WAVEFORM is determined by the duration of the external signal. External control signal must be $> +3$ V, $+20$ V, into 10 k Ω ; > 150 ns, < 100 s.**Marker outputs:** ARMING OUTPUT connector supplies a signal whose duration defines the Start Arm to Stop Arm Interval. Signals are 1 V p-p into 50 Ω .**Self-check:** 5360A main frame counts internal 10 MHz signal.**Indicator lamps:** Arm, Count, Compute, Display.**Digital output:** character serial, 4-bit parallel, 4-line BCD, -8421 code with 1111 representing Blank; 15 characters including sign, 12 digits and measurement units; 1 MHz rate.

Computer inputs

With accessory keyboard Model 5375A, fixed program shell, Model 10538A or other programming and data entry devices, all commands including count from input module, plug-in and self-check can be programmed.

One-number input and output storage.

Operating temperature: 0 to $+50^\circ\text{C}$.**Power requirements:** 115 or 230 V rms $\pm 10\%$, 50 to 60 Hz approx. 250 V.**Weight:** 55 lb (25 kg) net.**Accessories furnished:** power cord, 7 $\frac{1}{2}$ ft (200 cm), NEMA plug. HP 10503A Cable, 4 ft (120 cm), male BNC connectors. Circuit board extenders. Rack mount conversion parts.**Dimensions:** 5-7/32" high x 16 $\frac{3}{4}$ " wide x 16 $\frac{3}{8}$ " deep (133 x 424 x 416 mm).**Price:** Model 5360A Mainframe with Model 5365A Input Module, \$6500.

Time Base

Crystal frequency (internal): 5 MHz.

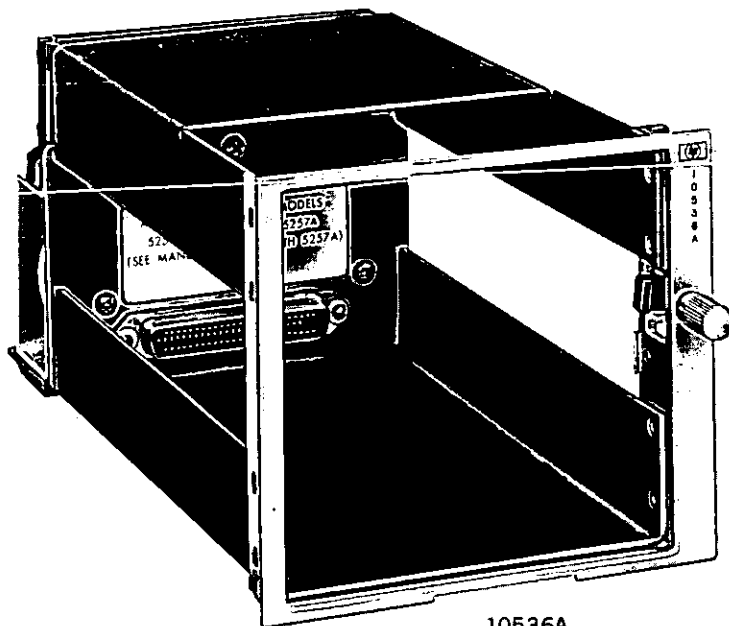
Stability

Aging rate: < 5 parts in 10^{10} per 24 hours after warm-up. Short Term (rms fractional frequency deviation): Better than 5 parts in 10^{11} for 1 second averaging time.**Temperature:** < 5 parts in $10^{11}/^\circ\text{C}$ from 0° to 50°C (< 2.5 parts in 10^9 within the entire span of 0° to 50°C).**Line voltage:** ± 1 part in 10^{10} for 10% change in line voltage from 115 V or 230 V rms.**Load stability:** typically $< \pm 2$ parts in 10^{11} for any of the following loads: open, short, 50 Ω resistive, 50 Ω inductive, 50 Ω capacitive.

ACCESSORIES TO 5360A COUNTER
Plug-in adapter/fixed program shell
Model 10536A and Model 10538A



FREQUENCY COUNTERS



10536A

Model 10536A Adapter

Advantages:

- Extends 5360A basic frequency range to 18 GHz
- Uses existing 5245 Series Plug-ins
- Reduces chance of obsolescence by providing interface between 5360A and existing conventional counter plug-ins

The HP 10536A Plug-in Adapter provides interfacing circuitry for extending the frequency range of the 5360A Computing Counter to 18 GHz. The 5245 series Plug-ins that are available for use with the computing counter are:

- HP Model 5251A Frequency Converter, 20-100 MHz.
- HP Model 5252A Prescaler (count rate must be set to "200").
- HP Model 5253A/B Frequency Converter, 50-512 MHz.
- HP Model 5254A/B Frequency Converter, 0.2-3.0 GHz.
- HP Model 5255A Frequency Converter, 8-18 GHz.
- HP Model 5257A Transfer Oscillator (when used in conjunction with HP Model 5375A Keyboard).
- HP Model 5258A Prescaler, 1-200 MHz.
- HP Model 5261A Video Amplifier, 10 Hz-50 MHz.

(Data sheets available on request).

The frequency converters convert a CW or pulsed RF input signal to a lower more usable frequency. The converters subtract multiples of 50 or 200 MHz (depending on converter used) from the input signal and provide the difference to be measured by the counter. The measured frequency is then the sum of the counter display and dial readings. If the dial readings are manually entered into the accessory keyboard, the counter will add them to the difference frequency and display the final answer directly.

When using the 5257A Transfer Oscillator, the harmonic number, N, is obtained and multiplied by 4. The 5375A keyboard is programmed to divide by 4 and multiply by N to obtain a direct reading. Measurements taken with the plug-in

adapter combination yield the same speed, accuracy, and resolution that is associated with the 5360A Computing Counter.

Operating temperature limits: 0°C to +50°C.

Dimensions: L. 11-3/16", W. 5-7/16", H. 4 3/4".

Weight: 1.56 lb (0.70 kg).

Price: Model 10536A, \$175.00.

10538A Program Shell

Advantages:

- Programs can be designed by the user.
- Ideal in system use where a repetitive program is required.

The Model 10538A Program Shell allows the user of a computing counter to design his own programs by plugging diodes into appropriate coordinates of a matrix within the program shell. The matrix then becomes a read-only memory that generates a sequence of 5-line operation codes. Diodes are packaged in groups so that each plug-in package provides one 5-line operation code. A maximum of eighteen operation codes can be generated in a series. Basically, the available operation codes are:

- a. **Input:** count, recall constant, manual digit entry, etc.
- b. **Transfer:** interchange register contents, etc.
- c. **Arithmetic:** add, subtract, multiply, divide, square root, invert, etc.
- d. **Sub-programs:** derive basic time interval from interpolator outputs, etc.
- e. **Output:** display; print, or store.

Operation consists of inserting proper diode packages for the desired program, connecting program shell to computing counter EXTERNAL CONTROL connector, and pressing EXT pushbutton on computing counter. The selected program is then executed automatically.

Weight: net 5 oz. Shipping 1 lb 5 oz.

Dimensions: L. 4", W. 7/8", H. 4".

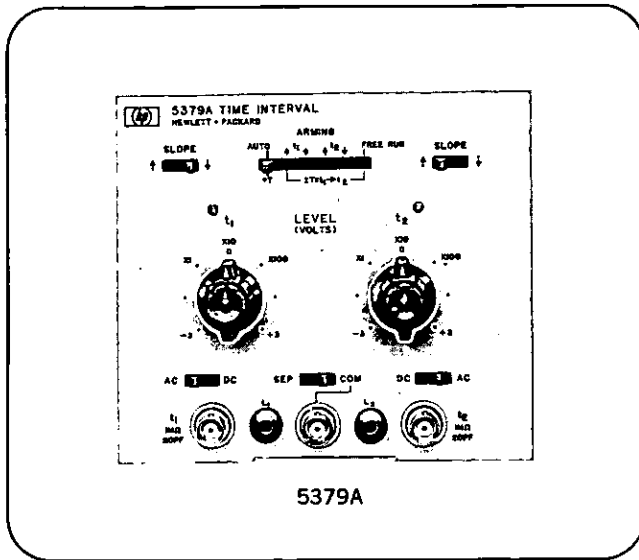
Price: Model 10538A, \$190.00.



TIME INTERVAL PLUG-IN

100 ps resolution

Model 5379A



Advantages:

- Time interval accuracy of 1 ns with a 100 ps resolution. Minimum measurable time extended to zero.
- Negative as well as positive intervals can be measured (the start pulse T_1 occurs after stop pulse T_2).
- Armed by either input signal.
- External arming provisions.
- High input impedance.
- Direct measurements of velocity and rotational speed through keyboard programming.

Keyboard Programming

Model 5379A Time Interval Plug-in converts the Model 5360A Computing Counter into an accurate time interval counter with 100 ps resolution. Overall accuracy of time interval measurement using the 5379A Time Interval Plug-in is 1 nanosecond \pm time base error. The effect of input amplifier rise time (<2 ns) can be made insignificant by proper adjustment of the 5379A level controls. In addition to the high accuracy and resolution, two unique features of the unit set it apart from other time interval counters:

1. The 5360A's counting techniques have extended the minimum measurable time to zero.
2. Negative as well as positive time intervals can be measured, i.e., the T_2 pulse can arrive before T_1 pulse. This feature is made possible by the arming controls.

Unlike other time interval units, the unit may be armed by either input signal. This allows choosing one time interval out of the several that are possible when measuring two repetitive input signals. The unit also has external arming provisions. Front panel LEVEL jacks allow dc voltmeter monitoring or external setting of trigger levels. The unit's high accuracy and resolution increases (compared to a conventional counter) the information obtained when measuring cable delay, radar ranging, phase difference, pulse width, rise time, etc. The plug-in's 1 megohm input impedance, shunted by less than 20 pF, permits using oscilloscope probes to measure, for example, input-output delay of logic or transistor stages. Programming allows direct measurements of velocity and rotational speed; this is

accomplished with the 5375A Keyboard. Using the H01-5379A, which has separate stop arming, unwanted signals may be ignored until the actual desired stop signal arrives.

Operation

Trigger points start and stop the time interval measurement. These trigger levels can be adjusted with the LEVEL and SLOPE controls, along positive or negative going slopes. Arming the counter to accept trigger information can be (optional) internally, in AUTO or FREE RUN modes, as well as externally.

Specifications

(Time Interval Displayed = $T = t_1 \rightarrow t_2$)

Input Specifications

- Sensitivity:** 300 mV peak to peak minimum, 120 V rms maximum.
- Separation:** $|t_1 \rightarrow t_2|$: 0 seconds minimum.
- Trigger pulse width:** 10 nanoseconds minimum width input at minimum input voltage.
- Repetition rate:** 15 MHz maximum input.
- Range:** $T = +100$ seconds maximum to -100 seconds minimum.
- Impedance:** 1 M Ω shunted by less than 20 pF (500 k Ω and 40 pF for COMMON) constant over a range of ± 3 V times LEVEL multiplier setting.

Measurement Specifications

- Accuracy:** 1 nanosecond \pm time base accuracy.
- Displayed resolution limit:** 100 picoseconds.
- Measurement rate:** Greater than 1000 per second.
- Input amplifiers:** less than 2 nanoseconds response time; effect upon accuracy can be virtually eliminated through proper adjustment of LEVEL controls.

Controls

- Level:** -3 volts to $+3$ volts times LEVEL multiplier X1, X10, X100; separate for t_1 and t_2 .
- Slope:** $+$ or $-$, separate for t_1 and t_2 .
- Input:** common or separate circuits, ac or dc input coupling controlled by switch.
- Arming:** <50 ns delay between arming and acceptance of start pulse from t_1 or t_2 .
 AUTO = $+T$ only (counter starts only on t_1) 15 ns minimum T_1 input arms automatically.
 $t_1 \uparrow = +$ or $-T$, input arms on positive transition of t_1 input.
 $t_1 \downarrow = +$ or $-T$, input arms on negative transition of t_1 input.
 $t_2 \uparrow = +$ or $-T$, input arms on positive transition of t_2 .
 $t_2 \downarrow = +$ or $-T$, input arms on negative transition of t_2 .
 Free Run = $+$ or $-T$, input arms automatically.
 ($\uparrow \downarrow$ indicates slope: $\uparrow = +$, $\downarrow = -$)
- External arming:** 5360A Main Frame allows external arming.
- Start/stop markers:** available on 5360A Main Frame rear panel.
- Triggering lamps:** lamps indicate when t_1 and t_2 are being triggered.
- Level jacks:** dc voltmeter monitoring or external setting of trigger levels.

Readout

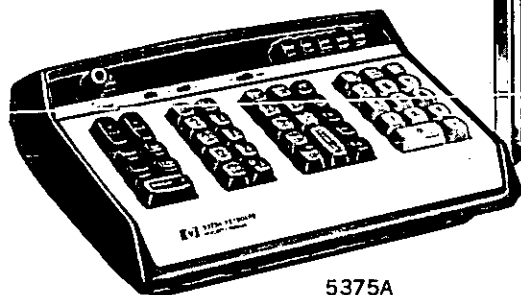
- Automatic with correct units, fixed decimal, and blanking of insignificant digits.
- When the plug-in receives two start pulses before a stop pulse, the asterisk lights and the counter is not reset. The asterisk lights and the counter is reset when counter specifications are exceeded.
- Weight:** net 3.65 lb (1.64 kg), shipping: 6.25 lb (2.8 kg).
- Price:** Model 5379A, \$750.00.
 Option H01-5379A, add \$75.

COMPUTING COUNTER KEYBOARD

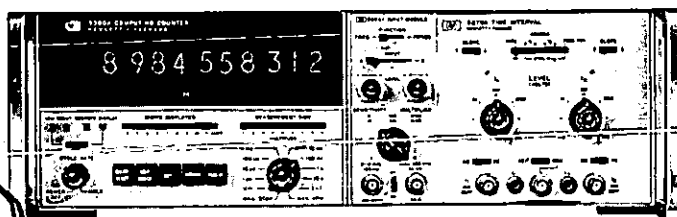
Mathematically process measurements
Model 5375A



FREQUENCY COUNTERS



5375A



5360A

As an accessory to the computing counter, the Model 5375A Keyboard allows the user to mathematically process measurements made by the counter, in real time.

Typical Uses

1. Measure Fractional Frequency Deviation

Fractional frequency deviation (sometimes called short term stability) is a quantitative measure of the amount of frequency or phase noise present on a frequency source.

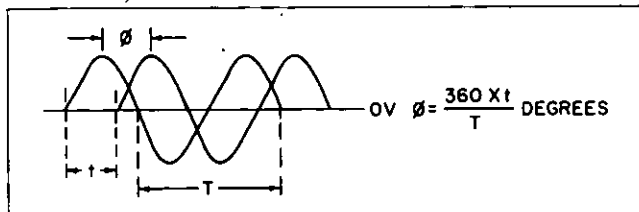
$$\langle \sigma_2 \frac{\Delta f}{f} \rangle = \frac{1}{f_0} \sqrt{\frac{1}{2N} \sum_{i=1}^N (f_{2i} - f_{2i-1})^2}$$

A simple 25 step keyboard program allows the computing counter to display the fractional deviation of the N frequency measurement f_i directly.

2. Measure Phase Shift

The phase difference between two equal frequency signals may be related to the time displacement t between the signals and the period of either one of them, viz:

In conjunction with the Model 5379A Time Interval



Plug-in an eight step program enables the computing counter to compute and display, in real-time, the phase-shift between two signals.

3. Picosecond Resolution Time Interval Measurement

The average \bar{t} of N time interval measurements t_i is,

$$\bar{t} = \frac{1}{N} \sum_{i=1}^N t_i$$

By averaging successive time interval measurements with the keyboard programmed to solve the above equation, pico-

second resolution time interval measurements can be obtained.

4. FM Deviation

The peak to peak FM deviation of an FM carrier may be automatically measured and displayed with the appropriate keyboard program. By randomly sampling the FM carrier, the computing counter stores the maximum and minimum frequencies of N samples and then displays the difference.

5. Limit Testing

Results of measurements of computations may be compared against predetermined limits on a Hi, Lo, or Hi, Go, Lo basis. Appropriate keyboard outputs are provided for control purposes.

Other uses include normalizing, ranging and crystal impedance measurements. Rate of change measurements e.g., velocity as a rate of change of distance are easily accomplished. Another class of measurements now possible are statistical in nature, e.g., variance, standard deviation, weighted averages, etc. The computing counter/keyboard combination may also be used as a desk calculator, where numbers may be entered and arithmetics operations performed.

Description

The keyboard gives to the user direct access to the computing counter's arithmetic capability. This allows solutions to equations $f(x)$ to be computed and displayed in real time, where x are measurements made by the counter's input module or plug-in.

Operations

Arithmetic: Add, subtract, multiply, divide, square root, reciprocal, 10X and 1/10.

Measurement: MOD A, MOD B, PLUG-IN. Single key-strokes of any of these keys cause measurements to be made from the A input of the 5365A Input Module, the B input or the plug-in respectively.

Machine Registers

Active Registers: There are three active registers, x , y , and z . These registers are used whenever a measurement is made, or when arithmetic operations are involved. The results of a

Real-time processing of measurement

measurement or arithmetic operation is kept in the x register.

Storage Register: Three storage registers, a, b, and c are available for the storage of constants or intermediate results in a program.

Display Register: This register is used to display the contents of the x Register. The DISPLAY x key commands the computing counter to copy the contents of the x Register into the Display Register.

Register Capacity: All registers store a number in floating point form with a mantissa of up to 11 digits, a mantissa sign, an exponent of up to 10^{22} (except Display Register -10^{14}) and exponent sign.

Register Operations:

- Interchange:** interchange the contents of the respective registers.
- Copy:** copy the contents of the first named register into the second, and the contents of the second register into the third. The contents of the third register are lost and that of the first named register unchanged.

Programming

Up to 32 program steps may be stored in the keyboard memory. The memory is in two sections, a main program of up to 16 steps and a sub-program of similar length.

Program Keys:

- XFER PROG enables transfer of the program from main to sub or vice versa.
- REPEAT allows the sub-program to be repeated N times for each pass through the main program. N is set by the REPEAT LOOP control to be in decade steps from 1 to 10^4 .
- PAUSE. The action of this key depends on the settings of the PAUSE DISPLAY and PAUSE HOLD switches. With PAUSE HOLD set, the program stops when it reaches this step. This allows for example, numbers to

be entered at specific points in a program. The program is restarted by pressing START. With PAUSE DISPLAY set and PAUSE HOLD off, the PAUSE key acts just like DISPLAY x. With PAUSE HOLD set as well the program stops and displays. The program is restarted by pressing START.

- CONDITIONAL BRANCHING. The two keys IF x>a and IF x<b may be used for conditional branching. If the comparison is true the program moves to the next step, if it is not the next step is skipped. The SKIP STEP key gives added flexibility.

Numerical Entry

The right hand set of keys are used for numerical entry into the computing counter. Numbers can be entered in floating or fixed point form in the following order: mantissa sign—positive unless ENTER MINUS key is used; mantissa; exponent if necessary by the ENTER PREFIX key followed by the prefix eg, $5\mu = 10^{-6}$.

Operation Modes

Man—The keyboard is in the manual mode of operation. Operations are performed and the result displayed with each keystroke.

Learn—Enables access to the keyboard's memory. A program may be entered by pressing the appropriate keys. All operations may be programmed into memory except the number numerical entry keys.

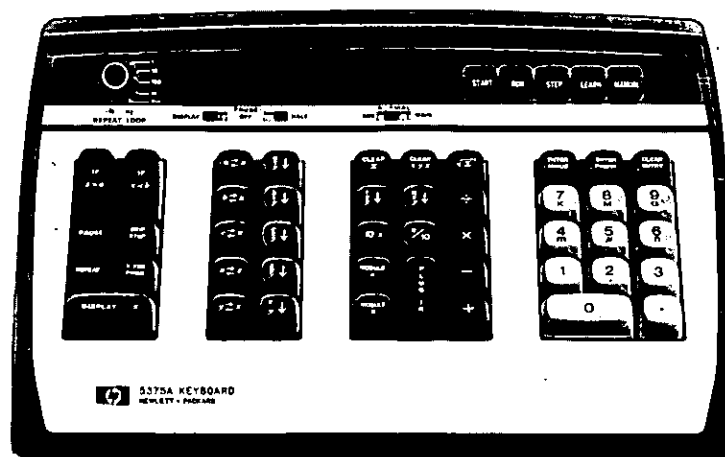
Run—Allows cycling of program from LEARN mode (momentarily depressing START button initiates cycling).

Step—Steps through a program one step at a time each time START is pressed. The results of each operation are displayed. This key is therefore used as a program check device.

Dimensions: height $3\frac{3}{4}$ ", width $11\frac{1}{2}$ ", depth 9 inches.

Weight: net 10 lb (4,5 kg); shipping 15 lb (6,8 kg).

Price: Model 5375A, \$1350.



5375A

ELECTRONIC COUNTERS

50 MHz and 150 MHz plug-in counters

5245 Series



FREQUENCY COUNTERS

Hewlett-Packard's most accurate and versatile counters—and the plug-ins that go with them—are described on the next 17 pages. All counter models have been developed

from HP's 5245L—the industry standard for quality since its introduction in 1961.

For your convenience in comparing these instruments, a summary of the various counters is given below.

Comparison and Summary of 50 and 150 MHz Counters (Models 5245-46-48)						
Model	5245L M54-5245L (pp. 584, 589)	5248L M54-5248L (pp. 587, 589)	5248M M54-5248M (pp. 587, 589)	5245M M54-5245M (pp. 584, 589)	5246L (p. 590)	
Basic measurement range	0-50 MHz	0-150 MHz		0-50 MHz	0-50 MHz	
Digits in readout	8				6 (7 or 8 optional)	
Measurement Functions F=freq., S=input scaling, R=ratio, P=period, M=multiple	F, P, R, MP, MR, S				F, R, MR	
Time base aging rate	$<3 \times 10^{-9}/24$ hours		$<5 \times 10^{-10}/24$ hours		$<2 \times 10^{-7}/\text{mo.}^1$	
Time base warm-up	Normal		Rapid		Room Temp. xtal ¹	
Input impedance	1 M Ω /25 pF				1 M Ω /25 pF	
Gate times	1 μ s-10 s				1 μ s-1 s	
Time base outputs (in decade steps)	0.1 Hz-10 MHz		0.1 Hz-10 MHz, fixed 5 MHz ²		Fixed 1 MHz (10 MHz special order)	
BCD output	Yes				Optional	
Remote programming	Optional				Not available	
Input coupling	ac or dc				ac or dc	
Input attenuator	Yes				No	
Trigger level adjustment	Yes				No	
Freq. ratio measurement (f_1/f_2); range, sensitivity, input resistance	f_1	0-50 MHz	0-150 MHz, 0.1 V, 1 M Ω		0-50 MHz	0-50 MHz, 0.1 V, 1 M Ω
	f_2	0-1 MHz, 0.1 V, 1 M Ω				100 Hz-1 MHz, 1 V, 500 Ω
Compatible 5245 series plug-ins	All (on pages 591-597)				All ³ (on pages 591-597)	
Price	5245L: \$2480 M54-5245L: on request	5248L: \$2900 M54-5248L: on request	5248M: \$3300 M54-5248M: on request	5245M: \$3100 M54-5245M: on request	\$1800	

¹ Oven enclosed crystal ($<3 \times 10^{-9}$ /day aging rate) optional.

² 5 MHz output has high spectral purity; 5×10^{-11} (rms for 1 s averaging time) short term stability; is available whenever counter is connected to ac line.

³ Six digits restricts time interval range to 10^6 s (7, 8-digits optional). In 5246L, Preset Unit 5264A will only multiply and divide frequencies by N and preset count.

FREQUENCY COUNTERS



ELECTRONIC COUNTERS

Versatile 50 MHz plug-in counters

Models 5245L, 5245M

Advantages:

- Accepts plug-ins for wide variety of measurements
- High input impedance on all ranges
- Ac or dc coupling
- Two-mode trigger level control
- Readout storage; BCD output
- Ultra-stable time base in 5245M

These solid-state counters, which are identical except for their internal time bases, measure frequency, period, multiple period average, ratio, and multiple ratio. They can also be used to scale (divide) a frequency by decades. Plug-ins, which go directly into the front panel, extend frequency measurements to 18 GHz, permit time interval measurements, and will perform a variety of other functions. The basic counters (without plug-ins) offer a counting rate of 50 MHz with 8-digit resolution.

Ultra-stable time base

Several years ago the time base oscillator in the 5245L, with its $< 3 \times 10^{-9}$ /day aging rate, represented the state of the art in counter time bases, and it still serves as a secondary frequency standard in many applications today. But recently HP developed a compact, ultra-stable, rapid warm-up time base for use where even better performance is required. This new time base is installed in Model 5245M.

Compared to standard electronic counter time bases available previously, the 5245M's ultra-stable 5 MHz oscillator has a significantly better short-term stability ($< 5 \times 10^{-11}$ rms for 1 s averaging) and long-term stability ($< 5 \times 10^{-10}$ /day aging rate), and significantly less frequency change due to variations in line voltage, external load and temperature. The time base has rapid warm-up, excellent spectral purity, and the same usefulness as costly secondary frequency standards. These advancements mean greater precision, lower investment for counter calibration equipment, and greater versatility because of excellent performance and convenience when employed as a secondary frequency standard. The very low aging rate of the ultra-stable oscillator extends the time between calibrations, thereby keeping the counter in use

longer and reducing the time and money spent on calibration.

For maximum accuracy, the 5245M's time base is kept energized as long as the counter power cord is plugged into an energized power receptacle, whether the front panel switch is ON or OFF. The counter has a separate, internal, regulated power supply to permit operation of the oscillator when the remainder of the counter is turned off. The 5 MHz time base output is usable while the counter is being used for measurements.

Display storage

Both models have readout storage, which provides a continuous display of the most recent measurement. This display is held even while the instrument is gated for a new count. If the new count differs from the stored count, the display will shift to the new reading directly. Storage can be disabled.

Sample rate

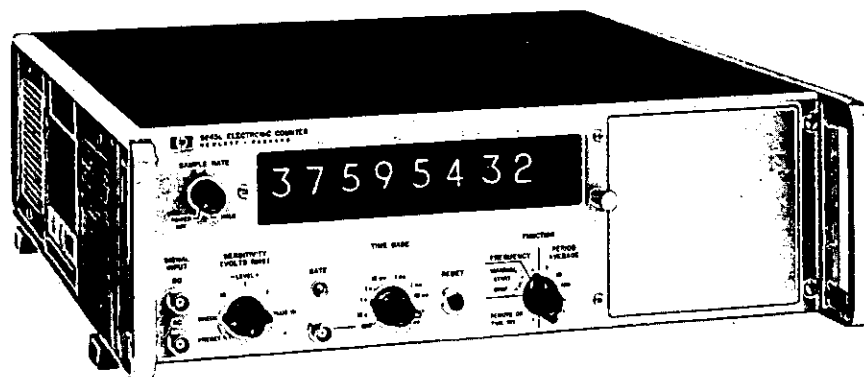
A sample rate control is provided which determines the length of time following the gate closure during which the gate may not be reopened. When the Function Selector is set to Frequency, the Sample Rate adjusts the time between gates from less than 0.2 sec. to at least 5 seconds and is independent of gate time. The control may also be set to hold a display indefinitely.

Input amplifier

A dual FET input amplifier provides 1 meg/25 pF input impedance, independent of attenuator setting and frequency up to 50 MHz. Therefore, one needs not be concerned about input impedance changes affecting the signal source when the input attenuator switch is rotated. Also, low VSWR is more easily attainable. High impedance probes (e.g., HP 10000 Series) may be directly connected to the input and used in the same manner as with high frequency oscilloscopes.

Basic counter operation

The 5245L/M (without plug-ins) measure frequencies and repetition rates of periodic or random pulses from 0 to



5245L

50 MHz. Gate times from 1 μ s to 10 seconds are selected with a front panel switch. Multiple period and multiple averaging ratio to 10^5 periods is obtained without need for a separate plug-in. This capability makes possible accurate frequency determination at low and intermediate frequencies. The increase in accuracy over that possible in single period or ratio is a direct result of division of the trigger error by the averaging factor, as well as the result of increased resolution. Ratios of frequencies that are almost identical can be accurately resolved.

The basic counter will also scale (divide) an input frequency as high as 50 MHz in decade steps by factors up to 10^9 . For example a 14 MHz signal can be divided to 0.014 Hz. A rear panel BNC connector and switch provide a choice of nine output frequencies.

Specifications, 5245L, 5245M

Frequency measurements

Range: dc coupled, 0 to 50 MHz; ac coupled, 25 Hz to 50 MHz (typical response of input amplifier $< \pm 1$ dB over entire range).

Gate time: 1 μ s to 10 seconds in decade steps.

Accuracy: ± 1 count \pm time base accuracy.

Readout: kHz or MHz with positioned decimal point; units annunciator in line with digital display.

Self-check: counts 10 MHz for the gate time chosen.

Period average measurements

Range: Single Period 0 to 1 MHz.
Multiple Period 0 to 300 kHz.

Periods averaged: 1 period to 10^5 periods in decade steps;

Frequency counted:

1 and 10 Period 1 Hz to 10 MHz in decade steps.
100 Period 10 Hz to 10 MHz.
1,000 Period 100 Hz to 10 MHz.
10,000 Period 1 kHz to 10 MHz.
100,000 Period 10 kHz to 10 MHz.

Accuracy: ± 1 count \pm time base accuracy \pm trigger error.*

Readout: s, ms, or μ s, with positioned decimal point; units annunciator in line with digital display.

Self-check: checks operation from 1 period to 10^5 periods.

Ratio measurements

Displays: (f_1/f_2) times period multiplier; multiplier: $1 \cdot 10^5$.

Range: f_1 : 0 to 50 MHz. f_2 : 0 to 1 MHz in single ratio, 0 to 300 kHz in multiple ratio; ratios averaged 1 to 10^5 in decade steps.

Sensitivity: 0.1 V rms, each input (max).

Accuracy: ± 1 count of $f_1 \pm$ trigger error* of f_2 . f_1 is applied to the decimal counters (enters "Ext." jack on front panel); f_2 is applied to decade dividers (enters Signal Input jack).

Readout: dimensionless; decimal point positioned for number of periods averaged.

Self-check: Period Average Self-check applies.

Scaling

Frequency range: 0 to 50 MHz.

Factor: by decades up to 10^9 , switch selected on rear panel. For $\div 2$, $\div 4$, $\div 8$, add HP 5252A Prescaler.

Input: front panel, Signal Input jack.

Output: in place of time base output frequencies.

General

Display: 8 digits in-line with rectangular Nixie® tubes; 99,999,999 maximum display; total width of display including units annunciator and auto-positioned decimal point indication does not exceed 7 inches.

Display storage: holds reading between samples; rear panel switch overrides storage.

Sample rate: time following a gate closing during which the gate may not be reopened is variable from < 0.2 s to 5 s in Frequency mode, independent of gate time; display can be held indefinitely.

*See bottom page 586; ® Burroughs Corporation.

Input signal triggering

Models 5245L and M have a front panel trigger level control with both preset and adjustable modes. In PRESET, trigger level is optimum for signals which are symmetrical about ground; it is useful for most applications, and is automatically selected when plug-ins are used (without moving the TRIGGER control to PRESET). In ADJUSTABLE, the control can be rotated for counting positive or negative pulses, or for unusual signal conditions.

Electrical readout and remote control

Four-line BCD code output is provided and is suitable for systems use or for output devices, such as Model 562A or 5050B Digital Recorder, and Model 580A or 581A Digital to Analog Converter. Other codes and remote control of front panel switches are optional.



Signal input

Maximum sensitivity: 100 mV rms.

Coupling: ac or dc, separate BNC connectors. AC coupling has 600 V dc, 0.022 μ F capacitor (-3 dB at approx. 7 Hz).

Impedance: 1 M Ω in parallel with approx. 25 pF, all ranges.

Attenuation: step attenuator (SENSITIVITY switch) provides nominal sensitivities of 0.1, 1, and 10 V rms.

Trigger level adjustment (min.): front panel control has ± 0.3 V trigger level range on 0.1 V position, ± 3 V range on 1 V position, ± 30 V range on 10 V position. A PRESET position automatically centers trigger level at 0 V.

Overload protection: diodes protect input circuit for up to 120 V rms (< 500 Hz) on 0.1 V range, 240 V rms on 1 V range, 500 V rms on 10 V range. Input resistance for overload conditions (input amplitude $>$ ten times SENSITIVITY) is 100 k Ω on 0.1 V range, and is approximately 1 M Ω on other ranges.

Pulse measurements: front panel TRIGGER LEVEL adjustment allows counting positive or negative pulses.

External input (selected by front panel Time Base switch):

Maximum sensitivity: 100 mV rms.

Impedance: 1 M Ω , approx. 20 pF, dc coupled.

Overload: diodes protect input circuit up to 120 V rms (< 500 Hz).

Digital output: 4-line BCD 4-2-2-1, "1" state positive; includes decimal point and measurement unit. 8-4-2-1 available as Option 002 ("1" state positive) and Option 003 ("1" state negative); digits only (see J35- and J36-options below).

"0" STATE LEVEL: -8 V. "1" STATE LEVEL: $+18$ V.

Impedance: 100 k Ω , each line.

BCD reference levels: approximately $+9.5$ V, 350 Ω source; approximately -1 v, 1000 Ω source.

Print command: $+13$ V to 0 V step; dc-coupled.

Hold-off requirement: $+15$ V min., $+25$ V max. from chassis ground (1000 Ω source).

Cable connector: Amphenol 50-pin 57-30500-375, HP Part No. 1251-0086, 1 required.

Operating temperature range: -20°C to $+65^\circ\text{C}$.

Power supply: 115 or 230 volts $\pm 10\%$; 50 to 60 Hz; 95 watts. (5245M only: 150 W maximum during approximately first 2 minutes after power line is energized.) 50 to 400 or 1000 Hz operation, price on request.

Weight: net, 32 lbs (14.4 kg) with blank plug-in panel. shipping, 40 lbs (18.2 kg).

Connectors: BNC (except remote program and BCD out).

Accessories furnished: 10503A Cable, 4 ft. (120 cm) long, male BNC connectors. Detachable power cord, 7½ ft. (200 cm) long, NEMA plug. Circuit Board Extender, rack mount conversion parts.

Dimensions: 5¼" high, 16¾" wide, 16¾" deep (133 x 425 x 416 mm).

FREQUENCY COUNTERS *continued*

Versatile 50 MHz plug-in counters Models 5245L, 5245M

Prices: Model 5245L, \$2,480.00.
Model 5245M, \$3,100.00.

Optional and special features

Option 002. 4-line BCD 8-4-2-1, "1" state positive (for digits only) in lieu of 4-2-2-1 (identical in other respects to above specifications), add \$10.00.

Option 003. 4-line BCD 8-4-2-1, "1" state negative (for digits only) in lieu of 4-2-2-1 (identical in other respects to above specifications), add \$10.00.

J35-5245L/M: similar to Option 002, except has 8-4-2-1 output, "1" state positive for measurement units and decimal point as well as digits. (Note: M47-562A and 5050B Option 001 Printers are especially suitable for J35-5245L/M.)

Prices: on request.

J36-5245L/M: similar to Option 003, except has 8-4-2-1 output, "1" state negative for measurement units and decimal point as well as digits. (Note: P64-562A and 5050B Option 002 Printers are especially suitable for J36-5245L/M.)

Prices: on request.

Electromagnetic compatibility: Models H60-5245L/M meet the requirements of military specification MIL-I-6181D. (Plug-in model numbers must also be prefixed H60.)

Prices: available on request.

Remote operation: all functions which may be controlled from the front panel controls (in normal use) may be programmed from a remote location except for the "Sample Rate" (as defined above) and the sensitivity and trigger control setting. Mating half of the control connectors (2 required) is Amphenol 36 pin 57-30360.

Prices: H65-5245 L/M, available on request;

M07-5245L/M: have "GHz" added to readout and are controlled from 5260A Option 002 Automatic Frequency Divider. Readout is inhibited when 5260A "searches." All remote capabilities of Option H65-5245L/M are included (see above.)

Prices: available on request.

Time Base, Model 5245L	Time Base, Model 5245M
<p>Crystal frequency (internal): 1 MHz.</p> <p>Stability</p> <p>Aging rate: <3 parts in 10^9 per 24 hours.**</p> <p>Short term: <2 parts in 10^{10} rms with measurement averaging time of one second under constant environmental and line voltage conditions.</p> <p>Temperature: <2 parts in 10^{10} per °C from -20°C to +55°C.</p> <p>Line voltage: <±5 parts in 10^{10} for 10% change in line voltage from 115 V or 230 V rms.</p> <p>Adjustment: fine frequency adjustment (range approximately 4×10^{-8}) and medium frequency adjustment (range approximately 1×10^{-6}) are available from the front panel through the plug-in hole. Coarse frequency adjustment (range approximately 1×10^{-3}) is available at the rear of the instrument.</p> <p>Output frequencies</p> <ol style="list-style-type: none"> At rear panel: 0.1 Hz to 10 MHz in decade steps, selected by rear panel switch. All frequencies available in manual function without interruption at reset except 100 Hz, 10 Hz, 1 Hz, and 0.1 Hz which are interrupted by manual reset; 10 kHz to 10 MHz available continuously in all functions; 1 kHz available continuously for all functions except 10^5 period average; stability same as internal time base. Output is: 5 volts p-p rectangular wave with 1000 Ω source impedance at 1 MHz and lower; 1 V rms sine wave with 1000 Ω source impedance only at 10 MHz. At front panel: 0.1 Hz to 1 MHz in decade steps; available at "Ext." jack, selected by Time Base switch; availability same as in paragraph 1 (above); stability same as internal time base; 1 V peak-to-peak. <p>External standard frequency: 1 MHz, 1 V rms into 1000 Ω. Can be substituted for internal time base via rear panel EXT. STD. FREQ. connector.</p>	<p>Crystal frequency (internal): 5 MHz.</p> <p>Stability</p> <p>Aging rate: <5 parts in 10^{10} per 24 hours after warm-up.**</p> <p>Short term (rms fractional frequency deviation): better than 5 parts in 10^{11} for 1 second averaging time.</p> <p>Temperature: <5 parts in 10^{11}/°C from 0°C to 50°C (<2.5 parts in 10^9 within the entire span of 0°C to 50°C).</p> <p>Line voltage: <±1 part in 10^{10} for 10% change in line voltage from 115 V or 230 V rms.</p> <p>Load stability: typically <±2 parts in 10^{11} for any of the following loads: open, short, 50 Ω resistive, 50 Ω inductive, 50 Ω capacitive.</p> <p>Warm-up: for "off" periods up to approximately 24 hours: 1 hour typical to reach 5 parts in 10^9 of the frequency that existed when turned off. The 5 MHz crystal oscillator operates whenever the power cord is connected.</p> <p>Adjustment: fine frequency adjustment, range approx. 5×10^{-8}, 16-turn control accessible through plug-in accessory compartment in front panel. Coarse frequency adjustment, range approx. 1×10^{-6}, 20-turn control at rear panel.</p> <p>Output frequencies</p> <ol style="list-style-type: none"> At rear panel: 5 MHz sine wave. 1 V rms into 50 Ω. Available at all times whenever power line cord is energized, whether front panel power switch is ON or OFF. Stability is as defined above. Signal-to-Noise Ratio typically >87 dB below rated output. Harmonic Distortion typically >40 dB below rated output. Non-harmonic components typically >80 dB below rated output. At rear panel: 0.1 Hz to 10 MHz in decade steps; switch selected on rear panel; all frequencies available in manual function without interruption at reset except 100 Hz, 10 Hz, 1 Hz, and 0.1 Hz which are interrupted by manual reset; 10 kHz to 10 MHz available continuously in all functions; 1 kHz available continuously for all functions except 10^5 period average; stability same as internal time base; 5 V p-p rectangular wave with 1000 Ω source impedance at 1 MHz and lower; 1 V rms sine wave with 1000 Ω source impedance only at 10 MHz. At front panel: 0.1 Hz to 1 MHz in decade steps; available at "Ext." jack, selected by Time Base switch; availability same as in paragraph 2 (above); stability same as internal time base; 1 V peak-to-peak. <p>External standard frequency: 5 or 10 MHz, 1 V rms, into 1000 Ω. Can be substituted for internal time base via rear panel EXT. STD. FREQ. connector.</p>

*Trigger error is <±0.3% of one period + periods averaged for signals with 40 dB or better signal-to-noise ratio, and 100 mV rms amplitude; error decreases as signal-to-noise ratio and input level increase.

**Up to 72 hours continuous operation may be required to reach this aging rate after transportation or lengthy "off" periods.

ELECTRONIC COUNTERS

New 150 MHz plug-in counters
Models 5248L, 5248M



FREQUENCY COUNTERS

Advantages:

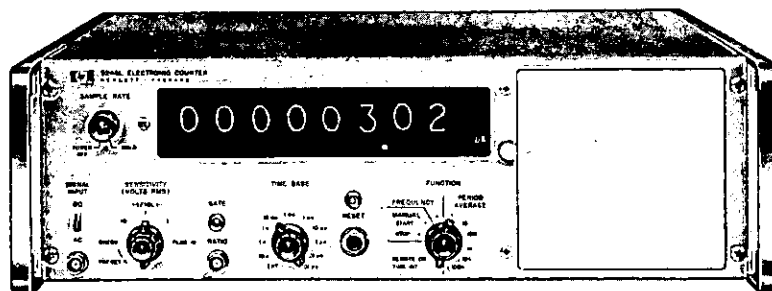
- 0-150 MHz basic ranges
- Ultra-stable time base in 5248M
- Accept all plug-ins for 5245 Series

These new counters have the accuracy, plug-in accessory versatility and field-proven circuitry of the 5245L and M, and also introduce several additional major features. The most important additions are extension of the basic frequency range to 150 MHz; period measurement resolution of 10 ns; and, with the new HP 5267A Time Interval plug-in, time interval resolution of 10 ns.

Except for time base characteristics, the 5248L and M are

identical. The 5248M, like the 5245M, has a rapid warm-up, ultra-stable (<5 parts in 10^{10} per day aging rate) time base having a high degree of spectral purity. Its performance rivals that of many high-quality quartz oscillators now being used as secondary frequency standards. The 5248L has the same excellent time base used in the 5245L with an aging rate of <3 parts in 10^9 per day.

Another notable feature of the 5248L/M counters is their single input connector for both ac and dc coupling. A front panel switch selects the desired coupling. Also, scaling can be performed on input signals as high as 150 MHz by decades up to 10^9 . Minimum sample time is ≈ 0.05 s.



5248L, 5248M

Specifications

Frequency measurement

Range: dc coupled, 0 to 150 MHz.
ac coupled, 25 Hz to 150 MHz (typical response of input amplifier ± 1 dB over entire range.)

Gate time: 1 μ s to 10 seconds in decade steps.

Accuracy: ± 1 count \pm time base accuracy.

Readout: kHz or MHz with positioned decimal point; units annunciator in line with digital display.

Self-check: counts 100 MHz for the gate time chosen.

Period average measurements

Range: single period 0 to 1 MHz
multiple period 0 to 300 kHz

Periods averaged: 1 period to 10^5 periods in decade steps.

Frequency counted:

1 and 10 Period 1 Hz to 100 MHz in decade steps
100 Period 10 Hz to 100 MHz
1,000 Period 100 Hz to 100 MHz
10,000 Period 1 kHz to 100 MHz
100,000 Period 10 kHz to 100 MHz

Accuracy: ± 1 count \pm time base accuracy \pm trigger error.*

Readout: s, ms, μ s, with positioned decimal point; units annunciator in line with digital display.

Self-check: checks operation from 1 period to 10^5 periods.

Ratio measurements

Displays: (f_1/f_2) times period multiplier; multiplier: $1 \cdot 10^5$.

Range: f_1 : 0 to 150 MHz. f_2 : 0 to 1 MHz in single ratio, 0 to 300 kHz in multiple ratio; ratios averaged 1 to 10^5 in decade steps.

Sensitivity: 0.1 V rms, each input (max).

Accuracy: ± 1 count of f_1 , \pm trigger error* of f_2 . f_2 is applied to

the decade dividers (enters ratio jack on front panel), f_1 is frequency applied to decimal counters (enters Signal Input jack).

Readout: dimensionless; decimal point positioned for number of periods averaged.

Self-check: period average self-check applies.

Scaling

Frequency range: 0 to 150 MHz, 10^2 to 10^9 (50 MHz max., for ± 10 step only).

Factor: by decades up to 10^9 , switch selected on rear panel. For $\div 2$, $\div 4$, $\div 8$, add HP 5252A Prescaler.

Input: front panel, Signal Input.

Output: in place of time base output frequencies.

General

Display: 8 digits in-line with rectangular Nixie® tubes; 99,999,999 max. display; total width of display including units annunciator and auto-positioned decimal point indication does not exceed 7 inches.

Display storage: holds reading between samples; rear panel switch overrides storage.

Sample rate: time following a gate closing during which the gate may not be reopened is variable from less than 0.05 s to 2 s in Frequency mode, independent of gate time; display can be held indefinitely.

Signal input

Maximum sensitivity: 100 mV rms.

Coupling: ac or dc, selected by front panel switch. Ac coupling has 600 V dc, 0.022 μ F capacitor (-3 dB at approx. 7 Hz).

Impedance: 1 meg. parallel with approx. 25 pF, all ranges.

*See bottom page 586; © Burroughs Corporation.

FREQUENCY COUNTERS *continued***Period measurement resolution of ions**

Attenuation: step attenuator (SENSITIVITY switch) provides nominal sensitivities of 0.1, 1, and 10 V rms.

Trigger level adjustment (min.): front panel control has ± 0.3 V trigger level range on 0.1 V position, ± 3 V range on 1 V position, ± 30 V range on 10 V position. A PRESET position automatically centers trigger level at 0 V.

Overload protection: diodes protect input circuit for up to 120 V rms (< 500 Hz) on 0.1 V range, 250 V rms on 1 V range, 500 V rms on 10 V range. Input resistance for overload conditions (input amplitude $>$ ten times SENSITIVITY) is 100 k Ω on 0.1 V range, and is approximately 1 M Ω on other ranges.

Pulse measurements: front panel TRIGGER LEVEL adjustment allows counting positive or negative pulses.

Ratio input (front panel):

Maximum sensitivity: 100 mV rms.

Impedance: 1 M Ω , approx. 20 pF, dc coupled.

Overload: diodes protect input ckt. up to 120 V rms.

Digital output: 4-line BCD 8-4-2-1, "1" state positive; includes decimal point and measurement unit. "0" STATE LEVEL: -8 V. "1" STATE LEVEL: $+18$ V. For "1" state negative, order Option 003; 4-2-2-1, Option 002.

Impedance: 100 k Ω , each line.

BCD reference levels: approximately $+9.5$ V, 350 Ω source; approximately -1 V, 1000 Ω source.

Print command: $+13$ V to 0 V step, dc coupled.

Time Base, Model 5248L

Crystal frequency (internal): 1 MHz.

Stability

Aging rate: < 3 parts in 10^9 per 24 hours.**

Short term: < 2 parts in 10^{10} rms with measurement averaging time of one second under constant environment and line voltage conditions.

Temperature: < 2 parts in 10^{10} per $^{\circ}\text{C}$ from -20° to $+55^{\circ}\text{C}$.

Line voltage: $< \pm 5$ parts in 10^{10} for 10% change in line voltage from 115 V or 230 V rms.

Adjustment: fine frequency adjustment (range approximately 4×10^{-9}) and medium frequency adjustment (range approximately 1×10^{-6}) are available from the front panel through the plug-in hole. Coarse frequency adjustment (range approximately 1×10^{-3}) is available at the rear of the instrument.

Output frequencies

At rear panel: 0.1 Hz to 10 MHz in decade steps, switch selected on rear panel. All frequencies available in manual function without interruption at reset except 100 Hz, 10 Hz, 1 Hz, and 0.1 Hz which are interrupted by manual reset; 10 kHz to 10 MHz available continuously in all functions; 1 kHz available continuously for all functions except 10^5 period average; stability same as internal time base. Output is: 5 volts p-p rectangular wave with 1000 Ω source impedance at 1 MHz and lower; 1 V rms sine wave with 1000 Ω source impedance only at 10 MHz. Separate BNC gives 100 MHz sine wave, 100 Ω source.

External standard frequency: 1 MHz, 1 V rms into 1000 Ω . Can be substituted for internal time base via rear panel EXT. STD. FREQ. connector.

Hold-off requirement: $+15$ V min., $+25$ V max. from chassis ground (1000 Ω source).

Cable connector: amphenol 50-pin 57-30500-375, HP part no. 1251-0086, 1 required.

Operating temperature range: -20°C to $+65^{\circ}\text{C}$.

Power supply: 115 or 230 volts $\pm 10\%$, 50 to 60 Hz; 125 watts $\pm 10\%$. (50 to 1000 Hz operation, price on request.)

Weight: net, 31 lbs (14 kg) with blank plug-in panel. shipping, 37 lbs (17 kg).

Connectors: BNC (except remote program and BCD out).

Accessories furnished: 10503A cable, 4 ft. (120 cm) long, male BNC connectors. Detachable power cord, 7 $\frac{1}{2}$ ft. (230 cm) long, NEMA plug. Circuit board extender, rack mount conversion parts.

Dimensions: 5 $\frac{7}{32}$ " high x 16 $\frac{3}{4}$ " wide x 16 $\frac{3}{8}$ " deep (133 x 425 x 416 mm).

Prices: Model 5248L, \$2900.00; Model 5248M, \$3300.00.

Optional and special features (at added cost):

Option 002. 4-line BCD 4-2-2-1, "1" state positive. Add \$25.

Option 003. 4-line BCD 8-4-2-1, "1" state negative, digits only (identical in other respects to above output data). Add \$10.

Electromagnetic compatibility: Option H60-5248L/M meet military specifications MIL-I-6181D. Price on request.

Remote operation: Option H65-5248L/M, same as "Remote Operation" in 5245L/M specs. Price on request.

Option M07-5248L/M: same as Option M07-5245L/M. Price on request.

Time Base, Model 5248M

Crystal frequency (internal): 5 MHz.

Stability

Aging rate: < 5 parts in 10^{10} per 24 hours after warm-up.**

Short term (rms fractional frequency deviation): better than 5 parts in 10^{11} for 1 second averaging time.

Temperature: < 5 parts in $10^{11}/^{\circ}\text{C}$ from 0°C to 50°C (< 2.5 parts in 10^9 within the entire span of 0°C to 50°C).

Line voltage: $< \pm 1$ part in 10^{10} for 10% change in line voltage from 115 V or 230 V rms.

Load stability: typically $< \pm 2$ parts in 10^{11} for any of the following loads: open, short, 50 Ω resistive, 50 Ω inductive, 50 Ω capacitive.

Warm-up: for "off" periods up to approximately 24 hours: 1 hour typical to reach 5 parts in 10^9 of the frequency that existed when turned off. The 5 MHz crystal oscillator operates whenever the power cord is connected.

Adjustment: fine frequency adjustment, range approx. 5×10^{-8} , 16-turn control accessible through plug-in accessory compartment in front panel. Coarse frequency adjustment, range approx. 1×10^{-6} , 20-turn control at rear panel.

Output frequencies

1. **At rear panel:** 5 MHz sine wave. 1 V rms into 50 Ω . Available at all times whenever power line cord is energized, whether front panel power switch is ON or OFF. Stability is as defined above. Signal-to-Noise Ratio typically > 87 dB below rated output. Harmonic Distortion typically > 40 dB below rated output. Non-harmonic Components typically > 80 dB below rated output.

2. **At rear panel:** 0.1 Hz to 10 MHz in decade steps; switch selected on rear panel; all frequencies available in manual function without interruption at reset except 100 Hz, 10 Hz, 1 Hz, and 0.1 Hz which are interrupted by manual reset; 10 kHz to 10 MHz available continuously in all functions; 1 kHz available continuously for all functions except 10^5 period average; stability same as internal time base; 5 V p-p rectangular wave with 1000 Ω source impedance at 1 MHz and lower; 1 V rms sine wave with 1000 Ω source impedance only at 10 MHz. Separate BNC gives 100 MHz sine wave, 100 Ω source.

External standard frequency: 5 or 10 MHz, 1 V rms, into 1000 Ω . Can be substituted for internal time base via rear panel EXT. STD. FREQ. connector.

*Trigger error is $< (\pm 0.3\% \text{ of one period} \pm \text{periods averaged})$ for signals with 40 dB or better signal-to-noise ratio, and 100 mV rms amplitude; error decreases as signal-to-noise ratio and input level increase.

® Burroughs Corporation.

**Up to 72 hours continuous operation may be required to reach this aging rate after transportation or lengthy "off" periods.

ELECTRONIC COUNTER

High performance, plug-in, dc to 50 MHz operation
Models M54-5245L/M M54-5248L/M



FREQUENCY COUNTERS

Advantages:

- New enclosure meets MIL specification for RFI and drip proofing
- Operationally identical to 5245L/M, and 5248L/M Counters
- Meets MIL-specification for temperature, humidity, vibration, shock, altitude
- Easily carried and handled

Functional performance and operating specifications of the M54-5245L, M54-5245M, M54-5248L, and M54-5248M are identical to the 5245L, 5245M, 5248L, and 5248M, respectively, as described on pages 584 to 588. Frequency range can be extended to 18 GHz by using plug-in units, and all of the other plug-in units for the 5245L/M and 5248L/M can be used too. Plug-ins must be ordered with "H60 modification" if they are to meet the military RFI (radio frequency interference or electromagnetic compatibility) specification MIL-I-6181D.

Environmental Specifications

RFI: (MIL-I-6181D) meets all four sections of the specification—limits on radiated and conducted interference generation and on susceptibility to radiated and conducted interference.

Enclosure: meets MIL-STD-108D section on drip proof enclosures.

Operating temperature: operating range of -20°C to $+55^{\circ}\text{C}$, M54-5245L and M54-5248L; -20°C to $+50^{\circ}\text{C}$, M54-5245M and M54-5248M. Meets and exceeds MIL-E-4158C for indoor equipment and MIL-E-16400, Class 4.

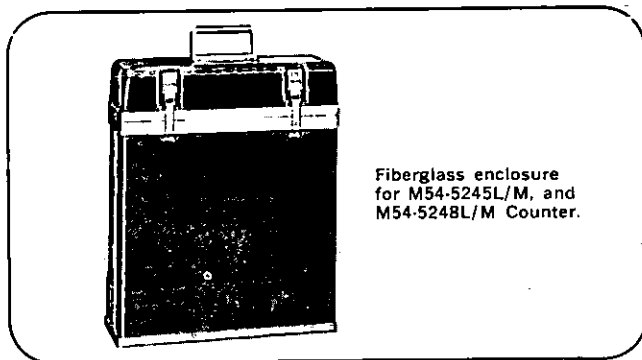
Non-operating temperature: meets all classes of MIL-E-16400F. -62°C to $+85^{\circ}\text{C}$.

Humidity: meets MIL-E-16400F for Class 3 and 4 equipment. 95% RH over operating temperature range.

Vibration: when operating in cabinet configuration, it meets MIL-T-21200 for Class 2 and 3 equipment. 5-15 Hz at 0.06 inch double amplitude. 15-25 Hz at 0.04 inch double amplitude. 25-55 Hz at 0.02 inch double amplitude.

Shock: meets MIL-T-21200F for all classes of equipment. Three impact shocks of 30 G's applied to each of the six sides. Each shock has a duration of 11 ms \pm 1 ms and a half sine wave shape.

The environmental resistance of the already rugged 5245L/M and 5248L/M has been increased in the M54 versions by a tough, fiberglass enclosure. The main improvements are drip proofing and improved RFI specifications. The fiberglass enclosure includes a detachable front panel cover with a conveniently located carrying handle (shown below).



Fiberglass enclosure for M54-5245L/M, and M54-5248L/M Counter.

Operating altitude: operation at 15,000 ft meets and exceeds MIL-E-4158C up to at least $+25^{\circ}\text{C}$ (consult Hewlett-Packard regarding higher temperatures).

Non-operating altitude: exposure to 50,000 ft altitude without ill effect; meets and exceeds MIL-E-4158C. If additional environmental data are needed, please consult Hewlett-Packard.

Operating Specifications

(Except for those listed below, Operating Specifications are same as for the 5245L/M and 5248L/M given in this catalog.)

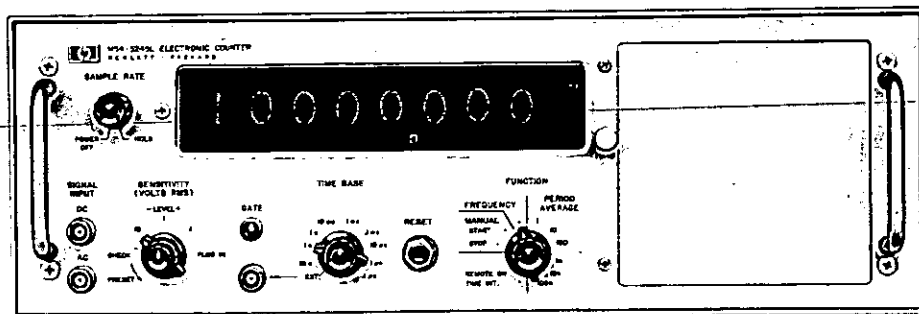
Power supply: 115 or 230 volts \pm 10%, 50 to 400 Hz; 95 watts.

Weight: net, 37 lbs (15,5 kg).

Accessories furnished: fiberglass front panel cover. Detachable power cord, 7½ feet (200 cm) long, NEMA plug.

Dimensions: 5⅞" high, 16-15/16" wide, 16½" deep (14,9 x 43 x 42 cm) without front panel cover; 21⅛" (53,8 cm) deep with front panel cover.

Price: on request.



M54-5245L/M

FREQUENCY COUNTERS



ELECTRONIC COUNTER

Economical 50 MHz plug-in counter
Model 5246L

The 5246L offers the basic 0-50 MHz range, many of the circuit benefits, and plug-in accessory features of the 5245L. Although, in the interest of economy, some of the 5245L capabilities are omitted from the 5246L, versatility can be increased by optional features.

The 5246L has display storage, a 6-digit readout (7 and 8 digits optional), and without any plug-ins will measure frequency and frequency ratio. BCD output and a higher stability ($<3 \times 10^{-9}$ /day) crystal time base are optional. A dual field-effect transistor input amplifier offers almost constant 1 megohm/25 pF input impedance, and HP 10000 Series Probes can be used.

Frequency ratio (f_1/f_2) is measured by connecting signal f_2 (100 Hz to 1 MHz) in place of the counter's time base (BNC at rear), and connecting f_1 (up to 50 MHz) to the SIGNAL INPUT. Multiple ratios can be measured from 10 to 10^6 in decade steps.

Specifications

Frequency measurement,

Range: dc coupled, 0 to 50 MHz.

ac coupled, 25 Hz to 50 MHz (typical response of input amplifier $< \pm 1$ dB over entire range).

Gate time: 1 μ s to 1.0 second in decade steps.

Accuracy: ± 1 count \pm time base accuracy.

Readout: kHz or MHz with positioned decimal point; units annunciator in line with digital display.

Time base

Frequency (internal): 1 MHz.

Stability

Aging rate: less than 2×10^{-7} per month.

Temperature: less than ± 2 parts in 10^6 ($+10^\circ$ to $+50^\circ$ C) ± 2 parts in 10^5 (0° C to 65° C).

Line voltage: less than ± 1 part in 10^3 for 10% change from 115 V or 230 V rms.

Output frequency: 1 MHz, >3 V p-p into 1 k Ω .

External input: sensitivity: 1 volt rms into 500 ohms, 1 kHz to 1 MHz; 2 V rms into 500 Ω , 100 Hz to 1 kHz.

General

Display: 6 digits in-line with rectangular Nixie[®] tubes and display storage: 999,999 max. display.

Display storage: holds reading between samples; rear panel switch overrides storage.

Sample rate: time following a gate closing during which the gate may not be reopened is continuously variable from less than 0.2 s to 5 s in Frequency mode, independent of gate time; display can be held indefinitely.

Signal input

Maximum sensitivity: 100 mV rms.

Coupling: ac or dc, separate BNC connectors. Ac coupling has

600 V dc, 0.022 μ F capacitor (-3 dB at approximately 7 Hz).

Impedance: 1 M Ω shunted by 25 pF.

Overload: diode clamps in series with 100 k Ω and 0.001 μ F protect input circuit for up to 120 V rms (<500 Hz). Input resistance for overload condition (beyond approx. 1 V) is approximately 0.1 M Ω .

Self-check: counts 10 MHz for the gate time chosen by the time base selector switch.

Operating temperature range: 0° C to $+65^\circ$ C.

Power supply: 115 or 230 volts $\pm 10\%$, 50 to 60 Hz; 95 W (50 to 1000 Hz operation, price on request).

Weight: net, 28 lbs (12.8 kg) with blank plug-in. shipping, 36 lbs (16.4 kg).

Accessories furnished: HP 10503A Cable, 4 ft. (120 cm) long, male BNC connectors. Detachable power cord, $7\frac{1}{2}$ ft. (230 cm) long, NEMA plug. Circuit board extender. Rack mount conversion parts.

Dimensions: 5-7/32" high x $16\frac{3}{4}$ " wide x $16\frac{3}{8}$ " deep (133 x 425 x 416 mm).

Price: Model 5246L, \$1800.00.

Options

Option 001: 7 digit readout, \$100.

Option 002: 8 digit readout, \$200.

Option 003: 4-2-2-1 "1" state positive 4-line BCD output. (digits only).

"0" State Level: -8 V.

"1" State Level: $+18$ V.

Impedance: 100 K ohms, each line.

BCD Reference Levels:

Approximately $+9.5$ V, 350 Ω source.

Approximately -1 V, 1000 Ω source.

Print Command: $+13$ V to 0 V step, dc coupled.

Hold-off Requirement: $+15$ V min., $+25$ V max. from chassis ground (1000 Ω source).

Cable Connector: Amphenol 57-30500-375 (HP No. 1251-0086), 1 required.

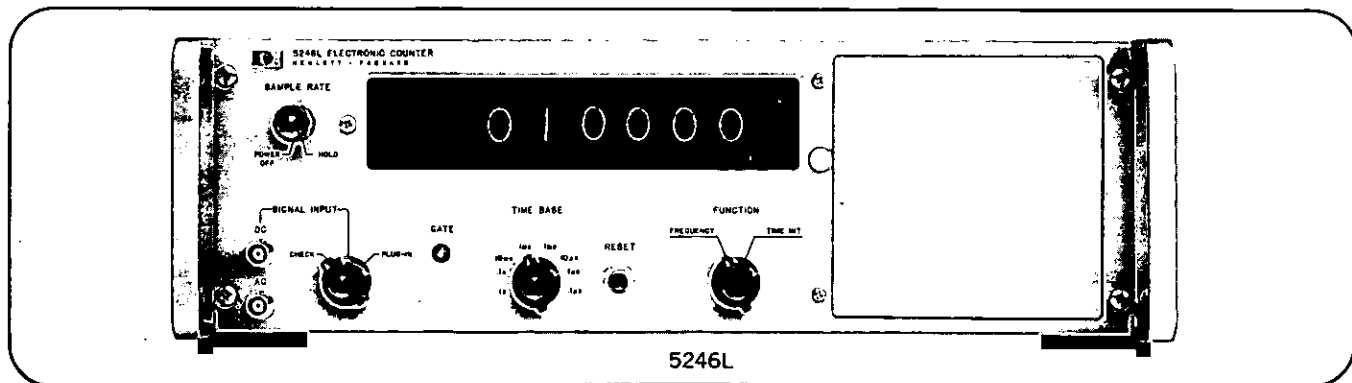
Price: Option 003, \$75.

Option 004: similar to Option 003 except output is 8-4-2-1 "1" state negative 4-line BCD, \$85.

Option 005: similar to Option 003 except output is 8-4-2-1 "1" state positive 4-line BCD, \$85.

Option 006: high-stability time base oscillator. "Stability" specifications for Model 5245L Time Base apply. Also, External input: 1 V rms into 1000 Ω , 1 MHz; (2 V rms, 100 Hz to 1 kHz; 1 V rms, 1 kHz to 1 MHz into 1000 Ω available on special order). External input must be 1 MHz for readout in kHz or MHz. For frequency ratio measurements, external input can be 100 Hz to 1 MHz with the above sensitivities. Frequency and voltage specifications apply for sine wave inputs. Price: Option 006, add \$300.

® Burroughs Corporation



PRESCALER; DIGITAL VOLTMETER

Increase capability of 5245L/M, 5248L/M, 5246L
Models 5252A, 5258A, 5265A



FREQUENCY COUNTERS

5252A Prescaler

The direct-counting frequency of the HP 5245L/M, 5248L/M, 5246L and 5247M Counters is extended to 350 MHz using the Model 5252A Prescaler Plug-in. Prescaling is accomplished with transistor binary dividers which operate over the frequency range dc to 350 MHz. No tuning is required. A trigger level adjustment permits counting when unusual measurement conditions are encountered.

Prescalers divide the input frequency by a factor of 2, 4 or 8, and at the same time adjusting the counter's time base to provide a direct reading in frequency.

Specifications, 5252A*

Operating frequency range: dc to 350 MHz.
Accuracy: same as the basic counter.
Input sensitivity: 100mV rms.
Maximum input: 2 volts, +20 dBm, or 100 mW.
Input impedance: 50 ohms (nominal).
Operating temperature range: -20°C to +55°C.
Scaled output: 100 mV rms into 50 ohms is available at the AUX A BNC connector of the basic counter.
Weight: net 2.2 lb (1 kg); shipping 4 lb (1.8 kg).
Price: Model 5252A, \$685.

5258A Sensitive Prescaler

5258A installation, use and operation are similar to the 5252A. It is also useful as a video amplifier.

Specifications, 5258A*

Operating frequency range: 1 MHz to 200 MHz.
Accuracy: same as the basic counter.
Input sensitivity: 1 mV/10 mV/0.2 V rms as selected by front panel switch.
Resolution: 1 Hz in 4 s, 10 Hz in 0.4 s, etc.
Maximum input: 3 V, +22.5 dBm, or 180 mW.
Input impedance: 50Ω.
Operating temperature range: -20°C to +65°C.
Scaled output: 100 mV rms into 50Ω is available at the Aux A output BNC connector of the basic counter.

Weight: net 5 lb (2,16 kg); shipping 7 lb (3,1 kg).
Price: Model 5258A, \$900.

5265A Digital Voltmeter

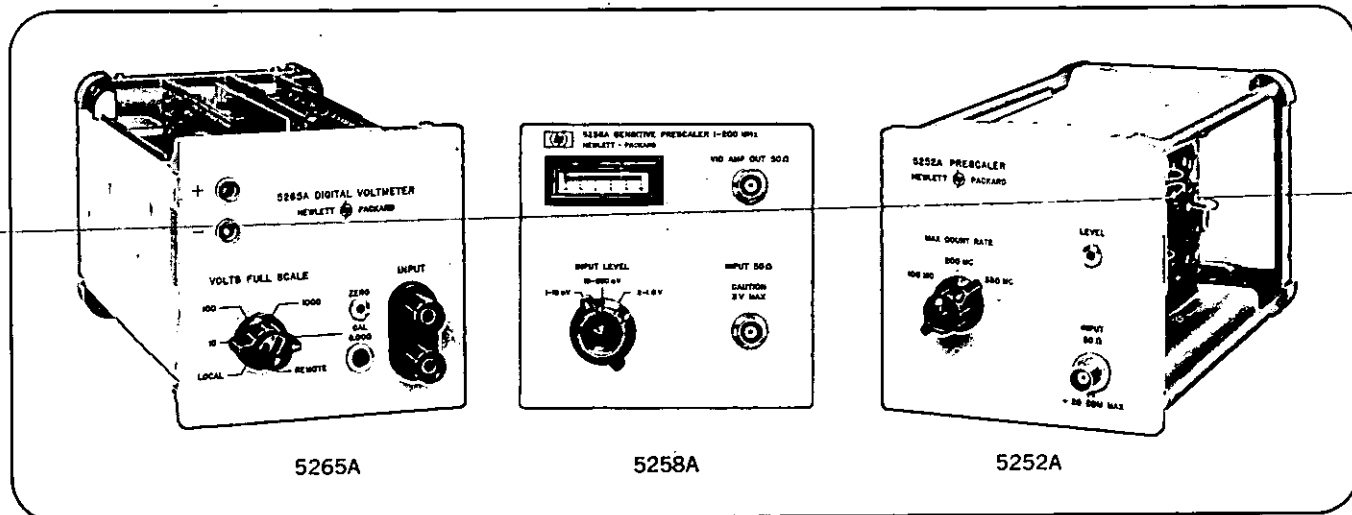
The HP 5265A Digital Voltmeter Plug-in quickly converts your 5245L/M, 5248L/M or 5246L Electronic Counter to an accurate dc digital voltmeter. Operation is straightforward—simply set range switch, connect the voltage to be measured and read.

A Local-Remote switch permits remote selection of the DVM mode or the regular electronic counter functions when used with an H65-5245L/M or H65-5248L/M Counter (remote control option).

Specifications, 5265A**

Voltage range: 6-digit presentation of 10.0000, 100.000, and 1000.00 V full scale with 5% overrange capability.
Registration: on electronic counter.
Reads in: dc volts with decimal point positioned by range switch; automatic polarity indicator.
Accuracy (0° to +50°C): ±0.1% of reading; ±0.01% of fs < 1/10 fs (within 24 hrs and ±10°C temperature change since last front-panel calibration adjustment and within 6 mos. of calibration of internal zener reference).
Range selection: manual.
Sample rate: 5 per second. Has storage.
Input resistance: 10.2 megohms to dc on all ranges.
Input filter:
AC rejection: 30 dB at 60 Hz, increasing at 12 dB per octave.
Response time: less than 450 ms to a step function to within 0.05% of final value.
Accessory furnished: 5060-0630 22-pin extender board.
Weight: net 2½ lb (1,1 kg); shipping 5 lb (2,3 kg).
Price: Model 5265A, \$625.

*When used with HP 5245L (serial prefixed 402 and above) 5245M, 5248L/M, 5247M or 5246L Electronic Counters plus M-54 versions.
**When used with HP 5245L/M, 5248L/M, or 5246L Electronic Counter.



FREQUENCY COUNTERS



FREQ MULT; TIME INT; AMPL
 Measure LF faster; 0.1 μ s reso; 1 mV sensitivity
 Models 5268A, 5262A, 5261A

5268A Frequency Multiplier Plug-In*

By multiplying the input signal frequency the 5268A improves measurement resolution (or increases measurement speed) of HP 5245-46-48 Counters by the multiplication factor used. For example, when measuring 60 Hz over a 1 s interval (gate time) normally the counter would read 60 ± 1 count. Using the 5268A for the same 1 s measurement, the reading becomes 60.000 ± 2 counts. Thus high resolution is obtained without resorting to a period measurement, which requires calculation of the reciprocal to obtain frequency. Alternately the gate time can be reduced to 1 ms and a readout of 60 ± 1 count can be obtained at one-thousandth of the previous gate time. A correct readout at all times is assured; if an input signal is not phase locked to the internal oscillator, the counter reads all zeros and a front panel lamp lights.

Multiplier vs. frequency range: X1 (no multiplier), 5 Hz to 1 MHz; X10, 1 kHz to 100 kHz; X100, 100 Hz to 10 kHz; X1000 (high range), 10 Hz to 1 kHz; X1000 (low range), 5 Hz to 50 Hz.

Signal input: sine wave sensitivity, 100 mV rms. Pulse sensitivity (internal for + or - pulses), 500 mV peak down to 5% duty factor.

Impedance: approx 1 M Ω /35 pF.

Accuracy: X1, X10 ranges: 0 count \pm counter accuracy; X100 range,** ± 1 count \pm counter accuracy; X1000 range (<500 Hz**), ± 1 count \pm counter accuracy; X1000 range (500 Hz to 1 kHz**), ± 2 counts \pm counter accuracy.

Phase lock time constants (typical)

Frequency rate of change vs. phase lock maintainability:
 1 decade per 2 s, >100 Hz. 1 decade per 3 s, 10 Hz to 100 Hz.
 1 decade per 8 s, 5 Hz to 50 Hz.

Lock time after decade step frequency change: 1 s, >100 Hz. 1.5 s, 10 Hz to 100 Hz. 3 s, 5 Hz to 50 Hz.

Operating temperature: 0°C to 50°C.

Weight: net, 2 lb (0.9 kg); shipping, 4.5 lb (2.0 kg).

Price: \$650.

5262A Time Interval Unit*

The economical 5262A permits Hewlett-Packard plug-in counters to make accurate time interval measurements. It measures pulse length, spacing and delays, and it triggers from separate or common signals. START and STOP triggers can be set for + or - input signals from either single or dual input lines (interval between like-polarity events cannot be measured using a single input line; however, the newer 5267A

—see previous page—can accomplish this). Model 5262A may be used as an amplitude discriminator, counting only signals that exceed the trigger level setting. Time is read from the counter with units and decimal point indicated.

Range: 1 μ s to 10⁸ s (8-digit counter); 1 μ s to 10⁶ s (6-digit counter).

Standard frequency counted: 10⁷ to 1 Hz in decade steps from Hewlett-Packard counter or external frequency.

Accuracy (pulse): ± 1 period of standard frequency counted \pm time base accuracy.

Registration: on electronic counter.

Input voltage: 0.3 volt, p-p, minimum, direct-coupled input.

Input impedance: 10 k Ω /80 pF to 10 M Ω /20 pF depending upon multiplier setting.

Trigger slope: + and - on both channels, independently selected.

Trigger amplitude: both channels adjustable, -250 to +250 V.

Frequency range: 0 to above 2 MHz when used as input signal discriminator.

Markers: (HP 5245L/M, 5248L/M only) separate output steps, 0.5 V p-p from source of approx 7 k Ω /100 pF; at counter rear with "-" step coincident with trigger points on input waveforms for "+" slope and "+" step coincident for "-" slope.

Weight: net 2.5 lb (1.1 kg); shipping 4 lb (1.8 kg).

Price: HP 5262A, \$250.

Model 5263A: similar to 5262A but available only in Europe. Please consult your local European Hewlett-Packard office for details.

5261A Video Amplifier*

Increases sensitivity of Hewlett-Packard plug-in counters to 1 mV from 10 Hz to 50 MHz. Auxiliary 50-ohm output permits monitoring counter input with an oscilloscope.

Input: 10 Hz to 50 MHz, 1 mV to 300 mV rms.

Input impedance: approximately 1 megohm, 15 pF shunt.

Output level meter: shows acceptable signal level.

Accuracy: retains accuracy of electronic counter.

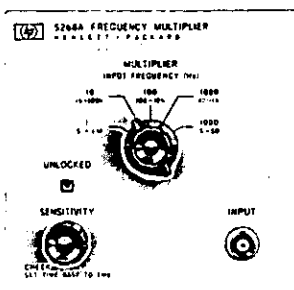
Aux output: front-panel BNC for scope monitor or driving ext equipment; 50 Ω source impedance; on most sensitive attenuator range, 1 mV rms at input gives at least 100 mV at aux output into 50 Ω ; max undistorted output, 300 mV rms, 50 Ω .

Accessories available: 10003A 10:1 probe, 10 pF shunt, 600 V max, \$30; 10100A 50-ohm feed-thru termination, \$15.

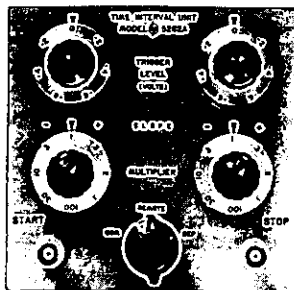
Weight: net 2 lb (0.90 kg); shipping 4 lb (1.8 kg).

Price: HP 5261A, \$325.

*Specs apply only with HP 5245L/M, 5248L/M, M54-5245L/M, 5246L Counters.
 5261A used with 5248L/M, 5247M to 50 MHz only.
 **At 1 s time base.



5268A



5262A



5261A

10 ns TIME INTERVAL UNIT

Highly versatile, 10 ns resolution
Model 5267A



FREQUENCY COUNTERS

Advantages:

- Resolution to 10 ns
- High, constant input impedance
- Versatile trigger controls
- Trigger point markers
- Measure time interval or pulse length, spacing or delay
- Will measure interval between pulses on single or dual inputs

Model 5267A Time Interval Plug-in converts the 150 MHz HP Models 5248L and 5248M Counters into highly versatile, highly accurate time interval counters with a resolution of 10 nanoseconds from 100 ns to 1 s (total range is 10^6 s). Resolution of this order is of special importance in time interval measurements involving projectiles, explosives, shock waves, laser pulses, and other fast phenomena (light travels only 10 feet in 10 nanoseconds). Among other applications, 10 ns resolution is also valuable for measuring pulse length, spacing and delay when calibrating pulse generators, and for measuring cable length using pulse transmission or pulse reflection techniques.

The 5267A will measure the length of or spacing between electrical events regardless of polarity or wave shape; it is not limited to pulse measurements, but will handle sine waves, triangular waves, etc. Measurements are made in a precise straightforward manner, even where the events occur in two different circuits. Steering circuitry in the 5267A permits measuring intervals between the starts of consecutive events, even when the events are of like polarity and occur on a single input line (the older 5262A Plug-in cannot do this).

Time is read directly on the counter with the units and decimal indicated. Since the counted signal is derived from its precise oscillator, counter time base accuracy is retained. High input impedance (constant on all ranges) and high sensitivity permit measurements on high-impedance, low-voltage circuits.

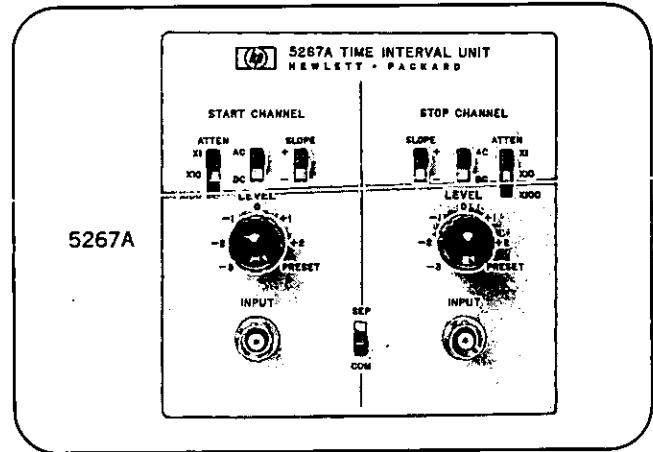
Marker pulses, generated each time the input signal crosses the threshold set by the dual trigger level controls, are available on the rear panel of the counter for oscilloscope intensity (Z-axis) modulation. These marker dots identify the measured interval on the displayed input waveform.

By combining all the above capabilities in one relatively inexpensive plug-in, the 5267A offers a flexibility that was previously unavailable in most special-purpose time interval counters and counter plug-ins.

The 5267A can be also used in HP 5245L or M, M54-5245L or M, and 5246L Counters. It brings all the above features to those models except that the minimum interval is 1 μ s and maximum resolution is 100 ns.

Operation

The count is started by a signal applied to the "Start" channel of the 5267A and is stopped by a signal applied to the "Stop" channel. To ensure maximum versatility in time interval measurement, the 5267A has separate threshold controls for each channel. These controls select the magnitude and polarity of the voltage as well as the slope of the signal required to actuate the channels. In addition, either two separate waveforms or the same waveform can operate the channels since separate input connectors are provided for the "Start" and "Stop" channels. The inputs can be connected together, when preferred, by a front panel SEP-COM switch on the 5267A.



Specifications

Range:

- 100 ns to 10^6 s with HP 5248L or M Counter, or M54 versions.
- 1 μ s to 10^6 s with 5245L, 5245M, M54-5245L or M, or 5243L Counter.
- 1 μ s to 10^6 s with 6-digit 5246L Counter.

Maximum resolution:

- 10 ns for intervals from 100 ns to 1 s with HP 5248L/M or M54 versions; 0.1 μ s for intervals from 1 μ s to 10 s with 5245L, 5245M, M54-5245L or M, 5246L, or 5243L Counter.

Input repetition rate: 5 MHz, max.

Input coupling: ac or dc (front panel switch for each channel).

Standard frequency counted: 100 MHz to 1 Hz* in decade steps from counter or externally applied frequency up to 150 MHz** in HP 5248L or M Counter.

Input sensitivity: 0.3 V p-p (min.) x ATTENUATOR setting.

Input impedance: 1 M Ω /35 pF for peak input voltages up to 3 times the ATTENUATOR setting.

Maximum input:

- 120 V rms for X1 ATTEN. setting.
- 250 V rms for X10 ATTEN. setting.
- 500 V rms for X100 ATTEN. setting.

Accuracy (pulse): ± 1 period of standard frequency counted \pm time base accuracy.

Registration: on counter.

Start-stop: independent or common channels.

Trigger slope: positive or negative on Start and Stop channels, independently selected.

Trigger amplitude: both channels adjustable from -300 to +300 V peak.

Markers: separate output pulses coincident with Start and Stop trigger points on input waveforms; -10 volt amplitude, 0.7 μ s width, from source impedance of approximately 1.5 k Ω ; available at rear panel of counter.

Reads in: μ s, ms, sec, with measurements unit indicated and decimal point positioned.

Accessories furnished: 10503A Cable Assembly, male BNC to male BNC, 48 inches (122 cm) long.

Weight: net, 1.6 lb (710 gms), shipping 3.5 lb (1,6 kg).

Price: Model 5267A, \$400.00.

*10 MHz to 1 Hz in HP 5245L or M, M54-5245L or M, 5246L, or 5243L Counter.
**50 MHz in HP 5245L or M, M54-5245L or M, or 5246L.

FREQUENCY COUNTERS



PRESET UNIT

Normalized readings; div. by N; count N events
Model 5264A

The HP Model 5264A Preset Unit extends the versatility of the time bases of the HP 5245L/M, 5248L/M and 5246L Counters, and the counters retain their basic functions and measurement range. Decade dividers in the preset unit control the counter gate; N may be any integer between 1 and 100,000. The 5264A makes possible the following:

N x frequency measurements: gate time is controlled by the preset decades (N) and the counter's Time Base switch. The gate is held open for N periods of the time base setting.

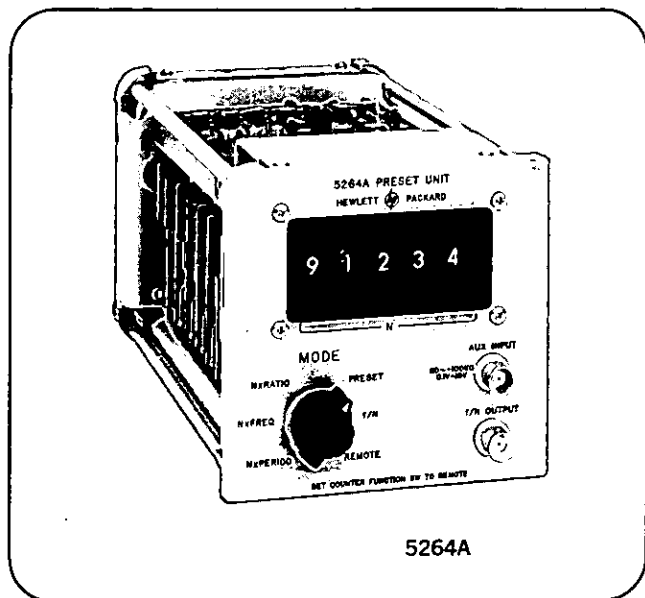
This selectable gate time makes possible normalized readings or conversion of frequencies into practical units. The long gate times that are available (5245L/M and 5248L/M — 10^6 s; 5246L — 10^5 s) permit accurate measurement of low frequencies.

N x period measurements (5245L/M and 5248L/M only): measures the time for N events to occur in increments of 0.1 μ s (5245) or 10 ns (5248) to 10 seconds, depending on the setting of the counter's Time Base switch. Period and multiple period measurements are also easily made. Period average is determined by dividing the time reading by N.

Ratio, N x ratio measurements (5245L/M, 5248L/M only): measures ratio with choice of normalizing factors from 1 to 100,000 in one-digit steps. Counter displays $Nf_1 \div f_2$; f_1 is counted for N periods of f_2 .

Dividing by N: permits division by N of any input frequency up to 100 kHz. The counter's prescaling capability (up to 10^9 in decade steps) allows frequencies as high as 50 MHz in 5245L/M and 150 MHz in 5248L/M to be divided by a five-digit number, provided that the frequency supplied the preset units (from the counter) does not exceed 100 kHz.

Preset Counting: N events are counted. The first event opens the gate; the Nth closes it. This feature is useful in batching, and the gate signal can be used to control external circuitry or relays.



Specifications, 5264A*

N x frequency (counter Signal Input)

Range: 0 to 50 MHz (to 150 MHz in 5248L/M).

Maximum sensitivity: 0.1 V rms.

Input impedance: 1 megohm shunted by 25 pF.

Gate time: (set by counter Time Base and "N" switches)

10 μ s to 1 s in 10 μ s steps

100 μ s to 10 s in 100 μ s steps

1 ms to 100 s in 1 ms steps

10 ms to 10^3 s in 10 ms steps

0.1 s to 10^4 s in 0.1 s steps

1 s to 10^5 s in 1 s steps

†10 s to 10^6 s in 10 s steps

Accuracy: ± 1 count \pm time base accuracy (5245L/M, 5246L)

± 1 count \pm time base accuracy ± 0.02 μ s gate uncertainty (5248L/M).

†N x period (counter signal input)

Input frequency range: 0 Hz to 100 kHz.

Maximum sensitivity: 0.1 V rms.

Input impedance: 1 megohm shunted by 25 pF.

Time units: 0.1 μ s (5245) to 10 s in decade steps or 10 ns (5248).

Accuracy: ± 1 count \pm time base accuracy \pm trigger error.**

†N x ratio

Reads: $N \times f_1/f_2$.

Accuracy: ± 1 count of $f_1 \pm$ trigger error of f_2 .

	5248L/M		5245L/M	
	f1	f2	f1	f2
Freq. range MHz; dc to	150 MHz	100 kHz	50 MHz	100 kHz
Sensitivity V rms	0.1	0.1	0.1	0.1
Input impedance	1 M Ω /25 pF	1 M Ω /20 pF	1 M Ω /20 pF	1 M Ω /25 pF
Connects to counter BNC:	Signal input	Ratio	Ext. Time base	Signal input

Divide by N (5264A Auxiliary Input, f/N mode)

Frequency range: 20 Hz to 100 kHz (sinusoidal).

Sensitivity: 0.1 V rms.

Input impedance: 1 megohm, 50 pF shunt.

Overload: signals in excess of 10 V rms may damage the instrument.

†**Prescaling:** in decade steps to 10^9 of maximum rate of counter; (scaled output frequency ≤ 100 kHz).

Output: 0.2 V peak to peak centered at 0 volts, into high-impedance load; rise time < 1 μ s, duration approximately 5 μ s.

Preset (5264A Auxiliary input)

Input frequency range: 20 Hz to 100 kHz.

Maximum sensitivity: 0.1 V rms.

Input impedance: 1 megohm, 50 pF shunt.

Overload: signals in excess of 10 V rms may damage the instrument.

Preset range: 1 to 99,999 in steps of one.

Weight: net 3lbs (1,4 kg); shipping 5 lbs (2,3 kg).

Accessory furnished: 10503A cable, 4 ft (1220 mm) long, male BNC connectors.

Price: HP 5264A, \$650.

*When used with HP 5245L/M, 5248L/M or HP 5246L Electronic counters, and M54 series. 5245L with serial no. prefix below 402 requires modification.

** Trigger error (sine wave) $< 0.3\%$ of one period + N for ≥ 40 dB signal-to-noise ratio on input signal; trigger error decreases with increased signal amplitude and slope.

†HP 5245L/M or 5248L/M only.

FREQUENCY CONVERTERS

Measure to 18 GHz with counter accuracy
Models 5251A, 5253B, 5254C, 5255A, 5256A



FREQUENCY COUNTERS

Advantages:

- Retains counter accuracy
- Up to 1 Hz resolution in 1 to 4 seconds counter gate time
- Easy to operate—has smooth, backlash-free, spurious-free tuning and a level indicator
- Cover dc to 3 GHz with 1 converter (5254C); to 18 GHz with 3 converters (add 5255A and 5256A).
- Sensitivity is high and relatively constant
- AC coupled input in most models

Frequency converters can increase the range of your 5245L/M, 5248L/M, 5246L or 5247M Counter to 18 GHz for CW signals. The stability and accuracy of the basic counter are retained in these higher frequency measurements because the converters use a multiple of the 10 MHz signal from the electronic counter crystal oscillator to beat with the signal to be measured. Operation of the equipment is simple and convenient permitting non-technical personnel to make frequency measurements up to 18 GHz quickly and accurately.

The basic measurement ranges of the counter are retained with the converter installed. Measurements to 50 or 150 MHz are obtained simply by moving the counter Sensitivity control off the "plug-in" position and connecting the input signal directly to the counter input.

The AC coupled inputs of the 5251A, 5253B, and 5254C prevent DC voltages which may be present along with the signal from affecting the measurement sensitivity or damaging the mixer circuits in the converter. The higher frequency AC coupled converters (5253B and 5254C) are unique in that the AC coupling is integrated into the input circuit, so it behaves as a transmission line with good VSWR; this results in relatively constant impedance (and converter sensitivity) over the entire frequency range. Thus, performance of these higher frequency converters is better than if AC coupling were achieved by simply using a series capacitor. VSWRs of the 5255A and 5256A are also excellent.

Models 5253B, 5254C, 5255A, and 5256A are cavity-tuned. Since constant bandwidth cavities are used, tuning peaks and dial "feel" (tuning peak spread) are the same over the entire dial.

Operation

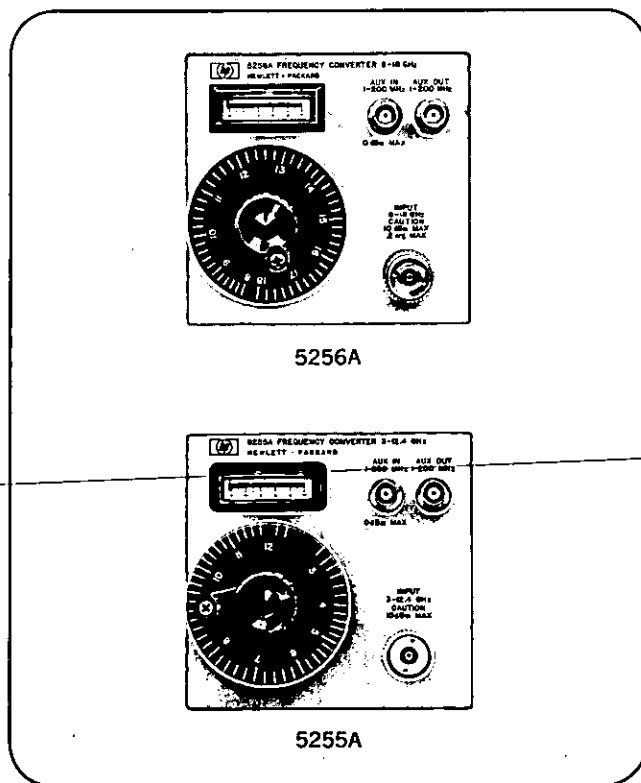
The converter subtracts multiples of 10, 50, or 200 MHz (depending upon converter model) from the CW frequency to be measured and provides the difference to be measured by the counter. For example, if a frequency of 279.25 MHz is to be measured with the 5253B, the operator tunes the converter dial upward until the converter Level Indicator shows an acceptable voltage level. This will occur at a dial reading (mixing frequency) of 270 MHz for a 279.25 MHz input. At this dial setting, the converter will subtract 270 MHz from the input signal and pass 9.25 MHz, which the counter will measure and display. The measured frequency is then the sum of the counter reading and the 5253B dial reading.

Readout resolution is 1 Hz with the counter gate time set at 1 second, 0.1 Hz at 10 seconds, 10 Hz at 0.1 second, etc. Counter gate time is automatically multiplied by 4 when the 5255A and 5256A are used. A technical article on the 5255A appeared in the Hewlett-Packard Journal, Sept. '66.

Model 5255A and 5256A

The 5256A's high frequency measuring range is unique in the microwave converter field. Previously, only transfer oscillators could make high accuracy measurements up to 18 GHz. Now, the 5255A and 5256A enable frequency measurements through X-band with greater speed, accuracy, and simplicity at comparable price.

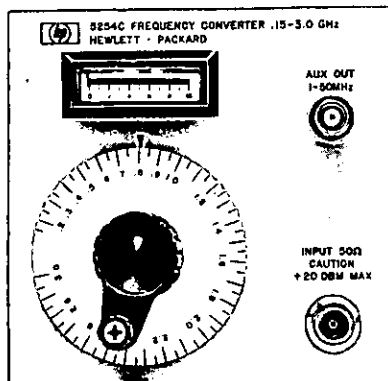
The 5255A or 5256A can be used as a prescaler to extend the counting and direct readout range of the counter to 200 MHz. This is because the converters have an internal prescaler which divides both the 0 to 200 MHz heterodyne difference frequency and the counter's time base by a factor of four to achieve direct readout in MHz on the 50 or 150 MHz counter. Prescaler input is available at the AUX IN port; inputs as low as 5 mV between 1 and 200 MHz are prescaled by 4 and displayed in MHz on the counter. 5254C, 5255A and 5256A are also useful as down-converters; the heterodyne difference frequency is available at the AUX OUT port, so that microwave inputs can be beat down to 200 MHz max (5254C, 50 MHz), for oscilloscope observation, etc. Similarly, by adding a detector at AUX OUT, the units serve as receivers.



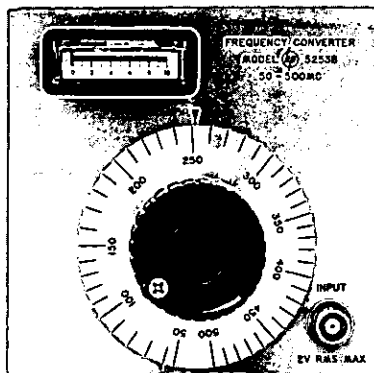
FREQUENCY COUNTERS *continued*
Plug-ins for increased counter versatility
Specifications

	5256A*	5255A*	5254C*	5253B**	5251A†
RANGE	8 to 18 GHz; as a prescaler, 1 MHz to 200 MHz	3 to 12.4 GHz; as a prescaler, 1 MHz to 200 MHz	0.15 to 3 GHz	50 to 512 MHz	20 to 100 MHz
MIXING FREQUENCIES	8 to 18 GHz in 200 MHz steps	2.8 to 12.4 GHz in 200 MHz steps	0.15 to 3 GHz in 50 MHz steps	50 to 500 MHz in 10 MHz steps	20 to 100 MHz in 10 MHz steps
INPUT VOLTAGE RANGE (min. to max., rms)	100 mV (-7 dBm) to 0.7V (+10 dBm); as a prescaler, 5 mV (-33 dBm) to 0.22 V (0 dBm)	100 mV (-7 dBm) to 0.7 V (+10 dBm); as a prescaler, 5 mV (-33 dBm) to 0.22 V (0 dBm)	50 mV (-13 dBm) to 1 V (+13 dBm)	50 mV (-13 dBm) to 1 V (+13 dBm)	50 mV (-13 dBm) to 1 V (13 dBm); typical sensitivity, 20 mV
MAXIMUM INPUT OVERLOAD	0.7 V rms (+10 dBm) (as a converter)	0.7 V rms (+10 dBm) (as a converter)	2.2 V rms (+20 dBm); 125 V dc	2 V rms (+19 dBm), 100 V dc	2 V rms (+19 dBm), 100 V dc
NOMINAL INPUT IMPEDANCE	50 ohms nominal	50 ohms	50 ohms	50 ohms	50 ohms
INPUT COUPLING	dc	dc	ac	ac	ac.
ACCURACY	maintains counter accuracy				
REGISTRATION	counter display in MHz is added to converter dial reading				
LEVEL INDICATOR	meter aids frequency selection and indicates usable signal level				
INSTALLATION	into front panel plug-in compartment of some HP Electronic Counters (see footnote)				
INPUT CONNECTOR	Precision Type APC-7 Connector (Precision Type N Optional, no charge)	Precision Type N female (APC-7 optional; add \$25)	Type N female	BNC female	BNC female
WEIGHT net shipping	8¼ lbs. (3.8 kg) 10 lbs. (4.6 kg)	8¼ lbs. (3.8 kg) 10 lbs. (4.6 kg)	5 lbs. (2.3 kg) 7 lbs. (3.2 kg)	5 lbs. (2.3 kg) 7 lbs. (3.2 kg)	2 lbs. (0.9 kg) 4 lbs. (1.8 kg)
PRICE	\$1,950	\$1,850	\$825	\$500††	\$300††

Specifications apply when used with HP Electronic Counter Model No.: *5245L/M, 5248L/M, 5246L, 5247M (5245L with serial no. below 402 will require a minor modification); **5245L/M, 5248L/M, 5246L, 5247M or 5243L, and M54 versions, as well as 5360A computing counter (Model 10536A required); †5245L/M, 5248L/M, 5246L or 5243L, but 5253B is recommended for 5245L/M, 5248L/M and 5246L, 5247M, since 0 to 512 MHz is thereby covered with the one plug-in. ††Accessory furnished: HP 10503A Cable, 4 ft. (122 cm) long, male BNC connectors.



5254C



5253B



5251A

TRANSFER OSCILLATOR

Measures from .05 to 18 GHz; down converter
Model 5257A



FREQUENCY COUNTERS

Advantages:

- Measures CW, FM, or pulsed carriers
- Direct readout in frequency—no offset to add
- Tuning meter replaces oscilloscope pattern
- Automatic phase lock for CW and FM carriers
- No readout until tuned (CW inputs)
- Simple single dial tuning—no stubs

The HP Model 5257A Transfer Oscillator Plug-in extends the frequency measuring range of HP plug-in counters to 18 GHz. It is designed for use with the following counters: HP Models 5245L, 5245M, 5246L, 5248L/M and M54 versions. HP Model 5257A measures CW signals and FM carriers to within the counter's accuracy due to an automatic phase lock circuit (APC). The APC has a wide lock range (approx. $\pm 0.2\%$ of input frequency). It will track a rapidly drifting signal, with intermittent signals it relocks without retuning whenever the signal is present, and it locks to carriers with heavy FM; e.g., 4 GHz carrier with 1 MHz peak deviation at a 10 kHz rate. Pulsed carriers with pulse widths as short as 0.5 μsec may be measured with this instrument. The HP 5257A uniquely uses a tuning meter for this and other non-APC operation without loss of accuracy over CRT indicators. Optionally, a large screen oscilloscope may be connected to monitor zero beat tuning.

Sensitivity

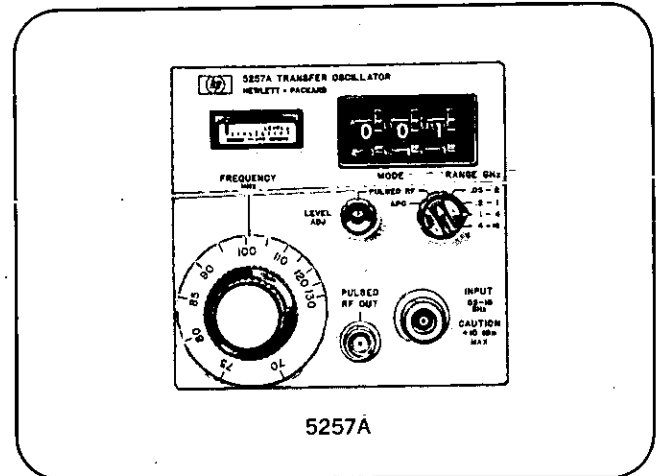
High input sensitivity, even at the higher frequencies, is achieved by the wideband sampler at the input. There are no stubs to tune and the harmonic generator generally used in transfer oscillators is eliminated. By using an external oscilloscope for zero beat indication, and without phase lock, measurements may be made of CW signals down to -70 dBm and of pulsed signals down to -55 dBm.

Direct readout

Frequency is read directly on the counter when the proper vfo harmonic number is set on the front panel "N" thumbwheels. Thus, repeated measurements can be made quickly within certain bandwidth restrictions for the same "N". When "N" is unknown it is easily found by taking two measurements and dividing the difference into the second of the two. An inhibit circuit prevents false readings in the APC mode by causing all zeros to be displayed unless the unit is locked into a CW signal.

Down conversion

The HP Model 5257A offers extra value by conveniently providing an 18 GHz hot carrier diode sampler driven by a tunable high stability oscillator from which the frequency converted amplified output is made available for other instrumentation. The carrier of this output is variable from dc to about 1 MHz by tuning the vfo. Input signals from 16.7 MHz to 18GHz can be down converted. Applications include



measurement of residual FM, FM deviation and FM modulation linearity, inspection of AM modulation envelopes on an oscilloscope, % AM measurements, and frequency domain measurements with a wave analyzer.

For additional data see HP Journal, Feb. '68.

Specifications*

Frequency range: 50 MHz to 18 GHz.

Input signal capability: CW Signals. Pulsed RF Signals. Signals with high FM content.

CW measurement accuracy: retains counter accuracy.

Input sensitivity: 100 mV rms (-7 dBm) for input frequencies of 50 MHz to 15 GHz. 140 mV rms (-4 dBm) for input frequencies of 15 to 18 GHz and VFO FREQUENCY of 125-133.3 MHz. Typical sensitivity: -24 to -7 dBm.

Input impedance: 50 ohms nominal.

Maximum input: $+10$ dBm for CW Signals. 2 volts p-p for Pulsed RF Signals.

APC lock range: approximately $\pm 0.2\%$ of input frequency.

Meter: APC MODE—Indicates loop phase error under locked conditions. PULSED RF MODE—Zero beat indicator.

Pulsed RF out: for external oscilloscope, 0.5 volt p-p. Output frequency range of dc to 1 MHz, approx.

Pulse carrier frequency measurements: minimum pulse width $-0.5 \mu\text{s}$. Minimum repetition rate—10 pulses per second. Accuracy—0.01 cycle per pulse width (typical error ± 20 kHz or less) for pulse width $> 2 \mu\text{s}$; ± 50 kHz $< 2 \mu\text{s}$; < 1 kHz rep rate.

VFO: frequency range—66.7 to 133.3 MHz. Drift—(With constant temperature in operational range of 0° to 55°C) typically ± 2 parts in 10^5 per minute immediately after turn on. Typically ± 1 part in 10^5 per minute after 2 hours of operation. Temperature variation—typically 1 part in 10^5 per degree C.

Input connector: precision type N female.

Weight: net, $7\frac{1}{4}$ lb (3.3 kg); shipping, 8 lb (3.6 kg).

Price: \$2,100.00.

Option 001: precision type APC-7 input connector, add \$25.00.

*When used with HP 5245M, 5245L (serial prefix 402 or above and other serial prefixes when suitably modified), 5248L, 5248M, 5246L, M54-5245L, or 5247M Counters.

FREQUENCY COUNTERS



AUTO FREQUENCY DIVIDER

Extends automatic counting range to 12.4 GHz
Model 5260A

Advantages

- Automatic measurement, 0.3 GHz to 12.4 GHz
- Direct readout, no calculations or offset
- Maintains counter accuracy
- Essentially constant 100 mV sensitivity

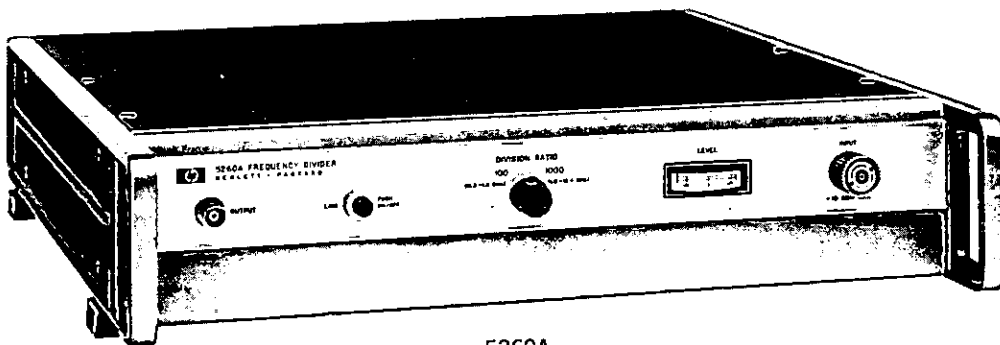
Automatic measurement and direct readout of an unusually wide range of CW microwave frequencies can now be achieved using the HP Model 5260A with a suitable electronic counter, i.e., 5245L/M and 5248L/M. The 5260A divides input signals in the 300 MHz to 12.4 GHz frequency range by 100 or 1000 to provide an output signal in the 1 MHz to 12.4 MHz frequency range. Measurements are rapid and simple, with accuracy the same as for basic counter measurements, the frequency being displayed directly on the electronic counter. For automatic inhibit until phase lock established, see Option 002. There is no ambiguity of offset, and no calculations are needed. Except for selecting the proper division ratio, ALL TUNING IS AUTOMATIC AND NO ADJUSTMENTS BY THE OPERATOR ARE REQUIRED TO OBTAIN THE CORRECT OUTPUT READOUT.

Fast phase lock acquisition (typically <100 ms) allows measurement of swept frequencies. Signals with AM up to 65% and FM from 10 to several hundred MHz, depending on frequency, can be accommodated without losing phase lock.

Measuring dc to 12.4 GHz

A system for rapid, automatic, direct readout of frequencies from dc to 12.4 GHz can be assembled by combining an HP 5245L or M, 5248L or M, 5247M or 5246L Electronic Counter (dc to 50 or 150 MHz), 5252A Prescaler Plug-in (dc to 350 MHz), and 5260A Automatic Frequency Divider (300 MHz to 12.4 GHz). It is only necessary to select the frequency range desired and read the electronic counter readout; no tuning or calculations are required. Note, however, that the 5252A Prescaler is NOT required for operating the counters from the 5260A. The 5252A Prescaler is only necessary for measurements from 300 MHz down to the top of the counter's basic range.

For theory of operation see HP Journal, April '67.



5260A

Specifications

Ranges: 0.3 GHz to 1.2 GHz and 1 GHz to 12.4 GHz.

Accuracy: retains accuracy of electronic counter.

Input sensitivity: 100 mV rms (-7 dBm).

Input impedance: 50 ohms nominal.

Input VSWR		
Freq.	Typical	Max.
0.3-8 GHz	1.2:1	1.4:1
8-10 GHz	1.4:1	1.6:1
10-12.4 GHz	1.8:1	2:1

Maximum input: +10 dBm.

Level indicator: front panel meter indicates approximate input level, -10 dBm to +10 dBm.

Division ratio: front panel switch selects + 100 (for use up to 1.2 GHz) or + 1000 (from 1 to 12.4 GHz) operation.

Input connector: precision Type N female. (APC-7 Optional).

Operation: completely automatic once the DIVISION RATIO switch is positioned.

Output frequency: 1/100 or 1/1000 of input (1 to 12.4 MHz).

Output impedance: designed for 50 ohm (or higher impedance) load.

Output level: 0 dBm nominal, AGC'd.

Registration: input frequencies from 0.3 to 12.4 GHz are measured by measuring the 5260A output with a counter such as the HP 5245L or M, 5248L or M, 5247M, 5246L or 5244L, and suitably positioning the decimal point. Readout is direct with no offset, ambiguity, or arithmetic processing. See also Option 002, below.

Measurement time: set by electronic counter gate time.

Power supply: 115 or 230 V $\pm 10\%$, 50 to 60 Hz. 47 watts (52 watts with Option 002). Other frequencies on special order.

Weight: net 29 lbs (13.2 kg); shipping 33 lbs (15 kg).

Dimensions: 16 $\frac{3}{4}$ " wide, 3-15/32" high, 16 $\frac{3}{8}$ " deep (425 x 88 x 416 mm).

Price: Model 5260A Automatic Frequency Divider, \$3,700.

Options:

001. Amphenol APC-7 Input Connector, add \$25.

002. Provides 5260A with circuitry such that, when used with the HP Model M07-5245L or M07-5248L or M Counter, the decimal point will be automatically positioned for readout in GHz, and the symbol "GHz" will appear in the counter's readout. Readout is inhibited and displays all zeros unless an adequate input signal is present. Add \$175.

DIGITAL FREQUENCY METER

Automatic Measurement to 12.4 GHz

Model 5240A



FREQUENCY COUNTERS

Advantages:

- Completely automatic operation in each range
- No readout unless phase lock is established
- 8 digit readout with decimal point and units
- BCD output with decimal point and units

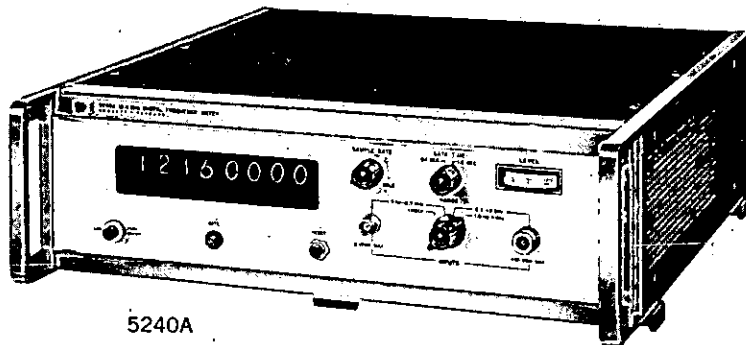
Completely automatic measurement and direct readout of frequencies from 0.3 to 12.4 GHz can now be achieved with the HP Model 5240A Digital Frequency Meter. Even an unskilled operator can make fast and accurate measurements since no adjustments or calculations are needed to obtain the correct readout. The only front panel controls are Gate Time and Range switches and a Sample Rate control.

The 5240A consists of an automatic frequency divider

and an integrated circuit counter in a completely self-contained unit. Low frequencies from 10 Hz to 12.4 MHz can also be measured by using the counter section only.

Correct counting depends on having established phase lock, so the 5240A was designed to automatically inhibit display and printer output until lock is obtained. Any signal between -10 dBm and $+10$ dBm will be counted—no sensitivity adjustment necessary. These features are especially useful in computer controlled systems.

Fast phase lock acquisition (typically <100 ms) allows measurement of swept frequencies. Signals with AM up to 65% and FM from 10 to several hundred MHz, depending on frequency, can be accommodated without losing phase lock.



Specifications

Automatic frequency divider

Ranges: 0.3 GHz to 1.2 GHz and 1 GHz to 12.4 GHz.

Input sensitivity: 100 mV (-7 dBm).

Input impedance: 50 ohm nominal.

Input VSWR (type N or APC-7 connectors):

Frequency	Typical	Maximum
0.3 - 8 GHz	1.2:1	1.4:1
8 - 10 GHz	1.4:1	1.6:1
10 - 12.4 GHz	1.8:1	2:1

Maximum input: $+10$ dBm.

Level indicator: front panel meter indicates approximate input level from -10 dBm to $+10$ dBm.

Input connector: type N precision female (APC-7 optional).

Operation: completely automatic after RANGE switch is set.

Output frequency: 0.01 or 0.001 of input available from rear panel BNC connector.

Low frequency counter

Frequency measurements:

Range: 10 Hz to 12.5 MHz.

Gate times: 0.1, 1.0 s (10 s available on special order).

Accuracy: ± 1 count \pm time base accuracy.

Readout: MHz or GHz with positioned decimal point.

Self check: counts and displays 1-MHz for the gate time chosen.

Time base:

Crystal frequency: 1 MHz.

Stability

Aging rate: <2 parts in 10^7 per month.

Temperature: <2 parts in 10^6 over the range $+10^\circ\text{C}$ to 50°C ; <20 parts in 10^6 over the range 0°C to $+65^\circ\text{C}$.

Line voltage: 1 part in 10^5 for $\pm 10\%$ change in line voltage from 115 V or 230 V.

Output frequency: 1 MHz, 2 V square wave into 6 k Ω available from rear panel BNC connector.

External time base: requires 1 MHz, 2 V square wave into 1 k Ω .

Signal input:

Coupling: ac.

Sensitivity: 100 mV rms.

Maximum input: 2 V rms.

Impedance: 1 megohm shunted by 25 pF.

Remote reset: counter display and internal count reset to zero by grounding center of BNC connector on rear panel.

General:

Display: 8 digits in line, with decimal point and units.

BCD output: compatible with HP Models 562A and 5050B Digital Recorders with 8-4-2-1 "1" state positive. Printers can record decimal point and measurement units.

Output connector: Amphenol or Cinch Type 57-40500-375, HP 1251-0087, 50 pin, female. Mating connector Amphenol or Cinch Type 57-30500-375, HP 1251-0086, 50 pin, male.

"0" state level: 0 V.

"1" state level: $+5$ V.

Impedance: 5 k Ω , each line.

BCD reference levels: ground; ± 5 V, 1 k Ω source.

Print command: 1.5 V to 10 V step.

Hold-off requirements:

Maximum: $+15$ V.

Minimum: $+7.5$ V.

Power: 115 V or 230 V $\pm 10\%$, 50 Hz to 60 Hz, 90 W.

Weight:

Net: 34 lbs (16.8 kg).

Shipping: 39 lbs (17.8 kg).

Dimensions: 5 $\frac{7}{32}$ " high, 16 $\frac{3}{4}$ " wide, 16 $\frac{3}{8}$ " deep (133 x 425 x 416 mm).

Accessory furnished: detachable power cord, 7 $\frac{1}{2}$ feet (231 cm) long with NEMA plug.

Price: HP Model 5240A, \$4750.

Option:

001. Amphenol APC-7 Input Connector on high frequency input, add \$25.

FREQUENCY COUNTERS



FREQUENCY CONVERTER

Measure frequency to 15 GHz at counter accuracy
Model 2590B

Model 2590B, in a single compact all-solid-state instrument, performs the functions of a transfer oscillator and a transfer oscillator synchronizer.

By phase-locking an internal transfer oscillator to the signal frequency, Model 2590B makes CW frequency measurements inherently equal to the accuracy of the external time base used, even on rapidly drifting signals. With the HP 5253B and 5245L or 5246L complete coverage is provided from dc to 15 GHz with attainable accuracy as high as 2 parts in 10^{10} . Permanently phase-locked, the signal frequency's drift may be tracked continuously over long periods.

The 2590B automatic phase-lock is augmented by an automatic search oscillator, to simplify synchronization at system set-up. An automatic gain control eliminates input level adjustments. The instrument incorporates a precision FM discriminator and an envelope detector, for observation and accurate measurement of FM deviation, deviation rate and signal amplitude modulation.

FM and other short-term frequency disturbances can be observed on an oscilloscope while phase-locked to the signal. For signals with carrier frequency sufficiently stable not to require phase-locking, accurate measurements of FM deviation and deviation rate may be made with the precision built-in discriminator. A separate output from the envelope detector provides for oscilloscope observation and measurement of signal AM, in either FM or phase-locked operating modes.

The carrier frequency of pulsed signals can be determined to well within ± 4 parts in 10^6 using the 2590B with an oscilloscope. FM on the pulse can also be observed.

Specifications

Frequency range: 0.5 to 15 GHz.

Signal input: minimum level, typically -30 dBm at 0.5 GHz, -40 dBm at 5 GHz, and -15 dBm at 13 GHz.

Lock-on range: $\pm 0.15\%$ minimum of signal frequency over entire transfer oscillator range. Track mode increases lock-range to

$\pm 0.35\%$ of signal frequency at 240 MHz end of transfer oscillator range, decreasing to $\pm 0.1\%$ at 390 MHz end.

Accuracy: \pm stability \pm resolution of measurement of transfer oscillator fundamental; stability, same as 10 MHz reference supplied; resolution, ± 1 count at transfer oscillator frequency, equivalent to 4.2 to 2.5 parts in 10^9 with 1 sec counter gate or 4.2 to 2.5 parts in 10^{10} with 10 sec gate over 240 to 390 MHz range.

External reference: 10 MHz, 0.1 V min. into 90 ohms.

FM measurement: discriminator characteristics when in FM mode: linearity (max. deviation from straight line through origin), better than $\pm 1\%$ over bandwidth of ± 500 kHz, better than $\pm 5\%$ over bandwidth of ± 2 MHz; video frequency response; 5 Hz to 1 MHz (3 dB points); center frequency, 30 MHz (nominal); sensitivity, 5 V/MHz ($\pm 5\%$); output impedance, 1.2 k ohm.

AM measurement: output, 200 mV p-p (nominal) for 100% modulation at 1 kHz; frequency response, 30 Hz to 1 MHz, load impedance, 10^6 ohms shunted by 12 pF max.

APC monitor: FM on signal may be monitored when in APC operating mode; sensitivity, ± 2 V minimum for frequency deviation of $\pm 0.25\%$; deviation limits, APC mode can follow frequency deviations to full lock-on range at rates up to 100 Hz; above 100 Hz, deviation decreases at 6 dB/octave; impedance, measuring device should have min. input impedance of 10^6 ohms, shunt capacitance not greater than 150 pF.

Transfer oscillator: fundamental frequency range, 240 to 390 MHz; drift, less than $5/10^4$ per hour immediately after turn-on, less than $1/10^5$ per hour after 3 hours' operation (oscillator automatically corrected for drift in APC mode); residual FM less than 10 Hz rms; dial, $2\frac{1}{4}$ " dia. calibrated in 5 MHz increments.

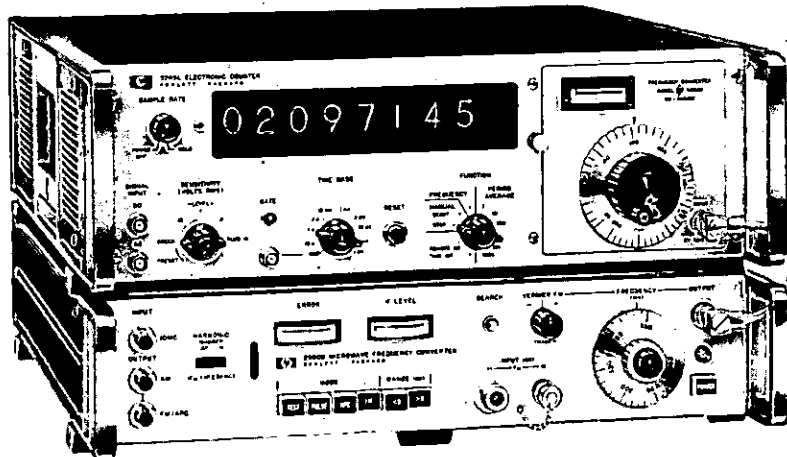
Power: 115/230 V $\pm 10\%$, 50 to 400 Hz, approx. 35 W.

Operating conditions: ambient temperatures 0 to 55°C, relative humidities to 95% at 40°C.

Dimensions: $16\frac{3}{4}$ " wide, $3\frac{1}{2}$ " high, $16\text{-}5/16$ " deep behind panel (426 x 86 x 414 mm); instrument is fully enclosed for use on bench; may be mounted in 19" rack with side extensions to panel (furnished).

Weight: net 23 lbs (10,4 kg); shipping 30 lbs (13,6 kg).

Price: Model 2590B, \$2300.



2590B (lower instrument) shown with 5245L Counter, 5253B Plug-In

DC TO 40 GHz MEASUREMENT

Versatile, accurate; uses standard measurements
Model 5245L Option E40



FREQUENCY COUNTERS

5245L Option E40 Specifications

12.4 to 40 GHz

Input signal capability: CW signals. Signals with high FM content. Pulsed RF signals (using external oscilloscope).

CW measurement accuracy: ± 2 parts in 10^7 or better.

input sensitivity: better than -30 dBm at 12 GHz, -20 dBm at 40 GHz.

Input impedance: 50 ohms nominal.

Maximum input: 1 mW.

Auto phase control lock range: better than 0.1% of input signal frequency.

Capture range: approximately 20% of Lock Range.

Lock indication: lamp turns off when system phase locks to CW or FM signals; meter indicates phase error.

VFO frequency range: 2 GHz to 4 GHz.

DC to 18 GHz

Specifications of HP 5245L Counter and 5257A Transfer Oscillator apply (listed elsewhere in this catalog).

Superseded Counters

The instruments listed below have been largely superseded by newer integrated circuit models offering greater versatility, and wider range, generally coupled with greater economy.

5214L Preset Counter

This highly popular instrument is superseded by the even more versatile 5330A and 5330B. The Model 5330A has: a preset (variable) time base for normalizing measurements, higher frequency range than 5214L, programmability, use as a frequency divider, plus the compactness, lightweight and low power dissipation of integrated circuits. Many optional features are available, including preset zero offset. 5330B adds upper and lower preset counting limits to the 5330A's other capabilities, and is therefore a versatile combination measuring and controlling instrument.

5223L and 5233L Universal Counter/Timer

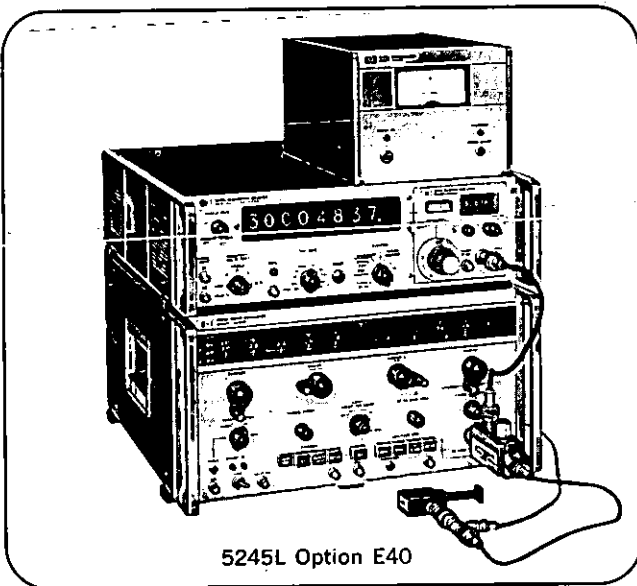
In comparison, the newer Models 5325B and 5326A/B offer: higher frequency range (20 and 50 MHz, respectively), programmability, superior input and trigger level setting circuits, two types of marker outputs for observing time interval trigger points on oscilloscope, 7 digit readout, BCD buffer storage, and fast reset. The 5325B also offers lower price. 5326B has an internal-DVM for precise, digital definition of counter trigger levels and for uses where both frequency and dc voltage must be measured economically. For even greater accuracy, 5326A/B can measure the average time interval of repetitive input pulses.

5244L Counter—50 MHz

See Model 5326A/B of paragraph immediately above this one.

5512A and 5532A

Model 5216A offers advantages of higher frequency range (12.5 MHz), 7 digit readout, lower price.



5245L Option E40

Continuous coverage freq. measurements, dc to 40 GHz
Wide phase lock range tolerates 0.1% FM
Calibrated local oscillator (l.o.) speeds measurements
High l.o. frequency avoids crowded lock points
Typical sensitivity -30 dBm
Adjustable l.o. power allows optimizing sensitivity
Uses standard Hewlett-Packard instruments

This versatile dc to 40 GHz frequency measuring system, which consists mostly of standard Hewlett-Packard instruments, gives superior performance and easier operation than previously available. The standard Hewlett-Packard instruments are fully usable as general purpose instruments; owners of some or all of these can build the system with a cost saving.

A 5245L Counter and 5257A Transfer Oscillator measure dc to 18 GHz. From 12 to 40 GHz, the HP 8690A Sweep Oscillator and 8692B Option H15 Plug-in are the 2-4 GHz l.o. of a second transfer oscillator; an 8709A Synchronizer phase locks it to clean or heavily FM'd CW signals. The tee separates out the 20 MHz IF. For pulsed RF inputs the 8709A isn't needed but an external oscilloscope is (to display zero beat). The high l.o. frequency (2-4 GHz) spreads out lock points for easy tuning and permits 20 to 40 GHz measurements using a harmonic number of 10 to for easy calculation. It can measure CW signals to 1% accuracy using the 8690A dial (without 5257A). Please request data sheet.

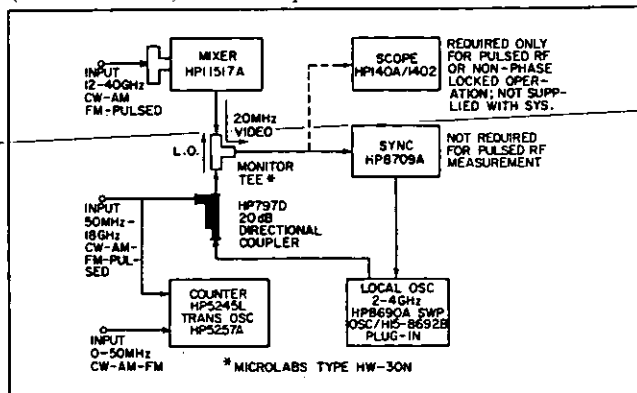


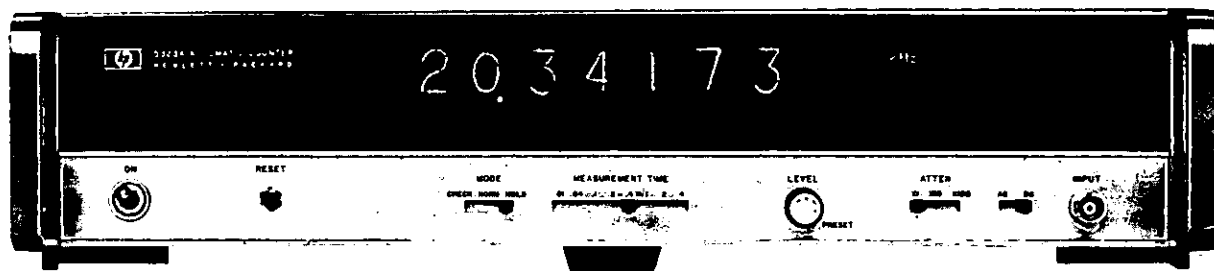
Figure 1. 5245L Option E40.



AUTOMATIC COUNTER

Easily used in systems or on bench

Model 5323A



Model 5323A

Advantages:

- Automatic operation
- Fast measurements with high resolution
- Armed operation—gates only when signal is present
- Displays 7-digits at all frequencies
- Auto range switching with frequency hysteresis
- Settable to optimum gate time
- Remotely programmable

Uses:

- General purpose frequency measurements
- Production line instrumentation
- Programmed instrument systems
- Audio, ultra-sonic, and rf frequencies
- Tone bursts
- Measures rpm directly

Model 5323A Automatic Counter measures frequencies from 0.125 Hz to 20 MHz. The display shows an automatically positioned decimal point and correct units (Hz, kHz, or MHz) such that, for rapid reading, no more than three digits lead the point. The correct number of displayed digits for the selected measurement time and frequency are also decided by the counter. Thus, use of the 5323A prevents measurement errors—the reading is easily interpreted and always correct.

Additionally, at unit range change frequencies, such as 1 kHz and 1 MHz, a 10% hysteresis prevents annoying display jumps when monitoring frequencies which oscillate about these points. Hysteresis may be manually switched off.

Remote control of the 5323A is through a rear panel connector. All controls except trigger level, input attenuator, and ac/dc selector can be programmed by a contact closure to ground or a voltage equal to DTL/TTL logic levels. Trigger level can be controlled remotely by application of a dc bias.

Because of its excellent frequency resolution, the 5323A allows direct RPM measurements with one pulse per revolution inputs. This function is enabled with a rear panel switch. It is possible to make up to 15 repetitive RPM measurements per second with 5-digit resolution using a single magnetic or photo-electric transducer.

The 5323A gating synchronizes with the input signal, i.e., the signal itself starts the measurement. When the counter is ready for a measurement but there is no signal, it is "armed" until a signal appears at the input. The length of counting time, or number of input cycles counted, depends upon the front panel measurement time setting. Calculation for the display takes about 1 ms after the count. These features permit applications not possible with conventional counters.

For instance, tone bursts and other intermittent signals can be measured; it can monitor circuits for measurement at precise times such as power lines at the instant of overload; velocity measurements of physical events such as bullet speeds and dynamic braking speeds.

Accuracy

The 5323A makes high accuracy measurements, even at the lowest frequency of 0.125 Hz, very rapidly by measuring waveform period (which is a type of time interval measurement). From this period, it computes the reciprocal and displays the answer directly in terms of frequency. The resolution, then, results from the counted internal clock frequency of 10 MHz and the gate time rather than the input frequency as in a conventional counter. Yet this counter is not restricted to decade number of cycles counted or decade values of time. A front panel slide switch selects times in decade and non-decade values. The actual time must end at an integral period of the input signal over the selected time. Thus, the user may speed up the measurement to suit his requirement or extend the measurement over a larger number of input cycles in order to average out the trigger error at the start and stop of counting.

Pulse and square wave inputs can be measured more accurately than sine waves because trigger error is not present when measuring fast rise time pulses.

Figure 1 shows the accuracy and speed advantages of the 5323A.

Pulsed Signals

The 5323A can automatically measure the frequency of a pulsed signal ("tone burst"). Other methods require either a manually operated transfer oscillator or a modified conventional counter of limited usage.

Two methods can be used with this automatic counter: (1) apply an external gate signal and, as long as the gate signal is removed before the input burst ends, the counter will measure the carrier frequency; (2) Set the front panel measurement time selector to a time known to be shorter than the burst and the mode selector to HOLD. Then apply a reset pulse to the 5323A sometime between bursts. It will start counting when the burst starts, and will stop before the burst ends. Sometimes reset can be applied during the initial portion of the burst to eliminate the first cycle or two as the counter's reset time is extremely fast. The counter will not make an erroneous reading but will read zero if the burst ends before the measurement is completed.

5323A Specifications

Range: dc coupled: 0.125 Hz-20 MHz.

ac coupled: 10 Hz-20 MHz.

Measurement time: selectable; 0.01, 0.04, 0.1, 0.2, 0.4, 1.0, 2.0, 4.0 s, or any time up to 4 s determined by the duration of an external gate signal.

Gate time: automatically selected; is some value between measurement time and twice the measurement time (see Figure 2).

Sample rate: sum of gate time and computing time of approximately 1 ms (see Figure 2).

Accuracy: ± 1 count \pm time base error \pm noise (see Figure 1).

Range selection: automatic.

Hysteresis: range switching will automatically position the most significant digit in the first display position, except when the frequency is decreasing from 10 ... to 09 In this case range switching is delayed until the input drops below 09 This 10% hysteresis prevents unnecessary range changes due to input frequency jitter. Hysteresis may be inhibited by a rear panel switch.

Signal input:

Sensitivity (min.): 0.1 V rms sine wave. 0.3 V p-p pulse, 25 ns minimum pulse width. Sensitivity can be decreased by 10 or 100 times using the ATTENUATOR switch.

Impedance: 1 M Ω shunted by 35 pF.

Trigger level: PRESET to center triggering about 0 V, or adjustable.

Trigger threshold band: <1.0 mV, referred to input at 20 MHz.

Time Base

Crystal frequency: 10 MHz.

Crystal oven: self-regulating solid-state type.

Stability:

Aging rate: less than 3 parts in 10^7 /mo.

Temperature: $\leq \pm 7$ parts in 10^8 /°C.

Line voltage: $\leq \pm 1$ part in 10^7 for $\pm 10\%$ line voltage variation.

Oscillator output: 10 MHz, 1.0 V p-p, 50 Ω (approx.) source impedance at rear panel BNC.

External input: 1.0 V rms at a frequency of 1, 2.5, 5, or 10 MHz.

General

Display: 7-digit in-line Nixie® digital readout plus positioned decimal point, units annunciator, and RPM annunciator.

Blanking: all non-significant digits will be automatically blanked if the measurement time selected on the front panel is too short to guarantee full accuracy.

Display storage: holds reading and digital output constant between samples.

RPM display: rear panel switch converts measurement from pulses per second to rpm.

® Burroughs Corporation

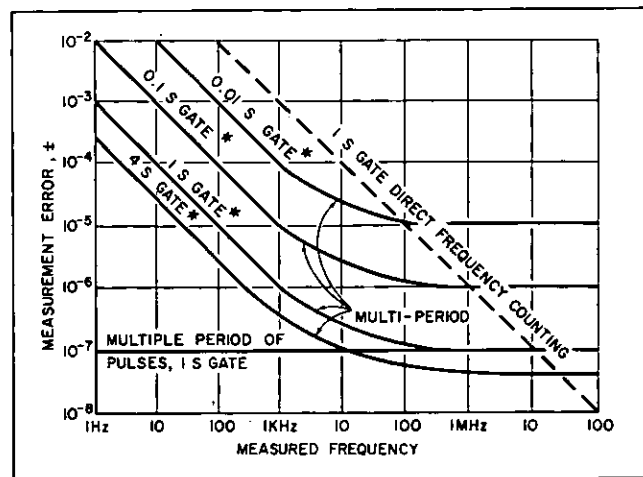


Figure 1. Accuracy vs. Gate Time for period measurement (5323A) and conventional direct frequency counting. Time base errors, which would affect both methods equally, are excluded. Multi-period plots are for 100 mV sine wave input with 40 dB signal-to-noise ratio, and are statistical (99% confidence level).

*Low Frequency accuracy limitation (sloping part of curves) is due to assumed input noise.

"Armed" lamp: is illuminated between time of reset and when input signal first reaches trigger level thereafter (point A, Figure 2).

Gate output: 0 V while gate open, +4 while gate closed (point A to B, Figure 2). Available at rear panel BNC.

Reset: front panel pushbutton switch resets the counter and causes display to be 0 Hz. Rear panel BNC for external reset.

Automatic reset: counter automatically resets to zero if input is removed during measurement, or if period of input signal is longer than twice the selected measurement time.

Hold: retains displayed information indefinitely while new measurement is made. New information is displayed immediately when "hold" is removed. A single measurement may be made by re-setting from the "hold" position.

Self-check: measures internal 10 MHz signal.

Remote programming: all front panel function controls are programmable. Single line control for each function. Operated by DTL or TTL integrated circuits or contact closure to ground. Amplifier trigger level can be set by the level of an external ± 1 V input (which is multiplied by the ATTENUATOR settings: X1, X10, X100).

Digital output:

Code: all numerals, decimal point, and unit information are available as 4-line 8-4-2-1 coded signals. Logic "0" state approximately 0.4 V at -5 mA sink; logic "1" state 4.6 V min., open circuit, 2.5 k Ω impedance.

Print command: +5 V to 0 V step, dc coupled; occurs at end of measuring and computing cycle.

Storage: buffer storage is provided so BCD output is held constant while next measurement is being made.

Hold-off: inhibits transfer of data to buffer storage when cycle time is less than time required for external equipment to interrogate BCD outputs. Positive inhibit +5 V min., +20 V max.

Connectors: all are BNC's except for Remote Programming (Cinch or Amphenol 57-40360, which mates with Cinch or Amphenol 57-30360, and HP 1251-0086) and Digital Output.

Chassis connector: special Hewlett-Packard manufactured connector assembly. (See Accessories Available below).

Operating temperature: 0° to 50°C.

Power requirements: 115 or 230 volts $\pm 10\%$, 50 to 400 Hz, 45 watts max. Fast circuit breaker action with internal power reset switch protects supply. Also resets when main power is turned off. No cooling fan required.

Weight: net, 14 lb (6.4 kg). Shipping, 19 lb (8.6 kg).

Price: \$2,150.00.

Dimensions: 3-15/32" high, 16 3/4" wide, 11 1/4" deep (88.2 x 425 x 286 mm).

Accessories available: HP Cable 10524A (6 ft, 183 cm) to connect to HP 5050B Digital Recorder. Price, \$65.00.

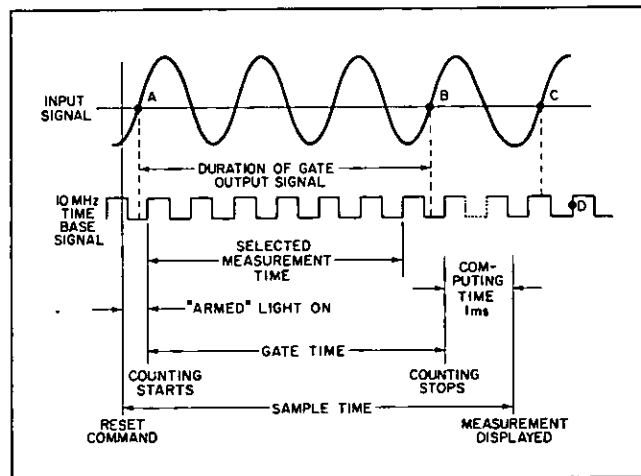


Figure 2. The Measurement Cycle.



ELECTRONIC COUNTERS

Model 5325B versatile 20 MHz universal counter

Advantages

- Dual FET differential amplifier inputs
- Differential Schmitt trigger circuits, <1 mV threshold
- Dual trigger level controls
- Remote programming of all functions
- Oscilloscope intensity markers
- Measurement resolution of $0.1 \mu\text{s}$
- Minimum $100 \mu\text{s}$ sample rate
- BCD output with buffer storage
- Readout blanking of undesirable zeros to left of count total

Uses:

- Measure frequency
- Measure time interval, period, period average
- Count periodic and random pulses
- Determine ratio and multiple ratio
- With transducers, measure speed, flow rate, and other physical variables
- Scale input signals up to 10^8

Model 5325B Universal Counter is a general purpose 20 MHz instrument having dual, level adjustable, high impedance inputs.

Push-button function switches instantly select the desired operating mode. The sample rate is variable from $100 \mu\text{s}$ to 5 s (including hold) for adjustment to optimum readout speed, and it includes buffer storage (print inhibit holds BCD transfer pulse) to hold information for external use.

Time base pulses are available at a rear panel connector. In start, the pulses are a scaled frequency equal to input A signal divided by the time base/multiplier switch setting.

In check, the 5325B counts its own 10 MHz for the gate times selected.

Dual channel inputs

The HP Model 5325B has dual channel, ac or dc coupled, level controllable differential input amplifiers. Its unique differential Schmitt trigger circuits have a threshold band (error zone) of less than 1 mV to protect against false counting. Trigger level settings are, thus, clear cut and well defined for a count or no count, and undesired signals and noise below the trigger levels are rejected. These controls also select the start-stop points in time interval measurements. A three step attenuator changes the control range maximum in decades of ± 1 volt, ± 10 volts, and ± 100 volts. A separate/common switch allows the inputs to operate from separate input signals or a single input signal. This design results in high stability, high sensitivity, and an input impedance of $1 \text{ M}\Omega$ shunted by only 35 pF.

Measurements

The 5325B measures frequencies from 0 to 20 MHz of either periodic or random signals. The counter's gate time is selectable in decade steps from $0.1 \mu\text{s}$ through 10 s with the decimal point and units automatically displayed.

Accuracy of 5325B frequency measurements are excellent for its price class. A fast warm-up, oven stabilized, 10 MHz quartz crystal provides a dependable time base with an aging rate of less than 3 parts in 10^7 per month. And the 10 s gate realizes a least significant figure of ± 0.1 Hz.

Time intervals of $0.1 \mu\text{s}$ to 10^8 s can be measured with the 5325B. Rear panel BNC connectors furnish channel A and channel B marker pulses, $0.7 \mu\text{s}$ wide, for displaying and setting trigger levels with an oscilloscope or they may be used for actuating other circuits. A particularly valuable feature of the 5325B for time interval measurements is the gate pulse, on a rear BNC connector, for intensifying on an oscilloscope the waveform segment between start-stop points.

The 5325B will measure the period of a single input cycle with a selectable resolution of $0.1 \mu\text{s}$ to 10 s for frequencies from dc to 10 MHz. Periods are fully displayed up to a 7 digit readout; e.g., 999999.9 μs . When the count exceeds the number of digits in the readout an overflow lamp lights on the front panel.

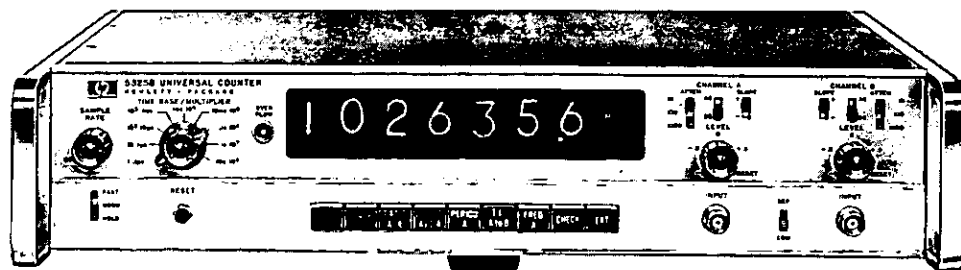
The 5325B offers period average measurements to reduce the effect of trigger error and \pm one count ambiguity. Periods averaged are selectable from 1 to 10^8 in decade steps for input rates from 0 to 10 MHz. Period average measurements result in higher accuracy at low frequencies and faster measurements at high frequencies for equivalent resolution.

The 5325B offers frequency ratio measurements with a range of 0-10 MHz. For the ratio of two frequencies, F_a/F_b , the number of cycles of F_a that occur during a period of F_b are counted. The number of periods of F_b can be increased in decade steps to 10^8 periods for an increase in measurement accuracy. Decimal points are automatically positioned to give F_a/F_b , but no units are displayed since ratio is dimensionless.

Digital output and storage

The 5325B provides 4-line 1-2-4-8 output with "1" state positive. This output is suitable for systems use or output devices such as the HP Model 5050B Digital Recorder. The BCD output is stored after count so that peripheral equipment can examine this information while a new count is being made. This increased the overall speed of a measuring-recording system. Buffer storage on/off choice can be made with a rear panel switch. Inhibit input provision.

Display storage provides a continuous display of the most recent measurement, even while the instrument is gating for a new count. The display changes only when a new count differs from the stored count. Storage may be switched off if desired.



5325B

Specifications

Input channels A and B

Range: dc coupled: 0-20 MHz.

ac coupled: 10 Hz-20 MHz.

Sensitivity: 0.1 V rms sine wave.

0.3 V p-p pulse, 50 ns minimum pulse width.

Impedance: 1 M Ω shunted by 30 pF.

Maximum input: 120 V rms (<1 kHz) X1 range

250 V rms X10 range

500 V rms X100 range

Overload level: 1.5 V rms X ATTENUATOR settings.

Trigger level:

PRESET to trigger at 0 V, or adjustable:

± 1 V X1 range

± 10 V X10 range

± 100 V X100 range

Trigger threshold band <1.0 mV, referred to input at 12.5 MHz.

Slope: independent selection of positive or negative slope.

Channel inputs: common or separate lines.

Marker outputs: rear panel BNC. -5 V pulse, 0.7 μ s width, into 5 k Ω load to intensity modulate scopes, (Marker A and B) at start and stop of gate time.

Start

(Totalizing and scaling)

Frequency range: 0-10 MHz.

Function setting: START push-button.

Factor: 1-10⁵ selectable in decade steps.

Input: channel A on front panel.

Output: rear panel TIME BASE BNC.

Display: channel A input divided by scaling factor.

Frequency

Range: 0-20 MHz.

Input: channel A.

Gate time: 0.1 μ s to 10 seconds in decade steps.

Accuracy: ± 1 count \pm time base accuracy.

Readout: MHz or kHz with positioned decimal point.

Time interval measurement

Range: 0.1 μ s to 10⁸ seconds.

Input: channels A and B; can be common or separate.

Time base frequency counted: 10 MHz to 0.1 Hz selectable in decade steps.

Accuracy: ± 1 count \pm time base accuracy \pm trigger error.*

Readout: μ s, ms, seconds, or 10's of seconds with positioned decimal.

Period

Range: 0-10 MHz.

Input: channel A on front panel.

Frequency counted: 10 MHz to 0.1 Hz selectable in decade steps.

Accuracy: ± 1 count \pm time base accuracy \pm trigger error.**

Readout: μ s, ms, seconds, or 10's of seconds with positioned decimal.

Period average

Range: 0-10 MHz.

Periods averaged: 1-10⁵ selectable in decade steps.

Input: channel A on front panel.

Frequency counted: 10 MHz.

Accuracy: ± 1 count \pm time base accuracy \pm trigger error.**

Readout: ns, μ s with positioned decimal.

Ratio

Displays: Fa/Fb x Multiplier (M). M = 1 through 10⁵, selectable in decade steps.

Range: channel A 0-20 MHz

channel B 0-10.0 MHz

Accuracy: ± 1 count of Fa \pm trigger error** of Fb.

Readout: dimensionless; positioned decimal point for number of periods averaged.

Time base

Crystal frequency: 10 MHz.

Crystal oven: self regulating solid-state type.

Stability:

Aging rate: less than 3 parts x 10⁷/mo.

Temperature: $\leq \pm 2.5$ parts in 10⁶, 0 $^\circ$ to 50 $^\circ$ C.

Line voltage: $\leq \pm 1$ part in 10⁷ for $\pm 10\%$ line voltage variation.

Oscillator output: 10 MHz, 1.0 V rms, 50 Ω source impedance at rear panel BNC.

External input: 1 MHz 1.0 V rms

2.5 MHz 1.0 V rms

5 MHz 1.0 V rms

10 MHz 1.0 V rms

Time base output: negative pulses, +4 V to 0 V (open circuit), 100 ns wide. In all functions except START and RATIO, rate is 10 MHz divided by TIME BASE/MULTIPLIER switch setting. Available at rear panel BNC.

Scaling: TIME BASE/MULTIPLIER switch selects division of Channel A frequency in the START function. Available at TIME BASE connector.

Gate output: 0 V while gate open, +4 V while gate closed. Available at rear panel BNC.

General

Display: 7 digits; long-life neon digital display tubes.

Blanking: suppresses display of unwanted zeros left of the most significant digit.

Display storage: holds reading between samples. Rear panel switch overrides storage.

Sample rate: FAST position: Continuously variable from less than 100 μ s to approximately 20 ms. NORM position: Continuously variable from less than 20 ms to approximately 5 seconds. HOLD position: Display can be held indefinitely.

Reset: manual.

Overflow: front panel neon indicates when the display range has been exceeded.

Remote programming: all front panel controls are single line programmable except:

SEP-COM (separate-common) switch

Input Attenuators (see Option 001)

AC-DC Input Signal Coupling (see Option 001)

Measurement units and decimal points are each single line programmable

Connector mates with 50-pin Amphenol 57-30500 (HP 1251-0086)

Control signal: single line control for each FUNCTION. Control signal zero (0) volts dc may be a contact closure to ground or electronic or TTL drive.

Digital output (for numerals only)

Code: 4-line 1-2-4-8 BCD, "1" state positive.

"0" state: +0.25 V at -1 mA; +0.4 V at -5 mA.

"1" state: +4.6 V min. open circuit, 2.5 k Ω source impedance, nominal.

Print command: +5 V to 0 V, dc coupled; occurs at end of gate.

Storage: buffer storage is provided so BCD output is constant while next measurement is being made.

Inhibit input: inhibits transfer of data to buffer storage (or main gate) when cycle time is less than time required for external equipment to interrogate BCD outputs. Positive inhibit +5 V.

Chassis connector: special HP manufactured connector assembly. (See Accessories Available below.)

Connectors: all are BNC's except for Remote Programming (Cinch or Amphenol 57-40500) and BCD output.

Operating temperature: 0 $^\circ$ to 50 $^\circ$ C.

Power requirements: 115 or 230 volts $\pm 10\%$, 50 to 400 Hz, 35 watts maximum. Fast circuit breaker action with internal power reset switch protects supply. Also resets when main power switch is turned off.

Weight: net, 10 lb (4.6 kg); shipping 15 lb (6.8 kg).

Accessories furnished: power cord, 7 $\frac{1}{2}$ ft HP 10503A, 50 Ω BNC to BNC cable, 4 ft. (122 cm), 2 each. Rack mount kit with P.C. extender board.

Price: \$1,300.00.

Dimensions: 16 $\frac{3}{4}$ " (425 mm) wide, 11 $\frac{1}{4}$ " (286 mm) deep, 3 $\frac{5}{8}$ " (88.2 mm) high.

Accessories available: HP Cable 10513A (6 ft, 183 cm) to connect to HP 5050B Digital Recorder, Price, \$65.00.

Option 001: remotely programmable attenuator switch and ac/dc switch. Price: \$75.00.

*For any waveshape, trigger error is less than 0.0025

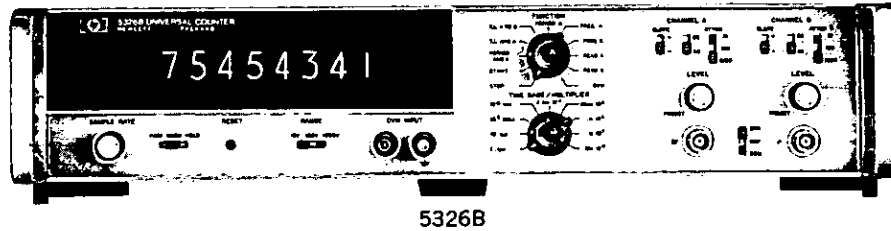
$\pm \frac{\text{Signal Slope (volts/ μ s)}}{\text{microseconds}}$

**Trigger error is less than $\pm 0.3\%$ of one period + periods averaged for signals with 40 dB or better signal-to-noise ratio and 100 mV rms amplitude.

FREQUENCY COUNTERS



FREQUENCY COUNTERS 50 MHz Timer/Counter/DVM Model 5326A/B



Advantages

- Internal integrating digital voltmeter
- Switchable front and rear frequency inputs
- Read A & B trigger levels digitally—precisely
- Dual FET differential amplifier inputs
- Dual trigger level controls
- Remote programming of all functions
- Minimum 100 μ s sample rate
- BCD output with buffer storage
- Readout blanking of undesirable zeros to left of count total

Uses

- Measure frequency
- Measure period, period average
- Measure time interval, time interval average
- Measure dc voltage
- Quantitative time interval measurements
- Count random input pulses
- Scale input signals up to 10^8

The 5326A/B Universal Counter is both a general purpose lab instrument and a fast, efficient systems instrument. Frequency measurements to 50 MHz, high resolution time interval average measurements, and voltage measurements in the 5326B make the 5326-series the most versatile universal counter available. A single set of controls and one readout provide either frequency or voltage data which leads to easy manual operation. A single BCD connector and remote programming connector cuts the interface requirements to automated systems in half for dc voltage and standard counter functions.

Dual Channel Inputs

The HP Model 5326A/B has dual channel, ac or dc coupled, level controllable differential input amplifiers. Its unique differential Schmitt trigger circuits have a threshold band (error zone) of less than 1 mV to protect against false counting. Trigger level settings are, thus, clear cut and well defined for a "count" or "no count," and undesired signals and noise below the trigger levels are rejected. These controls also select the start-stop points in time interval measurements. A three step attenuator changes the control range maximum in decades of ± 2 volt, ± 20 volts, and ± 200 volts. A separate/common switch allows the inputs to operate from separate input signals or a single input signal. This design results in high stability, high sensitivity, and an input impedance of 1 M Ω shunted by less than 25 pF.

Measurements

The 5326A/B measures frequencies from 0 to 50 MHz of either periodic or random signals. The counter's gate time is selectable in decade steps from 0.1 μ s through 10 s with the decimal point and units automatically displayed. A rear panel frequency input is front panel selectable for use with external scaling devices or for system applications.

The 5326A/B will measure the period of a single input cycle with a selectable resolution of 0.1 μ s to 10 s for frequencies from dc to 10 MHz. Periods are fully displayed with a 7 digit readout (8 digits optional); e.g., 999999.9 μ s. When the count exceeds the number of digits in the readout, an overflow lamp lights on the front panel.

Period average measurements are provided with the 5326A/B to reduce effect of trigger error and \pm one count ambiguity. Periods averaged are selectable from 1 to 10^8 in decade steps for input rates from 0 to 10 MHz. Period average measurements result in higher accuracy at low frequencies and faster measurements at high frequencies for equivalent resolution.

Time intervals of 0.1 μ s to 10^8 s can be measured with the 5326A/B. Rear panel BNC connectors furnish Channel A and Channel B marker pulses, 1 μ s wide, for displaying trigger levels with an oscilloscope or they may be used for actuating other circuits.

Time interval averaging capability is also offered in the 5326A/B to provide time interval measurements ranging from 15 ns to 1 s. Optimum resolution of these measurements made on repetitive signals is $100 \text{ ns}/\sqrt{\text{intervals averaged}}$. Since a measurement can be averaged over 10^8 intervals, maximum resolution can be in the 10 ps region.

The 5326B offers dc voltage measurements in addition to the above described capability. DC ranges of 10, 100 and 1000 volts provide autopolarity with measurement times front panel selectable from 1 ms (2 digits) to 1 sec (5 digits). The highly linear and stable V-F Converter affords excellent accuracy.

Quantitative Time Interval

The 5326B has two functions which make it absolutely unique among universal counter/timers. The READ A and READ B functions allow the DVM to accurately measure the 2 internal input amplifier trigger points to within .05%, and display that value. Consequently, 50% points, 10%-90% rise time points, and others can be accurately set for time interval measurements by using the internal DVM functions. Coupling the time interval averaging capability to the foregoing yields an extremely powerful measurement tool—quantitative time interval. This measurement accurately determines both relevant signal parameters—time between measure points and their respective levels.

Input Channels A and B

Range: dc coupled: 0-50 MHz; ac coupled: 20 Hz-50 MHz.
Sensitivity: 0.1 V rms sine wave; 3 V p-p pulse, 50 nsec. width.
Impedance: 1 M Ω shunted by 25 pF.
Maximum input: 200 V rms (<1 kHz); 300 V rms X100 range.
Slope: independent selection of positive or negative slope.
Channel inputs: common or separate lines.
Marker outputs: rear panel BNC's. DTL pulse, >1 μ s width (Marker A & B) when each channel is triggered.

Input Channel C

Range: dc coupled: 0-50 MHz (rear panel).
Sensitivity: 0.3 V rms sine wave; 1.0 V p-p pulse; for frequencies <100 kHz fast risetime pulses are recommended.
Impedance: 50 Ω nominal.
Maximum input: ± 4 volts peak.
Trigger level: 0 volts.

Start**(Totalizing and Scaling)**

Range: 0-10 MHz.
Factor: 1-10³ selectable in decade steps.
Output: rear panel TIME BASE BNC.
Display: Channel A input divided by scaling factor.

Frequency

Range: 0-50 MHz.
Input: Channel A on front panel or Channel C on rear panel.
Gate time: 0.1 μ s to 10 sec in decade steps.
Accuracy: ± 1 count \pm time base accuracy.

Time Interval

Range: 0.1 μ s to 10³ seconds.
Input: Channels A and B; can be common or separate.
Frequency counted: 10 MHz to 0.1 Hz in decade steps.
Accuracy: ± 1 count \pm time base accuracy \pm trigger error.*

Time Interval Average

Range: 15 ns to 1 second.
Intervals averaged: 1-10³ selectable in decade steps.
Input: Channels A and B; can be common or separate.
Frequency counted: 10 MHz.
Accuracy: \pm time base accuracy \pm trigger error ± 100 ns/
 $\sqrt{\text{intervals averaged}}$.

Period

Range: 0-10 MHz.
Frequency counted: 10 MHz to 0.1 Hz in decade steps.
Accuracy: ± 1 count \pm time base accuracy \pm trigger error.**

Period Average

Range: 0-10 MHz.
Periods averaged: 1-10³ selectable in decade steps.
Frequency counted: 10 MHz.
Accuracy: ± 1 count \pm time base accuracy \pm trigger error.**

Ratio

Displays: Fa/Fext x Multiplier (M) M = 1 to 10³, selectable in decade steps.
Range: Fa (input A or input C) 0-50 MHz. Fext (External time base input) 100 Hz-10 MHz.
Accuracy: ± 1 count of Fa \pm trigger error** of Fext.

Time Base

Crystal frequency: 10 MHz.

Stability

Aging rate: <3 parts in 10⁷/mo.
Temperature: $\leq \pm 2.5$ parts in 10⁶, 0 $^\circ$ to 50 $^\circ$ C.
Line voltage: $\leq \pm 1$ part in 10⁷ for 10% line variation.
Time base output: negative pulses, +4 V to 0 V (open circuit), 100 ns wide. In all functions except START, TIME INTERVAL AVERAGE and PERIOD AVERAGE, rate is 10 MHz divided by TIME BASE/MULTIPLIER switch setting. Available at rear panel BNC.
Gate output: TTL pulses; low while gate open, high while gate closed. Available at rear panel BNC.

*For any waveshape, trigger error is less than $\pm \frac{0.0025}{\text{signal slope (V/\mu s)}}$

**Trigger error is less than $\pm 0.3\%$ of one period \div periods averaged for signals with 40 dB or better signal-to-noise ratio and 100 mV rms amplitude.

Integrating Digital Voltmeter Specifications**(5326B only)**

Voltage ranges: manual selection.

Range (VDC)	Resolution (1 sec Integration Time)	Input Impedance
10	100 μ V	>1000 M Ω
100	1 mV	10 M Ω
1000	10 mV	10 M Ω

Input: single ended, high impedance.

Polarity: automatic polarity detection.

Overrange: 25% overranging on 10 and 100 volt ranges.

Overload protection: 1100 VDC all ranges.

Accuracy: within 1% at turn-on; full accuracy after 10 minutes.

Range	Temp. drift (% Reading)	Linearity (% Range)	Zero Drift (% Range)	Counter
10	$\pm .03\%$	$\pm .01\%$	$\pm .01\%$	± 1 count
100	$\pm .03\%$	$\pm .01\%$	$\pm .01\%$	± 1 count
1000	$\pm .08\%$	$\pm .01\%$	$\pm .01\%$	± 1 count

AC normal mode rejection: >60 dB for multiples of 10 Hz; 100 ms integration time.

Measurement time: selectable, from 1 ms for 2 digits, to 1 s for 5 digits in decade steps.

Operating temperature: 10 $^\circ$ to 40 $^\circ$ C.

Response time: less than 100 μ s for full accuracy with a step function input.

General Specifications**(5326A and 5326B)**

Display: 7 digits (8 op.); long life neon digital display.

Blanking: suppresses display of unwanted zeros left of the most significant digit.

Display storage: holds reading between samples. Rear panel switch overrides storage.

Sample rate: FAST position: continuously variable from less than 100 μ s to approximately 20 ms. NORM position: continuously variable from less than 20 ms to approximately 5 seconds. HOLD position: display can be held indefinitely.

Overflow: neon indicates when display range is exceeded.

Operating temperature: 0 $^\circ$ to 50 $^\circ$ C (see IDVM temp. range).

Power requirements: 115 or 230 volts $\pm 10\%$, 50 to 60 Hz, 50 watts maximum.

Dimensions: 16 $\frac{3}{4}$ " (425 mm) wide, 11 $\frac{1}{4}$ " (286 mm) deep, 3-15/32" (88.2 mm) high.

Option 001: 8 digit display.

Option 002: remote programming.

Controls: all front panel controls are single line programmable except:

FAST/NORM MODE; SEP-COM (separate-common) switch; the check function is programmable.

Input attenuators.

AC-DC Input Signal Coupling.

Control signal: single line control using either contact closure to ground or TTL drive on all lines except trigger levels which are analog programmed (± 2 VDC).

Option 003: digital output (for numerals and polarity only).

Code: 4 line 1-2-4-8 BCD, "1" state high. "0" state: +0.25 V at +1 mA; +4 V at +5 mA. "1" state: +5 V open circuit, 2.5 k Ω source impedance, nominal.

Print command: +5 V to 0 V, dc coupled; at end of gate.

Storage: buffer storage is provided so BCD output is constant while next measurement is being made.

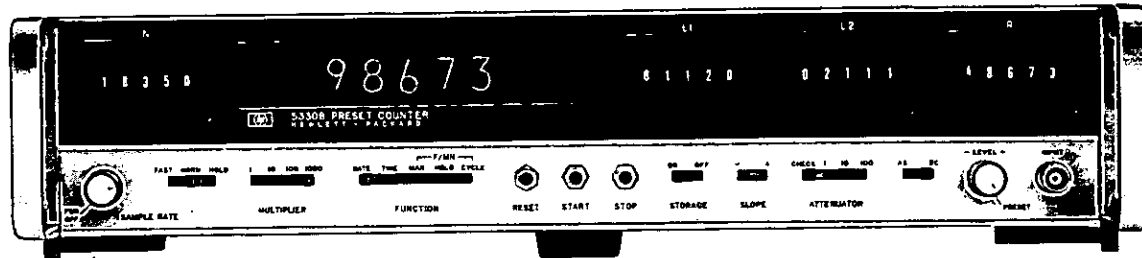
Inhibit input: inhibits gate when instrument's cycle time is less than time required for external equipment to interrogate BCD outputs. Positive inhibit +5 V.

FREQUENCY COUNTERS



NORMALIZING COUNTERS

Most versatile preset counters available
Models 5330A, 5330B



5330B, Option 001

Advantages:

- Displays value in desired engineering units (normalizes)
- Go/no go control signals from preset limits (5330B only)
- Programmable operation for systems

Uses:

Measure normalized rate and ratio, time for N events to occur, time interval, measure with count offsets (optional), frequency division pulse and digital delay generator (5330B only).

Model 5330A features a preset (variable) time base for normalized measurements and Model 5330B combines this capability with dual preset limits for control applications. In both models, all front panel switch functions are remotely programmable as well as the trigger level control. Preset thumbwheel switches are remotely programmable by adding optional remote cable connectors. A preset-reset option allows the count to start from any number up to 99,999 rather than zero. This can take care of offsets in transducer input signals, for true value readouts and for counting up from some "norm".

Rate or frequency measurement

By varying the gate time of the counter with preset switches, a measurement can be made directly in the desired engineering units, e.g., gals. per min., miles per hr., etc. In operation, the gate time equals NM periods of a 1 MHz internal quartz crystal clock ($1 \mu\text{s} \times \text{NM}$). "N" thumbwheel-presets adjust from 1 to 100,000 while the "M" slide switch selects decade multiples from 1 to 1000. This gives a total NM range from 1 to 10^8 providing gate times between $1 \mu\text{s}$ and 100 s. Specials may include even wider ranges.

Selection of gate time to normalize a reading or to convert frequencies to practical units requires only a simple calculation: e.g., with a tachometer generator producing 100 pulses per revolution you can set gate time to .01 s and measure rps directly or set it to 0.6 s to measure rpm.

Ratio measurements

The normalized ratio of two signals is measured by applying F1 to the front panel input and F2 to a rear panel connector; F2 is substituted for the internal time base when an internal/external switch is positioned in "external".

Time measurements

Measurement of Time for N events to occur is similar to the measurement of Period or Period Average of a conventional counter where the applied signal starts and stops the count while the time base internal to the counter is counted. In this case, however, the number of periods or N events can be any integer from 1 to 100,000. "M" selects the counted time increments of $1 \mu\text{s}$, $10 \mu\text{s}$, $100 \mu\text{s}$ or 1 ms. Average time or average period is easily obtained by dividing the time reading by N.

F/MN function

Frequency divided by MN generates pulses which are variable in rate from 10 MHz down to 0 Hz but related to a master clock frequency by an exact ratio. This is useful for circuit testing, timing, or

control of external equipment. The F/MN mode is also employed for counting by groups from many input events or generating a control pulse after a preset number of counts. The frequency being divided may be an external signal applied to the counter input or the counter's own internal 1 MHz clock which is applied to the input when switched to the "check" mode.

Time interval

Time interval is measured in the F/MN mode by counting the counter's internal clock over the time of the event. The counter operates in the "check" mode with the interval determined by the START/STOP lines or pushbutton. Each count equals $1 \mu\text{s}$ times MN allowing a measurement range of over 3 years for a 5 digit display.

Limit switching

Model 5330B only includes limit switches for controller applications. Operation of limits in rate and time functions provide on/off control of speeds or delay times, respectively. Under the F/MN function there are three operating modes useful for batching, alarms, pulse generation, etc. These are: Manual for continuous totalizing until externally reset; Hold where counting stops at the greater limit until externally reset; and Cycle where the counter automatically resets to 0 at the greater limit (recycle time is only $1 \mu\text{s}$!). Three control lines provide signals for use external to the counter.

The instrument can be used as both a generator of time delays and a generator of precision pulse trains. Pulses are 0 to 5 V; time characteristics are digitally set by the limit switches, and are as precise as the quartz oscillator time base.

Remote operation

The 5330A and 5330B are suitable for systems operating using its full remote control capability as well as its digital recorder output.

Specifications

Models 5330A and 5330B

(Both Models Except Where Noted)

FUNCTIONS

Signal input:

Range*: dc coupled, 0 to 10 MHz; ac coupled, 10 Hz to 10 MHz.

Impedance: $1 \text{ M}\Omega$ shunted by 30 pF.

Sensitivity: 0.1 V rms sine wave. 0.3 V p-p pulse, 50 ns minimum pulse width.

Trigger level: PRESET to trigger at 0 V or adjustable: $\pm 3 \text{ V}$, X1 range; $\pm 30 \text{ V}$, X10 range; $\pm 300 \text{ V}$, X100 range. Independent selection of + or - slope.

Rate (frequency)

Range: 0 to 10 MHz for frequency measurements. 0 to 2 MHz for frequency limit detection.

Gate times: M = 1: $1 \mu\text{s}$ to 0.1 s in $1 \mu\text{s}$ steps.

M = 10: $10 \mu\text{s}$ to 1 s in $10 \mu\text{s}$ steps.

M = 100: $100 \mu\text{s}$ to 10 s in $100 \mu\text{s}$ steps.

M = 1000: 1 ms to 100 s in 1 ms steps.

*On special order reduced bandwidths are available for use in electrically noisy environments.

Display: (events/sec) $\times 10^{-6} \times MN$.

Accuracy: ± 1 count \pm time base accuracy.

Time (period)

Range: 0 to 2 MHz.

Periods averaged: 1 to 10^5 selected by "N" switch.

Time units: 1 μ s, 10 μ s, 100 μ s, or 1 ms ("M" switch).

Display: (N \times period in sec.) \div (M $\times 10^{-6}$).

Accuracy: ± 1 count, \pm time base error, \pm trigger error.**

Ratio (rate mode) (time mode)

Range: F1—0 to 10 MHz. F2—1 kHz to 2 MHz.

Sensitivity: F1 same as input amplifier. F2, 1 volt rms sine wave into 1 k Ω .

Display Rate Mode: (F1 \times MN)/F2; time mode (F2 \times N)/(F1 \times M).

Accuracy: ± 1 count of F1, \pm trigger error of F2.

Time interval (use F/MN Mode & Check)

Range: 10 μ s to 10^5 s.

Time increments (Check Mode): 1 μ s to 100 s (1 μ s \times MN).

Display: total (MN \times 1 μ s) time increments.

Accuracy: ± 1 count \pm time base error.

F/MN Mode

Range: 0 to 10 MHz (0 to 2 MHz if M = 1).

N switch: 1 to 100,000 selected by "N" digits.

Multiplier: 1, 10, 100, or 1000 selected by "M".

Display: total count \div (M \times N).

LIMIT SWITCH FUNCTIONS (Model 5330B)

General

Limits: 2 sets, 5 digits each. † Range: 0 to 2 MHz.

Control line outputs

Source impedance: 2.5 K Ω for +4.75 V min; sinks 10 mA at .05 V.

	Nominal Voltages		
	LO	IN	HI
Control lines:			
Count < low limit:	0 V	+5 V	+5 V
Low limit \leq count < high limit:	+5 V	0 V	+5 V
Count \geq high limit:	+5 V	+5 V	0 V

Storage (Rate and Time Modes)

On: control and overflow lines "latch", i.e. store, and change only if future measurement results in different limit conditions.

Off: control and overflow lines return to "pre-lower limit" values upon reset.

TIME BASE

Crystal frequency: 1 MHz.

Stability

Aging rate: less than 5 parts in 10^7 /mo.

Temperature: $< \pm 3$ parts in 10^5 (0° to 65°C). $< \pm 5$ parts in 10^5 (10° to 40°C).

Line voltage: $< \pm 1$ part in 10^6 for $\pm 10\%$ line voltage variation.

Output (for ext. use): 1 MHz, 3 V p-p o.c., 100 Ω source.

**Trigger error is less than $\pm 0.3\%$ of one period \div periods averaged for signals with 40 dB or better signal-to-noise ratio and 100 mV rms amplitude.
†Other choices on special order.

External input

Sensitivity: 1 V rms into 1 k Ω , 1 kHz to 1 MHz.

N switch: 1 to 100,000 selected by "N" digits.

Multiplier: 1, 10, 100, or 1000 selected by "M".

Display: 5 long-life neon digital tubes. †

Display storage: holds reading between samples. Front panel switch overrides storage.

Overflow: front panel light indicates off-scale count.

Sample rate

FAST: continuously variable, 100 μ s to approx 12 ms. **NORM:** continuously variable, 12 ms to 5 s. **HOLD:** display held indefinitely.

Reset: manual by pushbutton or remote line.

External gate: level change at gate closure from 2.4 to .4 V min.

Digital output

Code: 4-line 1-2-4-8 BCD, "1" state positive.

"0" state: $< +0.5$ V at -10 ma.

"1" state: > 4.6 V open ckt; 2.5 K Ω nom source.

Reference levels: ground and +5 V; negligible impedance.

Print command: negative 5 V to 0 V pulse, 20 μ s width, occurs at end of gate time.

Hold-off requirements: $> +2.4$ V prevents data transfer to buffer storage.

Chassis connector: special Hewlett-Packard manufactured connector assembly. (See Accessories Available below.)

Operating temperature range: 0°C to 50°C.

Remote operation: single line for function, slope and multiplier; 4-line/digit for N. Remote enable line when activated, overrides front panel switches. REM'T indicator illuminated.

Remote line requirements: compatible with DTL and TTL integrated circuits.

Connectors: BNC inputs. Remote Function HP 1251-0292 (Cinch or Amphenol female 57-40240). ‡

Power requirements: 115 or 230 V $\pm 10\%$, 50 to 400 Hz, 35 W maximum.

Weight: net 12 lbs (5.5 kg); shipping 17 lbs (7.8 kg).

Price: Model 5330A, \$1200; Model 5330B, \$1550.

Dimensions: 16 $\frac{3}{4}$ " (425 mm), 11 $\frac{1}{4}$ " (286 mm) deep, 3-15/32" (88.2 mm) high.

Accessories available

HP Cable 10513A (6 ft, 183 cm) to connect to HP 4050B Digital Recorder. ‡ Price, \$65.

Option 001: Presettable Offset Counting (Preset-Reset). Counter resets to number dialed into 5 decade digit switches. Thus, counting starts from that number rather than 0. \$100.

Option 002: remote N switch connector. ‡ \$50.

Option 003: remote R switch connector. ‡ \$50.

Option 004: remote L1 and L2 connectors. ‡ (5330B only). \$100.

Specials: some of the many modifications are:

- 6- or 7-digit of readout for both models.
- 6-digit preset for Option 001 with 6 or 7 digit readout for both models.
- Single 5-digit preset limit control for Model 5330B.
- 6-digit single or dual preset limits for Model 5330B.
- Delete the preset time base from either model.
- Add standard decade divider time base to any model.
- Extend M divider to 8 decades.

†Other choices on special order.

‡Mates with HP 1251-0293 (male Amphenol 57-30240).

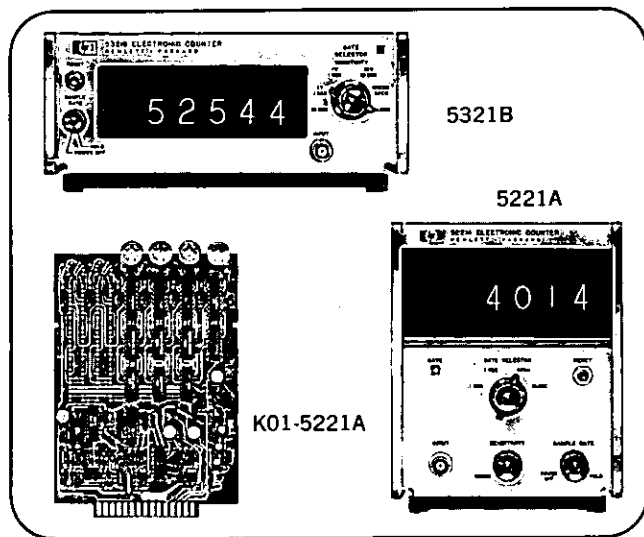
FREQUENCY COUNTERS



ELECTRONIC COUNTERS

Low cost, IC, modular 10 MHz counters

Models 5221A/B, 5321A/B, H01-5321A, K01-5221A — K04-5221A



Advantages:

- High count rate at low price
- Compact, rugged, lightweight
- Blanking of insignificant zeros
- Crystal controlled gate in some models
- BCD output is standard in some models

These four HP counters make extensive use of integrated circuits resulting in instruments which are lightweight, compact, reliable in service, and low cost. They feature a greater frequency range and more measurement versatility than were formerly available in low-cost counters. All four counters have a sinusoidal frequency measurement range of 5 Hz to 10 MHz. Minimum input sensitivity over this range is 100 mV with an input impedance of 1 M Ω shunted by 30 pF. Pulses can be counted at repetition rates over this range and at any lesser rate. Longlife neon digital display tubes provide a bright and very legible readout.

Use of integrated circuits in these counters made possible the incorporation of sophisticated display and storage features not usually found in such low cost instruments. Readout storage provides a continuous display of the most recent measurement which is held even while the instrument is gating for a new count. The display changes only if the new count differs from the old. A unique blanking feature suppresses the display of all unwanted zeros to the left of the count total. Blanking and display storage can be disabled with a rear panel switch. Models 5221B and 5321B have, in addition, BCD output in the 8-4-2-1 code.

A sample rate control sets the length of time between counts. It is adjustable from approximately 50 ms to 5 s, and is independent of gate time. A hold position allows the display to be held indefinitely. All four counters include a check function where the counter counts its own time base for time interval measurements and for reassurance of proper operation of the instrument.

In electrical design Models 5221A and 5321A are identical; and Model 5221B is electrically the same as Model 5321B. For each of these versions there are available two types of cabinets. Models 5221A and 5221B are housed in HP's standard 1/3 width module enclosures, while Models 5321A and 5321B are housed in HP's standard 1/2 width module enclosures. Thus, they may be mounted in a variety of combinations using the

HP 5060 Series of adapter frames, filler panels, and accessory drawers (refer to Modular Enclosure Systems in this catalog). Up to four units may be installed in a single adapter frame.

The lower cost 5221A/5321A Counters make frequency and time interval measurements using the power line frequency as a time base. A crystal time base is optional. For frequency, gate times of .1 s and 1 s are available, and with the gate open, input pulses are totalized. Time interval is measured by controlling gate time externally at a rear panel connector.

Models 5221A and 5321A include a 4-digit display as a standard feature. When the count is higher than can be totally displayed, the readout is the 4 least significant figures. Optional displays of 5 and 6 digits are offered. With the .1 s time base for 4, 5, and 6 digits respectively the maximum frequencies for full display are 99.99 kHz, 999.99 kHz, and 9.99999 MHz.

Models 5221B and 5321B Counters include a high quality room temperature quartz crystal time base with an aging rate of less than 1 part in 10⁶ per month. Also featured are a calibrated 3-decade sensitivity switch and selectable gate times from .01 s to 10 s for frequency measurements. Also the gate may be opened and closed manually for totalizing input pulses. Time interval is measured by controlling gate time externally at a rear panel connector. The ratio of two frequencies may be measured: a switch replaces the internal time base with the external signal source for gate control, inserted at the rear panel. The gate selector divides this external time base signal in decade steps of 10¹, 10², 10³, and 10⁴.

Models 5221B and 5321B include a 5-digit display as standard with the option of a 6-digit display. With .01 s gate time and the standard 5-digits the instruments will display the count fully up to 10 MHz with a 100 Hz resolution. A 6-digit display and .1 s gate time will give the full count up to 10 MHz at a 10 Hz resolution.

H01-5321A

Measures high frequencies at minimum cost; e.g. monitors frequency of HP 8601A, a 0.1 to 110 MHz generator/sweeper with a divided by 10 auxiliary output. It is similar to the 5321A with Option 002 and Option 003 with the following exceptions: guaranteed to count to 11 MHz; gate times of .01 s and .1 s; and rear panel BNC paralleled with input connector. Price: \$750.

K01-5221A to K04-5221A

These are counter boards for built-in use. Models K01-5221A, K02-5221A, and K03-5221A are identical to the main board used in the 5221A/5321A Counter with 4, 5, and 6 digit displays, respectively. The same features are offered except for off-board controlling switches, controls, and input amplifier. Additional board variations are also available (see 5221A/5321A Data Sheet). Required inputs to the single printed board connector are: input signal to be counted between +3 V and +5 V amplitude, 40 ms minimum pulse width, less than 10 ns rise and fall times; 5.1 V dc at 750 mA, 170 V dc at 1.5 mA for display tubes; 9 V rms at 60 Hz for the time base.

Model K04-5221A input amplifier board gives the same input characteristics as the 5221A Counter for the above counter boards. It eliminates the need for preshaping input signals and provides a 1 M Ω , 30 pF input impedance.

Prices: K01-5221A	\$300
K02-5221A	\$350
K03-5221A	\$400
K04-5221A	\$ 30

Specifications

Models 5221A, 5321A

Frequency measurement

Range: 5 Hz to 10 MHz.*

Input: .1 V rms max. sensitivity; 1 M Ω /30 pF.

Gate time: 1 s and 0.1 s derived from 60 Hz line frequency.

Accuracy: ± 1 count \pm power line frequency accuracy. (Line frequency accuracy is typically better than 0.1% for commercial power in the U.S.)

Time interval measurement

Range: 1 to 9999 counts at 1/60 s each (1 μ s with Opt. 03).

Input: with GATE SELECTOR switch in OPEN, grounding EXTERNAL GATE BNC connector closes gate.

Frequency counted: 60 Hz (1 MHz with Opt. 03).

Accuracy: ± 1 count \pm time base accuracy \pm accuracy of external gate control signal.

Readout: multiply reading by 16.7 for ms interval.

Reset: press front panel RESET switch to reset counter to zero after each reading.

Time base: 60 Hz power line frequency.

General

Display: 4 digits (5 and 6 available) with display storage, and automatic blanking of leading zeros. Rear panel switch disables blanking and display storage.

Sample rate: 50 ms to at least 5 s. Automatic or manual reset.

Signal input

Sensitivity: .1 V rms sine wave maximum sensitivity from 5 Hz to 10 MHz.

Pulses: 300 mV peak voltage (internal control adjusts for positive or negative pulses); 50 ns minimum pulse width.

Impedance: approximately 1 M Ω shunted by 30 pF.

Attenuation: continuous attenuator on front panel for counting from 100 mV to 250 V rms (approx.).

Overload: at maximum sensitivity, input should not exceed 3.5 V rms to retain rated input impedance. Damage level is 15 V rms maximum sensitivity and 250 V rms at minimum sensitivity.

Self check: counts power line frequency (crystal frequency with Option 03).

Operating temperature range: 0°C to 50°C.

Power requirements: 115 or 230 V $\pm 10\%$, 60 Hz, 12 W max.

Weight: net 5¼ lbs (2,4 kg); shipping 7¾ lbs (3,5 kg).

Accessories supplied: 7½ feet (231 cm) power cord. HP 10503A, 4 feet (122 cm), 50 Ω BNC to BNC cable.

Price: HP Model 5221A, \$425; 5321A, \$425.

Dimensions:

5221A: 5½" (130 mm) wide, 6¾" (155 mm) high, 8" (203 mm) deep.

5321A: 7¾" (197 mm) wide, 3" (76 mm) high, 11" (279 mm) deep.

Options

001: 5-digit display, add \$75.

002: 6-digit display, add \$125.

003: 1 MHz crystal time base (same as 5221B/5321B), add \$100.00.

004: noise rejection (100 kHz bandwidth), no charge.

010: 50 Hz operation, add \$25.

5221B, 5321B

Frequency measurement

Range: 5 Hz to 10 MHz.*

Input: .1 V rms sensitivity; 1 M Ω /30 pF.

Gate time: rotary switch; .01, .1, 1, 10 seconds.

Accuracy: ± 1 count \pm time base accuracy.

Readout: 5 digits; 6 digits (Option 01).

*Sinusoidal signal range for rated sensitivity. Pulses can be counted over this range and at any lesser repetition rate.

Ratio measurement

Displays: M x f_a/f_b ; M can be 10⁴, 10⁵, 10⁶, 10⁷.

Range: f_a : 5 Hz to 10 MHz; f_b : 1 kHz to 1 MHz.

Sensitivity: f_a : 0.1 V rms/1 M Ω ; f_b : 1 V rms/1 k Ω .

Accuracy: ± 1 count of $f_a \pm$ trigger error of f_b .

f_b applied to EXT-TIME input on rear panel.

f_a is applied to INPUT on front panel.

Time interval measurement

Range: 5 μ s to 99,999 μ s (5 digits), 5 to 999,999 μ s (6 digits).

Input: with GATE SELECTOR switch in OPEN, grounding EXTERNAL GATE BNC connector closes gate.

Frequency counted: 1 MHz.

Accuracy: ± 1 count \pm time base accuracy \pm accuracy of external gate control signal.

Readout: time interval in μ s.

Reset: press front panel RESET switch to reset counter to zero after each reading.

Time base

Crystal frequency: 1 MHz.

Stability: aging rate: $<|1|$ part in 10⁶/month; Temperature ± 3 parts in 10⁵ (0°C to 50°C) ± 5 parts in 10⁶ (10°C to 40°C); Line Voltage: $<\pm 1$ part in 10⁶ for $\pm 10\%$ variation in line voltage.

Output frequencies: 1 MHz, 3 V p-p open circuit, 100 Ω .

External input: sensitivity: 1 V rms into 1 k Ω (10 V rms max).

Range: 1 kHz to 1 MHz.

General

Display: 5 digits (6 optional). Display storage and blanking are standard. Rear panel switch disables both.

Sample rate: 50 ms to at least 5 s, automatic or manual reset.

Signal input: sensitivity: 0.1 V rms sine wave from 5 Hz to 10 MHz. Stepped attenuator on front panel (.1, 1, 10 V rms) permits counting from 0.1 V to 300 V rms (approx.); Pulses: .3 V p-p voltage; internal adjustment for + or - pulses; 50 ns min. pulse width. Impedance: 1 M Ω shunted by 30 pF.

Overload level: input not to exceed 100 times attenuator setting to retain input impedance. Damage level: 15/300/300 V at attenuator settings of 0.1/1/10 V.

Self-check: counts 1 MHz for selected gate time.

Digital output: code: 8-4-2-1 "1" level positive; "0" Level: 0 V open circuit, 5.1 k Ω ; "1" Level: 5 V open circuit, 7.6 k Ω ; Reference Levels: Ground, +5 V. Print Command: Step from 5 V to 0 V, dc coupled; 5 k Ω at 5 V. Hold-off Requirements: >2 V dc inhibits gate opening; 56 k Ω .

Chassis connectors: special HP-manufactured 36-pin connector consisting of: 1 each HP part Nos. 1251-0334 and 1251-1115; 2 each 10513-4001.

Operating temperature range: 0°C to 50°C.

Power requirements: 115 or 230 V $\pm 10\%$, 50 — 400 Hz, 17 W max.

Weight: net 5.5 lb (2,5 kg); shipping, 8 lb (3,6 kg).

Accessories furnished: power cord 7½ feet (231 cm) long. HP 10503A, 4 feet (122 cm), 50 Ω BNC to BNC cable.

Price: Models 5221B and 5321 B, \$775.

Dimensions:

5221B: 5½" (130 mm) wide, 6¾" (155 mm) high, 8" (203 mm) deep.

5321B: 7¾" (197 mm) wide, 3" (76 mm) high, 11" (279 mm) deep.

Option 001: 6 digit display, add \$75.

Option 002: noise rejection (100 kHz bandwidth), no charge.

Accessories available: HP cable 10513A to connect to 562A and 5050A Digital Recorders. Price: \$65.00.

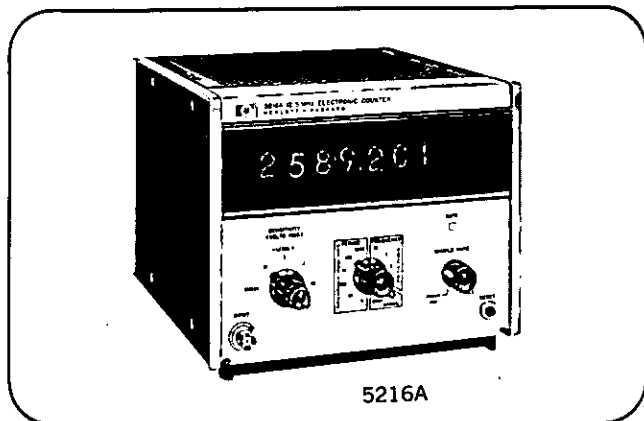
FREQUENCY COUNTERS



ELECTRONIC COUNTER

Versatile, IC, 12.5 MHz counter

Model 5216A



Advantages:

Precision measurements: frequency, period, multiple period average, ratio, multiple ratio, time interval
 Crystal time base
 10 mV sensitivity
 Blanking of insignificant zeros
 BCD output (standard)

Model 5216A is a general purpose counter capable of a variety of measurements. It is designed extensively with integrated circuits providing the advantages of smaller size, less weight, and higher reliability.

The 5216A has a maximum counting rate of 12.5 MHz. Minimum input sensitivity is 10 mV rms which may be raised in decade steps to 10 V rms with a front panel control. Gate times offered for frequency measurements are in decade steps from .01 s to 10 s, which are derived from a high stability quartz crystal oscillator. This counter will also measure single periods and average up to 10^5 periods.

Internal storage, which may be disabled if desired, results in a continuous display of the most recent measurement on the 7-digit readout. At the same time the information is available in 4-line BCD code at the rear panel.

The 5216A is housed in a standard $\frac{1}{2}$ module cabinet, which is convenient for bench use and easily rack mounted using the HP 5060-0797 adapter frame.

Specifications

Frequency measurement

Range: 3 Hz to 12.5 MHz.
Input: 10 mV rms sensitivity; 1 M Ω /50 pF.
Gate times: 10, 1, 0.1, 0.01 s.
Accuracy: ± 1 count \pm time base accuracy.
Readout: MHz and kHz with positioned decimal point.

Time interval measurement

Range: 10 μ s to 10 s.
Input: contact closure or saturated NPN transistor to ground. Signal duration ≥ 1 μ s. Current ≥ 2 mA. START signal must end before STOP signal begins. Time from STOP to next START: ≥ 30 ms for external reset or ≥ 30 ms + sample time for internal reset. Rear panel BNC inputs.
Frequency counted: 1 MHz internal, or external standard.

Period measurement

Range: 3 Hz to 1 MHz single period; to 2 MHz in multiple periods averaged.

Periods averaged: 1, 10, 10^2 , 10^3 , 10^4 , 10^5 .

Input: 10 mV rms max. sensitivity; 100 mV rms < 1 kHz.

Frequency counted: 1 MHz internal, or external standard.

Accuracy: ± 1 count \pm time base accuracy \pm trigger error.

Ratio measurement

Displays: $(f_1/f_2) \times$ multiplier; multiplier: 1- 10^5 .

Range, sensitivity: f_1 : 1 kHz to 10 MHz into external time base BNC connector, 1 V rms minimum into 1 K Ω . f_2 : 3 Hz to 1 MHz single period; to 2 MHz in multiple period; 10 mV rms sensitivity except 100 mV rms below 1 kHz.

Accuracy: ± 1 count of $f_1 \pm$ trigger error of f_2 .

Time base

Crystal frequency: 1 MHz.

Stability

Aging rate: $< \pm |1| \times 10^{-6}$ /month.

Temperature: $< \pm 5 \times 10^{-6}$ from $+10^\circ\text{C}$ to $+40^\circ\text{C}$;
 $< \pm 3 \times 10^{-5}$ from 0°C to $+50^\circ\text{C}$.

Line voltage: $< 1 \times 10^{-6}$ for $\pm 10\%$ change.

Output frequency: 1 MHz, 3 V p-p minimum open circuit; source impedance is 2 k Ω max.

External standard input: 1 kHz to 2 MHz sinewave, 1 V rms into 1 k Ω (10 V rms maximum).

General

Display: 7 digits, long-life Nixie[®] tubes.

Display storage, blanking: yes.

Reset: automatic or manual by pushbutton or remote.

Sample time: 50 ms to 5 s or hold until reset.

Signal input

Sensitivity: 10 mV rms max.; 30 mV peak pulse, min. width 40 ns.

Impedance: approx. 1 M Ω shunted by 50 pF.

Attenuation: step attenuator, .01, 0.1, 1, 10 V rms.

Trigger level adjustment: continuously variable within stepped attenuator ranges.

Overload: input voltage should be < 60 dB above attenuator setting or < 300 V rms damage level.

Self-check: works on all functions.

Digital output

Code: 8-4-2-1, "1" state positive; "0" level: 0 V nominal; "1" level: +5 V open circuit, nominal; source impedance: 7.5 k Ω maximum, each line.

Reference levels: ground; +5 V, low impedance.

Print command: step from 0 V to +5 V, dc coupled.

Hold-off requirements: voltage from -10 V to -15 V.

Chassis connector: accepts HP Cable 10513A with one special connector for the 5216A and one 50 pin Amphenol or Cinch type 57-30500-375, HP part number 1251-0086, male connector, for HP 5050B or 562A Digital Recorder.

Operating temperature range: 0°C to $+50^\circ\text{C}$.

Power requirements: 115/230 V $\pm 10\%$, 50 - 400 Hz, 20 W maximum.

Weight: net 7 lbs (3.1 kg); shipping 8 $\frac{1}{2}$ lbs (3.9 kg).

Accessories furnished: HP 10503A 4 feet, 50 Ω cable, BNC connectors. Detachable power cord 7 $\frac{1}{2}$ feet (231 cm) long, NEMA plug.

Dimensions: 7-25/32" (190 mm) wide, 6-3/32" (155) high, 11" (279) deep.

Price: HP Model 5216A, \$985.

REVERSIBLE COUNTER

Counts up, down at 2 MHz rate; very versatile
Model 5280A with 5285A Plug-in



FREQUENCY COUNTERS

This high performance, extremely versatile, reversible counter is an excellent choice for measuring positive and negative quantities in physical quantity measurement and control, and for frequency comparisons or drift measurements. It can be used with transducers such as interferometers and optical and magnetic encoders. Its two input channels ("A" and "B") have a range of dc to 2 MHz to prevent loss of count due to input data jitter. Superior trigger level controls accommodate a wide range of inputs, and drift of the differential dc input amplifiers is unusually low to provide accurate definition and retention of trigger points.

The 5285A is necessary for 5280A operation and must be ordered with it.

Algebraic A, B Mode

A: A input is totalized while the main gate is open.

A — B: Input A minus B is totalized, 1 MHz each channel, for the gate open period. The 1 MHz rate is retained even while reversing direction of count, and while passing through zero.

A + B: The input A plus the input B is totalized, dc to 1 MHz each channel, for the gate open period.

B: The B input is totalized, dc to more than 2 MHz, for the length of time the main gate is open.

An anticoincidence circuit prevents loss of counts that arrive simultaneously.

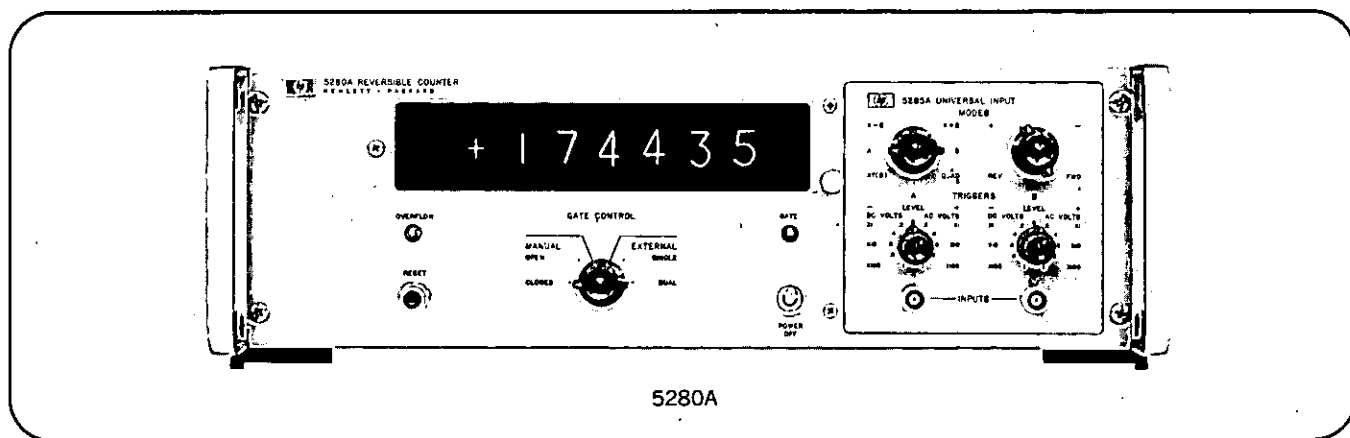
Af (B) Mode

A is counted forward when B input is more positive than its trigger level setting, and is counted in reverse when more negative. A unique gating system prevents the inherent read-out decade propagation delay from limiting the input frequency capability. The maximum input to channel A is 2 MHz even when the 7th and 8th digits (special order) have been added. Count direction can be reversed without error with 250 ns, min., between the reverse command and the next input pulse.

A Quad B Mode

This mode is designed for transducers having two outputs separated 90° in phase. "A" is totalized, up or down, depending upon phase relationship with B input. Count direction may be reversed at a 1 MHz rate.

Request Application Note 85 and 5280A Data Sheet for more data.



5280A

Specifications 5280A Reversible Counter (with 5285A Plug-In)

Range: dc to 2 MHz Channel A or Channel B when totalizing or for Af(B) Mode; to 1 MHz for A + B, A — B or A Quad B Modes.

Input channels (A and B)

Impedance: approximately 1 megohm, 75 pF shunt.

Sensitivity: 0.1 volt rms sine wave; 1 volt pulse, 0.2 μ s minimum width.

Trigger level: —100 to +100 volts, adjustable, independent controls on each channel.

Display: 6 long-life rectangular Nixie® tubes and \pm sign.

Overflow: front panel neon lamp and electrical signal (swing from +17 V to —13 V) show when count exceeds full scale.

Reset time: less than 10 μ s.

Gate control: manual or single or dual line remote (adjustable trigger level +10 V to —10 V, 1 V rms sensitivity, 100 k Ω /25 pF impedance rear panel).

Printer output: 4 line 1-2-4-8 BCD; "0" = —14 V, "1" = +10 V; 100 k Ω each line; 0 V reference.

Power: 115 or 230 volts \pm 10%, 50 to 60 Hz, 110 W.

Operating temperature: 0°C (32°F) to +65°C (+149°F).

Dimensions: 5¼" H, 16¾" W, 16⅜" D (132 x 425 x 416 mm).

Weight: net 29 lbs (13,2 kg); shipping 40 lbs (18,1 kg). Plug-in included.

Price: 5280A, \$1600; 5285A, \$500.

Option 001: 4 line BCD 4-2-2-1 "1" state positive in lieu of 8-4-2-1 "1" state positive. \$15 per decade.

Option H19: addition of 100 kHz internal time base allows gate times of 0.1 s, 1 s, and 10 s. The time base is the same as in the HP 5223L Counter (aging rate $< \pm 2 \times 10^{-6}$ /week).

Option H20: "Readout on the Fly" enables the count to be saved in an internal buffer storage register on command (within 10 μ s) without interrupting counting.

Special order: 7 or 8 digits of readout and many other items; please consult Hewlett-Packard.

FREQUENCY COUNTERS



PRESET CONTROLLERS/COUNTERS

Versatile, accurate, wide range

Models 5331A/B, 5332A/B

These instruments count events and issue output signals when preset count values are reached; the 5332A and 5332B also measure and limit-detect input rates or frequencies. Except for data normalizing and "preset reset" (See Models 5330A/B), they provide practically all the features required in digital control and measurement: programmability, three versatile operating modes, wide frequency and voltage counting range, very fast recycling, high input impedance and sensitivity, lighted overflow indicator, readout storage for easy reading, self-checking, and BCD output for recording. The counters can also generate a wide range of very precise time intervals (or delays) and pulse trains.

5331B and 5332B have two sets of preset limits, while 5331A and 5332A have but one set.

5332A and 5332B have crystal time bases to permit measuring and limit-detecting frequencies (or rates) of random or periodic events for precise gate times of .001, .01, .1, 1, and 10 seconds. They also measure and limit-detect single and multiple frequency ratios as well as time intervals from 10 μ s to 1.0 second. In contrast, the 5331A/B are strictly preset controllers and do not have these additional capabilities.

Use as a delay generator

All models can generate time intervals (or delays) with great accuracy and adjustability. Here, the Hold mode is

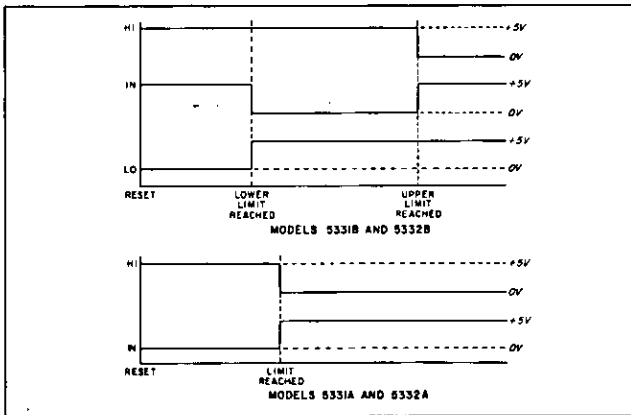


Figure 1. Control line outputs in MANUAL and HOLD modes.

used, the counter counts a precision "counted frequency" (described in next paragraph), and the interval or delay is defined by changes in control line output levels occurring when the count preset on the limit switches is reached (Fig. 1). For example, if the "counted frequency" is 100 kHz and if the lower limit switch is at "1000", the output level changes after 1000 cycles of 100 kHz, or 0.01 s. Thus, limit switch setting represents interval in tens of μ s.

In 5332A/B the "counted frequency" is 100 kHz from the internal precision quartz crystal time base. For longer intervals, 1 kHz or 10 kHz (or an external signal) are substitutable by minor wiring change. 5331A/B have no time base, so an external "counted frequency" (500 kHz max.) must be supplied.

Use as a pulse generator

In this use, the counters generate precision pulse trains. Principle of operation is similar to when used as a delay generator except that the counter RECYCLE mode is used. The counter counts a fixed frequency and voltages on the control lines change when the preset limit (or limits) are reached (Fig. 2). The counted signal is a precise 100 kHz from the time base in the 5332A/B (1 or 10 kHz available by minor change); in 5331A/B an external frequency must be used.

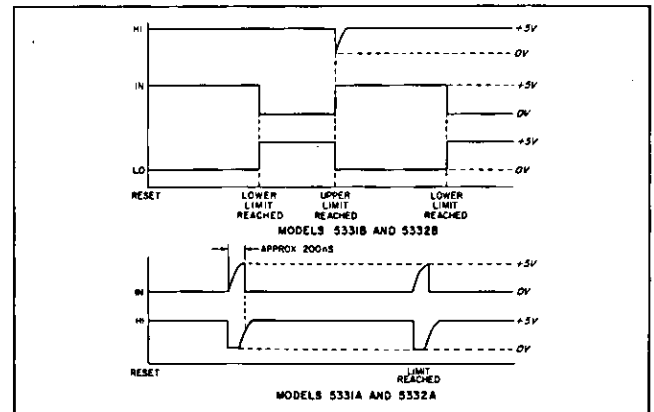
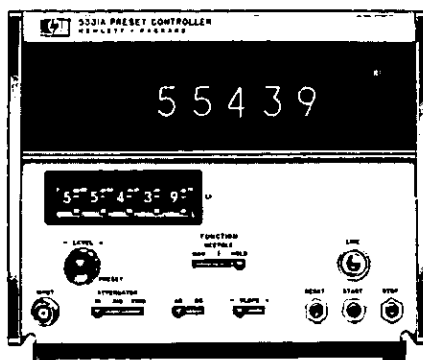
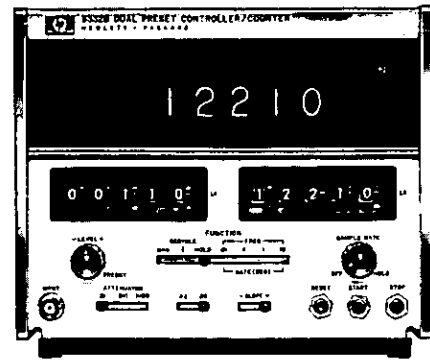


Figure 2. Control line outputs in RECYCLE mode.



5331A



5332B

Specifications 5332A and 5332B only

Frequency measurements

Range: 0 to 10 MHz for measuring; 0 to 2 MHz for limit detecting.

Gate times: 0.01, 0.1, 1, 10 seconds.

Accuracy: ± 1 count \pm time base accuracy.

Time interval measurements (MANUAL mode)

Range: 10 μ s to 1.0 second.

Input:

Start/stop: START/STOP pushbuttons or remote.

Frequency counted: 100 kHz with rear panel OPERATE-CHECK switch at CHECK (1 and 10 kHz available by minor wiring change; or 1 MHz is available at FREQ. STD. connector with rear panel switch at OPERATE).

Accuracy: ± 1 count \pm time base accuracy \pm any error in external trigger circuit.

Readout: time interval in microseconds (counting 100 kHz).

Ratio measurements (FREQUENCY mode)

Display: $f_1/f_2 \times$ multiplier M. M can be 10^4 , 10^5 , 10^6 , 10^7 .

Range and sensitivity:

f1: 0 to 10 MHz for measuring; 0 to 2 MHz for limit detecting. 0.1 V rms into 1 M Ω /30 pF.

f2: 1 kHz to 1 MHz. 1 V rms into 1 k Ω .

Accuracy: ± 1 count \pm trigger error of f_2 .*

Input:

f1: INPUT BNC.

f2: 1 kHz to 1 MHz. 1 V rms into 1 k Ω .

Time base

Frequency: 1 MHz crystal oscillator.

Stability:

Aging rate: $< |0.5|$ parts in 10^6 /month.

Temperature: $< \pm 3$ parts in 10^5 (0° to 65°C). $< \pm 5$ parts in 10^6 (10° to 40°C).

Line voltage: $< \pm 1$ part in 10^6 for $\pm 10\%$ line variation.

Output: (for external use).

Frequency: 1 MHz. Voltage: 3 V p-p open circuit.

Impedance: 100 Ω source.

External input (to use external frequency for time base):

Sensitivity: 1 V rms into 1 k Ω , 1 kHz to 1 MHz.

All models

Display: 5 digits (4 and 6 optional).

Overflow: indicator glows when count exceeds 99999.

Sample rate (5332A and 5332B only): 1 ms to 5 s or HOLD.

Reset: RESET pushbutton or remote.

Signal input:

Frequency range for rated sensitivity:

Mode	Freq.	Manual	Hold	Recycle
dc coupled, 0 Hz to:	2 MHz	2 MHz	1 MHz	500 kHz
ac coupled, 10 Hz to:	2 MHz	2 MHz	1 MHz	500 kHz

Impedance: 1 M Ω shunted by 30 pF.

Sensitivity: 0.1/1/10 V rms sine wave. 0.3 V p-p pulse, 50 ns minimum pulse width.

Maximum input: 120 V rms, X1 range; 250 V rms, X10 range; 500 V rms, X100 range.

Trigger level: PRESET to trigger at 0 V or adjustable: ± 1 V on X1 range; ± 10 V on X10 range; ± 100 V on X100 range.

Slope: independent selection of positive or negative slope.

Operating modes (selected at front panel or remotely)

Manual: control outputs are generated when the count reaches the number set on the limit switch or switches, but counting continues until reset manually.

Hold: control outputs are generated when the count reaches any preset limit; counting stops when the limit number is reached in 5331A, 5332A or when the greater limit number is reached in 5331B, 5332B.

Recycle: control outputs are generated when the count equals

any preset limit; controller automatically resets to zero when the limit number is reached in 5331A, 5332A or when the greater limit is reached in 5331B, 5332B. The counting cycle then repeats.

Frequency: see Frequency Measurements.

Control line outputs

Nominal levels: +5 V and 0 V per Figure 1. Source impedance 2.5 k Ω for +5 V; can sink 10 mA at 0 V.

Cycling: per Figures 1 and 2: When counter is reset, voltages return to the "pre-lower limit" values. Exception: when in FREQUENCY mode and with STORAGE switch on, the control line voltages "latch"; that is, they are stored and will change only if some future measurement falls into a different limit condition than the previous measurement (in FREQUENCY mode and with STORAGE off, control lines return to "pre-lower limit" values when counter is reset).

In RECYCLE, counter resets when count exceeds larger limit (the only limit in 5331A, 5332A); also, HI line drops to 0 V momentarily.

Digital output (corresponds to readout display)

Code: 1-2-4-8 BCD, "1" state positive. "0" level: 0 V. "1" level: 5 V.

Print command: step from +5 V to 0 V, dc coupled; impedance, 5 k Ω at +5 V.

Reference levels: ground and ± 5 V; negligible impedance.

Hold-off requirements: > 2 V dc; 56 k Ω input impedance.

Operating temperature: 0° to 50°C .

Remote operation: separate line for RESET, START, STOP and FUNCTION (switch set to MANUAL) operated by DTL or TTL circuits (saturated NPN transistor to ground) or contact closure to ground. See Options.

Also, START and STOP lines can be connected together and driven as a single line with pulses 500 ns wide; first pulse starts counting, second pulse stops it.

5331A/B also have an additional control line; counting occurs as long as this line is held "low".

Power requirements: 115/230 V, 50 to 400 Hz, 22 W.

Weight: net, 8 lbs (3.6 kg); shipping, 10 lb (4.5 kg).

Dimensions: 7-25/32" W x 6-3/32" H x 8.0" D (190 x 155 x 203 mm).

Prices: 5331A, \$950; 5331B, \$1050; 5332A, \$1100; 5332B, \$1200.

Accessories available: HP 10513A Cable to connect HP 5050B Digital Recorder. Price, \$65.

Option 001: add 1 digit of readout and limit switches (6 total), add \$100.

Option 002: delete 1 digit of readout and limit switches (4 total), \$75 less.

Option 003: remote control of 1 limit setting (4-line BCD), 5331A, 5332A, add \$35.

Option 004: remote control of 2 limit settings (4-line BCD), 5331B, 5332B, add \$50.

Other variations (contact closure limit outputs, etc.) on special order.

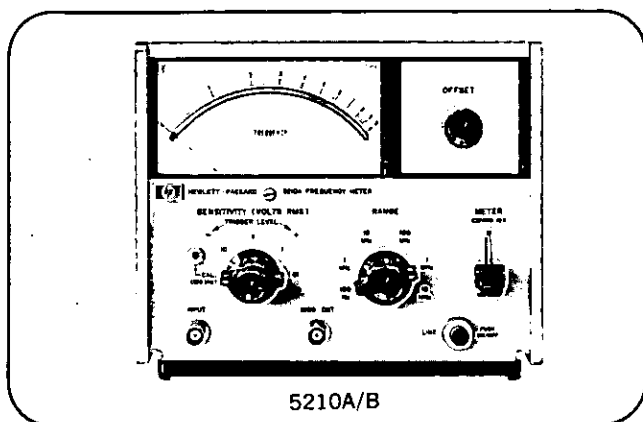
*Trigger error is caused by input signal noise and finite rise time, and it decreases as signal noise and rise time decrease or as signal amplitude increases. For a 100 mV sine wave input signal of < 1 mV rms noise content (i.e., > 40 dB signal-to-noise ratio) trigger error is $\leq 0.3\%$ (\pm M multiplier for ratio measurements) when level control is set to trigger on sinusoidal input signal zero crossing. Trigger error is extremely low for inputs that are clean pulses of short rise time.

FREQUENCY COUNTERS



FREQUENCY METER

Wideband, highly linear FM Discriminator
Model 5210A



The Model 5210A Frequency Meter/FM Discriminator directly measures frequency or repetition rate of signals from 3 Hz to 10 MHz, independent of input voltage waveform. A sensitivity control allows for measurement of noisy signals. The special log linear scale offers an accuracy of 1% of reading from 10% of full scale up. With calibrated offset (Option 001) the accuracy is up to 0.2% of full scale.

The 5210A is also a wideband highly linear FM Discriminator with a 3 dB output bandwidth of better than 1 MHz for precise measurements on FM and PM signals. With output filters (HP 10531A) frequency deviation, modulation index, frequency response, distortion, incidental FM, and FM noise can be determined as well as "flutter" and "wow" to better than 100 dB below carrier frequency.

For more application details see HP Journal, March, 1967, and HP Application Note 87.

Specifications, 5210A

Frequency range: 3 Hz to 10 MHz in six decade ranges from 100 Hz full scale to 10 MHz full scale.

Expanded scale: with a continuously adjustable OFF-SET control, meter and recorder output display any 10% of full scale expanded to full scale.

Sensitivity: maximum sensitivity of 10 mV rms from 20 Hz to 10 MHz increasing to 200 mV at 3 Hz with four attenuator ranges of 0.01, 0.1, 1.0 and 10 V.

Input impedance: 1 M Ω shunted by 30 pF; used with HP 10003A 10:1 divider probe 10 M Ω shunted by 10 pF.

Accuracy:

Discriminator output current: 0.2% of reading below 1 MHz, 0.3% of reading on 10 MHz range.

Meter: 1% of reading from 10% of full scale to full scale.

Expanded scale: 0.1% of full scale for differential frequency readings.

Calibration: crystal calibration oscillator at 100 kHz accurate to $\pm 0.01\%$.

Line voltage and frequency: changes in line voltage of $\pm 10\%$ and frequency of 50-1000 Hz cause less than 0.05% change in output.

Temperature: frequency reading changes less than 0.02%/°C 100 Hz to 1 MHz ranges, 0.04%/°C 10 MHz range from 0 to +55°C.

Recorder output:

Level: potentiometer outputs of 10 mV and 100 mV, adjustable from 9 mV to 11 mV and 90 mV to 110 mV for full scale; galvanometer output 1 mA into 2 k Ω max for full scale. Adjustable $\pm 10\%$ for 1 k Ω to 2 k Ω loads.

Linearity: 0.025% of full scale 100 Hz to 100 kHz ranges; 0.05% of full scale 1 MHz range; 0.1% of full scale to 10 MHz range.

Accuracy: same as discriminator output current above.

Time constant: approximately 100 ms.

Discriminator output:

Level: adjustable 0.8 to 1.2 V for full scale.

Linearity: 0.025% of full scale 100 Hz to 100 kHz ranges; 0.05% of full scale 1 MHz range; 0.1% of full scale 10 MHz range.

Bandwidth: 3 dB down at greater than 1 MHz.

Residual FM noise: rms line frequency components below 300 Hz are 100 dB below the 1 V full scale output. At other frequencies the rms noise deviations are at least 120 dB below the carrier frequency when the noise is measured in a 6 Hz bandwidth.

Power requirements: 115 or 230 V ac $\pm 10\%$ 50-1000 Hz at less than 10 W.

Dimensions: 7-25/32" wide, 6-3/32" high and 11" deep; (190 x 155 x 279 mm).

Weight: net, 9 lbs (4 kg); shipping, 11 lbs (4.8 kg).

Price: HP 5210A \$625; Option 001 add \$125.

Option 001, Calibrated Offset

General: the calibrated offset provides for display of any of the 10 major divisions on a separate full meter scale (the EXPAND scale). This allows frequency measurements to be made with higher accuracy than is possible using the meter in the NORMAL mode.

Discriminator output: same as above except bandwidth is 3 dB down at greater than 750 kHz.

Accuracy: 0.2% of full scale (range switch setting) for 100 Hz to 1 MHz ranges; 0.3% of full scale (range switch setting) for the 10 MHz range.

Temperature: the accuracy specification is increased by 0.01%/°C of reading on the 100 Hz to 1 MHz ranges and 0.03%/°C of reading on the 10 MHz range from 0°C to 55°C for deviations from 25°C when zero and self-calibration adjustments are made at the ambient temperature.

Price: add \$125 to price of 5210A.

HP 10531A, Filter Kit

General: the HP 10531A Accessory Filter Kit provides a series of three plug-in low pass filters which can be adjusted to cover frequencies from 100 Hz to 1 MHz. These filters provide rejection of carrier and carrier harmonics while passing modulation components. Thus it is possible to measure demodulated signal components up to 20% of the carrier frequency using the HP 302A or 310A Wave Analyzers or similar narrow band voltmeters on their most sensitive ranges. By lowering filter cut-off frequency or in case of wide deviation signals measurements may be made using less selective voltmeters or other instruments.

Frequency range: the upper cut-off frequency can be adjusted from 100 Hz to 1 MHz. The lower cut-off frequency will vary up to 10 Hz, depending on load resistance used with the filter.

Carrier rejection: with the output filter the carrier and its harmonics are less than 30 mV rms total when the filter cut-off is less than 15% of the carrier frequency and drops to 1.0 mV maximum for filter cut-off frequencies less than 5% of the carrier frequency.

Output impedance: nominal 600 Ω . However, matched loads are not required. Low frequency cutoff for 100 Ω load, <6 Hz; for 1 K Ω load, <3 Hz.

Output level: zero to full scale deviations give 1 V open-circuit at discriminator output.

Price: HP 10531A \$175.

FREQUENCY-TIME STANDARDS



FREQUENCY & TIME STANDARDS

Hewlett-Packard offers Frequency & Time Standards systems which provide accurate frequencies, time intervals and timekeeping capabilities. Further, Hewlett-Packard systems provide means for comparing these quantities against national standards such as the National Bureau of Standards (NBS). Units of frequency or time cannot be kept in vault for ready reference. They must be generated for each use, hence must be regularly compared against recognized primary standards.

Frequency and Time Standard systems manufactured by Hewlett-Packard are used for control and calibration at observatories, national centers for measurement standards, physical research laboratories, missile and satellite tracking stations, manufacturing plants and radio monitoring and transmitting stations.

Four performance characteristics are of vital interest to users of frequency and time measurement equipment and standards: accuracy, precision, stability and reliability. Hewlett-Packard systems offer these four in ample measure, plus operational simplicity.

Types of frequency standards

At the present time, four types of frequency standards are in common use. These are:

1. The atomic hydrogen maser.
2. The cesium atomic beam controlled oscillator.
3. The rubidium gas cell controlled oscillator, and
4. The quartz crystal oscillator.

Of these four standards, the first two are referred to as primary frequency standards and the last two as secondary frequency standards. The distinction between a primary standard and a secondary standard is that the primary standard does not require any other reference for calibration; whereas the secondary standard requires calibrations both during manufacturing and during use as well as at certain intervals depending on the accuracy desired. Hewlett-Packard is currently manufacturing 3 of these frequency standards. The models are: for the cesium beam frequency standard, the HP Model 5061A; for the rubidium standard, the HP Model 5065A; and for the quartz crystal oscillators, the HP Model 105A. Table 1 gives a summary of the advantages and

limitations for these 4 types of frequency standards and the following paragraphs give more detailed descriptions.

Atomic hydrogen maser

The hydrogen maser is an active oscillator powered by energy from the hydrogen atom. The information extracted from it is the frequency that is characteristic of the energy emitted by the atoms as they change energy states. In this respect the hydrogen maser differs from the more widely used atomic frequency sources, i.e., from cesium-beam-tube-controlled oscillators and rubidium-gas-cell-controlled oscillators. In these standards, the cesium and rubidium devices are passive elements of frequency-control loops, while the actual outputs are generated by quartz oscillators.

The hydrogen maser shares with cesium standards the property of high intrinsic reproducibility, which means that it can be built and aligned without reference to any other standard. It can therefore serve as a primary frequency standard.

hydrogen maser has not yet proved to be a practical frequency source for most applications. Invented about nine years ago, it is still at an early stage of development, and early models have been large, heavy, and costly.

Development work is continuing. Recently, prototype hydrogen masers have been built that are about half as large and half as heavy as previous versions. Further improvements are possible, and there is reason to expect that within the next few years the hydrogen maser will become a practical frequency standard for use where the highest attainable precision is needed.

Cesium beam frequency standard

Cesium beam standards are in use wherever the goal is very high accuracy primary frequency standard. In fact, the NBS frequency standard itself is of the cesium beam type. The cesium beam standard is an atomic resonance device which provides access to one of nature's invariant frequencies in accordance with the relationship of quantum mechanics.

TABLE 1
Sources of Advantages and Limitations for Frequency Standards

Standard	Principal construction feature	Principal advantage	Principal limitation
Atomic Hydrogen Maser	Active maser with coated wall storage cell having longest atomic interaction time	Greatest intrinsic reproducibility, long and short-term stability. Primary standard capability	Size and weight
Cesium Atomic Beam Resonator Controlled Oscillator	Atomic beam interaction with fields—minimum disturbance of resonating atoms due to collisions and extraneous influences	High intrinsic reproducibility and long-term stability. Designated as primary standard for definition of time interval	Short-term stability
Rubidium Gas Cell Resonator Controlled Oscillator	Gas buffered resonance cell with optically pumped state selection	Compact and light weight. Very high degree of short-term stability	Requires calibration against primary standard
Quartz Crystal Oscillator	Piezoelectrically active quartz crystal with electronic stabilization	Very compact, light and rugged. Inexpensive	Long term stability. Requires calibration against primary standard

The atomic hydrogen maser is the most stable type of frequency source known. Its short-term stability, or spectral purity, is excellent. In long-term measurements, its frequency uncertainty is less than one part in 10^{11} , which corresponds to a time uncertainty of one second in three million years.

However, despite its high stability, the

The cesium standard is a true primary standard and requires no other reference for calibration.

The HP Model 5061A is a portable cesium beam standard proved capable of realizing the cesium transition frequency to the same levels of accuracy and long-term stability usually achieved by large-scale laboratory models.

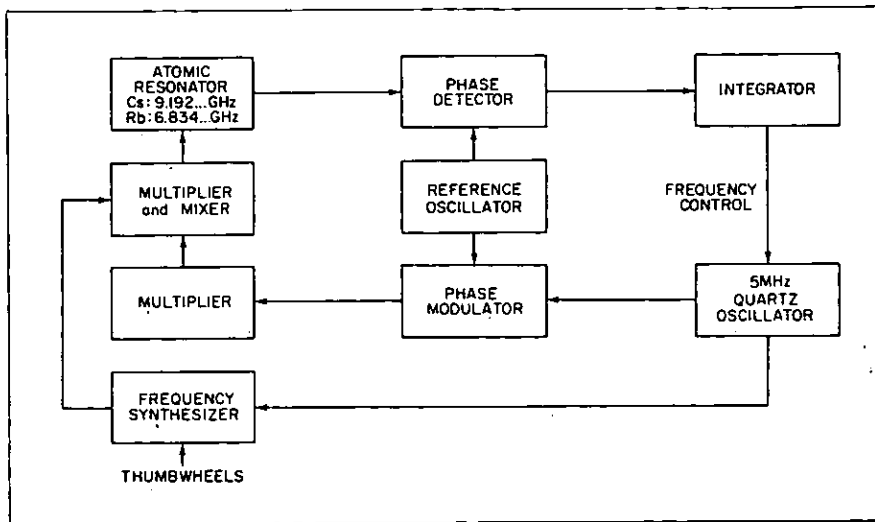


Figure 1. Typical atomic standard phase-lock loop system.

The 5061A operates to keep an ultra stable quartz oscillator precisely "on frequency" via servo-control that refers, ultimately, to the center of the atomic resonance. The output signal is derived from the quartz oscillator, the cesium beam tube serves as its reference—and the two are linked by circuitry that includes means to adjust the frequency of the quartz oscillator to automatically compensate for its aging or drift. Figure 1 shows the block diagram of an atomic standard.

Rubidium vapor standard

Rubidium vapor or rubidium gas cell frequency standards feature a high order of both short-term and long-term frequency stability. Both are important for progress in certain fields such as deep-space communications, satellite ranging, and doppler radar. Also, rubidium standards are noted for being of small size.

Rubidium standards are similar to cesium beam standards in that an atomic resonant element prevents drift of a standard frequency quartz oscillator through a phase lock loop. Such a system is shown in Figure 1. Yet the rubidium type is a secondary standard. Since the atomic resonant frequency of a rubidium gas cell is dependent upon gas mixture and gas pressure in the cell, it must be calibrated and then it is subject to a small degree of drift. The drift is typically 100 times less than the best quartz crystal standard.

Quartz crystal oscillators

Quartz oscillators are used in virtually every frequency control application. They are an integral part of atomic standards and are used extensively as independent frequency sources for the less demand-

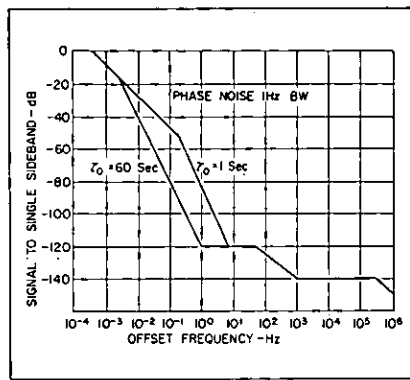


Figure 2. 5061A phase noise.

ing applications. The quartz oscillator designs have improved over the years to provide a relatively low cost, small size source of frequency.

However, an inherent characteristic of crystal oscillators is that their resonant frequency changes slightly as they age. This "aging rate" or "drift" of a well-behaved oscillator is almost constant. After the initial aging period (a few days to a month) the rate can be taken to be constant with but slight error. Over a long period, the accumulated error drift

could amount to a serious error. Thus, periodic frequency checks are needed to maintain a quartz crystal frequency standard.

Hewlett-Packard offers the Models 105A/B Quartz Oscillators rated at 5 parts in 10^{10} per day long term stability. Selected units can provide stabilities on the order of 5×10^{-11} per 24 hours. They also have very good short term stability rated at 5×10^{-12} rms for 1 s averaging times. Such stability (and, substantially better performance is attained under normal operating conditions) results from careful attention to all controllable factors such as selection of the highest quality crystals, their operation in precision temperature controlled ovens, and their incorporation into inherently stable circuits designed for low power dissipation within the crystal.

Spectral purity

Spectral purity is the degree to which a signal is coherent or, expressed in another way, a single frequency with a minimum of side band noise power. It is greatly desirable to have high spectral purity in a standard signal from two standpoints. One, when used as a frequency and time reference the short term perturbations will be less for higher accuracy. And two, in applications where the standard frequency is multiplied to very high or microwave frequencies the frequency spectrum of the signal will be reasonably narrow.

The signal and its frequency spectrum are analogous to a frequency modulated wave where the total power is constant. If the frequency multiplying device is broadband, the ratio of the total sideband power to the signal power increases as the square of the multiplying factor. For frequency multiplication the standard's signal-to-noise ratio will be degraded 6 dB per octave and 20 dB per decade.

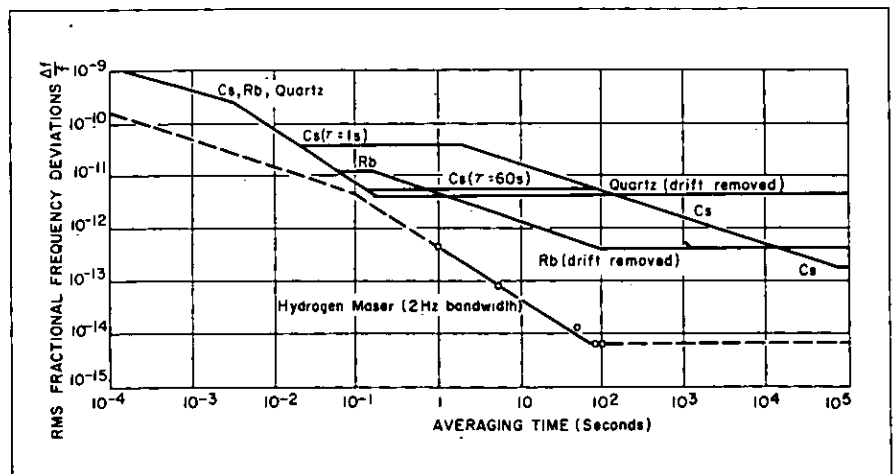


Figure 3. Short term stabilities of various frequency standards.

Hewlett-Packard oscillators are designed to give exceptional spectral purity. One method of indicating spectral purity is with a phase noise plot. Figure 2 shows the performance of the HP 5061A Cesium Beam Atomic Frequency Standard. (See Hewlett-Packard Application Note 52, "Frequency and Time Standards", Page 3-4 and 5-1 for details of noise measurement).

Stability



Long term stability refers to slow changes in the average frequency with time due to secular changes in the resonator and is usually expressed in fractional parts per unit of time. Short term stability refers to changes in average frequency over a time sufficiently short so that change in frequency due to long term effects is negligible. To be meaningful, this specification should reflect variation in frequency caused by unwanted components of noise and spurious signals.

A short term stability specification should include a statement of averaging time to be meaningful. The longer the averaging time used, the more deviation is obscured since the average must approach the mean or nominal output frequency in the long run. In comparing specifications for standards, one should keep these facts in mind.

Short term stabilities of the various standards offered by Hewlett-Packard are compared in Figure 3. The long term drift was removed from the curves so that the short term variations could be more readily recognized.

Long term stability, or long-term instability in the alternate sense, refers to gradual drift in average frequency due to changes in the resonator or changes in other components of the oscillator. For quartz oscillators this is often termed "aging rate" and specified in "parts per day". Rubidium standards being more invariant are specified in "parts per month." On the other hand, Cesium Beam Standards and Hydrogen Maser Standards are primary units having little or no change or drift. Therefore, these primary standards are given a specified accuracy to within which the frequency is guaranteed.

Frequency standards and clocks

Time standards and frequency standards have no fundamental differences—they are based upon dual aspects of the same phenomenon. The reciprocal of the interval is frequency. Frequency measurements are measurements of the number of cycles—counted one by one—per time interval (seconds). For precision

oscillators, a complete statement of frequency must include the time scale in use, so that the exact length of the time interval is specified.

A cesium beam standard is an excellent frequency standard to drive a clock because of its extremely good long-term stability. If a quartz oscillator or other secondary standard is used, it must be evaluated for rate of drift and be kept carefully corrected.

Frequency comparison by VLF broadcast

One excellent way to keep a local system's frequency—hence, time interval—referenced against master time interval is by use of a low frequency standard broadcast such as the National Bureau of Standards WWVB, 60 kHz. Prime means for doing this with ease and convenience is the HP 117A Receiver. This unit is a complete system in itself. The strip chart produced by the 117A records minute by minute the results of a precision phase comparison (resolution, 1 μ sec.) of the local signal against the received signal to show frequency offset or error of the local standard.

Reliable, fail-safe operation

Hewlett-Packard frequency and time standards have many features that ensure ease of operation and maintenance. This allows house frequency standards and timekeeping systems to be operated at the highest possible accuracies. Hewlett-Packard standards have built-in dependability.

Standby power supplies

Minimum down-time, important for any system, is vital to a time standard. Its worth depends directly on continuity of operation. Non-interrupted operation is also important to ultraprecise quartz oscillators.

Hewlett-Packard standby power supplies ensure continued operation despite line interruptions, and operate over a range of ac line voltage to supply regulated dc to operate frequency standards and frequency dividers and clocks. The batteries in the supplies assume the full load immediately when ac power fails.

Atomic and universal time scales

The time interval of the atomic time scale is the International Second, defined in October 1967 by the Thirteenth General Conference of Weights and Measures:

The Universal Time Scale, UT2 is related to the earth's rotation and has been proceeding at a rate slightly slower than that of the atomic scale. Its time interval—second—is slightly longer.

U.S. Standard Time, kept by the U.S. Naval Observatory's master clock, differs from nominal UT2 by an integral number of hours. The time interval broadcast by NBS stations WWV, WWVH and WWVL is that of a stepped approximation to UT2. WWVB (60 kHz) broadcasts the atomic second, without offset.

A time scale which approximates UT2 can be produced by oscillations offset from the atomic frequency in an amount proportional to the difference in the intervals employed. By international agreement, the amount of this frequency offset is fixed each year by the Bureau International de l'Heure, in Paris: for 1969 it is -300×10^{-10} .

The HP 5061A and HP 5065A can be easily referenced to either of the two time scales, Atomic, A.1, or UTC. The UTC time scale is the stepped approximation of the UT2 time scale. These changes are accomplished by simply changing the setting on a set of 4 thumb-wheel switches located inside the unit under the top cover. The HP 117A Comparator is adjustable simply by a gear ratio change in the translator kit.

Hewlett-Packard time and frequency standard

The Hewlett-Packard House Standard has as its basic reference the HP 5060A Cesium Beam Standard. The output is continually compared in phase with the U.S. National Bureau of Standards (NBS-A) at Boulder, Colorado by reception of NBS standards stations WWVB and WWVL via HP 117A Receivers. The standard may also be compared to the U.S. Navy's VLF stations. Time is correlated on each occasion when the HP Flying Clocks visit U.S. national timekeeping centers. Frequency is maintained in agreement with NBS-A with an accuracy of parts in 10^{12} . Studies have shown this standard to rank among the world's most accurate.

Time is maintained relative to the Naval Observatory's master clock to an accuracy of better than ± 2.5 microseconds. This accuracy is verified with Flying Clock trips from the Naval Observatory to both Hewlett-Packard Palo Alto and Hewlett-Packard Geneva. Both locations have been designated U.S. Naval Observatory Time Reference Stations.

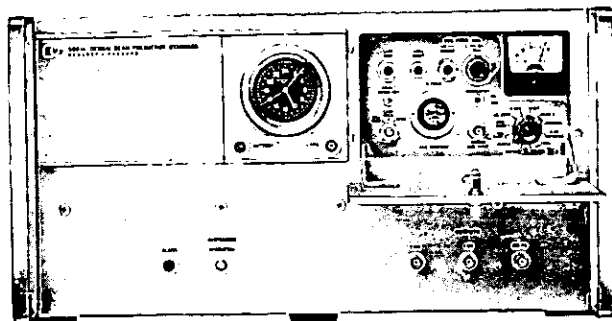
Hewlett-Packard Application Note 52, "Frequency and Time Standards", discusses practical aspects of equipment, operation, and time scales (100 pages).

FREQUENCY & TIME STANDARDS

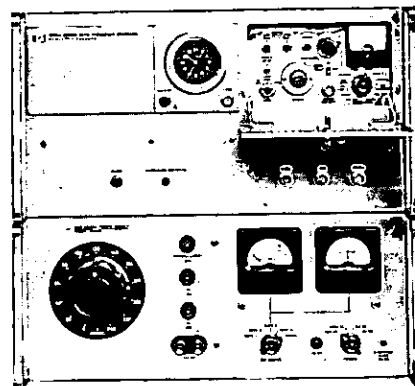


CESIUM BEAM FREQUENCY STANDARD

Compact primary standard, $\pm 1 \times 10^{-11}$ accuracy
Models 5061A, E21-5061A



5061A



E21-5061A

Advantages:

- Accuracy of ± 1 part in 10^{11}
- 3 year warranty
- Clock and Digital Divider built-in (optional)
- Standby battery supply built-in (optional)
- Proven performance

The Hewlett-Packard Model 5061A is a compact, self-contained primary standard of the atomic beam type, utilizing Cesium 133. A cesium beam tube resonator stabilizes the output frequency of a high quality quartz oscillator. Solid-state modular design is used throughout, and the closed-loop, self-checking control circuit yields exceptional accuracy of $\pm 1 \times 10^{-11}$. The 5061A has provision for an optional internal clock and digital divider and for battery with $\frac{1}{2}$ hour standby power capacity and automatic charging. The 5061A can easily be referred to either of the two time scales in widespread scientific use: UTC or Atomic. The change is accomplished by changing a set of 4 thumbwheel switches and a slide switch, located under the top cover.

The quartz crystal oscillator used in the 5061A has superior characteristics even without control by the atomic resonator. The quartz oscillator portion of this cesium beam standard is identical to the HP 105A.

The 5061A is compact and portable, no complex permanent installation is required.

Accuracy and Intrinsic Reproducibility

The data in figure 1 is based on over 150 independently aligned Model 5061A's. It demonstrates that the cesium beam tube frequency perturbations are so small that all units are within $\pm 5 \times 10^{-12}$ of each other and the National Bureau of Standards. The one sigma standard deviation was less than 1×10^{-12} between the standards. This performance is intrinsic to the 5061A primary type frequency standard and is achieved without calibration.

Reliability and Warranty

Over 5.5 million operational hours of history have proven the performance and reliability of Hewlett-Packard cesium beam standards in various worldwide applications. The units have provided dependable microsecond accuracy in aircraft,

ship, and fixed environments.

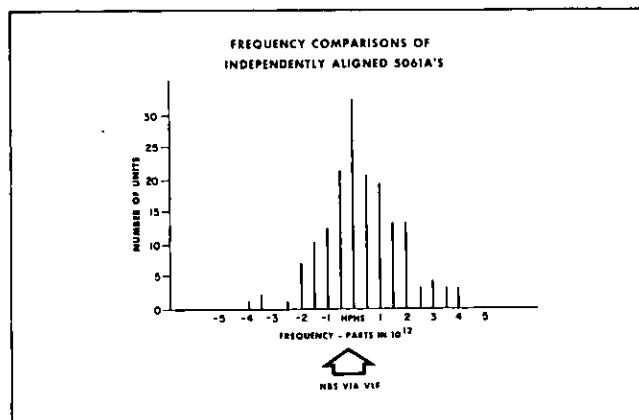
A 3 year instrument warranty* is now provided as a result of the 5061A's proven field reliability. This warranty includes the replacement of the cesium beam tube if it should fail within 3 years. Typically the beam tube life is in excess of 3 years.

Applications

Hewlett-Packard Cesium Beam Standards are used in critical applications such as Apollo timing and missile tracking where their inherent reliability and accuracy play an important role. They are also used in worldwide navigation stations (Loran C and Omega), various national observatories and scientific laboratories around the world, calibration labs, and in the field as very accurate, portable frequency and time-standards for instrument and clock calibration. Other areas of application include precision mapping, long baseline interferometry, investigation of radio transmission phenomena, and aircraft collision avoidance systems. As indicated above, success of the cesium beam standard in each of these applications is dependent on its high reliability and accuracy.

E21-5061A Flying Clock

The E21-5061A consists of a 5061A Cesium Beam Standard



*1 year for battery and clock.

and a K02-5060A Power Supply (page 628) joined together to make one portable unit. The power supply, which can be operated from 6 or 12 V dc, 24 to 30 V dc, or 115/230 V $\pm 10\%$, 50 to 400 Hz, will provide approximately 7 hours standby power (from sealed nickel-cadmium batteries) for the 5061A Cesium Beam Standard.

This wide range of operating power capabilities enables the E21-5061A to operate on local power in virtually any country

in the world. Operation is approved aboard commercial aircraft. The E21-5061A may be operated in almost any vehicle. Seven hours of standby capability make it possible to go where there is no power available and, of course, allow the E21-5061A to conveniently be transported between power sources.

The E21-5061A is a reliable, truly portable primary frequency standard. And, with Option 001 in the 5061A, it becomes a complete "flying clock".

Hewlett-Packard Journal, August 1966 and December 1967.

Specifications

5061A Cesium Beam Standard

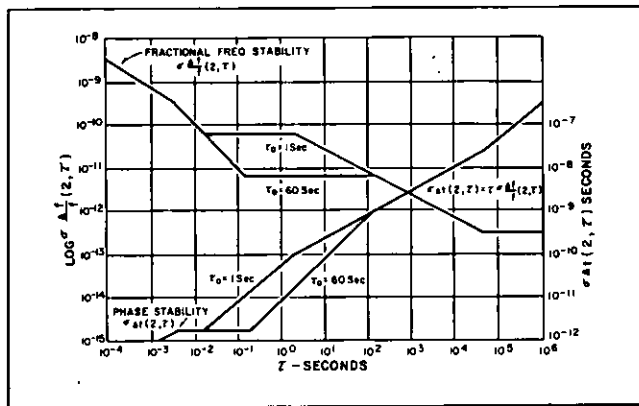
Accuracy: $\pm 1 \times 10^{-11}$ maintain when subjected to temperatures from 0 to 50°C. Magnetic fields up to 2 gauss or any combination thereof.

Reproducibility: $\pm 5 \times 10^{-12}$.

Settability (frequency): $\pm 7 \times 10^{-12}$.

Long-term stability: $\pm 5 \times 10^{-12}$ for life of cesium tube.

Short-term stability



Time constant: adjustable slide switch for 1 and 60 seconds, recommend 1 s for normal operation. Use 60 s for increased short-term stability in controlled environment.

Warm-up time: 45 minutes to fully operational from 25°C ambient temperature.

Harmonic distortion: (5 MHz, 1 MHz, and 100 kHz.) Down more than 40 dB from rated output.

Nonharmonically related output: (5 MHz, 1 MHz, and 100 kHz.) Down more than 80 dB from rated output.

Signal-to-noise ratio: for 1 and 5 MHz, >87 dB at rated output (in a 30 kHz noise bandwidth, 5 MHz output filter bandwidth is approx. 100 Hz).

Output frequencies: 5 MHz, 1 MHz, 100 kHz sinusoidal, 100 kHz clock drive.

Output voltages: 1 V rms into 50Ω; clock drive 0.5 V rms into 1 kΩ.

Output terminals: 5 MHz, 1 MHz, 100 kHz and rear BNC connectors, 100 kHz clock drive, rear BNC connector.

Time scale: adjustable with 4 thumbwheel switches and a slide switch from 0 to -700×10^{-10} . 12.63 . . . MHz test frequency available on rear panel.

Quartz Oscillator

The high quality internal oscillator may be used without turning on the cesium beam tube.

Aging rate: $< |5|$ parts in 10^{10} per 24 hours.

Frequency adjustments:

Fine adjustment: 5 parts in 10^8 range, with dial reading parts in 10^{10} .

Coarse adjustment: 1 part in 10^6 , screwdriver adjustment at front panel.

Stability:

As a function of ambient temperature: $< 2.5 \times 10^{-9}$ total from 0° to +50°C.

As a function of load: $< \pm 2 \times 10^{-11}$ for open circuit to short, and 50Ω R, L, C load change.

As a function of supply voltage: $< \pm 5 \times 10^{-11}$ for 22 to 30 V dc, or for 115/230 V ac, $\pm 10\%$.

General

Warranty: 3 years, including the cesium beam tube. 1 year for optional battery and clock.

Environmental:

Temperature: operating, 0 to 50°C. Stability, over full operating temperature range, $< \pm 5 \times 10^{-12}$ change from 25°C reference. Nonoperating, -40 to +75°C.

Production units have passed type testing as follows:

Humidity: 0 to 95% operating.

Altitude: $< 2 \times 10^{-12}$ change up to 40,000 ft. operating.

Magnetic: stability in 2 gauss field, any orientation, $< \pm 2 \times 10^{-12}$ change.

Vibration: MIL-STD-167 and MIL-T-21200 with isolators.

Shock: MIL-T-21200, Class 1 and MIL-E-5400 (30 G's).

EMC: MIL-I-6181D. Also known as RFI.

Power: 115 or 230 V ac $\pm 10\%$, 50 to 400 Hz, or 22 to 30 V dc.

Approx. power required: 39 watts dc, 75 watts ac, with Option 03.

Net weight: 60 lb. Option 001, add 2 lb. Option 002, add 5 lb.

Accessories furnished: power cord, 6 ft. (180 cm), detachable. Rack Mounting Kit, HP 5060-0777. Accessory Kit, HP 5061-6070, includes two extender boards, test cables, maintenance tools, and a mating connector 1251-0126 for Ext. dc input.

Accessories available: ext. dc cable, connects 5061A to 5085A Standby Supply, 103A-16A, \$21.50.

Mating connectors:

Ext. dc input: 1251-0126 (5-contact), Cannon MS 3106E-14S-5S (Series ME) furnished.

Clock output: 1251-0127 (4-contact), Cannon MS 3160E-14S-2P (Series ME).

Ac line: 1251-0038, Cannon MS 3160A-10SL-35 (C).

Price: HP Model 5061A, \$14,800.00

Option 001 Time Standard

Clock pulse:

Rate: 1 pulse per second.

Amplitude: +10 V $\pm 10\%$ peak.

Width: 20 μ s min.

Rise time: < 50 ns.

Fall time: < 1 μ s.

Jitter: < 5 ns rms pulse-to-pulse.

All specs are with 50Ω load.

Synchronization (rear BNC): automatic, 10 μ s (± 1 μ s) delayed from reference input pulse. Manual adj. to $< \pm 50$ ns. Reference pulse must be $\geq +5$ V, with a rise time of < 50 ns.

Clock movement: 24 hrs. Patek Philippe.

Price: Option 001, add \$1,500.00

Option 002 Standby Power Supply

Capacity: 30 minutes minimum (1 hour typical) at 25°C at full charge. Includes Option 001.

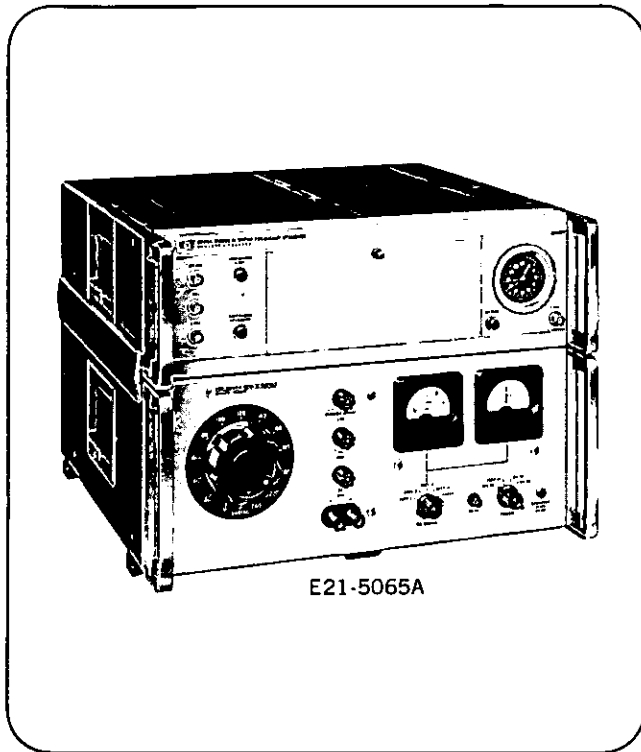
Charge control: automatic when ac power is connected.

Indicator: a front panel light flashes when ac power is interrupted and battery is being used.

Price: Option 002, add \$600.00.

Option 003 (combines Option 001 and 002)

Price: Option 003, add \$2,100.00.


RUBIDIUM FREQUENCY STANDARD
Compact, lightweight atomic standard
Models 5065A, E21-5065A

E21-5065A
Advantages:

- Low price atomic standard.
- Long term drift rate of $< 2 \times 10^{-11}$ /mo.
- Short term stability of $< 7 \times 10^{-13}$ for 100 s average.
- Frequency synthesizer time scale changer.
- Calibrated fine frequency adjustment.
- Battery standby power guards against power failure (optional).
- Built in clock and digital divider (optional)

Uses:

- Precise frequency source for systems operating in the radio spectrum.
- Coherent signal sources of all types.
- Precision timekeeping.
- House standards and calibration laboratories.
- Doppler radar

The HP Model 5065A is an atomic-type secondary frequency standard which uses a rubidium vapor resonance cell as the stabilizing element. As a result, its long term stability exceeds typical quartz oscillator frequency standards by 10 to 100 times. Furthermore, it has excellent short term stability. These features contribute to its desirability as a coherent signal source, as a master oscillator for radio and radar systems where special requirements for stability and/or narrow bandwidth must be met, as a precision timekeeper where the better performance of a cesium beam primary standard is not required, and as a house frequency standard for improved accuracy with fewer NBS calibrations compared to that required with quartz standards.

A thumbwheel settable frequency synthesizer is a standard feature of this frequency standard. The user can, himself, easily

set his 5065A Standard to either Atomic or UTC time, or other offsets to suit a particular requirement, with 4 thumbwheels and a slide switch.

Front panel controls and circuit check meter of the 5065A are protected by a panel door. The magnetic field control provides fine frequency adjustment with which the frequency can be set to a precision of better than 2×10^{-12} without reference to a chart. Oscillator frequency adjustments correct for aging of the 5 MHz low noise quartz oscillator which is phase locked to the atomic frequency and provides the standard 5 MHz, 1 MHz, and 100 kHz outputs. The circuit check meter with selector switch monitors key voltages and currents for routine maintenance readings, calibration procedures, and fault finding.

The 5065A is designed for assured operation—to give the user confidence that the standard output signals are correct and locked to the atomic frequency. Logic within the unit maintains power to a "continuous operation" light on the front panel. If operation is interrupted, even momentarily, for any reason the light goes out and stays out until manually reset. An integrator limit light warns when the frequency correcting servo loop is approaching the limit of its dynamic range.

A time standard option generates 1 pulse per second, available at a front panel BNC connector. The clock pulse phase is adjustable with respect to a reference in precise increments from 1 μ s to 0.1 s. A variable control allows adjustment from 0 to 1 μ s. A clock movement indicates hours, minutes, and seconds.

The HP Model 5065A is contained in a small sized package and is lightweight in comparison to a cesium beam standards. Additionally, the rubidium resonance cell is much more frequency stable than quartz oscillators while subjected to shock and vibration. Its environmental specifications include temperature, shock, vibration, EMC, humidity, and magnetic field effects.

E21-5065A
Portable time standard

E21-5065A portable time standard is a complete system for precision timekeeping and for transporting time from one location to another. Its main components are the Option H09-506A Rubidium Standard with digital clock and divider (option 01) and the K02-5060A power supply with 6 or more hours standby. Its batteries recharge from a wide variety of power sources including 115 or 200 V $\pm 10\%$ 50 - 400 Hz, ac and 6 or 12 V dc. Thus, it may be powered from commercial aircraft, auto electrical systems, storage batteries, commercial power lines, or its own internal batteries. The component units are held together by two side bars.

Weight: 110 lb (50 kg).

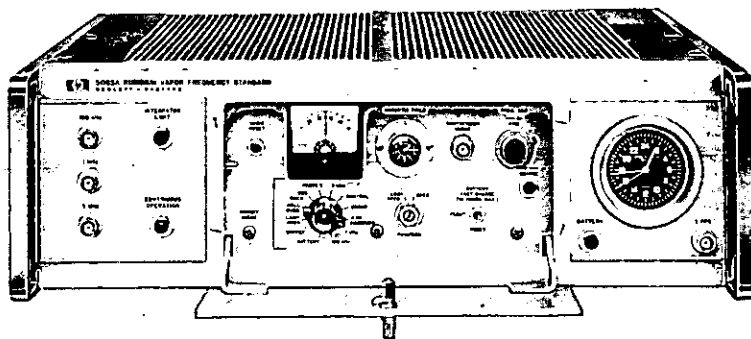
Dimensions: 16 $\frac{3}{4}$ " (425 mm) wide, 14" (355 mm) high, 18 $\frac{3}{8}$ " (467 mm) deep.

Price: \$12,225.

E20-5065A
Portable time standard

Electrically identical to the E21-5065A described above, the E20-5065A differs in that the component instruments are enclosed in a single aluminum cabinet.

Price: available on request.



HP 5065A shown with Option 03 consisting of clock and standby battery

Specifications, 5065A

Frequency stability:

Long term: 2×10^{-11} per month (maximum limit of drift rate).

Short term: $\frac{\Delta f}{f}$ (Std. Dev.) Avg. Time

$< 7 \times 10^{-12}$	1 sec.
$< 2.2 \times 10^{-12}$	10 sec.
$< 7 \times 10^{-13}$	100 sec.

Calibration accuracy: set at factory to $< \pm 1 \times 10^{-11}$ of specified time scale.

Time scale: set at factory to UTC unless specified differently.

Tunability:

Coarse frequency synthesizer adjustment:

Range: 1000×10^{-10} .

Resolution: $< 2 \times 10^{-9}$, thumbwheel adjustable.

Fine frequency magnetic field adjustment:

Range: 2×10^{-9} .

Resolution: 2×10^{-12} .

Warm-up: within 1×10^{-10} in one hour and 5×10^{-11} in 4 hours after 24 hours "off" time.

Outputs:

Frequencies: 5 MHz, 1 MHz, 100 kHz and isolated 100 kHz clock drive for external clocks.

Voltage levels: 1 V rms into 50 ohms at 5 MHz, 1 MHz, 100 kHz; 0.5 V rms into 100 ohms at 100 kHz, clock drive.

Connectors: BNC front and rear for 5 MHz, 1 MHz, 100 kHz; BNC rear for 100 kHz clock drive.

Harmonic distortion: (5 MHz, 1 MHz, 100 kHz) > 40 dB down from rated output.

Non-harmonic distortion: (5 MHz, 1 MHz, 100 kHz) > 80 dB down from rated output.

Signal-to-noise ratio: for 1 and 5 MHz, > 87 dB at rated output (in a 30 kHz noise bw, 5 MHz output filter bw is approx. 100 Hz).

Environmental:

Temperature, operating: 0° to 50°C . Frequency change is $< 5 \times 10^{-11}$ over this range.

Temperature, non-operating: -40° to $+75^\circ\text{C}$. (With options to 50°C .)

Production units have passed type tests as follows:

Humidity: 0 to 95% relative humidity.

Magnetic field: $< 1 \times 10^{-11}$ frequency change for 1 Gauss change (earth's field is typically 0.5 Gauss).

Vibration: MIL-Std-167, and MIL-E-5400, with isolators.

Shock: MIL-T-21200, Class 1 (30 G's).

Electromagnetic compatibility (EMC): MIL-I-6181D.

Altitude: $< 5 \times 10^{-11}$ up to 40,000 ft.

Mating connectors:

EXT DC input: 1251-0126 (5-contact), Cannon MS 3106E-14S-5S (Series ME) furnished.

Clock output: 1251-0127 (4 contact), Cannon MS 3106E-14S-2P (Series ME).

AC line: 1251-0038, Cannon MS 3106A-10SL-35 (C).

Power: 115 or 230 V ac $\pm 10\%$, 50 to 400 Hz; or 23 to 30 V dc. Approx. power required:

	24 V dc	115 V ac
Without options:	35 W	49 W
Option 001	Add 8 W	9 W
Option 002	0 W	6 W
Option 003	Add 8 W	15 W

Accessories furnished: power cord, 6 ft (180 cm) detachable. Rack Mounting Kit, HP 5060-0775. Accessory Kit, HP 05065-6066, includes Micon connector adapter male-male, mating connector 1251-0126 for EXT DC input, 3 circuit board extenders, test cable, and a special coil tuning screwdriver.

Dimensions: $16\frac{3}{4}$ " (425 mm) wide, $5\text{-}7/32$ " (132.6 mm) high, $18\frac{3}{8}$ " (467 mm) deep.

Weight: net, 37 lb (16.8 kg). Option 001 add 2 lb (.9 kg); Option 002 add 3.5 lb (1.6 kg).

Accessories available: EXT DC cable: connect 5065A to 5085A standby supply, 103A-16A, \$21.50.

Price: \$7,500.00.

Option 001 time standard

Clock pulse:

Rate: 1 pulse per second.

Fall time: $< 1 \mu\text{s}$.

Amplitude: $+10 \text{ V} \pm 10\%$.

Jitter: $< 5 \text{ ns}$.

Width: 20 μs min.

All specs are with 50 Ω load.

Rise time: $< 50 \text{ ns}$.

Synchronization: 10 μs ($\pm 1 \mu\text{s}$) delayed from reference input pulse (rear BNC). Reference pulse must be $> +5 \text{ V}$, with a rise time $< 50 \text{ ns}$ and width $> 0.5 \mu\text{s}$; adjustable to $\pm 50 \text{ ns}$.

Clock movement: 24 hrs., Patek Philippe.

Price: Option 001, add \$1,500.00.

Option 002 standby power supply

Capacity: 10-minute minimum at 25°C after full charge (incl. Option 01).

Charge control: front panel Fast-Float-Reset charge switch.

Indicator: a front panel light flashes when ac power is interrupted and battery is being used.

Price: Option 002, add \$300.

Option 003

(Combines Options 001 and 002)

Price: Option 003, add \$1,800.00.

Performance of quartz oscillator only (Rubidium control loop open)

Aging rate: $< 5 \times 10^{-10}$ per 24 hours.

Frequency adjustments:

Fine adjustment: 5×10^3 range, with dial reading parts in 10^0 .

Coarse adjustment: 1 part in 10^6 , screwdriver adjustment at front panel.

Stability:

As a function of ambient temperature: $< 2.5 \times 10^{-9}$ total, 0° to $+50^\circ\text{C}$.

As a function of load: $< \pm 2 \times 10^{-11}$ for open circuit to short, and 50 Ω R, L, C load change.

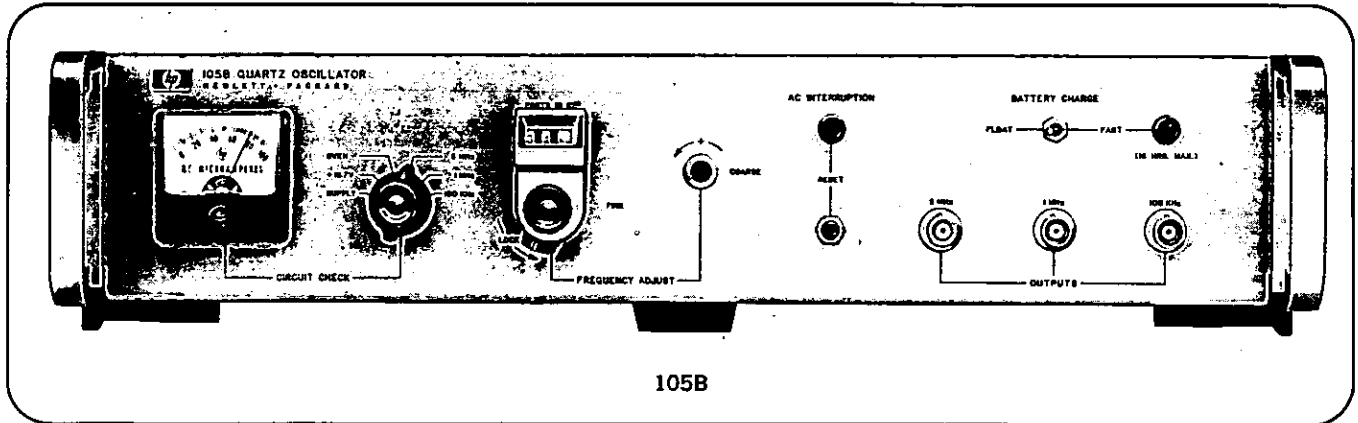
As a function of supply voltage: $< \pm 5 \times 10^{-11}$ for 22 to 30 V dc, or for 115/230 V ac, $\pm 10\%$.

FREQUENCY & TIME STANDARDS



QUARTZ OSCILLATORS

State-of-the-art frequency stability
Models 105A/B



Advantages:

- High spectral purity
- Well-buffered outputs
- Solid-state reliability

Uses:

- In-house frequency and time standards
- Microwave spectroscopy
- Comparisons with atomic standards
- Advanced navigation, communication systems

Models 105A and B Quartz Oscillators provide state-of-the-art application in precision frequency and time standard systems because of their excellent long and short term stability characteristics, spectrally pure outputs, unexcelled reliability, and ability to operate under a wide range of environmental conditions. They fill a need for a smaller and more economical and yet highly stable precision quartz oscillator for frequency and time standards. Both models can be operated from the ac line; the 105B has a built-in 8-hour standby battery supply for uninterrupted operation should line power fail. Both models have 5 MHz, 1 MHz, and 100 kHz sinusoidal outputs with excellent short term stability (5 parts in 10^{12} rms for 1 s averaging time) and aging rate (<5 parts in 10^{10} per day).

The 105A/B features rapid warm-up. Typically, the oscillator will be within 1 part in 10^9 of the previous frequency in 20 minutes after an "off" period of approximately 24 hours under lab conditions. The basis of these oscillators is an extremely stable 5 MHz, 5th overtone quartz crystal developed by Hewlett-Packard. New technologies in the crystal mounting and packaging have resulted in a cleaner crystal which in turn has a lower aging time. The crystal, oscillator and AGC circuit are all enclosed in a proportional oven which reduces the temperature effects on these components and circuits.

Each frequency output of the 105A/B is buffered to provide an output stable to within ± 2 parts in 10^{11} regardless of load changes occurring at any other output. The 105A and 105B may be used in complex systems with complete assurance that loading changes, such as accidental shorts or disconnections in other outputs, will not affect the frequency of the output of primary concern.

Provision has been made in Models 105A/B to control the output frequency, using an externally applied voltage for uses such as phase lock systems. A 10 V change in applied voltage will change the 5 MHz output frequency by approximately 5 parts in 10^9 .

Particular care was taken to provide a spectrally pure 5 MHz output which, when multiplied high into the microwave region, provides signals with spectra only a few cycles wide. Spectra less than 1 Hz wide can be obtained in X-band (8.2 to 12.4 GHz). The stability and purity of the 5 MHz output make it suitable for doppler measurements, microwave spectroscopy, and similar applications where the reference frequency must be multiplied by a large factor.

Output frequencies: 5 MHz, 1 MHz, 100 kHz sinusoidal; 100 kHz clock drive.

Output voltages: 5 MHz, 1 MHz, and 100 kHz, 1 V rms into 50 ohms; 100 kHz for driving Hewlett-Packard frequency divider and clocks, 0.5 V rms into 1000 ohms.

Stability

Long term: $<|5| \times 10^{-10}$ per 24 hours.

Temperature: $<2.5 \times 10^{-9}$ total from 0°C to $+50^\circ\text{C}$.

Load: $<\pm 2 \times 10^{-11}$ for open, short, 50Ω resistive, inductive and capacitive.

Supply voltage: $<\pm 5 \times 10^{-11}$ for 22-30 V dc or for 115/230 V ac $\pm 10\%$.

Warm-up: returns within 1×10^{-9} of previous frequency in $\frac{1}{2}$ hour (24 hr off time).

RMS deviation of 5 MHz (short-term stability)

Averaging time	Max. rms fractional-frequency deviation ($\Delta f/f$)	Max. rms phase deviation (milliradians)
1 ms	8×10^{-10}	0.026
10 ms	1.5×10^{-10}	0.047
0.1 s	1.5×10^{-11}	0.047
1 s	5×10^{-12}	0.16
10 s	5×10^{-12}	1.6

Noise-to-signal ratio (5 MHz): >90 dB below rated output; output filter bandwidth (3 dB) is 100 Hz.

Harmonic distortion (5 MHz, 1 MHz, and 100 kHz): down more than 40 dB from rated output.

Non-harmonically related output (5 MHz, 1 MHz, and 100 kHz): down more than 80 dB from rated output.

Output terminals: 5 MHz, 1 MHz, 100 kHz, front and rear BNC connectors; clock drive and electrical frequency control, rear BNC connectors.

Frequency adjustments

Fine adjustment: 5×10^{-8} total, with digital dial reading parts in 10^{10} .

Coarse adjustment: 1×10^{-6} (screwdriver adjustment).

Environmental

Storage temperature: -40°C to 75°C (Mfr. specifies -40°C to $+50^\circ\text{C}$ limit for 105B battery storage).

Operating temperature: 0°C to $+50^\circ\text{C}$.

Humidity: 0-95%.

Vibration and shock: Mil-STD-167, 30 G's.

Weight: 105A, net 16 lbs (7.3 kg); shipping 23 lbs (10.4 kg). 105B, net 24 lbs (10.9 kg); shipping 31 lbs (14.1 kg).

Dimensions

Height: 3-15/32" (88 mm).

Width: 16 3/4" (425 mm).

Depth: 11 1/4" (286 mm).

Power: 105A, 115/230 V $\pm 10\%$, 50-400 Hz, at 17 W (70 W warm-up). 105B, 115/230 V $\pm 10\%$, 50-400 Hz, at 18 W (72 W warm-up), at float charge. Add 12 W for fast charge. Both, 22-30 V dc at 6.4 W (10.3 W warm-up).

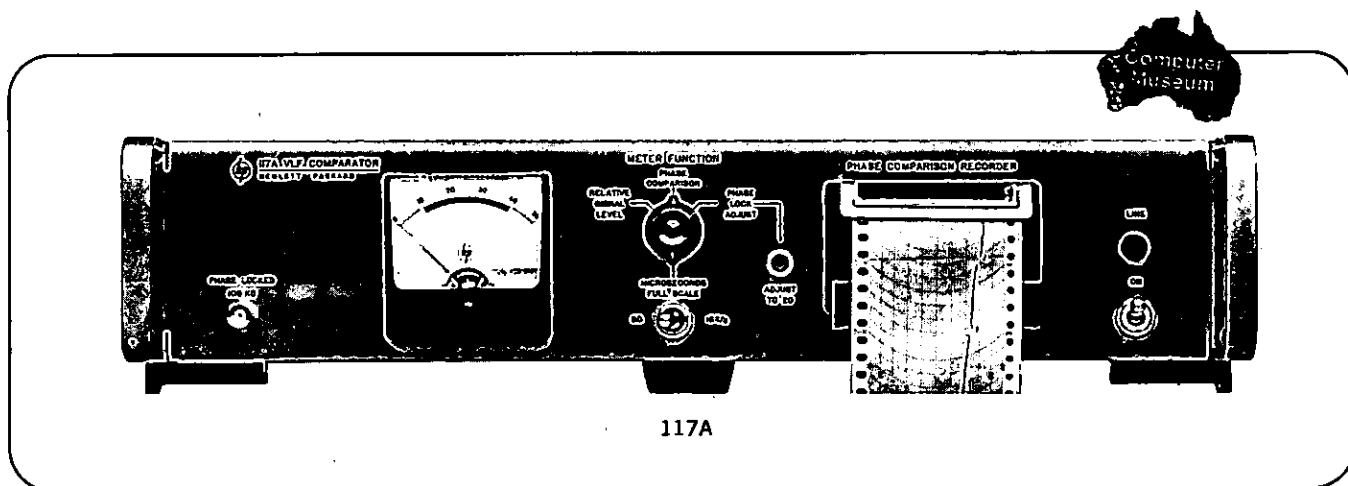
Price: Model 105A, \$1500. Model 105B, \$1800.

VLF COMPARATOR

Compares frequency against NBS standard
Model 117A



FREQUENCY & TIME
STANDARDS



Advantages:

- Plots minute-by-minute phase record
- Provides all equipment needed for frequency comparison
- Offers one microsecond resolution
- Makes available 100 kHz phase-locked output

Uses:

- Offset and drift determinations for crystal oscillators
- Quick and easy checks of counter time-base accuracy
- Monitors atomic standards against N.B.S.

The HP 117A VLF Comparator measures the frequency offset of a local standard frequency source against a radio signal based on the N.B.S. Frequency Standard to an accuracy that can reach a few parts in 10^{11} in a 24-hour period. The HP 117A thus provides a link between house frequency standards and the Boulder, Colorado, laboratories of the National Bureau of Standards (NBS) via station WWVB, which broadcasts at 60 kHz on a continuous basis.

The strip chart produced by the HP 117A records, minute by minute, the results of a precision phase comparison of the local signal against the received signal to show frequency offset or error of the local standard, and over a few hours to a day or more, its drift rate.

Local precision frequency sources, such as quartz crystal oscillators that drive clocks or synthesizers or that serve as counter time bases, can be quickly compared in frequency for purposes of calibration or can be monitored over as long a time as desired to determine their behavior and to measure long-term drift rate.

Method of Operation

The VLF Comparator is a complete system (exclusive of local standard) which consists in one package of a receiver, an electronic servo-controlled oscillator which functions as a narrow band tracking filter, a linear phase comparator, and a strip chart recorder. The servo loop and phase-locked oscillator provide a continuous output signal despite noise and interfering signals. A front panel meter can be switched to show relative signal level, phase lock with WWVB, or phase comparison. Output terminals on the rear provide for the connection of external galvanometer and potentiometer recordings if desired. A loop antenna with built-in preamplifier and 30 meters of lead-in cable is included.

The recorded trace is easily evaluated directly in terms of

frequency offset with a transparent template supplied with the instrument. Chart speed is 1 inch per hour and full-scale chart width may be set for either 50 μ sec or 16-2/3 μ sec by operation of a front panel switch. The readability of the trace and the overall stability of the comparator easily provide a resolution of better than 1 μ sec under normally encountered laboratory conditions.

NBS Standard Broadcast WWVB

The WWVB 60 kHz signal reaches a primary service area that includes the entire continental United States. NBS controls the broadcast frequency to within $\pm 2 \times 10^{-11}$ of its intended value. NBS publishes monthly, in *Proceedings of the IEEE*, frequency correction data relative to WWVB and also to the other standard broadcasts, which are WWV and WWHV (high frequency) and WWVL.

WWVB is referenced to the National Bureau of Standards Frequency Standard and its frequency is *not* offset. WWVB seconds pulses are those of the time scale NBS-A, for which time interval is the international (atomic) second. (Frequency of the other NBS services is offset by an amount coordinated through the Bureau International de l'Heure: for 1969, offset is -300×10^{-10} . Purpose of the offset is to make the second of time interval correspond closely to that of UT-2, the time scale in ordinary use.)

Accuracy of the HP 117A approaches that of the broadcast signal itself. The HP 117A takes advantage of the phase-stable nature of the lower frequencies to make possible quick comparisons to accuracies far exceeding those achieved by use of the older high frequency services. In the continental U.S., frequency standard comparisons to an accuracy of a part in 10^{10} can be approached in an 8-hr. period. A 24-hr. period may give 2 parts in 10^{11} , and a 30-day period may give accuracies of parts in 10^{12} . The local standard being calibrated must, of course, be of a quality commensurate with the realization of such high accuracies.

Template

A transparent template, overlaid on the HP 117A's strip chart recording, enables the operator to read at a glance the frequency offset of his local standard. The template curve most nearly matching the chart's trace is selected, then offset is read directly, together with its sign. The sign indicates whether local frequency lies above or below reference frequency.

Atomic and UT-2 Time Scales

Many users prefer to maintain their local frequency standard referenced to the interval of UT-2, the time scale in ordinary use, rather than to NBS-A. (These two scales are explained at the beginning of the "Frequency and Time Standards" section.) Use of a translator kit adapts the 117A for UT-2 service. Hewlett-Packard offers two translators:

The 00117-91027 Translator Kit installs in the 117A. A power-line-driven synchronous motor and gear train rotate a phase shifter to continuously retard the phase of the WWVB signal, thereby decreasing the frequency. Power-line frequency changes of 0.1% cause translation errors of only about 1.5×10^{-11} . Most lines average much less than 0.1% frequency deviation over extended periods.

The K10-117A Translator is a separate instrument for use external to the 117A. It also uses a motor-driven phase shifter. It shifts the frequency of, and derives its time base from, the external 100 kHz (1 MHz, optional) source being compared with WWVB, and is unaffected by line frequency. The direction of translation can be changed.

In both translators, the correct gear ratio is supplied for coordinated frequency offset in effect at time of purchase. Different gear ratios will be available at a nominal charge to change the translation ratio when the offset is changed. The 117A is available with the 00117-91027 translator installed (see Specifications).

Antenna

The loop antenna supplied with the 117A contains a pre-amplifier which allows at least 300 meters of cable (30.5 meters supplied) between antenna and receiver. The cable's center conductor carries power to the preamplifier.

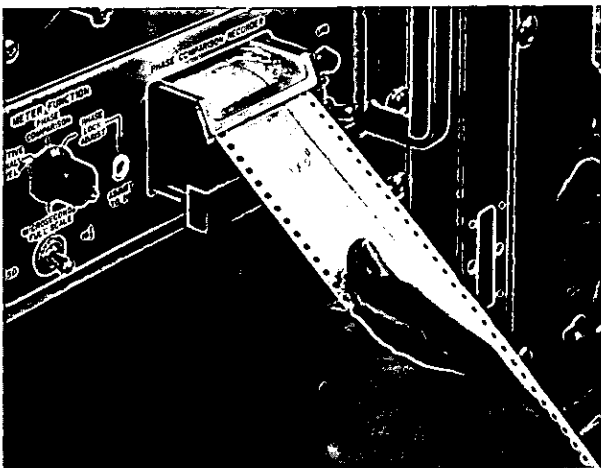
Antenna location and orientation are important. For best signal pick-up it should be mounted on the roof (it is sealed against the weather) and oriented with the plane of the loop aligned with signal direction.

Additional Information

A complete discussion of the use of lower frequency broadcasts in frequency standardization is included in Hewlett-Packard Application Note 52, "Frequency and Time Standards."

Phase Comparison Record

The slope of the trace plotted by the 117A's strip chart recorder is, at a given instant, frequency offset between the local standard and the received signal. This slope may be read at a glance with the transparent template supplied with the instrument. Two offset readings separated by a span of time usually chosen to be one day give all data needed to allow a determination of the drift rate of the local standard (drift rate is given by the difference in offset over a specified elapsed time).



Greatest accuracy results when the user selects the times he makes observations to fall in a period when propagation conditions are stable, as revealed by the nature of the trace. VLF signals are normally highly stable when the entire propagation path is in sunlight. Near sunrise and sunset, the diurnal shift makes an apparent change in the offset.

Any VLF Comparator is but one element of the system which the user must consider: (1) transmitted signal, (2) transmission path, (3) VLF comparator, and (4) local standard. Since the first two elements are not under the user's control, he must make his observations in accordance with reception conditions. While VLF signals are noted for their stability, variations in propagation conditions do exist and must be taken into account.

European service

Optional H44-117A may be used to receive the 75 kHz frequency and time broadcast of HBG, Prangins, Switzerland. This station is one of the most accurate services in Europe.

It broadcasts the atomic standard frequency to a published accuracy of 2×10^{-11} , and is received throughout Europe.

Specifications, 117A

Received standard frequency: 60 kHz, NBS station WWVB.

Sensitivity: 1 μ V into 50 Ω .

Local standard input: 100 kHz, 1 V rms into 1000 Ω (divider to accept 1 MHz at extra cost).

100 kHz phase-locked output: 5 V rectangular positive pulses into 5000 Ω .

60 kHz test output: self-checks the 117A.

Recorder outputs: phase comparison and relative signal strength: 0-1 mA dc into 1400 Ω and 0.100 mV dc from 2000 Ω .

Overall phase stability: $\pm 1 \mu$ s 0-50°C.

Chart speed: 1 in/hr (6 or 12 in/hr available).

Chart width: 50 μ s or 16 $\frac{2}{3}$ μ s (selected by front panel switch).

Meter readings: three switch positions: (1) relative signal level; (2) phase comparison calibrated scale 0-50 μ s 0-16 $\frac{2}{3}$ μ s full scale; (3) phase-lock range indicated insures negligible phase error.

Adjustments: a front panel control adjusts free-running frequency of voltage-controlled oscillator; three rear panel adjustments provide calibration of phase comparison, full-scale adjustment for internal recorder, internal meter, and external galvanometer recorder.

Storage temperature: -50° to +75°C.

Operating temperature: 0° to 50°C.

Dimensions: 16 $\frac{3}{4}$ " wide, 3-15/32" high, 13 $\frac{1}{4}$ " deep (425 x 88 x 337 mm).

Weight: 117A: net 20 lbs (9.1 kg), shipping 22 lbs (10 kg); antenna: net 12.5 lbs (5.7 kg), shipping 21 lbs (9.5 kg).

Power: 115 or 230 V $\pm 10\%$, 60 cycles, 40 watts.

Accessories (included):

10509A loop antenna: antenna has electrical height of 1.6 cm, is 43 in (109 cm) in diameter and mounts on 1-in. pipe thread. Operating temperature: -60° to +80°C. Also available separately (for use only with HP 117A). \$280.

10512A coaxial lead-in cable: 50 Ω BNC-BNC connectors 100 feet (30.5 m) long. Also available separately, \$30.

Accessories (not included with 117A):

Time Scale Translators:

00117-91027 translator kit, \$350.

K10-117A translator, \$1,100.

9281-0081 recorder chart paper: box of six 30-ft rolls, \$12.50.

Prices: Model 117A including 10509A antenna/pre-amp and 10512A lead-in cable, \$1400.

Option H21-117A: is model 117A with 0117-91027 translator installed, \$1775.

Option H44-117A: is 117A with 10509A antenna/pre-amp and 10512A lead-in cable, modified for 75 Hz, \$1900.

STANDBY POWER SUPPLIES

For Frequency and Time Standards

Models 5085A, K02-5060A



FREQUENCY & TIME STANDARDS

Advantages:

- 2 amperes at 24 volts
- Up to 18 ampere-hours of standby
- Solid state, modular

Uses:

- Continued operation of primary standards when ac line power is interrupted

The HP Model 5085A 24 volt 2 ampere power supply keeps primary frequency or time standard systems in operation when ac line power is interrupted. Specifically designed to deliver standby power to the HP Cesium Beam Standards, Rubidium Vapor Standard, and peripheral equipment, the 5085A will also serve HP Quartz Oscillator Frequency Standards. The only requirement is that the total current drawn from the supply not exceed 2 A for any extended period of time.

The frequency and time standard system is not affected during changeover since no switching is used in transferring power from line to battery operation and back again.

Vented nickel-cadmium batteries with an 18 ampere-hour guaranteed capacity (derated from 25) are used in the 5085A. They provide about 10 hours of standby power for the 5061A Cesium Standard or 5065A Rubidium Standard (at average ambient temperature of 25°C).

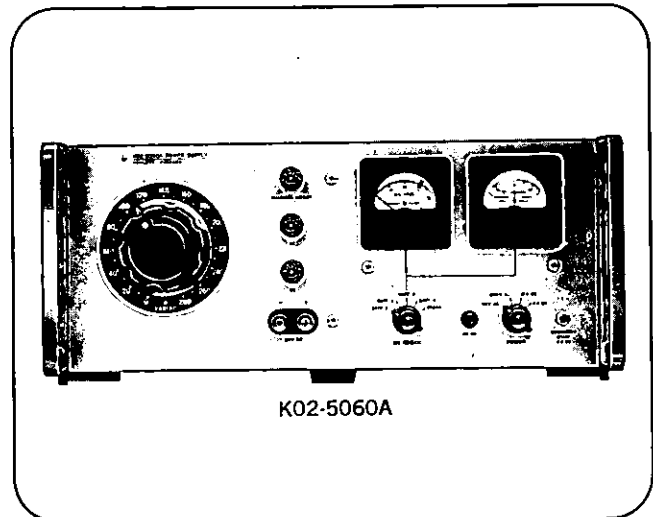
Front panel lights indicate mode of operation, report fuse failure, ac interrupt.

Specifications, 5085A

- Output voltage:** 24 \pm 2 V dc at rated current.
- Maximum rated current** (total external load): 2 amperes.*
- Standby capacity:** (At 25°C**) 18 ampere hours after 48 hours with manually operated CHARGE switch set to CHARGE.
- Alarm indicators:** Panel lamps indicate: (1) FUSE FAILURE, (2) AC POWER, (3) AC INTERRUPT, (4) CHARGE.
- Remote alarm provisions:** SPDT relay contacts provided at rear terminals for operating remote alarm from separate power system. Contacts rated at 3 A (resistive) 115 V ac or 28 V dc.
- Panel meters:** Voltmeter and ammeter indicate battery voltage and battery charge/discharge current.
- Power requirements:** 115 or 230 \pm 10% Vac; 50 to 400 Hz (2.0 A max. at 115 V line).
- Output connectors:** MS type female connectors at rear mate with 106AR, 107AR, 5061A, 5065A power cables (Cannon Part No. MS3102R14S-5P, HP No. 1251-0129).
- Battery (supplied)** Vented nickel-cadmium 25 ampere-hour capacity derated to 18 ampere-hours. Periodic maintenance required.
- Additional (external) battery provision:** MS3102R14S-2S female connector, with cap, at rear.
- Dimensions:** 16 $\frac{3}{4}$ " wide, 6-31/32" high, 16 $\frac{3}{8}$ " deep (425 x 177 x 467 mm).
- Weight:** net, 75 lbs (34.1 kg); shipping, 101 lbs (45.9 kg) including battery. Option 01 (no batteries) is 50 lbs (22.8 kg) less.
- Accessories furnished:**
 - AC Power Line Power Cable, 6 feet long.
 - Instrument Extension Slides (for std. 24" deep rack).
- Price:** Model 5085A (complete with batteries), \$1700.
- Options:** Specify Option 001 if batteries are to be excluded. Model 5085A with Option 001 is \$1060.

* 2.5 A for 30 minutes.

** Derate capacity to 75% at high temperature (50°C) and low temperature (0°C).



K02-5060A

The K02-5060A was specifically made as a portable standby power supply for the 5061A and 5065A "Flying Clocks" and incorporates a number of features not found in the 5085A. The K02-5060A has a special inverter which will allow it to operate from 6 or 12 V dc or 24 to 30 V dc besides 115/230 V. The nickel-cadmium batteries are of the sealed type and thus spill-proof.

Tentative Specifications, K02-5060A

- Output voltages:** 115/230 V ac, (nominal), 50 to 400 Hz, 26 \pm 4 volts dc.
- Output current:**
 - ac, 0.5 A
 - dc, 2 A.
- Standby capacity:** 12 ampere-hours at 25°C, 7 hours standby when used in E21-5061A, 6 hours in E21-5065A.
- Recharging:** 1.6 hours recharging time required for each ampere hour of discharge.
- Alarm indicator:** external power failure.
- Panel meters:** Voltmeter, Ammeter indicating voltage and current of 4 internal batteries and load.
- Power requirements:** 6 or 12 V dc -10% $+20\%$; or 24 to 30 V dc; or 115/230 \pm 10% V ac, 50 to 400 Hz. Can be connected simultaneously with ac or other dc power inputs for extra standby reserve.
- Output connectors:**
 - ac: CA-3102R-10SL-5S.
 - dc: MS-3102R-14S-5S.
- Input connectors on instrument:**
 - 6 and 12 V dc: MS-3102R-16-11P.
 - 24 to 30 V dc: GR type.
 - ac: MS-3102R-10SL-3P.
- Battery:** four paralleled, 20 series Ni-Cd cell, 3.5 ampere-hour, rechargeable batteries that can be individually removed from the circuit without interfering with power supply operation.
- Dimensions:** 16 $\frac{3}{4}$ " wide, 6-31/32" high, 16 $\frac{3}{8}$ " deep (425 x 177 x 416 mm).
- Weight:** net, 67 lbs.
- Accessories furnished:** ac Power line cable, 6 feet long.
- Price:** \$2850.

FREQUENCY & TIME STANDARDS



FREQUENCY SYNTHESIZER APPLICATIONS

Communications applications

The high spectral purity of synthesizer output signals makes them ideal as local oscillators in receiver applications where frequency agility and/or narrow I.F. bandwidths are required of the receiver.

Their very stable output frequencies make these synthesizers suitable for use in homodyne receiver circuitry. The advantages of using a synthesizer in this application are simplicity and freedom from image problems, both of which plague many receiver designs.

Data handling systems in all areas of industry and military applications use magnetic tape as a storage medium, linking the receiver to the data processing and analysis equipment. However, magnetic tape is not without fault, introducing certain distortions to the data. A synthesizer may be used to eliminate the degrading effects wow and flutter have on information that is received and stored on magnetic tape. This use is facilitated by the ability of the user to bypass the internal crystal filter in the synthesizer driver section. The input reference frequency may be offset by as much as 0.25%, with the same percentage offset translated to any output frequency. Thus, a recorded reference channel on the tape can be used as the reference frequency of the synthesizer, and wow and flutter can be removed by comparing the data channel with a convenient synthesizer output frequency derived from the reference channel.

A surveillance receiver system which monitors multiple data channels by rapidly switching between channels is an ideal area of application for one of the Hewlett-Packard frequency synthesizers. With its rapid, highly repeatable switching capability, a synthesizer will serve as the local oscillator in this type of receiver, providing the proper local oscillator frequency for each channel under surveillance. A similar application arises in radio sounding applications, used to determine the maximum usable frequency allowed by ionospheric conditions. Since these conditions are always in a state of change, the ability of a synthesizer to generate test transmissions rapidly over the entire hf spectrum makes it an important tool for radio sounding.

The high spectral purity which characterizes the Hewlett-Packard synthesizers allows signal multiplication to microwave frequencies. HP synthesizers are

ideal for use as the local oscillator in microwave communications systems.

A laboratory-type receiver capable of flat response over a broad range can easily be arranged with use of one of the synthesizers, as the local oscillator, together with a broadband mixer and a narrow-band amplifier. For example, a combination of the HP 5105A/5110B Synthesizer, the HP 10514A Mixer, and the HP 415D SWR Meter exhibits an exceedingly flat response over the range 100 kHz to 500 MHz and a sensitivity greater than 10^{-16} watt.

Radar applications

The 5100B/5110B is capable of switching between output frequencies in 0.01 Hz increments at a very fast rate; thus it is capable of making very good approximations of frequency versus time functions. This performance feature finds application in high performance "chirp" radar installations, which require an ultra linear sweep.

In doppler radar applications the Hewlett-Packard frequency synthesizer easily supplies all the necessary requirements for precise velocity measurements. The excellent stability of the synthesizer makes it ideal as the basic signal source in the transmitter, which requires stability capable of staying within a receiver bandwidth only a few cycles wide in the microwave region. A 5100B/5110B or another of the synthesizers also is well suited for use as the local oscillator in the doppler receiver, where the local oscillator must be capable of rapid change in order to keep the returning signal within the narrow receiver bandwidth.

NMR applications

Nuclear magnetic resonance spectroscopy methods are used to determine the qualitative and quantitative structure of molecules. In NMR, the strength of an applied dc magnetic field and the frequency of simultaneously applied rf field uniquely determine the spin-interaction of nuclei. In this application the broad frequency range and precise 0.01 Hz increments of frequency are very valuable.

Short-term stability measurements

Hewlett-Packard synthesizers are ideal for use in systems to evaluate short-term frequency stability. Often denoted as phase noise, short-term stability can be

characterized by three measures: a phase noise vs. frequency of offset plot, a total measurement of instability over a frequency band, and statistical parameters. Their own excellent stability makes HP synthesizers ideal for use in systems to make these measurements on signal sources (such as oscillators) and on a variety of circuits: amplifiers, limiters, and filters. Systems for phase noise measurement utilizing the synthesizer offer a practical solution to problems of production testing. A synthesizer can serve as the frequency reference and also as the source of excitation for the circuit to be evaluated.

Reliability

Since their introduction in 1963, Hewlett-Packard synthesizers have found many unusual applications. Users have been quick to take advantage of synthesizer versatility and have shown great ingenuity in applying synthesizers to many research, manufacturing, and field instrumentation needs that otherwise could have been met only by costly laboratory-designed equipment.

The synthesizers have proven over the past six years their high performance and reliability in many critical applications. Their continued use in deep space tracking systems, military satellite communication systems and radar applications attest to their performance and reliability. Actual operating field history has demonstrated a mean time between failure (MTBF) in excess of 10,000 hours for the synthesizer system. You can be certain your synthesizer needs will be met with the proven performance and reliability of the Hewlett-Packard synthesizers.

Hewlett-Packard frequency synthesizers translate the stable frequency of a precision frequency standard to any selected one of thousands, even billions of frequencies over a broad spectrum that extends from dc to 500 MHz. The selected frequency is known to quartz crystal oscillator accuracy; resolution is as fine as 0.01 Hz; and a new frequency can be switched upon electronic command in 20 μ s or from a keyboard as fast as the operator can push buttons. One synthesizer can do the work of a whole battery of oscillators and special-purpose signal generators and can do it better.

Synthesizers find application in many areas where the stability of a high-quality standard is required, including advanced communications, radio sounding, testing

FREQUENCY SYNTHESIZERS



FREQUENCY & TIME STANDARDS

of frequency sensitive devices, and spectrum analysis.

The range of synthesized frequencies available is greatly extended with the Hewlett-Packard Synthesizer, Model 5105A/5110B, which covers 0.1 MHz to 500 MHz.

Hewlett-Packard Synthesizers

Model No.	Range	Minimum Step
5100B/5110B	0.01 Hz to 50 MHz	0.01 Hz
5102A	0.1 Hz to 1 MHz 0.01 Hz to 100 kHz	0.1 Hz 0.01 Hz
5103A	1 Hz to 10 MHz 0.1 Hz to 1 MHz	1 Hz 0.1 Hz
5105A/5110B	0.1 MHz to 500 MHz	0.1 Hz

All of the Hewlett-Packard Synthesizers offer digital selection from a push-button keyboard or by remote switch closure, and in addition, a search oscillator for continuously variable frequency selection. All derive their output frequency by the direct synthesis technique, one capable of translating the stability and spectral purity of the source to the selected output. All have a self-contained 1 MHz source, a precision quartz oscillator of excellent stability, and all can use in its place an external 1 MHz or 5 MHz standard.

Direct vs. indirect synthesis

Two basic approaches to frequency synthesis are "direct" and "indirect". Direct synthesis simply performs a series of arithmetic operations on the signal from the frequency standard to achieve the desired output frequency. In indirect synthesis, a master oscillator is phase locked to signals derived from the standard.

The direct synthesis approach has the pronounced advantages of permitting fine resolution, fast switching, and a spectrally pure output signal.

Indirect synthesis, on the other hand, can offer the advantage of lower cost for less stringent applications where use of the more sophisticated, high spectral purity, rapidly programmed, direct frequency synthesizer is unwarranted.

The synthesis operation

The 5100B/5110B and the 5105A/5110B synthesizers are made up of two completely solid-state units: the synthesizer proper, and the driver.

The driver contains a frequency source, a spectrum generator, and appropriate selective networks. The source is a high quality crystal oscillator housed

in an oven. It is well protected from line voltage variations, and has an aging rate of less than 3 parts in 10^9 per day. A crystal filter at the oscillator output limits the noise bandwidth to about 150 Hz.

The spectrum generator is a step-recovery diode. Active filtering, synchronously tuned transistor stages and frequency dividers provide a series of fixed frequencies between 3 and 39 MHz which are fed to the synthesizer unit.

The synthesizer unit contains harmonic generators and suitable mixers, dividers, and amplifiers to derive the desired output frequency as a function of the fixed frequencies. The front-panel pushbuttons actuate a diode switching matrix. All frequencies appearing at the inputs to this matrix are always present. This is one of the key advantages of the direct synthesis method. The limitations on switching speed are just the time constants on the filtering circuits in the supply line to the switch and circuit bandwidths.

High-speed switching

The oscillogram of Figure 1 shows the speed which is typical of Hewlett-Packard synthesizers when they change output frequency under electronic command. The upper waveform is synthesizer output; the lower is the externally applied switching voltage. Note the virtual absence of dead time and switching transients.

Synthesizer programmer

The HP Model 2759B Synthesizer Programmer provides a means to interface a parallel BCD controller command (such as a computer) to the 10 line remote control input requirement of the synthesizers. The programmer transfers new frequency information in digit-serial form, least significant digit first, exactly as required by the internal frequency generating chain of the synthesizer. This technique results in generation of a new

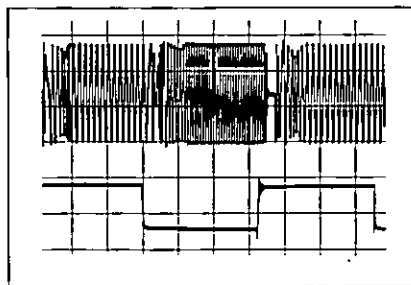


Figure 1. Switching speed, Model 5103A: 1.2 MHz to 2.7 MHz, 30 kHz switching rate. 5 μ s/cm, 10 MHz Range.

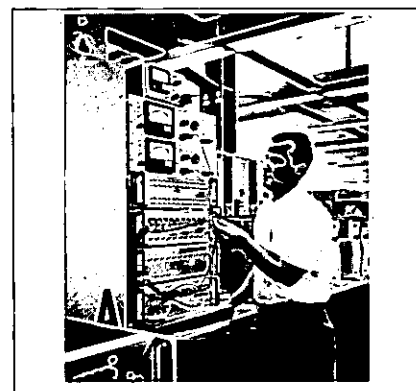


Figure 2. Stability monitoring equipment.

frequency with the least possible effects from propagation delays in the chain or undesirable transients in the output. The 2759B thus provides rapid and smooth transition between frequency changes for critical applications while changing at a rate of 25,000 per second.

Signal purity

Two of the central design objectives for the Hewlett-Packard synthesizers were (1) virtual elimination of non-harmonically related spurious signals and (2) the reduction of noise to as low a level as possible. Noise appears as a small, random phase modulation which adversely affects the short-term stability of a signal.

Performance of the Model 5100B/5110B is typical of Hewlett-Packard synthesizers and attests to the attainment of these objectives: non-harmonically related signals are at least 90 dB below the selected frequency, and signal to phase noise ratio is greater than 54 dB (in a 30 kHz noise bandwidth centered on the signal, with a 1 Hz central band excluded).

At Hewlett-Packard, a considerable number of engineering years have been spent on problems of frequency stability and its measurement. Routine production line tests are made of frequency stability with the use of specially designed equipment of a sophistication not often found even in frequency measurement research laboratories. Figure 2 shows a multi-channel short-term frequency stability monitor used to check each Hewlett-Packard synthesizer driver. This equipment monitors both rms and peak phase noise of all the driver outputs at the same time and shows an alarm light if any one of the set limits is exceeded. For additional information on the theory of operation, refer to Hewlett-Packard Application Note No. 96.

FREQUENCY & TIME STANDARDS



FREQUENCY SYNTHESIZERS

Broad frequency coverage, dual-range
Models 5102A, 5103A

The HP Models 5102A and 5103A Frequency Synthesizers increase synthesizer capability, providing instruments with dual-output frequency ranges of 100 kHz and 1 MHz (5102A), and 1 MHz and 10 MHz (5103A).

The 5102A provides output frequencies from 0.01 Hz to 100 kHz and from 0.1 Hz to 1 MHz in increments of 0.01 Hz and 0.1 Hz respectively. Output frequencies from 0.1 Hz to 1 MHz in increments of 0.1 Hz, and from 1 Hz to 10 MHz in 1 Hz increments are provided by the 5103A. Both instruments synthesize the output frequency from a single frequency source, translating the stability of the source to the output frequency via a direct synthesis technique. A very stable quartz oscillator, provided with each synthesizer, or an external 1 MHz (or 5 MHz) frequency standard may be used as the frequency source.

A Level control on the front panel allows continuous adjustment from 300 mV to 1 volt rms, of frequencies greater than 50 Hz available at the front-panel BNC. For frequencies below 50 Hz, the signal is taken from a rear-panel Low Level output BNC. Frequencies available at the rear-panel BNC have a signal strength of approximately 80 mV for the 5102A and 20 mV for the 5103A.

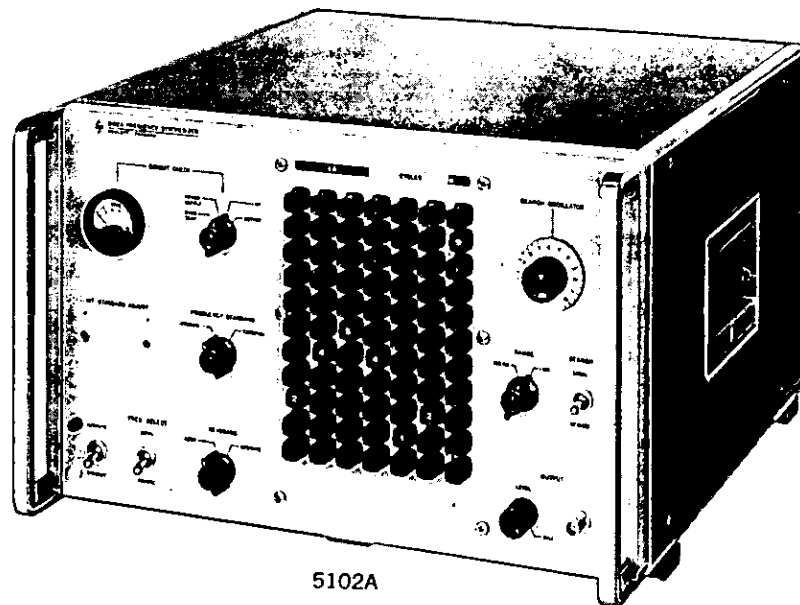
Dual-range feature

The two distinct (dual) frequency ranges of the 5102A and 5103A provide the user with extended capability at minimum cost and without sacrifice of a convenient module size. The upper range extends the frequency capability of each model, at the same time retaining high levels of stability and spectral purity. The higher frequency capability has frequency increments that are the same percentage of the range maximum as in the lower frequency range.

The choice of frequency range is dependent on the maximum frequency required and is selected by the Range switch located on the front panel. The Range switch also positions a moveable label bar, conveniently indicating the decimal value of each column of pushbuttons. For both ranges the output frequency is selected three ways.

With the Frequency Select switch in the Local position, the output frequency is selected by seven columns of pushbuttons, arranged for rapid frequency selection. A locking switch is provided to prevent accidental operation of the pushbuttons once they are set. In addition, the full range of each column may be continuously varied either manually or externally by a search oscillator. Any frequency or search oscillator position locally controlled may be remotely selected via rear-panel connectors to each of the front-panel pushbuttons. The Frequency Select switch is positioned in Remote for remote control. Combined local-remote operation also is possible with the switch in the Local position. Any column not locally selected may be remotely controlled. Less than 20 μ s are required to switch between frequencies in the local mode of selection and also in the remote mode if proper impedance levels are selected for the remote controller. The switching speed is very rapid and accurate, due to the direct synthesis technique used, which eliminates slower, phase-locked loops.

The search oscillator provides continuous tuning in any selected column plus an external sweep capability. This is an L-C oscillator which allows the operator to continuously "search" any significant column from 1 MHz to 0.1 Hz either manually by a front-panel control or remotely by application of a suitable voltage. The typical voltage vs frequency characteristic is shown in Figure 1. The approximate slope is



5102A

10% of the selected column's range per V. The search oscillator may be frequency modulated from an external source at a maximum sine wave rate of 1 kHz while retaining the voltage control calibration.

If the search oscillator is used, the stability of the synthesizer output is determined by either that of the standard instrument or that of the search oscillator—depending on the column which is "searched."

Outputs from the 5102A and 5103A are very clean over the full frequency ranges. Careful design and solid-state modular construction yield the high order of spectral purity essential for applications requiring clean and stable frequencies.

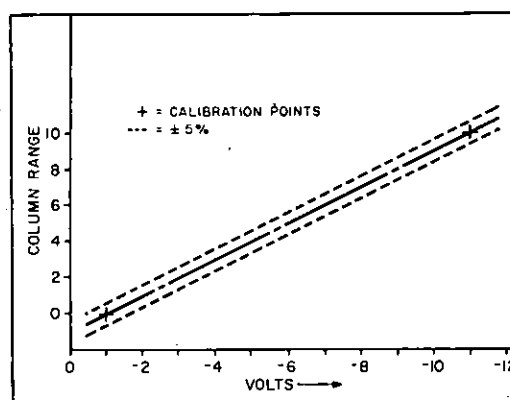
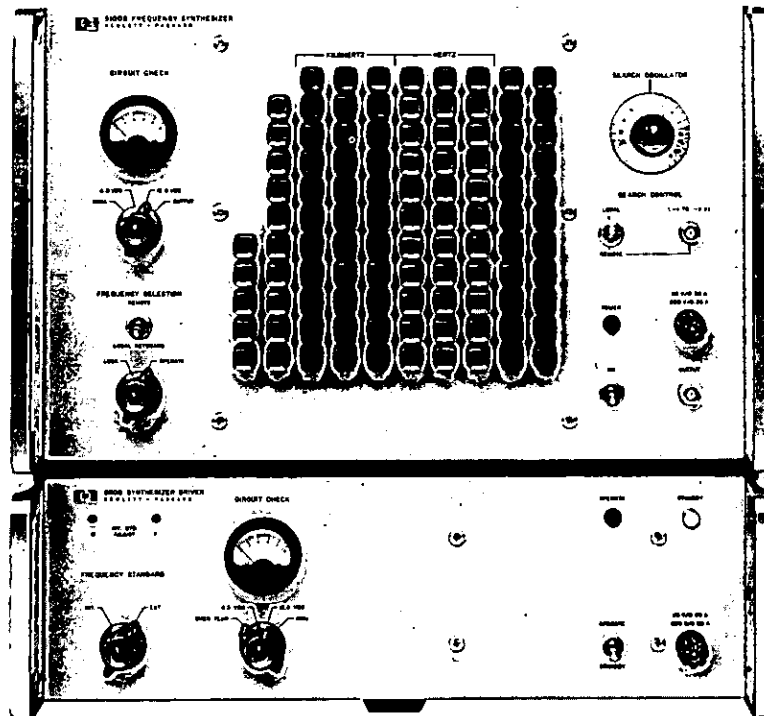


Figure 1.

Specifications

HP Model	5102A	5103A								
Output frequency:	100 kHz range: 50 Hz to 100 kHz; 1 MHz range: 50 Hz to 1 MHz	1 MHz range: 50 Hz to 1 MHz; 10 MHz range: 50 Hz to 10 MHz								
Output voltages:	Maximum output 1 V rms \pm 1 dB into 50 Ω resistive load. Level control (front panel output BNC) provides a minimum of 10 dB continuously variable attenuation.									
Auxiliary outputs:	(1) Low level: dc to value of range, both ranges (rear-panel BNC); (2) $f_0 + 30$ MHz (f_0 is selected frequency, dc to 1 MHz, both ranges) rear-panel BNC; (3) 1 MHz frequency standard (rear-panel BNC)									
Auxiliary output voltage:	(1) Low level 80 mV rms (minimum) open circuit (2) $f_0 + 30$ MHz: 1 volt rms, \pm 2 dB into a 50 Ω resistive load (3) 1 MHz: 1 volt rms, \pm 1.5 dB into a 50 Ω resistive load 20 mV rms (minimum) open circuit									
Digital frequency selection:	100 kHz range: 0.01 Hz to 10 kHz steps; 1 MHz range: 0.1 Hz to 100 kHz steps Selection by front-panel pushbutton or by remote contact closure; any change in frequency may be accomplished in $< 20 \mu$ s provided appropriate rear-panel connection is used	1 MHz range: 0.1 Hz to 100 kHz steps; 10 MHz range: 1 Hz to 1 MHz steps								
Switching time:	$< 20 \mu$ s for any change in frequency									
Search oscillator:	Provides continuously variable frequency selection in any desired column over complete range of that column; manual by a front-panel control or by an external voltage (-1 to -11 volts)									
Signal-to-phase noise ratio (output)*:	(Output): 100 kHz range, > 74 dB 1 MHz range, > 64 dB ($f_0 + 30$ MHz): > 60 dB	(Output): 1 MHz range, > 64 dB 10 MHz range, > 54 dB ($f_0 + 30$ MHz): > 60 dB								
Signal-to-AM noise ratio*:	(Output): 100 kHz range, > 80 dB for frequencies above 30 kHz; 1 MHz range, > 74 dB for frequencies above 100 kHz ($f_0 + 30$ MHz): > 80 dB	(Output): 1 MHz range, > 74 dB for frequencies above 100 kHz; 10 MHz range, > 74 dB for frequencies above 500 kHz ($f_0 + 30$ MHz): > 80 dB								
RMS fractional frequency deviation:	(Output):									
	100 kHz range	1 MHz range	1 MHz range	10 MHz range						
	Avg. Time	100 kHz Output Frequency	Avg. Time	100 kHz Output Frequency	1 MHz Output Frequency	Avg. Time	1 MHz Output Frequency	Avg. Time	10 MHz Output Frequency	
	10 ms	3×10^{-8}	10 ms	1×10^{-7}	10 ms	1×10^{-8}	10 ms	1×10^{-8}	10 ms	3×10^{-9}
	1 s	3×10^{-10}	1 s	1×10^{-9}	1 s	1×10^{-10}	1 s	1×10^{-10}	1 s	3×10^{-11}
(Output):		(Output):								
Averaging Time		Output Frequency		Averaging Time		Output Frequency				
10 ms		6×10^{-10}		10 ms		6×10^{-10}				
1 s		1×10^{-11}		1 s		1×10^{-11}				
Spurious signals:	100 kHz range: > 90 dB; 1 MHz range: > 70 dB (below selected output for non-harmonically related signals)	1 MHz range: > 70 dB; 10 MHz range: > 50 dB								
Harmonic signals:	> 35 dB on all ranges, all outputs (with proper termination)									
Internal frequency standard:	1 MHz quartz oscillator									
Internal frequency standard aging rate:	less than ± 3 parts in 10^9 per 24 hours									
Stability of internal frequency standard (as function of ambient temp.): (as function of line voltage):	$\pm 2 \times 10^{-10}$ per $^\circ\text{C}$ from 0°C to $+55^\circ\text{C}$ $\pm 5 \times 10^{-11}$ for a $\pm 10\%$ change in line voltage (115 or 230 V)									
External frequency standard:	1 MHz or 5 MHz, 0.2 V to 5 V rms across 500 Ω									
Standard input requirements:	stability and spectral purity of synthesizer will be partially determined by the characteristics of external standard if used									
Operating temperature range:	0 to $+55^\circ\text{C}$									
Dimensions:	16 $\frac{3}{4}$ " wide, 10-15/32" high, 16 $\frac{1}{2}$ " deep (425 x 266 x 416 mm)									
Weight; power:	net 75 lbs (34 kg), shipping 132 lbs (60 kg); 115 or 230 V $\pm 10\%$, 50-400 Hz, 50W									
Price:	\$7,200	\$7,800								

*In a 30 kHz band centered on the carrier, excluding a 1 Hz band centered on the carrier.



DC to 50 MHz in 0.01 Hz increments
 Model 5100B/5110B

Advantages:

- Frequencies from dc to 500 MHz
- Pushbutton selection
- Search oscillator
- Remote programming
- Switching speed typically 20 μ s
- Very low spurious
- Proven reliability

Uses:

- Offers high levels of spectral purity and stability for such applications as:
 - Accurate doppler measurements
 - Microwave spectroscopy
 - Narrow-band telemetry
 - Automatic testing of frequency-sensitivity devices
 - Communications systems

The Models 5105A/5110B and 5100B/5110B together provide complete frequency coverage from dc to 500 MHz. The instruments both use direct synthesis to achieve their very fast switching speeds and high spectral purity. This

technique translates the stability and spectral purity of a reference source to the selected output and in addition provides a fail-safe output. A precision high stability 1 MHz quartz oscillator is provided, or an external 1 MHz or 5 MHz standard may be used. Both units provide pushbutton or remote frequency selection and include a selectable search capability. The 5105A has 0.1 Hz steps from 100 kHz to 500 MHz in addition to a variable output level and phase modulation. The 5100B provides 0.01 Hz steps from dc to 50 MHz (dc to 100 kHz from separate connector). The 5110B Synthesizer Driver supplies 22 fixed frequencies required to input to the 5105A or 5100B. Both units or any combination of them up to four may be driven by the 5110B.

Continuous Tuning, Sweep, FM

For both units a search oscillator provides continuously variable frequency selection over the range of any one column except the left-hand two. Operation of a front-panel control manually tunes the search oscillator over the complete frequency range of the selected digit (column). One of the advantages afforded by continuous control is the easy identification of an unknown frequency by beating it against the synthesizer output.

The search oscillator also may be controlled by application of a dc voltage (-1 to -11 volts, linearity $\pm 5\%$) which enables remote operation and gives sweep capability.

The search oscillator can be frequency modulated from an external source (sinewave) at a maximum rate of 1 kHz while retaining the voltage control calibration.

Remote Operation

The 5105A/5110B and 5100B/5110B Synthesizers provide great control flexibility of a precision frequency source over a range greater than ever before available. Any frequency or search oscillator position available from the keyboard can be remotely selected and can be rapidly switched: in 20 μ s, typically.

Rear panel connectors on the 5105A/5100B provide pins corresponding to each front panel pushbutton, a ground connection, and a -12.6 volt line for use in remote programming. A combination of remote and local programming may be used, if so desired.

No actual contact closure, such as a relay, is required. The -12.6 volts dc may be applied to the selected pin by electronic means.

The remarkably fast switching speed, valuable for such tasks as automatic digital frequency tracking, is one of the significant advantages of the direct synthesis method.

Fast Switching

Figure 1 shows (upper trace) the 5105A/5110B output frequency switched between 399.8 MHz and 400.2 MHz with 400 MHz subtracted to display switching in greater detail. The sweep is 25 μ s/cm. The lower trace is that of the switching waveform applied to the synthesizer. The 5100B/5110B displays similar performance up to 50 MHz.

Low Noise Performance

To achieve the excellent low-noise output specified for the Hewlett-Packard Synthesizers over the full range requires the utmost care in design to identify and minimize noise sources followed by extensive testing at each stage of manufacture.

Figure 2 shows phase noise distribution for both synthesizers. The ratio of output signal to single-sideband phase noise (in a 1 Hz bandwidth) is plotted against frequency of offset from the signal.

The noise performance reflected in this plot is remarkable for instruments as complex and versatile as the 5105A and 5100B. It also demonstrates their suitability for applications where spectrum requirements are critical.

Spectral Purity and Stability

Particular care has been exercised in the design of the Hewlett-Packard Synthesizers to insure a very clean output signal is provided over the entire frequency range of the instruments. A high order of spectral purity is essential for accurate doppler measurements, microwave spectroscopy, narrow band telemetry, communications and similar applications. The careful design and modular construction of the synthesizers make it possible to obtain output signals with spurious content at least 90 dB below the selected output in the case of the 5100B. The 5105A spurious signals are at least 70 dB below its output over the entire 500 MHz range.

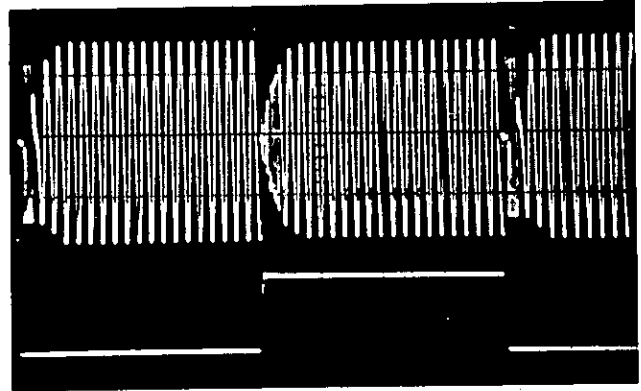


Figure 1. Synthesizer switching speed (25 μ s/cm).

Specifications

Specifications for the 5105A and 5100B Synthesizers are presented on page 634. Specifications for the 5110B Synthesizer Driver are presented on page 635.

Modular Construction

Modular construction has been used throughout the Synthesizers. The modular concept enables the system to meet stringent demands regarding spurious signals since the isolation that it affords minimizes spurious coupling. It also enhances serviceability. Careful design and quality control insure that all modules are interchangeable from one instrument to another.

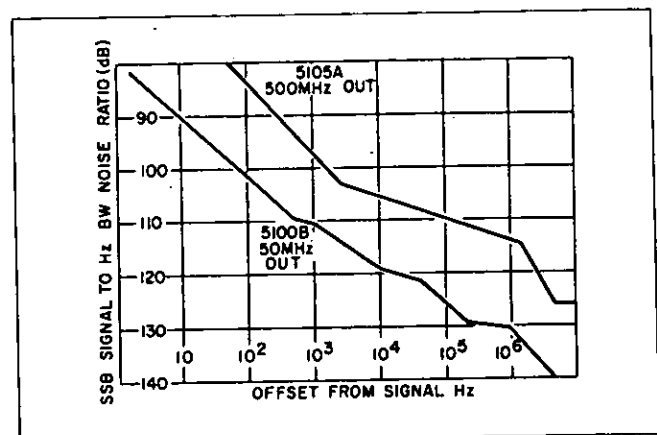


Figure 2. Composite phase noise plot for Hewlett-Packard synthesizer.

Specifications
5105A, 5100B Synthesizers

Specifications	5105A*	5100B*										
Output frequency	100 kHz to 500 MHz	dc to 50 MHz										
Digital frequency selection	0.1 Hz through 100 MHz per step. Selection by front panel pushbutton or by remote switch closure. Any change in frequency may be accomplished in 20 μ s typically.	0.01 Hz through 10 MHz per step. Selection by front panel pushbutton or by remote switch closure. Any change in frequency may be accomplished in 20 μ s typically.										
Output voltage	Fixed: 0 dBm \pm 1 dBm into a 50 ohm resistive load. Variable: -6 dBm to \geq 6 dBm into a 50 ohm resistive load.	1 volt rms \pm 1 dB from 100 kHz to 50 MHz. 1 volt rms +2 dB, -4 dB from 50 Hz to 100 kHz, into a 50 ohm resistive load. Nominal source impedance is 50 ohms. 15 mV rms minimum open circuit from 100 kHz down to dc, at separate rear output connector, source impedance of 10,000 ohms with shunt capacitance approximately 70 pF.										
Search oscillator	Provides continuous variable frequency selection with a selectable incremental range of 1.0 Hz through 10 MHz. Manual or external voltage (-1 to -11 volts) control with linearity of \pm 5%. The search oscillator may be externally swept up to a 1 kHz sinewave rate.	Provides continuously variable frequency selection with an incremental range of 0.1 Hz through 1 MHz. Manual or external voltage (-1 to -11 volts) control with linearity of \pm 5%.										
Phase modulation	(rear panel input) \pm 3 radians maximum deviation; dc -1 MHz rate.											
Signal-to-phase noise ratio	Measured in a 30 kHz band centered on the signal (excluding a 1 Hz band centered on the signal) is greater than: <table border="1" style="margin-left: auto; margin-right: auto;"> <tr> <td style="text-align: center;">Output frequency—MHz</td> <td style="text-align: center;">1</td> <td style="text-align: center;">50</td> <td style="text-align: center;">100</td> <td style="text-align: center;">500</td> </tr> <tr> <td style="text-align: center;">Ratio—dB</td> <td style="text-align: center;">48</td> <td style="text-align: center;">48</td> <td style="text-align: center;">48</td> <td style="text-align: center;">40</td> </tr> </table>	Output frequency—MHz	1	50	100	500	Ratio—dB	48	48	48	40	Greater than 54 dB in a 30 kHz band centered on the signal (excluding a 1 Hz band centered on the signal).
Output frequency—MHz	1	50	100	500								
Ratio—dB	48	48	48	40								
Signal-to-AM noise ratio	(Above 100 kHz): Greater than 74 dB in a 30 kHz band.											
RMS fractional frequency deviation (with a 30 kHz noise bandwidth)	Averaging time	Output Frequency	Output Frequency									
		1 MHz	50 MHz	100 MHz	500 MHz	1 MHz	5 MHz	10 MHz	50 MHz			
	10 ms	1 x 10 ⁻⁷	2 x 10 ⁻⁹	1 x 10 ⁻⁹	6 x 10 ⁻¹⁰	3 x 10 ⁻⁸	6 x 10 ⁻⁹	3 x 10 ⁻⁹	6 x 10 ⁻¹⁰			
	1 s	2 x 10 ⁻⁹	4 x 10 ⁻¹¹	2 x 10 ⁻¹¹	1 x 10 ⁻¹¹	3 x 10 ⁻¹⁰	6 x 10 ⁻¹¹	3 x 10 ⁻¹¹	1 x 10 ⁻¹¹			
Spurious signals	Non-harmonically related signals are at least 70 dB below the selected frequency.				Non-harmonically related signals are at least 90 dB below the selected frequency.							
Harmonic signals	25 dB below the selected frequency, (applicable to fixed output when terminated in 50 ohms).				30 dB below the selected frequency (when terminated in 50 ohms).							
Dimensions	16 $\frac{3}{4}$ " wide, 16 $\frac{3}{8}$ " deep, 10-15/32" high (425 x 416 x 266 mm).											
Weight	net, 82 lbs (37 kg); shipping, 96 lbs (44 kg).				net, 84 lbs (34 kg); shipping, 97 lbs (44 kg).							
Equipment furnished	Decade test cable: 05105-6054/55. Cable Assembly (connects 5105A-Synthesizer to 5110B Driver) permits up to approx. 2.5 feet vertical separation.				05100-6180 Decade Test Cable, 05100-6066 Output Cable, 05100-6212/13 Cable Assembly connects 5100B Synthesizer to 5110B Driver. Permits rack mounting a 5100B up to approx. 2.5 ft. above or below the 5110B Driver. A special-length-cable assembly will be required for other mounting arrangements.							
Special cable	Special cable available. Specify configuration and length (50 ft. max.). Cable is supplied in four-foot increments. Price: \$40 per four-foot increment.				If a special-length cable assembly is required, order spec C05-5110B. Specify configuration and length (max. separation 50 feet). Cable is supplied in four-foot increments only. Price: \$40 per four-foot increment.							
Price	model 5105A, \$9450. (Requires 5110B)				model 5100B, \$8150. (Requires 5110B)							

*Requires 5110B Driver which has an internal frequency standard. When the 5110B Driver utilizes an external frequency standard, this will affect the stability and spectral purity of the output. Performance data stated above are based on the excellent internal frequency standard in the 5110B. The data are also an indication of synthesizer contribution to over-all performance when an external standard of less spectral purity than in the 5110B is connected to the 5110B.

SYNTHESIZER DRIVER

For the 5100B and 5105A Synthesizers
Model 5110B



FREQUENCY & TIME
STANDARDS

The HP 5110B Synthesizer Driver supplies the HP 5100B and 5105A Synthesizers with 22 fixed, spectrally pure signals derived from a 1 MHz precision quartz oscillator.

The frequency synthesizer system comprising the 5105A Synthesizer and the 5110B Driver provides output frequencies from 0.1 to 500 MHz in increments as small as 0.1 Hz. The 5100B-5110B system provides output frequencies from dc to 50 MHz in increments as small as 0.01 Hz. These synthesizers are described on pages 632-634.

The 1 MHz quartz oscillator which is the source for all output frequencies of the synthesizer driver is stable to 3 parts in 10^9 per 24 hours. To help maintain this excellent crystal stability, oven circuits are energized any time the instrument is connected to the power line. A circuit check meter allows verification of correct oven operation.

Where special requirements make it necessary that synthesized frequencies be derived from an external frequency standard, a rear panel connector on the 5110B accepts a 1 MHz or 5 MHz signal. The output spectral purity is partially dependent on the purity of the remote frequency standard.

These synthesizer drivers are each capable of driving up to four synthesizers. Drivers equipped in accordance with Options 002 through 004, for driving from two to four synthesizers, must have additional outputs not in use terminated in 50 ohms in order that full specified spurious performance be met.

Specifications

Synthesizer Driver 5110B

For the 5100B and 5105A Synthesizers

Output frequencies: Provides 22 fixed frequencies for Frequency Synthesizer operation; 3.0 through 3.9 MHz in 0.1 MHz steps (50 mV ± 1 , -3 dB) 30 through 39 MHz in 1 MHz steps, 24 MHz, and 20 MHz (100 mV ± 1.5 dB), 50 Ω system. Note: 20 MHz is not used with the 5100B Synthesizer.

1 MHz buffered output (1 V ± 1.5 dB into a 50 Ω resistive load) available at rear panel connector.

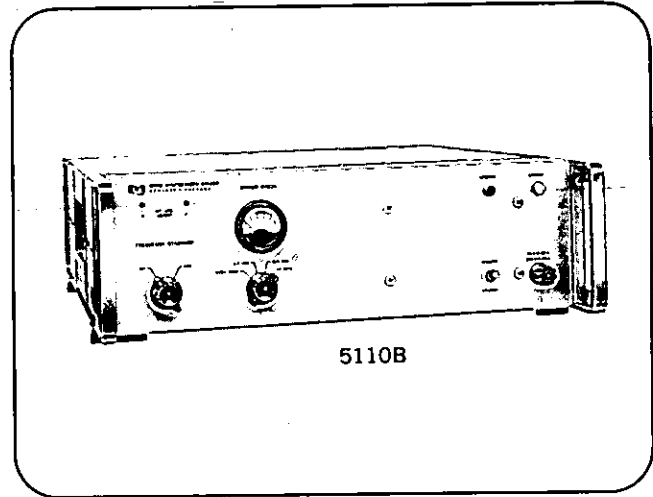
Internal frequency standard:

Type: 1 MHz Quartz Oscillator.

Aging rate: Less than 3 parts in 10^9 per 24 hours.

Stability: As a function of ambient temperature: $\pm 2 \times 10^{-10}$ per $^{\circ}\text{C}$ from 0°C to $+55^{\circ}\text{C}$. As a function of line voltage $\pm 5 \times 10^{-11}$ for a $\pm 10\%$ change in line voltage (rated at 115 or 230 volts rms line voltage).

Short term (with internal crystal filter): Adequate to provide the 5100B and 5105A performances noted on page 634.



5110B

Phase-locking capability: A voltage control feature allows 5 parts in 10^9 frequently control for -5 to +5 volts applied externally.

External frequency standard input requirements: 1 MHz or 5 MHz, 0.2 V rms minimum, 5 V maximum across 500 ohms. Stability and spectral purity of Frequency Synthesizer will be partially determined by the characteristics of the external standard if used.

Dimensions: 16 $\frac{3}{4}$ " wide, 5-7/32" high, 16 $\frac{3}{8}$ " deep (425 x 133 x 416 mm).

Weight: Net, 54 lbs (25 kg). Shipping, 67 lbs (30 kg).

Operating temperature range: 0 to $+55^{\circ}\text{C}$.

Interference: Complies with MIL-I-26600, Class 1 and 3, MIL-I-6181D.*

Susceptibility: Complies with MIL-I-26600, Class 1 and 3, MIL-I-6181D.

Power: 115 or 230 V $\pm 10\%$, 50 to 400 cycles, 35 W.

Optional features: The Synthesizer Drivers are capable of driving up to four Frequency Synthesizers:

Option 002, outputs for driving two synthesizers, \$125; Option 003, for three, \$235; Option 004, for four, \$345.

Accessories available: 10510A BNC termination, 50 Ω . If Option 002-004 has been selected, outputs not connected to a Synthesizer must be terminated in 50 Ω if full specified spurious performance is required. For each set of outputs not connected to a Synthesizer, 22 of these 50 Ω terminations are required; thus, if Option 004 Driver is connected to only one Synthesizer, 66 would be required. Price, \$5 each. Special interconnecting cable sets are described on page 634.

Note: Small phase jumps may be experienced in additional synthesizer when first is switched in frequency.

Price: model 5110B, \$4350.

*Interference compliance requires that the 5100B/5105A and 5110B are connected by a low inductance path such as adjacent rack mounting.

MISCELLANEOUS



CABINETS

Rugged, durable, and ready-to-use
2940A Series

The 2940A Series Cabinets (shown on page 100) are fully-wired ready-to-use electronic instrument enclosures designed and manufactured by Hewlett-Packard to give excellent structural stability and a clean, professional appearance. Cabinets are available in a choice of three heights, three widths, solid or transparent doors, convenient writing shelves, and other complementary accessories. All aluminum, modular construction offers significant savings in weight, space, and shipping costs in addition to superior structural stability and durability. Each bay is built around a frame of four rugged aluminum columns that are anchored, top and bottom, to massive aluminum end castings. In multi-bay cabinets, adjacent columns are doubly bolted together at top and bottom to assure maximum rigidity of the total cabinet structure. All cabinets are equipped with casters for easy movement. Heavy-duty eyebolts, capable of supporting 5600 pounds, allow the cabinets to be handled and moved safely by an overhead crane. An optional front base extension prevents tipover when heavy instruments, such as a Hewlett-Packard computer or magnetic tape unit are swung out for servicing. As an added benefit, modular design also lends itself to making quick repairs on cabinets that have suffered damage to structure or appearance, by replacing the affected parts—difficult or impossible with welded steel structures.

All cabinets are wired in accordance with current IEC recommendations. An important feature of this wiring arrangement is that all power input leads, except safety ground, are interrupted in event of a short circuit in any bay. Cabinets are available with optional input wiring configurations to meet operating power requirements.

A highly efficient ventilation system holds internal cabinet temperature at proper equipment operating level. Air is drawn in from the rear through a permanent, snap-in type filter and exhausted through louvers at the top of the rear panel.

Instrument support rails are supplied with each cabinet depending on the size: 4 pairs with 35-inch cabinets, 5 pairs per bay with 56-inch cabinets, and 6 pairs per bay with 70-inch cabinets.

Systems supplied in 2940A Cabinets are delivered completely cabled and ready for operation with required instrument support rails in place and blank panels installed to cover all unoccupied panel space, at no additional charge.

Ordering Information

Cabinets

Cabinet prices cover fully-equipped cabinet including caster base, forged eyebolts, and a complete electrical system meeting IEC specifications. (Specify electrical power desired by ordering from the POWER OPTIONS table below.) Blank panels are also provided as required when cabinets are ordered with a system.

BAYS	HEIGHT		ORDER 2940A W/Option	WIDTH Overall	WEIGHT		PRICE \$
	Panel	Overall			Net	Ship	
ONE BAY	35 (889)	43.25 (1099)	135	21 (533)	128 (58.1)	230 (104.4)	750
	56 (1422)	64.25 (1632)	156		161 (73.1)	280 (127.1)	
	70 (1778)	78.25 (1988)	170		181 (82.2)	332 (150.7)	
TWO BAYS	2 x 56 (2 x 1422)	64.25 (1632)	256	42 (1067)	294 (133.5)	471 (213.8)	1,450
	2 x 70 (2 x 1778)	78.25 (1988)	270		333 (151.2)	554 (253.8)	
THREE BAYS	3 x 56 (3 x 1422)	64.25 (1632)	356	63 (1600)	434 (197.0)	672 (305.1)	2,000
	3 x 70 (3 x 1778)	78.25 (1988)	370		494 (224.3)	796 (361.4)	

NOTES:
 1. Dimensions in inches and (millimeters)
 2. Usable depth 27 3/4 in. (702 mm). Overall depth 30 in. (762 mm)
 3. Overall height includes casters, but not eyebolts
 4. Weight in pounds and (kilograms)

Power options

Power options provide complete electrical wiring systems for cabinets and fully comply with the latest IEC electrical specifications. Cabinets include fan(s), master circuit breaker, on-off switch, multiple outlet power strip(s), and line-terminated cord, except as follows: two-bay cabinets are supplied with line cord less plug and three-bay cabinets are supplied less line cord. Power strips are provided as follows: 6 outlets per 35-inch cabinet are rated 10 amperes per bay at 115 VAC (5 amperes at 230 VAC); 9 outlets per bay per 56-inch cabinet and 11 outlets per bay per 70-inch cabinet are rated 20 amperes per bay at 115 VAC (10 amperes at 230 VAC). Internal temperature rise is less than 15°C over ambient temperature where internal power dissipation per bay does not exceed 500 watts in a 35-inch cabinet, or 2000 watts in a 56- or 70-inch cabinet. Under these conditions, the remaining available power from the cabinet can be used to power external devices such as teleprinters at no increase in cabinet temperature. Power options are based on 50-60 Hz line frequency. Specify power option by ordering 2940A Cabinet option plus power option, e.g., for 35-inch cabinet with 115 VAC electrical systems, specify a 2940A Cabinet with Options 135 and 51.

2940A Option No.	PRIMARY POWER INPUT			
	115 Vac Option No. ①	230 Vac (Europe) Option No. ②	230 Vac (U.S.A.) Option No. ③	120/208 Vac, 3 phase Option No. ④
135	51	50	⑤	Not available
156	52	55	⑥	Not available
170	52	55	⑦	Not available
256	53	56	58	⑧
270	53	56	58	⑨
356	54	57	⑩	59
370	54	57	⑪	59

① Internal power strips wired for 115 Vac
 ② Internal power strips wired for 230 Vac
 ③ Internal power strips wired for 115 Vac
 ④ Internal power strips wired for 120 Vac
 ⑤ Available on special order. Consult H-P Field Sales Office.

POWER STRIP OPTIONS (Additional convenience outlets only, does not increase load capacity.)

Option 60 Six additional outlets for 35-inch cabinet, add \$40.

Option 61 Nine additional outlets for 56-inch cabinet, add \$45.

CABINET, ENCLOSURES *continued***Modular Enclosure Systems**

Option 62 Eleven additional outlets for 70-inch cabinet, add \$50.

Front doors

Standard doors provide 2-9/16 inches of usable space from front of rack-mounted instrument to inside of door to allow for knobs and other protrusions. This adds 2 inches to the overall cabinet depth. Standard doors are designed for mounting in cabinets with total enclosed panel height equal to specified door height. Order by Accessory No. The 56- and 70-inch doors are for full-length mounting.

Transparent Panel

Height in (mm)	Accessory No.	Net weight Lb (kg)	Price \$
12¼ (311)	12696A	6 (2,7)	180
31½ (800)	12693A	12 (5,4)	190
56 (1422)	12677A	18½ (8,2)	200
70 (1778)	12687A	22½ (10)	200

HP Grey Panel

12¼ (311)	12697A	5½ (2,4)	160
31½ (800)	12694A	10 (4,5)	170
56 (1422)	12678A	16 (7,2)	180
70 (1778)	12688A	19½ (8,8)	180

Wood-Grain Panel

12¼ (311)	12698A	6 (2,7)	160
31½ (800)	12695A	12 (5,4)	170
56 (1422)	12686A	18½ (8,2)	180
70 (1778)	12689A	22½ (10)	180

Front door options. (Specify Accessory No. plus Option No.)

Option 03 Extra-deep door for 56- or 70-inch cabinet. Allows 5-9/16 inches of usable space from instrument front panel to inside of door. Adds 5 inches to overall cabinet depth. Price: add \$20.

Equipment slides

Accessory slides are designed for mounting Hewlett-Packard instruments and are rated at 150 pounds load limit per pair. A cabinet base extension, Option 16, 26, or 36 is recommended when using slides.

Accessory No. 12692A. Slide for 30-inch deep cabinet, less instrument adapter brackets. Specify Option 02, or 03 for mounting a Hewlett-Packard instrument. Price: \$60.

Option 02 Brackets for mounting 3½-inch high Hewlett-Packard instruments with side rail cabinet. Price: add \$15.

Option 03 Brackets for mounting Hewlett-Packard instruments greater than 3½ inches high with handle recess. Price: add \$15.

Option 12 Tilt slides. (Do not use with computers or instruments not balanced about pivot center.) No charge.

Cabinet Modifications (Order by Option Number)

Option 16 Base Extension for One-Bay Cabinet, \$50.

Option 26 Base Extension for Two-Bay Cabinet, \$80.

Option 36 Base Extension for Three-Bay Cabinet, \$120.

Note: Option 16, 26, or 36 adds 7¾ inches to the front of the cabinet base to prevent tip-over. These modifications are essential on cabinets containing Hewlett-Packard computers, magnetic tape units, or other heavy instruments that swing out for servicing.

Cabinet Accessories (Order by Accessory Number)

Storage Drawers (slide-mounted). Installed at bottom of cabinet if other location is not specified.

Height		Depth		Accessory No.	Price
in.	mm	in.	mm		
3.5	89	16	406	12672A	\$90
5.25	133	16	406	12673A	

Instrument Support Rails, one pair with attaching hardware, accessory number 12679A, \$10, not including installation.

Writing Surfaces, topped with white Formica. Fixed shelves are removed for shipping. Slideout shelf is installed if ordered with cabinet.

Type of shelf	Usable area in. (mm)	Panel height	Accessory No.	Price
1-Bay Slide out	16 x 16.5 (406 x 419)	3.5 (89)	12674A	\$140
1-Bay Fixed	15 x 20 (381 x 508)	1.75 (44)	12675A	\$100
2-Bay Fixed	15 x 41 (381 x 1041)	1.75 (44)	12676A	\$150

Blank Panels with Standard mounting holes, finished in Hewlett-Packard grey enamel.

Height in. (mm)	Accessory No.	Price	Height in. (mm)	Accessory No.	Price
1.75 (115)	12680A	\$10	7 (178)	12683A	\$10
3.5 (89)	12681A		8.75 (222)	12684A	
5.25 (133)	12682A		10.5 (267)	12685A	

Modular Enclosure Systems

The Hewlett-Packard modular enclosure system provides a complete solution to instrument packaging and mounting problems. The system is in accord with EIA standard rack and panel dimensions, yet each enclosure is equally well suited to bench or field use.

The matching enclosures offer an enviable combination of economy, strength and appearance. They are rugged enough to meet many of the stringent military requirements and present a rich, professional appearance which enhances the value of the instrument.

Two types of instruments

Basically, instruments enclosed in the modular system fall into two classes:

1. Those units which require the full EIA rack width (Figure 1). This class of instruments mounts directly in racks with the two brackets and filler-strip included with the instrument. Feet and tilt stand also are provided with full-module instruments for bench use, and the instruments can be stacked conveniently for maximum utilization of available space. For semi-permanent stacking, joining brackets are available which effectively combine two instruments into a single physical unit. Control panel covers are also available for these instruments to protect them in transit.
2. Those units which do not need the full rack width (Figure 2). These instruments are standardized at one-half or one-third the width of the full module. Because of their size they are easily portable and can be used readily in the field, as well as on the bench. In addition, adapter frames are available to mount these units in the standard EIA racks. The HP 1051A, 1052A Combining Cases also can be used for a multi-instrument package that is both portable and easily rack mounted with the hardware provided. Both combining cases and rack adapter frames use blank panels to fill areas not used by instruments and accept one-third width drawers for convenient storage of leads,

probes, etc. Model 1052A Combining Cases also accept cooling kits to maintain proper ambient temperature.

Characteristic of both classes of modular instruments is ease of maintenance. Top and bottom covers, as well as side panels, are removable to provide access to all adjustments and test points within the instruments.

Instrument Case (1/3 module)

A rugged, high impact plastic instrument case for Hewlett-Packard 1/3 module instruments is available. Instruments can be operated, stored or carried in the splash-proof case. A dual purpose tilt stand also serves as a carrying handle. At the rear of the case is an accessible compartment for the power cord; and in the front lid is a storage space for cables, etc.

Specifications Combining cases

- 11046A** (Fig. 2) accepts third- or half-module instruments.
Dimensions: 19 1/4" wide, 8 3/8" high, 13 1/4" deep (489 x 213 x 367 mm), \$150.
- 1051A** (Fig. 3) accepts third- or half-module instruments up to 11 1/4" (286 mm) deep.
Dimensions: 16 3/4" wide, 7 1/4" high, 13 1/4" deep (425 x 185 x 337 mm); hardware furnished for conversion to rack mount 19" wide, 6-31/32" high, 11 1/4" deep behind panel (483 x 177 x 286 mm).
Weight: net 11 lbs (5 kg); shipping 15 lbs (6,8 kg).
Price: HP 1051A, \$135.
- 1052A** (not shown) accepts third- or half-module instruments up to 16 3/8" (416 mm) deep.
Dimensions: 16 3/4" wide, 7 1/4" high, 18 3/8" deep (425 x 185 x 467 mm); hardware furnished for conversion to rack mount 19" wide, 6-31/32" high, 16 3/8" deep behind panel (483 x 177 x 416 mm).
Weight: net 13 lbs (5,9 kg); shipping 18 lbs (8 kg).
Price: HP 1052A, \$150.

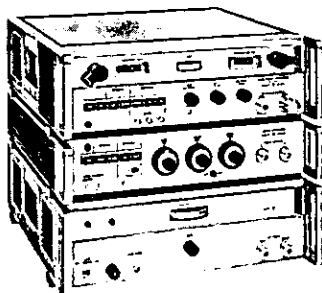


Figure 1. Full rack width cabinets stack one atop the other.

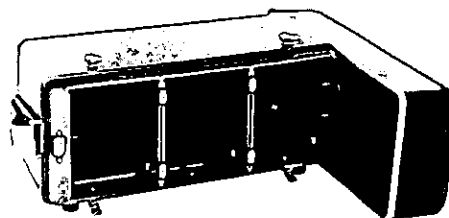


Figure 2. The 11046A Combining Case encloses two one-half module or three one-third module instruments. Included is a splash-proof cover and storage space.

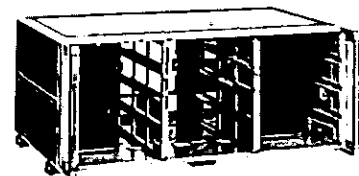


Figure 3. HP 1051A Combining Case.

Modular Enclosure Systems

Rack Adapter Frame

5060-0797 Adapter (not shown) rack mounts third- and/or half-module instruments up to 6-3/32" high (155 mm), \$25.

5060-0808 Adapter (not shown) rack mounts third- and/or half-module instruments up to 3" high (75 mm), \$25.

Control Panel Covers

These covers quickly convert full-width cabinets to easily carried portable units.

Control panel covers

Part No.	EIA Panel Height		Price
	(in.)	(mm)	
5060-0826	3-15/32	88	\$22.50
5060-0827	5-7/32	133	\$25.00
5060-0828*	6-31/32	177	\$27.50
5060-0829	8-23/32	222	\$28.50
5060-0830	10-15/32	266	\$30.00
5060-0831	12-7/32	310	\$32.50

*Also fits HP 1051A and 1052A.

Joining brackets

5060-0215 Joining Bracket Kit (Fig. 4) for semi-permanently joining any two full-module instruments 11¼" (286 mm) deep behind the front panel, \$20.

5060-0216 Joining Bracket Kit (Fig. 4) for semi-permanently joining any two full-module instruments 16¾" (416 mm) deep behind the front panel, \$25.

Instrument cases

11075A (Fig. 5) accepts third-module instrument 6½" high, 8" deep.

Weight: net 3 lbs (1,4 kg); shipping 5 lbs (2,3 kg).

Price: HP 11075A, \$45.

11076A accepts third-module instrument 6½" high, 11" deep.

Weight: net 3 lbs (1,4 kg); shipping 6 lbs (2,7 kg).

Price: HP 11076A, \$45.

Field cases

The Hewlett-Packard field cases are rugged protective outer shells for use when instruments must be frequently transported and used away from laboratory conditions. They are

molded of strong fiberglass-reinforced plastic. All are sealed tightly with O-ring gaskets and clamping latches. They are rainproof under the test conditions of MIL-STD-108. With heavier hardware and larger gaskets that are available on request, cases can be fabricated that meet the environmental requirements of MIL-C-4150 without exception. Carrying handles are conveniently placed, fold flat when not in use. Two basic case styles are available: transit and operating. A selection of case sizes is available to accommodate nearly any instrument and combination of accessories. Special size cases can also be ordered.

Transit cases

Transit cases are typically provided with foam cushions custom-formed to fit the standard Hewlett-Packard modular cabinets. This arrangement provides maximum protection against damage from handling, dropping, or crushing.

Operating cases

Operating cases are equipped internally with shock-mounted frames that accept any standard 19-inch rack-mounting instruments up to the maximum height of the frames. This arrangement offers the convenience of operation without removing the instrument from its carrying case. At the same time, environmental protection is afforded.

More than one instrument may be combined in a single operating case for convenience in setting up and operating. Patch-cable interconnections may then be left in place within the case, so that when the unit has been transported to its place of use the covers are removed and the instruments inside are ready to put into use with a minimum of delay.

Drawers are available in three different heights so that small accessories, tools, etc., can be kept inside the case with the instruments. Fitted foam cushions can be made to accommodate nearly any shape articles.

On special order, complete transportable field instrument groups can be assembled to suit individual requirements.

A caster kit is available to fit either the operating or the transit case style. With casters, the operating case becomes a mobile rack. Once the kit is installed, the casters themselves may be attached or removed in seconds. With casters removed, the attaching hardware adds nothing to the overall dimensions of the case. Complete specifications and ordering information are available on request.

Price: \$70 to \$595, in standard sizes.

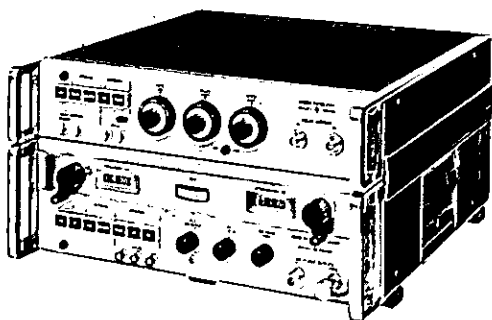


Figure 4. Joining brackets effectively weld instruments into a single physical unit.

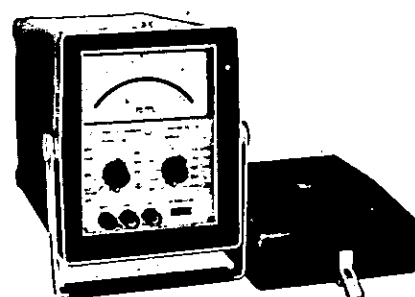


Figure 5. Rugged instrument case and tilt stand.



F3B Line Follower	120
G2B Null Detector	120
2FA Recorder, 2 pen 11" x 17" X-Y	115
3LVA5 Linear Velocity Transducers	154
3LV1 Linear Velocity Transducers	154
6LV1, 6LV4 Linear Velocity Transducers	154
7 30" x 30" X-Y Recorder	114
7DCDT Displacement Transducer	154
7LV20 Linear Velocity Transducers	154
24DCDT Linear Displacement Transducers	154
53 Battery Converter	128
55 Digital Clock	108

100

105A,B Quartz Oscillator	624
117A VLF Comparator	625
120A-83A CRT Amber Filter	536
120A-83B CRT Blue Filter	536
120A-83G CRT Green Filter	536
120B 450 kHz Oscilloscope	477
122A,AR Dual Trace Oscilloscope	478
130C 200 μ V/cm Oscilloscope	479
132A Dual Beam Oscilloscope	480
135A 8½" x 11" X-Y Recorder	114
136A Recorder, 2 pen 8½" x 11" X-Y	115
140A,B Plug-In Oscilloscope Main Frame	493
140S Spectrum Analyzer & Display Section	408
141A,B Variable Persistence Oscilloscope Main Frame	494
141S Spectrum Analyzer & Display Section	434
143A Large-Screen Oscilloscope Main Frame	495
143S Spectrum Analyzer & Display Section	408
180A,AR Plug-In Oscilloscope Main Frame	521
181A,AR Variable Persistence Oscilloscope Main Frame	522
183A,B Oscilloscope Mainframe	530, 531
190A Q Meter	229
191A TV Waveform Oscilloscope	438
195A Oscilloscope Camera	539
197A Oscilloscope Camera	540
198A Oscilloscope Camera	541

200

200AB,ABR Audio Oscillator	278, 279
200CD,CDR Wide-Range Oscillator	278, 279
201C,CR Audio Oscillator	278, 279
202C,CR Low Frequency Oscillator	279
202H FM-AM Signal Generator	290
202J FM-AM Signal Generator	291
203A Variable-Phase Generator	272
204C,D Oscillator	276
205AG,AGR Audio Signal Generator	279
207H Univerter	291
208A Test Oscillator	277
209A Sine/Square Oscillator	276
211A Signal Generator	309
211A Square Wave Generator	309
211B Square Wave Generator	246
213B Pulse Generator	248
214A Pulse Generator	250
215A Pulse Generator	251
216A Pulse Generator	252
218A Digital Delay Generator	249
220A Square Wave Generator	247
221A Square Wave Generator	247
222A Pulse Generator	253
230B Signal Generator Power Amplifier	471

232A Glide Slope Signal Generator	309
236A Telephone Test Oscillator	431
241A Pushbutton Oscillator	277
250B RX Meter	228
260A Q Meter	230
281A,B series Waveguide-to-Coax Adapters	355
292A,B series Waveguide-to-Waveguide Adapters	337-339
297A Sweep Drive	458
299A 1-Channel Portable Rec. Sys., Thermal	127, 128

300

301 1-Channel Portable Rec. Sys., Thermal	127, 128
302A,AR Wave Analyzer	458
310A Wave Analyzer	459
311A Transducer Amp-Indicator	153
312A Wave Analyzer	460, 461
313A Tracking Oscillator	433, 460, 461
320 2-Channel Portable Rec. Sys., Thermal	127, 129
321 2-Channel Portable Rec. Sys., Thermal	127, 129
322A 2-Channel Portable Rec. Sys., Thermal	127, 129
331A Distortion Analyzer	449-450
332A Distortion Analyzer	449-450
333A Distortion Analyzer	449-450
340B Noise Figure Meter	350-351
342A Noise Figure Meter	350-351
343A VHF Noise Source	350-351
345B IF Noise Source	350-351
347A Series Waveguide Noise Source	350-351
349A UHF Noise Source	350-351
350C Attenuator Set	283
350D Attenuator Set	283
353A Patch Panel	283, 429
354A Coaxial Step Attenuator	343
355C,D Variable Coaxial Attenuator	341
360-series Filters, Microwave	348
362A series Waveguide Low Pass Filters	348
375A series Waveguide Variable Attenuator	344
382 series Waveguide Variable Attenuator	344
393A Precision Variable Coaxial Attenuator	341
394A Precision Variable Coaxial Attenuator	341

400

400D,DR Vacuum Tube Voltmeter	179
400E High Accuracy AC Voltmeter	178
400E,EL AC to DC Converter	220
400EL High Accuracy AC Voltmeter	178
400F Fast Response Voltmeter	176
400FL Fast Response Voltmeter	176
400GL High Frequency DB Voltmeter	177
400H Vacuum Tube Voltmeter	179
400HR Vacuum Tube Voltmeter	179
400L Vacuum Tube Voltmeter	179
400LR Vacuum Tube Voltmeter	179
403A AC Portable Voltmeters	180
403B AC Portable Voltmeters	180
410B,BR Vacuum Tube Voltmeter	185
410C Multifunction Voltmeter	184
411A,AR RF Millivoltmeter	187
412A,AR Voltmeter, Ammeter, Ohmmeter	190
413A,AR DC Null Voltmeter	188
414A Auto Voltmeter	188
415B SWR Indicator	364
415E SWR Meter	363
416B Ratio Meter	365

419A DC Null Volt-Ammeter	167, 189
420A,B Crystal Detector, Microwave	345
422A Series Crystal Detector, Microwave	345
423A Crystal Detector, Microwave	345
424A Series Crystal Detector, Microwave	345
425A,AR DC Microvolt-Ammeter	191
427A Multi-Function Meter	183
428B,BR Clip-on DC Milliammeter	194
430C Power Meter, Microwave	397
432A Power Meter	394, 395
434A Calorimetric Power Meter	398
440A Detector Mount	353
442B Slotted Line Probes, Microwave	354
444A Slotted Line Detector Probe	354
446B Slotted Line Probes, Microwave	354
447B Probe, Coaxial, Microwave	357
448A Slotted Line Sweep Adapter	353
450A,AR Stabilized Amplifier	467
456A AC Current Probe	195
457A AC to DC Converter	220
461A General Purpose Amplifier	470
462A Fast Pulse Amplifier	470
463A Precision AC Amplifier	469
465A General Purpose Amplifier	468
466A General Purpose Amplifier	467
467A Power and Voltage Amplifier	468
477B Thermistor Mount	397
478A Thermistor Mount	396
485B Detector Mounts	338, 364
486A series Thermistor Mount	396
487 series Thermistor Mount	397
489A Microwave Amplifier	472
491C Microwave Amplifier	472
493A Microwave Amplifier	472
495A Microwave Amplifier	472

500

501 Tripod	61
532 series Frequency Meter	346
536A Coax Frequency Meter	346
537A Coax Frequency Meter	346
561B Digital Recorder	110
562A Digital Recorder	109
565A Digital Recorder	110
571B Digital Clock	108
580A Digital-Analog Converters	111
581A Digital-Analog Converters	111
585DT Linear Displacement AC Transducer	153, 154
595DT Linear Displacement AC Transducer	153, 154

600

606A HF Signal Generator	286, 287
606B HF Signal Generator	286, 287
608E,F Signal Generator, VHF	292-295
612A Signal Generator, UHF	297
614A,B Signal Generator, UHF	300
616B Signal Generator, UHF	300
618C Signal Generator, SHF	302, 303
620B Signal Generator, SHF	302, 303
623B,C SHF Test Set	301
624B,C X-Band Test Set	301
626A SHF Signal Generator	304, 305
628A SHF Signal Generator	304, 305
651B Test Oscillator	281

652A Test Oscillator	281
653A Test Oscillator	435
654A Test Oscillator	282
675A Sweeping Signal Generator	317
675A, 676A Network Analyzer	372, 373
676A Phase/Amplitude Tracking Detector	372, 373
680 5" Strip Chart Recorder	126

700

712C DC Power Supply, Medium Voltage	562
715A, 716B Klystron Power Supplies	349
721A DC Power Supply, Bench	555
735A DC Transfer Standard	159
738BR Voltmeter Calibration System	167
740B DC Standard/Differential Voltmeter	162
741B AC-DC Differential Voltmeter/DC Standard	164
745A AC Calibrator	160
752 series Waveguide Directional Couplers	335-340, 362
770 Dual Directional Couplers	360, 361
778D Dual Directional Coupler	359
779D Directional Coupler	359
780 series Directional Detectors	360, 361
786D, 787D,	
788C, 789C Coax Directional Detectors	360, 361
790 series Directional Couplers	360, 361
796D, 797D, 798C Coax Directional Couplers	360, 361

800

805C Slotted Line, Coaxial, Microwave	354
809C Carriage, Waveguide, Microwave	354
810B Slotted Section	335-340, 354
814B Carriage, Waveguide, Microwave	340, 354
815B series Slotted Section	340, 353
816A Coaxial Slotted Section	352
817A Coaxial Swept Slotted Line System	352
851B Display Section, Spectrum Analyzer	409, 414, 434, 517
852A Display Section, Spectrum Analyzer	409, 414
870A series Slide-screw Tuners	339, 358
885A series Waveguide Phase Shifters	336, 338, 339
890A DC Power Supply—Med. Voltage Supplies	562
895A DC Power Supply—Med. Voltage Supply	562

900

905A Sliding Load	356
907A Sliding Load	356
908A Termination (Coax)	356
909A Termination (Coax)	356
910 series Waveguide Terminations	335-339, 357
X913A Termination, high-power	338, 357
920A,B series Waveguide Shorts	335-340, 357
X930A Shorting Switch, Waveguide	338, 357
932A Waveguide Harmonic Mixer	339
934A Harmonic Mixer	355
938A Frequency Doubler Set	306
940A Frequency Doubler Set	306

1000

1000 Tripod	61
1051A, 1052A Combining Case	638, 639
1104A, 1106A Trigger Countdown	513
1104A, 1108A Trigger Countdown	513
1105A, 1106A Pulse Generator	513
1105A, 1108A Pulse Generator	513

3604A Voice Channel	152
3605A FM Frequency Source	152
3680A AC Power Supply	152
3681A Tape Servo	152
3701/2/3A Microwave Link Analyzer	440-447
3721A Correlator	415-420
3722A Option H01 Noise Generator	262-265
3750A Attenuator—75Ω	444
3907-11A Remote Control Unit	152
3950-series Instrumentation Magnetic Tape Recorders	142-148
3955-series Instrumentation Magnetic Tape Recorders	142-148
3960A,B,C,D Instrumentation Recorders	144, 149-151

4000

4204A Digital Oscillator	280
4260A Universal Bridge	226
4270A Automatic Capacitance Bridge	227
4328A Milliohmmeter	192
4329A Resistance Meter	193
4440B Decade Capacitor	192
4470A Transistor Noise Analyzer	422
4800A Vector Impedance Meter	222
4815A RF Vector Impedance Meter	223
4900A Cable Fault Locator	423
4901A Cable Fault Locator	423
4904A Cable Fault Locator	423
4905A Ultrasonic Translator Detector	423
4920A Coaxial Fault Analyzer	424
4910B Open Fault Locator	423
4916A Ultrasonic Translator Detector	423
4917A Ultrasonic Translator Detector	423
4918A Ultrasonic Translator Detector	423
4950A Ultrasonic Translator Detector	423

5000

5050B Digital Recorder	107
K02-5060A Standby Power Supply	627
5060 Modular Accessories	639
5061A Cesium Beam Frequency Standard	620, 621
E21-5061A Cesium Beam Time Standard	620, 621
5065A Rubidium Frequency Standard	622, 623
E21-5065A Rubidium Time Standard	622, 623
5085A Standby Power Supply	627
5100B Frequency Synthesizer	632, 634
5102A Frequency Synthesizer	630
5103A Frequency Synthesizer	630
5110B Frequency Synthesizer Driver	632, 634
5201L Scaler-Timer, Pulse Height Analyzer	45, 46
5210A Frequency Meter/FM Discriminator	616
5216A Electronic Counter	612
5221A,B Electronic Counter	610, 611
5240A Digital Frequency Meter	599
5245L,M Electronic Counter	584, 586
M54-5245L Electronic Counter	589
5246L Electronic Counter	590
5248L,M Electronic Counter	587, 588
M54-5248M Electronic Counter	589
5251A Frequency Converter Plug-in	595, 596
5252A Prescaler Plug-in	591
5253B Frequency Converter Plug-in	595, 596
5254C Frequency Converter Plug-in	595, 596
5255A Frequency Converter Plug-in	595, 596
5256A Frequency Converter Plug-in	595, 596
5257A Transfer Oscillator Plug-in	597

5258A Prescaler Plug-in	591
5260A Automatic Frequency Divider	598
5261A Video Amplifier Plug-in	592
5262A Time Interval Plug-in	592
5264A Preset Plug-in	594
5265A Digital Voltmeter Plug-in	591
5267A Time Interval Counter Plug-in	593
5268A Frequency Multiplier Plug-in	592
5280A Reversible Electronic Counter	613
5285A Universal Input Plug-in	613
5321A,B Electronic Counter	610, 611
5323A Automatic Counter	602, 603
5325A Universal Electronic Counter	604, 605
5326A Universal Electronic Counter	606, 607
5330A,B Normalizing Preset Counters	608, 609
5331A,B Preset Counter Controller	614, 615
5332A,B Preset Controllers/Counters	614, 615
5360A Computing Counter	577, 578
5365A Computing Counter Input Module	577, 578
5375A Computing Counter Keyboard	581
5379A Time Interval Plug-in for 5360A	580
5401B Multichannel Analyzer	35-37
5405A, 5406A Multiparameter Analyzer	38, 39
5450A Fourier Analyzer	40, 41
5480A Signal Analyzer	42, 43
5554A Preamplifier	44
5580B NIM Power Supply	44
5582A Linear Amplifier	45, 46
5583A Single Channel Analyzer	45, 46
5584A Dual Timing Pickoff	45, 46
5585A Fast Coincidence	45, 46
5590A Scaler-Timer	45, 46
5610A A to D Converter	99
5636 H-Band Test Set	301

6000

6101A-6116A STB Power Supplies	548
6130B Digital Voltage Source	88
6131B Digital Voltage Source	88
6177B-6186B Constant Current DC Power Supply	550, 551
6200B-6209B LAB DC Power Supply	556, 557
6213A-6218A DC Power Supply, Bench	554, 555
6220B-6226B DC Power Supplies, MPM	552
6227B Dual DC Power Supply	553
6228B Dual DC Power Supply	553
6253A DPR Power Supplies	558, 559
6255A DPR Power Supplies	558, 559
6256B DC Power Supplies, LVR	560, 561
6274A DC Power Supplies, LVR	560, 561
6281A MPB-5 Power Supplies	558, 559
6282A MPB-5 Power Supplies	558, 559
6284A MPB-3 Power Supply	558, 559
6285A MPB-5 Power Supplies	558, 559
6286A MPB-5 Power Supplies	558, 559
6289A MPB-3 Power Supplies	558, 559
6290A MPB-5 Power Supplies	558, 559
6291A MPB-5 Power Supplies	558, 559
6294A MPB-3 Power Supplies	558, 559
6296A MPB-5 Power Supplies	558, 559
6299A MPB-3 Power Supplies	558, 559
6384A ICS Power Supply	569
6427B-6448B SCR-1P Power Supply	563
6453A-6459A SCR-3 Power Supply	564
6463A SCR-10 Power Supply	565
6483B SCR-10 Power Supplies	565
6515A High Voltage Power Supply	570
6516A High Voltage Power Supply	570

6521A to 11136A

6521A-6525A DC Power Supplies, High Voltage	570
6823A DC Power Supply/Amplifier	568
6824A DC Power Supply/Amplifier	568
6920B AC/DC Meter Calibrator	168
6921A AC Meter Calibrator	169
6933A D/A Converter	87
6946A Precision Raster Display 17" Screen	436, 437
6947A Precision Raster Display 14" Screen	436, 437

7000

7000A 11" x 17" X-Y Recorder	116
7001A 11" x 17" X-Y Recorder	116
7004B 11" x 17" X-Y Recorder with Plug-in Modules	117
7005B 11" x 17" X-Y Recorder	113
7030A 8½" x 11" X-Y Recorder	116
7034A 8½" x 11" X-Y Recorder	117
7035B 8½" x 11" X-Y Recorder	113
7100B 10" Strip Chart Recorder, Dual Channel	124, 125
7101B 10" Strip Chart Recorder, Single Channel	124, 125
7127A 10" Strip Chart Recorder, Single Channel	124, 125
7128A 10" Strip Chart Recorder, Dual Channel	124, 125
7200A Graphic Recorder	80, 81
7562A Log Converters	182
7563A Logarithmic Amplifier	182
7591A Point Plotting System	121
7701B 1-Channel Oscillograph, Thermal	130
7702B 2-Channel Oscillograph, Thermal	131
7704B 4-Channel Oscillograph, Thermal	132
7706B 6-Channel Oscillograph, Thermal	133
7708B 8-Channel Oscillograph, Thermal	133
7727A 6-Channel Oscillograph, Thermal	140
7729A 8-Channel Oscillograph, Thermal	140
7731A 16-Channel Oscillograph, Thermal	140
7825A Trend Recorder	121
7858B 8-Channel Oscillograph, Ink	134, 135
7878A 8-Channel Oscillograph, Ink	141

8000

8002A Pulse Generator	240, 241
8003A Pulse Generator	240, 241
8004A Pulse Generator	242, 243
8005A Pulse Generator	242, 243
8006A Word Generator	239
8010A Pulse Generator	244, 245
8051A Loudness Analyzer	55, 56
8052A Impulse Sound Level Meter	49
8054A Real-Time Audio Spectrum Analyzer	51, 54
8055A Filter Set	58, 59
8056A Filter Set	58, 59
8057A Precision Noise Generator	57
8060A Real Time Spectrum Module	51, 54
8062A Impulse Sound Level Meter	49
8403A Modulator	310, 311
8404A 8690 Power Meter Level Amplifier	328
8405A Vector Voltmeter	377, 378
8406A Frequency-Comb Generator	414
8407A Network Analyzer	374, 376
8410A Network Analyzer	383
8410S Network Analyzer System	379
8411A Harmonic Converter	383

8412A Phase-Magnitude Display	374, 376
8413A Phase-Gain Indicator	383
8414A Polar Display	374, 376, 383
8418A Auxiliary Power Supply	384
8430 series Filters, Microwave	384, 409, 414
8439A Notch Filter	409, 414
8441A Preselector	409, 414
8442A Crystal Filter, Microwave	409, 414
8470A Crystal Detector, Microwave	345
8471A Crystal Detector, Microwave	345
8472A Crystal Detector, Microwave	345
8477A Power Meter Calibrator	394, 395
8478B Thermistor Mount	396
8485A Power Meter	392, 393
8490 series Fixed Coaxial Attenuators	342
8542 series Automatic Network Analyzer	386, 388
8551B Spectrum Analyzer	399, 402
8552A Spectrum Analyzer	403, 408
8553B Spectrum Analyzer	399, 402
8554L Spectrum Analyzer	399, 402, 517
8601A Generator/Sweeper	288
8614A Signal Generator	298, 299
8614B Signal Source	298, 299
8616A Signal Generator	298, 299
8616B Signal Source	298, 299
8618A Signal Generator	298, 299
8690-series Sweep Oscillator	312, 315, 320, 328
E15-8690A High Power Sweep Oscillator System	328
E20-8690A Stabilized Oscillator Systems	314, 327
8698B RF Unit	326
8699B RF Unit	324, 325
8705A Signal Multiplexers	327
8706A Control Unit	327
8707A RF Unit Holder	327
8708A Synchronizer	292, 293, 294, 295
8709A Synchronizer	327
8717A Transistor Bias Supply	385
8730 series PIN Modulators	310, 311, 318
8740A Transmission Test Unit	383
8741A Reflection Test Unit	383
8742A Reflection Test Unit	383
8743A Reflection/Transmission Test Unit	384
8745 S-Parameter Test Set	384, 385
8747A series Waveguide Reflection/Transmission Test Sys.	339, 384
8761A,B Coaxial Switch	347
8801A Low Gain DC Preamp	136
8802A Med. Gain DC Preamp	136
8803A High Gain DC Preamp	137
8805A Carrier Preamp	137
8806B Phase Sen, Demod	138, 139
8807A AC-DC Converter	139
8808A Log Level Preamp	139
8809A Spec. Purp. DC Preamp	138
8820A 8-Channel Low Gain Amp	141
8821A 8-Channel Med. Gain Amp	141
8875A Differential Amplifier	464
8900B Peak Power Calibrator	391
8925A DME/ATC Test Set	308

9000

9100A,B Computing Calculator	82, 83
9120A Calculator Printer	83, 84
9125A Calculator Plotter	84
9150A Calculator Display	85
9160A Calculator Marked Card Reader	85
9500A Automatic Test System	90, 91

00000-00610

00103A Inductor for 260A	231
00513A Q Standard for 260A	231
00515A Coax Adapter Kit	228
00518A Q Standard for 260A	231
00564A Coupling Transformer	231
00590A Inductors	229
00591A Set of six 00590A	229
00600A Probe Accessory Kit for 4815A	223
00601A Component Mounting Adapter for 4815A	223
00610A Terminal Shield for 4800A	222

10000

10001A-10003A Resistive Divider Probes	536
10004A-10006A Miniature Resistive Divider Probes	536
10009A Resistive Divider Probe for 191A	537
10012A Miniature Resistive Divider Probe	536
10020A Resistive Divider Probes for 1802A	508
10025A 1:1 Probe	536
10035A, 10036A, 10037A Probe Tip Kits	535
10100A,B Feed Thru Terminations	535
10110A, 10111A, 10112A BNC to Banana Adapters	283
10120A-10128A Cable Assemblies	537
10164B Panel Cover for 180A and 181A	537
10166A Panel Cover for 1200A	537
10167A Carrying Cover for 180A and 181A	537
10169A Panel Cover for 1200 series	537
10175A,B, 10176A Viewing Hoods	536
10178A, 10182A CRT Contrast Filters	536
10214A 10:1 Divider	508
10215A Divider Tip	508
10216A Isolator	508
10217A Blocking Capacitor	508
10218A, 10219A, 10220A Probe Adapters	508
10221A 50 ohm Tee	508
10229 Probe Tip	534
10241A 10:1 Divider for 1120A	534
10242A Bandwidth Limiter for 1120A	534
10243A 100:1 Divider for 1120A	534
10352A, 10353A Camera Backs	542
10355A-10357A Bezel Adapters	542
10358B Camera Carrying Case	542
10360A-10363A Bezel Adapters	542
10365A Camera Backs	542
10406A 140 System Plug-in Extender	537
10407A 180 System Plug-in Extender	537
10452A-10456A Rise Time Converters	516
10457A, 10458A 50 to 75 ohm Adapters	516
10475A, 10476A Testmobile Drawers	538
10477A, 10478A 140 System Blank Plug-in	536
10479A,B Testmobile Tilt Tray	538
10480A,B Testmobile Storage Cabinet	538

10500

10501A Cable Assembly	196
10502A Cable Assembly	196
10503A Cable Assembly	196
10511A Spectrum Generator	296
10514A,B Double Balanced Mixer	235
10515A Frequency Doubler	296
10525A Logic Probe	92

10534A,B,C Double Balanced Mixer	235
10536A Counter Plug-in Adapter	579
10538A Counter Fixed Program Shell	579

11000

11000A Cable Assembly	196
11001A Cable Assembly	196
11002A Test Leads	196
11003A Test Leads	196
11004A Line Matching Transformer	283
11005A Line Matching Transformer	283
11018A Adapter	185
11021A Divider Probe for 425A	191
11022A Probe Tip Pen for 411A	187
11023A VHF Probe Tip for 411A	187
11024A Type N "T" Probe Tip for 411A	187
11025A Probe Tip for 411A	187
11026A 100:1 Probe Tip for 411A	187
11027A Probe Kit for 411A	187
11028A 100:1 Current Divider for 456A	195
11035A Cable Assembly	195
11036A AC Probe for 410C	185
11039A Capacitive Voltage Divider	185
11040A Capacitive Voltage Divider	185
11041A 100:1 Voltage Divider	176
11042A Probe Coaxial "T" Connector	185
11043A Probe Coaxial "N" Connector	185
11044A 100:1 DC Voltage Divider for 410B	185
11045A Capacitive Voltage Divider	185
11046A Instrument Enclosures	638
11048B 50-ohm Feed-Thru	283
11049A Thermal Converter	165
11050A Thermal Converter	165
11051A Thermal Converter	165
11054A Input Cable Assembly for 740B	162, 163
11055B Output Cable Assembly for 740B	162, 163
11061A 10:1 Divider Tip for 3406A	187
11063A 50-ohm "T" for 3406A	187
11064A Accessory Probe Kit for 3406A	187
11065A Cable Assembly for 3460A, 3462A	216
11071A Accessory Probe Kit for 3406A	187
11072A Isolation Probe Tip for 3406A	187
11073A Pen Type Probe for 3406A	187
11074A Voltage Divider Probe	177
11075A Instrument Case 8" deep	639
11076A Instrument Case 11" deep	639
11077A Ohms Converter for 3450A	211
11078A AC Converter for 3450A	211
11079A Limit Test Plug-in for 3450A	211
11080A Printer Output Plug-in for 3450A	211
11085A Remote Control Cable for 3460B	216
11086A Cable Assembly	196
11090A Rear Input Cable for 3461A	217
11091A Rear Output Cable for 3460B, 3461A	217
11092A Interface Logic Cable for 3460B, 3461A	217
11093A Remote Control Cable for 3461A	217
11094A 75-ohm Feed-Thru	283
11095A 600-ohm Feed-Thru	283
11096A High Frequency Probe	195
11097A RF Detector for 675A	317
11098A Leveling Detector for 675A	317
11099A Remote Control Plug-in for 3450A	211
11112A Limit Selector for 3450A Op. 003	211
11133A Rear Input Cable for 3450A	211
11135A AC Power Pack for 204D	276
11136A Mercury Power Pack for 204D	276

MODEL NUMBER INDEX *continued***11137A to 80511P**

11137A Rechargeable Battery Pack for 204D	276
11138A Impedance Adapter for 675A, 676A	372
11300A Single Frequency Marker for 675A	317

11500-11600

11500A Cable Assembly, 50 ohm	195
11501A Cable Assembly, 50 ohm	195
11503A, 11504A Flexible Waveguide	338, 339
11505A Bench Stand for 297A	458
11507A Output Termination	294, 295
11509A Fuseholder	294, 295
11511A Short	356
11512A Short	356
11515A K-Band Flange Adapter	340
11516A R-Band Flange Adapter	340
11517A Waveguide Mixer P,K,R Band	414
11518A Waveguide Adapter P-band to 11517A	414
11519A Waveguide Adapter K-band to 11517A	414
11520A Waveguide Adapter R-band to 11517A	414
11521A Waveguide Mixer, X-band	414
11524A 75Ω Coupling Link	355
11525A 75Ω Cable Assembly	355
11530A Balanced Probe for 312A	461
11531 Test Unit for 8690B	328
11533A Adapter	355
11536A 50-Ohm "T"	378
11539A Reproduce Track Selector	152
11540A Waveguide Stand	355
11541A-11548A Waveguide Clamps	355
11549A Power Splitter	378
11553A Pack Sensor	152
11565A Short	356
11566A Airline Extension	513
11567A Airline Extension	513
11570A Accessory Kit for 8405A	378
11572 Digital Reel Hub Adapter	152
11581A Coaxial Attenuator Sets	343
11582A Coaxial Attenuator Set	343
11583A Coaxial Attenuator Set	343
11587A Accessory Kit	384
11588A Coax Swivel Adapter (Rotary Joint)	347
11589 Bias Network	385
11590 Bias Network	385
11599A Quick-Connect Adapter	384
11600A Transistor Fixture	385
11602A Transistor Fixture	385
11604A Universal Extension	384
11605A Transmission Measurement Arm	384
11606A Coax Rotary Airline	347
11650A Accessory Kit for 8410S	384
11651A Transmission Kit for 8407A	374, 376
11652A Reflection-Transmission Kit for 8407A	374, 376
11654A Passive Probe Kit for 8407A	374, 376

13000

13060A Remote Control for 3960 Series	151
13061A DC/AC Inverter for 3960 Series	151
13063A Voice Channel for 3960 Series	151
13065A Rack Mount Kit for 3960 Series	151
13066A Transit Case for 3960 Series	151
13510A Transistor Test Jig	228
13515A Frequency Doubler Probe	289
13525A Calibration Resistor for 4800A	222

15000-16000

15108B Preamplifier	60, 62
15109B Condenser Microphone Assy	60, 62
15114A Microphone Power Supply	61
15117A Sound Level Calibrator	61, 62
15118A Preamplifier	60, 62
15119A Condenser Microphone Assy	60-62
15124A, 15125A Insert Voltage Adapter	61
15127A Cable Amplifier	61
15134A, 15142A Capacitive Termination	61
15170A Piezo Electric Accelerometer	60, 62
15526A Accessory Kit for 3701/2/3A	444, 447
15527A Cable-Thermistor Mount	396
16008A Resistivity Cell	193

17000

17005A Chart Advance Incremental	120
17006A Manual Chart Advance	120
17009B Character Accessory Printer	120
17012B,C Point Plotter, Single Head	119
17108A Time Base	120
17170A Plug-in (7004A) DS Coupler	118
17171A Plug-in (7004A) DC Preamplifier	118
17172A Plug-in (7004A) Time Base	118
17173A Plug-in (7004A) Null Detector	118
17174A Plug-in (7004A) DC Offset	119
17175A Plug-in (7004A) Input Filter	119
17176A Plug-in (7004A) Scanner	119
17178A Plug-in (7004A) DC Attenuator	119
17500A Plug-in (7100B, 7101B, 7127A, 7128A) Multi-Span Input Module	125
17501A Plug-in (7100B, 7101B, 7127A, 7128A) Multi-Span (1 mV) Input Module	125
17502A Plug-in (7100B, 7101B, 7127A, 7128A) Temperature Input Module	125
17503A Plug-in (7100B, 7101B, 7127A, 7128A) Single Span (1 mV) Input Module	125
17504A Plug-in (7100B, 7101B, 7127A, 7128A) Single Span Input Module	125

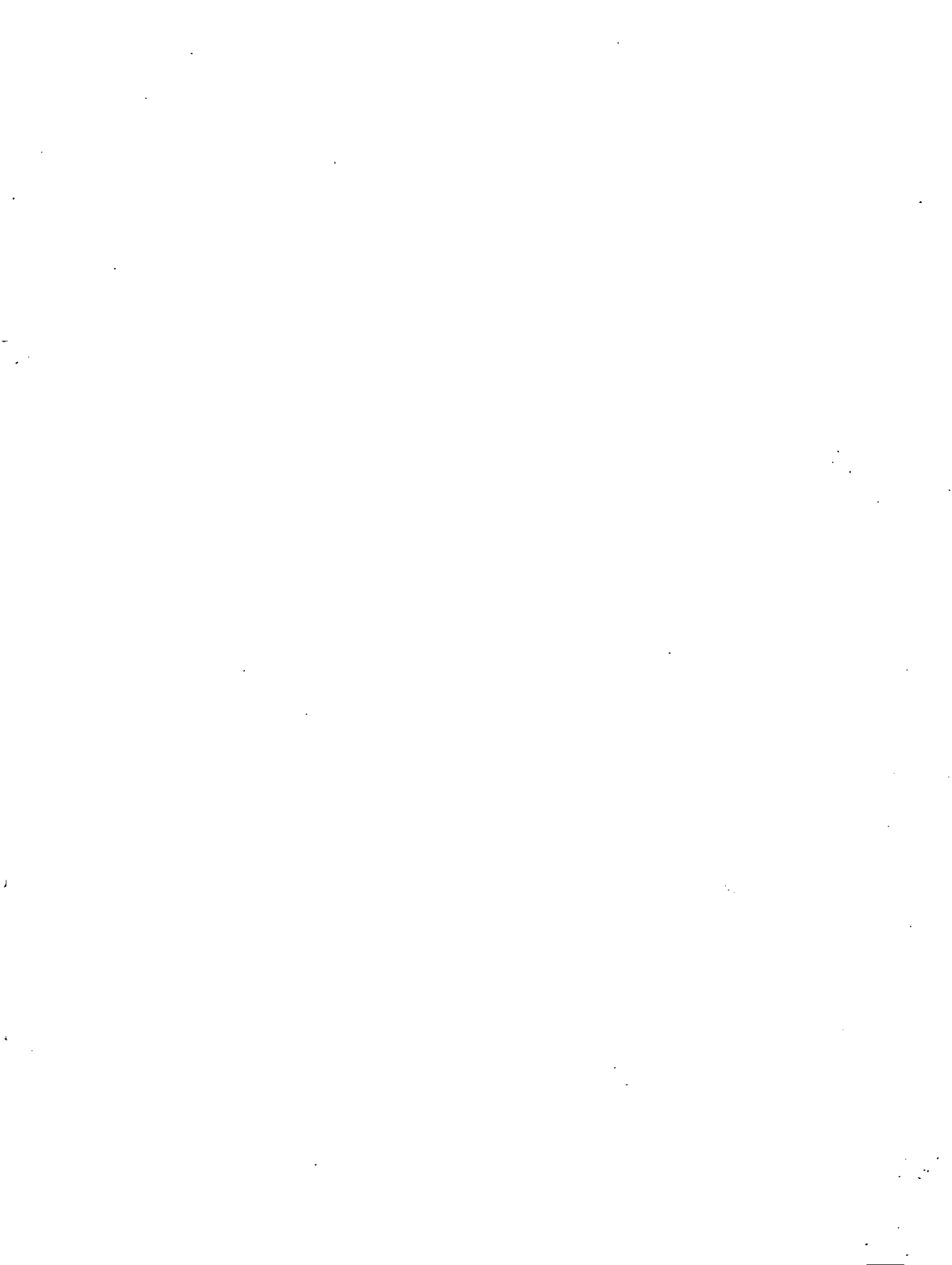
33000-35000

33000C,D Absorptive Modulators	235
33001C,D Absorptive Modulators	235
33002-5A,B Comb Generators	235
33006A S.P.D.T. Switch	234
33008C,D Absorptive Modulators	235
33100 series S.P.S.T. Switches	234
33600 series S.P.S.T. Switches	234
33711A Limiter	234
33801-3A,B Mixers	235
33820A,B X-Band Limiter/Detectors	235
33900A series Coax Attenuators	234
35000A 0.1-100 MHz Microcircuit Preamplifier	233
35001A 0.1-100 MHz Microcircuit Power Amplifier	233
35002A 0.1-400 MHz Microcircuit Preamplifier	233
35005A 0.1-2.0 GHz Microcircuit Amplifier	233
35009A 2-4 GHz YIG-Tuned Oscillator	233
35800-2A Microwave Transistors, Chip	232
35803-6B,E Microwave Transistors, Stripline Package	232
35807A Microwave Transistor, Chip	232

60000-80000

60153D Dual Slot Power Supplies	567
60155C Dual Slot Power Supplies	567
60063A-60246B Slot Power Supplies	566
80501A Audio Data Processor	63, 65
80511P Sound Level Recorder	49







HEWLETT (hp) PACKARD

